

GENERAL INFORMATION

SECTION **GI**

GI

MA

EM

LC

EF &
EC

FE

CL

MT

AT

PD

FA

RA

BR

ST

BF

HA

EL

CONTENTS

PRECAUTIONS	2	Checking Equipment.....	13
General Precautions.....	2	IDENTIFICATION INFORMATION	14
Precautions for Multiport Fuel Injection System or E.C.C.S. Engine.....	3	Model Variation.....	14
Precautions for Three Way Catalyst.....	4	Identification Number.....	15
Precautions for Fuel.....	4	Dimensions.....	17
HOW TO USE THIS MANUAL	5	Wheels and Tires.....	17
HOW TO READ WIRING DIAGRAMS	7	LIFTING POINTS AND TOW TRUCK TOWING	18
HOW TO FOLLOW FLOW CHART IN TROUBLE		Garage Jack and Safety Stand.....	18
DIAGNOSES	10	2-pole Lift.....	18
CONSULT CHECKING SYSTEM	13	Tow Truck Towing.....	19
Function and System Application.....	13	TIGHTENING TORQUE OF STANDARD BOLTS	20

PRECAUTIONS

Observe the following precautions to ensure safe and proper servicing. These precautions are not described in each individual section.

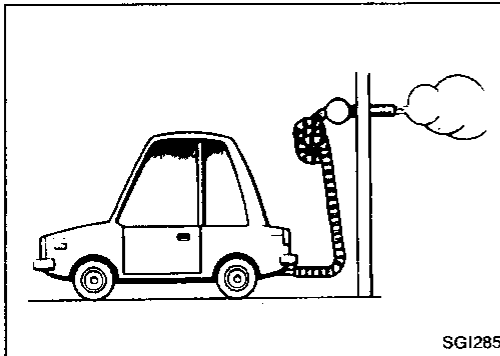

General Precautions

1. Do not operate the engine for an extended period of time without proper exhaust ventilation. Keep the work area well ventilated and free of any inflammable materials. Special care should be taken when handling any inflammable or poisonous materials, such as gasoline, refrigerant gas, etc. When working in a pit or other enclosed area, be sure to properly ventilate the area before working with hazardous materials. Do not smoke while working on the vehicle.

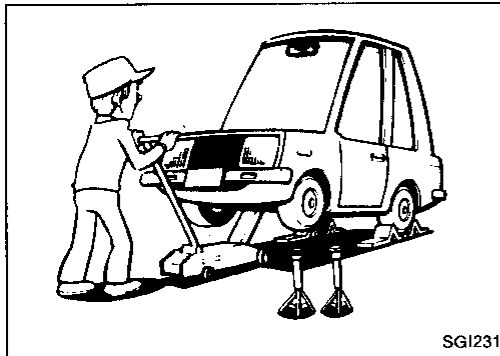

2. Before jacking up the vehicle, apply wheel chocks or other tire blocks to the wheels to prevent the vehicle from moving. After jacking up the vehicle, support the vehicle weight with safety stands at the points designated for proper lifting and towing before working on the vehicle. These operations should be done on a level surface.
3. When removing a heavy component such as the engine or transaxle/transmission, be careful not to lose your balance and drop them. Also, do not allow them to strike adjacent parts, especially the brake tubes and master cylinder.

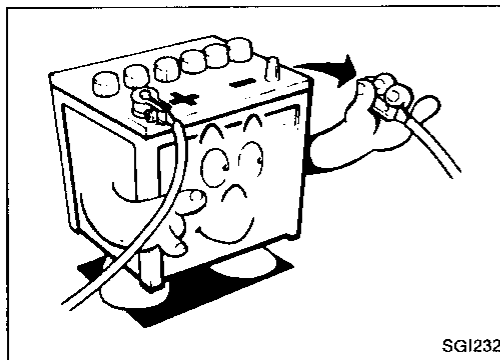

4. Before starting repairs which do not require battery power, always turn off the ignition switch, then disconnect the ground cable from the battery to prevent accidental short circuit.

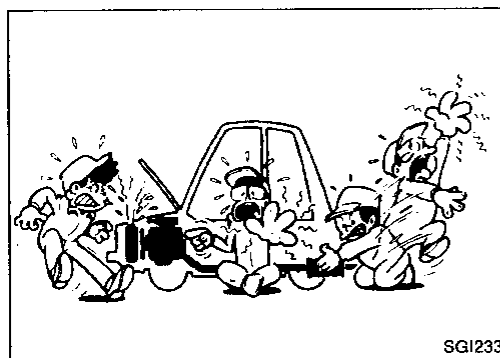

5. To prevent serious burns, avoid contact with hot metal parts such as the radiator, exhaust manifold, tail pipe and muffler. Do not remove the radiator cap when the engine is hot.

PRECAUTIONS

General Precautions (Cont'd)

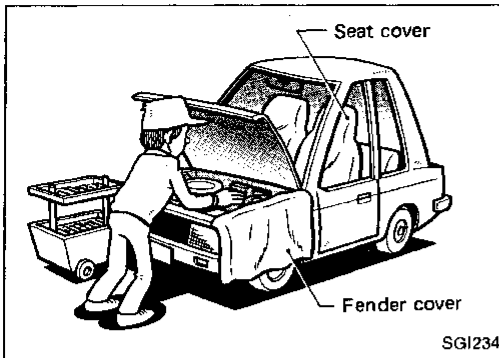

6. Before servicing the vehicle, protect fenders, upholstery and carpeting with appropriate covers. Take caution that keys, buckles or buttons on your person do not scratch the paint.

7. Clean all disassembled parts in the designated liquid or solvent prior to inspection or assembly.
8. Replace oil seals, gaskets, packings, O-rings, locking washers, cotter pins, self-locking nuts, etc. with new ones.
9. Replace inner and outer races of tapered roller bearings and needle bearings as a set.
10. Arrange the disassembled parts in accordance with their assembled locations and sequence.
11. Do not touch the terminals of electrical components which use microcomputers (such as ECMs). Static electricity may damage internal electronic components.
12. After disconnecting vacuum or air hoses, attach a tag to indicate the proper connection.
13. Use only the lubricants specified in MA section.
14. Use approved bonding agent, sealants or their equivalents when required.
15. Use tools and recommended special tools where specified for safe and efficient service repairs.
16. When repairing the fuel, oil, water, vacuum or exhaust systems, check all affected lines for leaks.
17. Dispose of drained oil or the solvent used for cleaning parts in an appropriate manner.

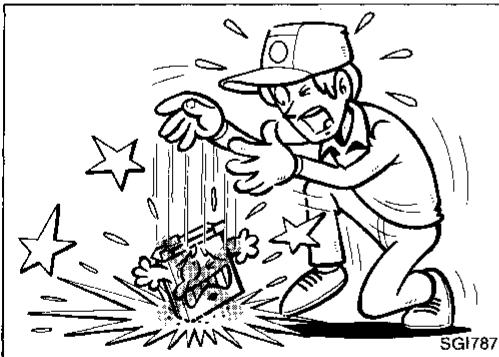

Precautions for Multiport Fuel Injection System or E.C.C.S. Engine

1. Before connecting or disconnecting multiport fuel injection system or E.C.C.S. harness connector to or from any multiport fuel injection system or ECM (ECCS control module), be sure to turn the ignition switch to the "OFF" position and disconnect the negative battery terminal. Otherwise, there may be damage to ECM.
2. Before disconnecting pressurized fuel line from fuel pump to injectors, be sure to release fuel pressure to eliminate danger.
3. Be careful not to jar components such as ECM and mass air flow sensor.

GI

MA

EM

LC

EF &
EC

FE

CL

MT

AT

PD

FA

RA

BR

ST

BF

HA

EL

PRECAUTIONS

Precautions for Three Way Catalyst

If a large amount of unburned fuel flows into the converter, the converter temperature will be excessively high. To prevent this, follow the procedure below:

1. Use unleaded gasoline only. Leaded gasoline will seriously damage the catalytic converter.
2. When checking for ignition spark or measuring engine compression, make tests quickly and only when necessary.
3. Do not run engine when the fuel tank level is low, otherwise the engine may misfire causing damage to the converter.
4. Do not place the vehicle on inflammable material. Keep inflammable material off the exhaust pipe.

Precautions for Fuel

Use unleaded premium gasoline with an octane rating of at least 91 AKI (Anti-Knock Index) number (research octane number 96).

If unleaded premium gasoline is not available, unleaded regular gasoline with an octane rating of at least 87 AKI (research octane number 91) can be used.

However, for maximum vehicle performance, the use of unleaded premium gasoline is recommended.

CAUTION:

Do not use leaded gasoline. Using leaded gasoline will damage the catalytic converter.

HOW TO USE THIS MANUAL



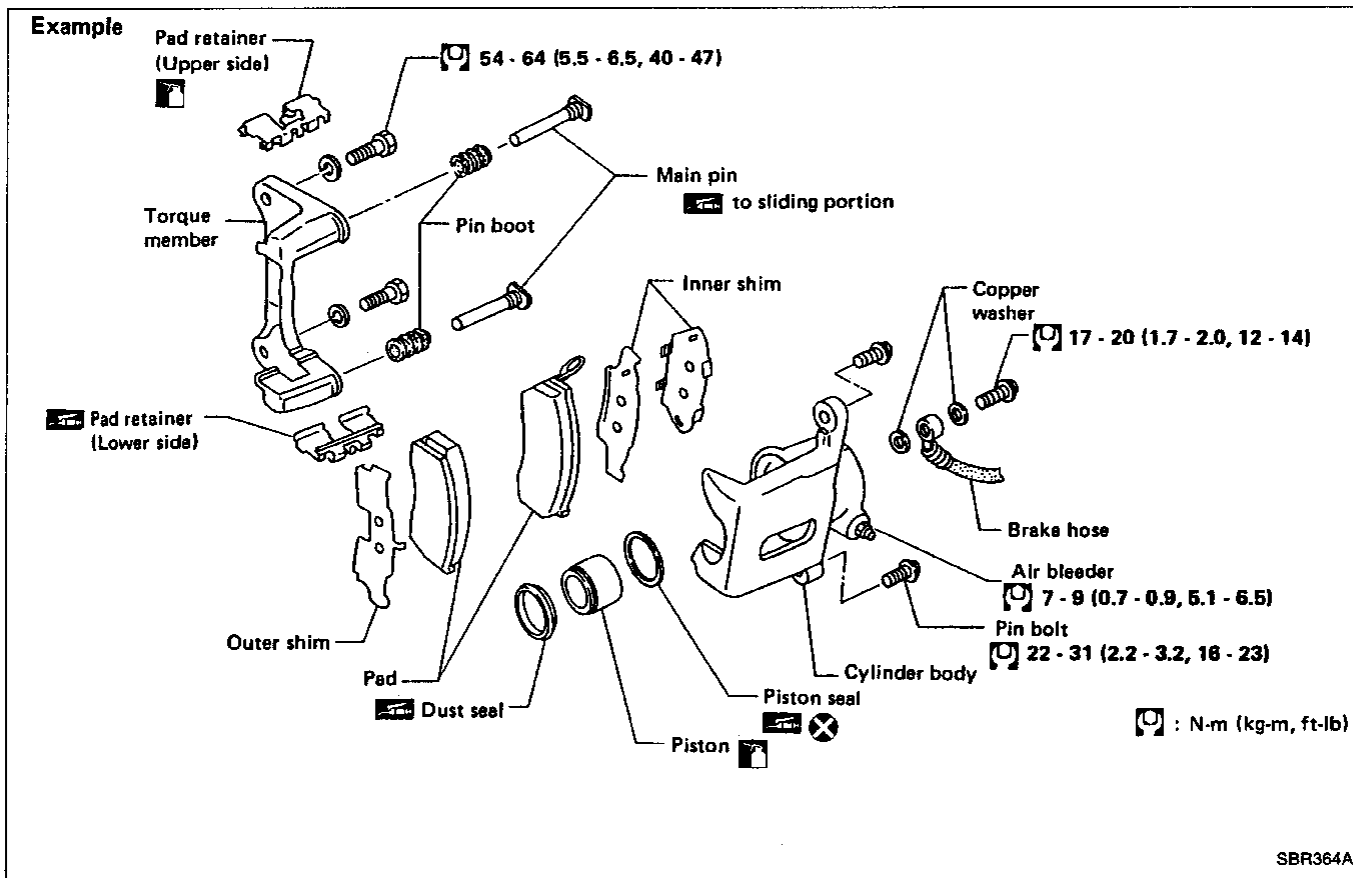





1. **A QUICK REFERENCE INDEX**, a black tab (e.g. **BR**) is provided on the first page. You can quickly find the first page of each section by mating it to the section's black tab.
2. **THE CONTENTS** are listed on the first page of each section.
3. **THE TITLE** is indicated on the upper portion of each page and shows the part or system.
4. **THE PAGE NUMBER** of each section consists of two letters which designate the particular section and a number (e.g. "BR-5").
5. **THE LARGE ILLUSTRATIONS** are exploded views (See below) and contain tightening torques, lubrication points and other information necessary to perform repairs. The illustrations should be used in reference to service matters only. When ordering parts, refer to the appropriate **PARTS CATALOG**.



6. **THE SMALL ILLUSTRATIONS** show the important steps such as inspection, use of special tools, knacks of work and hidden or tricky steps which are not shown in the previous large illustrations. Assembly, inspection and adjustment procedures for the complicated units such as the automatic transaxle or transmission, etc. are presented in a step-by-step format where necessary.

HOW TO USE THIS MANUAL

7. The following **SYMBOLS AND ABBREVIATIONS** are used:

	:	Tightening torque	M/T	:	Manual Transaxle/Transmission
	:	Should be lubricated with grease. Unless otherwise indicated, use recommended multi-purpose grease.	A/T	:	Automatic Transaxle/Transmission
	:	Should be lubricated with oil.	Tool	:	Special Service Tools
	:	Sealing point	L.H.D.	:	Left-Hand Drive
	:	Checking point	R.H.D.	:	Right-Hand Drive
	:	Always replace after every disassembly.	A.T.F.	:	Automatic Transmission Fluid
	:	Apply petroleum jelly.	D ₁	:	Drive range 1st gear
	:	Apply A.T.F.	D ₂	:	Drive range 2nd gear
★	:	Select with proper thickness.	D ₃	:	Drive range 3rd gear
☆	:	Adjustment is required.	D ₄	:	Drive range 4th gear
S.D.S.	:	Service Data and Specifications	O.D.	:	Overdrive
L.H., R.H.	:	Left-Hand, Right-Hand	2 ₂	:	2nd range 2nd gear
			2 ₁	:	2nd range 1st gear
			1 ₂	:	1st range 2nd gear
			1 ₁	:	1st range 1st gear

8. The **UNITS** given in this manual are primarily expressed as the SI UNIT (International System of Unit), and alternatively expressed in the metric system and in the yard/pound system.

“Example”

Tightening torque:

59 - 78 N·m (6.0 - 8.0 kg-m, 43 - 58 ft-lb)

9. **TROUBLE DIAGNOSES** are included in sections dealing with complicated components.

10. **SERVICE DATA AND SPECIFICATIONS** are contained at the end of each section for quick reference of data.

11. The captions **WARNING** and **CAUTION** warn you of steps that must be followed to prevent personal injury and/or damage to some part of the vehicle.

- **WARNING** indicates the possibility of personal injury if instructions are not followed.
- **CAUTION** indicates the possibility of component damage if instructions are not followed.
- **BOLD TYPED STATEMENTS** except **WARNING** and **CAUTION** give you helpful information.

HOW TO READ WIRING DIAGRAMS

WIRING DIAGRAM

Symbols used in WIRING DIAGRAM are shown below:

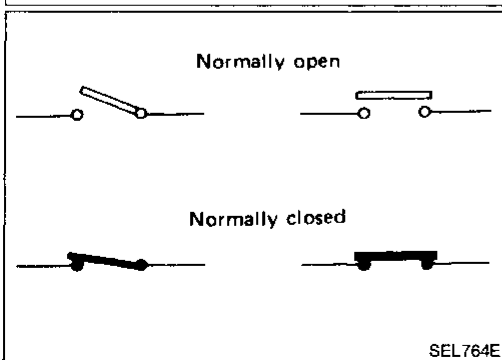
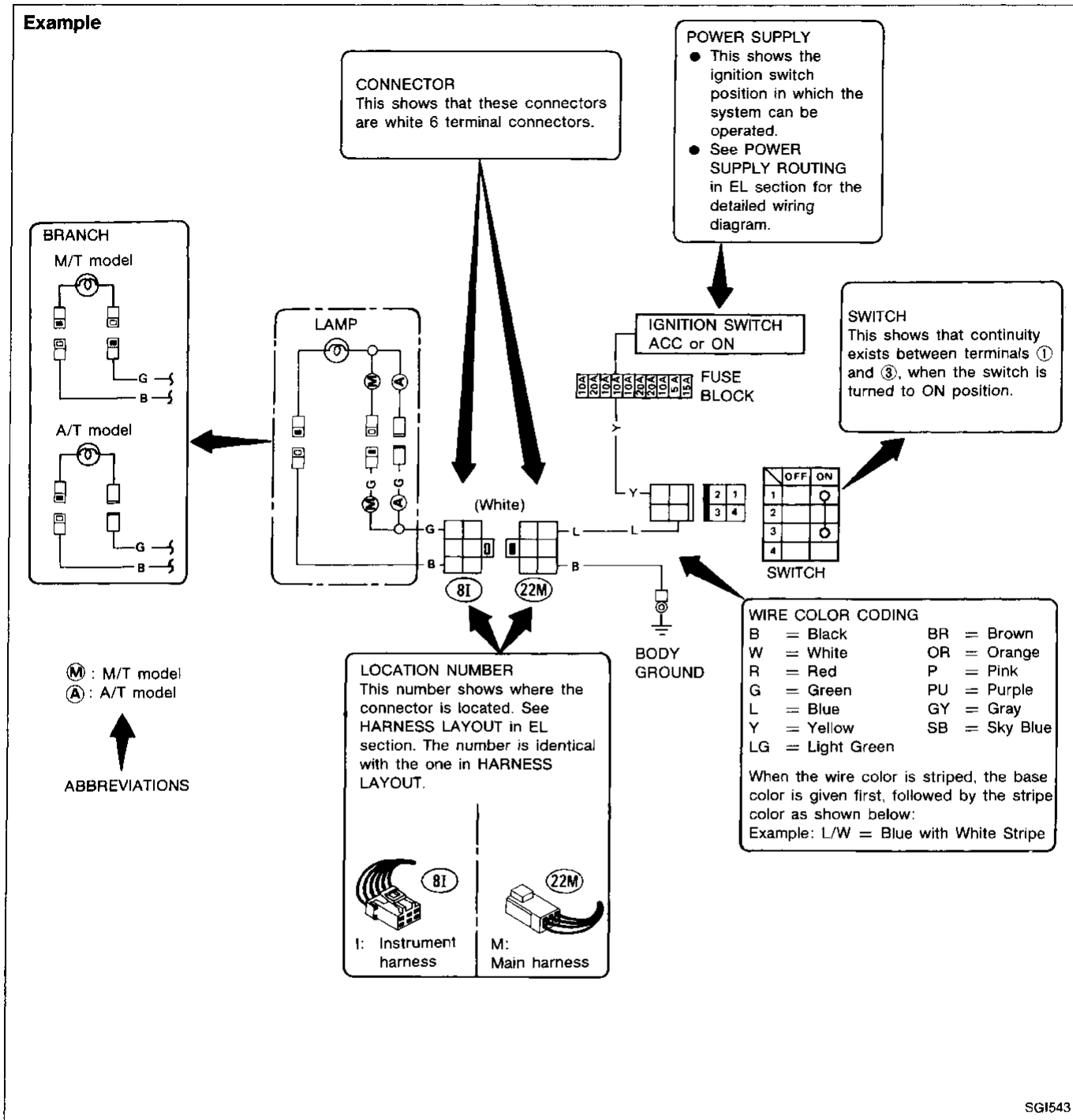

SWITCH POSITIONS

Wiring diagram switches are shown with the vehicle in the following condition.

- Ignition switch "OFF".
- Doors, hood and trunk lid/back door closed.
- Pedals are not depressed and parking brake is released.

GI

MA

EM

LC

EF &
EC

FE

CL

MT

AT

PD

FA

RA

BR

ST

BF

HA

EL

HOW TO READ WIRING DIAGRAMS

Example

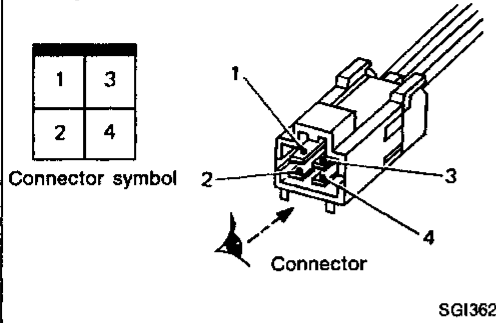

CONNECTOR SYMBOLS

- All connector symbols in wiring diagrams are shown from the terminal side.

Example

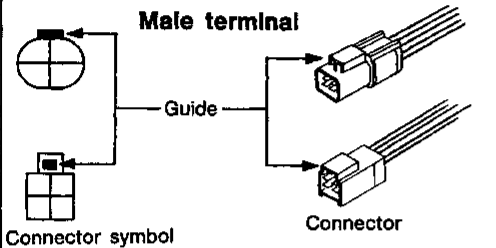

- Male and female terminals
Connector guides for male terminals are shown in black and female terminals in white in wiring diagrams.

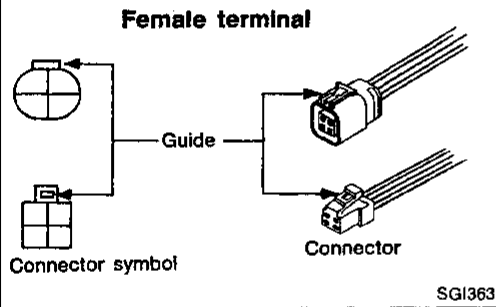

MULTIPLE SWITCH

The continuity of the multiple switch is identified in the switch chart in wiring diagrams.

Example

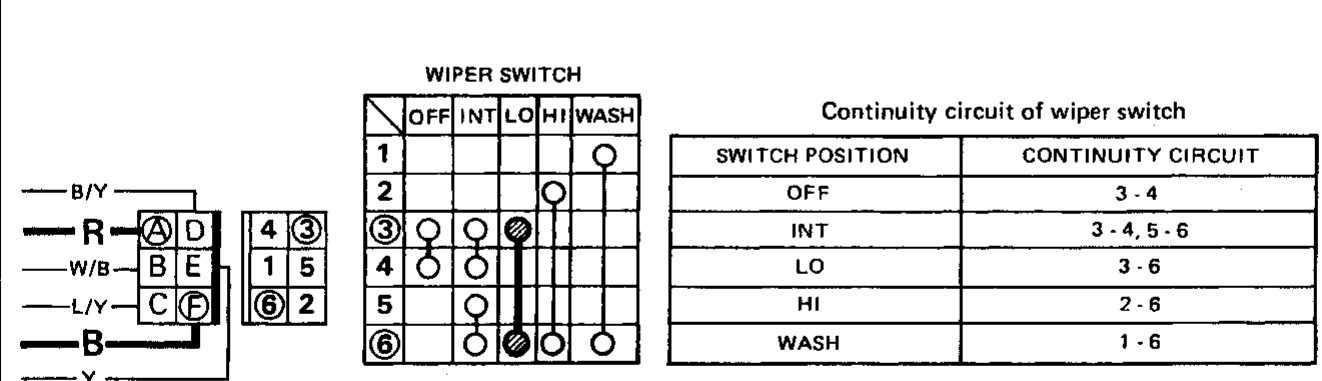

Example: Wiper switch in LO position

Continuity circuit: Red wire - (A) terminal - (③) terminal - Wiper switch (● - ●) : LO) - (⑥) terminal - (F) terminal - Black wire

SGI365

HOW TO READ WIRING DIAGRAMS

SUPER MULTIPLE JUNCTION (S.M.J.)

- The "S.M.J." indicated in wiring diagrams is shown in a simplified form. The terminal arrangement should therefore be referred to in the foldout at the end of the Service Manual.
- The foldout should be spread to read the entire wiring diagram.

Example

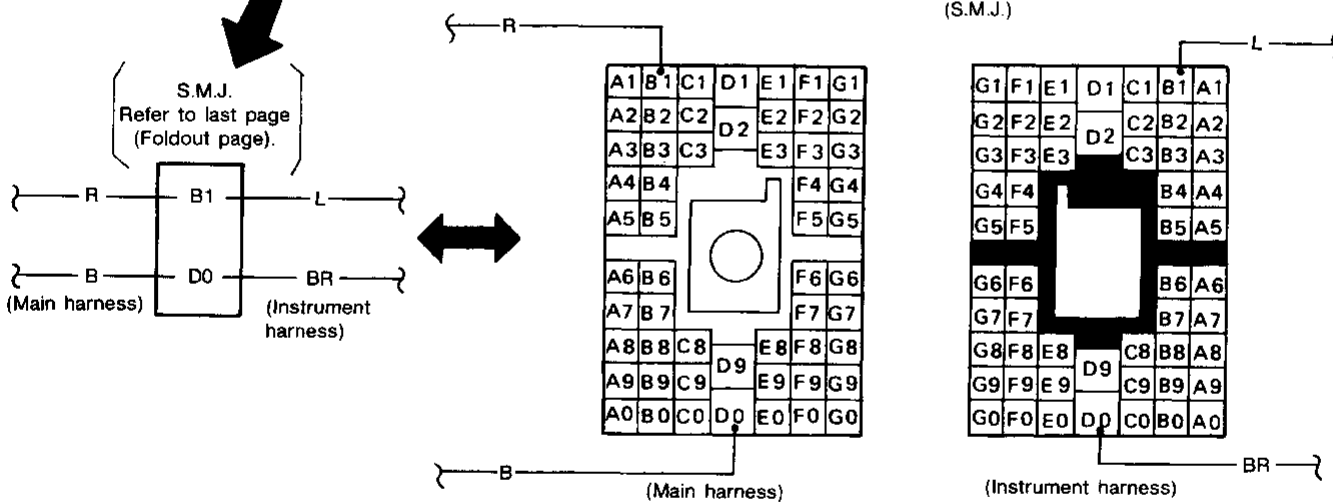
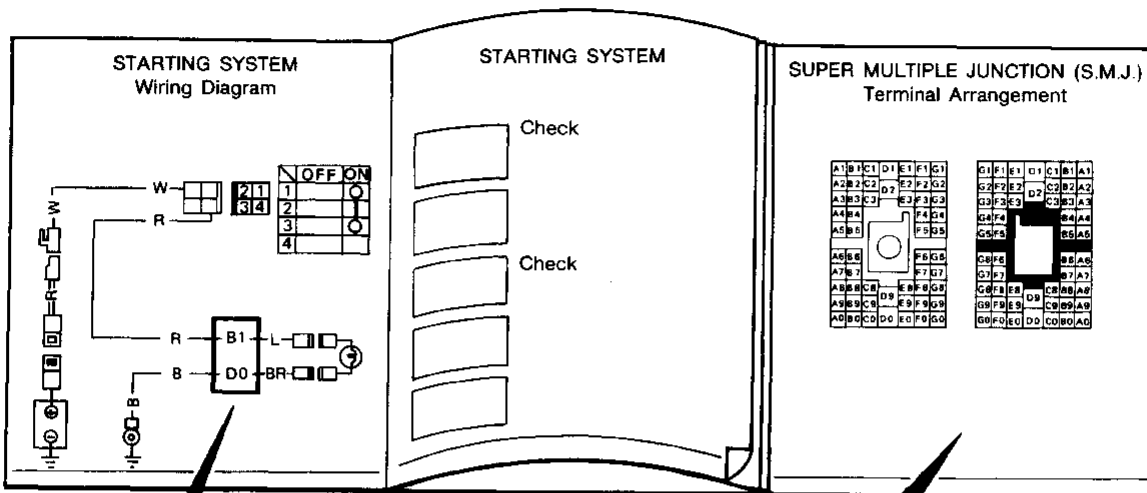

SEL653F

HOW TO FOLLOW FLOW CHART IN TROUBLE DIAGNOSES

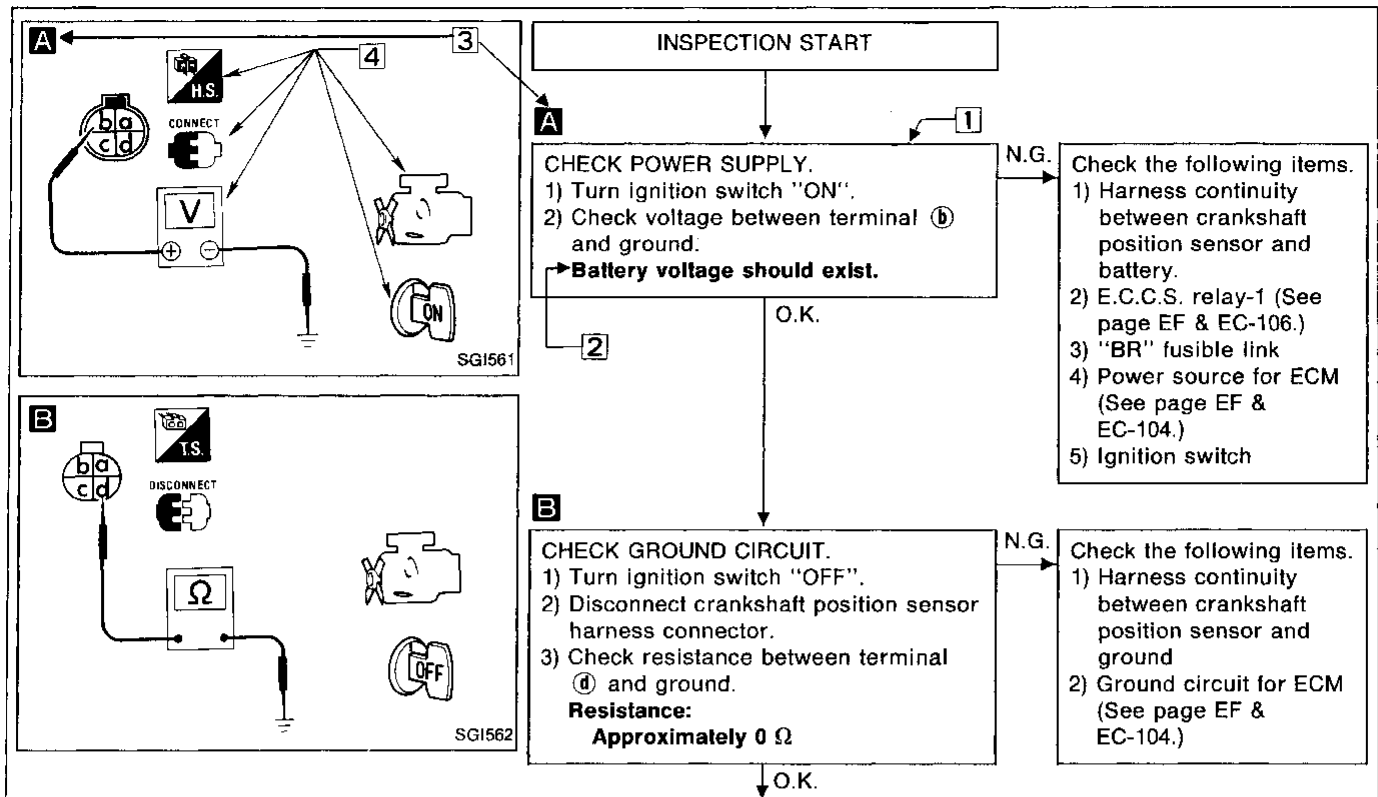

NOTICE

The flow chart indicates work procedures required to diagnose problems effectively. Observe the following instructions before diagnosing.

- 1) Use the flow chart after locating probable causes of a problem following the "Preliminary Check" or the "Symptom Chart".
- 2) After repairs, re-check that the problem has been completely eliminated.
- 3) Refer to Component Parts Location and Harness Layout for the Systems described in each section for identification/location of components and harness connectors.
- 4) Refer to the Circuit Diagram for Quick Pinpoint Check. If you must check circuit continuity between harness connectors in more detail, such as when a sub-harness is used, refer to Wiring Diagram and Harness Layout in EL section for identification of harness connectors.
- 5) When checking circuit continuity, ignition switch should be "OFF".
- 6) Before checking voltage at connectors, check battery voltage.
- 7) After accomplishing the Diagnostic Procedures and Electrical Components Inspection, make sure that all harness connectors are reconnected as they were.

HOW TO FOLLOW THIS FLOW CHART

1 Work and diagnostic procedure

Start to diagnose a problem using procedures indicated in enclosed blocks, as shown in the following example.

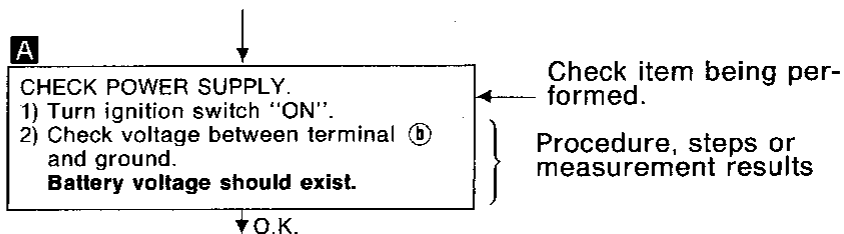

2 Measurement results

Required results are indicated in bold type in the corresponding block, as shown below.

These have the following meanings:

Battery voltage → 11 - 14V or approximately 12V

Voltage: Approximately 0V → Less than 1V

3 Cross reference of work symbols in the text and illustrations

Illustrations are provided as visual aids for work procedures. For example, symbol **A** indicated in the left upper portion of each illustration corresponds with the symbol in the flowchart for easy identification. More precisely, the procedure under the "CHECK POWER SUPPLY" outlined previously is indicated by an illustration **A**.

4 Symbols used in illustrations

Symbols included in illustrations refer to measurements or procedures. Before diagnosing a problem, familiarize yourself with each symbol.

Direction mark

A direction mark is shown to clarify the side of connector (terminal side or harness side).

Direction marks are mainly used in the illustrations indicating terminal inspection.



: View from terminal side ... T.S.

- All connector symbols shown from the terminal side are enclosed by a single line.







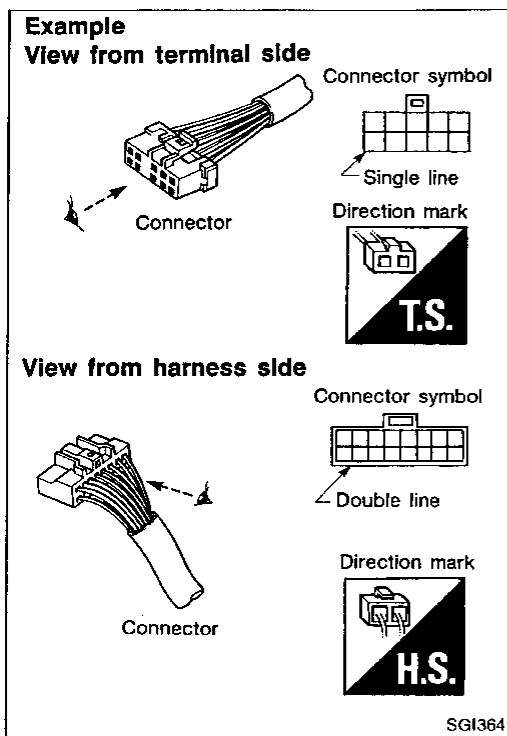





























: View from harness side ... H.S.

- All connector symbols shown from the harness side are enclosed by a double line.

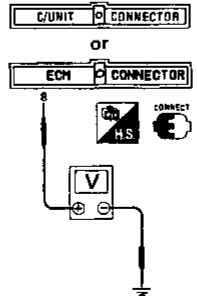

HOW TO FOLLOW FLOW CHART IN TROUBLE DIAGNOSES

Key to symbols signifying measurements or procedures

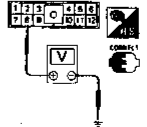
Symbol	Symbol explanation	Symbol	Symbol explanation	
	Check after disconnecting the connector to be measured.		Procedure without CONSULT	
	Check after connecting the connector to be measured.		A/C switch is "OFF".	
	Insert key into ignition switch.		A/C switch is "ON".	
	Turn ignition switch to "OFF" position.		REC switch is "ON".	
	Turn ignition switch to "ON" position.		REC switch is "OFF".	
	Turn ignition switch to "START" position.		DEF switch is "ON".	
	Turn ignition switch from "OFF" to "ACC" position.		VENT switch is "ON".	
	Turn ignition switch from "ACC" to "OFF" position.		Fan switch is "ON". (At any position except for "OFF" position)	
	Turn ignition switch from "OFF" to "ON" position.		Fan switch is "OFF".	
	Turn ignition switch from "ON" to "OFF" position.		Apply battery voltage directly to components.	
	Do not start engine, or check with engine stopped.		Drive vehicle.	
	Start engine, or check with engine running.		Disconnect battery negative cable.	
	Apply parking brake.		Depress brake pedal.	
	Release parking brake.		Release brake pedal.	
	Check after engine is warmed up sufficiently.		Depress accelerator pedal.	
	Voltage should be measured with a voltmeter.		Release accelerator pedal.	
	Circuit resistance should be measured with an ohmmeter.		Pin terminal check for S.M.J. type ECM and A/T control unit connectors. For details regarding the terminal arrangement, refer to the foldout page.	
				Current should be measured with an ammeter.
	Procedure with CONSULT			

CONSULT CHECKING SYSTEM

Function and System Application

Diagnostic test mode	Function	E.C.C.S.	A/T	HICAS
Work support	This mode enables a technician to adjust some devices faster and more accurately by following the indications on CONSULT.	X	—	—
Self-diagnostic results	Self-diagnostic results can be read and erased quickly.	X	X	X
Data monitor	Input/Output data in the ECM can be read.	X	X	X
Active test	Diagnostic Test Mode in which CONSULT drives some actuators apart from the ECMs and also shifts some parameters in a specified range.	X	—	X
ECM part number	ECM part number can be read.	X	X	X
Function test	E.C.C.S. faults can be isolated to a general area, semi-automatically and in a short time, by following the directions on the screen.	X	—	—

X: Applicable

Checking Equipment

When ordering the below equipment, contact your NISSAN distributor.

Tool name	Description
NISSAN CONSULT kit ① CONSULT unit and accessories ② Program card (UE920) ③ Operation manuals ④ Binder ⑤ Carrying case ⑥ Thermal paper (Rolls)	

IDENTIFICATION INFORMATION

Model Variation

Destination			Body	Engine	Transmission	
					5-speed manual	4-speed auto-matic
					FS5W71C	RE4R01A
U.S.A.	Non-California	L.H.D.	Coupe	KA24DE	ML-FU	ML-AU
			Fastback		RML-FU	RML-AU
	California		Coupe		RMLK-FU	RMLK-AU
			Fastback		ML-FV	ML-AV
	Canada		Coupe		RML-FV	RML-AV
			Fastback		RMLK-FV	RMLK-AV
					ML-FN	ML-AN
					RML-FN	RML-AN
					RMLK-FN	RMLK-AN

Prefix and suffix designations:

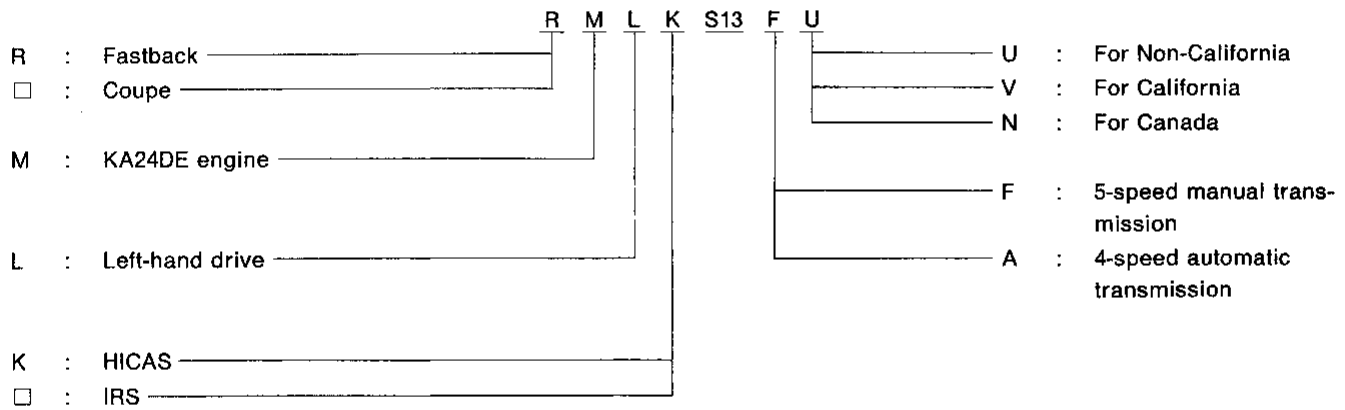

□ : means no indication.

IDENTIFICATION INFORMATION

Identification Number

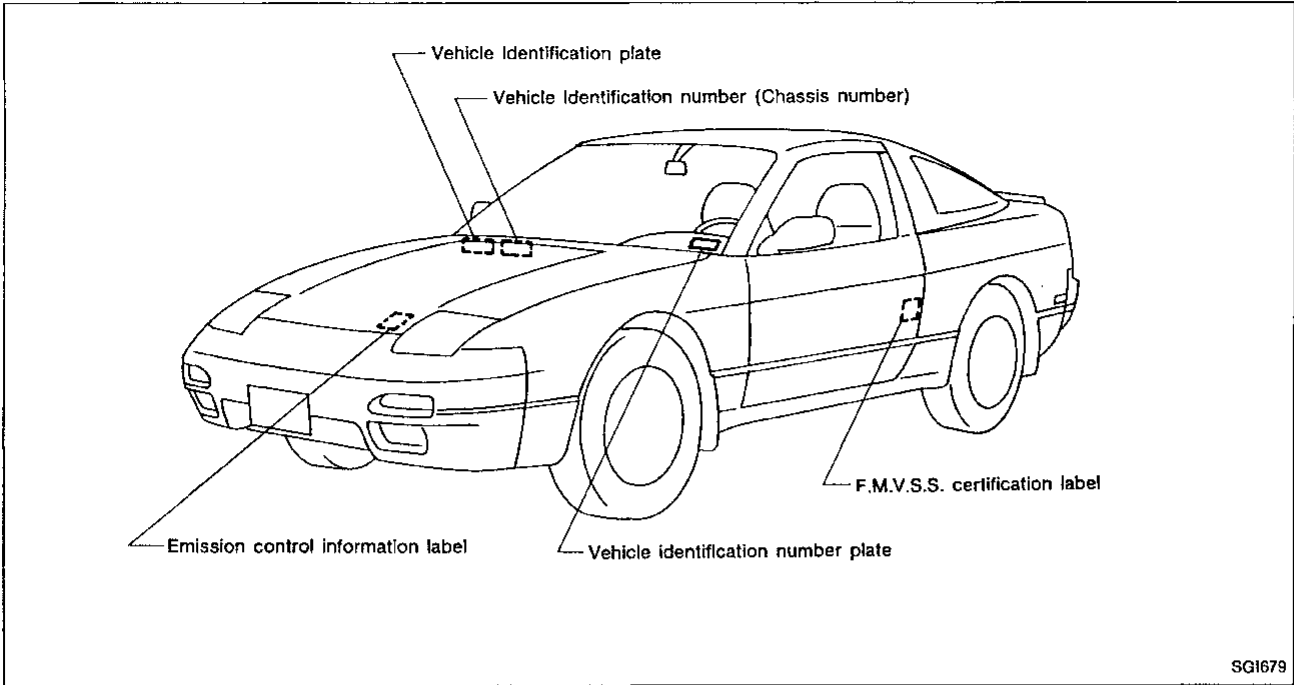

VEHICLE IDENTIFICATION NUMBER ARRANGEMENT

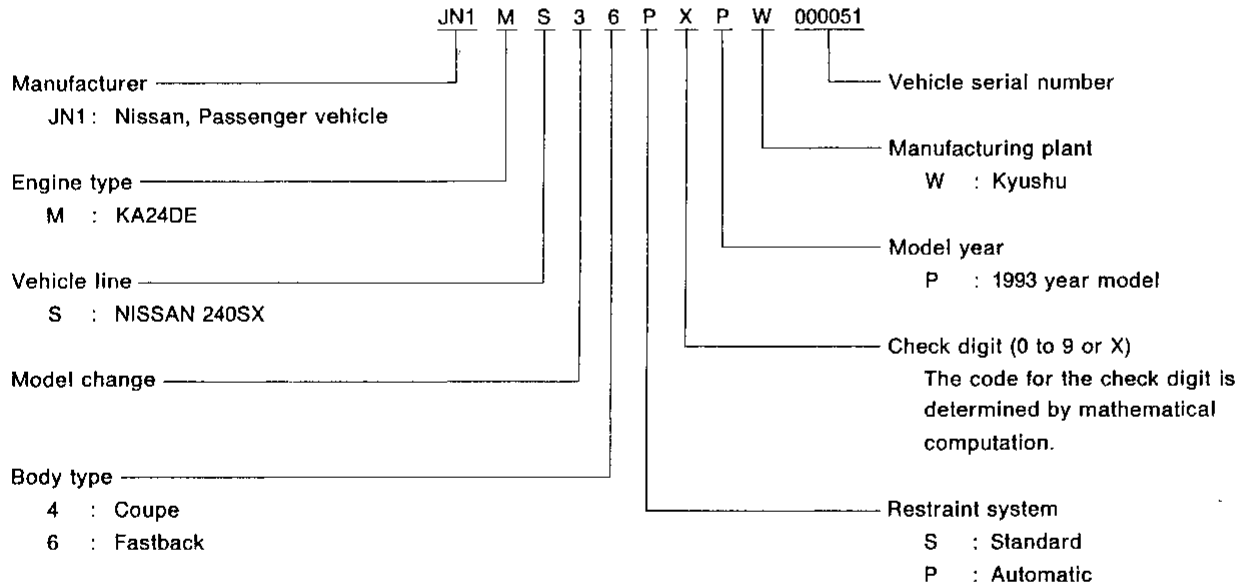

GI
MA
EM
LC
EF & EC
FE
CL
MT
AT
PD
FA
RA
BR
ST
BF
HA
EL

IDENTIFICATION INFORMATION

Identification Number (Cont'd) IDENTIFICATION PLATE

NISSAN MOTOR CO., LTD. JAPAN		
型式	TYPE TIPO	△
CHASSIS NO NO DE CHASSIS		△
MODEL MODELO		△
○ カラー COLOR TRIM △ カラー COLOR GUARNICION		△ △ ○
エンジン ENGINE シリンダー MOTOR		△ △ CC
ミッション TRANS. AXLE アクスル TRANS. EJE		△ △
	工場 PLANT PLANTA	
日産自動車株式会社		MADE IN JAPAN

- 1 Type
- 2 Vehicle identification number (Chassis number)
- 3 Model
- 4 Body color code
- 5 Trim color code
- 6 Engine model
- 7 Engine displacement
- 8 Transmission model
- 9 Axle model

SGI315

ENGINE SERIAL NUMBER

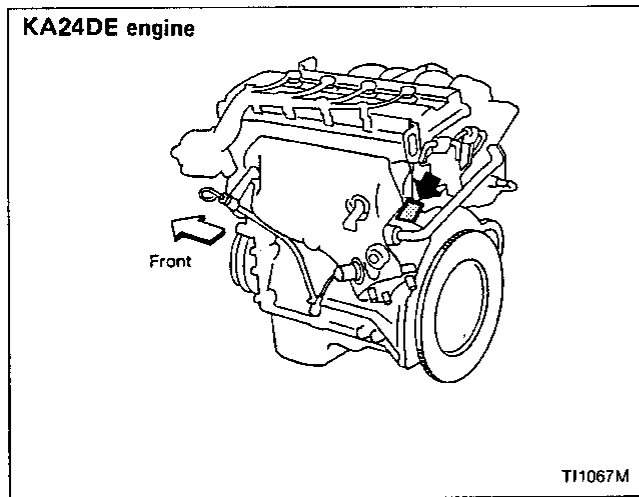

MANUAL TRANSMISSION NUMBER

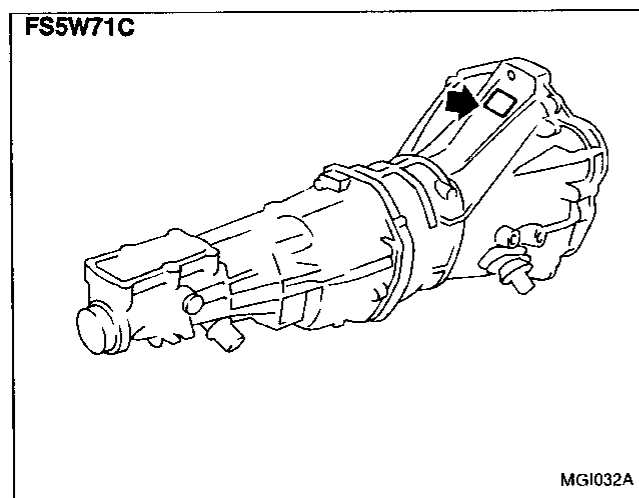

AUTOMATIC TRANSMISSION NUMBER

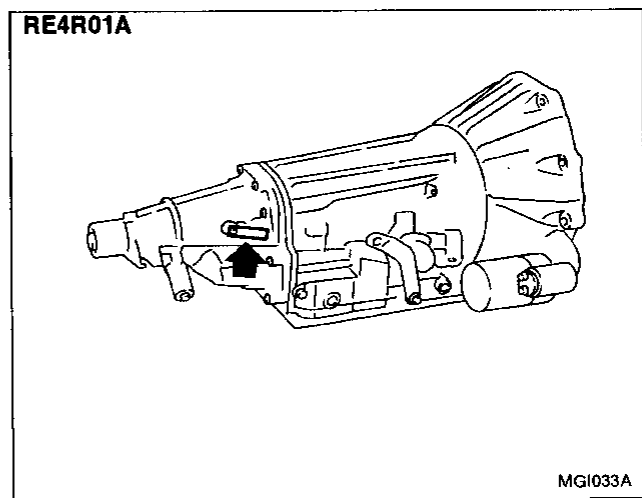

IDENTIFICATION INFORMATION

Dimensions

	Unit: mm (in)	
	Coupe	Fastback
Overall length	4,520 (178.0)	4,520 (178.0)
Overall width	1,690 (66.5)	1,690 (66.5)
Overall height	1,290 (50.8)	1,290 (50.8)
Front tread	1,465 (57.7)	1,465 (57.7)
Rear tread	1,460 (57.5)	1,460 (57.5)
Wheelbase	2,475 (97.4)	2,475 (97.4)

Wheels and Tires

Road wheel	Steel		15x6-JJ 15x4T*1, 16x4T*1
	Aluminum		15x6-JJ
	Offset	mm (in)	40 (1.57) 35 (1.38)*3
Tire size	Conventional		P195/60R15 86H P205/60R15 89H*2
	Spare		T125/70D15 T135/70D16

*1: For spare tire

*2: Option

*3: Offset for 4Tx16

LIFTING POINTS AND TOW TRUCK TOWING

Garage Jack and Safety Stand

WARNING:

- Never get under the vehicle while it is supported only by the jack. Always use safety stands to support the frame when you have to get under the vehicle.
- Place wheel chocks at the front wheels when the rear wheels are raised and place wheel chocks at the rear wheels when the front wheels are raised.

CAUTION:

Place a wooden or rubber block between safety stand and vehicle body when the supporting body is flat.

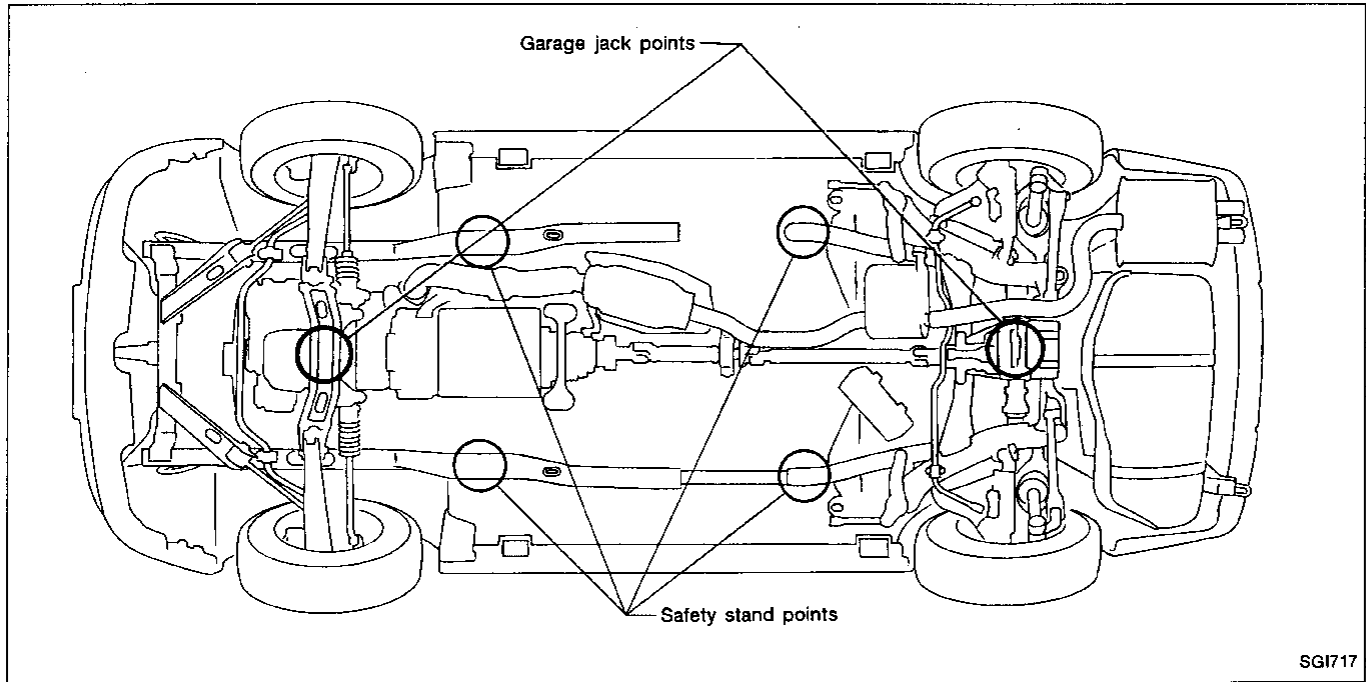

SGI717

2-pole Lift

WARNING:

When lifting the vehicle, open the lift arms as wide as possible and ensure that the front and rear of the vehicle are well balanced.

When setting the lift arm, do not allow the arm to contact the brake tubes and fuel lines.

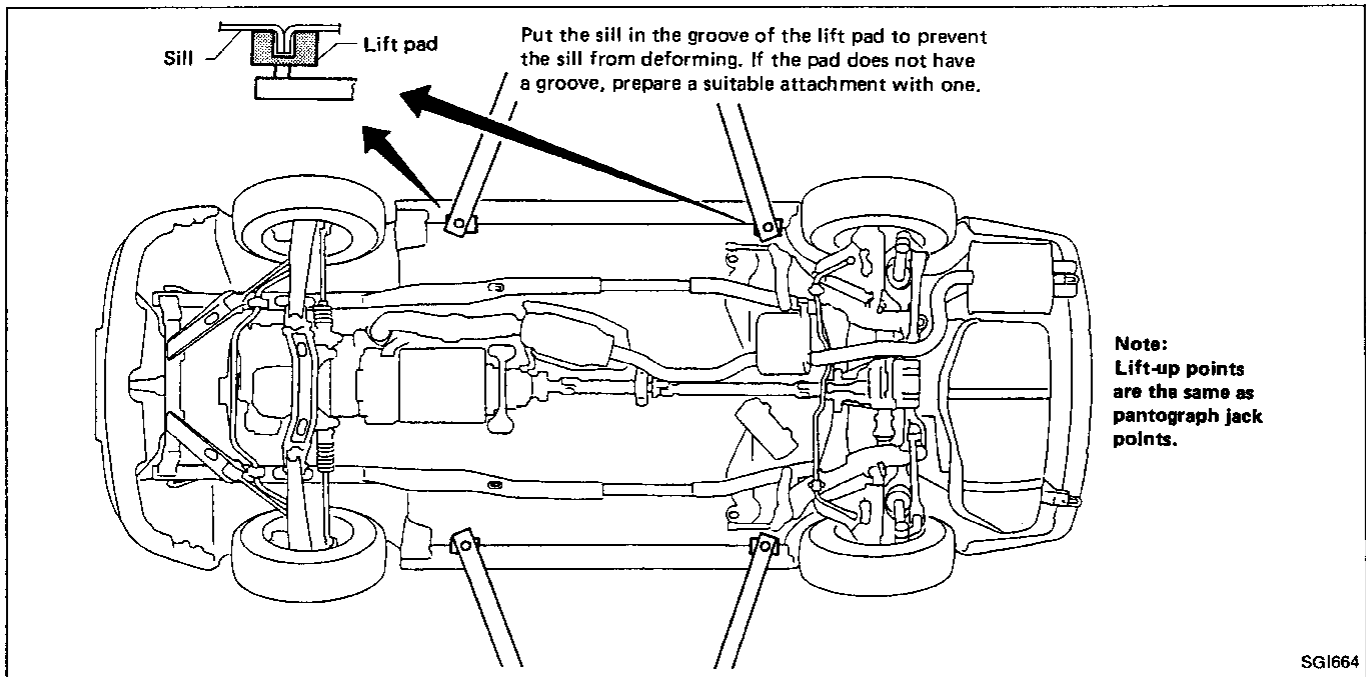

SGI664

Tow Truck Towing

CAUTION:

- All applicable state or Provincial (in Canada) laws and local laws regarding the towing operation must be obeyed.
- It is necessary to use proper towing equipment to avoid possible damage to the vehicle during towing operation. Towing is in accordance with Towing Procedure Manual at dealer.
- When towing with the rear wheels on the ground, release the parking brake and move the gearshift lever to neutral position ("N" position).

GI

MA

EM

LC

EF &
EC

FE

CL

MT

AT

PD

FA

RA

BR

ST

BF

HA

EL

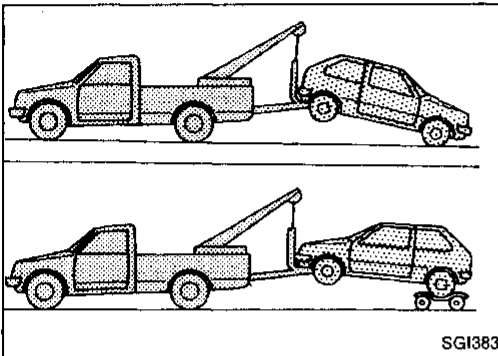

SGI383

NISSAN recommends that vehicle be towed with the driving (rear) wheels off the ground as illustrated.

TOWING AN AUTOMATIC TRANSMISSION MODEL WITH FOUR WHEELS ON GROUND OR TOWING WITH FRONT WHEELS RAISED (With rear wheels on ground)

Observe the following restricted towing speeds and distances.

Speed:

Below 50 km/h (30 MPH)

Distance:

Less than 65 km (40 miles)

If the speed or distance must necessarily be greater, remove the propeller shaft beforehand to prevent damage to the transmission.

TOWING POINT

Always pull the cable straight out from the vehicle. Never pull on the hook at a sideways angle.

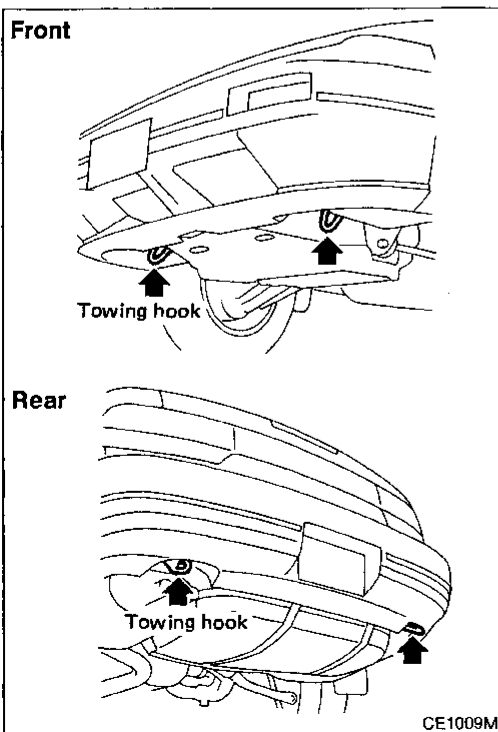

CE1009M

TIGHTENING TORQUE OF STANDARD BOLTS

Grade	Bolt size	Bolt diameter* mm	Pitch mm	Tightening torque (Without lubricant)					
				Hexagon head bolt			Hexagon flange bolt		
				N·m	kg·m	ft·lb	N·m	kg·m	ft·lb
4T	M6	6.0	1.0	5.1	0.52	3.8	6.1	0.62	4.5
	M8	8.0	1.25	13	1.3	9	15	1.5	11
			1.0	13	1.3	9	16	1.6	12
	M10	10.0	1.5	25	2.5	18	29	3.0	22
			1.25	25	2.6	19	30	3.1	22
	M12	12.0	1.75	42	4.3	31	51	5.2	38
1.25			46	4.7	34	56	5.7	41	
M14	14.0	1.5	74	7.5	54	88	9.0	65	
7T	M6	6.0	1.0	8.4	0.86	6.2	10	1.0	7
	M8	8.0	1.25	21	2.1	15	25	2.5	18
			1.0	22	2.2	16	26	2.7	20
	M10	10.0	1.5	41	4.2	30	48	4.9	35
			1.25	43	4.4	32	51	5.2	38
	M12	12.0	1.75	71	7.2	52	84	8.6	62
1.25			77	7.9	57	92	9.4	68	
M14	14.0	1.5	127	13.0	94	147	15.0	108	
9T	M6	6.0	1.0	12	1.2	9	15	1.5	11
	M8	8.0	1.25	29	3.0	22	35	3.6	26
			1.0	31	3.2	23	37	3.8	27
	M10	10.0	1.5	59	6.0	43	70	7.1	51
			1.25	62	6.3	46	74	7.5	54
	M12	12.0	1.75	98	10.0	72	118	12.0	87
1.25			108	11.0	80	137	14.0	101	
M14	14.0	1.5	177	18.0	130	206	21.0	152	

- Special parts are excluded.
- This standard is applicable to bolts having the following marks embossed on the bolt head.

*: Nominal diameter

Grade	Mark
4T	4
7T	7
9T	9

