

# SERVICE MANUAL

DATSUN 260Z  
MODEL S30 SERIES

## SECTION EL

# ENGINE LUBRICATION SYSTEM

EL

ENGINE LUBRICATION SYSTEM .....	EL- 2
SERVICE DATA AND SPECIFICATIONS .....	EL- 5
TRUBLE DIAGNOSES AND CORRECTIONS .....	EL- 5
SPECIAL SERVICE TOOL .....	EL- 6



**NISSAN MOTOR CO., LTD.**  
TOKYO, JAPAN

## ENGINE LUBRICATION SYSTEM

## CONTENTS

LUBRICATION CIRCUIT .....	EL-2	INSPECTION .....	EL-3
OIL PUMP .....	EL-2	OIL PRESSURE REGULATOR VALVE .....	EL-3
REMOVAL .....	EL-2	OIL FILTER .....	EL-4
INSTALLATION .....	EL-2	OIL PRESSURE RELIEF VALVE .....	EL-4
DISASSEMBLY AND ASSEMBLY .....	EL-3	OIL PRESSURE WARNING SWITCH .....	EL-4

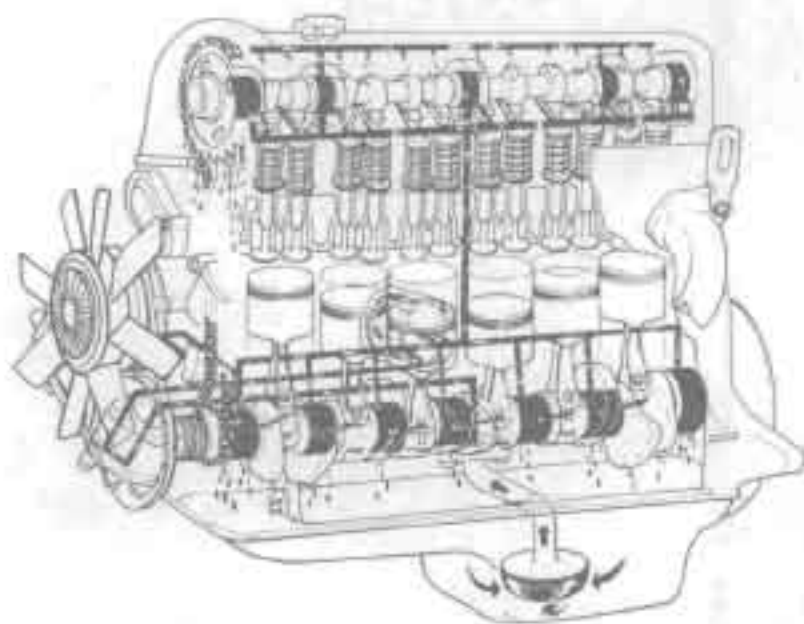

EL041

Fig. EL-1 Lubricating circuit

## LUBRICATION CIRCUIT

The pressure lubrication of the engine is accomplished by a trochoid-type oil pump. This pump draws the oil through the oil strainer into the pump housing and then forces it through the full flow type oil filter into the main oil gallery. Part of the oil is supplied to all camshaft bearings, the chain tensioner and the timing chain. Oil supplied to the camshaft bearings is fed to the connecting rod bearings through the drilled passages in the crankshaft. Oil injected from jet holes on the connecting rods lubricates the cylinder walls and piston pins. The other part

of the oil is brought to the oil gallery in the cylinder head to provide lubrication of the valve mechanism and timing chain as shown in Figure EL-2.

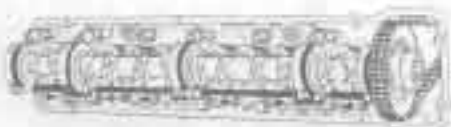

EL021

Fig. EL-2 Lubricating cylinder head

From this gallery, oil holes go directly to all camshaft bearings through cam brackets.

Oil supplied through the No. 2 and No. 4 camshaft bearings is then fed to the rocker arm, valve and cam lobe through the oil cam tube.

## OIL PUMP

The oil pump is located in the bottom of the front cover attached by four bolts and driven by the oil pump drive spindle assembly which is driven by the helical gear on the crankshaft.

The oil pump assembly consists of an oil pressure regulator valve and outer and inner rotors.

The spring-loaded oil pressure regulator valve limits the oil pressure to a maximum of  $5.6 \text{ kg/cm}^2$  (80 psi) at 3,000 rpm.

## REMOVAL

1. Remove distributor.
2. Drain engine oil.
3. Remove oil pump body with drive spindle assembly.

## INSTALLATION

1. Before installing oil pump in engine, turn crankshaft so that No. 1 piston is at T.D.C.
2. Fill pump housing with engine oil, then align punch mark of drive spindle with hole in oil pump as shown in Figure EL-3.

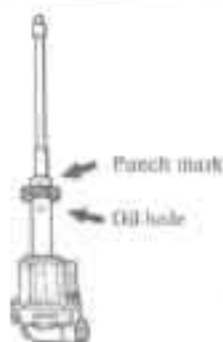

Fig. EL-3 Aligning punch mark and oil hole

3. Using a new gasket, install oil pump and drive spindle assembly so that the projection on its top is located in an 11 : 25 a.m. position. At this time, the smaller bow-shape will be placed toward the front as shown in Figure EL-4.

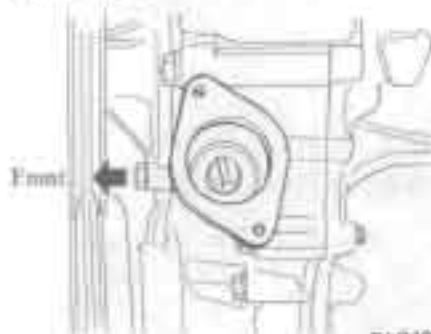

Fig. EL-4 Setting drive spindle

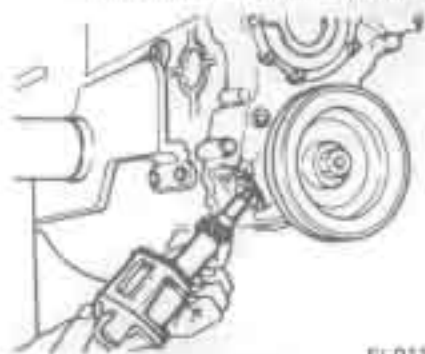

Fig. EL-5 Installing oil pump

Ascertain whether the engagement is in order or not by checking the top of spindle through distributor fitting hole.

4. Tighten bolts securing oil pump to front cover.

## DISASSEMBLY AND ASSEMBLY

1. Remove pump cover attaching bolts, pump cover and oil pump gasket, and slide out pump rotors.

2. Remove regulator cap, regulator valve and spring.

3. Assemble oil pump in reverse order of disassembly.

**Note:** The mark dotted on outer and inner rotor should face to oil pump body.

- 1 Oil pump body
- 2 Outer rotor
- 3 Inner rotor and shaft
- 4 Gasket
- 5 Oil pump cover
- 6 Regulator valve
- 7 Regulator spring

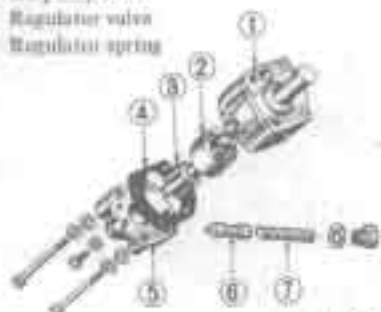

Fig. EL-6 Oil pump

## INSPECTION

Wash all parts in cleaning solvent and dry with compressed air.

Use a brush to clean the inside of pump housing and pressure regulator valve chamber. Be sure all dirt and metal particles are removed.

1. Inspect pump body and cover for cracks or excessive wear.
2. Inspect pump rotors for damage or excessive wear.

3. Check inner rotor shaft for looseness in pump body.

4. Inspect regulator valve for wear or scoring.

5. Check regulator spring to see that it is not worn on its side or collapsed.

6. Check regulator valve free operation in the bore.

7. Using a feeler gauge, check tip clearance and outer rotor-to-body clearances shown in Figure EL-7.

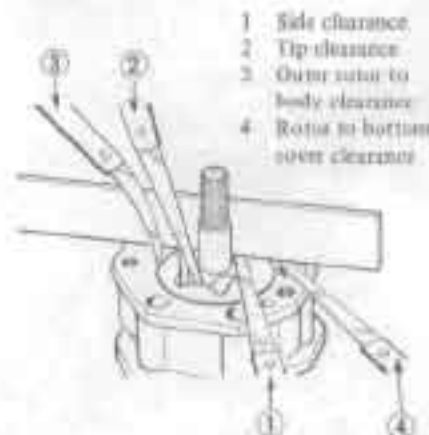

Fig. EL-7 Checking rotor clearances

8. Place a straight edge across the face of pump as shown in Figure EL-7. Check side clearance (outer to inner rotor) and gap between body and straight edge.

The gap should be  $-0.03$  to  $0.06$  mm ( $-0.0012$  to  $0.0024$  in), then rotor to bottom cover clearance with gasket should satisfy the specifications.

		Standard	Wear limit
Rotor side clearance (outer to inner rotor)	mm (in)	0.04 to 0.08 (0.0016 to 0.0031)	0.20 (0.0079)
Rotor tip clearance	mm (in)	Less than 0.12 (0.0047)	0.20 (0.0079)
Outer rotor to body clearance	mm (in)	0.15 to 0.21 (0.0059 to 0.0083)	0.5 (0.0197)
Rotor to bottom cover clearance	mm (in)	0.03 to 0.13 (0.0012 to 0.0051)	0.20 (0.0079)

**Note:** The outer and inner rotor are not serviced separately. If the oil pump body is damaged or worn, replace the entire oil pump assembly.

## OIL PRESSURE REGULATOR VALVE

The oil pressure regulator valve is

not adjustable. At the released position, the valve permits the oil to by-pass through the passage in the pump cover to the inlet side of the pump. Check regulator valve spring to ensure that spring tension is correct.

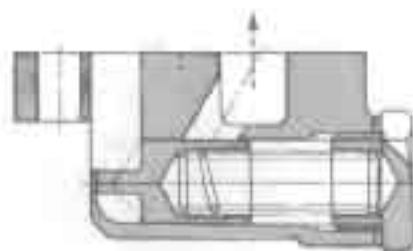

EL014

Fig. EL-8 Regulator valve

**Specifications**

Oil pressure at idling

kg/cm<sup>2</sup> (psi) ..... 0.8 to 2.8 (11 to 40)

Regulator valve spring

Free length

mm (in) ..... 52.5 (2.067)

Installed length/load

mm/kg (in/lb) ..... 34.8/7.9 to 8.7 (1.370/17.4 to 19.2)

Regulator valve opening pressure

kg/cm<sup>2</sup> (psi) ..... 3.5 to 5.0 (51 to 71)

**OIL FILTER**

The oil filter is of a cartridge type. The oil filter element should be replaced with the use of Oil Filter Wrench ST19320000. See Figure EL-9.

When removing an oil filter, loosen it after stopping engine about several minutes to drain out the oil from oil filter to oil pan.

When installing an oil filter, fasten it on cylinder block by hand.

**OIL PRESSURE RELIEF VALVE**

The relief valve located at the center portion securing oil filter in the cylinder block by-passes the oil into the main gallery when the oil filter element is excessively clogged.

With oil filter removed, check valve unit for operation. Inspect for a cracked or broken valve. If replacement is necessary, remove valve by prying it out with a screwdriver. Install a new valve in place by tapping it in.

**OIL PRESSURE WARNING SWITCH**

The oil warning switch is located on right hand center of cylinder block and wired to an indicator lamp in the instrument cluster.

The warning light glows whenever the oil pressure drops below 0.2 to 0.4 kg/cm<sup>2</sup> (2.8 to 5.7 psi).

Prior to installing a switch to cylinder block, be sure to apply a conductive sealer to threads of new switch.

Note: Do not overtighten filter, or oil leakage may occur.

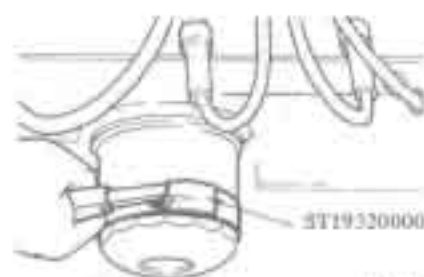

EL015

Fig. EL-9 Removing oil filter

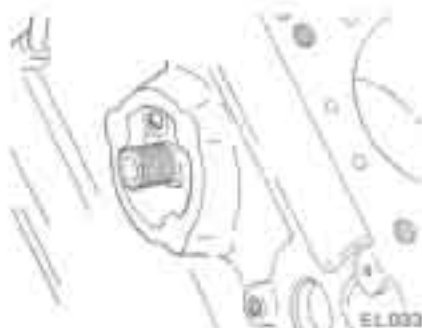

EL003

Fig. EL-10 Relief valve

**SERVICE DATA AND SPECIFICATIONS****Oil pump**

		Standard	Wear limit
Rotor side clearance (outer to inner rotor)	mm (in) .....	0.04 to 0.08 (0.0016 to 0.0031)	0.20 (0.0079)
Rotor tip clearance	mm (in) .....	less than 0.12 (0.0047)	0.20 (0.0079)
Outer rotor to body clearance	mm (in) .....	0.15 to 0.21 (0.0059 to 0.0083)	0.5 (0.0197)
Rotor to bottom cover clearance	mm (in) .....	0.03 to 0.13 (0.0012 to 0.0051)	0.20 (0.0079)

**Oil pressure regulator valve**

Oil pressure at idling	kg/cm <sup>2</sup> (psi) .....	0.8 to 2.8 (11 to 40)
Regulator valve spring:		
Free length	mm (in) .....	52.5 (2.067)
Installed length/load	mm/kg (in/lb) .....	34.8/7.9 to 8.7 (1.370/17.4 to 19.2)
Regulator valve opening pressure	kg/cm <sup>2</sup> (psi) .....	3.5 to 5.0 (51 to 71)

**Tightening torque:**

Oil pump mounting bolts	kg-m (ft-lb) .....	1.1 to 1.5 (8.0 to 11)
Oil pump cover bolts	kg-m (ft-lb) .....	0.7 to 1.0 (5.1 to 7.2)
Regulator valve cap nut	kg-m (ft-lb) .....	4 to 5 (29 to 36)

**TROUBLE DIAGNOSES AND CORRECTIONS**

Condition	Probable cause	Corrective action
Oil leakage	Damaged or cracked body cover. Oil leakage from gasket. Oil leakage from regulator valve. Oil leakage from blind plug.	Replace. Replace. Tighten or replace. Replace.
Decreased oil pressure	Leak of oil in engine oil pan. Dirty oil strainer. Damaged or worn pump rotors. Malfunctioning regulator. Use of poor quality engine oil.	Correct. Clean or replace. Replace. Replace. Replace.
Warning light remains "on" engine running	Decreased oil pressure. Oil pressure switch unserviceable. Electrical fault.	Previously mentioned. Replace. Check circuit.
Noise	Excessive backlash in pump rotors.	Replace.



### SPECIAL SERVICE TOOL

No.	Tool number & tool name	Description Unit: mm (in)	For use on	Reference page or figure No.
1.	ST19320000 Oil filter wrench	This tool is used to take oil filter out of place. In tightening the filter, do not use this tool to prevent excess tightening.    SE 197	All models	Fig. EL-9