

1981 DATSUN 280ZX

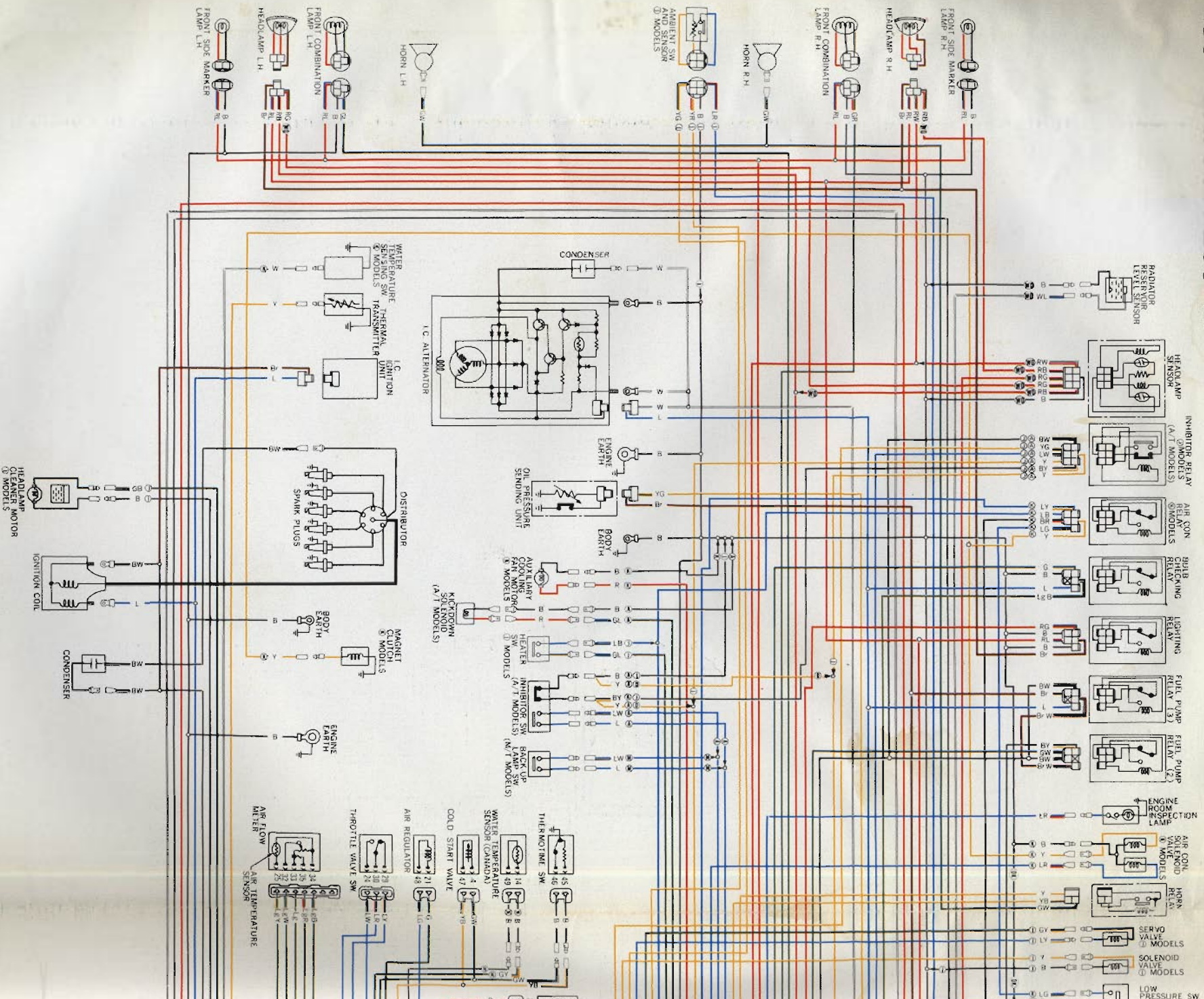

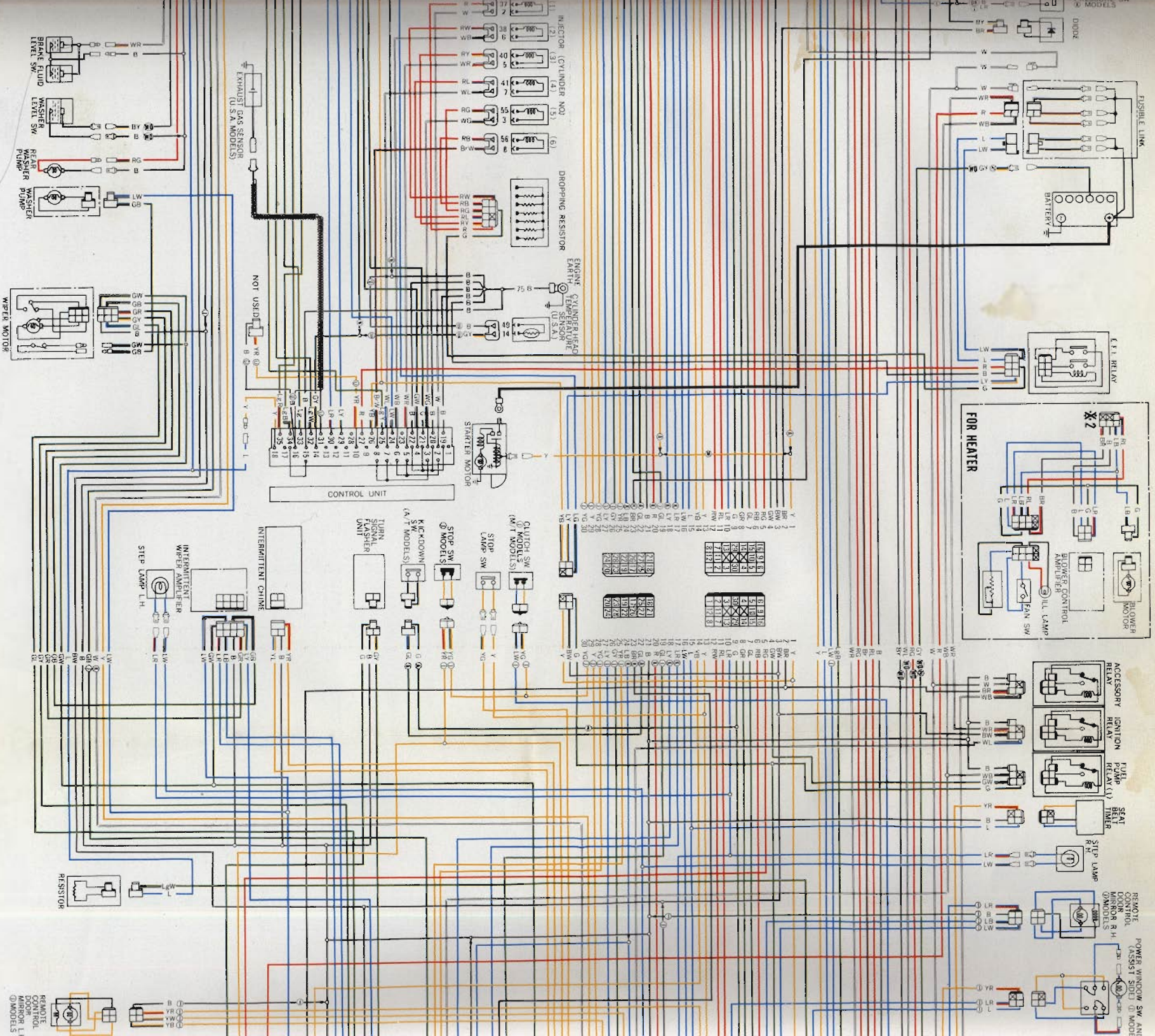

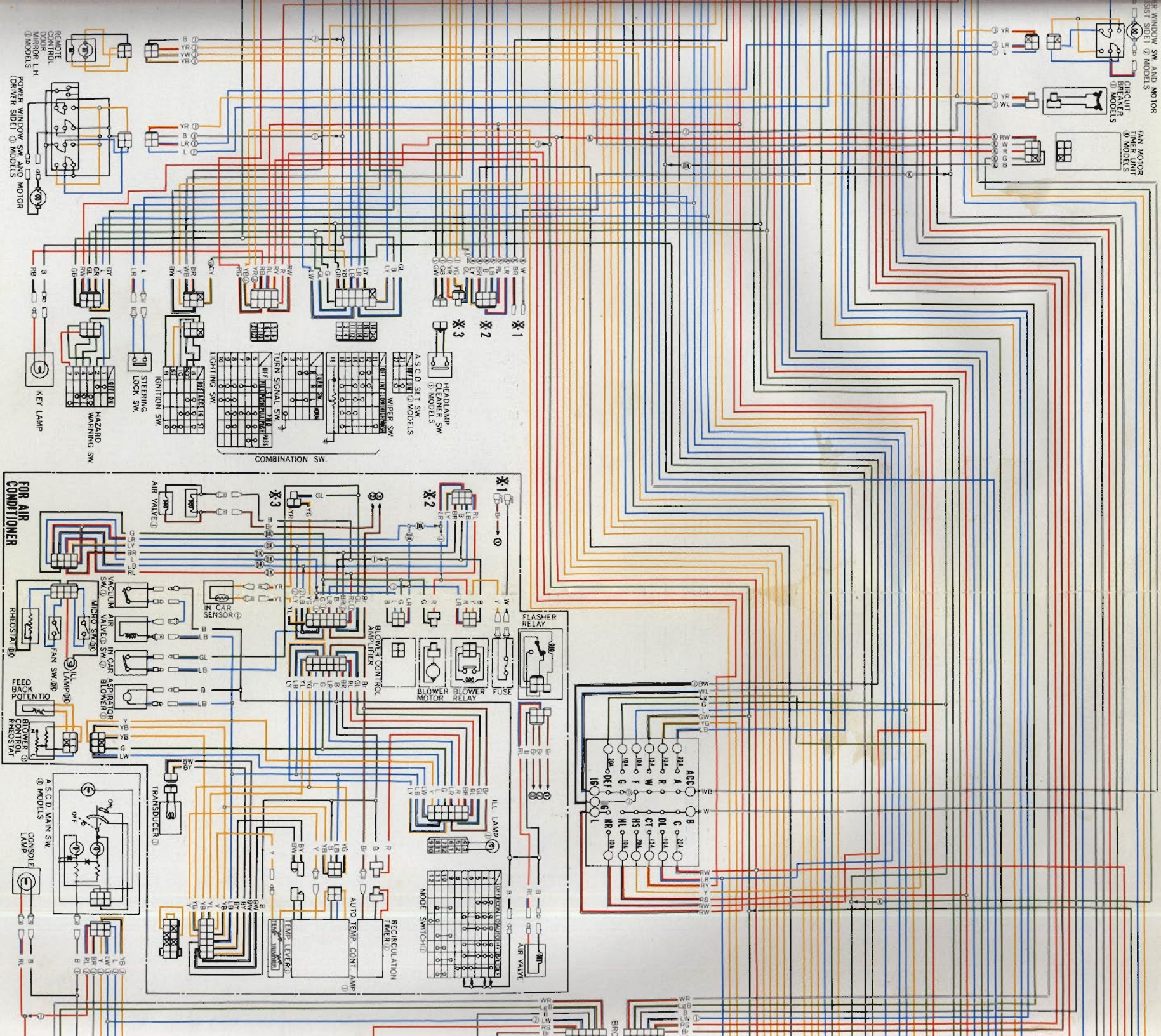

(CONTINUED ON NEXT PAGE)

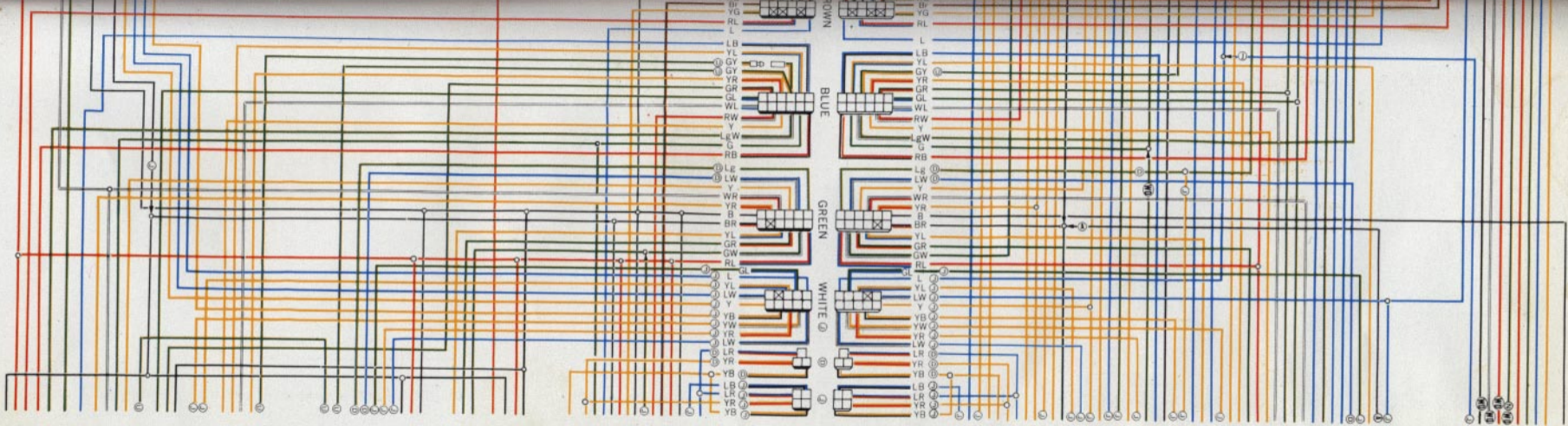

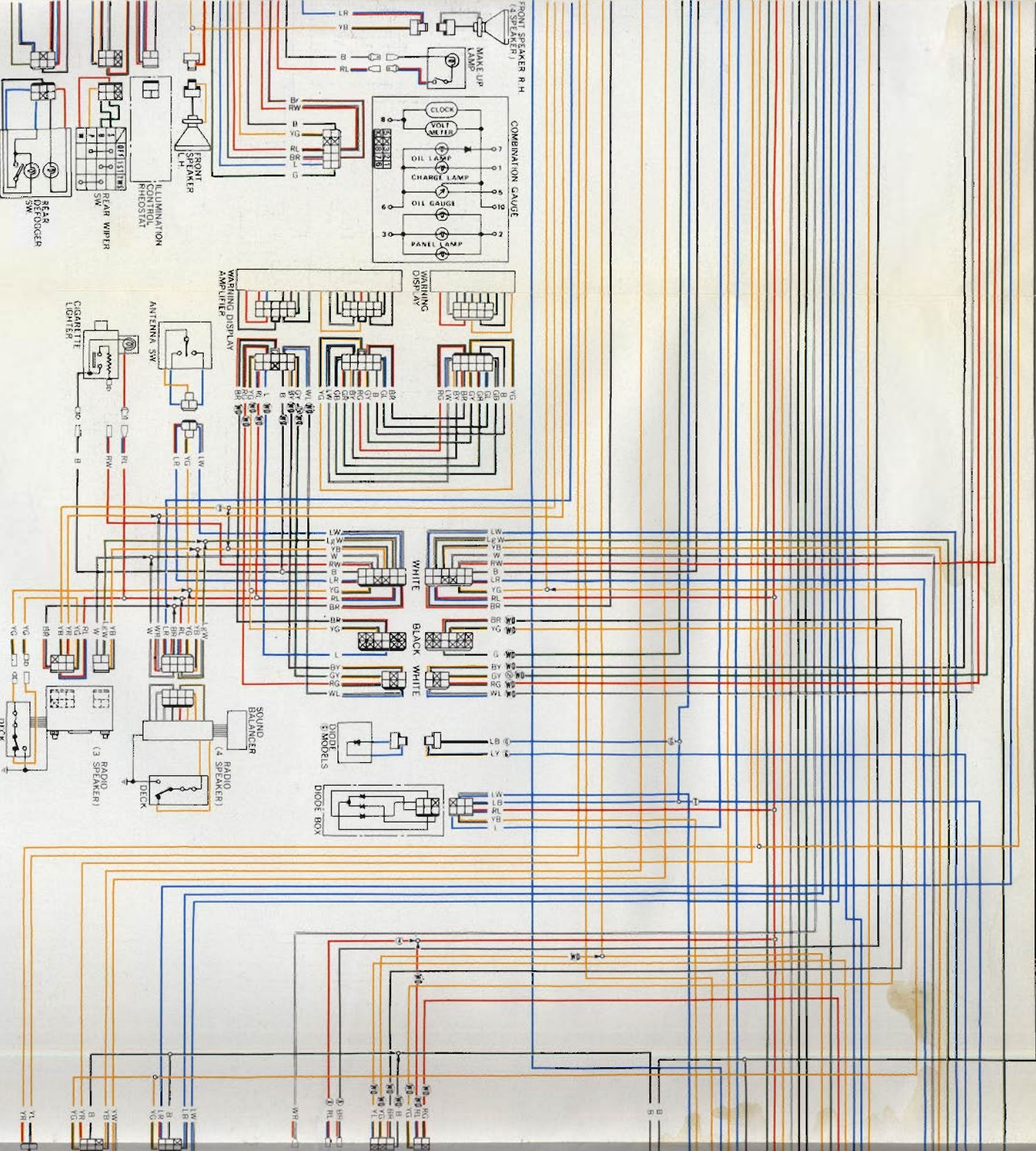

COMBINATION METER

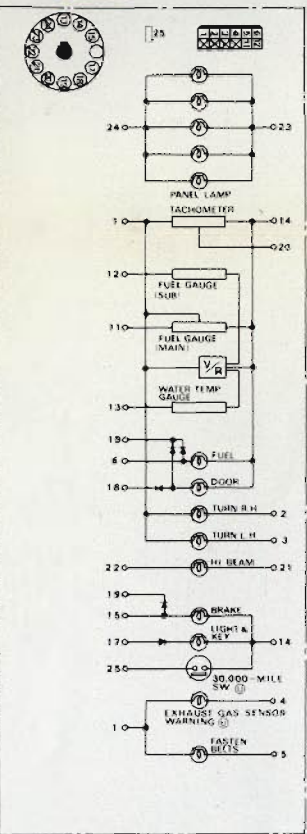

This wiring diagram has been prepared on the basis of the factory equipment. It is fully equipped, (including all factory options). The right is reserved to make changes in the wiring without prior notice.
 Note: Each cable is color-coded based on following two tone colored cables, such as GW and BR partial white stripe and black cable with partial white stripe.

The color of lines near connectors in the wiring diagram as shown below is the same as that of actual lines in the car.

- BLACK
- WHITE
- RED
- GREEN
- BLUE
- YELLOW
- LIGHT GREEN
- BROWN

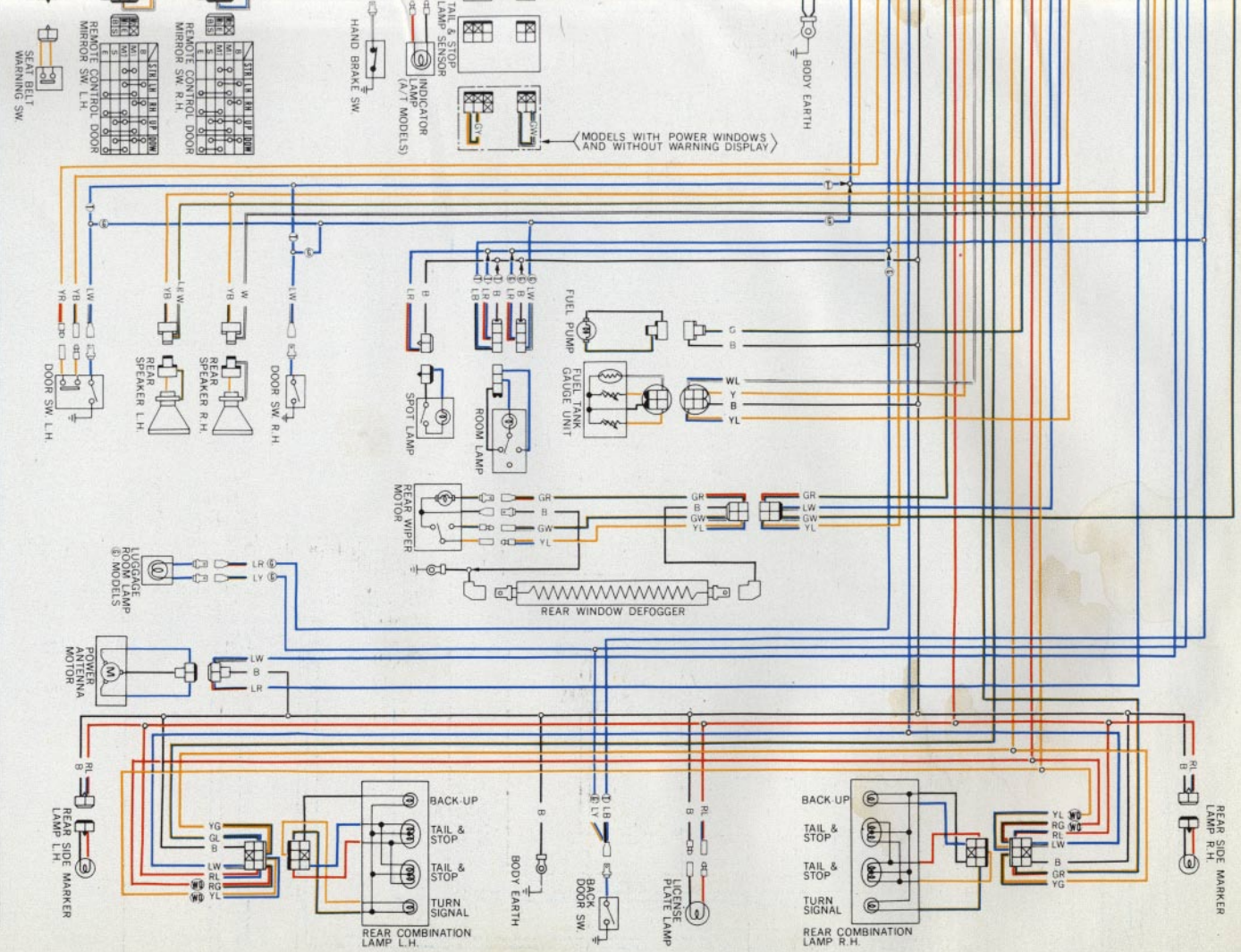

- ① AUTOMATIC TRANSMISSION MODELS
- ② MANUAL TRANSMISSION MODELS
- ③ 2 SEATER MODELS
- ④ 2 + 2 SEATER MODEL
- ⑤ GRAND LUXURY MODELS
- ⑥ WARNING DISPLAY
- ⑦ AIR CONDITIONER
- ⑧ EXCEPT GRAND LUXURY MODELS
- ⑨ AIR CONDITIONER EQUIPPED MODELS
- ⑩ U.S.A. MODELS
- ⑪ CANADA MODELS

- POSITION
- Ignition sw. in lock
 - Light sw. and wiper sw. in off
 - Door closed
 - Transmission in neutral (A/T selector lever in parking)
 - Parking brake pulled
 - Driver's seat belt unlocked

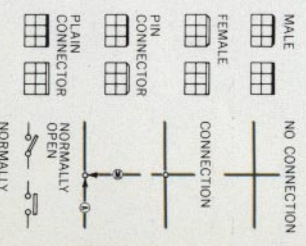

assumption that the car
 al equipment)
 wiring diagram at
 r colors.
 mean green cable with
 al red stripe, respectively.



1981 DATSUN 280ZX GL MODELS

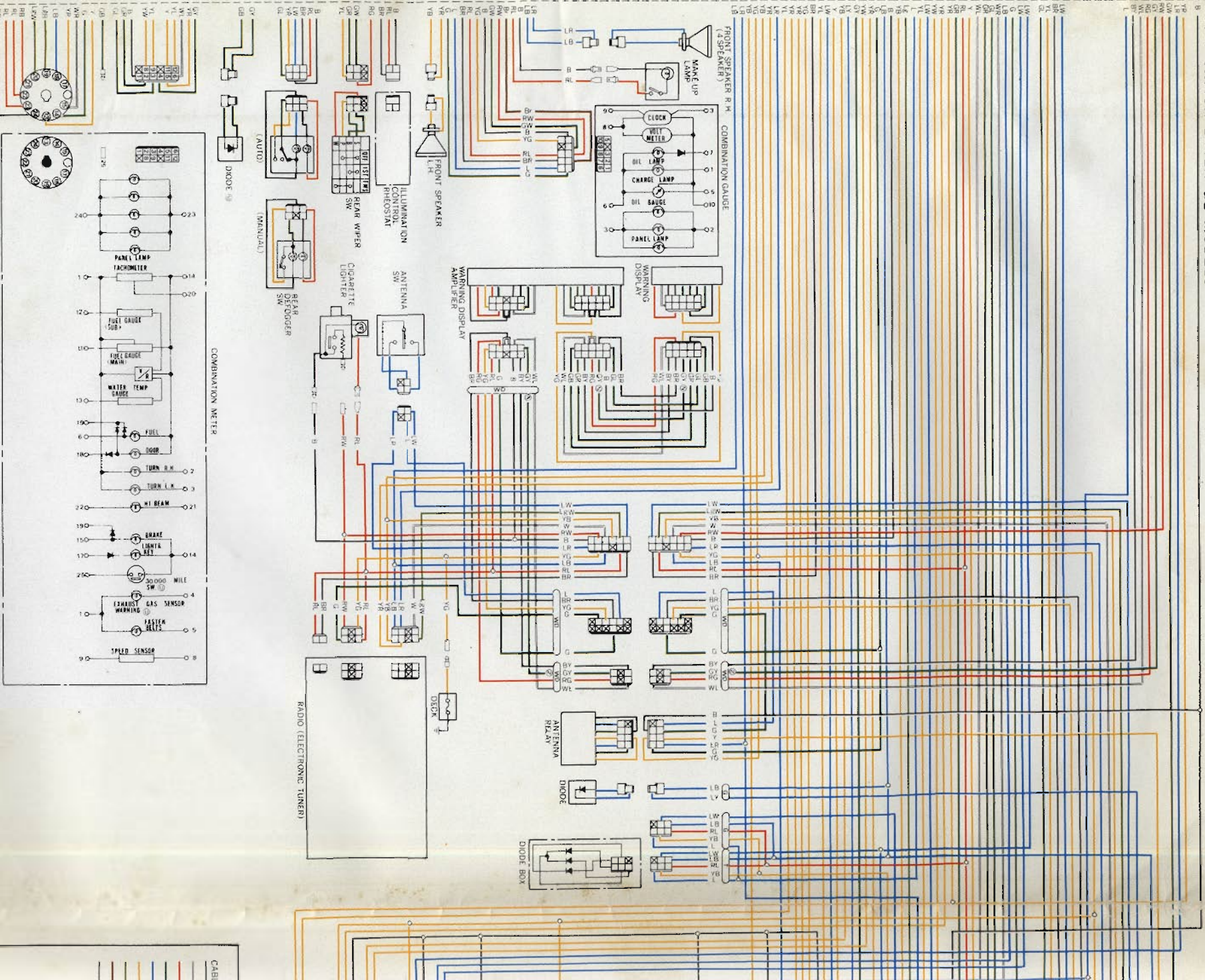

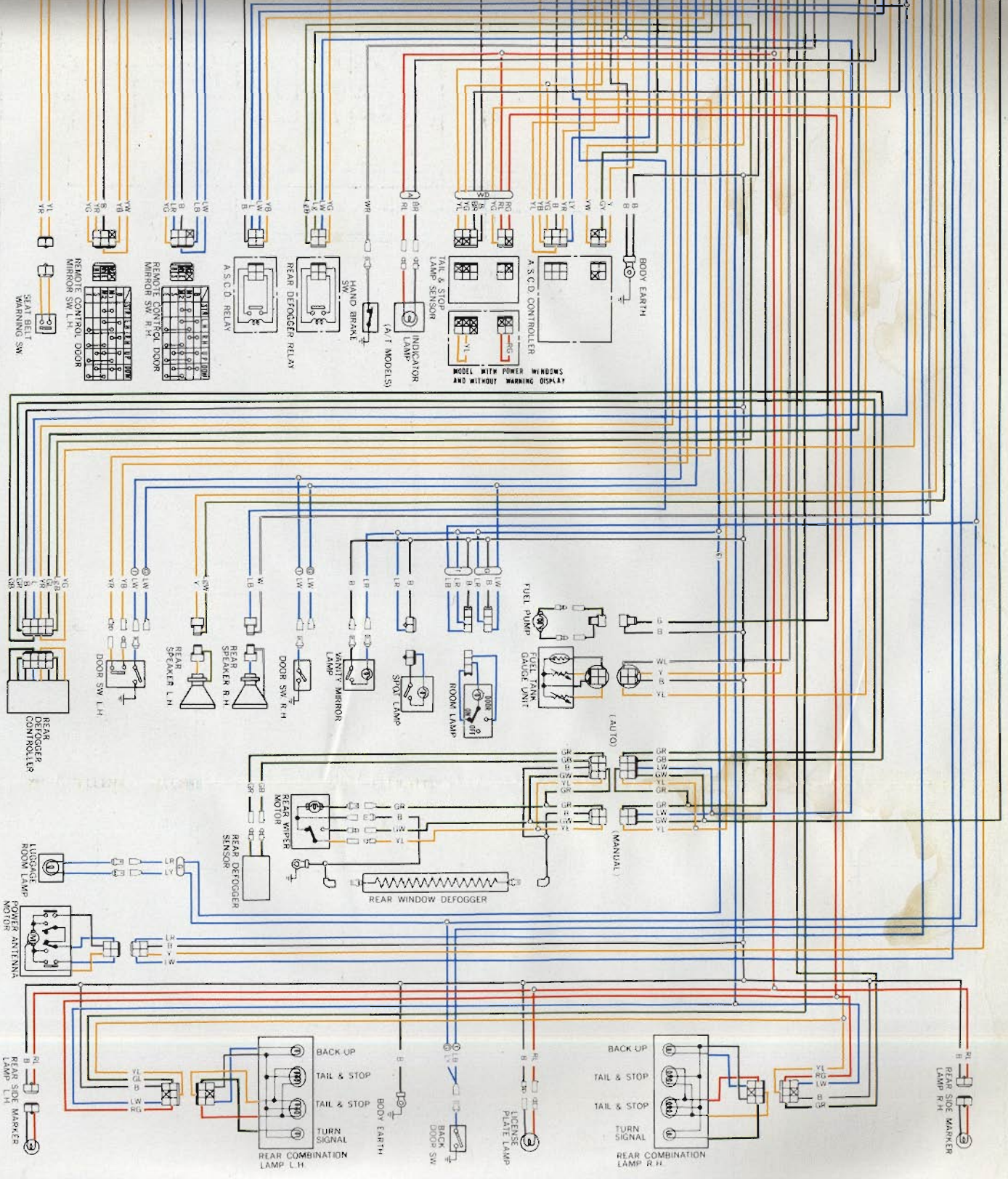

- COLORS**
- B BLACK
 - W WHITE
 - R RED
 - G GREEN
 - L BLUE
 - Y YELLOW
 - Lg LIGHT GREEN
 - Br BROWN
 - Gr GRAY

IN THE CASE OF TWO-TONE COLOR CABLE, CABLE COLOR IS INDICATED BY BASE COLOR ONLY AND STRIPE COLOR IS NOT SHOWN.

- (Example)
- GW GREEN with WHITE Stripe
 - LB BLUE with GREEN Stripe

- ① AUTOMATIC TRANSMISSION MODELS
- ② MANUAL TRANSMISSION MODELS
- ③ 2 SEATER MODELS
- ④ 2+2 SEATER MODEL
- ⑤ GRAND LUXURY MODELS
- ⑥ WARNING DISPLAY
- ⑦ AIR CONDITIONER
- ⑧ EXCEPT GRAND LUXURY MODELS
- ⑨ AIR CONDITIONER EQUIPPED MODELS
- ⑩ U.S.A. MODELS
- ⑪ CANADA MODELS

- POSITION**
- Ignition sw. in lock
 - Light sw. and wiper sw. in off
 - Door closed
 - Transmission in neutral (A.F. selector lever in parking)
 - Parking brake pulled
 - Driver's seat belt unlocked

