

SECTION **DEF**  
 DEFOGGER

A  
B  
C  
D  
E  
F  
G  
H  
I  
J  
K

CONTENTS

<b>COUPE</b>		
<b>BASIC INSPECTION</b> .....	5	
<b>DIAGNOSIS AND REPAIR WORK FLOW</b> .....	5	
Work Flow .....	5	
<b>SYSTEM DESCRIPTION</b> .....	6	
<b>REAR WINDOW DEFOGGER SYSTEM</b> .....	6	
<b>WITH NAVIGATION</b> .....	6	
WITH NAVIGATION : System Diagram .....	6	
WITH NAVIGATION : System Description .....	6	
WITH NAVIGATION : Component Parts Location.....	7	
WITH NAVIGATION : Component Description .....	7	
<b>WITHOUT NAVIGATION</b> .....	7	
WITHOUT NAVIGATION : System Diagram .....	8	
WITHOUT NAVIGATION : System Description .....	8	
WITHOUT NAVIGATION : Component Parts Location .....	9	
WITHOUT NAVIGATION : Component Description .....	9	
<b>DIAGNOSIS SYSTEM (BCM)</b> .....	10	
<b>COMMON ITEM</b> .....	10	
COMMON ITEM : CONSULT Function (BCM - COMMON ITEM) .....	10	
<b>REAR WINDOW DEFOGGER</b> .....	11	
REAR WINDOW DEFOGGER : CONSULT Function (BCM - REAR DEFOGGER) (For Coupe) .....	11	
<b>DTC/CIRCUIT DIAGNOSIS</b> .....	13	
<b>POWER SUPPLY AND GROUND CIRCUIT</b> .....	13	
<b>BCM</b> .....	13	
BCM : Diagnosis Procedure .....	13	
<b>REAR WINDOW DEFOGGER SWITCH</b> .....	14	
<b>WITH NAVIGATION</b> .....	14	
WITH NAVIGATION : Description .....	14	
WITH NAVIGATION : Component Function Check .....	14	
WITH NAVIGATION : Diagnosis Procedure .....	14	
<b>WITHOUT NAVIGATION</b> .....	14	
WITHOUT NAVIGATION : Description .....	14	
WITHOUT NAVIGATION : Component Function Check .....	14	
WITHOUT NAVIGATION : Diagnosis Procedure .....	14	
<b>REAR WINDOW DEFOGGER RELAY</b> .....	16	
Description .....	16	
Component Function Check .....	16	
Diagnosis Procedure .....	16	
Component Inspection .....	17	
<b>REAR WINDOW DEFOGGER</b> .....	18	
Description .....	18	
Component Function Check .....	18	
Diagnosis Procedure .....	18	
Component Inspection .....	20	
<b>REAR WINDOW DEFOGGER ON SIGNAL</b> .....	21	
Description .....	21	
Component Function Check .....	21	
Diagnosis Procedure .....	21	
<b>DOOR MIRROR DEFOGGER</b> .....	23	
Description .....	23	
Component Function Check .....	23	
Diagnosis Procedure .....	23	
<b>DRIVER SIDE DOOR MIRROR DEFOGGER</b> .....	24	
Description .....	24	
Component Function Check .....	24	
Diagnosis Procedure .....	24	
<b>PASSENGER SIDE DOOR MIRROR DEFOGGER</b> .....	26	
Description .....	26	

**DEF**

M  
N  
O  
P

Component Function Check .....	26	FOR USA AND CANADA : Precaution for Supplemental Restraint System (SRS) "AIR BAG" and "SEAT BELT PRE-TENSIONER" .....	89
Diagnosis Procedure .....	26	FOR USA AND CANADA : Precaution for Battery Service .....	89
<b>REAR WINDOW DEFOGGER SYSTEM .....</b>	<b>28</b>	FOR USA AND CANADA : Precautions For Xenon Headlamp Service .....	89
Wiring Diagram - DEFOGGER (WITH NAVI) - .....	28	<b>FOR MEXICO .....</b>	<b>90</b>
Wiring Diagram - DEFOGGER (WITHOUT NAVI) - .....	34	FOR MEXICO : Precaution for Supplemental Restraint System (SRS) "AIR BAG" and "SEAT BELT PRE-TENSIONER" .....	90
<b>ECU DIAGNOSIS INFORMATION .....</b>	<b>40</b>	FOR MEXICO : Precaution for Battery Service .....	90
<b>BCM (BODY CONTROL MODULE) .....</b>	<b>40</b>	FOR MEXICO : Precautions For Xenon Headlamp Service .....	90
Reference Value .....	40	<b>REMOVAL AND INSTALLATION .....</b>	<b>92</b>
Wiring Diagram - BCM - .....	64	<b>FILAMENT .....</b>	<b>92</b>
Fail-safe .....	78	Inspection and Repair .....	92
DTC Inspection Priority Chart .....	79	<b>CONDENSER .....</b>	<b>94</b>
DTC Index .....	80	Exploded View .....	94
<b>SYMPTOM DIAGNOSIS .....</b>	<b>83</b>	Removal and Installation .....	94
<b>REAR WINDOW DEFOGGER DOES NOT OPERATE .....</b>	<b>83</b>	<b>ROADSTER</b>	
Diagnosis Procedure .....	83	<b>BASIC INSPECTION .....</b>	<b>95</b>
<b>REAR WINDOW DEFOGGER AND DOOR MIRROR DEFOGGERS DO NOT OPERATE ...</b>	<b>84</b>	<b>DIAGNOSIS AND REPAIR WORK FLOW .....</b>	<b>95</b>
Diagnosis Procedure .....	84	Work Flow .....	95
<b>REAR WINDOW DEFOGGER DOES NOT OPERATE BUT BOTH DOOR MIRROR DEFOGGERS OPERATE .....</b>	<b>85</b>	<b>SYSTEM DESCRIPTION .....</b>	<b>96</b>
Diagnosis Procedure .....	85	<b>REAR WINDOW DEFOGGER SYSTEM .....</b>	<b>96</b>
<b>DOOR MIRROR DEFOGGER DOES NOT OPERATE .....</b>	<b>86</b>	<b>WITH NAVIGATION .....</b>	<b>96</b>
<b>BOTH SIDES .....</b>	<b>86</b>	WITH NAVIGATION : System Diagram .....	96
BOTH SIDES : Diagnosis Procedure .....	86	WITH NAVIGATION : System Description .....	96
<b>DRIVER SIDE .....</b>	<b>86</b>	WITH NAVIGATION : Component Parts Location... ..	97
DRIVER SIDE : Diagnosis Procedure .....	86	WITH NAVIGATION : Component Description .....	97
<b>PASSENGER SIDE .....</b>	<b>86</b>	<b>WITHOUT NAVIGATION .....</b>	<b>97</b>
PASSENGER SIDE : Diagnosis Procedure .....	86	WITHOUT NAVIGATION : System Diagram .....	98
<b>ON IS NOT DISPLAYED WHEN PRESSING REAR WINDOW DEFOGGER SWITCH BUT IT OPERATES .....</b>	<b>87</b>	WITHOUT NAVIGATION : System Description .....	98
Diagnosis Procedure .....	87	WITHOUT NAVIGATION : Component Parts Location .....	99
<b>REAR WINDOW DEFOGGER INDICATOR DOES NOT ILLUMINATE .....</b>	<b>88</b>	WITHOUT NAVIGATION : Component Description .....	99
<b>WITH NAVIGATION .....</b>	<b>88</b>	<b>DIAGNOSIS SYSTEM (BCM) .....</b>	<b>100</b>
WITH NAVIGATION : Diagnosis Procedure .....	88	<b>COMMON ITEM .....</b>	<b>100</b>
<b>WITHOUT NAVIGATION .....</b>	<b>88</b>	COMMON ITEM : CONSULT Function (BCM - COMMON ITEM) .....	100
WITHOUT NAVIGATION : Diagnosis Procedure ... ..	88	<b>REAR WINDOW DEFOGGER .....</b>	<b>101</b>
<b>PRECAUTION .....</b>	<b>89</b>	REAR WINDOW DEFOGGER : CONSULT Function (BCM - REAR DEFOGGER) (For Roadster) .	101
<b>PRECAUTIONS .....</b>	<b>89</b>	<b>DTC/CIRCUIT DIAGNOSIS .....</b>	<b>103</b>
<b>FOR USA AND CANADA .....</b>	<b>89</b>	<b>POWER SUPPLY AND GROUND CIRCUIT ...</b>	<b>103</b>

<b>BCM</b> .....	103	<b>ECU DIAGNOSIS INFORMATION</b> .....	131	A
BCM : Diagnosis Procedure .....	103	<b>BCM (BODY CONTROL MODULE)</b> .....	131	B
<b>REAR WINDOW DEFOGGER SWITCH</b> .....	104	Reference Value .....	131	
<b>WITH NAVIGATION</b> .....	104	Wiring Diagram - BCM - .....	155	
WITH NAVIGATION : Description .....	104	Fail-safe .....	169	
WITH NAVIGATION : Component Function		DTC Inspection Priority Chart .....	170	
Check .....	104	DTC Index .....	171	C
WITH NAVIGATION : Diagnosis Procedure .....	104	<b>SOFT TOP CONTROL UNIT</b> .....	174	
<b>WITHOUT NAVIGATION</b> .....	104	Reference Value .....	174	
WITHOUT NAVIGATION : Description .....	104	Fail-safe .....	181	D
WITHOUT NAVIGATION : Component Function		DTC Inspection Priority Chart .....	182	
Check .....	104	DTC Index .....	183	
WITHOUT NAVIGATION : Diagnosis Procedure..	104	<b>SYMPTOM DIAGNOSIS</b> .....	186	E
<b>REAR WINDOW DEFOGGER RELAY</b> .....	106	<b>REAR WINDOW DEFOGGER AND DOOR</b>		
Description .....	106	<b>MIRROR DEFOGGERS DO NOT OPERATE</b> .	186	F
Component Function Check .....	106	Diagnosis Procedure .....	186	
Diagnosis Procedure .....	106	<b>REAR WINDOW DEFOGGER DOES NOT</b>		
Component Inspection .....	107	<b>OPERATE BUT BOTH DOOR MIRROR DE-</b>		
<b>SOFT TOP CONTROL UNIT</b> .....	108	<b>FOGGERS OPERATE</b> .....	187	G
Description .....	108	Diagnosis Procedure .....	187	
Component Function Check .....	108	<b>DOOR MIRROR DEFOGGER DOES NOT OP-</b>		
Diagnosis Procedure .....	108	<b>ERATE</b> .....	188	H
<b>REAR WINDOW DEFOGGER</b> .....	110	<b>BOTH SIDES</b> .....	188	I
Description .....	110	BOTH SIDES : Diagnosis Procedure .....	188	
Component Function Check .....	110	<b>DRIVER SIDE</b> .....	188	J
Diagnosis Procedure .....	110	DRIVER SIDE : Diagnosis Procedure .....	188	
Component Inspection .....	111	<b>PASSENGER SIDE</b> .....	188	K
<b>REAR WINDOW DEFOGGER ON SIGNAL</b> ...	112	PASSENGER SIDE : Diagnosis Procedure .....	188	
Description .....	112	<b>ON IS NOT DISPLAYED WHEN PRESSING</b>		
Component Function Check .....	112	<b>REAR WINDOW DEFOGGER SWITCH BUT</b>		
Diagnosis Procedure .....	112	<b>IT OPERATES</b> .....	189	DEF
<b>DOOR MIRROR DEFOGGER</b> .....	114	Diagnosis Procedure .....	189	
Description .....	114	<b>REAR WINDOW DEFOGGER INDICATOR</b>		
Component Function Check .....	114	<b>DOES NOT ILLUMINATE</b> .....	190	M
Diagnosis Procedure .....	114	<b>WITH NAVIGATION</b> .....	190	
<b>DRIVER SIDE DOOR MIRROR DEFOGGER</b> ..	115	WITH NAVIGATION : Diagnosis Procedure .....	190	N
Description .....	115	<b>WITHOUT NAVIGATION</b> .....	190	
Component Function Check .....	115	WITHOUT NAVIGATION : Diagnosis Procedure ..	190	O
Diagnosis Procedure .....	115	<b>PRECAUTION</b> .....	191	
Component Inspection .....	116	<b>PRECAUTIONS</b> .....	191	P
<b>PASSENGER SIDE DOOR MIRROR DEFOG-</b>		<b>FOR USA AND CANADA</b> .....	191	
<b>GER</b> .....	117	FOR USA AND CANADA : Precaution for Supple-		
Description .....	117	mental Restraint System (SRS) "AIR BAG" and		
Component Function Check .....	117	"SEAT BELT PRE-TENSIONER" .....	191	
Diagnosis Procedure .....	117	FOR USA AND CANADA : Precaution for Battery		
Component Inspection .....	118	Service .....	191	
<b>REAR WINDOW DEFOGGER SYSTEM</b> .....	119			
Wiring Diagram - DEFOGGER (WITH NAVI) -	119			
Wiring Diagram - DEFOGGER (WITHOUT NAVI)				
- .....	125			

---

FOR USA AND CANADA : Precautions For Xenon Headlamp Service .....	191	FOR MEXICO : Precautions For Xenon Headlamp Service .....	192
<b>FOR MEXICO .....</b>	<b>192</b>	<b>REMOVAL AND INSTALLATION .....</b>	<b>194</b>
FOR MEXICO : Precaution for Supplemental Restraint System (SRS) "AIR BAG" and "SEAT BELT PRE-TENSIONER" .....	192	<b>FILAMENT .....</b>	<b>194</b>
FOR MEXICO : Precaution for Battery Service ....	192	Inspection and Repair .....	194

## BASIC INSPECTION

### DIAGNOSIS AND REPAIR WORK FLOW

#### Work Flow

INFOID:000000009363299

#### DETAILED FLOW

#### 1.OBTAIN INFORMATION ABOUT SYMPTOM

Interview the customer to obtain as much malfunction information (conditions and environment when the malfunction occurs) as possible when the customer brings the vehicle in.

>> GO TO 2.

#### 2.CHECK DTC

Perform self-diagnosis with CONSULT.

Are any DTC detected?

YES >> Refer to [BCS-99. "DTC Index"](#).

NO >> GO TO 3.

#### 3.REPRODUCE THE MALFUNCTION INFORMATION

Check the malfunction on the vehicle that the customer describes.  
Inspect the relation of the symptoms and the condition when the symptoms occur.

>> GO TO 4.

#### 4.IDENTIFY THE MALFUNCTIONING SYSTEM WITH "SYMPTOM DIAGNOSIS"

Use "Symptom diagnosis" from the symptom inspection result in step 3. Then identify where to start performing the diagnosis based on possible causes and symptoms.

>> GO TO 5.

#### 5.IDENTIFY MALFUNCTIONING PARTS WITH "COMPONENT DIAGNOSIS"

Perform the diagnosis with "Component diagnosis" of the applicable system.

>> GO TO 6.

#### 6.REPAIR OR REPLACE THE MALFUNCTIONING PARTS

Repair or replace the specified malfunctioning parts.

>> GO TO 7.

#### 7.FINAL CHECK

Check that malfunctions are not reproduced when obtaining the malfunction information from the customer, referring to the symptom inspection result in step 3.

Are all malfunctions corrected?

YES >> INSPECTION END

NO >> GO TO 4.

A  
B  
C  
D  
E  
F  
G  
H  
I  
J  
K  
DEF  
M  
N  
O  
P

# REAR WINDOW DEFOGGER SYSTEM

< SYSTEM DESCRIPTION >

[COUPE]

## SYSTEM DESCRIPTION

### REAR WINDOW DEFOGGER SYSTEM WITH NAVIGATION

#### WITH NAVIGATION : System Diagram

INFOID:000000009363300

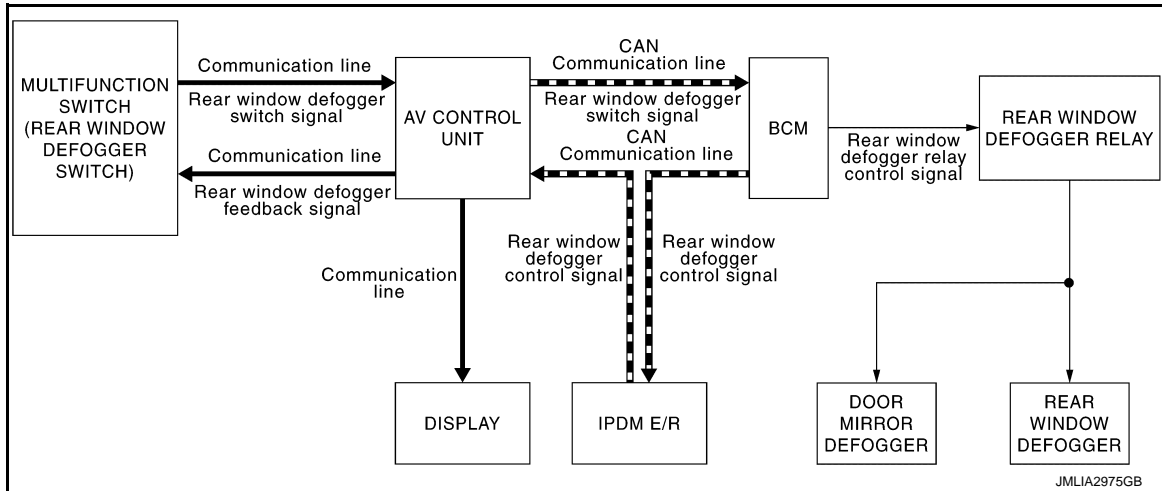

#### WITH NAVIGATION : System Description

INFOID:000000009363301

##### OPERATION DESCRIPTION

- Turn rear window defogger switch ON when the ignition switch is ON. Then multifunction switch (rear window defogger switch) transmits rear window defogger switch signal to AV control unit via AV communication. AV control unit transmits rear window defogger switch signal to BCM via CAN communication.
- BCM turns rear window defogger relay ON and transmits rear window defogger ON signal to IPDM E/R via CAN communication when rear window defogger switch signal is received.
- Rear window defogger and door mirror defogger are supplied with power and operate when rear window defogger relay turns ON.
- IPDM E/R transmits rear window defogger ON signal to AV control unit via CAN communication.
- When receiving the signal, AV control unit indicates rear defogger ON on the display. At the same time, AV control unit transmits rear defogger ON signal to multifunction switch (rear window defogger switch) via AV communication and illuminates rear window defogger switch indicator.

##### TIMER FUNCTION

- BCM turns rear window defogger relay ON for approximately 15 minutes when rear window defogger switch is turned ON. It makes rear window defogger and door mirror defoggers operate.
- Timer is canceled after pressing rear window defogger switch again during timer operation. Then BCM turns rear window defogger relay OFF. The same operation also occurs during timer operation, if the ignition switch is turned OFF.

# REAR WINDOW DEFOGGER SYSTEM

[COUPE]

< SYSTEM DESCRIPTION >

## WITH NAVIGATION : Component Parts Location

INFOID:000000009363302

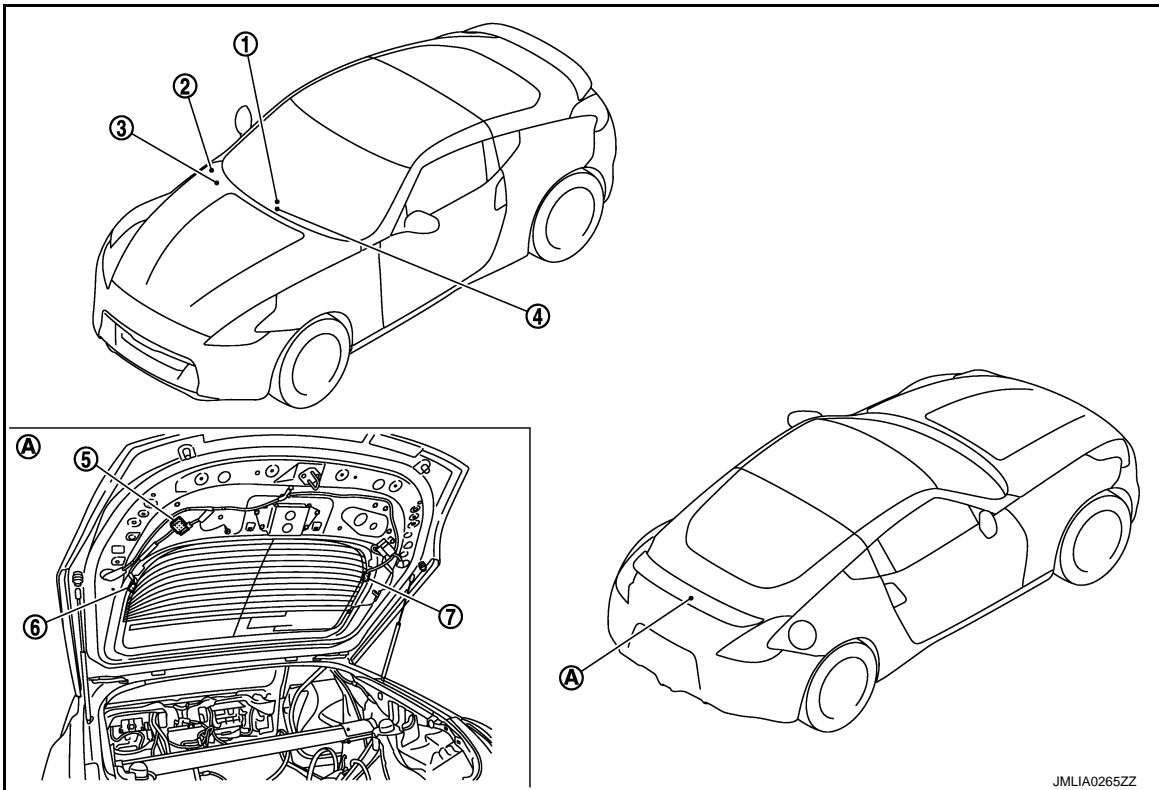

1. Multifunction switch (rear window defogger switch)
2. IPDM E/R  
Refer to [PCS-5. "Component Parts Location"](#).
3. BCM  
Refer to [BCS-11. "Component Parts Location"](#).
4. AV control unit  
Refer to [AV-140. "Component Parts Location"](#).
5. Condenser
6. Rear window defogger connector
7. Rear window defogger connector
- A. Behind back door assembly

## WITH NAVIGATION : Component Description

INFOID:000000009363303

Multifunction switch (Rear window defogger switch)	<ul style="list-style-type: none"> <li>The rear window defogger switch is installed.</li> <li>Turns the indicator lamp ON when detecting the operation of rear window defogger relay.</li> </ul>
AV control unit	Displays the rear window defogger is ON on the display when detecting the operation of rear window defogger relay.
BCM	<ul style="list-style-type: none"> <li>Operates the rear window defogger relay when receiving rear window defogger switch signal.</li> <li>Performs the timer control of rear window defogger relay.</li> </ul>
Rear window defogger relay	Operates the rear window defoggers and door mirror defogger with the control signal from BCM.
Rear window defogger	Heats the heating wire with the power supply from the rear window defogger relay to prevent the rear window from fogging up.
Door mirror defogger	Heats the heating wire with the power supply from the rear window defogger relay to prevent the door mirror from fogging up.
IPDM E/R	Transmits rear window defogger ON signal to AV control unit via CAN communication.

## WITHOUT NAVIGATION

A  
B  
C  
D  
E  
F  
G  
H  
I  
J  
K

DEF

M  
N  
O  
P

# REAR WINDOW DEFOGGER SYSTEM

[COUPE]

< SYSTEM DESCRIPTION >

WITHOUT NAVIGATION : System Diagram

INFOID:00000009363304

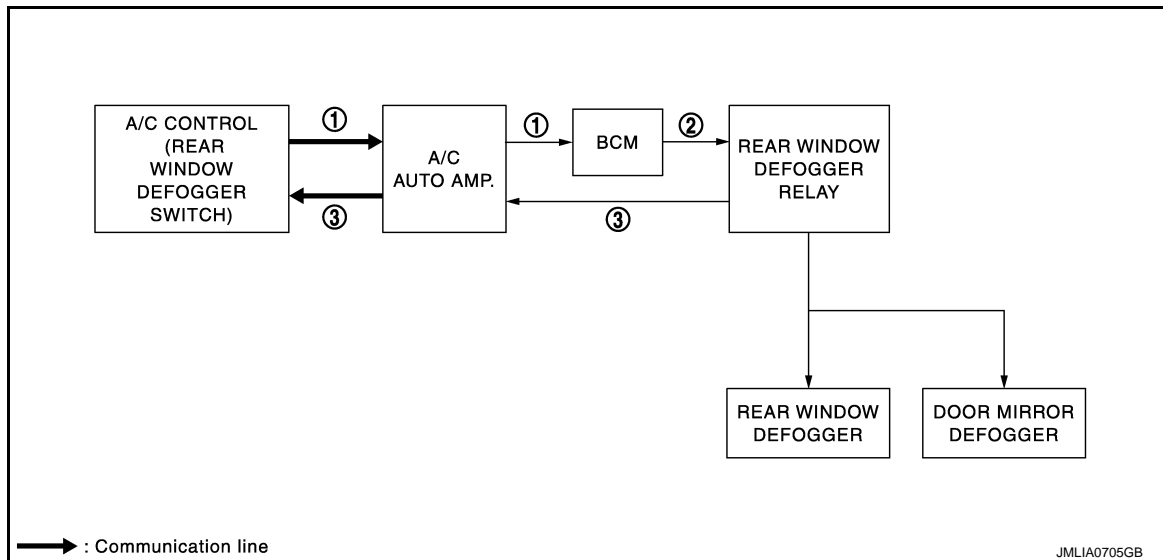

1. Rear window defogger switch signal
2. Rear window defogger relay ON signal
3. Rear window defogger ON signal

WITHOUT NAVIGATION : System Description

INFOID:00000009363305

## OPERATION DESCRIPTION

- Turn rear window defogger switch ON when the ignition switch is ON. Then A/C control (rear window defogger switch) transmits rear window defogger switch signal to A/C auto amp. and BCM.
- BCM turns rear window defogger relay ON when rear window defogger switch signal is received.
- Rear window defogger and door mirror defogger (with mirror defogger) are supplied with power and operates when rear window defogger relay turns ON.
- Rear window defogger relay transmits rear window defogger ON signal to A/C auto amp. when rear window defogger operates.
- At the same time, A/C auto amp. transmits rear defogger ON signal to A/C controller (rear window defogger switch) and illuminates rear window defogger switch indicator.

## TIMER FUNCTION

- BCM turns rear window defogger relay ON for approximately 15 minutes when rear window defogger switch is turned ON. It makes rear window defogger and door mirror defoggers (with mirror defogger) operate.
- Timer is canceled after pressing rear window defogger switch again during timer operation. Then BCM turns rear window defogger relay OFF. The same operation also occurs during timer operation, if the ignition switch is turned OFF.



# REAR WINDOW DEFOGGER SYSTEM

< SYSTEM DESCRIPTION >

[COUPE]

## WITHOUT NAVIGATION : Component Parts Location

INFOID:000000009363306

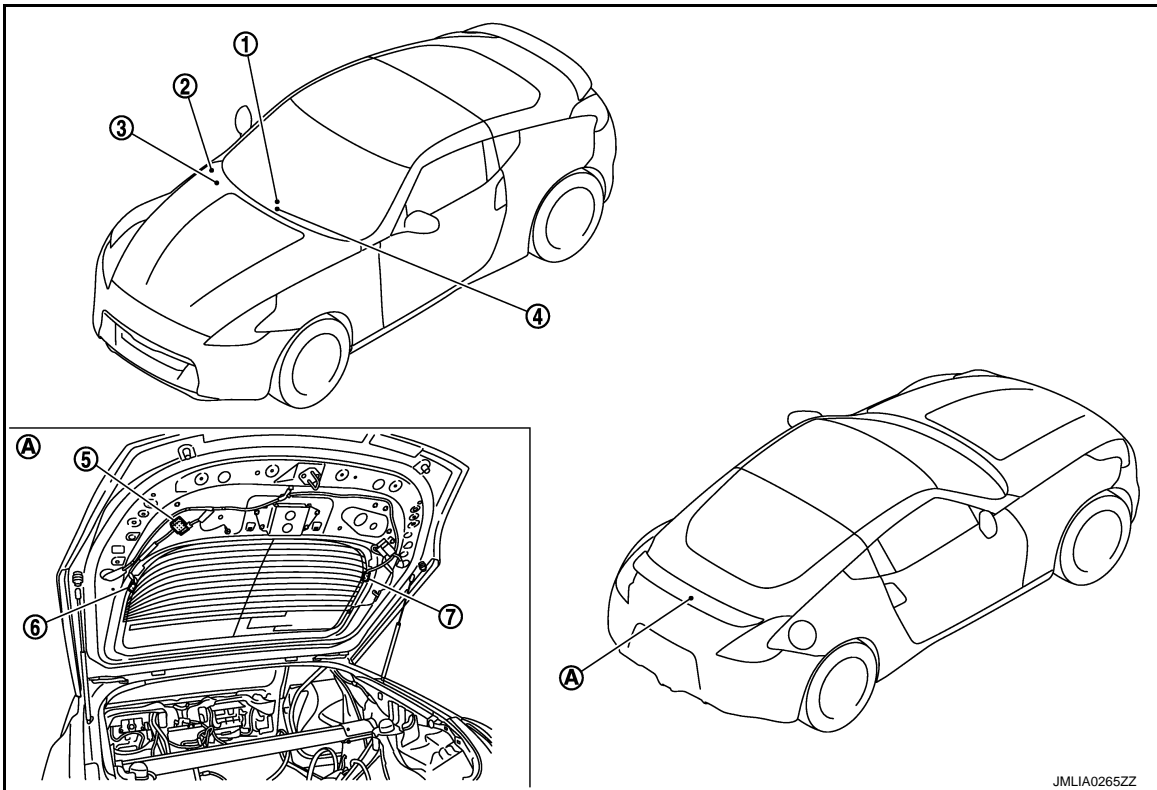

- |   |   |   |
|---|---|---|
| 1. A/C controller   | 2. IPDM E/R<br>Refer to <a href="#">PCS-5, "Component Parts Location"</a> . | 3. BCM<br>Refer to <a href="#">BCS-11, "Component Parts Location"</a> . |
| 4. A/C auto amp.<br>Refer to <a href="#">HAC-23, "Component Parts Location"</a> . | 5. Condenser  | 6. Rear window defogger connector                                       |
| 7. Rear window defogger connector   |   |   |
| A. Behind back door assembly  |   |   |

## WITHOUT NAVIGATION : Component Description

INFOID:000000009363307

A/C control (Rear window defogger switch)	<ul style="list-style-type: none"> <li>The rear window defogger switch is installed.</li> <li>Turns the indicator lamp ON when detecting the operation of rear window defogger relay.</li> </ul>
A/C auto amp.	Transmit rear window defogger switch signal to BCM via CAN communication.
BCM	<ul style="list-style-type: none"> <li>Operates the rear window defogger relay with the operation of rear window defogger switch.</li> <li>Performs the timer control of rear window defogger relay.</li> </ul>
Rear window defogger relay	Operates the rear window defogger and door mirror defogger (with mirror defogger) with the control signal from BCM.
Rear window defogger	Heats the heating wire with the power supply from the rear window defogger relay to prevent the rear window from fogging up.
Door mirror defogger (with mirror defogger)	Heats the heating wire with the power supply from the rear window defogger relay to prevent the door mirror from fogging up.

# DIAGNOSIS SYSTEM (BCM)

[COUPE]

< SYSTEM DESCRIPTION >

## DIAGNOSIS SYSTEM (BCM)

### COMMON ITEM

#### COMMON ITEM : CONSULT Function (BCM - COMMON ITEM)

INFOID:000000009363308

#### APPLICATION ITEM

CONSULT performs the following functions via CAN communication with BCM.

Diagnosis mode	Function Description
Work Support	Changes the setting for each system function.
Self Diagnostic Result	Displays the diagnosis results judged by BCM.
CAN Diag Support Monitor	Monitors the reception status of CAN communication viewed from BCM.
Data Monitor	The BCM input/output signals are displayed.
Active Test	The signals used to activate each device are forcibly supplied from BCM.
Ecu Identification	The BCM part number is displayed.
Configuration	<ul style="list-style-type: none"> <li>Read and save the vehicle specification.</li> <li>Write the vehicle specification when replacing BCM.</li> </ul>

#### SYSTEM APPLICATION

BCM can perform the following functions for each system.

#### NOTE:

It can perform the diagnosis modes except the following for all sub system selection items.

×: Applicable item

System	Sub system selection item	Diagnosis mode		
		Work Support	Data Monitor	Active Test
Door lock	DOOR LOCK	×	×	×
Rear window defogger	REAR DEFOGGER		×	×
Warning chime	BUZZER		×	×
Interior room lamp timer	INT LAMP	×	×	×
Exterior lamp	HEAD LAMP	×	×	×
Wiper and washer	WIPER	×	×	×
Turn signal and hazard warning lamps	FLASHER	×	×	×
—	AIR CONDITONER*			
<ul style="list-style-type: none"> <li>Intelligent Key system</li> <li>Engine start system</li> </ul>	INTELLIGENT KEY	×	×	×
Combination switch	COMB SW		×	
Body control system	BCM	×		
NVIS - NATS	IMMU		×	×
Interior room lamp battery saver	BATTERY SAVER	×	×	×
Back door/Trunk lid open	TRUNK		×	×
Vehicle security system	THEFT ALM	×	×	×
RAP system	RETAINED PWR		×	
Signal buffer system	SIGNAL BUFFER		×	×
TPMS	TPMS (AIR PRESSURE MONITOR)	×	×	×

#### NOTE:

\*: This item is displayed, but is not used.

#### FREEZE FRAME DATA (FFD)

The BCM records the following vehicle condition at the time a particular DTC is detected, and displays on CONSULT.

# DIAGNOSIS SYSTEM (BCM)

< SYSTEM DESCRIPTION >

[COUPE]

CONSULT screen item	Indication/Unit	Description
Vehicle Speed	km/h	Vehicle speed of the moment a particular DTC is detected
Odo/Trip Meter	km	Total mileage (Odometer value) of the moment a particular DTC is detected
Vehicle Condition	SLEEP>LOCK	While turning BCM status from low power consumption mode to normal mode (Power supply position is "LOCK"*)
	SLEEP>OFF	While turning BCM status from low power consumption mode to normal mode (Power supply position is "OFF".)
	LOCK>ACC	While turning power supply position from "LOCK"* to "ACC"
	ACC>ON	While turning power supply position from "ACC" to "IGN"
	RUN>ACC	While turning power supply position from "RUN" to "ACC" (Except emergency stop operation)
	CRANK>RUN	While turning power supply position from "CRANKING" to "RUN" (From cranking up the engine to run it)
	RUN>URGENT	While turning power supply position from "RUN" to "ACC" (Emergency stop operation)
	ACC>OFF	While turning power supply position from "ACC" to "OFF"
	OFF>LOCK	While turning power supply position from "OFF" to "LOCK"*
	OFF>ACC	While turning power supply position from "OFF" to "ACC"
	ON>CRANK	While turning power supply position from "IGN" to "CRANKING"
	OFF>SLEEP	While turning BCM status from normal mode (Power supply position is "OFF".) to low power consumption mode
	LOCK>SLEEP	While turning BCM status from normal mode (Power supply position is "LOCK"*. ) to low power consumption mode
	LOCK	Power supply position is "LOCK"*
	OFF	Power supply position is "OFF" (Ignition switch OFF)
	ACC	Power supply position is "ACC" (Ignition switch ACC)
	ON	Power supply position is "IGN" (Ignition switch ON with engine stopped)
	ENGINE RUN	Power supply position is "RUN" (Ignition switch ON with engine running)
CRANKING	Power supply position is "CRANKING" (At engine cranking)	
IGN Counter	0 - 39	The number of times that ignition switch is turned ON after DTC is detected <ul style="list-style-type: none"> <li>• The number is 0 when a malfunction is detected now.</li> <li>• The number increases like 1 → 2 → 3...38 → 39 after returning to the normal condition whenever ignition switch OFF → ON.</li> <li>• The number is fixed to 39 until the self-diagnosis results are erased if it is over 39.</li> </ul>

**NOTE:**

\*: Power supply position shifts to "LOCK" from "OFF", when ignition switch is in the OFF position, selector lever is in the P position (A/T models), and any of the following conditions are met.

- Closing door
- Opening door
- Door is locked using door request switch
- Door is locked using Intelligent Key

The power supply position shifts to "ACC" when the push-button ignition switch (push switch) is pushed at "LOCK".

## REAR WINDOW DEFOGGER

### REAR WINDOW DEFOGGER : CONSULT Function (BCM - REAR DEFOGGER) (For Coupe)

INFOID:000000009363309

## DATA MONITOR

**NOTE:**

# DIAGNOSIS SYSTEM (BCM)

[COUPE]

## < SYSTEM DESCRIPTION >

The following table includes information (items) inapplicable to this vehicle. For information (items) applicable to this vehicle, refer to CONSULT display items.

Monitor Item	Description
REAR DEF SW	<ul style="list-style-type: none"><li>Without navigation: Displays "Press (ON)/other (OFF)" status determined with the rear window defogger switch</li><li>With navigation: This is displayed even when it is not equipped</li></ul>
PUSH SW	Indicates [ON/OFF] condition of push switch

## ACTIVE TEST

Test Item	Description
REAR DEFOGGER	Rear window defogger operates when "ON" on CONSULT screen is touched

# POWER SUPPLY AND GROUND CIRCUIT

< DTC/CIRCUIT DIAGNOSIS >

[COUPE]

## DTC/CIRCUIT DIAGNOSIS

### POWER SUPPLY AND GROUND CIRCUIT

#### BCM

#### BCM : Diagnosis Procedure

INFOID:000000009363310

#### 1. CHECK FUSE AND FUSIBLE LINK

Check that the following fuse and fusible link are not blown.

Signal name	Fuse and fusible link No.
Battery power supply	K
	10

#### Is the fuse fusing?

YES >> Replace the blown fuse or fusible link after repairing the affected circuit if a fuse or fusible link is blown.

NO >> GO TO 2.

#### 2. CHECK POWER SUPPLY CIRCUIT

1. Turn ignition switch OFF.
2. Disconnect BCM connectors.
3. Check voltage between BCM harness connector and ground.

Terminals		Voltage (Approx.)
(+)	(-)	
BCM		Ground  Battery voltage
Connector	Terminal	
M118	1	
M119	11	

#### Is the measurement value normal?

YES >> GO TO 3.

NO >> Repair harness or connector.

#### 3. CHECK GROUND CIRCUIT

Check continuity between BCM harness connector and ground.

BCM		Ground	Continuity
Connector	Terminal		
M119	13		Existed

#### Does continuity exist?

YES >> INSPECTION END

NO >> Repair harness or connector.

# REAR WINDOW DEFOGGER SWITCH

< DTC/CIRCUIT DIAGNOSIS >

[COUPE]

## REAR WINDOW DEFOGGER SWITCH WITH NAVIGATION

### WITH NAVIGATION : Description

INFOID:000000009363311

- The rear window defogger and door mirror defogger (with mirror defogger) are operated by turning the rear window defogger switch ON.
- The indicator lamp in the multifunction switch illuminates when the rear window defogger and door mirror defogger (with door mirror defogger) are operating.

### WITH NAVIGATION : Component Function Check

INFOID:000000009363312

#### 1.CHECK FUNCTION

Check that the indicator lamp of rear window defogger illuminates when rear window defogger switch is ON.

Is the inspection result normal?

- YES >> Rear window defogger switch function is OK.  
NO >> Refer to [DEF-14. "WITH NAVIGATION : Diagnosis Procedure"](#).

### WITH NAVIGATION : Diagnosis Procedure

INFOID:000000009363313

#### 1.CHECK MULTIFUNCTION SWITCH (REAR WINDOW DEFOGGER SWITCH)

Check multifunction switch (rear window defogger switch) operate.

Refer to [AV-152. "On Board Diagnosis Function"](#).

Is the inspection result normal?

- YES >> INSPECTION END  
NO >> Repair or replace the malfunctioning parts.

## WITHOUT NAVIGATION

### WITHOUT NAVIGATION : Description

INFOID:000000009363314

- The rear window defogger is operated by turning the rear window defogger switch ON.
- The indicator lamp in the A/C controller illuminates when the rear window defogger is operating.

### WITHOUT NAVIGATION : Component Function Check

INFOID:000000009363315

#### 1.CHECK FUNCTION

Ⓟ With CONSULT

1. Turn ignition switch ON.
2. Select "REAR DEFOGGER" or "BCM" using CONSULT.
3. Select "REAR DEF SW" in "DATA MONITOR" mode.
4. Check that the function operates normally according to the following conditions.

Monitor item	Condition	Status
REAR DEF SW	Rear window defogger switch ON	On
	OFF	Off

Is the inspection result normal?

- YES >> Rear window defogger switch function is OK.  
NO >> Refer to [DEF-14. "WITHOUT NAVIGATION : Diagnosis Procedure"](#).

### WITHOUT NAVIGATION : Diagnosis Procedure

INFOID:000000009363316

#### 1.CHECK A/C CONTROL (REAR WINDOW DEFOGGER SWITCH)

Check A/C control system.

Refer to [HAC-5. "Work Flow"](#).

Is the inspection result normal?

- YES >> GO TO 2.

# REAR WINDOW DEFOGGER SWITCH

[COUPE]

< DTC/CIRCUIT DIAGNOSIS >

NO >> Repair or replace the malfunctioning parts.

## 2. CHECK BCM OUTPUT SIGNAL

1. Turn ignition switch OFF.
2. Disconnect A/C auto amp. connector.
3. Turn ignition switch ON.
4. Check signal between A/C auto amp. harness connector and ground with oscilloscope.

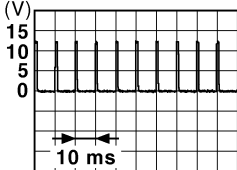
(+)		(-)	Signal (Reference value)
A/C auto amp.			
Connector	Terminal		
M66	27	Ground	 <p style="text-align: right; font-size: small;">JPMA0012GB</p>

Is the inspection result normal?

YES >> Replace A/C auto amp. Refer to [HAC-85. "BASE AUDIO : Removal and Installation"](#) (Base audio) or [HAC-86. "BOSE AUDIO WITHOUT NAVIGATION : Removal and Installation"](#) (BOSE audio without navigation).

NO >> GO TO 3.

## 3. CHECK REAR WINDOW DEFOGGER SWITCH CIRCUIT

1. Turn ignition switch OFF.
2. Disconnect BCM connector.
3. Check continuity between BCM harness connector and A/C auto amp. connector.

BCM		A/C auto amp.		Continuity
Connector	Terminal	Connector	Terminal	
M123	130	M66	27	Existed

4. Check continuity between BCM harness connector and ground.

BCM		Ground	Continuity
Connector	Terminal		
M123	130		Not existed

Is the inspection result normal?

YES >> Replace BCM. Refer to [BCS-106. "Removal and Installation"](#).

NO >> Repair or replace harness.

# REAR WINDOW DEFOGGER RELAY

< DTC/CIRCUIT DIAGNOSIS >

[COUPE]

## REAR WINDOW DEFOGGER RELAY

### Description

INFOID:00000000936317

Power is supplied to the rear window defogger with BCM control.

### Component Function Check

INFOID:00000000936318

#### 1.CHECK FUNCTION

Ⓟ With CONSULT

1. Turn ignition switch ON.
2. Select "REAR DEFOGGER" of "BCM" using CONSULT.
3. Select "REAR DEFOGGER" in "ACTIVE TEST" mode.
4. Touch "ON".
5. Check that the rear window heating wire is getting warmer.

Is the inspection result normal?

- YES >> Rear window defogger relay power supply circuit function is OK.  
 NO >> Refer to [DEF-16. "Diagnosis Procedure"](#).

### Diagnosis Procedure

INFOID:00000000936319

#### 1.CHECK FUSE

1. Turn ignition switch OFF.
2. Check 10A fuse [No.3, located in fuse block (J/B)].

Is the inspection result normal?

- YES >> GO TO 2.  
 NO >> Replace the blown fuse after repairing the affected circuit if a fuse is blown.

#### 2.CHECK REAR WINDOW DEFOGGER RELAY CIRCUIT 1

1. Turn ignition switch ON.
2. Check voltage between BCM harness connector and ground.

(+)		(-)	Condition	Voltage (V) (Approx.)	
BCM					
Connector	Terminal				
M123	151	Ground	Rear window de-fogger switch	ON	0
			OFF	Battery voltage	

Is the inspection result normal?

- YES >> GO TO 6.  
 NO >> GO TO 3.

#### 3.CHECK REAR WINDOW DEFOGGER RELAY CIRCUIT 2

1. Turn ignition switch OFF.
2. Disconnect BCM connector and fuse block (J/B).
3. Check continuity between BCM harness connector and fuse block (J/B) harness connector.

BCM		Fuse block (J/B)		Continuity
Connector	Terminal	Connector	Terminal	
M123	151	M2	4B	Existed

4. Check continuity between BCM harness connector and ground.

BCM		Ground	Continuity
Connector	Terminal		
M123	151		Not existed



# REAR WINDOW DEFOGGER RELAY

[COUPE]

## < DTC/CIRCUIT DIAGNOSIS >

Is the inspection result normal?

- YES >> GO TO 4.
- NO >> Repair or replace harness.

### 4.CHECK REAR WINDOW DEFOGGER RELAY

1. Remove rear window defogger relay,
  2. Check rear window defogger relay.
- Refer to [DEF-17. "Component Inspection"](#).

Is the inspection result normal?

- YES >> GO TO 5.
- NO >> Replace rear window defogger relay.

### 5.CHECK FUSE BLOCK (J/B)

1. Install the rear window defogger relay.
2. Turn ignition switch ON.
3. Check voltage between fuse block (J/B) (fuse block side) and ground.

(+)		(-)	Voltage (V) (Approx.)
Fuse block (J/B)			
Connector	Terminal		
M2	4B	Ground	Battery voltage

Is the inspection result normal?

- YES >> GO TO 6.
- NO >> Repair or replace fuse block (J/B).

### 6.CHECK INTERMITTENT INCIDENT

Check intermittent incident.  
Refer to [GI-45. "Intermittent Incident"](#).

>> INSPECTION END

## Component Inspection

INFOID:000000009363320

### 1.CHECK REAR WINDOW DEFOGGER RELAY

1. Turn ignition switch OFF.
2. Remove rear window defogger relay.
3. Check continuity between rear window defogger relay terminals.

Terminal		Condition	Continuity
Rear window defogger relay			
3	5	12 V direct current supply between terminals 1 and 2	Existed
		No current supply	Not existed

Is the inspection result normal?

- YES >> INSPECTION END
- NO >> Replace rear window defogger relay.

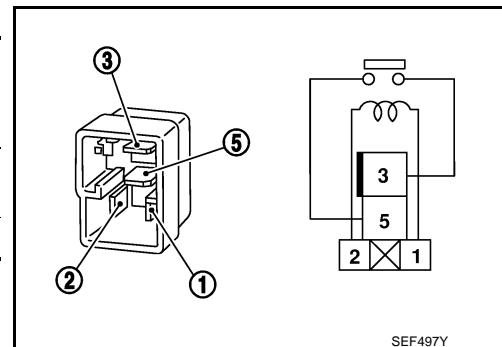

SEF497Y

# REAR WINDOW DEFOGGER

[COUPE]

< DTC/CIRCUIT DIAGNOSIS >

## REAR WINDOW DEFOGGER

### Description

INFOID:000000009363321

Heats the heating wire with the power supply from the rear window defogger relay to prevent the rear window from fogging up.

### Component Function Check

INFOID:000000009363322

#### 1.CHECK REAR WINDOW DEFOGGER

Ⓟ With CONSULT

1. Turn ignition switch ON.
2. Select "REAR DEFOGGER" of "BCM" using CONSULT.
3. Select "REAR DEFOGGER" in "ACTIVE TEST" mode.
4. Touch "ON".
5. Check that the rear window heating wire is getting warmer.

Is the inspection result normal?

- YES >> Rear window defogger is OK.  
 NO >> Refer to [DEF-18, "Diagnosis Procedure"](#).

### Diagnosis Procedure

INFOID:000000009363323

#### 1.CHECK FUSE

1. Turn ignition switch OFF.
2. Check 20A fuse [No.14, No.15, located in fuse block (J/B)].

Is the inspection result normal?

- YES >> GO TO 2.  
 NO >> Replace the blown fuse after repairing the affected circuit if a fuse is blown.

#### 2.CHECK POWER SUPPLY CIRCUIT

1. Turn ignition switch ON.
2. Check voltage between rear window defogger harness connector and ground.

(+)		(-)	Condition	Voltage (V) (Approx.)
Connector	Terminal			
D201	1	Ground	Rear window defogger switch	Battery voltage
			ON	OFF

Is the inspection result normal?

- YES >> GO TO 3.  
 NO >> GO TO 4.

#### 3.CHECK GROUND CIRCUIT

1. Turn ignition switch OFF.
2. Disconnect rear window defogger connector.
3. Check continuity between rear window defogger harness connector and ground.

Rear window defogger		Ground	Continuity
Connector	Terminal		
D107	2		Existed

Is the inspection result normal?

- YES >> GO TO 7.  
 NO >> Repair or replace harness.

#### 4.CHECK REAR WINDOW DEFOGGER CIRCUIT 1

# REAR WINDOW DEFOGGER

[COUPE]

## < DTC/CIRCUIT DIAGNOSIS >

1. Turn ignition switch OFF.
2. Disconnect condenser connector and rear window defogger connector.
3. Check continuity between condenser (condenser side) connector and rear window defogger harness connector.

Condenser		Rear window defogger		Continuity
Connector	Terminal	Connector	Terminal	
D106	1	D201	1	Existed

4. Check continuity between condenser (condenser side) connector and ground.

Condenser		Ground	Continuity
Connector	Terminal		
D106	1		Not existed

Is the inspection result normal?

YES >> GO TO 5.

NO >> Replace condenser. Refer to [DEF-94. "Removal and Installation"](#).

## 5. CHECK REAR WINDOW DEFOGGER CIRCUIT 2

1. Disconnect fuse block (J/B) connector.
2. Check continuity between fuse block (J/B) harness connector and condenser harness connector.

Fuse block (J/B)		Condenser		Continuity
Connector	Terminal	Connector	Terminal	
B6	10G	D106	1	Existed
	11G			

3. Check continuity between fuse block (J/B) harness connector and ground.

Fuse block (J/B)		Ground	Continuity
Connector	Terminal		
B6	10G		Not existed
	11G		

Is the inspection result normal?

YES >> GO TO 6.

NO >> Repair or replace harness.

## 6. CHECK FUSE BLOCK (J/B)

1. Turn ignition switch ON.
2. Check voltage between fuse block (J/B) (fuse block side) and ground.

(+)		(-)	Condition	Voltage (V) (Approx.)	
Fuse block (J/B)					
Connector	Terminal				
B6	10G	Ground	Rear window defogger switch	ON	Battery voltage
			OFF	0	
	11G		ON	Battery voltage	
			OFF	0	

Is the inspection result normal?

YES >> GO TO 8.

NO >> Repair or replace fuse block (J/B).

## 7. CHECK FILAMENT

Check filament.

# REAR WINDOW DEFOGGER

[COUPE]

< DTC/CIRCUIT DIAGNOSIS >

Refer to [DEF-20, "Component Inspection"](#).

Is the inspection result normal?

YES >> GO TO 8.

NO >> Repair or replace filament. Refer to [DEF-92, "Inspection and Repair"](#).

## 8.CHECK INTERMITTENT INCIDENT

Check intermittent incident.

Refer to [GI-45, "Intermittent Incident"](#).

>> INSPECTION END

## Component Inspection

INFOID:000000009363324

## 1.CHECK FILAMENT

Check the filament for damage.

Refer to [DEF-92, "Inspection and Repair"](#).

Is the inspection result normal?

YES >> INSPECTION END

NO >> Repair filament.

# REAR WINDOW DEFOGGER ON SIGNAL

[COUPE]

< DTC/CIRCUIT DIAGNOSIS >

## REAR WINDOW DEFOGGER ON SIGNAL

### Description

INFOID:000000009363325

Turns the indicator lamp in the rear window defogger switch ON when operating the rear window defogger.

### Component Function Check

INFOID:000000009363326

#### 1.CHECK FUNCTION

Check that the indicator lamps of rear window defogger switch are illuminated when turning the rear window defogger switch ON.

Is the inspection result normal?

- YES >> Rear window defogger ON signal function is OK.
- NO >> Refer to [DEF-21. "Diagnosis Procedure"](#).

### Diagnosis Procedure

INFOID:000000009363327

#### 1.CHECK FUSE

1. Turn ignition switch OFF.
2. Check 10A fuse [No.13, located in fuse block (J/B)].

Is the inspection result normal?

- YES >> GO TO 2.
- NO >> Replace the blown fuse after repairing the affected circuit if a fuse is blown.

#### 2.CHECK REAR WINDOW DEFOGGER INDICATOR LAMP ON SIGNAL

1. Turn ignition switch ON.
2. Check voltage between A/C auto amp. harness connector ground.

(+)		(-)	Condition	Voltage (V) (Approx.)
A/C auto amp.				
Connector	Terminal			
M66	26	Ground	Rear window defogger switch	ON OFF
			Battery voltage 0	

Is the inspection result normal?

- YES >> Replace A/C auto amp. Refer to [HAC-85. "BASE AUDIO : Removal and Installation"](#) (base audio) or [HAC-86. "BOSE AUDIO WITHOUT NAVIGATION : Removal and Installation"](#) (Bose audio without navigation).
- NO >> GO TO 3.

#### 3.CHECK REAR WINDOW DEFOGGER INDICATOR LAMP CIRCUIT

1. Turn ignition switch OFF.
2. Disconnect fuse block (J/B) connector and A/C auto amp. connector.
3. Check continuity between fuse block (J/B) harness connector and A/C auto amp. harness connector.

Fuse block (J/B)		A/C auto amp.		Continuity
Connector	Terminal	Connector	Terminal	
M3	9C	M66	26	Existed

4. Check continuity between fuse block (J/B) harness connector and ground.

Fuse block (J/B)		Ground	Continuity
Connector	Terminal		
M3	9C		Not existed

Is the inspection result normal?

- YES >> Repair or replace fuse block (J/B).

## REAR WINDOW DEFOGGER ON SIGNAL

< DTC/CIRCUIT DIAGNOSIS >

[COUPE]

---

NO >> Repair or replace harness.

# DOOR MIRROR DEFOGGER

[COUPE]

< DTC/CIRCUIT DIAGNOSIS >

## DOOR MIRROR DEFOGGER

### Description

INFOID:000000009363328

Heats the heating wire with the power supply from the rear window defogger relay to prevent the door mirror from fogging up.

### Component Function Check

INFOID:000000009363329

#### 1.CHECK DOOR MIRROR DEFOGGER

Ⓜ With CONSULT

1. Turn ignition switch ON.
2. Select "REAR DEFOGGER" of "BCM" using CONSULT.
3. Select "REAR DEFOGGER" in "ACTIVE TEST" mode.
4. Touch "ON".
5. Check that both side door mirror glass is getting warmer.

Is the inspection result normal?

- YES >> Door mirror defogger is OK.  
 NO >> Refer to [DEF-23, "Diagnosis Procedure"](#).

### Diagnosis Procedure

INFOID:000000009363330

#### 1.CHECK FUSE

1. Turn ignition switch OFF.
2. Check 10A fuse [No.13, located in fuse block (J/B)].

Is the inspection result normal?

- YES >> GO TO 2.  
 NO >> Replace the blown fuse after repairing the affected circuit if a fuse is blown.

#### 2.CHECK POWER SUPPLY CIRCUIT

1. Disconnect fuse block (J/B) connector.
2. Turn ignition switch ON.
3. Check voltage between fuse block (J/B) connector and ground.

(+)		(-)	Condition	Voltage (V) (Approx.)	
Fuse block (J/B)					
Connector	Terminal				
M3	9C	Ground	Rear window defogger switch	ON	Battery voltage
			OFF	0	
	10C		Rear window defogger switch	ON	Battery voltage
			OFF	0	

Is the inspection result normal?

- YES >> GO TO 3.  
 NO >> Replace fuse block (J/B).

#### 3.CHECK INTERMITTENT INCIDENT

Check intermittent incident.  
 Refer to [GI-45, "Intermittent Incident"](#).

>> INSPECTION END

A  
B  
C  
D  
E  
F  
G  
H  
I  
J  
K  
M  
N  
O  
P

DEF

# DRIVER SIDE DOOR MIRROR DEFOGGER

< DTC/CIRCUIT DIAGNOSIS >

[COUPE]

## DRIVER SIDE DOOR MIRROR DEFOGGER

### Description

INFOID:00000000936331

Heats the heating wire with the power supply from the rear window defogger relay to prevent the door mirror from fogging up.

### Component Function Check

INFOID:00000000936332

#### 1.CHECK DRIVER SIDE DOOR MIRROR DEFOGGER

1. Perform Active Test ("REAR DEFOGGER") with CONSULT.
2. Touch "ON".
3. Check that the driver side door mirror glass is getting warmer.

Is the inspection result normal?

- YES >> Driver side door mirror defogger is OK.  
NO >> Refer to [DEF-24, "Diagnosis Procedure"](#).

### Diagnosis Procedure

INFOID:00000000936333

#### 1.CHECK POWER SUPPLY CIRCUIT

1. Turn ignition switch OFF.
2. Disconnect door mirror (driver side) connector.
3. Turn ignition switch ON.
4. Check voltage between door mirror (driver side) harness connector and ground.

(+)		(-)	Condition	Voltage (V) (Approx.)	
Connector	Terminal				
D3	4	Ground	Rear window defogger switch	ON OFF	Battery voltage 0

Is the inspection result normal?

- YES >> GO TO 3.  
NO >> GO TO 2.

#### 2.CHECK DRIVER SIDE DOOR MIRROR DEFOGGER CIRCUIT

1. Turn ignition switch OFF.
2. Check continuity between fuse block (J/B) harness connector and door mirror (driver side) harness connector.

Fuse block (J/B)		Door mirror (driver side)		Continuity
Connector	Terminal	Connector	Terminal	
M3	10C	D3	4	Existed

3. Check continuity between fuse block (J/B) harness connector and ground.

Fuse block (J/B)		Ground	Continuity
Connector	Terminal		
M3	10C		Not existed

Is the inspection result normal?

- YES >> GO TO 4.  
NO >> Repair or replace harness.

#### 3.CHECK GROUND CIRCUIT

1. Turn ignition switch OFF.
2. Check continuity between door mirror (driver side) harness connector and ground.



# DRIVER SIDE DOOR MIRROR DEFOGGER

< DTC/CIRCUIT DIAGNOSIS >

[COUPE]

Door mirror (driver side)		Ground	Continuity
Connector	Terminal		Existed
D3	8		

Is the inspection result normal?

YES >> Replace door mirror glass (driver side). Refer to [GW-19, "Removal and Installation"](#).

NO >> Repair or replace harness.

## 4.CHECK INTERMITTENT INCIDENT

Check intermittent incident.

Refer to [GI-45, "Intermittent Incident"](#).

Is the inspection result normal?

>> INSPECTION END

A  
B  
C  
D  
E  
F  
G  
H  
I  
J  
K  
DEF  
M  
N  
O  
P

DEF

# PASSENGER SIDE DOOR MIRROR DEFOGGER

[COUPE]

< DTC/CIRCUIT DIAGNOSIS >

## PASSENGER SIDE DOOR MIRROR DEFOGGER

### Description

INFOID:000000009363334

Heats the heating wire with the power supply from the rear window defogger relay to prevent the door mirror from fogging up.

### Component Function Check

INFOID:000000009363335

#### 1.CHECK PASSENGER SIDE DOOR MIRROR DEFOGGER

1. Perform Active Test ("REAR DEFOGGER") with CONSULT.
2. Touch "ON".
3. Check that the passenger side door mirror glass is getting warmer.

Is the inspection result normal?

- YES >> Passenger side door mirror defogger is OK.  
NO >> Refer to [DEF-26, "Diagnosis Procedure"](#).

### Diagnosis Procedure

INFOID:000000009363336

#### 1.CHECK POWER SUPPLY CIRCUIT

1. Turn ignition switch OFF.
2. Disconnect door mirror (passenger side) connector.
3. Turn ignition switch ON.
4. Check voltage between door mirror (passenger side) harness connector and ground.

(+)		(-)	Condition		Voltage (V) (Approx.)
Door mirror (passenger side) Connector	Terminal				
D33	4	Ground	Rear window defogger switch	ON	Battery voltage
				OFF	0

Is the inspection result normal?

- YES >> GO TO 3.  
NO >> GO TO 2.

#### 2.CHECK PASSENGER SIDE DOOR MIRROR DEFOGGER CIRCUIT

1. Turn ignition switch OFF.
2. Check continuity between fuse block (J/B) harness connector and door mirror (passenger side) harness connector.

Fuse block (J/B)		Door mirror (passenger side)		Continuity
Connector	Terminal	Connector	Terminal	
M3	9C	D33	4	Existed

3. Check continuity between fuse block (J/B) harness connector and ground.

Fuse block (J/B)		Ground	Continuity
Connector	Terminal		
M3	9C		Not existed

Is the inspection result normal?

- YES >> GO TO 4.  
NO >> Repair or replace harness.

#### 3.CHECK GROUND CIRCUIT

1. Turn ignition switch OFF.
2. Check continuity between door mirror (passenger side) harness connector and ground.

# PASSENGER SIDE DOOR MIRROR DEFOGGER

< DTC/CIRCUIT DIAGNOSIS >

[COUPE]

Door mirror (passenger side)		Ground	Continuity
Connector	Terminal		Existed
D33	8		

Is the inspection result normal?

YES >> Replace door mirror glass (passenger side). Refer to [GW-19, "Removal and Installation"](#).

NO >> Repair or replace harness.

## 4. CHECK INTERMITTENT INCIDENT

Check intermittent incident.

Refer to [GI-45, "Intermittent Incident"](#).

>> INSPECTION END

A  
B  
C  
D  
E  
F  
G  
H  
I  
J  
K  
DEF  
M  
N  
O  
P

DEF

# REAR WINDOW DEFOGGER SYSTEM

< DTC/CIRCUIT DIAGNOSIS >

[COUPE]

## REAR WINDOW DEFOGGER SYSTEM

### Wiring Diagram - DEFOGGER (WITH NAVI) -

INFOID:000000009363337

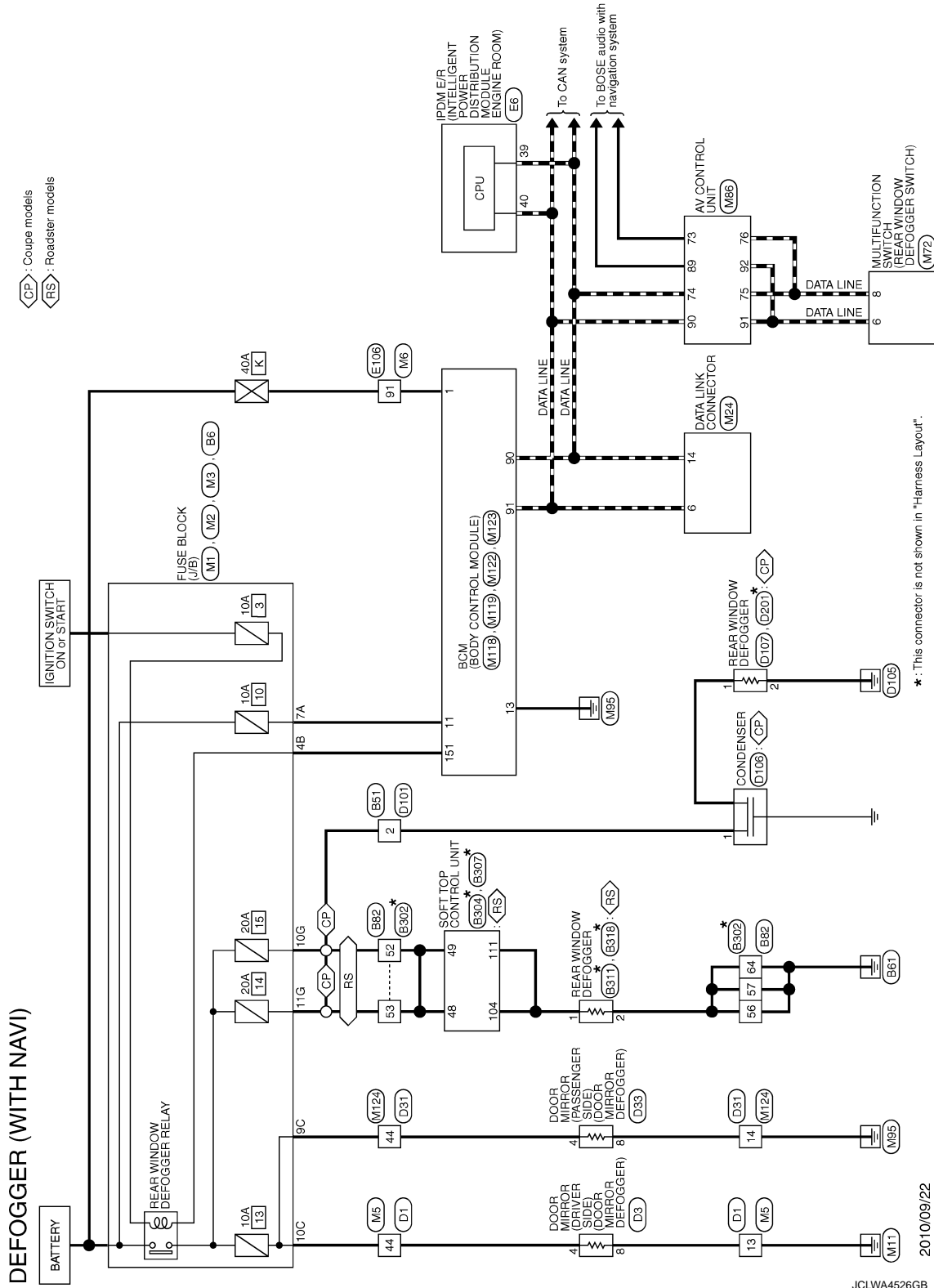

JCLWA4526GB

2010/09/22

# REAR WINDOW DEFOGGER SYSTEM

< DTC/CIRCUIT DIAGNOSIS >

[COUPE]

## DEFOGGER (WITH NAVI)

Connector No.	B8
Connector Name	FUSE BLOCK (J/B)
Connector Type	NS1ZFR-CS



Terminal No.	Color of Wire	Signal Name [Specification]
5G	LG	-
10G	W	- [Coupe models]
10G	P	- [Roadster models]
11G	W	- [Coupe models]
11G	G	- [Roadster models]
12G	Y	-

Connector No.	B51
Connector Name	WIRE TO WIRE
Connector Type	M04MY-LC



Terminal No.	Color of Wire	Signal Name [Specification]
2	Y	-
4	B	-

Connector No.	B82
Connector Name	WIRE TO WIRE
Connector Type	NS18FR-CS



Terminal No.	Color of Wire	Signal Name [Specification]
52	P	-
53	G	-
55	R	-
56	B	-
57	B	-
58	Y	-
59	B	-
60	LG	-
61	L	-
62	L	-
63	L	-
64	B	-
65	Y	-
66	Y	-

Connector No.	B302
Connector Name	WIRE TO WIRE
Connector Type	NS16MW-CS



Terminal No.	Color of Wire	Signal Name [Specification]
52	R	-
53	R	-
55	V	-
56	B	-
57	B	-
58	SB	-
59	DG	-
60	DG	-
62	R	-
63	R	-
64	B	-
65	R	-
66	R	-

Connector No.	B304
Connector Name	SOFT TOP CONTROL UNIT
Connector Type	NS12FW-CS



Terminal No.	Color of Wire	Signal Name [Specification]
41	DG	TRUNK OPENER ACTUATOR
48	R	REAR WINDOW DEF IN 2
49	R	REAR WINDOW DEF IN 1

Connector No.	B307
Connector Name	SOFT TOP CONTROL UNIT
Connector Type	NS18FW-CS



Terminal No.	Color of Wire	Signal Name [Specification]
96	W	SWITCHING VALVE 4
97	LG	SWITCHING VALVE 3
98	L	SWITCHING VALVE 2
99	D	SWITCHING VALVE 1
100	BR	HYDRAULIC PUMP RELAY 2 +
101	SB	HYDRAULIC PUMP RELAY 1 +
102	P	SWITCHING VALVE 5
103	B	HYDRAULIC UNIT GND
104	R	REAR WINDOW DEF OUT 2
111	R	REAR WINDOW DEF OUT 1

Connector No.	B311
Connector Name	REAR WINDOW DEFOGGER
Connector Type	-



Terminal No.	Color of Wire	Signal Name [Specification]
1	-	-

Connector No.	B318
Connector Name	REAR WINDOW DEFOGGER
Connector Type	-



Terminal No.	Color of Wire	Signal Name [Specification]
2	-	-

A  
B  
C  
D  
E  
F  
G  
H  
I  
J  
K  
DEF  
M  
N  
O  
P

# REAR WINDOW DEFOGGER SYSTEM

< DTC/CIRCUIT DIAGNOSIS >

[COUPE]

## DEFOGGER (WITH NAVI)

Connector No.	D1
Connector Name	WIRE TO WIRE
Connector Type	TH40FW-CS15



Terminal No.	Color of Wire	Signal Name (Specification)
7	Y	-
8	Y	-
9	G	-
10	BG	-
11	P	- [With BOSE system] - [Without BOSE system]
12	L	-
13	B	-
14	SB	- [Coupe models] - [Roadster models]
15	W	-
19	Y	-
23	Y/B	-
25	R	-
26	SHIELD	-
35	G	-
44	L	-
47	B	-
48	SB	-
49	W	-
50	LG	-
51	R	-
52	V	-
53	BG	-
54	GR	-
55	G	-

Connector No.	D3
Connector Name	DOOR MIRROR (DRIVER SIDE)
Connector Type	TH88MW-NH



Terminal No.	Color of Wire	Signal Name (Specification)
1	BR	-
2	L	-
3	Y	-
4	L	-
8	B	-

Connector No.	D31
Connector Name	WIRE TO WIRE
Connector Type	TH40FW-CS15



Terminal No.	Color of Wire	Signal Name (Specification)
10	V	-
11	LG	-
12	P	- [With BOSE system] - [Without BOSE system]
13	V	- [Coupe models without BOSE system] - [Except for coupe models without BOSE system]
14	B	-
15	W	-
19	Y	-
23	Y/B	-
25	R	-
26	SHIELD	-
35	G	-
44	L	-
50	Y	-
51	R	-
52	V	-
53	BG	-
54	GR	-
55	G	-

33	BG	-
34	GR	-
35	L	-

Connector No.	D33
Connector Name	DOOR MIRROR (PASSENGER SIDE)
Connector Type	TH88MW-NH



Terminal No.	Color of Wire	Signal Name (Specification)
1	BG	-
2	GR	-
3	L	-
4	L	-
8	B	-

Connector No.	D101
Connector Name	WIRE TO WIRE
Connector Type	M04FW-LC



Terminal No.	Color of Wire	Signal Name (Specification)
2	Y	-
4	B	-

Connector No.	D106
Connector Name	CONDENSER
Connector Type	M01FW-LC



Terminal No.	Color of Wire	Signal Name (Specification)
1	Y	-

Connector No.	D107
Connector Name	REAR WINDOW DEFOGGER
Connector Type	P01FB-A



Terminal No.	Color of Wire	Signal Name (Specification)
2	B	-

Connector No.	D201
Connector Name	REAR WINDOW DEFOGGER
Connector Type	P01FB-A



Terminal No.	Color of Wire	Signal Name (Specification)
1	B	-

JRLWC4811GB

# REAR WINDOW DEFOGGER SYSTEM

< DTC/CIRCUIT DIAGNOSIS >

[COUPE]

## DEFOGGER (WITH NAVI)

Connector No.	E108
Connector Name	POWER INTELLIGENT POWER DISTRIBUTION MODULE (PDRM) (HORN)
Connector Type	TH886FW-NH



Terminal No.	Color of Wire	Signal Name (Specification)
39	P	-
40	L	-
41	B/W	-
42	Y	-
43	SB	-
44	W	-
45	G	-
46	V	-

Connector No.	E108
Connector Name	WIRE TO WIRE
Connector Type	TH886FW-CS16-TM4

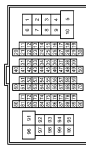

Terminal No.	Color of Wire	Signal Name (Specification)
1	Y	-
3	L	-
4	L	-
7	B	-
8	P	-
9	E	-
11	V	-
12	R	-
13	L	-
14	GR	-
15	P	-
16	W	-
17	SB	-
20	LG	-

21	BR	- [Coupe models] - [Roadster models]
21	G	-
31	L	-
32	Y	-
36	Y	-
37	V	-
38	R	-
39	B	-
40	W	-
41	LG	-
42	SB	-
43	G	-
44	GR	- [Except for roadster models with M/T] - [Roadster models with M/T]
44	R	-
45	BG	-
46	W	-
47	P	-
58	SHIELD	-
59	L	-
70	P	-
80	W	-
81	P	-
82	G	-
83	V	-
84	L	-
85	BG	-
86	LG	-
87	R	-
89	P	-
91	W	-
92	L	-
93	G	-
94	Y	-
96	Y	-
97	BR	-
98	GR	-
99	LG	-
100	BG	-

Connector No.	M1
Connector Name	FUSE BLOCK (J/B)
Connector Type	NS08FW-M2



Terminal No.	Color of Wire	Signal Name (Specification)
1A	V	-
2A	G	-
3A	L	-
4A	P	-
5A	L	-
6A	Y	-
7A	BR	-
8A	L	-

Connector No.	M2
Connector Name	FUSE BLOCK (J/B)
Connector Type	NS10FW-CS

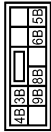

Terminal No.	Color of Wire	Signal Name (Specification)
3B	P	-
4B	G	-
5B	O	-
6B	Y	-
8B	R	-
9B	SB	-

Connector No.	M3
Connector Name	FUSE BLOCK (J/B)
Connector Type	NS12FW-CS



Terminal No.	Color of Wire	Signal Name (Specification)
8C	R	-
9C	B	-
9C	O	-
10C	L	-

11C	LG
12C	O

Connector No.	M5
Connector Name	WIRE TO WIRE
Connector Type	TH40MW-CS15

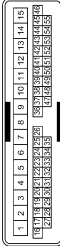

Terminal No.	Color of Wire	Signal Name (Specification)
7	Y	-
8	Y	-
9	G	-
10	V	-
11	V	-
12	L	-
13	B	-
14	Y	-
15	W	-
19	Y	-
23	Y/B	-
25	Y	-
26	SHIELD	-
35	BR	-
44	L	-
47	B	-
48	SB	-
49	Y	-
50	W	-
51	R	-
52	L	-
53	W	-
54	C	-
55	R	-

A  
B  
C  
D  
E  
F  
G  
H  
I  
J  
K  
DEF  
M  
N  
O  
P

# REAR WINDOW DEFOGGER SYSTEM

< DTC/CIRCUIT DIAGNOSIS >

[COUPE]

## DEFOGGER (WITH NAVI)

Connector No.	M6
Connector Name	WIRES TO WIRE
Connector Type	TH38MM-CST6-TM4



Terminal No.	Color of Wire	Signal Name (Specification)
1	Y	-
3	L	-
4	L	-
7	B	-
8	P	-
9	B	-
11	GR	-
12	R	-
13	L	-
14	G	-
15	P	-
16	W	-
17	BR	-
20	GR	-
21	R	-
31	BR	-
32	V	-
36	SB	-
37	Y	-
38	LG	-
39	SB	-
40	W	-
41	LG	-
42	R	-
43	G	-
44	G	-
44	R	- [With A/T] - [With M/T]
45	O	-
46	G	-
47	BR	-
58	SHIELD	-
59	-	-
70	R	-
80	LG	-
81	GR	-
82	V	-
83	V	-
84	L	-

85	BR	-
86	Y	-
87	G	-
89	P	-
91	W	-
92	P	-
93	P	-
94	Y	-
96	P	-
97	GR	-
98	O	-
99	W	-
100	R	-

Connector No.	M24
Connector Name	DATA LINK CONNECTOR
Connector Type	BD18FW

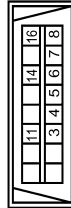

Terminal No.	Color of Wire	Signal Name (Specification)
3	LG	- [Coupe models] - [Reader models]
4	B	-
5	B	-
6	L	-
7	Y	-
8	G	-
11	LG	- [Coupe models] - [Reader models]
14	P	-
16	Y	-

Connector No.	M72
Connector Name	MULTIFUNCTION SWITCH
Connector Type	TH18FW-NH

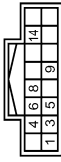

Terminal No.	Color of Wire	Signal Name (Specification)
1	B	GROUND
3	L	ACC
4	R	ILL
5	W	ILL CONT
6	LG	AV COMM (H) [Coupe models] AV COMM (H) [Reader models]
8	Y	AV COMM (L) [Coupe models] AV COMM (L) [Reader models]
9	BR	SW GND
14	SB	DISK EJECT SIGNAL

Connector No.	M86
Connector Name	AV CONTROL UNIT
Connector Type	TH32FW-NH



Terminal No.	Color of Wire	Signal Name (Specification)
65	O	PARKING BRAKE SIGNAL
67	L	COMPOSITE IMAGE GND
68	G	COMPOSITE IMAGE SIGNAL
71	SHIELD	MICROPHONE GND
72	R	MICROPHONE VCC
74	D	COMM (CONT->DISP)
74	D	COMM (CONT->DISP)
75	LG	AV COMM (L) [Coupe models] AV COMM (L) [Reader models]
75	V	AV COMM (L) [Coupe models] AV COMM (L) [Reader models]
76	LG	AV COMM (L) [Coupe models] AV COMM (L) [Reader models]
76	V	AV COMM (L) [Coupe models] AV COMM (L) [Reader models]
79	R	ILL*

80	G	IGNITION SIGNAL
81	O	REVERSE SIGNAL
82	Y	VEHICLE SPEED SIGNAL (8-PULSE)
83	B	SHIELD
84	Y	-
87	G	MICROPHONE SIGNAL
89	R	COMM (DISP->CONT)
90	L	COMM (DISP->CONT)
91	Y	AV COMM (H) [Coupe models] AV COMM (H) [Reader models]
91	LG	AV COMM (H) [Coupe models] AV COMM (H) [Reader models]
92	Y	AV COMM (H) [Coupe models] AV COMM (H) [Reader models]
92	LG	AV COMM (H) [Coupe models] AV COMM (H) [Reader models]

Connector No.	M118
Connector Name	BCM (BODY CONTROL MODULE)
Connector Type	M03FB-4C



Terminal No.	Color of Wire	Signal Name (Specification)
1	W	BAT (E/L)
2	W	POWER WINDOW POWER SUPPLY (BAT)
3	Y	POWER WINDOW POWER SUPPLY (IGN)



# REAR WINDOW DEFOGGER SYSTEM

< DTC/CIRCUIT DIAGNOSIS >

[COUPE]

## DEFOGGER (WITH NAVI)

Connector No.	M119
Connector Name	BOM (BODY CONTROL MODULE)
Connector Type	INS18FV-CS



4	5	11	13	14	18	19
---	---	----	----	----	----	----

Terminal No.	Color of Wire	Signal Name (Specification)
4	R	INTERIOR ROOM LAMP POWER SUPPLY
5	G	PASSENGER DOOR UNLOCK OUTPUT
8	V	ALL DOOR FUEL LID LOCK OUTPUT
9	G	DRIVER DOOR FUEL LID UNLOCK OUTPUT
11	BR	BAT (FUSE)
13	B	GROUND
14	R	PUSH-BUTTON IGNITION SW ILL GND
15	Y	ACC IND
17	W	TURN SIGNAL RH (FRONT, SIDE)
18	O	TURN SIGNAL LH (FRONT, SIDE)
19	P	ROOM LAMP TIMER CONTROL

Connector No.	M122
Connector Name	BOM (BODY CONTROL MODULE)
Connector Type	TH40FF-NH



10	11	12	13	14	15	16	17	18	19
----	----	----	----	----	----	----	----	----	----

Terminal No.	Color of Wire	Signal Name (Specification)
72	L	ROOM ANT 2-
73	P	ROOM ANT 2+
74	SB	PASSENGER DOOR ANT-
75	BR	PASSENGER DOOR ANT+
76	V	DRIVER DOOR ANT-
77	LG	DRIVER DOOR ANT+
78	L	ROOM ANT 1-
79	R	ROOM ANT 1+
80	GR	MATS ANT AMP
81	W	MATS ANT AMP
82	R	IGN RELAY (P/B) CONT

83	GR	KYLS ENT RECEIVER (FRONT) COMM
87	BR	COMBI SW INPUT 5
88	V	COMBI SW INPUT 3
90	P	CAN-L
91	L	CAN-H
92	LG	KEY SLOT ILL
93	V	ON IND
95	O	ACC RELAY CONT
96	Y	A/T SHIFT SELECTOR POWER SUPPLY
99	R	SHIFT P/CLUTCH PEDAL POS SW
100	GR	PASSENGER DOOR REQUEST SW
101	Y	DRIVER DOOR REQUEST SW
102	O	BLOWER FAN MOTOR RELAY CONT
103	LG	KYLS ENT RECEIVER (FRONT) PMR SUPPLY
107	LG	COMBI SW INPUT 1
108	R	COMBI SW INPUT 4
109	Y	COMBI SW INPUT 2
110	P	HAZARD SW

Connector No.	M123
Connector Name	BOM (BODY CONTROL MODULE)
Connector Type	TH40FG-NH



10	11	12	13	14	15	16	17	18	19
----	----	----	----	----	----	----	----	----	----

Terminal No.	Color of Wire	Signal Name (Specification)
113	O	OPTICAL SENSOR
114	R	CLUTCH INTERLOCK SW
115	O	-
116	SB	STOP LAMP SW 1
118	P	STOP LAMP SW 2
119	SB	DR DOOR UNLOCK SENSOR
121	R	KEY SLOT SW
123	W	IGN F/2B
124	LG	PASSENGER DOOR SW
126	O	TRUNK LID OPENER CANCEL SW
129	L	REL DEFROGGER SW
132	V	P/B SW & SEAT TO LOCK (Master model)
133	G	POWER WINDOW SW COMM (Cruise model)
134	GR	PUSH BUTTON IGNITION SW ILL POWER LOCK IND
137	P	RECEIVER SENSOR GND
138	V	RECEIVER & SENSOR POWER SUPPLY
139	L	THE PRESS RECEV COMM

140	G	P/N POSITION
141	Y	SECURITY INDICATOR
142	O	COMBI SW OUTPUT 5
143	P	COMBI SW OUTPUT 1
144	G	COMBI SW OUTPUT 2
145	L	COMBI SW OUTPUT 3
146	SB	COMBI SW OUTPUT 4
150	GR	DRIVER DOOR SW
151	G	REAR WINDOW DEFOGGER RELAY CONT

Connector No.	M124
Connector Name	WIRE TO WIRE
Connector Type	TH40MW-CS15



1	2	3	4	5	6	7	8	9	10	11	12	13	14	15
---	---	---	---	---	---	---	---	---	----	----	----	----	----	----

Terminal No.	Color of Wire	Signal Name (Specification)
10	G	-
11	V	-
12	LG	-
13	V	-
14	B	-
15	W	-
19	Y	-
23	Y/B	-
25	W	-
26	SHIELD	-
35	B	-
44	O	-
50	Y	-
51	Y	-
52	GR	-
53	W	-
54	G	-
55	R	-

A  
B  
C  
D  
E  
F  
G  
H  
I  
J  
K  
M  
N  
O  
P

DEF

JRLWC4814GB

# REAR WINDOW DEFOGGER SYSTEM

< DTC/CIRCUIT DIAGNOSIS >

[COUPE]

## Wiring Diagram - DEFOGGER (WITHOUT NAVI) -

INFOID:00000009363338

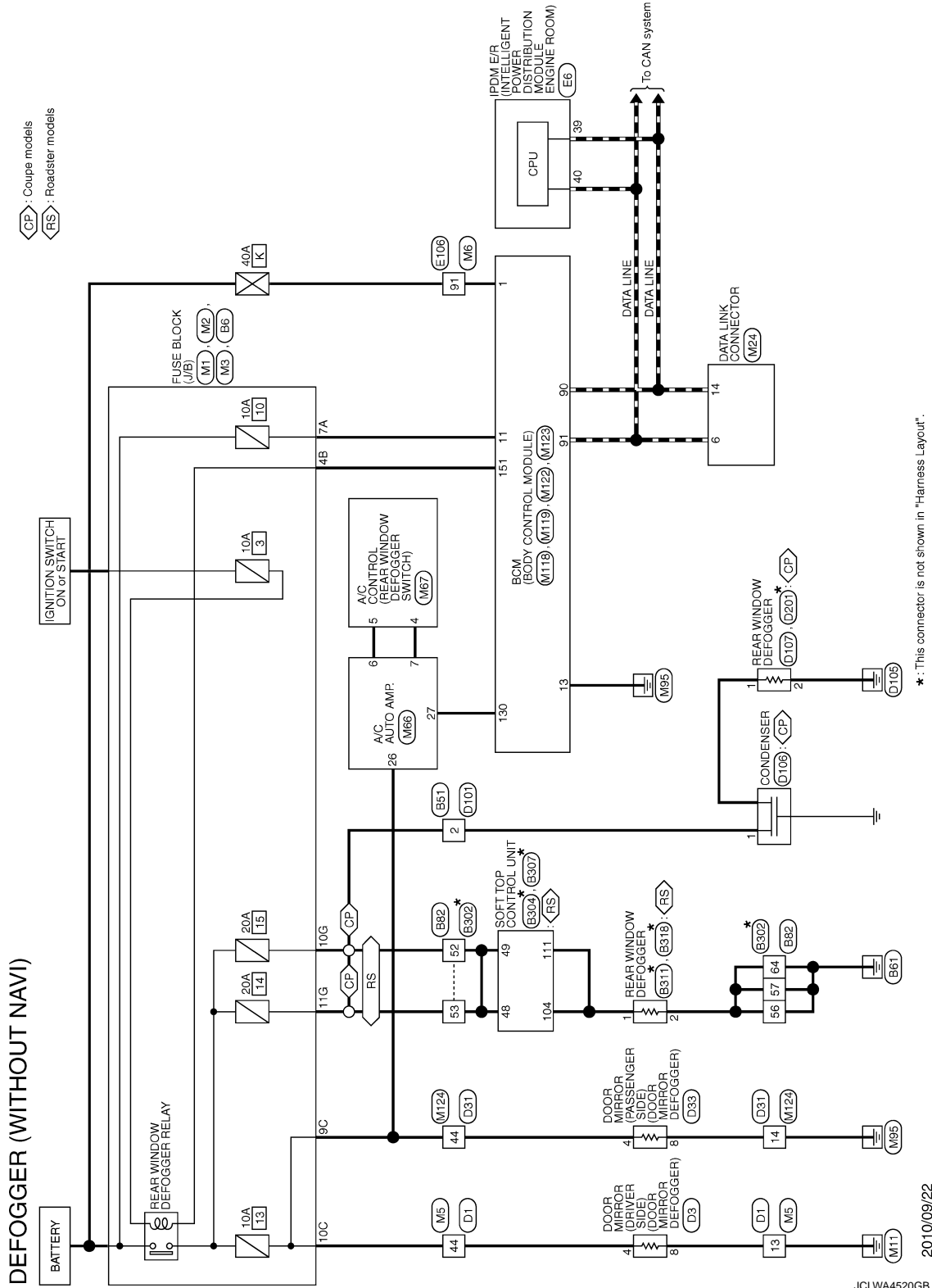

# REAR WINDOW DEFOGGER SYSTEM

< DTC/CIRCUIT DIAGNOSIS >

[COUPE]

## DEFOGGER (WITHOUT NAVI)

Connector No.	B8
Connector Name	FUSE BLOCK (J/B)
Connector Type	NS1ZFR-CS



Terminal No.	Color of Wire	Signal Name (Specification)
5G	LG	-
10G	W	- [Coupe models]
10G	P	- [Roadster models]
11G	W	- [Coupe models]
11G	G	- [Roadster models]
12G	Y	-

Connector No.	B51
Connector Name	WIRE TO WIRE
Connector Type	M04MY-LC



Terminal No.	Color of Wire	Signal Name (Specification)
2	Y	-
4	B	-

Connector No.	B82
Connector Name	WIRE TO WIRE
Connector Type	NS18FF-CS



Terminal No.	Color of Wire	Signal Name (Specification)
52	P	-
53	G	-
55	R	-
56	B	-
57	B	-
58	Y	-
59	B	-
60	LG	-
61	L	-
62	L	-
63	L	-
64	B	-
65	Y	-
66	Y	-

Connector No.	B302
Connector Name	WIRE TO WIRE
Connector Type	NS16MW-CS



Terminal No.	Color of Wire	Signal Name (Specification)
52	R	-
53	R	-
55	V	-
56	B	-
57	B	-
58	SB	-
59	DG	-
60	DG	-
62	R	-
63	R	-
64	B	-
66	R	-

Connector No.	B304
Connector Name	SOFT TOP CONTROL UNIT
Connector Type	NS12FW-CS



Terminal No.	Color of Wire	Signal Name (Specification)
41	DG	TRUNK OPENER ACTUATOR
48	R	REAR WINDOW DEF IN 2
49	R	REAR WINDOW DEF IN 1

Connector No.	B307
Connector Name	SOFT TOP CONTROL UNIT
Connector Type	NS18FW-CS



Terminal No.	Color of Wire	Signal Name (Specification)
96	W	SWITCHING VALVE 4
97	LG	SWITCHING VALVE 3
98	L	SWITCHING VALVE 2
99	D	SWITCHING VALVE 1
100	BR	HYDRAULIC PUMP RELAY 2 +
101	SB	HYDRAULIC PUMP RELAY 1 +
102	P	SWITCHING VALVE 5
103	B	HYDRAULIC UNIT GND
104	R	REAR WINDOW DEF OUT 2
111	R	REAR WINDOW DEF OUT 1

Connector No.	B311
Connector Name	REAR WINDOW DEFOGGER
Connector Type	-



Terminal No.	Color of Wire	Signal Name (Specification)
1	-	-

Connector No.	B318
Connector Name	REAR WINDOW DEFOGGER
Connector Type	-



Terminal No.	Color of Wire	Signal Name (Specification)
2	-	-

A  
B  
C  
D  
E  
F  
G  
H  
I  
J  
K  
DEF  
M  
N  
O  
P

# REAR WINDOW DEFOGGER SYSTEM

< DTC/CIRCUIT DIAGNOSIS >

[COUPE]

## DEFOGGER (WITHOUT NAVI)

Connector No.	D1
Connector Name	WIRE TO WIRE
Connector Type	TH40FW-CS15

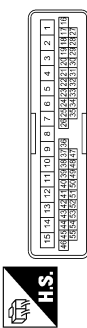

Terminal No.	Color of Wire	Signal Name (Specification)
7	Y	-
8	Y	-
9	G	-
10	BG	-
11	P	- [With BOSE system] - [Without BOSE system]
12	L	-
13	B	-
14	SB	- [Coupe models] - [Roadster models]
15	W	-
19	Y	-
23	Y/B	-
25	R	-
26	SHIELD	-
35	G	-
44	L	-
47	B	-
48	SB	-
49	W	-
50	LG	-
51	R	-
52	V	-
53	BG	-
54	GR	-
55	G	-

Connector No.	D3
Connector Name	DOOR MIRROR (DRIVER SIDE)
Connector Type	TH88MW-NH



Terminal No.	Color of Wire	Signal Name (Specification)
1	BR	-
2	L	-
3	Y	-
4	L	-
8	B	-

Connector No.	D31
Connector Name	WIRE TO WIRE
Connector Type	TH40FW-CS15



Terminal No.	Color of Wire	Signal Name (Specification)
10	V	-
11	LG	-
12	P	- [With BOSE system] - [Without BOSE system]
13	V	- [Coupe models without BOSE system] - [Except for coupe models without BOSE system]
14	B	-
15	W	-
19	Y	-
23	Y/B	-
25	R	-
26	SHIELD	-
35	G	-
44	L	-
50	LG	-
51	R	-
52	V	-
53	BG	-
54	GR	-
55	G	-

33	BG	-
34	GR	-
35	L	-

Connector No.	D33
Connector Name	DOOR MIRROR (PASSENGER SIDE)
Connector Type	TH88MW-NH



Terminal No.	Color of Wire	Signal Name (Specification)
1	BG	-
2	GR	-
3	L	-
4	L	-
8	B	-

Connector No.	D101
Connector Name	WIRE TO WIRE
Connector Type	M04FW-LC



Terminal No.	Color of Wire	Signal Name (Specification)
2	Y	-
4	B	-

Connector No.	D106
Connector Name	CONDENSER
Connector Type	M01FW-LC



Terminal No.	Color of Wire	Signal Name (Specification)
1	Y	-

Connector No.	D107
Connector Name	REAR WINDOW DEFOGGER
Connector Type	P01FB-A



Terminal No.	Color of Wire	Signal Name (Specification)
2	B	-

Connector No.	D201
Connector Name	REAR WINDOW DEFOGGER
Connector Type	P01FB-A



Terminal No.	Color of Wire	Signal Name (Specification)
1	B	-

JRLWC4806GB

# REAR WINDOW DEFOGGER SYSTEM

< DTC/CIRCUIT DIAGNOSIS >

[COUPE]

## DEFOGGER (WITHOUT NAVI)

Connector No.	E106
Color of Wire	WIRE TO WIRE
Connector Name	TH880FW-CS16-TM4
Connector Type	TH880FW-NH

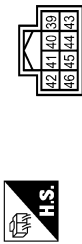

Terminal No.	Color of Wire	Signal Name (Specification)
39	P	-
40	L	-
41	B/W	-
42	Y	-
43	SB	-
44	W	-
45	G	-
46	V	-

Connector No.	E106
Color of Wire	WIRE TO WIRE
Connector Name	TH880FW-CS16-TM4
Connector Type	TH880FW-NH

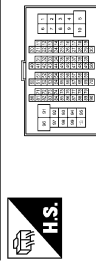

Terminal No.	Color of Wire	Signal Name (Specification)
1	Y	-
3	L	-
4	L	-
7	B	-
8	P	-
9	E	-
11	V	-
12	R	-
13	L	-
14	GR	-
15	P	-
16	W	-
17	SB	-
20	LG	-

21	BR	- [Coupe models]
21	G	- [Roadster models]
31	L	-
32	Y	-
36	Y	-
37	V	-
38	R	-
39	B	-
40	W	-
41	LG	-
42	SB	-
43	G	-
44	GR	- [Except for roadster models with M/T]
44	R	- [Roadster models with M/T]
45	BG	-
46	W	-
47	P	-
58	SHIELD	-
59	L	-
70	P	-
80	W	-
81	P	-
82	G	-
83	V	-
84	L	-
85	BG	-
86	LG	-
87	R	-
89	P	-
91	W	-
92	L	-
93	G	-
94	Y	-
96	Y	-
97	BR	-
98	GR	-
99	LG	-
100	BG	-

Connector No.	M1
Color of Wire	FUSE BLOCK (J/B)
Connector Name	NS08FW-M2
Connector Type	NS08FW-M2



Terminal No.	Color of Wire	Signal Name (Specification)
31	Y	-
32	G	-
3A	L	-
4A	P	-
5A	L	-
6A	Y	-
7A	BR	-
8A	L	-

Connector No.	M2
Color of Wire	FUSE BLOCK (J/B)
Connector Name	NS10FW-CS
Connector Type	NS10FW-CS



Terminal No.	Color of Wire	Signal Name (Specification)
3B	P	-
4B	G	-
5B	O	-
6B	Y	-
8B	R	-
9B	SB	-

Connector No.	M3
Color of Wire	FUSE BLOCK (J/B)
Connector Name	NS12FW-CS
Connector Type	NS12FW-CS

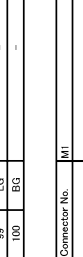

Terminal No.	Color of Wire	Signal Name (Specification)
7C	R	-
8C	R	-
9C	B	-
10C	L	-

Terminal No.	Color of Wire	Signal Name (Specification)
1A	Y	-
2A	G	-
3A	L	-
4A	P	-
5A	L	-
6A	Y	-
7A	BR	-
8A	L	-

Connector No.	M5
Color of Wire	WIRE TO WIRE
Connector Name	TH40MW-CS15
Connector Type	TH40MW-CS15

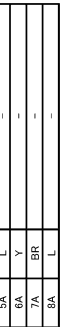

Terminal No.	Color of Wire	Signal Name (Specification)
7	Y	-
8	Y	-
9	G	-
10	V	-
11	V	-
12	L	-
13	B	-
14	Y	-
15	W	-
19	Y	-
23	Y/B	-
25	Y	-
26	SHIELD	-
35	BR	-
44	L	-
47	B	-
48	SB	-
49	Y	-
50	W	-
51	R	-
52	L	-
53	W	-
54	C	-
55	R	-

Connector No.	M2
Color of Wire	FUSE BLOCK (J/B)
Connector Name	NS10FW-CS
Connector Type	NS10FW-CS

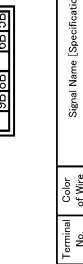

Terminal No.	Color of Wire	Signal Name (Specification)
3B	P	-
4B	G	-
5B	O	-
6B	Y	-
8B	R	-
9B	SB	-

Connector No.	M3
Color of Wire	FUSE BLOCK (J/B)
Connector Name	NS12FW-CS
Connector Type	NS12FW-CS

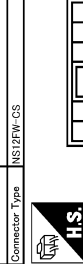

Terminal No.	Color of Wire	Signal Name (Specification)
7C	R	-
8C	R	-
9C	B	-
10C	L	-

A  
B  
C  
D  
E  
F  
G  
H  
I  
J  
K  
DEF  
M  
N  
O  
P

# REAR WINDOW DEFOGGER SYSTEM

< DTC/CIRCUIT DIAGNOSIS >

[COUPE]

## DEFOGGER (WITHOUT NAVI)

Connector No.	M6
Connector Name	WIRE TO WIRE
Connector Type	TH80MM-CST6-TM4

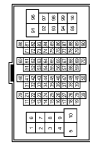

Terminal No.	Color of Wire	Signal Name (Specification)
1	Y	-
3	L	-
4	L	-
7	B	-
8	P	-
9	B	-
11	GR	-
12	R	-
13	L	-
14	G	-
15	P	-
16	W	-
17	BR	-
20	GR	-
21	R	-
31	BR	-
32	V	-
36	SB	-
37	Y	-
38	LG	-
39	SB	-
40	W	-
41	LG	-
42	R	-
43	G	-
44	G	-
44	R	- [With A/T] - [With M/T]
45	O	-
46	G	-
47	BR	-
58	SHIELD	-
59	-	-
70	R	-
80	LG	-
81	GR	-
82	V	-
83	V	-
84	L	-

85	BR	-
86	Y	-
87	G	-
89	P	-
91	W	-
92	P	-
93	P	-
94	Y	-
96	P	-
97	GR	-
98	O	-
99	W	-
100	R	-

Connector No.	M24
Connector Name	DATA LINK CONNECTOR
Connector Type	BD18FW

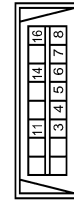

Terminal No.	Color of Wire	Signal Name (Specification)
3	LG	- [Coupe models] - [Reader models]
4	B	-
5	B	-
6	L	-
7	Y	-
8	G	-
11	Y	- [Coupe models] - [Reader models]
11	LG	-
14	P	-
16	Y	-

Connector No.	M66
Connector Name	A/C AUTO AMP.
Connector Type	SAB40FW

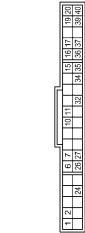

Terminal No.	Color of Wire	Signal Name (Specification)
1	L	CAN-H
2	P	CAN-L
6	L	TX (AMP-CONT)
7	P	RX (CONT-AMP)
10	BR	LAM SIGNAL
11	Y	EACH DOOR MOTOR POWER SUPPLY
15	O	SUNLOAD SENSOR SIGNAL
16	R	INTAKE SENSOR SIGNAL
17	L	ACC POWER SUPPLY
19	B	GROUND
20	G	IGNITION POWER SUPPLY
24	O	ECV SIGNAL
26	R	REAR WINDOW DEFOGGER FEEDBACK SIGNAL
27	L	REAR WINDOW DEFOGGER ON SIGNAL
32	P	BLOWER MOTOR CONTROL SIGNAL
34	G	A/C AUTO AMP CONNECTION RECOGNITION SIGNAL
35	V	AMBIENT SENSOR SIGNAL
36	LG	IN-VEHICLE SENSOR SIGNAL
37	GR	SENSOR GROUND
39	B	GROUND
40	Y	BATTERY POWER SUPPLY

Connector No.	M67
Connector Name	A/C CONTROL
Connector Type	TH18P-NH

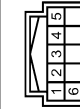

Terminal No.	Color of Wire	Signal Name (Specification)
1	G	IGNITION POWER SUPPLY

2	R	ILL+
3	W	ILL-
4	P	TX (SWZAMP)
5	L	RX (AMP/SW)
6	B	GROUND

Connector No.	M118
Connector Name	BCM (BODY CONTROL MODULE)
Connector Type	MO3FB-LC



Terminal No.	Color of Wire	Signal Name (Specification)
1	W	BAT (F/L)
2	W	POWER WINDOW POWER SUPPLY (BAT)
3	Y	POWER WINDOW POWER SUPPLY (IGN)

Connector No.	M119
Connector Name	BCM (BODY CONTROL MODULE)
Connector Type	NS18FW-CS

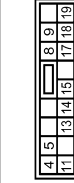

Terminal No.	Color of Wire	Signal Name (Specification)
4	R	INTERIOR ROOM LAMP POWER SUPPLY
5	G	PASSENGER DOOR UNLOCK OUTPUT
8	V	ALL DOORS FUEL LID LOCK OUTPUT
9	G	DRIVER DOOR FUEL LID UNLOCK OUTPUT
11	BR	BAT (FUSE)
13	B	GROUND
14	B	PUSH-BUTTON IGNITION SW ILL GND
15	Y	ACC I/O
15	Y	ACC I/O
18	O	TURN SIGNAL Lf (FRONT SIDE)
18	O	TURN SIGNAL Lr (FRONT SIDE)
19	P	ROOM LAMP TIMER CONTROL

# REAR WINDOW DEFOGGER SYSTEM

< DTC/CIRCUIT DIAGNOSIS >

[COUPE]

## DEFOGGER (WITHOUT NAVI)

Connector No.	M122
Connector Name	BOM (BODY CONTROL MODULE)
Connector Type	TH40FE-NH

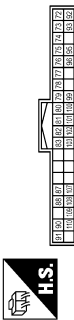

Terminal No.	Color of Wire	Signal Name (Specification)
72	L	ROOM ANT 2-
73	P	ROOM ANT 2+
74	SB	PASSENGER DOOR ANT-
75	BR	PASSENGER DOOR ANT+
76	V	DRIVER DOOR ANT-
77	LG	DRIVER DOOR ANT+
78	L	ROOM ANT 1-
79	R	ROOM ANT 1+
80	GR	NATS ANT AMP.
82	R	IGN RELAY (F/B) CONT
83	GR	KYLS ENT RECEIVER (FRONT) COMM
87	BR	COMBI SW INPUT 5
88	V	COMBI SW INPUT 3
90	P	CAN-L
91	L	CAN-H
92	LG	KEY SLOT ILL
93	V	ON IND
95	O	ACC RELAY CONT
96	Y	A/T SHIFT SELECTOR POWER SUPPLY
99	R	SHIFT P/CLUTCH PEDAL POS SW
100	GR	PASSENGER DOOR REQUEST SW
101	Y	DRIVER DOOR REQUEST SW
102	O	BLOWER FAN MOTOR RELAY CONT
103	LG	KYLS ENT RECEIVER (FRONT) PWR SUPPLY
107	LG	COMBI SW INPUT 1
108	R	COMBI SW INPUT 4
109	Y	COMBI SW INPUT 2
110	P	HAZARD SW

Connector No.	M123
Connector Name	BOM (BODY CONTROL MODULE)
Connector Type	TH40FC-NH

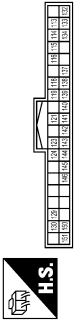

Terminal No.	Color of Wire	Signal Name (Specification)
113	O	OPTICAL SENSOR
114	R	CLUTCH INTERLOCK SW
115	O	-
116	SB	STOP LAMP SW 1
118	P	STOP LAMP SW 2
119	SB	DR DOOR UNLOCK SENSOR
121	R	KEY SLOT SW
123	W	IGN F/B
124	LG	PASSENGER DOOR SW
129	O	TRUNK LID OPENER CANCEL SW
130	L	REAR DEFOGGER SW
132	V	P/W SW & SOFT TOP C/U COMM (Resistor models)
132	Y	POWER WINDOW SW COMM (Coupe models)
133	G	PUSH BUTTON IGNITION SW ILL POWER
134	GR	LOCK IND
137	P	RECEIVER SENSOR GND
138	V	RECEIVER & SENSOR POWER SUPPLY
139	L	THE PRESS RECEIV COMM
140	G	P/N POSITION
141	Y	SECURITY INDICATOR
142	O	COMBI SW OUTPUT 5
143	P	COMBI SW OUTPUT 1
144	G	COMBI SW OUTPUT 2
145	L	COMBI SW OUTPUT 3
146	SB	COMBI SW OUTPUT 4
150	GR	DRIVER DOOR SW
151	G	REAR WINDOW DEFOGGER RELAY CONT

Connector No.	M124
Connector Name	WIRE TO WIRE
Connector Type	TH40MW-CS15

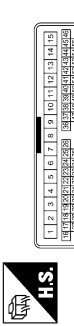

Terminal No.	Color of Wire	Signal Name (Specification)
10	G	-
11	V	-
12	LG	-
13	V	-
14	B	-
15	W	-
19	Y	-
23	Y/B	-
25	W	-
26	SHIELD	-
35	B	-
44	O	-
50	Y	-
51	Y	-
52	GR	-
53	W	-
54	G	-
55	R	-

JRLWC4809GB

A  
B  
C  
D  
E  
F  
G  
H  
I  
J  
K  
DEF  
M  
N  
O  
P

# BCM (BODY CONTROL MODULE)

< ECU DIAGNOSIS INFORMATION >

[COUPE]

## ECU DIAGNOSIS INFORMATION

### BCM (BODY CONTROL MODULE)

#### Reference Value

INFOID:000000009760852

#### VALUES ON THE DIAGNOSIS TOOL

##### NOTE:

The following table includes information (items) inapplicable to this vehicle. For information (items) applicable to this vehicle, refer to CONSULT display items.

##### CONSULT MONITOR ITEM

Monitor Item	Condition	Value/Status
FR WIPER HI	Other than front wiper switch HI	Off
	Front wiper switch HI	On
FR WIPER LOW	Other than front wiper switch LO	Off
	Front wiper switch LO	On
FR WASHER SW	Front washer switch OFF	Off
	Front washer switch ON	On
FR WIPER INT	Other than front wiper switch INT	Off
	Front wiper switch INT	On
FR WIPER STOP	Front wiper is not in STOP position	Off
	Front wiper is in STOP position	On
INT VOLUME	Wiper intermittent dial is in a dial position 1 - 7	Wiper intermittent dial position
TURN SIGNAL R	Other than turn signal switch RH	Off
	Turn signal switch RH	On
TURN SIGNAL L	Other than turn signal switch LH	Off
	Turn signal switch LH	On
TAIL LAMP SW	Other than lighting switch 1ST and 2ND	Off
	Lighting switch 1ST or 2ND	On
HI BEAM SW	Other than lighting switch HI	Off
	Lighting switch HI	On
HEAD LAMP SW 1	Other than lighting switch 2ND	Off
	Lighting switch 2ND	On
HEAD LAMP SW 2	Other than lighting switch 2ND	Off
	Lighting switch 2ND	On
PASSING SW	Other than lighting switch PASS	Off
	Lighting switch PASS	On
AUTO LIGHT SW	Other than lighting switch AUTO	Off
	Lighting switch AUTO	On
FR FOG SW	<b>NOTE:</b> The item is indicated, but not monitored.	Off
RR FOG SW	Rear fog lamp switch OFF	Off
	Rear fog lamp switch ON	On
DOOR SW-DR	Driver door closed	Off
	Driver door opened	On
DOOR SW-AS	Passenger door closed	Off
	Passenger door opened	On



# BCM (BODY CONTROL MODULE)

< ECU DIAGNOSIS INFORMATION >

[COUPE]

Monitor Item	Condition	Value/Status	
DOOR SW-RR	<b>NOTE:</b> The item is indicated, but not monitored.	Off	A
DOOR SW-RL	<b>NOTE:</b> The item is indicated, but not monitored.	Off	B
DOOR SW-BK	<ul style="list-style-type: none"> <li>• Back door closed (Coupe models)</li> <li>• Trunk lid closed (Roadster models)</li> </ul>	Off	C
	<ul style="list-style-type: none"> <li>• Back door opened (Coupe models)</li> <li>• Trunk lid opened (Roadster models)</li> </ul>	On	
CDL LOCK SW	Other than door lock and unlock switch LOCK	Off	D
	Door lock and unlock switch LOCK	On	
CDL UNLOCK SW	Other than door lock and unlock switch UNLOCK	Off	E
	Door lock and unlock switch UNLOCK	On	
KEY CYL LK-SW	Other than driver door key cylinder LOCK position	Off	F
	Driver door key cylinder LOCK position	On	
KEY CYL UN-SW	Other than driver door key cylinder UNLOCK position	Off	G
	Driver door key cylinder UNLOCK position	On	
KEY CYL SW-TR	<b>NOTE:</b> The item is indicated, but not monitored.	Off	H
HAZARD SW	Hazard switch is OFF	Off	I
	Hazard switch is ON	On	
REAR DEF SW <b>NOTE:</b> For models with NAVI this item is not monitored.	Rear window defogger switch OFF	Off	J
	Rear window defogger switch ON	On	
H/L WASH SW	<b>NOTE:</b> The item is indicated, but not monitored.	Off	K
TR CANCEL SW	Trunk lid opener cancel switch OFF	Off	DEF
	Trunk lid opener cancel switch ON	On	
TR/BD OPEN SW	<ul style="list-style-type: none"> <li>• Back door opener switch OFF (Coupe models)</li> <li>• Trunk lid opener switch OFF (Roadster models)</li> </ul>	Off	
	<ul style="list-style-type: none"> <li>• While the back door opener switch is turned ON (Coupe models)</li> <li>• While the trunk lid opener switch is turned ON (Roadster models)</li> </ul>	On	
TRNK/HAT MNTR	<b>NOTE:</b> The item is indicated, but not monitored.	Off	M
RKE-LOCK	LOCK button of the Intelligent Key is not pressed	Off	N
	LOCK button of the Intelligent Key is pressed	On	
RKE-UNLOCK	UNLOCK button of the Intelligent Key is not pressed	Off	O
	UNLOCK button of the Intelligent Key is pressed	On	
RKE-TR/BD <b>NOTE:</b> For Coupe models this item is not monitored.	TRUNK OPEN button of the Intelligent Key is not pressed	Off	P
	TRUNK OPEN of the Intelligent Key is pressed	On	
RKE-PANIC	PANIC button of the Intelligent Key is not pressed	Off	P
	PANIC button of the Intelligent Key is pressed	On	
RKE-P/W OPEN	UNLOCK button of the Intelligent Key is not pressed	Off	P
	UNLOCK button of the Intelligent Key is pressed and held	On	
RKE-MODE CHG	LOCK/UNLOCK button of the Intelligent Key is not pressed and held simultaneously	Off	P
	LOCK/UNLOCK button of the Intelligent Key is pressed and held simultaneously	On	

# BCM (BODY CONTROL MODULE)

< ECU DIAGNOSIS INFORMATION >

[COUPE]

Monitor Item	Condition	Value/Status
OPTICAL SENSOR	Bright outside of the vehicle	Close to 5 V
	Dark outside of the vehicle	Close to 0 V
REQ SW -DR	Driver door request switch is not pressed	Off
	Driver door request switch is pressed	On
REQ SW -AS	Passenger door request switch is not pressed	Off
	Passenger door request switch is pressed	On
REQ SW -RR	<b>NOTE:</b> The item is indicated, but not monitored.	Off
REQ SW -RL	<b>NOTE:</b> The item is indicated, but not monitored.	Off
REQ SW -BD/TR	<ul style="list-style-type: none"> <li>• Back door request switch is not pressed (Coupe models)</li> <li>• Trunk lid door request switch is not pressed (Roadster models)</li> </ul>	Off
	<ul style="list-style-type: none"> <li>• Back door request switch is pressed (Coupe models)</li> <li>• Trunk lid door request switch is pressed (Roadster models)</li> </ul>	On
PUSH SW	Push-button ignition switch (push switch) is not pressed	Off
	Push-button ignition switch (push switch) is pressed	On
IGN RLY2 -F/B	<b>NOTE:</b> The item is indicated, but not monitored.	Off
ACC RLY -F/B	<b>NOTE:</b> The item is indicated, but not monitored.	Off
CLUCH SW <b>NOTE:</b> For A/T models this item is not monitored.	The clutch pedal is not depressed	Off
	The clutch pedal is depressed	On
BRAKE SW 1	The brake pedal is depressed when No. 7 fuse is blown	Off
	The brake pedal is not depressed when No. 7 fuse is blown, or No. 7 fuse is normal	On
BRAKE SW 2	The brake pedal is not depressed	Off
	The brake pedal is depressed	On
DETE/CANCL SW <b>NOTE:</b> For M/T models with Synchro-Rev Match mode this item is not monitored.	<ul style="list-style-type: none"> <li>• Selector lever in P position (A/T models)</li> <li>• The clutch pedal is depressed (M/T models without SynchroRev Match mode)</li> </ul>	Off
	<ul style="list-style-type: none"> <li>• Selector lever in any position other than P (A/T models)</li> <li>• The clutch pedal is not depressed (M/T models without SynchroRev Match mode)</li> </ul>	On
SFT PN/N SW <b>NOTE:</b> For roadster M/T models and coupe M/T models without SynchroRev Match mode this item is not monitored.	<ul style="list-style-type: none"> <li>• Selector lever in any position other than P and N (A/T models)</li> <li>• Control lever in any position other than neutral position (Coupe M/T models with SynchroRev Match mode)</li> </ul>	Off
	<ul style="list-style-type: none"> <li>• Selector lever in P or N position (A/T models)</li> <li>• Control lever in neutral position (Coupe M/T models with SynchroRev Match mode)</li> </ul>	On
S/L -LOCK	<b>NOTE:</b> The item is indicated but not monitored.	Off
S/L -UNLOCK	<b>NOTE:</b> The item is indicated but not monitored.	Off
S/L RELAY-F/B	<b>NOTE:</b> The item is indicated but not monitored.	Off
UNLK SEN -DR	Driver door is unlocked	Off
	Driver door is locked	On
PUSH SW -IPDM	Push-button ignition switch (push-switch) is not pressed	Off
	Push-button ignition switch (push-switch) is pressed	On

# BCM (BODY CONTROL MODULE)

< ECU DIAGNOSIS INFORMATION >

[COUPE]

Monitor Item	Condition	Value/Status	
IGN RLY1 -F/B	Ignition switch in OFF or ACC position	Off	A
	Ignition switch in ON position	On	
DETE SW -IPDM	Selector lever in any position other than P	Off	B
	Selector lever in P position	On	
SFT PN -IPDM	<ul style="list-style-type: none"> <li>• Selector lever in any position other than P and N (A/T models)</li> <li>• The clutch pedal is not depressed (M/T models)</li> </ul>	Off	C
	<ul style="list-style-type: none"> <li>• Selector lever in P or N position (A/T models)</li> <li>• The clutch pedal is depressed (M/T models)</li> </ul>	On	
SFT P -MET	Selector lever in any position other than P	Off	D
	Selector lever in P position	On	
SFT N -MET	Selector lever in any position other than N	Off	E
	Selector lever in N position	On	
ENGINE STATE	Engine stopped	Stop	F
	While the engine stalls	Stall	
	At engine cranking	Crank	
	Engine running	Run	
S/L LOCK-IPDM	<b>NOTE:</b> The item is indicated but not monitored.	Off	G
S/L UNLK-IPDM	<b>NOTE:</b> The item is indicated but not monitored.	Off	H
S/L RELAY-REQ	<b>NOTE:</b> The item is indicated but not monitored.	Off	I
VEH SPEED 1	While driving	Equivalent to speedometer reading	J
VEH SPEED 2	While driving	Equivalent to speedometer reading	
DOOR STAT-DR	Driver door is locked	LOCK	K
	Wait with selective UNLOCK operation (60 seconds)	READY	
	Driver door is unlocked	UNLOCK	
DOOR STAT-AS	Passenger door is locked	LOCK	DEF
	Wait with selective UNLOCK operation (60 seconds)	READY	
	Passenger door is unlocked	UNLOCK	
ID OK FLAG	Driver side door is open after ignition switch is turned OFF (Shift position is in the P position)	Reset	M
	Ignition switch ON	Set	
PRMT ENG STRT	The engine start is prohibited	Reset	N
	The engine start is permitted	Set	
PRMT RKE STRT	<b>NOTE:</b> The item is indicated, but not monitored.	Reset	O
KEY SW -SLOT	The Intelligent Key is not inserted into key slot	Off	P
	The Intelligent Key is inserted into key slot	On	
RKE OPE COUN1	During the operation of the Intelligent Key	Operation frequency of the Intelligent Key	
RKE OPE COUN2	During the operation of the Intelligent Key	Operation frequency of the Intelligent Key	

# BCM (BODY CONTROL MODULE)

< ECU DIAGNOSIS INFORMATION >

[COUPE]

Monitor Item	Condition	Value/Status
CONFIRM ID ALL	The key ID that the key slot receives is not recognized by any key ID registered to BCM.	Yet
	The key ID that the key slot receives is recognized by any key ID registered to BCM.	Done
CONFIRM ID4	The key ID that the key slot receives is not recognized by the fourth key ID registered to BCM.	Yet
	The key ID that the key slot receives is recognized by the fourth key ID registered to BCM.	Done
CONFIRM ID3	The key ID that the key slot receives is not recognized by the third key ID registered to BCM.	Yet
	The key ID that the key slot receives is recognized by the third key ID registered to BCM.	Done
CONFIRM ID2	The key ID that the key slot receives is not recognized by the second key ID registered to BCM.	Yet
	The key ID that the key slot receives is recognized by the second key ID registered to BCM.	Done
CONFIRM ID1	The key ID that the key slot receives is not recognized by the first key ID registered to BCM.	Yet
	The key ID that the key slot receives is recognized by the first key ID registered to BCM.	Done
TP 4	The ID of fourth Intelligent Key is not registered to BCM	Yet
	The ID of fourth Intelligent Key is registered to BCM	Done
TP 3	The ID of third Intelligent Key is not registered to BCM	Yet
	The ID of third Intelligent Key is registered to BCM	Done
TP 2	The ID of second Intelligent Key is not registered to BCM	Yet
	The ID of second Intelligent Key is registered to BCM	Done
TP 1	The ID of first Intelligent Key is not registered to BCM	Yet
	The ID of first Intelligent Key is registered to BCM	Done
AIR PRESS FL	Ignition switch ON (Only when the signal from the transmitter is received)	Air pressure of front LH tire
AIR PRESS FR	Ignition switch ON (Only when the signal from the transmitter is received)	Air pressure of front RH tire
AIR PRESS RR	Ignition switch ON (Only when the signal from the transmitter is received)	Air pressure of rear RH tire
AIR PRESS RL	Ignition switch ON (Only when the signal from the transmitter is received)	Air pressure of rear LH tire
ID REGST FL1	ID of front LH tire transmitter is registered	Done
	ID of front LH tire transmitter is not registered	Yet
ID REGST FR1	ID of front RH tire transmitter is registered	Done
	ID of front RH tire transmitter is not registered	Yet
ID REGST RR1	ID of rear RH tire transmitter is registered	Done
	ID of rear RH tire transmitter is not registered	Yet
ID REGST RL1	ID of rear LH tire transmitter is registered	Done
	ID of rear LH tire transmitter is not registered	Yet
WARNING LAMP	Tire pressure indicator OFF	Off
	Tire pressure indicator ON	On
BUZZER	Tire pressure warning alarm is not sounding	Off
	Tire pressure warning alarm is sounding	On

# BCM (BODY CONTROL MODULE)

< ECU DIAGNOSIS INFORMATION >

[COUPE]

## TERMINAL LAYOUT

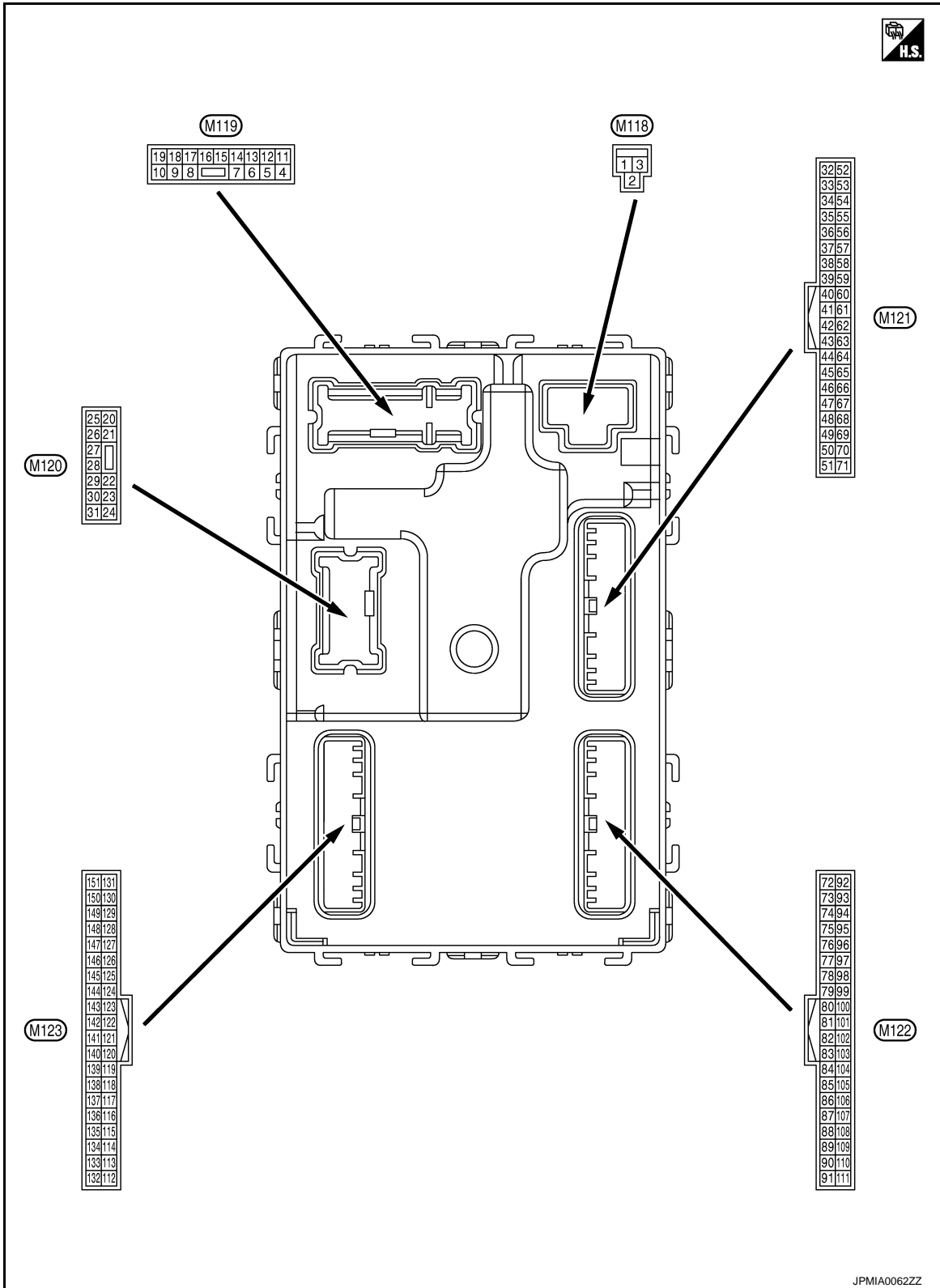

## PHYSICAL VALUES

A  
B  
C  
D  
E  
F  
G  
H  
I  
J  
K  
DEF  
M  
N  
O  
P

# BCM (BODY CONTROL MODULE)

< ECU DIAGNOSIS INFORMATION >

[COUPE]

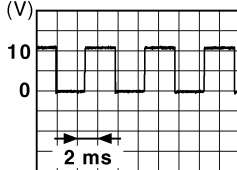
Terminal No. (Wire color)		Description		Condition		Value (Approx.)
		Signal name	Input/ Output			
+	-					
1 (W)	Ground	Battery power supply	Input	Ignition switch OFF		Battery voltage
2 (W)	Ground	P/W power supply (BAT)	Output	Ignition switch OFF		12 V
3 (Y)	Ground	P/W power supply (IGN)	Output	Ignition switch ON		12 V
4 (R)	Ground	Interior room lamp power supply	Output	Interior room lamp battery saver is activated. (Cuts the interior room lamp power supply)		0 V
				Interior room lamp battery saver is not activated. (Outputs the interior room lamp power supply)		12 V
5 (G)	Ground	Passenger door UN- LOCK	Output	Passenger door	UNLOCK (Actuator is activated)	12 V
					Other than UNLOCK (Actuator is not activated)	0 V
8 (V)	Ground	All doors, fuel lid LOCK	Output	All doors, fuel lid	LOCK (Actuator is activated)	12 V
					Other than LOCK (Actuator is not activated)	0 V
9 (G)	Ground	Driver door, fuel lid UNLOCK	Output	Driver door, fuel lid	UNLOCK (Actuator is activated)	12 V
					Other than UNLOCK (Actuator is not activated)	0 V
11 (BR)	Ground	Battery power supply	Input	Ignition switch OFF		Battery voltage
13 (B)	Ground	Ground	—	Ignition switch ON		0 V
14 (R)	Ground	Push-button ignition switch illumination ground	Output	Tail lamp	OFF	0 V
					ON	<p><b>NOTE:</b> When the illumination brightening/dimming level is in the neutral position.</p>  <p style="text-align: right; font-size: small;">JSNIA0010GB</p>
15 (Y)	Ground	ACC indicator lamp	Output	Ignition switch	OFF (LOCK indicator is not illuminated)	Battery voltage
					ACC	0 V

# BCM (BODY CONTROL MODULE)

< ECU DIAGNOSIS INFORMATION >

[COUPE]

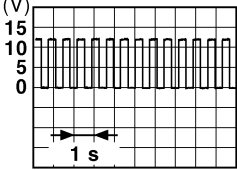
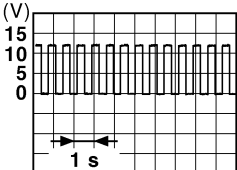
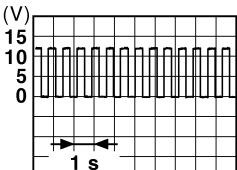
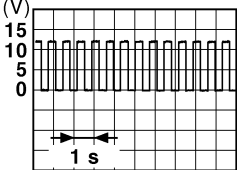
Terminal No. (Wire color)		Description		Condition	Value (Approx.)	
		Signal name	Input/ Output			
+	-					
17 (W)	Ground	Turn signal RH (Front and side)	Output	Ignition switch ON	Turn signal switch OFF	0 V
					Turn signal switch RH	 <p style="text-align: right; font-size: small;">PKID0926E</p>
18 (O)	Ground	Turn signal LH (Front and side)	Output	Ignition switch ON	Turn signal switch OFF	0 V
					Turn signal switch LH	 <p style="text-align: right; font-size: small;">PKID0926E</p>
19 (P)	Ground	Interior room lamp control	Output	Interior room lamp	OFF	12 V
					ON	0 V
20 (V)	Ground	Turn signal RH (Rear)	Output	Ignition switch ON	Turn signal switch OFF	0 V
					Turn signal switch RH	 <p style="text-align: right; font-size: small;">PKID0926E</p>
23 (L) <sup>*1</sup> (Y) <sup>*2</sup>	Ground	Back door/Trunk lid open	Output	Back door/ Trunk lid	OPEN (Back door/Trunk lid opener actuator is activated)	12 V
					Other than OPEN (Back door/Trunk lid opener actuator is not activated)	0 V
24 <sup>*8</sup> (O)	Ground	Rear fog lamp	Output	Rear fog lamp	OFF	0 V
					ON	12 V
25 (LG)	Ground	Turn signal LH (Rear)	Output	Ignition switch ON	Turn signal switch OFF	0 V
					Turn signal switch LH	 <p style="text-align: right; font-size: small;">PKID0926E</p>
30 (R)	Ground	Luggage room/Trunk room lamp	Output	Luggage room/ Trunk room lamp	ON	0 V
					OFF	12 V

A  
B  
C  
D  
E  
F  
G  
H  
I  
J  
K  
DEF  
M  
N  
O  
P

# BCM (BODY CONTROL MODULE)

< ECU DIAGNOSIS INFORMATION >

[COUPE]

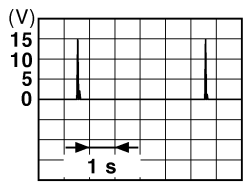
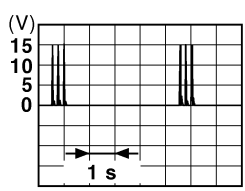
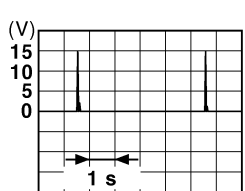
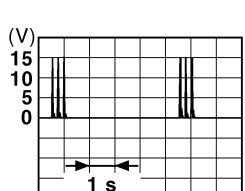
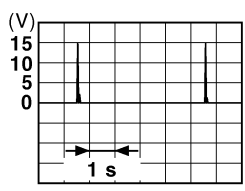
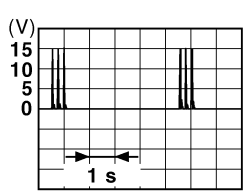
Terminal No. (Wire color)		Description		Condition	Value (Approx.)
+	-	Signal name	Input/ Output		
34 (G)	Ground	Luggage room/Trunk room antenna (-)	Output	Ignition switch OFF	When Intelligent Key is in the passenger compartment  <p style="text-align: right; font-size: small;">JMKIA0062GB</p>
				Ignition switch OFF	When Intelligent Key is not in the passenger compartment  <p style="text-align: right; font-size: small;">JMKIA0063GB</p>
35 (R)	Ground	Luggage room/Trunk room antenna (+)	Output	Ignition switch OFF	When Intelligent Key is in the passenger compartment  <p style="text-align: right; font-size: small;">JMKIA0062GB</p>
				Ignition switch OFF	When Intelligent Key is not in the passenger compartment  <p style="text-align: right; font-size: small;">JMKIA0063GB</p>
38 (B)	Ground	Rear bumper antenna (-)	Output	When the back door/trunk lid door request switch is operated with ignition switch OFF	When Intelligent Key is in the antenna detection area  <p style="text-align: right; font-size: small;">JMKIA0062GB</p>
				When the back door/trunk lid door request switch is operated with ignition switch OFF	When Intelligent Key is not in the antenna detection area  <p style="text-align: right; font-size: small;">JMKIA0063GB</p>



# BCM (BODY CONTROL MODULE)

< ECU DIAGNOSIS INFORMATION >

[COUPE]

Terminal No. (Wire color)		Description		Condition	Value (Approx.)	
		Signal name	Input/ Output			
+	-					
39 (W)	Ground	Rear bumper antenna (+)	Output	When the back door/trunk lid door request switch is operated with ignition switch OFF	When Intelligent Key is in the antenna detection area	<p style="text-align: right; font-size: small;">JMKIA0062GB</p>
				When Intelligent Key is not in the antenna detection area	<p style="text-align: right; font-size: small;">JMKIA0063GB</p>	
47 (V)	Ground	Ignition relay (IPDM E/R) control	Output	Ignition switch	OFF or ACC ON 12 V 0 V	
52 (SB)	Ground	Starter relay control	Output	Ignition switch ON (A/T models)	When selector lever is in P or N position	12 V
				Ignition switch ON (M/T models)	When selector lever is not in P or N position	0 V
				Ignition switch ON (M/T models)	When the clutch pedal is depressed	Battery voltage
				Ignition switch ON (M/T models)	When the clutch pedal is not depressed	0 V
60 (BR)	Ground	Push-button ignition switch (Push switch)	Input	Push-button ignition switch (push switch)	Pressed	0 V
				Push-button ignition switch (push switch)	Not pressed	Battery voltage
61 (W)	Ground	Back door/Trunk Lid door request switch	Input	Back door/Trunk lid door request switch	ON (Pressed)	0 V
				Back door/Trunk lid door request switch	OFF (Not pressed)	<p style="text-align: right; font-size: small;">JPMAI0016GB</p> 1.0 V
64 (G)	Ground	Intelligent Key warning buzzer	Output	Intelligent Key warning buzzer	Sounding	0 V
				Intelligent Key warning buzzer	Not sounding	12 V
66 (R)	Ground	Back door/Trunk room lamp switch	Input	Back door/Trunk room lamp switch	OFF (Door close)	<p style="text-align: right; font-size: small;">JPMAI0011GB</p> 11.8 V
				Back door/Trunk room lamp switch	ON (Door open)	0 V

A  
B  
C  
D  
E  
F  
G  
H  
I  
J  
K

DEF

M  
N  
O  
P

# BCM (BODY CONTROL MODULE)

< ECU DIAGNOSIS INFORMATION >

[COUPE]

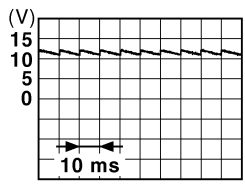
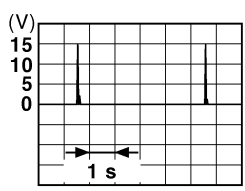
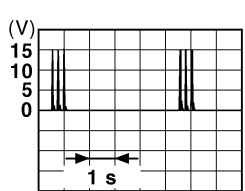
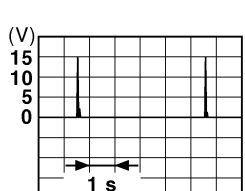
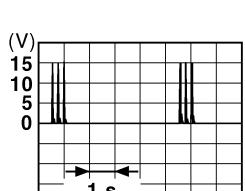
Terminal No. (Wire color)		Description		Condition	Value (Approx.)	
+	-	Signal name	Input/ Output			
67 (GR)	Ground	Back door/Trunk lid opener switch	Input	Back door/ Trunk lid open- er switch	Pressed	0 V
				Not pressed	 <p style="text-align: right; font-size: small;">JPMIA0011GB</p>	
72 (L)	Ground	Room antenna 2 (-) (Center console)	Output	Ignition switch OFF	When Intelligent Key is in the passenger compart- ment	 <p style="text-align: right; font-size: small;">JMKIA0062GB</p>
				When Intelligent Key is not in the passenger compart- ment	 <p style="text-align: right; font-size: small;">JMKIA0063GB</p>	
73 (P)	Ground	Room antenna 2 (+) (Center console)	Output	Ignition switch OFF	When Intelligent Key is in the passenger compart- ment	 <p style="text-align: right; font-size: small;">JMKIA0062GB</p>
				When Intelligent Key is not in the passenger compart- ment	 <p style="text-align: right; font-size: small;">JMKIA0063GB</p>	

# BCM (BODY CONTROL MODULE)

< ECU DIAGNOSIS INFORMATION >

[COUPE]

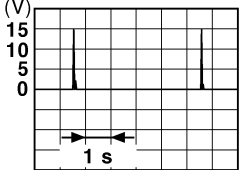
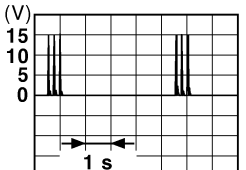
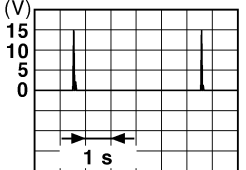
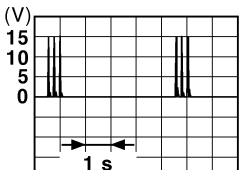
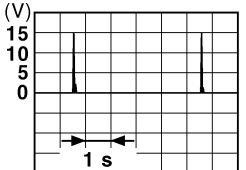
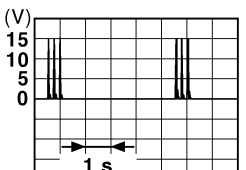
Terminal No. (Wire color)		Description		Condition	Value (Approx.)
		Signal name	Input/ Output		
+	-				
74 (SB)	Ground	Passenger door antenna (-)	Output	When the Intelligent Key is in the antenna detection area	 <p style="text-align: right; font-size: small;">JMkia0062GB</p>
				When the passenger door request switch is operated with ignition switch OFF	 <p style="text-align: right; font-size: small;">JMkia0063GB</p>
75 (BR)	Ground	Passenger door antenna (+)	Output	When Intelligent Key is in the antenna detection area	 <p style="text-align: right; font-size: small;">JMkia0062GB</p>
				When the passenger door request switch is operated with ignition switch OFF	 <p style="text-align: right; font-size: small;">JMkia0063GB</p>
76 (V)	Ground	Driver door antenna (-)	Output	When Intelligent Key is in the antenna detection area	 <p style="text-align: right; font-size: small;">JMkia0062GB</p>
				When the driver door request switch is operated with ignition switch OFF	 <p style="text-align: right; font-size: small;">JMkia0063GB</p>

A  
B  
C  
D  
E  
F  
G  
H  
I  
J  
K  
M  
N  
O  
P

DEF

# BCM (BODY CONTROL MODULE)

< ECU DIAGNOSIS INFORMATION >

[COUPE]

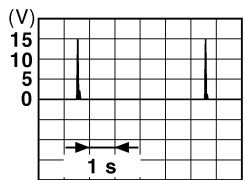
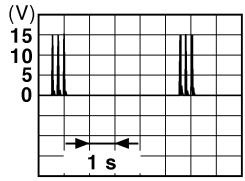
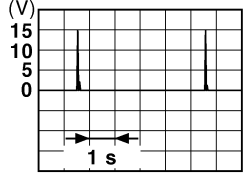
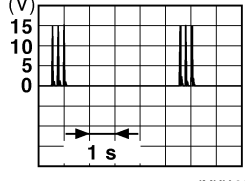
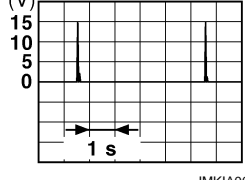
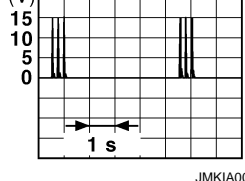
Terminal No. (Wire color)		Description		Condition	Value (Approx.)	
		Signal name	Input/ Output			
+	-					
77 (LG)	Ground	Driver door antenna (+)	Output	When the driver door request switch is operated with ignition switch OFF	When Intelligent Key is in the antenna detection area	 <p style="text-align: right; font-size: small;">JMKIA0062GB</p>
				When Intelligent Key is not in the antenna detection area	 <p style="text-align: right; font-size: small;">JMKIA0063GB</p>	
78*2 (L)	Ground	Room antenna 1 (-) (Instrument panel)	Output	Ignition switch OFF	When Intelligent Key is in the passenger compartment	 <p style="text-align: right; font-size: small;">JMKIA0062GB</p>
				When Intelligent Key is not in the passenger compartment	 <p style="text-align: right; font-size: small;">JMKIA0063GB</p>	
79*2 (R)	Ground	Room antenna 1 (+) (Instrument panel)	Output	Ignition switch OFF	When Intelligent Key is in the passenger compartment	 <p style="text-align: right; font-size: small;">JMKIA0062GB</p>
				When Intelligent Key is not in the passenger compartment	 <p style="text-align: right; font-size: small;">JMKIA0063GB</p>	

# BCM (BODY CONTROL MODULE)

< ECU DIAGNOSIS INFORMATION >

[COUPE]

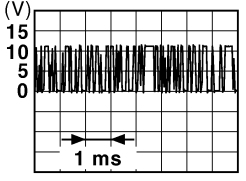
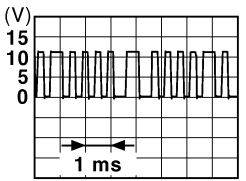
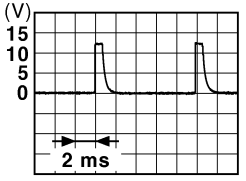
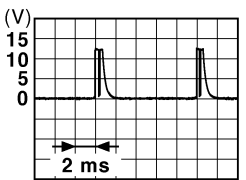
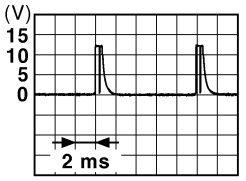
Terminal No. (Wire color)		Description		Condition		Value (Approx.)
+	-	Signal name	Input/ Output			
80 (GR)	Ground	NATS antenna amp.	Input/ Output	During waiting	Ignition switch is pressed while inserting the Intelligent Key into the key slot.	Just after pressing ignition switch. Pointer of tester should move.
81 (W)	Ground	NATS antenna amp.	Input/ Output	During waiting	Ignition switch is pressed while inserting the Intelligent Key into the key slot.	Just after pressing ignition switch. Pointer of tester should move.
82 (R)	Ground	Ignition relay [Fuse block (J/B)] control	Output	Ignition switch	OFF or ACC	0 V
					ON	12 V
83 (GR)	Ground	Remote keyless entry receiver (front) communication	Input/ Output	During waiting		 <p style="text-align: right; font-size: small;">JMKIA0064GB</p>
				When operating either button on the Intelligent Key		 <p style="text-align: right; font-size: small;">JMKIA0065GB</p>
87 (BR)	Ground	Combination switch INPUT 5	Input	Combination switch	All switches OFF (Wiper intermittent dial 4)	 <p style="text-align: right; font-size: small;">JPMIA0041GB</p> <p style="text-align: center;">1.4 V</p>
					Rear fog lamp switch ON (Wiper intermittent dial 4)	 <p style="text-align: right; font-size: small;">JPMIA0038GB</p> <p style="text-align: center;">1.3 V</p>
					Any of the conditions below with all switches OFF • Wiper intermittent dial 1 • Wiper intermittent dial 2 • Wiper intermittent dial 6 • Wiper intermittent dial 7	 <p style="text-align: right; font-size: small;">JPMIA0040GB</p> <p style="text-align: center;">1.3 V</p>



A  
B  
C  
D  
E  
F  
G  
H  
I  
J  
K  
M  
N  
O  
P

DEF

# BCM (BODY CONTROL MODULE)

< ECU DIAGNOSIS INFORMATION >

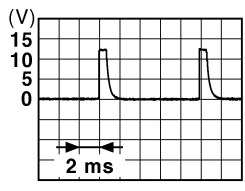
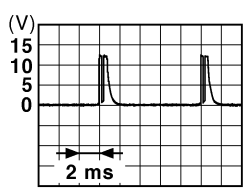
[COUPE]

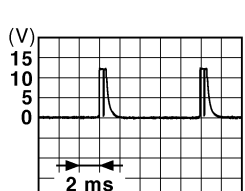
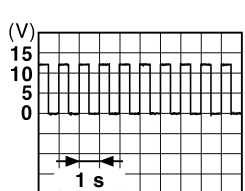
Terminal No. (Wire color)		Description		Condition	Value (Approx.)
		Signal name	Input/ Output		
+	-				
88 (V)	Ground	Combination switch INPUT 3	Input	Combination switch	All switches OFF (Wiper intermittent dial 4) <div style="text-align: right;">  <p style="font-size: small; margin: 0;">JPMIA0041GB</p> <p style="margin: 0;">1.4 V</p> </div>
					Lighting switch HI (Wiper intermittent dial 4) <div style="text-align: right;">  <p style="font-size: small; margin: 0;">JPMIA0036GB</p> <p style="margin: 0;">1.3 V</p> </div>
					Lighting switch 2ND (Wiper intermittent dial 4) <div style="text-align: right;">  <p style="font-size: small; margin: 0;">JPMIA0037GB</p> <p style="margin: 0;">1.3 V</p> </div>
					Any of the conditions below with all switches OFF <ul style="list-style-type: none"> <li>• Wiper intermittent dial 1</li> <li>• Wiper intermittent dial 2</li> <li>• Wiper intermittent dial 3</li> </ul> <div style="text-align: right;">  <p style="font-size: small; margin: 0;">JPMIA0040GB</p> <p style="margin: 0;">1.3 V</p> </div>
90 (P)	Ground	CAN-L	Input/ Output	—	—
91 (L)	Ground	CAN-H	Input/ Output	—	—
92 (LG)	Ground	Key slot illumination	Output	Key slot illumina- tion	OFF <div style="text-align: right;">  <p style="font-size: small; margin: 0;">JPMIA0015GB</p> <p style="margin: 0;">6.5 V</p> </div>
					ON <div style="text-align: right;"> <p style="margin: 0;">12 V</p> </div>
93 (V)	Ground	ON indicator lamp	Output	Ignition switch	OFF (LOCK indicator is not illuminated) <div style="text-align: right;"> <p style="margin: 0;">Battery voltage</p> </div>
					ON <div style="text-align: right;"> <p style="margin: 0;">0 V</p> </div>

# BCM (BODY CONTROL MODULE)

< ECU DIAGNOSIS INFORMATION >

[COUPE]

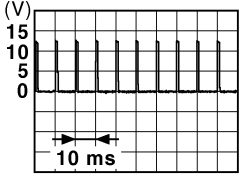
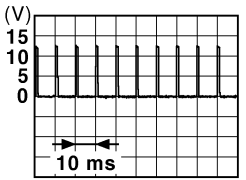

Terminal No. (Wire color)		Description		Condition		Value (Approx.)
		Signal name	Input/ Output			
+	-					
95 (O)	Ground	ACC relay control	Output	Ignition switch	OFF	0 V
					ACC or ON	12 V
96*3 (Y)	Ground	A/T shift selector (Detention switch) power supply	Output	—		12 V
99*6 (R)	Ground	Selector lever P position switch (A/T models)	Input	Selector lever	P position	0 V
					Any position other than P	12 V
		Clutch pedal position switch (M/T models without SynchroRev Match mode)		Clutch pedal position switch	OFF (Clutch pedal is depressed)	0 V
					ON (Clutch pedal is not depressed)	Battery voltage
100 (GR)	Ground	Passenger door request switch	Input	Passenger door request switch	ON (Pressed)	0 V
					OFF (Not pressed)	 <p style="text-align: right; font-size: small;">JPMA0016GB 1.0 V</p>
101 (Y)	Ground	Driver door request switch	Input	Driver door request switch	ON (Pressed)	0 V
					OFF (Not pressed)	 <p style="text-align: right; font-size: small;">JPMA0016GB 1.0 V</p>
102 (O)	Ground	Blower fan motor relay control	Output	Ignition switch	OFF or ACC	0 V
					ON	12 V
103 (LG)	Ground	Remote keyless entry receiver (front) power supply	Output	Ignition switch OFF		12 V

A  
B  
C  
D  
E  
F  
G  
H  
I  
J  
K  
DEF  
M  
N  
O  
P

# BCM (BODY CONTROL MODULE)

< ECU DIAGNOSIS INFORMATION >

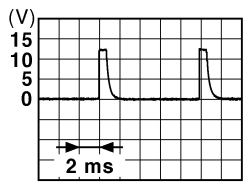
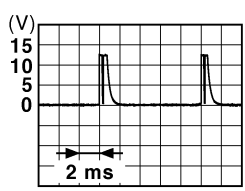
[COUPE]

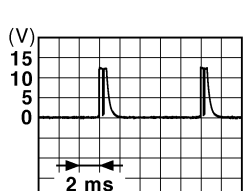
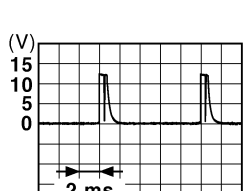

Terminal No. (Wire color)		Description		Condition	Value (Approx.)	
+	-	Signal name	Input/ Output			
107 (LG)	Ground	Combination switch INPUT 1	Input	Combination switch (Wiper intermit- tent dial 4)	All switches OFF	 <p style="text-align: right; margin-right: 20px;">JPMIA0041GB</p> <p style="text-align: center;">1.4 V</p>
					Turn signal switch LH	 <p style="text-align: right; margin-right: 20px;">JPMIA0037GB</p> <p style="text-align: center;">1.3 V</p>
					Turn signal switch RH	 <p style="text-align: right; margin-right: 20px;">JPMIA0036GB</p> <p style="text-align: center;">1.3 V</p>
					Front wiper switch LO	 <p style="text-align: right; margin-right: 20px;">JPMIA0038GB</p> <p style="text-align: center;">1.3 V</p>
					Front washer switch ON	 <p style="text-align: right; margin-right: 20px;">JPMIA0039GB</p> <p style="text-align: center;">1.3 V</p>



# BCM (BODY CONTROL MODULE)

< ECU DIAGNOSIS INFORMATION >

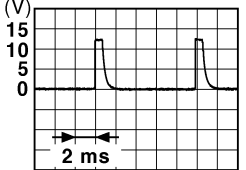
[COUPE]

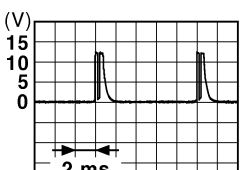
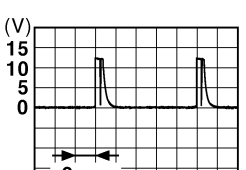
Terminal No. (Wire color)		Description		Condition	Value (Approx.)
		Signal name	Input/ Output		
+	-				
108 (R)	Ground	Combination switch INPUT 4	Input	Combination switch	All switches OFF (Wiper intermittent dial 4) <div style="text-align: right;">  <p style="font-size: small;">JPMIA0041GB</p> </div>
				Combination switch	Lighting switch AUTO (Wiper intermittent dial 4) <div style="text-align: right;">  <p style="font-size: small;">JPMIA0038GB</p> </div>
				Combination switch	Lighting switch 1ST (Wiper intermittent dial 4) <div style="text-align: right;">  <p style="font-size: small;">JPMIA0036GB</p> </div>
				Combination switch	Any of the conditions be- low with all switches OFF <ul style="list-style-type: none"> <li>• Wiper intermittent dial 1</li> <li>• Wiper intermittent dial 5</li> <li>• Wiper intermittent dial 6</li> </ul> <div style="text-align: right;">  <p style="font-size: small;">JPMIA0039GB</p> </div>

A  
B  
C  
D  
E  
F  
G  
H  
I  
J  
K  
DEF  
M  
N  
O  
P

DEF

# BCM (BODY CONTROL MODULE)

< ECU DIAGNOSIS INFORMATION >

[COUPE]

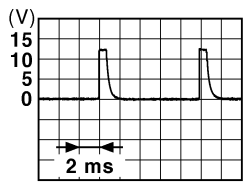
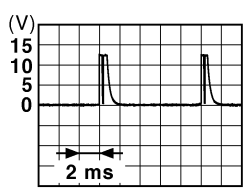
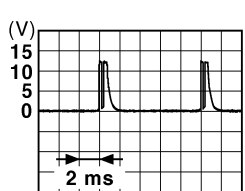
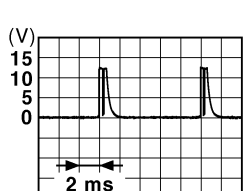
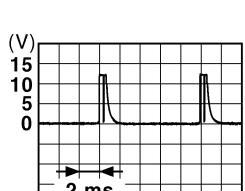
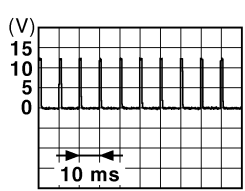
Terminal No. (Wire color)		Description		Condition	Value (Approx.)	
+	-	Signal name	Input/ Output			
109 (Y)	Ground	Combination switch INPUT 2	Input	Combination switch (Wiper intermittent dial 4)	All switches OFF	 <small>JPMIA0041GB</small> 1.4 V
					Lighting switch PASS	 <small>JPMIA0037GB</small> 1.3 V
					Lighting switch 2ND	 <small>JPMIA0036GB</small> 1.3 V
					Front wiper switch INT	 <small>JPMIA0038GB</small> 1.3 V
					Front wiper switch HI	 <small>JPMIA0040GB</small> 1.3 V
					ON	0 V
110 (P)	Ground	Hazard switch	Input	Hazard switch	OFF	 <small>JPMIA0012GB</small> 1.1 V

# BCM (BODY CONTROL MODULE)

< ECU DIAGNOSIS INFORMATION >

[COUPE]

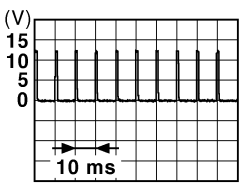
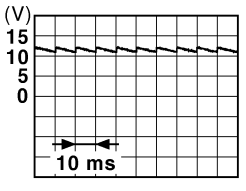
Terminal No. (Wire color)		Description		Condition	Value (Approx.)
		Signal name	Input/ Output		
+	-				
113 (O)	Ground	Optical sensor	Input	Ignition switch ON	When bright outside of the vehicle Close to 5 V
					When dark outside of the vehicle Close to 0 V
114*4 (R)	Ground	Clutch interlock switch	Input	Clutch interlock switch	OFF (Clutch pedal is not depressed) 0 V
					ON (Clutch pedal is de- pressed) Battery voltage
115*9 (O)	—	—	—	—	—
116 (SB)	Ground	Stop lamp switch 1	Input	—	Battery voltage
118 (P)	Ground	Stop lamp switch 2	Input	Stop lamp switch	OFF (Brake pedal is not depressed) 0 V
					ON (Brake pedal is de- pressed) Battery voltage
119 (SB)	Ground	Driver side door lock assembly (Unlock sensor)	Input	Driver door	LOCK status (Unlock sensor switch OFF)  1.1 V
					UNLOCK status (Unlock switch sensor ON) 0 V
121 (R)	Ground	Key slot switch	Input	When the Intelligent Key is inserted into key slot	12 V
				When the Intelligent Key is not inserted into key slot	0 V
123 (W)	Ground	IGN feedback	Input	Ignition switch	OFF or ACC 0 V
					ON Battery voltage
124 (LG)	Ground	Passenger door switch	Input	Passenger door switch	OFF (Door close)  11.8 V
					ON (Door open) 0 V

A  
B  
C  
D  
E  
F  
G  
H  
I  
J  
K  
DEF  
M  
N  
O  
P

# BCM (BODY CONTROL MODULE)

< ECU DIAGNOSIS INFORMATION >

[COUPE]

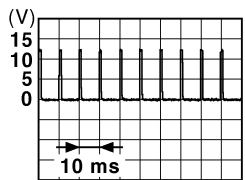
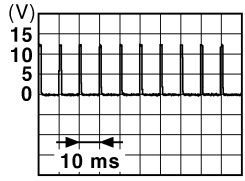
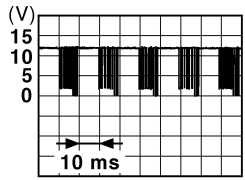
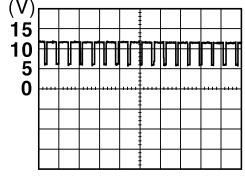
Terminal No. (Wire color)		Description		Condition	Value (Approx.)	
+	-	Signal name	Input/ Output			
129*2 (O)	Ground	Trunk lid opener cancel switch	Input	Trunk lid opener cancel switch	CANCEL	 <small>JPMIA0012GB</small> 1.1 V
				ON	0 V	
130*7 (L)	Ground	Rear window defogger switch	Input	Ignition switch ON	Rear window defogger switch OFF	 <small>JPMIA0012GB</small> 1.1 V
				Rear window defogger switch ON	0 V	
132 (Y)*1 (V)*2	Ground	Power window switch and soft top control unit communication	Input/ Output	Ignition switch ON	Ignition switch ON	 <small>JPMIA0013GB</small> 10.2 V
				Ignition switch OFF or ACC	12 V	
133 (G)	Ground	Push-button ignition switch illumination	Output	Push-button ignition switch illumination	ON (Tail lamps OFF)	9.5 V
					ON (Tail lamps ON)	<p style="text-align: center;"><b>NOTE:</b> The pulse width of this wave is varied by the illumination brightening/dimming level.</p>  <small>JPMIA0159GB</small>
					OFF	0 V
134 (GR)	Ground	LOCK indicator lamp	Output	LOCK indicator lamp	OFF	Battery voltage
					ON	0 V
137 (P)	Ground	Receiver and sensor ground	Input	Ignition switch ON		0 V
138 (V)	Ground	Receiver and sensor power supply	Output	Ignition switch	OFF	0 V
					ACC or ON	5.0 V

# BCM (BODY CONTROL MODULE)

< ECU DIAGNOSIS INFORMATION >

[COUPE]

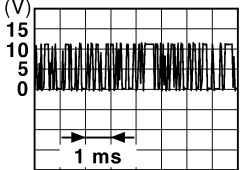
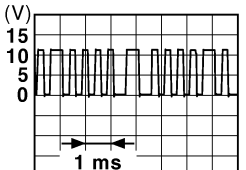
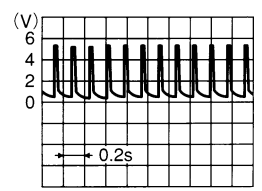
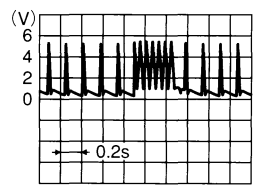
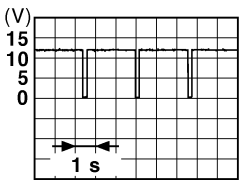



Terminal No. (Wire color)		Description		Condition	Value (Approx.)		
		Signal name	Input/ Output				
+	-						
139 (L)	Ground	Tire pressure receiver communication	Input/ Output	Ignition switch OFF (Remote key-less entry receiver communication)	During waiting	 <small>JMKIA0064GB</small>	
					When operating either button on the Intelligent Key	 <small>JMKIA0065GB</small>	
				Ignition switch ON (Tire pressure receiver communication)	Standby state	 <small>OCC3881D</small>	
					When receiving the signal from the transmitter	 <small>OCC3880D</small>	
140*5 (G)	Ground	Selector lever P/N position (A/T models)	Input	Selector lever	P or N position	12 V	
				Except P and N positions		0 V	
		Park/neutral position switch (Coupe M/T models with Synchro-Rev Match mode)		Ignition switch ON	Control lever in neutral position		Battery voltage
					Control lever in any position other than neutral		0 V
141 (Y)	Ground	Security indicator lamp	Output	Security indicator lamp	ON	0 V	
					Blinking	 <small>JPMIA0014GB</small>	
					OFF	11.3 V	
					12 V		

A  
B  
C  
D  
E  
F  
G  
H  
I  
J  
K  
DEF  
M  
N  
O  
P

# BCM (BODY CONTROL MODULE)

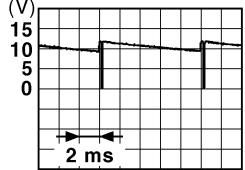
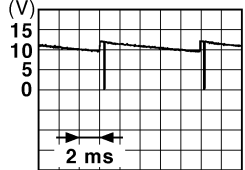
< ECU DIAGNOSIS INFORMATION >

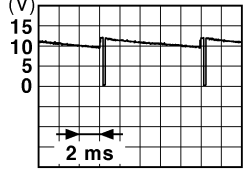
[COUPE]

Terminal No. (Wire color)		Description		Condition	Value (Approx.)	
		Signal name	Input/ Output			
+	-					
142 (O)	Ground	Combination switch OUTPUT 5	Output	Combination switch (Wiper intermit- tent dial 4)	All switches OFF	0 V
					Lighting switch 1ST	
					Lighting switch HI	
					Lighting switch 2ND	
					Turn signal switch RH	
143 (P)	Ground	Combination switch OUTPUT 1	Output	Combination switch	All switches OFF (Wiper intermittent dial 4)	0 V
					Front wiper switch HI (Wiper intermittent dial 4)	
					Any of the conditions below with all switches OFF <ul style="list-style-type: none"> <li>• Wiper intermittent dial 1</li> <li>• Wiper intermittent dial 2</li> <li>• Wiper intermittent dial 3</li> <li>• Wiper intermittent dial 6</li> <li>• Wiper intermittent dial 7</li> </ul>	
144 (G)	Ground	Combination switch OUTPUT 2	Output	Combination switch	All switches OFF (Wiper intermittent dial 4)	0 V
					Front washer switch ON (Wiper intermittent dial 4)	
					Any of the conditions below with all switches OFF <ul style="list-style-type: none"> <li>• Wiper intermittent dial 1</li> <li>• Wiper intermittent dial 5</li> <li>• Wiper intermittent dial 6</li> </ul>	
145 (L)	Ground	Combination switch OUTPUT 3	Output	Combination switch (Wiper intermit- tent dial 4)	All switches OFF	0 V
					Front wiper switch INT	
					Front wiper switch LO	
					Lighting switch AUTO	
					Rear fog lamp switch ON	
146 (SB)	Ground	Combination switch OUTPUT 4	Output	Combination switch (Wiper intermit- tent dial 4)	All switches OFF	0 V
					Lighting switch 2ND	
					Lighting switch PASS	
					Turn signal switch LH	

# BCM (BODY CONTROL MODULE)

< ECU DIAGNOSIS INFORMATION >

[COUPE]

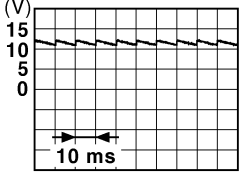
Terminal No. (Wire color)		Description		Condition	Value (Approx.)	
		Signal name	Input/ Output			
+	-					
150 (GR)	Ground	Driver door switch	Input	Driver door switch	OFF (Door close)	 11.8 V
				ON (Door open)	0 V	
151 (G)	Ground	Rear window defog- ger relay control	Output	Rear window defogger	Active	0 V
				Not activated	Battery voltage	

- \*1: Coupe models
- \*2: Roadster models
- \*3: A/T models
- \*4: M/T models
- \*5: With A/T or coupe models with M/T and SynchroRev Match mode
- \*6: With A/T or with M/T without SynchroRev Match mode
- \*7: Without NAVI
- \*8: With rear fog lamp
- \*9: BCM does not use this terminal for control.

A  
B  
C  
D  
E  
F  
G  
H  
I  
J  
K  
L  
M  
N  
O  
P

DEF

# BCM (BODY CONTROL MODULE)

< ECU DIAGNOSIS INFORMATION >

[COUPE]

## Wiring Diagram - BCM -

INFOID:00000009760853

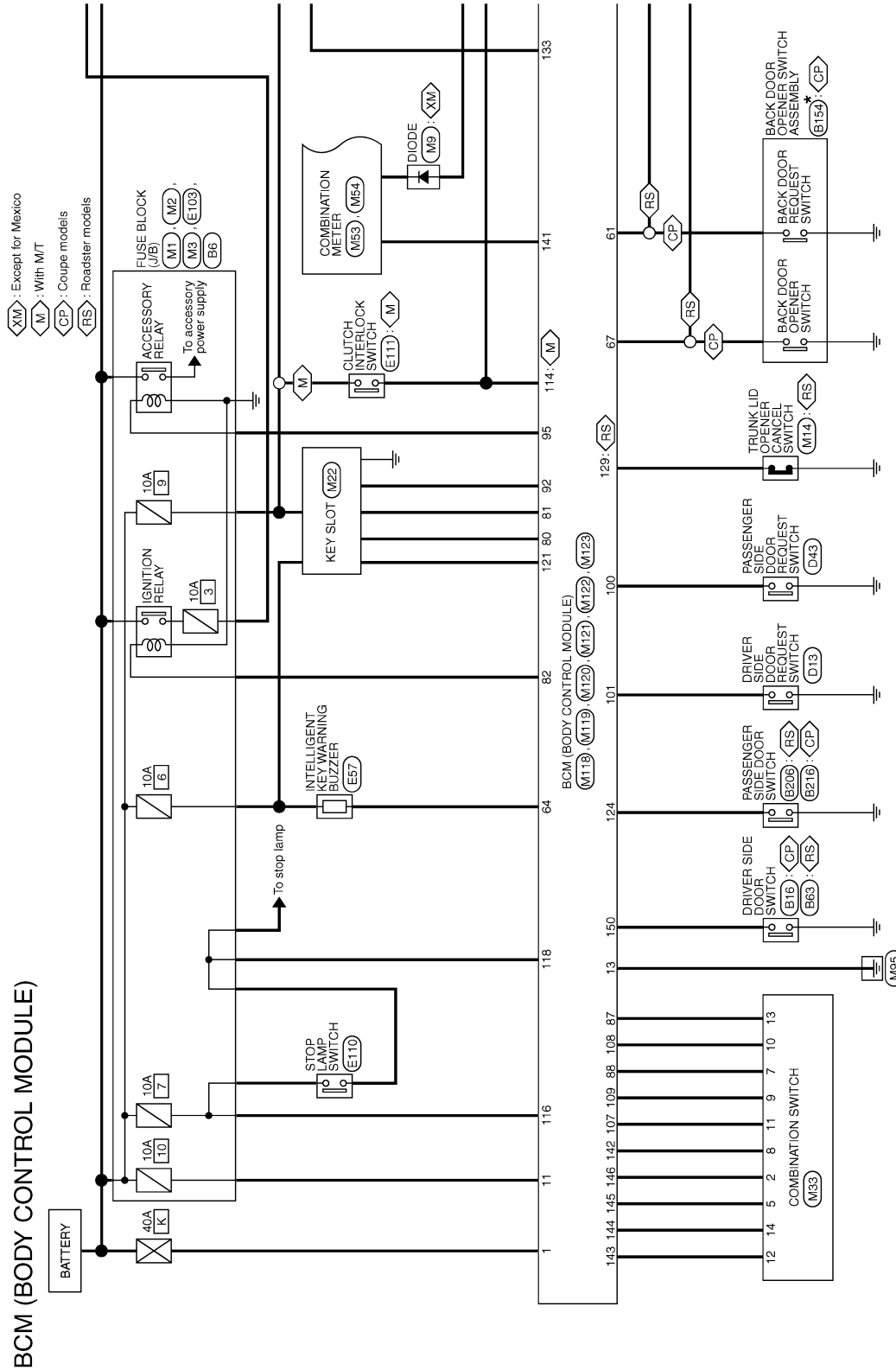

\*: This connector is not shown in "Harness Layout".

2012/04/18

JRMWD0778GB



# BCM (BODY CONTROL MODULE)

< ECU DIAGNOSIS INFORMATION >

[COUPE]

- ◊ XM ◊ : Except for Mexico
- ◊ CP ◊ : Coupe models
- ◊ A ◊ : With AT
- ◊ RS ◊ : Roadster models
- ◊ M ◊ : With M/T
- ◊ CS ◊ : Coupe models with M/T and SynchroRev Match mode

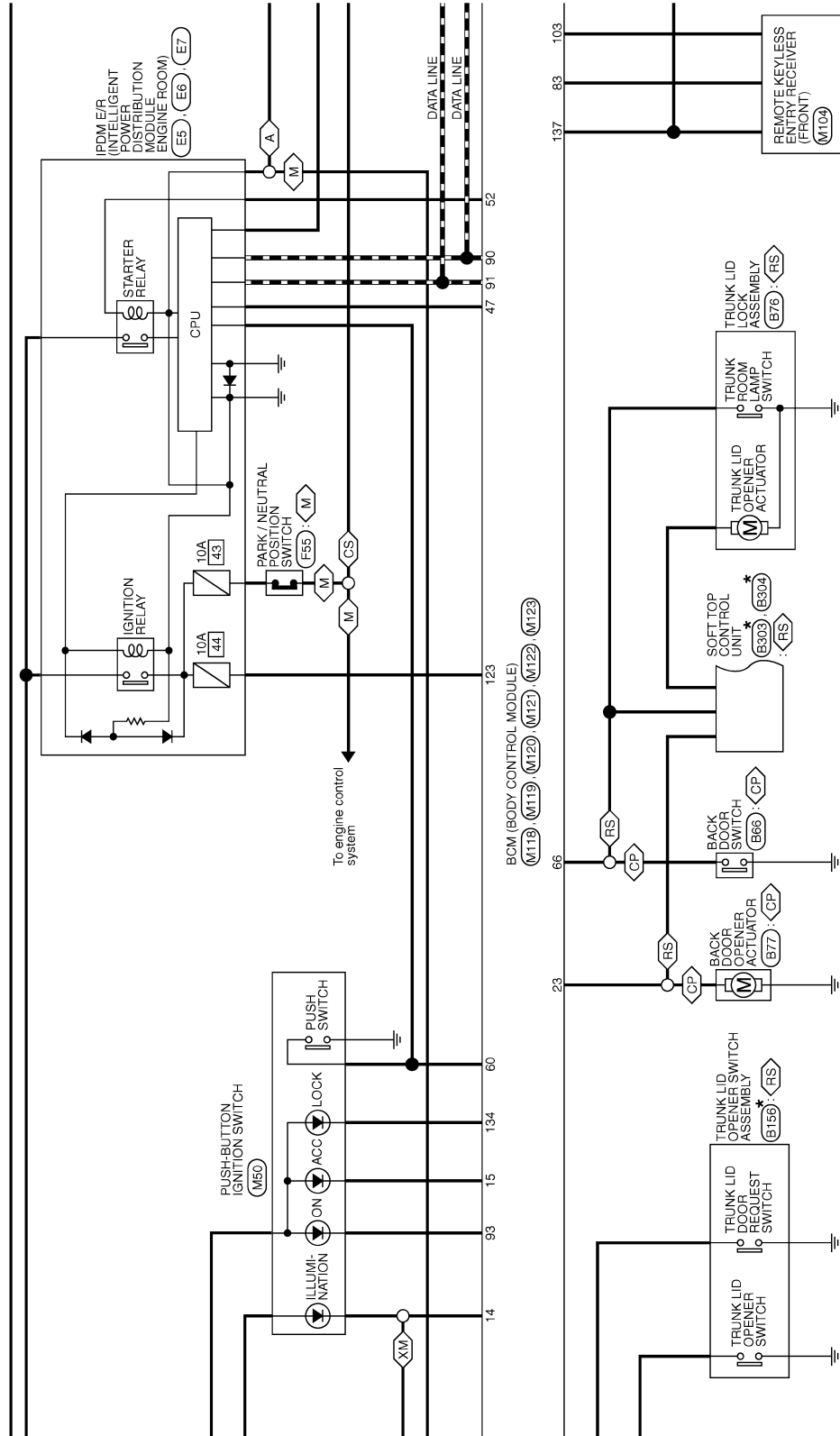

\* : This connector is not shown in "Harness Layout".

JRMWD0779GB

A  
B  
C  
D  
E  
F  
G  
H  
I  
J  
K  
DEF  
M  
N  
O  
P

# BCM (BODY CONTROL MODULE)

< ECU DIAGNOSIS INFORMATION >

[COUPE]

- ◊A◊ : With A/T
- ◊AC◊ : With A/T or coupe models with M/T and SynchroRev Match mode
- ◊AD◊ : With A/T or with M/T without SynchroRev Match mode
- ◊CS◊ : Coupe models with M/T and SynchroRev Match mode
- ◊MC◊ : With M/T without SynchroRev Match mode
- ◊CP◊ : Coupe models
- ◊RS◊ : Roadster models

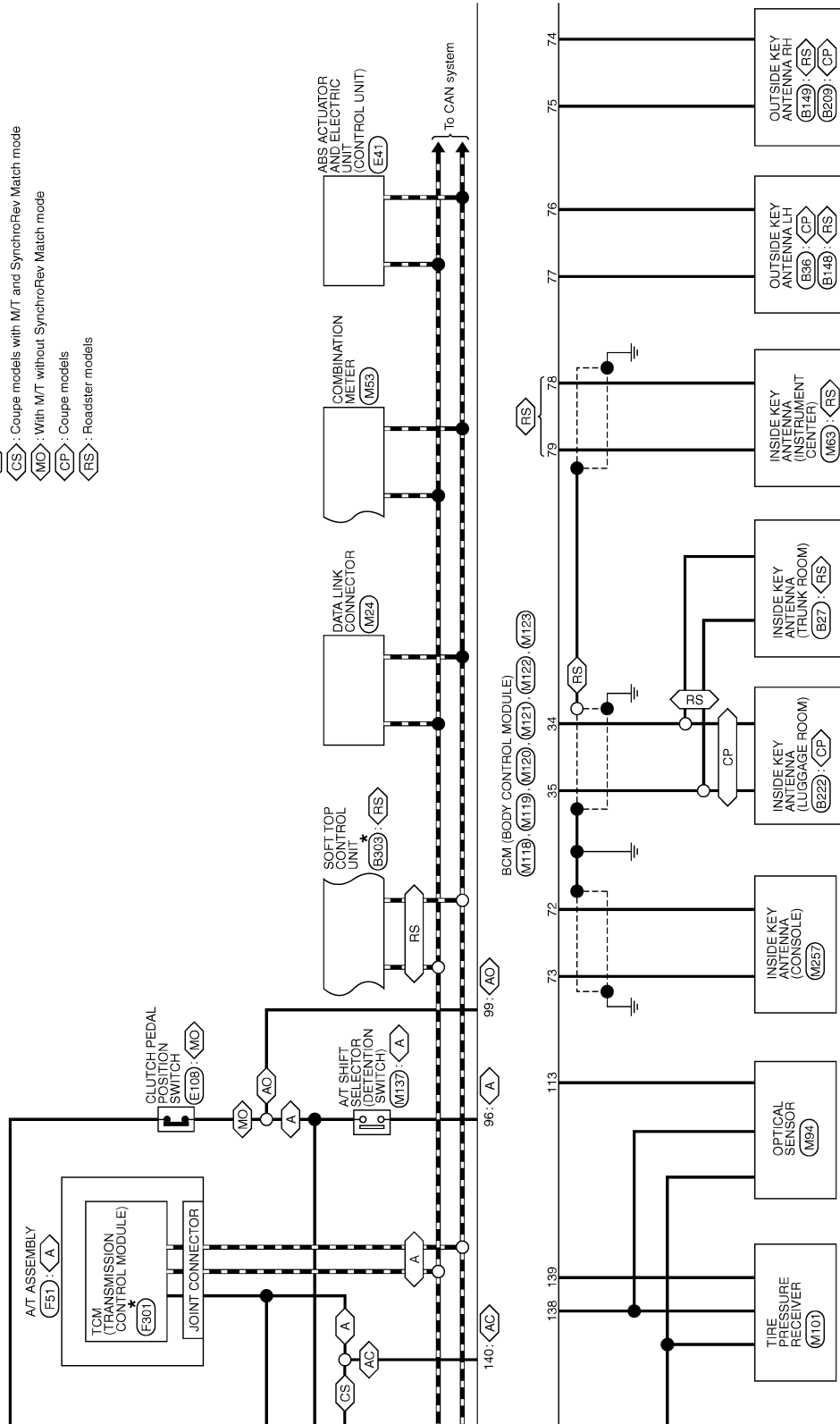

JRMWD0780GB

# BCM (BODY CONTROL MODULE)

< ECU DIAGNOSIS INFORMATION >

[COUPE]

- ◊CF◊ : Coupe models
- ◊RS◊ : Roadster models
- ◊WP◊ : With power seat
- ◊ON◊ : Without NAVI

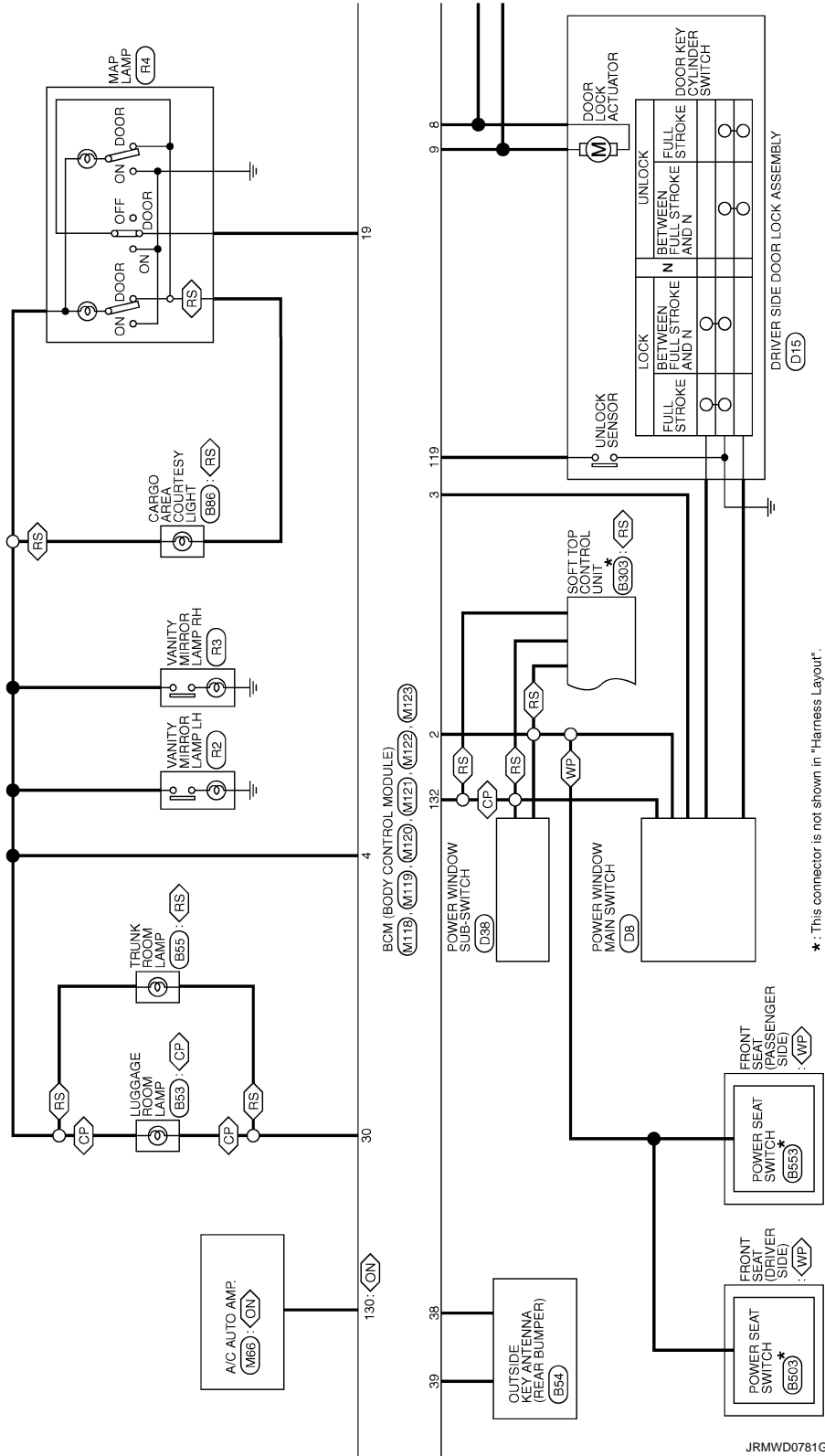

A  
B  
C  
D  
E  
F  
G  
H  
I  
J  
K  
DEF  
M  
N  
O  
P

# BCM (BODY CONTROL MODULE)

< ECU DIAGNOSIS INFORMATION >

[COUPE]

- : With A/T
- : With M/T
- : With rear fog lamp

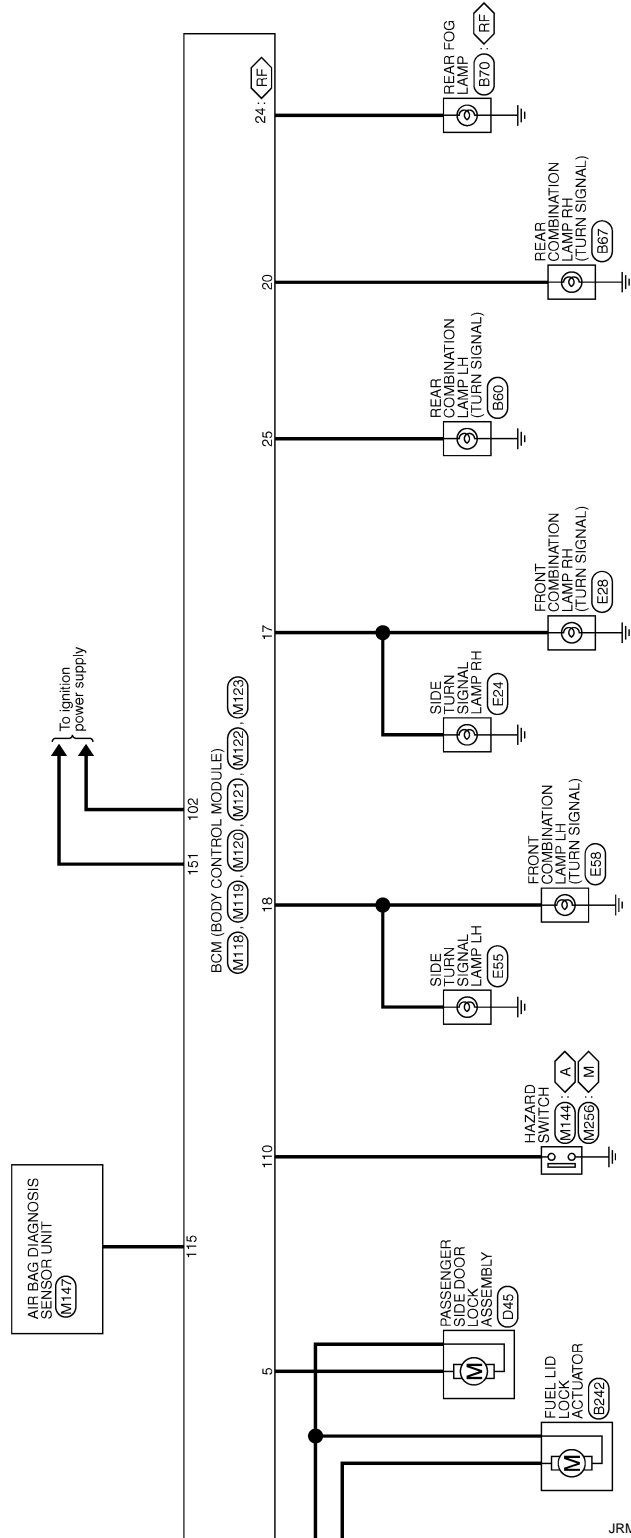

JRMWD0782GB

# BCM (BODY CONTROL MODULE)

< ECU DIAGNOSIS INFORMATION >

[COUPE]

## BCM (BODY CONTROL MODULE)

Connector No.	B8
Connector Name	FUSE BLOCK (J/B)
Connector Type	INS1ZFR-CS



Terminal No.	Color of Wire	Signal Name (Specification)
5G	LG	-
10G	W	- [Coupe models]
11G	P	- [Roadster models]
12G	Y	- [Roadster models]

Connector No.	B16
Connector Name	DRIVER SIDE DOOR SWITCH
Connector Type	A03FW



Terminal No.	Color of Wire	Signal Name (Specification)
2	GR	-

Connector No.	B27
Connector Name	INSIDE KEY ANTENNA (TRUNK ROOM)
Connector Type	RG0ZFGY



Terminal No.	Color of Wire	Signal Name (Specification)
1	V	-
2	SB	-

Connector No.	B38
Connector Name	OUTSIDE KEY ANTENNA LH
Connector Type	RG02M3Y



Terminal No.	Color of Wire	Signal Name (Specification)
1	LG	-
2	V	-

Connector No.	B53
Connector Name	LUGGAGE ROOM LAMP
Connector Type	GJ0ZFGY

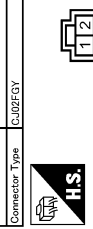

Terminal No.	Color of Wire	Signal Name (Specification)
1	BR	-
2	R	-

Connector No.	B54
Connector Name	OUTSIDE KEY ANTENNA (REAR BUMPER)
Connector Type	RG0ZFGY



Terminal No.	Color of Wire	Signal Name (Specification)
1	W	-
2	B	-

Connector No.	B55
Connector Name	TRUNK ROOM LAMP
Connector Type	S02ZFW



Terminal No.	Color of Wire	Signal Name (Specification)
1	BR	-
2	R	-

Connector No.	B60
Connector Name	REAR COMBINATION LAMP LH
Connector Type	RS0BFCY-FR



Terminal No.	Color of Wire	Signal Name (Specification)
1	G	-
2	R	- [Coupe models]

Connector No.	B63
Connector Name	DRIVER SIDE DOOR SWITCH
Connector Type	A03FW



Terminal No.	Color of Wire	Signal Name (Specification)
2	GR	-
3	B	-

Connector No.	B66
Connector Name	BACK DOOR SWITCH
Connector Type	A03FW



Terminal No.	Color of Wire	Signal Name (Specification)
1	L	-
3	B	-

A  
B  
C  
D  
E  
F  
G  
H  
I  
J  
K  
DEF  
M  
N  
O  
P

JRMWD9611GB

# BCM (BODY CONTROL MODULE)

< ECU DIAGNOSIS INFORMATION >

[COUPE]

## BCM (BODY CONTROL MODULE)

Connector No.	B87
Connector Name	REAR COMBINATION LAMP RH
Connector Type	RS0BFGY-PR



Terminal No.	Color of Wire	Signal Name (Specification)
1	LG	-
2	R	-
3	B	-
4	V	-
6	BG	-

Connector No.	B70
Connector Name	REAR FOG LAMP
Connector Type	RS02FGY

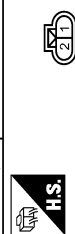

Terminal No.	Color of Wire	Signal Name (Specification)
1	BG	-
2	B	-

Connector No.	B78
Connector Name	TRUNK LID LOCK ASSEMBLY
Connector Type	NS02FH-GS

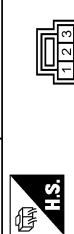

Terminal No.	Color of Wire	Signal Name (Specification)
1	L	-
2	LG	-
3	B	-

Connector No.	B77
Connector Name	BACK DOOR OPENER ACTUATOR
Connector Type	M04FW-LC



Terminal No.	Color of Wire	Signal Name (Specification)
1	Y	-
2	B	-

Connector No.	B88
Connector Name	CARGO AREA COURTESY LIGHT
Connector Type	S02FW



Terminal No.	Color of Wire	Signal Name (Specification)
1	R	-
2	B	-

Connector No.	B148
Connector Name	OUTSIDE KEY ANTENNA LH
Connector Type	RK02MGY

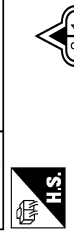

Terminal No.	Color of Wire	Signal Name (Specification)
1	LG	-
2	V	-

Connector No.	B149
Connector Name	OUTSIDE KEY ANTENNA RH
Connector Type	RK02MGY

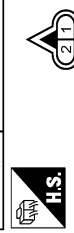

Terminal No.	Color of Wire	Signal Name (Specification)
1	BR	-
2	GR	-

Connector No.	B154
Connector Name	BACK DOOR OPENER SWITCH ASSEMBLY
Connector Type	RH04FB

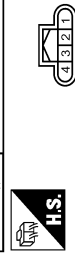

Terminal No.	Color of Wire	Signal Name (Specification)
1	GR	-
2	W	-

Connector No.	B156
Connector Name	TRUNK LID OPENER SWITCH ASSEMBLY
Connector Type	RH04FB

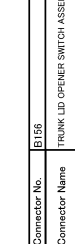

Terminal No.	Color of Wire	Signal Name (Specification)
1	GR	-
2	W	-
3	B	-
4	B	-

Connector No.	B206
Connector Name	PASSENGER SIDE DOOR SWITCH
Connector Type	A03FW

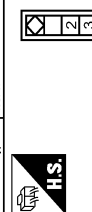

Terminal No.	Color of Wire	Signal Name (Specification)
2	LG	-
3	B	-

JRMWD9612GB

# BCM (BODY CONTROL MODULE)

< ECU DIAGNOSIS INFORMATION >

[COUPE]

## BCM (BODY CONTROL MODULE)

Connector No.	B209
Connector Name	OUTSIDE KEY ANTENNA RH
Connector Type	PK02MGY

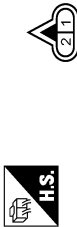

Terminal No.	Color of Wire	Signal Name (Specification)
1	BR	-
2	GR	-

Connector No.	B216
Connector Name	PASSENGER SIDE DOOR SWITCH
Connector Type	A03FW



Terminal No.	Color of Wire	Signal Name (Specification)
2	LG	-

Connector No.	B222
Connector Name	INSIDE KEY ANTENNA (LOUAGRE ROOM)
Connector Type	RK02EGY



Terminal No.	Color of Wire	Signal Name (Specification)
1	Y	-
2	SB	-

Connector No.	B242
Connector Name	FUEL LID LOCK ACTUATOR
Connector Type	M04FW-LC

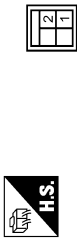

Terminal No.	Color of Wire	Signal Name (Specification)
1	G	-
2	W	-

Connector No.	B303
Connector Name	SOFT TOP CONTROL UNIT
Connector Type	TH40FB-NH

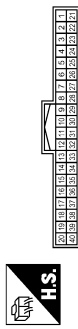

Terminal No.	Color of Wire	Signal Name (Specification)
1	BR	SENSOR POWER SUPPLY (ROOF STRIKER SENSOR LH)
3	DG	ROOF STRIKER SENSOR RH
4	W	ROOF STRIKER SENSOR LH
8	Y	REVERSE SIGNAL
9	SB	POWER CONDITION (POWER WINDOW)
10	O	TRUNK LID OPEN SIGNAL
11	O	ROOF STATUS SIGNAL (AUDIO)
14	T	ROOF OPEN / CLOSE SWITCH (CLOSE)
15	LG	ROOF OPEN / CLOSE SWITCH (OPEN)
18	V	TRUNK ROOM LAMP SWITCH
17	EG	CAN-H
18	P	CAN-L
19	LG	LOCAL COMMUNICATION (POWER WINDOW)
20	V	LOCAL COMMUNICATION (ECM)
21	BR	SENSOR POWER SUPPLY (ROOF STRIKER SENSOR RH)
29	DG	GROUND
35	P	ROOF OPEN / CLOSE SWITCH (GND)

Connector No.	B304
Connector Name	SOFT TOP CONTROL UNIT
Connector Type	NS12FW-CS

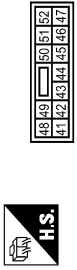

Terminal No.	Color of Wire	Signal Name (Specification)
41	DG	TRUNK OPENER ACTUATOR
48	R	REAR WINDOW DEF IN 2
49	R	REAR WINDOW DEF IN 1

Connector No.	B503
Connector Name	POWER SEAT SWITCH
Connector Type	M06MW-LC

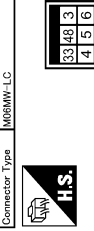

Terminal No.	Color of Wire	Signal Name (Specification)
3	O	-
4	L	-
5	W/R	-
6	W	-
33	R	-
48	B	-

Connector No.	B553
Connector Name	POWER SEAT SWITCH
Connector Type	M06MW-LC

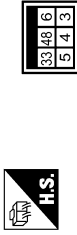

Terminal No.	Color of Wire	Signal Name (Specification)
3	O	-
4	L	-
5	W/R	-
6	W	-
33	R	-
48	B	-

Connector No.	D8
Connector Name	POWER WINDOW MAIN SWITCH
Connector Type	NS18FW-CS

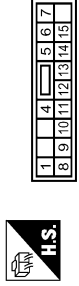

Terminal No.	Color of Wire	Signal Name (Specification)
1	W	-
4	Y	-
5	BG	-
8	GR	-
7	Y	-
9	LG	-
10	V	-
11	BR	-
12	SB	- [Coupe models]
13	R	- [Rear-drive models]
14	O	-
15	B	-

A  
B  
C  
D  
E  
F  
G  
H  
I  
J  
K  
DEF  
M  
N  
O  
P

JRMWD9613GB

# BCM (BODY CONTROL MODULE)

< ECU DIAGNOSIS INFORMATION >

[COUPE]

## BCM (BODY CONTROL MODULE)

Connector No.	D13
Connector Name	DRIVER SIDE DOOR REQUEST SWITCH
Connector Type	RK02FL



Terminal No.	Color of Wire	Signal Name [Specification]
1	W	-
2	B	-

Connector No.	D15
Connector Name	DRIVER SIDE DOOR LOCK ASSEMBLY
Connector Type	ED0FCY-RS



Terminal No.	Color of Wire	Signal Name [Specification]
1	BG	-
2	G	-
3	SB	-
4	B	-
5	V	-
6	GR	-

Connector No.	D38
Connector Name	POWER WINDOW SUB-SWITCH
Connector Type	NS1BEF-CS



Terminal No.	Color of Wire	Signal Name [Specification]
3	G	-
4	BG	-
8	L	-
9	BR	-
10	W	-
11	B	-
12	R	-
14	Y	-
15	LG	-
16	Y	-

Connector No.	D43
Connector Name	PASSENGER SIDE DOOR REQUEST SWITCH
Connector Type	RK02FL



Terminal No.	Color of Wire	Signal Name [Specification]
1	B	-
2	G	-

Connector No.	D45
Connector Name	PASSENGER SIDE DOOR LOCK ASSEMBLY
Connector Type	ED0FCY-RS



Terminal No.	Color of Wire	Signal Name [Specification]
1	V	-
2	LG	-

Connector No.	E5
Connector Name	ENGINE ROOM INTELLIGENT POWER DISTRIBUTION MODULE
Connector Type	TH0BFY-IM-1V



Terminal No.	Color of Wire	Signal Name [Specification]
4	V	-
5	L	-
7	R	-
7	V	- [Roadster models]
12	B/W	-
13	Y	-
16	LG	-
19	W	-
25	G	-
27	Y	-
28	L	-
30	GR	-
36	G	-

Connector No.	E6
Connector Name	ENGINE ROOM INTELLIGENT POWER DISTRIBUTION MODULE
Connector Type	TH0BFY-RH



Terminal No.	Color of Wire	Signal Name [Specification]
39	P	-
40	L	-
41	B/W	-
42	Y	-
43	SB	-
44	W	-
45	G	-
46	V	-

Connector No.	E7
Connector Name	ENGINE ROOM INTELLIGENT POWER DISTRIBUTION MODULE
Connector Type	TH0BFY-OS1P-M4

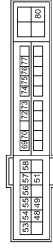

Terminal No.	Color of Wire	Signal Name [Specification]
48	L	-
49	BG	-
51	Y	-
53	W	-
54	V	-
55	SB	-
56	LG	-
57	G	-
58	P	-
69	BR	-
70	BG	-
72	GR	-
73	GR	-
74	G	-
75	SB	-
76	Y	-
77	R	-
80	W	-

Connector No.	E24
Connector Name	SIDE TURN SIGNAL LAMP RH
Connector Type	RK02FCY



Terminal No.	Color of Wire	Signal Name [Specification]
1	V	-
2	B	-



# BCM (BODY CONTROL MODULE)

< ECU DIAGNOSIS INFORMATION >

[COUPE]

## BCM (BODY CONTROL MODULE)

Connector No.	E28
Connector Name	FRONT COMBINATION LAMP RH
Connector Type	RS0BFGY-PR



Terminal No.	Color of Wire	Signal Name (Specification)
3	B	-
4	B/W	-
5	R	-
6	LG	-
7	BR	-
8	P	-

Connector No.	E41
Connector Name	ABS ACTIVATOR AND ELECTRIC UNIT (CONTROL UNIT)
Connector Type	BAA4ZFB-AH24-LH

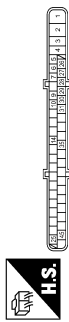

Terminal No.	Color of Wire	Signal Name (Specification)
1	B	GROUND
2	G	UBMR
3	R	UBVR
4	B	GROUND
5	Y	DS FL
6	EG	DS RL
7	BR	DS PR
8	B	DS FR
10	W	DS FR
14	Y	GAN-L
23	Y	BUS-L
26	LG	DP-FL
27	GR	DS RL
28	G	UZ
29	P	DS RR
30	SB	BLS

31	R	VDC OFF SW
35	L	GAN-H
45	B	BUS-H

Connector No.	E55
Connector Name	SIDE TURN SIGNAL LAMP LH
Connector Type	RK0ZFGY



Terminal No.	Color of Wire	Signal Name (Specification)
1	GR	- [Coupe models]
2	B	- [Reader models]

Connector No.	E57
Connector Name	INTELLIGENT KEY WARNING BUZZER
Connector Type	RK03FER



Terminal No.	Color of Wire	Signal Name (Specification)
1	LG	+BATT (VOL SMALL)
3	R	BUZZER SIGNAL

Connector No.	E58
Connector Name	FRONT COMBINATION LAMP LH
Connector Type	RS0BFGY-PR



Terminal No.	Color of Wire	Signal Name (Specification)
3	B	-
4	B/W	-
5	P	-
6	GR	-
7	LG	-
8	EG	-

Connector No.	E103
Connector Name	FUSE BLOCK (J/B)
Connector Type	NS18FW-CS

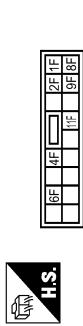

Terminal No.	Color of Wire	Signal Name (Specification)
1F	SB	-
2F	W	-
4F	G	-
6F	EG	-
8F	L	-
8F	B	- [Coupe models]
8F	Y	- [Reader models]
11F	W	-

Connector No.	E108
Connector Name	CLUTCH PEDAL POSITION SWITCH
Connector Type	IS02FL



Terminal No.	Color of Wire	Signal Name (Specification)
1	SB	- [With SynchroRev Match mode]
1	G	- [Without SynchroRev Match mode]
2	B	- [With SynchroRev Match mode]
2	BR	- [Without SynchroRev Match mode]

Connector No.	E110
Connector Name	STOP LAMP SWITCH
Connector Type	MD4FW-LC

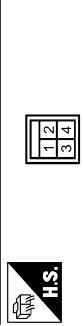

Terminal No.	Color of Wire	Signal Name (Specification)
1	L	-
2	W	-
3	G	-
4	P	-

A  
B  
C  
D  
E  
F  
G  
H  
I  
J  
K  
M  
N  
O  
P

DEF

JRMWD9615GB

# BCM (BODY CONTROL MODULE)

< ECU DIAGNOSIS INFORMATION >

[COUPE]

## BCM (BODY CONTROL MODULE)

Connector No.	E111
Connector Name	GLITCH INTERLOCK SWITCH
Connector Type	ISOFL



Terminal No.	Color of Wire	Signal Name [Specification]
1	G	-
2	GR	-

Connector No.	F51
Connector Name	A/T ASSEMBLY
Connector Type	RK10FC-DGY

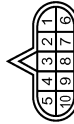

Terminal No.	Color of Wire	Signal Name [Specification]
1	Y	POWER SUPPLY
2	BR	POWER SUPPLY (MEMORY BACK-UP)
3	L	CAN-H
4	V	K-LINE
5	B	GROUND
6	Y	POWER SUPPLY
7	W	BACK-UP LAMP RELAY
8	P	CAN-L
9	GR	STARTER RELAY
10	B	GROUND

Connector No.	F35
Connector Name	PARK / NEUTRAL POSITION SWITCH
Connector Type	RK02FB



Terminal No.	Color of Wire	Signal Name [Specification]
1	G	-
2	W	-

Connector No.	F301
Connector Name	TCM (TRANSMISSION CONTROL MODULE)
Connector Type	SP10FG

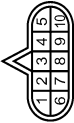

Terminal No.	Color of Wire	Signal Name [Specification]
1	W	POWER SUPPLY
2	B	POWER SUPPLY (MEMORY BACK-UP)
3	R	CAN-H
4	O	K-LINE
5	G	GROUND
6	GR	POWER SUPPLY
7	L	BACK-UP LAMP RELAY
8	BR	CAN-L
9	Y	STARTER RELAY
10	W/B	GROUND

Connector No.	M1
Connector Name	FUSE BLOCK (J/B)
Connector Type	NS10FY-M2



Terminal No.	Color of Wire	Signal Name [Specification]
1A	V	-
2A	G	-
3A	L	-
4A	P	-
5A	L	-
6A	Y	-
7A	BR	-
8A	L	-

Connector No.	M2
Connector Name	FUSE BLOCK (J/B)
Connector Type	NS10FY-CS



Terminal No.	Color of Wire	Signal Name [Specification]
3B	P	-
4B	G	-
5B	O	-
6B	Y	-
8B	R	-
8B	SB	-

Connector No.	M3
Connector Name	FUSE BLOCK (J/B)
Connector Type	NS10FY-CS



Terminal No.	Color of Wire	Signal Name [Specification]
6C	R	-
7C	B	-
9C	O	-
10C	L	-
11C	LG	-
12C	O	-

Connector No.	M9
Connector Name	DIODE
Connector Type	Z4335-C3960



Terminal No.	Color of Wire	Signal Name [Specification]
1	W	-
2	R	-

JRMWD9616GB

# BCM (BODY CONTROL MODULE)

< ECU DIAGNOSIS INFORMATION >

[COUPE]

## BCM (BODY CONTROL MODULE)

Connector No.	M14
Connector Name	TRUNK LID OPENER CANCEL SWITCH
Connector Type	S02FW



Terminal No.	Color of Wire	Signal Name [Specification]
1	O	-
2	B	-

Connector No.	M22
Connector Name	KEY SLOT
Connector Type	TH12FW-NH

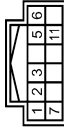

Terminal No.	Color of Wire	Signal Name [Specification]
1	P	BAT
2	GR	CLOCK
3	W	DATA
5	Y	ILL BATT
6	LG	ILL
7	B	GROUND
11	R	KEY SWITCH SIGNAL

Connector No.	M24
Connector Name	DATA LINK CONNECTOR
Connector Type	BD18FW

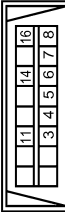

Terminal No.	Color of Wire	Signal Name [Specification]
3	LG	- [Coupe models]
3	Y	- [Reader models]
4	B	-
5	B	-
6	L	-
7	Y	-
8	G	-
11	Y	- [Coupe models]
11	LG	- [Reader models]
14	P	-
16	Y	-

Connector No.	M33
Connector Name	COMBINATION SWITCH
Connector Type	TH18FW-NH



Terminal No.	Color of Wire	Signal Name [Specification]
1	P	FR WASHERR (-)
2	SB	OUTPUT 4
3	W	WASHER MOTOR
4	G	WASHER WATE POWER SUPPLY
5	L	OUTPUT 3
6	B	GROUND
7	V	INPUT 3
8	O	OUTPUT 5
9	Y	INPUT 2
10	R	INPUT 4
11	LG	INPUT 1

12	P	OUTPUT 1
13	BR	INPUT 5
14	G	OUTPUT 2

Connector No.	M50
Connector Name	PUSH-BUTTON IGNITION SWITCH
Connector Type	TK08FER



Terminal No.	Color of Wire	Signal Name [Specification]
1	B	-
2	R	-
3	G	-
4	BR	-
5	GR	-
6	Y	-
7	V	-
8	P	-

Connector No.	M53
Connector Name	COMBINATION METER
Connector Type	TH24FW-NH



Terminal No.	Color of Wire	Signal Name [Specification]
1	V	BATTERY POWER SUPPLY
2	O	IGNITION SIGNAL
3	L	VEHICLE SPEED SIGNAL (2-PULSE)
4	V	VEHICLE SPEED SIGNAL (1-PULSE) (Except for Mexico)
5	B	VEHICLE SPEED SIGNAL (3-PULSE) (For Mexico)
6	R	ILLUMINATION CONTROL SIGNAL
8	Y	ROOF STATUS SIGNAL
9	BR	COMMUNICATION SIGNAL (METER->TRIPLE METER)

10	L	COMMUNICATION SIGNAL (TRIPLE METER->METER)
11	Y	AT SNOW
12	G	S-MODE SWITCH SIGNAL
15	L	ACC POWER SUPPLY
16	R	AIR BAG SIGNAL
17	B	GROUND
18	V	AMBIENT SENSOR SIGNAL
19	G	A/C AUTO AMP. CONNECTION RECOGNITION SIGNAL
20	GR	AMBIENT SENSOR GROUND
21	L	CAN-H
22	P	CAN-L
23	B	GROUND
24	Y	FUEL LEVEL SENSOR GROUND

Connector No.	M54
Connector Name	COMBINATION METER
Connector Type	TH18FW-NH



Terminal No.	Color of Wire	Signal Name [Specification]
25	W	ALTERNATOR SIGNAL
26	O	PARKING BRAKE SWITCH SIGNAL
27	LG	BRAKE FLUID LEVEL SWITCH SIGNAL
28	Y	SECURITY SIGNAL
29	GR	WASHER LEVEL SWITCH SIGNAL
32	G	PADDLE SHIFTER DOWN SIGNAL
33	O	PADDLE SHIFTER UP SIGNAL
34	BR	FUEL LEVEL SENSOR SIGNAL
35	L	SEAT BELT BUCKLE SWITCH SIGNAL (DRIVER SIDE)
36	P	PASSENGER SEAT BELT WARNING SIGNAL (Except for Mexico)
37	C	NON-MANUAL MODE SIGNAL
38	V	MANUAL MODE SHIF DOWN SIGNAL
39	L	MANUAL MODE SHIF UP SIGNAL
40	W	MANUAL MODE SIGNAL

A  
B  
C  
D  
E  
F  
G  
H  
I  
J  
K  
M  
N  
O  
P

DEF

# BCM (BODY CONTROL MODULE)

< ECU DIAGNOSIS INFORMATION >

[COUPE]

## BCM (BODY CONTROL MODULE)

Connector No.	M83
Connector Name	INSIDE KEY ANTENNA (INSTRUMENT CENTER)
Connector Type	TK02FGY

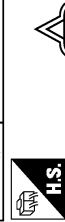

Terminal No.	Color of Wire	Signal Name [Specification]
1	R	-
2	L	-

Connector No.	M66
Connector Name	A/C AUTO AMP.
Connector Type	SAE4DFW

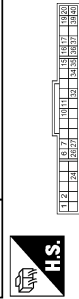

Terminal No.	Color of Wire	Signal Name [Specification]
1	L	CAN-H
2	P	CAN-L
6	L	TX (AMP/CONT)
7	P	RX (CONT/AMP)
10	BR	LAN SIGNAL
11	Y	EACH DOOR MOTOR POWER SUPPLY
15	O	SUNLOAD SENSOR SIGNAL
16	R	INTAKE SENSOR SIGNAL
17	L	ACC POWER SUPPLY
19	B	GROUND
20	G	IGNITION POWER SUPPLY
24	O	ECV SIGNAL
26	R	REAR WINDOW DEFOGGER FEEDBACK SIGNAL
27	L	REAR WINDOW DEFOGGER ON SIGNAL
32	P	BLOWER MOTOR CONTROL SIGNAL
34	G	A/C AUTO AMP CONNECTION RECOGNITION SIGNAL
35	V	AMBIENT SENSOR SIGNAL
39	LG	IN-VEHICLE SENSOR SIGNAL
37	GR	SENSOR GROUND
39	B	GROUND

40	Y	BATTERY POWER SUPPLY
----	---	----------------------

Connector No.	M84
Connector Name	OPTICAL SENSOR
Connector Type	TK03FW



Terminal No.	Color of Wire	Signal Name [Specification]
1	V	POWER
2	O	OUTPUT
3	P	GROUND

Connector No.	M101
Connector Name	TIRE PRESSURE RECEIVER
Connector Type	TK04FW

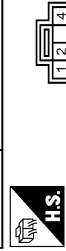

Terminal No.	Color of Wire	Signal Name [Specification]
1	P	GROUND
2	L	SIGNAL
4	V	BATTERY

Connector No.	M104
Connector Name	REMOTE KEYLESS ENTRY RECEIVER (FRONT)
Connector Type	JAB04FB

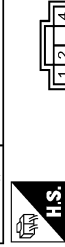

Terminal No.	Color of Wire	Signal Name [Specification]
1	P	GROUND
2	GR	SIGNAL OUTPUT
4	LG	BATTERY

Connector No.	M118
Connector Name	BCM (BODY CONTROL MODULE)
Connector Type	M03FB-LC

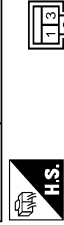

Terminal No.	Color of Wire	Signal Name [Specification]
1	W	BAT (F/L)
2	W	POWER WINDOW POWER SUPPLY (BAT)
3	Y	POWER WINDOW POWER SUPPLY (IGN)

Connector No.	M119
Connector Name	BCM (BODY CONTROL MODULE)
Connector Type	NS18EY-CS

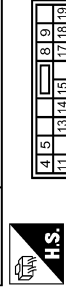

Terminal No.	Color of Wire	Signal Name [Specification]
4	W	11
5	W	13
8	W	14
9	W	15
18	W	17
19	W	18
19	W	19

4	R	INTERIOR ROOM LAMP POWER SUPPLY
5	G	PASSENGER DOOR UNLOCK OUTPUT
8	V	ALL DOOR FUEL LID LOCK OUTPUT
9	G	DRIVER DOOR FUEL LID UNLOCK OUTPUT
11	BR	BAT (FUSE)
13	B	GROUND
14	R	PUSH-BUTTON IGNITION SW ILL GND
15	Y	ACC IND
17	W	TURN SIGNAL RH (FRONT, SIDE)
18	O	TURN SIGNAL LH (FRONT, SIDE)
19	P	ROOM LAMP TIMER CONTROL

Connector No.	M120
Connector Name	BCM (BODY CONTROL MODULE)
Connector Type	NS12FY-CS

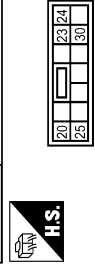

Terminal No.	Color of Wire	Signal Name [Specification]
20	V	TURN SIGNAL RH (REAR)
23	L	BACK DOOR OPEN OUTPUT [Coupe models]
23	Y	TRUNK LID OPEN OUTPUT [Sedan models]
24	O	REAR FOG OUTPUT
25	LG	TURN SIGNAL LH (REAR)
30	R	LUGGAGE/TRUNK ROOM LAMP OUTPUT

# BCM (BODY CONTROL MODULE)

< ECU DIAGNOSIS INFORMATION >

[COUPE]

## BCM (BODY CONTROL MODULE)

Connector No.	M121
Connector Name	BCM (BODY CONTROL MODULE)
Connector Type	TH40FG-NH

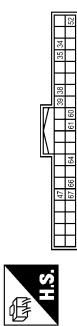

Terminal No.	Color of Wire	Signal Name (Specification)
34	G	LUGGAGE/TRUNK ROOM ANT-
35	R	LUGGAGE/TRUNK ROOM ANT+
38	B	REAR BUMPER ANT-
39	W	REAR BUMPER ANT+
47	V	IGN RELAY (IPDM E/R) CONT
52	SB	STARTER RELAY CONT
60	BR	PUSH SW
61	W	BACK DOOR/TRUNK LID DOOR REQUEST SW
64	G	1-KEY WARN BUZZER (ENG ROOM)
66	R	BACK DOOR/TRUNK ROOM LAMP SW
67	GR	BACK DOOR/TRUNK LID OPENER SW

Connector No.	M122
Connector Name	BCM (BODY CONTROL MODULE)
Connector Type	TH40FE-NH

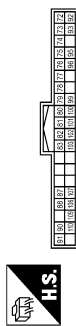

Terminal No.	Color of Wire	Signal Name (Specification)
72	L	ROOM ANT 2-
73	P	ROOM ANT 2+
74	SB	PASSENGER DOOR ANT-
75	BR	PASSENGER DOOR ANT+
76	V	DRIVER DOOR ANT-
77	LG	DRIVER DOOR ANT+
78	L	ROOM ANT 1-
79	R	ROOM ANT 1+
80	GR	MATS ANT AMP-
81	W	MATS ANT AMP+
82	R	IGN RELAY (P/B) CONT

83	GR	KYLS ENT RECEIVER (FRONT) COMM
87	BR	COMBI SW INPUT 5
88	V	COMBI SW INPUT 3
90	P	CAN-L
91	L	CAN-H
92	LG	KEY SLOT ILL
93	V	ON IND
95	O	ACC RELAY CONT
96	Y	A/T SHIFT SELECTOR POWER SUPPLY
99	R	SHIFT P/CLUTCH PEDAL POS SW
100	GR	PASSENGER DOOR REQUEST SW
101	Y	DRIVER DOOR REQUEST SW
102	O	BLOWER FAN MOTOR RELAY CONT
103	LG	KYLS ENT RECEIVER (FRONT) PMR SUPPLY
107	LG	COMBI SW INPUT 4
108	R	COMBI SW INPUT 1
109	Y	COMBI SW INPUT 2
110	P	HAZARD SW

Connector No.	M123
Connector Name	BCM (BODY CONTROL MODULE)
Connector Type	TH40FG-NH

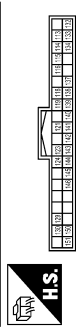

Terminal No.	Color of Wire	Signal Name (Specification)
113	O	OPTICAL SENSOR
114	R	CLUTCH INTERLOCK SW
115	O	STOP LAMP SW 1
116	SB	STOP LAMP SW 2
118	P	DR DOOR UNLOCK SENSOR
119	SB	KEY SLOT SW
121	R	IGN L2/B
123	W	PASSENGER DOOR SW
124	LG	TRUNK LID OPENER CANCEL SW
126	O	REG DEFROGGER SW
129	V	P/B SW & SEAT LOCK (Consider models)
132	Y	POWER WINDOW SW COMM (Consider models)
133	G	PUSH BUTTON POSITION SW ILL POWER
134	GR	LOCK IND
137	P	RECEIVER SENSOR GND
138	V	RECEIVER & SENSOR POWER SUPPLY
139	L	THE PRESS RECEV COMM

140	G	P/N POSITION
141	Y	SECURITY INDICATOR
142	O	COMBI SW OUTPUT 5
143	P	COMBI SW OUTPUT 1
144	G	COMBI SW OUTPUT 2
145	L	COMBI SW OUTPUT 3
146	SB	COMBI SW OUTPUT 4
150	GR	DRIVER DOOR SW
151	G	REAR WINDOW DEFOGGER RELAY CONT

Connector No.	M137
Connector Name	A/T SHIFT SELECTOR
Connector Type	TK10FW



Terminal No.	Color of Wire	Signal Name (Specification)
1	W	-
2	V	-
3	L	-
4	B	-
5	G	-
6	R	-
7	W	-
8	P	-
9	Y	-
10	R	-

Connector No.	M144
Connector Name	HAZARD SWITCH
Connector Type	TR60FW

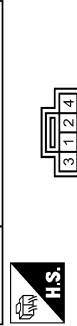

Terminal No.	Color of Wire	Signal Name (Specification)
1	GR	GROUND

2	P	BCM
3	R	ILL+
4	B	ILL-

Connector No.	M147
Connector Name	AIR BAG DIAGNOSIS SENSOR UNIT
Connector Type	NH28FY-EX

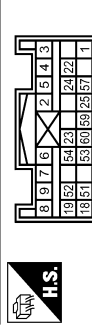

Terminal No.	Color of Wire	Signal Name (Specification)
1	LG	IGN
2	B	GND
3	Y	DR 1 (+)
4	Y	DR 1 (-) DR 2 (-)
5	Y	DR 2 (+)
6	Y	AS 1 (+)
7	Y	AS 1 (-)
8	Y	AS 2 (+)
9	Y	AS 2 (-)
18	R	EGS (+)
19	L	EGS (-)
22	SHIELD	GND
23	R	AIRBAG W/L
24	P	SEAT BELT
25	R	CUTOFF TELLTALE
51	W	SATELLITE RH2 (+)
52	B	SATELLITE RH2 (-)
53	Y	SATELLITE LH2 (+)
54	BR	SATELLITE LH2 (-)
57	O	DEPLOYMENT INFORMATION OUTPUT
58	L	CAN-H
60	P	CAN-L

A  
B  
C  
D  
E  
F  
G  
H  
I  
J  
K  
M  
N  
O  
P

DEF

JRMWD9619GB

# BCM (BODY CONTROL MODULE)

< ECU DIAGNOSIS INFORMATION >

[COUPE]

## BCM (BODY CONTROL MODULE)

Connector No.	M256
Connector Name	HAZARD SWITCH
Connector Type	TK04FW



Terminal No.	Color of Wire	Signal Name [Specification]
1	B	GROUND
2	G	BCM
3	SB	ILL+
4	BG	ILL- [Coupe models]
	O	ILL- [Roadster models]

Connector No.	M257
Connector Name	INSIDE KEY ANTENNA (CONSOLE)
Connector Type	FK02FGY



Terminal No.	Color of Wire	Signal Name [Specification]
1	P	- [Coupe models]
1	G	- [Roadster models]
2	L	- [Coupe models]
2	R	- [Roadster models]

Connector No.	R2
Connector Name	VANITY MIRROR LAMP LH
Connector Type	MCA02FW



Terminal No.	Color of Wire	Signal Name [Specification]
1	B	-
2	R	-

Connector No.	R3
Connector Name	VANITY MIRROR LAMP RH
Connector Type	MCA02FW



Terminal No.	Color of Wire	Signal Name [Specification]
1	B	-
2	R	-

Connector No.	R4
Connector Name	MAP LAMP
Connector Type	TK08FGY



Terminal No.	Color of Wire	Signal Name [Specification]
1	R	-
2	V	-

3	B
4	SB
5	Y
6	GR

## Fail-safe

### FAIL-SAFE CONTROL BY DTC

BCM performs fail-safe control when any DTC are detected.

JRMWD9620GB

INFOID:000000009760854

# BCM (BODY CONTROL MODULE)

< ECU DIAGNOSIS INFORMATION >

[COUPE]

Display contents of CONSULT	Fail-safe	Cancellation
B2190: NATS ANTENNA AMP	Inhibit engine cranking	Erase DTC
B2191: DIFFERENCE OF KEY	Inhibit engine cranking	Erase DTC
B2192: ID DISCORD BCM-ECM	Inhibit engine cranking	Erase DTC
B2193: CHAIN OF BCM-ECM	Inhibit engine cranking	Erase DTC
B2195: ANTI SCANNING	Inhibit engine cranking	Ignition switch ON → OFF
B2560: STARTER CONT RELAY	Inhibit engine cranking	500 ms after the following CAN signal communication status becomes consistent <ul style="list-style-type: none"> <li>• Starter control relay signal</li> <li>• Starter relay status signal</li> </ul>
B2608: STARTER RELAY	Inhibit engine cranking	500 ms after the following signal communication status becomes consistent <ul style="list-style-type: none"> <li>• Starter motor relay control signal</li> <li>• Starter relay status signal (CAN)</li> </ul>
B260A: IGNITION RELAY	Inhibit engine cranking	500 ms after the following conditions are fulfilled <ul style="list-style-type: none"> <li>• IGN relay (IPDM E/R) control signal: OFF (Battery voltage)</li> <li>• Ignition ON signal (CAN to IPDM E/R): OFF (Request signal)</li> <li>• Ignition ON signal (CAN from IPDM E/R): OFF (Condition signal)</li> </ul>
B260F: ENG STATE SIG LOST	Maintains the power supply position attained at the time of DTC detection	When any of the following conditions are fulfilled <ul style="list-style-type: none"> <li>• Power position changes to ACC</li> <li>• Receives engine status signal (CAN)</li> </ul>
B2617: STARTER RELAY CIRC	Inhibit engine cranking	1 second after the starter motor relay control inside BCM becomes normal
B2618: BCM	Inhibit engine cranking	1 second after the ignition relay (IPDM E/R) control inside BCM becomes normal
B261E: VEHICLE TYPE	Inhibit engine cranking	BCM initialization
B26E8: CLUTCH SW	Inhibit engine cranking	When any of the following BCM recognition conditions are fulfilled <ul style="list-style-type: none"> <li>• Status 1 <ul style="list-style-type: none"> <li>- Clutch switch signal (CAN from ECM): ON</li> <li>- Clutch interlock switch signal: OFF (0 V)</li> </ul> </li> <li>• Status 2 <ul style="list-style-type: none"> <li>- Clutch switch signal (CAN from ECM): OFF</li> <li>- Clutch interlock switch signal: ON (Battery voltage)</li> </ul> </li> </ul>

## DTC Inspection Priority Chart

INFOID:000000009760855

If some DTCs are displayed at the same time, perform inspections one by one based on the following priority chart.

Priority	DTC
1	B2562: LOW VOLTAGE
2	<ul style="list-style-type: none"> <li>• U1000: CAN COMM CIRCUIT</li> <li>• U1010: CONTROL UNIT (CAN)</li> </ul>
3	<ul style="list-style-type: none"> <li>• B2190: NATS ANTENNA AMP</li> <li>• B2191: DIFFERENCE OF KEY</li> <li>• B2192: ID DISCORD BCM-ECM</li> <li>• B2193: CHAIN OF BCM-ECM</li> <li>• B2195: ANTI SCANNING</li> </ul>

# BCM (BODY CONTROL MODULE)

< ECU DIAGNOSIS INFORMATION >

[COUPE]

Priority	DTC
4	<ul style="list-style-type: none"> <li>• B2553: IGNITION RELAY</li> <li>• B2555: STOP LAMP</li> <li>• B2556: PUSH-BTN IGN SW</li> <li>• B2557: VEHICLE SPEED</li> <li>• B2560: STARTER CONT RELAY</li> <li>• B2601: SHIFT POSITION</li> <li>• B2602: SHIFT POSITION</li> <li>• B2603: SHIFT POSI STATUS</li> <li>• B2604: PNP SW</li> <li>• B2605: PNP SW</li> <li>• B2608: STARTER RELAY</li> <li>• B260A: IGNITION RELAY</li> <li>• B260F: ENG STATE SIG LOST</li> <li>• B2614: BCM</li> <li>• B2615: BCM</li> <li>• B2616: BCM</li> <li>• B2617: BCM</li> <li>• B2618: BCM</li> <li>• B261A: PUSH-BTN IGN SW</li> <li>• B261E: VEHICLE TYPE</li> <li>• B26E8: CLUTCH SW</li> <li>• B26EA: KEY REGISTRATION</li> <li>• C1729: VHCL SPEED SIG ERR</li> <li>• U0415: VEHICLE SPEED SIG</li> </ul>
5	<ul style="list-style-type: none"> <li>• C1704: LOW PRESSURE FL</li> <li>• C1705: LOW PRESSURE FR</li> <li>• C1706: LOW PRESSURE RR</li> <li>• C1707: LOW PRESSURE RL</li> <li>• C1708: [NO DATA] FL</li> <li>• C1709: [NO DATA] FR</li> <li>• C1710: [NO DATA] RR</li> <li>• C1711: [NO DATA] RL</li> <li>• C1716: [PRESSDATA ERR] FL</li> <li>• C1717: [PRESSDATA ERR] FR</li> <li>• C1718: [PRESSDATA ERR] RR</li> <li>• C1719: [PRESSDATA ERR] RL</li> <li>• C1734: CONTROL UNIT</li> </ul>
6	<ul style="list-style-type: none"> <li>• B2621: INSIDE ANTENNA</li> <li>• B2622: INSIDE ANTENNA</li> <li>• B2623: INSIDE ANTENNA</li> </ul>

## DTC Index

INFOID:000000009760856

### NOTE:

The details of time display are as follows.

- CRNT: A malfunction is detected now.
- PAST: A malfunction was detected in the past.

IGN counter is displayed on Freeze Frame Data. For details of Freeze Frame Data, refer to [BCS-21, "COMMON ITEM : CONSULT Function \(BCM - COMMON ITEM\)"](#).

CONSULT display	Fail-safe	Freeze Frame Data •Vehicle Speed •Odo/Trip Meter •Vehicle condition	Intelligent Key warning lamp ON	Tire pressure monitor warning lamp ON	Reference
No DTC is detected. further testing may be required.	—	—	—	—	—
U1000: CAN COMM CIRCUIT	—	—	—	—	<a href="#">BCS-50</a>
U1010: CONTROL UNIT (CAN)	—	—	—	—	<a href="#">BCS-51</a>
U0415: VEHICLE SPEED SIG	—	—	—	—	<a href="#">BCS-52</a>



# BCM (BODY CONTROL MODULE)

< ECU DIAGNOSIS INFORMATION >

[COUPE]

CONSULT display	Fail-safe	Freeze Frame Data •Vehicle Speed •Odo/Trip Meter •Vehicle condition	Intelligent Key warning lamp ON	Tire pressure monitor warning lamp ON	Reference
B2190: NATS ANTENNA AMP	×	—	—	—	<a href="#">SEC-46</a>
B2191: DIFFERENCE OF KEY	×	—	—	—	<a href="#">SEC-49</a>
B2192: ID DISCORD BCM-ECM	×	—	—	—	<a href="#">SEC-50</a>
B2193: CHAIN OF BCM-ECM	×	—	—	—	<a href="#">SEC-52</a>
B2195: ANTI SCANNING	×	—	—	—	<a href="#">SEC-53</a>
B2553: IGNITION RELAY	—	×	—	—	<a href="#">PCS-51</a>
B2555: STOP LAMP	—	×	—	—	<a href="#">SEC-54</a>
B2556: PUSH-BTN IGN SW	—	×	×	—	<a href="#">SEC-56</a>
B2557: VEHICLE SPEED	×	×	×	—	<a href="#">SEC-58</a>
B2560: STARTER CONT RELAY	×	×	×	—	<a href="#">SEC-59</a>
B2562: LOW VOLTAGE	—	×	—	—	<a href="#">BCS-53</a>
B2601: SHIFT POSITION	×	×	×	—	<a href="#">SEC-60</a>
B2602: SHIFT POSITION	×	×	×	—	<a href="#">SEC-63</a>
B2603: SHIFT POSI STATUS	×	×	×	—	<a href="#">SEC-66</a>
B2604: PNP SW	×	×	×	—	<a href="#">SEC-69</a>
B2605: PNP SW	×	×	×	—	<a href="#">SEC-71</a>
B2608: STARTER RELAY	×	×	×	—	<a href="#">SEC-73</a>
B260A: IGNITION RELAY	×	×	×	—	<a href="#">PCS-53</a>
B260F: ENG STATE SIG LOST	×	×	×	—	<a href="#">SEC-75</a>
B2614: BCM	—	×	×	—	<a href="#">PCS-55</a>
B2615: BCM	—	×	×	—	<a href="#">PCS-58</a>
B2616: BCM	—	×	×	—	<a href="#">PCS-61</a>
B2617: BCM	×	×	×	—	<a href="#">SEC-79</a>
B2618: BCM	×	×	×	—	<a href="#">PCS-64</a>
B261A: PUSH-BTN IGN SW	—	×	×	—	<a href="#">PCS-65</a>
B261E: VEHICLE TYPE	×	×	× (Turn ON for 15 seconds)	—	<a href="#">SEC-82</a>
B2621: INSIDE ANTENNA	—	×	—	—	<a href="#">DLK-280</a>
B2622: INSIDE ANTENNA	—	×	—	—	• <a href="#">DLK-84</a> (Coupe) • <a href="#">DLK-282</a> (Roadster)
B2623: INSIDE ANTENNA	—	×	—	—	• <a href="#">DLK-86</a> (Coupe) • <a href="#">DLK-284</a> (Roadster)
B26E8: CLUTCH SW	×	×	×	—	<a href="#">SEC-76</a>
B26EA: KEY REGISTRATION	—	×	× (Turn ON for 15 seconds)	—	<a href="#">SEC-78</a>
C1704: LOW PRESSURE FL	—	—	—	×	<a href="#">WT-23</a>
C1705: LOW PRESSURE FR	—	—	—	×	
C1706: LOW PRESSURE RR	—	—	—	×	
C1707: LOW PRESSURE RL	—	—	—	×	

A  
B  
C  
D  
E  
F  
G  
H  
I  
J  
K  
DEF  
M  
N  
O  
P

# BCM (BODY CONTROL MODULE)

< ECU DIAGNOSIS INFORMATION >

[COUPE]

CONSULT display	Fail-safe	Freeze Frame Data •Vehicle Speed •Odo/Trip Meter •Vehicle condition	Intelligent Key warning lamp ON	Tire pressure monitor warn- ing lamp ON	Reference
C1708: [NO DATA] FL	—	—	—	×	<a href="#">WT-25</a>
C1709: [NO DATA] FR	—	—	—	×	
C1710: [NO DATA] RR	—	—	—	×	
C1711: [NO DATA] RL	—	—	—	×	
C1716: [PRESSDATA ERR] FL	—	—	—	×	<a href="#">WT-28</a>
C1717: [PRESSDATA ERR] FR	—	—	—	×	
C1718: [PRESSDATA ERR] RR	—	—	—	×	
C1719: [PRESSDATA ERR] RL	—	—	—	×	
C1729: VHCL SPEED SIG ERR	—	—	—	×	<a href="#">WT-30</a>
C1734: CONTROL UNIT	—	—	—	×	<a href="#">WT-32</a>

# REAR WINDOW DEFOGGER DOES NOT OPERATE

< SYMPTOM DIAGNOSIS >

[COUPE]

## SYMPTOM DIAGNOSIS

### REAR WINDOW DEFOGGER DOES NOT OPERATE

#### Diagnosis Procedure

INFOID:000000009363344

#### 1.CHECK POWER SUPPLY AND GROUND CIRCUIT

Check power supply and ground circuit.

Refer to [DEF-13, "BCM : Diagnosis Procedure"](#).

Is the inspection result normal?

YES >> GO TO 2.

NO >> Repair or replace the malfunctioning parts.

#### 2.CHECK REAR WINDOW DEFOGGER SWITCH

Check rear window defogger switch.

• With Navigation: Refer to [DEF-14, "WITH NAVIGATION : Component Function Check"](#).

• Without Navigation: Refer to [DEF-14, "WITHOUT NAVIGATION : Component Function Check"](#).

Is the inspection result normal?

YES >> GO TO 3.

NO >> Repair or replace the malfunctioning parts.

#### 3.CHECK REAR WINDOW DEFOGGER RELAY

Check rear window defogger relay.

Refer to [DEF-16, "Component Function Check"](#).

Is the inspection result normal?

YES >> GO TO 4.

NO >> Repair or replace the malfunctioning parts.

#### 4.CHECK REAR WINDOW DEFOGGER

Check rear window defogger.

Refer to [DEF-18, "Component Function Check"](#).

Is the inspection result normal?

YES >> GO TO 5.

NO >> Repair or replace the malfunctioning parts.

#### 5.CONFIRM THE OPERATION

Confirm the operation again.

Is the result normal?

YES >> Check intermittent incident. Refer to [GI-45, "Intermittent Incident"](#).

NO >> GO TO 1.

A  
B  
C  
D  
E  
F  
G  
H  
I  
J  
K  
DEF  
M  
N  
O  
P

# REAR WINDOW DEFOGGER AND DOOR MIRROR DEFOGGER DO NOT OPERATE

[COUPE]

< SYMPTOM DIAGNOSIS >

## REAR WINDOW DEFOGGER AND DOOR MIRROR DEFOGGER DO NOT OPERATE

### Diagnosis Procedure

INFOID:000000009363345

#### 1. CHECK POWER SUPPLY AND GROUND CIRCUIT

---

Check power supply and ground circuit.

Refer to [DEF-13, "BCM : Diagnosis Procedure"](#).

Is the inspection result normal?

YES >> GO TO 2.

NO >> Repair or replace the malfunctioning parts.

#### 2. CHECK REAR WINDOW DEFOGGER SWITCH

---

Check rear window defogger switch.

Refer to [DEF-14, "WITH NAVIGATION : Component Function Check"](#) (With Navi) or [DEF-14, "WITHOUT NAVIGATION : Component Function Check"](#) (Without Navi).

Is the inspection result normal?

YES >> GO TO 3.

NO >> Repair or replace the malfunctioning parts.

#### 3. CHECK REAR WINDOW DEFOGGER RELAY

---

Check rear window defogger relay.

Refer to [DEF-16, "Component Function Check"](#).

Is the inspection result normal?

YES >> GO TO 4.

NO >> Repair or replace the malfunctioning parts.

#### 4. CONFIRM THE OPERATION

---

Confirm the operation again.

Is the inspection result normal?

YES >> Check intermittent incident. Refer to [GI-45, "Intermittent Incident"](#).

NO >> GO TO 1.

# REAR WINDOW DEFOGGER DOES NOT OPERATE BUT BOTH DOOR MIRROR DEFOGGERS OPERATE

< SYMPTOM DIAGNOSIS >

[COUPE]

## REAR WINDOW DEFOGGER DOES NOT OPERATE BUT BOTH DOOR MIRROR DEFOGGERS OPERATE

### Diagnosis Procedure

INFOID:000000009363346

#### 1. CHECK REAR WINDOW DEFOGGER

Check rear window defogger.

Refer to [DEF-18, "Component Function Check"](#).

Is the inspection result normal?

YES >> GO TO 2.

NO >> Repair or replace the malfunctioning parts.

#### 2. CONFIRM THE OPERATION

Confirm the operation again

Is the inspection result normal?

YES >> Check intermittent incident. Refer to [GI-45, "Intermittent Incident"](#).

NO >> GO TO 1.

A  
B  
C  
D  
E  
F  
G  
H  
I  
J  
K  
DEF  
M  
N  
O  
P

# DOOR MIRROR DEFOGGER DOES NOT OPERATE

[COUPE]

< SYMPTOM DIAGNOSIS >

## DOOR MIRROR DEFOGGER DOES NOT OPERATE BOTH SIDES

BOTH SIDES : Diagnosis Procedure

INFOID:00000000936347

### 1.CHECK DOOR MIRROR DEFOGGER

Check door mirror defogger.

Refer to [DEF-23, "Component Function Check"](#).

Is the inspection result normal?

YES >> GO TO 2.

NO >> Repair or replace the malfunctioning parts.

### 2.CONFIRM THE OPERATION

Confirm the operation again.

Is the inspection result normal?

YES >> Check intermittent incident. Refer to [GI-45, "Intermittent Incident"](#).

NO >> GO TO 1.

## DRIVER SIDE

DRIVER SIDE : Diagnosis Procedure

INFOID:00000000936348

### 1.CHECK DRIVER SIDE DOOR MIRROR DEFOGGER

Check driver side door mirror defogger.

Refer to [DEF-24, "Component Function Check"](#).

Is the inspection result normal?

YES >> GO TO 2.

NO >> Repair or replace the malfunctioning parts.

### 2.CONFIRM THE OPERATION

Confirm the operation again.

Is the inspection result normal?

YES >> Check intermittent incident. Refer to [GI-45, "Intermittent Incident"](#).

NO >> GO TO 1.

## PASSENGER SIDE

PASSENGER SIDE : Diagnosis Procedure

INFOID:00000000936349

### 1.CHECK PASSENGER SIDE DOOR MIRROR DEFOGGER.

Check passenger side door mirror defogger.

Refer to [DEF-26, "Component Function Check"](#).

Is the inspection result normal?

YES >> GO TO 2.

NO >> Repair or replace the malfunctioning parts.

### 2.CONFIRM THE OPERATION

Confirm the operation again.

Is the inspection result normal?

YES >> Check intermittent incident. Refer to [GI-45, "Intermittent Incident"](#).

NO >> GO TO 1.

# ON IS NOT DISPLAYED WHEN PRESSING REAR WINDOW DEFOGGER SWITCH BUT IT OPERATES

< SYMPTOM DIAGNOSIS >

[COUPE]

## ON IS NOT DISPLAYED WHEN PRESSING REAR WINDOW DEFOGGER SWITCH BUT IT OPERATES

### Diagnosis Procedure

INFOID:000000009363350

#### 1. CHECK AV CONTROL FUNCTION

Check that the AV control unit is operating normally. Refer to [AV-200, "Work Flow"](#).

Is the inspection result normal?

YES >> GO TO 2.

NO >> Repair or replace the malfunctioning parts.

#### 2. CONFIRM THE OPERATION

Confirm the operation again.

Is the inspection result normal?

YES >> Check intermittent incident. Refer to [GI-45, "Intermittent Incident"](#).

NO >> GO TO 1.

A  
B  
C  
D  
E  
F  
G  
H  
I  
J  
K  
DEF  
M  
N  
O  
P

DEF

# REAR WINDOW DEFOGGER INDICATOR DOES NOT ILLUMINATE

< SYMPTOM DIAGNOSIS >

[COUPE]

## REAR WINDOW DEFOGGER INDICATOR DOES NOT ILLUMINATE WITH NAVIGATION

WITH NAVIGATION : Diagnosis Procedure

INFOID:000000009363351

### 1.CHECK REAR WINDOW DEFOGGER OPERATION

Check rear window defogger operation.

Is the inspection result normal?

YES >> Check AV control system. Refer to [AV-200. "Work Flow"](#).

NO >> Check rear window defogger system. Refer to [DEF-5. "Work Flow"](#).

## WITHOUT NAVIGATION

WITHOUT NAVIGATION : Diagnosis Procedure

INFOID:000000009363352

### 1.CHECK A/C CONTROL FUNCTION

Check that the A/C control is operating normally.

Is the inspection result normal?

YES >> GO TO 2.

NO >> Check A/C control system. Refer to [HAC-5. "Work Flow"](#).

### 2.CHECK REAR WINDOW DEFOGGER ON SIGNAL

Check rear window defogger ON signal.

Refer to [DEF-21. "Component Function Check"](#).

Is the inspection result normal?

YES >> Replace A/C control (rear window defogger switch). Refer to [HAC-83. "BASE AUDIO : Removal and Installation"](#) (Base audio) or [HAC-86. "BOSE AUDIO WITHOUT NAVIGATION : Removal and Installation"](#) (BOSE audio without navigation).

NO >> Repair or replace the malfunctioning parts.



PRECAUTION

PRECAUTIONS  
FOR USA AND CANADA

FOR USA AND CANADA : Precaution for Supplemental Restraint System (SRS) "AIR BAG" and "SEAT BELT PRE-TENSIONER"

INFOID:000000009363353

The Supplemental Restraint System such as "AIR BAG" and "SEAT BELT PRE-TENSIONER", used along with a front seat belt, helps to reduce the risk or severity of injury to the driver and front passenger for certain types of collision. This system includes seat belt switch inputs and dual stage front air bag modules. The SRS system uses the seat belt switches to determine the front air bag deployment, and may only deploy one front air bag, depending on the severity of a collision and whether the front occupants are belted or unbelted. Information necessary to service the system safely is included in the "SRS AIR BAG" and "SEAT BELT" of this Service Manual.

**WARNING:**

Always observe the following items for preventing accidental activation.

- To avoid rendering the SRS inoperative, which could increase the risk of personal injury or death in the event of a collision that would result in air bag inflation, all maintenance must be performed by an authorized NISSAN/INFINITI dealer.
- Improper maintenance, including incorrect removal and installation of the SRS, can lead to personal injury caused by unintentional activation of the system. For removal of Spiral Cable and Air Bag Module, see "SRS AIR BAG".
- Never use electrical test equipment on any circuit related to the SRS unless instructed to in this Service Manual. SRS wiring harnesses can be identified by yellow and/or orange harnesses or harness connectors.

PRECAUTIONS WHEN USING POWER TOOLS (AIR OR ELECTRIC) AND HAMMERS

**WARNING:**

Always observe the following items for preventing accidental activation.

- When working near the Air Bag Diagnosis Sensor Unit or other Air Bag System sensors with the ignition ON or engine running, never use air or electric power tools or strike near the sensor(s) with a hammer. Heavy vibration could activate the sensor(s) and deploy the air bag(s), possibly causing serious injury.
- When using air or electric power tools or hammers, always switch the ignition OFF, disconnect the battery, and wait at least 3 minutes before performing any service.

FOR USA AND CANADA : Precaution for Battery Service

INFOID:000000009363354

Before disconnecting the battery, lower both the driver and passenger windows. This will prevent any interference between the window edge and the vehicle when the door is opened/closed. During normal operation, the window slightly raises and lowers automatically to prevent any window to vehicle interference. The automatic window function will not work with the battery disconnected.

FOR USA AND CANADA : Precautions For Xenon Headlamp Service

INFOID:000000009601611

**WARNING:**

Comply with the following warnings to prevent any serious accident.

- Disconnect the battery cable (negative terminal) or the power supply fuse before installing, removing, or touching the xenon headlamp (bulb included). The xenon headlamp contains high-voltage generated parts.
- Never work with wet hands.
- Check the xenon headlamp ON-OFF status after assembling it to the vehicle. Never turn the xenon headlamp ON in other conditions. Connect the power supply to the vehicle-side connector. (Turning it ON outside the lamp case may cause fire or visual impairments.)
- Never touch the bulb glass immediately after turning it OFF. It is extremely hot.

**CAUTION:**

Comply with the following cautions to prevent any error and malfunction.

- Install the xenon bulb securely. (Insufficient bulb socket installation may melt the bulb, the connector, the housing, etc. by high-voltage leakage or corona discharge.)

A

B

C

D

E

F

G

H

I

J

K

DEF

M

N

O

P

# PRECAUTIONS

[COUPE]

< PRECAUTION >

- Never perform HID circuit inspection with a tester.
- Never touch the xenon bulb glass with hands. Never put oil and grease on it.
- Dispose of the used xenon bulb after packing it in thick vinyl without breaking it.
- Never wipe out dirt and contamination with organic solvent (thinner, gasoline, etc.).

## FOR MEXICO

### FOR MEXICO : Precaution for Supplemental Restraint System (SRS) "AIR BAG" and "SEAT BELT PRE-TENSIONER"

INFOID:000000009363355

The Supplemental Restraint System such as "AIR BAG" and "SEAT BELT PRE-TENSIONER", used along with a front seat belt, helps to reduce the risk or severity of injury to the driver and front passenger for certain types of collision. Information necessary to service the system safely is included in the "SRS AIR BAG" and "SEAT BELT" of this Service Manual.

#### **WARNING:**

Always observe the following items for preventing accidental activation.

- To avoid rendering the SRS inoperative, which could increase the risk of personal injury or death in the event of a collision that would result in air bag inflation, all maintenance must be performed by an authorized NISSAN/INFINITI dealer.
- Improper maintenance, including incorrect removal and installation of the SRS, can lead to personal injury caused by unintentional activation of the system. For removal of Spiral Cable and Air Bag Module, see "SRS AIR BAG".
- Never use electrical test equipment on any circuit related to the SRS unless instructed to in this Service Manual. SRS wiring harnesses can be identified by yellow and/or orange harnesses or harness connectors.

### PRECAUTIONS WHEN USING POWER TOOLS (AIR OR ELECTRIC) AND HAMMERS

#### **WARNING:**

Always observe the following items for preventing accidental activation.

- When working near the Air Bag Diagnosis Sensor Unit or other Air Bag System sensors with the ignition ON or engine running, never use air or electric power tools or strike near the sensor(s) with a hammer. Heavy vibration could activate the sensor(s) and deploy the air bag(s), possibly causing serious injury.
- When using air or electric power tools or hammers, always switch the ignition OFF, disconnect the battery, and wait at least 3 minutes before performing any service.

### FOR MEXICO : Precaution for Battery Service

INFOID:000000009363356

Before disconnecting the battery, lower both the driver and passenger windows. This will prevent any interference between the window edge and the vehicle when the door is opened/closed. During normal operation, the window slightly raises and lowers automatically to prevent any window to vehicle interference. The automatic window function will not work with the battery disconnected.

### FOR MEXICO : Precautions For Xenon Headlamp Service

INFOID:000000009601832

#### **WARNING:**

Comply with the following warnings to prevent any serious accident.

- Disconnect the battery cable (negative terminal) or the power supply fuse before installing, removing, or touching the xenon headlamp (bulb included). The xenon headlamp contains high-voltage generated parts.
- Never work with wet hands.
- Check the xenon headlamp ON-OFF status after assembling it to the vehicle. Never turn the xenon headlamp ON in other conditions. Connect the power supply to the vehicle-side connector. (Turning it ON outside the lamp case may cause fire or visual impairments.)
- Never touch the bulb glass immediately after turning it OFF. It is extremely hot.

#### **CAUTION:**

Comply with the following cautions to prevent any error and malfunction.

- Install the xenon bulb securely. (Insufficient bulb socket installation may melt the bulb, the connector, the housing, etc. by high-voltage leakage or corona discharge.)
- Never perform HID circuit inspection with a tester.
- Never touch the xenon bulb glass with hands. Never put oil and grease on it.
- Dispose of the used xenon bulb after packing it in thick vinyl without breaking it.

# PRECAUTIONS

< PRECAUTION >

[COUPE]

- Never wipe out dirt and contamination with organic solvent (thinner, gasoline, etc.).

A

B

C

D

E

F

G

H

I

J

K

DEF

M

N

O

P

# REMOVAL AND INSTALLATION

## FILAMENT

### Inspection and Repair

INFOID:000000009363357

#### INSPECTION

1. When measuring voltage, wrap tin foil around the top of the negative probe. Then press the foil against the wire with your finger.

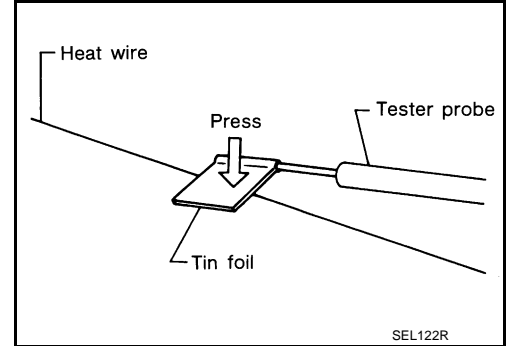

2. Attach probe circuit tester (in Volt range) to middle portion of each filament.

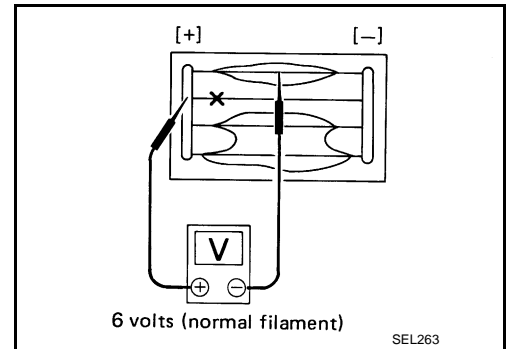

3. If a filament is burned out, circuit tester registers 0 or battery voltage.
4. To locate burned out point, move probe to left and right along filament. Test needle swings abruptly when probe passes the point.

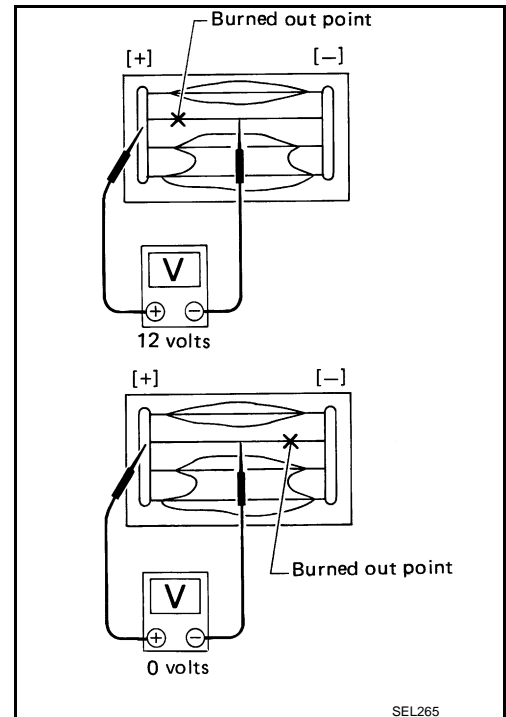

#### REPAIR

##### REPAIR EQUIPMENT

- Conductive silver composition (Dupont No. 4817 or an equivalent)

# FILAMENT

[COUPE]

## < REMOVAL AND INSTALLATION >

- Ruler 30 cm (11.8 in) long
- Drawing pen
- Heat gun
- Alcohol
- Cloth

### REPAIRING PROCEDURE

1. Wipe broken heat wire and its surrounding area clean with a cloth dampened in alcohol.
2. Apply a small amount of conductive silver composition to tip of drawing pen. Shake silver composition container before use.
3. Place ruler on glass along broken line. Deposit conductive silver composition on break with drawing pen. Slightly overlap existing heat wire on both sides [preferably 5 mm (0.20 in)] of the break.

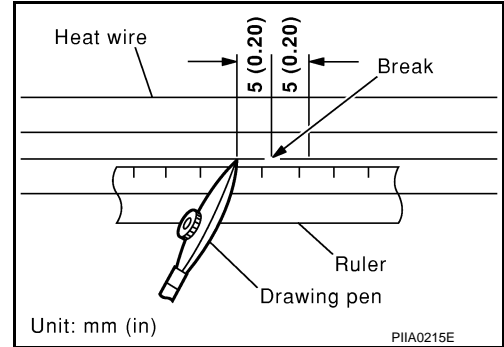

4. After repair has been complete, check repaired wire for continuity. This check should be conducted 10 minutes after silver composition is deposited. Do not touch repaired area while test is being conducted.

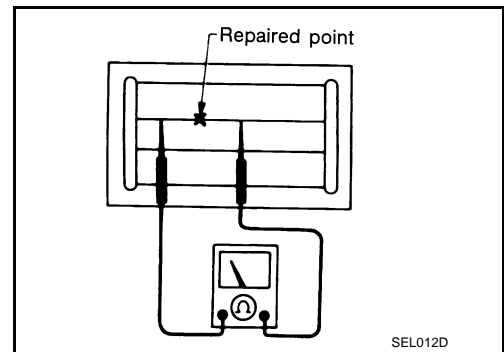

5. Apply a constant stream of hot air directly to the repaired area for approximately 20 minutes with a heat gun. A minimum distance of 3 cm (1.2 in) should be kept between repaired area and hot air outlet. If a heat gun is not available, let the repaired area dry for 24 hours.

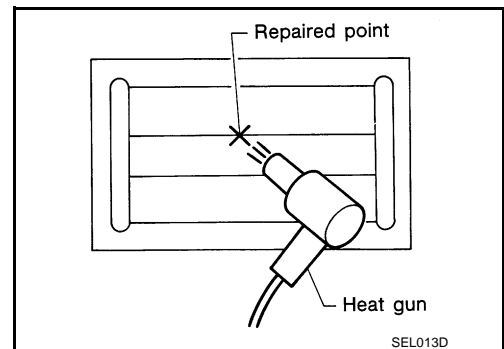

A  
B  
C  
D  
E  
F  
G  
H  
I  
J  
K  
DEF  
M  
N  
O  
P

# CONDENSER

< REMOVAL AND INSTALLATION >

[COUPE]

## CONDENSER

Exploded View

INFOID:000000009363358

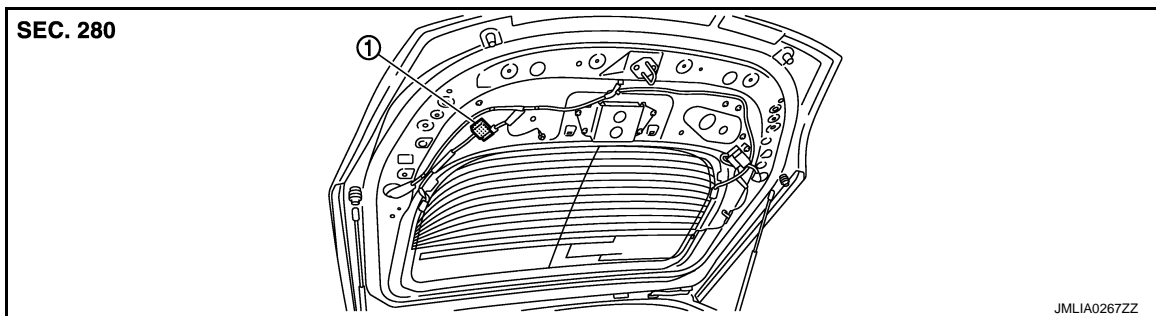

1. Condenser

## Removal and Installation

INFOID:000000009363359

### REMOVAL

1. Remove the back door finisher lower.  
Refer to [INT-33, "Removal and Installation"](#).
2. Remove bolt (A), and then remove condenser (1) from the vehicle body.

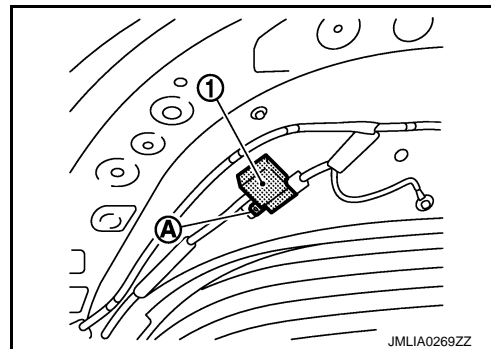

### INSTALLATION

Install in the reverse order of removal.

# BASIC INSPECTION

## DIAGNOSIS AND REPAIR WORK FLOW

### Work Flow

INFOID:000000009363360

#### DETAILED FLOW

#### 1.OBTAIN INFORMATION ABOUT SYMPTOM

Interview the customer to obtain as much malfunction information (conditions and environment when the malfunction occurs) as possible when the customer brings the vehicle in.

>> GO TO 2.

#### 2.CHECK DTC

Perform self-diagnosis with CONSULT.

Are any DTC detected?

YES >> Refer to [BCS-99. "DTC Index"](#).

NO >> GO TO 3.

#### 3.REPRODUCE THE MALFUNCTION INFORMATION

Check the malfunction on the vehicle that the customer describes.

Inspect the relation of the symptoms and the condition when the symptoms occur.

>> GO TO 4.

#### 4.IDENTIFY THE MALFUNCTIONING SYSTEM WITH "SYMPTOM DIAGNOSIS"

Use "Symptom diagnosis" from the symptom inspection result in step 3. Then identify where to start performing the diagnosis based on possible causes and symptoms.

>> GO TO 5.

#### 5.IDENTIFY MALFUNCTIONING PARTS WITH "COMPONENT DIAGNOSIS"

Perform the diagnosis with "Component diagnosis" of the applicable system.

>> GO TO 6.

#### 6.REPAIR OR REPLACE THE MALFUNCTIONING PARTS

Repair or replace the specified malfunctioning parts.

>> GO TO 7.

#### 7.FINAL CHECK

Check that malfunctions are not reproduced when obtaining the malfunction information from the customer, referring to the symptom inspection result in step 3.

Are all malfunctions corrected?

YES >> INSPECTION END

NO >> GO TO 4.

A  
B  
C  
D  
E  
F  
G  
H  
I  
J  
K  
DEF  
M  
N  
O  
P

## SYSTEM DESCRIPTION

### REAR WINDOW DEFOGGER SYSTEM WITH NAVIGATION

#### WITH NAVIGATION : System Diagram

INFOID:000000009363361

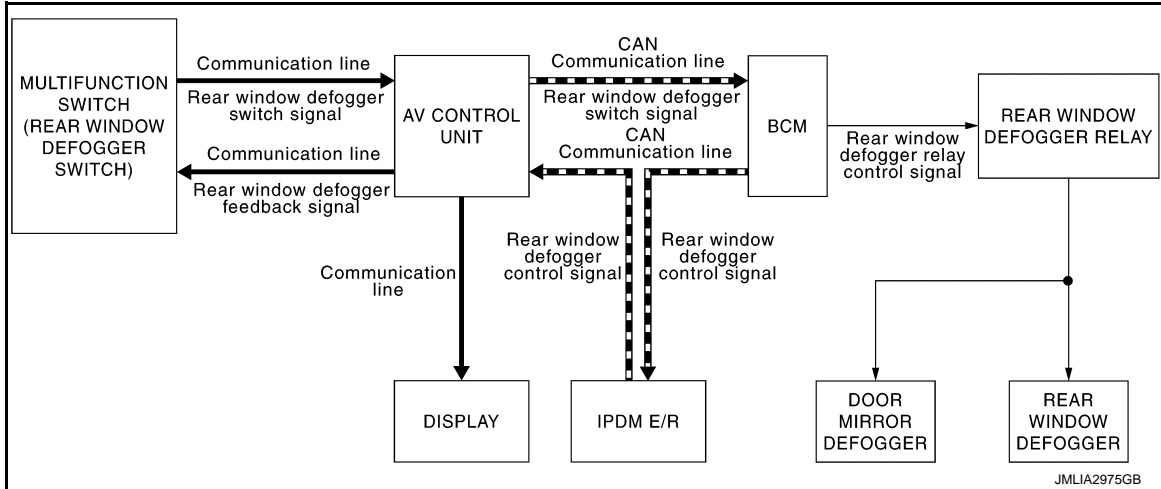

JMLIA2975GB

#### WITH NAVIGATION : System Description

INFOID:000000009363362

#### OPERATION DESCRIPTION

- Turn rear window defogger switch ON when the ignition switch is ON. Then multifunction switch (rear window defogger switch) transmits rear window defogger switch signal to AV control unit via AV communication. AV control unit transmits rear window defogger switch signal to BCM via CAN communication.
- BCM turns rear window defogger relay ON and transmits rear window defogger ON signal to IPDM E/R via CAN communication when rear window defogger switch signal is received.
- Door mirror defoggers are supplied with power and operate when rear window defogger relay turns ON.
- Rear window defogger relay sends power supply to soft top control unit.
- Soft top control unit detects roof state and controls rear window defogger operation.
- IPDM E/R transmits rear window defogger ON signal to AV control unit via CAN communication.
- When receiving the signal, AV control unit indicates rear defogger ON on the display. At the same time, AV control unit transmits rear defogger ON signal to multifunction switch (rear window defogger switch) via AV communication and illuminates rear window defogger switch indicator.

#### TIMER FUNCTION

- BCM turns rear window defogger relay ON for approximately 15 minutes when rear window defogger switch is turned ON. It makes rear window defogger and door mirror defoggers operate.
- Timer is canceled after pressing rear window defogger switch again during timer operation. Then BCM turns rear window defogger relay OFF. The same operation also occurs during timer operation, if the ignition switch is turned OFF.



# REAR WINDOW DEFOGGER SYSTEM

< SYSTEM DESCRIPTION >

[ROADSTER]

## WITH NAVIGATION : Component Parts Location

INFOID:000000009363363

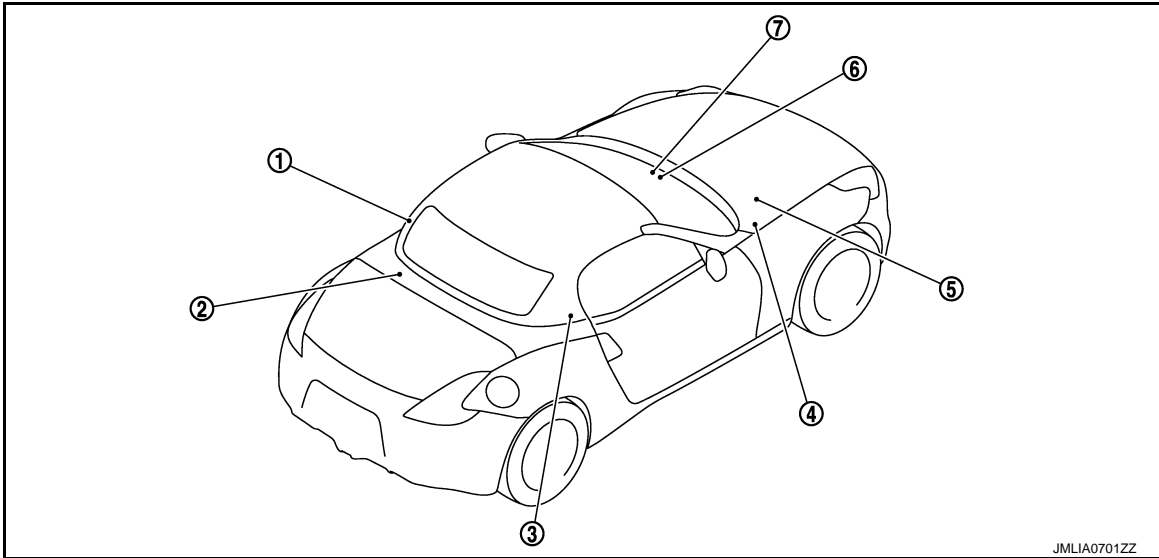

- |   |  |   |
|---|--|---|
| 1. Rear window defogger connector   | 2. Soft top control unit<br>Refer to <a href="#">RF-11, "Component Parts Location"</a> . | 3. Rear window defogger connector   |
| 4. IPDM E/R<br>Refer to <a href="#">PCS-5, "Component Parts Location"</a> . | 5. BCM<br>Refer to <a href="#">BCS-11, "Component Parts Location"</a> .                  | 6. AV control unit<br>Refer to <a href="#">AV-140, "Component Parts Location"</a> . |
| 7. Multifunction switch (rear window defogger switch)                       |  |   |

## WITH NAVIGATION : Component Description

INFOID:000000009363364

Multifunction switch (Rear window defogger switch)	<ul style="list-style-type: none"> <li>The rear window defogger switch is installed.</li> <li>Turns the indicator lamp ON when detecting the operation of rear window defogger relay.</li> </ul>
AV control unit	Displays the rear window defogger is ON on the display when detecting the operation of rear window defogger relay.
BCM	<ul style="list-style-type: none"> <li>Operates the rear window defogger relay when receiving rear window defogger switch signal.</li> <li>Performs the timer control of rear window defogger relay.</li> </ul>
Rear window defogger relay	<ul style="list-style-type: none"> <li>Operates the door mirror defoggers with the control signal from BCM.</li> <li>Power is supplied to the soft top control unit (rear window defogger) with the control signal from BCM.</li> </ul>
Door mirror defogger	Heats the heating wire with the power supply from the rear window defogger relay to prevent the door mirror from fogging up.
Soft top control unit	Soft top control unit detects roof state and controls rear window defogger operation.
Rear window defogger	Heats the heating wire with the power supply from the soft top control unit to prevent the rear window from fogging up.
IPDM E/R	Transmits rear window defogger ON signal to AV control unit via CAN communication.

## WITHOUT NAVIGATION

# REAR WINDOW DEFOGGER SYSTEM

< SYSTEM DESCRIPTION >

[ROADSTER]

## WITHOUT NAVIGATION : System Diagram

INFOID:000000009363365

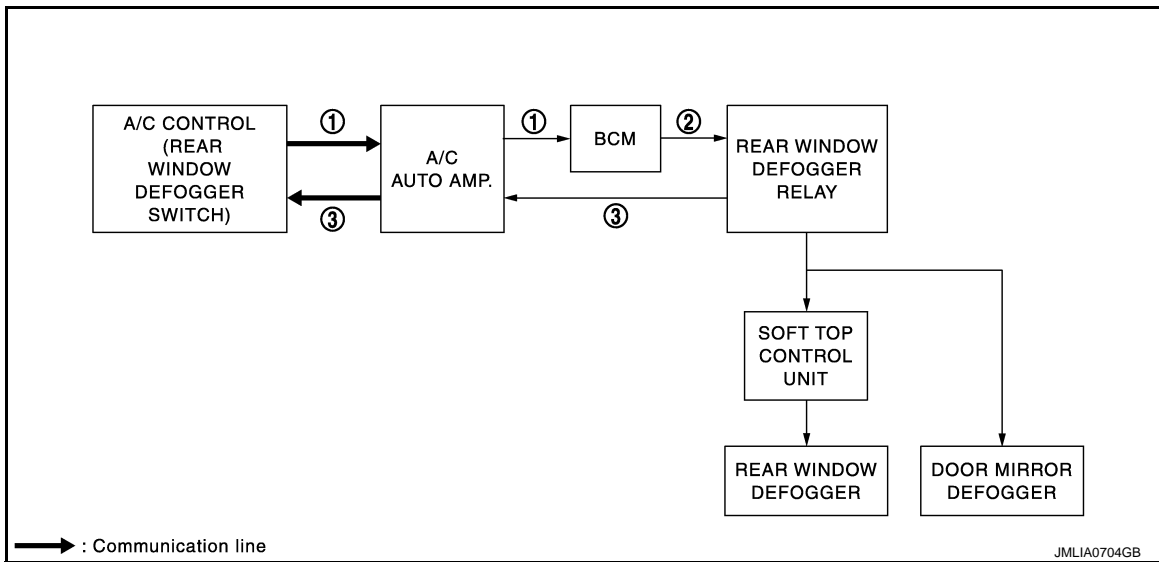

1. Rear window defogger switch signal
2. Rear window defogger relay ON signal
3. Rear window defogger ON signal

## WITHOUT NAVIGATION : System Description

INFOID:000000009363366

### OPERATION DESCRIPTION

- Turn rear window defogger switch ON when the ignition switch is ON. Then A/C control (rear window defogger switch) transmits rear window defogger switch signal to A/C auto amp. and BCM.
- BCM turns rear window defogger relay ON when rear window defogger switch signal is received.
- Door mirror defoggers are supplied with power and operate when rear window defogger relay turns ON.
- Rear window defogger relay sends power supply to soft top control unit.
- Soft top control unit detects roof state and controls rear window defogger operation.
- Rear window defogger relay transmits rear window defogger ON signal to A/C auto amp. when rear window defogger operates.
- At the same time, A/C auto amp. transmits rear defogger ON signal to A/C controller (rear window defogger switch) and illuminates rear window defogger switch indicator.

### TIMER FUNCTION

- BCM turns rear window defogger relay ON for approximately 15 minutes when rear window defogger switch is turned ON. It makes rear window defogger and door mirror defoggers operate.
- Timer is canceled after pressing rear window defogger switch again during timer operation. Then BCM turns rear window defogger relay OFF. The same operation also occurs during timer operation, if the ignition switch is turned OFF.

# REAR WINDOW DEFOGGER SYSTEM

< SYSTEM DESCRIPTION >

[ROADSTER]

## WITHOUT NAVIGATION : Component Parts Location

INFOID:000000009363367

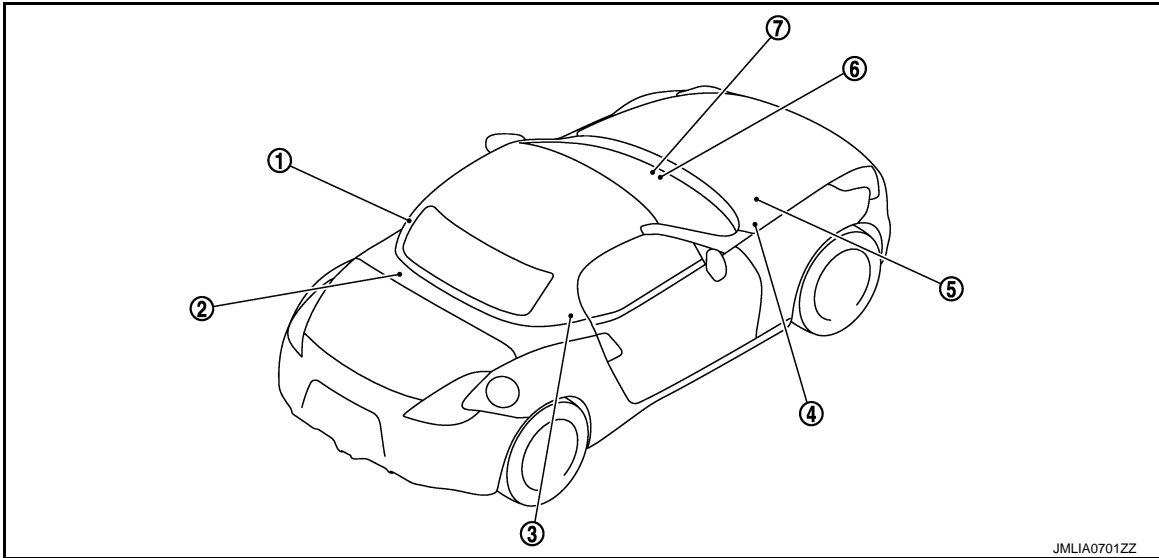

- |   |  |   |
|---|--|---|
| 1. Rear window defogger connector   | 2. Soft top control unit<br>Refer to <a href="#">RF-11, "Component Parts Location"</a> . | 3. Rear window defogger connector   |
| 4. IPDM E/R<br>Refer to <a href="#">PCS-5, "Component Parts Location"</a> . | 5. BCM<br>Refer to <a href="#">BCS-11, "Component Parts Location"</a> .                  | 6. A/C auto amp.<br>Refer to <a href="#">HAC-23, "Component Parts Location"</a> . |
| 7. A/C control (rear window defogger switch)                                |  |   |

## WITHOUT NAVIGATION : Component Description

INFOID:000000009363368

A/C control (Rear window defogger switch)	<ul style="list-style-type: none"> <li>The rear window defogger switch is installed.</li> <li>Turns the indicator lamp ON when detecting the operation of rear window defogger relay.</li> </ul>
A/C auto amp.	Transmit rear window defogger switch signal to BCM via CAN communication.
BCM	<ul style="list-style-type: none"> <li>Operates the rear window defogger relay with the operation of rear window defogger switch.</li> <li>Performs the timer control of rear window defogger relay.</li> </ul>
Rear window defogger relay	<ul style="list-style-type: none"> <li>Operates the door mirror defogger with the control signal from BCM.</li> <li>Power is supplied to the soft top control unit (rear window defogger) with the control signal from BCM.</li> </ul>
Door mirror defogger	Heats the heating wire with the power supply from the rear window defogger relay to prevent the door mirror from fogging up.
Soft top control unit	Soft top control unit detects roof state and controls rear window defogger operation.
Rear window defogger	Heats the heating wire with the power supply from the rear window defogger relay to prevent the rear window from fogging up.

# DIAGNOSIS SYSTEM (BCM)

[ROADSTER]

< SYSTEM DESCRIPTION >

## DIAGNOSIS SYSTEM (BCM)

### COMMON ITEM

#### COMMON ITEM : CONSULT Function (BCM - COMMON ITEM)

INFOID:000000009363369

#### APPLICATION ITEM

CONSULT performs the following functions via CAN communication with BCM.

Diagnosis mode	Function Description
Work Support	Changes the setting for each system function.
Self Diagnostic Result	Displays the diagnosis results judged by BCM.
CAN Diag Support Monitor	Monitors the reception status of CAN communication viewed from BCM.
Data Monitor	The BCM input/output signals are displayed.
Active Test	The signals used to activate each device are forcibly supplied from BCM.
Ecu Identification	The BCM part number is displayed.
Configuration	<ul style="list-style-type: none"> <li>Read and save the vehicle specification.</li> <li>Write the vehicle specification when replacing BCM.</li> </ul>

### SYSTEM APPLICATION

BCM can perform the following functions for each system.

#### NOTE:

It can perform the diagnosis modes except the following for all sub system selection items.

×: Applicable item

System	Sub system selection item	Diagnosis mode		
		Work Support	Data Monitor	Active Test
Door lock	DOOR LOCK	×	×	×
Rear window defogger	REAR DEFOGGER		×	×
Warning chime	BUZZER		×	×
Interior room lamp timer	INT LAMP	×	×	×
Exterior lamp	HEAD LAMP	×	×	×
Wiper and washer	WIPER	×	×	×
Turn signal and hazard warning lamps	FLASHER	×	×	×
—	AIR CONDITONER*			
<ul style="list-style-type: none"> <li>Intelligent Key system</li> <li>Engine start system</li> </ul>	INTELLIGENT KEY	×	×	×
Combination switch	COMB SW		×	
Body control system	BCM	×		
NVIS - NATS	IMMU		×	×
Interior room lamp battery saver	BATTERY SAVER	×	×	×
Back door/Trunk lid open	TRUNK		×	×
Vehicle security system	THEFT ALM	×	×	×
RAP system	RETAINED PWR		×	
Signal buffer system	SIGNAL BUFFER		×	×
TPMS	TPMS (AIR PRESSURE MONITOR)	×	×	×

#### NOTE:

\*: This item is displayed, but is not used.

### FREEZE FRAME DATA (FFD)

The BCM records the following vehicle condition at the time a particular DTC is detected, and displays on CONSULT.

# DIAGNOSIS SYSTEM (BCM)

< SYSTEM DESCRIPTION >

[ROADSTER]

CONSULT screen item	Indication/Unit	Description	
Vehicle Speed	km/h	Vehicle speed of the moment a particular DTC is detected	A
Odo/Trip Meter	km	Total mileage (Odometer value) of the moment a particular DTC is detected	B
Vehicle Condition	SLEEP>LOCK	While turning BCM status from low power consumption mode to normal mode (Power supply position is "LOCK"*)	B
	SLEEP>OFF	While turning BCM status from low power consumption mode to normal mode (Power supply position is "OFF".)	C
	LOCK>ACC	While turning power supply position from "LOCK"* to "ACC"	D
	ACC>ON	While turning power supply position from "ACC" to "IGN"	D
	RUN>ACC	While turning power supply position from "RUN" to "ACC" (Except emergency stop operation)	E
	CRANK>RUN	While turning power supply position from "CRANKING" to "RUN" (From cranking up the engine to run it)	E
	RUN>URGENT	While turning power supply position from "RUN" to "ACC" (Emergency stop operation)	F
	ACC>OFF	While turning power supply position from "ACC" to "OFF"	F
	OFF>LOCK	While turning power supply position from "OFF" to "LOCK"*	G
	OFF>ACC	While turning power supply position from "OFF" to "ACC"	G
	ON>CRANK	While turning power supply position from "IGN" to "CRANKING"	H
	OFF>SLEEP	While turning BCM status from normal mode (Power supply position is "OFF".) to low power consumption mode	H
	LOCK>SLEEP	While turning BCM status from normal mode (Power supply position is "LOCK"*. ) to low power consumption mode	I
	LOCK	Power supply position is "LOCK"*	I
	OFF	Power supply position is "OFF" (Ignition switch OFF)	J
	ACC	Power supply position is "ACC" (Ignition switch ACC)	J
	ON	Power supply position is "IGN" (Ignition switch ON with engine stopped)	K
	ENGINE RUN	Power supply position is "RUN" (Ignition switch ON with engine running)	K
CRANKING	Power supply position is "CRANKING" (At engine cranking)	K	
IGN Counter	0 - 39	The number of times that ignition switch is turned ON after DTC is detected <ul style="list-style-type: none"> <li>• The number is 0 when a malfunction is detected now.</li> <li>• The number increases like 1 → 2 → 3...38 → 39 after returning to the normal condition whenever ignition switch OFF → ON.</li> <li>• The number is fixed to 39 until the self-diagnosis results are erased if it is over 39.</li> </ul>	DEF

**NOTE:**

\*: Power supply position shifts to "LOCK" from "OFF", when ignition switch is in the OFF position, selector lever is in the P position (A/T models), and any of the following conditions are met.

- Closing door
- Opening door
- Door is locked using door request switch
- Door is locked using Intelligent Key

The power supply position shifts to "ACC" when the push-button ignition switch (push switch) is pushed at "LOCK".

## REAR WINDOW DEFOGGER

### REAR WINDOW DEFOGGER : CONSULT Function (BCM - REAR DEFOGGER) (For Roadster)

INFOID:000000009363370

## DATA MONITOR

**NOTE:**

# DIAGNOSIS SYSTEM (BCM)

[ROADSTER]

## < SYSTEM DESCRIPTION >

The following table includes information (items) inapplicable to this vehicle. For information (items) applicable to this vehicle, refer to CONSULT display items.

Monitor Item	Description
REAR DEF SW	<ul style="list-style-type: none"><li>• Without navigation: Displays "Press (ON)/other (OFF)" status determined with the rear window defogger switch</li><li>• With navigation: This is displayed even when it is not equipped</li></ul>
PUSH SW	Indicates [ON/OFF] condition of push switch

## ACTIVE TEST

Test Item	Description
REAR DEFOGGER	Rear window defogger operates when "ON" on CONSULT screen is touched

# POWER SUPPLY AND GROUND CIRCUIT

< DTC/CIRCUIT DIAGNOSIS >

[ROADSTER]

## DTC/CIRCUIT DIAGNOSIS

### POWER SUPPLY AND GROUND CIRCUIT

#### BCM

#### BCM : Diagnosis Procedure

INFOID:000000009363371

#### 1. CHECK FUSE AND FUSIBLE LINK

Check that the following fuse and fusible link are not blown.

Signal name	Fuse and fusible link No.
Battery power supply	K
	10

#### Is the fuse fusing?

YES >> Replace the blown fuse or fusible link after repairing the affected circuit if a fuse or fusible link is blown.

NO >> GO TO 2.

#### 2. CHECK POWER SUPPLY CIRCUIT

1. Turn ignition switch OFF.
2. Disconnect BCM connectors.
3. Check voltage between BCM harness connector and ground.

Terminals		Voltage (Approx.)
(+)	(-)	
BCM		Ground  Battery voltage
Connector	Terminal	
M118	1	
M119	11	

#### Is the measurement value normal?

YES >> GO TO 3.

NO >> Repair harness or connector.

#### 3. CHECK GROUND CIRCUIT

Check continuity between BCM harness connector and ground.

BCM		Ground	Continuity
Connector	Terminal		
M119	13		Existed

#### Does continuity exist?

YES >> INSPECTION END

NO >> Repair harness or connector.

A  
B  
C  
D  
E  
F  
G  
H  
I  
J  
K  
DEF  
M  
N  
O  
P

# REAR WINDOW DEFOGGER SWITCH

< DTC/CIRCUIT DIAGNOSIS >

[ROADSTER]

## REAR WINDOW DEFOGGER SWITCH WITH NAVIGATION

### WITH NAVIGATION : Description

INFOID:000000009363374

- The rear window defogger or door mirror defogger (with mirror defogger) are operated by turning the rear window defogger switch ON.
- The indicator lamp in the rear window defogger illuminates when the rear window defogger or door mirror defogger (with mirror defogger) are operating.

### WITH NAVIGATION : Component Function Check

INFOID:000000009363373

#### 1.CHECK FUNCTION

Check that the indicator lamp of rear window defogger illuminates when rear window defogger switch is ON.

Is the inspection result normal?

- YES >> Rear window defogger switch function is OK.  
NO >> Refer to [DEF-104, "WITH NAVIGATION : Diagnosis Procedure"](#).

### WITH NAVIGATION : Diagnosis Procedure

INFOID:000000009363374

#### 1.CHECK MULTIFUNCTION SWITCH (REAR WINDOW DEFOGGER SWITCH)

Check multifunction switch (rear window defogger switch) operate. Refer to [AV-152, "Description"](#).

Is the inspection result normal?

- YES >> INSPECTION END  
NO >> Repair or replace the malfunctioning parts.

## WITHOUT NAVIGATION

### WITHOUT NAVIGATION : Description

INFOID:000000009363375

- The rear window defogger or door mirror defogger (with mirror defogger) are operated by turning the rear window defogger switch ON.
- The indicator lamp in the rear window defogger illuminates when the rear window defogger or door mirror defogger (with mirror defogger) are operating.

### WITHOUT NAVIGATION : Component Function Check

INFOID:000000009363376

#### 1.CHECK FUNCTION

 With CONSULT

1. Turn ignition switch ON.
2. Select "REAR DEFOGGER" or "BCM" using CONSULT.
3. Select "REAR DEF SW" in "DATA MONITOR" mode.
4. Check that the function operates normally according to the following conditions.

Monitor item	Condition	Status
REAR DEF SW	Rear window defogger switch ON	On
	OFF	Off

Is the inspection result normal?

- YES >> Rear window defogger switch function is OK.  
NO >> Refer to [DEF-104, "WITHOUT NAVIGATION : Diagnosis Procedure"](#).

### WITHOUT NAVIGATION : Diagnosis Procedure

INFOID:000000009363377

#### 1.CHECK A/C CONTROL (REAR WINDOW DEFOGGER SWITCH)

Check A/C control system.

Refer to [HAC-5, "Work Flow"](#).

Is the inspection result normal?



# REAR WINDOW DEFOGGER SWITCH

[ROADSTER]

## < DTC/CIRCUIT DIAGNOSIS >

- YES >> GO TO 2.
- NO >> Repair or replace the malfunctioning parts.

### 2. CHECK BCM OUTPUT SIGNAL

1. Turn ignition switch OFF.
2. Disconnect A/C auto amp. connector.
3. Turn ignition switch ON.
4. Check signal between A/C auto amp. harness connector and ground with oscilloscope.

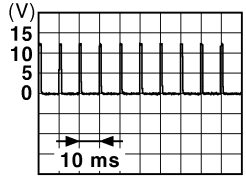
(+)		(-)	Signal (Reference value)
A/C auto amp.			
Connector	Terminal		
M66	27	Ground	 <p style="text-align: right; font-size: small;">JPMA0012GB</p>

Is the inspection result normal?

- YES >> Replace A/C auto amp. Refer to [HAC-86, "BOSE AUDIO WITHOUT NAVIGATION : Removal and Installation"](#) (Base audio without navigation) or [HAC-85, "BASE AUDIO : Removal and Installation"](#) (Base audio).
- NO >> GO TO 3.

### 3. CHECK REAR WINDOW DEFOGGER SWITCH CIRCUIT

1. Turn ignition switch OFF.
2. Disconnect BCM connector.
3. Check continuity between BCM harness connector and A/C auto amp. connector.

BCM		A/C auto amp.		Continuity
Connector	Terminal	Connector	Terminal	
M123	130	M66	27	Existed

4. Check continuity between BCM harness connector and ground.

BCM		Ground	Continuity
Connector	Terminal		
M123	130		Not existed

Is the inspection result normal?

- YES >> Replace BCM. Refer to [BCS-106, "Removal and Installation"](#).
- NO >> Repair or replace harness.

A  
B  
C  
D  
E  
F  
G  
H  
I  
J  
K  
M  
N  
O  
P

DEF

# REAR WINDOW DEFOGGER RELAY

< DTC/CIRCUIT DIAGNOSIS >

[ROADSTER]

## REAR WINDOW DEFOGGER RELAY

### Description

INFOID:000000009363378

- Operates the door mirror defogger (with door mirror defogger) with the control signal from BCM.
- Power is supplied to the soft top control unit (rear window defogger) with the control signal from BCM.

### Component Function Check

INFOID:000000009363379

#### 1.CHECK FUNCTION

##### Ⓟ With CONSULT

1. Turn ignition switch ON.
2. Select "REAR DEFOGGER" of "BCM" using CONSULT.
3. Select "REAR DEFOGGER" in "ACTIVE TEST" mode.
4. Touch "ON".
5. Check that the rear window heating wire is getting warmer.

##### Is the inspection result normal?

- YES >> Rear window defogger relay power supply circuit function is OK.  
 NO >> Refer to [DEF-106, "Diagnosis Procedure"](#).

### Diagnosis Procedure

INFOID:000000009363380

#### 1.CHECK FUSE

1. Turn ignition switch OFF.
2. Check 10A fuse [No.3, located in fuse block (J/B)].

##### Is the inspection result normal?

- YES >> GO TO 2.  
 NO >> Replace the blown fuse after repairing the affected circuit if a fuse is blown.

#### 2.CHECK REAR WINDOW DEFOGGER RELAY CIRCUIT 1

1. Turn ignition switch ON.
2. Check voltage between BCM harness connector and ground.

(+)		(-)	Condition	Voltage (V) (Approx.)	
BCM					
Connector	Terminal				
M123	151	Ground	Rear window de-fogger switch	ON	0
				OFF	Battery voltage

##### Is the inspection result normal?

- YES >> GO TO 6.  
 NO >> GO TO 3.

#### 3.CHECK REAR WINDOW DEFOGGER RELAY CIRCUIT 2

1. Turn ignition switch OFF.
2. Disconnect BCM connector and fuse block (J/B).
3. Check continuity between BCM harness connector and fuse block (J/B) harness connector.

BCM		Fuse block (J/B)		Continuity
Connector	Terminal	Connector	Terminal	
M123	151	M2	4B	Existed

4. Check continuity between BCM harness connector and ground.

BCM		Ground	Continuity
Connector	Terminal		
M123	151		Not existed

# REAR WINDOW DEFOGGER RELAY

[ROADSTER]

## < DTC/CIRCUIT DIAGNOSIS >

Is the inspection result normal?

- YES >> GO TO 4.
- NO >> Repair or replace harness.

### 4.CHECK REAR WINDOW DEFOGGER RELAY

1. Disconnect rear window defogger relay,
  2. Check rear window defogger relay.
- Refer to [DEF-107. "Component Inspection"](#).

Is the inspection result normal?

- YES >> GO TO 5.
- NO >> Replace rear window defogger relay.

### 5.CHECK FUSE BLOCK (J/B)

1. Install the rear window defogger relay.
2. Turn ignition switch ON.
3. Check voltage between fuse block (J/B) (fuse block side) and ground.

(+)		(-)	Voltage (V) (Approx.)
Fuse block (J/B)			
Connector	Terminal		
M2	4B	Ground	Battery voltage

Is the inspection result normal?

- YES >> GO TO 6.
- NO >> Repair or replace fuse block (J/B).

### 6.CHECK INTERMITTENT INCIDENT

Check intermittent incident.  
Refer to [GI-45. "Intermittent Incident"](#).

>> INSPECTION END

## Component Inspection

INFOID:000000009363381

### 1.CHECK REAR WINDOW DEFOGGER RELAY

1. Turn ignition switch OFF.
2. Disconnect rear window defogger relay.
3. Check continuity between rear window defogger relay terminals.

Terminal		Condition	Continuity
Rear window defogger relay			
3	5	12 V direct current supply between terminals 1 and 2	Existed
		No current supply	Not existed

Is the inspection result normal?

- YES >> INSPECTION END
- NO >> Replace rear window defogger relay.

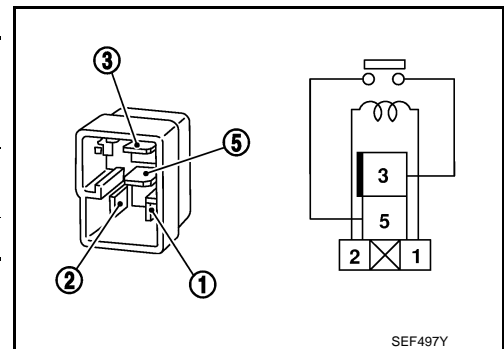

SEF497Y

# SOFT TOP CONTROL UNIT

< DTC/CIRCUIT DIAGNOSIS >

[ROADSTER]

## SOFT TOP CONTROL UNIT

### Description

INFOID:000000009363382

Soft top control unit detects roof state and controls rear defogger.

### Component Function Check

INFOID:000000009363383

## 1.CHECK REAR WINDOW DEFOGGER

④ With CONSULT

1. Turn ignition switch ON and soft top fully close.
2. Select "REAR DEFOGGER" of "BCM" using CONSULT.
3. Select "REAR DEFOGGER" in "ACTIVE TEST" mode.
4. Touch "ON".
5. Check that the rear window heating wire is getting warmer.

Is the inspection result normal?

- YES >> Soft top control unit is OK.  
 NO >> Refer to [DEF-108, "Diagnosis Procedure"](#).

## Diagnosis Procedure

INFOID:000000009363384

## 1.CHECK FUSE

1. Turn ignition switch OFF.
2. Check the following.
  - 20A fuse [No.14, located in fuse block (J/B)]
  - 20A fuse [No.15, located in fuse block (J/B)]

Is the inspection result normal?

- YES >> GO TO 2.  
 NO >> Replace the blown fuse after repairing the affected circuit if a fuse is blown.

## 2.CHECK SOFT TOP CONTROL UNIT CIRCUIT

1. Disconnect soft top control unit connector and fuse block (J/B) connector.
2. Check continuity between soft top control unit and fuse block (J/B) harness connector.

Fuse block (J/B)		Soft top control unit		Continuity
Connector	Terminal	Connector	Terminal	
B6	10G	B304	49	Existed
	11G		48	

3. Check continuity between soft top control unit and ground.

Soft top control unit		Ground	Continuity
Connector	Terminal		
B304	49		Not existed
	48		

Is the inspection result normal?

- YES >> GO TO 3.  
 NO >> Repair or replace harness and ground.

## 3.CHECK FUSE BLOCK (J/B)

1. Turn ignition switch ON.
2. Check voltage between fuse block (J/B) (fuse block side) and ground.

# SOFT TOP CONTROL UNIT

< DTC/CIRCUIT DIAGNOSIS >

[ROADSTER]

(+)		(-)	Condition	Voltage (V) (Approx.)	
Fuse block (J/B)					
Connector	Terminal				
B6	10G	Ground	Rear window defogger	ON	Battery voltage
				OFF	0
	11G			ON	Battery voltage
				OFF	0

Is the inspection result normal?

YES >> GO TO 4.

NO >> Repair or replace fuse block (J/B).

## 4.CHECK INTERMITTENT INCIDENT

Check intermittent incident.

Refer to [GI-45, "Intermittent Incident"](#).

>> INSPECTION END.

A  
B  
C  
D  
E  
F  
G  
H  
I  
J  
K  
M  
N  
O  
P

DEF

# REAR WINDOW DEFOGGER

< DTC/CIRCUIT DIAGNOSIS >

[ROADSTER]

## REAR WINDOW DEFOGGER

### Description

INFOID:000000009363385

Heats the heating wire with the power supply from the rear window defogger relay to prevent the rear window from fogging up.

### Component Function Check

INFOID:000000009363386

#### 1.CHECK REAR WINDOW DEFOGGER

Ⓟ With CONSULT

1. Turn ignition switch ON.
2. Select "REAR DEFOGGER" of "BCM" using CONSULT.
3. Select "REAR DEFOGGER" in "ACTIVE TEST" mode.
4. Touch "ON".
5. Check that the rear window heating wire is getting warmer.

Is the inspection result normal?

- YES >> Rear window defogger is OK.  
 NO >> Refer to [DEF-110, "Diagnosis Procedure"](#).

### Diagnosis Procedure

INFOID:000000009363387

#### 1.CHECK POWER SUPPLY CIRCUIT

1. Turn ignition switch ON and soft top fully close.
2. Check voltage between rear window defogger harness connector and ground.

(+)		(-)	Condition		Voltage (V) (Approx.)
Rear window defogger					
Connector	Terminal				
B311	1	Ground	Rear window defogger switch	ON	Battery voltage
				OFF	0

Is the inspection result normal?

- YES >> GO TO 3.  
 NO >> GO TO 2.

#### 2.CHECK REAR WINDOW DEFOGGER CIRCUIT

1. Turn ignition switch OFF.
2. Disconnect soft top control unit connector.
3. Check continuity between soft top control unit harness connector and rear window defogger harness connector.

Soft top control unit		Rear window defogger		Continuity
Connector	Terminal	Connector	Terminal	
B307	104	B311	1	Existed
	111			

4. Check continuity between soft top control unit harness connector and ground.

Soft top control unit		Ground	Continuity
Connector	Terminal		
B307	104		Not existed
	111		

Is the inspection result normal?

- YES >> Replace soft top control unit. Refer to [RF-246, "Removal and Installation"](#).  
 NO >> Repair or replace harness.

# REAR WINDOW DEFOGGER

< DTC/CIRCUIT DIAGNOSIS >

[ROADSTER]

## 3.CHECK GROUND CIRCUIT

1. Turn ignition switch OFF.
2. Disconnect rear window defogger connector.
3. Check continuity between rear window defogger harness connector and ground.

Rear window defogger		Ground	Continuity
Connector	Terminal		Existed
B318	2		Existed

Is the inspection result normal?

- YES >> GO TO 4.  
NO >> Repair or replace harness.

## 4.CHECK FILAMENT

Check filament.

Refer to [DEF-111, "Component Inspection"](#).

Is the inspection result normal?

- YES >> GO TO 5.  
NO >> Repair or replace filament. Refer to [DEF-194, "Inspection and Repair"](#).

## 5.CHECK INTERMITTENT INCIDENT

Check intermittent incident.

Refer to [GI-45, "Intermittent Incident"](#).

>> INSPECTION END

## Component Inspection

INFOID:000000009363388

## 1.CHECK FILAMENT

Check the filament for damage.

Refer to [DEF-194, "Inspection and Repair"](#).

Is the inspection result normal?

- YES >> INSPECTION END  
NO >> Repair filament.

A  
B  
C  
D  
E  
F  
G  
H  
I  
J  
K  
M  
N  
O  
P

DEF

# REAR WINDOW DEFOGGER ON SIGNAL

< DTC/CIRCUIT DIAGNOSIS >

[ROADSTER]

## REAR WINDOW DEFOGGER ON SIGNAL

### Description

INFOID:000000009363389

Turns the indicator lamp in the rear window defogger switch ON when operating the rear window defogger.

### Component Function Check

INFOID:000000009363390

#### 1.CHECK FUNCTION

Check that the indicator lamps of rear window defogger switch are illuminated when turning the rear window defogger switch ON.

Is the inspection result normal?

YES >> Rear window defogger ON signal function is OK.

NO >> Refer to [DEF-112, "Diagnosis Procedure"](#).

### Diagnosis Procedure

INFOID:000000009363391

#### 1.CHECK FUSE

1. Turn ignition switch OFF.
2. Check 10A fuse [No.13, located in fuse block (J/B)].

Is the inspection result normal?

YES >> GO TO 2.

NO >> Replace the blown fuse after repairing the affected circuit if a fuse is blown.

#### 2.CHECK REAR WINDOW DEFOGGER INDICATOR LAMP ON SIGNAL

1. Turn ignition switch ON.
2. Check voltage between A/C auto amp. harness connector ground.

(+)		(-)	Condition		Voltage (V) (Approx.)
A/C auto amp.					
Connector	Terminal	Ground	Rear window defogger switch	ON	Battery voltage
M66	26				

Is the inspection result normal?

YES >> Replace A/C auto amp. Refer to [HAC-86, "BOSE AUDIO WITHOUT NAVIGATION : Removal and Installation"](#) (Bose audio without navigation) or [HAC-85, "BASE AUDIO : Removal and Installation"](#) (Base audio).

NO >> GO TO 3.

#### 3.CHECK REAR WINDOW DEFOGGER INDICATOR LAMP CIRCUIT

1. Turn ignition switch OFF.
2. Disconnect fuse block (J/B) connector and A/C auto amp. connector.
3. Check continuity between fuse block (J/B) harness connector and A/C auto amp. harness connector.

Fuse block (J/B)		A/C auto amp.		Continuity
Connector	Terminal	Connector	Terminal	
M3	9C	M66	26	Existed

4. Check continuity between fuse block (J/B) harness connector and ground.

Fuse block (J/B)		Ground	Continuity
Connector	Terminal		
M3	9C		Not existed

Is the inspection result normal?

YES >> Repair or replace fuse block (J/B).



# REAR WINDOW DEFOGGER ON SIGNAL

< DTC/CIRCUIT DIAGNOSIS >

[ROADSTER]

NO >> Repair or replace harness.

A

B

C

D

E

F

G

H

I

J

K

**DEF**

M

N

O

P

# DOOR MIRROR DEFOGGER

< DTC/CIRCUIT DIAGNOSIS >

[ROADSTER]

## DOOR MIRROR DEFOGGER

### Description

INFOID:000000009363392

Power is supplied to the door mirror defogger with BCM control.

### Component Function Check

INFOID:000000009363393

#### 1.CHECK DOOR MIRROR DEFOGGER

##### Ⓟ With CONSULT

1. Turn ignition switch ON.
2. Select "REAR DEFOGGER" of "BCM" using CONSULT.
3. Select "REAR DEFOGGER" in "ACTIVE TEST" mode.
4. Touch "ON".
5. Check that both side door mirror glass is getting warmer.

##### Is the inspection result normal?

- YES >> Door mirror defogger is OK.  
NO >> Refer to [DEF-114, "Diagnosis Procedure"](#).

### Diagnosis Procedure

INFOID:000000009363394

#### 1.CHECK FUSE

1. Turn ignition switch OFF.
2. Check the following.
  - 10A fuse (No.13, located in fuse block (J/B))

##### Is the inspection result normal?

- YES >> GO TO 2.  
NO >> Replace the blown fuse after repairing the affected circuit if a fuse is blown.

#### 2.CHECK FUSE BLOCK (J/B)

1. Turn ignition switch ON.
2. Check voltage between fuse block (J/B) (fuse block side) and ground.

(+)		(-)	Condition	Voltage (V) (Approx.)	
Fuse block (J/B)					
Connector	Terminal				
M3	9C	Ground	Rear window de-fogger switch	ON	Battery voltage
			OFF	0	
	10C		ON	Battery voltage	
			OFF	0	

##### Is the inspection result normal?

- YES >> INSPECTION END.  
NO >> Replace fuse block (J/B).

# DRIVER SIDE DOOR MIRROR DEFOGGER

< DTC/CIRCUIT DIAGNOSIS >

[ROADSTER]

## DRIVER SIDE DOOR MIRROR DEFOGGER

### Description

INFOID:000000009363395

Heats the heating wire with the power supply from the rear window defogger relay to prevent the door mirror from fogging up.

### Component Function Check

INFOID:000000009363396

#### 1.CHECK DRIVER SIDE DOOR MIRROR DEFOGGER

ⓂWith CONSULT

1. Turn ignition switch ON.
2. Select "REAR DEFOGGER" of "BCM" using CONSULT.
3. Select "REAR DEFOGGER" in "ACTIVE TEST" mode.
4. Touch "ON".
5. Check that the driver side door mirror glass is getting warmer.

Is the inspection result normal?

- YES >> Driver side door mirror defogger is OK.  
NO >> Refer to [DEF-115, "Diagnosis Procedure"](#).

### Diagnosis Procedure

INFOID:000000009363397

#### 1.CHECK POWER SUPPLY CIRCUIT

1. Turn ignition switch OFF.
2. Disconnect door mirror (driver side) connector.
3. Turn ignition switch ON.
4. Check voltage between door mirror (driver side) harness connector and ground.

(+)		(-)	Condition	Voltage (V) (Approx.)	
Door mirror (driver side) Connector	Terminal				
D3	4	Ground	Rear window de-fogger switch	ON	Battery voltage
			OFF	0	

Is the inspection result normal?

- YES >> GO TO 4.  
NO >> GO TO 2.

#### 2.CHECK FUSE BLOCK (J/B) OUTPUT SIGNAL

1. Turn ignition switch OFF.
2. Disconnect fuse block (J/B) connector.
3. Turn ignition switch ON.
4. Check voltage between fuse block (J/B) harness connector and ground.

(+)		(-)	Condition	Voltage (V) (Approx.)	
Fuse block (J/B) Connector	Terminal				
M3	10C	Ground	Rear window de-fogger switch	ON	Battery voltage
			OFF	0	

Is the inspection result normal?

- YES >> GO TO 3.  
NO >> Replace fuse block (J/B).

#### 3.CHECK DRIVER SIDE DOOR MIRROR DEFOGGER CIRCUIT

1. Turn ignition switch OFF.

A  
B  
C  
D  
E  
F  
G  
H  
I  
J  
K  
M  
N  
O  
P

DEF

# DRIVER SIDE DOOR MIRROR DEFOGGER

[ROADSTER]

## < DTC/CIRCUIT DIAGNOSIS >

2. Check continuity between fuse block (J/B) harness connector and door mirror (driver side) harness connector.

Fuse block (J/B)		Door mirror (driver side)		Continuity
Connector	Terminal	Connector	Terminal	
M3	10C	D3	4	Existed

3. Check continuity between fuse block (J/B) harness connector and ground.

Fuse block (J/B)		Ground	Continuity
Connector	Terminal		
M3	10C	Ground	Not existed

Is the inspection result normal?

YES >> GO TO 6.

NO >> Repair or replace harness.

## 4.CHECK GROUND CIRCUIT

1. Turn ignition switch OFF.
2. Check continuity between door mirror (driver side) harness connector and ground.

Door mirror (driver side)		Ground	Continuity
Connector	Terminal		
D3	8	Ground	Existed

Is the inspection result normal?

YES >> GO TO 5.

NO >> Repair or replace harness.

## 5.CHECK DRIVER SIDE DOOR MIRROR DEFOGGER

Check driver side door mirror defogger.

Refer to [DEF-116, "Component Inspection"](#).

Is the inspection result normal?

YES >> GO TO 6.

NO >> Replace door mirror (driver side). Refer to [GW-19, "Removal and Installation"](#).

## 6.CHECK INTERMITTENT INCIDENT

Check intermittent incident.

Refer to [GI-45, "Intermittent Incident"](#).

Is the inspection result normal?

>> INSPECTION END.

## Component Inspection

INFOID:000000009363398

## 1.CHECK DRIVER SIDE DOOR MIRROR DEFOGGER

1. Turn ignition switch OFF.
2. Disconnect door mirror (driver side) connector.
3. Check continuity between door mirror terminals.

Door mirror (driver side)			Continuity
Connector	Terminal		
D3	4	8	Existed

Is the inspection result normal?

YES >> INSPECTION END.

NO >> Replace door mirror (driver side). Refer to [GW-19, "Removal and Installation"](#).

# PASSENGER SIDE DOOR MIRROR DEFOGGER

< DTC/CIRCUIT DIAGNOSIS >

[ROADSTER]

## PASSENGER SIDE DOOR MIRROR DEFOGGER

### Description

INFOID:000000009363399

Heats the heating wire with the power supply from the rear window defogger relay to prevent the door mirror from fogging up.

### Component Function Check

INFOID:000000009363400

#### 1.CHECK PASSENGER SIDE DOOR MIRROR DEFOGGER

Ⓜ With CONSULT

1. Turn ignition switch ON.
2. Select "REAR DEFOGGER" of "BCM" using CONSULT.
3. Select "REAR DEFOGGER" in "ACTIVE TEST" mode.
4. Touch "ON".
5. Check that the passenger side door mirror glass is getting warmer.

Is the inspection result normal?

- YES >> Passenger side door mirror defogger is OK.  
 NO >> Refer to [DEF-117, "Diagnosis Procedure"](#).

### Diagnosis Procedure

INFOID:000000009363401

#### 1.CHECK POWER SUPPLY CIRCUIT

1. Turn ignition switch OFF.
2. Disconnect door mirror (passenger side) connector.
3. Turn ignition switch ON.
4. Check voltage between door mirror (passenger side) harness connector and ground.

(+)		(-)	Condition	Voltage (V) (Approx.)
Door mirror (Passenger side) Connector	Terminal			
D33	4	Ground	Rear window de-fogger switch	ON Battery voltage
			OFF	0

Is the inspection result normal?

- YES >> GO TO 4.  
 NO >> GO TO 2.

#### 2.CHECK FUSE BLOCK (J/B) OUTPUT SIGNAL

1. Turn ignition switch OFF.
2. Disconnect fuse block (J/B) connector.
3. Turn ignition switch ON.
4. Check voltage between fuse block (J/B) harness connector and ground.

(+)		(-)	Condition	Voltage (V) (Approx.)
Fuse block (J/B) Connector	Terminal			
M3	9C	Ground	Rear window de-fogger switch	ON Battery voltage
			OFF	0

Is the inspection result normal?

- YES >> GO TO 3.  
 NO >> Replace fuse block (J/B).

#### 3.CHECK PASSENGER SIDE DOOR MIRROR DEFOGGER

1. Turn ignition switch OFF.

DEF

# PASSENGER SIDE DOOR MIRROR DEFOGGER

[ROADSTER]

< DTC/CIRCUIT DIAGNOSIS >

2. Check continuity between fuse block (J/B) harness connector and door mirror (passenger side) harness connector.

Fuse block (J/B)		Door mirror (passenger side)		Continuity
Connector	Terminal	Connector	Terminal	
M3	9C	D33	4	Existed

3. Check continuity between fuse block (J/B) harness connector and ground.

Fuse block (J/B)		Ground	Continuity
Connector	Terminal		
M3	9C	Ground	Not existed

Is the inspection result normal?

YES >> GO TO 6.

NO >> Repair or replace harness.

## 4.CHECK GROUND CIRCUIT

1. Turn ignition switch OFF.
2. Check continuity between door mirror (passenger side) harness connector and ground.

Door mirror (passenger side)		Ground	Continuity
Connector	Terminal		
D33	8	Ground	Existed

Is the inspection result normal?

YES >> GO TO 5.

NO >> Repair or replace harness.

## 5.CHECK PASSENGER SIDE DOOR MIRROR DEFOGGER

Check passenger side door mirror defogger.

Refer to [DEF-118, "Component Inspection"](#).

Is the inspection result normal?

YES >> GO TO 6.

NO >> Replace door mirror (passenger side). Refer to [GW-19, "Removal and Installation"](#).

## 6.CHECK INTERMITTENT INCIDENT

Check intermittent incident.

Refer to [GI-45, "Intermittent Incident"](#).

>> INSPECTION END.

## Component Inspection

INFOID:000000009363402

## 1.CHECK PASSENGER DOOR MIRROR DEFOGGER

1. Turn ignition switch OFF.
2. Disconnect door mirror (passenger side) connector.
3. Check continuity between door mirror terminals.

Door mirror (passenger side)			Continuity
Connector	Terminal		
D33	4	8	Existed

Is the inspection result normal?

YES >> INSPECTION END.

NO >> Replace door mirror (passenger side). Refer to [GW-19, "Removal and Installation"](#).

# REAR WINDOW DEFOGGER SYSTEM

< DTC/CIRCUIT DIAGNOSIS >

[ROADSTER]

## REAR WINDOW DEFOGGER SYSTEM

### Wiring Diagram - DEFOGGER (WITH NAVI) -

INFOID:000000009363403

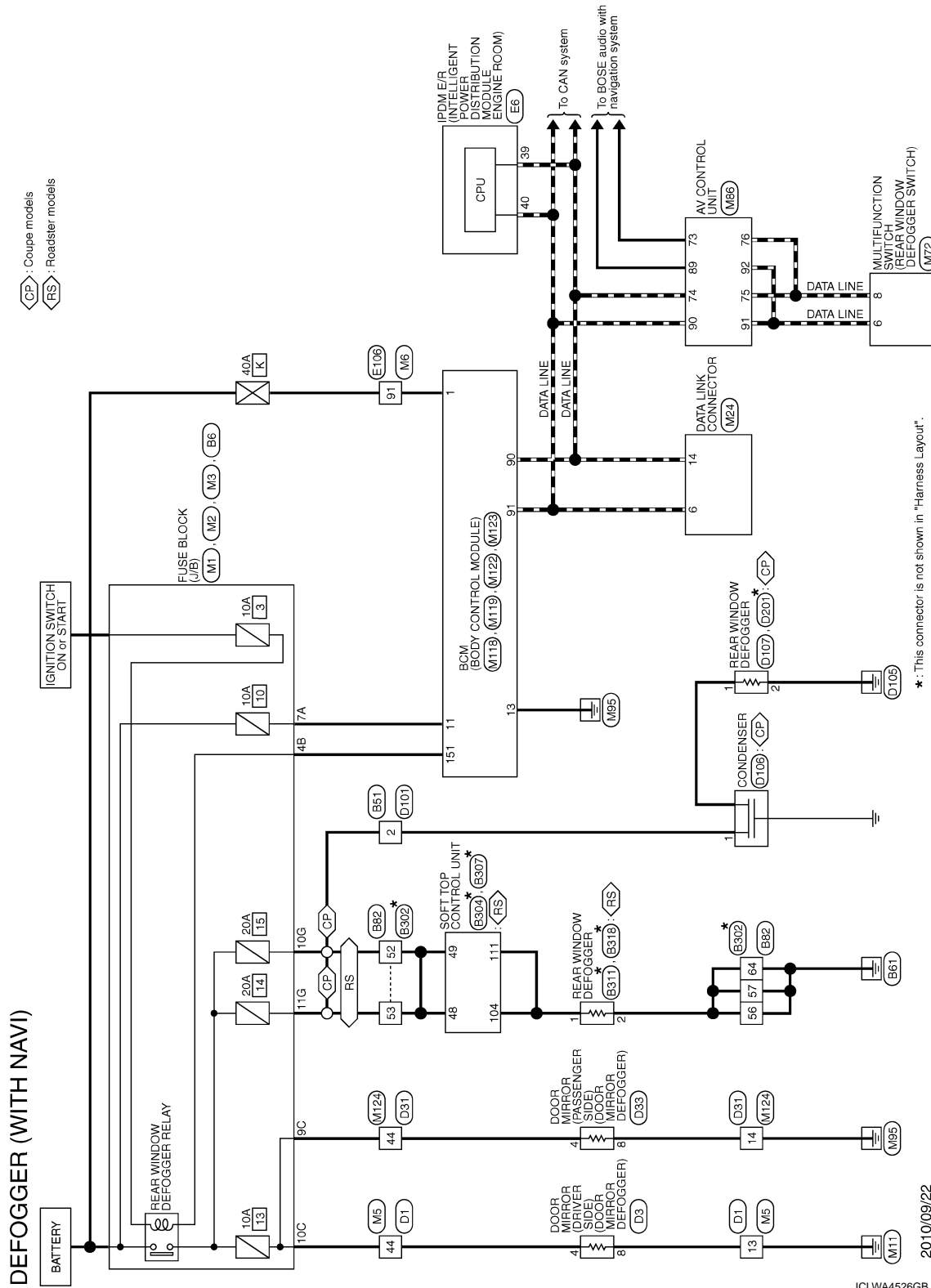

A  
B  
C  
D  
E  
F  
G  
H  
I  
J  
K  
DEF  
M  
N  
O  
P

# REAR WINDOW DEFOGGER SYSTEM

< DTC/CIRCUIT DIAGNOSIS >

[ROADSTER]

## DEFOGGER (WITH NAVI)

Connector No.	BB
Connector Name	FUSE BLOCK (J/B)
Connector Type	NS1ZFR-CS



Terminal No.	Color of Wire	Signal Name [Specification]
5G	LG	-
10G	W	- [Coupe models]
11G	W	- [Roadster models]
12G	Y	- [Roadster models]

Connector No.	B51
Connector Name	WIRE TO WIRE
Connector Type	M04MM-LC



Terminal No.	Color of Wire	Signal Name [Specification]
2	Y	-
4	B	-

Connector No.	B82
Connector Name	WIRE TO WIRE
Connector Type	NS1ZFR-CS



Terminal No.	Color of Wire	Signal Name [Specification]
52	P	-
53	G	-
55	R	-
56	B	-
57	B	-
58	Y	-
59	B	-
60	LG	-
61	L	-
62	L	-
63	L	-
64	B	-
65	Y	-
66	Y	-

Connector No.	B302
Connector Name	WIRE TO WIRE
Connector Type	NS16MM-CS

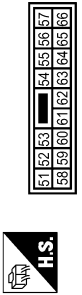

Terminal No.	Color of Wire	Signal Name [Specification]
52	R	-
53	R	-
55	V	-
56	B	-
57	B	-
58	SB	-
59	DG	-
60	DG	-
61	R	-
62	R	-
63	R	-
64	B	-
65	R	-
66	R	-

Connector No.	B304
Connector Name	SOFT TOP CONTROL UNIT
Connector Type	NS1ZFR-CS

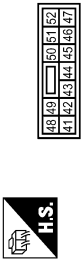

Terminal No.	Color of Wire	Signal Name [Specification]
41	DG	TRUNK OPENER ACTUATOR
48	R	REAR WINDOW DEF IN 2
49	R	REAR WINDOW DEF IN 1

Connector No.	B307
Connector Name	SOFT TOP CONTROL UNIT
Connector Type	NS18FW-CS

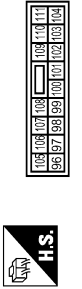

Terminal No.	Color of Wire	Signal Name [Specification]
96	W	SWITCHING VALVE 4
97	LG	SWITCHING VALVE 3
98	L	SWITCHING VALVE 2
99	O	SWITCHING VALVE 1
100	BR	HYDRAULIC PUMP RELAY 2 +
101	SB	HYDRAULIC PUMP RELAY 1 +
102	P	SWITCHING VALVE 5
103	B	HYDRAULIC UNIT GND
104	R	REAR WINDOW DEF OUT 2
111	R	REAR WINDOW DEF OUT 1

Connector No.	B311
Connector Name	REAR WINDOW DEFOGGER
Connector Type	-



Terminal No.	Color of Wire	Signal Name [Specification]
1	-	-

Connector No.	B318
Connector Name	REAR WINDOW DEFOGGER
Connector Type	-



Terminal No.	Color of Wire	Signal Name [Specification]
2	-	-



# REAR WINDOW DEFOGGER SYSTEM

< DTC/CIRCUIT DIAGNOSIS >

[ROADSTER]

## DEFOGGER (WITH NAVI)

Connector No.	D1
Connector Name	WIRE TO WIRE
Connector Type	TH40FY-CS15

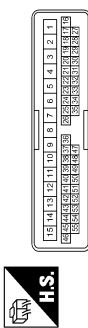

Terminal No.	Color of Wire	Signal Name (Specification)
7	Y	-
8	Y	-
9	G	-
10	BG	-
11	P	- [With BOSE system]
11	V	- [Without BOSE system]
12	L	-
13	B	-
14	SB	- [Coupe model]
14	Y	- [Roadster model]
15	W	-
19	Y	-
23	Y/B	-
25	R	-
26	SHIELD	-
35	G	-
44	L	-
47	B	-
48	SB	-
49	W	-
50	LG	-
51	R	-
52	V	-
53	BG	-
54	GR	-
55	G	-

Connector No.	D3
Connector Name	DOOR MIRROR (DRIVER SIDE)
Connector Type	TH08MW-NH



Terminal No.	Color of Wire	Signal Name (Specification)
1	BR	-
2	L	-
3	Y	-
4	L	-
8	B	-

Connector No.	D31
Connector Name	WIRE TO WIRE
Connector Type	TH40FY-CS15

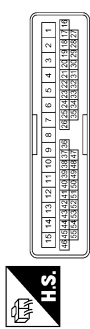

Terminal No.	Color of Wire	Signal Name (Specification)
10	V	-
11	LG	-
12	P	- [With BOSE system]
12	LG	- [Without BOSE system]
13	V	- [Coupe model without BOSE system]
13	L	- [Except for coupe model without BOSE system]
14	B	-
15	W	-
19	Y	-
23	Y/B	-
25	R	-
26	SHIELD	-
35	G	-
44	L	-
50	Y	-
51	Y	-
52	G	-

53	BG	-
54	GR	-
55	L	-

Connector No.	D33
Connector Name	DOOR MIRROR (PASSENGER SIDE)
Connector Type	TH08MW-NH



Terminal No.	Color of Wire	Signal Name (Specification)
1	BG	-
3	L	-
4	L	-
8	B	-

Connector No.	D101
Connector Name	WIRE TO WIRE
Connector Type	M04FW-LC



Terminal No.	Color of Wire	Signal Name (Specification)
2	Y	-
4	B	-

Connector No.	D106
Connector Name	CONDENSER
Connector Type	M01FW-LC



Terminal No.	Color of Wire	Signal Name (Specification)
1	Y	-

Connector No.	D107
Connector Name	REAR WINDOW DEFOGGER
Connector Type	P01FB-A



Terminal No.	Color of Wire	Signal Name (Specification)
2	B	-

Connector No.	D201
Connector Name	REAR WINDOW DEFOGGER
Connector Type	P01FB-A

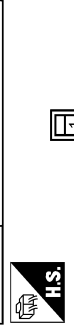

Terminal No.	Color of Wire	Signal Name (Specification)
1	B	-

JRLWC4811GB

A  
B  
C  
D  
E  
F  
G  
H  
I  
J  
K  
DEF  
M  
N  
O  
P

# REAR WINDOW DEFOGGER SYSTEM

< DTC/CIRCUIT DIAGNOSIS >

[ROADSTER]

## DEFOGGER (WITH NAVI)

Connector No.	EB
Connector Name	FROM E-INTELLIGENT POWER DISTRIBUTION MODULE (ENGINE ROOM)
Connector Type	TH88FW-NH



Terminal No.	Color of Wire	Signal Name (Specification)
39	P	-
40	L	-
41	B/W	-
42	Y	-
43	SB	-
44	W	-
45	G	-
46	Y	-

Connector No.	E106
Connector Name	WIRE TO WIRE
Connector Type	TH88FW-CS16-TM4

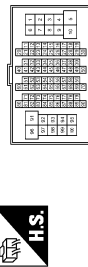

Terminal No.	Color of Wire	Signal Name (Specification)
1	Y	-
3	L	-
4	L	-
7	B	-
8	P	-
9	B	-
11	Y	-
12	R	-
13	L	-
14	GR	-
15	W	-
16	W	-
17	SB	-
20	LG	-

21	BR	- [Coupe models] - [Roadster models]
21	G	-
31	L	-
32	Y	-
36	Y	-
37	Y	-
38	R	-
39	B	-
40	W	-
41	LG	-
42	SB	-
43	G	-
44	GR	- [Except for roadster models with M/T] - [Roadster models with M/T]
45	EG	-
46	W	-
47	P	-
58	SHIELD	-
59	L	-
70	P	-
80	W	-
81	P	-
82	G	-
83	V	-
84	L	-
85	EG	-
86	LG	-
87	R	-
89	P	-
91	W	-
92	L	-
93	G	-
94	Y	-
96	Y	-
97	BR	-
98	GR	-
99	LG	-
100	EG	-

Connector No.	M1
Connector Name	FUSE BLOCK (J/B)
Connector Type	NS08FW-M2



Terminal No.	Color of Wire	Signal Name (Specification)
31	Y	-
32	Y	-
36	Y	-
37	Y	-
38	R	-
39	B	-
40	W	-
41	LG	-
42	SB	-
43	G	-
44	GR	-
45	EG	-
46	W	-
47	P	-
58	SHIELD	-
59	L	-
70	P	-
80	W	-
81	P	-
82	G	-
83	V	-
84	L	-
85	EG	-
86	LG	-
87	R	-
89	P	-
91	W	-
92	L	-
93	G	-
94	Y	-
96	Y	-
97	BR	-
98	GR	-
99	LG	-
100	EG	-

Connector No.	M2
Connector Name	FUSE BLOCK (J/B)
Connector Type	NS10FW-CS

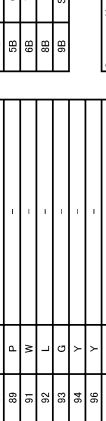

Terminal No.	Color of Wire	Signal Name (Specification)
31	Y	-
32	Y	-
36	Y	-
37	Y	-
38	R	-
39	B	-
40	W	-
41	LG	-
42	SB	-
43	G	-
44	GR	-
45	EG	-
46	W	-
47	P	-
58	SHIELD	-
59	L	-
70	P	-
80	W	-
81	P	-
82	G	-
83	V	-
84	L	-
85	EG	-
86	LG	-
87	R	-
89	P	-
91	W	-
92	L	-
93	G	-
94	Y	-
96	Y	-
97	BR	-
98	GR	-
99	LG	-
100	EG	-

Connector No.	M3
Connector Name	FUSE BLOCK (J/B)
Connector Type	NS12FW-CS

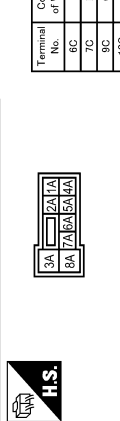

Terminal No.	Color of Wire	Signal Name (Specification)
11C	LG	-
12C	O	-

Connector No.	M5
Connector Name	WIRE TO WIRE
Connector Type	TH40MW-CS15



Terminal No.	Color of Wire	Signal Name (Specification)
7	Y	-
8	Y	-
9	G	-
10	V	-
11	V	-
12	L	-
13	B	-
14	Y	-
15	W	-
19	Y	-
23	Y/B	-
25	Y	-
26	SHIELD	-
35	BR	-
44	L	-
47	B	-
48	SB	-
49	Y	-
50	W	-
51	R	-
52	L	-
53	W	-
54	G	-
55	R	-

Connector No.	M4
Connector Name	FUSE BLOCK (J/B)
Connector Type	NS10FW-CS

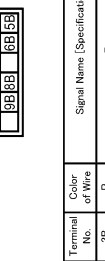

Terminal No.	Color of Wire	Signal Name (Specification)
31	Y	-
32	Y	-
36	Y	-
37	Y	-
38	R	-
39	B	-
40	W	-
41	LG	-
42	SB	-
43	G	-
44	GR	-
45	EG	-
46	W	-
47	P	-
58	SHIELD	-
59	L	-
70	P	-
80	W	-
81	P	-
82	G	-
83	V	-
84	L	-
85	EG	-
86	LG	-
87	R	-
89	P	-
91	W	-
92	L	-
93	G	-
94	Y	-
96	Y	-
97	BR	-
98	GR	-
99	LG	-
100	EG	-

Connector No.	M6
Connector Name	FUSE BLOCK (J/B)
Connector Type	NS12FW-CS

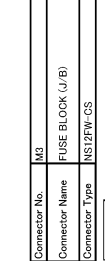

Terminal No.	Color of Wire	Signal Name (Specification)
7	Y	-
8	Y	-
9	G	-
10	V	-
11	V	-
12	L	-
13	B	-
14	Y	-
15	W	-
19	Y	-
23	Y/B	-
25	Y	-
26	SHIELD	-
35	BR	-
44	L	-
47	B	-
48	SB	-
49	Y	-
50	W	-
51	R	-
52	L	-
53	W	-
54	G	-
55	R	-

Connector No.	M7
Connector Name	FUSE BLOCK (J/B)
Connector Type	NS12FW-CS



JRLWC4812GB

# REAR WINDOW DEFOGGER SYSTEM

< DTC/CIRCUIT DIAGNOSIS >

[ROADSTER]

## DEFOGGER (WITH NAVI)

Connector No.	M6
Connector Name	WIRE TO WIRE
Connector Type	TH8MMH-CST16-TM4



Terminal No.	Color of Wire	Signal Name (Specification)
1	Y	-
3	L	-
4	L	-
7	B	-
8	P	-
9	B	-
11	GR	-
12	R	-
13	L	-
14	G	-
15	P	-
16	W	-
17	BR	-
20	GR	-
21	R	-
31	BR	-
32	V	-
36	SB	-
37	Y	-
38	LG	-
39	SB	-
40	W	-
41	LG	-
42	R	-
43	G	-
44	G	-
44	R	-
45	O	-
46	G	-
47	BR	-
58	SHIELD	-
59	L	-
70	R	-
80	LG	-
81	GR	-
82	V	-
83	V	-
84	L	-

85	BR	-
86	Y	-
87	G	-
89	P	-
91	W	-
92	P	-
93	P	-
94	Y	-
96	P	-
97	GR	-
98	O	-
99	W	-
100	R	-

Connector No.	M24
Connector Name	DATA LINK CONNECTOR
Connector Type	BD18FW



Terminal No.	Color of Wire	Signal Name (Specification)
3	LG	- [Coupe models]
4	Y	-
5	B	-
6	L	-
7	Y	-
8	G	-
11	Y	-
11	LG	- [Coupe models]
14	P	-
16	Y	-

Connector No.	M72
Connector Name	MULTIFUNCTION SWITCH
Connector Type	TH18FW-NH

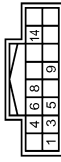

Terminal No.	Color of Wire	Signal Name (Specification)
1	B	GROUND
3	L	ACC
4	R	ILL
5	W	ILL CONT
6	LG	AV COMM (H) [Coupe models]
8	Y	AV COMM (H) [Roadster models]
8	P	AV COMM (L) [Coupe models]
9	BR	AV COMM (L) [Roadster models]
14	SB	DISK EJECT SIGNAL

Connector No.	M88
Connector Name	AV CONTROL UNIT
Connector Type	TH32FW-NH



Terminal No.	Color of Wire	Signal Name (Specification)
65	O	PARKING BRAKE SIGNAL
67	L	COMPOSITE IMAGE GND
68	G	COMPOSITE IMAGE SIGNAL
71	SHIELD	MICROPHONE GND
72	R	MICROPHONE VCC
73	G	COMM (CONT->DISP)
74	P	GAN-L
75	LG	AV COMM (L) [Coupe models]
75	Y	AV COMM (L) [Roadster models]
76	LG	AV COMM (L) [Coupe models]
76	Y	AV COMM (L) [Roadster models]
79	R	ILL+

80	G	IGNITION SIGNAL
81	O	REVERSE SIGNAL
82	Y	VEHICLE SPEED SIGNAL (8-PULSE)
83	B	SHIELD
84	Y	-
87	G	MICROPHONE SIGNAL
89	R	COMM (DISP->CONT)
90	L	GAN-H
91	Y	AV COMM (H) [Coupe models]
91	LG	AV COMM (H) [Roadster models]
92	Y	AV COMM (H) [Coupe models]
92	LG	AV COMM (H) [Roadster models]

Connector No.	M118
Connector Name	ECM (BODY CONTROL MODULE)
Connector Type	M03FB-4C



Terminal No.	Color of Wire	Signal Name (Specification)
1	W	BAT. F/L
2	W	POWER WINDOW POWER SUPPLY (BAT)
3	Y	POWER WINDOW POWER SUPPLY (IGN)

A  
B  
C  
D  
E  
F  
G  
H  
I  
J  
K  
DEF  
M  
N  
O  
P

# REAR WINDOW DEFOGGER SYSTEM

< DTC/CIRCUIT DIAGNOSIS >

[ROADSTER]

## DEFOGGER (WITH NAVI)

Connector No.	M119
Connector Name	BCM (BODY CONTROL MODULE)
Connector Type	MS18FM-CS



4	5	11	13	14	15	17	18	19
---	---	----	----	----	----	----	----	----

Terminal No.	Color of Wire	Signal Name (Specification)
4	R	INTERIOR ROOM LAMP POWER SUPPLY
5	G	PASSENGER DOOR UNLOCK OUTPUT
8	V	ALL DOOR FUEL LID LOCK OUTPUT
9	G	DRIVER DOOR FUEL LID UNLOCK OUTPUT
11	BR	BAT (FUSE)
13	B	GROUND
14	R	PUSH-BUTTON IGNITION SW ILL GND
15	Y	ACC IND
17	W	TURN SIGNAL RH (FRONT, SIDE)
18	O	TURN SIGNAL LH (FRONT, SIDE)
19	P	ROOM LAMP TIMER CONTROL

Connector No.	M122
Connector Name	BCM (BODY CONTROL MODULE)
Connector Type	TH40FE-NH



10	11	12	13	14	15	16	17	18	19
----	----	----	----	----	----	----	----	----	----

Terminal No.	Color of Wire	Signal Name (Specification)
72	L	ROOM ANT 2-
73	P	ROOM ANT 2+
74	SB	PASSENGER DOOR ANT-
75	BR	PASSENGER DOOR ANT+
76	V	DRIVER DOOR ANT-
77	LG	DRIVER DOOR ANT+
78	L	ROOM ANT 1-
79	B	ROOM ANT 1+
80	GR	MAT'S ANT AMP-
81	W	MAT'S ANT AMP+
82	R	IGN RELAY (P/B) CONT

83	GR	KYLS ENT RECEIVER (FRONT) COMM
87	BR	COMBI SW INPUT 5
88	V	COMBI SW INPUT 3
90	P	GAN-L
91	L	GAN-H
92	LG	KEY SLOT ILL
93	V	ON IND
95	O	ACC RELAY CONT
96	Y	A/T SHIFT SELECTOR POWER SUPPLY
99	R	SHIFT P/CLUTCH PEDAL POS SW
100	GR	PASSENGER DOOR REQUEST SW
101	Y	DRIVER DOOR REQUEST SW
102	O	BLOWER FAN MOTOR RELAY CONT
103	LG	KYLS ENT RECEIVER (FRONT) PMR SUPPLY
107	LG	COMBI SW INPUT 1
108	R	COMBI SW INPUT 4
109	Y	COMBI SW INPUT 2
110	P	HAZARD SW

Connector No.	M123
Connector Name	BCM (BODY CONTROL MODULE)
Connector Type	TH40FG-NH



10	11	12	13	14	15	16	17	18	19
----	----	----	----	----	----	----	----	----	----

Terminal No.	Color of Wire	Signal Name (Specification)
113	O	OPTICAL SENSOR
114	R	CLUTCH INTERLOCK SW
115	O	-
116	SB	STOP LAMP SW 1
118	P	STOP LAMP SW 2
119	SB	DR DOOR UNLOCK SENSOR
121	R	KEY SLOT SW
123	W	IGN F/B
124	LG	PASSENGER DOOR SW
129	O	TRUNK LID OPENER CANCEL SW
130	L	REAR DEFOGGER SW
132	V	P/W SW & START TOP GLL COMM (Roadster model)
132	Y	POWER WINDOW SW COMM (Cruiser model)
133	O	PUSH BUTTON IGNITION SW ILL POWER
134	GR	LOCK ING
137	P	RECEIVER SENSOR GND
138	V	RECEIVER SENSOR POWER SUPPLY
139	L	THE PRESS RECEV COMM

140	G	P/N POSITION
141	Y	SECURITY INDICATOR
142	O	COMBI SW OUTPUT 5
143	P	COMBI SW OUTPUT 1
144	G	COMBI SW OUTPUT 2
145	L	COMBI SW OUTPUT 3
146	SB	COMBI SW OUTPUT 4
150	GR	DRIVER DOOR SW
151	G	REAR WINDOW DEFOGGER RELAY CONT

Connector No.	M124
Connector Name	WIRE TO WIRE
Connector Type	TH40MW-CS15



1	2	3	4	5	6	7	8	9	10	11	12	13	14	15
---	---	---	---	---	---	---	---	---	----	----	----	----	----	----

Terminal No.	Color of Wire	Signal Name (Specification)
10	G	-
11	V	-
12	LG	-
13	V	-
14	B	-
15	W	-
19	Y	-
23	Y/B	-
25	W	-
26	SHIELD	-
35	B	-
44	O	-
50	Y	-
51	Y	-
52	GR	-
53	W	-
54	G	-
55	R	-

# REAR WINDOW DEFOGGER SYSTEM

< DTC/CIRCUIT DIAGNOSIS >

[ROADSTER]

## Wiring Diagram - DEFOGGER (WITHOUT NAVI) -

INFOID:000000009363404

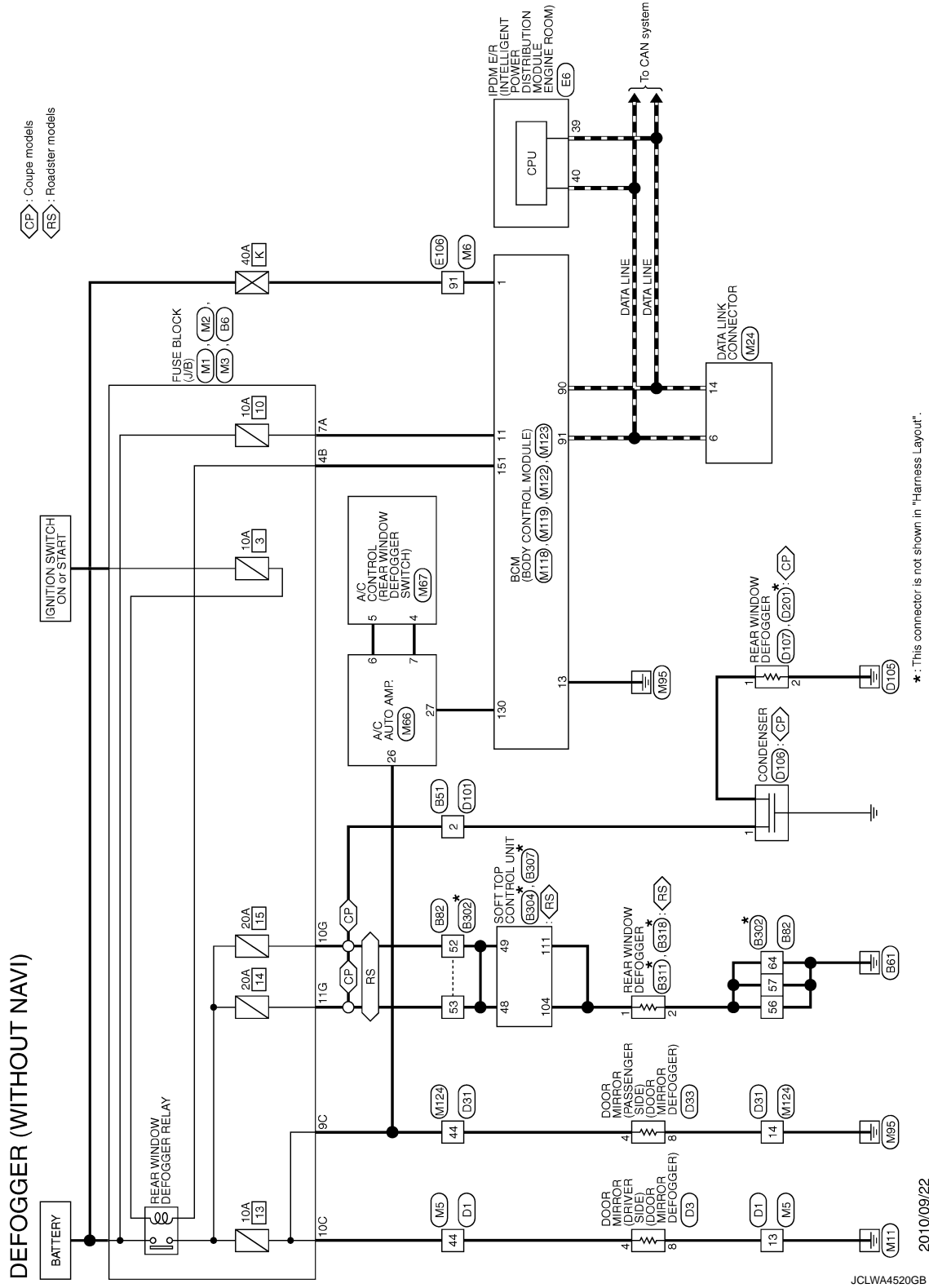

A  
B  
C  
D  
E  
F  
G  
H  
I  
J  
K  
DEF  
M  
N  
O  
P

# REAR WINDOW DEFOGGER SYSTEM

< DTC/CIRCUIT DIAGNOSIS >

[ROADSTER]

## DEFOGGER (WITHOUT NAVI)

Connector No.	BB
Connector Name	FUSE BLOCK (J/B)
Connector Type	NS1ZFR-CS



Terminal No.	Color of Wire	Signal Name [Specification]
5G	LG	-
10G	W	- [Coupe models]
10G	P	- [Roadster models]
11G	W	- [Coupe models]
11G	G	- [Roadster models]
12G	Y	-



Connector No.	B51
Connector Name	WIRE TO WIRE
Connector Type	M04MM-LC



Terminal No.	Color of Wire	Signal Name [Specification]
2	Y	-
4	B	-



Connector No.	B82
Connector Name	WIRE TO WIRE
Connector Type	NS1ZFR-CS



Terminal No.	Color of Wire	Signal Name [Specification]
52	P	-
53	G	-
55	R	-
56	B	-
57	B	-
58	Y	-
59	B	-
60	LG	-
61	L	-
62	L	-
63	L	-
64	B	-
65	Y	-
66	Y	-

Connector No.	B302
Connector Name	WIRE TO WIRE
Connector Type	NS16MM-CS



Terminal No.	Color of Wire	Signal Name [Specification]
52	R	-
53	R	-
55	V	-
56	B	-
57	B	-
58	SB	-
59	DG	-
60	DG	-
61	R	-
62	R	-
63	R	-
64	B	-
65	R	-
66	R	-

Connector No.	B304
Connector Name	SOFT TOP CONTROL UNIT
Connector Type	NS1ZFR-CS



Terminal No.	Color of Wire	Signal Name [Specification]
41	DG	TRUNK OPENER ACTUATOR
48	R	REAR WINDOW DEF IN 2
49	R	REAR WINDOW DEF IN 1

Connector No.	B307
Connector Name	SOFT TOP CONTROL UNIT
Connector Type	NS16FW-CS

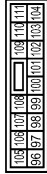

Terminal No.	Color of Wire	Signal Name [Specification]
96	W	SWITCHING VALVE 4
97	LG	SWITCHING VALVE 3
98	L	SWITCHING VALVE 2
99	O	SWITCHING VALVE 1
100	BR	HYDRAULIC PUMP RELAY 2 +
101	SB	HYDRAULIC PUMP RELAY 1 +
102	P	SWITCHING VALVE 5
103	B	HYDRAULIC UNIT GND
104	R	REAR WINDOW DEF OUT 2
111	R	REAR WINDOW DEF OUT 1

Connector No.	B311
Connector Name	REAR WINDOW DEFOGGER
Connector Type	-



Terminal No.	Color of Wire	Signal Name [Specification]
1	-	-

Connector No.	B318
Connector Name	REAR WINDOW DEFOGGER
Connector Type	-



Terminal No.	Color of Wire	Signal Name [Specification]
2	-	-

# REAR WINDOW DEFOGGER SYSTEM

< DTC/CIRCUIT DIAGNOSIS >

[ROADSTER]

## DEFOGGER (WITHOUT NAVI)

Connector No.	D1
Connector Name	WIRE TO WIRE
Connector Type	TH40FY-CS15

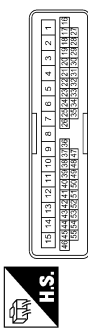

Terminal No.	Color of Wire	Signal Name (Specification)
7	Y	-
8	Y	-
9	G	-
10	BG	-
11	P	- [With BOSE system]
11	V	- [Without BOSE system]
12	L	-
13	B	-
14	SB	- [Coupe models]
14	Y	- [Roadster models]
15	W	-
19	Y	-
23	Y/B	-
25	R	-
26	SHIELD	-
35	G	-
44	L	-
47	B	-
48	SB	-
49	W	-
50	LG	-
51	R	-
52	V	-
53	BG	-
54	GR	-
55	G	-

Connector No.	D3
Connector Name	DOOR MIRROR (DRIVER SIDE)
Connector Type	TH08MW-HH



Terminal No.	Color of Wire	Signal Name (Specification)
1	BR	-
2	L	-
3	Y	-
4	L	-
8	B	-

Connector No.	D31
Connector Name	WIRE TO WIRE
Connector Type	TH40FY-CS15



Terminal No.	Color of Wire	Signal Name (Specification)
10	V	-
11	LG	-
12	P	- [With BOSE system]
12	LG	- [Without BOSE system]
13	V	- [Coupe models without BOSE system]
13	L	- [Except for coupe models without BOSE system]
14	B	-
15	W	-
19	Y	-
23	Y/B	-
25	R	-
26	SHIELD	-
35	G	-
44	L	-
50	Y	-
51	Y	-
52	G	-

53	BG	-
54	GR	-
55	L	-

Connector No.	D33
Connector Name	DOOR MIRROR (PASSENGER SIDE)
Connector Type	TH08MW-HH

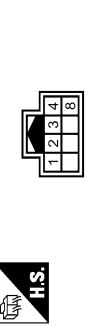

Terminal No.	Color of Wire	Signal Name (Specification)
1	BG	-
3	L	-
4	L	-
8	B	-

Connector No.	D101
Connector Name	WIRE TO WIRE
Connector Type	M04FW-LC



Terminal No.	Color of Wire	Signal Name (Specification)
2	Y	-
4	B	-

Connector No.	D106
Connector Name	CONDENSER
Connector Type	M01FW-LC



Terminal No.	Color of Wire	Signal Name (Specification)
1	Y	-

Connector No.	D107
Connector Name	REAR WINDOW DEFOGGER
Connector Type	P01FB-A



Terminal No.	Color of Wire	Signal Name (Specification)
2	B	-

Connector No.	D201
Connector Name	REAR WINDOW DEFOGGER
Connector Type	P01FB-A



Terminal No.	Color of Wire	Signal Name (Specification)
1	B	-

JRLWC4806GB

A  
B  
C  
D  
E  
F  
G  
H  
I  
J  
K  
DEF  
M  
N  
O  
P

# REAR WINDOW DEFOGGER SYSTEM

< DTC/CIRCUIT DIAGNOSIS >

[ROADSTER]

## DEFOGGER (WITHOUT NAVI)

Connector No.	EB
Color of Wire	FROM E-INTELLIGENT POWER DISTRIBUTION MODULE (ROUSE SIGNAL)
Connector Name	TH88FW-NH
Connector Type	



Terminal No.	Color of Wire	Signal Name (Specification)
39	P	-
40	L	-
41	B/W	-
42	Y	-
43	SB	-
44	W	-
45	G	-
46	Y	-

Connector No.	E106
Color of Wire	WIRE TO WIRE
Connector Name	TH88FW-CS16-TM4
Connector Type	

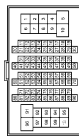

Terminal No.	Color of Wire	Signal Name (Specification)
1	Y	-
3	L	-
4	L	-
7	B	-
8	P	-
9	B	-
11	Y	-
12	R	-
13	L	-
14	GR	-
15	Y	-
19	W	-
17	SB	-
20	LG	-

21	BR	- [Coupe models]
21	G	- [Roadster models]
31	L	-
32	Y	-
36	V	-
37	Y	-
38	R	-
39	B	-
40	W	-
41	LG	-
42	SB	-
43	G	-
44	GR	- [Except for roadster models with M/T]
44	R	- [Roadster models with M/T]
45	EG	-
46	W	-
47	P	-
58	SHIELD	-
59	L	-
70	P	-
80	W	-
81	P	-
82	G	-
83	V	-
84	L	-
85	EG	-
86	LG	-
87	R	-
89	P	-
91	W	-
92	L	-
93	G	-
94	Y	-
96	Y	-
97	BR	-
98	GR	-
99	LG	-
100	EG	-

Connector No.	M1
Color of Wire	FUSE BLOCK (J/B)
Connector Name	NS08FW-M2
Connector Type	



Terminal No.	Color of Wire	Signal Name (Specification)
3B	P	-
4B	G	-
5B	O	-
6B	Y	-
8B	R	-
9B	SB	-

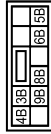

Terminal No.	Color of Wire	Signal Name (Specification)
13	B	-
14	Y	-
15	W	-
19	Y	-
23	Y/B	-
25	Y	-
26	SHIELD	-
35	BR	-
44	L	-
47	B	-
48	SB	-
49	Y	-
50	W	-
51	R	-
52	L	-
53	W	-
54	G	-
55	R	-

Connector No.	M3
Color of Wire	FUSE BLOCK (J/B)
Connector Name	NS12FW-CS
Connector Type	



Terminal No.	Color of Wire	Signal Name (Specification)
6C	R	-
7C	B	-
8C	O	-
10C	L	-

Terminal No.	Color of Wire	Signal Name (Specification)
11C	LG	-
12C	O	-

Connector No.	M5
Color of Wire	WIRE TO WIRE
Connector Name	TH40MW-CS15
Connector Type	

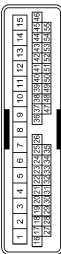

Terminal No.	Color of Wire	Signal Name (Specification)
7	Y	-
8	Y	-
9	G	-
10	V	-
11	V	-
12	L	-
13	B	-
14	Y	-
15	W	-
19	Y	-
23	Y/B	-
25	Y	-
26	SHIELD	-
35	BR	-
44	L	-
47	B	-
48	SB	-
49	Y	-
50	W	-
51	R	-
52	L	-
53	W	-
54	G	-
55	R	-

JRLWC4807GB



# REAR WINDOW DEFOGGER SYSTEM

< DTC/CIRCUIT DIAGNOSIS >

[ROADSTER]

## DEFOGGER (WITHOUT NAVI)

Connector No.	M6
Connector Name	WIRE TO WIRE
Connector Type	TH80MH-CST16-TM4



Terminal No.	Color of Wire	Signal Name (Specification)
1	Y	-
3	L	-
4	L	-
7	B	-
8	P	-
9	B	-
11	GR	-
12	R	-
13	L	-
14	G	-
15	P	-
16	W	-
17	BR	-
20	GR	-
21	R	-
31	BR	-
32	V	-
36	SB	-
37	Y	-
38	LG	-
39	SB	-
40	W	-
41	LG	-
42	R	-
43	G	-
44	G	-
44	R	- [With A/T] - [With M/T]
45	O	-
46	G	-
47	BR	-
58	SHIELD	-
59	L	-
70	R	-
80	LG	-
81	GR	-
82	V	-
83	V	-
84	L	-

85	BR	-
86	Y	-
87	G	-
89	P	-
91	W	-
92	P	-
93	P	-
94	Y	-
96	P	-
97	GR	-
98	O	-
99	W	-
100	R	-

Connector No.	M24
Connector Name	DATA LINK CONNECTOR
Connector Type	BD18FW

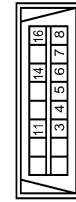

Terminal No.	Color of Wire	Signal Name (Specification)
3	LG	- [Coupe models] - [Roadster models]
4	B	-
5	B	-
6	L	-
7	Y	-
8	G	-
11	Y	- [Coupe models] - [Roadster models]
11	LG	-
14	P	-
16	Y	-

Connector No.	M66
Connector Name	A/C AUTO AMP.
Connector Type	SAB40FW



Terminal No.	Color of Wire	Signal Name (Specification)
1	L	CAN-H
2	P	CAN-L
6	L	TX (AMP>CONT)
7	P	RX (CONT>AMP)
10	BR	LAN SIGNAL
11	Y	EACH DOOR MOTOR POWER SUPPLY
15	O	SUNLOAD SENSOR SIGNAL
16	R	INTAKE SENSOR SIGNAL
17	L	ACC POWER SUPPLY
19	B	GROUND
20	G	IGNITION POWER SUPPLY
24	O	ECV SIGNAL
26	R	REAR WINDOW DEFOGGER FEEDBACK SIGNAL
27	L	REAR WINDOW DEFOGGER ON SIGNAL
32	P	BLOWER MOTOR CONTROL SIGNAL
34	G	A/C AUTO AMP CONNECTION RECOGNITION SIGNAL
35	V	AMBIENT SENSOR SIGNAL
36	LG	IN-VEHICLE SENSOR SIGNAL
37	GR	SENSOR GROUND
39	B	GROUND
40	Y	BATTERY POWER SUPPLY

Connector No.	M67
Connector Name	A/C CONTROL
Connector Type	THIR3E-NH

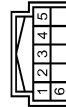

Terminal No.	Color of Wire	Signal Name (Specification)
1	G	IGNITION POWER SUPPLY

2	R	ILL+
3	W	ILL-
4	P	TX (SW>AMP)
5	L	RX (AMP>SW)
6	B	GROUND

Connector No.	M118
Connector Name	ECM (BODY CONTROL MODULE)
Connector Type	M03FB-LC



Terminal No.	Color of Wire	Signal Name (Specification)
1	W	BAT (F/L)
2	W	POWER WINDOW POWER SUPPLY (BAT)
3	Y	POWER WINDOW POWER SUPPLY (IGN)

Connector No.	M119
Connector Name	ECM (BODY CONTROL MODULE)
Connector Type	NIS18FY-CS



Terminal No.	Color of Wire	Signal Name (Specification)
4	R	INTERIOR ROOM LAMP POWER SUPPLY
5	G	PASSENGER DOOR UNLOCK OUTPUT
6	V	ALL DOORS FUEL LID LOCK OUTPUT
9	O	DRIVER DOOR FUEL LID UNLOCK OUTPUT
11	BR	BAT (F/USE)
13	B	GROUND
14	R	PUSH-BUTTON IGNITION SW ILL GND
15	Y	ACC I/O
17	W	TURN SIGNAL RH (FRONT-SIDE)
18	O	TURN SIGNAL LH (FRONT-SIDE)
19	P	ROOM LAMP TIMER CONTROL

JRLWC4808GB

A  
B  
C  
D  
E  
F  
G  
H  
I  
J  
K  
DEF  
M  
N  
O  
P

# REAR WINDOW DEFOGGER SYSTEM

< DTC/CIRCUIT DIAGNOSIS >

[ROADSTER]

## DEFOGGER (WITHOUT NAVI)

Connector No.	M122
Connector Name	BCM (BODY CONTROL MODULE)
Connector Type	TH40FE-NH

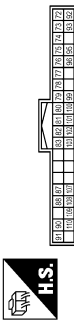

Terminal No.	Color of Wire	Signal Name (Specification)
72	L	ROOM ANT 2-
73	P	ROOM ANT 2+
74	SB	PASSENGER DOOR ANT-
75	BR	PASSENGER DOOR ANT+
76	V	DRIVER DOOR ANT-
77	LG	DRIVER DOOR ANT+
78	L	ROOM ANT 1-
79	R	ROOM ANT 1+
80	GR	MATS ANT AMP.
81	W	MATS ANT AMP.
82	R	IGN RELAY (F/B) CONT
83	GR	KYLS ENT RECEIVER (FRONT) COMM
87	BR	COMBI SW INPUT 5
88	V	COMBI SW INPUT 3
90	P	CAN-L
91	L	CAN-H
92	LG	KEY SLOT ILL
93	V	ON IND
95	O	ACC RELAY CONT
96	Y	A/T SHIFT SELECTOR POWER SUPPLY
99	R	SHIFT P/CLUTCH PEDAL POS SW
100	GR	PASSENGER DOOR REQUEST SW
101	Y	DRIVER DOOR REQUEST SW
102	O	BLOWER FAN MOTOR RELAY CONT
103	LG	KYLS ENT RECEIVER (FRONT) PWR SUPPLY
107	LG	COMBI SW INPUT 1
108	R	COMBI SW INPUT 4
109	Y	COMBI SW INPUT 2
110	P	HAZARD SW

Connector No.	M123
Connector Name	BCM (BODY CONTROL MODULE)
Connector Type	TH40FC-NH

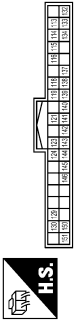

Terminal No.	Color of Wire	Signal Name (Specification)
113	O	OPTICAL SENSOR
114	R	CLUTCH INTERLOCK SW
115	O	-
116	SB	STOP LAMP SW 1
118	P	STOP LAMP SW 2
119	SB	DR DOOR UNLOCK SENSOR
121	R	KEY SLOT SW
123	W	IGN F/B
124	LG	PASSENGER DOOR SW
129	O	TRUNK LID OPENER CANCEL SW
130	L	REAR DEFOGGER SW
132	V	P-W SW & SFT Top C/U COMM [Roadster models]
132	Y	POWER WINDOW SW COMM [Coupe models]
133	G	PUSH BUTTON IGNITION SW ILL POWER
134	GR	LOCK IND
137	P	RECEIVER SENSOR GND
138	V	RECEIVER & SENSOR POWER SUPPLY
139	L	TIRE PRESS RECEV COMM
140	G	P/N POSITION
141	Y	SECURITY INDICATOR
142	O	COMBI SW OUTPUT 5
143	P	COMBI SW OUTPUT 1
144	G	COMBI SW OUTPUT 2
145	L	COMBI SW OUTPUT 3
146	SB	COMBI SW OUTPUT 4
150	GR	DRIVER DOOR SW
151	G	REAR WINDOW DEFOGGER RELAY CONT

Connector No.	M124
Connector Name	WIRE TO WIRE
Connector Type	TH40MM-CST5

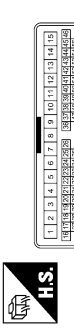

Terminal No.	Color of Wire	Signal Name (Specification)
10	G	-
11	V	-
12	LG	-
13	V	-
14	B	-
15	W	-
19	Y	-
23	Y/B	-
25	W	-
26	SHIELD	-
35	B	-
44	O	-
50	Y	-
51	Y	-
52	GR	-
53	W	-
54	G	-
55	R	-

# BCM (BODY CONTROL MODULE)

< ECU DIAGNOSIS INFORMATION >

[ROADSTER]

## ECU DIAGNOSIS INFORMATION

### BCM (BODY CONTROL MODULE)

#### Reference Value

INFOID:000000009760857

#### VALUES ON THE DIAGNOSIS TOOL

##### NOTE:

The following table includes information (items) inapplicable to this vehicle. For information (items) applicable to this vehicle, refer to CONSULT display items.

##### CONSULT MONITOR ITEM

Monitor Item	Condition	Value/Status
FR WIPER HI	Other than front wiper switch HI	Off
	Front wiper switch HI	On
FR WIPER LOW	Other than front wiper switch LO	Off
	Front wiper switch LO	On
FR WASHER SW	Front washer switch OFF	Off
	Front washer switch ON	On
FR WIPER INT	Other than front wiper switch INT	Off
	Front wiper switch INT	On
FR WIPER STOP	Front wiper is not in STOP position	Off
	Front wiper is in STOP position	On
INT VOLUME	Wiper intermittent dial is in a dial position 1 - 7	Wiper intermittent dial position
TURN SIGNAL R	Other than turn signal switch RH	Off
	Turn signal switch RH	On
TURN SIGNAL L	Other than turn signal switch LH	Off
	Turn signal switch LH	On
TAIL LAMP SW	Other than lighting switch 1ST and 2ND	Off
	Lighting switch 1ST or 2ND	On
HI BEAM SW	Other than lighting switch HI	Off
	Lighting switch HI	On
HEAD LAMP SW 1	Other than lighting switch 2ND	Off
	Lighting switch 2ND	On
HEAD LAMP SW 2	Other than lighting switch 2ND	Off
	Lighting switch 2ND	On
PASSING SW	Other than lighting switch PASS	Off
	Lighting switch PASS	On
AUTO LIGHT SW	Other than lighting switch AUTO	Off
	Lighting switch AUTO	On
FR FOG SW	<b>NOTE:</b> The item is indicated, but not monitored.	Off
RR FOG SW	Rear fog lamp switch OFF	Off
	Rear fog lamp switch ON	On
DOOR SW-DR	Driver door closed	Off
	Driver door opened	On
DOOR SW-AS	Passenger door closed	Off
	Passenger door opened	On

# BCM (BODY CONTROL MODULE)

< ECU DIAGNOSIS INFORMATION >

[ROADSTER]

Monitor Item	Condition	Value/Status
DOOR SW-RR	<b>NOTE:</b> The item is indicated, but not monitored.	Off
DOOR SW-RL	<b>NOTE:</b> The item is indicated, but not monitored.	Off
DOOR SW-BK	<ul style="list-style-type: none"> <li>• Back door closed (Coupe models)</li> <li>• Trunk lid closed (Roadster models)</li> </ul>	Off
	<ul style="list-style-type: none"> <li>• Back door opened (Coupe models)</li> <li>• Trunk lid opened (Roadster models)</li> </ul>	On
CDL LOCK SW	Other than door lock and unlock switch LOCK	Off
	Door lock and unlock switch LOCK	On
CDL UNLOCK SW	Other than door lock and unlock switch UNLOCK	Off
	Door lock and unlock switch UNLOCK	On
KEY CYL LK-SW	Other than driver door key cylinder LOCK position	Off
	Driver door key cylinder LOCK position	On
KEY CYL UN-SW	Other than driver door key cylinder UNLOCK position	Off
	Driver door key cylinder UNLOCK position	On
KEY CYL SW-TR	<b>NOTE:</b> The item is indicated, but not monitored.	Off
HAZARD SW	Hazard switch is OFF	Off
	Hazard switch is ON	On
REAR DEF SW <b>NOTE:</b> For models with NAVI this item is not monitored.	Rear window defogger switch OFF	Off
	Rear window defogger switch ON	On
H/L WASH SW	<b>NOTE:</b> The item is indicated, but not monitored.	Off
TR CANCEL SW	Trunk lid opener cancel switch OFF	Off
	Trunk lid opener cancel switch ON	On
TR/BD OPEN SW	<ul style="list-style-type: none"> <li>• Back door opener switch OFF (Coupe models)</li> <li>• Trunk lid opener switch OFF (Roadster models)</li> </ul>	Off
	<ul style="list-style-type: none"> <li>• While the back door opener switch is turned ON (Coupe models)</li> <li>• While the trunk lid opener switch is turned ON (Roadster models)</li> </ul>	On
TRNK/HAT MNTR	<b>NOTE:</b> The item is indicated, but not monitored.	Off
RKE-LOCK	LOCK button of the Intelligent Key is not pressed	Off
	LOCK button of the Intelligent Key is pressed	On
RKE-UNLOCK	UNLOCK button of the Intelligent Key is not pressed	Off
	UNLOCK button of the Intelligent Key is pressed	On
RKE-TR/BD <b>NOTE:</b> For Coupe models this item is not monitored.	TRUNK OPEN button of the Intelligent Key is not pressed	Off
	TRUNK OPEN of the Intelligent Key is pressed	On
RKE-PANIC	PANIC button of the Intelligent Key is not pressed	Off
	PANIC button of the Intelligent Key is pressed	On
RKE-P/W OPEN	UNLOCK button of the Intelligent Key is not pressed	Off
	UNLOCK button of the Intelligent Key is pressed and held	On
RKE-MODE CHG	LOCK/UNLOCK button of the Intelligent Key is not pressed and held simultaneously	Off
	LOCK/UNLOCK button of the Intelligent Key is pressed and held simultaneously	On

# BCM (BODY CONTROL MODULE)

< ECU DIAGNOSIS INFORMATION >

[ROADSTER]

Monitor Item	Condition	Value/Status	
OPTICAL SENSOR	Bright outside of the vehicle	Close to 5 V	A
	Dark outside of the vehicle	Close to 0 V	
REQ SW -DR	Driver door request switch is not pressed	Off	B
	Driver door request switch is pressed	On	
REQ SW -AS	Passenger door request switch is not pressed	Off	C
	Passenger door request switch is pressed	On	
REQ SW -RR	<b>NOTE:</b> The item is indicated, but not monitored.	Off	D
REQ SW -RL	<b>NOTE:</b> The item is indicated, but not monitored.	Off	D
REQ SW -BD/TR	<ul style="list-style-type: none"> <li>• Back door request switch is not pressed (Coupe models)</li> <li>• Trunk lid door request switch is not pressed (Roadster models)</li> </ul>	Off	E
	<ul style="list-style-type: none"> <li>• Back door request switch is pressed (Coupe models)</li> <li>• Trunk lid door request switch is pressed (Roadster models)</li> </ul>	On	
PUSH SW	Push-button ignition switch (push switch) is not pressed	Off	F
	Push-button ignition switch (push switch) is pressed	On	
IGN RLY2 -F/B	<b>NOTE:</b> The item is indicated, but not monitored.	Off	G
ACC RLY -F/B	<b>NOTE:</b> The item is indicated, but not monitored.	Off	H
CLUCH SW <b>NOTE:</b> For A/T models this item is not monitored.	The clutch pedal is not depressed	Off	H
	The clutch pedal is depressed	On	I
BRAKE SW 1	The brake pedal is depressed when No. 7 fuse is blown	Off	I
	The brake pedal is not depressed when No. 7 fuse is blown, or No. 7 fuse is normal	On	J
BRAKE SW 2	The brake pedal is not depressed	Off	J
	The brake pedal is depressed	On	K
DETE/CANCL SW <b>NOTE:</b> For M/T models with Synchro-Rev Match mode this item is not monitored.	<ul style="list-style-type: none"> <li>• Selector lever in P position (A/T models)</li> <li>• The clutch pedal is depressed (M/T models without SynchroRev Match mode)</li> </ul>	Off	K
	<ul style="list-style-type: none"> <li>• Selector lever in any position other than P (A/T models)</li> <li>• The clutch pedal is not depressed (M/T models without SynchroRev Match mode)</li> </ul>	On	DEF
SFT PN/N SW <b>NOTE:</b> For roadster M/T models and coupe M/T models without SynchroRev Match mode this item is not monitored.	<ul style="list-style-type: none"> <li>• Selector lever in any position other than P and N (A/T models)</li> <li>• Control lever in any position other than neutral position (Coupe M/T models with SynchroRev Match mode)</li> </ul>	Off	M
	<ul style="list-style-type: none"> <li>• Selector lever in P or N position (A/T models)</li> <li>• Control lever in neutral position (Coupe M/T models with SynchroRev Match mode)</li> </ul>	On	N
S/L -LOCK	<b>NOTE:</b> The item is indicated but not monitored.	Off	O
S/L -UNLOCK	<b>NOTE:</b> The item is indicated but not monitored.	Off	P
S/L RELAY-F/B	<b>NOTE:</b> The item is indicated but not monitored.	Off	P
UNLK SEN -DR	Driver door is unlocked	Off	
	Driver door is locked	On	
PUSH SW -IPDM	Push-button ignition switch (push-switch) is not pressed	Off	
	Push-button ignition switch (push-switch) is pressed	On	

# BCM (BODY CONTROL MODULE)

< ECU DIAGNOSIS INFORMATION >

[ROADSTER]

Monitor Item	Condition	Value/Status
IGN RLY1 -F/B	Ignition switch in OFF or ACC position	Off
	Ignition switch in ON position	On
DETE SW -IPDM	Selector lever in any position other than P	Off
	Selector lever in P position	On
SFT PN -IPDM	<ul style="list-style-type: none"> <li>• Selector lever in any position other than P and N (A/T models)</li> <li>• The clutch pedal is not depressed (M/T models)</li> </ul>	Off
	<ul style="list-style-type: none"> <li>• Selector lever in P or N position (A/T models)</li> <li>• The clutch pedal is depressed (M/T models)</li> </ul>	On
SFT P -MET	Selector lever in any position other than P	Off
	Selector lever in P position	On
SFT N -MET	Selector lever in any position other than N	Off
	Selector lever in N position	On
ENGINE STATE	Engine stopped	Stop
	While the engine stalls	Stall
	At engine cranking	Crank
	Engine running	Run
S/L LOCK-IPDM	<b>NOTE:</b> The item is indicated but not monitored.	Off
S/L UNLK-IPDM	<b>NOTE:</b> The item is indicated but not monitored.	Off
S/L RELAY-REQ	<b>NOTE:</b> The item is indicated but not monitored.	Off
VEH SPEED 1	While driving	Equivalent to speedometer reading
VEH SPEED 2	While driving	Equivalent to speedometer reading
DOOR STAT-DR	Driver door is locked	LOCK
	Wait with selective UNLOCK operation (60 seconds)	READY
	Driver door is unlocked	UNLOCK
DOOR STAT-AS	Passenger door is locked	LOCK
	Wait with selective UNLOCK operation (60 seconds)	READY
	Passenger door is unlocked	UNLOCK
ID OK FLAG	Driver side door is open after ignition switch is turned OFF (Shift position is in the P position)	Reset
	Ignition switch ON	Set
PRMT ENG STRT	The engine start is prohibited	Reset
	The engine start is permitted	Set
PRMT RKE STRT	<b>NOTE:</b> The item is indicated, but not monitored.	Reset
KEY SW -SLOT	The Intelligent Key is not inserted into key slot	Off
	The Intelligent Key is inserted into key slot	On
RKE OPE COUN1	During the operation of the Intelligent Key	Operation frequency of the Intelligent Key
RKE OPE COUN2	During the operation of the Intelligent Key	Operation frequency of the Intelligent Key

# BCM (BODY CONTROL MODULE)

< ECU DIAGNOSIS INFORMATION >

[ROADSTER]

Monitor Item	Condition	Value/Status	
CONFIRM ID ALL	The key ID that the key slot receives is not recognized by any key ID registered to BCM.	Yet	A
	The key ID that the key slot receives is recognized by any key ID registered to BCM.	Done	B
CONFIRM ID4	The key ID that the key slot receives is not recognized by the fourth key ID registered to BCM.	Yet	C
	The key ID that the key slot receives is recognized by the fourth key ID registered to BCM.	Done	D
CONFIRM ID3	The key ID that the key slot receives is not recognized by the third key ID registered to BCM.	Yet	E
	The key ID that the key slot receives is recognized by the third key ID registered to BCM.	Done	F
CONFIRM ID2	The key ID that the key slot receives is not recognized by the second key ID registered to BCM.	Yet	G
	The key ID that the key slot receives is recognized by the second key ID registered to BCM.	Done	H
CONFIRM ID1	The key ID that the key slot receives is not recognized by the first key ID registered to BCM.	Yet	I
	The key ID that the key slot receives is recognized by the first key ID registered to BCM.	Done	J
TP 4	The ID of fourth Intelligent Key is not registered to BCM	Yet	K
	The ID of fourth Intelligent Key is registered to BCM	Done	L
TP 3	The ID of third Intelligent Key is not registered to BCM	Yet	M
	The ID of third Intelligent Key is registered to BCM	Done	N
TP 2	The ID of second Intelligent Key is not registered to BCM	Yet	O
	The ID of second Intelligent Key is registered to BCM	Done	P
TP 1	The ID of first Intelligent Key is not registered to BCM	Yet	Q
	The ID of first Intelligent Key is registered to BCM	Done	R
AIR PRESS FL	Ignition switch ON (Only when the signal from the transmitter is received)	Air pressure of front LH tire	S
AIR PRESS FR	Ignition switch ON (Only when the signal from the transmitter is received)	Air pressure of front RH tire	T
AIR PRESS RR	Ignition switch ON (Only when the signal from the transmitter is received)	Air pressure of rear RH tire	U
AIR PRESS RL	Ignition switch ON (Only when the signal from the transmitter is received)	Air pressure of rear LH tire	V
ID REGST FL1	ID of front LH tire transmitter is registered	Done	W
	ID of front LH tire transmitter is not registered	Yet	X
ID REGST FR1	ID of front RH tire transmitter is registered	Done	Y
	ID of front RH tire transmitter is not registered	Yet	Z
ID REGST RR1	ID of rear RH tire transmitter is registered	Done	AA
	ID of rear RH tire transmitter is not registered	Yet	AB
ID REGST RL1	ID of rear LH tire transmitter is registered	Done	AC
	ID of rear LH tire transmitter is not registered	Yet	AD
WARNING LAMP	Tire pressure indicator OFF	Off	AE
	Tire pressure indicator ON	On	AF
BUZZER	Tire pressure warning alarm is not sounding	Off	AG
	Tire pressure warning alarm is sounding	On	AH

# BCM (BODY CONTROL MODULE)

< ECU DIAGNOSIS INFORMATION >

[ROADSTER]

## TERMINAL LAYOUT

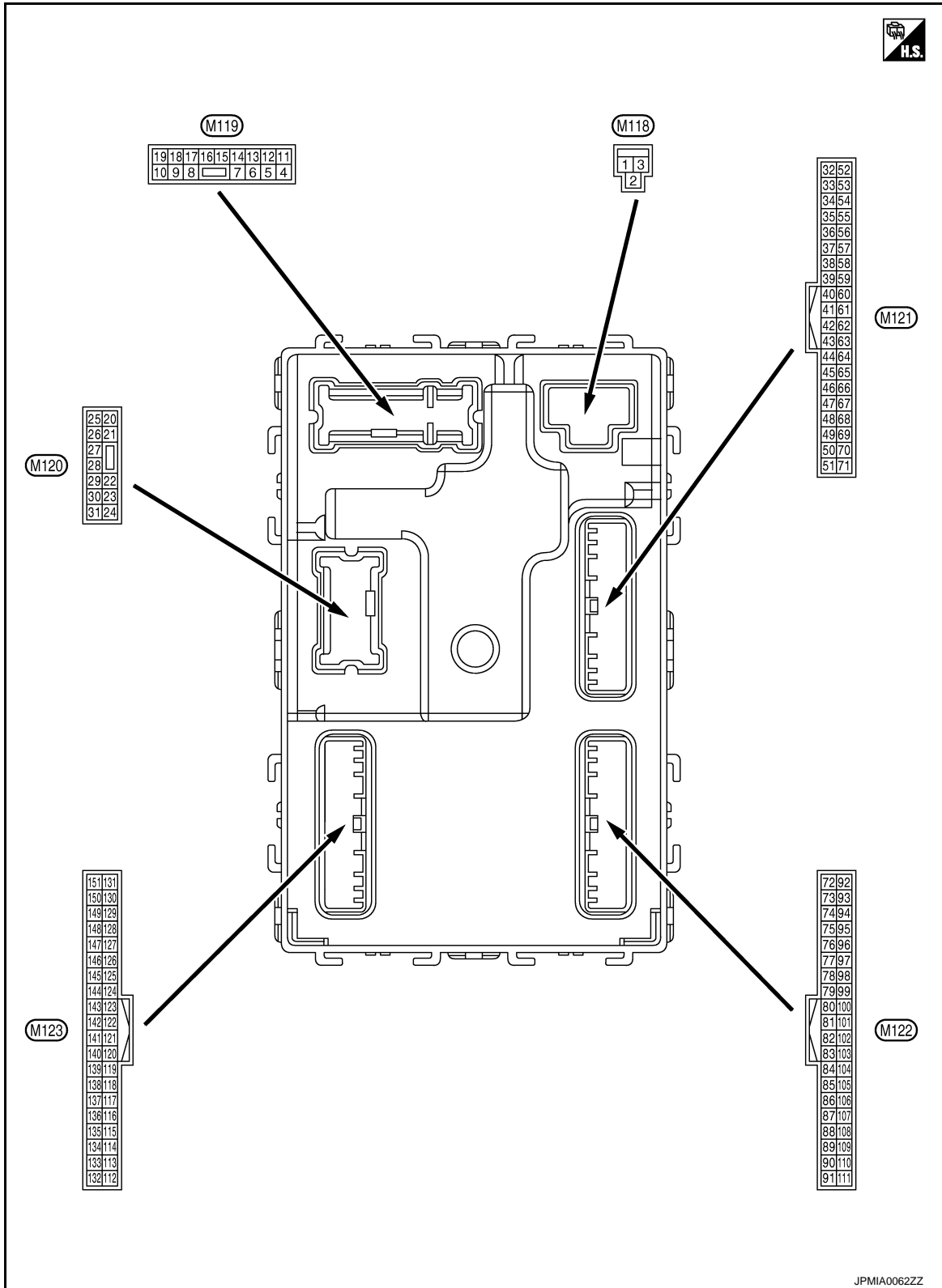

## PHYSICAL VALUES



# BCM (BODY CONTROL MODULE)

< ECU DIAGNOSIS INFORMATION >

[ROADSTER]

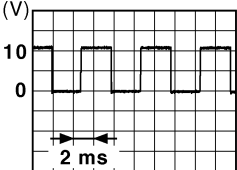
Terminal No. (Wire color)		Description		Condition		Value (Approx.)
		Signal name	Input/ Output			
+	-					
1 (W)	Ground	Battery power supply	Input	Ignition switch OFF		Battery voltage
2 (W)	Ground	P/W power supply (BAT)	Output	Ignition switch OFF		12 V
3 (Y)	Ground	P/W power supply (IGN)	Output	Ignition switch ON		12 V
4 (R)	Ground	Interior room lamp power supply	Output	Interior room lamp battery saver is activated. (Cuts the interior room lamp power supply)		0 V
				Interior room lamp battery saver is not activated. (Outputs the interior room lamp power supply)		12 V
5 (G)	Ground	Passenger door UN- LOCK	Output	Passenger door	UNLOCK (Actuator is activated)	12 V
					Other than UNLOCK (Ac- tuator is not activated)	0 V
8 (V)	Ground	All doors, fuel lid LOCK	Output	All doors, fuel lid	LOCK (Actuator is activated)	12 V
					Other than LOCK (Actuator is not activated)	0 V
9 (G)	Ground	Driver door, fuel lid UNLOCK	Output	Driver door, fuel lid	UNLOCK (Actuator is activated)	12 V
					Other than UNLOCK (Actuator is not activated)	0 V
11 (BR)	Ground	Battery power supply	Input	Ignition switch OFF		Battery voltage
13 (B)	Ground	Ground	—	Ignition switch ON		0 V
14 (R)	Ground	Push-button ignition switch illumination ground	Output	Tail lamp	OFF	0 V
					ON	<p><b>NOTE:</b> When the illumination brighten- ing/dimming level is in the neutral position.</p>  <p style="text-align: right; font-size: small;">JSNIA0010GB</p>
15 (Y)	Ground	ACC indicator lamp	Output	Ignition switch	OFF (LOCK indicator is not illuminated)	Battery voltage
					ACC	0 V

A  
B  
C  
D  
E  
F  
G  
H  
I  
J  
K  
DEF  
M  
N  
O  
P

# BCM (BODY CONTROL MODULE)

< ECU DIAGNOSIS INFORMATION >

[ROADSTER]

Terminal No. (Wire color)		Description		Condition	Value (Approx.)
		Signal name	Input/ Output		
+	-				
17 (W)	Ground	Turn signal RH (Front and side)	Output	Ignition switch OFF	0 V
				Ignition switch ON	Turn signal switch RH
18 (O)	Ground	Turn signal LH (Front and side)	Output	Ignition switch OFF	0 V
				Ignition switch ON	Turn signal switch LH
19 (P)	Ground	Interior room lamp control	Output	Interior room lamp OFF	12 V
				Interior room lamp ON	0 V
20 (V)	Ground	Turn signal RH (Rear)	Output	Ignition switch OFF	0 V
				Ignition switch ON	Turn signal switch RH
23 (L)*1 (Y)*2	Ground	Back door/Trunk lid open	Output	Back door/Trunk lid OPEN (Back door/Trunk lid opener actuator is activated)	12 V
				Back door/Trunk lid Other than OPEN (Back door/Trunk lid opener actuator is not activated)	0 V
24*8 (O)	Ground	Rear fog lamp	Output	Rear fog lamp OFF	0 V
				Rear fog lamp ON	12 V
25 (LG)	Ground	Turn signal LH (Rear)	Output	Ignition switch OFF	0 V
				Ignition switch ON	Turn signal switch LH
30 (R)	Ground	Luggage room/Trunk room lamp	Output	Luggage room/Trunk room lamp ON	0 V
				Luggage room/Trunk room lamp OFF	12 V

# BCM (BODY CONTROL MODULE)

< ECU DIAGNOSIS INFORMATION >

[ROADSTER]

Terminal No. (Wire color)		Description		Condition	Value (Approx.)
		Signal name	Input/ Output		
+	-				
34 (G)	Ground	Luggage room/Trunk room antenna (-)	Output	Ignition switch OFF	<p style="text-align: right; font-size: small;">JMKIA0062GB</p>
				When Intelligent Key is not in the passenger compart- ment	<p style="text-align: right; font-size: small;">JMKIA0063GB</p>
35 (R)	Ground	Luggage room/Trunk room antenna (+)	Output	Ignition switch OFF	<p style="text-align: right; font-size: small;">JMKIA0062GB</p>
				When Intelligent Key is not in the passenger compart- ment	<p style="text-align: right; font-size: small;">JMKIA0063GB</p>
38 (B)	Ground	Rear bumper anten- na (-)	Output	When the back door/trunk lid door request switch is oper- ated with igni- tion switch OFF	<p style="text-align: right; font-size: small;">JMKIA0062GB</p>
				When Intelligent Key is not in the antenna detection area	<p style="text-align: right; font-size: small;">JMKIA0063GB</p>

A  
B  
C  
D  
E  
F  
G  
H  
I  
J  
K  
DEF  
M  
N  
O  
P



# BCM (BODY CONTROL MODULE)

< ECU DIAGNOSIS INFORMATION >

[ROADSTER]

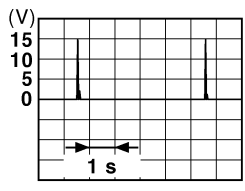
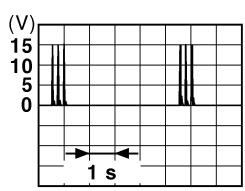
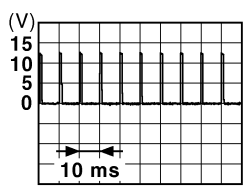
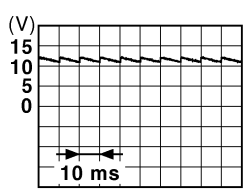
Terminal No. (Wire color)		Description		Condition	Value (Approx.)	
		Signal name	Input/ Output			
+	-					
39 (W)	Ground	Rear bumper antenna (+)	Output	When the back door/trunk lid door request switch is operated with ignition switch OFF	When Intelligent Key is in the antenna detection area	 <p style="text-align: right; font-size: small;">JMkia0062GB</p>
				When Intelligent Key is not in the antenna detection area	 <p style="text-align: right; font-size: small;">JMkia0063GB</p>	
47 (V)	Ground	Ignition relay (IPDM E/R) control	Output	Ignition switch	OFF or ACC ON 12 V 0 V	
52 (SB)	Ground	Starter relay control	Output	Ignition switch ON (A/T models)	When selector lever is in P or N position	12 V
				Ignition switch ON (M/T models)	When selector lever is not in P or N position	0 V
				Ignition switch ON (M/T models)	When the clutch pedal is depressed	Battery voltage
				Ignition switch ON (M/T models)	When the clutch pedal is not depressed	0 V
60 (BR)	Ground	Push-button ignition switch (Push switch)	Input	Push-button ignition switch (push switch)	Pressed	0 V
				Push-button ignition switch (push switch)	Not pressed	Battery voltage
61 (W)	Ground	Back door/Trunk Lid door request switch	Input	Back door/Trunk lid door request switch	ON (Pressed)	0 V
				Back door/Trunk lid door request switch	OFF (Not pressed)	 <p style="text-align: right; font-size: small;">JPMIA0016GB</p> 1.0 V
64 (G)	Ground	Intelligent Key warning buzzer	Output	Intelligent Key warning buzzer	Sounding	0 V
				Intelligent Key warning buzzer	Not sounding	12 V
66 (R)	Ground	Back door/Trunk room lamp switch	Input	Back door/Trunk room lamp switch	OFF (Door close)	 <p style="text-align: right; font-size: small;">JPMIA0011GB</p> 11.8 V
				Back door/Trunk room lamp switch	ON (Door open)	0 V

# BCM (BODY CONTROL MODULE)

< ECU DIAGNOSIS INFORMATION >

[ROADSTER]

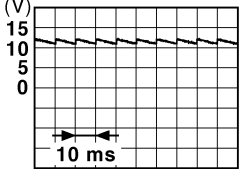
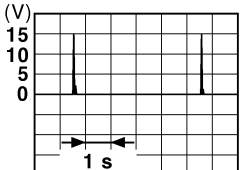
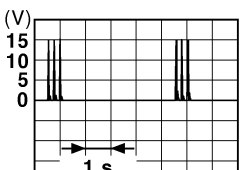
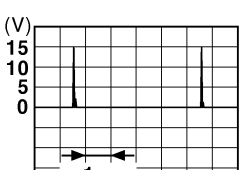
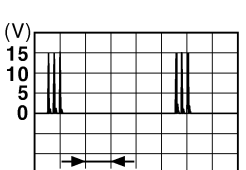
Terminal No. (Wire color)		Description		Condition	Value (Approx.)	
		Signal name	Input/ Output			
+	-					
67 (GR)	Ground	Back door/Trunk lid opener switch	Input	Back door/ Trunk lid open- er switch	Pressed	0 V
					Not pressed	 <p style="text-align: right; font-size: small;">JPMIA0011GB 11.8 V</p>
72 (L)	Ground	Room antenna 2 (-) (Center console)	Output	Ignition switch OFF	When Intelligent Key is in the passenger compart- ment	 <p style="text-align: right; font-size: small;">JMKIA0062GB</p>
					When Intelligent Key is not in the passenger compart- ment	 <p style="text-align: right; font-size: small;">JMKIA0063GB</p>
73 (P)	Ground	Room antenna 2 (+) (Center console)	Output	Ignition switch OFF	When Intelligent Key is in the passenger compart- ment	 <p style="text-align: right; font-size: small;">JMKIA0062GB</p>
					When Intelligent Key is not in the passenger compart- ment	 <p style="text-align: right; font-size: small;">JMKIA0063GB</p>

A  
B  
C  
D  
E  
F  
G  
H  
I  
J  
K  
M  
N  
O  
P

DEF

# BCM (BODY CONTROL MODULE)

< ECU DIAGNOSIS INFORMATION >

[ROADSTER]

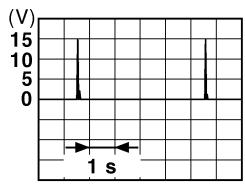
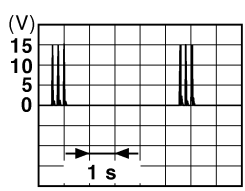
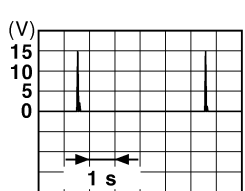
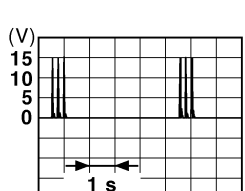
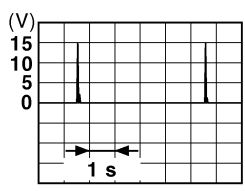
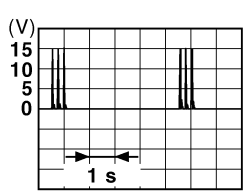
Terminal No. (Wire color)		Description		Condition	Value (Approx.)
		Signal name	Input/ Output		
+	-				
74 (SB)	Ground	Passenger door antenna (-)	Output	When Intelligent Key is in the antenna detection area	
				When the passenger door request switch is operated with ignition switch OFF	
75 (BR)	Ground	Passenger door antenna (+)	Output	When Intelligent Key is in the antenna detection area	
				When the passenger door request switch is operated with ignition switch OFF	
76 (V)	Ground	Driver door antenna (-)	Output	When Intelligent Key is in the antenna detection area	
				When the driver door request switch is operated with ignition switch OFF	

# BCM (BODY CONTROL MODULE)

< ECU DIAGNOSIS INFORMATION >

[ROADSTER]



Terminal No. (Wire color)		Description		Condition	Value (Approx.)
+	-	Signal name	Input/ Output		
77 (LG)	Ground	Driver door antenna (+)	Output	When Intelligent Key is in the antenna detection area	<p>JMKIA0062GB</p>
				When the driv- er door request switch is oper- ated with igni- tion switch OFF	When Intelligent Key is not in the antenna detection area
78*2 (L)	Ground	Room antenna 1 (-) (Instrument panel)	Output	Ignition switch OFF	<p>JMKIA0062GB</p>
				When Intelligent Key is not in the passenger compart- ment	<p>JMKIA0063GB</p>
79*2 (R)	Ground	Room antenna 1 (+) (Instrument panel)	Output	Ignition switch OFF	<p>JMKIA0062GB</p>
				When Intelligent Key is not in the passenger compart- ment	<p>JMKIA0063GB</p>

A  
B  
C  
D  
E  
F  
G  
H  
I  
J  
K  
DEF  
M  
N  
O  
P

# BCM (BODY CONTROL MODULE)

< ECU DIAGNOSIS INFORMATION >

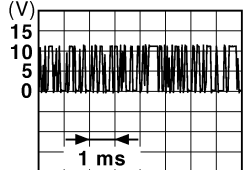
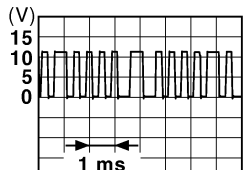
[ROADSTER]

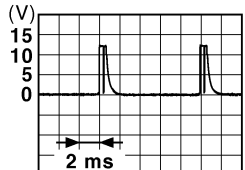



Terminal No. (Wire color)		Description		Condition		Value (Approx.)
+	-	Signal name	Input/ Output			
80 (GR)	Ground	NATS antenna amp.	Input/ Output	During waiting	Ignition switch is pressed while inserting the Intelligent Key into the key slot.	Just after pressing ignition switch. Pointer of tester should move.
81 (W)	Ground	NATS antenna amp.	Input/ Output	During waiting	Ignition switch is pressed while inserting the Intelligent Key into the key slot.	Just after pressing ignition switch. Pointer of tester should move.
82 (R)	Ground	Ignition relay [Fuse block (J/B)] control	Output	Ignition switch	OFF or ACC ON	0 V 12 V
83 (GR)	Ground	Remote keyless entry receiver (front) communication	Input/ Output	During waiting		 <p style="text-align: right; font-size: small;">JMKIA0064GB</p>
				When operating either button on the Intelligent Key		 <p style="text-align: right; font-size: small;">JMKIA0065GB</p>
87 (BR)	Ground	Combination switch INPUT 5	Input	Combination switch	All switches OFF (Wiper intermittent dial 4)	 <p style="text-align: right; font-size: small;">JPMIA0041GB</p> <p style="text-align: center;">1.4 V</p>
					Rear fog lamp switch ON (Wiper intermittent dial 4)	 <p style="text-align: right; font-size: small;">JPMIA0038GB</p> <p style="text-align: center;">1.3 V</p>
					Any of the conditions below with all switches OFF <ul style="list-style-type: none"> <li>• Wiper intermittent dial 1</li> <li>• Wiper intermittent dial 2</li> <li>• Wiper intermittent dial 6</li> <li>• Wiper intermittent dial 7</li> </ul>	 <p style="text-align: right; font-size: small;">JPMIA0040GB</p> <p style="text-align: center;">1.3 V</p>

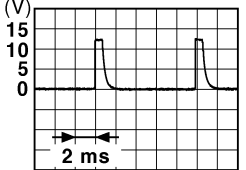

# BCM (BODY CONTROL MODULE)

< ECU DIAGNOSIS INFORMATION >

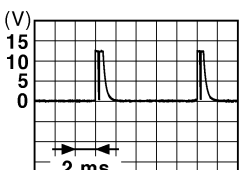
[ROADSTER]

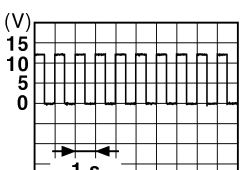
Terminal No. (Wire color)		Description		Condition	Value (Approx.)	
		Signal name	Input/ Output			
+	-					
88 (V)	Ground	Combination switch INPUT 3	Input	Combination switch	All switches OFF (Wiper intermittent dial 4)	 <small>JPMIA0041GB</small> 1.4 V
					Lighting switch HI (Wiper intermittent dial 4)	 <small>JPMIA0036GB</small> 1.3 V
					Lighting switch 2ND (Wiper intermittent dial 4)	 <small>JPMIA0037GB</small> 1.3 V
					Any of the conditions below with all switches OFF <ul style="list-style-type: none"> <li>• Wiper intermittent dial 1</li> <li>• Wiper intermittent dial 2</li> <li>• Wiper intermittent dial 3</li> </ul>	 <small>JPMIA0040GB</small> 1.3 V
90 (P)	Ground	CAN-L	Input/ Output	—	—	
91 (L)	Ground	CAN-H	Input/ Output	—	—	
92 (LG)	Ground	Key slot illumination	Output	Key slot illumi- nation	OFF	0 V
					Blinking	 <small>JPMIA0015GB</small> 6.5 V
93 (V)	Ground	ON indicator lamp	Output	Ignition switch	OFF (LOCK indicator is not illuminated)	Battery voltage
					ON	0 V

A  
B  
C  
D  
E  
F  
G  
H  
I  
J  
K

DEF

M  
N  
O  
P

# BCM (BODY CONTROL MODULE)

< ECU DIAGNOSIS INFORMATION >



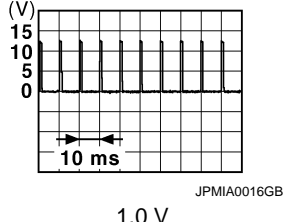
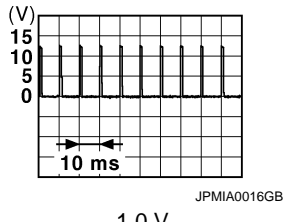

[ROADSTER]

Terminal No. (Wire color)		Description		Condition		Value (Approx.)
		Signal name	Input/ Output			
+	-					
95 (O)	Ground	ACC relay control	Output	Ignition switch	OFF	0 V
					ACC or ON	12 V
96*3 (Y)	Ground	A/T shift selector (Detention switch) power supply	Output	—		12 V
99*6 (R)	Ground	Selector lever P position switch (A/T models)	Input	Selector lever	P position	0 V
					Any position other than P	12 V
		Clutch pedal position switch (M/T models without SynchroRev Match mode)		Clutch pedal position switch	OFF (Clutch pedal is depressed)	0 V
					ON (Clutch pedal is not depressed)	Battery voltage
100 (GR)	Ground	Passenger door request switch	Input	Passenger door request switch	ON (Pressed)	0 V
					OFF (Not pressed)	 <p style="text-align: center;">1.0 V</p>
101 (Y)	Ground	Driver door request switch	Input	Driver door request switch	ON (Pressed)	0 V
					OFF (Not pressed)	 <p style="text-align: center;">1.0 V</p>
102 (O)	Ground	Blower fan motor relay control	Output	Ignition switch	OFF or ACC	0 V
					ON	12 V
103 (LG)	Ground	Remote keyless entry receiver (front) power supply	Output	Ignition switch OFF		12 V

# BCM (BODY CONTROL MODULE)

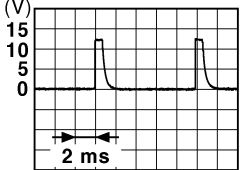
< ECU DIAGNOSIS INFORMATION >

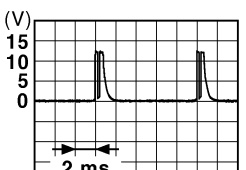
[ROADSTER]

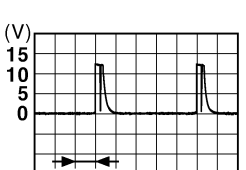
Terminal No. (Wire color)		Description		Condition	Value (Approx.)	
		Signal name	Input/ Output			
+	-					
107 (LG)	Ground	Combination switch INPUT 1	Input	Combination switch (Wiper intermittent dial 4)	All switches OFF	 1.4 V
					Turn signal switch LH	 1.3 V
					Turn signal switch RH	 1.3 V
					Front wiper switch LO	 1.3 V
					Front washer switch ON	 1.3 V

A  
B  
C  
D  
E  
F  
G  
H  
I  
J  
K  
DEF  
M  
N  
O  
P

DEF

# BCM (BODY CONTROL MODULE)

< ECU DIAGNOSIS INFORMATION >



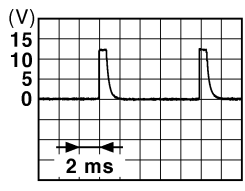
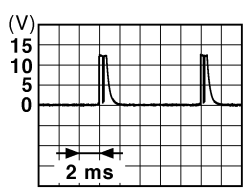
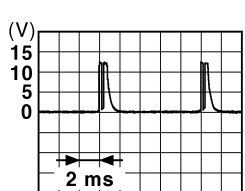
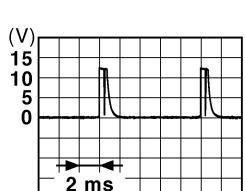

[ROADSTER]

Terminal No. (Wire color)		Description		Condition	Value (Approx.)	
		Signal name	Input/ Output			
+	-					
108 (R)	Ground	Combination switch INPUT 4	Input	Combination switch	All switches OFF (Wiper intermittent dial 4)	 1.4 V
				Combination switch	Lighting switch AUTO (Wiper intermittent dial 4)	 1.3 V
				Combination switch	Lighting switch 1ST (Wiper intermittent dial 4)	 1.3 V
				Combination switch	Any of the conditions be- low with all switches OFF <ul style="list-style-type: none"> <li>• Wiper intermittent dial 1</li> <li>• Wiper intermittent dial 5</li> <li>• Wiper intermittent dial 6</li> </ul>	 1.3 V

# BCM (BODY CONTROL MODULE)

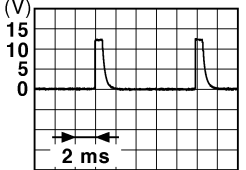
< ECU DIAGNOSIS INFORMATION >

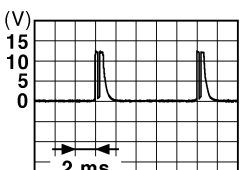
[ROADSTER]

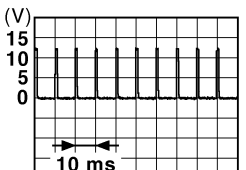
Terminal No. (Wire color)		Description		Condition	Value (Approx.)	
		Signal name	Input/ Output			
+	-					
109 (Y)	Ground	Combination switch INPUT 2	Input	Combination switch (Wiper intermit- tent dial 4)	All switches OFF	 <small>JPMIA0041GB</small> 1.4 V
					Lighting switch PASS	 <small>JPMIA0037GB</small> 1.3 V
					Lighting switch 2ND	 <small>JPMIA0036GB</small> 1.3 V
					Front wiper switch INT	 <small>JPMIA0038GB</small> 1.3 V
					Front wiper switch HI	 <small>JPMIA0040GB</small> 1.3 V
					ON	0 V
110 (P)	Ground	Hazard switch	Input	Hazard switch	OFF	 <small>JPMIA0012GB</small> 1.1 V

A  
B  
C  
D  
E  
F  
G  
H  
I  
J  
K  
DEF  
M  
N  
O  
P



# BCM (BODY CONTROL MODULE)

< ECU DIAGNOSIS INFORMATION >

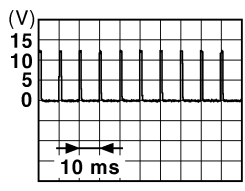
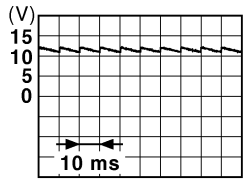

[ROADSTER]

Terminal No. (Wire color)		Description		Condition	Value (Approx.)	
		Signal name	Input/ Output			
+	-					
113 (O)	Ground	Optical sensor	Input	Ignition switch ON	When bright outside of the vehicle	Close to 5 V
					When dark outside of the vehicle	Close to 0 V
114*4 (R)	Ground	Clutch interlock switch	Input	Clutch interlock switch	OFF (Clutch pedal is not depressed)	0 V
					ON (Clutch pedal is de- pressed)	Battery voltage
115*9 (O)	—	—	—	—	—	—
116 (SB)	Ground	Stop lamp switch 1	Input	—	—	Battery voltage
118 (P)	Ground	Stop lamp switch 2	Input	Stop lamp switch	OFF (Brake pedal is not depressed)	0 V
					ON (Brake pedal is de- pressed)	Battery voltage
119 (SB)	Ground	Driver side door lock assembly (Unlock sensor)	Input	Driver door	LOCK status (Unlock sensor switch OFF)	 <p style="text-align: right; font-size: small;">JPMA0012GB</p>
					UNLOCK status (Unlock switch sensor ON)	0 V
121 (R)	Ground	Key slot switch	Input	When the Intelligent Key is inserted into key slot	—	12 V
				When the Intelligent Key is not inserted into key slot	—	0 V
123 (W)	Ground	IGN feedback	Input	Ignition switch	OFF or ACC	0 V
					ON	Battery voltage
124 (LG)	Ground	Passenger door switch	Input	Passenger door switch	OFF (Door close)	 <p style="text-align: right; font-size: small;">JPMA0011GB</p>
					ON (Door open)	0 V

# BCM (BODY CONTROL MODULE)

< ECU DIAGNOSIS INFORMATION >

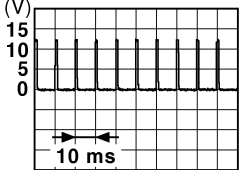
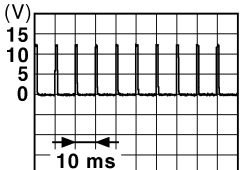
[ROADSTER]

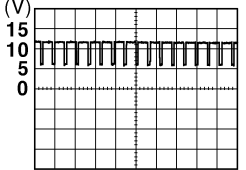
Terminal No. (Wire color)		Description		Condition		Value (Approx.)
+	-	Signal name	Input/ Output			
129*2 (O)	Ground	Trunk lid opener cancel switch	Input	Trunk lid opener cancel switch	CANCEL	 1.1 V
					ON	0 V
130*7 (L)	Ground	Rear window defogger switch	Input	Ignition switch ON	Rear window defogger switch OFF	 1.1 V
					Rear window defogger switch ON	0 V
132 (Y)*1 (V)*2	Ground	Power window switch and soft top control unit communication	Input/ Output	Ignition switch ON	 10.2 V	
				Ignition switch OFF or ACC	12 V	
133 (G)	Ground	Push-button ignition switch illumination	Output	Push-button ignition switch illumination	ON (Tail lamps OFF)	9.5 V
					ON (Tail lamps ON)	<p style="text-align: center;"><b>NOTE:</b> The pulse width of this wave is varied by the illumination brightening/dimming level.</p>  JPMA0159GB
134 (GR)	Ground	LOCK indicator lamp	Output	LOCK indicator lamp	OFF	Battery voltage
					ON	0 V
137 (P)	Ground	Receiver and sensor ground	Input	Ignition switch ON		0 V
138 (V)	Ground	Receiver and sensor power supply	Output	Ignition switch	OFF	0 V
					ACC or ON	5.0 V

A  
B  
C  
D  
E  
F  
G  
H  
I  
J  
K  
M  
N  
O  
P

DEF

# BCM (BODY CONTROL MODULE)

< ECU DIAGNOSIS INFORMATION >

[ROADSTER]

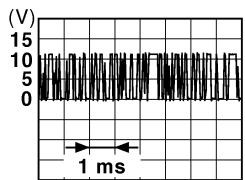
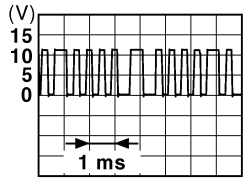
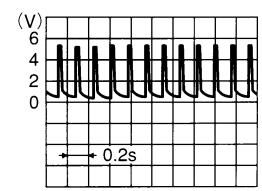
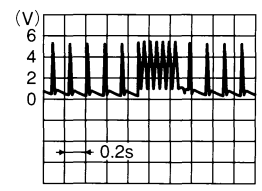
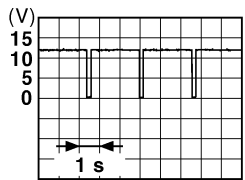
Terminal No. (Wire color)		Description		Condition	Value (Approx.)	
		Signal name	Input/ Output			
+	-					
139 (L)	Ground	Tire pressure receiver communication	Input/ Output	Ignition switch OFF (Remote key-less entry receiver communication)	During waiting	 <p style="text-align: right; font-size: small;">JMKIA0064GB</p>
				Ignition switch ON (Tire pressure receiver communication)	When operating either button on the Intelligent Key	 <p style="text-align: right; font-size: small;">JMKIA0065GB</p>
				Ignition switch ON (Tire pressure receiver communication)	Standby state	 <p style="text-align: right; font-size: small;">OCC3881D</p>
				Ignition switch ON (Tire pressure receiver communication)	When receiving the signal from the transmitter	 <p style="text-align: right; font-size: small;">OCC3880D</p>
140 <sup>+5</sup> (G)	Ground	Selector lever P/N position (A/T models)	Input	Selector lever	P or N position	12 V
		Park/neutral position switch (Coupe M/T models with Synchro-Rev Match mode)		Ignition switch ON	Control lever in neutral position	Battery voltage
		Park/neutral position switch (Coupe M/T models with Synchro-Rev Match mode)	Ignition switch ON	Control lever in any position other than neutral	0 V	
		Park/neutral position switch (Coupe M/T models with Synchro-Rev Match mode)	Ignition switch ON	Control lever in any position other than neutral	0 V	
141 (Y)	Ground	Security indicator lamp	Output	Security indicator lamp	ON	0 V
				Security indicator lamp	Blinking	 <p style="text-align: right; font-size: small;">JPMIA0014GB</p>
				Security indicator lamp	OFF	11.3 V
				OFF	12 V	



# BCM (BODY CONTROL MODULE)

< ECU DIAGNOSIS INFORMATION >

[ROADSTER]

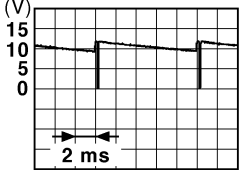
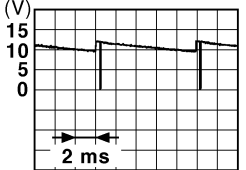
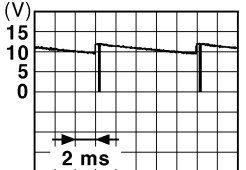
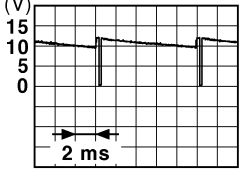
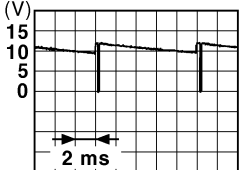
Terminal No. (Wire color)		Description		Condition	Value (Approx.)	
		Signal name	Input/ Output			
+	-					
142 (O)	Ground	Combination switch OUTPUT 5	Output	Combination switch (Wiper intermit- tent dial 4)	All switches OFF	0 V
					Lighting switch 1ST	
					Lighting switch HI	
					Lighting switch 2ND	
					Turn signal switch RH	
143 (P)	Ground	Combination switch OUTPUT 1	Output	Combination switch	All switches OFF (Wiper intermittent dial 4)	0 V
					Front wiper switch HI (Wiper intermittent dial 4)	
					Any of the conditions below with all switches OFF <ul style="list-style-type: none"> <li>• Wiper intermittent dial 1</li> <li>• Wiper intermittent dial 2</li> <li>• Wiper intermittent dial 3</li> <li>• Wiper intermittent dial 6</li> <li>• Wiper intermittent dial 7</li> </ul>	
144 (G)	Ground	Combination switch OUTPUT 2	Output	Combination switch	All switches OFF (Wiper intermittent dial 4)	0 V
					Front washer switch ON (Wiper intermittent dial 4)	
					Any of the conditions below with all switches OFF <ul style="list-style-type: none"> <li>• Wiper intermittent dial 1</li> <li>• Wiper intermittent dial 5</li> <li>• Wiper intermittent dial 6</li> </ul>	
145 (L)	Ground	Combination switch OUTPUT 3	Output	Combination switch (Wiper intermit- tent dial 4)	All switches OFF	0 V
					Front wiper switch INT	
					Front wiper switch LO	
					Lighting switch AUTO	
					Rear fog lamp switch ON	
146 (SB)	Ground	Combination switch OUTPUT 4	Output	Combination switch (Wiper intermit- tent dial 4)	All switches OFF	0 V
					Lighting switch 2ND	
					Lighting switch PASS	
					Turn signal switch LH	

A  
B  
C  
D  
E  
F  
G  
H  
I  
J  
K  
DEF  
M  
N  
O  
P

# BCM (BODY CONTROL MODULE)

< ECU DIAGNOSIS INFORMATION >

[ROADSTER]

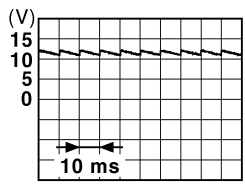
Terminal No. (Wire color)		Description		Condition	Value (Approx.)	
		Signal name	Input/ Output			
+	-					
150 (GR)	Ground	Driver door switch	Input	Driver door switch	OFF (Door close)	 11.8 V
				ON (Door open)	0 V	
151 (G)	Ground	Rear window defogger relay control	Output	Rear window defogger	Active	0 V
				Not activated	Battery voltage	

- \*1: Coupe models
- \*2: Roadster models
- \*3: A/T models
- \*4: M/T models
- \*5: With A/T or coupe models with M/T and SynchroRev Match mode
- \*6: With A/T or with M/T without SynchroRev Match mode
- \*7: Without NAVI
- \*8: With rear fog lamp
- \*9: BCM does not use this terminal for control.

# BCM (BODY CONTROL MODULE)

< ECU DIAGNOSIS INFORMATION >

[ROADSTER]

## Wiring Diagram - BCM -

INFOID:000000009760858

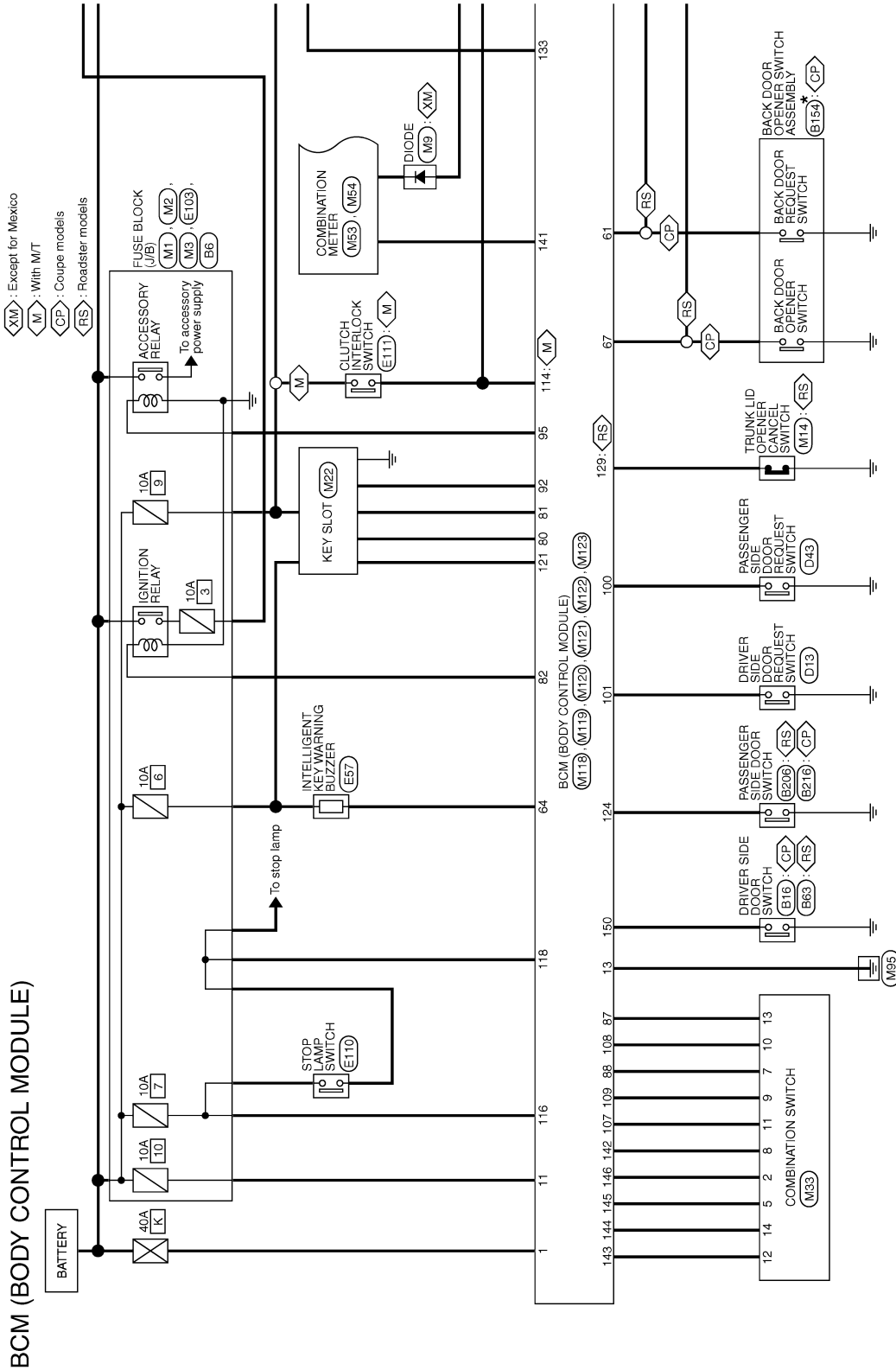

\*: This connector is not shown in "Harness Layout".

2012/04/18

JRMWD0778GB

A  
B  
C  
D  
E  
F  
G  
H  
I  
J  
K  
DEF  
M  
N  
O  
P

# BCM (BODY CONTROL MODULE)

< ECU DIAGNOSIS INFORMATION >

[ROADSTER]

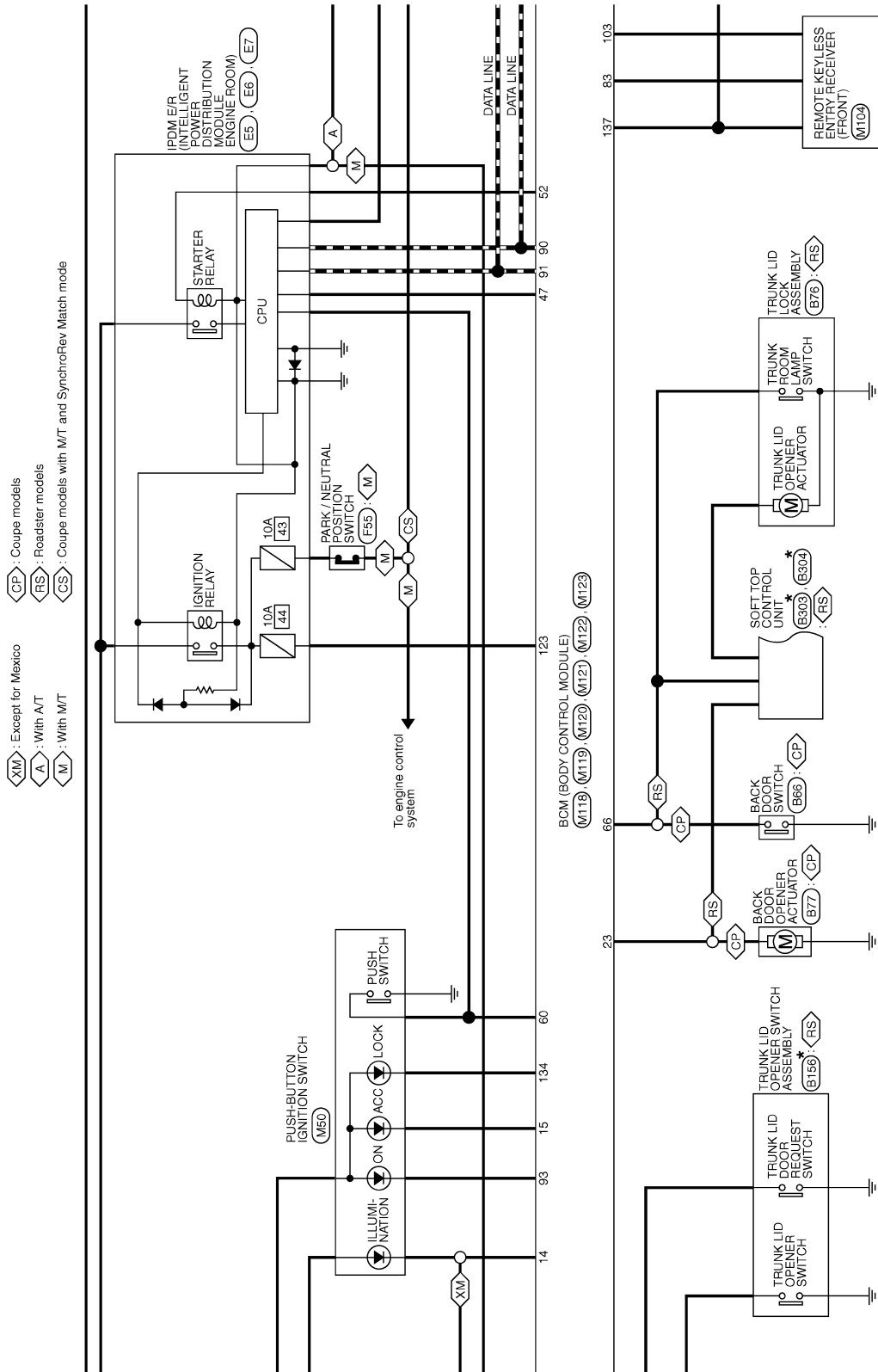

JRMWD0779GB

# BCM (BODY CONTROL MODULE)

< ECU DIAGNOSIS INFORMATION >

[ROADSTER]

- <A> : With A/T
- <AC> : With A/T or coupe models with M/T and SynchroRev Match mode
- <AD> : With A/T or with M/T without SynchroRev Match mode
- <CS> : Coupe models with M/T and SynchroRev Match mode
- <MD> : With M/T without SynchroRev Match mode
- <CP> : Coupe models
- <RS> : Roadster models

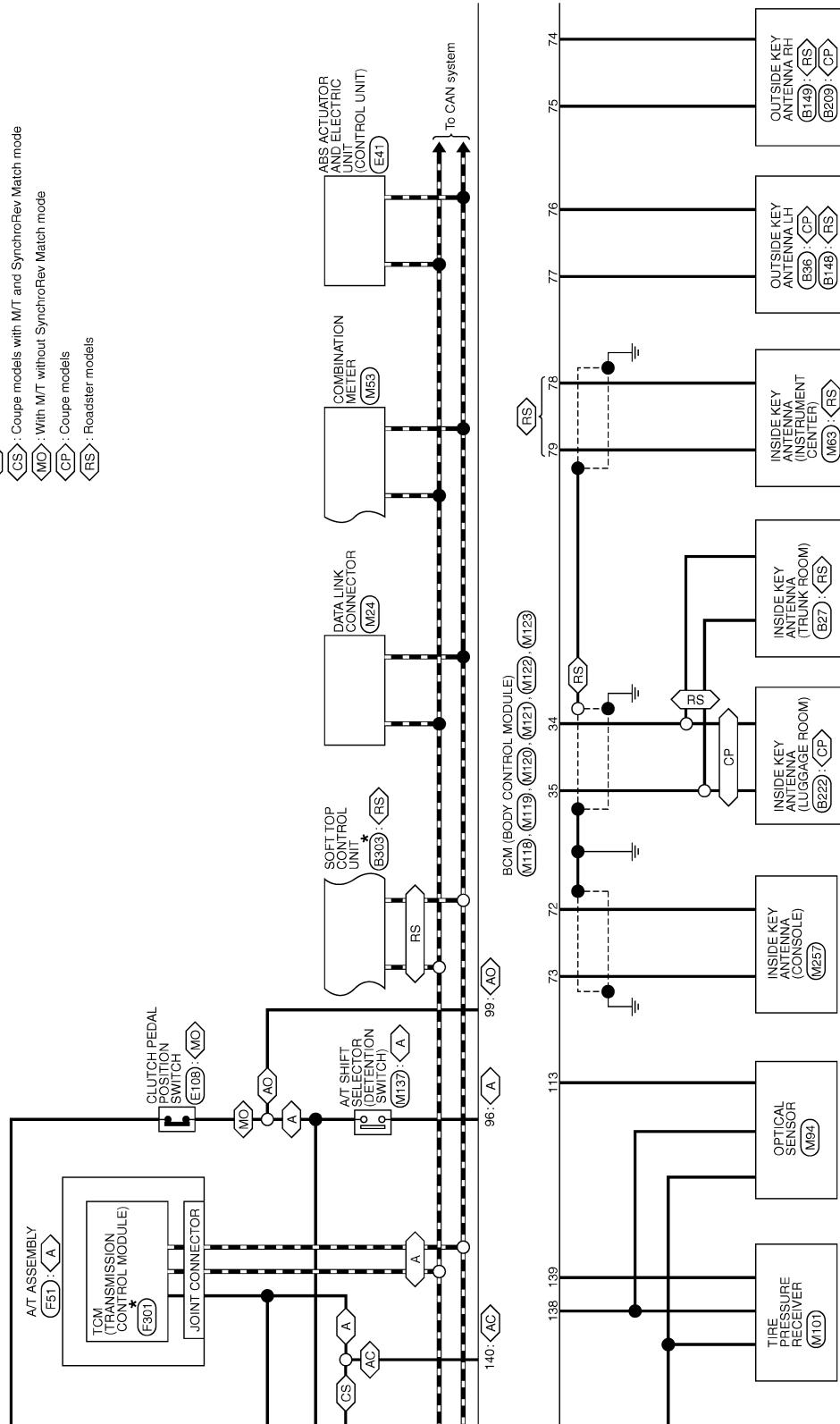

\*: This connector is not shown in "Harness Layout".

JRMWD0780GB

A  
B  
C  
D  
E  
F  
G  
H  
I  
J  
K  
DEF  
M  
N  
O  
P

# BCM (BODY CONTROL MODULE)

< ECU DIAGNOSIS INFORMATION >

[ROADSTER]

CP : Coupe models  
RS : Roadster models  
WP : With power seat  
ON : Without NAVI

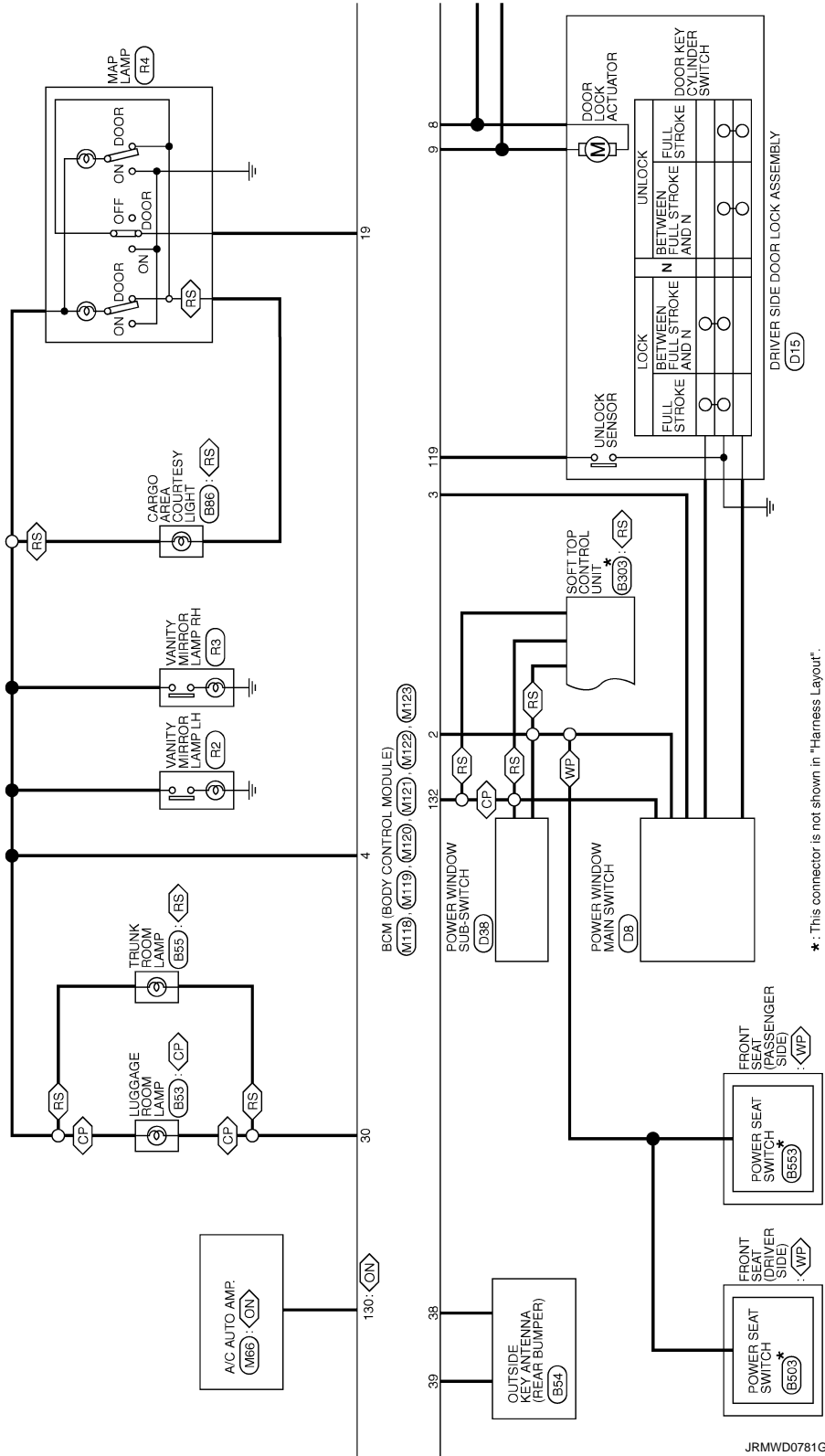

# BCM (BODY CONTROL MODULE)

< ECU DIAGNOSIS INFORMATION >

[ROADSTER]

- : With A/T
- : With M/T
- : With rear fog lamp

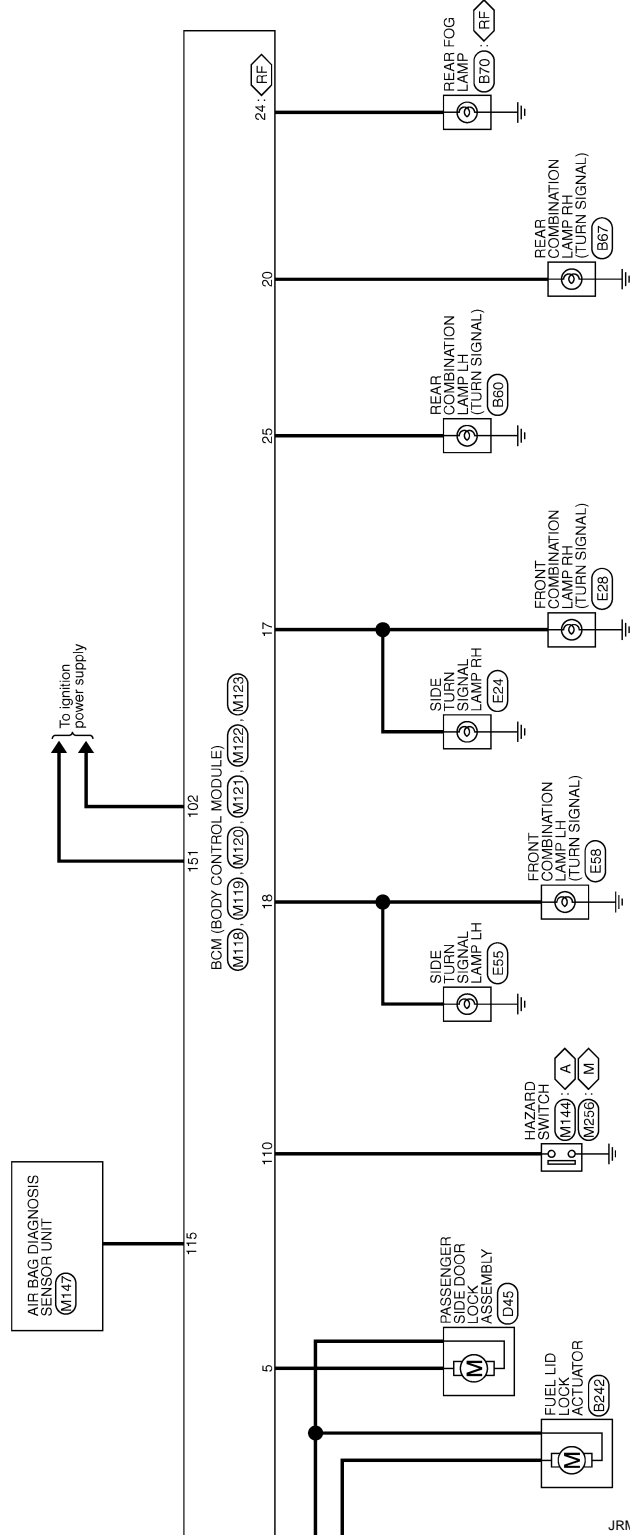

JRMWD0782GB

A  
B  
C  
D  
E  
F  
G  
H  
I  
J  
K  
DEF  
M  
N  
O  
P

# BCM (BODY CONTROL MODULE)

< ECU DIAGNOSIS INFORMATION >

[ROADSTER]

## BCM (BODY CONTROL MODULE)

Connector No.	B8
Connector Name	FUSE BLOCK (J/B)
Connector Type	INS12FER-CS



Terminal No.	Color of Wire	Signal Name [Specification]
5G	LG	-
10G	W	- [Coupe models]
11G	W	- [Roadster models]
12G	Y	-

Connector No.	B16
Connector Name	DRIVER SIDE DOOR SWITCH
Connector Type	A03FW



Terminal No.	2	GR	Signal Name [Specification]
--------------	---	----	-----------------------------

Connector No.	B27
Connector Name	INSIDE KEY ANTENNA (TRUNK ROOM)
Connector Type	RK02FGY



Terminal No.	1	V	Signal Name [Specification]
2	SB	-	-

Connector No.	B38
Connector Name	OUTSIDE KEY ANTENNA LH
Connector Type	RK02MGY



Terminal No.	1	LG	Signal Name [Specification]
2	V	-	-

Connector No.	B53
Connector Name	LUGGAGE ROOM LAMP
Connector Type	GJ02FGY



Terminal No.	1	BR	Signal Name [Specification]
2	R	-	-

Connector No.	B54
Connector Name	OUTSIDE KEY ANTENNA (REAR BUMPER)
Connector Type	RK02FGY



Terminal No.	1	W	Signal Name [Specification]
2	B	-	-

Connector No.	B55
Connector Name	TRUNK ROOM LAMP
Connector Type	S02FW



Terminal No.	1	BR	Signal Name [Specification]
2	R	-	-

Connector No.	B60
Connector Name	REAR COMBINATION LAMP LH
Connector Type	RS06FGY-PR



Terminal No.	1	G	Signal Name [Specification]
2	R	-	- [Coupe models]

Terminal No.	2	V	Signal Name [Specification]
3	B	-	- [Roadster models]
4	LG	-	-
6	BG	-	-

Connector No.	B83
Connector Name	DRIVER SIDE DOOR SWITCH
Connector Type	A03FW



Terminal No.	2	GR	Signal Name [Specification]
3	B	-	-

Connector No.	B66
Connector Name	BACK DOOR SWITCH
Connector Type	A03FW



Terminal No.	1	L	Signal Name [Specification]
3	B	-	-

JRMWD9611GB



# BCM (BODY CONTROL MODULE)

< ECU DIAGNOSIS INFORMATION >

[ROADSTER]

## BCM (BODY CONTROL MODULE)

Terminal No.	Color of Wire	Signal Name [Specification]
1	L	
2	LG	
3	B	

Connector No.	B87
Connector Name	REAR COMBINATION LAMP RH
Connector Type	RS0BFGY-PR



Terminal No.	Color of Wire	Signal Name [Specification]
1	LG	
2	R	
3	B	
4	V	
6	BG	

Connector No.	B70
Connector Name	REAR FOOT LAMP
Connector Type	RS02FGY



Terminal No.	Color of Wire	Signal Name [Specification]
1	BG	
2	B	

Connector No.	B76
Connector Name	TRUNK LID LOCK ASSEMBLY
Connector Type	RS03RF-CS



Terminal No.	Color of Wire	Signal Name [Specification]
1	L	
2	LG	
3	B	

Connector No.	B77
Connector Name	BACK DOOR OPENER ACTUATOR
Connector Type	M04FW-LC



Terminal No.	Color of Wire	Signal Name [Specification]
1	Y	
2	B	

Connector No.	B88
Connector Name	CARGO AREA COURTESY LIGHT
Connector Type	S02FW



Terminal No.	Color of Wire	Signal Name [Specification]
1	B	
2	B	

Connector No.	B148
Connector Name	OUTSIDE KEY ANTENNA LH
Connector Type	PK02MGY



Terminal No.	Color of Wire	Signal Name [Specification]
1	LG	
2	V	

Connector No.	B149
Connector Name	OUTSIDE KEY ANTENNA RH
Connector Type	PK02MGY



Terminal No.	Color of Wire	Signal Name [Specification]
1	BR	
2	GR	

Connector No.	B154
Connector Name	BACK DOOR OPENER SWITCH ASSEMBLY
Connector Type	PK04FB



Terminal No.	Color of Wire	Signal Name [Specification]
1	GR	
2	W	

Terminal No.	Color of Wire	Signal Name [Specification]
3	B	
4	B	

Connector No.	B156
Connector Name	TRUNK LID OPENER SWITCH ASSEMBLY
Connector Type	PK04FB



Terminal No.	Color of Wire	Signal Name [Specification]
1	GR	
2	W	
3	B	
4	B	

Connector No.	B206
Connector Name	PASSENGER SIDE DOOR SWITCH
Connector Type	A03FW



Terminal No.	Color of Wire	Signal Name [Specification]
2	LG	
3	B	

A  
B  
C  
D  
E  
F  
G  
H  
I  
J  
K  
DEF  
M  
N  
O  
P

# BCM (BODY CONTROL MODULE)

< ECU DIAGNOSIS INFORMATION >

[ROADSTER]

## BCM (BODY CONTROL MODULE)

Connector No.	B209
Connector Name	OUTSIDE KEY ANTENNA RH
Connector Type	RK02MGY



Terminal No.	Color of Wire	Signal Name (Specification)
1	BR	-
2	GR	-

Connector No.	B216
Connector Name	PASSENGER SIDE DOOR SWITCH
Connector Type	A03FW



Terminal No.	Color of Wire	Signal Name (Specification)
2	LG	-

Connector No.	B222
Connector Name	INSIDE KEY ANTENNA (LUGGAGE ROOM)
Connector Type	RK02FGY



Terminal No.	Color of Wire	Signal Name (Specification)
2	SB	-

Connector No.	B242
Connector Name	FUEL LID LOCK ACTUATOR
Connector Type	MD0FW-LC

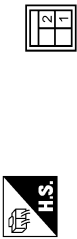

Terminal No.	Color of Wire	Signal Name (Specification)
1	G	-
2	W	-

Connector No.	B303
Connector Name	SOFT TOP CONTROL UNIT
Connector Type	TH40FB-NH

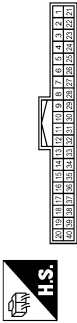

Terminal No.	Color of Wire	Signal Name (Specification)
1	BR	SENSOR POWER SUPPLY (ROOF STRIKER SENSOR LH)
3	DG	ROOF STRIKER SENSOR RH
4	W	ROOF STRIKER SENSOR LH
8	Y	REVERSE SIGNAL
9	SB	POWER CONDITION (POWER WINDOW)
10	O	TRUNK LID OPEN SIGNAL
11	O	ROOF STATUS SIGNAL (INDICATOR)
12	SB	ROOF OPEN / CLOSE SWITCH (AUDIO)
14	L	ROOF OPEN / CLOSE SWITCH (CLOSE)
15	LG	ROOF OPEN / CLOSE SWITCH (OPEN)
16	V	TRUNK ROOM LAMP SWITCH
17	EG	CAN-H
18	P	CAN-L
19	LG	LOCAL COMMUNICATION (POWER WINDOW)
20	V	LOCAL COMMUNICATION (ECM)
21	BR	SENSOR POWER SUPPLY (ROOF STRIKER SENSOR RH)
29	DG	GROUND
33	P	ROOF OPEN / CLOSE SWITCH (GND)

Connector No.	B304
Connector Name	SOFT TOP CONTROL UNIT
Connector Type	NS18FY-CS

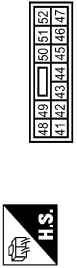

Terminal No.	Color of Wire	Signal Name (Specification)
41	DG	TRUNK OPENER ACTUATOR
48	R	REAR WINDOW DEF IN 2
49	R	REAR WINDOW DEF IN 1

Connector No.	B503
Connector Name	POWER SEAT SWITCH
Connector Type	MD0MW-LC



Terminal No.	Color of Wire	Signal Name (Specification)
3	O	-
4	L	-
5	W/R	-
6	W	-
33	R	-
48	B	-

Connector No.	B553
Connector Name	POWER SEAT SWITCH
Connector Type	MD0MW-LC



Terminal No.	Color of Wire	Signal Name (Specification)
3	O	-
4	L	-
5	W/R	-
6	W	-
33	R	-
48	B	-

Connector No.	D8
Connector Name	POWER WINDOW MAIN SWITCH
Connector Type	NS18FY-CS

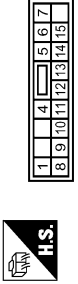

Terminal No.	Color of Wire	Signal Name (Specification)
1	W	-
4	Y	-
5	BG	-
6	GR	-
7	V	-
8	L	-
9	LG	-
10	Y	-
11	BR	-
12	SB	- [Coupe models]
13	Y	- [Roadster models]
13	R	-
14	G	-
15	B	-

# BCM (BODY CONTROL MODULE)

< ECU DIAGNOSIS INFORMATION >

[ROADSTER]

## BCM (BODY CONTROL MODULE)

Connector No.	D13
Connector Name	DRIVER SIDE DOOR REQUEST SWITCH
Connector Type	PK02FL



Terminal No.	Color of Wire	Signal Name [Specification]
1	W	-
2	B	-

Connector No.	D15
Connector Name	DRIVER SIDE DOOR LOCK ASSEMBLY
Connector Type	ED0FGY-RS



Terminal No.	Color of Wire	Signal Name [Specification]
1	BG	-
2	G	-
3	SB	-
4	B	-
5	V	-
6	GR	-

Connector No.	D38
Connector Name	POWER WINDOW SUB-SWITCH
Connector Type	NS18FF-CS



Terminal No.	Color of Wire	Signal Name [Specification]
3	G	-
4	BG	-
8	L	-
9	BR	-
10	W	-
11	B	-
12	R	-
14	Y	-
15	LG	-
16	Y	-

Connector No.	D43
Connector Name	PASSENGER SIDE DOOR REQUEST SWITCH
Connector Type	PK02FL



Terminal No.	Color of Wire	Signal Name [Specification]
1	B	-
2	G	-

Connector No.	D45
Connector Name	PASSENGER SIDE DOOR LOCK ASSEMBLY
Connector Type	ED0FGY-RS



Terminal No.	Color of Wire	Signal Name [Specification]
1	V	-
2	LG	-

Connector No.	E5
Connector Name	FRONT INTELLIGENT POWER DISTRIBUTION MODULE (ENGINE ROOM)
Connector Type	TH08FW-OS1P-M-1V



Terminal No.	Color of Wire	Signal Name [Specification]
4	V	-
5	L	-
7	R	- (Coupe models)
7	V	- (Roadster models)
12	B/W	-
13	Y	-
16	LG	-
19	W	-
25	G	-
27	Y	-
28	L	-
30	GR	-
36	G	-

Connector No.	E6
Connector Name	FRONT INTELLIGENT POWER DISTRIBUTION MODULE (ENGINE ROOM)
Connector Type	TH08FW-NH



Terminal No.	Color of Wire	Signal Name [Specification]
38	P	-
40	I	-
41	B/W	-
42	Y	-
43	SB	-
44	W	-
45	G	-
46	V	-

Connector No.	E7
Connector Name	FRONT INTELLIGENT POWER DISTRIBUTION MODULE (ENGINE ROOM)
Connector Type	TH08FW-OS1P-M4

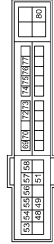

Terminal No.	Color of Wire	Signal Name [Specification]
48	L	-
48	BG	-
51	Y	-
53	W	-
54	V	-
55	SB	-
56	LG	-
57	G	-
58	P	-
69	BR	-
70	BG	-
72	GR	-
73	GR	-
74	G	-
75	SB	-
76	Y	-
77	R	-
80	W	-

Connector No.	E24
Connector Name	SIDE TURN SIGNAL LAMP RH
Connector Type	PK02GY



Terminal No.	Color of Wire	Signal Name [Specification]
1	V	-
2	B	-

A  
B  
C  
D  
E  
F  
G  
H  
I  
J  
K  
DEF  
M  
N  
O  
P



# BCM (BODY CONTROL MODULE)

< ECU DIAGNOSIS INFORMATION >

[ROADSTER]

## BCM (BODY CONTROL MODULE)

Connector No.	E111
Connector Name	GLUTCH INTERLOCK SWITCH
Connector Type	S02FL



Terminal No.	Color of Wire	Signal Name [Specification]
1	G	-
2	GR	-

Connector No.	F51
Connector Name	A/T ASSEMBLY
Connector Type	RK10FC-DGY

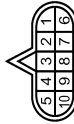

Terminal No.	Color of Wire	Signal Name [Specification]
1	Y	POWER SUPPLY
2	BR	POWER SUPPLY (MEMORY BACK-UP)
3	L	CAN-H
4	V	K-LINE
5	B	GROUND
6	Y	POWER SUPPLY
7	W	BACK-UP LAMP RELAY
8	P	CAN-L
9	GR	STARTER RELAY
10	B	GROUND

Connector No.	F55
Connector Name	PARK / NEUTRAL POSITION SWITCH
Connector Type	RK02FB



Terminal No.	Color of Wire	Signal Name [Specification]
1	G	-
2	W	-

Connector No.	F301
Connector Name	TCM (TRANSMISSION CONTROL MODULE)
Connector Type	SP10FG

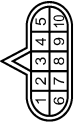

Terminal No.	Color of Wire	Signal Name [Specification]
1	W	POWER SUPPLY
2	B	POWER SUPPLY (MEMORY BACK-UP)
3	R	CAN-H
4	O	K-LINE
5	G	GROUND
6	GR	POWER SUPPLY
7	L	BACK-UP LAMP RELAY
8	BR	CAN-L
9	Y	STARTER RELAY
10	W/B	GROUND

Connector No.	M1
Connector Name	FUSE BLOCK (J/B)
Connector Type	NS08FY-M2



Terminal No.	Color of Wire	Signal Name [Specification]
1A	V	-
2A	G	-
3A	L	-
4A	P	-
5A	L	-
6A	Y	-
7A	BR	-
8A	L	-

Connector No.	M2
Connector Name	FUSE BLOCK (J/B)
Connector Type	NS10FY-CS



Terminal No.	Color of Wire	Signal Name [Specification]
3B	P	-
4B	G	-
5B	O	-
6B	Y	-
8B	B	-
9B	SB	-

Connector No.	M3
Connector Name	FUSE BLOCK (J/B)
Connector Type	NS12FY-CS



Terminal No.	Color of Wire	Signal Name [Specification]
6C	R	-
7C	B	-
9C	O	-
10C	L	-
11C	LG	-
12C	O	-

Connector No.	M9
Connector Name	DIODE
Connector Type	24335 C3900



Terminal No.	Color of Wire	Signal Name [Specification]
1	W	-
2	R	-

A  
B  
C  
D  
E  
F  
G  
H  
I  
J  
K  
DEF  
M  
N  
O  
P

# BCM (BODY CONTROL MODULE)

< ECU DIAGNOSIS INFORMATION >

[ROADSTER]

## BCM (BODY CONTROL MODULE)

Connector No.	M14
Connector Name	TRUNK LID OPENER CANCEL SWITCH
Connector Type	SD2FW



Terminal No.	Color of Wire	Signal Name [Specification]
1	O	-
2	B	-

Connector No.	M22
Connector Name	KEY SLOT
Connector Type	TH12FW-NH

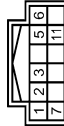

Terminal No.	Color of Wire	Signal Name [Specification]
1	P	BAT
2	GR	CLOCK
3	W	DATA
5	Y	ILL BAT
6	LG	ILL
7	B	GROUND
11	R	KEY SWITCH SIGNAL

Connector No.	M21
Connector Name	DATA LINK CONNECTOR
Connector Type	BD16FW



Terminal No.	Color of Wire	Signal Name [Specification]
3	LG	- [Coupe models]
3	Y	- [Roadster models]
4	B	-
5	B	-
6	L	-
7	Y	-
8	G	-
11	Y	- [Coupe models]
11	LG	- [Roadster models]
14	P	-
16	Y	-

Connector No.	M33
Connector Name	COMBINATION SWITCH
Connector Type	TH16FW-NH



Terminal No.	Color of Wire	Signal Name [Specification]
1	P	FR WASHER (-)
2	SB	OUTPUT 4
3	W	WASHER MOTOR
4	C	WASHER MTS POWER SUPPLY
5	L	OUTPUT 3
6	B	GROUND
7	V	INPUT 3
8	O	OUTPUT 5
9	Y	INPUT 2
10	R	INPUT 4
11	LG	INPUT 1

12	P	OUTPUT 1
13	BR	INPUT 5
14	G	OUTPUT 2

Connector No.	M50
Connector Name	PUSH-BUTTON IGNITION SWITCH
Connector Type	TK08FER



Terminal No.	Color of Wire	Signal Name [Specification]
1	B	-
2	R	-
3	G	-
4	BR	-
5	GR	-
6	Y	-
7	V	-
8	P	-

Connector No.	M53
Connector Name	COMBINATION METER
Connector Type	TH24FW-NH



Terminal No.	Color of Wire	Signal Name [Specification]
1	V	BATTERY POWER SUPPLY
2	O	IGNITION SIGNAL
3	L	VEHICLE SPEED SIGNAL (2-PULSE)
4	V	VEHICLE SPEED SIGNAL (MULTI-PULSE) (Coupe Model)
4	V	VEHICLE SPEED SIGNAL (2-PULSE) (Roadster Model)
5	B	ILLUMINATION CONTROL SIGNAL
6	R	ROOF STATUS SIGNAL
8	V	POP-UP
9	BR	COMMUNICATION SIGNAL (METER->TRIPLE METER)

10	L	COMMUNICATION SIGNAL (TRIPLE METER->METER)
11	Y	AT SNOW
12	G	S-MODE SWITCH SIGNAL
15	L	ACC POWER SUPPLY
16	R	AIR BAG SIGNAL
17	B	GROUND
18	V	AMBIENT SENSOR SIGNAL
19	G	A/C AUTO AMP CONNECTION RECOGNITION SIGNAL
20	GR	AMBIENT SENSOR GROUND
21	L	CAN-H
22	P	CAN-L
23	B	GROUND
24	Y	FUEL LEVEL SENSOR GROUND

Connector No.	M54
Connector Name	COMBINATION METER
Connector Type	TH16FW-NH



Terminal No.	Color of Wire	Signal Name [Specification]
25	W	ALTERNATOR SIGNAL
26	O	PARKING BRAKE SWITCH SIGNAL
27	LG	BRAKE FLUID LEVEL SWITCH SIGNAL
28	Y	SECURITY SIGNAL
29	GR	WASHER LEVEL SWITCH SIGNAL
32	G	PADDLE SHIFTER DOWN SIGNAL
33	O	PADDLE SHIFTER UP SIGNAL
34	BR	FUEL LEVEL SENSOR SIGNAL
35	L	SEAT BELT BUCKLE SWITCH SIGNAL (DRIVER SIDE)
36	P	PASSENGER SEAT BELT WARNING SIGNAL (Except for Model)
36	L	PASSENGER SEAT BELT WARNING SIGNAL (For Model)
37	G	NON-MANUAL MODE SIGNAL
38	V	MANUAL MODE SHIF DOWN SIGNAL
39	L	MANUAL MODE SHIF UP SIGNAL
40	W	MANUAL MODE SIGNAL

# BCM (BODY CONTROL MODULE)

< ECU DIAGNOSIS INFORMATION >

[ROADSTER]

## BCM (BODY CONTROL MODULE)

Connector No.	M63
Connector Name	INSIDE KEY ANTENNA (INSTRUMENT CENTER)
Connector Type	IRK02FCY



Terminal No.	Color of Wire	Signal Name [Specification]
1	R	-
2	L	-

Connector No.	M66
Connector Name	A/C AUTO AMP.
Connector Type	SAE40FW



Terminal No.	Color of Wire	Signal Name [Specification]
1	L	CAN-H
2	P	CAN-L
6	L	TX (AMP-CONT)
7	P	RX (CONT-AMP)
10	BR	LAN SIGNAL
11	Y	EACH DOOR MOTOR POWER SUPPLY
15	O	SUNLOAD SENSOR SIGNAL
16	R	INTAKE SENSOR SIGNAL
17	L	ACC POWER SUPPLY
19	B	GROUND
20	G	IGNITION POWER SUPPLY
24	O	ECU SIGNAL
26	R	REAR WINDOW DEFROGGER FEEDBACK SIGNAL
27	L	REAR WINDOW DEFROGGER ON SIGNAL
32	P	BLOWER MOTOR CONTROL SIGNAL
34	G	A/C AUTO AMPLIFICATION COMPASS SIGNAL
35	V	AMBIENT SENSOR SIGNAL
36	LG	IN-VEHICLE SENSOR SIGNAL
37	GR	SENSOR GROUND
39	B	GROUND

Connector No.	40
Connector Name	BATTERY POWER SUPPLY
Connector Type	Y

Connector No.	M64
Connector Name	OPTICAL SENSOR
Connector Type	TK03FW



Terminal No.	Color of Wire	Signal Name [Specification]
1	V	POWER
2	O	OUTPUT
3	P	GROUND

Connector No.	M101
Connector Name	THRE PRESSURE RECEIVER
Connector Type	TK04FW



Terminal No.	Color of Wire	Signal Name [Specification]
1	P	SIGNAL
2	L	GROUND
4	V	BATTERY

Connector No.	M104
Connector Name	REMOTE KEYLESS ENTRY RECEIVER (FRONT)
Connector Type	JAB04FB



Terminal No.	Color of Wire	Signal Name [Specification]
1	P	GROUND
2	GR	SIGNAL OUTPUT
4	LG	BATTERY

Connector No.	M118
Connector Name	BCM (BODY CONTROL MODULE)
Connector Type	M03FB-LC



Terminal No.	Color of Wire	Signal Name [Specification]
1	W	BAT (E/L)
2	W	POWER WINDOW POWER SUPPLY (BAT)
3	Y	POWER WINDOW POWER SUPPLY (IGN)

Connector No.	M119
Connector Name	BCM (BODY CONTROL MODULE)
Connector Type	NS12FW-CS

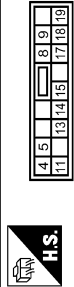

Terminal No.	Color of Wire	Signal Name [Specification]
1	LG	GROUND

4	R	INTERIOR ROOM LAMP POWER SUPPLY
5	G	PASSENGER DOOR UNLOCK OUTPUT
8	V	ALL DOOR FUEL LID LOCK OUTPUT
9	G	DRIVER DOOR FUEL LID UNLOCK OUTPUT
11	BR	BAT (FUSE)
13	B	GROUND
14	R	PUSH-BUTTON IGNITION SW ILL GND
15	Y	ACC IND
17	W	TURN SIGNAL RH (FRONT, SIDE)
18	O	TURN SIGNAL LH (FRONT, SIDE)
19	P	ROOM LAMP TIMER CONTROL

Connector No.	M120
Connector Name	BCM (BODY CONTROL MODULE)
Connector Type	NS12FW-CS

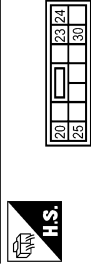

Terminal No.	Color of Wire	Signal Name [Specification]
20	V	TURN SIGNAL RH (REAR)
23	L	BACK DOOR OPEN OUTPUT [Coupe models]
23	Y	TRUNK LID OPEN OUTPUT [Roadster models]
24	O	REAR FOG OUTPUT
25	LG	TURN SIGNAL LH (REAR)
30	R	LUGGAGE/TRUNK ROOM LAMP OUTPUT

A  
B  
C  
D  
E  
F  
G  
H  
I  
J  
K

DEF

M  
N  
O  
P

# BCM (BODY CONTROL MODULE)

< ECU DIAGNOSIS INFORMATION >

[ROADSTER]

## BCM (BODY CONTROL MODULE)

Connector No.	M121
Connector Name	BCM (BODY CONTROL MODULE)
Connector Type	TH40FY-NH



Terminal No.	Color of Wire	Signal Name [Specification]
34	G	LUGGAGE/TRUNK ROOM ANT-
35	G	LUGGAGE/TRUNK ROOM ANT+
38	B	REAR BUMPER ANT-
39	W	REAR BUMPER ANT+
47	V	IGN RELAY (IPDM E/R) CONT
52	SB	STARTER RELAY CONT
60	BR	PUSH SW
61	W	BACK DOOR/TRUNK LID DOOR REQUEST SW
64	G	I-KEY WARN BUZZER (ENG ROOM)
66	R	BACK DOOR/TRUNK ROOM LAMP SW
67	GR	BACK DOOR/TRUNK LID OPENER SW

Connector No.	M122
Connector Name	BCM (BODY CONTROL MODULE)
Connector Type	TH40FE-NH



Terminal No.	Color of Wire	Signal Name [Specification]
72	L	ROOM ANT 2-
73	P	ROOM ANT 2+
74	SB	PASSENGER DOOR ANT-
75	BR	PASSENGER DOOR ANT+
76	V	DRIVER DOOR ANT-
77	LG	DRIVER DOOR ANT+
78	L	ROOM ANT 1-
79	B	ROOM ANT 1+
80	GR	MAT'S ANT AMP-
81	W	MAT'S ANT AMP+
82	R	IGN RELAY (P/B) CONT

83	GR	KYLS ENT RECEIVER (FRONT) COMM
87	BR	COMBI SW INPUT 5
88	V	COMBI SW INPUT 3
90	P	CAN-L
91	L	CAN-H
92	LG	KEY SLOT ILL
93	V	ON IND
95	O	ACC RELAY CONT
96	Y	A/T SHIFT SELECTOR POWER SUPPLY
99	R	SHIFT P/CLUTCH PEDAL POS SW
100	GR	PASSENGER DOOR REQUEST SW
101	Y	DRIVER DOOR REQUEST SW
102	O	BLOWER FAN MOTOR RELAY CONT
103	LG	KYLS ENT RECEIVER (FRONT) PMR SUPPLY
107	LG	COMBI SW INPUT 4
108	R	COMBI SW INPUT 1
109	Y	COMBI SW INPUT 2
110	P	HAZARD SW

Connector No.	M123
Connector Name	BCM (BODY CONTROL MODULE)
Connector Type	TH40FG-NH



Terminal No.	Color of Wire	Signal Name [Specification]
113	O	OPTICAL SENSOR
114	R	CLUTCH INTERLOCK SW
115	O	STOP LAMP SW 1
116	SB	STOP LAMP SW 2
118	P	DR DOOR UNLOCK SENSOR
119	SB	IGN Z/B
121	R	KEY SLOT SW
123	W	PASSENGER DOOR SW
124	LG	TRUNK LID OPENER CANCEL SW
129	O	REAR DEFROGGER SW
130	V	P/W SW & START TOP GLL COMM (Roadster model)
132	V	POWER WINDOW SW COMM (Other model)
133	O	PUSH BUTTON LIGHTON SW ILL POWER
134	GR	LOCK IND
137	P	RECEIVER SENSOR GND
138	V	RECEIVER & SENSOR POWER SUPPLY
139	L	THE PRESS RECEV COMM

140	G	P/N POSITION
141	Y	SECURITY INDICATOR
142	O	COMBI SW OUTPUT 5
143	P	COMBI SW OUTPUT 1
144	G	COMBI SW OUTPUT 2
145	L	COMBI SW OUTPUT 3
146	SB	COMBI SW OUTPUT 4
150	GR	DRIVER DOOR SW
151	G	REAR WINDOW DEFOGGER RELAY CONT

Connector No.	M137
Connector Name	A/T SHIFT SELECTOR
Connector Type	TK10FW



Terminal No.	Color of Wire	Signal Name [Specification]
1	W	-
2	V	-
3	L	-
4	B	-
5	G	-
6	R	-
7	W	-
8	P	-
9	Y	-
10	R	-

Connector No.	M144
Connector Name	HAZARD SWITCH
Connector Type	TK04FW



Terminal No.	Color of Wire	Signal Name [Specification]
1	GR	GROUND

2	P	ECM
3	R	ILL+
4	B	ILL-

Connector No.	M147
Connector Name	AIR BAG DIAGNOSIS SENSOR UNIT
Connector Type	NH28FY-EX

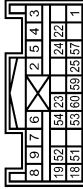

Terminal No.	Color of Wire	Signal Name [Specification]
1	LG	IGN
2	B	GND
3	Y	DR 1 (+)
4	Y	DR 1 (-) DR 2 (-)
5	Y	DR 2 (+)
6	Y	AS 1 (+)
7	Y	AS 1 (-)
8	Y	AS 2 (+)
9	Y	AS 2 (-)
18	R	EG2S (+)
19	L	EG2S (-)
22	SHIELD	GND
23	R	AIRBAG W/L
24	P	SEAT BELT
25	R	CUTOFF TELLTALE
51	W	SATELLITE RH2 (+)
52	B	SATELLITE RH2 (-)
53	Y	SATELLITE LH2 (+)
54	BR	SATELLITE LH2 (-)
57	O	DEPLOYMENT INFORMATION OUTPUT
58	L	CAN-H
60	P	CAN-L



# BCM (BODY CONTROL MODULE)

< ECU DIAGNOSIS INFORMATION >

[ROADSTER]

## BCM (BODY CONTROL MODULE)

Connector No.	M256
Connector Name	HAZARD SWITCH
Connector Type	TK04FW



Terminal No.	Color of Wire	Signal Name (Specification)
1	B	GROUND
2	G	BCM
3	SB	ILL+
4	BG	ILL- [Coupe models]
	O	ILL- [Roadster models]

Connector No.	M257
Connector Name	INSIDE KEY ANTENNA (CONSOLE)
Connector Type	RR02FGY



Terminal No.	Color of Wire	Signal Name (Specification)
1	P	- [Coupe models]
	G	- [Roadster models]
2	L	- [Coupe models]
	R	- [Roadster models]

Connector No.	R2
Connector Name	VANITY MIRROR LAMP LH
Connector Type	MCA02FW



Terminal No.	Color of Wire	Signal Name (Specification)
1	B	-
2	R	-

Connector No.	R3
Connector Name	VANITY MIRROR LAMP RH
Connector Type	MCA02FW



Terminal No.	Color of Wire	Signal Name (Specification)
1	B	-
2	R	-

Connector No.	R4
Connector Name	MAP LAMP
Connector Type	TK08FGY



Terminal No.	Color of Wire	Signal Name (Specification)
1	R	-
2	V	-

## Fail-safe

### FAIL-SAFE CONTROL BY DTC

BCM performs fail-safe control when any DTC are detected.

JRMWD9620GB

INFOID:000000009760859

A  
B  
C  
D  
E  
F  
G  
H  
I  
J  
K  
DEF  
M  
N  
O  
P

# BCM (BODY CONTROL MODULE)

< ECU DIAGNOSIS INFORMATION >

[ROADSTER]

Display contents of CONSULT	Fail-safe	Cancellation
B2190: NATS ANTENNA AMP	Inhibit engine cranking	Erase DTC
B2191: DIFFERENCE OF KEY	Inhibit engine cranking	Erase DTC
B2192: ID DISCORD BCM-ECM	Inhibit engine cranking	Erase DTC
B2193: CHAIN OF BCM-ECM	Inhibit engine cranking	Erase DTC
B2195: ANTI SCANNING	Inhibit engine cranking	Ignition switch ON → OFF
B2560: STARTER CONT RELAY	Inhibit engine cranking	500 ms after the following CAN signal communication status becomes consistent <ul style="list-style-type: none"> <li>• Starter control relay signal</li> <li>• Starter relay status signal</li> </ul>
B2608: STARTER RELAY	Inhibit engine cranking	500 ms after the following signal communication status becomes consistent <ul style="list-style-type: none"> <li>• Starter motor relay control signal</li> <li>• Starter relay status signal (CAN)</li> </ul>
B260A: IGNITION RELAY	Inhibit engine cranking	500 ms after the following conditions are fulfilled <ul style="list-style-type: none"> <li>• IGN relay (IPDM E/R) control signal: OFF (Battery voltage)</li> <li>• Ignition ON signal (CAN to IPDM E/R): OFF (Request signal)</li> <li>• Ignition ON signal (CAN from IPDM E/R): OFF (Condition signal)</li> </ul>
B260F: ENG STATE SIG LOST	Maintains the power supply position attained at the time of DTC detection	When any of the following conditions are fulfilled <ul style="list-style-type: none"> <li>• Power position changes to ACC</li> <li>• Receives engine status signal (CAN)</li> </ul>
B2617: STARTER RELAY CIRC	Inhibit engine cranking	1 second after the starter motor relay control inside BCM becomes normal
B2618: BCM	Inhibit engine cranking	1 second after the ignition relay (IPDM E/R) control inside BCM becomes normal
B261E: VEHICLE TYPE	Inhibit engine cranking	BCM initialization
B26E8: CLUTCH SW	Inhibit engine cranking	When any of the following BCM recognition conditions are fulfilled <ul style="list-style-type: none"> <li>• Status 1 <ul style="list-style-type: none"> <li>- Clutch switch signal (CAN from ECM): ON</li> <li>- Clutch interlock switch signal: OFF (0 V)</li> </ul> </li> <li>• Status 2 <ul style="list-style-type: none"> <li>- Clutch switch signal (CAN from ECM): OFF</li> <li>- Clutch interlock switch signal: ON (Battery voltage)</li> </ul> </li> </ul>

## DTC Inspection Priority Chart

INFOID:000000009760860

If some DTCs are displayed at the same time, perform inspections one by one based on the following priority chart.

Priority	DTC
1	B2562: LOW VOLTAGE
2	<ul style="list-style-type: none"> <li>• U1000: CAN COMM CIRCUIT</li> <li>• U1010: CONTROL UNIT (CAN)</li> </ul>
3	<ul style="list-style-type: none"> <li>• B2190: NATS ANTENNA AMP</li> <li>• B2191: DIFFERENCE OF KEY</li> <li>• B2192: ID DISCORD BCM-ECM</li> <li>• B2193: CHAIN OF BCM-ECM</li> <li>• B2195: ANTI SCANNING</li> </ul>

# BCM (BODY CONTROL MODULE)

< ECU DIAGNOSIS INFORMATION >

[ROADSTER]

Priority	DTC	
4	• B2553: IGNITION RELAY	A
	• B2555: STOP LAMP	
	• B2556: PUSH-BTN IGN SW	
	• B2557: VEHICLE SPEED	B
	• B2560: STARTER CONT RELAY	
	• B2601: SHIFT POSITION	
	• B2602: SHIFT POSITION	
	• B2603: SHIFT POSI STATUS	C
	• B2604: PNP SW	
	• B2605: PNP SW	
	• B2608: STARTER RELAY	
	• B260A: IGNITION RELAY	D
	• B260F: ENG STATE SIG LOST	
	• B2614: BCM	
	• B2615: BCM	
	• B2616: BCM	E
	• B2617: BCM	
	• B2618: BCM	
	• B261A: PUSH-BTN IGN SW	
	• B261E: VEHICLE TYPE	F
• B26E8: CLUTCH SW		
• B26EA: KEY REGISTRATION		
• C1729: VHCL SPEED SIG ERR	G	
• U0415: VEHICLE SPEED SIG		
5	• C1704: LOW PRESSURE FL	
	• C1705: LOW PRESSURE FR	H
	• C1706: LOW PRESSURE RR	
	• C1707: LOW PRESSURE RL	
	• C1708: [NO DATA] FL	
	• C1709: [NO DATA] FR	I
	• C1710: [NO DATA] RR	
	• C1711: [NO DATA] RL	
	• C1716: [PRESSDATA ERR] FL	
	• C1717: [PRESSDATA ERR] FR	J
	• C1718: [PRESSDATA ERR] RR	
	• C1719: [PRESSDATA ERR] RL	
	• C1734: CONTROL UNIT	K
6	• B2621: INSIDE ANTENNA	
	• B2622: INSIDE ANTENNA	
	• B2623: INSIDE ANTENNA	

DEF

## DTC Index

INFOID:000000009760861

### NOTE:

The details of time display are as follows.

- CRNT: A malfunction is detected now.
- PAST: A malfunction was detected in the past.

IGN counter is displayed on Freeze Frame Data. For details of Freeze Frame Data, refer to [BCS-21. "COMMON ITEM : CONSULT Function \(BCM - COMMON ITEM\)"](#).

CONSULT display	Fail-safe	Freeze Frame Data •Vehicle Speed •Odo/Trip Meter •Vehicle condition	Intelligent Key warning lamp ON	Tire pressure monitor warning lamp ON	Reference
No DTC is detected. further testing may be required.	—	—	—	—	—
U1000: CAN COMM CIRCUIT	—	—	—	—	<a href="#">BCS-50</a>
U1010: CONTROL UNIT (CAN)	—	—	—	—	<a href="#">BCS-51</a>
U0415: VEHICLE SPEED SIG	—	—	—	—	<a href="#">BCS-52</a>

M

N

O

P

# BCM (BODY CONTROL MODULE)

< ECU DIAGNOSIS INFORMATION >

[ROADSTER]

CONSULT display	Fail-safe	Freeze Frame Data •Vehicle Speed •Odo/Trip Meter •Vehicle condition	Intelligent Key warning lamp ON	Tire pressure monitor warning lamp ON	Reference
B2190: NATS ANTENNA AMP	×	—	—	—	<a href="#">SEC-46</a>
B2191: DIFFERENCE OF KEY	×	—	—	—	<a href="#">SEC-49</a>
B2192: ID DISCORD BCM-ECM	×	—	—	—	<a href="#">SEC-50</a>
B2193: CHAIN OF BCM-ECM	×	—	—	—	<a href="#">SEC-52</a>
B2195: ANTI SCANNING	×	—	—	—	<a href="#">SEC-53</a>
B2553: IGNITION RELAY	—	×	—	—	<a href="#">PCS-51</a>
B2555: STOP LAMP	—	×	—	—	<a href="#">SEC-54</a>
B2556: PUSH-BTN IGN SW	—	×	×	—	<a href="#">SEC-56</a>
B2557: VEHICLE SPEED	×	×	×	—	<a href="#">SEC-58</a>
B2560: STARTER CONT RELAY	×	×	×	—	<a href="#">SEC-59</a>
B2562: LOW VOLTAGE	—	×	—	—	<a href="#">BCS-53</a>
B2601: SHIFT POSITION	×	×	×	—	<a href="#">SEC-60</a>
B2602: SHIFT POSITION	×	×	×	—	<a href="#">SEC-63</a>
B2603: SHIFT POSI STATUS	×	×	×	—	<a href="#">SEC-66</a>
B2604: PNP SW	×	×	×	—	<a href="#">SEC-69</a>
B2605: PNP SW	×	×	×	—	<a href="#">SEC-71</a>
B2608: STARTER RELAY	×	×	×	—	<a href="#">SEC-73</a>
B260A: IGNITION RELAY	×	×	×	—	<a href="#">PCS-53</a>
B260F: ENG STATE SIG LOST	×	×	×	—	<a href="#">SEC-75</a>
B2614: BCM	—	×	×	—	<a href="#">PCS-55</a>
B2615: BCM	—	×	×	—	<a href="#">PCS-58</a>
B2616: BCM	—	×	×	—	<a href="#">PCS-61</a>
B2617: BCM	×	×	×	—	<a href="#">SEC-79</a>
B2618: BCM	×	×	×	—	<a href="#">PCS-64</a>
B261A: PUSH-BTN IGN SW	—	×	×	—	<a href="#">PCS-65</a>
B261E: VEHICLE TYPE	×	×	× (Turn ON for 15 seconds)	—	<a href="#">SEC-82</a>
B2621: INSIDE ANTENNA	—	×	—	—	<a href="#">DLK-280</a>
B2622: INSIDE ANTENNA	—	×	—	—	• <a href="#">DLK-84</a> (Coupe) • <a href="#">DLK-282</a> (Roadster)
B2623: INSIDE ANTENNA	—	×	—	—	• <a href="#">DLK-86</a> (Coupe) • <a href="#">DLK-284</a> (Roadster)
B26E8: CLUTCH SW	×	×	×	—	<a href="#">SEC-76</a>
B26EA: KEY REGISTRATION	—	×	× (Turn ON for 15 seconds)	—	<a href="#">SEC-78</a>
C1704: LOW PRESSURE FL	—	—	—	×	<a href="#">WT-23</a>
C1705: LOW PRESSURE FR	—	—	—	×	
C1706: LOW PRESSURE RR	—	—	—	×	
C1707: LOW PRESSURE RL	—	—	—	×	

# BCM (BODY CONTROL MODULE)

< ECU DIAGNOSIS INFORMATION >

[ROADSTER]

CONSULT display	Fail-safe	Freeze Frame Data •Vehicle Speed •Odo/Trip Meter •Vehicle condition	Intelligent Key warning lamp ON	Tire pressure monitor warning lamp ON	Reference
C1708: [NO DATA] FL	—	—	—	×	<a href="#">WT-25</a>
C1709: [NO DATA] FR	—	—	—	×	
C1710: [NO DATA] RR	—	—	—	×	
C1711: [NO DATA] RL	—	—	—	×	
C1716: [PRESSDATA ERR] FL	—	—	—	×	<a href="#">WT-28</a>
C1717: [PRESSDATA ERR] FR	—	—	—	×	
C1718: [PRESSDATA ERR] RR	—	—	—	×	
C1719: [PRESSDATA ERR] RL	—	—	—	×	
C1729: VHCL SPEED SIG ERR	—	—	—	×	<a href="#">WT-30</a>
C1734: CONTROL UNIT	—	—	—	×	<a href="#">WT-32</a>

A  
B  
C  
D  
E  
F  
G  
H  
I  
J  
K  
DEF  
M  
N  
O  
P

DEF

# SOFT TOP CONTROL UNIT

< ECU DIAGNOSIS INFORMATION >

[ROADSTER]

## SOFT TOP CONTROL UNIT

### Reference Value

INFOID:000000009760862

### VALUES ON THE DIAGNOSIS TOOL

**NOTE:**

The following table includes information (items) inapplicable to this vehicle. For information (items) applicable to this vehicle, refer to CONSULT display items.

CONSULT MONITOR ITEM

Monitor Item	Condition	Status/Value	
ROOF LATCHED RH	State of roof lock is in roof latch RH	Lock position	ON
		Other than above	OFF
		Roof striker sensor RH circuit is open or short	NG
ROOF LATCHED LH	State of roof lock is in roof latch LH	Lock position	ON
		Other than above	OFF
		Roof striker sensor LH circuit is open or short	NG
F/CENTER LOCK	State of roof latch cylinder	Lock	ON
		Other than above	OFF
		Roof latch lock sensor circuit is open or short	NG
R/RAIL RAISED LH	State of roof drive cylinder LH	Soft top is close	ON
		Other than above	OFF
		Roof status sensor LH circuit is open or short	NG
R/RAIL RAISED RH	State of roof drive cylinder RH	Soft top is close	ON
		Other than above	OFF
		Roof status sensor RH circuit is open or short	NG
R/RAIL LOWERED	State of roof drive cylinder LH	Soft top is open	ON
		Other than above	OFF
		Roof status sensor LH circuit is open or short	NG
5TH BOW LOWERED	State of 5th bow drive cylinder LH	5th bow is close	ON
		Other than above	OFF
		5th bow status sensor LH circuit is open or short	NG
5TH BOW RAISED	State of 5th bow drive cylinder RH	5th bow is open	ON
		Other than above	OFF
		5th bow status sensor RH circuit is open or short	NG
S/LID OPEN LH	State of storage lid drive cylinder LH	Storage lid is open	ON
		Other than above	OFF
		Storage lid status sensor LH circuit is open or short	NG
S/LID OPEN RH	State of storage lid drive cylinder RH	Storage lid is open	ON
		Other than above	OFF
		Storage lid status sensor RH circuit is open or short	NG

# SOFT TOP CONTROL UNIT

< ECU DIAGNOSIS INFORMATION >

[ROADSTER]

Monitor Item	Condition	Status/Value		
S/LID CLOSE RH	State of storage lid drive cylinder RH	Storage lid is close	ON	A
		Other than above	OFF	
		Storage lid status sensor RH circuit is open or short	NG	B
5TH BOW LATCH OP	State of 5th bow latch cylinder	Unlock	ON	
		Other than above	OFF	C
		5th bow latch open sensor circuit is open or short	NG	
SWITCHING VALVE 1	Operation of switching valve 1	Operate	ON	D
		Stop	OFF	
		Switching valve 1 circuit is short	NG	E
SWITCHING VALVE 2	Operation of switching valve 2	Operate	ON	
		Stop	OFF	F
		Switching valve 2 circuit is short	NG	
SWITCHING VALVE 3	Operation of switching valve 3	Operate	ON	
		Stop	OFF	G
		Switching valve 3 circuit is short	NG	
SWITCHING VALVE 4	Operation of switching valve 4	Operate	ON	
		Stop	OFF	H
		Switching valve 4 circuit is short	NG	
SWITCHING VALVE 5	Operation of switching valve 5	Operate	ON	
		Stop	OFF	I
		Switching valve 5 circuit is short	NG	
PUMP OUT (RH)	Operation of hydraulic pump motor	Turning clockwise	ON	J
		Other than above	OFF	
		Hydraulic pump motor (RH) circuit is short	NG	
PUMP OUT (LH)	Operation of hydraulic pump motor	Turning counterclockwise	ON	K
		Other than above	OFF	
		Hydraulic pump motor (LH) circuit is short	NG	DEF
5TH BOW LATCH CL	State of 5th bow latch cylinder	Lock	ON	
		Other than above	OFF	
		5th bow latch close sensor circuit is open or short	NG	M
ROOF SW (OPEN)	State of roof open/close switch	OPEN operation is in operation	ON	
		Other than above	OFF	N
ROOF SW (CLOSE)	State of roof open/close switch	CLOSE operation is in operation	ON	
		Other than above	OFF	O
SHIFT R SIGNAL	Shift position	R position	ON	
		Other than R position	OFF	
TRUNK OPEN OUT	Operation of trunk lid opener actuator	OPEN operation is in operation	ON	P
		Other than above	OFF	
THER PROTEC PUMP	Thermo protection hydraulic pump	In non-operation	OK	
		In operation	NG	
THER PROTEC RCU	Thermo protection soft top control unit	In non-operation	OK	
		In operation	NG	

## SOFT TOP CONTROL UNIT

< ECU DIAGNOSIS INFORMATION >

[ROADSTER]

Monitor Item	Condition	Status/Value	
PWR COND RCU	Power supply voltage state of soft top control unit	Normal	OK
		Malfunction	NG
PWR COND P/W	Power supply voltage state of power window	Normal	OK
		Malfunction	NG
LOCAL COMM 1	State of local communication 1	Normal	OK
		It is in sleep mode	SLEEP
		Communication error	NG
LOCAL COMM 2	State of local communication 2	Normal	OK
		It is in sleep mode	SLEEP
		Communication error	NG
REAR DEF OUT	Operation of rear window defogger	Roof position is full close	OK
		Other than above	NG
5BOW STRIK LATCH	State of 5th bow latch	5th bow striker is in 5th bow latch	ON
		Other than above	OFF
		5th bow striker sensor circuit is open or short	NG
P/W OP REQ SW SIG	State of request switch signal	OPEN operation is in operation	ON
		Stop	OFF
PROHIBIT P/W UP	Prohibit of power window up	In operation	ON
		In non-operation	OFF
IGN ON SIG(BCM)	Power position signal	Ignition switch ON	ON
		Other than above	OFF
RF OP REQ SW SIG	State of request switch signal	OPEN operation is in operation	ON
		Stop	OFF



# SOFT TOP CONTROL UNIT

< ECU DIAGNOSIS INFORMATION >

[ROADSTER]

## TERMINAL LAYOUT

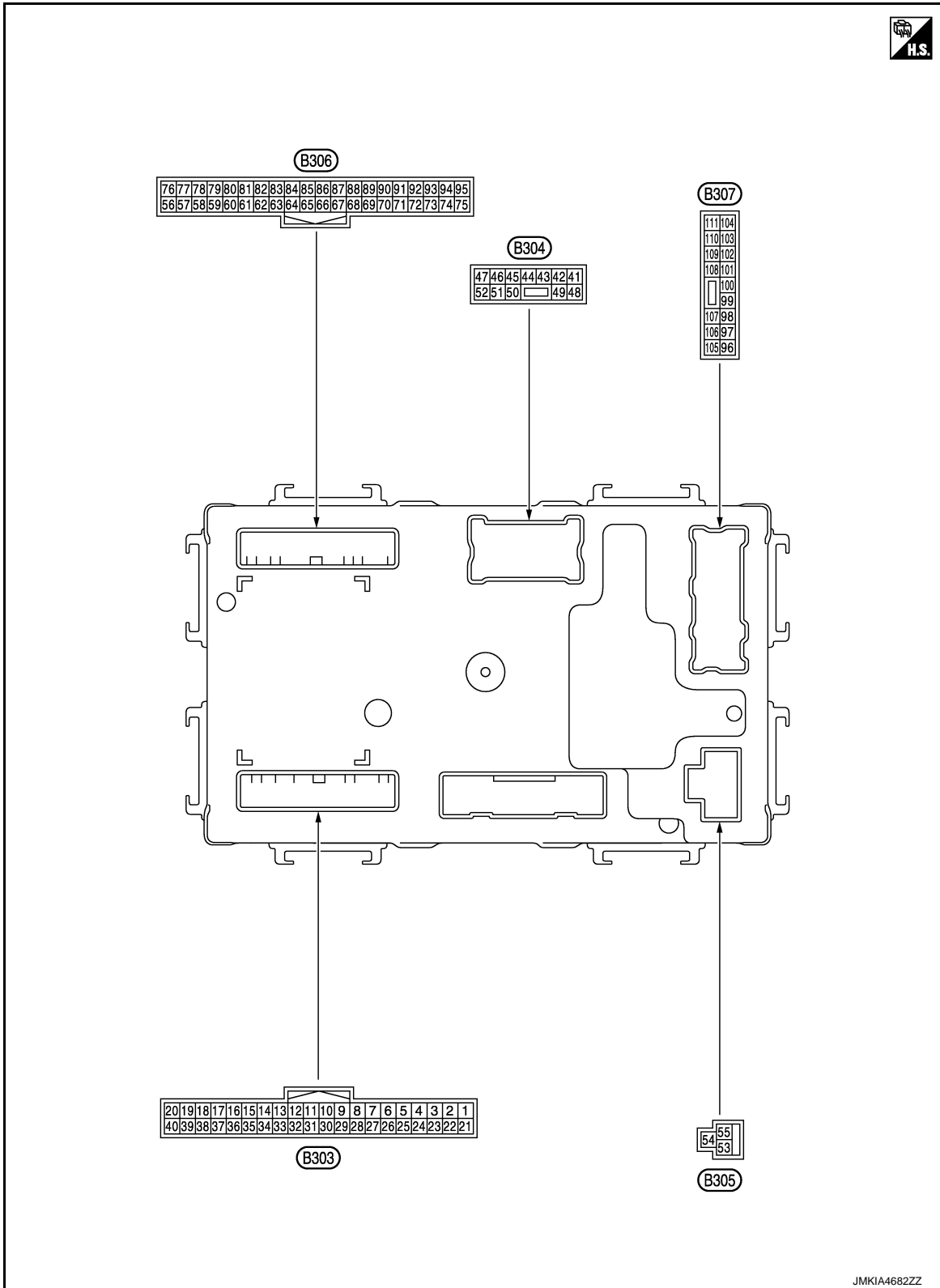

## PHYSICAL VALUES

A  
B  
C  
D  
E  
F  
G  
H  
I  
J  
K  
DEF  
M  
N  
O  
P

# SOFT TOP CONTROL UNIT

< ECU DIAGNOSIS INFORMATION >

[ROADSTER]

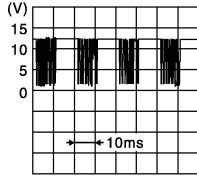
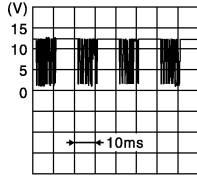
Terminal No. (Wire color)		Description		Condition	Value (Approx.)
+	-	Signal name	Input/ Output		
1 (BR)	Ground	Sensor power supply (Roof striker sensor LH)	Output	[Engine is running]	12 V
3 (DG)	Ground	Roof striker sensor RH	Input	[Engine is running] • Roof lock assembly	Hooked 0.8 V Released 3.0 V
4 (W)	Ground	Roof striker sensor LH	Input	[Engine is running] • Roof lock assembly	Hooked 0.8 V Released 3.0 V
8 (Y)	Ground	Back up lamp signal	Input	[Ignition switch: ON] • Shift position	R position Battery voltage Other than above 0 V
9 (SB)	Ground	Power source (Power window)	Input	[Ignition switch: OFF]	Battery voltage
10 (O)	Ground	Trunk lid open re- quest signal (BCM)	Input	[Ignition switch: ON] • Trunk opener	Operate 0 V → Battery voltage → 0 V Other than above 0 V
11 (O)	Ground	Roof status signal (Indicator lamp)	Output	[Engine is running] • Soft top indicator lamp	Illuminate 0 V Not illuminate Battery voltage
12 (SB)	Ground	Roof status signal (Audio)	Output	[Engine is running] • Soft top system	Fully open 9.5 V Other than above 0 V
14 (L)	Ground	Roof open/close switch (Close)	Input	[Engine is running] • Close switch	Pressed 0 V Released Battery voltage
15 (LG)	Ground	Roof open/close switch (Open)	Input	[Engine is running] • Open switch	Pressed 0 V Released Battery voltage
16 (V)	Ground	Trunk room lamp switch	Input	[Ignition switch: ON] • Trunk lid	Open 0 V Other than above Battery voltage
17 (BG)	Ground	CAN-H	Input/ Output	—	—
18 (P)	Ground	CAN-L	Input/ Output	—	—
19 (LG)	Ground	Local communication (Power window)	Input/ Output	—	 <p style="text-align: right; font-size: small;">JMKIA4024GB</p>
20 (V)	Ground	Local communication (BCM)	Input/ Output	—	 <p style="text-align: right; font-size: small;">JMKIA4024GB</p>

# SOFT TOP CONTROL UNIT

< ECU DIAGNOSIS INFORMATION >

[ROADSTER]

Terminal No. (Wire color)		Description		Condition		Value (Approx.)	
+	-	Signal name	Input/ Output				
21 (BR)	Ground	Sensor power supply (Roof striker sensor RH)	Output	[Engine is running]		12 V	A
29 (DG)	Ground	Ground	—	—		—	B
35 (P)	Ground	Ground (Roof open/close switch)	—	—		—	C
41 (DG)	Ground	Trunk lid opener ac- tuator	Output	Trunk lid opener	Operate	0 V → Battery voltage → 0 V	D
					Stop	0 V	E
48 (R)	Ground	Power source (Rear window defog- ger)	Input	[Engine is running] • Rear window defogger	Active	Battery voltage	F
					Not active	0 V	G
49 (R)	Ground	Power source (Rear window defog- ger)	Input	[Engine is running] • Rear window defogger	Active	Battery voltage	H
					Not active	0 V	I
53 (R)	Ground	Power source (Roof)	Input	[Engine is running]		Battery voltage	J
54 (B)	Ground	Ground (Roof)	—	—		—	K
56 (W)	Ground	5th bow latch close sensor	Input	[Engine is running] • 5th bow latch	Lock	0.8 V	L
					Other than above	3.0 V	M
57 (G)	Ground	5th bow latch open sensor	Input	[Engine is running] • 5th bow latch	Unlock	0.8 V	N
					Other than above	3.0 V	O
58 (LG)	Ground	Storage lid status sensor RH (Open)	Input	[Engine is running] • Storage lid	Full open	0.8 V	P
					Other than above	3.0 V	Q
59 (W)	Ground	Storage lid status sensor RH (Close)	Input	[Engine is running] • Storage lid	Full close	0.8 V	R
					Other than above	3.0 V	S
60 (DG)	Ground	Storage lid status sensor LH (Open)	Input	[Engine is running] • Storage lid	Full open	0.8 V	T
					Other than above	3.0 V	U
61 (Y)	Ground	Roof status sensor RH (Close)	Input	[Engine is running] • Soft top	Raised	0.8 V	V
					Other than above	3.0 V	W
66 (L)	Ground	Roof status sensor LH (Open)	Input	[Engine is running] • Soft top	Lowered	0.8 V	X
					Other than above	3.0 V	Y
68 (P)	Ground	5th bow status sen- sor RH	Input	[Engine is running] • 5th bow	Raised	0.8 V	Z
					Other than above	3.0 V	AA
69 (V)	Ground	Roof status sensor LH (Close)	Input	[Engine is running] • Soft top	Raised	0.8 V	AB
					Other than above	3.0 V	AC

# SOFT TOP CONTROL UNIT

< ECU DIAGNOSIS INFORMATION >

[ROADSTER]

Terminal No. (Wire color)		Description		Condition		Value (Approx.)
+	-	Signal name	Input/ Output			
70 (O)	Ground	5th bow status sensor LH	Input	[Engine is running] • 5th bow	Lowered	0.8 V
					Other than above	3.0 V
71 (SB)	Ground	Roof latch lock sensor	Input	[Engine is running] • Roof lock assembly	Lock	0.8 V
					Other than above	3.0 V
72 (W/R)	Ground	Hydraulic pump temperature sensor	Input	[Engine is running]		0 - 4.8 V Output voltage varies with hydraulic pump temperature.
73 (R)	Ground	Hydraulic pump relay 2 ON signal	Input	[Engine is running] • Hydraulic pump motor (Right rotation)	Active	12 V
					Inactive	0 V
74 (R/B)	Ground	Hydraulic pump relay 1 ON signal	Input	[Engine is running] • Hydraulic pump motor (Left rotation)	Active	12 V
					Inactive	0 V
75 (BR)	Ground	Sensor power supply (Roof status sensor LH/5th bow latch open sensor/5th bow latch close sensor/5th bow striker sensor)	Output	[Engine is running]		12 V
76 (L)	Ground	5th bow striker sensor	Input	[Engine is running] • 5th bow striker	Hooked	0.8 V
					Released	3.0 V
92 (BG)	Ground	Sensor ground (Hydraulic pump temperature sensor)	—	—		—
93 (BR)	Ground	Sensor power supply (Roof status sensor RH/Storage lid status sensor RH)	Output	[Engine is running]		12 V
94 (BR)	Ground	Sensor power supply (Roof latch lock sensor/5th bow status sensor LH)	Output	[Engine is running]		12 V
95 (BR)	Ground	Sensor power supply (Storage lid status sensor/5th bow status sensor RH)	Output	[Engine is running]		12 V
96 (W)	Ground	Switching valve 4	Output	[Engine is running] • Switching valve 4	Active	12 V
					Inactive	0 V
97 (LG)	Ground	Switching valve 3	Output	[Engine is running] • Switching valve 3	Active	12 V
					Inactive	0 V
98 (L)	Ground	Switching valve 2	Output	[Engine is running] • Switching valve 2	Active	12 V
					Inactive	0 V
99 (O)	Ground	Switching valve 1	Output	[Engine is running] • Switching valve 1	Active	12 V
					Inactive	0 V
100 (BR)	Ground	Hydraulic pump relay 2	Output	[Engine is running] • Hydraulic pump motor (Right rotation)	Active	12 V
					Inactive	0 V

# SOFT TOP CONTROL UNIT

< ECU DIAGNOSIS INFORMATION >

[ROADSTER]

Terminal No. (Wire color)		Description		Condition		Value (Approx.)
+	-	Signal name	Input/ Output			
101 (SB)	Ground	Hydraulic pump relay 1	Output	[Engine is running] • Hydraulic pump motor (Left rotation)	Active	12 V
					Inactive	0 V
102 (P)	Ground	Switching valve 5	Output	[Engine is running] • Switching valve 5	Active	12 V
					Inactive	0 V
103 (B)	Ground	Hydraulic unit ground	—	—	—	—
104 (R)	Ground	Rear window defogger power supply	Output	[Engine is running] • Rear window defogger <b>NOTE:</b> Roof is fully closed.	Active	Battery voltage
					Not active	0 V
111 (R)	Ground	Rear window defogger power supply	Output	[Engine is running] • Rear window defogger <b>NOTE:</b> Roof is fully closed.	Active	Battery voltage
					Not active	0 V

## Fail-safe

INFOID:000000009760863

## FAIL-SAFE CONTROL BY DTC

Soft top control unit performs fail-safe control when any of the following DTCs is detected.

Display contents of CONSULT		Fail-safe	Cancellation
U1000	CAN COMM CIRCUIT	Inhibit soft top operation.	Communication is normal.
U1010	CONTROL UNIT (CAN)	Inhibit soft top operation.	Communication is normal.
U0140	LOCAL COMM-1	Inhibit soft top operation.	Communication is normal.
U0215	LOCAL COMM-2	Inhibit soft top operation.	Communication is normal.
B1701	ROOF CONTROL UNIT	Inhibit soft top operation.	Replace soft top control unit.
B1702	ROOF CONTROL UNIT	Inhibit soft top operation.	Replace soft top control unit.
B1709	ROOF SWITCH(OPEN)	Inhibit soft top operation.	Detects roof open/close switch (OPEN) is OFF.
B170A	ROOF SWITCH(CLOSE)	Inhibit soft top operation.	Detects roof open/close switch (CLOSE) is OFF.
B170F	SENSOR POWER SUPPLY	Inhibit soft top operation.	Detects normal value.
B171A	HYDRAULIC PMP(LH)	Inhibit soft top operation.	Detects normal value.
B171B	HYDRAULIC PMP(RH)	Inhibit soft top operation.	Detects normal value.
B171C	SWITCHING VALVE 1	Inhibit soft top operation.	Detects normal value.
B171D	SWITCHING VALVE 2	Inhibit soft top operation.	Detects normal value.
B172C	ROOF STATE SIG(TRUNK)*	Inhibit soft top operation.	Detects normal value.
B1731	HYDRAULIC STATE 1	Inhibit soft top operation.	Turn ignition switch OFF.
B1758	THERMO PROTECTION	Inhibit soft top operation.	Turn ignition switch OFF and wait at least 5 minutes.
B175C	PWR SOURCE(ROOF)	Inhibit soft top operation.	Power source is 11.4 (V) or more for 0.5 second.
B175D	PWR SOURCE(ROOF)	Inhibit soft top operation.	Power source is 14.5 (V) or more for 4 seconds.
B175E	PWR SOURCE(WINDOW)	Inhibit soft top operation and rear power window operation.	Power source (power window) is 9.5 (V) or more.
B175F	PWR SOURCE(WINDOW)	Inhibit soft top operation and rear power window operation.	Power source (power window) is 15.5 (V) or more.
B1766	SWITCHING VALVE 3	Inhibit soft top operation.	Detects normal value.
B1767	SWITCHING VALVE 4	Inhibit soft top operation.	Detects normal value.

# SOFT TOP CONTROL UNIT

< ECU DIAGNOSIS INFORMATION >

[ROADSTER]

Display contents of CONSULT		Fail-safe	Cancellation
B1768	SWITCHING VALVE 5	Inhibit soft top operation.	Detects normal value.
B176A	THERMO PROTECTION	Inhibit soft top operation.	Turn ignition switch OFF and wait at least 5 minutes.
B176B	ROOF WARNING LAMP	Inhibit soft top operation.	Detects normal value.
B176C	STRIKER SENSOR RH	Inhibit soft top operation.	Detects normal value.
B176D	STRIKER SENSOR LH	Inhibit soft top operation.	Detects normal value.
B176E	ROOF LATCH LOCK SENSOR	Inhibit soft top operation.	Detects normal value.
B176F	ROOF STATUS SEN LH	Inhibit soft top operation.	Detects normal value.
B1770	ROOF STATUS SEN RH	Inhibit soft top operation.	Detects normal value.
B1771	ROOF STATUS SEN LH	Inhibit soft top operation.	Detects normal value.
B1772	5BOW STATUS SEN LH	Inhibit soft top operation.	Detects normal value.
B1773	5BOW STATUS SEN RH	Inhibit soft top operation.	Detects normal value.
B1774	S/LID STATUS SEN LH	Inhibit soft top operation.	Detects normal value.
B1775	S/LID STATUS SEN RH	Inhibit soft top operation.	Detects normal value.
B1776	S/LID STATUS SEN RH	Inhibit soft top operation.	Detects normal value.
B1777	REAR DEF OUT SIG	Inhibit soft top and rear window defogger operation.	Detects normal value.
B1778	TRUNK OPEN OUT SIG	Inhibit soft top and trunk lid opener actuator operation.	Detects normal value.
B1779	THERMO PROTECTION	Inhibit soft top operation.	Detects normal value.
B177A	ROOF STATE INCORRECT	Inhibit soft top operation.	Detects normal value.
B177B	ROOF STATE INCORRECT	Inhibit soft top operation.	Detects normal value.
B177C	THERMO PROTECTION	Inhibit soft top operation.	Detects normal value.
B177D	5BOW LATCH OPEN SEN	Inhibit soft top operation.	Detects normal value.
B177E	5BOW LATCH CLOSE SEN	Inhibit soft top operation.	Detects normal value.
B177F	5BOW STRIKER SENSOR	Inhibit soft top operation.	Detects normal value.

\*: This item indicates the roof status signal (Audio).

## DTC Inspection Priority Chart

INFOID:000000009760864

If some DTCs are displayed at the same time, perform inspections one by one based on the following priority chart.

Priority	Display contents of CONSULT	
1	U1000	CAN COMM CIRCUIT
	U1010	CONTROL UNIT (CAN)
	B170F	SENSOR POWER SUPPLY
	B175C	PWR SOURCE(ROOF)
	B175D	PWR SOURCE(ROOF)
	B175E	PWR SOURCE(WINDOW)
	B175F	PWR SOURCE(WINDOW)
	B1701	ROOF CONTROL UNIT
	B1702	ROOF CONTROL UNIT

# SOFT TOP CONTROL UNIT

< ECU DIAGNOSIS INFORMATION >

[ROADSTER]

Priority	Display contents of CONSULT		
2	B1709	ROOF SWITCH(OPEN)	A
	B170A	ROOF SWITCH(CLOSE)	
	B176B	ROOF WARNING LAMP	B
	B176C	STRIKER SENSOR RH	
	B176D	STRIKER SENSOR LH	
	B176E	ROOF LATCH LOCK SEN	C
	B176F	ROOF STATUS SEN LH	
	B1770	ROOF STATUS SEN RH	
	B1771	ROOF STATUS SEN LH	D
	B1772	5BOW STATUS SEN LH	
	B1773	5BOW STATUS SEN RH	E
	B1774	S/LID STATUS SEN LH	
	B1775	S/LID STATUS SEN RH	F
	B1776	S/LID STATUS SEN RH	
	B177D	5BOW LATCH OPEN SEN	
	B177E	5BOW LATCH CLOSE SEN	G
	B177F	5BOW STRIKER SENSOR	
3	U0140	LOCAL COMM-1	H
	U0215	LOCAL COMM-2	
	B171A	HYDRAULIC PMP(LH)	
	B171B	HYDRAULIC PMP(RH)	I
	B171C	SWITCHING VALVE 1	
	B171D	SWITCHING VALVE 2	
	B172C	ROOF STATE SIG(TRUNK)*	J
	B1731	HYDRAULIC STATE 1	
	B1758	THERMO PROTECTION	K
	B1766	SWITCHING VALVE 3	
	B1767	SWITCHING VALVE 4	
	B1768	SWITCHING VALVE 5	DEF
	B176A	THERMO PROTECTION	
	B1777	REAR DEF OUT SIG	M
	B1778	TRUNK OPEN OUT SIG	
	B1779	THERMO PROTECTION	
	B177A	ROOF STATE INCORRECT	N
B177B	ROOF STATE INCORRECT		
B177C	THERMO PROTECTION	O	

\*: This item indicates the roof status signal (Audio).

## DTC Index

INFOID:000000009760865

### NOTE:

For details of Freeze Frame Data, refer to [RF-28, "CONSULT Function"](#).

Display contents of CONSULT		Fail-safe	Freeze Frame Data	Reference page
No DTC is detected. Further testing may be required.		—	—	—
U1000	CAN COMM CIRCUIT	×	×	<a href="#">RF-70</a>

# SOFT TOP CONTROL UNIT

< ECU DIAGNOSIS INFORMATION >

[ROADSTER]

Display contents of CONSULT		Fail-safe	Freeze Frame Data	Reference page
U1010	CONTROL UNIT (CAN)	×	×	<a href="#">RF-71</a>
U0140	LOCAL COMM-1	×	×	<a href="#">RF-72</a>
U0215	LOCAL COMM-2	×	×	<a href="#">RF-73</a>
B1701	ROOF CONTROL UNIT	×	×	<a href="#">RF-75</a>
B1702	ROOF CONTROL UNIT	×	×	<a href="#">RF-76</a>
B1709	ROOF SWITCH-OPEN	×	×	<a href="#">RF-77</a>
B170A	ROOF SWITCH-CLOSE	×	×	<a href="#">RF-79</a>
B170F	SENSOR POWER SUPPLY	×	×	<a href="#">RF-81</a>
B171A	HYDRAULIC PMP(LH)	×	×	<a href="#">RF-84</a>
B171B	HYDRAULIC PMP(RH)	×	×	<a href="#">RF-87</a>
B171C	SWITCHING VALVE 1	×	×	<a href="#">RF-90</a>
B171D	SWITCHING VALVE 2	×	×	<a href="#">RF-92</a>
B172C	ROOF STATE SIG(TRUNK)*	×	×	<a href="#">RF-94</a>
B1731	HYDRAULIC STATE 1	×	×	<a href="#">RF-96</a>
B1758	THERMO PROTECTION	×	×	<a href="#">RF-97</a>
B175C	PWR SOURCE(ROOF)	×	×	<a href="#">RF-98</a>
B175D	PWR SOURCE(ROOF)	×	×	<a href="#">RF-99</a>
B175E	PWR SOURCE(WINDOW)	×	×	<a href="#">RF-100</a>
B175F	PWR SOURCE(WINDOW)	×	×	<a href="#">RF-102</a>
B1766	SWITCHING VALVE 3	×	×	<a href="#">RF-104</a>
B1767	SWITCHING VALVE 4	×	×	<a href="#">RF-106</a>
B1768	SWITCHING VALVE 5	×	×	<a href="#">RF-108</a>
B176A	THERMO PROTECTION	×	×	<a href="#">RF-110</a>
B176B	ROOF WARNING LAMP	×	×	<a href="#">RF-111</a>
B176C	STRIKER SENSOR RH	×	×	<a href="#">RF-113</a>
B176D	STRIKER SENSOR LH	×	×	<a href="#">RF-115</a>
B176E	ROOF LATCH LOCK SEN	×	×	<a href="#">RF-117</a>
B176F	ROOF STATUS SEN LH	×	×	<a href="#">RF-119</a>
B1770	ROOF STATUS SEN RH	×	×	<a href="#">RF-121</a>
B1771	ROOF STATUS SEN LH	×	×	<a href="#">RF-123</a>
B1772	5BOW STATUS SEN LH	×	×	<a href="#">RF-125</a>
B1773	5BOW STATUS SEN RH	×	×	<a href="#">RF-127</a>
B1774	S/LID STATUS SEN LH	×	×	<a href="#">RF-129</a>
B1775	S/LID STATUS SEN RH	×	×	<a href="#">RF-131</a>
B1776	S/LID STATUS SEN RH	×	×	<a href="#">RF-133</a>
B1777	REAR DEF OUT SIG	×	×	<a href="#">RF-135</a>
B1778	TRUNK OPEN OUT SIG	×	×	<a href="#">RF-136</a>
B1779	THERMO PROTECTION	×	×	<a href="#">RF-138</a>
B177A	ROOF STATE INCORRECT	×	×	<a href="#">RF-140</a>
B177B	ROOF STATE INCORRECT	×	×	<a href="#">RF-141</a>
B177C	THERMO PROTECTION	×	×	<a href="#">RF-142</a>
B177D	5BOW LATCH OPEN SEN	×	×	<a href="#">RF-143</a>
B177E	5BOW LATCH CLOSE SEN	×	×	<a href="#">RF-145</a>
B177F	5BOW STRIKER SENSOR	×	×	<a href="#">RF-147</a>



# SOFT TOP CONTROL UNIT

< ECU DIAGNOSIS INFORMATION >

[ROADSTER]

\*: This item indicates the roof status signal (Audio).

A

B

C

D

E

F

G

H

I

J

K

**DEF**

M

N

O

P

# REAR WINDOW DEFOGGER AND DOOR MIRROR DEFOGGER DO NOT OPERATE

< SYMPTOM DIAGNOSIS >

[ROADSTER]

## SYMPTOM DIAGNOSIS

### REAR WINDOW DEFOGGER AND DOOR MIRROR DEFOGGER DO NOT OPERATE

#### Diagnosis Procedure

INFOID:000000009363414

#### 1. CHECK POWER SUPPLY AND GROUND CIRCUIT

Check power supply and ground circuit.

Refer to [DEF-103, "BCM : Diagnosis Procedure"](#).

Is the inspection result normal?

YES >> GO TO 2.

NO >> Repair or replace the malfunctioning parts.

#### 2. CHECK REAR WINDOW DEFOGGER SWITCH

Check rear window defogger switch.

• With Navigation: Refer to [DEF-104, "WITH NAVIGATION : Component Function Check"](#).

• Without Navigation: Refer to [DEF-104, "WITHOUT NAVIGATION : Component Function Check"](#).

Is the inspection result normal?

YES >> GO TO 3.

NO >> Repair or replace the malfunctioning parts.

#### 3. CHECK REAR WINDOW DEFOGGER RELAY

Check rear window defogger relay.

Refer to [DEF-106, "Component Function Check"](#).

Is the inspection result normal?

YES >> GO TO 4.

NO >> Repair or replace the malfunctioning parts.

#### 4. CONFIRM THE OPERATION

Confirm the operation again.

Is the inspection result normal?

YES >> Check intermittent incident. Refer to [GI-45, "Intermittent Incident"](#).

NO >> GO TO 1.

# REAR WINDOW DEFOGGER DOES NOT OPERATE BUT BOTH DOOR MIRROR DEFOGGERS OPERATE

< SYMPTOM DIAGNOSIS >

[ROADSTER]

## REAR WINDOW DEFOGGER DOES NOT OPERATE BUT BOTH DOOR MIRROR DEFOGGERS OPERATE

### Diagnosis Procedure

INFOID:000000009363415

#### 1. CHECK SOFT TOP CONTROL UNIT CIRCUIT

Check soft top control unit circuit.

Refer to [DEF-108, "Component Function Check"](#).

Is the inspection result normal?

YES >> GO TO 2.

NO >> Repair or replace the malfunctioning parts.

#### 2. CHECK REAR WINDOW DEFOGGER

Check rear window defogger.

Refer to [DEF-110, "Component Function Check"](#).

Is the inspection result normal?

YES >> GO TO 3.

NO >> Repair or replace the malfunctioning parts.

#### 3. CONFIRM THE OPERATION

Confirm the operation again

Is the inspection result normal?

YES >> Check intermittent incident. Refer to [GI-45, "Intermittent Incident"](#).

NO >> GO TO 1.

A  
B  
C  
D  
E  
F  
G  
H  
I  
J  
K  
M  
N  
O  
P

DEF

# DOOR MIRROR DEFOGGER DOES NOT OPERATE

< SYMPTOM DIAGNOSIS >

[ROADSTER]

## DOOR MIRROR DEFOGGER DOES NOT OPERATE BOTH SIDES

BOTH SIDES : Diagnosis Procedure

INFOID:000000009363416

### 1. CHECK DOOR MIRROR DEFOGGER

Check door mirror defogger.

Refer to [DEF-114, "Component Function Check"](#).

Is the inspection result normal?

YES >> GO TO 2.

NO >> Repair or replace the malfunctioning parts.

### 2. CONFIRM THE OPERATION

Confirm the operation again.

Is the inspection result normal?

YES >> Check intermittent incident. Refer to [GI-45, "Intermittent Incident"](#).

NO >> GO TO 1.

## DRIVER SIDE

DRIVER SIDE : Diagnosis Procedure

INFOID:000000009363417

### 1. CHECK DRIVER SIDE DOOR MIRROR DEFOGGER

Check driver side door mirror defogger.

Refer to [DEF-115, "Component Function Check"](#).

Is the inspection result normal?

YES >> GO TO 2.

NO >> Repair or replace the malfunctioning parts.

### 2. CONFIRM THE OPERATION

Confirm the operation again.

Is the inspection result normal?

YES >> Check intermittent incident. Refer to [GI-45, "Intermittent Incident"](#).

NO >> GO TO 1.

## PASSENGER SIDE

PASSENGER SIDE : Diagnosis Procedure

INFOID:000000009363418

### 1. CHECK PASSENGER SIDE DOOR MIRROR DEFOGGER.

Check passenger side door mirror defogger.

Refer to [DEF-117, "Component Function Check"](#).

Is the inspection result normal?

YES >> GO TO 2.

NO >> Repair or replace the malfunctioning parts.

### 2. CONFIRM THE OPERATION

Confirm the operation again.

Is the inspection result normal?

YES >> Check intermittent incident. Refer to [GI-45, "Intermittent Incident"](#).

NO >> GO TO 1.

# ON IS NOT DISPLAYED WHEN PRESSING REAR WINDOW DEFOGGER SWITCH BUT IT OPERATES

< SYMPTOM DIAGNOSIS >

[ROADSTER]

## ON IS NOT DISPLAYED WHEN PRESSING REAR WINDOW DEFOGGER SWITCH BUT IT OPERATES

### Diagnosis Procedure

INFOID:000000009363419

#### 1.CHECK AV CONTROL FUNCTION

Check that the AV control unit is operating normally. Refer to [AV-200, "Work Flow"](#).

Is the inspection result normal?

YES >> GO TO 2.

NO >> Repair or replace the malfunctioning parts.

#### 2.CONFIRM THE OPERATION

Confirm the operation again.

Is the inspection result normal?

YES >> Check intermittent incident. Refer to [GI-45, "Intermittent Incident"](#).

NO >> GO TO 1.

A  
B  
C  
D  
E  
F  
G  
H  
I  
J  
K  
DEF  
M  
N  
O  
P

DEF

# REAR WINDOW DEFOGGER INDICATOR DOES NOT ILLUMINATE

< SYMPTOM DIAGNOSIS >

[ROADSTER]

## REAR WINDOW DEFOGGER INDICATOR DOES NOT ILLUMINATE WITH NAVIGATION

WITH NAVIGATION : Diagnosis Procedure

INFOID:000000009363420

### 1.CHECK REAR WINDOW DEFOGGER OPERATION

Check rear window defogger operation.

Is the inspection result normal?

YES >> Check AV control system. Refer to [AV-200. "Work Flow"](#).

NO >> Check rear window defogger system. Refer to [DEF-95. "Work Flow"](#).

## WITHOUT NAVIGATION

WITHOUT NAVIGATION : Diagnosis Procedure

INFOID:000000009363421

### 1.CHECK A/C CONTROL FUNCTION

Check that the A/C control is operating normally.

Is the inspection result normal?

YES >> GO TO 2.

NO >> Check A/C control system. Refer to [HAC-5. "Work Flow"](#).

### 2.CHECK REAR WINDOW DEFOGGER ON SIGNAL

Check rear window defogger ON signal.

Refer to [DEF-112. "Component Function Check"](#).

Is the inspection result normal?

YES >> Replace A/C control (rear window defogger switch). Refer to [HAC-83. "BASE AUDIO : Removal and Installation"](#) (Base audio) or [HAC-84. "BOSE AUDIO WITHOUT NAVIGATION : Removal and Installation"](#) (BOSE audio without navigation).

NO >> Repair or replace the malfunctioning parts.

PRECAUTION

PRECAUTIONS  
FOR USA AND CANADA

FOR USA AND CANADA : Precaution for Supplemental Restraint System (SRS) "AIR BAG" and "SEAT BELT PRE-TENSIONER"

INFOID:000000009363422

The Supplemental Restraint System such as "AIR BAG" and "SEAT BELT PRE-TENSIONER", used along with a front seat belt, helps to reduce the risk or severity of injury to the driver and front passenger for certain types of collision. This system includes seat belt switch inputs and dual stage front air bag modules. The SRS system uses the seat belt switches to determine the front air bag deployment, and may only deploy one front air bag, depending on the severity of a collision and whether the front occupants are belted or unbelted. Information necessary to service the system safely is included in the "SRS AIR BAG" and "SEAT BELT" of this Service Manual.

**WARNING:**

Always observe the following items for preventing accidental activation.

- To avoid rendering the SRS inoperative, which could increase the risk of personal injury or death in the event of a collision that would result in air bag inflation, all maintenance must be performed by an authorized NISSAN/INFINITI dealer.
- Improper maintenance, including incorrect removal and installation of the SRS, can lead to personal injury caused by unintentional activation of the system. For removal of Spiral Cable and Air Bag Module, see "SRS AIR BAG".
- Never use electrical test equipment on any circuit related to the SRS unless instructed to in this Service Manual. SRS wiring harnesses can be identified by yellow and/or orange harnesses or harness connectors.

PRECAUTIONS WHEN USING POWER TOOLS (AIR OR ELECTRIC) AND HAMMERS

**WARNING:**

Always observe the following items for preventing accidental activation.

- When working near the Air Bag Diagnosis Sensor Unit or other Air Bag System sensors with the ignition ON or engine running, never use air or electric power tools or strike near the sensor(s) with a hammer. Heavy vibration could activate the sensor(s) and deploy the air bag(s), possibly causing serious injury.
- When using air or electric power tools or hammers, always switch the ignition OFF, disconnect the battery, and wait at least 3 minutes before performing any service.

FOR USA AND CANADA : Precaution for Battery Service

INFOID:000000009363423

Before disconnecting the battery, lower both the driver and passenger windows. This will prevent any interference between the window edge and the vehicle when the door is opened/closed. During normal operation, the window slightly raises and lowers automatically to prevent any window to vehicle interference. The automatic window function will not work with the battery disconnected.

FOR USA AND CANADA : Precautions For Xenon Headlamp Service

INFOID:000000009601837

**WARNING:**

Comply with the following warnings to prevent any serious accident.

- Disconnect the battery cable (negative terminal) or the power supply fuse before installing, removing, or touching the xenon headlamp (bulb included). The xenon headlamp contains high-voltage generated parts.
- Never work with wet hands.
- Check the xenon headlamp ON-OFF status after assembling it to the vehicle. Never turn the xenon headlamp ON in other conditions. Connect the power supply to the vehicle-side connector. (Turning it ON outside the lamp case may cause fire or visual impairments.)
- Never touch the bulb glass immediately after turning it OFF. It is extremely hot.

**CAUTION:**

Comply with the following cautions to prevent any error and malfunction.

- Install the xenon bulb securely. (Insufficient bulb socket installation may melt the bulb, the connector, the housing, etc. by high-voltage leakage or corona discharge.)

A  
B  
C  
D  
E  
F  
G  
H  
I  
J  
K

DEF

M  
N  
O  
P

# PRECAUTIONS

[ROADSTER]

< PRECAUTION >

- Never perform HID circuit inspection with a tester.
- Never touch the xenon bulb glass with hands. Never put oil and grease on it.
- Dispose of the used xenon bulb after packing it in thick vinyl without breaking it.
- Never wipe out dirt and contamination with organic solvent (thinner, gasoline, etc.).

## FOR MEXICO

### FOR MEXICO : Precaution for Supplemental Restraint System (SRS) "AIR BAG" and "SEAT BELT PRE-TENSIONER"

INFOID:000000009363424

The Supplemental Restraint System such as "AIR BAG" and "SEAT BELT PRE-TENSIONER", used along with a front seat belt, helps to reduce the risk or severity of injury to the driver and front passenger for certain types of collision. Information necessary to service the system safely is included in the "SRS AIR BAG" and "SEAT BELT" of this Service Manual.

#### **WARNING:**

Always observe the following items for preventing accidental activation.

- To avoid rendering the SRS inoperative, which could increase the risk of personal injury or death in the event of a collision that would result in air bag inflation, all maintenance must be performed by an authorized NISSAN/INFINITI dealer.
- Improper maintenance, including incorrect removal and installation of the SRS, can lead to personal injury caused by unintentional activation of the system. For removal of Spiral Cable and Air Bag Module, see "SRS AIR BAG".
- Never use electrical test equipment on any circuit related to the SRS unless instructed to in this Service Manual. SRS wiring harnesses can be identified by yellow and/or orange harnesses or harness connectors.

## PRECAUTIONS WHEN USING POWER TOOLS (AIR OR ELECTRIC) AND HAMMERS

#### **WARNING:**

Always observe the following items for preventing accidental activation.

- When working near the Air Bag Diagnosis Sensor Unit or other Air Bag System sensors with the ignition ON or engine running, never use air or electric power tools or strike near the sensor(s) with a hammer. Heavy vibration could activate the sensor(s) and deploy the air bag(s), possibly causing serious injury.
- When using air or electric power tools or hammers, always switch the ignition OFF, disconnect the battery, and wait at least 3 minutes before performing any service.

## FOR MEXICO : Precaution for Battery Service

INFOID:000000009363425

Before disconnecting the battery, lower both the driver and passenger windows. This will prevent any interference between the window edge and the vehicle when the door is opened/closed. During normal operation, the window slightly raises and lowers automatically to prevent any window to vehicle interference. The automatic window function will not work with the battery disconnected.

## FOR MEXICO : Precautions For Xenon Headlamp Service

INFOID:000000009601838

#### **WARNING:**

Comply with the following warnings to prevent any serious accident.

- Disconnect the battery cable (negative terminal) or the power supply fuse before installing, removing, or touching the xenon headlamp (bulb included). The xenon headlamp contains high-voltage generated parts.
- Never work with wet hands.
- Check the xenon headlamp ON-OFF status after assembling it to the vehicle. Never turn the xenon headlamp ON in other conditions. Connect the power supply to the vehicle-side connector. (Turning it ON outside the lamp case may cause fire or visual impairments.)
- Never touch the bulb glass immediately after turning it OFF. It is extremely hot.

#### **CAUTION:**

Comply with the following cautions to prevent any error and malfunction.

- Install the xenon bulb securely. (Insufficient bulb socket installation may melt the bulb, the connector, the housing, etc. by high-voltage leakage or corona discharge.)
- Never perform HID circuit inspection with a tester.
- Never touch the xenon bulb glass with hands. Never put oil and grease on it.
- Dispose of the used xenon bulb after packing it in thick vinyl without breaking it.



# PRECAUTIONS

< PRECAUTION >

[ROADSTER]

- Never wipe out dirt and contamination with organic solvent (thinner, gasoline, etc.).

A

B

C

D

E

F

G

H

I

J

K

DEF

M

N

O

P

# REMOVAL AND INSTALLATION

## FILAMENT

### Inspection and Repair

INFOID:000000009363426

#### INSPECTION

1. When measuring voltage, wrap tin foil around the top of the negative probe. Then press the foil against the wire with your finger.

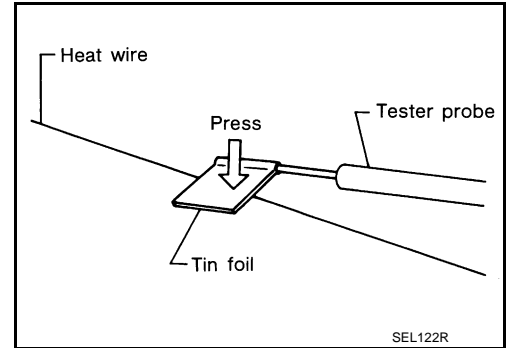

2. Attach probe circuit tester (in Volt range) to middle portion of each filament.

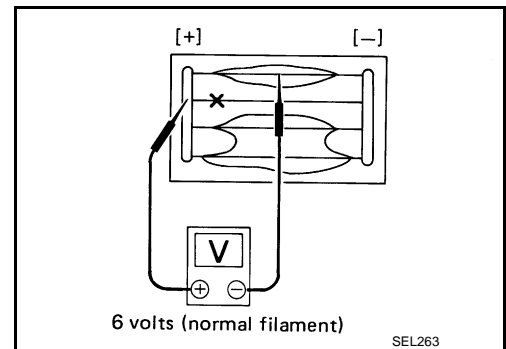

3. If a filament is burned out, circuit tester registers 0 or battery voltage.
4. To locate burned out point, move probe to left and right along filament. Test needle swings abruptly when probe passes the point.

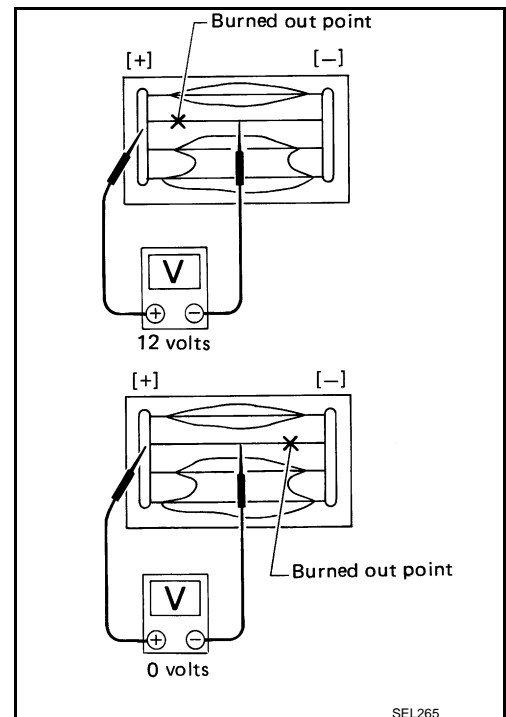

#### REPAIR

##### REPAIR EQUIPMENT

- Conductive silver composition (Dupont No. 4817 or an equivalent)

# FILAMENT

[ROADSTER]

## < REMOVAL AND INSTALLATION >

- Ruler 30 cm (11.8 in) long
- Drawing pen
- Heat gun
- Alcohol
- Cloth

### REPAIRING PROCEDURE

1. Wipe broken heat wire and its surrounding area clean with a cloth dampened in alcohol.
2. Apply a small amount of conductive silver composition to tip of drawing pen. Shake silver composition container before use.
3. Place ruler on glass along broken line. Deposit conductive silver composition on break with drawing pen. Slightly overlap existing heat wire on both sides [preferably 5 mm (0.20 in)] of the break.

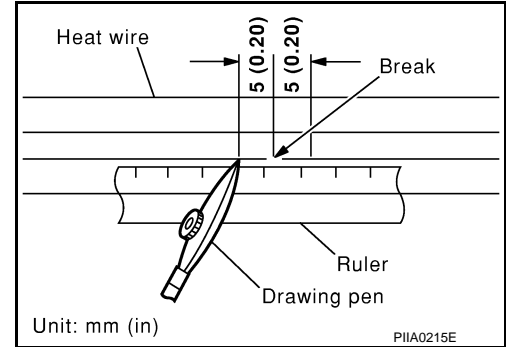

4. After repair has been complete, check repaired wire for continuity. This check should be conducted 10 minutes after silver composition is deposited. Do not touch repaired area while test is being conducted.

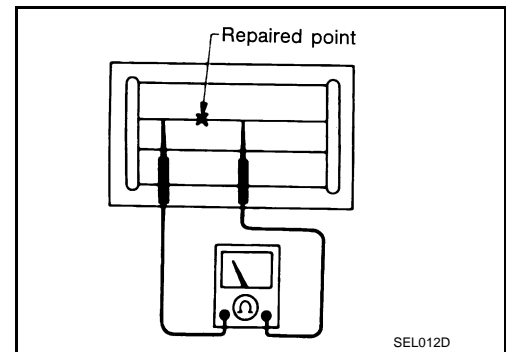

5. Apply a constant stream of hot air directly to the repaired area for approximately 20 minutes with a heat gun. A minimum distance of 3 cm (1.2 in) should be kept between repaired area and hot air outlet. If a heat gun is not available, let the repaired area dry for 24 hours.

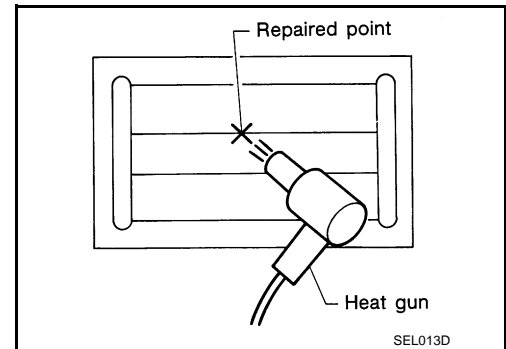

A  
B  
C  
D  
E  
F  
G  
H  
I  
J  
K  
DEF  
M  
N  
O  
P