

SECTION **SBC**

SEAT BELT CONTROL SYSTEM

A
B
C
D
E
F
G
SBC
I
J
K
L
M
N
O
P

CONTENTS

BASIC INSPECTION	SEAT BELT WARNING LAMP CIRCUIT	9	
	Diagnosis Procedure	9	
DIAGNOSIS AND REPAIR WORK FLOW	SEAT BELT WARNING SYSTEM	10	
Work Flow	Wiring Diagram - SRS AIR BAG CONTROL SYS-	10	
	TEM -	10	
SYSTEM DESCRIPTION	ECU DIAGNOSIS INFORMATION	13	
SEAT BELT WARNING SYSTEM	DIAGNOSIS SENSOR UNIT	13	
System Diagram	DTC Index	13	
System Description	Wiring Diagram - SRS AIR BAG CONTROL SYS-	16	
Component Parts Location	TEM -	16	
Component Description	SYMPTOM DIAGNOSIS	22	
DTC/CIRCUIT DIAGNOSIS	SEAT BELT WARNING LAMP DOES NOT	22	
SEAT BELT BUCKLE SWITCH	TURN OFF	22	
DRIVER SIDE	Diagnosis Procedure	22	
DRIVER SIDE : Description	SEAT BELT WARNING LAMP DOES NOT	23	
DRIVER SIDE : Component Function Check	TURN ON	23	
DRIVER SIDE : Diagnosis Procedure	Diagnosis Procedure	23	
DRIVER SIDE : Component Inspection (Belt	PRECAUTION	24	
Buckle Switch)	PRECAUTIONS	24	
PASSENGER SIDE	Precaution for Supplemental Restraint System	24	
PASSENGER SIDE : Description	(SRS) "AIR BAG" and "SEAT BELT PRE-TEN-	24	
PASSENGER SIDE : Component Function Check	SIONER"	24	
.....6	Precaution for Seat Belt Service	24	
PASSENGER SIDE : Diagnosis Procedure	Precaution for Battery Service	25	
PASSENGER SIDE : Component Inspection (Belt			
Buckle Switch)			

DIAGNOSIS AND REPAIR WORK FLOW

< BASIC INSPECTION >

BASIC INSPECTION

DIAGNOSIS AND REPAIR WORK FLOW

Work Flow

INFOID:000000004496358

DETAILED FLOW

1.OBTAIN INFORMATION ABOUT SYMPTOM

Interview the customer to obtain as much malfunction information (conditions and environment when the malfunction occurs) as possible when the customer brings the vehicle in.

>> GO TO 2.

2.REPRODUCE THE MALFUNCTION INFORMATION

Check the malfunction on the vehicle that the customer describes.
Inspect the relation of the symptoms and the condition when the symptoms occur.

>> GO TO 3.

3.IDENTIFY THE MALFUNCTIONING SYSTEM WITH "SYMPTOM DIAGNOSIS"

Use "Symptom diagnosis" from the symptom inspection result in step 2 and then identify where to start performing the diagnosis based on possible causes and symptoms.

>> GO TO 4.

4.IDENTIFY THE MALFUNCTIONING PARTS WITH "COMPONENT DIAGNOSIS"

Perform the diagnosis with "Component diagnosis" of the applicable system.

>> GO TO 5.

5.REPAIR OR REPLACE THE MALFUNCTIONING PARTS

Repair or replace the specified malfunctioning parts.

>> GO TO 6.

6.FINAL CHECK

Check that the malfunction is not reproduced, referring to the symptom inspection result in step 2.

Are the malfunctions corrected?

YES >> INSPECTION END
NO >> GO TO 3.

SEAT BELT WARNING SYSTEM

< SYSTEM DESCRIPTION >

SYSTEM DESCRIPTION

SEAT BELT WARNING SYSTEM

System Diagram

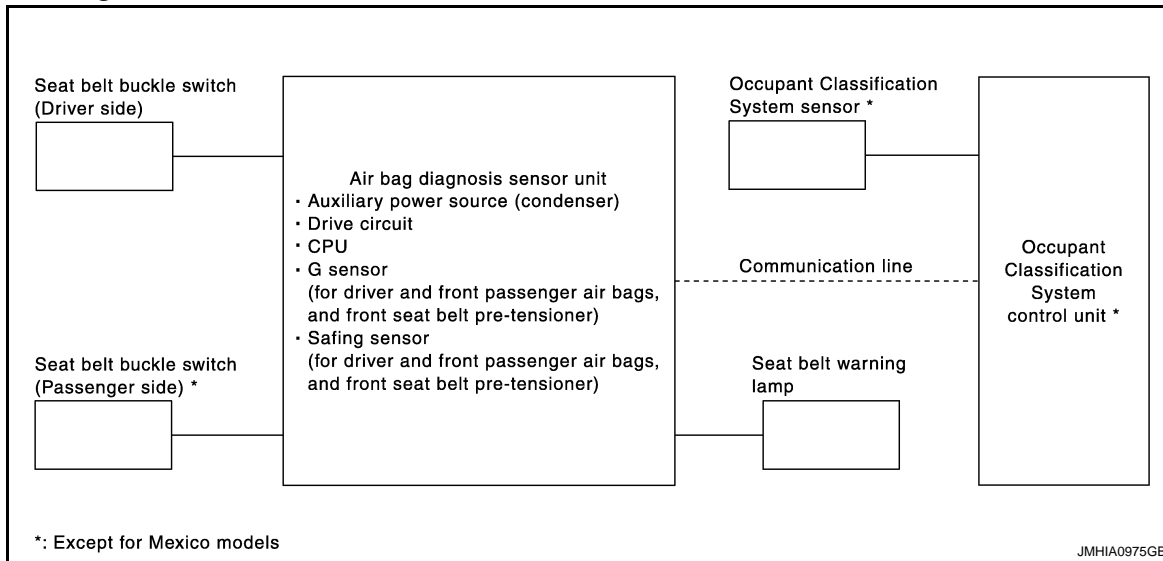

System Description

INFOID:000000004496360

SBC

- Turns ON seat belt warning lamp, when the Occupant Classification System judges adult or child in the front passenger seat and the passenger seat belt buckle switch is OFF.*¹
- Operation of air bag diagnosis sensor unit when air bag diagnosis sensor unit receives information from Occupant Classification System.
- In addition, seat belt warning lamp illuminates, when the driver side seat belt is not fasten. This does not relate to the air bag diagnosis sensor unit.
- For driver seat belt function, refer to [MWI-6. "METER SYSTEM : System Diagram"](#)

Status (front passenger seat)* ¹	Seat belt warning lamp (When front passenger seat is unbuckled)* ¹
Empty	OFF
An object	OFF
Child/ child-seat	ON
Adult	ON
Malfunction	OFF

*¹: Except for Mexico

SEAT BELT WARNING SYSTEM

< SYSTEM DESCRIPTION >

Component Parts Location

INFOID:000000004496361

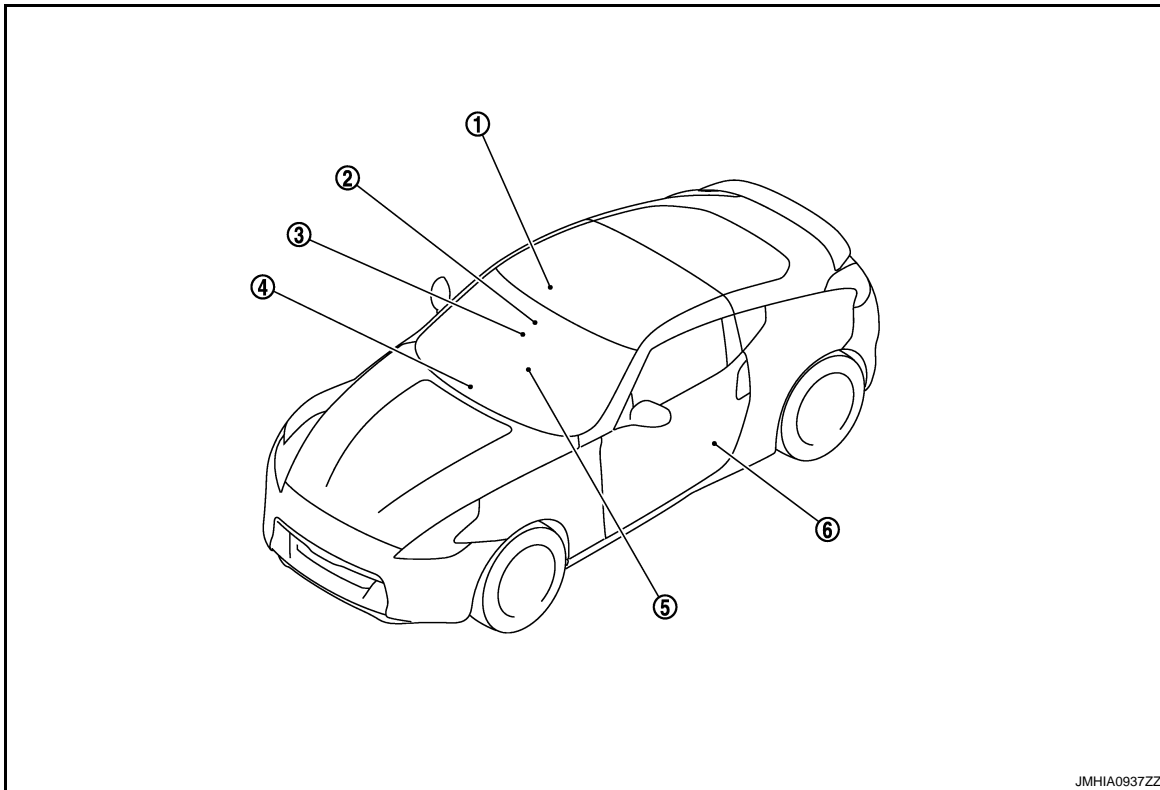

JMHIA0937ZZ

- | | | |
|---|--|--|
| 1. Seat belt buckle switch (passenger side) B213* ¹ | 2. Occupant Classification System control unit B214* ¹
Refer to SRC-10, "Component Parts Location" | 3. Occupant Classification System seat sensor* ¹
Refer to SRC-10, "Component Parts Location" |
| 4. Front passenger air bag OFF indicator M73
Refer to SRC-10, "Component Parts Location" | 5. Air bag diagnosis sensor unit B15, B215, M147* ¹
Refer to SRC-10, "Component Parts Location" | 6. Seat belt buckle switch (driver side) B13 |

*1: Except for Mexico

Component Description

INFOID:000000004496362

Component parts	Outline of function
Seat belt buckle switch (Driver side)	Detects if the seat belt buckle switch (driver side) is fastened or unfastened
Seat belt buckle switch (Passenger side)* ¹	Detects if the seat belt buckle switch (passenger side) is fastened or unfastened
Seat belt warning lamp	Turns the seat belt warning lamp ON when the seat belt is unfastened
Occupant Classification System control unit* ¹	Judges the passenger seat condition based on the information from Occupant Classification System control unit
Occupant Classification System seat sensor* ¹	Detects if the passenger seat is empty or occupied
Air bag diagnosis sensor unit* ¹	Turns ON seat belt warning lamp based on the information from Occupant Classification System control unit
Front passenger air bag OFF indicator	Turns the front passenger air bag OFF indicator lamp ON when the front passenger seat is occupied by a child or a child seat

*1: Except for Mexico

SEAT BELT BUCKLE SWITCH

< DTC/CIRCUIT DIAGNOSIS >

DTC/CIRCUIT DIAGNOSIS

SEAT BELT BUCKLE SWITCH

DRIVER SIDE

DRIVER SIDE : Description

INFOID:000000004496363

- Performs the control of tension reducer according to the seat belt buckle switch ON/OFF.
- Detects whether or not the seat belt is fastened when the ignition switch turns ON. If the seat belt is not fastened, it illuminates the seat belt warning lamp on the combination meter.
- The seat belt buckle switch is installed in the seat belt buckle.

DRIVER SIDE : Component Function Check

INFOID:000000004496364

1.CHECK SEAT BELT BUCKLE SWITCH

 With CONSULT-III

When checking "BUCKLE SW" in DATA MONITOR in METER/M&A, check that ON/OFF display changes synchronized with the insertion operation to the seat belt buckle.

Monitor item	Condition
BUCKLE SW	When driver side seat belt is not fastened: ON
	When driver side seat belt is fastened: OFF

Is the inspection result normal?

- YES >> Seat belt buckle switch (driver side) circuit is normal.
 NO >> Refer to [SBC-5. "DRIVER SIDE : Diagnosis Procedure"](#).

DRIVER SIDE : Diagnosis Procedure

INFOID:000000004496365

1.CHECK SEAT BELT BUCKLE SWITCH (DRIVER SIDE) CIRCUIT

1. Turn ignition switch ON.
2. Check voltage between seat belt buckle switch (driver side) harness connector and ground.

(+)		(-)	Condition	Voltage (V) (Approx.)
Connector	Terminal			
B13	1	Ground	When driver side seat belt is fastened	Battery voltage
			When driver side seat belt is not fastened	0

Is the inspection result normal?

- YES >> GO TO 3.
 NO >> GO TO 2.

2.CHECK SEAT BELT BUCKLE SWITCH (DRIVER SIDE) CIRCUIT

1. Turn ignition switch OFF.
2. Disconnect combination meter and seat belt buckle switch (driver side) connector.
3. Check continuity between combination meter harness connector and seat belt buckle switch (driver side) harness connector.

Combination meter		Seat belt buckle switch (driver side)		Continuity
Connector	Terminal	Connector	Terminal	
M54	35	B13	1	Existed

4. Check continuity between combination meter harness connector and ground.

SEAT BELT BUCKLE SWITCH

< DTC/CIRCUIT DIAGNOSIS >

Combination meter		Ground	Continuity
Connector	Terminal		
M54	35		Not existed

Is the inspection result normal?

YES >> Repair or replace combination meter. Refer to [MWI-94, "Removal and Installation"](#).

NO >> Repair or replace harness.

3.CHECK SEAT BELT BUCKLE SWITCH GROUND CIRCUIT

Check continuity between seat belt buckle switch (driver side) harness connector and ground.

Seat belt buckle switch (driver side)		Ground	Continuity
Connector	Terminal		
B13	2		Existed

Is the inspection result normal?

YES >> GO TO 4.

NO >> Repair or replace harness.

4.CHECK SEAT BELT BUCKLE SWITCH (DRIVER SIDE)

Check seat belt buckle switch (driver side). Refer to [SBC-6, "DRIVER SIDE : Component Inspection \(Belt Buckle Switch\)"](#).

Is the inspection result normal?

YES >> INSPECTION END

NO >> Replace seat belt buckle switch (driver side). Refer to [SB-8, "SEAT BELT BUCKLE : Removal and Installation"](#).

DRIVER SIDE : Component Inspection (Belt Buckle Switch)

INFOID:000000004496366

1.CHECK SEAT BELT BUCKLE SWITCH (DRIVER SIDE)

1. Turn ignition switch OFF
2. Disconnect seat belt buckle switch connector.
3. Check continuity of seat belt buckle (driver side).

Seat belt buckle switch (driver side)		Condition	Continuity
Terminal			
1	2	When driver side seat belt is not fastened	Existed
		When driver side seat belt is fastened	Not existed

Is the inspection result normal?

YES >> INSPECTION END

NO >> Replace seat belt buckle switch (driver side).

PASSENGER SIDE

PASSENGER SIDE : Description

INFOID:000000004496367

- Performs the control of tension reducer according to the seat belt buckle switch ON/OFF.
- Detects whether or not the seat belt is fastened when the ignition switch turns ON. If the seat belt switch is not fastened, it illuminates the seat belt warning lamp on the combination meter.
- The seat belt buckle switch is installed in the seat belt buckle.

PASSENGER SIDE : Component Function Check

INFOID:000000004496368

1.CHECK SEAT BELT WARNING FUNCTION

1. Sit down in passenger seat.
2. Check that seat belt warning lamp turns OFF when passenger seat belt is fastened, and then turns ON when passenger seat belt is unfastened.

SEAT BELT BUCKLE SWITCH

< DTC/CIRCUIT DIAGNOSIS >

Is the inspection result normal?

- YES >> Seat belt buckle switch (passenger side) circuit is normal.
 NO >> Refer to [SBC-7, "PASSENGER SIDE : Diagnosis Procedure"](#).

PASSENGER SIDE : Diagnosis Procedure

INFOID:000000004496369

1.CHECK SEAT BELT BUCKLE SWITCH (PASSENGER SIDE) CIRCUIT

- Turn ignition switch ON.
- Check that voltage between seat belt buckle switch (passenger side) and ground.

(+)		(-)	Condition	Voltage (V) (Approx.)
Connector	Terminal			
B213	1	Ground	When passenger side seat belt is fastened	2.0 or more
			When passenger side seat belt is not fastened	0

Is the inspection result normal?

- YES >> GO TO 3.
 NO >> GO TO 2.

2.CHECK SEAT BELT BUCKLE SWITCH (PASSENGER SIDE) CIRCUIT

- Turn ignition switch OFF.
- Disconnect air bag diagnosis sensor unit connector and seat belt buckle switch (passenger side) connector.
- Check continuity between air bag diagnosis sensor unit harness connector and seat belt buckle switch (passenger side) harness connector.

Air bag diagnosis sensor unit		Seat belt buckle switch (passenger side)		Continuity
Connector	Terminal	Connector	Terminal	
B215	29	B213	1	Existed

- Check continuity between air bag diagnosis sensor unit harness connector and ground.

Air bag diagnosis sensor unit		Ground	Continuity
Connector	Terminal		
B215	29		Not existed

Is the inspection result normal?

- YES >> Replace air bag diagnosis sensor unit. Refer to [SR-25, "Removal and Installation"](#).
 NO >> Repair or replace harness between air bag diagnosis sensor unit and seat belt buckle switch (passenger side).

3.CHECK SEAT BELT BUCKLE SWITCH GROUND CIRCUIT

Check continuity between seat belt buckle switch (passenger side) harness connector and ground.

Seat belt buckle switch (passenger side)		Ground	Continuity
Connector	Terminal		
B213	2		Existed

Is the inspection result normal?

- YES >> GO TO 4.
 NO >> Repair or replace harness.

4.CHECK SEAT BELT BUCKLE SWITCH (PASSENGER SIDE)

Check seat belt buckle switch (passenger side). Refer to [SBC-8, "PASSENGER SIDE : Component Inspection \(Belt Buckle Switch\)"](#).

Is the inspection result normal?

- YES >> INSPECTION END

SEAT BELT BUCKLE SWITCH

< DTC/CIRCUIT DIAGNOSIS >

NO >> Replace seat belt buckle switch (passenger side). Refer to [SB-8. "SEAT BELT BUCKLE : Removal and Installation"](#).

PASSENGER SIDE : Component Inspection (Belt Buckle Switch)

INFOID:000000004496370

1. CHECK SEAT BELT BUCKLE SWITCH (PASSENGER SIDE)

1. Turn ignition switch OFF.
2. Disconnect seat belt buckle switch connector.
3. Check continuity of seat belt buckle (passenger side).

Seat belt buckle switch (passenger side)		Condition	Continuity
Terminal			
1	2	When driver side seat belt is not fastened	Existed
		When driver side seat belt is fastened	Not existed

Is the inspection result normal?

YES >> INSPECTION END

NO >> Replace seat belt buckle switch (passenger side). Refer to [SB-8. "SEAT BELT BUCKLE : Removal and Installation"](#).

SEAT BELT WARNING LAMP CIRCUIT

< DTC/CIRCUIT DIAGNOSIS >

SEAT BELT WARNING LAMP CIRCUIT

Diagnosis Procedure

INFOID:000000004695839

1. CHECK SEAT BELT WARNING LAMP CIRCUIT

1. Turn ignition switch OFF.
2. Disconnect combination meter connector.
3. Turn ignition switch ON.
4. Check that voltage between combination meter harness connector and ground.

combination meter		Ground	Voltage (V) (Approx.)
Connector	Terminal		Battery voltage
M53	36		

Is the inspection result normal?

YES >> GO TO 2.

NO >> Repair or replace combination meter. Refer to [MWI-94, "Removal and Installation"](#).

2. CHECK SEAT BELT WARNING LAMP CIRCUIT

1. Turn ignition switch OFF.
2. Disconnect air bag diagnosis sensor unit connector.
3. Check continuity between combination meter harness connector and air bag diagnosis sensor unit harness connector.

Combination meter		Air bag diagnosis sensor unit		Continuity
Connector	Terminal	Connector	Terminal	
B53	36	M147	24	Existed

4. Check continuity between combination meter and ground.

Combination meter		Ground	Continuity
Connector	Terminal		Not existed
B53	36		

Is the inspection result normal?

YES >> Replace air bag diagnosis sensor unit. Refer to [SR-25, "Removal and Installation"](#).

NO >> Repair or replace harness.

A
B
C
D
E
F
G
I
J
K
L
M
N
O
P

SBC

SEAT BELT WARNING SYSTEM

< DTC/CIRCUIT DIAGNOSIS >

SEAT BELT WARNING SYSTEM

Wiring Diagram - SRS AIR BAG CONTROL SYSTEM -

INFOID:000000004496372

SEAT BELT WARNING SYSTEM

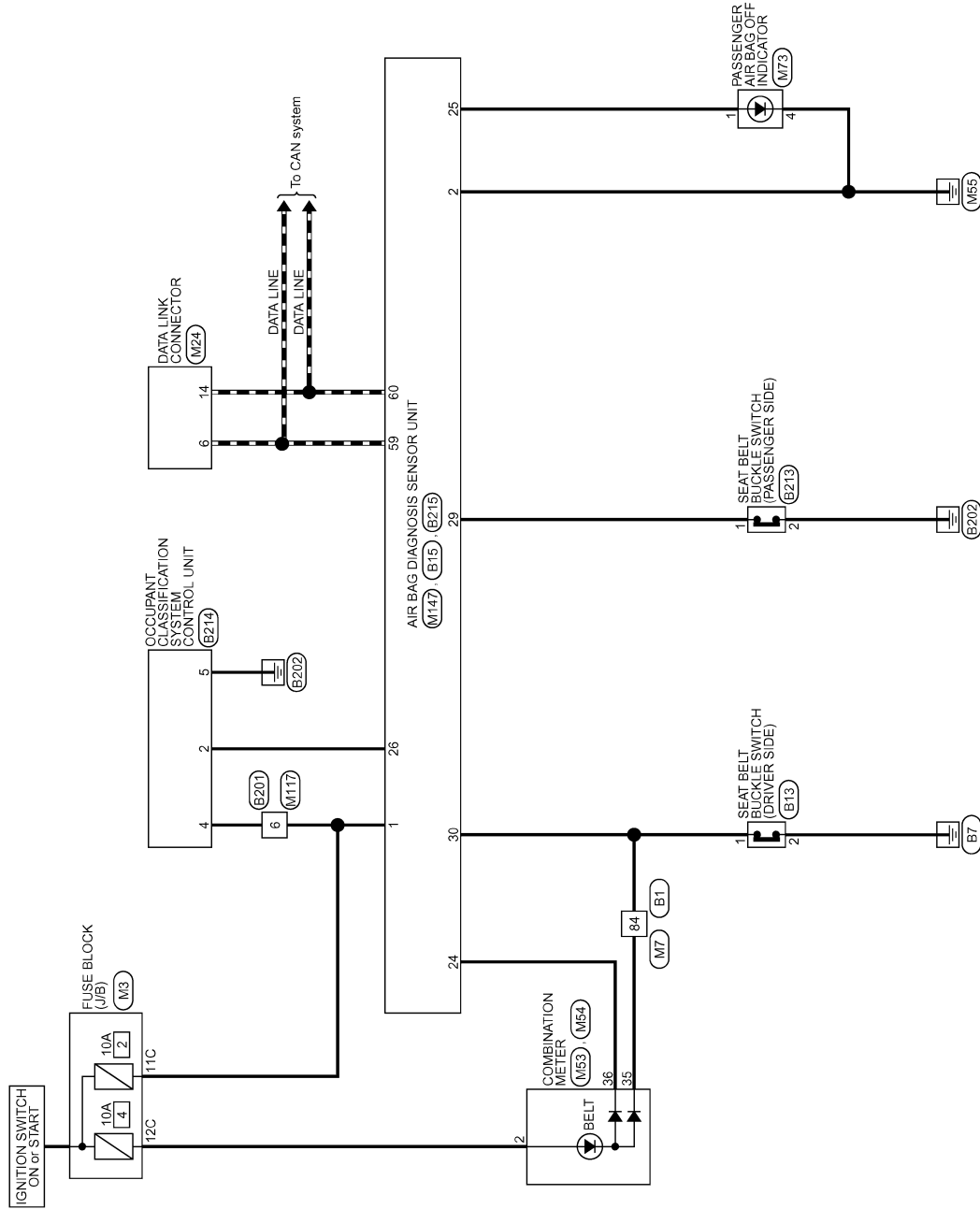

2008/09/12

JCHWA0270GE

SEAT BELT WARNING SYSTEM

< DTC/CIRCUIT DIAGNOSIS >

SEAT BELT WARNING SYSTEM

Connector No.	B1
Connector Name	WIRE TO WIRE
Connector Type	TH80FW-CS16-TM4

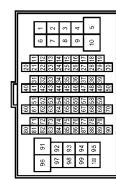

Terminal No.	84	G	Signal Name [Specification]	
--------------	----	---	-----------------------------	--

Connector No.	B13
Connector Name	SEAT BELT BUCKLE SWITCH (DRIVER SIDE)
Connector Type	A03FW

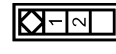

Terminal No.	1	G	Signal Name [Specification]	
2	B			

Connector No.	B15
Connector Name	AIR BAG DIAGNOSIS SENSOR UNIT
Connector Type	NH22FY-2V-EX

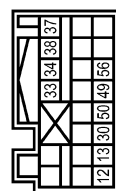

Terminal No.	30	SB	Signal Name [Specification]	LH BUCKLE SW INPUT
--------------	----	----	-----------------------------	--------------------

Connector No.	B201
Connector Name	WIRE TO WIRE
Connector Type	TH80FW-CS16-TM4

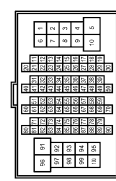

Terminal No.	6	R	Signal Name [Specification]	
--------------	---	---	-----------------------------	--

Connector No.	B213
Connector Name	SEAT BELT BUCKLE SWITCH (PASSENGER SIDE)
Connector Type	A03FW

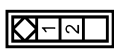

Terminal No.	1	LG	Signal Name [Specification]	
2	B			

Connector No.	B214
Connector Name	OCCUPANT CLASSIFICATION SYSTEM CONTROL UNIT
Connector Type	TH80FW-RH

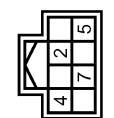

Terminal No.	2	V	Signal Name [Specification]	COMMUNICATION
4	R		IGN	
5	B		GND	

Connector No.	B215
Connector Name	AIR BAG DIAGNOSIS SENSOR UNIT
Connector Type	NH22FY-1V-EX

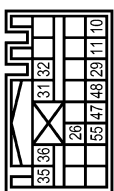

Terminal No.	28	V	Signal Name [Specification]	ODS INPUT
29	LG		RH BUCKLE SW INPUT	

Connector No.	M3
Connector Name	FUSE BLOCK (J/B)
Connector Type	NS12FY-CS

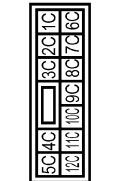

Terminal No.	11C	LG	Signal Name [Specification]	
12C	O			

JCHWA0271GE

A
B
C
D
E
F
G
SBC
I
J
K
L
M
N
O
P

SEAT BELT WARNING SYSTEM

< DTC/CIRCUIT DIAGNOSIS >

SEAT BELT WARNING SYSTEM

Connector No.	M7
Connector Name	WIRE TO WIRE
Connector Type	TH80MW-CS16-TM4

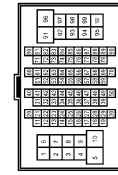

Terminal No.	84	L	
Color of Wire			
Signal Name [Specification]			

Connector No.	M24
Connector Name	DATA LINK CONNECTOR
Connector Type	BD16FW



Terminal No.	6	L	
Color of Wire			
Signal Name [Specification]			

Connector No.	M83
Connector Name	COMBINATION METER
Connector Type	TH24FW-NH

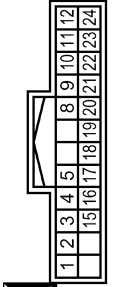

Terminal No.	2	O	
Color of Wire			
Signal Name [Specification]			IGNITION SIGNAL

Connector No.	M84
Connector Name	COMBINATION METER
Connector Type	TH16FW-NH

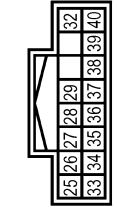

Terminal No.	35	L	
Color of Wire			
Signal Name [Specification]			SEAT BELT BUCKLE SWITCH SIGNAL (DRIVER SIDE)
	36	P	
			PASSENGER SEAT BELT WARNING SIGNAL

Connector No.	M73
Connector Name	PASSENGER AIR BAG OFF INDICATOR
Connector Type	JAS30FB



Terminal No.	1	R	
Color of Wire			
Signal Name [Specification]			

Connector No.	M117
Connector Name	WIRE TO WIRE
Connector Type	TH80MW-CS16-TM4

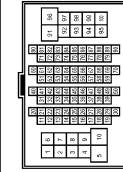

Terminal No.	6	LG	
Color of Wire			
Signal Name [Specification]			

Connector No.	M147
Connector Name	AIR BAG DIAGNOSIS SENSOR UNIT
Connector Type	NH28FY-EX

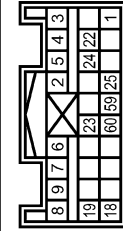

Terminal No.	1	LG	
Color of Wire			
Signal Name [Specification]			IGN
	2	B	
			GND
	24	P	
			SEAT BELT
	25	R	
			CUTOFF TELLTALE
	59	L	
			CAN-H
	60	P	
			CAN-L

DIAGNOSIS SENSOR UNIT

< ECU DIAGNOSIS INFORMATION >

ECU DIAGNOSIS INFORMATION

DIAGNOSIS SENSOR UNIT

DTC Index

INFOID:000000004703567

DTC	Diagnostic item	Explanation		Reference page
—	NO DTC IS DETECTED.	When malfunction is indicated by the "AIR BAG" warning lamp in the user mode	Low battery voltage (Less than 9 V)	SRC-27, "DTC Logic" .
			<ul style="list-style-type: none"> Self-diagnosis result "SELF-DIAG [PAST]" (previously stored in the memory) might not be erased after repair Intermittent malfunction is detected in the past 	SRC-14, "Diagnosis with Air Bag Warning Lamp" , SRC-19, "CONSULT-III Function" .
		No malfunction is detected		—
B1001-B1015	CONTROL UNIT	Air bag diagnosis sensor unit is malfunctioning		<ul style="list-style-type: none"> SRC-21, "DTC Logic". SRC-23, "DTC Logic". SRC-25, "DTC Logic".
B1017 B1020 B1021	OCCUPANT SENS C/U [UNIT FAIL]	Malfunction occurs in Occupant Classification System control unit		SRC-27, "DTC Logic" .
B1018	OCCUPANT SENS [UNIT FAIL]	Malfunction occurs in Occupant Classification System sensor		SRC-29, "DTC Logic" .
B1022	OCCUPANT SENS C/U [COMM FAIL]	Malfunction occurs in Occupant Classification System control unit, circuit of Occupant Classification System control unit air bag diagnosis sensor unit, or air bag diagnosis sensor unit		SRC-31, "DTC Logic" .
B1023	PASS A/B INDCTR CKT	Passenger air bag OFF indicator circuit is open or shorted to ground or the circuits are shorted each other		SRC-33, "DTC Logic" .
B1025 B1032 B1048	OCS SENSOR	Malfunction occurs in Occupant Classification System control unit, circuit of Occupant Classification System control unit air bag diagnosis sensor unit, or air bag diagnosis sensor unit		SRC-35, "DTC Logic" .
B1026-B1031	CONTROL UNIT	Air bag diagnosis sensor unit is malfunctioning or out of the specified specification		SRC-37, "DTC Logic" .
B1033 B1034	CRASH ZONE SEN [UNIT FAIL]	Crash zone sensor is malfunctioning		SRC-39, "DTC Logic" .
B1035	CRASH ZONE SEN [COMM FAIL]	Crash zone sensor is malfunctioning or out of the specified specification		SRC-41, "DTC Logic" .
B1036	CRASH ZONE SEN [UNMATCH]			
B1037 B1039 B1041	CRASH ZONE SEN1	Crash zone sensor is malfunctioning		SRC-43, "DTC Logic" .
B1042-B1047	CONTROL UNIT	Air bag diagnosis sensor unit is malfunctioning		SRC-45, "DTC Logic" .
B1049 B1054	DRIVER AIRBAG MODULE [OPEN]	Driver air bag module circuit is open (including the spiral cable)		SRC-47, "DTC Logic" .
B1050 B1055	DRIVER AIRBAG MODULE [VB-SHORT]	Driver air bag module circuit is shorted to power supply circuit (including the spiral cable)		SRC-49, "DTC Logic" .
B1051 B1056	DRIVER AIRBAG MODULE [GND-SHORT]	Driver air bag module circuit is shorted to ground (including the spiral cable)		SRC-51, "DTC Logic" .
B1052 B1057	DRIVER AIRBAG MODULE [SHORT]	Driver air bag module circuits are shorted to each other (including spiral cable)		SRC-53, "DTC Logic" .

A

B

C

D

E

F

G

SBC

I

J

K

L

M

N

O

P

DIAGNOSIS SENSOR UNIT

< ECU DIAGNOSIS INFORMATION >

DTC	Diagnostic item	Explanation	Reference page
B1058-B1063	CONTROL UNIT	Air bag diagnosis sensor unit is malfunctioning	SRC-55, "DTC Logic" .
B1065 B1070	ASSIST A/B MODULE [OPEN]	Passenger air bag module circuit is open	SRC-57, "DTC Logic" .
B1066 B1071	ASSIST A/B MODULE [VB-SHORT]	Passenger air bag module circuit is shorted to power supply circuit	SRC-59, "DTC Logic" .
B1067 B1072	ASSIST A/B MODULE [GND-SHORT]	Passenger air bag module circuit is shorted to ground	SRC-61, "DTC Logic" .
B1068 B1073	ASSIST A/B MODULE [SHORT]	Passenger air bag module circuits are shorted to each other	SRC-63, "DTC Logic" .
B1074-B1079	CONTROL UNIT	Air bag diagnosis sensor unit is malfunctioning	SRC-65, "DTC Logic" .
B1080 B1096	DRIVER AIRBAG MODULE [SHORT]	Driver air bag module circuits are shorted to each other (including spiral cable)	SRC-67, "DTC Logic" .
B1081	PRE-TEN FRONT RH [OPEN]	Seat belt pre-tensioner RH circuit is open	SRC-69, "DTC Logic" .
B1082	PRE-TEN FRONT RH [VB-SHORT]	Seat belt pre-tensioner RH circuit is shorted to power supply circuit	SRC-71, "DTC Logic" .
B1083	PRE-TEN FRONT RH [GND-SHORT]	Seat belt pre-tensioner RH circuit is shorted to ground	SRC-73, "DTC Logic" .
B1084	PRE-TEN FRONT RH [SHORT]	Seat belt pre-tensioner RH circuits are shorted to each other	SRC-75, "DTC Logic" .
B1086	PRE-TEN FRONT LH [OPEN]	Seat belt pre-tensioner LH circuit is open	SRC-77, "DTC Logic" .
B1087	PRE-TEN FRONT LH [VB-SHORT]	Seat belt pre-tensioner LH circuit is shorted to power supply circuit	SRC-79, "DTC Logic" .
B1088	PRE-TEN FRONT LH [GND-SHORT]	Seat belt pre-tensioner LH circuit is shorted to ground	SRC-81, "DTC Logic" .
B1089	PRE-TEN FRONT LH [SHORT]	Seat belt pre-tensioner LH circuits are shorted to each other	SRC-83, "DTC Logic" .
B1090-B1095	CONTROL UNIT	Air bag diagnosis sensor unit is malfunctioning	SRC-85, "DTC Logic" .
B1106-B1111	CONTROL UNIT	Air bag diagnosis sensor unit is malfunctioning	SRC-87, "DTC Logic" .
B1113 B1114	SATELLITE SENS RH [UNIT FAIL]	Satellite sensor RH is malfunctioning	SRC-89, "DTC Logic" .
B1115	SATELLITE SENS RH [COMM FAIL]	Satellite sensor RH is malfunctioning or mis-installed	SRC-91, "DTC Logic" .
B1116	SATELLITE SENS RH [UNMATCH]		
B1118 B1119	SATELLITE SENS LH [UNIT FAIL]	Satellite sensor LH is malfunctioning	SRC-93, "DTC Logic" .
B1120	SATELLITE SENS LH [COMM FAIL]	Satellite sensor LH is malfunctioning or mis-installed	SRC-95, "DTC Logic" .
B1121	SATELLITE SENS LH [UNMATCH]		
B1122-B1127	CONTROL UNIT	Air bag diagnosis sensor unit is malfunctioning	SRC-97, "DTC Logic" .
B1129	SIDE MODULE RH [OPEN]	Side air bag module RH circuit is open	SRC-99, "DTC Logic" .
B1130	SIDE MODULE RH [VB-SHORT]	Side air bag module RH circuit is shorted to power supply circuit	SRC-101, "DTC Logic" .

DIAGNOSIS SENSOR UNIT

< ECU DIAGNOSIS INFORMATION >

DTC	Diagnostic item	Explanation	Reference page
B1131	SIDE MODULE RH [GND-SHORT]	Side air bag module RH circuit is shorted to ground	SRC-103, "DTC Logic"
B1132	SIDE MODULE RH [SHORT]	Seat belt pre-tensioner RH circuits are shorted to each other	SRC-105, "DTC Logic"
B1134	SIDE MODULE LH [OPEN]	Side air bag module LH circuit is open	SRC-107, "DTC Logic"
B1135	SIDE MODULE LH [VB-SHORT]	Side air bag module LH circuit is shorted to power supply circuit	SRC-109, "DTC Logic"
B1136	SIDE MODULE LH [GND-SHORT]	Side air bag module LH circuit is shorted to ground	SRC-111, "DTC Logic"
B1137	SIDE MODULE LH [SHORT]	Side air bag module LH circuits are shorted to each other	SRC-113, "DTC Logic"
B1138-B1143	CONTROL UNIT	Air bag diagnosis sensor unit is malfunctioning	SRC-115, "DTC Logic"
B1144	CONTROL UNIT	Air bag diagnosis sensor unit is malfunctioning or out of the specified specification	SRC-117, "DTC Logic"
B1145	CURTAIN MODULE RH [OPEN]	Curtain air bag module RH circuit is open	SRC-118, "DTC Logic"
B1146	CURTAIN MODULE RH [VB-SHORT]	Curtain air bag module RH circuit is shorted to power supply circuit	SRC-120, "DTC Logic"
B1147	CURTAIN MODULE RH [GND-SHORT]	Curtain air bag module RH circuit is shorted to ground	SRC-122, "DTC Logic"
B1148	CURTAIN MODULE RH [SHORT]	Curtain air bag module RH circuits are shorted to each other	SRC-124, "DTC Logic"
B1150	CURTAIN MODULE LH [OPEN]	Curtain air bag module LH circuit is open	SRC-126, "DTC Logic"
B1151	CURTAIN MODULE LH [VB-SHORT]	Curtain air bag module LH circuit is shorted to power supply circuits	SRC-128, "DTC Logic"
B1152	CURTAIN MODULE LH [GND-SHORT]	Curtain air bag module LH circuit is shorted to ground	SRC-130, "DTC Logic"
B1153	CURTAIN MODULE LH [SHORT]	Curtain air bag module LH circuits are shorted to each other	SRC-132, "DTC Logic"
B1154-B1159	CONTROL UNIT	Air bag diagnosis sensor unit is malfunctioning	SRC-134, "DTC Logic"
B1170-B1175	CONTROL UNIT	Air bag diagnosis sensor unit is malfunctioning	SRC-136, "DTC Logic"
B1186-B1191	CONTROL UNIT	Air bag diagnosis sensor unit is malfunctioning	SRC-138, "DTC Logic"
B1202-B1207	CONTROL UNIT	Air bag diagnosis sensor unit is malfunctioning	SRC-140, "DTC Logic"
B1209	FRONTAL COLLISION DETECTION	Seat belt pre-tensioner, driver side air bag and passenger air bag are deployed	SRC-142, "DTC Logic"
B1210	SIDE COLLISION DETECTION	Side air bag and curtain air bag are deployed	SRC-143, "DTC Logic"
B1211	ROLLOVER DETECTION	Seat belt pre-tensioner side curtain air bag module are deployed because of rollover detection	SRC-144, "DTC Logic"
B1212-B1214	RH1 SAT-SENS	Satellite sensor RH is malfunctioning	SRC-145, "DTC Logic"
B1215-B1217	LH1 SAT-SENS	Satellite sensor LH is malfunctioning	SRC-147, "DTC Logic"
B1218-B1223	CONTROL UNIT	Air bag diagnosis sensor unit is malfunctioning	SRC-149, "DTC Logic"

A

B

C

D

E

F

G

SBC

I

J

K

L

M

N

O

P

DIAGNOSIS SENSOR UNIT

< ECU DIAGNOSIS INFORMATION >

Wiring Diagram - SRS AIR BAG CONTROL SYSTEM -

INFOID:000000004703568

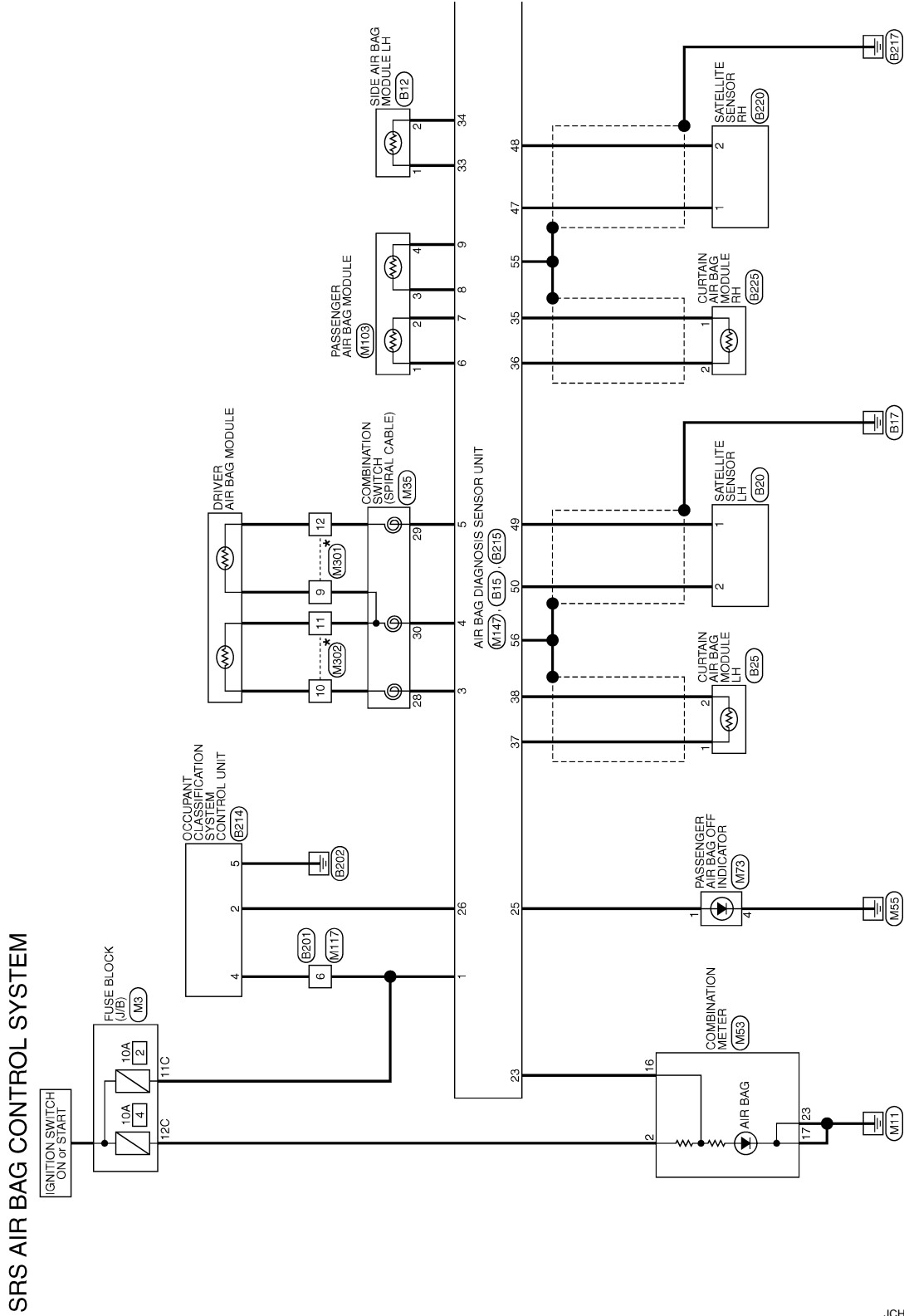

*: This connector is not shown in "Harness Layout".

2008/09/12

JCHWA0273GE

DIAGNOSIS SENSOR UNIT

< ECU DIAGNOSIS INFORMATION >

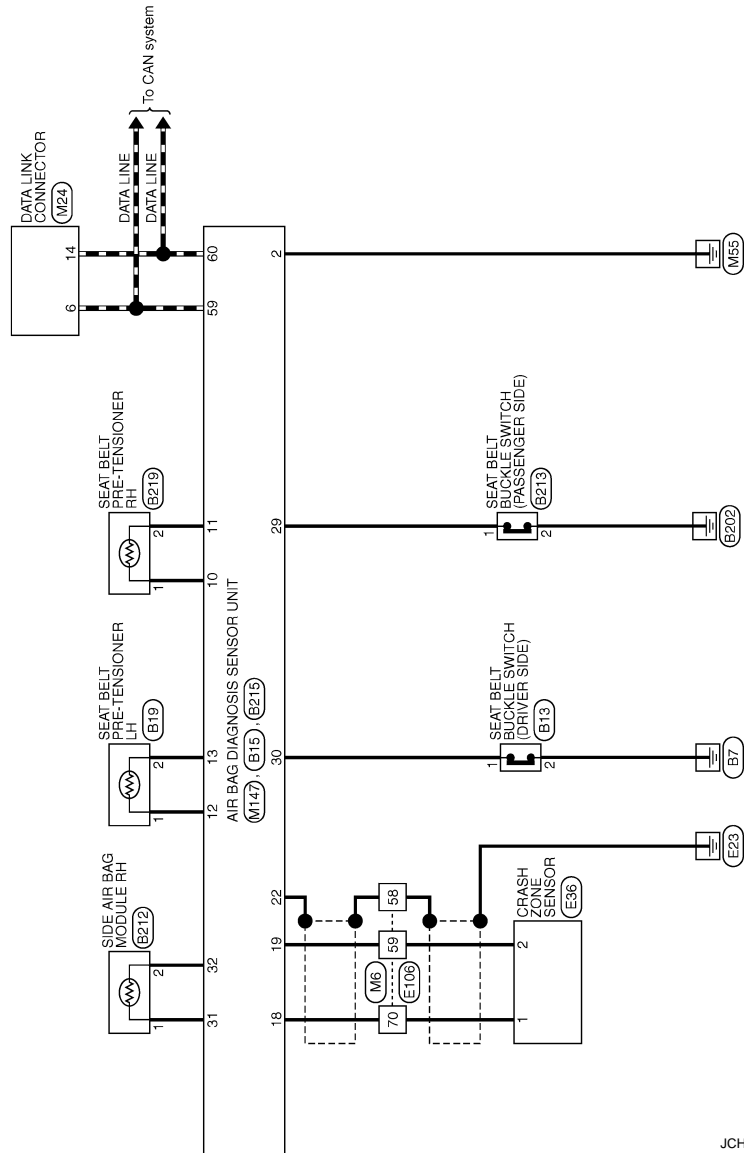

JCHWA0274GE

A
B
C
D
E
F
G
H
I
J
K
L
M
N
O
P

SBC

DIAGNOSIS SENSOR UNIT

< ECU DIAGNOSIS INFORMATION >

SRS AIR BAG CONTROL SYSTEM

Connector No.	B12
Connector Name	SIDE AIR BAG MODULE LH
Connector Type	TK02FY-EX-1V



Terminal No.	Color of Wire	Signal Name [Specification]
1	Y	-
2	Y	-

Connector No.	B13
Connector Name	SEAT BELT BUCKLE SWITCH (DRIVER SIDE)
Connector Type	A03FW

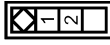

Terminal No.	Color of Wire	Signal Name [Specification]
1	G	-
2	B	-

Connector No.	B15
Connector Name	AIR BAG DIAGNOSIS SENSOR UNIT
Connector Type	NH2ZFV-2V-EX

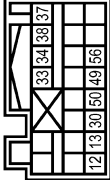

Terminal No.	Color of Wire	Signal Name [Specification]
12	Y	PRH(+)
13	Y	PRH(-)
30	SB	LH BUCKLE SW INPUT
33	Y	SRH(+)
34	Y	SRH(-)
37	G	OLH(+)
38	R	OLH(-)
49	P	SATELLITE LH(+)
50	L	SATELLITE LH(-)
56	SHIELD	GND

Connector No.	B19
Connector Name	SEAT BELT PRE-TENSIONER LH
Connector Type	ACA02FY-2V



Terminal No.	Color of Wire	Signal Name [Specification]
1	Y	-
2	Y	-

Connector No.	B20
Connector Name	SATELLITE SENSOR LH
Connector Type	TK02FY-1V-EX-LC



Terminal No.	Color of Wire	Signal Name [Specification]
1	P	-
2	L	-

Connector No.	B25
Connector Name	CURTAIN AIR BAG MODULE LH
Connector Type	ACA02FY-2V



Terminal No.	Color of Wire	Signal Name [Specification]
1	G	-
2	R	-

Connector No.	B201
Connector Name	WIRE TO WIRE
Connector Type	TH02PW-CS16-TM4

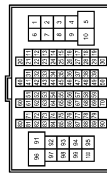

Terminal No.	Color of Wire	Signal Name [Specification]
6	R	-

Connector No.	B212
Connector Name	SIDE AIR BAG MODULE RH
Connector Type	TK02FY-EX-1V



Terminal No.	Color of Wire	Signal Name [Specification]
1	Y	-
2	Y	-

JCHWA0275GE

DIAGNOSIS SENSOR UNIT

< ECU DIAGNOSIS INFORMATION >

SRS AIR BAG CONTROL SYSTEM

Connector No.	B213
Connector Name	SEAT BELT BUCKLE SWITCH (PASSENGER SIDE)
Connector Type	AC3FW

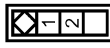

Terminal No.	Color of Wire	Signal Name [Specification]
1	LG	-
2	B	-

Connector No.	B214
Connector Name	OCCUPANT CLASSIFICATION SYSTEM CONTROL UNIT
Connector Type	TH88FW-RH

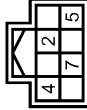

Terminal No.	Color of Wire	Signal Name [Specification]
2	V	COMMUNICATION
4	R	IGN
5	B	GND

Connector No.	B215
Connector Name	AIR BAG DIAGNOSIS SENSOR UNIT
Connector Type	HN22FY-IV-EX

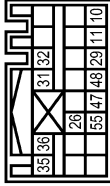

Terminal No.	Color of Wire	Signal Name [Specification]
10	Y	PRK(+)
11	Y	PRK(-)
26	V	ODS INPUT
29	LG	RH BUCKLE SW INPUT
31	Y	SRM(+)
32	Y	SRM(-)
35	P	ORH(+)
36	L	ORH(-)
47	G	SATELLITE RH(+)
48	R	SATELLITE RH(-)
55	SHIELD	GND

Connector No.	B219
Connector Name	SEAT BELT PRE-TENSIONER RH
Connector Type	ACA02FY-2V



Terminal No.	Color of Wire	Signal Name [Specification]
1	Y	-
2	Y	-

Connector No.	B220
Connector Name	SATELLITE SENSOR RH
Connector Type	HK02FY-IV-EX-LC



Terminal No.	Color of Wire	Signal Name [Specification]
1	G	-
2	R	-

Connector No.	B225
Connector Name	CURTAIN AIR BAG MODULE RH
Connector Type	ACA02FY-2V



Terminal No.	Color of Wire	Signal Name [Specification]
1	P	-
2	L	-

Connector No.	E36
Connector Name	CRASH ZONE SENSOR
Connector Type	HK02FY-IV-EX-LC



Terminal No.	Color of Wire	Signal Name [Specification]
1	P	-
2	L	-

Connector No.	E106
Connector Name	WIRE TO WIRE
Connector Type	TH88FW-CSI6-7M4



Terminal No.	Color of Wire	Signal Name [Specification]
58	SHIELD	-
59	L	-
70	P	-

A
B
C
D
E
F
G
SBC
I
J
K
L
M
N
O
P

DIAGNOSIS SENSOR UNIT

< ECU DIAGNOSIS INFORMATION >

SRS AIR BAG CONTROL SYSTEM

Connector No.	M3
Connector Name	FUSE BLOCK (J/B)
Connector Type	NS12FW-CS

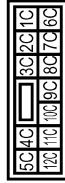

Terminal No.	Color of Wire	Signal Name [Specification]
11C	LG	-
12C	O	-

Connector No.	M6
Connector Name	WIRE TO WIRE
Connector Type	TH80MW-CS16-TM4



Terminal No.	Color of Wire	Signal Name [Specification]
58	SHIELD	-
59	L	-
70	R	-

Connector No.	M24
Connector Name	DATA LINK CONNECTOR
Connector Type	BD16FW

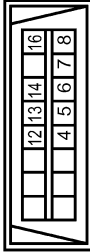

Terminal No.	Color of Wire	Signal Name [Specification]
6	L	-
14	P	-

Connector No.	M35
Connector Name	COMBINATION SWITCH (SPIRAL CABLE)
Connector Type	TK08FY-EX-TV



Terminal No.	Color of Wire	Signal Name [Specification]
28	Y	-
29	Y	-
30	Y	-

Connector No.	M53
Connector Name	COMBINATION METER
Connector Type	TH14FW-IN1



Terminal No.	Color of Wire	Signal Name [Specification]
2	O	IGNITION SIGNAL
16	R	AIR BAG SIGNAL
17	B	GROUND
23	B	GROUND

Connector No.	M73
Connector Name	PASSENGER AIR BAG OFF INDICATOR
Connector Type	JAB03FB



Terminal No.	Color of Wire	Signal Name [Specification]
1	R	-
4	B	-

Connector No.	M103
Connector Name	PASSENGER AIR BAG MODULE
Connector Type	RC04FY-BD

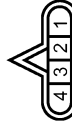

Terminal No.	Color of Wire	Signal Name [Specification]
1	Y	-
2	Y	-
3	Y	-
4	Y	-

Connector No.	M117
Connector Name	WIRE TO WIRE
Connector Type	TH80MW-CS16-TM4



Terminal No.	Color of Wire	Signal Name [Specification]
6	LG	-

JCHWA0277GE

DIAGNOSIS SENSOR UNIT

< ECU DIAGNOSIS INFORMATION >

SRS AIR BAG CONTROL SYSTEM

Connector No.	M147
Connector Name	AIR BAG DIAGNOSIS SENSOR UNIT
Connector Type	RHEB7Y-EX

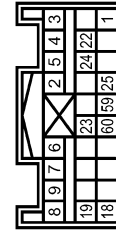

Terminal No.	Color of Wire	Signal Name [Specification]
1	LG	IGN
2	B	GND
3	Y	DR1 (+)
4	Y	DR1 (-) DR2 (-)
5	Y	DR2 (+)
6	Y	AS1 (+)
7	Y	AS1 (-)
8	Y	AS2 (+)
9	Y	AS2 (-)
18	R	EGZS (+)
18	L	EGZS (-)

22	SHIELD	GND
23	R	AIRBAG W/L
25	R	CUTOFF TELLTALE
58	L	CAN-H
80	P	CAN-L

Connector No.	M801
Connector Name	DRIVER AIR BAG MODULE
Connector Type	ACAGEFOR



Terminal No.	Color of Wire	Signal Name [Specification]
9	-	-
12	-	-

Connector No.	M302
Connector Name	DRIVER AIR BAG MODULE
Connector Type	ACAR2FY-2V



Terminal No.	Color of Wire	Signal Name [Specification]
10	-	-
11	-	-

A
B
C
D
E
F
G
SBC
I
J
K
L
M
N
O
P

SEAT BELT WARNING LAMP DOES NOT TURN OFF

< SYMPTOM DIAGNOSIS >

SYMPTOM DIAGNOSIS

SEAT BELT WARNING LAMP DOES NOT TURN OFF

Diagnosis Procedure

INFOID:000000004496375

1. CHECK SEAT BELT BUCKLE SWITCH CIRCUIT (DRIVER SIDE)

Check seat belt buckle switch circuit (driver side). Refer to [SBC-5. "DRIVER SIDE : Component Function Check"](#)

Is the inspection result normal?

- YES >> GO TO 2.
- NO >> Repair or replace the malfunctioning parts.

2. CHECK SEAT BELT BUCKLE SWITCH CIRCUIT (PASSENGER SIDE)

Check seat belt buckle switch circuit (passenger side). Refer to [SBC-6. "PASSENGER SIDE : Component Function Check"](#)

NOTE:

Except for Mexico

Is the inspection result normal?

- YES >> GO TO 3.
- NO >> Repair or replace the malfunctioning parts.

3. CHECK SEAT BELT WARNING LAMP CIRCUIT

Check seat belt warning lamp circuit. Refer to [SBC-9. "Diagnosis Procedure"](#)

Is the inspection result normal?

- YES >> GO TO 4.
- NO >> Repair or replace the malfunctioning parts.

4. CONFIRM THE OPERATION

Confirm the operation again.

Is the inspection result normal?

- YES >> Check intermittent incident. Refer to [GI-39. "Intermittent Incident"](#).
- NO >> GO TO 1.

SEAT BELT WARNING LAMP DOES NOT TURN ON

< SYMPTOM DIAGNOSIS >

SEAT BELT WARNING LAMP DOES NOT TURN ON

Diagnosis Procedure

INFOID:000000004496376

1.CHECK SELF DIAGNOSIS RESULT

Perform "COMBINATION METER" self diagnostic result. Refer to [MWI-33, "CONSULT-III Function \(METER/M&A\)"](#)

Is DTC detected?

- YES >> Repair or replace the malfunctioning parts.
- NO >> GO TO 2.

2.CHECK POWER SUPPLY

Check that fuses are not blown.

Check ignition power supply of combination meter. Refer to [MWI-44, "COMBINATION METER : Diagnosis Procedure"](#)

Is the inspection result normal?

- YES >> GO TO 3.
- NO >> Repair or replace the malfunctioning parts.

3.CHECK SEAT BELT BUCKLE SWITCH CIRCUIT (DRIVER SIDE)

Check seat belt buckle switch circuit (driver side). Refer to [SBC-5, "DRIVER SIDE : Component Function Check"](#)

Is the inspection result normal?

- YES >> GO TO 4.
- NO >> Repair or replace the malfunctioning parts.

4..CHECK SEAT BELT BUCKLE SWITCH CIRCUIT (PASSENGER SIDE)

Check seat belt buckle switch circuit (passenger side). Refer to [SBC-6, "PASSENGER SIDE : Component Function Check"](#)

NOTE:

Except for Mexico

Is the inspection result normal?

- YES >> GO TO 5.
- NO >> Repair or replace the malfunctioning parts.

5..CHECK SEAT BELT WARNING LAMP CIRCUIT

Check seat belt warning lamp circuit. Refer to [SBC-9, "Diagnosis Procedure"](#)

Is the inspection result normal?

- YES >> GO TO 6.
- NO >> Repair or replace the malfunctioning parts.

6.CONFIRM THE OPERATION

Confirm the operation again.

Is the inspection result normal?

- YES >> Check intermittent incident. Refer to [GI-39, "Intermittent Incident"](#).
- NO >> GO TO 1.

A
B
C
D
E
F
G
I
J
K
L
M
N
O
P

SBC

PRECAUTIONS

< PRECAUTION >

PRECAUTION

PRECAUTIONS

Precaution for Supplemental Restraint System (SRS) "AIR BAG" and "SEAT BELT PRE-TENSIONER"

INFOID:000000004496377

The Supplemental Restraint System such as "AIR BAG" and "SEAT BELT PRE-TENSIONER", used along with a front seat belt, helps to reduce the risk or severity of injury to the driver and front passenger for certain types of collision. This system includes seat belt switch inputs and dual stage front air bag modules. The SRS system uses the seat belt switches to determine the front air bag deployment, and may only deploy one front air bag, depending on the severity of a collision and whether the front occupants are belted or unbelted. Information necessary to service the system safely is included in the "SRS AIR BAG" and "SEAT BELT" of this Service Manual.

WARNING:

- To avoid rendering the SRS inoperative, which could increase the risk of personal injury or death in the event of a collision which would result in air bag inflation, all maintenance must be performed by an authorized NISSAN/INFINITI dealer.
- Improper maintenance, including incorrect removal and installation of the SRS, can lead to personal injury caused by unintentional activation of the system. For removal of Spiral Cable and Air Bag Module, see the "SRS AIR BAG".
- Do not use electrical test equipment on any circuit related to the SRS unless instructed to in this Service Manual. SRS wiring harnesses can be identified by yellow and/or orange harnesses or harness connectors.

PRECAUTIONS WHEN USING POWER TOOLS (AIR OR ELECTRIC) AND HAMMERS

WARNING:

- When working near the Air Bag Diagnosis Sensor Unit or other Air Bag System sensors with the ignition ON or engine running, DO NOT use air or electric power tools or strike near the sensor(s) with a hammer. Heavy vibration could activate the sensor(s) and deploy the air bag(s), possibly causing serious injury.
- When using air or electric power tools or hammers, always switch the ignition OFF, disconnect the battery, and wait at least 3 minutes before performing any service.

Precaution for Seat Belt Service

INFOID:000000004496378

CAUTION:

- Before removing the seat belt pre-tensioner assembly, turn the ignition switch off, disconnect the both battery cables and wait at least 3 minutes.
- Do not use electrical test equipment for seat belt pre-tensioner connector.
- After replacing or reinstalling seat belt pre-tensioner assembly, or reconnecting front seat belt pre-tensioner connector, check the system function. Refer to [SRC-14, "Diagnosis Description"](#).
- Do not use disassemble buckle or seat belt assembly.
- Replace anchor bolts if they are deformed or worn out.
- Never oil tongue and buckle.
- If any component of seat belt assembly is questionable, do not repair. Replace the whole seat belt assembly.
- If webbing is cut, frayed, or damaged, replace seat belt assembly.
- When replacing seat belt assembly, use a genuine NISSAN seat belt assembly.

AFTER A COLLISION

WARNING:

Inspect all seat belt assemblies including retractors and attaching hardware after any collision. NISSAN recommends that all seat belt assemblies in use during a collision be replaced unless the collision was minor and the belts show no damage and continue to operate properly. Failure to do so could result in serious personal injury in an accident. Seat belt assemblies not in use during a collision should also be replaced if either damage or improper operation is noted. Seat belt pre-tensioner should be replaced even if the seat belts are not in use during a frontal collision in which the air bags are deployed.

Replace any seat belt assembly (including anchor bolts) if:

PRECAUTIONS

< PRECAUTION >

- The seat belt was in use at the time of a collision (except for minor collisions and the belts, retractors and buckles show no damage and continue to operate properly).
- The seat belt was damaged in an accident. (i.e. torn webbing, bent retractor or guide).
- The seat belt attaching point was damaged in an accident. Inspect the seat belt attaching area for damage or distortion and repair as necessary before installing a new seat belt assembly.
- Anchor bolts are deformed or worn out.
- The seat belt pre-tensioner should be replaced even if the seat belts are not in use during the collision in which the air bags are deployed.

Precaution for Battery Service

INFOID:000000004496379

Before disconnecting the battery, lower both the driver and passenger windows. This will prevent any interference between the window edge and the vehicle when the door is opened/closed. During normal operation, the window slightly raises and lowers automatically to prevent any window to vehicle interference. The automatic window function will not work with the battery disconnected.

A
B
C
D
E
F
G
I
J
K
L
M
N
O
P

SBC