

SECTION **SBC**

SEAT BELT CONTROL SYSTEM

A
B
C
D
E
F
G
SBC
I
J
K
L
M
N
O
P

CONTENTS

<p>BASIC INSPECTION 2</p> <p>DIAGNOSIS AND REPAIR WORK FLOW 2</p> <p style="padding-left: 20px;">Work Flow2</p> <p>SYSTEM DESCRIPTION 3</p> <p>SEAT BELT WARNING SYSTEM 3</p> <p style="padding-left: 20px;">System Diagram3</p> <p style="padding-left: 20px;">System Description3</p> <p style="padding-left: 20px;">Component Parts Location4</p> <p style="padding-left: 20px;">Component Description4</p> <p>DTC/CIRCUIT DIAGNOSIS 5</p> <p>SEAT BELT BUCKLE SWITCH 5</p> <p>DRIVER SIDE5</p> <p style="padding-left: 20px;">DRIVER SIDE : Description5</p> <p style="padding-left: 20px;">DRIVER SIDE : Component Function Check5</p> <p style="padding-left: 20px;">DRIVER SIDE : Diagnosis Procedure5</p> <p style="padding-left: 20px;">DRIVER SIDE : Component Inspection (Belt Buckle Switch)6</p> <p>PASSENGER SIDE6</p> <p style="padding-left: 20px;">PASSENGER SIDE : Description6</p> <p style="padding-left: 20px;">PASSENGER SIDE : Component Function Check7</p> <p style="padding-left: 20px;">PASSENGER SIDE : Diagnosis Procedure7</p> <p style="padding-left: 20px;">PASSENGER SIDE : Component Inspection (Belt Buckle Switch)8</p> <p>SEAT BELT WARNING LAMP CIRCUIT 9</p> <p style="padding-left: 20px;">Diagnosis Procedure9</p> <p>SEAT BELT WARNING SYSTEM10</p> <p style="padding-left: 20px;">Wiring Diagram - SEAT BELT WARNING SYSTEM - 10</p>	<p>ECU DIAGNOSIS INFORMATION16</p> <p>DIAGNOSIS SENSOR UNIT16</p> <p style="padding-left: 20px;">List of ECU Reference16</p> <p>SYMPTOM DIAGNOSIS17</p> <p>SEAT BELT WARNING LAMP DOES NOT TURN OFF17</p> <p style="padding-left: 20px;">Diagnosis Procedure17</p> <p>SEAT BELT WARNING LAMP DOES NOT TURN ON18</p> <p style="padding-left: 20px;">Diagnosis Procedure18</p> <p>PRECAUTION19</p> <p>PRECAUTIONS19</p> <p>EXCEPT FOR MEXICO19</p> <p style="padding-left: 20px;">EXCEPT FOR MEXICO : Precautions for Supplemental Restraint System (SRS) "AIR BAG" and "SEAT BELT PRE-TENSIONER"19</p> <p style="padding-left: 20px;">EXCEPT FOR MEXICO : Precaution for Battery Service19</p> <p style="padding-left: 20px;">EXCEPT FOR MEXICO : Precautions For Xenon Headlamp Service19</p> <p style="padding-left: 20px;">EXCEPT FOR MEXICO : Precautions for Removing Battery Terminal20</p> <p>FOR MEXICO20</p> <p style="padding-left: 20px;">FOR MEXICO : Precaution for Supplemental Restraint System (SRS) "AIR BAG" and "SEAT BELT PRE-TENSIONER"20</p> <p style="padding-left: 20px;">FOR MEXICO : Precaution for Battery Service20</p> <p style="padding-left: 20px;">FOR MEXICO : Precautions For Xenon Headlamp Service21</p> <p style="padding-left: 20px;">FOR MEXICO : Precautions for Removing Battery Terminal21</p>
---	--

DIAGNOSIS AND REPAIR WORK FLOW

< BASIC INSPECTION >

BASIC INSPECTION

DIAGNOSIS AND REPAIR WORK FLOW

Work Flow

INFOID:0000000010837429

DETAILED FLOW

1.OBTAIN INFORMATION ABOUT SYMPTOM

Interview the customer to obtain as much malfunction information (conditions and environment when the malfunction occurs) as possible when the customer brings the vehicle in.

>> GO TO 2.

2.REPRODUCE THE MALFUNCTION INFORMATION

Check the malfunction on the vehicle that the customer describes.
Inspect the relation of the symptoms and the condition when the symptoms occur.

>> GO TO 3.

3.IDENTIFY THE MALFUNCTIONING SYSTEM WITH "SYMPTOM DIAGNOSIS"

Use "Symptom diagnosis" from the symptom inspection result in step 2 and then identify where to start performing the diagnosis based on possible causes and symptoms.

>> GO TO 4.

4.IDENTIFY THE MALFUNCTIONING PARTS WITH "COMPONENT DIAGNOSIS"

Perform the diagnosis with "Component diagnosis" of the applicable system.

>> GO TO 5.

5.REPAIR OR REPLACE THE MALFUNCTIONING PARTS

Repair or replace the specified malfunctioning parts.

>> GO TO 6.

6.FINAL CHECK

Check that the malfunction is not reproduced, referring to the symptom inspection result in step 2.

Are the malfunctions corrected?

YES >> INSPECTION END
NO >> GO TO 3.

SEAT BELT WARNING SYSTEM

< SYSTEM DESCRIPTION >

SYSTEM DESCRIPTION

SEAT BELT WARNING SYSTEM

System Diagram

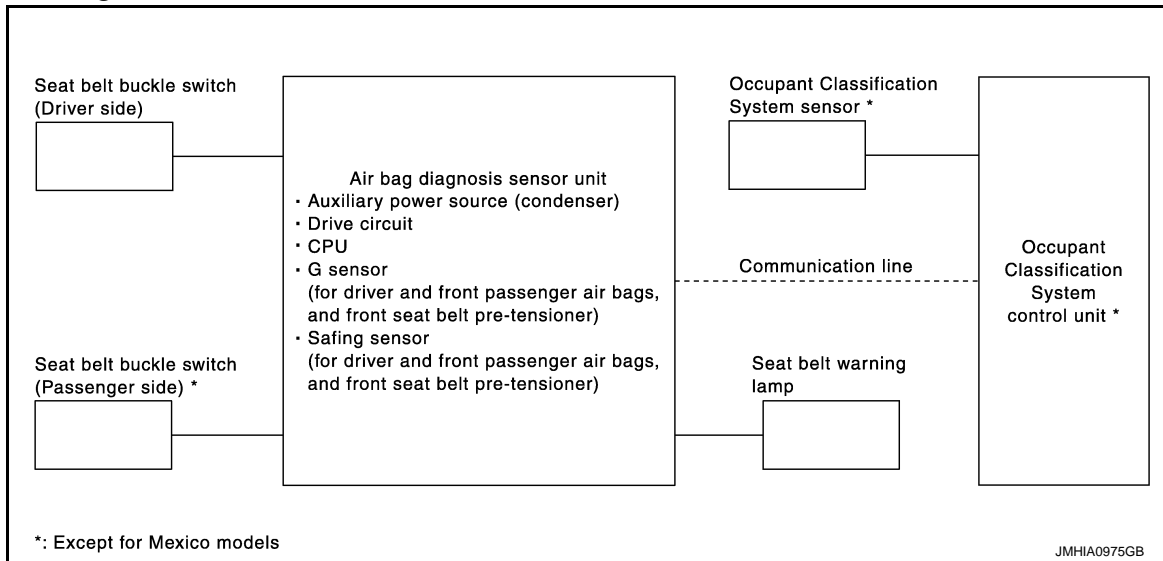

System Description

INFOID:0000000010837431

SBC

- Turns ON seat belt warning lamp, when the Occupant Classification System judges adult or child in the front passenger seat and the passenger seat belt buckle switch is OFF.*¹
- Operation of air bag diagnosis sensor unit when air bag diagnosis sensor unit receives information from Occupant Classification System.
- In addition, seat belt warning lamp illuminates, when the driver side seat belt is not fasten. This does not relate to the air bag diagnosis sensor unit.
- For driver seat belt function, refer to [MWI-6. "METER SYSTEM : System Diagram"](#)

Status (front passenger seat)* ¹	Seat belt warning lamp (When front passenger seat is unbuckled)* ¹
Empty	OFF
An object	OFF
Child/ child-seat	ON
Adult	ON
Malfunction	OFF

*¹: Except for Mexico

SEAT BELT WARNING SYSTEM

< SYSTEM DESCRIPTION >

Component Parts Location

INFOID:0000000110837432

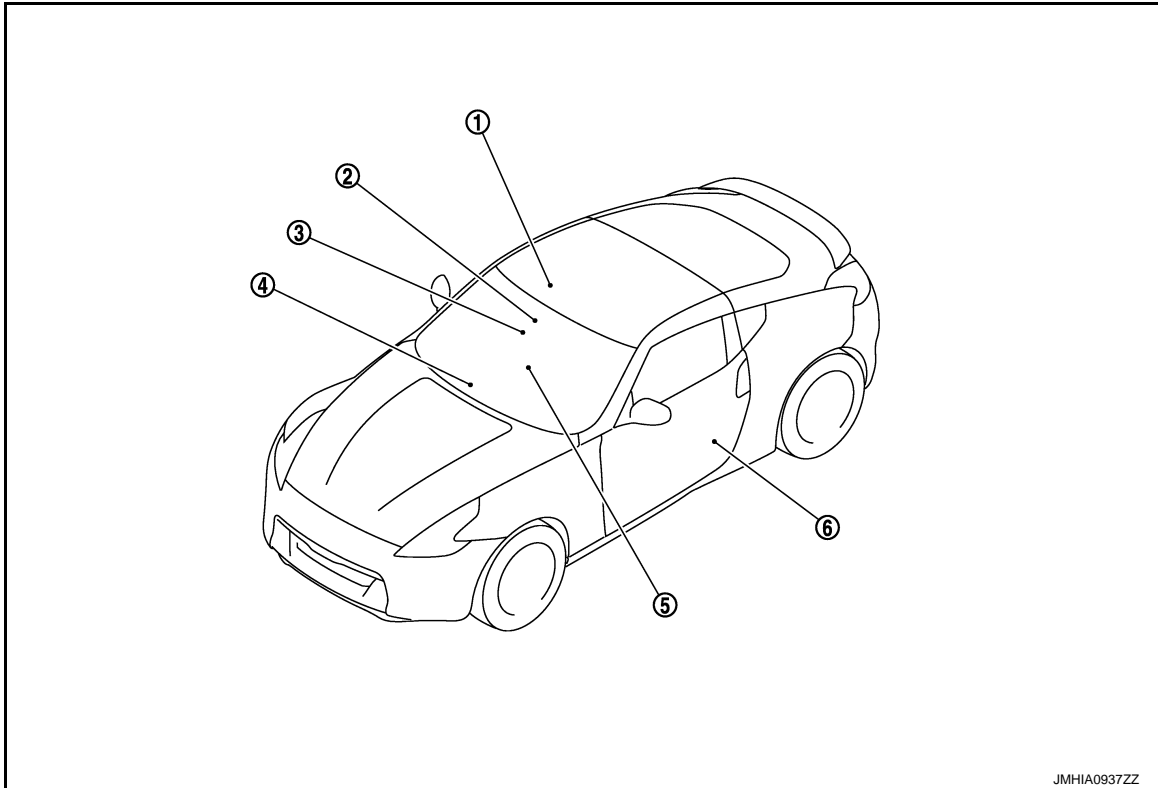

- | | | |
|---|---|--|
| 1. Seat belt buckle switch (passenger side) | 2. Occupant Classification System control unit *1
Refer to SRC-105. "Component Parts Location" | 3. Occupant Classification System seat sensor *1
Refer to SRC-105. "Component Parts Location" |
| 4. Front passenger air bag OFF indicator *1
Refer to SRC-105. "Component Parts Location" | 5. Air bag diagnosis sensor unit
Refer to SRC-105. "Component Parts Location" | 6. Seat belt buckle switch (driver side) |

*1: Except for Mexico

Component Description

INFOID:0000000110837433

Component parts	Outline of function
Seat belt buckle switch (Driver side)	Detects if the seat belt buckle switch (driver side) is fastened or unfastened
Seat belt buckle switch (Passenger side)	Detects if the seat belt buckle switch (passenger side) is fastened or unfastened
Seat belt warning lamp	Turns the seat belt warning lamp ON when the seat belt is unfastened
Occupant Classification System control unit *1	Judges the passenger seat condition based on the information from Occupant Classification System control unit
Occupant Classification System seat sensor *1	Detects if the passenger seat is empty or occupied
Air bag diagnosis sensor unit	Turns ON seat belt warning lamp based on the information from Occupant Classification System control unit
Front passenger air bag OFF indicator *1	Turns the front passenger air bag OFF indicator lamp ON when the front passenger seat is occupied by a child or a child seat

*1: Except for Mexico

SEAT BELT BUCKLE SWITCH

< DTC/CIRCUIT DIAGNOSIS >

DTC/CIRCUIT DIAGNOSIS

SEAT BELT BUCKLE SWITCH DRIVER SIDE

DRIVER SIDE : Description

INFOID:000000010837434

- Performs the control of tension reducer according to the seat belt buckle switch ON/OFF.
- Detects whether or not the seat belt is fastened when the ignition switch turns ON. If the seat belt is not fastened, it illuminates the seat belt warning lamp on the combination meter.
- The seat belt buckle switch is installed in the seat belt buckle.

DRIVER SIDE : Component Function Check

INFOID:000000010837435

1.CHECK SEAT BELT BUCKLE SWITCH

 With CONSULT

When checking "BUCKLE SW" in DATA MONITOR in METER/M&A, check that ON/OFF display changes synchronized with the insertion operation to the seat belt buckle.

Monitor item	Condition
BUCKLE SW	When driver side seat belt is not fastened: ON
	When driver side seat belt is fastened: OFF

Is the inspection result normal?

- YES >> Seat belt buckle switch (driver side) circuit is normal.
 NO >> Refer to [SBC-5. "DRIVER SIDE : Diagnosis Procedure"](#).

DRIVER SIDE : Diagnosis Procedure

INFOID:000000010837436

1.CHECK SEAT BELT BUCKLE SWITCH (DRIVER SIDE) CIRCUIT

1. Turn ignition switch ON.
2. Check voltage between seat belt buckle switch (driver side) harness connector and ground.

(+)		(-)	Condition	Voltage (V) (Approx.)
Connector	Terminal			
B13 ^{*1} B515 ^{*2}	1	Ground	When driver side seat belt is fastened	Battery voltage
			When driver side seat belt is not fastened	0

*1:Without climate controlled seat

*2:With climate controlled seat

Is the inspection result normal?

- YES >> GO TO 3.
 NO >> GO TO 2.

2.CHECK SEAT BELT BUCKLE SWITCH (DRIVER SIDE) CIRCUIT

1. Turn ignition switch OFF.
2. Disconnect combination meter and seat belt buckle switch (driver side) connector.
3. Check continuity between combination meter harness connector and seat belt buckle switch (driver side) harness connector.

Combination meter		Seat belt buckle switch (driver side)		Continuity
Connector	Terminal	Connector	Terminal	
M54	35	B13 ^{*1} B515 ^{*2}	1	Existed

*1:Without climate controlled seat

SEAT BELT BUCKLE SWITCH

< DTC/CIRCUIT DIAGNOSIS >

*2:With climate controlled seat

- Check continuity between combination meter harness connector and ground.

Combination meter		Ground	Continuity
Connector	Terminal		
M54	35		Not existed

Is the inspection result normal?

- YES >> Repair or replace combination meter. Refer to [MWI-103. "Removal and Installation"](#).
 NO >> Repair or replace harness.

3.CHECK SEAT BELT BUCKLE SWITCH GROUND CIRCUIT

Check continuity between seat belt buckle switch (driver side) harness connector and ground.

Seat belt buckle switch (driver side)		Ground	Continuity
Connector	Terminal		
B13* ¹ B515* ²	2		Existed

*1:Without climate controlled seat

*2:With climate controlled seat

Is the inspection result normal?

- YES >> GO TO 4.
 NO >> Repair or replace harness.

4.CHECK SEAT BELT BUCKLE SWITCH (DRIVER SIDE)

Check seat belt buckle switch (driver side). Refer to [SBC-6. "DRIVER SIDE : Component Inspection \(Belt Buckle Switch\)"](#).

Is the inspection result normal?

- YES >> INSPECTION END
 NO >> Replace seat belt buckle switch (driver side). Refer to [SB-11. "SEAT BELT BUCKLE : Removal and Installation"](#).

DRIVER SIDE : Component Inspection (Belt Buckle Switch)

INFOID:0000000010837437

1.CHECK SEAT BELT BUCKLE SWITCH (DRIVER SIDE)

- Turn ignition switch OFF
- Disconnect seat belt buckle switch connector.
- Check continuity of seat belt buckle (driver side).

Seat belt buckle switch (driver side)		Condition	Continuity
Terminal			
1	2	When driver side seat belt is not fastened	Existed
		When driver side seat belt is fastened	Not existed

Is the inspection result normal?

- YES >> INSPECTION END
 NO >> Replace seat belt buckle switch (driver side).

PASSENGER SIDE

PASSENGER SIDE : Description

INFOID:0000000010837438

- Performs the control of tension reducer according to the seat belt buckle switch ON/OFF.
- Detects whether or not the seat belt is fastened when the ignition switch turns ON. If the seat belt switch is not fastened, it illuminates the seat belt warning lamp on the combination meter.
- The seat belt buckle switch is installed in the seat belt buckle.

SEAT BELT BUCKLE SWITCH

< DTC/CIRCUIT DIAGNOSIS >

PASSENGER SIDE : Component Function Check

INFOID:0000000110837439

1. CHECK SEAT BELT WARNING FUNCTION

1. Sit down in passenger seat.
2. Check that seat belt warning lamp turns OFF when passenger seat belt is fastened, and then turns ON when passenger seat belt is unfastened.

Is the inspection result normal?

- YES >> Seat belt buckle switch (passenger side) circuit is normal.
 NO >> Refer to [SBC-7, "PASSENGER SIDE : Diagnosis Procedure"](#).

PASSENGER SIDE : Diagnosis Procedure

INFOID:0000000110837440

1. CHECK SEAT BELT BUCKLE SWITCH (PASSENGER SIDE) CIRCUIT

1. Turn ignition switch ON.
2. Check that voltage between seat belt buckle switch (passenger side) and ground.

(+)		(-)	Condition	Voltage (V) (Approx.)
Seat belt buckle switch (passenger side)				
Connector	Terminal			
B213*1	1	Ground	When passenger side seat belt is fastened	2.0 or more
B565*2			When passenger side seat belt is not fastened	0

*1:Without climate controlled seat

*2:With climate controlled seat

Is the inspection result normal?

- YES >> GO TO 3.
 NO >> GO TO 2.

2. CHECK SEAT BELT BUCKLE SWITCH (PASSENGER SIDE) CIRCUIT

1. Turn ignition switch OFF.
2. Disconnect air bag diagnosis sensor unit connector and seat belt buckle switch (passenger side) connector.
3. Check continuity between air bag diagnosis sensor unit harness connector and seat belt buckle switch (passenger side) harness connector.

Air bag diagnosis sensor unit		Seat belt buckle switch (passenger side)		Continuity
Connector	Terminal	Connector	Terminal	
B215	29	B213*1 B565*2	1	Existed

*1:Without climate controlled seat

*2:With climate controlled seat

4. Check continuity between air bag diagnosis sensor unit harness connector and ground.

Air bag diagnosis sensor unit		Ground	Continuity
Connector	Terminal		
B215	29		Not existed

Is the inspection result normal?

- YES >> Replace air bag diagnosis sensor unit. Refer to [SR-27, "COUPE : Removal and Installation"](#).
 NO >> Repair or replace harness between air bag diagnosis sensor unit and seat belt buckle switch (passenger side).

3. CHECK SEAT BELT BUCKLE SWITCH GROUND CIRCUIT

Check continuity between seat belt buckle switch (passenger side) harness connector and ground.

A
B
C
D
E
F
G
I
J
K
L
M
N
O
P

SBC

SEAT BELT BUCKLE SWITCH

< DTC/CIRCUIT DIAGNOSIS >

Seat belt buckle switch (passenger side)		Ground	Continuity
Connector	Terminal		
B213*1 B565*2	2		Existed

*1:Without climate controlled seat

*2:With climate controlled seat

Is the inspection result normal?

YES >> GO TO 4.

NO >> Repair or replace harness.

4.CHECK SEAT BELT BUCKLE SWITCH (PASSENGER SIDE)

Check seat belt buckle switch (passenger side). Refer to [SBC-8, "PASSENGER SIDE : Component Inspection \(Belt Buckle Switch\)"](#).

Is the inspection result normal?

YES >> INSPECTION END

NO >> Replace seat belt buckle switch (passenger side). Refer to [SB-11, "SEAT BELT BUCKLE : Removal and Installation"](#).

PASSENGER SIDE : Component Inspection (Belt Buckle Switch)

INFOID:0000000010837441

1.CHECK SEAT BELT BUCKLE SWITCH (PASSENGER SIDE)

1. Turn ignition switch OFF.
2. Disconnect seat belt buckle switch connector.
3. Check continuity of seat belt buckle (passenger side).

Seat belt buckle switch (passenger side)		Condition	Continuity
Terminal			
1	2	When driver side seat belt is not fastened	Existed
		When driver side seat belt is fastened	Not existed

Is the inspection result normal?

YES >> INSPECTION END

NO >> Replace seat belt buckle switch (passenger side). Refer to [SB-11, "SEAT BELT BUCKLE : Removal and Installation"](#).

SEAT BELT WARNING LAMP CIRCUIT

< DTC/CIRCUIT DIAGNOSIS >

SEAT BELT WARNING LAMP CIRCUIT

Diagnosis Procedure

INFOID:000000010837442

1. CHECK SEAT BELT WARNING LAMP CIRCUIT

1. Turn ignition switch OFF.
2. Disconnect combination meter connector.
3. Turn ignition switch ON.
4. Check that voltage between combination meter harness connector and ground.

combination meter		Ground	Voltage (V) (Approx.)
Connector	Terminal		Battery voltage
M53	36		

Is the inspection result normal?

YES >> GO TO 2.

NO >> Repair or replace combination meter. Refer to [MWI-103, "Removal and Installation"](#).

2. CHECK SEAT BELT WARNING LAMP CIRCUIT

1. Turn ignition switch OFF.
2. Disconnect air bag diagnosis sensor unit connector.
3. Check continuity between combination meter harness connector and air bag diagnosis sensor unit harness connector.

Combination meter		Air bag diagnosis sensor unit		Continuity
Connector	Terminal	Connector	Terminal	
B53	36	M147	24	Existed

4. Check continuity between combination meter and ground.

Combination meter		Ground	Continuity
Connector	Terminal		Not existed
B53	36		

Is the inspection result normal?

YES >> Replace air bag diagnosis sensor unit. Refer to [SR-27, "COUPE : Removal and Installation"](#).

NO >> Repair or replace harness.

A
B
C
D
E
F
G
SBC
I
J
K
L
M
N
O
P

SEAT BELT WARNING SYSTEM

< DTC/CIRCUIT DIAGNOSIS >

SEAT BELT WARNING SYSTEM

Wiring Diagram - SEAT BELT WARNING SYSTEM -

INFOID:000000010837443

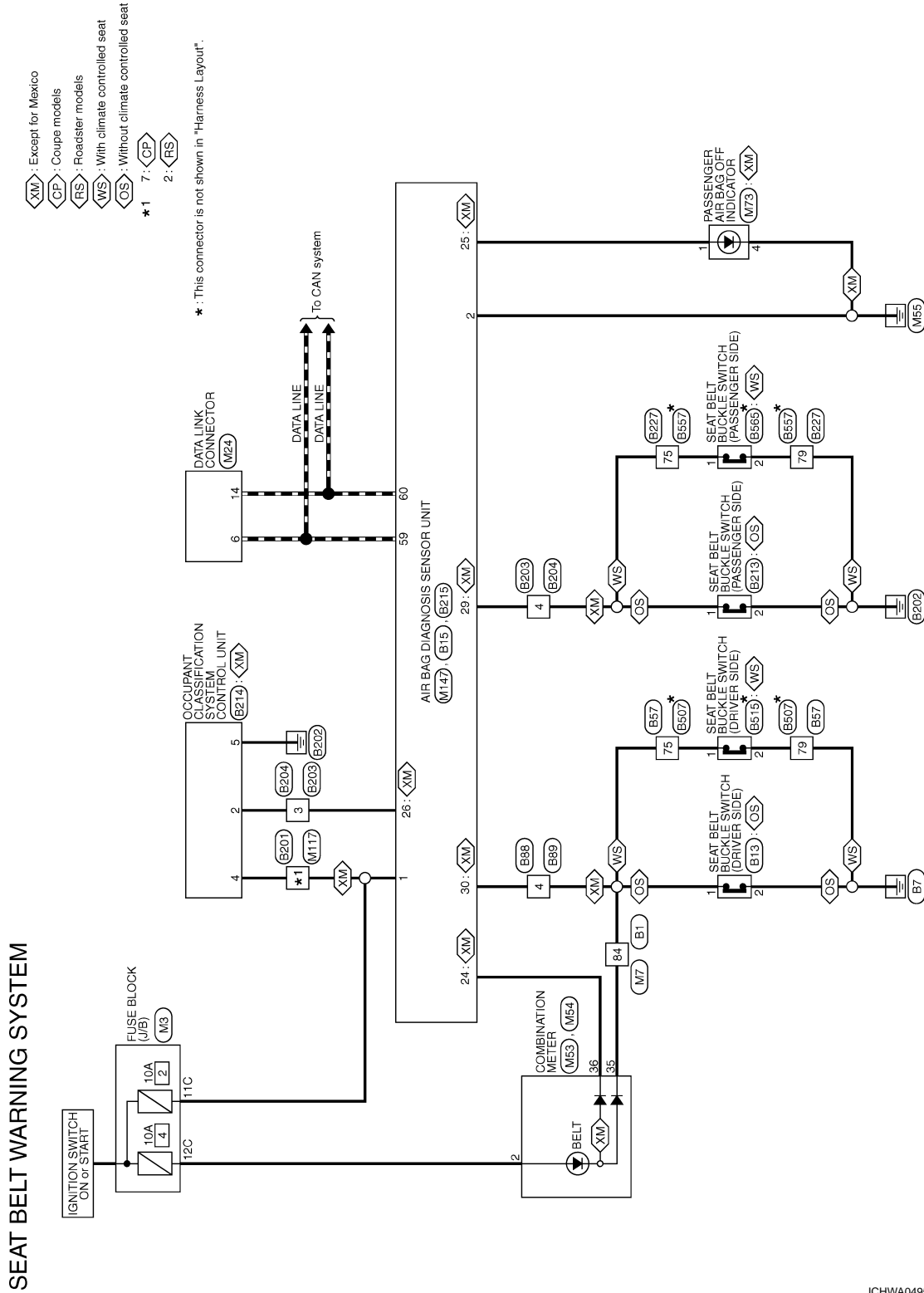

2010/09/22

JCHWA0495GB

SEAT BELT WARNING SYSTEM

< DTC/CIRCUIT DIAGNOSIS >

SEAT BELT WARNING SYSTEM

Connector No.	B1
Connector Name	WIRE TO WIRE
Connector Type	TR80FW-CS16-TM4

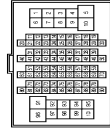

Terminal No.	Color Of Wire	Signal Name [Specification]
1	G	-
2	BG	-
3	Y	-
4	W	-
5	V	-
6	LG	-
7	GR	-
8	SB	-
9	BR	-
10	Y	-
11	Y	-
12	W	-
13	BR	-
14	LG	-
15	B	-
16	V	-
17	R	-
18	B	-
19	SB	-
20	SB	-
21	G	-
22	GR	-
23	V	-
24	BG	-
25	L	-
26	P	-
27	W	-
28	SHIELD	-
31	W	-
32	B	-
33	P	-
33	W	- [Couple models]
34	R	- [Roaster models]
35	B	- [Roaster models]
35	W	- [Couple models]
36	B	- [Roaster models]
40	Y	-
41	L	-

42	GR	-
43	BR	-
44	R	-
45	BG	-
46	SB	- [Roaster models]
46	SHIELD	- [Couple models]
47	V	-
51	W	-
52	R	-
57	SHIELD	-
58	B	-
61	SB	-
62	SHIELD	-
63	BR	-
64	Y	-
68	SHIELD	-
68	P	-
67	L	-
68	SHIELD	-
69	R	-
70	G	-
71	V	-
72	P	-
73	BR	-
74	GR	-
75	BG	-
80	Y	-
81	R	-
82	B	-
83	GR	-
84	G	- [Couple models]
84	L	- [Roaster models]
85	LG	-
86	V	-
87	BR	-
88	GR	-
93	Y	-
94	G	- [Roaster models]
94	L	- [Couple models]
95	GR	- [Roaster models]
95	LG	- [Couple models]
96	L	-
97	Y	-
98	W	- [Couple models]
98	Y/B	- [Roaster models]
99	LG	-
100	B	-

Connector No.	B13
Connector Name	SEAT BELT BUCKLE SWITCH (DRIVER SIDE)
Connector Type	A03FW

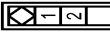

Terminal No.	Color Of Wire	Signal Name [Specification]
1	G	- [Couple models]
1	L	- [Roaster models]
2	B	-

Connector No.	B15
Connector Name	AIR BAG DIAGNOSIS SENSOR UNIT
Connector Type	IN42FY-2V-EX

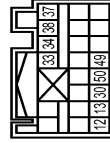

Terminal No.	Color Of Wire	Signal Name [Specification]
12	Y	PLH (+)
13	Y	PLH (-)
30	SB	LH-BUCKLE SW INPUT
33	Y	SLH (+)
34	Y	SLH (-)
37	Y	CLH (+)
38	Y/B	CLH (-)
48	B	SATELLITE LH (+) [Roaster models]
48	P	SATELLITE LH (+) [Couple models]
50	L	SATELLITE LH (-) [Couple models]
50	W	SATELLITE LH (-) [Roaster models]

Connector No.	B57
Connector Name	WIRE TO WIRE
Connector Type	NS16FW-CS

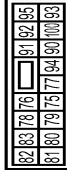

Terminal No.	Color Of Wire	Signal Name [Specification]
76	L	-
76	B	-
78	LG	-
78	B	-
90	B	-
91	P	-
92	V	-
93	G	-
94	BG	-
95	GR	-
100	BR	-

Connector No.	B68
Connector Name	WIRE TO WIRE
Connector Type	TR40FW-NH



Terminal No.	Color Of Wire	Signal Name [Specification]
4	SB	-

A
B
C
D
E
F
G
H
I
J
K
L
M
N
O
P

SBC

JRHWC2298GB

SEAT BELT WARNING SYSTEM

< DTC/CIRCUIT DIAGNOSIS >

SEAT BELT WARNING SYSTEM

Connector No.	B89
Connector Name	WIRE TO WIRE
Connector Type	TR04MW-NH



Terminal No.	Color Of Wire	Signal Name [Specification]
4	SB	-

Connector No.	B201
Connector Name	WIRE TO WIRE
Connector Type	TR06FW-CS1S-TM4

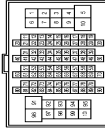

Terminal No.	Color Of Wire	Signal Name [Specification]
2	BR	- [Coupe models]
2	R	- [Roadster models]
3	B	- [Roadster models]
3	Y	- [Coupe models]
4	G	-
7	R	- [Roadster models]
7	Y	- [Roadster models]
8	LG	-
9	Y	-
11	R	-
20	G	-
21	R	-
30	B	-
40	W	-
41	V	-
42	G	-
43	L	-
44	SB	-
51	P	-

52	L	-
53	SHIELD	-
54	BR	-
55	Y	-
56	SHIELD	-
57	G	- [Coupe models]
57	P	- [Roadster models]
58	L	- [Roadster models]
59	R	- [Coupe models]
59	B	-
60	W	-
61	GR	-
62	B	-
63	Y	-
64	V	-
65	SB	-
66	BC	-
67	V	-
68	P	-
69	L	-
70	G	-
71	B	- [Roadster models]
71	V	- [Coupe models]
72	L	- [Roadster models]
72	P	- [Coupe models]
73	L	- [Coupe models]
73	P	- [Roadster models]
74	P	-
75	B	-
76	B	- [Coupe models]
76	W	- [Roadster models]
77	W	-
92	LG	- [Roadster models]
92	SB	- [Coupe models]
93	V	- [Coupe models]
93	W	- [Roadster models]
94	G	- [Roadster models]
94	SHIELD	- [Coupe models]
95	GR	- [Coupe models]
95	LG	- [Roadster models]
97	LG	- [Coupe models]
97	Y	- [Roadster models]
98	W	- [Coupe models]
98	Y/B	- [Roadster models]
99	G	-
100	BR	- [Coupe models]
100	Y	- [Roadster models]

Connector No.	B203
Connector Name	WIRE TO WIRE
Connector Type	TR04FW-NH



Terminal No.	Color Of Wire	Signal Name [Specification]
3	V	-
4	LG	-

Connector No.	B204
Connector Name	WIRE TO WIRE
Connector Type	TR04MW-NH



Terminal No.	Color Of Wire	Signal Name [Specification]
3	V	-
4	LG	-

Connector No.	B213
Connector Name	SEAT BELT BUCKLE SWITCH (PASSENGER'S SIDE)
Connector Type	A03FW

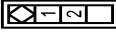

Terminal No.	Color Of Wire	Signal Name [Specification]
1	G	- [For Mexico]
1	LG	- [Except for Mexico]
2	B	-

Connector No.	B214
Connector Name	OCCUPANT CLASSIFICATION SYSTEM CONTROL UNIT
Connector Type	TR06FW-NH

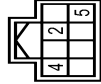

Terminal No.	Color Of Wire	Signal Name [Specification]
2	V	COMMUNICATION
4	R	IGN
5	B	GROUND

SEAT BELT WARNING SYSTEM

< DTC/CIRCUIT DIAGNOSIS >

SEAT BELT WARNING SYSTEM

Connector No.	B215
Connector Name	AIR BAG DIAGNOSIS SENSOR UNIT
Connector Type	NEZFV-1V-EX

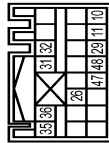

Terminal No.	Color Of Wire	Signal Name [Specification]
10	Y	PRH (+)
11	Y	PRH (-)
26	Y	ODS/NEUT
28	LG	RH BUCKLE SW INPUT
31	Y	SRH (+)
32	Y	SRH (-)
35	Y	CRH (+)
36	Y/B	CRH (-)
47	B	SATELLITE RH (+) [Roadster models]
47	G	SATELLITE RH (+) [Coupe models]
48	R	SATELLITE RH (-) [Coupe models]
48	W	SATELLITE RH (-) [Roadster models]



Connector No.	B227
Connector Name	WIRE TO WIRE
Connector Type	NS16FW-CS

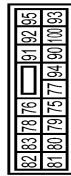

Terminal No.	Color Of Wire	Signal Name [Specification]
75	LG	-
76	B	-
78	G	-
78	B	-
90	B	-
91	L	-
92	G	-
93	Y	-

94	SB
95	V
100	W

Connector No.	B507
Connector Name	WIRE TO WIRE
Connector Type	NS16AW-CS



Terminal No.	Color Of Wire	Signal Name [Specification]
75	L	-
76	B	-
78	LG	-
79	B	-
90	B	-
91	P	-
92	V	-
93	G	-
94	BG	-
95	GR	-
100	BR	-

Connector No.	B515
Connector Name	SEAT BELT BUCKLE SWITCH (DRIVER SIDE)
Connector Type	TK03FW



Terminal No.	Color Of Wire	Signal Name [Specification]
1	LW	-
2	O	-

Connector No.	B557
Connector Name	WIRE TO WIRE
Connector Type	NS16AW-CS

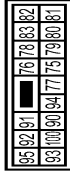

Terminal No.	Color Of Wire	Signal Name [Specification]
75	LG	-
76	B	-
78	G	-
79	B	-
90	B	-
91	L	-
92	G	-
93	Y	-
94	SB	-
95	V	-
100	W	-

Connector No.	B555
Connector Name	SEAT BELT BUCKLE SWITCH (PASSENGER SIDE)
Connector Type	TK03FW



Terminal No.	Color Of Wire	Signal Name [Specification]
1	LW	-
2	O	-

Connector No.	M3
Connector Name	FUSE BLOCK (JIB)
Connector Type	NS12FW-CS



Terminal No.	Color Of Wire	Signal Name [Specification]
10C	L	-
11C	LG	-
12C	O	-
9C	R	-
7C	B	-
9C	O	-

Connector No.	M7
Connector Name	WIRE TO WIRE
Connector Type	TH80MM-CS16-TM4

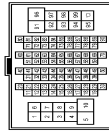

Terminal No.	Color Of Wire	Signal Name [Specification]
1	BR	-
2	O	-
3	LG	-
4	O	-
6	V	-
7	LG	-
8	SB	-
9	GR	-
11	Y	-
12	V	-
13	BR	-
14	V	-
15	B	-
18	V	-

A
B
C
D
E
F
G
SBC
I
J
K
L
M
N
O
P

SEAT BELT WARNING SYSTEM

< DTC/CIRCUIT DIAGNOSIS >

SEAT BELT WARNING SYSTEM

17	R	-	-
18	L	-	-
20	SB	-	-
21	G	-	-
22	GR	-	-
23	V	-	-
24	R	-	-
25	L	-	-
26	P	-	-
27	B	-	-
28	SHIELD	-	-
31	W	-	-
32	B	-	-
33	W	-	-
34	R	-	-
35	B	-	-
36	L	-	-
40	L	-	-
41	R	-	-
42	GR	-	-
43	R	-	-
44	R	-	-
45	O	-	-
46	G	-	-
47	R	-	-
51	V	-	-
52	R	-	-
57	SHIELD	-	-
58	B	-	-
60	L	-	-
61	R	-	-
62	SHIELD	-	-
63	R	-	-
64	G	-	-
65	SHIELD	-	-
66	LG	-	-
67	V	-	-
68	SHIELD	-	-
69	L	-	-
70	P	-	-
71	V	-	-
72	P	-	-
73	BR	-	-
74	GR	-	-
75	O	-	-
80	Y	-	-
81	W	-	-
82	BR	-	-

83	GR	-	-
84	L	-	-
85	LG	-	-
86	V	-	-
87	BR	-	-
88	SB	-	-
93	Y	-	-
94	L	-	-
94	SB	-	-
95	GR	-	-
95	W	-	-
96	L	-	-
97	LG	-	-
97	Y	-	-
98	BG	-	-
98	V/B	-	-
99	W	-	-
100	B	-	-

Connector No.	M24
Connector Name	DATA LINK CONNECTOR
Connector Type	BD18FW

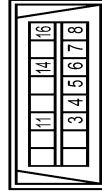

Terminal No.	Wire	Signal Name (Specification)
3	LG	- [Coupe models]
4	B	- [Roaster models]
5	B	-
6	L	-
7	Y	-
8	G	-
11	LG	- [Roaster models]
14	Y	- [Coupe models]
16	Y	-

Connector No.	M63
Connector Name	COMBINATION METER
Connector Type	TH24FW-NH

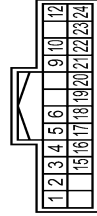

Terminal No.	Wire	Signal Name (Specification)
1	V	BATTERY POWER SUPPLY
2	O	IGNITION SIGNAL
3	L	VEHICLE SPEED SIGNAL (2 PULSE)
4	V	VEHICLE SPEED SIGNAL (PULSE) [For Mexico]
4	Y	VEHICLE SPEED SIGNAL (PULSE) [For Mexico]
5	B	ILLUMINATION CONTROL SIGNAL
6	R	ROOF STATUS SIGNAL
9	BR	COMMUNICATION SIGNAL (METER-TRIPLE METER)
10	L	COMMUNICATION SIGNAL (TRIPLE METER)
12	G	S-MODE SWITCH SIGNAL
15	L	ACC POWER SUPPLY
16	R	AIR BAG SIGNAL
17	B	GROUND
18	V	AMBIENT SENSOR SIGNAL
19	G	A/C AUTO AMP. CONNECTION RECOGNITION SIGNAL
20	GR	AMBIENT SENSOR GROUND
21	L	CANH
22	P	CANH
23	B	GROUND
24	Y	FUEL LEVEL SENSOR GROUND

Connector No.	M54
Connector Name	COMBINATION METER
Connector Type	TH16FW-NH

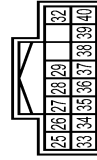

Terminal No.	Wire	Signal Name (Specification)
25	W	ALTERNATOR SIGNAL
26	O	PARKING BRAKE SWITCH SIGNAL
27	LG	BRAKE FLUID LEVEL SWITCH SIGNAL
28	Y	SECURITY SIGNAL
29	GR	WASHER LEVEL SWITCH SIGNAL
32	G	PADDLE SHIFTER DOWN SIGNAL
33	O	PADDLE SHIFTER UP SIGNAL
34	BR	FUEL LEVEL SENSOR SIGNAL
35	L	SEAT BELT BUCKLE SWITCH SIGNAL (DRIVER SIDE)
36	P	PASSENGER SEAT BELT WARNING SIGNAL (For Mexico)
37	G	NON-MANUAL MODE SIGNAL
38	V	MANUAL MODE SHIFT DOWN SIGNAL
39	L	MANUAL MODE SHIFT UP SIGNAL
40	W	MANUAL MODE SIGNAL

Connector No.	M73
Connector Name	PASSENGER AIR BAG OFF INDICATOR
Connector Type	JAB03FB



Terminal No.	Wire	Signal Name (Specification)
1	R	-
4	B	-

JRHWC2301GB

SEAT BELT WARNING SYSTEM

< DTC/CIRCUIT DIAGNOSIS >

SEAT BELT WARNING SYSTEM

Connector No.	M117
Connector Name	WIRE TO WIPE
Connector Type	TR80MM-CS16-TM4

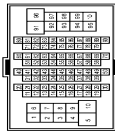

Terminal No.	Color	Wire	Signal Name [Specification]
1	GR	-	- [Coupe models]
2	LG	-	- [Roaster models]
3	B	-	- [Roaster models]
3	O	-	- [Coupe models]
4	W	-	-
7	LG	-	- [Coupe models]
7	Y	-	- [Roaster models]
8	LG	-	-
9	Y	-	-
11	R	-	-
20	G	-	-
21	R	-	-
30	B	-	-
40	O	-	-
41	Y	-	-
42	G	-	-
43	L	-	-
44	SB	-	-
51	R	-	-
52	G	-	-
53	SHIELD	-	-
54	LG	-	-
55	V	-	-
56	SHIELD	-	-
57	G	-	- [Coupe models]
57	P	-	- [Roaster models]
58	L	-	- [Roaster models]
58	R	-	- [Coupe models]
60	W	-	-
61	GR	-	-
62	B	-	-
63	Y	-	-
64	L	-	-
65	G	-	-
66	O	-	-

67	V	-	-
68	P	-	-
69	L	-	-
70	L	-	-
71	B	-	-
72	B	-	-
73	B	-	-
74	B	-	-
75	B	-	-
76	B	-	-
77	B	-	- [Coupe models]
92	LG	-	- [Roaster models]
93	R	-	- [Coupe models]
93	V	-	- [Roaster models]
94	G	-	- [Roaster models]
94	SHIELD	-	- [Coupe models]
96	LG	-	- [Roaster models]
96	SB	-	- [Coupe models]
97	LG	-	- [Coupe models]
97	Y	-	- [Roaster models]
98	V	-	- [Coupe models]
98	Y/B	-	- [Roaster models]
99	G	-	-
100	BR	-	- [Coupe models]
100	Y	-	- [Roaster models]

Connector No.	M147
Connector Name	AIR BAG DIAGNOSIS SENSOR UNIT
Connector Type	NI28FY-EX

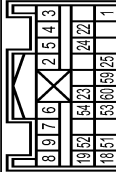

Terminal No.	Wire	Signal Name [Specification]
1	LG	IGN
2	B	GND
3	Y	DR1 (+)
4	Y	DR1 (-)
5	Y	DR2 (+)
6	Y	DR2 (-)
7	Y	AS1 (+)
7	Y	AS1 (-)
8	Y	AS2 (+)

9	Y	AS2 (-)
18	R	ECZS (+)
19	L	ECZS (-)
22	SHIELD	GND
23	R	AIRBAG W/L
24	P	SEAT BELT
25	R	CUTOFF TELLTALE
51	W	SATELLITE RH2 (+)
52	B	SATELLITE RH2 (-)
53	Y	SATELLITE LH2 (+)
54	BR	SATELLITE LH2 (-)
59	L	CANH
60	P	CANL

A
B
C
D
E
F
G
H
I
J
K
L
M
N
O
P

SBC

JRHWC2302GB

DIAGNOSIS SENSOR UNIT

< ECU DIAGNOSIS INFORMATION >

ECU DIAGNOSIS INFORMATION

DIAGNOSIS SENSOR UNIT

List of ECU Reference

INFOID:0000000010837444

ECU	Body type	Reference
Diagnosis sensor unit	Coupe	SRC-248, "DTC Index"
		SRC-252, "Wiring Diagram - SRS AIR BAG CONTROL SYSTEM -"
	Roadster	SRC-433, "DTC Index"
		SRC-437, "Wiring Diagram - SRS AIR BAG CONTROL SYSTEM -"

SEAT BELT WARNING LAMP DOES NOT TURN OFF

< SYMPTOM DIAGNOSIS >

SYMPTOM DIAGNOSIS

SEAT BELT WARNING LAMP DOES NOT TURN OFF

Diagnosis Procedure

INFOID:0000000010837445

1. CHECK SEAT BELT BUCKLE SWITCH CIRCUIT (DRIVER SIDE)

Check seat belt buckle switch circuit (driver side). Refer to [SBC-5, "DRIVER SIDE : Component Function Check"](#)

Is the inspection result normal?

YES >> GO TO 2.

NO >> Repair or replace the malfunctioning parts.

2. CHECK SEAT BELT BUCKLE SWITCH CIRCUIT (PASSENGER SIDE)

Check seat belt buckle switch circuit (passenger side). Refer to [SBC-7, "PASSENGER SIDE : Component Function Check"](#)

NOTE:

Except for Mexico

Is the inspection result normal?

YES >> GO TO 3.

NO >> Repair or replace the malfunctioning parts.

3. CHECK SEAT BELT WARNING LAMP CIRCUIT

Check seat belt warning lamp circuit. Refer to [SBC-9, "Diagnosis Procedure"](#)

Is the inspection result normal?

YES >> GO TO 4.

NO >> Repair or replace the malfunctioning parts.

4. CONFIRM THE OPERATION

Confirm the operation again.

Is the inspection result normal?

YES >> Check intermittent incident. Refer to [GI-44, "Intermittent Incident"](#).

NO >> GO TO 1.

A
B
C
D
E
F
G
SBC
I
J
K
L
M
N
O
P

SEAT BELT WARNING LAMP DOES NOT TURN ON

< SYMPTOM DIAGNOSIS >

SEAT BELT WARNING LAMP DOES NOT TURN ON

Diagnosis Procedure

INFOID:000000010837446

1. CHECK SELF DIAGNOSIS RESULT

Perform "COMBINATION METER" self diagnostic result. Refer to [MWI-34, "CONSULT Function \(METER/M&A\)"](#)

Is DTC detected?

- YES >> Repair or replace the malfunctioning parts.
- NO >> GO TO 2.

2. CHECK POWER SUPPLY

Check that fuses are not blown.

Check ignition power supply of combination meter. Refer to [MWI-45, "COMBINATION METER : Diagnosis Procedure"](#)

Is the inspection result normal?

- YES >> GO TO 3.
- NO >> Repair or replace the malfunctioning parts.

3. CHECK SEAT BELT BUCKLE SWITCH CIRCUIT (DRIVER SIDE)

Check seat belt buckle switch circuit (driver side). Refer to [SBC-5, "DRIVER SIDE : Component Function Check"](#)

Is the inspection result normal?

- YES >> GO TO 4.
- NO >> Repair or replace the malfunctioning parts.

4. CHECK SEAT BELT BUCKLE SWITCH CIRCUIT (PASSENGER SIDE)

Check seat belt buckle switch circuit (passenger side). Refer to [SBC-7, "PASSENGER SIDE : Component Function Check"](#)

NOTE:

Except for Mexico

Is the inspection result normal?

- YES >> GO TO 5.
- NO >> Repair or replace the malfunctioning parts.

5. CHECK SEAT BELT WARNING LAMP CIRCUIT

Check seat belt warning lamp circuit. Refer to [SBC-9, "Diagnosis Procedure"](#)

Is the inspection result normal?

- YES >> GO TO 6.
- NO >> Repair or replace the malfunctioning parts.

6. CONFIRM THE OPERATION

Confirm the operation again.

Is the inspection result normal?

- YES >> Check intermittent incident. Refer to [GI-44, "Intermittent Incident"](#).
- NO >> GO TO 1.

PRECAUTIONS

< PRECAUTION >

PRECAUTION

PRECAUTIONS

EXCEPT FOR MEXICO

EXCEPT FOR MEXICO : Precautions for Supplemental Restraint System (SRS) "AIR BAG" and "SEAT BELT PRE-TENSIONER"

INFOID:000000010837447

The Supplemental Restraint System such as "AIR BAG" and "SEAT BELT PRE-TENSIONER", used along with a front seat belt, helps to reduce the risk or severity of injury to the driver and front passenger for certain types of collision. This system includes seat belt switch inputs and dual stage front air bag modules. The SRS system uses the seat belt switches to determine the front air bag deployment, and may only deploy one front air bag, depending on the severity of a collision and whether the front occupants are belted or unbelted. Information necessary to service the system safely is included in the "SRS AIR BAG" and "SEAT BELT" of this Service Manual.

WARNING:

Always observe the following items for preventing accidental activation.

- To avoid rendering the SRS inoperative, which could increase the risk of personal injury or death in the event of a collision that would result in air bag inflation, all maintenance must be performed by an authorized NISSAN/INFINITI dealer.
- Improper maintenance, including incorrect removal and installation of the SRS, can lead to personal injury caused by unintentional activation of the system. For removal of Spiral Cable and Air Bag Module, see "SRS AIR BAG".
- Never use electrical test equipment on any circuit related to the SRS unless instructed to in this Service Manual. SRS wiring harnesses can be identified by yellow and/or orange harnesses or harness connectors.

PRECAUTIONS WHEN USING POWER TOOLS (AIR OR ELECTRIC) AND HAMMERS

WARNING:

Always observe the following items for preventing accidental activation.

- When working near the Air Bag Diagnosis Sensor Unit or other Air Bag System sensors with the ignition ON or engine running, never use air or electric power tools or strike near the sensor(s) with a hammer. Heavy vibration could activate the sensor(s) and deploy the air bag(s), possibly causing serious injury.
- When using air or electric power tools or hammers, always switch the ignition OFF, disconnect the battery, and wait at least 3 minutes before performing any service.

EXCEPT FOR MEXICO : Precaution for Battery Service

INFOID:000000010837448

Before disconnecting the battery, lower both the driver and passenger windows. This will prevent any interference between the window edge and the vehicle when the door is opened/closed. During normal operation, the window slightly raises and lowers automatically to prevent any window to vehicle interference. The automatic window function will not work with the battery disconnected.

EXCEPT FOR MEXICO : Precautions For Xenon Headlamp Service

INFOID:000000011337878

WARNING:

Comply with the following warnings to prevent any serious accident.

- Disconnect the battery cable (negative terminal) or the power supply fuse before installing, removing, or touching the xenon headlamp (bulb included). The xenon headlamp contains high-voltage generated parts.
- Never work with wet hands.
- Check the xenon headlamp ON-OFF status after assembling it to the vehicle. Never turn the xenon headlamp ON in other conditions. Connect the power supply to the vehicle-side connector. (Turning it ON outside the lamp case may cause fire or visual impairments.)
- Never touch the bulb glass immediately after turning it OFF. It is extremely hot.

CAUTION:

Comply with the following cautions to prevent any error and malfunction.

- Install the xenon bulb securely. (Insufficient bulb socket installation may melt the bulb, the connector, the housing, etc. by high-voltage leakage or corona discharge.)

PRECAUTIONS

< PRECAUTION >

- **Never perform HID circuit inspection with a tester.**
- **Never touch the xenon bulb glass with hands. Never put oil and grease on it.**
- **Dispose of the used xenon bulb after packing it in thick vinyl without breaking it.**
- **Never wipe out dirt and contamination with organic solvent (thinner, gasoline, etc.).**

EXCEPT FOR MEXICO : Precautions for Removing Battery Terminal

INFOID:000000011337876

- When removing the 12V battery terminal, turn OFF the ignition switch and wait at least 30 seconds.

NOTE:

ECU may be active for several tens of seconds after the ignition switch is turned OFF. If the battery terminal is removed before ECU stops, then a DTC detection error or ECU data corruption may occur.

- For vehicles with the 2-batteries, be sure to connect the main battery and the sub battery before turning ON the ignition switch.

NOTE:

If the ignition switch is turned ON with any one of the terminals of main battery and sub battery disconnected, then DTC may be detected.

- After installing the 12V battery, always check "Self Diagnosis Result" of all ECUs and erase DTC.

NOTE:

The removal of 12V battery may cause a DTC detection error.

FOR MEXICO

FOR MEXICO : Precaution for Supplemental Restraint System (SRS) "AIR BAG" and "SEAT BELT PRE-TENSIONER"

INFOID:000000010837449

The Supplemental Restraint System such as "AIR BAG" and "SEAT BELT PRE-TENSIONER", used along with a front seat belt, helps to reduce the risk or severity of injury to the driver and front passenger for certain types of collision. Information necessary to service the system safely is included in the "SRS AIR BAG" and "SEAT BELT" of this Service Manual.

WARNING:

Always observe the following items for preventing accidental activation.

- **To avoid rendering the SRS inoperative, which could increase the risk of personal injury or death in the event of a collision that would result in air bag inflation, all maintenance must be performed by an authorized NISSAN/INFINITI dealer.**
- **Improper maintenance, including incorrect removal and installation of the SRS, can lead to personal injury caused by unintentional activation of the system. For removal of Spiral Cable and Air Bag Module, see "SRS AIR BAG".**
- **Never use electrical test equipment on any circuit related to the SRS unless instructed to in this Service Manual. SRS wiring harnesses can be identified by yellow and/or orange harnesses or harness connectors.**

PRECAUTIONS WHEN USING POWER TOOLS (AIR OR ELECTRIC) AND HAMMERS

WARNING:

Always observe the following items for preventing accidental activation.

- **When working near the Air Bag Diagnosis Sensor Unit or other Air Bag System sensors with the ignition ON or engine running, never use air or electric power tools or strike near the sensor(s) with a hammer. Heavy vibration could activate the sensor(s) and deploy the air bag(s), possibly causing serious injury.**
- **When using air or electric power tools or hammers, always switch the ignition OFF, disconnect the battery, and wait at least 3 minutes before performing any service.**

FOR MEXICO : Precaution for Battery Service

INFOID:000000010837450

Before disconnecting the battery, lower both the driver and passenger windows. This will prevent any interference between the window edge and the vehicle when the door is opened/closed. During normal operation, the window slightly raises and lowers automatically to prevent any window to vehicle interference. The automatic window function will not work with the battery disconnected.

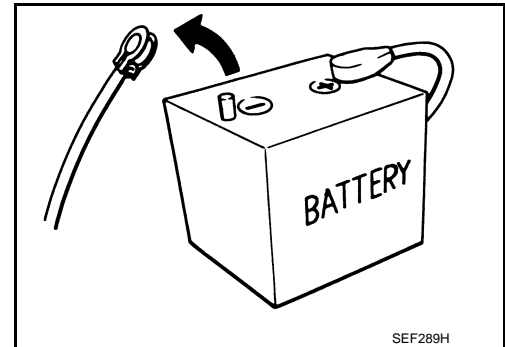

PRECAUTIONS

< PRECAUTION >

FOR MEXICO : Precautions For Xenon Headlamp Service

INFOID:000000011337879

WARNING:

Comply with the following warnings to prevent any serious accident.

- Disconnect the battery cable (negative terminal) or the power supply fuse before installing, removing, or touching the xenon headlamp (bulb included). The xenon headlamp contains high-voltage generated parts.
- Never work with wet hands.
- Check the xenon headlamp ON-OFF status after assembling it to the vehicle. Never turn the xenon headlamp ON in other conditions. Connect the power supply to the vehicle-side connector. (Turning it ON outside the lamp case may cause fire or visual impairments.)
- Never touch the bulb glass immediately after turning it OFF. It is extremely hot.

CAUTION:

Comply with the following cautions to prevent any error and malfunction.

- Install the xenon bulb securely. (Insufficient bulb socket installation may melt the bulb, the connector, the housing, etc. by high-voltage leakage or corona discharge.)
- Never perform HID circuit inspection with a tester.
- Never touch the xenon bulb glass with hands. Never put oil and grease on it.
- Dispose of the used xenon bulb after packing it in thick vinyl without breaking it.
- Never wipe out dirt and contamination with organic solvent (thinner, gasoline, etc.).

FOR MEXICO : Precautions for Removing Battery Terminal

INFOID:000000011337877

- When removing the 12V battery terminal, turn OFF the ignition switch and wait at least 30 seconds.

NOTE:

ECU may be active for several tens of seconds after the ignition switch is turned OFF. If the battery terminal is removed before ECU stops, then a DTC detection error or ECU data corruption may occur.

- For vehicles with the 2-batteries, be sure to connect the main battery and the sub battery before turning ON the ignition switch.

NOTE:

If the ignition switch is turned ON with any one of the terminals of main battery and sub battery disconnected, then DTC may be detected.

- After installing the 12V battery, always check "Self Diagnosis Result" of all ECUs and erase DTC.

NOTE:

The removal of 12V battery may cause a DTC detection error.

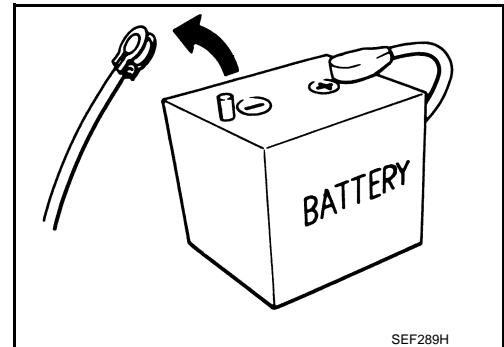

A
B
C
D
E
F
G
SBC
I
J
K
L
M
N
O
P