

SECTION **HAC**

HEATER & AIR CONDITIONING CONTROL SYSTEM

CONTENTS

AUTOMATIC AIR CONDITIONER		A
BASIC INSPECTION	4	
DIAGNOSIS AND REPAIR WORKFLOW	4	B
Work Flow	4	
INSPECTION AND ADJUSTMENT	5	C
Description & Inspection	5	
FUNCTION DIAGNOSIS	9	D
AUTOMATIC AIR CONDITIONER SYSTEM	9	E
System Diagram	9	
System Description	9	
Component Part Location	15	
Component Description	17	
CAN COMMUNICATION SYSTEM	19	F
System Description	19	
DIAGNOSIS SYSTEM (AUTO AMP.)	20	G
CONSULT-III Function	20	
DIAGNOSIS SYSTEM (BCM)	25	H
COMMON ITEM	25	
COMMON ITEM : CONSULT-III Function	25	
AIR CONDITIONER	25	HAC
AIR CONDITIONER : CONSULT-III Function (BCM - AUTO AIR CONDITIONER)	25	
MODE DOOR CONTROL SYSTEM	26	J
Description	26	
AIR MIX DOOR CONTROL SYSTEM	28	K
Description	28	
INTAKE DOOR CONTROL SYSTEM	30	L
Description	30	
BLOWER MOTOR CONTROL SYSTEM	32	M
Description	32	
ELECTRIC COMPRESSOR CONTROL SYSTEM	34	
Description	34	
HEATER PUMP CONTROL SYSTEM	35	
Description	35	
COMPONENT DIAGNOSIS	36	
B2578, B2579 IN-VEHICLE SENSOR	36	
Description	36	
DTC Logic	37	
Diagnosis Procedure	37	
Component Inspection	38	
B257B, B257C AMBIENT SENSOR	39	
Description	39	
DTC Logic	39	
Diagnosis Procedure	40	
Component Inspection	41	
B2581, B2582 INTAKE SENSOR	42	
Description	42	
DTC Logic	42	
Diagnosis Procedure	42	
Component Inspection	44	
B2630, B2631 SUNLOAD SENSOR	45	
Description	45	
DTC Logic	45	
Diagnosis Procedure	46	
Component Inspection	47	
B2632, B2633 AIR MIX DOOR MOTOR PBR (DRIVER SIDE)	49	N
Description	49	
DTC Logic	49	
Diagnosis Procedure	49	
B2634, B2635 AIR MIX DOOR MOTOR PBR (PASSENGER SIDE)	52	O
Description	52	

DTC Logic	52	U1000 CAN COMM CIRCUIT	81
Diagnosis Procedure	52	Description	81
B2636, B2637, B2638, B2639, B2654, B2655		DTC Logic	81
MODE DOOR MOTOR	55	Diagnosis Procedure	81
Description	55	U1010 CONTROL UNIT (CAN)	82
DTC Logic	55	Description	82
Diagnosis Procedure	55	DTC Logic	82
B263D B263E, B263F, B2656 INTAKE DOOR		Diagnosis Procedure	82
MOTOR	58	BLOWER MOTOR	83
Description	58	Description	83
DTC Logic	58	Component Function Check	83
Diagnosis Procedure	58	Diagnosis Procedure	83
B2640, B2641, B2642 ELECTRIC COMPRES-		Component Inspection	85
SOR	61	HEATER PUMP	86
Description	61	Description	86
DTC Logic	61	Component Function Check	86
Diagnosis Procedure	61	Diagnosis Procedure	86
B2643, B2644 ELECTRIC COMPRESSOR	64	POWER SUPPLY AND GROUND CIRCUIT	
Description	64	FOR AUTO AMP.	88
DTC Logic	64	Description	88
Diagnosis Procedure	64	Component Function Check	88
B2645, B2653 ELECTRIC COMPRESSOR	65	Diagnosis Procedure	88
Description	65	ELECTRIC COMPRESSOR	90
DTC Logic	65	Description	90
Diagnosis Procedure	65	Component Function Check	91
B2646, B2647, B2648, B2649, B264A,		Diagnosis Procedure	92
B264C, B264D ELECTRIC COMPRESSOR	66	Component Inspection	92
Description	66	ECU DIAGNOSIS	93
DTC Logic	66	ECM	93
Diagnosis Procedure	66	Reference Value	93
B264E ELECTRIC COMPRESSOR	68	HV ECU	104
Description	68	Reference Value	104
DTC Logic	68	BCM (BODY CONTROL MODULE)	113
Diagnosis Procedure	68	Reference Value	113
B264F ELECTRIC COMPRESSOR	69	Terminal Layout	117
Description	69	Physical Values	118
DTC Logic	69	AUTO AMP.	136
Diagnosis Procedure	69	Reference Value	136
B2651, B2652 ELECTRIC COMPRESSOR	71	Wiring Diagram — AIR CONDITIONER CON-	
Description	71	TROL SYSTEM —	140
DTC Logic	71	DTC Index	149
Diagnosis Procedure	71	SYMPTOM DIAGNOSIS	152
P0AA6-611 ELECTRIC COMPRESSOR	73	AIR CONDITIONER CONTROL	152
Description	73	Diagnosis Chart By Symptom	152
DTC Logic	73	INSUFFICIENT COOLING	153
Diagnosis Procedure	73	Description	153
U0424 ELECTRIC COMPRESSOR	76	Inspection procedure	153
Description	76	INSUFFICIENT HEATING	154
DTC Logic	76		
Diagnosis Procedure	76		

Description	154	Precaution for Supplemental Restraint System (SRS) "AIR BAG" and "SEAT BELT PRE-TENSIONER"	158	A
Inspection procedure	154	Precautions For High-Voltage System	158	B
NOISE	156	Precaution for Procedure without Cowl Top Cover	158	B
Description	156	Precaution for Working with HFC-134a (R-134a)	158	
Inspection procedure	156	Contaminated Refrigerant	159	
MEMORY FUNCTION DOES NOT OPERATE. 157		General Refrigerant Precaution	159	C
Description	157	Precaution for Leak Detection Dye	159	C
Inspection procedure	157	A/C Identification Label	159	
PRECAUTION	158	Precaution for Refrigerant Connection	159	D
PRECAUTIONS	158	Precaution for Service of Electric Compressor	163	D
		Precaution for Service Equipment	163	
				E
				F
				G
				H
				HAC
				J
				K
				L
				M
				N
				O
				P

BASIC INSPECTION

DIAGNOSIS AND REPAIR WORKFLOW

Work Flow

INFOID:000000001504797

DETAILED FLOW

1. LISTEN TO CUSTOMER COMPLAINT

Listen to customer complaint. (Get detailed information about the conditions and environment when the symptom occurs.)

>> GO TO 2.

2. CHECK DTC

1. Check DTC.
2. Perform the following procedure if DTC is displayed.
 - Record DTC and freeze frame data. (Print them out with CONSULT-III.)
 - Erase DTC. (Refer to [EC-86, "Diagnosis Description"](#).)
 - Study the relationship between the cause detected by DTC and the symptom described by the customer. (Symptom Table is useful. Refer to [HAC-152, "Diagnosis Chart By Symptom"](#).)
3. Check related service bulletins for information.

NOTE:

Freeze frame data is useful if the DTC is not detected.

Is any DTC detected?

- YES >> GO TO 3.
NO >> GO TO 4.

3. PERFORM DTC CONFIRMATION PROCEDURE

Perform DTC CONFIRMATION PROCEDURE for the displayed DTC, and then make sure that DTC is detected again. (Refer to [HAC-149, "DTC Index"](#) below).

>> GO TO 6.

4. VERIFY THE SYMPTOM WITH OPERATIONAL CHECK

Verify the symptom with Operational Check. Refer to [HAC-5, "Description & Inspection"](#).

>> GO TO 5.

5. GO TO APPROPRIATE TROUBLE DIAGNOSIS

Go to appropriate trouble diagnosis (Refer to [HAC-152, "Diagnosis Chart By Symptom"](#) below).

>> GO TO 6.

6. REPAIR OR REPLACE

Repair or replace the specific parts

>> GO TO 7.

7. FINAL CHECK

Final check.

Is the inspection result normal?

- YES >> CHECK OUT
NO >> GO TO 2.

INSPECTION AND ADJUSTMENT

< BASIC INSPECTION >

[AUTOMATIC AIR CONDITIONER]

INSPECTION AND ADJUSTMENT

Description & Inspection

INFOID:000000001504798

DESCRIPTION

The purpose of the operational check is to check if the individual system operates properly.

Conditions : After READY

INSPECTION PROCEDURE

Memory Function

1. Turn temperature control dial (driver side) clockwise until 32°C (90°F) is displayed.
2. Press OFF switch.
3. Turn ignition switch OFF.
4. Turn ignition switch ON (READY).
5. Press AUTO switch.
6. Confirm that the set temperature remains at previous temperature.
7. Press OFF switch.

If NG, go to trouble diagnosis procedure for [HAC-157, "Inspection procedure"](#).

If OK, continue the check.

Blower

1. Turn fan control dial clockwise. Blower should operate on low speed.
2. Turn fan control dial clockwise again, and continue checking blower speed and fan symbol until all speeds are checked.
3. Leave blower on max. speed.

If NG, go to trouble diagnosis procedure for [HAC-83, "Diagnosis Procedure"](#).

If OK, continue the check.

Discharge Air

1. Press MODE switch and DEF switch.
2. Each position indicator should illuminate.
3. Confirm that discharge air comes out according to the air distribution table. Refer to [HAC-9, "System Description"](#).

Without rear ventilation

Discharge air flow				
Mode position indication	Air outlet/distribution			
	VENT	FOOT		DEF
		Front	Rear	
	100%	—	—	—
	44%	42%	14%	—
	22% (17%)	57% (21%)	21% (16%)	— (24%)
	16%	37%	15%	32%
	12%	—	—	88%

() : Manually control





JPIIA0231GB

INSPECTION AND ADJUSTMENT

< BASIC INSPECTION >

[AUTOMATIC AIR CONDITIONER]

With rear ventilation

Discharge air flow						
Mode position indication	Condition	Air outlet/distribution				
		VENT		FOOT		DEF
		Front	Rear	Front	Rear	
	Rear ventilator door: OPEN	85%	15%	—	—	—
		39%	17%	33%	11%	—
		19% (15%)	20% (16%)	42% (34%)	19% (15%)	— (20%)
		14%	15%	29%	13%	29%
		11%	13%	—	—	76%

() : Manually control

JPIIA0232GB

If NG, go to trouble diagnosis procedure for [HAC-55. "Diagnosis Procedure"](#).

If OK, continue the check.

NOTE:

Confirm that the intake door position is at FRE when the D/F or DEF is selected.

Intake Air

1. Press recirculation (REC) switch. Recirculation indicator should illuminate.
2. Press recirculation (REC) switch again. Recirculation indicator should not illuminate.
3. Listen for intake door position change. (Slight change of blower sound can be heard.)

If NG, go to trouble diagnosis procedure for [HAC-58. "Diagnosis Procedure"](#).

If OK, continue the check.

NOTE:

Confirm that the intake door position is at FRE when the D/F or DEF is selected.

Temperature Decrease

1. Turn temperature control dial (driver side) counterclockwise until 18°C (60°F) is displayed.
2. Check for cold air at discharge air outlets.

If NG, go to trouble diagnosis procedure for [HAC-153. "Inspection procedure"](#).

If OK, continue the check.

Temperature Increase

1. Turn temperature control dial (driver side) clockwise until 32°C (90°F) is displayed.
2. Check for hot air at discharge air outlets.

If NG, go to trouble diagnosis procedure for [HAC-154. "Inspection procedure"](#).

If OK, continue the check.

A/C Switch

1. Press AUTO switch and A/C switch.
2. A/C switch indicator will turn ON.

Auto Mode

1. Press AUTO switch and A/C switch.
2. AUTO switch indicator will turn ON.
 - Confirm that discharge air and blower speed will depend on ambient, in-vehicle, and set temperatures.

If NG, go to trouble diagnosis procedure for [HAC-88. "Diagnosis Procedure"](#), then if necessary, trouble diagnosis procedure for [HAC-92. "Diagnosis Procedure"](#).

If all operational checks are OK (symptom cannot be duplicated), go to Incident Simulation Tests in [GI-38. "Work Flow"](#) and perform tests as outlined to simulate driving conditions environment. If symptom appears, refer to [HAC-152. "Diagnosis Chart By Symptom"](#) and perform applicable trouble diagnosis procedures.

AUXILIARY MECHANISM

Temperature Setting Trimmer

INSPECTION AND ADJUSTMENT

< BASIC INSPECTION >

[AUTOMATIC AIR CONDITIONER]

The trimmer compensates for differences in range of $\pm 3^{\circ}\text{C}$ ($\pm 6^{\circ}\text{F}$) between temperature setting and temperature felt by customer using CONSULT-III.

Operating procedures for this trimmer are as follows:

1. Turn ignition switch ON (READY).
2. Perform "TEMP SET CORRECT" in "WORK SUPPORT" with CONSULT-III.
3. Temperature will change at a rate of 0.5°C (1.0°F).

NOTE:

When low voltage battery cable is disconnected or battery voltage is below 10 V, trimmer operation is canceled. Temperature set becomes that of initial condition, i.e. 0.0°C (0.0°F).

Foot Position Setting Trimmer

Wind distribution ratio in FOOT mode can be set.

Operating procedures for this trimmer are as follows:

1. Turn ignition switch ON (READY).
2. Perform "BLOWER FAN SET" in "WORK SUPPORT" with CONSULT-III.
3. Foot mode is selected by setting the following.

Blower Fan Set (Without rear ventilation)

Work Item	Discharge air flow							
	Automatically controls the mode door				Manually controls the mode door			
	VENT	FOOT		DEF	VENT	FOOT		DEF
		Front	Rear			Front	Rear	
MODE 1	17%	43%	16%	24%	17%	43%	16%	24%
MODE 2*	22%	57%	21%	—	17%	43%	16%	24%
MODE 3	22%	57%	21%	—	22%	57%	21%	—
MODE 4	17%	43%	16%	24%	22%	57%	21%	—

*: Initial setting

Blower Fan Set (With rear ventilation)

Work Item	Discharge air flow									
	Automatically controls the mode door					Manually controls the mode door				
	VENT		FOOT		DEF	VENT		FOOT		DEF
	Front	Rear	Front	Rear		Front	Rear	Front	Rear	
MODE 1	15%	16%	34%	15%	20%	15%	16%	34%	15%	20%
MODE 2*	19%	20%	42%	19%	—	15%	16%	34%	15%	20%
MODE 3	19%	20%	42%	19%	—	19%	20%	42%	19%	—
MODE 4	15%	16%	34%	15%	20%	19%	20%	42%	19%	—

*: Initial setting

NOTE:

When low voltage battery cable is disconnected or battery voltage is below 10 V, trimmer operation is canceled. Wind distribution ratio set becomes that of initial condition.

REC Memory Function

When ignition switch is turned from OFF to ON, inlet port can be set to AUTO or manual.

Operating procedures for this trimmer are as follows:

1. Turn ignition switch ON (READY).
2. Perform "REC MEMORY SET" in "WORK SUPPORT" with CONSULT-III.
3. REC memory function is selected by setting the following.

REC MEMORY SET	Setting status
MODE 1	Manual REC status is memorized. (Initial setting)
MODE 2	AUTO control

NOTE:

INSPECTION AND ADJUSTMENT

< BASIC INSPECTION >

[AUTOMATIC AIR CONDITIONER]

When low voltage battery cable is disconnected or battery voltage is below 10 V, memory function is canceled. Memory function set becomes that of initial condition.

FRE Memory Function

When ignition switch is turned from OFF to ON, inlet port can be set to AUTO or manual.

Operating procedures for this trimmer are as follows:

1. Turn ignition switch ON (READY).
2. Perform "FRE MEMORY SET" in "WORK SUPPORT" with CONSULT-III.
3. FRE memory function is selected by setting the following.

FRE MEMORY SET	Setting status
MODE 1	Manual FRE status is memorized.
MODE 2	AUTO control (Initial setting)

NOTE:

When low voltage battery cable is disconnected or battery voltage is below 10 V, memory function is canceled. Memory function set becomes that of initial condition.

AUTOMATIC AIR CONDITIONER SYSTEM

< FUNCTION DIAGNOSIS >

[AUTOMATIC AIR CONDITIONER]

FUNCTION DIAGNOSIS

AUTOMATIC AIR CONDITIONER SYSTEM

System Diagram

INFOID:000000001504799

CONTROL SYSTEM

The control system consists of input sensors, switches, auto amp. (microcomputer) and outputs. The relationship of these components is shown in the figure below:

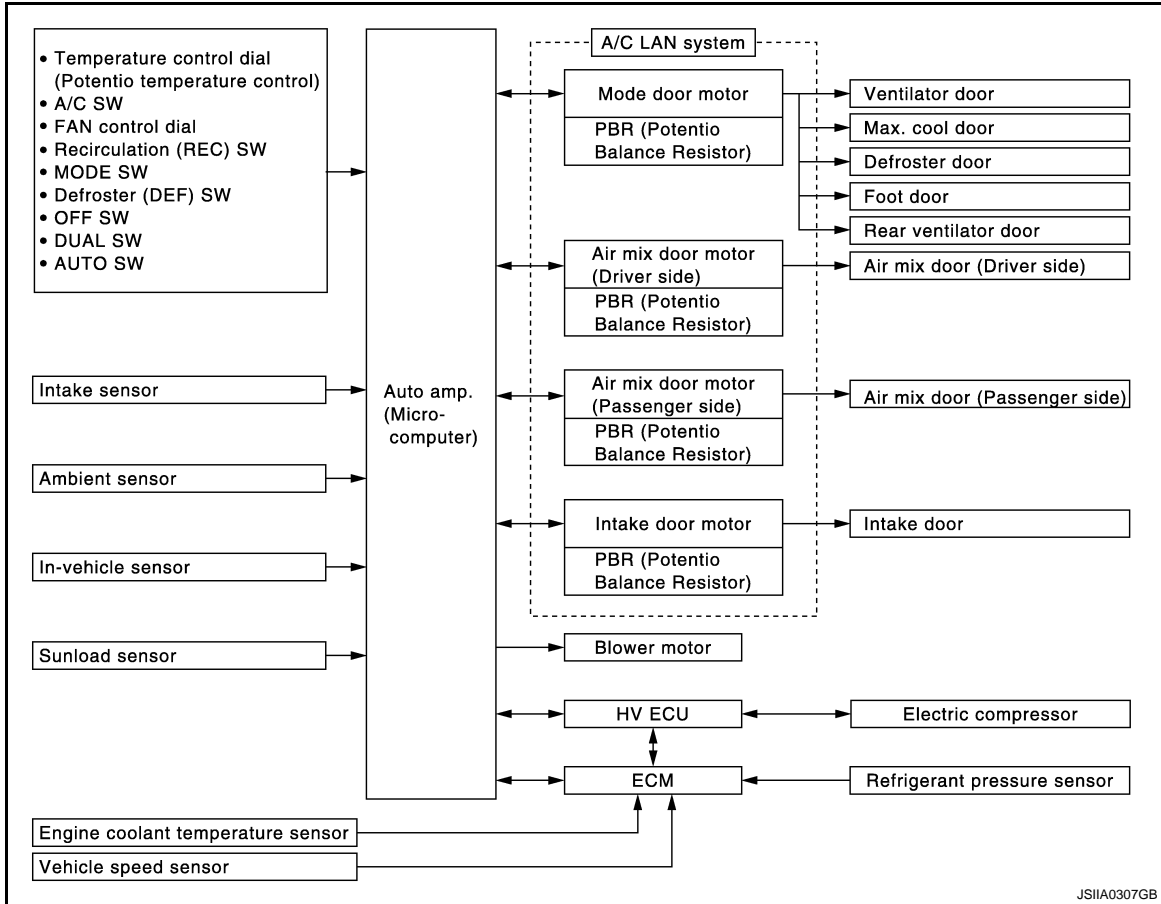

System Description

INFOID:000000001504800

CONTROL OPERATION

Controller

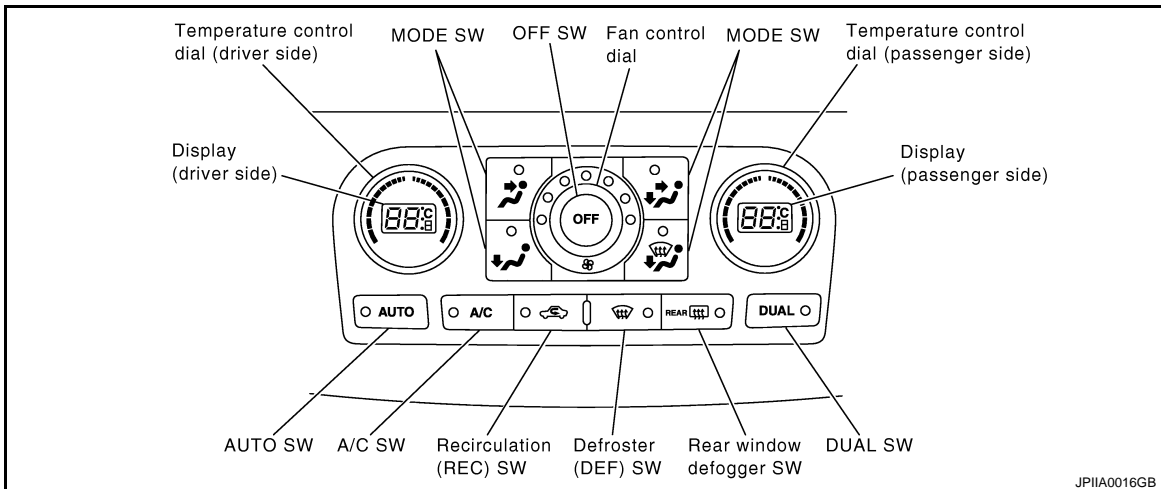

AUTOMATIC AIR CONDITIONER SYSTEM

< FUNCTION DIAGNOSIS >

[AUTOMATIC AIR CONDITIONER]

MODE Switch

The air discharge outlets is controlled with this switch.

Temperature Control Dial (Potentio Temperature Control) (Driver Side)

The set temperature is increased or decreased with this dial.

Temperature Control Dial (Potentio Temperature Control) (Passenger Side)

- The set temperature is increased or decreased with this dial.
- When the temperature control dial is turned, the DUAL switch indicator will automatically illuminate.

AUTO Switch

- The compressor, intake door, air mix doors, mode doors and blower speed are automatically controlled so that the in-vehicle temperature will reach, and be maintained at the set temperature selected by the operator.
- When pressing AUTO switch, air inlet, air outlet, fan speed, and discharge air temperature are automatically controlled.

Defroster (DEF) Switch

Mode doors are set to the defrost position with this switch. Also, intake door is set to the outside air position, and compressor turns ON.

A/C Switch

Compressor is ON or OFF with this switch.

(Pressing the A/C switch when the A/C switch is ON will turn OFF the A/C switch and compressor.)

FAN Control Dial

The blower speed is manually controlled with this dial. Seven speeds are available for manual control (as shown on the LEDs).

OFF Switch

Compressor and blower are OFF, intake doors and the mode doors are automatically controlled.

Rear Window Defogger Switch

When illumination is ON, rear window is defogged.

Recirculation (REC) Switch

- When recirculation (REC) switch is ON, REC LED turns ON, and air inlet is fixed to REC.
- When press recirculation (REC) switch again, REC LED turns OFF, and then, automatic control mode is entered.
- When REC LED is turned OFF, shifting mode position to D/F or DEF, or when compressor is turned from ON to OFF, recirculation (REC) switch is automatically turned OFF (fixed to automatic control mode). REC mode can be re-entered by pressing recirculation (REC) switch again, and then compressor is turned ON. (Except D/F or DEF position)

DUAL Switch

- When the DUAL switch LED is turned ON, the driver side and passenger side, temperature can each be set independently.
- When the DUAL switch LED is not turned OFF, the driver side outlet and setting temperature is applied to both sides.

AUTOMATIC AIR CONDITIONER SYSTEM

< FUNCTION DIAGNOSIS >

[AUTOMATIC AIR CONDITIONER]

DISCHARGE AIR FLOW

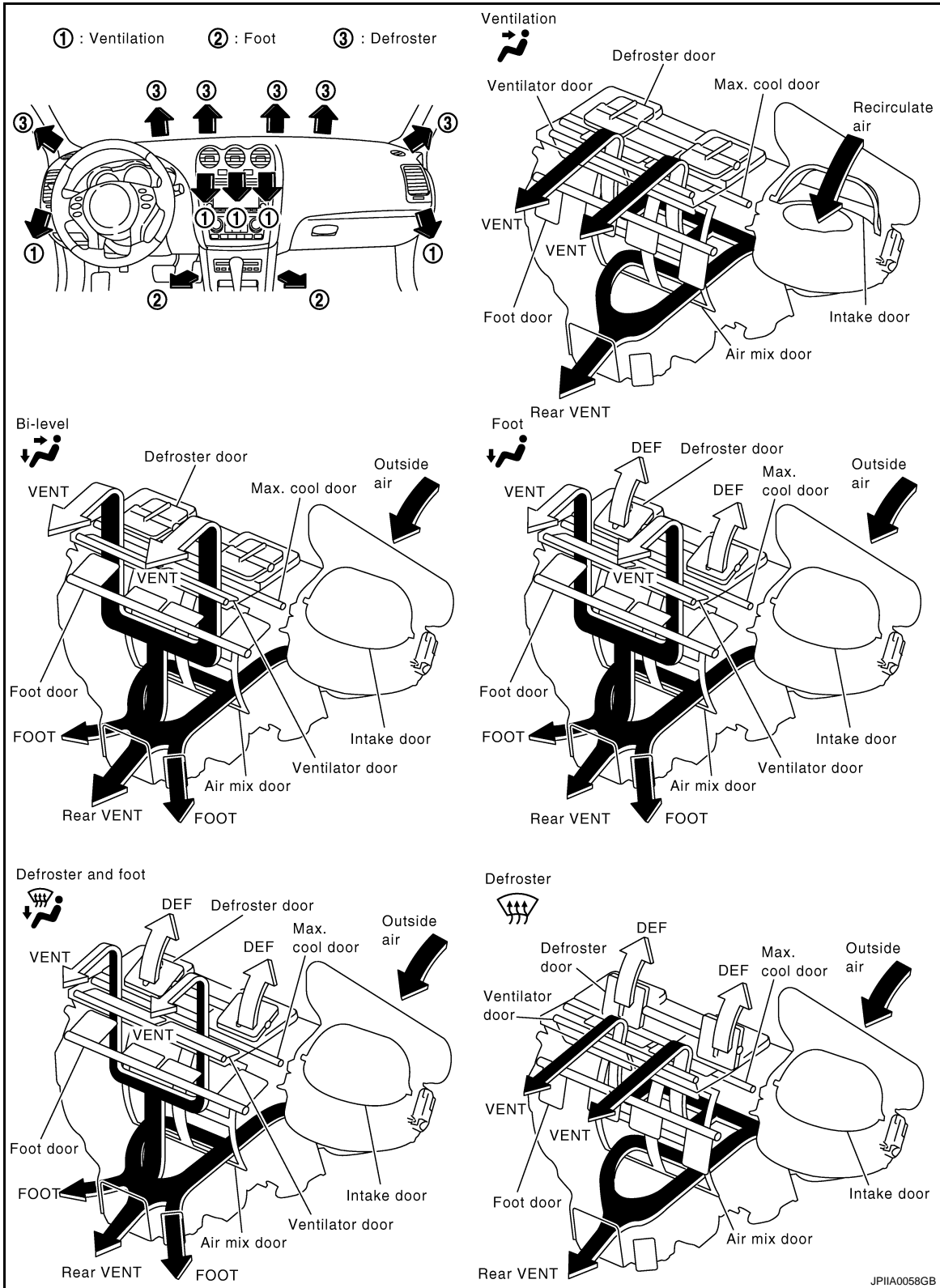

A
B
C
D
E
F
G
H
IAC
J
K
L
M
N
O
P

AUTOMATIC AIR CONDITIONER SYSTEM

< FUNCTION DIAGNOSIS >

[AUTOMATIC AIR CONDITIONER]

SWITCHES AND THEIR CONTROL FUNCTION

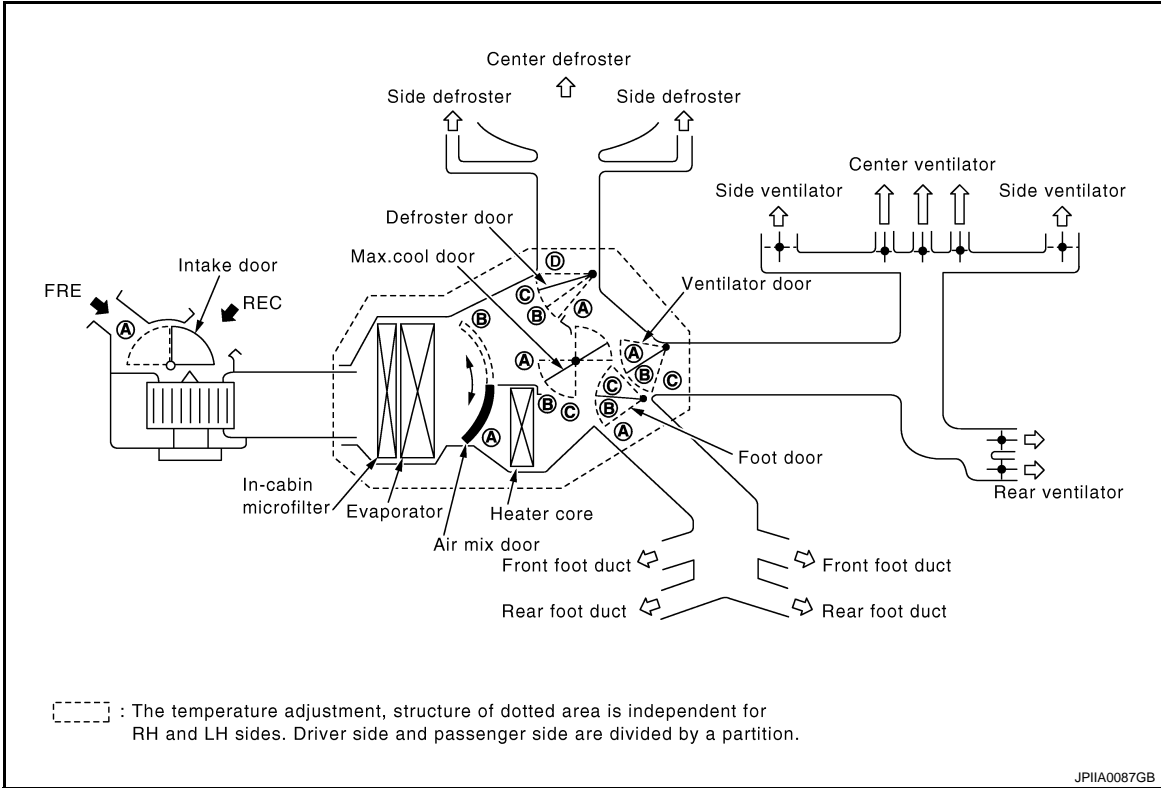

Position or switch	DUAL SW	MODE SW				DEF SW		AUTO SW	REC SW	Temperature control dial(Driver side)		Temperature control dial(Passenger side)		OFF SW
	DUAL ○	VENT	B/L	FOOT	D/F	ON	OFF	○ AUTO	○	☀	18°C (60°F) ↔ 32°C (90°F)	18°C (60°F) ↔ 32°C (90°F)	○ OFF	
Door	☀	☀	☀	☀	☀	☀	○	☀	○	☀	18°C (60°F) ↔ 32°C (90°F)	18°C (60°F) ↔ 32°C (90°F)	○ OFF	
Ventilator door	—	(A)	(B)	(C)	(C)	(C)	—	—	—	—	—	—	AUTO	
Max.cool door	—	(A)	(B)	(B)	(B)	(C)	—	—	—	—	—	—		
Defroster door	—	(D)	(D)	(D) ^{*1}	(C)	(B)	(A)	—	—	—	—	—		
Foot door	—	(A)	(B)	(C)	(C)	(C)	—	AUTO	(A) ^{*2}	—	—	—		
Intake door	—	—	—	—	AUTO	AUTO	—	—	—	—	—	—	—	
Air mix door (Driver side)	—	—	—	—	—	—	—	—	—	(A) AUTO	(B)	—	—	
Air mix door (Passenger side)	ON	—	—	—	—	—	—	—	—	—	(A) AUTO	(B)	—	
	OFF	—	—	—	—	—	—	—	—	(A) AUTO	(B)	—	—	

*1: This position is selected only when the mode door is automatically controlled.

*2: Inlet status is displayed under the automatic control.

JPIIA0088GB

AIR CONDITIONER LAN CONTROL SYSTEM

The LAN (Local Area Network) system consists of auto amp., mode door motor, air mix door motors and intake door motor.

AUTOMATIC AIR CONDITIONER SYSTEM

< FUNCTION DIAGNOSIS >

[AUTOMATIC AIR CONDITIONER]

A configuration of these components is shown in the figure below.

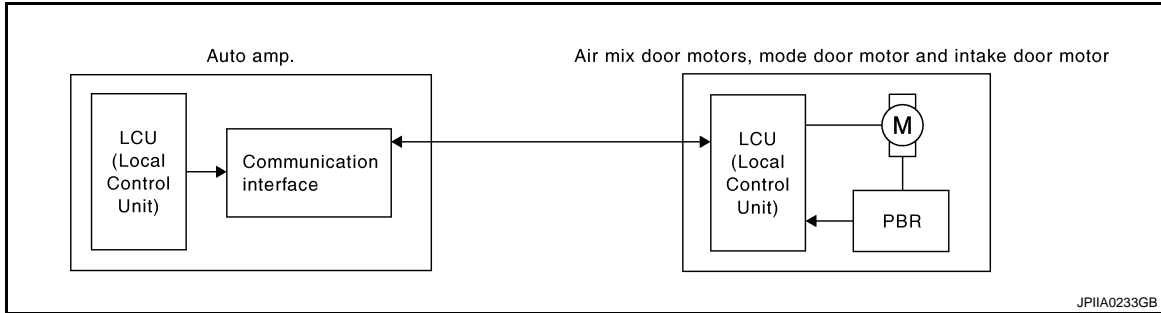

SYSTEM CONSTRUCTION

A small network is constructed between the auto amp., mode door motor, air mix door motors and intake door motor. The auto amp. and motors are connected by data transmission lines and motor power supply lines. The LAN network is built through the ground circuits of each door motor.

Addresses, motor opening angle signals, motor stop signals and error checking messages are all transmitted through the data transmission lines connecting the auto amp. and each door motor.

The following functions are contained in LCUs built into the mode door motor, the air mix door motors and the intake door motor.

- Address
- Motor opening angle signals
- Data transmission
- Motor stop and drive decision
- Opening angle sensor (PBR function)
- Comparison
- Decision (Auto amp. indicated value and motor opening angle comparison)

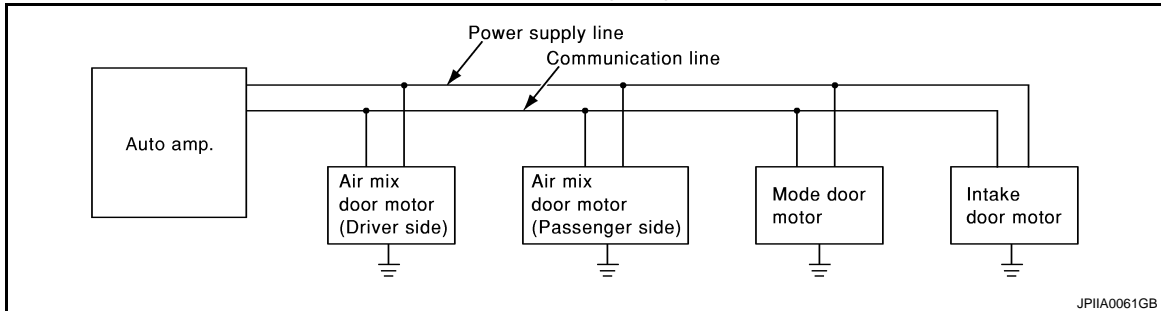

Operation

The auto amp. receives data from each of the sensors. The auto amp. sends mode door, air mix door and intake door opening angle data to the mode door motor LCU, air mix door motor LCUs and intake door motor LCU.

The mode door motor, air mix door motors and intake door motor read their respective signals according to the address signal. Opening angle indication signals received from the auto amp. and each of the motor position sensors is compared by the LCUs in each door motor with the existing decision and opening angles. Subsequently, HOT/COLD, DEF/VENT and FRE/REC operation is selected. The new selection data is returned to the auto amp.

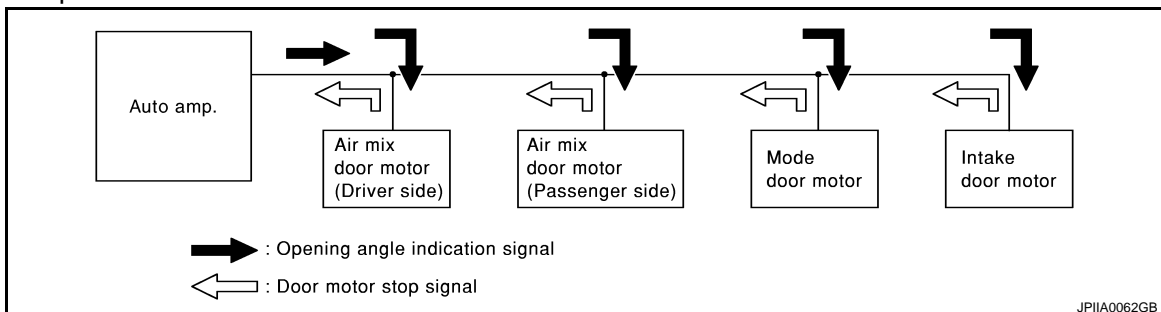

Transmission Data and Transmission Order

Auto amp. data is transmitted consecutively to each of the doors motor following the form shown in the figure below.

A
B
C
D
E
F
G
H
J
K
L
M
N
O
P

HAC

AUTOMATIC AIR CONDITIONER SYSTEM

< FUNCTION DIAGNOSIS >

[AUTOMATIC AIR CONDITIONER]

START:

- Initial compulsory signal is sent to each of the door motors.

ADDRESS:

- Data sent from the auto amp. are selected according to data-based decisions made by the mode door motor, air mix door motors and intake door motor.
- If the addresses are identical, the opening angle data and error check signals are received by the door motor LCUs. The LCUs then make the appropriate error decision. If the opening angle data have no error, door control begins.
- If an error exists, the received data are rejected and corrected data received. Finally, door control is based upon the corrected opening angle data.

OPENING ANGLE:

- Data that shows the indicated door opening angle of each door motor.

ERROR CHECK:

- In this procedure, transmitted and received data is checked for errors. Error data are then compiled. The error check prevents corrupted data from being used by the mode door motor, the air mix door motors and the intake door motor. Error data can be related to the following symptoms.
 - Malfunction of electrical frequency
 - Poor electrical connections
 - Signal leakage from transmission lines
 - Signal level fluctuation

STOP SIGNAL:

- At the end of each transmission, a stop operation, in-operation, or internal malfunction message is delivered to the auto amp. This completes one data transmission and control cycle.

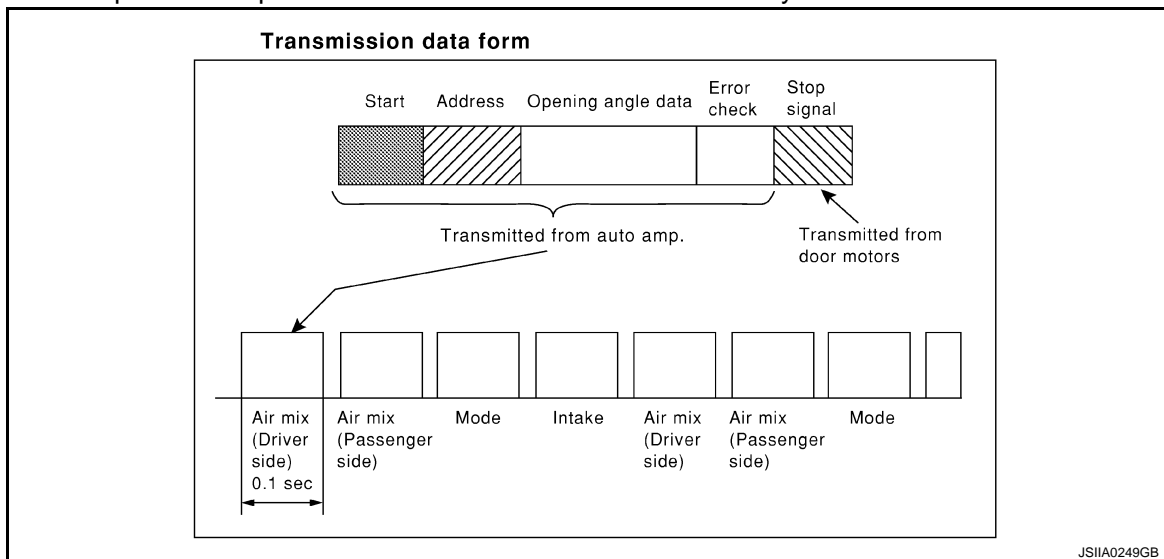

AIR MIX DOOR CONTROL (AUTOMATIC TEMPERATURE CONTROL)

The air mix doors are automatically controlled so that in-vehicle temperature is maintained at a predetermined value by the temperature setting, ambient temperature, in-vehicle temperature and amount of sunload.

FAN SPEED CONTROL

Blower speed is automatically controlled by the temperature setting, ambient temperature, in-vehicle temperature, intake temperature, amount of sunload and air mix door position.

With pressing AUTO switch, the blower motor starts to gradually increase air flow volume.

When engine coolant temperature is low, the blower motor operation is delayed to prevent cool air from flowing.

INTAKE DOOR CONTROL

The intake door is automatically controlled by the temperature setting, ambient temperature, in-vehicle temperature, intake temperature, amount of sunload, temperature of high voltage battery and ON/OFF operation of the compressor.

MODE DOOR CONTROL

AUTOMATIC AIR CONDITIONER SYSTEM

< FUNCTION DIAGNOSIS >

[AUTOMATIC AIR CONDITIONER]

The mode door is automatically controlled by the temperature setting, ambient temperature, in-vehicle temperature, intake temperature and amount of sunload.

ELECTRIC COMPRESSOR CONTROL

When A/C switch, AUTO switch, DEF switch is pressed or when shifting mode position D/F, auto amp. transmits compressor control signal to HV ECU (High Voltage ECU).

HV ECU turns ON to the electric compressor.

HV ECU sends compressor feedback signal to auto amp., then, uses input compressor feedback signal to control air inlet.

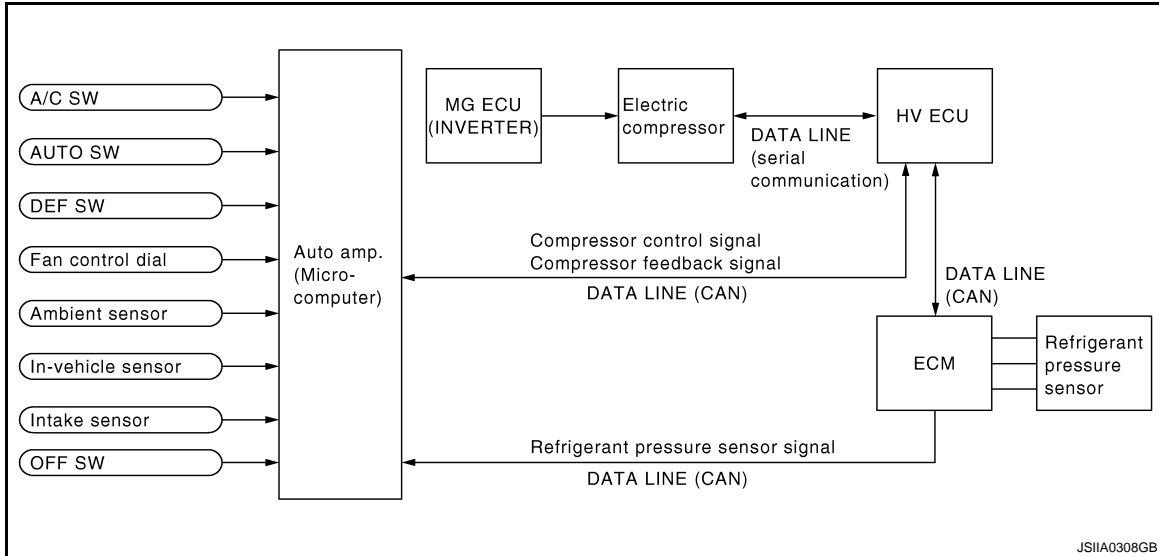

COMPRESSOR SPEED CONTROL

- The auto amp. calculates the target compressor speed based on the target evaporator temperature (calculated from the intake sensor, ambient sensor, and sunload sensor) and the actual evaporator temperature detected by the intake sensor. Then, the auto amp. transmits the target speed to the HV ECU. The HV ECU controls the electric compressor (inverter) based on the target speed data in order to control the compressor to a speed that suits the operating condition of the air conditioning system.
- The auto amp. calculates the target evaporator temperature, which includes corrections based on the in-vehicle sensor, ambient sensor, sunload sensor, and intake sensor. Accordingly, the auto amp. controls the compressor speed to an extent that does not inhibit the proper cooling performance or defogging performance. As a result, comfort and low fuel consumption can be realized.

Component Part Location

INFOID:000000001504801

ENGINE COMPARTMENT

AUTOMATIC AIR CONDITIONER SYSTEM

< FUNCTION DIAGNOSIS >

[AUTOMATIC AIR CONDITIONER]

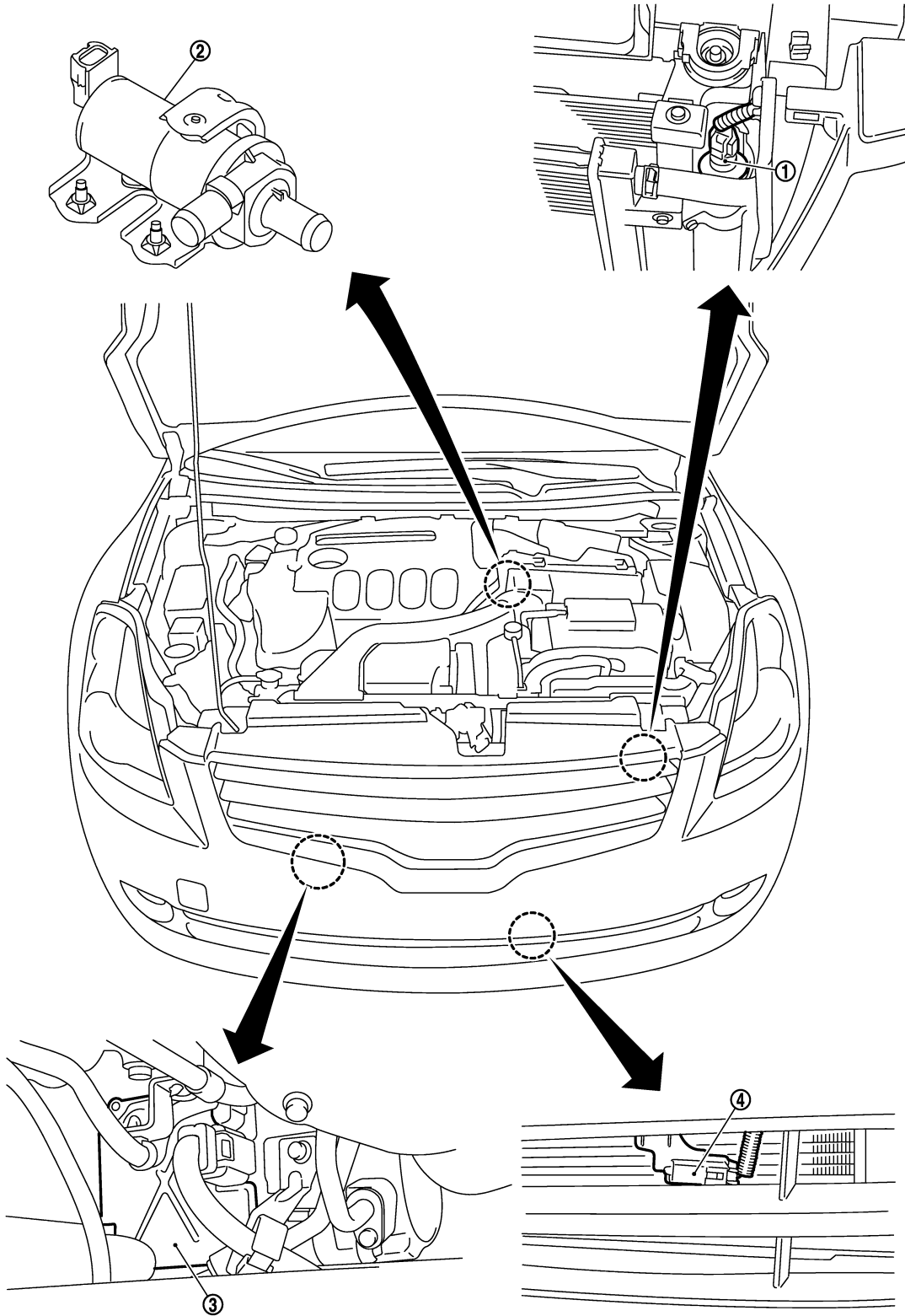

JPIIA0010ZZ

1. Refrigerant pressure sensor

2. Heater pump

3. Electric compressor

4. Ambient sensor

PASSENGER COMPARTMENT

AUTOMATIC AIR CONDITIONER SYSTEM

< FUNCTION DIAGNOSIS >

[AUTOMATIC AIR CONDITIONER]

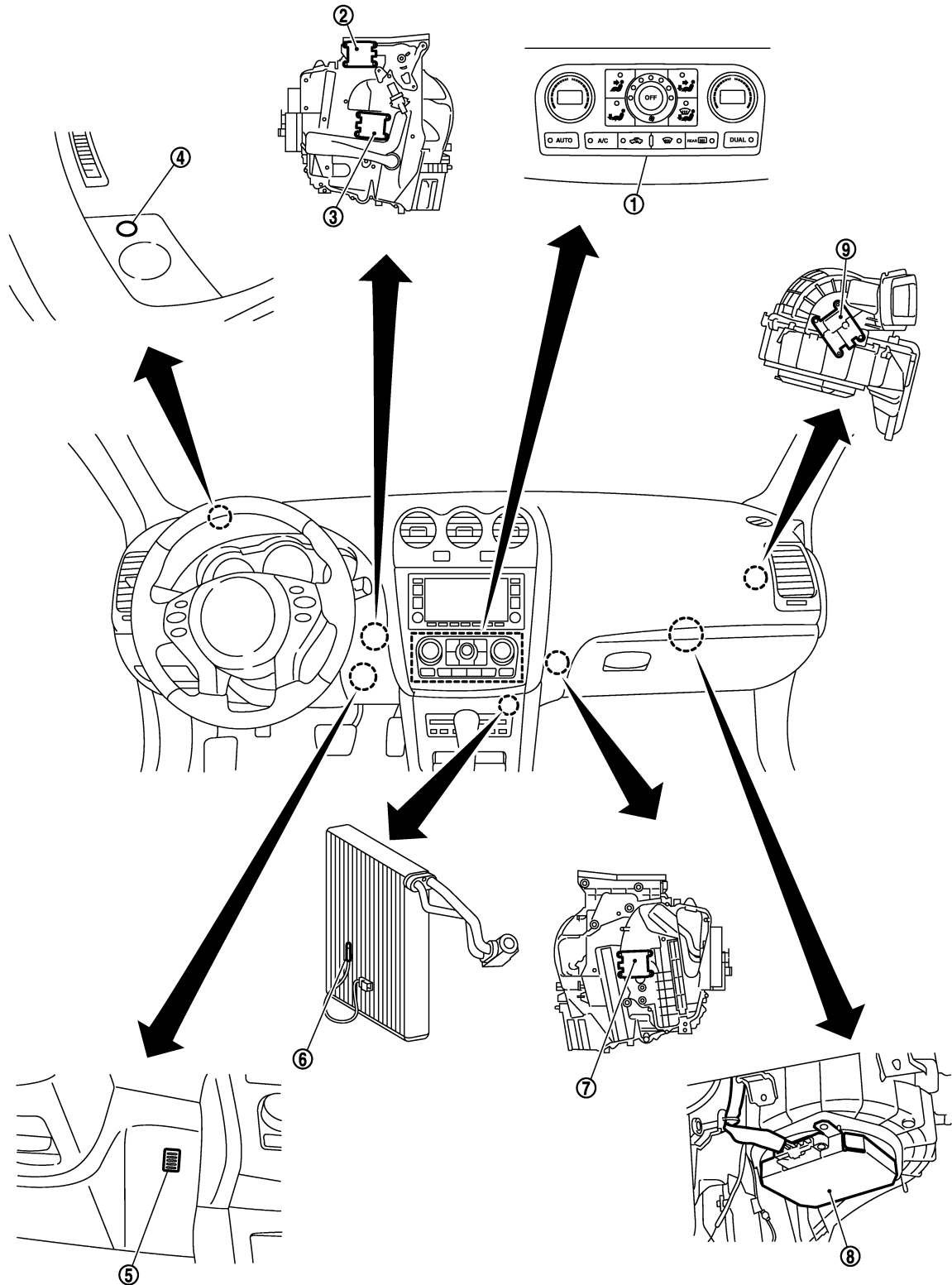

A
B
C
D
E
F
G
H
HAC
J
K
L
M
N
O
P

- | | | |
|--|----------------------|-------------------------------------|
| 1. Controller (auto amp.) | 2. Mode door motor | 3. Air mix door motor (driver side) |
| 4. Sunload sensor | 5. In-vehicle sensor | 6. Intake sensor |
| 7. Air mix door motor (passenger side) | 8. Blower motor | 9. Intake door motor |

JPIIA0011ZZ

Component Description

INFOID:000000001504802

AUTOMATIC AIR CONDITIONER SYSTEM

< FUNCTION DIAGNOSIS >

[AUTOMATIC AIR CONDITIONER]

Component	Reference
Air mix door motor (driver side)	HAC-49. "Description"
Air mix door motor (passenger side)	HAC-52. "Description"
Ambient sensor	HAC-39. "Description"
Blower motor	HAC-83. "Description"
Electric compressor	HAC-90. "Description"
Intake door motor	HAC-58. "Description"
Intake sensor	HAC-42. "Description"
In-vehicle sensor	HAC-36. "Description"
Mode door motor	HAC-55. "Description"
Refrigerant pressure sensor	HAC-92. "Component Inspection"
Sunload sensor	HAC-45. "Description"
Controller (Auto amp.)	HAC-88. "Description"
Heater pump	HAC-86. "Description"

CAN COMMUNICATION SYSTEM

System Description

INFOID:000000001504803

CAN (Controller Area Network) is a serial communication line for real time application. It is an on-vehicle multiplex communication line with high data communication speed and excellent error detection ability. Many electronic control units are equipped onto a vehicle, and each control unit shares information and links with other control units during operation (not independent). In CAN communication, control units are connected with 2 communication lines (CAN-H line, CAN-L line) allowing a high rate of information transmission with less wiring. Each control unit transmits/receives data but selectively reads required data only. For details, refer to [LAN-27, "CAN System Specification Chart"](#).

A
B
C
D
E
F
G
H
J
K
L
M
N
O
P

HAC

DIAGNOSIS SYSTEM (AUTO AMP.)

< FUNCTION DIAGNOSIS >

[AUTOMATIC AIR CONDITIONER]

DIAGNOSIS SYSTEM (AUTO AMP.)

CONSULT-III Function

INFOID:000000001504804

FUNCTION

Diagnostic test mode	Function
Work support	Change the setting for each system function.
Self-diagnostic results	Display the diagnosis result judged by auto amp.
Data monitor	The auto amp. Input/Output signals are displayed.
CAN diagnostic support monitor	The results of transmit/receive diagnosis of CAN communication can be read.
Active test	The signals used to activate each device are forcibly supplied from auto amp.
ECU part number	Auto amp. part number can be read.

WORK SUPPORT MODE

Work Item

Work Item	Setting Item	Setting	
TEMP SET CORRECT	—	The temperature setting correction compensates for difference in range of $\pm 3^{\circ}\text{C}$ ($\pm 6^{\circ}\text{F}$)	
REC MEMORY SET	MODE 1*	Manual REC status is memorized	When ignition switch is turned OFF to ON, inlet port can be set to AUTO or manual.
	MODE 2	Auto control	
FRE MEMORY SET	MODE 1*	Manual FRE status is memorized	
	MODE 2	Auto control	
BLOWER FAN SET	MODE 1	Distribution ratio in FOOT mode can be set. Discharge air flow is shown in the table below.	
	MODE 2*		
	MODE 3		
	MODE 4		

*: Initial setting

Blower Fan Set (Without rear ventilation)

Work Item	Discharge air flow							
	Automatically controls the mode door				Manually controls the mode door			
	VENT	FOOT		DEF	VENT	FOOT		DEF
Front		Rear	Front			Rear		
MODE 1	17%	43%	16%	24%	17%	43%	16%	24%
MODE 2*	22%	57%	21%	—	17%	43%	16%	24%
MODE 3	22%	57%	21%	—	22%	57%	21%	—
MODE 4	17%	43%	16%	24%	22%	57%	21%	—

*: Initial setting

Blower Fan Set (With rear ventilation)

Work Item	Discharge air flow									
	Automatically controls the mode door					Manually controls the mode door				
	VENT		FOOT		DEF	VENT		FOOT		DEF
	Front	Rear	Front	Rear		Front	Rear	Front	Rear	
MODE 1	15%	16%	34%	15%	20%	15%	16%	34%	15%	20%
MODE 2*	19%	20%	42%	19%	—	15%	16%	34%	15%	20%

DIAGNOSIS SYSTEM (AUTO AMP.)

< FUNCTION DIAGNOSIS >

[AUTOMATIC AIR CONDITIONER]

Work Item	Discharge air flow									
	Automatically controls the mode door					Manually controls the mode door				
	VENT		FOOT		DEF	VENT		FOOT		DEF
	Front	Rear	Front	Rear		Front	Rear	Front	Rear	
MODE 3	19%	20%	42%	19%	—	19%	20%	42%	19%	—
MODE 4	15%	16%	34%	15%	20%	19%	20%	42%	19%	—

*: Initial setting

NOTE:

When low voltage battery cable is disconnected or battery voltage is below 10 V, trimmer operation is canceled. Work items becomes that of initial setting.

SELF-DIAG RESULTS MODE

Display Item List

Reading items of DTC. Refer to [HAC-149. "DTC Index"](#).

DATA MONITOR MODE

Monitor Item

x: Applicable

Monitor item	Unit	Description
AMB TEMP SEN	°C/°F	Indicate value of the ambient temperature signal received from ambient sensor.
IN-VEH TEMP	°C/°F	Indicate value of the in-vehicle temperature signal received from in-vehicle sensor.
IN TEMP SEN	°C/°F	Indicate value of the evaporator temperature signal received from intake sensor.
SUNLOAD SEN	W/m ²	Indicate value of the sunload signal received from sunload sensor.
AMB SEN CAL	°C/°F	Indicate the ambient temperature computed from ambient sensor signal.
IN-VEH CAL	°C/°F	Indicate the in-vehicle temperature computed from in-vehicle sensor signal.
INT TEMP CAL	°C/°F	Indicate the evaporator temperature computed from intake sensor signal.
SUNL SEN CAL	W/m ²	Indicate the amount of sunload computed from sunload sensor signal.
COMP REQ SIG	On/Off	Indicate the status of the electric compressor ON request signal from auto amp. to HV ECU.
FAN REQ SIG	On/Off	Indicate the status of the blower fan request signal.
FAN DUTY	%	Indicate value of the blower motor signal received blower motor.
XM	°C/°F	DR SIDE TARGET TEMPERATURE
ENG COOL TEMP	°C/°F	Indicate value of the engine coolant temperature signal received from ECM via CAN communication.
VEHICLE SPEED	km/h/MPH	Indicate value of the vehicle speed signal received from HV ECU via CAN communication.
COMP RPM	rpm	Indicate value of the electric compressor speed signal received from HV ECU via CAN communication.
AC INV VOLT	W	AC INVERTER INPUT VOLTAGE SIGNAL
AC INV CRNT	A	AC INVERTER CURRENT DIRECTION
AC INV TEMP	°C/°F	AC INVERTER TEMPERATURE SENSOR SIGNAL (Alternate between motor housing temperature and inverter temperature.)
AC INV VOLT	V	AC INVERTER VOLTAGE SENSOR SIGNAL
USE POWER	W	USEABLE POWER
PWR SUPP FAIL	—	MAIN POWER SUPPLY FAILURE
OUTPUT FAIL	—	OUTPUT FAILURE
LOAD FAIL	—	LOAD FAILURE
NETWORK FAIL	—	NETWORK FAILURE
START UP FAIL	—	START UP FAILURE
CONTROL FAIL	—	CONTROL FAILURE

DIAGNOSIS SYSTEM (AUTO AMP.)

[AUTOMATIC AIR CONDITIONER]

< FUNCTION DIAGNOSIS >

Monitor item	Unit	Description
STB SHORT	—	STB (electric compressor stand-by signal line) SHORT
STB STATUS	On/Off	STB (electric compressor stand-by signal line) STATUS
INV OVERHEAT	—	INVERTER OVERHEAT
STB REQUEST	On/Off	STB (electric compressor stand-by signal line) ON/OFF REQUEST
HTR WTR PUMP	On/Off	Indicate the status of the heater pump ON request signal transmitted to HV ECU via CAN communication.
ENG ON REQ	On/Off	Indicate the status of the engine ON request signal transmitted to HV ECU via CAN communication.
NETWRK STAT	—	NETWORK STATUS SIGNAL
STB OPEN	—	STB (electric compressor stand-by signal line) OPEN DETECTION
STB STAT ANS	On/Off	STB (electric compressor stand-by signal line) STATUS ANSWER
A/C PD CUT	On/Off	A/C PD CUT FLAG
CLIM COOL REQ	On/Off	Indicate the status of the electric compressor ON request signal from auto amp. to HV ECU.
NE HEATER	rpm	Indicate value of the target engine speed signal transmitted to HV ECU via CAN communication.
HEATER NUP	On/Off	Indicate the status of the target engine speed up request signal to HV ECU via CAN communication.

ACTIVE TEST MODE

Test Item

ALL SEG

Test Item	Operation	Description
ALL SEG	Off	Checks LEDs illumination and display of auto amp.
	On	

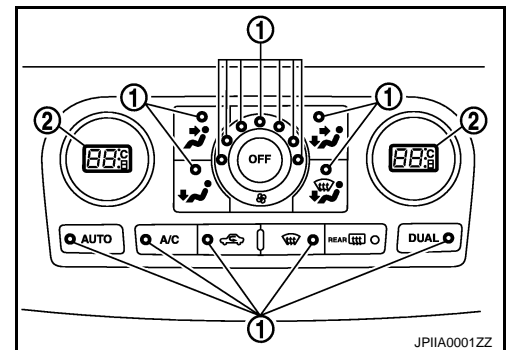

1. LEDs
2. Display

HVAC TEST

DIAGNOSIS SYSTEM (AUTO AMP.)

< FUNCTION DIAGNOSIS >

[AUTOMATIC AIR CONDITIONER]

Test Item	Operation	Description
HVAC TEST	MODE 0 (Off)	Checks discharge air flow, air temperature, blower motor duty ratio, compressor operation, heater pump operation and engine operation.
	MODE 1	
	MODE 2	
	MODE 3	
	MODE 4	
	MODE 5	
	MODE 6	
	MODE 7	

Refer to the following chart and check discharge air flow, air temperature, blower motor duty ratio, compressor operation, heater pump operation and engine operation.

CAUTION:

Complete this inspection within 10 seconds if there is no water in the heater pump.

Operation	MODE 1	MODE 2	MODE 3	MODE 4	MODE 5	MODE 6	MODE 7
Mode door position	VENT	B/L 1	B/L 2	FOOT	D/F	DEF	—
Intake door position	FRE	20% FRE	20% FRE	FRE	FRE	FRE	—
Air mix door (driver side) position	FULL COOL	FULL COOL	FULL HOT	FULL HOT	FULL HOT	FULL HOT	—
Air mix door (passenger side) position	FULL COOL	FULL COOL	FULL HOT	FULL HOT	FULL HOT	FULL HOT	—
Blower motor duty ratio	47%	59%	59%	87%	87%	59%	OFF
Compressor	2,000 rpm	4,500 rpm	OFF	OFF	OFF	4,500 rpm	OFF
Heater pump	OFF	OFF	ON	ON	ON	ON	ON
Engine ON request	OFF	OFF	OFF	OFF	ON	OFF	OFF

Checks must be made visually, by listening the sound, or by touching air outlets with hand, etc. for improper operation.

Without rear ventilation

Discharge air flow				
Mode position indication	Air outlet/distribution			
	VENT	FOOT		DEF
		Front	Rear	
	100%	—	—	—
	44%	42%	14%	—
	22% (17%)	57% (21%)	21% (16%)	— (24%)
	16%	37%	15%	32%
	12%	—	—	88%

() : Manually control





JPIIA0231GB

DIAGNOSIS SYSTEM (AUTO AMP.)

< FUNCTION DIAGNOSIS >

[AUTOMATIC AIR CONDITIONER]

With rear ventilation

Discharge air flow						
Mode position indication	Condition	Air outlet/distribution				
		VENT		FOOT		DEF
		Front	Rear	Front	Rear	
	Rear ventilator door: OPEN	85%	15%	—	—	—
		39%	17%	33%	11%	—
		19% (15%)	20% (16%)	42% (34%)	19% (15%)	— (20%)
		14%	15%	29%	13%	29%
		11%	13%	—	—	76%

() : Manually control

JPIIA0232GB

DIAGNOSIS SYSTEM (BCM)

< FUNCTION DIAGNOSIS >

[AUTOMATIC AIR CONDITIONER]

DIAGNOSIS SYSTEM (BCM)

COMMON ITEM

COMMON ITEM : CONSULT-III Function

INFOID:000000001504805

ECU IDENTIFICATION

Displays the BCM part No.

SELF-DIAG RESULT

Refer to [BCS-74, "DTC Index"](#).

AIR CONDITIONER

AIR CONDITIONER : CONSULT-III Function (BCM - AUTO AIR CONDITIONER)

INFOID:000000001504805

DATA MONITOR

Display Item List

Monitor Item [Unit]	Contents
IGN SW [On/Off]	Display [ignition switch position (On)/(Off), ACC position (Off)] status as judged form ignition switch signal.
FAN ON SIG [On/Off]	Display [FAN (On)/FAN (Off)] status as judged form blower fan motor switch signal.
AIR COND SW [On/Off]	Display [COMP (On)/COMP (Off)] status as judged form air conditioner switch signal.

A
B
C
D
E
F
G
H
J
K
L
M
N
O
P

HAC

MODE DOOR CONTROL SYSTEM

< FUNCTION DIAGNOSIS >

[AUTOMATIC AIR CONDITIONER]

MODE DOOR CONTROL SYSTEM

Description

INFOID:000000001504807

SYSTEM DESCRIPTION

Component Parts

Mode door control system components are:

- Auto amp.
- Mode door motor (LCU)
- A/C LAN system (PBR built-in mode door motor, air mix door motor and intake door motor)
- In-vehicle sensor
- Ambient sensor
- Sunload sensor
- Intake sensor

System Operation

- The auto amp. receives data from each of the sensors.
- The auto amp. sends air mix door, mode door and intake door opening angle data to the air mix door motor LCUs, mode door motor LCU and intake door motor LCU.
- The air mix door motors, mode door motor and intake door motor read their respective signals according to the address signal. Opening angle indication signals received from the auto amp. and each of the motor position sensors are compared by the LCUs in each door motor with the existing decision and opening angles.
- Subsequently, HOT/COLD, DEF/VENT and FRE/REC operation is selected. The new selection data are returned to the auto amp.

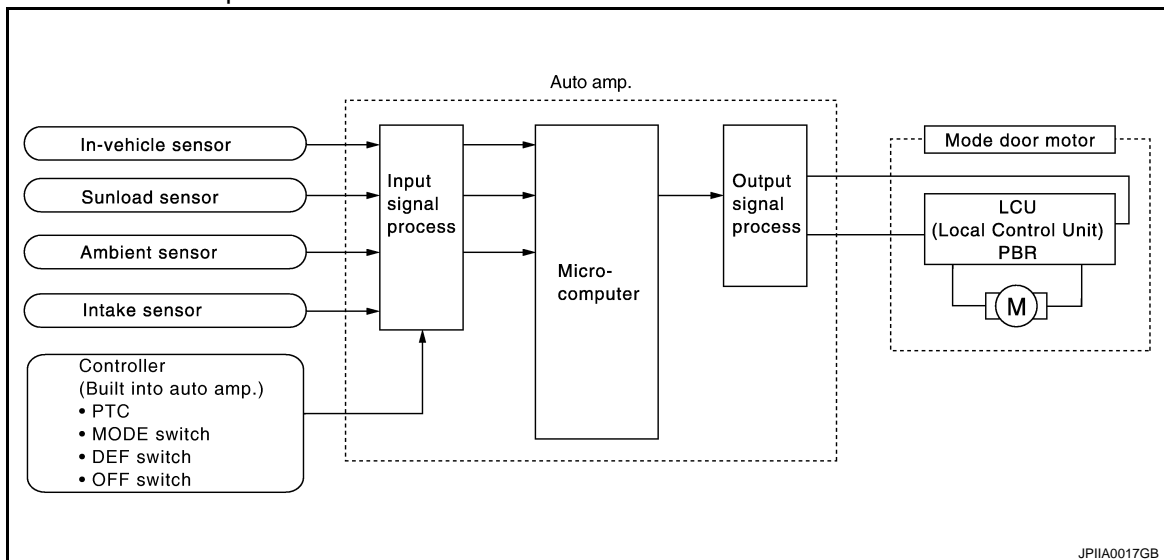

JPIIA0017GB

MODE DOOR CONTROL SYSTEM

[AUTOMATIC AIR CONDITIONER]

< FUNCTION DIAGNOSIS >

LAN System Circuit

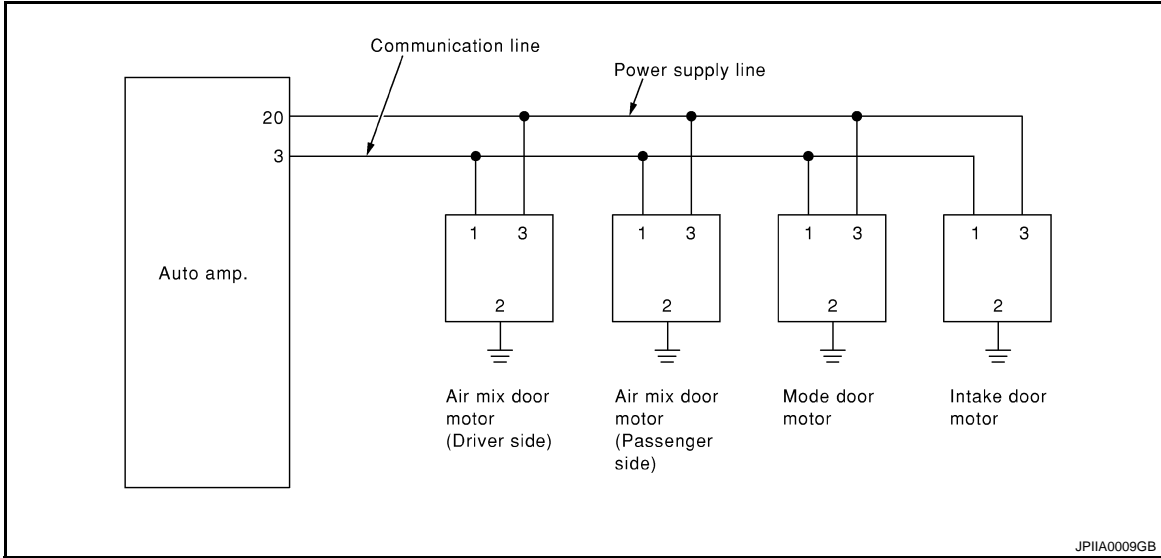

Mode Door Control Specification

Mode position can be selected manually by pressing MODE switch or DEF switch of the controller. This enables to fix a mode position. Automatic control by auto amp. Pressing AUTO switch allows automatic control by auto amp. During the automatic control of mode position, a mode door position (VENT, B/L, FOOT, or D/F) is selected based on a target air mix door opening angle and sunload depending on a temperature calculated by auto amp. In addition, D/F is selected to prevent windshield fogging only when ambient temperature is extremely low with mode position FOOT.

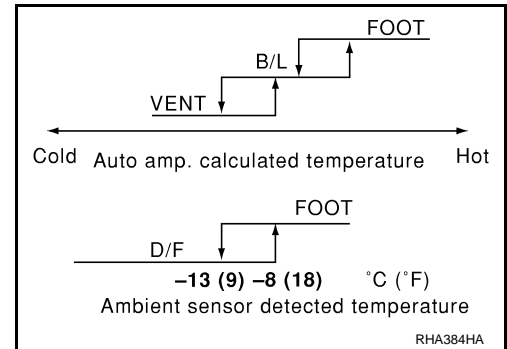

A
B
C
D
E
F
G
H
HAC
J
K
L
M
N
O
P

AIR MIX DOOR CONTROL SYSTEM

< FUNCTION DIAGNOSIS >

[AUTOMATIC AIR CONDITIONER]

AIR MIX DOOR CONTROL SYSTEM

Description

INFOID:000000001504808

SYSTEM DESCRIPTION

Component Parts

Air mix door control system components are:

- Auto amp.
- Air mix door motor (LCU)
- A/C LAN system (PBR built-in mode door motor, air mix door motor and intake door motor)
- In-vehicle sensor
- Ambient sensor
- Sunload sensor
- Sunload sensor
- Intake sensor

System Operation

The auto amp. receives data from each of the sensors. The auto amp. sends air mix doors, mode door and intake door opening angle data to the air mix door motor LCUs, mode door motor LCU and intake door motor LCU.

The air mix door motors, mode door motor and intake door motor read their respective signals according to the address signal. Opening angle indication signals received from the auto amp. and each of the motor position sensors are compared by the LCUs in each door motor with the existing decision and opening angles. Subsequently, HOT/COLD, DEF/VENT and FRE/REC operation is selected. The new selection data are returned to the auto amp.

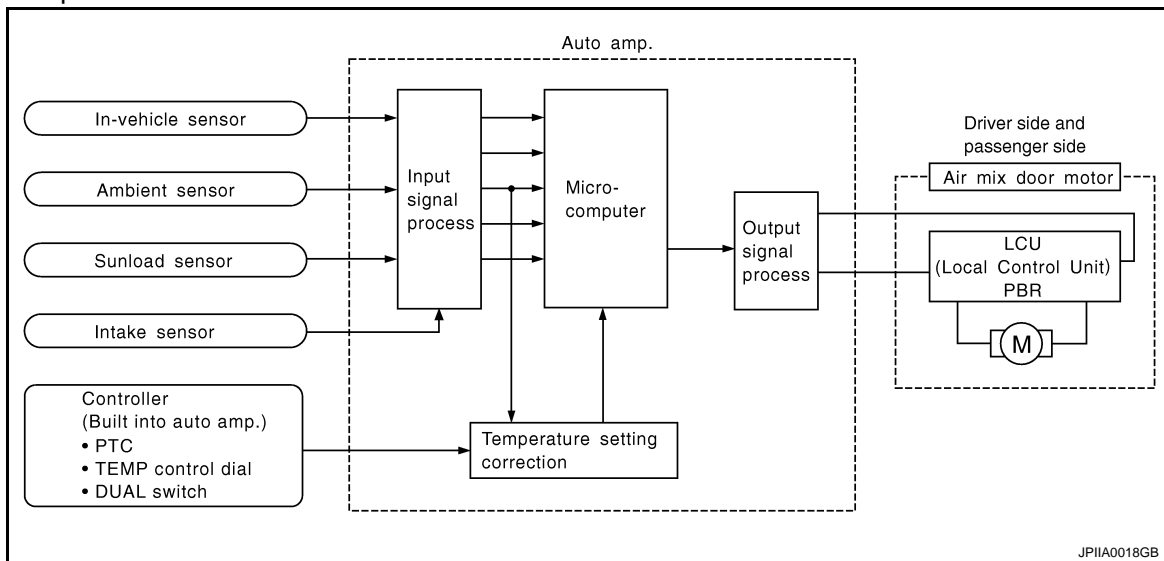

AIR MIX DOOR CONTROL SYSTEM

[AUTOMATIC AIR CONDITIONER]

< FUNCTION DIAGNOSIS >

LAN System Circuit

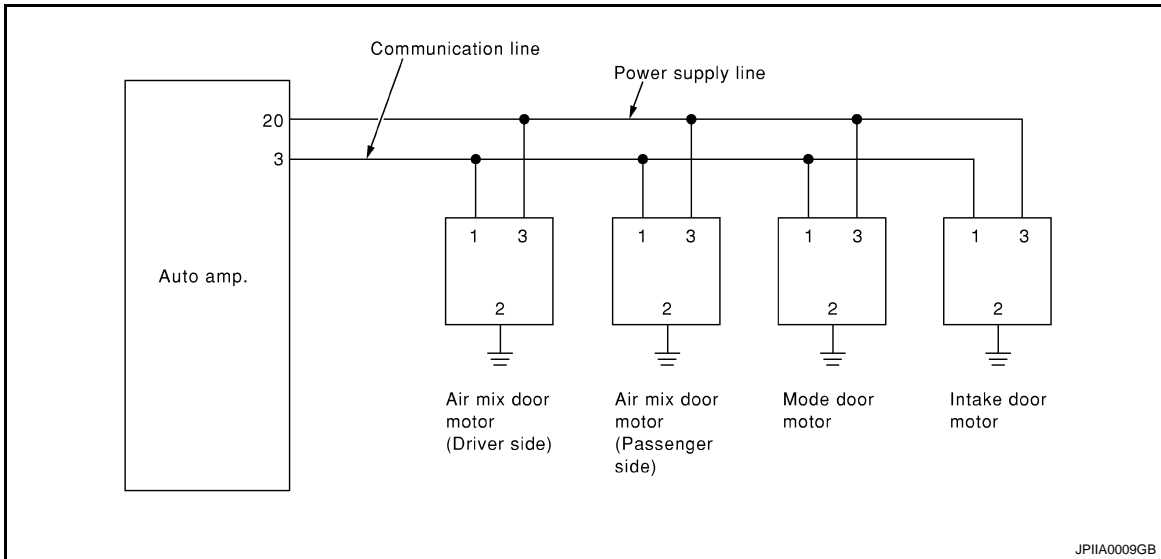

Air Mix Door Control Specification

When ignition switch is ON, Auto amp. continuously and automatically controls temperatures regardless of air conditioner operational condition. When setting a target temperature with temperature control dial, Auto amp. corrects the set temperature and decides a target air mix door opening angle. Auto amp. controls air mix door according to the target air mix door opening angle and current air mix door opening angle in order to keep an optimum air mix door opening angle. When a temperature is set at 18°C (60°F), air mix door is fixed at full cold, and when a temperature is set at 32°C (90°F), it is set at full hot.

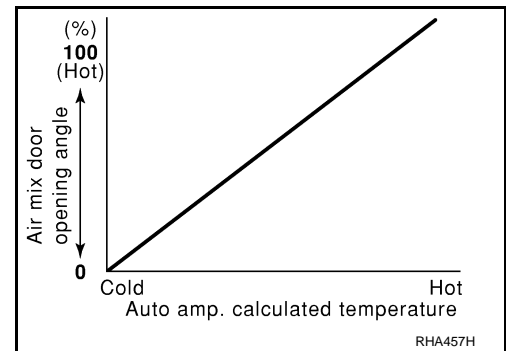

A
B
C
D
E
F
G
H
I
J
K
L
M
N
O
P

HAC

INTAKE DOOR CONTROL SYSTEM

< FUNCTION DIAGNOSIS >

[AUTOMATIC AIR CONDITIONER]

INTAKE DOOR CONTROL SYSTEM

Description

INFOID:000000001504809

SYSTEM DESCRIPTION

Component Parts

Intake door control system components are:

- Auto amp.
- Intake door motor (LCU)
- A/C LAN system (PBR built-in mode door motor, air mix door motor and intake door motor)
- In-vehicle sensor
- Ambient sensor
- Sunload sensor
- Intake sensor

System Operation

The intake door control determines intake door position based on the ambient temperature, the intake air temperature and the in-vehicle temperature. When shifting mode position D/F, when the DEF or OFF switches are pressed, or when A/C switch is OFF, the auto amp. sets the intake door at the FRE position.

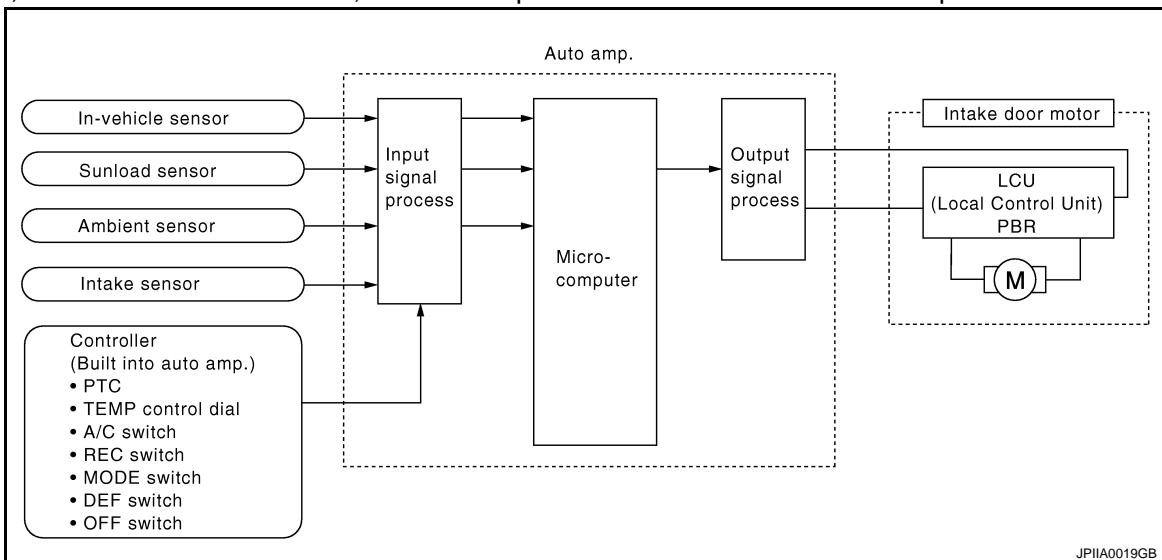

LAN System Circuit

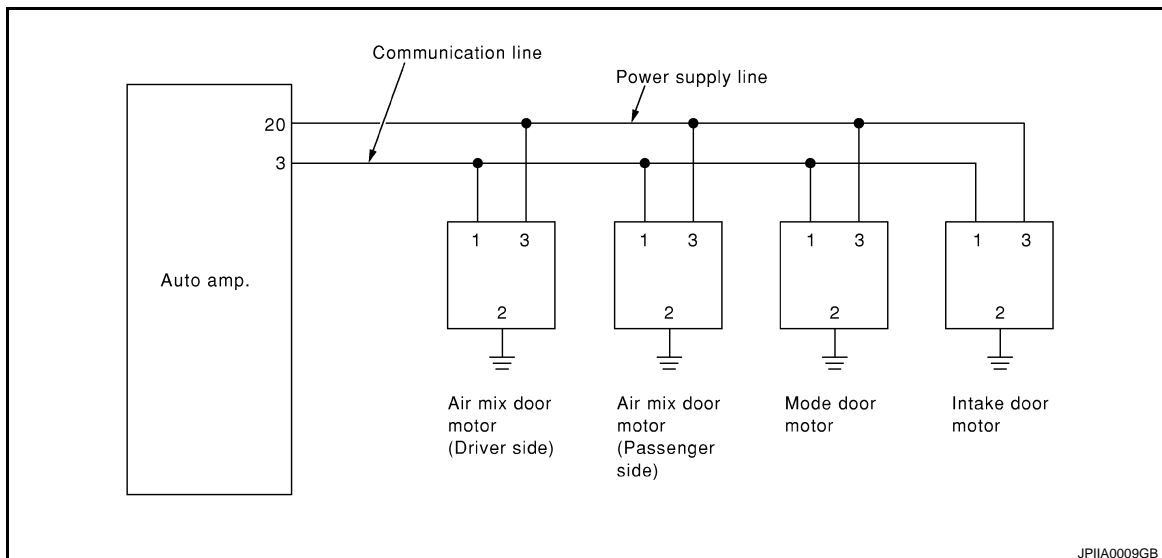

Intake Door Control Specification

INTAKE DOOR CONTROL SYSTEM

[AUTOMATIC AIR CONDITIONER]

< FUNCTION DIAGNOSIS >

Intake door position is basically fixed at FRE when FRE indicator lamps of DEF switch and intake switch turn ON, and fixed at REC when REC indicator lamp of intake switch turns ON.

Intake door automatic control selects FRE, 20%FRE, or REC depending on a target air mix door opening angle, based on in-vehicle temperature, ambient temperature, and sunload.

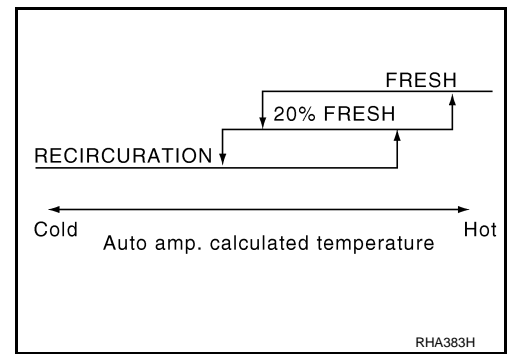

A
B
C
D
E
F
G
H
J
K
L
M
N
O
P

HAC

BLOWER MOTOR CONTROL SYSTEM

< FUNCTION DIAGNOSIS >

[AUTOMATIC AIR CONDITIONER]

BLOWER MOTOR CONTROL SYSTEM

Description

INFOID:000000001504810

SYSTEM DESCRIPTION

Component Parts

Fan speed control system components are:

- Auto amp.
- A/C LAN system (PBR built-in mode door motor, air mix door motor and intake door motor)
- In-vehicle sensor
- Ambient sensor
- Sunload sensor
- Intake sensor

System Operation

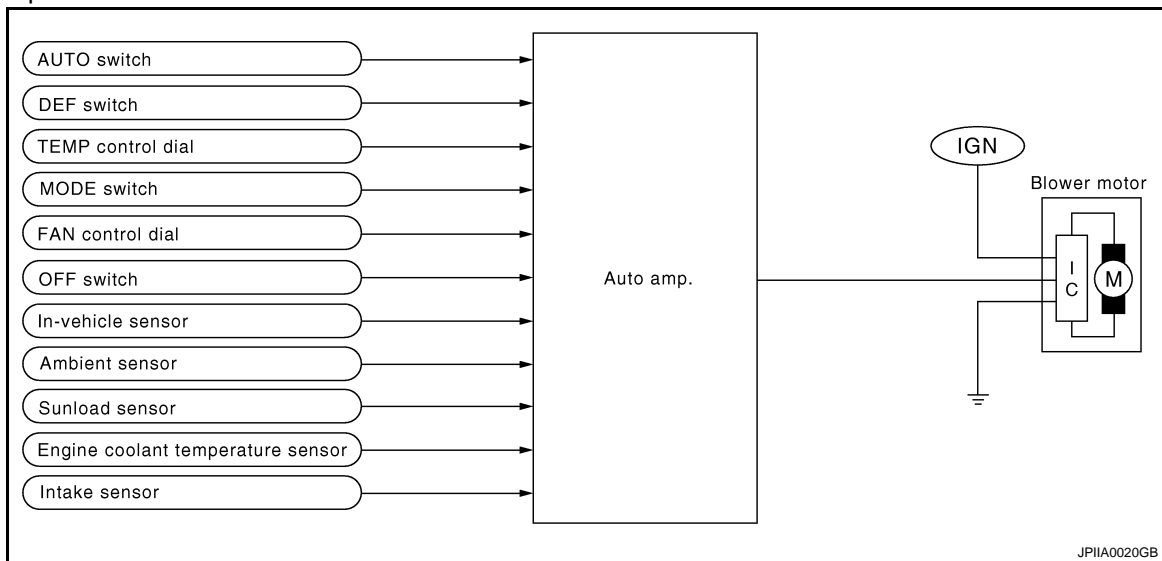

Blower motor circuit

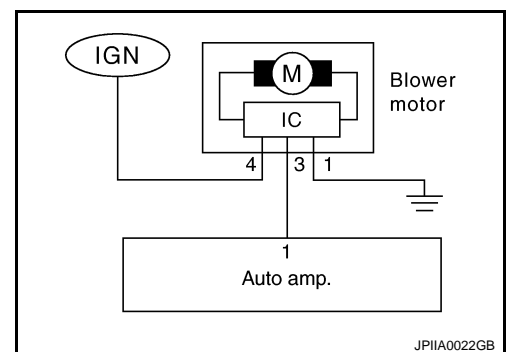

Automatic Mode

In the automatic mode, the blower motor speed is calculated by the auto amp. based on the input from the PBR, in-vehicle sensor, sunload sensor, intake sensor and ambient sensor.

When the air flow is increased, the duty ratio of the blower fan motor's drive signal is changed at 8%/sec. to prevent a sudden increase in air flow.

In addition to manual air flow control and the usual automatic air flow control, starting air flow control, low water temperature starting control and high passenger compartment temperature starting control are available.

Starting Fan Speed Control

Start up from COLD SOAK Condition (Automatic mode)

In a cold start up condition where the engine coolant temperature is below 56°C (133°F), the blower will not operate for a short period of time (up to 150 seconds). The exact start delay time varies depending on the ambient and engine coolant temperature.

BLOWER MOTOR CONTROL SYSTEM

[AUTOMATIC AIR CONDITIONER]

< FUNCTION DIAGNOSIS >

In the most extreme case (very low ambient) the blower starting delay will be 150 seconds as described above. After this delay, the blower will operate at low speed until the engine coolant temperature rises above 56°C (133°F), and then the blower speed will increase to the objective speed.

Start up from usual or HOT SOAK Condition (Automatic mode)

The blower will begin operation momentarily after the AUTO switch is pressed. The blower speed will gradually rise to the objective speed over a time period of 3 seconds or less (actual time depends on the objective blower speed).

Blower Speed Compensation

Sunload

When the in-vehicle temperature and the set temperature are very close, the blower will be operating at low speed. The low speed will vary depending on the sunload. During conditions of low or no sunload, the blower speed is at duty ratio 25%. During high sunload conditions, the auto amp. raise the blower speed (duty ratio 41%).

Fan Speed Control Specification

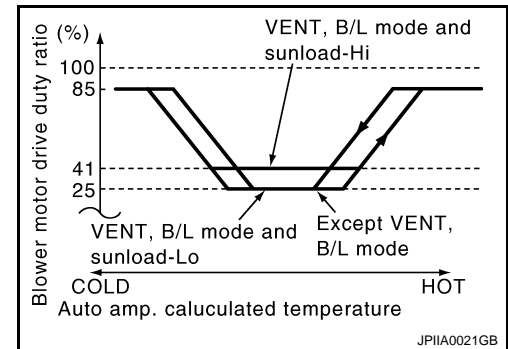

A
B
C
D
E
F
G
H
J
K
L
M
N
O
P

HAC

ELECTRIC COMPRESSOR CONTROL SYSTEM

< FUNCTION DIAGNOSIS >

[AUTOMATIC AIR CONDITIONER]

ELECTRIC COMPRESSOR CONTROL SYSTEM

Description

INFOID:000000001504811

SYSTEM DESCRIPTION

- The auto amp. calculates the target speed of the compressor based on the target evaporator temperature (which is calculated by the in-vehicle sensor, ambient sensor, and the sunload sensor) and the actual evaporator temperature that is detected by the intake sensor in order to control the compressor speed.
- The auto amp. calculates the target evaporator temperature, which includes corrections based on the in-vehicle sensor, ambient sensor, the sunload sensor, and intake sensor. Accordingly, the auto amp. controls the compressor speed to an extent that would not inhibit the proper cooling performance or defogging performance.

Electric Compressor Circuit

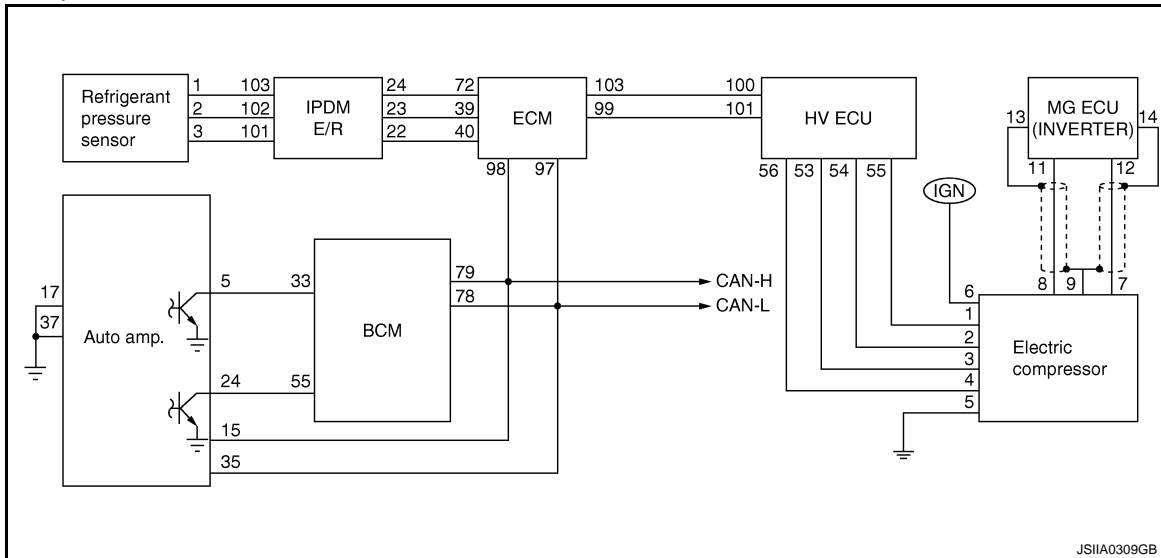

HEATER PUMP CONTROL SYSTEM

< FUNCTION DIAGNOSIS >

[AUTOMATIC AIR CONDITIONER]

HEATER PUMP CONTROL SYSTEM

Description

INFOID:000000001504812

The heater pump sends engine coolant to the heater core assembly while the engine is stopped to prevent heater effectiveness from becoming low. Directed by the ECM, the IPDM E/R operates the heater pump.

SYSTEM DESCRIPTION

Heater Pump Circuit

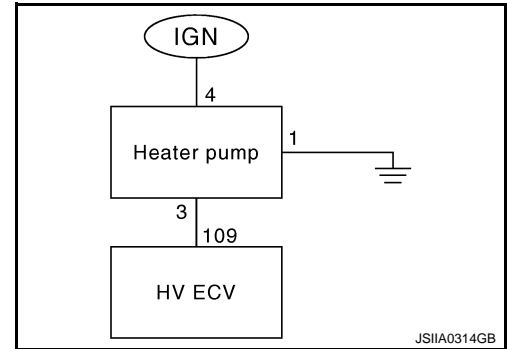

A
B
C
D
E
F
G
H
J
K
L
M
N
O
P

HAC

B2578, B2579 IN-VEHICLE SENSOR

< COMPONENT DIAGNOSIS >

[AUTOMATIC AIR CONDITIONER]

COMPONENT DIAGNOSIS

B2578, B2579 IN-VEHICLE SENSOR

Description

INFOID:000000001504813

In-vehicle Sensor

The in-vehicle sensor (1) is located on instrument lower cover. It converts variations in temperature of compartment air drawn from the aspirator into a resistance value. It is then input into the auto amp.

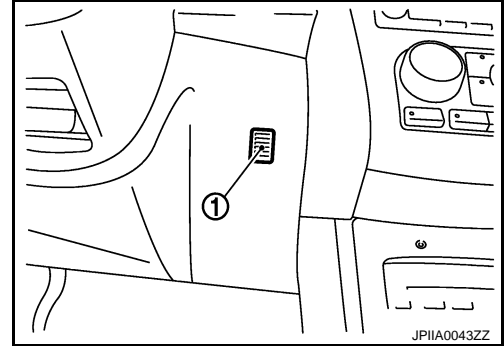

In-vehicle Sensor Circuit

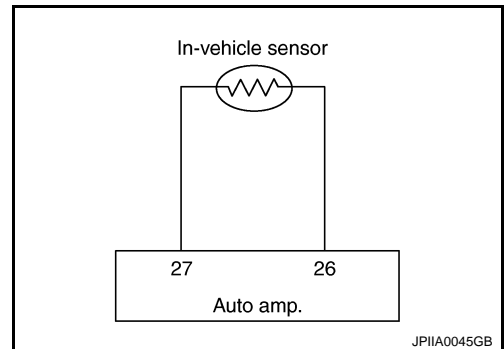

Aspirator

The aspirator (1) is located on driver's side of Heater & cooling unit assembly. It produces vacuum pressure due to air discharged from the heater & cooling unit assembly, continuously taking compartment air in the aspirator.

← Vehicle front

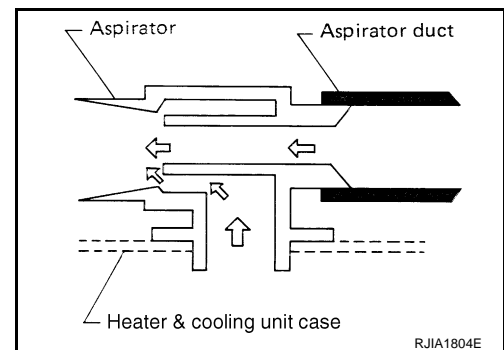
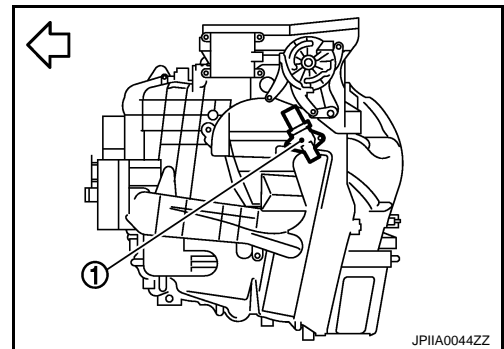

B2578, B2579 IN-VEHICLE SENSOR

< COMPONENT DIAGNOSIS >

[AUTOMATIC AIR CONDITIONER]

DTC Logic

INFOID:000000001504814

DTC DETECTION LOGIC

DTC No.	Trouble Diagnosis Name	DTC Detecting Condition	Possible Cause
B2578	IN CAR SENSOR OUT OF RANGE [LOW]	Short in In-vehicle sensor circuit.	<ul style="list-style-type: none"> In-vehicle sensor Auto amp. Harness or connectors (The sensor circuit is open or shorted.)
B2579	IN CAR SENSOR OUT OF RANGE [HI]	Open in In-vehicle sensor circuit.	

DTC CONFIRMATION PROCEDURE

1. PRECONDITIONING

If DTC Confirmation Procedure has been previously conducted, always turn ignition switch OFF and wait at least 10 seconds before conducting the next test.

>> GO TO 2.

2. PERFORM DTC CONFIRMATION PROCEDURE

- Turn ignition switch ON and wait at least 5 seconds.
- Check DTC.

Is DTC detected?

- YES >> Go to Diagnosis Procedure. [HAC-37, "Diagnosis Procedure"](#).
 NO >> END.

Diagnosis Procedure

INFOID:000000001504815

1. CHECK VOLTAGE BETWEEN IN-VEHICLE SENSOR AND GROUND

- Disconnect in-vehicle sensor connector.
- Turn ignition switch ON.
- Check voltage between in-vehicle sensor harness connector M34 terminal 1 and ground.

(+)		(-)		Voltage
Connector	Terminal	—		
M34	1	Ground		Approx. 5

Is the inspection result normal?

- YES >> GO TO 2.
 NO >> GO TO 4.

2. CHECK CIRCUIT CONTINUITY BETWEEN IN-VEHICLE SENSOR AND AUTO AMP.

- Turn ignition switch OFF.
- Disconnect auto amp. connector.
- Check continuity between in-vehicle sensor harness connector M34 terminal 2 and auto amp. harness connector M37 terminal 26.

In-vehicle sensor		Auto amp.		Continuity
Connector	Terminal	Connector	Terminal	
M34	2	M37	26	Continuity should exist

Is the inspection result normal?

- YES >> GO TO 3.
 NO >> Repair harness or connector.

3. CHECK IN-VEHICLE SENSOR

Refer to [HAC-38, "Component Inspection"](#).

B2578, B2579 IN-VEHICLE SENSOR

[AUTOMATIC AIR CONDITIONER]

< COMPONENT DIAGNOSIS >

Is the inspection result normal?

- YES >> Replace auto amp.
 NO >> Replace in-vehicle sensor.

4. CHECK CIRCUIT CONTINUITY BETWEEN IN-VEHICLE SENSOR AND AUTO AMP.

1. Turn ignition switch OFF.
2. Disconnect auto amp. connector.
3. Check continuity between in-vehicle sensor harness connector M34 terminal 1 and auto amp. harness connector M37 terminal 27.

In-vehicle sensor		Auto amp.		Continuity
Connector	Terminal	Connector	Terminal	
M34	1	M37	27	Continuity should exist

4. Check continuity between in-vehicle sensor harness connector M34 terminal 1 and ground.

In-vehicle sensor		—	Continuity
Connector	Terminal		
M34	1	Ground	Continuity should not exist

Is the inspection result normal?

- YES >> Replace auto amp.
 NO >> Repair harness or connector.

Component Inspection

INFOID:000000001504816

After disconnecting in-vehicle sensor (1) connector M34, measure resistance between terminals 1 and 2 at sensor side. Refer to table below.

Temperature °C (°F)	Resistance kΩ
-15 (5)	12.73
-10 (14)	9.92
-5 (23)	7.80
0 (32)	6.19
5 (41)	4.95
10 (50)	3.99
15 (59)	3.24
20 (68)	2.65
25 (77)	2.19
30 (86)	1.81
35 (95)	1.51
40 (104)	1.27
45 (113)	1.07

If NG, replace in-vehicle sensor.

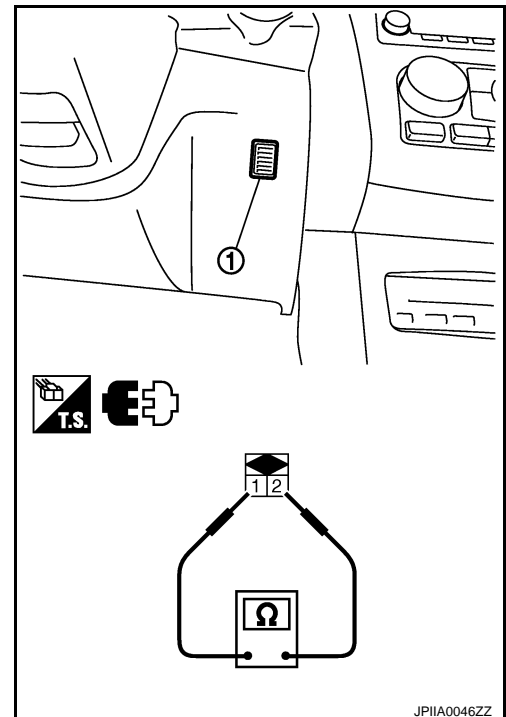

JPIIA0046ZZ

B257B, B257C AMBIENT SENSOR

< COMPONENT DIAGNOSIS >

[AUTOMATIC AIR CONDITIONER]

B257B, B257C AMBIENT SENSOR

Description

INFOID:000000001504817

COMPONENT DESCRIPTION

Ambient Sensor

The ambient sensor (1) is attached on the radiator core support (left side). It detects ambient temperature and converts it into a resistance value which is then input into the auto amp.

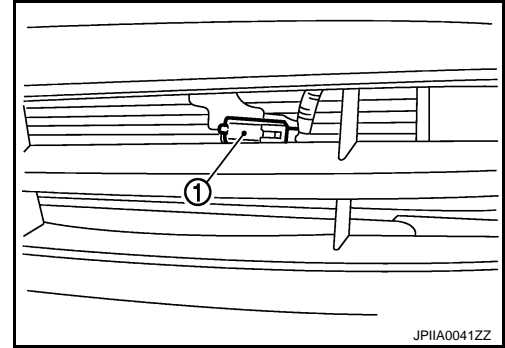

Ambient Sensor Circuit

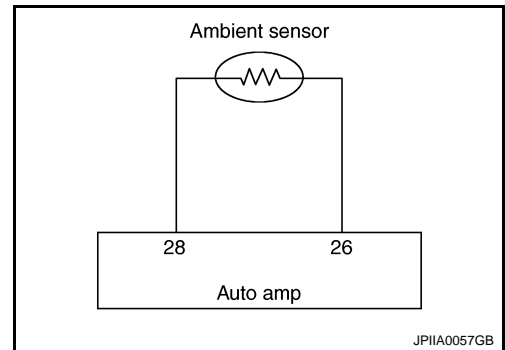

AMBIENT TEMPERATURE INPUT PROCESS

The auto amp. includes a processing circuit for the ambient sensor input. However, when the temperature detected by the ambient sensor increases quickly, the processing circuit retards the auto amp. function. It only allows the auto amp. to recognize an ambient temperature increase of 0.33°C (0.6°F) per 100 seconds. As an example, consider stopping for a few minutes after high speed driving. Although the actual ambient temperature has not changed, the temperature detected by the ambient sensor will increase. This is because the heat from the engine compartment can radiate to the front bumper area, location of the ambient sensor.

DTC Logic

INFOID:000000001504818

DTC DETECTION LOGIC

DTC No.	Trouble Diagnosis Name	DTC Detecting Condition	Possible Cause
B257B	AMB TEMP SEN SHORT	Short in ambient sensor circuit.	<ul style="list-style-type: none"> Ambient sensor Auto amp. Harness or connectors (The sensor circuit is open or shorted.)
B257C	AMB TEMP SEN OPEN	Open in ambient sensor circuit.	

DTC CONFIRMATION PROCEDURE

1. PRECONDITIONING

If DTC Confirmation Procedure has been previously conducted, always turn ignition switch OFF and wait at least 10 seconds before conducting the next test.

>> GO TO 2.

2. PERFORM DTC CONFIRMATION PROCEDURE

B257B, B257C AMBIENT SENSOR

[AUTOMATIC AIR CONDITIONER]

< COMPONENT DIAGNOSIS >

1. Turn ignition switch ON and wait at least 5 seconds.
2. Check DTC.

Is DTC detected?

- YES >> Go to Diagnosis Procedure. [HAC-40. "Diagnosis Procedure"](#).
NO >> END.

Diagnosis Procedure

INFOID:000000001504819

1. CHECK VOLTAGE BETWEEN AMBIENT SENSOR AND GROUND

1. Disconnect ambient sensor connector.
2. Turn ignition switch ON.
3. Check voltage between ambient sensor harness connector E211 terminal 1 and ground.

(+)		(-)	Voltage
Ambient sensor		—	
Connector	Terminal		
E211	1	Ground	Approx. 5

Is the inspection result normal?

- YES >> GO TO 2.
NO >> GO TO 4.

2. CHECK CIRCUIT CONTINUITY BETWEEN AMBIENT SENSOR AND AUTO AMP.

1. Turn ignition switch OFF.
2. Disconnect auto amp. connector.
3. Check continuity between ambient sensor harness connector E211 terminal 2 and auto amp. harness connector M37 terminal 26.

Ambient sensor		Auto amp.		Continuity
Connector	Terminal	Connector	Terminal	
E211	2	M37	26	Continuity should exist

Is the inspection result normal?

- YES >> GO TO 3.
NO >> Repair harness or connector.

3. CHECK AMBIENT SENSOR

Refer to [HAC-41. "Component Inspection"](#).

Is the inspection result normal?

- YES >> Replace auto amp.
NO >> Replace ambient sensor.

4. CHECK CIRCUIT CONTINUITY BETWEEN AMBIENT SENSOR AND AUTO AMP.

1. Turn ignition switch OFF.
2. Disconnect auto amp. connector.
3. Check continuity between ambient sensor harness connector E211 terminal 1 and auto amp. harness connector M37 terminal 28.

Ambient sensor		Auto amp.		Continuity
Connector	Terminal	Connector	Terminal	
E211	1	M37	28	Continuity should exist

4. Check continuity between ambient sensor harness connector E211 terminal 1 and ground.

B257B, B257C AMBIENT SENSOR

< COMPONENT DIAGNOSIS >

[AUTOMATIC AIR CONDITIONER]

Ambient sensor		—	Continuity
Connector	Terminal		
E211	1	Ground	Continuity should not exist

Is the inspection result normal?

YES >> Replace auto amp.

NO >> Repair harness or connector.

Component Inspection

INFOID:000000001504820

After disconnecting ambient sensor (1) connector E211, measure resistance between terminals 1 and 2 at sensor side. Refer to table below.

Temperature °C (°F)	Resistance kΩ
-15 (5)	12.73
-10 (14)	9.92
-5 (23)	7.80
0 (32)	6.19
5 (41)	4.95
10 (50)	3.99
15 (59)	3.24
20 (68)	2.65
25 (77)	2.19
30 (86)	1.81
35 (95)	1.51
40 (104)	1.27
45 (113)	1.07

If NG, replace ambient sensor.

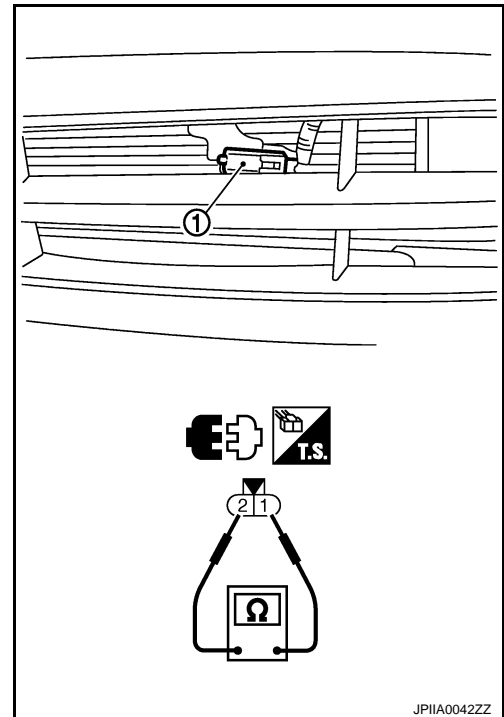

A
B
C
D
E
F
G
H
HAC
J
K
L
M
N
O
P

B2581, B2582 INTAKE SENSOR

< COMPONENT DIAGNOSIS >

[AUTOMATIC AIR CONDITIONER]

B2581, B2582 INTAKE SENSOR

Description

INFOID:000000001504821

Intake Sensor

The intake sensor (1) is located on the heater & cooling unit assembly. It converts temperature of air after it passes through the evaporator (2) into a resistance value which is then input to the auto amp.

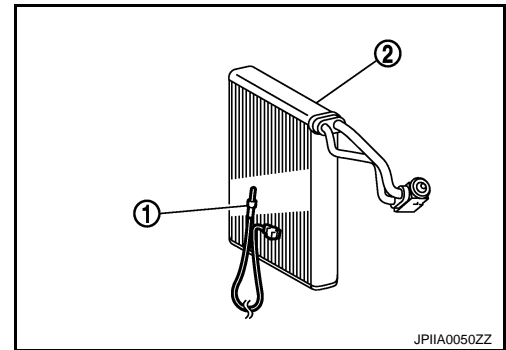

Intake Sensor Circuit

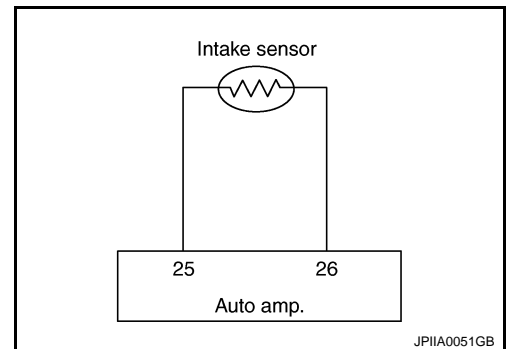

DTC Logic

INFOID:000000001504822

DTC DETECTION LOGIC

DTC No.	Trouble Diagnosis Name	DTC Detecting Condition	Possible Cause
B2581	EVAP TEMP SEN SHORT	Short in intake sensor circuit.	<ul style="list-style-type: none"> • Intake sensor • Auto amp. • Harness or connectors (The sensor circuit is open or shorted.)
B2582	EVAP TEMP SEN OPEN	Open in intake sensor circuit.	

DTC CONFIRMATION PROCEDURE

1. PRECONDITIONING

If DTC Confirmation Procedure has been previously conducted, always turn ignition switch OFF and wait at least 10 seconds before conducting the next test.

>> GO TO 2.

2. PERFORM DTC CONFIRMATION PROCEDURE

1. Turn ignition switch ON and wait at least 5 seconds.
2. Check DTC.

Is DTC detected?

- YES >> Go to Diagnosis Procedure. [HAC-42. "Diagnosis Procedure"](#).
- NO >> END.

Diagnosis Procedure

INFOID:000000001504823

1. CHECK VOLTAGE BETWEEN INTAKE SENSOR AND GROUND

B2581, B2582 INTAKE SENSOR

[AUTOMATIC AIR CONDITIONER]

< COMPONENT DIAGNOSIS >

1. Disconnect intake sensor connector.
2. Turn ignition switch ON.
3. Check voltage between intake sensor harness connector M39 terminal 1 and ground.

(+)		(-)		Voltage
Intake sensor		—		
Connector	Terminal			
M39	1	Ground		Approx. 5

Is the inspection result normal?

YES >> GO TO 2.

NO >> GO TO 4.

2. CHECK CIRCUIT CONTINUITY BETWEEN INTAKE SENSOR AND AUTO AMP.

1. Turn ignition switch OFF.
2. Disconnect auto amp. connector.
3. Check continuity between intake sensor harness connector M39 terminal 4 and auto amp. harness connector M37 terminal 26.

Intake sensor		Auto amp.		Continuity
Connector	Terminal	Connector	Terminal	
M39	4	M37	26	Continuity should exist

Is the inspection result normal?

YES >> GO TO 3.

NO >> Repair harness or connector.

3. CHECK INTAKE SENSOR

Refer to [HAC-44, "Component Inspection"](#).

Is the inspection result normal?

YES >> Replace auto amp.

NO >> Replace intake sensor.

4. CHECK CIRCUIT CONTINUITY BETWEEN INTAKE SENSOR AND AUTO AMP.

1. Turn ignition switch OFF.
2. Disconnect auto amp. connector.
3. Check continuity between intake sensor harness connector M39 terminal 1 and auto amp. harness connector M37 terminal 25.

Intake sensor		Auto amp.		Continuity
Connector	Terminal	Connector	Terminal	
M39	1	M37	25	Continuity should exist

4. Check continuity between intake sensor harness connector M39 terminal 1 and ground.

Intake sensor		—		Continuity
Connector	Terminal			
M39	1	Ground		Continuity should not exist

Is the inspection result normal?

YES >> Replace auto amp.

NO >> Repair harness or connector.

B2581, B2582 INTAKE SENSOR

< COMPONENT DIAGNOSIS >

[AUTOMATIC AIR CONDITIONER]

INFOID:000000001504824

Component Inspection

After disconnecting intake sensor (1) connector M39, measure resistance between terminals 1 and 4 at sensor side. Refer to table below.

Temperature °C (°F)	Resistance kΩ
-15 (5)	12.34
-10 (14)	9.62
-5 (23)	7.56
0 (32)	6.00
5 (41)	4.80
10 (50)	3.87
15 (59)	3.15
20 (68)	2.57
25 (77)	2.12
30 (86)	1.76
35 (95)	1.47
40 (104)	1.23
45 (113)	1.04

If NG, replace intake sensor.

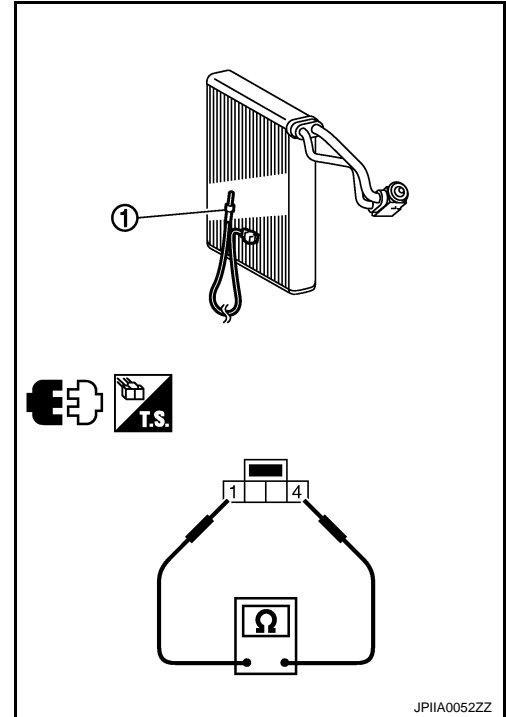

B2630, B2631 SUNLOAD SENSOR

< COMPONENT DIAGNOSIS >

[AUTOMATIC AIR CONDITIONER]

B2630, B2631 SUNLOAD SENSOR

Description

INFOID:000000001504825

COMPONENT DESCRIPTION

Sunload Sensor

The sunload sensor (1) is located on the driver's side front defroster grille. It detects sunload entering through windshield by means of a photo diode. The sensor converts the sunload into a current value which is then input into the auto amp.

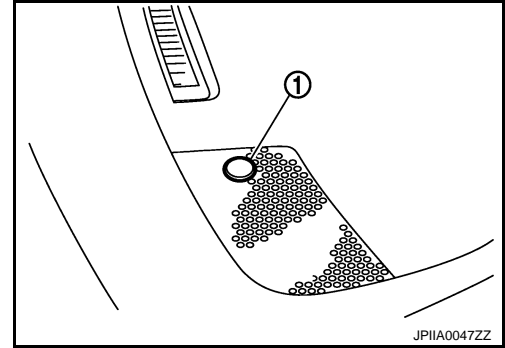

Sunload Sensor Circuit

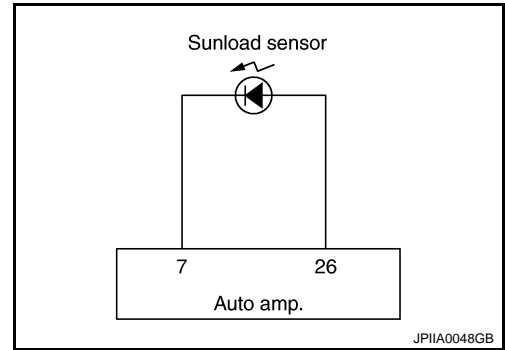

SUNLOAD INPUT PROCESS

The auto amp. also includes a processing circuit which averages the variations in detected sunload over a period of time. This prevents drastic swings in the HAC system operation due to small or quick variations in detected sunload.

For example, consider driving along a road bordered by an occasional group of large trees. The sunload detected by the sunload sensor will vary whenever the trees obstruct the sunlight. The processing circuit averages the detected sunload over a period of time, so that the (insignificant) effect of the trees momentarily obstructing the sunlight does not cause any change in the HAC system operation. On the other hand, shortly after entering a long tunnel, the system will recognize the change in sunload, and the system will react accordingly.

DTC Logic

INFOID:000000001504826

DTC DETECTION LOGIC

DTC No.	Trouble Diagnosis Name	DTC Detecting Condition	Possible Cause
B2630	SUNLOAD SEN SHORT	Short in sunload sensor circuit.	<ul style="list-style-type: none"> Sunload sensor Auto amp. Harness or connectors (The sensor circuit is open or shorted.)
B2631	SUNLOAD SEN OPEN	Open in sunload sensor circuit.	

DTC CONFIRMATION PROCEDURE

1. PRECONDITIONING

If DTC Confirmation Procedure has been previously conducted, always turn ignition switch OFF and wait at least 10 seconds before conducting the next test.

A
B
C
D
E
F
G
H
HAC
J
K
L
M
N
O
P

B2630, B2631 SUNLOAD SENSOR

< COMPONENT DIAGNOSIS >

[AUTOMATIC AIR CONDITIONER]

>> GO TO 2.

2. PERFORM DTC CONFIRMATION PROCEDURE

1. Turn ignition switch ON (READY) and wait at least 5 seconds.
2. Check DTC.

NOTE:

Perform DTC confirmation procedure under sunshine. When performing indoors, aim a light (more than 60 W) at sunload sensor, otherwise B2631 will indicate despite that sunload sensor is functioning properly.

3. Select "SELF-DIAG RESULTS" mode with CONDULT-III.
4. Touch "ERASE", and recheck DTC.

Is DTC detected?

- YES >> Go to Diagnosis Procedure. [HAC-46. "Diagnosis Procedure"](#).
NO >> END.

Diagnosis Procedure

INFOID:000000001504827

1. CHECK VOLTAGE BETWEEN SUNLOAD SENSOR AND GROUND

1. Disconnect sunload sensor connector.
2. Turn ignition switch ON.
3. Check voltage between sunload sensor harness connector M56 terminal 1 and ground.

(+)		(-)	Voltage
Sunload sensor		—	
Connector	Terminal		
M56	1	Ground	

Is the inspection result normal?

- YES >> GO TO 2.
NO >> GO TO 4.

2. CHECK CIRCUIT CONTINUITY BETWEEN SUNLOAD SENSOR AND AUTO AMP.

1. Turn ignition switch OFF.
2. Disconnect auto amp. connector.
3. Check continuity between sunload sensor harness connector M56 terminal 2 and auto amp. harness connector M37 terminal 26.

Sunload sensor		Auto amp.		Continuity
Connector	Terminal	Connector	Terminal	
M56	2	M37	26	Continuity should exist

Is the inspection result normal?

- YES >> GO TO 3.
NO >> Repair harness or connector.

3. CHECK SUNLOAD SENSOR

1. Reconnect sunload sensor connector and auto amp. connector.
2. Refer to [HAC-47. "Component Inspection"](#).

Is the inspection result normal?

- YES >> Replace auto amp.
NO >> Replace sunload sensor.

4. CHECK CIRCUIT CONTINUITY BETWEEN SUNLOAD SENSOR AND AUTO AMP.

1. Turn ignition switch OFF.
2. Disconnect auto amp. connector.
3. Check continuity between sunload sensor harness connector M56 terminal 1 and auto amp. harness connector M37 terminal 7.

B2630, B2631 SUNLOAD SENSOR

< COMPONENT DIAGNOSIS >

[AUTOMATIC AIR CONDITIONER]

Sunload sensor		Auto amp.		Continuity
Connector	Terminal	Connector	Terminal	
M56	1	M37	7	Continuity should exist

4. Check continuity between sunload sensor harness connector M56 terminal 1 and ground.

Sunload sensor		—	Continuity
Connector	Terminal		
M56	1	Ground	Continuity should not exist

Is the inspection result normal?

YES >> Replace auto amp.

NO >> Repair harness or connector.

Component Inspection

INFOID:000000001504828

Measure voltage between auto amp. harness connector M37 terminal 7 and ground.

1. Sunload sensor

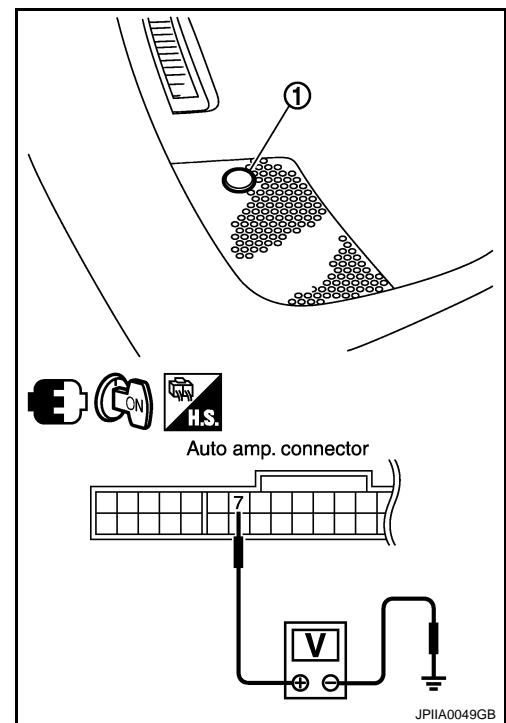

A
B
C
D
E
F
G
H
HAC
J
K
L
M
N
O
P

B2630, B2631 SUNLOAD SENSOR

< COMPONENT DIAGNOSIS >

[AUTOMATIC AIR CONDITIONER]

- When checking sunload sensor, select a place where sunshine directly on it.

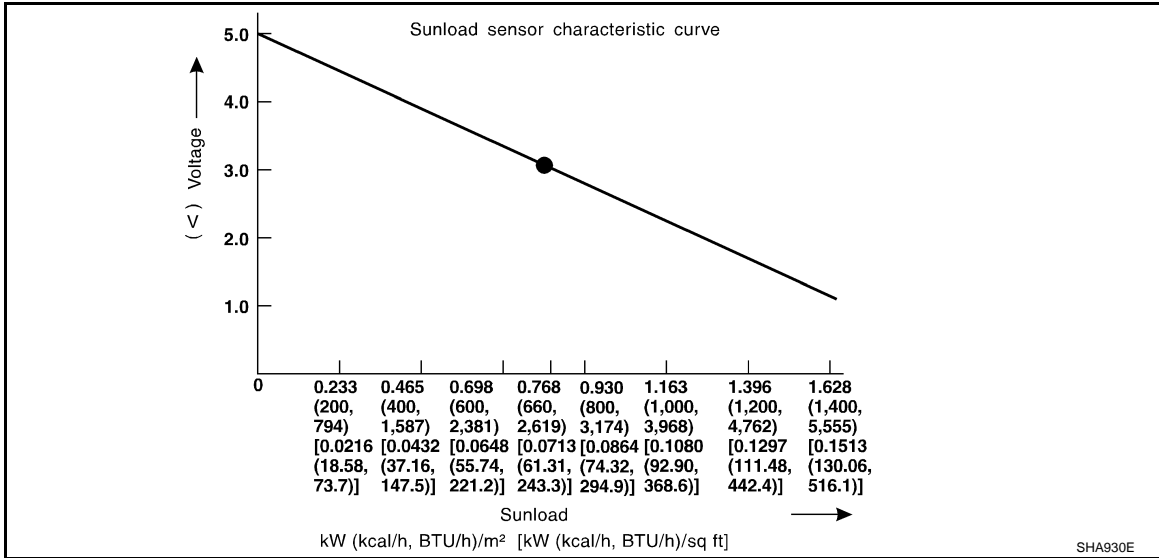

If NG, replace sunload sensor.

B2632, B2633 AIR MIX DOOR MOTOR PBR (DRIVER SIDE)

< COMPONENT DIAGNOSIS >

[AUTOMATIC AIR CONDITIONER]

B2632, B2633 AIR MIX DOOR MOTOR PBR (DRIVER SIDE)

Description

INFOID:000000001504829

COMPONENT DESCRIPTION

The air mix door motor (driver side) (1) is attached to the heater & cooling unit assembly. It rotates so that the air mix door is opened or closed to a position set by the auto amp. Motor rotation is then conveyed through a shaft and the air mix door position feedback is then sent to the auto amp. by PBR built-in air mix door motor.

← Vehicle front

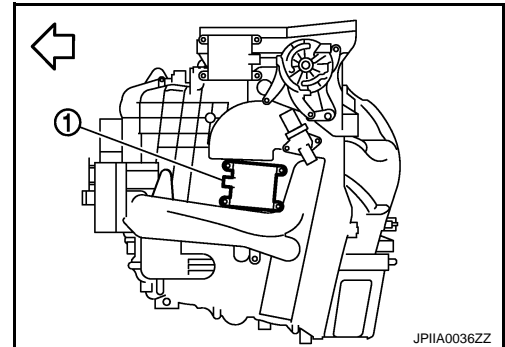

DTC Logic

INFOID:000000001504830

DTC DETECTION LOGIC

DTC No.	Trouble Diagnosis Name	DTC Detecting Condition	Possible Cause
B2632	DR AIRMIX ACTR SHORT	Air mix door (driver side) does not change even if auto amp. operates air mix door motor (driver side).	<ul style="list-style-type: none">• Air mix door motor (driver side)• Auto amp.• Harness or connectors (The door motor circuit is open or shorted.)
B2633	DR AIRMIX ACTR OPEN		

DTC CONFIRMATION PROCEDURE

1. PRECONDITIONING

If DTC Confirmation Procedure has been previously conducted, always turn ignition switch OFF and wait at least 10 seconds before conducting the next test.

>> GO TO 2.

2. PERFORM DTC CONFIRMATION PROCEDURE

1. Turn ignition switch ON and wait at least 50 seconds.
2. Check DTC.

Is DTC detected?

- YES >> Go to Diagnosis Procedure. [HAC-49. "Diagnosis Procedure"](#).
NO >> END.

Diagnosis Procedure

INFOID:000000001504831

1. CHECK AIR MIX DOOR MOTOR (DRIVER SIDE)

Check air mix door motor (driver side). Refer to [VTL-20. "Removal and Installation"](#).

Is it installed normally?

- YES >> GO TO 2.
NO >> Replace air mix door motor (driver side).

2. CHECK POWER SUPPLY FOR AUTO AMP.

1. Turn ignition switch ON.
2. Check voltage between auto amp. harness connector M37 terminal 20 and ground.

B2632, B2633 AIR MIX DOOR MOTOR PBR (DRIVER SIDE)

< COMPONENT DIAGNOSIS >

[AUTOMATIC AIR CONDITIONER]

(+) Auto amp.		(-)	Voltage
Connector	Terminal	—	
M37	20	Ground	Battery voltage

Is the inspection result normal?

YES >> GO TO 3.

NO >> Replace auto amp.

3.CHECK SIGNAL FOR AUTO AMP.

Confirm A/C LAN signal between auto amp. harness connector M37 terminal 3 and ground using an oscilloscope.

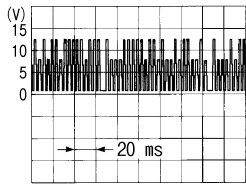
(+) Auto amp.		(-)	Voltage
Connector	Terminal	—	
M37	3	Ground	 SJIA1453J

Is the inspection result normal?

YES >> GO TO 4.

NO >> Replace auto amp.

4.CHECK POWER SUPPLY FOR AIR MIX DOOR MOTOR (DRIVER SIDE)

Check voltage between air mix door motor (driver side) harness connector M128 terminal 3 and ground.

(+) Air mix door motor (driver side)		(-)	Voltage
Connector	Terminal	—	
M128	3	Ground	Battery voltage

Is the inspection result normal?

YES >> GO TO 5.

NO >> Repair harness or connector.

5.CHECK SIGNAL FOR AIR MIX DOOR MOTOR (DRIVER SIDE)

Confirm A/C LAN signal between air mix door motor (driver side) harness connector M128 terminal 1 and ground using an oscilloscope.

B2632, B2633 AIR MIX DOOR MOTOR PBR (DRIVER SIDE)

< COMPONENT DIAGNOSIS >

[AUTOMATIC AIR CONDITIONER]

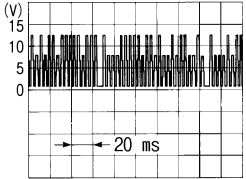
(+)		(-)	Voltage
Air mix door motor (driver side)		—	
Connector	Terminal		
M128	1	Ground	

Is the inspection result normal?

YES >> GO TO 6.

NO >> Repair harness or connector.

6. CHECK AIR MIX DOOR MOTOR (DRIVER SIDE) GROUND CIRCUIT

1. Turn ignition switch OFF.
2. Disconnect air mix door motor (driver side) connector.
3. Check continuity between air mix door motor (driver side) harness connector M128 terminal 2 and ground.

Air mix door motor (driver side)		—	Continuity
Connector	Terminal		
M128	2	Ground	Continuity should exist

Is the inspection result normal?

YES >> Replace air mix door motor (driver side).

NO >> Repair harness or connector.

A
B
C
D
E
F
G
H
J
K
L
M
N
O
P

HAC

B2634, B2635 AIR MIX DOOR MOTOR PBR (PASSENGER SIDE)

< COMPONENT DIAGNOSIS >

[AUTOMATIC AIR CONDITIONER]

B2634, B2635 AIR MIX DOOR MOTOR PBR (PASSENGER SIDE)

Description

INFOID:000000001504832

COMPONENT DESCRIPTION

The air mix door motor (passenger side) (1) is attached to the heater & cooling unit assembly. It rotates so that the air mix door is opened or closed to a position set by the auto amp. Motor rotation is then conveyed through a shaft and the air mix door position feedback is then sent to the auto amp. by PBR built-in air mix door motor.

← Vehicle front

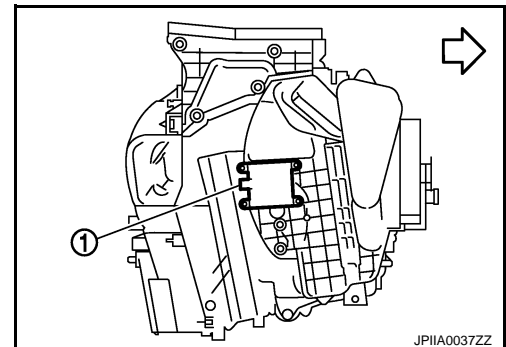

INFOID:000000001504833

DTC Logic

DTC DETECTION LOGIC

DTC No.	Trouble Diagnosis Name	DTC Detecting Condition	Possible Cause
B2634	PASS AIRMIX ACTR SHORT	Air mix door (passenger side) does not change even if auto amp. operates air mix door motor (passenger side).	<ul style="list-style-type: none">• Air mix door motor (passenger side)• Auto amp.• Harness or connectors (The door motor circuit is open or shorted.)
B2635	PASS AIRMIX ACTR OPEN		

DTC CONFIRMATION PROCEDURE

1. PRECONDITIONING

If DTC Confirmation Procedure has been previously conducted, always turn ignition switch OFF and wait at least 10 seconds before conducting the next test.

>> GO TO 2.

2. PERFORM DTC CONFIRMATION PROCEDURE

1. Turn ignition switch ON and wait at least 50 seconds.
2. Check DTC.

Is DTC detected?

- YES >> Go to Diagnosis Procedure. [HAC-52, "Diagnosis Procedure"](#).
NO >> END.

Diagnosis Procedure

INFOID:000000001504834

1. CHECK AIR MIX DOOR MOTOR (PASSENGER SIDE)

Check air mix door motor (passenger side). Refer to [VTL-20, "Removal and Installation"](#).

Is it installed normally?

- YES >> GO TO 2.
NO >> Replace air mix door motor (passenger side).

2. CHECK POWER SUPPLY FOR AUTO AMP.

1. Turn ignition switch ON.
2. Check voltage between auto amp. harness connector M37 terminal 20 and ground.

B2634, B2635 AIR MIX DOOR MOTOR PBR (PASSENGER SIDE)

< COMPONENT DIAGNOSIS >

[AUTOMATIC AIR CONDITIONER]

(+)		(-)	Voltage
Auto amp.		—	
Connector	Terminal		
M37	20	Ground	Battery voltage

Is the inspection result normal?

YES >> GO TO 3.

NO >> Replace auto amp.

3.CHECK SIGNAL FOR AUTO AMP.

Confirm A/C LAN signal between auto amp. harness connector M37 terminal 3 and ground using an oscilloscope.

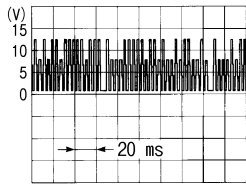
(+)		(-)	Voltage
Auto amp.		—	
Connector	Terminal		
M37	3	Ground	 SJA1453J

Is the inspection result normal?

YES >> GO TO 4.

NO >> Replace auto amp.

4.CHECK POWER SUPPLY FOR AIR MIX DOOR MOTOR (PASSENGER SIDE)

Check voltage between air mix door motor (passenger side) harness connector M129 terminal 3 and ground.

(+)		(-)	Voltage
Air mix door motor (passenger side)		—	
Connector	Terminal		
M129	3	Ground	Battery voltage

Is the inspection result normal?

YES >> GO TO 5.

NO >> Repair harness or connector.

5.CHECK SIGNAL FOR AIR MIX DOOR MOTOR (PASSENGER SIDE)

Confirm A/C LAN signal between air mix door motor (passenger side) harness connector M129 terminal 1 and ground using an oscilloscope.

A
B
C
D
E
F
G
H
J
K
L
M
N
O
P

HAC

B2634, B2635 AIR MIX DOOR MOTOR PBR (PASSENGER SIDE)

< COMPONENT DIAGNOSIS >

[AUTOMATIC AIR CONDITIONER]

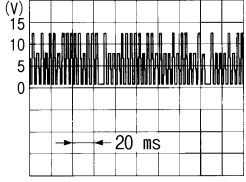
(+) Air mix door motor (passenger side)		(-)	Voltage
Connector	Terminal	—	
M129	1	Ground	 SJI1453J

Is the inspection result normal?

YES >> GO TO 6.

NO >> Repair harness or connector.

6. CHECK AIR MIX DOOR MOTOR (PASSENGER SIDE) GROUND CIRCUIT

1. Turn ignition switch OFF.
2. Disconnect air mix door motor (passenger side) connector.
3. Check continuity between air mix door motor (passenger side) harness connector M129 terminal 2 and ground.

Air mix door motor (passenger side)		(-)	Continuity
Connector	Terminal	—	
M129	2	Ground	Continuity should exist

Is the inspection result normal?

YES >> Replace air mix door motor (passenger side).

NO >> Repair harness or connector.

B2636, B2637, B2638, B2639, B2654, B2655 MODE DOOR MOTOR

< COMPONENT DIAGNOSIS >

[AUTOMATIC AIR CONDITIONER]

B2636, B2637, B2638, B2639, B2654, B2655 MODE DOOR MOTOR

Description

INFOID:000000001504835

COMPONENT DESCRIPTION

The mode door motor (1) are attached to the heater & cooling unit assembly. It rotates so that air is discharged from the outlet set by the unified meter and A/C amp. Motor rotation is conveyed to a link which activates the mode door.

←: Vehicle front

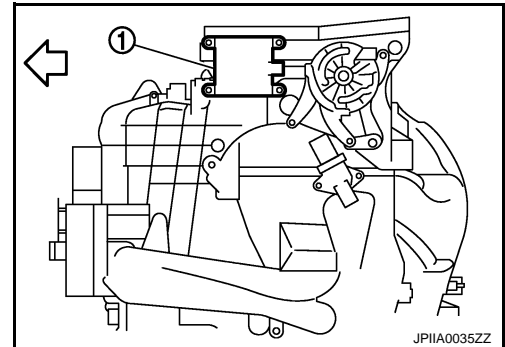

DTC Logic

INFOID:000000001504836

DTC DETECTION LOGIC

DTC No.	Trouble Diagnosis Name	DTC Detecting Condition	Possible Cause
B2636	DR VENT DOOR FAIL	Mode door does not change even if auto amp. operates mode door motor.	<ul style="list-style-type: none"> • Mode door motor • Auto amp. • Harness or connectors (The door motor circuit is open or shorted.)
B2637	DR B/L DOOR FAIL		
B2638	DR D/F1 DOOR FAIL		
B2639	DR DEF DOOR FAIL		
B2654	D/F2 DOOR FAIL		
B2655	B/L DOOR FAIL		

DTC CONFIRMATION PROCEDURE

1. PRECONDITIONING

If DTC Confirmation Procedure has been previously conducted, always turn ignition switch OFF and wait at least 10 seconds before conducting the next test.

>> GO TO 2.

2. PERFORM DTC CONFIRMATION PROCEDURE

1. Turn ignition switch ON and wait at least 50 seconds.
2. Check DTC.

Is DTC detected?

- YES >> Go to Diagnosis Procedure. [HAC-55. "Diagnosis Procedure"](#).
 NO >> END.

Diagnosis Procedure

INFOID:000000001504837

1. CHECK POWER SUPPLY FOR AUTO AMP.

1. Turn ignition switch ON.
2. Check voltage between auto amp. harness connector M37 terminal 20 and ground.

(+)		(-)	Voltage
Auto amp.		—	
Connector	Terminal		
M37	20	Ground	Battery voltage

Is the inspection result normal?

B2636, B2637, B2638, B2639, B2654, B2655 MODE DOOR MOTOR

[AUTOMATIC AIR CONDITIONER]

< COMPONENT DIAGNOSIS >

- YES >> GO TO 2.
 NO >> Replace auto amp.

2.CHECK SIGNAL FOR AUTO AMP.

Confirm A/C LAN signal between auto amp. harness connector M37 terminal 3 and ground using an oscilloscope.

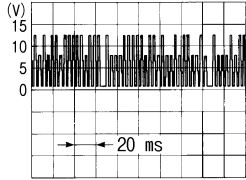
(+)		(-)	Voltage
Auto amp.		—	
Connector	Terminal		
M37	3	Ground	 <p style="text-align: right;">SJIA1453J</p>

Is the inspection result normal?

- YES >> GO TO 3.
 NO >> Replace auto amp.

3.CHECK POWER SUPPLY FOR MODE DOOR MOTOR

Check voltage between mode door motor harness connector M127 terminal 3 and ground.

(+)		(-)	Voltage
Mode door motor		—	
Connector	Terminal		
M127	3	Ground	Battery voltage

Is the inspection result normal?

- YES >> GO TO 4.
 NO >> Repair harness or connector.

4.CHECK SIGNAL FOR MODE DOOR MOTOR

Confirm A/C LAN signal between mode door motor harness connector M127 terminal 1 and ground using an oscilloscope.

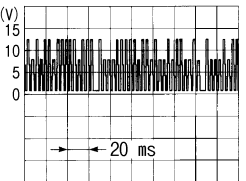
(+)		(-)	Voltage
Mode door motor		—	
Connector	Terminal		
M127	1	Ground	 <p style="text-align: right;">SJIA1453J</p>

Is the inspection result normal?

- YES >> GO TO 5.
 NO >> Repair harness or connector.

5.CHECK MOTOR GROUND CIRCUIT

1. Turn ignition switch OFF.
2. Disconnect mode door motor connector.

B2636, B2637, B2638, B2639, B2654, B2655 MODE DOOR MOTOR

< COMPONENT DIAGNOSIS >

[AUTOMATIC AIR CONDITIONER]

3. Check continuity between mode door motor harness connector M127 terminal 2 and ground.

Mode door motor		—	Continuity
Connector	Terminal		
M127	2	Ground	Continuity should exist

Is the inspection result normal?

YES >> Replace mode door motor.

NO >> Repair harness or connector.

A

B

C

D

E

F

G

H

HAC

J

K

L

M

N

O

P

B263D B263E, B263F, B2656 INTAKE DOOR MOTOR

< COMPONENT DIAGNOSIS >

[AUTOMATIC AIR CONDITIONER]

B263D B263E, B263F, B2656 INTAKE DOOR MOTOR

Description

INFOID:000000001504838

COMPONENT DESCRIPTION

The intake door motor (1) is attached to the blower unit. It rotates so that air is drawn from inlets set by the auto amp. Motor rotation is conveyed to a lever which activates the intake door.

←: Vehicle front

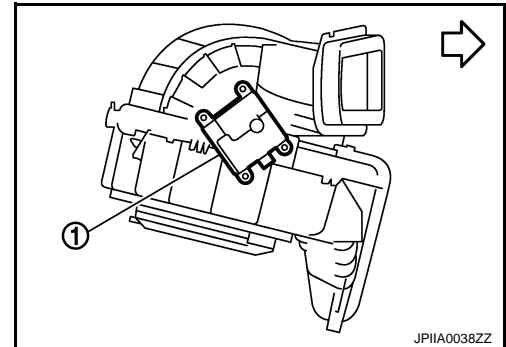

DTC Logic

INFOID:000000001504839

DTC DETECTION LOGIC

DTC No.	Trouble Diagnosis Name	DTC Detecting Condition	Possible Cause
B263D	FRE DOOR FAIL	Intake door does not change even if auto amp. operates intake door motor.	<ul style="list-style-type: none">• Intake door motor• Auto amp.• Harness or connectors (The door motor circuit is open or shorted.)
B263E	20P FRE DOOR FAIL		
B263F	REC DOOR FAIL		
B2656	BTC FRE DOOR FAIL		

DTC CONFIRMATION PROCEDURE

1. PRECONDITIONING

If DTC Confirmation Procedure has been previously conducted, always turn ignition switch OFF and wait at least 10 seconds before conducting the next test.

>> GO TO 2.

2. PERFORM DTC CONFIRMATION PROCEDURE

1. Turn ignition switch ON and wait at least 50 seconds.
2. Check DTC.

Is DTC detected?

- YES >> Go to Diagnosis Procedure. [HAC-55. "Diagnosis Procedure"](#).
NO >> END.

Diagnosis Procedure

INFOID:000000001504840

1. CHECK INTAKE DOOR CONTROL LINKAGE

Check intake door control linkage.

Is it installed normally?

- YES >> GO TO 2.
NO >> Repair or adjust control linkage.

2. CHECK POWER SUPPLY FOR AUTO AMP.

1. Turn ignition switch ON.
2. Check voltage between auto amp. harness connector M37 terminal 20 and ground.

B263D B263E, B263F, B265E INTAKE DOOR MOTOR

< COMPONENT DIAGNOSIS >

[AUTOMATIC AIR CONDITIONER]

(+) Auto amp.		(-)	Voltage
Connector	Terminal	—	
M37	20	Ground	Battery voltage

Is the inspection result normal?

YES >> GO TO 3.

NO >> Replace auto amp.

3.CHECK SIGNAL FOR AUTO AMP.

Confirm A/C LAN signal between auto amp. harness connector M37 terminal 3 and ground using an oscilloscope.

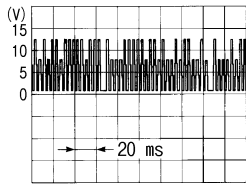
(+) Auto amp.		(-)	Voltage
Connector	Terminal	—	
M37	3	Ground	 <p style="text-align: right; font-size: small;">SJIA1453J</p>

Is the inspection result normal?

YES >> GO TO 4.

NO >> Replace auto amp.

4.CHECK POWER SUPPLY FOR INTAKE DOOR MOTOR

Check voltage between intake door motor harness connector M126 terminal 3 and ground.

(+) Intake door motor		(-)	Voltage
Connector	Terminal	—	
M126	3	Ground	Battery voltage

Is the inspection result normal?

YES >> GO TO 5.

NO >> Repair harness or connector.

5.CHECK SIGNAL FOR INTAKE DOOR MOTOR

Confirm A/C LAN signal between intake door motor harness connector M126 terminal 1 and ground using an oscilloscope.

A
B
C
D
E
F
G
H
J
K
L
M
N
O
P

HAC

B263D B263E, B263F, B2656 INTAKE DOOR MOTOR

< COMPONENT DIAGNOSIS >

[AUTOMATIC AIR CONDITIONER]

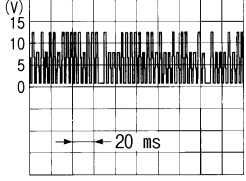
(+)		(-)	Voltage
Intake door motor		—	
Connector	Terminal		
M126	1	Ground	 <p style="text-align: right; font-size: small;">SJIA1453J</p>

Is the inspection result normal?

YES >> GO TO 6.

NO >> Repair harness or connector.

6. CHECK INTAKE DOOR MOTOR GROUND CIRCUIT

1. Turn ignition switch OFF.
2. Disconnect intake door motor connector.
3. Check continuity between intake door motor harness connector M126 terminal 2 and ground.

Intake door motor		—	Continuity
Connector	Terminal		
M126	2	Ground	Continuity should exist

Is the inspection result normal?

YES >> Replace intake door motor.

NO >> Repair harness or connector.

B2640, B2641, B2642 ELECTRIC COMPRESSOR

< COMPONENT DIAGNOSIS >

[AUTOMATIC AIR CONDITIONER]

B2640, B2641, B2642 ELECTRIC COMPRESSOR

Description

INFOID:000000001504841

The inverter monitors power voltage from the main battery in the circuit. It stops compressor control and outputs the DTC when the monitored voltage is outside the specified range. The output DTC of B2640 and B2641 are memorized only present trouble. On B2642, compressor control may not resume unless the ignition switch is turned OFF and waiting for 10 minutes.

CAUTION:

- **Wear electrically insulated gloves and pull out the service plug grip before inspection as procedures may require disconnecting high-voltage connectors. Be sure to carry the removed service plug grip because other workers may install it by mistake.**
- **Do not touch the high-voltage connectors or terminals for 10 minutes after the service plug grip is removed.**

NOTE:

The hybrid control system and air conditioning system output DTCs separately. Inspect DTCs following the flow chart for the hybrid control system first if any DTCs from those systems are output simultaneously.

DTC Logic

INFOID:000000001504842

DTC DETECTION LOGIC

DTC No.	Trouble Diagnosis Name	DTC Detecting Condition	Possible Cause
B2640	MAIN VOLT MIN	After READY and A/C ON	<ul style="list-style-type: none">• Harness or connector between electric compressor and MG ECU• Electric compressor• HV ECU• MG ECU• CAN communication system
B2641	MAIN VOLT MAX	After READY and A/C ON	
B2642	MAIN VOLT MALFNCTN	After READY and A/C ON	

DTC CONFIRMATION PROCEDURE

1. PRECONDITIONING

If DTC Confirmation Procedure has been previously conducted, always turn ignition switch OFF and wait at least 10 seconds before conducting the next test.

>> GO TO 2.

2. PERFORM DTC CONFIRMATION PROCEDURE

1. Turn ignition switch ON (READY) and wait at least 5 seconds.
2. Check DTC.

Is DTC detected?

- YES >> Go to Diagnosis Procedure. [HAC-61. "Diagnosis Procedure"](#).
NO >> END.

Diagnosis Procedure

INFOID:000000001504843

CAUTION:

- **Wear electrically insulated gloves and pull out the service plug grip before inspection as procedures may require disconnecting high-voltage connectors. Be sure to carry the removed service plug grip because other workers may install it by mistake.**
- **Do not touch the high-voltage connectors or terminals for 10 minutes after the service plug grip is removed.**

1. CHECK CAN COMMUNICATION

Use the CONSULT-III to check if the CAN Communication System is functioning normally.

Is DTC detected?

- YES >> Check CAN communication. Refer to [LAN-16. "Trouble Diagnosis Flow Chart"](#).
NO >> GO TO 2.

B2640, B2641, B2642 ELECTRIC COMPRESSOR

[AUTOMATIC AIR CONDITIONER]

< COMPONENT DIAGNOSIS >

2. CHECK DIAGNOSTIC TROUBLE CODE (HV ECU)

Check if DTCs for the hybrid control system are output using the CONSULT-III.

Is DTC detected?

YES >> GO TO 3.

NO >> Go to HV ECU. Refer to [HBC-9. "Work Flow"](#).

3. INSPECT ELECTRIC VEHICLE FUSE

1. Turn ignition switch OFF.

2. Remove the service plug grip.

CAUTION:

• Be sure to wear insulated gloves.

• Do not touch the high-voltage connectors or terminals for 10 minutes after the service plug grip is removed.

NOTE:

Do not start the engine with the service plug grip removed because it may cause a malfunction.

3. Remove the connector cover assembly.

CAUTION:

Be sure to wear insulated gloves.

NOTE:

Be sure to prevent foreign objects or water from entering the MG ECU.

4. Check that bolts A and B are tightened securely.

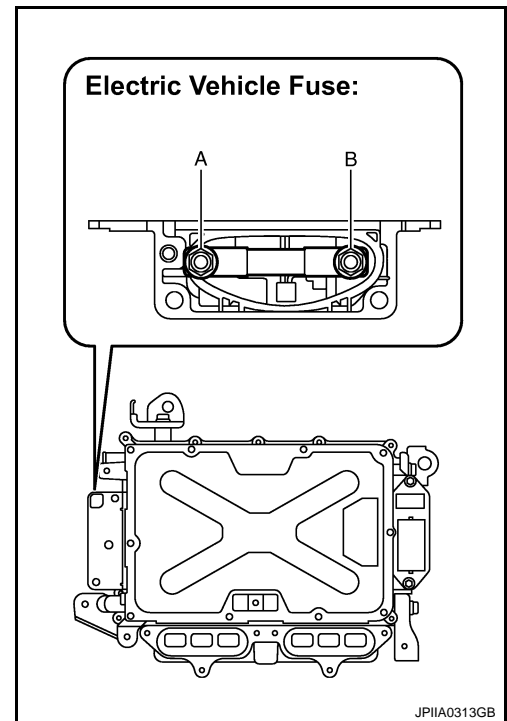

5. Measure the resistance according to the value(s) in the table below.

Electric compressor		Condition	Resistance (Ω)
A	B	Always	Below 1.0

Is the inspection result normal?

YES >> GO TO 4.

NO >> Replace electric vehicle fuse.

4. INSPECT MG ECU

CAUTION:

• Be sure to wear insulated gloves.

• Do not touch the high-voltage connectors or terminals for 10 minutes after the service plug grip is removed.

B2640, B2641, B2642 ELECTRIC COMPRESSOR

[AUTOMATIC AIR CONDITIONER]

< COMPONENT DIAGNOSIS >

1. Disconnect the connector from the MG ECU.
2. Measure the resistance according to the value(s) in the table below.

MG ECU				Condition	Resistance (Ω)
Connector	Terminal	Connector	Terminal		
F250	11	F225	1	Always	Below 1.0
	12		2		

Is the inspection result normal?

YES >> GO TO 5.

NO >> Replace MG ECU.

5.MG ECU CIRCUIT

1. Disconnect electric compressor connector.

CAUTION:

Be sure to wear insulated gloves.

2. Measure the resistance according to the value(s) in the table below.

Electric compressor		MG ECU		Condition	Resistance (Ω)
Connector	Terminal	Connector	Terminal		
F252	7	F250	12	Always	Below 1.0
	8		11		

Is the inspection result normal?

YES >> Replace electric compressor.

NO >> Repair harness or connector.

A

B

C

D

E

F

G

H

HAC

J

K

L

M

N

O

P

B2643, B2644 ELECTRIC COMPRESSOR

< COMPONENT DIAGNOSIS >

[AUTOMATIC AIR CONDITIONER]

B2643, B2644 ELECTRIC COMPRESSOR

Description

INFOID:000000001504844

The inverter in the electric compressor outputs high-voltage to operate the motor. If there is an open or short in the output circuit, the inverter in the electric compressor will stop compressor operation and output the DTC. The output DTC will be memorized as a past and present DTC. Compressor control may not resume unless the ignition switch is turned OFF, and waiting for 10 minutes.

CAUTION:

- Wear electrically insulated gloves and pull out the service plug grip before inspection as procedures may require disconnecting high-voltage connectors. Be sure to carry the removed service plug grip because other workers may install it by mistake.
- Do not touch the high-voltage connectors or terminals for 10 minutes after the service plug grip is removed.

DTC Logic

INFOID:000000001504845

DTC DETECTION LOGIC

DTC No.	Trouble Diagnosis Name	DTC Detecting Condition	Possible Cause
B2643	OUTPUT LINE SHORT	<ul style="list-style-type: none">• After READY and A/C ON• Open or short in A/C inverter high voltage output system.	<ul style="list-style-type: none">• Electric compressor• CAN communication system
B2644	OUTPUT LINE OPEN		

DTC CONFIRMATION PROCEDURE

1. PRECONDITIONING

If DTC Confirmation Procedure has been previously conducted, always turn ignition switch OFF and wait at least 10 seconds before conducting the next test.

>> GO TO 2.

2. PERFORM DTC CONFIRMATION PROCEDURE

1. Turn ignition switch ON (READY) and wait at least 5 seconds.
2. Check DTC.

Is DTC detected?

- YES >> Go to Diagnosis Procedure. [HAC-64, "Diagnosis Procedure"](#).
NO >> END.

Diagnosis Procedure

INFOID:000000001504846

CAUTION:

- Wear electrically insulated gloves and pull out the service plug grip before inspection as procedures may require disconnecting high-voltage connectors. Be sure to carry the removed service plug grip because other workers may install it by mistake.
- Do not touch the high-voltage connectors or terminals for 10 minutes after the service plug grip is removed.

1. CHECK CAN COMMUNICATION SYSTEM

Use the CONSULT-III to check if the CAN Communication System is functioning normally.

Is CAN DTC detected?

- YES >> Check CAN communication. Refer to [LAN-16, "Trouble Diagnosis Flow Chart"](#).
NO >> Replace electric compressor.

B2645, B2653 ELECTRIC COMPRESSOR

< COMPONENT DIAGNOSIS >

[AUTOMATIC AIR CONDITIONER]

B2645, B2653 ELECTRIC COMPRESSOR

Description

INFOID:000000001504847

CAUTION:

- Wear electrically insulated gloves and pull out the service plug grip before inspection as procedures may require disconnecting high-voltage connectors. Be sure to carry the removed service plug grip because other workers may install it by mistake.
- Do not touch the high-voltage connectors or terminals for 10 minutes after the service plug grip is removed.

DTC Logic

INFOID:000000001504848

DTC DETECTION LOGIC

DTC No.	Trouble Diagnosis Name	DTC Detecting Condition	Possible Cause
B2645	CURRENT MALFUNCTN	• After READY and A/C ON • A/C inverter malfunction.	• Electric compressor • CAN communication system
B2653	THARMO FAIL		

DTC CONFIRMATION PROCEDURE

1. PRECONDITIONING

If DTC Confirmation Procedure has been previously conducted, always turn ignition switch OFF and wait at least 10 seconds before conducting the next test.

>> GO TO 2.

2. PERFORM DTC CONFIRMATION PROCEDURE

1. Turn ignition switch ON (READY) and wait at least 5 seconds.
2. Check DTC.

Is DTC detected?

- YES >> Go to Diagnosis Procedure. [HAC-65. "Diagnosis Procedure"](#).
NO >> END.

Diagnosis Procedure

INFOID:000000001504849

CAUTION:

- Wear electrically insulated gloves and pull out the service plug grip before inspection as procedures may require disconnecting high-voltage connectors. Be sure to carry the removed service plug grip because other workers may install it by mistake.
- Do not touch the high-voltage connectors or terminals for 10 minutes after the service plug grip is removed.

1. CHECK CAN COMMUNICATION SYSTEM

Use the CONSULT-III to check if the CAN Communication System is functioning normally.

Is CAN DTC detected?

- YES >> Check CAN communication. Refer to [LAN-16. "Trouble Diagnosis Flow Chart"](#).
NO >> Replace electric compressor.

B2646, B2647, B2648, B2649, B264A, B264C, B264D ELECTRIC COMPRESSOR < COMPONENT DIAGNOSIS > [AUTOMATIC AIR CONDITIONER]

B2646, B2647, B2648, B2649, B264A, B264C, B264D ELECTRIC COMPRESSOR

Description

INFOID:000000001504850

The electric compressor stops compressor control and outputs this DTC if the rotation load is too large or too small while controlling motor rotation in the electric compressor. Possible causes are refrigerant gas leakage, overcharged refrigerant gas, insufficient cooling because of a condenser fan circuit malfunction, or compressor lock. The output DTC of B2646, B2647, B2648 and B264C are memorized only present trouble. On B264D, compressor control may not resume unless the ignition switch is turned OFF and waiting for 10 minutes.

DTC Logic

INFOID:000000001504851

DTC DETECTION LOGIC

DTC No.	Trouble Diagnosis Name	DTC Detecting Condition	Possible Cause
B2646	VOLT MAIN	After READY and A/C ON	<ul style="list-style-type: none">• Refrigerant volume• Electric compressor• Cooling fan system• CAN communication system
B2647	MOTOR CRNT LIMIT	After READY and A/C ON	
B2648	SOFT OVER CRNT	After READY and A/C ON	
B2649	OVER LOAD	<ul style="list-style-type: none">• After READY and A/C ON• Motor's rotation load while the compressor is operating is too large or too small.	
B264A	INPT OVR CRNT	After READY and A/C ON	
B264C	STARUP FAIL	<ul style="list-style-type: none">• After READY and A/C ON• Electric compressor cannot start or operate normally.	
B264D	SYS FAIL STOP		

DTC CONFIRMATION PROCEDURE

1. PRECONDITIONING

If DTC Confirmation Procedure has been previously conducted, always turn ignition switch OFF and wait at least 10 seconds before conducting the next test.

>> GO TO 2.

2. PERFORM DTC CONFIRMATION PROCEDURE

1. Turn ignition switch ON (READY) and wait at least 5 seconds.
2. Check DTC.

Is DTC detected?

YES >> Go to Diagnosis Procedure. [HAC-66, "Diagnosis Procedure"](#).

NO >> END.

Diagnosis Procedure

INFOID:000000001504852

1. CHECK CAN COMMUNICATION SYSTEM

Use the CONSULT-III to check if the CAN Communication System is functioning normally.

Is CAN DTC detected?

YES >> Check CAN communication. Refer to [LAN-16, "Trouble Diagnosis Flow Chart"](#).

NO >> GO TO 2.

2. PERFORM ACTIVE TEST

1. Turn ignition switch ON (READY).
2. Perform "FAN DUTY CONTROL" in "ACTIVE TEST" mode with CONSULT-III.

Does cooling fan operates smoothly?

YES >> GO TO 3.

B2646, B2647, B2648, B2649, B264A, B264C, B264D ELECTRIC COMPRESSOR
< COMPONENT DIAGNOSIS > [AUTOMATIC AIR CONDITIONER]

NO >> Go to cooling fan system. Refer to [EC-372. "Diagnosis Procedure"](#).

3.CHECK REFRIGERANT CYCLE PRESSURE

Connect refrigerant recovery/recycling recharging equipment to the vehicle and check the refrigerant cycle pressure. Refer to [HA-23. "HFC-134a \(R-134a\) Service Procedure"](#).

Is the inspection result normal?

YES >> Replace electric compressor.

NO >> Recharge refrigerant after repair or replace the parts according to the inspection results.

A
B
C
D
E
F
G
H
J
K
L
M
N
O
P

HAC

B264E ELECTRIC COMPRESSOR

< COMPONENT DIAGNOSIS >

[AUTOMATIC AIR CONDITIONER]

B264E ELECTRIC COMPRESSOR

Description

INFOID:000000001504853

The electric compressor monitors the controlling power voltage in the circuit. It stops the compressor circuit and outputs the DTC when the monitored voltage is outside the specified range. The output DTC is memorized as past and present trouble. The compressor control may not resume unless the ignition switch is turned OFF, and waiting for 10 minutes.

CAUTION:

- Wear electrically insulated gloves and pull out the service plug grip before inspection as procedures may require disconnecting high-voltage connectors. Be sure to carry the removed service plug grip because other workers may install it by mistake.
- Do not touch the high-voltage connectors or terminals for 10 minutes after the service plug grip is removed.

DTC Logic

INFOID:000000001504854

DTC DETECTION LOGIC

DTC No.	Trouble Diagnosis Name	DTC Detecting Condition	Possible Cause
B264E	INSIDE PWR	<ul style="list-style-type: none">• After READY and A/C ON• An open or short to ground in the inverter's controlling power voltage circuit.	<ul style="list-style-type: none">• Electric compressor• CAN communication system

DTC CONFIRMATION PROCEDURE

1. PRECONDITIONING

If DTC Confirmation Procedure has been previously conducted, always turn ignition switch OFF and wait at least 10 seconds before conducting the next test.

>> GO TO 2.

2. PERFORM DTC CONFIRMATION PROCEDURE

1. Turn ignition switch ON (READY) and wait at least 5 seconds.
2. Check DTC.

Is DTC detected?

- YES >> Go to Diagnosis Procedure. [HAC-68, "Diagnosis Procedure"](#).
NO >> END.

Diagnosis Procedure

INFOID:000000001504855

CAUTION:

- Wear electrically insulated gloves and pull out the service plug grip before inspection as procedures may require disconnecting high-voltage connectors. Be sure to carry the removed service plug grip because other workers may install it by mistake.
- Do not touch the high-voltage connectors or terminals for 10 minutes after the service plug grip is removed.

1. CHECK CAN COMMUNICATION SYSTEM

Use the CONSULT-III to check if the CAN Communication System is functioning normally.

Is CAN DTC detected?

- YES >> Check CAN communication. Refer to [LAN-16, "Trouble Diagnosis Flow Chart"](#).
NO >> Replace electric compressor.

B264F ELECTRIC COMPRESSOR

< COMPONENT DIAGNOSIS >

[AUTOMATIC AIR CONDITIONER]

B264F ELECTRIC COMPRESSOR

Description

INFOID:000000001504856

The inverter activation signal is sent to the electric compressor from the HV ECU. Compressor control is stopped and the DTC is output if there is an open or short in the signal circuit.

DTC Logic

INFOID:000000001504857

DTC DETECTION LOGIC

DTC No.	Trouble Diagnosis Name	DTC Detecting Condition	Possible Cause
B264F	STB SHORT	<ul style="list-style-type: none">After READY and A/C ONOpen or short in A/C inverter start-up signal system	<ul style="list-style-type: none">Harness or connector between HV ECU and electric compressorElectric compressorHybrid control systemCAN communication system

DTC CONFIRMATION PROCEDURE

1. PRECONDITIONING

If DTC Confirmation Procedure has been previously conducted, always turn ignition switch OFF and wait at least 10 seconds before conducting the next test.

>> GO TO 2.

2. PERFORM DTC CONFIRMATION PROCEDURE

- Turn ignition switch ON (READY) and wait at least 5 seconds.
- Check DTC.

Is DTC detected?

- YES >> Go to Diagnosis Procedure. [HAC-69. "Diagnosis Procedure"](#).
NO >> END.

Diagnosis Procedure

INFOID:000000001504858

CAUTION:

- Wear electrically insulated gloves and pull out the service plug grip before inspection as procedures may require disconnecting high-voltage connectors. Be sure to carry the removed service plug grip because other workers may install it by mistake.
- Do not touch the high-voltage connectors or terminals for 10 minutes after the service plug grip is removed.

1. CHECK CAN COMMUNICATION

Use the CONSULT-III to check if the CAN Communication System is functioning normally.

Is DTC detected?

- YES >> Check CAN communication. Refer to [LAN-16. "Trouble Diagnosis Flow Chart"](#).
NO >> GO TO 2.

2. CHECK DIAGNOSTIC TROUBLE CODE

Check if DTCs for the air conditioning system and the hybrid control system are output using the CONSULT-III.

Is DTC detected?

- YES-1 >> Only DTC B264F is output: GO TO 3.
YES-2 >> DTCs B264F and P3108 are output simultaneously (U0424 is not output): GO TO 3.
YES-3 >> DTCs B264F and U0424 are output simultaneously (P3108 is not output): Refer to [HAC-76. "Diagnosis Procedure"](#).
YES-4 >> DTCs B264F, B1498 and P3108 are output simultaneously: Refer to [HAC-76. "Diagnosis Procedure"](#).
YES-5 >> DTCs other than P3108 are output for hybrid control system: Refer to [HBC-9. "Work Flow"](#).

B264F ELECTRIC COMPRESSOR

[AUTOMATIC AIR CONDITIONER]

< COMPONENT DIAGNOSIS >

NO >> END.

3. CHECK HARNESS AND CONNECTOR BETWEEN HV ECU AND ELECTRIC COMPRESSOR

CAUTION:

- Be sure to wear insulated gloves.
- Do not touch the high-voltage connectors or terminals for 10 minutes after the service plug grip is removed.

1. Disconnect the HV ECU connector.
2. Disconnect the electric compressor connector.

CAUTION:

Do not disconnect the connector on the high-voltage side.

3. Measure the resistance according to the value(s) in the table below.

Electric compressor		HV ECU		Condition	Resistance (Ω)
Connector	Terminal	Connector	Terminal		
F251	4	E65	56	Always	Below 1.0

Electric compressor		-	Condition	Resistance (Ω)
Connector	Terminal			
F251	4	Ground	Always	10 k or higher

Is the inspection result normal?

YES >> GO TO 4.

NO >> Repair harness or connector.

4. INSPECT ELECTRIC COMPRESSOR

1. Reconnect the connector to the electric compressor.

CAUTION:

Be sure to wear insulated gloves.

2. Measure the voltage according to the value(s) in the table below.

(+)		(-)		Condition	Voltage (V)
HV ECU		-			
Connector	Terminal				
E65	56	Ground		IGN ON	10 to 14
				IGN OFF	Below 1.0

Is the inspection result normal?

YES >> Replace HV ECU.

NO >> Replace electric compressor.

B2651, B2652 ELECTRIC COMPRESSOR

< COMPONENT DIAGNOSIS >

[AUTOMATIC AIR CONDITIONER]

B2651, B2652 ELECTRIC COMPRESSOR

Description

INFOID:000000001504859

The temperature sensor of the electric compressor detects inverter temperature. If the temperature exceeds the maximum, the electric compressor stops compressor operation, and this DTC will be output. The output DTC of B2651 are memorized only present trouble. On B2652, compressor control may not resume unless the ignition switch is turned OFF and waiting for 10 minutes.

DTC Logic

INFOID:000000001504860

DTC DETECTION LOGIC

DTC No.	Trouble Diagnosis Name	DTC Detecting Condition	Possible Cause
B2651	INV OVERHEAT L	<ul style="list-style-type: none">• After READY and A/C ON• Temperature in the inverter is outside the specified range (temperature is too high), or there is an open or short to ground in the temperature sensor circuit.	<ul style="list-style-type: none">• Cooling fan system• Refrigerant volume• Electric compressor• CAN communication system
B2652	INV OVERHEAT S		

DTC CONFIRMATION PROCEDURE

1. PRECONDITIONING

If DTC Confirmation Procedure has been previously conducted, always turn ignition switch OFF and wait at least 10 seconds before conducting the next test.

>> GO TO 2.

2. PERFORM DTC CONFIRMATION PROCEDURE

1. Turn ignition switch ON (READY) and wait at least 5 seconds.
2. Check DTC.

Is DTC detected?

- YES >> Go to Diagnosis Procedure. [HAC-71, "Diagnosis Procedure"](#).
NO >> END.

Diagnosis Procedure

INFOID:000000001504861

1. CHECK CAN COMMUNICATION SYSTEM

Use the CONSULT-III to check if the CAN Communication System is functioning normally.

Is CAN DTC detected?

- YES >> Check CAN communication. Refer to [LAN-16, "Trouble Diagnosis Flow Chart"](#).
NO >> GO TO 2.

2. PERFORM ACTIVE TEST

1. Turn ignition switch ON (READY).
2. Perform "FAN DUTY CONTROL" in "ACTIVE TEST" mode with CONSULT-III.

Does cooling fan operates smoothly?

- YES >> GO TO 3.
NO >> Go to cooling fan system. Refer to [EC-372, "Diagnosis Procedure"](#).

3. CHECK REFRIGERANT CYCLE PRESSURE

Connect refrigerant recovery/recycling recharging equipment to the vehicle and check the refrigerant cycle pressure. Refer to [HA-23, "HFC-134a \(R-134a\) Service Procedure"](#).

Is the inspection result normal?

- YES >> GO TO 4.
NO >> Recharge refrigerant after repair or replace the parts according to the inspection results.

4. CHECK DTC

B2651, B2652 ELECTRIC COMPRESSOR

< COMPONENT DIAGNOSIS >

[AUTOMATIC AIR CONDITIONER]

Check DTC.

NOTE:

If the engine keeps idling when ambient temperature is high, the compressor may automatically stop to protect the inverter circuit, and DTC B2651, B2652 may be stored.

Is DTC B2651, B2652 detected?

YES >> Replace electric compressor.

NO >> END.

P0AA6-611 ELECTRIC COMPRESSOR

< COMPONENT DIAGNOSIS >

[AUTOMATIC AIR CONDITIONER]

P0AA6-611 ELECTRIC COMPRESSOR

Description

INFOID:000000001504862

The DTC is output if there is insulation trouble with the high-voltage circuits in the air conditioning system. Possible causes are poor insulation in the compressor with motor assembly, or mixing of any oil other than ND-OIL 11 in the refrigerant cycle. The motor driven with high-voltage is built into the electrical compressor and is cooled directly with refrigerant. Compressor oil (ND-OIL 11) with high insulation performance is used because a leakage of electrical power may occur if regular compressor oil (DH-PS or DH-PR) is used.

CAUTION:

- **Electrical insulation performance may decrease significantly if even a small amount of oil other than ND-OIL 11 is used (or enters) in the refrigerant cycle, causing the DTC to be output.**
- **If other oil is accidentally used and a DTC is output, collect the oil in the refrigerant cycle into the compressor and replace it with ND-OIL 11 to increase the ND-OIL 11 ratio amount.**
- **Replace the main components (evaporator, condenser, and compressor) if a large amount of oil other than ND-OIL 11 enters the system. Failing to do so may cause electrical insulation performance to remain low, causing the DTC to be output.**
- **Wear insulated gloves and pull out the service plug grip before inspection as procedures may require disconnecting high-voltage connectors.**
- **Be sure to carry the removed service plug grip because other workers may install it by mistake.**
- **Do not touch the high-voltage connectors or terminals for 10 minutes after the service plug grip is removed.**

DTC Logic

INFOID:000000001504863

DTC DETECTION LOGIC

DTC No.	Trouble Diagnosis Name	DTC Detecting Condition	Possible Cause
P0AA6-611	INSULATION RESIST	<ul style="list-style-type: none">• After READY and A/C ON• High voltage system insulation malfunction.	<ul style="list-style-type: none">• Compressor oil• Refrigerant pipe line• Electric compressor• CAN communication system

HAC

DTC CONFIRMATION PROCEDURE

1. PRECONDITIONING

If DTC Confirmation Procedure has been previously conducted, always turn ignition switch OFF and wait at least 10 seconds before conducting the next test.

>> GO TO 2.

2. PERFORM DTC CONFIRMATION PROCEDURE

1. Turn ignition switch ON (READY) and wait at least 5 seconds.
2. Check DTC.

Is DTC detected?

- YES >> Go to Diagnosis Procedure. [HAC-73. "Diagnosis Procedure"](#).
NO >> END.

Diagnosis Procedure

INFOID:000000001504864

CAUTION:

- **Wear electrically insulated gloves and pull out the service plug grip before inspection as procedures may require disconnecting high-voltage connectors. Be sure to carry the removed service plug grip because other workers may install it by mistake.**
- **Do not touch the high-voltage connectors or terminals for 10 minutes after the service plug grip is removed.**

NOTE:

If it can be confirmed that any compressor oil other than ND-OIL 11 has been used in the vehicle, replace the air conditioning cycle.

P0AA6-611 ELECTRIC COMPRESSOR

< COMPONENT DIAGNOSIS >

[AUTOMATIC AIR CONDITIONER]

1. CHECK CAN COMMUNICATION

Use the CONSULT-III to check if the CAN Communication System is functioning normally.

Is DTC detected?

- YES >> Check CAN communication. Refer to [LAN-16. "Trouble Diagnosis Flow Chart"](#).
- NO >> GO TO 2.

2. INSPECT ELECTRIC COMPRESSOR

1. Turn ignition switch ON.
2. Select "SELF-DIAG RESULTS" mode with CONSULT-III.
3. Touch "ERASE".
4. Turn fan control dial clockwise. Blower should operate on max. speed.
5. Turn temperature control dial (driver side) counterclockwise until 18°C (60°F).
6. A/C switch ON, and operate more than 3 minutes.
7. Turn ignition switch OFF.
8. Remove the service plug grip.
CAUTION:
 - Because the compressor has a high-voltage circuit, wear insulated gloves and pull out the service plug grip to cut off the high-voltage circuit before inspection.
 - Do not touch the high-voltage connectors or terminals for 10 minutes after the service plug grip is removed.
 - Do not start the engine with the service plug grip removed because it may cause a malfunction.
9. Disconnect electric compressor connector.
10. Using a megohmmeter, measure the resistance according to the value(s) in the table below.

Electric compressor		(—)	Resistance (Ω)	
Connector	Terminal			
F252	7	Ground	Always	2 MΩ or higher
	8			

Is DTC detected?

- YES >> GO TO 3.
- NO >> Replace electric compressor.

3. INSPECT ELECTRIC COMPRESSOR

1. Reconnect electric compressor connector.
2. Install the service plug grip.
CAUTION:
 - Because the compressor has a high-voltage circuit, wear insulated gloves and pull out the service plug grip to cut off the high-voltage circuit before inspection.
 - Do not touch the high-voltage connectors or terminals for 10 minutes after the service plug grip is removed.
 - Do not start the engine with the service plug grip removed because it may cause a malfunction.
3. Turn ignition switch ON.
4. Turn temperature control dial (driver side) clockwise until 25°C (77°F).
5. Turn fan control dial counterclockwise. Blower should operate on low speed, and then operate the compressor for 10 minutes to circulate the refrigerant cycle with refrigerant and collect as much compressor oil as possible.
6. Turn ignition switch OFF.
7. Using a spot cooler or other tools, cool down the compressor with motor assembly for 30 minutes, or leave the vehicle overnight before inspection.
CAUTION:
 - Do not operate the compressor before inspection.
8. Remove the service plug grip.
CAUTION:
 - Do not start the engine with the service plug grip removed because it may cause a malfunction.
9. Disconnect electric compressor connector.
10. Using a megohmmeter, measure the resistance according to the value(s) in the table below.

P0AA6-611 ELECTRIC COMPRESSOR

< COMPONENT DIAGNOSIS >

[AUTOMATIC AIR CONDITIONER]

Electric compressor		(—)	Resistance (Ω)	
Connector	Terminal			
F252	7	Ground	Always	3 M Ω or higher
	8			

CAUTION:

If the results are out of the specified range, replace the compressor without operating.

Is DTC detected?

- YES >> Replace electric compressor.
- NO >> Replace air conditioning cycle.

A
B
C
D
E
F
G
H
J
K
L
M
N
O
P

HAC

U0424 ELECTRIC COMPRESSOR

< COMPONENT DIAGNOSIS >

[AUTOMATIC AIR CONDITIONER]

U0424 ELECTRIC COMPRESSOR

Description

INFOID:000000001504865

The HV ECU and electric compressor transmit information to one another via a communication line. Compressor control is stopped and the DTC is output if communication information is cut off or abnormal information occurs. The DTC is also detected if high-voltage power supplied from the MG ECU to the compressor control circuit is shut off. The output DTC is memorized as current trouble.

CAUTION:

- Wear electrically insulated gloves and pull out the service plug grip before inspection as procedures may require disconnecting high-voltage connectors. Be sure to carry the removed service plug grip because other workers may install it by mistake.
- Do not touch the high-voltage connectors or terminals for 10 minutes after the service plug grip is removed.

DTC Logic

INFOID:000000001504866

DTC DETECTION LOGIC

DTC No.	Trouble Diagnosis Name	DTC Detecting Condition	Possible Cause
U0424	COMMUNICATION FAILURE	<ul style="list-style-type: none">• After READY and A/C ON• Communication line error or open between the HV ECU and the electric compressor.• High-voltage power source is shut off.	<ul style="list-style-type: none">• Harness or connector between HV ECU and electric compressor and ground• Electric compressor• HV ECU• MG ECU• Electric vehicle fuse• CAN communication system• Hybrid control system

DTC CONFIRMATION PROCEDURE

1. PRECONDITIONING

If DTC Confirmation Procedure has been previously conducted, always turn ignition switch OFF and wait at least 10 seconds before conducting the next test.

>> GO TO 2.

2. PERFORM DTC CONFIRMATION PROCEDURE

1. Turn ignition switch ON (READY) and wait at least 5 seconds.
2. Check DTC.

Is DTC detected?

- YES >> Go to Diagnosis Procedure. [HAC-76, "Diagnosis Procedure"](#).
NO >> END.

Diagnosis Procedure

INFOID:000000001504867

CAUTION:

- Wear electrically insulated gloves and pull out the service plug grip before inspection as procedures may require disconnecting high-voltage connectors. Be sure to carry the removed service plug grip because other workers may install it by mistake.
- Do not touch the high-voltage connectors or terminals for 10 minutes after the service plug grip is removed.

1. CHECK CAN COMMUNICATION

Use the CONSULT-III to check if the CAN Communication System is functioning normally.

Is DTC detected?

- YES >> Check CAN communication. Refer to [LAN-16, "Trouble Diagnosis Flow Chart"](#).
NO >> GO TO 2.

2. CHECK DIAGNOSTIC TROUBLE CODE

U0424 ELECTRIC COMPRESSOR

[AUTOMATIC AIR CONDITIONER]

< COMPONENT DIAGNOSIS >

Check if DTCs for the hybrid control system are output using the CONSULT-III.

Is DTC detected?

YES-1 >> Only DTC P3108 is output: GO TO 3.

YES-2 >> DTCs other than P3108 are output: Refer to [HBC-9. "Work Flow"](#).

NO >> GO TO 3.

3.INSPECT FUSE

1. Remove the 10A fuse [No. 3 located in the fuse block (J/B)]. Refer to [PG-63. "Terminal Arrangement"](#).

2. Measure the resistance according to the value(s) in the table below.

10A fuse (No. 3)		Condition	Resistance (Ω)
A	B	Always	Below 1.0

Is the inspection result normal?

YES >> GO TO 4.

NO >> Replace the 10A fuse [No. 3 located in the fuse block (J/B)]. Refer to [PG-63. "Terminal Arrangement"](#).

4.CHECK ELECTRIC COMPRESSOR GROUND CIRCUIT

1. Disconnect the electric compressor connector.

CAUTION:

Do not disconnect the connector on the high-voltage side.

2. Measure the resistance according to the value(s) in the table below.

Electric compressor		-	Condition	Resistance (Ω)
Connector	Terminal			
F251	5	Ground	Always	Below 1.0

Is the inspection result normal?

YES >> GO TO 5.

NO >> Repair harness or connector.

5.CHECK HARNESS AND CONNECTOR

1. Turn ignition switch ON.

2. Measure the voltage according to the value(s) in the table below.

(+)		(-)		Condition	Voltage (V)
Electric compressor					
Connector	Terminal	Connector	Terminal		
F251	6	F251	5	IGN SW: ON (READY)	10 to 14
				IGN SW: OFF	Below 1.0

Is the inspection result normal?

YES >> GO TO 6.

NO >> Repair harness or connector.

6.CHECK HARNESS AND CONNECTOR (HV ECU-ELECTRIC COMPRESSOR)

1. Disconnect the HV ECU connector.

2. Measure the voltage according to the value(s) in the table below.

Electric compressor		HV ECU		Condition	Resistance (Ω)
Connector	Terminal	Connector	Terminal		
F251	1	E65	55	Always	Below 1.0
	2		54		
	3		53		

A
B
C
D
E
F
G
H
J
K
L
M
N
O
P

HAC

U0424 ELECTRIC COMPRESSOR

< COMPONENT DIAGNOSIS >

[AUTOMATIC AIR CONDITIONER]

Electric compressor		-	Condition	Resistance (Ω)
Connector	Terminal			
F251	1	Ground	Always	10 k or higher
	2			
	3			

Is the inspection result normal?

YES >> GO TO 7.

NO >> Repair harness or connector.

7. INSPECT ELECTRIC VEHICLE FUSE

1. Turn ignition switch OFF.
2. Remove the service plug grip.

CAUTION:

- Be sure to wear insulated gloves.
- Do not touch the high-voltage connectors or terminals for 10 minutes after the service plug grip is removed.

NOTE:

Do not start the engine with the service plug grip removed because it may cause a malfunction.

3. Remove the connector cover assembly.

CAUTION:

Be sure to wear insulated gloves.

NOTE:

Be sure to prevent foreign objects or water from entering the MG ECU.

4. Check that bolts A and B are tightened securely.

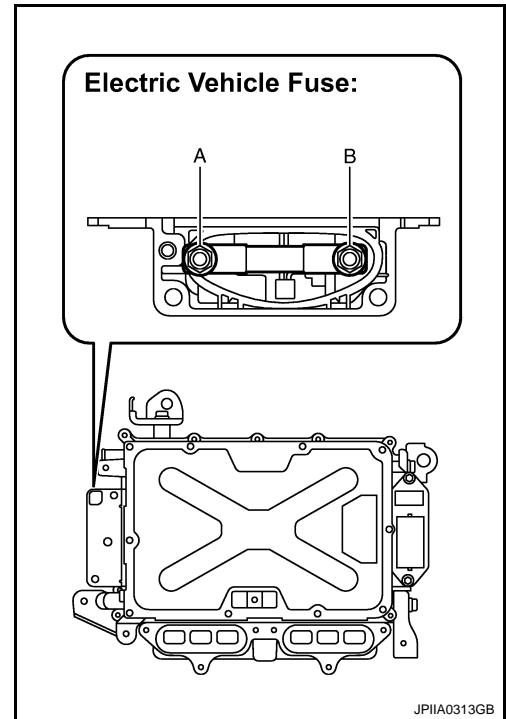

5. Measure the resistance according to the value(s) in the table below.

MG ECU		Condition	Resistance (Ω)
Electric vehicle fuse			
A	B	Always	Below 1.0

Is the inspection result normal?

YES >> GO TO 8.

NO >> Replace electric vehicle fuse.

U0424 ELECTRIC COMPRESSOR

< COMPONENT DIAGNOSIS >

[AUTOMATIC AIR CONDITIONER]

8.INSPECT MG ECU

CAUTION:

- Be sure to wear insulated gloves.
 - Do not touch the high-voltage connectors or terminals for 10 minutes after the service plug grip is removed.
1. Disconnect the MG ECU connector.
 2. Measure the resistance according to the value(s) in the table below.

MG ECU				Condition	Resistance (Ω)
Connector	Terminal	Connector	Terminal		
F250	11	F225	1	Always	Below 1.0
	12		2		

Is the inspection result normal?

YES >> GO TO 9.

NO >> Replace MG ECU.

9.MG ECU CIRCUIT

1. Disconnect the electric compressor connector.

CAUTION:

Be sure to wear insulated gloves.

2. Measure the resistance according to the value(s) in the table below.

Electric compressor		MG ECU		Condition	Resistance (Ω)
Connector	Terminal	Connector	Terminal		
F252	7	F250	12	Always	Below 1.0
	8		11		

Is the inspection result normal?

YES >> GO TO 10.

NO >> Repair harness or connector.

10.INSPECT ELECTRIC COMPRESSOR

1. Reconnect the electric compressor connector.
2. Turn ignition switch ON.
3. Measure the waveform according to the following tables.

A
B
C
D
E
F
G
H
J
K
L
M
N
O
P

HAC

U0424 ELECTRIC COMPRESSOR

< COMPONENT DIAGNOSIS >

[AUTOMATIC AIR CONDITIONER]

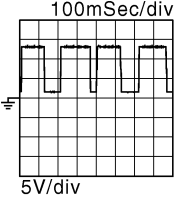
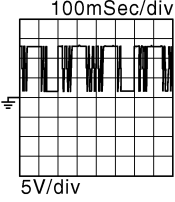
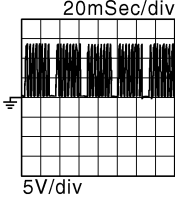
HV ECU		-	Condition	Value (Approx.)
Connector	Terminal			
E65	54	Ground	<ul style="list-style-type: none"> IGN SW: ON (READY) A/C system: Not operating 	 <p style="text-align: right; font-size: small;">JMCI A0001GB</p>
	54		<ul style="list-style-type: none"> IGN SW: ON (READY) A/C system: Operating 	 <p style="text-align: right; font-size: small;">JMCI A0002GB</p>
	55		IGN SW: ON (READY)	 <p style="text-align: right; font-size: small;">JMCI A0005GB</p>

Is the inspection result normal?

YES >> Replace HV ECU.

NO >> Replace electric compressor.

U1000 CAN COMM CIRCUIT

< COMPONENT DIAGNOSIS >

[AUTOMATIC AIR CONDITIONER]

U1000 CAN COMM CIRCUIT

Description

INFOID:000000001504868

CAN (Controller Area Network) is a serial communication line for real time application. It is an on-vehicle multiplex communication line with high data communication speed and excellent error detection ability. Many electronic control units are equipped onto a vehicle, and each control unit shares information and links with other control units during operation (not independent). In CAN communication, control units are connected with 2 communication lines (CAN-H line, CAN-L line) allowing a high rate of information transmission with less wiring. Each control unit transmits/receives data but selectively reads required data only.

DTC Logic

INFOID:000000001504869

DTC DETECTION LOGIC

DTC No.	Trouble diagnosis name	DTC detecting condition	Possible cause
U1000	CAN communication line	When ECM is not transmitting or receiving CAN communication signal of OBD (emission related diagnosis) for 2 seconds or more.	• Harness or connectors (CAN communication line is open or shorted)
U1001		When ECM is not transmitting or receiving CAN communication signal other than OBD (emission related diagnosis) for 2 seconds or more.	

DTC CONFIRMATION PROCEDURE

1. PERFORM DTC CONFIRMATION PROCEDURE

1. Turn ignition switch ON (READY) and wait at least 3 seconds.
2. Check DTC.

Is DTC detected?

- YES >> [HAC-81, "Diagnosis Procedure"](#).
NO >> END.

Diagnosis Procedure

INFOID:000000001504870

Go to [LAN-16, "Trouble Diagnosis Flow Chart"](#).

U1010 CONTROL UNIT (CAN)

< COMPONENT DIAGNOSIS >

[AUTOMATIC AIR CONDITIONER]

U1010 CONTROL UNIT (CAN)

Description

INFOID:000000001504871

CAN (Controller Area Network) is a serial communication line for real time application. It is an on-vehicle multiplex communication line with high data communication speed and excellent error detection ability. Many electronic control units are equipped onto a vehicle, and each control unit shares information and links with other control units during operation (not independent). In CAN communication, control units are connected with 2 communication lines (CAN-H line, CAN-L line) allowing a high rate of information transmission with less wiring. Each control unit transmits/receives data but selectively reads required data only.

DTC Logic

INFOID:000000001504872

DTC DETECTION LOGIC

DTC No.	Trouble diagnosis name	DTC detecting condition	Possible cause
U1010	CAN controller	When detecting error during the initial diagnosis of CAN controller of ECM.	<ul style="list-style-type: none">• Auto amp.

DTC CONFIRMATION PROCEDURE

1. PERFORM DTC CONFIRMATION PROCEDURE

1. Turn ignition switch ON (READY).
2. Check DTC.

Is DTC detected?

- YES >> Go to [HAC-82. "Diagnosis Procedure"](#).
NO >> END.

Diagnosis Procedure

INFOID:000000001504873

1. INSPECTION START

1. Turn ignition switch ON (READY).
2. Select "SELF-DIAG RESULTS" mode with CONSULT-III.
3. Touch "ERASE".
4. Perform DTC CONFIRMATION PROCEDURE.
See [HAC-82. "DTC Logic"](#).
5. Check DTC.

Is the DTC U1010 displayed again?

- YES >> Replace auto amp.
NO >> END.

BLOWER MOTOR

< COMPONENT DIAGNOSIS >

[AUTOMATIC AIR CONDITIONER]

BLOWER MOTOR

Description

INFOID:000000001504874

COMPONENT DESCRIPTION

Brush-less Motor

The blower motor utilizes a brush-less motor with a rotating magnet. Quietness is improved over previous motors where the brush was the point of contact and the coil rotated.

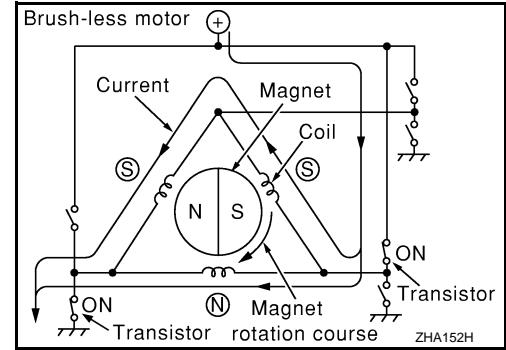

Component Function Check

INFOID:000000001504875

1. CONFIRM SYMPTOM BY PERFORMING THE FOLLOWING OPERATIONAL CHECK

1. Turn fan control dial clockwise. Blower should operate on low speed.
2. Turn fan control dial clockwise, and continue checking blower speed and fan LEDs until all speeds checked.

Is the inspection result normal?

YES >> END.

NO >> Go to diagnosis procedure. Refer to [HAC-83, "Diagnosis Procedure"](#)

Diagnosis Procedure

INFOID:000000001504876

1. CHECK BLOWER MOTOR OPERATING

Check blower motor operating.

Is blower motor operation under starting blower speed control?

YES >> END.

NO >> GO TO 2.

2. CHECK POWER SUPPLY FOR BLOWER MOTOR

1. Disconnect blower motor connector.
2. Turn ignition switch ON (READY).
3. Check voltage between blower motor harness connector M31 terminal 4 and ground.

(+)		(-)	Voltage
Blower motor		—	
Connector	Terminal		
M31	4	Ground	Battery voltage

Is the inspection result normal?

YES >> GO TO 3.

NO >> GO TO 6.

3. CHECK BLOWER MOTOR GROUND CIRCUIT

1. Turn ignition switch OFF.
2. Check continuity between blower motor harness connector M31 terminal 1 and ground.

BLOWER MOTOR

< COMPONENT DIAGNOSIS >

[AUTOMATIC AIR CONDITIONER]

Blower motor		—	Continuity
Connector	Terminal		
M31	1	Ground	Continuity should exist

Is the inspection result normal?

YES >> GO TO 4.

NO >> Repair harness or connector.

4. CHECK CIRCUIT CONTINUITY BETWEEN BLOWER MOTOR AND AUTO AMP.

1. Disconnect auto amp. connector.
2. Check continuity between blower motor harness connector M31 terminal 3 and auto amp. harness connector M37 terminal 1.

Blower motor		Auto amp.		Continuity
Connector	Terminal	Connector	Terminal	
M31	3	M37	1	Continuity should exist

Is the inspection result normal?

YES >> GO TO 5.

NO >> Repair harness or connector.

5. CHECK AUTO AMP. OUTPUT SIGNAL

1. Reconnect blower motor connector and auto amp. connector.
2. Turn ignition switch ON (READY).
3. Set MODE switch to VENT position.
4. Change fan speed from Lo to Hi, and check duty ratios between blower motor harness connector M31 terminal 3 and ground by using an oscilloscope. Normal terminal 3 drive signal duty ratios are shown in the table below.

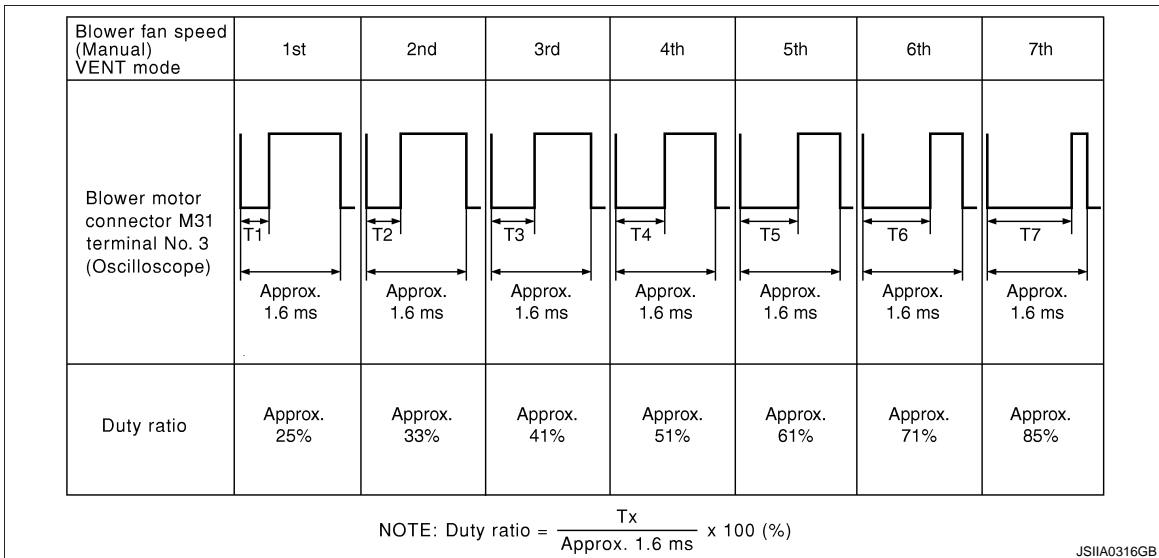

Is the inspection result normal?

YES >> Replace blower motor after confirming the fan air flow does not change.

NO >> Replace auto amp.

6. CHECK POWER VOLTAGE OF BLOWER FAN MOTOR RELAY

1. Turn ignition switch OFF.
2. Remove blower fan motor relay. Refer to [PG-55, "Electrical Units Location"](#).
3. Turn ignition switch ON (READY).
4. Check the voltage between blower fan motor relay fuse block terminals 1, 3 and body ground. Refer to [PG-61, "Description"](#) for relay terminal assignment.

BLOWER MOTOR

< COMPONENT DIAGNOSIS >

[AUTOMATIC AIR CONDITIONER]

(+)	(-)	Voltage
Blower fan motor relay	—	
1	Ground	Battery voltage
3		

Is the inspection result normal?

- YES >> GO TO 8.
- NO >> GO TO 7.

7.CHECK IGNITION SWITCH

Check ignition switch.

Is the inspection result normal?

- YES >> Repair harness or connector.
- NG >> Replace ignition switch.

8.CHECK BLOWER FAN MOTOR RELAY

1. Turn ignition switch OFF.
2. Install blower fan motor relay. Refer to [PG-55. "Electrical Units Location"](#).
3. Check operation sound of the blower fan motor relay after switching ignition switch ON.

Is the inspection result normal?

- YES >> GO TO 9.
- NO >> Replace blower fan motor relay.

9.CHECK FUSE

Check fuse 15A [Nos 21 and 22, located in the fuse block (J/B)]. Refer to [PG-63. "Terminal Arrangement"](#).

Is the inspection result normal?

- YES >> Repair harness or connector.
- NG >> Replace fuse.

Component Inspection

Confirm smooth rotation of the blower motor (1).

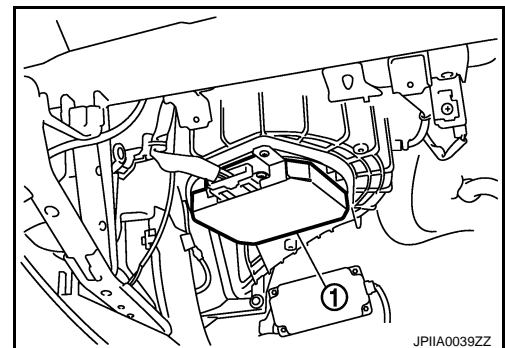

A
B
C
D
E
F
G
H
HAC
J
K
L
M
N
O
P

HEATER PUMP

< COMPONENT DIAGNOSIS >

[AUTOMATIC AIR CONDITIONER]

HEATER PUMP

Description

INFOID:000000001504878

SYSTEM DESCRIPTION

This vehicle uses an heater pump for air conditioning. This provides a stable heater performance even if the engine is stopped because of a function of the IPDM E/R.

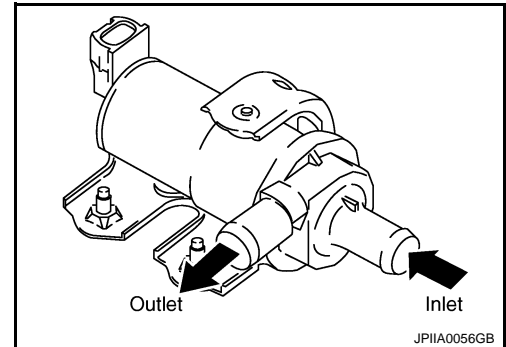

Component Function Check

INFOID:000000001504879

1. PERFORM DTC CONFIRMATION PROCEDURE

1. Turn ignition switch ON (READY) and wait at least 5 seconds.
2. Check DTC.

Is DTC is detected?

- YES >> Go to Diagnosis Procedure. [HAC-81, "Diagnosis Procedure"](#).
NO >> GO TO 2.

2. PERFORM AUTO ACTIVE TEST

Perform "AUTO ACTIVE TEST". Refer to [PCS-10, "Diagnosis Description"](#).

Does the heater pump operate?

- YES >> END.
NO >> Go to diagnosis procedure. Refer to [HAC-86, "Diagnosis Procedure"](#).

Diagnosis Procedure

INFOID:000000001504880

1. PERFORM ACTIVE TEST

1. Turn ignition switch ON (READY).
2. Press OFF switch. (A/C system does not operate.)
3. Perform "HVAC TEST" in "ACTIVE TEST" mode with CONSULT-III.
4. Select "MODE 7" in "HVAC TEST" active test item.

CAUTION:

Complete this inspection within 10 seconds if there is no water in the heater pump.

5. Check that heater pump operates.

MODE 7

: HEATER PUMP ON

Is the inspection result normal?

- YES >> GO TO 4.
NO >> Check 10A fuses (No. 41 located in IPDM E/R), and GO TO 2.

2. CHECK CIRCUIT CONTINUITY BETWEEN IPDM E/R AND HEATER PUMP

1. Turn ignition switch OFF.
2. Disconnect IPDM E/R connector and heater pump connector.
3. Check continuity between IPDM E/R harness connector F10 terminal 48 and heater pump harness connector E83 terminal 1.

HEATER PUMP

< COMPONENT DIAGNOSIS >

[AUTOMATIC AIR CONDITIONER]

IPDM E/R		Heater pump		Continuity
Connector	Terminal	Connector	Terminal	
F10	48	E83	1	Continuity should exist

Is the inspection result normal?

YES >> GO TO 3.

NO >> Repair harness or connector.

3. CHECK VOLTAGE BETWEEN HEATER PUMP AND GROUND

1. Turn ignition switch ON (READY).
2. Press OFF switch. (A/C system does not operate.)
3. Perform "HVAC TEST" in "ACTIVE TEST" mode with CONSULT-III.
4. Select "MODE 1 - 7" in "HVAC TEST" active test item.

CAUTION:

Complete this inspection within 10 seconds if there is no water in the heater pump.

5. Check voltage between heater pump harness connector E83 terminal 1 and ground.

MODE 1 - 2 : Approx. 0 V

MODE 3 - 7 : Battery voltage

Is the inspection result normal?

YES >> Replace heater pump.

NO >> Check IPDM E/R. Refer to [PCS-10, "Diagnosis Description"](#).

4. CHECK AUTO AMP. INPUT (HEATER PUMP ON) SIGNAL

Check heater pump ON/OFF signal in "DATA MONITOR". Refer to [HAC-136, "Reference Value"](#).

HEATER PUMP ON : HTR WTR PUMP ON

HEATER PUMP OFF : HTR WTR PUMP OFF

Is the inspection result normal?

YES >> GO TO 5.

NO >> Replace auto amp.

5. CHECK CAN COMMUNICATION

Check CAN communication. Refer to [PCS-10, "Diagnosis Description"](#).

- ECM – IPDM E/R

Is the inspection result normal?

YES >> Replace ECM.

NO >> Repair or replace malfunctioning part(s).

A
B
C
D
E
F
G
H
J
K
L
M
N
O
P

HAC

POWER SUPPLY AND GROUND CIRCUIT FOR AUTO AMP.

< COMPONENT DIAGNOSIS >

[AUTOMATIC AIR CONDITIONER]

POWER SUPPLY AND GROUND CIRCUIT FOR AUTO AMP.

Description

INFOID:000000001504881

COMPONENT DESCRIPTION

Auto Amp. (Automatic Amplifier)

The auto amp. (1) has a built-in microcomputer which processes information sent from various sensors needed for air conditioner operation. The air mix door motors, mode door motor, intake door motor, blower motor and compressor are then controlled.

The auto amp. is unitized with control mechanisms. Signal from various switches and potentiometer temperature control (PTC) are directly entered into auto amp.

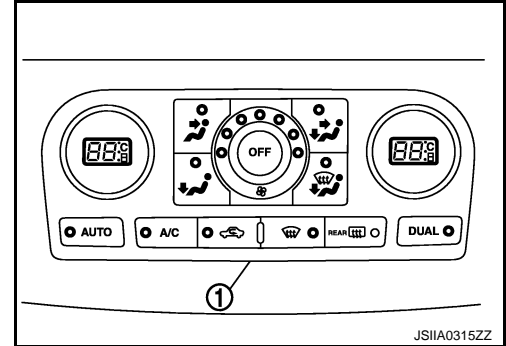

Power Supply and Ground Circuit for Auto Amp.

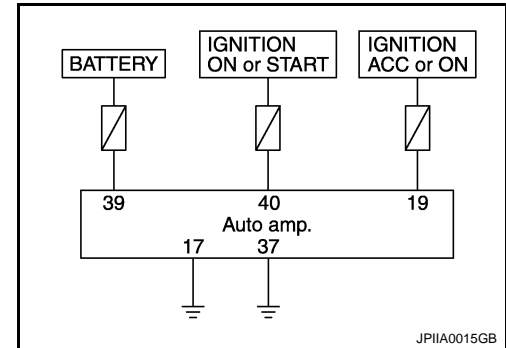

Potentiometer Temperature Control (PTC)

The PTC (1) is built into the auto amp. It can be set at an interval of 1°C (2°F) in the 18°C (60°F) to 32°C (90°F) temperature range by turning temperature control dial. The set temperature is displayed.

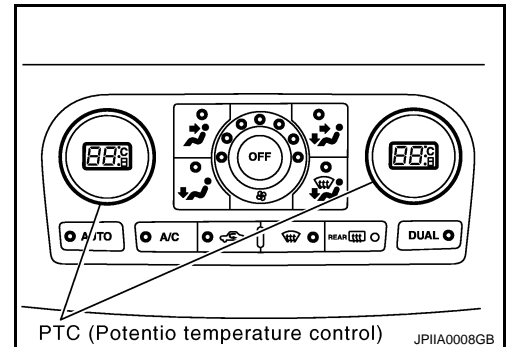

Component Function Check

INFOID:000000001504882

1. CONFIRM SYMPTOM BY PERFORMING THE FOLLOWING OPERATIONAL CHECK

1. Turn ignition switch ON (READY).
2. Press AUTO switch and A/C switch.
3. Each switch indicator will turn ON. Confirm that Discharge air and blower speed will depend on ambient, in-vehicle and set temperatures.

Is the inspection result normal?

YES >> END.

NO >> Go to Diagnosis Procedure. Refer to [HAC-88. "Diagnosis Procedure"](#).

Diagnosis Procedure

INFOID:000000001504883

1. CHECK POWER SUPPLY CIRCUIT FOR AUTO AMP.

POWER SUPPLY AND GROUND CIRCUIT FOR AUTO AMP.

[AUTOMATIC AIR CONDITIONER]

< COMPONENT DIAGNOSIS >

1. Disconnect auto amp. connector.
2. Check voltage between auto amp. harness connector M37 terminals 19, 39 and 40 and ground.

(+)		(-)	Ignition switch position		
Auto amp.		—	OFF	ACC	ON
Connector	Terminal				
M37	39		Battery voltage	Battery voltage	Battery voltage
	19		Approx. 0 V	Battery voltage	Battery voltage
	39	Approx. 0 V	Approx. 0 V	Battery voltage	

Is the inspection result normal?

- YES >> GO TO 3.
 NO >> GO TO 2.

2.CHECK FUSE

Check 10A fuses [Nos. 3, 6 and 19, located in the fuse block (J/B)]. Refer to [PG-63. "Terminal Arrangement"](#).

Is the inspection result normal?

- YES >> Check harness for open circuit. Repair or replace if necessary.
 NO >> Check harness for short circuit and replace fuse.

3.CHECK GROUND CIRCUIT FOR AUTO AMP.

1. Turn ignition switch OFF.
2. Check continuity between auto amp. harness connector M37 terminal 17, 37 and ground.

Auto amp.		(-)	Continuity	
Connector	Terminal	—	Ground	
M37	17			Continuity should exist
	37			

Is the inspection result normal?

- YES >> Replace auto amp.
 NO >> Repair harness or connector.

ELECTRIC COMPRESSOR

< COMPONENT DIAGNOSIS >

[AUTOMATIC AIR CONDITIONER]

ELECTRIC COMPRESSOR

Description

INFOID:000000001504884

COMPONENT DESCRIPTION

Electric Compressor

- The Air Conditioning (A/C) inverter is integrated with the compressor.

1. Discharge port
2. Suction port

- The electric motor is actuated by 3-phase alternating current supplied by the A/C inverter. As a result, the air conditioning control system is actuated without depending on the operation of the engine, thus realizing a comfortable air conditioning system and low fuel consumption.
- Due to the use of an electric compressor, the compressor speed can be controlled at the required speed calculated by the auto amp. Thus, the cooling and dehumidification performance and power consumption have been optimized.
- Low-moisture permeation hoses are used for the suction and discharge hoses at the compressor in order to minimize the entry of moisture into the refrigeration cycle.
- For details on the electric compressor control effected by the auto amp.

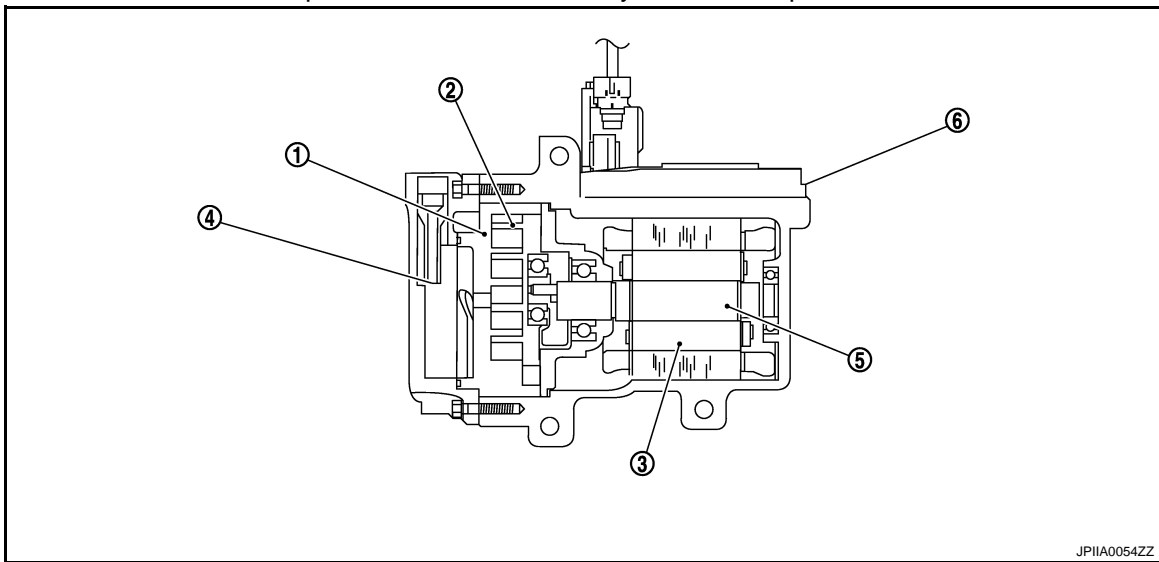
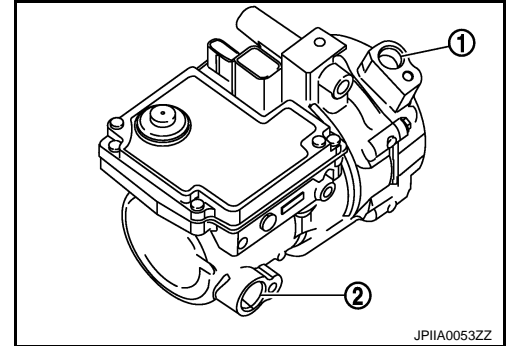

- | | | |
|------------------|--------------------|---------------------|
| 1. Fixed scroll | 2. Orbiting scroll | 3. Brush-less motor |
| 4. Oil separator | 5. Motor shaft | 6. A/C inverter |

- The electric compressor consists of a spirally wound fixed scroll and orbiting scroll that form a pair, a brush-less motor, an oil separator, a motor shaft and A/C inverter.
- The fixed scroll is integrated with the housing. Because the rotation of the shaft causes the orbiting scroll to revolve while maintaining the same posture, the volume of the space that is partitioned by both scrolls varies to perform the suction, compression, and the discharge of the refrigerant gas.
- Locating the suction port directly above the scrolls enables direct suction, thus realizing improved suction efficiency.
- Containing a built-in oil separator, this compressor is able to separate the compressor oil that is intermixed with the refrigerant and circulates in the refrigeration cycle, thus realizing a reduction in the oil circulation rate.
- This inverter converts the HV battery's nominal voltage of DC 244.8 V into AC and supplies power to operate the compressor.

ELECTRIC COMPRESSOR

< COMPONENT DIAGNOSIS >

[AUTOMATIC AIR CONDITIONER]

Operation

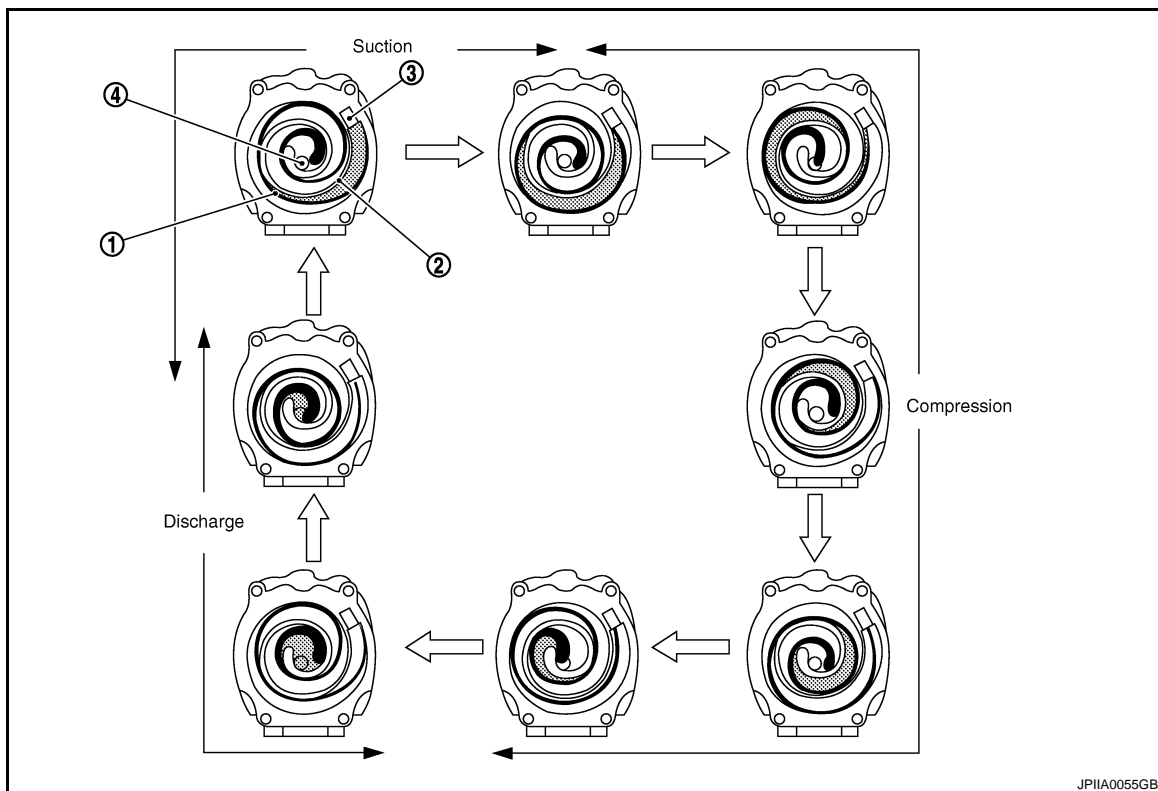

1. Orbiting scroll
2. Fixed scroll
3. Suction port
4. Discharge port

Suction

As the capacity of the compression chamber, which is created between the orbiting scroll and the fixed scroll, increases in accordance with the revolution of the orbiting scroll, refrigerant gas is drawn in from the intake port.

Compression

From the state at which the suction process has been completed, as the revolution of the orbiting scroll advances further, the capacity of the compression chamber decreases gradually. Consequently, the refrigerant gas that has been drawn in becomes compressed gradually and is sent to the center of the fixed scroll. The compression of the refrigerant gas is completed when the orbiting scroll completes approximately 2 revolutions.

Discharge

When the compression of the refrigerant gas is completed and the refrigerant pressure becomes high, the refrigerant gas discharges through the discharge port located in the center of the fixed scroll by pushing the discharge valve.

Component Function Check

INFOID:000000001504885

1. CONFIRM SYMPTOM BY PERFORMING THE FOLLOWING OPERATIONAL CHECK

1. Turn ignition switch ON (READY).
2. Press AUTO switch and A/C switch.
3. Each switch indicator will turn ON. Confirm that the electric compressor operate. (Discharge air and blower speed will depend on ambient, in-vehicle and set temperatures.)

Does the electric compressor operate?

YES >> END.

NO >> Go to Diagnosis Procedure. Refer to [HAC-92, "Diagnosis Procedure"](#).

ELECTRIC COMPRESSOR

[AUTOMATIC AIR CONDITIONER]

< COMPONENT DIAGNOSIS >

INFOID:000000001504886

Diagnosis Procedure

1. CHECK DTC

Check DTC.

Is DTC detected?

- YES >> Check according to [HAC-149. "DTC Index"](#).
- NO >> END.

2. CHECK REFRIGERANT PRESSURE SENSOR

1. Turn ignition switch ON (READY).
2. Check voltage of refrigerant pressure sensor in "DATA MONITOR". Refer to [HAC-93. "Reference Value"](#).

Is the inspection result normal?

- YES >> Replace ECM.
- NO >> Refer to [EC-392. "Diagnosis Procedure"](#).

Component Inspection

INFOID:000000001504887

REFRIGERANT PRESSURE SENSOR

The refrigerant pressure sensor (1) is attached to the liquid tank. Make sure that the A/C refrigerant pressure and the sensor output voltage are within the specified range as shown in the A/C operating condition figure. Refer to [EC-392. "Description"](#).

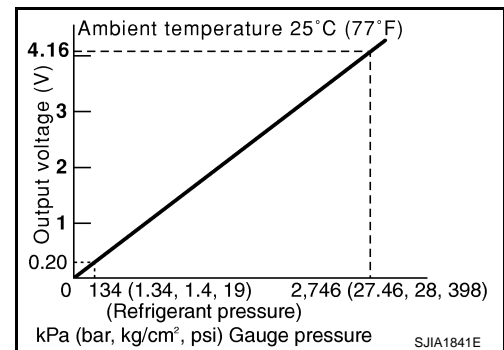
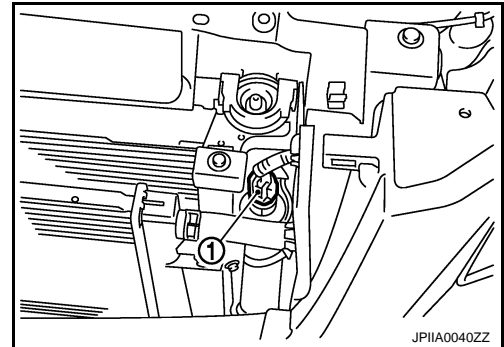

ECU DIAGNOSIS

ECM

Reference Value

INFOID:000000001504888

VALUES ON THE DIAGNOSIS TOOL

NOTE:

- Specification data are reference values.
- Specification data are output/input values which are detected or supplied by the ECM at the connector.
 - * Specification data may not be directly related to their components signals/values/operations.
 - i.e. Adjust ignition timing with a timing light before monitoring IGN TIMING, because the monitor may show the specification data in spite of the ignition timing not being adjusted to the specification data. this IGN TIMING monitors the data calculated by the ECM according to the signals input from the camshaft position sensor and other ignition timing related sensors.
- If necessary, activate "INSPECTION MODE 1" ([HBC-103](#)).

Monitor Item	Condition		Values/Status
ENG SPEED	See EC-11, "BASIC INSPECTION : Special Repair Requirement" .		
MAS A/F SE-B1	See EC-110, "Diagnosis Procedure" .		
B/FUEL SCHDL	See EC-110, "Diagnosis Procedure" .		
A/F ALPHA-B1	See EC-110, "Diagnosis Procedure" .		
COOLAN TEMP/S	• Engine: After warming up		More than 70°C (158°F)
A/F SEN1 (B1)	• Engine: After warming up	Maintaining engine speed at 2,500 rpm	Fluctuates around 2.2 V
HO2S2 (B1)	<ul style="list-style-type: none"> • Revving engine from idle up to 2,500 rpm quickly after the following conditions are met. <ul style="list-style-type: none"> - Engine: After warming up - Driving for 3 minutes at a speed of 80 km/h (50 MPH) or more (Keep the vehicle speed as steady as possible during the cruising.) 		0 - 0.3V ↔ Approx. 0.6 - 1.0V
HO2S3 (B1)	<ul style="list-style-type: none"> • Engine running after the following conditions are met. <ul style="list-style-type: none"> - Engine: After warming up - Driving for 3 minutes at a speed of 80 km/h (50 MPH) or more (Keep the vehicle speed as steady as possible during the cruising.) 		0 - 1.0V
HO2S2 MNTR (B1)	<ul style="list-style-type: none"> • Revving engine from idle up to 2,500 rpm quickly after the following conditions are met. <ul style="list-style-type: none"> - Engine: After warming up - Driving for 3 minutes at a speed of 80 km/h (50 MPH) or more (Keep the vehicle speed as steady as possible during the cruising.) 		LEAN ↔ RICH
VHCL SPEED SE	• Turn drive wheels and compare CONSULT-III value with the speedometer indication.		Almost the same speed as speedometer indication
BATTERY VOLT	• Ignition switch: ON (Engine stopped)		11 – 14V
TP SEN 1-B1	• Ignition switch: ON • Selector lever: D	Accelerator pedal: Fully released	More than 0.36V
		Accelerator pedal: Fully depressed	Less than 4.75V
TP SEN 2-B1*	• Ignition switch: ON • Selector lever: D	Accelerator pedal: Fully released	More than 0.36V
		Accelerator pedal: Fully depressed	Less than 4.75V
FUEL T/TMP SE	• Ignition switch: ON		Indicates fuel tank temperature
INT/A TEMP SE	• Ignition switch: ON		Indicates intake air temperature
EVAP SYS PRES	• Ignition switch: ON		Approx. 1.8 – 4.8V
FUEL LEVEL SE	• Ignition switch: ON		Depending on fuel level of fuel tank
START SIGNAL	<ul style="list-style-type: none"> • INSPECTION MODE • Ignition switch: ON → ON (READY) 		OFF → ON → OFF

ECM

< ECU DIAGNOSIS >

[AUTOMATIC AIR CONDITIONER]

Monitor Item	Condition	Values/Status	
CLSD THL POS	<ul style="list-style-type: none"> Ignition switch: ON (READY) 	ENG POWER RQST: 0 kW	ON
		ENG POWER RQST: Except 0 kW	OFF
AIR COND SIG	<ul style="list-style-type: none"> Ignition switch: ON (READY) 	Air conditioner switch: OFF	OFF
		Air conditioner switch: ON (Compressor operates.)	ON
P/N POSI SW	<ul style="list-style-type: none"> Ignition switch: ON 	Selector lever: P or N	ON
		Selector lever: Except above	OFF
PW/ST SIGNAL	<ul style="list-style-type: none"> Ignition switch: ON 		OFF
LOAD SIGNAL	<ul style="list-style-type: none"> Ignition switch: ON 	Rear window defogger switch: ON and/or Lighting switch: 2nd position	ON
		Rear window defogger switch and lighting switch: OFF	OFF
IGNITION SW	<ul style="list-style-type: none"> Ignition switch: ON → OFF → ON 		ON → OFF → ON
HEATER FAN SW	<ul style="list-style-type: none"> Ignition switch: ON (READY) 	Heater fan switch: ON	ON
		Heater fan switch: OFF	OFF
BRAKE SW	<ul style="list-style-type: none"> Ignition switch: ON 	Brake pedal: Fully released	OFF
		Brake pedal: Slightly depressed	ON
INJ PULSE-B1	<ul style="list-style-type: none"> Engine: After warming up Selector lever: P No load 	Idle	2.0 – 3.0 msec
		2,500 rpm	1.9 – 2.9 msec
IGN TIMING	<ul style="list-style-type: none"> Engine: After warming up Selector lever: N 	Idle	11° – 21° BTDC
CAL/LD VALUE	<ul style="list-style-type: none"> Engine: After warming up Selector lever: P No load 	Idle	10% – 35%
		2,500 rpm	10% – 35%
MASS AIRFLOW	<ul style="list-style-type: none"> Engine: After warming up Selector lever: P No load 	Idle	1.0 – 5.0 g·m/s
		2,500 rpm	4.0 – 12.0 g·m/s
PURG VOL C/V	<ul style="list-style-type: none"> Engine: After warming up 150 seconds or more after turning ignition switch ON (READY) 	Vehicle speed: 0 km/h (0 MPH)	0%
		Vehicle speed: 70 km/h (43 MPH) or more (Accelerator pedal: Depressed)	20% – 90%
INT/V TIM (B1)	<ul style="list-style-type: none"> Engine: After warming up Selector lever: P No load 	Idle	Approx. 20° – 30°CA
INT/V SOL (B1)	<ul style="list-style-type: none"> Engine: After warming up Selector lever: P No load 	Idle	Approx. 50% – 60%
FUEL PUMP RLY	<ul style="list-style-type: none"> For 1 seconds after turning ignition switch: ON Engine running or cranking 		ON
	<ul style="list-style-type: none"> Except above 		OFF
VENT CONT/V	<ul style="list-style-type: none"> Ignition switch: ON 		OFF
THRTL RELAY	<ul style="list-style-type: none"> Ignition switch: ON 		ON
HO2S2 HTR (B1)	<ul style="list-style-type: none"> Engine speed: Below 3,600 rpm after the following conditions are met. <ul style="list-style-type: none"> Engine: Running after warming up Driving for 3 minutes at a speed of 80 km/h (50 MPH) or more (Keep the vehicle speed as steady as possible during the cruising.) 		ON
	<ul style="list-style-type: none"> Engine speed: Above 3,600 rpm 		OFF

ECM

< ECU DIAGNOSIS >

[AUTOMATIC AIR CONDITIONER]

Monitor Item	Condition		Values/Status	
HO2S3 HTR (B1)	<ul style="list-style-type: none"> Engine speed: Below 3,600 rpm after the following conditions are met. <ul style="list-style-type: none"> - Engine: Running after warming up - Driving for 3 minutes at a speed of 80 km/h (50 MPH) or more (Keep the vehicle speed as steady as possible during the cruising.) 		ON	A
	<ul style="list-style-type: none"> Engine speed: Above 3,600 rpm 		OFF	B
VEHICLE SPEED	<ul style="list-style-type: none"> Turn drive wheels and compare CONSULT-III value with the speedometer indication. 		Almost the same speed as the speedometer indication	C
IDL A/V LEARN	<ul style="list-style-type: none"> Engine: running 	Idle air volume learning has not been performed yet.	YET	D
		Idle air volume learning has already been performed successfully.	CMPLT	
TRVL AFTER MIL	<ul style="list-style-type: none"> Ignition switch: ON 	Vehicle has traveled after MIL has turned ON.	0 – 65,535 km (0 – 40,723 miles)	E
A/F S1 HTR (B1)	<ul style="list-style-type: none"> Engine: After warming up, idle the engine (More than 140 seconds after starting engine.) 		4 – 100%	
AC PRESS SEN	<ul style="list-style-type: none"> Engine: Idle Both A/C switch and blower fan switch: ON (Compressor operates) 		1.0 – 4.0V	F
VHCL SPEED SE	<ul style="list-style-type: none"> Turn drive wheels and compare CONSULT-III value with the speedometer indication. 		Almost the same speed as the speedometer indication	G
SET VHCL SPD	<ul style="list-style-type: none"> Engine: Running 	ASCD: Operating	The preset vehicle speed is displayed	
MAIN SW	<ul style="list-style-type: none"> Ignition switch: ON 	MAIN switch: Pressed	ON	H
		MAIN switch: Released	OFF	
CANCEL SW	<ul style="list-style-type: none"> Ignition switch: ON 	CANCEL switch: Pressed	ON	HAC
		CANCEL switch: Released	OFF	
RESUME/ACC SW	<ul style="list-style-type: none"> Ignition switch: ON 	RESUME/ACCELERATE switch: Pressed	ON	J
		RESUME/ACCELERATE switch: Released	OFF	
SET SW	<ul style="list-style-type: none"> Ignition switch: ON 	SET/COAST switch: Pressed	ON	K
		SET/COAST switch: Released	OFF	
BRAKE SW1 (ASCD brake switch)	<ul style="list-style-type: none"> Ignition switch: ON 	Brake pedal: Fully released	ON	L
		Brake pedal: Slightly depressed	OFF	
BRAKE SW2 (Stop lamp switch)	<ul style="list-style-type: none"> Ignition switch: ON 	Brake pedal: Fully released	OFF	M
		Brake pedal: Slightly depressed	ON	
VHCL SPD CUT	<ul style="list-style-type: none"> Ignition switch: ON 		NON	
LO SPEED CUT	<ul style="list-style-type: none"> Ignition switch: ON 		NON	
AT OD MONITOR	<ul style="list-style-type: none"> Ignition switch: ON 		OFF	N
AT OD CANCEL	<ul style="list-style-type: none"> Ignition switch: ON 		OFF	
CRUISE LAMP	<ul style="list-style-type: none"> Ignition switch: ON 	MAIN switch: Pressed at the 1st time → at the 2nd time	ON → OFF	O
SET LAMP	<ul style="list-style-type: none"> Ignition switch: ON 		OFF	
A/F ADJ B1	<ul style="list-style-type: none"> Engine: running 		-0.330 – 0.330	P
FAN DUTY	<ul style="list-style-type: none"> Engine: Running 		0 – 100%	
ACCEL PEDAL POSI	<ul style="list-style-type: none"> Ignition switch: ON 		Depending on accelerator pedal position	
ENG POWER RQST	<ul style="list-style-type: none"> Ignition switch: ON (READY) 		Depending on signals from Hybrid vehicle control ECU	
ENG SPEED RQST	<ul style="list-style-type: none"> Ignition switch: ON (READY) 		Depending on signals from Hybrid vehicle control ECU	

ECM

< ECU DIAGNOSIS >

[AUTOMATIC AIR CONDITIONER]

Monitor Item	Condition	Values/Status
CATALYST TEMP-B1	<ul style="list-style-type: none"> Engine: Running after warming up 	More than 360°C (680°F)
ENG START RQST	<ul style="list-style-type: none"> Ignition switch: ON (READY) 	Depending on signals from Hybrid vehicle control ECU
ENG IDLE RQST	<ul style="list-style-type: none"> Ignition switch: ON (READY) 	Depending on signals from Hybrid vehicle control ECU
ENG F/C RQST	<ul style="list-style-type: none"> Ignition switch: ON (READY) 	Depending on signals from Hybrid vehicle control ECU
EVAP LEAK DIAG	<ul style="list-style-type: none"> Ignition switch: ON 	Depending on condition of EVAP leak diagnosis
EVAP DIAG READY	<ul style="list-style-type: none"> Ignition switch: ON (READY) 	Depending on ready condition of EVAP leak diagnosis
ENG START DIAG	<ul style="list-style-type: none"> Ignition switch: ON (READY) 	Depending on condition of engine does not start diagnosis
ENG ST DIAG RSLT	<ul style="list-style-type: none"> Ignition switch: ON (READY) 	Depending on result of engine does not start diagnosis

*: Throttle position sensor 2 signal is converted by ECM internally. Thus, it differs from ECM terminal voltage signal.

TERMINAL LAYOUT

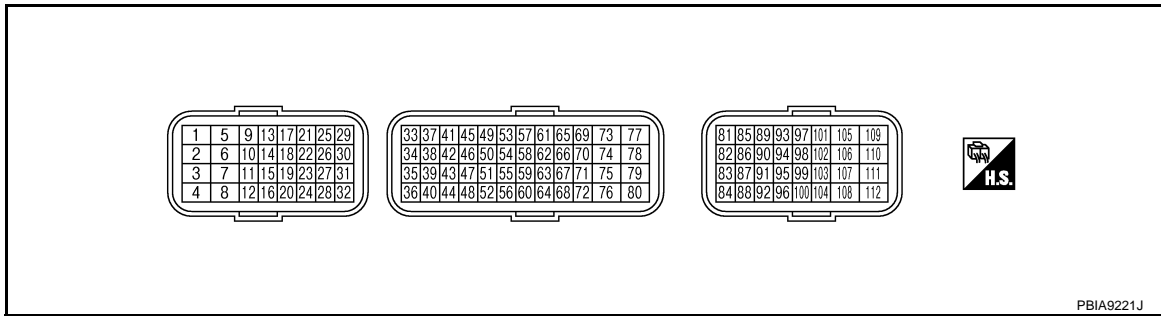

PHYSICAL VALUES

NOTE:

- ECM is located in the engine room left side near inverter with converter assembly.
- Specification data are reference values and are measured between each terminal and ground.
- Pulse signal is measured by CONSULT-III.
- If necessary, activate "INSPECTION MODE 1" ([HBC-103](#)).

CAUTION:

Do not use ECM ground terminals when measuring input/output voltage. Doing so may result in damage to the ECMs transistor. Use a ground other than ECM terminals, such as the ground.

Terminal No.		Wire color	Description		Condition	Value (Approx.)
+	---		Signal name	Input/Output		
2	Ground	G/W	Throttle control motor relay power supply	Input	[Ignition switch: ON]	BATTERY VOLTAGE (11 - 14V)
4	Ground	BR/Y	A/F sensor 1 heater	Output	[Engine is running] <ul style="list-style-type: none"> Warm-up condition Idle speed (More than 140 seconds after starting engine) 	2.9 - 8.8V★

ECM

< ECU DIAGNOSIS >

[AUTOMATIC AIR CONDITIONER]

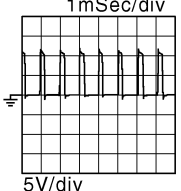
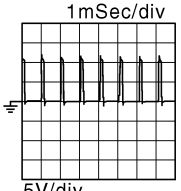
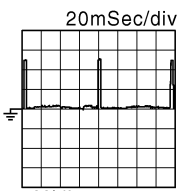
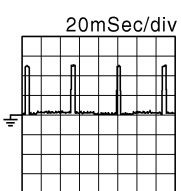
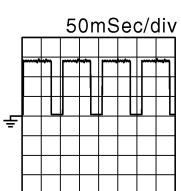
Terminal No.		Wire color	Description		Condition	Value (Approx.)
+	—		Signal name	Input/Output		
5	Ground	L	Throttle control motor (Open)	Output	[Ignition switch: ON] • Selector lever: D • Accelerator pedal: Fully depressed	0 - 14V★  1mSec/div 5V/div JMBIA0083GB
6	Ground	P	Throttle control motor (Close)	Output	[Ignition switch: ON] • Selector lever: D • Accelerator pedal: Fully released	0 - 14V★  1mSec/div 5V/div JMBIA0084GB
9 10 11 21	Ground	L/B G/R Y/R G/Y	Ignition signal No. 3 Ignition signal No. 2 Ignition signal No. 1 Ignition signal No. 4	Output	[Engine is running] • Warm-up condition • Idle speed NOTE: The pulse cycle changes depending on rpm at idle	0 - 0.2V★  20mSec/div 2V/div JMBIA0085GB
					[Engine is running] • Warm-up condition • Engine speed: 2,500 rpm	0 - 0.3V★  20mSec/div 2V/div JMBIA0086GB
12 16	Ground	B	ECM ground	—	[Engine is running] • Idle speed	Body ground
13	Ground	R	Heated oxygen sensor 2 heater	Output	[Engine is running] • Engine speed: Below 3,600 rpm after the following conditions are met - Engine: after warming up - Driving for 3 minutes at a speed of 80 km/h (50 MPH) or more (Keep the vehicle speed as steady as possible during the cruising.)	10V★  50mSec/div 5V/div JMBIA0037GB
					[Ignition switch: ON] • Engine stopped [Engine is running] • Engine speed: Above 3,600 rpm	BATTERY VOLTAGE (11 - 14V)

A
B
C
D
E
F
G
H
J
K
L
M
N
O
P

HAC

ECM

< ECU DIAGNOSIS >

[AUTOMATIC AIR CONDITIONER]

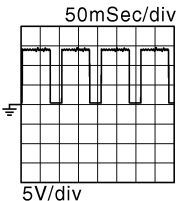
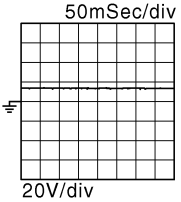
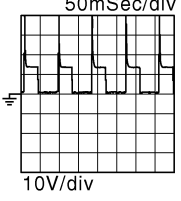
Terminal No.		Wire color	Description		Condition	Value (Approx.)
+	—		Signal name	Input/Output		
14	Ground	B/R	Fuel pump relay	Output	[Ignition switch: ON] • For 1 second after turning ignition switch ON [Engine is running]	0 - 1.0V
					[Ignition switch: ON] • More than 1 second after turning ignition switch ON	BATTERY VOLTAGE (11 - 14V)
15	Ground	O	Throttle control motor relay	Output	[Ignition switch: ON → OFF]	0 - 1.0V ↓ BATTERY VOLTAGE (11 - 14V) ↓ 0V
					[Ignition switch: ON]	0 - 1.0V
17	Ground	L	Heated oxygen sensor 3 heater	Output	[Engine is running] • Engine speed: Below 3,600 rpm after the following conditions are met - Engine: after warming up - Driving for 3 minutes at a speed of 80 km/h (50 MPH) or more (Keep the vehicle speed as steady as possible during the cruising.)	10V★  JMBIA0037GB
					[Engine is running] • Engine speed: Above 3,600 rpm [Ignition switch: ON]	BATTERY VOLTAGE (11 - 14V)
24	Ground	W/B	ECM relay (Self shut-off)	Output	[Engine is running] [Ignition switch: OFF] • A few seconds after turning ignition switch OFF	0 - 1.0V
					[Ignition switch: OFF] • More than a few seconds after turning ignition switch OFF	BATTERY VOLTAGE (11 - 14V)
25	Ground	P/L	EVAP canister purge volume control solenoid valve	Output	[Engine is running] • Idle speed	BATTERY VOLTAGE (11 - 14V)★  JMBIA0087GB
					[Engine is running] • 150 seconds or more after turning ignition switch ON (READY) • Vehicle speed: 70 km/h (43MPH) or more • Accelerator pedal: Depressed	BATTERY VOLTAGE (11 - 14V)★  JMBIA0088GB

ECM

< ECU DIAGNOSIS >

[AUTOMATIC AIR CONDITIONER]

Terminal No.		Wire color	Description		Condition	Value (Approx.)
+	—		Signal name	Input/Output		
29 30 31 32	Ground	LG/R R/Y R/W R/B	Fuel injector No. 4 Fuel injector No. 3 Fuel injector No. 2 Fuel injector No. 1	Output	[Engine is running] <ul style="list-style-type: none"> • Warm-up condition • Idle speed NOTE: The pulse cycle changes depending on rpm at idle	BATTERY VOLTAGE (11 - 14V)★
					[Engine is running] <ul style="list-style-type: none"> • Warm-up condition • Engine speed: 2,500 rpm 	BATTERY VOLTAGE (11 - 14V)★
33	Ground	LG	Heated oxygen sensor 2	Input	[Engine is running] <ul style="list-style-type: none"> • Revving engine from idle to 2,500 rpm quickly after the following conditions are met - Engine: after warming up - Driving for 3 minutes at a speed of 80 km/h (50 MPH) or more (Keep the vehicle speed as steady as possible during the cruising.) 	0 - 1.0V
34	Ground	W/L	Heated oxygen sensor 3	Input	[Engine is running] <ul style="list-style-type: none"> • Engine running after the following conditions are met - Engine: after warming up - Driving for 3 minutes at a speed of 80 km/h (50 MPH) or more (Keep the vehicle speed as steady as possible during the cruising.) 	0 - 1.0V
35	Ground	B/Y	Sensor ground (Heated oxygen sensor 2, Heated oxygen sensor 3)	—	[Engine is running] <ul style="list-style-type: none"> • Warm-up condition • Idle speed 	0V
36	Ground	B	Sensor ground (Throttle position sensor)	—	[Engine is running] <ul style="list-style-type: none"> • Warm-up condition • Idle speed 	0V
37	Ground	W	Throttle position sensor 1	Input	[Ignition switch: ON] <ul style="list-style-type: none"> • Selector lever: D • Accelerator pedal: Fully released 	More than 0.36V
					[Ignition switch: ON] <ul style="list-style-type: none"> • Selector lever: D • Accelerator pedal: Fully depressed 	Less than 4.75V

A
B
C
D
E
F
G
H
J
K
L
M
N
O
P

HAC

ECM

< ECU DIAGNOSIS >

[AUTOMATIC AIR CONDITIONER]

Terminal No.		Wire color	Description		Condition	Value (Approx.)
+	—		Signal name	Input/Output		
38	Ground	R	Throttle position sensor 2	Input	[Ignition switch: ON] • Selector lever: D • Accelerator pedal: Fully released	Less than 4.75V
					[Ignition switch: ON] • Selector lever: D • Accelerator pedal: Fully depressed	More than 0.36V
39	Ground	R	Refrigerant pressure sensor	Input	[Engine is running] • Warm-up condition • Both A/C switch and blower fan motor switch: ON (Compressor operates)	1.0 - 4.0V
40	Ground	G	Sensor ground (Refrigerant pressure sensor)	—	[Engine is running] • Warm-up condition • Idle speed	0V
45	Ground	B/W	A/F sensor 1 (bank 1)	Input	[Ignition switch: ON]	2.2V
46	Ground	Y	Engine coolant temperature sensor	Input	[Engine is running]	0 - 4.8V Output voltage varies with engine coolant temperature.
47	Ground	B	Sensor power supply (Throttle position sensor)	—	[Ignition switch: ON]	5V
49	Ground	L	A/F sensor 1	Input	[Engine is running] • Warm-up condition • Engine speed: 2,500 rpm	1.8V Output voltage varies with air fuel ratio.
50	Ground	L/Y	Intake air temperature sensor	Input	[Engine is running]	0 - 4.8V Output voltage varies with intake air temperature.
52	Ground	LG	Sensor ground (Engine coolant temperature sensor)	—	[Engine is running] • Warm-up condition • Idle speed	0V
56	Ground	G/B	Sensor ground (Mass air flow sensor, Intake air temperature sensor)	—	[Engine is running] • Warm-up condition • Idle speed	0V
58	Ground	O	Mass air flow sensor	Input	[Engine is running] • Warm-up condition • Selector lever: N • Idle speed	0.9 - 1.2V
					[Engine is running] • Warm-up condition • Selector lever: P • Engine speed: 2,500 rpm	1.5 - 1.8V
59	Ground	G/W	Sensor power supply [Camshaft position sensor (PHASE)]	—	[Ignition switch: ON]	5V
60	Ground	Y/B	Sensor ground [Crankshaft position sensor (POS)]	—	[Engine is running] • Warm-up condition • Idle speed	0V
61	Ground	W	Knock sensor	Input	[Engine is running] • Idle speed	2.5V
64	Ground	B/R	Sensor ground [Camshaft position sensor (PHASE)]	—	[Engine is running] • Warm-up condition • Idle speed	0V

ECM

< ECU DIAGNOSIS >

[AUTOMATIC AIR CONDITIONER]

Terminal No.		Wire color	Description		Condition	Value (Approx.)
+	—		Signal name	Input/Output		
65	Ground	W	Crankshaft position sensor (POS)	Input	[Engine is running] • Warm-up condition • Idle speed NOTE: The pulse cycle changes depending on rpm at idle	1.0 - 6.0★ JMBIA0091GB
					[Engine is running] • Engine speed: 2,500 rpm	1.0 - 6.0★ JMBIA0092GB
67	Ground	—	Sensor ground (Knock sensor)	—	[Engine is running] • Warm-up condition • Idle speed	0V
69	Ground	W/R	Camshaft position sensor (PHASE)	Input	[Engine is running] • Warm-up condition • Idle speed NOTE: The pulse cycle changes depending on rpm at idle	1.0 - 6.0★ JMBIA0093GB
					[Engine is running] • Engine speed is 2,500 rpm	1.0 - 6.0★ JMBIA0094GB
72	Ground	LG/B	Sensor power supply (Refrigerant pressure sensor)	—	[Ignition switch: ON]	5V
73	Ground	BR	CAN communication line	Input/Output	—	—
74	Ground	Y	CAN communication line	Input/Output	—	—
76	Ground	R/G	Sensor power supply [Crankshaft position sensor (POS)]	—	[Ignition switch: ON]	5V
77	Ground	W/L	Power supply for ECM (Back-up)	Input	[Ignition switch: OFF]	BATTERY VOLTAGE (11 - 14V)

A
B
C
D
E
F
G
H
J
K
L
M
N
O
P

HAC

ECM

< ECU DIAGNOSIS >

[AUTOMATIC AIR CONDITIONER]

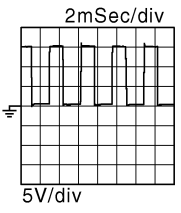
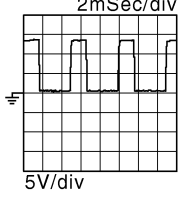
Terminal No.		Wire color	Description		Condition	Value (Approx.)
+	—		Signal name	Input/Output		
78	Ground	R/L	Intake valve timing control solenoid valve	Output	[Engine is running] • Warm-up condition • Idle speed	7 - 10V★  JMBIA0095GB
85	Ground	G/Y	ASCSD steering switch	Input	[Ignition switch: ON] • ASCD steering switch: OFF	4V
					[Ignition switch: ON] • MAIN switch: Pressed	0V
					[Ignition switch: ON] • CANCEL switch: Pressed	1V
					[Ignition switch: ON] • RESUME/ACCELERATE switch: Pressed	3V
					[Ignition switch: ON] • SET/COAST switch: Pressed	2V
86	Ground	LG	EVAP control system pressure sensor	Input	[Ignition switch: ON]	1.8 - 4.8V
88	Ground	W	Data link connector	Input/Output	—	—
91	Ground	BR/L	Sensor power supply (EVAP control system pressure sensor)	—	[Ignition switch: ON]	5V
92	Ground	R	Sensor ground (ASCSD steering switch)	—	[Engine is running] • Warm-up condition • Idle speed	0V
93	Ground	L/Y	Ignition switch	Input	[Ignition switch: OFF]	0V
					[Ignition switch: ON]	BATTERY VOLTAGE (11 - 14V)
95	Ground	R/Y	Fuel tank temperature sensor	Input	[Engine is running]	0 - 4.8V Output voltage varies with fuel tank temperature.
96	Ground	V	Sensor ground (EVAP control system pressure sensor)	—	[Engine is running] • Warm-up condition • Idle speed	0V
97	Ground	P	CAN communication line	Input/Output	—	—
98	Ground	L	CAN communication line	Input/Output	—	—
99	Ground	P	Engine speed signal output	Output	[Engine is running] • Warm-up condition • Idle speed NOTE: The pulse cycle changes depending on rpm at idle	0 - 14V★  JMCI A0009GB

ECM

< ECU DIAGNOSIS >

[AUTOMATIC AIR CONDITIONER]

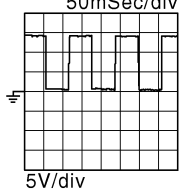
Terminal No.		Wire color	Description		Condition	Value (Approx.)
+	—		Signal name	Input/Output		
103	Ground	L	Engine TDC signal output	Output	[Engine is running] • Warm-up condition • Idle speed NOTE: The pulse cycle changes depending on rpm at idle	0 - 14V★  JMCIA0008GB
104	Ground	B/W	Sensor ground (Fuel tank temperature sensor)	—	[Engine is running] • Warm-up condition • Idle speed	0V
105	Ground	R/G	Power supply for ECM	Input	[Ignition switch: ON]	BATTERY VOLTAGE (11 - 14V)
106	Ground	SB	Stop lamp switch	Input	[Ignition switch: OFF] • Brake pedal: Fully released	0V
					[Ignition switch: OFF] • Brake pedal: Slightly depressed	BATTERY VOLTAGE (11 - 14V)
107 108	Ground	B B	ECM ground	—	[Engine is running] • Idle speed	Body ground
109	Ground	LG	EVAP canister vent control valve	Output	[Ignition switch: ON]	BATTERY VOLTAGE (11 - 14V)
110	Ground	G/B	ASCD brake switch	Input	[Ignition switch: ON] • Brake pedal: Slightly depressed	0V
					[Ignition switch: ON] • Brake pedal: Fully released	BATTERY VOLTAGE (11 - 14V)
111 112	Ground	B B	ECM ground	—	[Engine is running] • Idle speed	Body ground

★: Average voltage for pulse signal (Actual pulse signal can be confirmed by oscilloscope.)

A
B
C
D
E
F
G
H
HAC
J
K
L
M
N
O
P

HV ECU

Reference Value

INFOID:000000001504889

TERMINAL LAYOUT

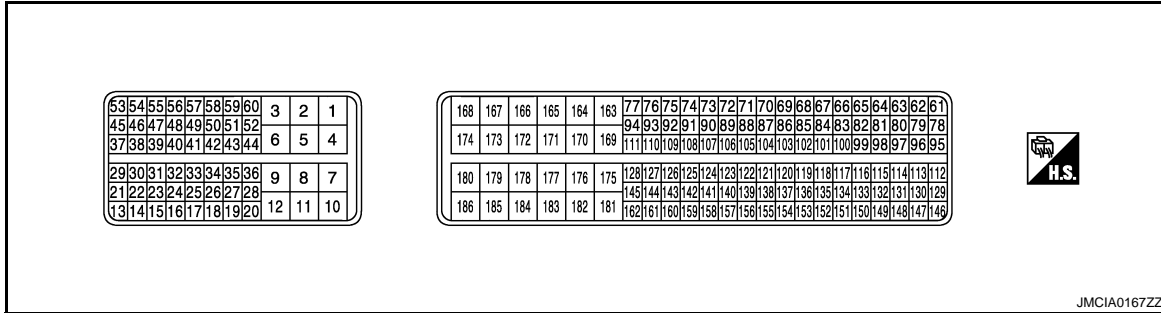

PHYSICAL VALUES

NOTE:

- The hybrid vehicle control ECU is located behind the passenger side instrument lower panel. For this inspection, remove passenger side instrument lower panel.
- Specification data are reference values and are measured between each terminal and ground.
- Pulse signal is measured by CONSULT-III.

CAUTION:

Do not use the hybrid vehicle control ECU ground terminals when measuring input/output voltage. Doing so may result in damage to the hybrid vehicle control ECUs transistor. Use a ground other than the hybrid vehicle control ECU terminals, such as the ground.

Terminal No.		Wire color	Description		Condition	Value (Approx.)
+	-		Signal name	Input/ Output		
10	Ground	B	hybrid vehicle control ECU ground	—	[Ignition switch: READY]	0V
11	Ground	B	hybrid vehicle control ECU ground	—	[Ignition switch: READY]	0V
12	Ground	B	hybrid vehicle control ECU ground	—	[Ignition switch: READY]	0V
13	Ground	L/R	Generator temperature sensor ground	—	[Ignition switch: READY]	0V
14	Ground	G/R	Generator temperature sensor	Input	[Ignition switch: ON] • Ambient temperature: 25°C (77°F)	3.4 - 4.9V
					[Ignition switch: ON] • Ambient temperature: 60°C (140°F)	2.2 - 3.3V
15	Ground	LG/R	Motor temperature sensor ground	—	[Ignition switch: READY]	0V
16	Ground	BR/R	Motor temperature sensor	Input	[Ignition switch: ON] • Ambient temperature: 25°C (77°F)	3.4 - 4.9V
					[Ignition switch: ON] • Ambient temperature: 60°C (140°F)	2.2 - 3.3V
20	Ground	W	Power supply for hybrid vehicle control ECU	Input	[Ignition switch: OFF]	BATTERY VOLTAGE (11 - 14V)

HV ECU

< ECU DIAGNOSIS >

[AUTOMATIC AIR CONDITIONER]

Terminal No.		Wire color	Description		Condition	Value (Approx.)	
+	-		Signal name	Input/Output			
37	Ground	R/B	BCM communication (PNP switch signal)	Output	[Ignition switch: ON] • Shift position: P or N	BATTERY VOLTAGE (11 - 14V)	A
					[Ignition switch: ON] • Shift position: Except above	0 - 1.5V	B
45	Ground	V	PNP switch (P position signal)	Input	[Ignition switch: ON] • Shift position: P	BATTERY VOLTAGE (11 - 14V)	C
					[Ignition switch: ON] • Shift position: Except above	0 - 1.5V	D
46	Ground	Y/B	PNP switch (R position signal)	Input	[Ignition switch: ON] • Shift position: R	BATTERY VOLTAGE (11 - 14V)	E
					[Ignition switch: ON] • Shift position: Except above	0 - 1.5V	E
47	Ground	G/B	PNP switch (N position signal)	Input	[Ignition switch: ON] • Shift position: N	BATTERY VOLTAGE (11 - 14V)	F
					[Ignition switch: ON] • Shift position: Except above	0 - 1.5V	F
48	Ground	L/B	PNP switch (D position signal)	Input	[Ignition switch: ON] • Shift position: D	BATTERY VOLTAGE (11 - 14V)	G
					[Ignition switch: ON] • Shift position: Except above	0 - 1.5V	H
49	Ground	LG/B	PNP switch (B position signal)	Input	[Ignition switch: ON] • Shift position: B	BATTERY VOLTAGE (11 - 14V)	HAC
					[Ignition switch: ON] • Engine stopped • Shift position: Except above	0 - 1.5V	HAC
50	Ground	GR/B	PNP switch (RV position signal)	Input	[Ignition switch: ON] • Shift position: R	BATTERY VOLTAGE (11 - 14V)	J
					[Ignition switch: ON] • Shift position: Except above	0 - 1.5V	K
51	Ground	P/B	PNP switch (FD position signal)	Input	[Ignition switch: ON] • Shift position: D or B	BATTERY VOLTAGE (11 - 14V)	L
					[Ignition switch: ON] • Engine stopped • Shift position: Except above	0 - 1.5V	L
52	Ground	W/R	PNP switch (MJ position signal)	Input	[Ignition switch: ON] • Shift position: P, R, N, D or B	BATTERY VOLTAGE (11 - 14V)	M
					[Ignition switch: ON] • Shift position: Except above	0 - 1.5V	N

HV ECU

< ECU DIAGNOSIS >

[AUTOMATIC AIR CONDITIONER]

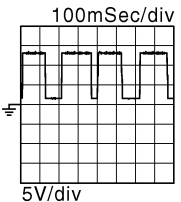
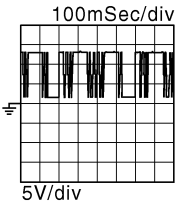
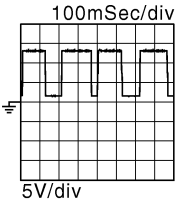
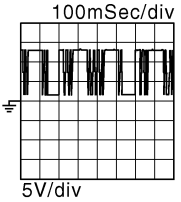
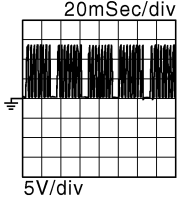
Terminal No.		Wire color	Description		Condition	Value (Approx.)
+	-		Signal name	Input/Output		
53	Ground	R	Compressor inverter communication	—	[Ignition switch: READY] • A/C system: Not operating	 <p style="text-align: right; font-size: small;">JMCIA0001GB</p> The wave form will vary depending on the content of the digital communication (digital signal).
					[Ignition switch: READY] • A/C system: Operating	 <p style="text-align: right; font-size: small;">JMCIA0002GB</p> The wave form will vary depending on the content of the digital communication (digital signal).
54	Ground	Y	Compressor inverter communication	—	[Ignition switch: READY] • A/C system: Not operating	 <p style="text-align: right; font-size: small;">JMCIA0001GB</p> The wave form will vary depending on the content of the digital communication (digital signal).
					[Ignition switch: READY] • A/C system: Operating	 <p style="text-align: right; font-size: small;">JMCIA0002GB</p> The wave form will vary depending on the content of the digital communication (digital signal).
55	Ground	L	Compressor inverter communication	—	[Ignition switch: READY]	 <p style="text-align: right; font-size: small;">JMCIA0005GB</p> The wave form will vary depending on the content of the digital communication (digital signal).

HV ECU

< ECU DIAGNOSIS >

[AUTOMATIC AIR CONDITIONER]

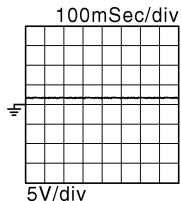
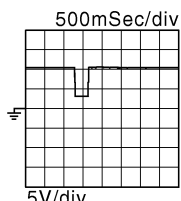
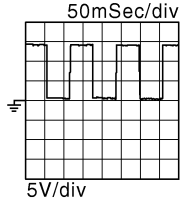
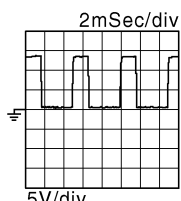
Terminal No.		Wire color	Description		Condition	Value (Approx.)
+	-		Signal name	Input/Output		
56	Ground	W	Compressor inverter communication	—	[Ignition switch: READY]	 <p>The wave form will vary depending on the content of the digital communication (digital signal).</p>
60	Ground	P	Power supply for PNP switch	—	[Ignition switch: ON]	BATTERY VOLTAGE (11 - 14V)
77	Ground	L/B	HV battery assembly (SMRP operation signal)	—	[Ignition switch: ON to READY]	
82	Ground	G/B	Back up lamp relay	Output	[Ignition switch: ON] • Shift position: R	0 - 1.5V
					[Ignition switch: ON] • Shift position: Except above	BATTERY VOLTAGE (11 - 14V)
94	Ground	GR/R	MG ECU communication (Interlock switch signal)	Input	[Ignition switch: ON] • Service plug grip: Connect	0 - 1.5V
					[Ignition switch: ON] • Service plug grip: Disconnect	BATTERY VOLTAGE (11 - 14V)
100	Ground	L	ECM (PHASE signal)	Input	[Engine is running] • Idle speed NOTE: The pulse cycle changes depending on rpm at idle.	 <p>The pulse cycle becomes shorter as the engine speed increased.</p>
101	Ground	P	ECM (POS signal)	Input	[Engine is running] • Idle speed	 <p>The pulse cycle becomes shorter as the engine speed increased.</p>

A
B
C
D
E
F
G
H
J
K
L
M
N
O
P

HAC

HV ECU

< ECU DIAGNOSIS >

[AUTOMATIC AIR CONDITIONER]

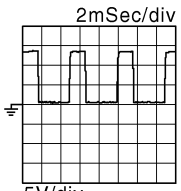
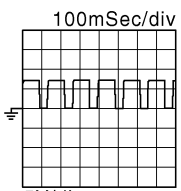
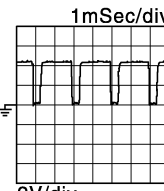
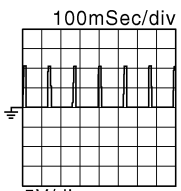
Terminal No.		Wire color	Description		Condition	Value (Approx.)
+	-		Signal name	Input/Output		
102	Ground	L/O	Brake ECU (Vehicle speed signal)	Input	[Ignition switch: READY] • Vehicle speed: 20 km/h (12 MPH)	 <p style="text-align: right; font-size: small;">JMCI A0009GB</p> The higher the vehicle speed, the shorter the cycle.
103	Ground	GR	HV battery assembly (DC/DC converter operation signal)	Input	[Ignition switch: ON]	0.1 - 0.5V
					[Ignition switch: READY]	5 - 7V
104	Ground	G/R	HV battery assembly (DC/DC converter operation signal)	Input	[Ignition switch: ON]	 <p style="text-align: right; font-size: small;">JMCI A0011GB</p> The cycle will vary depending on the specified voltage of the hybrid vehicle converter.
105	Ground	Y/R	HV battery blower fan motor	—	[Ignition switch: ON] • During ACTIVE TEST	 <p style="text-align: right; font-size: small;">JMCI A0122GB</p>
109	Ground	R	Inverter water pump	—	[Ignition switch: READY]	 <p style="text-align: right; font-size: small;">JMCI A0012GB</p>
112	Ground	O	Sensor power supply (Accelerator pedal position sensor 2)	—	[Ignition switch: ON]	5V
113	Ground	O/L	Sensor power supply (Accelerator pedal position sensor 1)	—	[Ignition switch: ON]	5V
118	Ground	G/B	ASCD brake switch	Input	[Ignition switch: OFF] • Brake pedal: Fully released	BATTERY VOLTAGE (11 - 14V)
					[Ignition switch: OFF] • Brake pedal: Slightly depressed	0 - 1.5V
121	Ground	L/W	MG ECU communication (MG shutdown signal)	Input	[Ignition switch: ON] [Ignition switch: READY]	0 - 1.5V
129	Ground	W/L	Sensor ground (Accelerator pedal position sensor 2)	—	[Ignition switch: READY]	0V

HV ECU

< ECU DIAGNOSIS >

[AUTOMATIC AIR CONDITIONER]

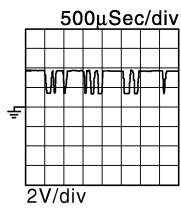
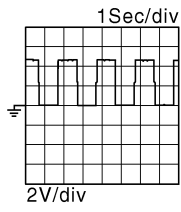
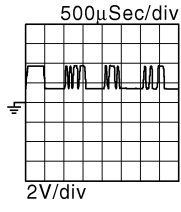
Terminal No.		Wire color	Description		Condition	Value (Approx.)
+	-		Signal name	Input/Output		
130	Ground	L/G	Sensor ground (Accelerator pedal position sensor 1)	—	[Ignition switch: READY]	0V
133	Ground	L/R	HV battery assembly (Battery smart unit communication signal)	Input	[Ignition switch: ON]	 <p>The wave form will vary depending on the content of the digital communication (digital signal).</p>
138	Ground	G/O	Air bag diagnosis sensor unit (Air bag activation signal)	Input	[Ignition switch: READY]	
146	Ground	W	Accelerator pedal position sensor 2	Input	[Ignition switch: ON] • Engine stopped • Shift position: P • Accelerator pedal: Fully released	1.0 - 2.2V
					[Ignition switch: ON] • Engine stopped • Shift position: P • Accelerator pedal: Fully depressed	3.4 - 5.3V
147	Ground	L/Y	Accelerator pedal position sensor 1	Input	[Ignition switch: ON] • Engine stopped • Shift position: P • Accelerator pedal: Fully released	0.4 - 1.4V
					[Ignition switch: ON] • Engine stopped • Shift position: P • Accelerator pedal: Fully depressed	2.6 - 4.5V
148	Ground	R/G	Stop lamp switch	Input	[Ignition switch: ON] • Brake pedal: Fully released	0 - 1.5V
					[Ignition switch: ON] • Brake pedal: Slightly depressed	BATTERY VOLTAGE (11 - 14V)
150	Ground	L/G	HV battery assembly (Battery smart unit communication signal)	Input	[Ignition switch: ON]	 <p>The wave form will vary depending on the content of the digital communication (digital signal).</p>

A
B
C
D
E
F
G
H
J
K
L
M
N
O
P

HAC

HV ECU

< ECU DIAGNOSIS >

[AUTOMATIC AIR CONDITIONER]

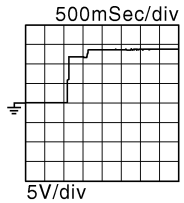
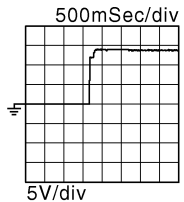
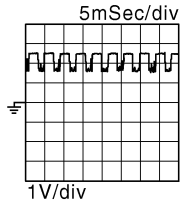
Terminal No.		Wire color	Description		Condition	Value (Approx.)
+	-		Signal name	Input/Output		
163	Ground	B	hybrid vehicle control ECU ground	—	[Ignition switch: READY]	0V
165	Ground	W/G	Power supply for hybrid vehicle control ECU	Input	[Ignition switch: OFF]	BATTERY VOLTAGE (11 - 14V)
166	Ground	BR/Y	IGCT relay	Output	[Ignition switch: ON]	BATTERY VOLTAGE (11 - 14V)
167	Ground	R	BCM communication (Start signal)	Input	[Ignition switch: ON]	BATTERY VOLTAGE (11 - 14V)
168	Ground	R/G	Power supply for hybrid vehicle control ECU	Input	[Ignition switch: ON]	BATTERY VOLTAGE (11 - 14V)
169	Ground	W/B	HV battery assembly (SMRB operation signal)	—	[Ignition switch: ON to READY]	
170	Ground	P	CAN communication line (TOYOTA)	Input/Output	—	—
171	Ground	L	CAN communication line (TOYOTA)	Input/Output	—	—
172	Ground	P	CAN communication line (NISSAN)	Input/Output	—	—
173	Ground	L	CAN communication line (NISSAN)	Input/Output	—	—
174	Ground	R/G	Power supply for hybrid vehicle control ECU	Input	[Ignition switch: ON]	BATTERY VOLTAGE (11 - 14V)
175	Ground	Y/B	HV battery assembly (SMRG operation signal)	—	[Ignition switch: ON to READY]	
176	Ground	LG	MG ECU communication	—	[Ignition switch: READY]	 <p>The wave form will vary depending on the content of the digital communication (digital signal).</p>

HV ECU

< ECU DIAGNOSIS >

[AUTOMATIC AIR CONDITIONER]

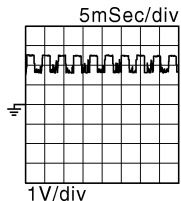
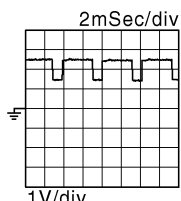
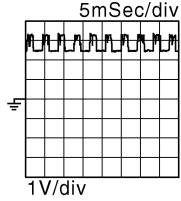
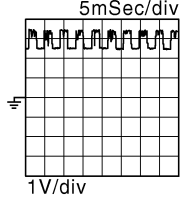
Terminal No.		Wire color	Description		Condition	Value (Approx.)
+	-		Signal name	Input/Output		
177	Ground	Y/L	MG ECU communication	Input	[Ignition switch: READY]	 <p>5mSec/div 1V/div JMCIA0019GB</p> <p>The wave form will vary depending on the content of the digital communication (digital signal).</p>
178	Ground	L/O	MG ECU communication	Input/Output	[Ignition switch: READY]	2V
179	Ground	BR	MG ECU communication	Input/Output	[Ignition switch: READY]	 <p>2mSec/div 1V/div JMCIA0020GB</p>
180	Ground	G/W	Ignition switch signal	Input	[Ignition switch: ON]	BATTERY VOLTAGE (11 - 14V)
181	Ground	B	hybrid vehicle control ECU ground	—	[Ignition switch: READY]	0V
182	Ground	V	MG ECU communication	—	[Ignition switch: READY]	 <p>5mSec/div 1V/div JMCIA0021GB</p> <p>The wave form will vary depending on the content of the digital communication (digital signal).</p>
183	Ground	Y/G	MG ECU communication	Input	[Ignition switch: READY]	 <p>5mSec/div 1V/div JMCIA0022GB</p> <p>The wave form will vary depending on the content of the digital communication (digital signal).</p>
184	Ground	W/L	MG ECU communication	Input/Output	[Ignition switch: READY]	3V

A
B
C
D
E
F
G
H
HAC
J
K
L
M
N
O
P

HV ECU

< ECU DIAGNOSIS >

[AUTOMATIC AIR CONDITIONER]

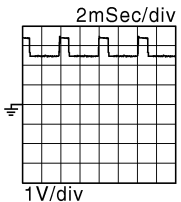
Terminal No.		Wire color	Description		Condition	Value (Approx.)
+	-		Signal name	Input/Output		
185	Ground	Y	MG ECU communication	Input/Output	[Ignition switch: READY]	 <p style="text-align: right; font-size: small;">JMCI A0023GB</p>
186	Ground	GR/R	HV battery blower fan relay	Input	[Ignition switch: OFF]	BATTERY VOLTAGE (11 - 14V)
					[Ignition switch: ON]	0V

BCM (BODY CONTROL MODULE)

< ECU DIAGNOSIS >

[AUTOMATIC AIR CONDITIONER]

BCM (BODY CONTROL MODULE)

Reference Value

INFOID:000000001504890

VALUES ON THE DIAGNOSIS TOOL

Monitor Item	Condition	Value/Status
FR WIPER HI	Other than front wiper switch HI	OFF
	Front wiper switch HI	ON
FR WIPER LOW	Other than front wiper switch LO	OFF
	Front wiper switch LO	ON
FR WASHER SW	Front washer switch OFF	OFF
	Front washer switch ON	ON
FR WIPER INT	Other than front wiper switch INT	OFF
	Front wiper switch INT	ON
FR WIPER STOP	Front wiper is not in STOP position	OFF
	Front wiper is in STOP position	ON
INT VOLUME	Wiper intermittent dial is in a dial position 1 - 7	Wiper intermittent dial position
TURN SIGNAL R	Other than turn signal switch RH	OFF
	Turn signal switch RH	ON
TURN SIGNAL L	Other than turn signal switch LH	OFF
	Turn signal switch LH	ON
TAIL LAMP SW	Other than lighting switch 1ST and 2ND	OFF
	Lighting switch 1ST or 2ND	ON
HI BEAM SW	Other than lighting switch HI	OFF
	Lighting switch HI	ON
HEAD LAMP SW 1	Other than lighting switch 2ND	OFF
	Lighting switch 2ND	ON
HEAD LAMP SW 2	Other than lighting switch 2ND	OFF
	Lighting switch 2ND	ON
PASSING SW	Other than lighting switch PASS	OFF
	Lighting switch PASS	ON
AUTO LIGHT SW	Other than lighting switch AUTO	OFF
	Lighting switch AUTO	ON
FR FOG SW	Front fog lamp switch OFF	OFF
	Front fog lamp switch ON	ON
DOOR SW-DR	Front door LH closed	OFF
	Front door LH opened	ON
DOOR SW-AS	Front door RH closed	OFF
	Front door RH opened	ON
DOOR SW-RR	Rear door RH closed	OFF
	Rear door RH opened	ON
DOOR SW-RL	Rear door LH closed	OFF
	Rear door LH opened	ON
DOOR SW-BK	NOTE: This item is displayed, but cannot be monitored.	OFF

A

B

C

D

E

F

G

H

HAC

J

K

L

M

N

O

P

BCM (BODY CONTROL MODULE)

< ECU DIAGNOSIS >

[AUTOMATIC AIR CONDITIONER]

Monitor Item	Condition	Value/Status
CDL LOCK SW	Other than power door lock switch LOCK	OFF
	Door lock/unlock switch LOCK	ON
CDL UNLOCK SW	Other than door lock/unlock switch UNLOCK	OFF
	Door lock/unlock switch UNLOCK	ON
KEY CYL LK-SW	Other than front door LH key cylinder LOCK position	OFF
	Front door LH key cylinder LOCK position	ON
KEY CYL UN-SW	Other than front door LH key cylinder UNLOCK position	OFF
	Front door LH key cylinder UNLOCK position	ON
KEY CYL SW-TR	NOTE: This item is displayed, but cannot be monitored.	OFF
HAZARD SW	When hazard switch is not pressed	OFF
	When hazard switch is pressed	ON
REAR DEF SW	When rear window defogger switch is pressed	ON
FAN ON SIG	When AUTO switch or fan switch is pressed	ON
AIR COND SW	When A/C switch is pressed	ON
TR CANCEL SW	Trunk lid opener cancel switch OFF	OFF
	Trunk lid opener cancel switch ON	ON
TR/BD OPEN SW	Trunk lid opener switch OFF	OFF
	While the trunk lid opener switch is turned ON	ON
TRNK/HAT MNTR	Trunk lid closed	OFF
	Trunk lid opened	ON
RKE-LOCK	When LOCK button of Intelligent Key is not pressed	OFF
	When LOCK button of Intelligent Key is pressed	ON
RKE-UNLOCK	When UNLOCK button of Intelligent Key is not pressed	OFF
	When UNLOCK button of Intelligent Key is pressed	ON
RKE-TR/BD	When TRUNK OPEN button of Intelligent Key is not pressed	OFF
	When TRUNK OPEN button of Intelligent Key is pressed	ON
RKE-PANIC	When PANIC button of Intelligent Key is not pressed	OFF
	When PANIC button of Intelligent Key is pressed	ON
RKE-P/W OPEN	When UNLOCK button of Intelligent Key is not pressed and held	OFF
	When UNLOCK button of Intelligent Key is pressed and held	ON
RKE-MODE CHG	When LOCK/UNLOCK button of Intelligent Key is not pressed and held simultaneously	OFF
	When LOCK/UNLOCK button of Intelligent Key is pressed and held simultaneously	ON
OPTICAL (LIGHT) SEN- SOR	When outside of the vehicle is bright	Close to 5 V
	When outside of the vehicle is dark	Close to 0 V
REQ SW-DR	When front door LH request switch is not pressed	OFF
	When front door LH request switch is pressed	ON
REQ SW-AS	When front door RH request switch is not pressed	OFF
	When front door RH request switch is pressed	ON
REQ SW-BD/TR	When trunk request switch is not pressed	OFF
	When trunk request switch is pressed	ON
PUSH SW	When push-button ignition switch is not pressed	OFF
	When push-button ignition switch is pressed	ON

BCM (BODY CONTROL MODULE)

< ECU DIAGNOSIS >

[AUTOMATIC AIR CONDITIONER]

Monitor Item	Condition	Value/Status	
IGN RLY -F/B	Ignition switch OFF or ACC	OFF	A
	Ignition switch ON	ON	
ACC RLY -F/B	Ignition switch OFF	OFF	B
	Ignition switch ACC or ON	ON	
BRAKE SW 1	When the brake pedal is not depressed	ON	C
	When the brake pedal is depressed	OFF	
DETE/CANCL SW	When selector lever is in P position	OFF	D
	When selector lever is in any position other than P	ON	
SFT PN/N SW	When selector lever is in any position other than P or N	OFF	E
	When selector lever is in P or N position	ON	
S/L -LOCK	Electronic steering column lock LOCK status	OFF	F
	Electronic steering column lock UNLOCK status	ON	
S/L -UNLOCK	Electronic steering column lock UNLOCK status	OFF	G
	Electronic steering column lock LOCK status	ON	
S/L RELAY-F/B	Ignition switch OFF or ACC	OFF	H
	Ignition switch ON	ON	
UNLK SEN-DR	Front door LH UNLOCK status	OFF	HAC
	Front door LH LOCK status	ON	
PUSH SW -IPDM	When push-button ignition switch is not pressed (IPDM E/R sends via CAN)	OFF	J
	When push-button ignition switch is pressed (IPDM E/R sends via CAN)	ON	
IGN RLY1 F/B	Ignition switch OFF or ACC	OFF	K
	Ignition switch ON	ON	
DETE SW -IPDM	When selector lever is in P position (IPDM E/R sends via CAN)	OFF	L
	When selector lever is in any position other than P (IPDM E/R sends via CAN)	ON	
SFT PN -IPDM	When selector lever is in any position other than P or N (IPDM E/R sends via CAN)	OFF	M
	When selector lever is in P or N position (IPDM E/R sends via CAN)	ON	
SFT P -MET	When selector lever is in any position other than P (combination meter sends via CAN)	OFF	N
	When selector lever is in P position (combination meter sends via CAN)	ON	
SFT N -MET	When selector lever is in any position other than N (combination meter sends via CAN)	OFF	O
	When selector lever is in N position (combination meter sends via CAN)	ON	
ENGINE STATE	Engine stopped	STOP	P
	While the engine stalls	STALL	
	At engine cranking	CRANK	
	Engine running	RUN	
S/L LOCK-IPDM	Electronic steering column lock LOCK status (IPDM E/R sends via CAN)	OFF	
	Electronic steering column lock UNLOCK status (IPDM E/R sends via CAN)	ON	

BCM (BODY CONTROL MODULE)

< ECU DIAGNOSIS >

[AUTOMATIC AIR CONDITIONER]

Monitor Item	Condition	Value/Status
S/L UNLCK-IPDM	Electronic steering column lock UNLOCK status (IPDM E/R sends via CAN)	OFF
	Electronic steering column lock LOCK status (IPDM E/R sends via CAN)	ON
S/L RELAY-REQ	Ignition switch OFF or ACC	OFF
	Ignition switch ON	ON
VEH SPEED 1	While driving	Equivalent to speedometer reading
VEH SPEED 2	While driving	Equivalent to speedometer reading
DR DOOR STATE	Front door LH LOCK status	LOCK
	Wait with selective UNLOCK operation (5 seconds)	READY
	Front door LH UNLOCK status	UNLK
AS DOOR STATE	Front door RH LOCK status	LOCK
	Wait with selective UNLOCK operation (5 seconds)	READY
	Front door RH UNLOCK status	UNLK
ID OK FLAG	Ignition switch ACC or ON	RESET
	Ignition switch OFF	SET
PRMT ENG STAT	When the hybrid system start is prohibited	RESET
	When the hybrid system start is permitted	SET
PRMT RKE STAT	NOTE: This item is displayed, but cannot be monitored.	RESET
KEY SW -SLOT	When Intelligent Key is not inserted into key slot	OFF
	When Intelligent Key is inserted into key slot	ON
RKE OPE COUN1	During the operation of Intelligent Key	Operation frequency of Intelligent Key
RKE OPE COUN2	NOTE: This item is displayed, but cannot be monitored.	Operation frequency of Intelligent Key
AIR PRESS FL	Ignition switch ON (only when the signal from the transmitter is received)	Air pressure of front LH tire
AIR PRESS FR	Ignition switch ON (only when the signal from the transmitter is received)	Air pressure of front RH tire
AIR PRESS RR	Ignition switch ON (only when the signal from the transmitter is received)	Air pressure of rear RH tire
AIR PRESS RL	Ignition switch ON (only when the signal from the transmitter is received)	Air pressure of rear LH tire
ID REGST FL1	When ID of front LH tire transmitter is registered (refer to WT-6, "ID Registration Procedure")	DONE
	When ID of front LH tire transmitter is not registered (refer to WT-6, "ID Registration Procedure")	YET
ID REGST FR1	When ID of front RH tire transmitter is registered (refer to WT-6, "ID Registration Procedure")	DONE
	When ID of front RH tire transmitter is not registered (refer to WT-6, "ID Registration Procedure")	YET
ID REGST RR1	When ID of rear RH tire transmitter is registered (refer to WT-6, "ID Registration Procedure")	DONE
	When ID of rear RH tire transmitter is not registered (refer to WT-6, "ID Registration Procedure")	YET
ID REGST RL1	When ID of rear LH tire transmitter is registered (refer to WT-6, "ID Registration Procedure")	DONE
	When ID of rear LH tire transmitter is not registered (refer to WT-6, "ID Registration Procedure")	YET

BCM (BODY CONTROL MODULE)

< ECU DIAGNOSIS >

[AUTOMATIC AIR CONDITIONER]

Monitor Item	Condition	Value/Status
WARNING LAMP	Tire pressure indicator OFF	OFF
	Tire pressure indicator ON	ON

Terminal Layout

INFOID:000000001504891

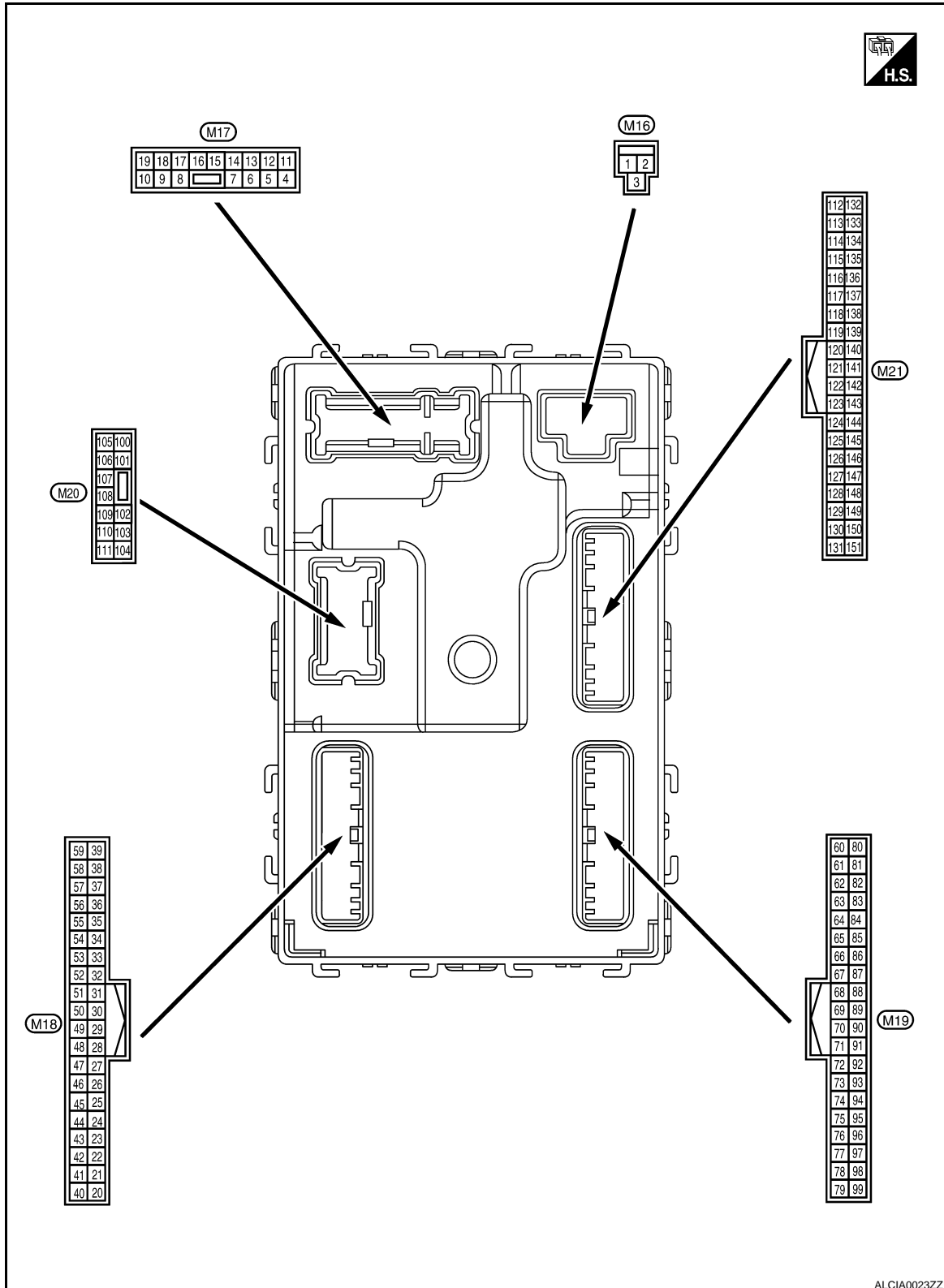

A
B
C
D
E
F
G
H
I
J
K
L
M
N
O
P

HAC

BCM (BODY CONTROL MODULE)

< ECU DIAGNOSIS >

[AUTOMATIC AIR CONDITIONER]

Physical Values

INFOID:000000001504892

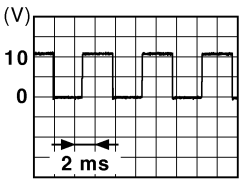
Terminal No. (Wire color)		Description		Condition		Value (Approx.)
		Signal name	Input/ Output			
(+)	(-)					
1 (W/B)	Ground	Battery power supply	Input	Ignition switch OFF		Battery voltage
2 (R/Y)	Ground	Battery power supply output	Output	Ignition switch OFF		Battery voltage
3 (L/W)	Ground	Ignition power supply output	Output	Ignition switch ON		Battery voltage
4 (P/W)	Ground	Interior room lamp power supply	Output	After passing the interior room lamp battery saver operation time		0V
				Any other time after passing the interior room lamp battery saver operation time		Battery voltage
5 (G/Y)	Ground	Front door RH UNLOCK	Output	Front door RH	UNLOCK (actuator is activated)	Battery voltage
					Other than UNLOCK (actuator is not activated)	0V
7 (R/W)	Ground	Step lamp	Output	Room lamp timer	ON	Battery voltage
					OFF	0V
8 (V)	Ground	All doors LOCK	Output	All doors	LOCK (actuator is activated)	Battery voltage
					Other than LOCK (actuator is not activated)	0V
9 (G)	Ground	Front door LH UNLOCK	Output	Front door LH	UNLOCK (actuator is activated)	Battery voltage
					Other than UNLOCK (actuator is not activated)	0V
10 (G/Y)	Ground	Rear door RH and rear door LH UNLOCK	Output	Rear door RH and rear door LH	UNLOCK (actuator is activated)	Battery voltage
					Other than UNLOCK (actuator is not activated)	0V
11 (Y/R)	Ground	Battery power supply	Input	Ignition switch OFF		Battery voltage
13 (B)	Ground	Ground	—	Ignition switch ON		0V
14 (R/Y)	Ground	Push-button ignition switch illumination ground	Input	Tail lamp	OFF	NOTE: When the illumination brightening/dimming level is in the neutral position 
					ON	
15 (Y/L)	Ground	ACC indicator lamp	Output	Ignition switch	OFF	Battery voltage
					ACC	0V

JSNIA0010GB

BCM (BODY CONTROL MODULE)

[AUTOMATIC AIR CONDITIONER]

< ECU DIAGNOSIS >

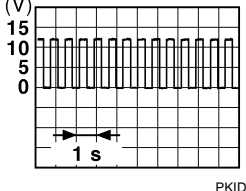
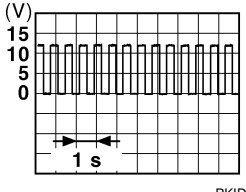
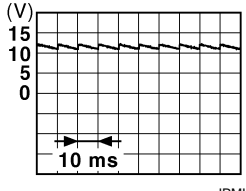
Terminal No. (Wire color)		Description		Condition	Value (Approx.)	
		Signal name	Input/ Output			
(+)	(-)					
17 (G/B)	Ground	Turn signal (RH)	Output	Turn signal switch OFF	0V	
				Turn signal switch ON	Turn signal switch RH	
18 (G/O)	Ground	Turn signal (LH)	Output	Turn signal switch OFF	0V	
				Turn signal switch ON	Turn signal switch LH	
19 (Y)	Ground	Room lamp timer control	Output	Interior room lamp	Lamps fully OFF	Battery voltage
				Lamps fully ON	0V	
21 (P/B)	Ground	Optical sensor signal	Input	Ignition switch ON	When outside of the vehicle is bright	Close to 5V
				When outside of the vehicle is dark	Close to 0V	
24 (R/W)	Ground	Stop lamp switch 1	Input	—	Battery voltage	
26 (O/L)	Ground	Stop lamp switch 2	Input	Stop lamp switch	OFF (brake pedal is not depressed)	0V
				ON (brake pedal is depressed)	Battery voltage	
			ICC brake hold relay (with ICC)	OFF	0V	
				ON	Battery voltage	
27 (G/W)	Ground	Front door lock assembly LH (unlock sensor)	Input	Front door LH	LOCK status	
					UNLOCK status	0V
				Key slot switch	Input	When Intelligent Key is inserted into key slot
29 (Y)	Ground	Key slot switch	Input	When Intelligent Key is not inserted into key slot	0V	
				ACC feedback signal	Input	Ignition switch
30 (V/Y)	Ground	ACC feedback signal	Input	Ignition switch	ACC or ON	Battery voltage
				Ignition relay-2 feedback signal	Input	Ignition switch
31 (G)	Ground	Ignition relay-2 feedback signal	Input	Ignition switch	ON	Battery voltage
				ON	Battery voltage	

A
B
C
D
E
F
G
H
J
K
L
M
N
O
P

HAC

BCM (BODY CONTROL MODULE)

[AUTOMATIC AIR CONDITIONER]

< ECU DIAGNOSIS >

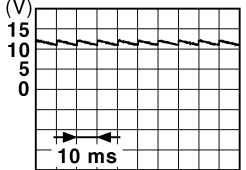
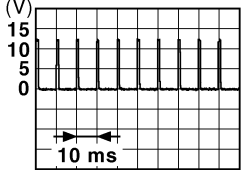
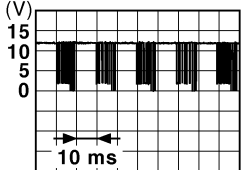
Terminal No. (Wire color)		Description		Condition	Value (Approx.)	
		Signal name	Input/ Output			
(+)	(-)					
32 (R/B)	Ground	Front door RH switch	Input	Front door RH switch	OFF (when front door RH closes)	 <p style="text-align: right; margin-right: 50px;">11.8V</p>
					ON (when front door RH opens)	0V
33 (SB)	Ground	Compressor ON signal	Input	A/C switch	OFF	Battery voltage
					ON	0V
34* (L/R)	Ground	Front door lock assembly LH (key cylinder switch) (unlock)	Input	Front door lock assembly LH (key cylinder switch)	OFF (neutral)	Battery voltage
					ON (unlock)	0V
36* (GR)	Ground	Lock switch signal	Input	Door lock/unlock switch	Lock	Battery Voltage
					Unlock	0V
37 (O)	Ground	Trunk lid opener cancel switch	Input	Trunk lid opener cancel switch	CANCEL	 <p style="text-align: right; margin-right: 50px;">1.1V</p>
					ON	0V
38 (GR/W)	Ground	Rear window defogger ON signal	Input	Rear window defogger switch	OFF	Battery Voltage V
					ON	0V
39* (GR/R)	Ground	Unlock switch signal	Input	Door lock/unlock switch	Unlock	Battery Voltage
					Lock	0V
40* (Y/G)	Ground	Power window serial link	Input/ Output	Ignition switch ON	 <p style="text-align: right; margin-right: 50px;">10.2V</p>	
				Ignition switch OFF or ACC	0V	
41 (W)	Ground	Push-button ignition switch illumination	Output	Engine switch (push switch) illumination	ON	5.5V
					OFF	0V
42 (R)	Ground	LOCK indicator lamp	Output	LOCK indicator lamp	ON	0V
					OFF	Battery voltage
45 (P)	Ground	Receiver & sensor ground	Input	Ignition switch ON	0V	

BCM (BODY CONTROL MODULE)

[AUTOMATIC AIR CONDITIONER]

< ECU DIAGNOSIS >

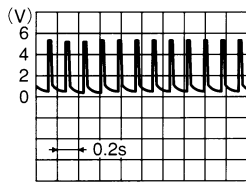
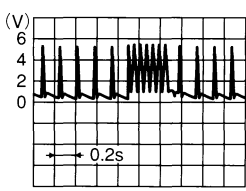
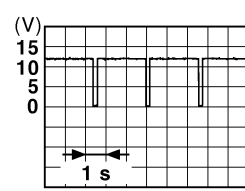
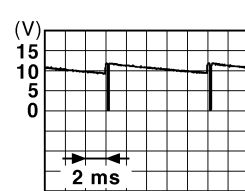
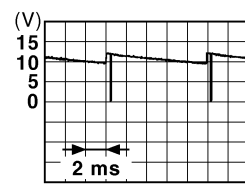
Terminal No. (Wire color)		Description		Condition	Value (Approx.)	
		Signal name	Input/ Output			
(+)	(-)					
46 (V/W)	Ground	Receiver & sensor power supply output	Output	Ignition switch	OFF	0V
					ACC or ON	5.0V
47 (G/O)	Ground	Tire pressure receiver signal	Input/ Output	Ignition switch ON	Standby state	 OCC3881D
					When receiving the signal from the transmitter	 OCC3880D
48 (R/B)	Ground	Selector lever P/N position signal	Input	Selector lever	P or N position	12.0V
					Except P and N positions	0V
49 (L/O)	Ground	Security indicator signal	Output	Security indicator	ON	0V
					Blinking	 JPMA0014GB 11.3V
50 (LG/ B)	Ground	Combination switch OUTPUT 5	Output	Combination switch (Wiper intermittent dial 4)	All switch OFF	Battery voltage
					Lighting switch 1ST	 JPMA0031GB 10.7V
					Lighting switch high-beam	
					Lighting switch 2ND	
Turn signal switch RH						
51 (L/W)	Ground	Combination switch OUTPUT 1	Output	Combination switch	All switch OFF (Wiper intermittent dial 4)	0V
					Front wiper switch HI (Wiper intermittent dial 4)	 JPMA0032GB 10.7V
				Any of the conditions below with all switch OFF		
					<ul style="list-style-type: none"> • Wiper intermittent dial 1 • Wiper intermittent dial 2 • Wiper intermittent dial 3 • Wiper intermittent dial 6 • Wiper intermittent dial 7 	

A
B
C
D
E
F
G
H
I
J
K
L
M
N
O
P

HAC

BCM (BODY CONTROL MODULE)

[AUTOMATIC AIR CONDITIONER]

< ECU DIAGNOSIS >

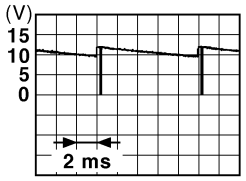
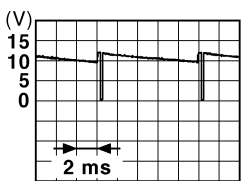
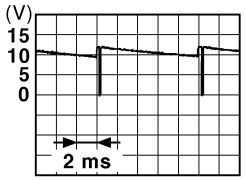
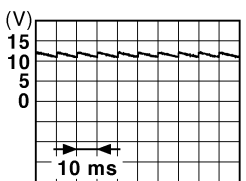
Terminal No. (Wire color)		Description		Condition		Value (Approx.)
(+)	(-)	Signal name	Input/ Output			
52 (G/B)	Ground	Combination switch OUTPUT 2	Output	Combination switch	All switch OFF (Wiper intermittent dial 4)	0V
					Front washer switch ON (Wiper intermittent dial 4)	 <p style="text-align: right; font-size: small;">JPMIA0033GB</p>
					Any of the conditions below with all switch OFF	
					<ul style="list-style-type: none"> • Wiper intermittent dial 1 • Wiper intermittent dial 5 • Wiper intermittent dial 6 	
53 (LG/ R)	Ground	Combination switch OUTPUT 3	Output	Combination switch (Wiper intermit- tent dial 4)	All switch OFF	0V
					Front wiper switch INT	 <p style="text-align: right; font-size: small;">JPMIA0034GB</p>
					Front wiper switch LO	
					Lighting switch AUTO	10.7V
54 (G/Y)	Ground	Combination switch OUTPUT 4	Output	Combination switch (Wiper intermit- tent dial 4)	All switch OFF	0V
					Front fog lamp switch ON	 <p style="text-align: right; font-size: small;">JPMIA0035GB</p>
					Lighting switch 2ND	
					Lighting switch flash-to- pass	
					Turn signal switch LH	10.7V
55 (BR/ W)	Ground	Front blower monitor	Input	Front blower mo- tor switch	ON	Battery voltage
					OFF	0V
56 (L/B)	Ground	Front door lock as- sembly LH (key cylin- der switch) (lock)	Input	Front door lock assembly LH (key cylinder switch)	OFF (neutral)	Battery voltage
					ON (lock)	0V
57 (W)	Ground	Tire pressure warn- ing check switch	Input	—	—	Battery voltage
58 (SB)	Ground	Front door LH switch	Input	Front door LH switch	OFF (front door LH CLOSE)	 <p style="text-align: right; font-size: small;">JPMIA0011GB</p>
					ON (front door LH OPEN)	
59 (G/R)	Ground	Rear window defog- ger relay	Output	Rear window de- fogger	Active	Battery voltage
					Not activated	0V

BCM (BODY CONTROL MODULE)

[AUTOMATIC AIR CONDITIONER]

< ECU DIAGNOSIS >

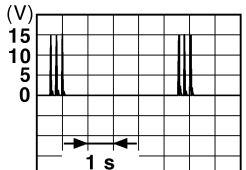
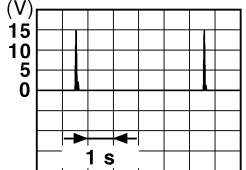
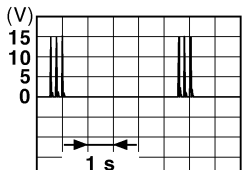
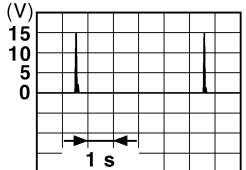
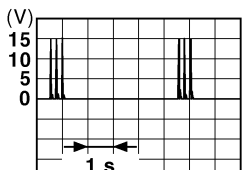
Terminal No. (Wire color)		Description		Condition	Value (Approx.)
(+)	(-)	Signal name	Input/ Output		
60 (B/R)	Ground	Front console antenna 2 (-)	Output		
				When Intelligent Key is not in the passenger compartment	 <p style="text-align: right; font-size: small;">JMKIA0063GB</p>
61 (W/R)	Ground	Center console antenna 2 (+)	Output	Ignition switch OFF	 <p style="text-align: right; font-size: small;">JMKIA0062GB</p>
				When Intelligent Key is not in the passenger compartment	 <p style="text-align: right; font-size: small;">JMKIA0063GB</p>
62 (B/Y)	Ground	Front outside handle RH antenna (-)	Output	When the front door RH request switch is operated with ignition switch OFF	 <p style="text-align: right; font-size: small;">JMKIA0062GB</p>
				When Intelligent Key is not in the antenna detection area	 <p style="text-align: right; font-size: small;">JMKIA0063GB</p>

A
B
C
D
E
F
G
H
J
K
L
M
N
O
P

HAC

BCM (BODY CONTROL MODULE)

[AUTOMATIC AIR CONDITIONER]

< ECU DIAGNOSIS >

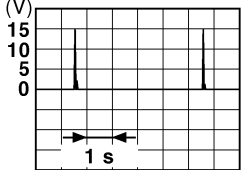
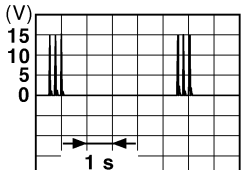
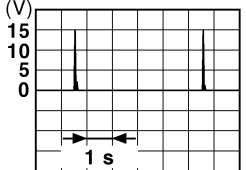
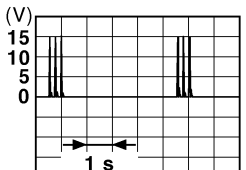
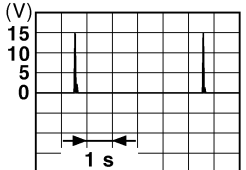
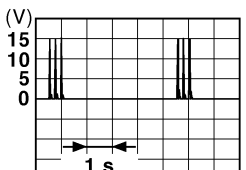
Terminal No. (Wire color)		Description		Condition	Value (Approx.)
(+)	(-)	Signal name	Input/ Output		
63 (LG)	Ground	Front outside handle RH antenna (+)	Output	When the front door RH request switch is operat- ed with ignition switch OFF	When Intelligent Key is in the antenna detection area 
				When Intelligent Key is not in the antenna detection area 	
64 (V)	Ground	Front outside handle LH antenna (-)	Output	When the front door LH request switch is operat- ed with ignition switch OFF	When Intelligent Key is in the antenna detection area 
				When Intelligent Key is not in the antenna detection area 	
65 (P)	Ground	Front outside handle LH antenna (+)	Output	When the front door LH request switch is operat- ed with ignition switch OFF	When Intelligent Key is in the antenna detection area 
				When Intelligent Key is not in the antenna detection area 	

BCM (BODY CONTROL MODULE)

[AUTOMATIC AIR CONDITIONER]

< ECU DIAGNOSIS >





Terminal No. (Wire color)		Description		Condition	Value (Approx.)
(+)	(-)	Signal name	Input/ Output		
66 (R)	Ground	Instrument panel antenna (-)	Output	Ignition switch OFF	<p>JMKIA0062GB</p>
				When Intelligent Key is not in the passenger compartment	<p>JMKIA0063GB</p>
67 (G)	Ground	Instrument panel antenna (+)	Output	Ignition switch OFF	<p>JMKIA0062GB</p>
				When Intelligent Key is not in the passenger compartment	<p>JMKIA0063GB</p>
68 (G/O)	Ground	NATS antenna amp (built in key slot)	Input/ Output	During waiting	Just after pressing ignition switch. Pointer of tester should move.
69 (O)	Ground	NATS antenna amp (built in key slot)	Input/ Output	During waiting	Just after pressing ignition switch. Pointer of tester should move.
70 (R/B)	Ground	Ignition relay-2 control	Output	Ignition switch OFF or ACC	0V
				ON	Battery voltage

A
B
C
D
E
F
G
H
HAC
J
K
L
M
N
O
P

BCM (BODY CONTROL MODULE)

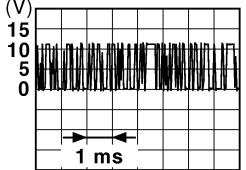
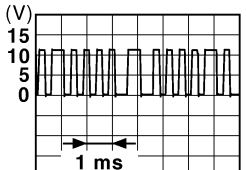
[AUTOMATIC AIR CONDITIONER]

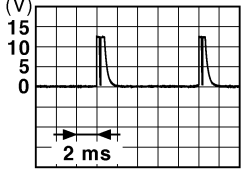

< ECU DIAGNOSIS >

Terminal No. (Wire color)		Description		Condition	Value (Approx.)
(+)	(-)	Signal name	Input/ Output		
71 (L/O)	Ground	Remote keyless entry receiver signal	Input/ Output	During waiting	 <p style="text-align: right; font-size: small;">JMKIA0064GB</p>
				When operating either button on Intelligent Key	 <p style="text-align: right; font-size: small;">JMKIA0065GB</p>
75 (R/Y)	Ground	Combination switch INPUT 5	Input	All switch OFF (Wiper intermittent dial 4)	 <p style="text-align: right; font-size: small;">JPMIA0041GB</p> <p style="text-align: center;">1.4V</p>
				Combination switch Front fog lamp switch ON (Wiper intermittent dial 4)	 <p style="text-align: right; font-size: small;">JPMIA0037GB</p> <p style="text-align: center;">1.3V</p>
				Any of the conditions below with all switch OFF	 <p style="text-align: right; font-size: small;">JPMIA0040GB</p> <p style="text-align: center;">1.3V</p>

BCM (BODY CONTROL MODULE)

< ECU DIAGNOSIS >

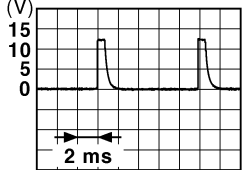
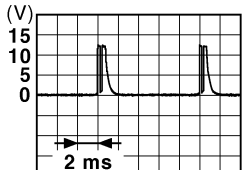
[AUTOMATIC AIR CONDITIONER]

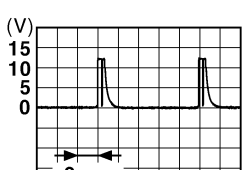
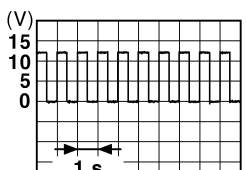
Terminal No. (Wire color)		Description		Condition	Value (Approx.)	
(+)	(-)	Signal name	Input/ Output			
76 (R/G)	Ground	Combination switch INPUT 3	Input	Combination switch	All switch OFF (Wiper intermittent dial 4)	 <small>JPMIA0041GB</small> 1.4V
					Lighting switch high-beam (Wiper intermittent dial 4)	 <small>JPMIA0036GB</small> 1.3V
					Lighting switch 2ND (Wiper intermittent dial 4)	 <small>JPMIA0037GB</small> 1.3V
					Any of the conditions below with all switch OFF <ul style="list-style-type: none"> • Wiper intermittent dial 1 • Wiper intermittent dial 2 • Wiper intermittent dial 3 	 <small>JPMIA0040GB</small> 1.3V
77 (BR)	Ground	Push-button ignition switch	Input	Engine switch (push switch)	Pressed Not pressed	0V Battery voltage
78 (P)	Ground	CAN-L	Input/ Output	—	—	—
79 (L)	Ground	CAN-H	Input/ Output	—	—	—
80 (R/L)	Ground	Key slot illumination	Output	Key slot illumina- tion	OFF	0V
					Blinking	 <small>JPMIA0015GB</small> 6.5V
					ON	Battery voltage

A
B
C
D
E
F
G
H
J
K
L
M
N
O
P

HAC

BCM (BODY CONTROL MODULE)

[AUTOMATIC AIR CONDITIONER]



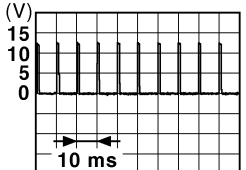
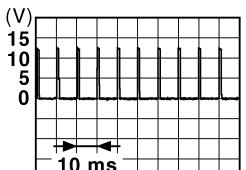

< ECU DIAGNOSIS >

Terminal No. (Wire color)		Description		Condition		Value (Approx.)
		Signal name	Input/ Output			
(+)	(-)					
81 (LG)	Ground	ON indicator lamp	Output	Ignition switch	OFF or ACC	Battery voltage
					ON	0V
83 (L)	Ground	ACC relay control	Output	Ignition switch	OFF	0V
					ACC or ON	Battery voltage
84 (Y/R)	Ground	ECTV device (detent switch)	Output	—		Battery voltage
85 (L/O)	Ground	Electronic steering column lock condition No. 1	Input	Electronic steering column lock	Lock status	0V
					Unlock status	Battery voltage
86 (G/R)	Ground	Electronic steering column lock condition No. 2	Input	Electronic steering column lock	Lock status	Battery voltage
					Unlock status	0V
87 (G/B)	Ground	ECTV device (detent switch)	Input	Selector lever	P position	0V
					Any position other than P	Battery voltage
88 (P/L)	Ground	Front door RH request switch	Input	Front door RH request switch	ON (pressed)	0V
					OFF (not pressed)	 <p style="text-align: right; margin-right: 50px;">JPMIA0016GB 1.0V</p>
89 (B/W)	Ground	Front door LH request switch	Input	Front door LH request switch	ON (pressed)	0V
					OFF (not pressed)	 <p style="text-align: right; margin-right: 50px;">JPMIA0016GB 1.0V</p>
90 (Y)	Ground	Front blower motor relay control	Output	Ignition switch	OFF or ACC	0V
					ON	Battery voltage
91 (L/R)	Ground	Remote keyless entry receiver power supply	Output	Ignition switch OFF		Battery voltage
94 (G/Y)	Ground	Electronic steering column lock CPU power supply	Output	Ignition switch	OFF or ACC	Battery voltage
					ON	0V

BCM (BODY CONTROL MODULE)

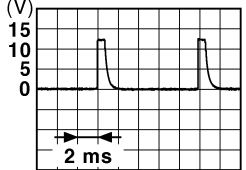
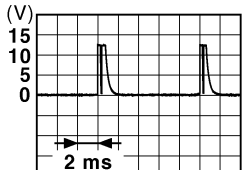
[AUTOMATIC AIR CONDITIONER]

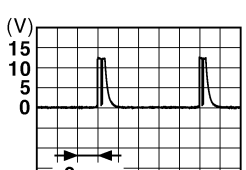
< ECU DIAGNOSIS >

Terminal No. (Wire color)		Description		Condition	Value (Approx.)
(+)	(-)	Signal name	Input/ Output		
95 (R/W)	Ground	Combination switch INPUT 1	Input	Combination switch (Wiper intermittent dial 4)	All switch OFF  1.4V
					Turn signal switch LH  1.3V
					Turn signal switch RH  1.3V
					Front wiper switch LO  1.3V
					Front washer switch ON  1.3V

A
B
C
D
E
F
G
H
J
K
L
M
N
O
P

HAC

BCM (BODY CONTROL MODULE)

[AUTOMATIC AIR CONDITIONER]



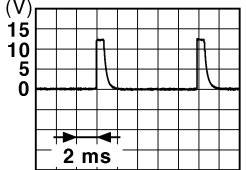
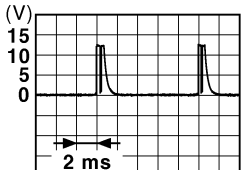
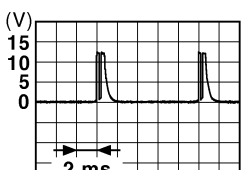
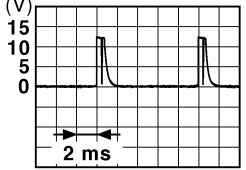

< ECU DIAGNOSIS >

Terminal No. (Wire color)		Description		Condition	Value (Approx.)
(+)	(-)	Signal name	Input/ Output		
96 (P/B)	Ground	Combination switch INPUT 4	Input	Combination switch	All switch OFF (Wiper intermittent dial 4) <div style="text-align: right;">  <p style="font-size: small; margin: 0;">JPMIA0041GB</p> <p style="margin: 0;">1.4V</p> </div>
				Lighting switch AUTO	Lighting switch AUTO (Wiper intermittent dial 4) <div style="text-align: right;">  <p style="font-size: small; margin: 0;">JPMIA0038GB</p> <p style="margin: 0;">1.3V</p> </div>
				Lighting switch 1ST	Lighting switch 1ST (Wiper intermittent dial 4) <div style="text-align: right;">  <p style="font-size: small; margin: 0;">JPMIA0036GB</p> <p style="margin: 0;">1.3V</p> </div>
				Any of the conditions below with all switch OFF	Any of the conditions below with all switch OFF <ul style="list-style-type: none"> • Wiper intermittent dial 1 • Wiper intermittent dial 5 • Wiper intermittent dial 6 <div style="text-align: right;">  <p style="font-size: small; margin: 0;">JPMIA0039GB</p> <p style="margin: 0;">1.3V</p> </div>

BCM (BODY CONTROL MODULE)

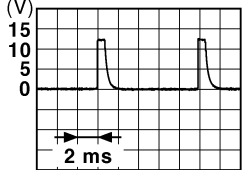
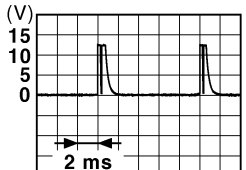
[AUTOMATIC AIR CONDITIONER]

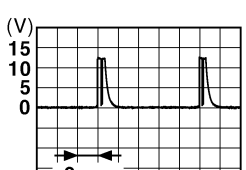
< ECU DIAGNOSIS >

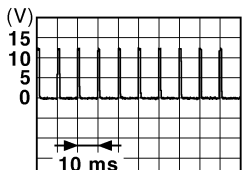
Terminal No. (Wire color)		Description		Condition	Value (Approx.)	
(+)	(-)	Signal name	Input/ Output			
97 (R/B)	Ground	Combination switch INPUT 2	Input	Combination switch (Wiper intermittent dial 4)	All switch OFF	 1.4V
					Lighting switch flash-to-pass	 1.3V
					Lighting switch 2ND	 1.3V
					Front wiper switch INT	 1.3V
					Front wiper switch HI	 1.3V
					Pressed	0 V
98 (G/R)	Ground	Hazard switch	Input	Hazard switch	Not pressed  1.1V	

A
B
C
D
E
F
G
H
J
K
L
M
N
O
P

HAC

BCM (BODY CONTROL MODULE)

[AUTOMATIC AIR CONDITIONER]

< ECU DIAGNOSIS >

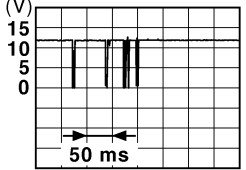
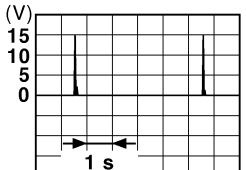
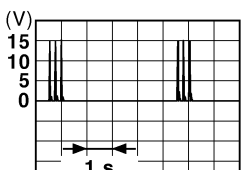
Terminal No. (Wire color)		Description		Condition	Value (Approx.)	
(+)	(-)	Signal name	Input/ Output			
99 (L/Y)	Ground	Electronic steering column lock CPU communication	Input/ Output	Electronic steer- ing column lock	LOCK status	Battery voltage
					LOCK or UNLOCK	 <p style="text-align: right; font-size: small;">JMKIA0066GB</p>
					For 15 seconds after UN- LOCK	Battery voltage
					15 seconds or later after UNLOCK	0V
103 (V)	Ground	Trunk lid opening	Output	Trunk lid	Open (trunk lid opener ac- tuator is activated)	Battery voltage
					Close (trunk lid opener ac- tuator is not activated)	0V
110 (V/W)	Ground	Trunk room lamp	Output	Trunk room lamp	ON	0V
					OFF	Battery voltage
114 (B)	Ground	Trunk room antenna 1 (-)	Output	Ignition switch OFF	When Intelligent Key is in the passenger compart- ment	 <p style="text-align: right; font-size: small;">JMKIA0062GB</p>
					When Intelligent Key is not in the passenger compart- ment	 <p style="text-align: right; font-size: small;">JMKIA0063GB</p>

BCM (BODY CONTROL MODULE)

[AUTOMATIC AIR CONDITIONER]

< ECU DIAGNOSIS >

Terminal No. (Wire color)		Description		Condition	Value (Approx.)
(+)	(-)	Signal name	Input/ Output		
115 (W)	Ground	Trunk room antenna 1 (+)	Output	Ignition switch OFF	<p>JMKIA0062GB</p>
				When Intelligent Key is not in the passenger compart- ment	<p>JMKIA0063GB</p>
118 (L/O)	Ground	Rear bumper anten- na (-)	Output	When the trunk lid request switch is operated with ignition switch OFF	<p>JMKIA0062GB</p>
				When Intelligent Key is not in the antenna detection area	<p>JMKIA0063GB</p>
119 (BR/ W)	Ground	Rear bumper anten- na (+)	Output	When the trunk lid request switch is operated with ignition switch OFF	<p>JMKIA0062GB</p>
				When Intelligent Key is not in the antenna detection area	<p>JMKIA0063GB</p>

A
B
C
D
E
F
G
H
J
K
L
M
N
O
P

HAC

BCM (BODY CONTROL MODULE)

[AUTOMATIC AIR CONDITIONER]

< ECU DIAGNOSIS >

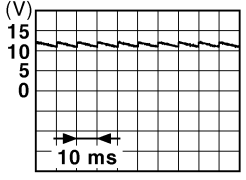
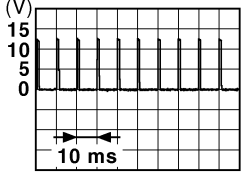
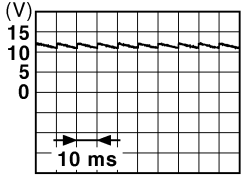
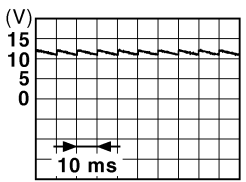
Terminal No. (Wire color)		Description		Condition	Value (Approx.)	
		Signal name	Input/ Output			
(+)	(-)					
127 (BR/ W)	Ground	Ignition relay (IPDM E/R) control	Output	Ignition switch	OFF or ACC	Battery voltage
					ON	0V
130 (Y/G)	Ground	Trunk room lamp switch	Input	Trunk room lamp switch	OFF (trunk is closed)	 <p style="text-align: right; font-size: small;">JPMIA0011GB</p> <p style="text-align: center;">11.8V</p>
					ON (trunk is open)	0V
132 (R)	Ground	Start signal	Output	Ignition switch ON	When selector lever is in P or N position and the brake peddle is not depressed	0V
					When selector lever is in P or N position and the brake peddle is depressed	Battery voltage
141 (G/R)	Ground	Trunk request switch	Input	Trunk request switch	ON (pressed)	0V
					OFF (not pressed)	 <p style="text-align: right; font-size: small;">JPMIA0016GB</p> <p style="text-align: center;">1.0V</p>
144 (GR)	Ground	Request switch buzz- er	Output	Request switch buzzer	Sounding	0V
					Not sounding	Battery voltage
147 (L/R)	Ground	Trunk lid opener switch	Input	Trunk lid opener switch	Pressed	0V
					Not pressed	 <p style="text-align: right; font-size: small;">JPMIA0011GB</p> <p style="text-align: center;">11.8V</p>
148 (R/W)	Ground	Rear door RH switch	Input	Rear door RH switch	OFF (when rear door RH closes)	 <p style="text-align: right; font-size: small;">JPMIA0011GB</p> <p style="text-align: center;">11.8V</p>
					ON (when rear door RH opens)	0V

BCM (BODY CONTROL MODULE)

< ECU DIAGNOSIS >

[AUTOMATIC AIR CONDITIONER]

Terminal No. (Wire color)		Description		Condition	Value (Approx.)
		Signal name	Input/ Output		
(+)	(-)				
149 (R/B)	Ground	Rear door LH switch	Input	Rear door LH switch	OFF (when rear door LH closes)
				ON (when rear door LH opens)	0V

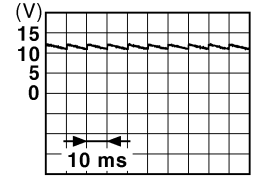

JPMIA0011GB

*: With LH and RH front window anti-pinch system

A
B
C
D
E
F
G
H
J
K
L
M
N
O
P

HAC

AUTO AMP.

< ECU DIAGNOSIS >

[AUTOMATIC AIR CONDITIONER]

AUTO AMP.

Reference Value

INFOID:000000001504893

VALUES ON THE DIAGNOSIS TOOL

Display Item List

Monitor Item	Condition	Value/Status	
AMB TEMP SEN	Ignition switch ON (READY)	-30 - 55°C	
IN-VEH TEMP	Ignition switch ON (READY)	-30 - 55°C	
INT TEMP SEN	Ignition switch ON (READY)	-30 - 55°C	
SUNLOAD SEN	Ignition switch ON (READY)	0 - 1275 W/m ²	
AMB SEN CAL	Ignition switch ON (READY)	-30 - 55°C	
IN-VEH CAL	Ignition switch ON (READY)	-30 - 55°C	
INT TEMP CAL	Ignition switch ON (READY)	-30 - 55°C	
SUNL SEN CAL	Ignition switch ON (READY)	0 - 1275 W/m ²	
COMP REQ SIG	Ignition switch ON (READY)	ON	On
		OFF	Off
FAN REQ SIG	Ignition switch ON (READY)	ON	On
		OFF	Off
FAN DUTY	Ignition switch ON (READY)	0 - 100%	
XM	Ignition switch ON (READY)	-100 - 155°C	
ENG COOL TEMP	Ignition switch ON (READY)	-40 - 215°C	
VEHICLE SPEED	Ignition switch ON (READY)	0 - 255 km/h	
COMP RPM	Ignition switch ON (READY)	0 - 12000 rpm	
AC INV VOLT	Ignition switch ON (READY)	0 - 10350 W	
AC INV TEMP	Ignition switch ON (READY)	0 - 155°C	
AC INV CRNT	Ignition switch ON (READY)	0 - 25.5 A	
AC INV VOLT	Ignition switch ON (READY)	100 - 610 V	
USE POWER	Ignition switch ON (READY)	0 - 10350 W	
PWR SUPP FAIL	Ignition switch ON (READY)	—	
OUTPUT FAIL	Ignition switch ON (READY)	—	
LOAD FAIL	Ignition switch ON (READY)	—	
NETWORK FAIL	Ignition switch ON (READY)	—	
START UP FAIL	Ignition switch ON (READY)	—	
CONTROL FAIL	Ignition switch ON (READY)	—	
STB SHORT	Ignition switch ON (READY)	—	
STB STATUS	Ignition switch ON (READY)	ON	On
		OFF	Off
INV OVERHEAT	Ignition switch ON (READY)	—	
STB REQUEST	Ignition switch ON (READY)	ON	On
		OFF	Off
HTR WTR PUMP	Ignition switch ON (READY)	ON	On
		OFF	Off
ENG ON REQ	Ignition switch ON (READY)	ON	On
		OFF	Off
NETWRK STAT	Ignition switch ON (READY)	—	

AUTO AMP.

< ECU DIAGNOSIS >

[AUTOMATIC AIR CONDITIONER]

Monitor Item	Condition	Value/Status
STB OPEN	Ignition switch ON (READY)	—
STB STAT ANS	Ignition switch ON (READY)	On
		Off
AC PD CUT	Ignition switch ON (READY)	On
		Off
CLIM COOL REQ	Ignition switch ON (READY)	On
		Off
NE HEATER	Ignition switch ON (READY)	0 - 6375 rpm
HEATER NUP	Ignition switch ON (READY)	On
		Off

TERMINAL LAYOUT

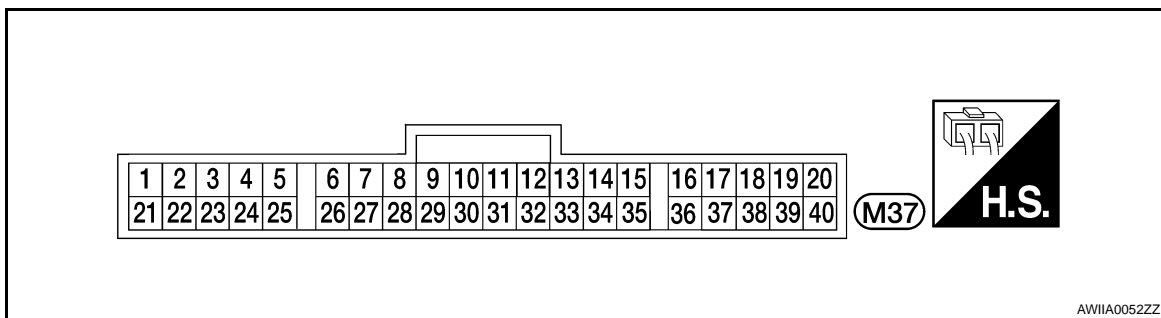

PHYSICAL VALUES

Terminal No. (Wire color)		Description		Condition	Value (Approx.)
+	-	Signal name	Input/ Output		
1 (L/Y)	Ground	Blower motor control signal	Output	<ul style="list-style-type: none"> Ignition switch ON Blower speed: 1st speed (manual) 	<p style="text-align: right; font-size: small;">JSIA0096ZZ</p>
3 (L/R)	Ground	A/C LAN signal	—	Ignition switch ON	<p style="text-align: right; font-size: small;">SJIA1453J</p>

AUTO AMP.

< ECU DIAGNOSIS >

[AUTOMATIC AIR CONDITIONER]

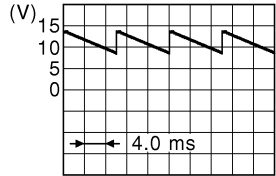
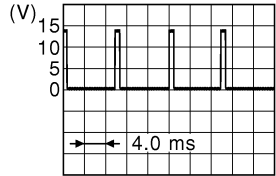
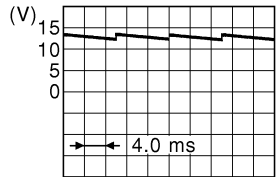
Terminal No. (Wire color)		Description		Condition	Value (Approx.)
+	-	Signal name	Input/ Output		
5 (SB)	Ground	Compressor ON signal	Output	<ul style="list-style-type: none"> Ignition switch ON (READY) A/C switch: ON (Blower motor operates.) 	0 V
				<ul style="list-style-type: none"> Ignition switch ON (READY) OFF switch: ON (A/C system: OFF) 	 <p style="text-align: right; font-size: small;">JP1IA0012GB</p>
7 (O)	Ground	Sunload sensor	Input	—	—
15 (L)	Ground	CAN-H	—	—	—
17 (B)	Ground	Ground	—	Ignition switch ON	0 V
19 (V/Y)	Ground	Power supply from ACC	—	Ignition switch ACC	Battery voltage
20 (L/W)	Ground	Power supply for each door motor	Output	Ignition switch ON	Battery voltage
22 (GR)	Ground	Rear window defogger feedback signal	Output	<ul style="list-style-type: none"> Ignition switch ON Rear window defogger switch: ON 	Battery voltage
				<ul style="list-style-type: none"> Ignition switch ON Rear window defogger switch: OFF 	0 V
23 (GR/W)	Ground	Rear window defogger ON signal	Output	<ul style="list-style-type: none"> Ignition switch ON Rear window defogger switch: While pressing 	0 V
				<ul style="list-style-type: none"> Ignition switch ON Rear window defogger switch: Not pressed 	 <p style="text-align: right; font-size: small;">JP1IA0013GB</p>
24 (BR/W)	Ground	Blower motor ON signal	Output	<ul style="list-style-type: none"> Ignition switch ON Fan control dial: ON (Blower motor operates.) 	0 V
				<ul style="list-style-type: none"> Ignition switch ON OFF switch: ON (A/C system: OFF) 	 <p style="text-align: right; font-size: small;">JP1IA0014GB</p>
25 (R/G)	Ground	Intake sensor	Input	—	—
26 (B/Y)	Ground	Sensor ground	—	Ignition switch ON	0 V

AUTO AMP.

< ECU DIAGNOSIS >

[AUTOMATIC AIR CONDITIONER]

Terminal No. (Wire color)		Description		Condition	Value (Approx.)
+	-	Signal name	Input/ Output		
27 (LG)	Ground	In-vehicle sensor	Input	—	—
28 (O/B)	Ground	Ambient sensor	Input	—	—
31 (P)	Ground	Power supply for ambient temperature display	Output	—	5 V
35 (P)	Ground	CAN-L	—	—	—
37 (B)	Ground	Ground (Power)	—	Ignition switch ON	0 V
39 (Y/R)	Ground	Power supply from BATT	—	Ignition switch OFF	Battery voltage
40 (G)	Ground	Power supply from IGN	—	Ignition switch ON	Battery voltage

A
B
C
D
E
F
G
H
I
J
K
L
M
N
O
P

HAC

AUTO AMP.

< ECU DIAGNOSIS >

[AUTOMATIC AIR CONDITIONER]

Wiring Diagram — AIR CONDITIONER CONTROL SYSTEM —

INFOID:000000001504894

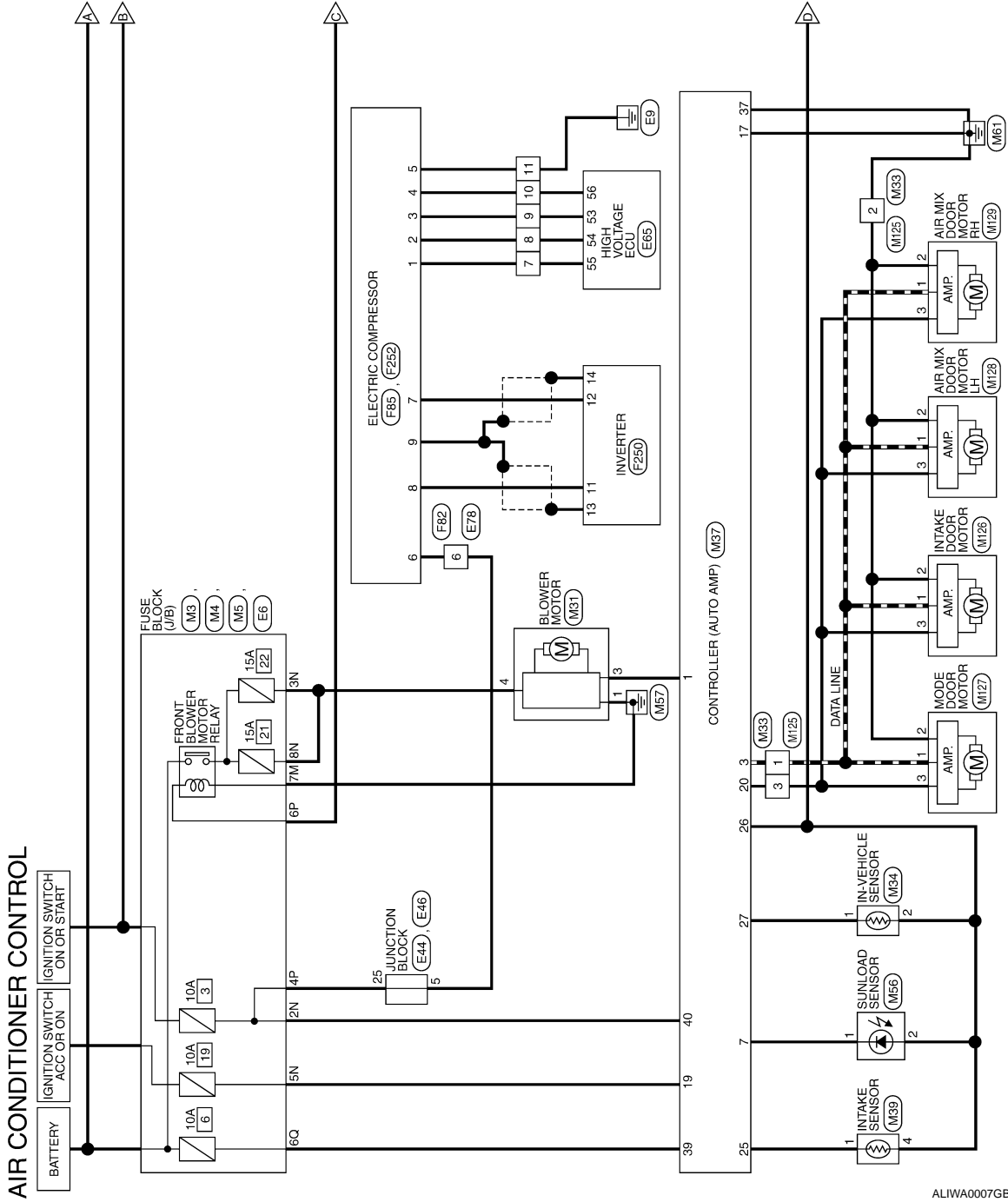

ALIWA0007GB

AUTO AMP.

< ECU DIAGNOSIS >

[AUTOMATIC AIR CONDITIONER]

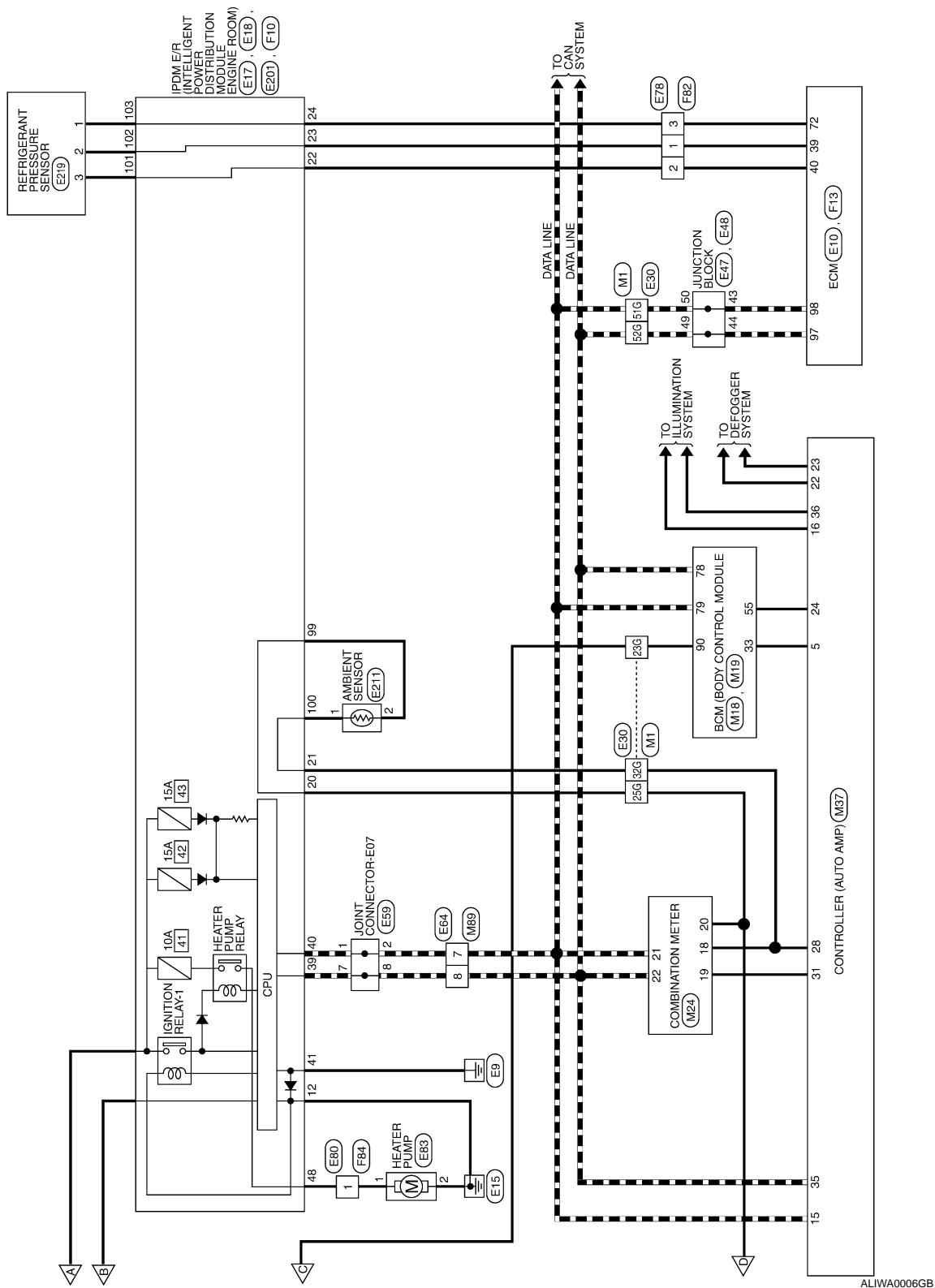

A
B
C
D
E
F
G
H
HAC
J
K
L
M
N
O
P

ALIWA0006GB

AIR CONDITIONER CONTROL CONNECTORS

Connector No.	M1
Connector Name	WIRE TO WIRE
Connector Color	WHITE

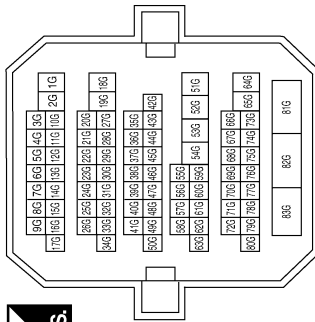

Terminal No.	Color of Wire	Signal Name
23G	Y	—
25G	BY	—
32G	O/B	—
51G	L	—
52G	P	—

Connector No.	M3
Connector Name	FUSE BLOCK (J/B)
Connector Color	WHITE

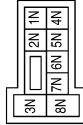

Terminal No.	Color of Wire	Signal Name
2N	G	—
3N	W/L	—
5N	V/Y	—
8N	W/L	—

Connector No.	M4
Connector Name	FUSE BLOCK (J/B)
Connector Color	WHITE

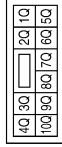

Terminal No.	Color of Wire	Signal Name
6Q	Y/R	—

Connector No.	M5
Connector Name	FUSE BLOCK (J/B)
Connector Color	WHITE

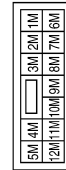

Terminal No.	Color of Wire	Signal Name
7M	B	—

Connector No.	M18
Connector Name	BCM (BODY CONTROL MODULE)
Connector Color	GREEN



Terminal No.	Color of Wire	Signal Name
33	SB	AIRCON SW
55	BR/W	BLOWER_FAN_SW/

Connector No.	M19
Connector Name	BCM (BODY CONTROL MODULE)
Connector Color	BLACK

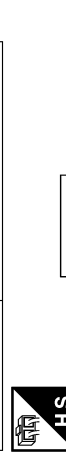

Terminal No.	Color of Wire	Signal Name
78	P	CAN-L
79	L	CAN-H
90	Y	IGN2_CONT

Connector No.	M24
Connector Name	COMBINATION METER
Connector Color	WHITE



1	2	3	4	5	6	7	8	9	10	11	12	13	14	15	16	17	18	19	20
21	22	23	24	25	26	27	28	29	30	31	32	33	34	35	36	37	38	39	40

Terminal No.	Color of Wire	Signal Name
18	O/B	OAT
19	P	OAT POWER
20	B/Y	GND (OAT POWER)
21	L	CAN-H
22	P	CAN-L

Connector No.	M31
Connector Name	BLOWER MOTOR
Connector Color	WHITE



6	5	4	3	2	1
---	---	---	---	---	---

Terminal No.	Color of Wire	Signal Name
1	B	GND
3	L/Y	FAN_PWM
4	W/L	B+

Connector No.	M33
Connector Name	WIRE TO WIRE
Connector Color	WHITE



3	2	1
---	---	---

Terminal No.	Color of Wire	Signal Name
1	L/W	—
2	L/R	—
3	B	—

Connector No.	M34
Connector Name	IN-VEHICLE SENSOR
Connector Color	WHITE



1	2
---	---

Terminal No.	Color of Wire	Signal Name
1	LG	INC SENS
2	B/Y	SENS GND

Connector No.	M37
Connector Name	CONTROLLER (AUTO AMP)
Connector Color	WHITE



1	2	3	4	5	6	7	8	9	10	11	12	13	14	15	16	17	18	19	20
21	22	23	24	25	26	27	28	29	30	31	32	33	34	35	36	37	38	39	40

Terminal No.	Color of Wire	Signal Name
1	L/Y	FAN_PWM
3	L/R	LAN_SIG
5	SB	COMP_ON
7	O	SUN_SENS
15	L	CAN_H

Terminal No.	Color of Wire	Signal Name
16	R/L	ILL +
17	B	GND
18	W/L	IGN_2
19	V/Y	ACC
20	L/W	VACTR
22	GR	RR_DEF_F/B
23	GR/W	RR_DEF_ON
24	BR/W	FAN_ON
25	R/G	INT SENS
26	B/Y	SENS GND
27	LG	INC SENS
28	O/B	AMB SENS
31	P	AMB_VDD
35	P	CAN-L
36	R/Y	ILL-
37	B	GND(POWER)
39	Y/R	BATT
40	G	IGN

A
B
C
D
E
F
G
H
HAC
J
K
L
M
N
O
P

AUTO AMP.

< ECU DIAGNOSIS >

[AUTOMATIC AIR CONDITIONER]

Connector No.	M39
Connector Name	INTAKE SENSOR
Connector Color	WHITE

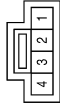

Terminal No.	Color of Wire	Signal Name
1	R/G	SENS
4	B/Y	GND

Connector No.	M56
Connector Name	SUNLOAD SENSOR
Connector Color	BLACK



Terminal No.	Color of Wire	Signal Name
1	O	SENS
2	B/Y	GND

Connector No.	M89
Connector Name	WIRE TO WIRE
Connector Color	WHITE

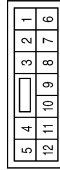

Terminal No.	Color of Wire	Signal Name
7	L	—
8	P	—

Connector No.	M125
Connector Name	WIRE TO WIRE
Connector Color	WHITE

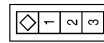

Terminal No.	Color of Wire	Signal Name
1	W	—
2	W	—
3	W	—

Connector No.	M126
Connector Name	INTAKE DOOR MOTOR
Connector Color	WHITE

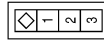

Terminal No.	Color of Wire	Signal Name
1	W	—
2	W	—
3	W	—

ALIIA0038GB

Connector No.	M129
Connector Name	AIR MIX DOOR MOTOR RH
Connector Color	WHITE

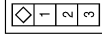

Terminal No.	Color of Wire	Signal Name
1	W	—
2	W	—
3	W	—

Connector No.	M128
Connector Name	AIR MIX DOOR MOTOR LH
Connector Color	WHITE

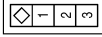

Terminal No.	Color of Wire	Signal Name
1	W	—
2	W	—
3	W	—

Connector No.	M127
Connector Name	MODE DOOR MOTOR
Connector Color	WHITE

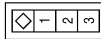

Terminal No.	Color of Wire	Signal Name
1	W	—
2	W	—
3	W	—

Connector No.	E17
Connector Name	IPDM E/R (INTELLIGENT POWER DISTRIBUTION MODULE ENGINE ROOM)
Connector Color	WHITE

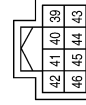

Terminal No.	Color of Wire	Signal Name
39	P	CAN-L
40	L	CAN-H
41	B	S-GND

Connector No.	E10
Connector Name	ECM
Connector Color	BLACK

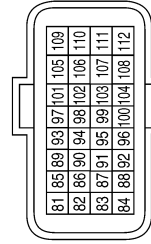

Terminal No.	Color of Wire	Signal Name
97	P	CAN-L
98	L	CAN-H

Connector No.	E6
Connector Name	FUSE BLOCK (J/B)
Connector Color	WHITE



Terminal No.	Color of Wire	Signal Name
4P	LG	—
6P	Y	—

ALIIA0039GB

A
B
C
D
E
F
G
H
HAC
J
K
L
M
N
O
P

AUTO AMP.

< ECU DIAGNOSIS >

[AUTOMATIC AIR CONDITIONER]

Connector No.	E18
Connector Name	IPDM E/R (INTELLIGENT POWER DISTRIBUTION MODULE ENGINE ROOM)
Connector Color	WHITE

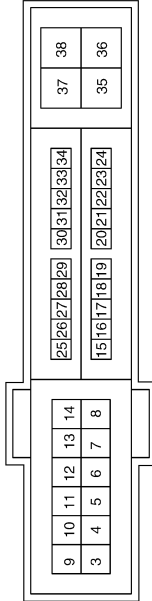

Terminal No.	Color of Wire	Signal Name
12	B	P-GND
20	B/Y	AMB SENS GND-E/R
21	O/B	AMB SENS SIG-E/R
22	W/R	PD SENS GND-E/R
23	B/R	PD SENS SIG-E/R
24	BR/W	PD SENS PWR-E/R

Connector No.	E30
Connector Name	WIRE TO WIRE
Connector Color	WHITE

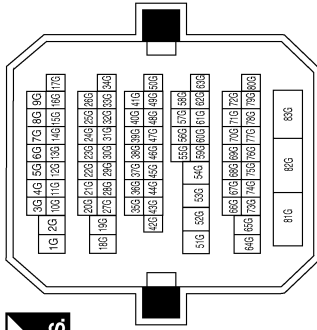

Terminal No.	Color of Wire	Signal Name
23G	Y	—
25G	B/Y	—
32G	O/B	—
51G	L	—
52G	P	—

Connector No.	E44
Connector Name	JUNCTION BLOCK
Connector Color	BROWN

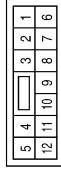

Terminal No.	Color of Wire	Signal Name
5	G/R	—

Connector No.	E46
Connector Name	JUNCTION BLOCK
Connector Color	WHITE

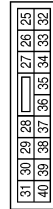

Terminal No.	Color of Wire	Signal Name
25	LG	—

Connector No.	E47
Connector Name	JUNCTION BLOCK
Connector Color	WHITE

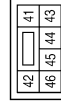

Terminal No.	Color of Wire	Signal Name
43	L	—
44	P	—

Connector No.	E48
Connector Name	JUNCTION BLOCK
Connector Color	WHITE

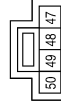

Terminal No.	Color of Wire	Signal Name
49	P	—
50	L	—

Connector No.	E65
Connector Name	HIGH VOLTAGE ECU
Connector Color	BLACK

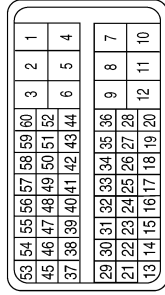

Terminal No.	Color of Wire	Signal Name
53	R	ET1
54	Y	ITE
55	L	CLK
56	W	STB

Connector No.	E64
Connector Name	WIRE TO WIRE
Connector Color	WHITE

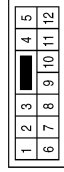

Terminal No.	Color of Wire	Signal Name
7	L	-
8	P	-

Connector No.	E59
Connector Name	JOINT CONNECTOR-E07
Connector Color	BLUE

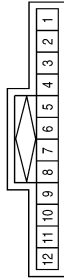

Terminal No.	Color of Wire	Signal Name
1	L	-
2	L	-
7	P	-
8	P	-

Connector No.	E83
Connector Name	HEATER PUMP
Connector Color	BLACK



Terminal No.	Color of Wire	Signal Name
1	R	-
2	B/Y	-

Connector No.	E80
Connector Name	WIRE TO WIRE
Connector Color	WHITE

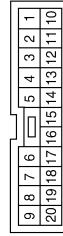

Terminal No.	Color of Wire	Signal Name
1	R	-

Connector No.	E78
Connector Name	WIRE TO WIRE
Connector Color	WHITE



Terminal No.	Color of Wire	Signal Name
1	B/R	-
2	W/R	-
3	BR/W	-
6	G/R	-
7	L	-
8	Y	-
9	R	-
10	W	-
11	B	-

ALIIA0041GB

AUTO AMP.

< ECU DIAGNOSIS >

[AUTOMATIC AIR CONDITIONER]

Connector No.	E201
Connector Name	IPDM E/R (INTELLIGENT POWER DISTRIBUTION MODULE ENGINE ROOM)
Connector Color	WHITE

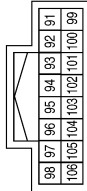

Terminal No.	Color of Wire	Signal Name
99	BR/W	AMB_SENS_GND-FEM
100	SB	AMB_SENS_SIG-FEM
101	O/L	PD_SENS_GND-FEM
102	R/B	PD_SENS_SIG-FEM
103	P	PD_SENS_PWR-FEM

Connector No.	F10
Connector Name	IPDM E/R (INTELLIGENT POWER DISTRIBUTION MODULE ENGINE ROOM)
Connector Color	WHITE

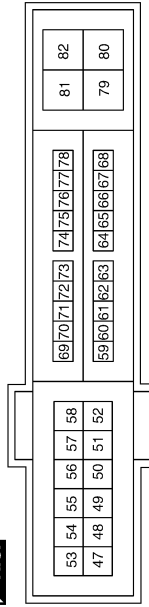

Terminal No.	Color of Wire	Signal Name
48	R	A/C_COMP

Connector No.	E211
Connector Name	AMBIENT SENSOR
Connector Color	BLACK



Terminal No.	Color of Wire	Signal Name
1	SB	AMB_SENS_SIG
2	BR/W	AMB_SENS_GND

Connector No.	F13
Connector Name	ECM
Connector Color	BROWN

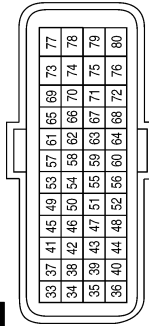

Terminal No.	Color of Wire	Signal Name
39	R	PDPRES
40	G	GND-PDPRES
72	LG/B	AVCC2-PDPRES (QR25DE)

Connector No.	E219
Connector Name	REFRIGERANT PRESSURE SENSOR
Connector Color	BLACK



Terminal No.	Color of Wire	Signal Name
1	P	AVCC2
2	R	SIGNAL
3	W	GND

Connector No.	F82
Connector Name	WIRE TO WIRE
Connector Color	WHITE

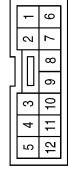

Terminal No.	Color of Wire	Signal Name
1	R	-
2	G	-
3	LG/B	-
6	G/B	-
7	L	-
8	Y	-
9	R	-
10	W	-
11	B	-

ALIIA0042GB

AUTO AMP.

< ECU DIAGNOSIS >

[AUTOMATIC AIR CONDITIONER]

Connector No.	F250
Connector Name	INVERTER
Connector Color	WHITE

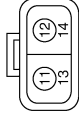

Terminal No.	Color of Wire	Signal Name
11	O	PBAT
12	O	PGND
13	SHIELD	SHIELD_PBAT
14	SHIELD	SHIELD_PGND

Connector No.	F85
Connector Name	ELECTRIC COMPRESSOR
Connector Color	BLACK

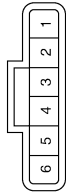

Terminal No.	Color of Wire	Signal Name
1	L	CLK
2	Y	DIN
3	R	DOUT
4	W	STB1
5	B	GND
6	G/R	IG

Connector No.	F84
Connector Name	WIRE TO WIRE
Connector Color	BROWN

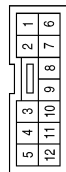

Terminal No.	Color of Wire	Signal Name
1	R	-

Connector No.	F252
Connector Name	ELECTRIC COMPRESSOR
Connector Color	ORANGE



Terminal No.	Color of Wire	Signal Name
7	O	PGND
8	O	PBAT
9	SHIELD	-

A
B
C
D
E
F
G
H
HAC
J
K
L
M
N
O
P

DTC Index

ALIIA0043GB

INFOID:000000001504895

HVAC related DTC

DTC	Items (CONSULT-III screen terms)	Condition	Reference page
U1000	CAN COMM CIRCUIT	IGN ON	EC-128, "DTC Logic"
U1010	CONTROL UNIT (CAN)	IGN ON	EC-129, "DTC Logic"

AUTO AMP.

< ECU DIAGNOSIS >

[AUTOMATIC AIR CONDITIONER]

DTC	Items (CONSULT-III screen terms)	Condition	Reference page
B2578	IN CAR SENSOR OUT OF RANGE [LOW]	IGN ON	HAC-37, "DTC Logic"
B2579	IN CAR SENSOR OUT OF RANGE [HI]	IGN ON	HAC-37, "DTC Logic"
B257B	AMB TEMP SEN SHORT	IGN ON	HAC-39, "DTC Logic"
B257C	AMB TEMP SEN OPEN	IGN ON	HAC-39, "DTC Logic"
B2581	EVAP TEMP SEN SHORT	IGN ON	HAC-42, "DTC Logic"
B2582	EVAP TEMP SEN OPEN	IGN ON	HAC-42, "DTC Logic"
B2630	SUNLOAD SEN* SHORT	IGN ON	HAC-45, "DTC Logic"
B2631	SUNLOAD SEN* OPEN	IGN ON	HAC-45, "DTC Logic"
B2632	DR AIRMIX ACTR SHORT	50 seconds passed after starting SELF-DIAG. after IGN ON	HAC-49, "DTC Logic"
B2633	DR AIRMIX ACTR OPEN	50 seconds passed after starting SELF-DIAG. after IGN ON	HAC-49, "DTC Logic"
B2634	PASS AIRMIX ACTR SHORT	50 seconds passed after starting SELF-DIAG. after IGN ON	HAC-52, "DTC Logic"
B2635	PASS AIRMIX ACTR OPEN	50 seconds passed after starting SELF-DIAG. after IGN ON	HAC-52, "DTC Logic"
B2636	DR VENT DOOR FAIL	50 seconds passed after starting SELF-DIAG. after IGN ON	HAC-55, "DTC Logic"
B2637	DR B/L DOOR FAIL	50 seconds passed after starting SELF-DIAG. after IGN ON	HAC-55, "DTC Logic"
B2638	DR D/F1 DOOR FAIL	50 seconds passed after starting SELF-DIAG. after IGN ON	HAC-55, "DTC Logic"
B2639	DR DEF DOOR FAIL	50 seconds passed after starting SELF-DIAG. after IGN ON	HAC-55, "DTC Logic"
B263D	FRE DOOR FAIL	50 seconds passed after starting SELF-DIAG. after IGN ON	HAC-58, "DTC Logic"
B263E	20P FRE DOOR FAIL	50 seconds passed after starting SELF-DIAG. after IGN ON	HAC-58, "DTC Logic"
B263F	REC DOOR FAIL	50 seconds passed after starting SELF-DIAG. after IGN ON	HAC-58, "DTC Logic"
B2654	D/F2 DOOR FAIL	50 seconds passed after starting SELF-DIAG. after IGN ON	HAC-55, "DTC Logic"
B2655	B/L2 DOOR FAIL	50 seconds passed after starting SELF-DIAG. after IGN ON	HAC-55, "DTC Logic"
B2656	BTC DOOR FAIL	50 seconds passed after starting SELF-DIAG. after IGN ON	HAC-55, "DTC Logic"

*: When checking sunload sensor, select a place where sunshine directly on it.

Compressor related DTC

DTC	Items (CONSULT-III screen terms)	Condition	Reference page
B2640	MAIN VOLT MIN	After READY and A/C ON	HAC-61, "DTC Logic"
B2641	MAIN VOLT MAX	After READY and A/C ON	HAC-61, "DTC Logic"
B2642	MAIN VOLT MALFNCTN	After READY and A/C ON	HAC-61, "DTC Logic"

AUTO AMP.

< ECU DIAGNOSIS >

[AUTOMATIC AIR CONDITIONER]

DTC	Items (CONSULT-III screen terms)	Condition	Reference page
B2643	OUTPUT LINE SHORT	After READY and A/C ON	HAC-64, "DTC Logic"
B2644	OUTPUT LINE OPEN	After READY and A/C ON	HAC-64, "DTC Logic"
B2645	CURRENT MALFUNCTN	After READY and A/C ON	HAC-64, "DTC Logic"
B2646	VOLT LIMIT	After READY and A/C ON	HAC-66, "DTC Logic"
B2647	MORTOR CRNT LIMMIT	After READY and A/C ON	HAC-66, "DTC Logic"
B2648	SOFT OVR CRNT	After READY and A/C ON	HAC-66, "DTC Logic"
B2649	OVER LOAD	After READY and A/C ON	HAC-66, "DTC Logic"
B264A	INPT OVR CRNT	After READY and A/C ON	HAC-66, "DTC Logic"
B264C	STARTUP FAIL	After READY and A/C ON	HAC-66, "DTC Logic"
B264D	SYS FAIL STOP	After READY and A/C ON	HAC-66, "DTC Logic"
B264E	INSIDE PWR	After READY and A/C ON	HAC-68, "DTC Logic"
B264F	STB SHORT	After READY and A/C ON	HAC-69, "DTC Logic"
B2651	INV OVERHEAT L	After READY and A/C ON	HAC-71, "DTC Logic"
B2652	INV OVERHEAT S	After READY and A/C ON	HAC-71, "DTC Logic"
B2653	THERMO FAIL	After READY and A/C ON	HAC-71, "DTC Logic"
P0AA6-611	INSULATION RESIST	After READY and A/C ON	HAC-73, "DTC Logic"
U0424	COMMUNICATION FAILURE	After READY and A/C ON	HAC-76, "DTC Logic"

A
B
C
D
E
F
G
H
J
K
L
M
N
O
P

HAC

AIR CONDITIONER CONTROL

[AUTOMATIC AIR CONDITIONER]

< SYMPTOM DIAGNOSIS >

SYMPTOM DIAGNOSIS

AIR CONDITIONER CONTROL

Diagnosis Chart By Symptom

INFOID:000000001504896

Symptom	Reference page	
A/C system does not come on.	Go to Trouble Diagnosis Procedure for A/C System.	HAC-88. "Diagnosis Procedure"
Air outlet does not change.	Go to Trouble Diagnosis Procedure for Mode Door Motor. (LAN)	HAC-55. "Diagnosis Procedure"
Mode door motor does not operate normally.		
Discharge air temperature (driver side) does not change.	Go to Trouble Diagnosis Procedure for Air Mix Door Motor (driver side). (LAN)	HAC-49. "Diagnosis Procedure"
Air mix door motor (driver side) does not operate normally.		
Discharge air temperature (passenger side) does not change.	Go to Trouble Diagnosis Procedure for Air Mix Door Motor (passenger side). (LAN)	HAC-52. "Diagnosis Procedure"
Air mix door motor (passenger side) does not operate normally.		
Intake door does not change.	Go to Trouble Diagnosis Procedure for Intake Door Motor. (LAN)	HAC-58. "Diagnosis Procedure"
Intake door motor does not operate normally.		
Blower motor operation is malfunctioning.	Go to Trouble Diagnosis Procedure for Blower Motor.	HAC-83. "Diagnosis Procedure"
Electric compressor does not operate.	Go to Trouble Diagnosis Procedure for Electric Compressor.	HAC-92. "Diagnosis Procedure"
Heater pump does not operate.	Go to Trouble Diagnosis Procedure for Heater Pump.	HAC-86. "Diagnosis Procedure"
Insufficient cooling	Go to Trouble Diagnosis Procedure for Insufficient Cooling.	HAC-153. "Inspection procedure"
Insufficient heating	Go to Trouble Diagnosis Procedure for Insufficient Heating.	HAC-154. "Inspection procedure"
Noise	Go to Trouble Diagnosis Procedure for Noise.	HAC-156. "Inspection procedure"
Memory function does not operate.	Go to Trouble Diagnosis Procedure for Memory Function.	HAC-157. "Inspection procedure"

INSUFFICIENT COOLING

< SYMPTOM DIAGNOSIS >

[AUTOMATIC AIR CONDITIONER]

INSUFFICIENT COOLING

Description

INFOID:000000001504897

Symptom

- Insufficient cooling
- No cold air comes out. (Air flow volume is normal.)

Inspection procedure

INFOID:000000001504898

1.CHECK DTC

Check DTC.

Is any DTC detected?

- YES >> Check according to [HAC-149. "DTC Index"](#).
NO >> GO TO 2.

2.CHECK WITH A GAUGE OF REFRIGERANT RECOVERY/RECYCLING RECHARGING EQUIPMENT

Connect the refrigerant recovery/recycling recharging equipment to the vehicle and perform the pressure inspection with the gauge.

Is there refrigerant?

- YES >> GO TO 3.
NO-1 >> Check for refrigerant leakages with the electronic refrigerant leak detector. Refer to [HA-26. "Electronic Refrigerant Leak Detector"](#).
NO-2 >> GO TO 3 after repairing or replacing the parts according to the inspection results.

3.CHECK CHARGED REFRIGERANT AMOUNT

1. Connect refrigerant recovery/recycling recharging equipment to the vehicle and discharge the refrigerant.
2. Recharge with the proper amount of refrigerant and perform the inspection with the electronic refrigerant leak detector. Refer to [HA-26. "Electronic Refrigerant Leak Detector"](#).

Is the inspection result normal?

- YES >> GO TO 4.
NO >> Recharge the refrigerant and repair or replace the parts according to the inspection results.

4.CHECK REFRIGERANT CYCLE PRESSURE

Connect refrigerant recovery/recycling recharging equipment to the vehicle and perform the performance test. Refer to [HA-24. "Performance Chart"](#).

Is the inspection result normal?

- YES >> GO TO 5.
NO >> Repair or replace the parts according to the inspection results.

5.CHECK SETTING OF TEMPERATURE SETTING TRIMMER

Check the setting of temperature setting trimmer using CONSULT-III. Refer to [HAC-5. "Description & Inspection"](#).

1. Perform "TEMP SET CORRECT" in "WORK SUPPORT" with CONSULT-III
2. Check that the temperature setting trimmer is set to "+ direction".

NOTE:

The control temperature can be set with the setting of temperature setting trimmer.

3. Set "TEMP SET CORRECT" to "0.0°C (0.0°F)".

Are the symptoms solved?

- YES >> Perform the setting separately if necessary. END.
NO >> GO TO 6.

6.CHECK AIR LEAKAGE FROM DUCT

Check duct and nozzle, etc. of A/C system for air leakage.

Is the inspection result normal?

- YES >> Perform the setting separately if necessary. GO TO 5.
NO >> Repair or replace parts according to the inspection results.

A
B
C
D
E
F
G
H
J
K
L
M
N
O
P

HAC

INSUFFICIENT HEATING

< SYMPTOM DIAGNOSIS >

[AUTOMATIC AIR CONDITIONER]

INSUFFICIENT HEATING

Description

INFOID:000000001504899

Symptom

- Insufficient heating
- No warm air comes out. (Air flow volume is normal.)

Inspection procedure

INFOID:000000001504900

1.CHECK DTC

Check DTC.

Is any DTC detected?

- YES >> Check according to [HAC-149. "DTC Index"](#).
NO >> GO TO 2.

2.CHECK COOLING SYSTEM

1. Check engine coolant level and check for leakage. Refer to [CO-11. "Changing Engine Coolant"](#).
2. Check radiator cap. Refer to [CO-10. "System Inspection"](#).
3. Check water flow sounds of engine coolant. Refer to [CO-11. "Changing Engine Coolant"](#).

Is the inspection result normal?

- YES >> GO TO 3.
NO >> Refill the engine coolant and repair or replace the parts according to the inspection results.

3.CHECK SETTING OF TEMPERATURE SETTING TRIMMER

Check the setting of temperature setting trimmer using CONSULT-III. Refer to [HAC-5. "Description & Inspection"](#).

1. Perform "TEMP SET CORRECT" in "WORK SUPPORT" with CONSULT-III
2. Check that the temperature setting trimmer is set to "- direction".

NOTE:

The control temperature can be set with the setting of temperature setting trimmer.

3. Set "TEMP SET CORRECT" to "0.0°C (0.0°F)".

Are the symptoms solved?

- YES >> Perform the setting separately if necessary. END.
NO >> GO TO 4.

4.CHECK OPERATION

1. Turn temperature dial (driver side) and raise temperature setting to 32°C (90°F) after warming up the engine.
2. Check that warm air blows from outlets.

Is the inspection result normal?

- YES >> END.
NO >> GO TO 5.

5.CHECK AIR LEAKAGE FROM DUCT

Check duct and nozzle, etc. of A/C system for air leakage.

Is the inspection result normal?

- YES >> GO TO 6.
NO >> Repair or replace parts according to the inspection results.

6.CHECK HEATER PUMP

Check heater pump function. Refer to [HAC-86. "Component Function Check"](#).

Is the inspection result normal?

- YES >> GO TO 7.
NO >> Repair or replace parts according to the inspection results.

7.CHECK HEATER HOSE INSTALLATION CONDITION

INSUFFICIENT HEATING

[AUTOMATIC AIR CONDITIONER]

< SYMPTOM DIAGNOSIS >

Check the heater hose installation condition visually (for twist, crush, etc.).

Is the inspection result normal?

YES >> GO TO 8.

NO >> Repair or replace parts according to the inspection results.

8.CHECK TEMPERATURE OF HEATER HOSE

1. Check the temperature of inlet hose and outlet hose of heater core.

2. Check that the inlet side of heater core is hot and the outlet side is slightly lower than/almost equal to the inlet side.

CAUTION:

The temperature inspection should be performed in a short time because the engine coolant temperature is too hot.

Is the inspection result normal?

YES >> GO TO 9.

NO >> Replace the heater core after performing the procedures after the cooling system inspection again. GO TO 2.

9.REPLACE HEATER CORE

Replace the heater core. Refer to heater core. Refer to [VTL-22. "Removal and Installation"](#).

Are the symptoms solved?

YES >> END.

NO >> Perform the procedures after the cooling system inspection again. GO TO 2.

A

B

C

D

E

F

G

H

HAC

J

K

L

M

N

O

P

NOISE**Description**

INFOID:000000001504901

Symptom

- Noise
- Noise is heard when the A/C system operates.

Inspection procedure

INFOID:000000001504902

1.CHECK OPERATION

1. Operate the A/C system and check the operation. Refer to [HAC-5. "Description & Inspection"](#).
2. Check the parts where noise is occurring.

Can the parts where noise is occurring be checked?

- YES-1 >> Noise from blower fan motor: GO TO 2.
 YES-2 >> Noise from electric compressor: GO TO 3.
 YES-3 >> Noise from expansion valve: GO TO 4.
 YES-4 >> Noise from A/C piping (pipe, flexible hose): GO TO 6.
 NO >> END.

2.CHECK BLOWER FAN MOTOR

1. Remove blower fan motor. Refer to [VTL-14. "Removal and Installation"](#)
2. Remove foreign materials that are in the blower unit.
3. Check the noise from blower fan motor again.

Is the inspection result normal?

- YES >> END.
 NO >> Replace blower fan motor.

3.REPLACE ELECRTCIC COMPRESSOR

1. Correct the refrigerant with refrigerant recover/recycling recharging equipment.
2. Recharge with the proper amount of the collected refrigerant after recycling or new refrigerant.
3. Check for the noise from electric compressor again.

Is the inspection result normal?

- YES >> END.
 NO >> Replace electric compressor.

4.CHECK REFRIGERANT CYCLE PRESSURE

Connect refrigerant recovery/recycling recharging equipment to the vehicle and check the refrigerant cycle pressure. Refer to [HA-23. "HFC-134a \(R-134a\) Service Procedure"](#).

Is the inspection result normal?

- YES >> GO TO 5.
 NO >> Repair or replace the parts according to the inspection results.

5.REPLACE EXPANSION VALVE

1. Correct the refrigerant with refrigerant recover/recycling recharging equipment.
2. Recharge with the proper amount of the collected refrigerant after recycling or new refrigerant.
3. Check for the noise from expansion valve again.

Are the symptoms solved?

- YES >> END.
 NO >> Replace expansion valve.

6.CHECK A/C PIPING (PIPE, FLEXIBLE HOSE)

1. Check A/C piping (pipe, flexible hose) (for deformation and damage, etc.).
2. Check the installation condition of clips and brackets, etc. of A/C piping (pipe, flexible hose).

Is the inspection result normal?

- YES >> Fix the line with rubber or come vibration absorbing material.
 NO >> Repair or replace parts according to the inspection results.

MEMORY FUNCTION DOES NOT OPERATE

< SYMPTOM DIAGNOSIS >

[AUTOMATIC AIR CONDITIONER]

MEMORY FUNCTION DOES NOT OPERATE

Description

INFOID:000000001504903

Symptom

- Memory function does not operate normally.
- The setting is not maintained. (It returns to the initial condition.)

Inspection procedure

INFOID:000000001504904

1.CHECK OPERATION

1. Turn ignition switch ON (READY).
2. Set temperature control dial to 32°C (90°F).
3. Press OFF switch.
4. Turn ignition switch OFF.
5. Turn ignition switch ON (READY).
6. Press AUTO switch.
7. Check that the set temperature is maintained.

Is the inspection result normal?

- YES >> END.
NO >> GO TO 2.

2.CHECK POWER SUPPLY AND GROUND CIRCUIT OF AUTO AMP

Check power supply and ground circuit of auto amp. Refer to [HAC-88, "Diagnosis Procedure"](#).

Is the inspection result normal?

- YES >> Replace auto amp.
NO >> Repair or replace malfunctioning part(s).

A
B
C
D
E
F
G
H
J
K
L
M
N
O
P

HAC

PRECAUTION

PRECAUTIONS

Precaution for Supplemental Restraint System (SRS) "AIR BAG" and "SEAT BELT PRE-TENSIONER"

INFOID:000000001504905

The Supplemental Restraint System such as "AIR BAG" and "SEAT BELT PRE-TENSIONER", used along with a front seat belt, helps to reduce the risk or severity of injury to the driver and front passenger for certain types of collision. This system includes seat belt switch inputs and dual stage front air bag modules. The SRS system uses the seat belt switches to determine the front air bag deployment, and may only deploy one front air bag, depending on the severity of a collision and whether the front occupants are belted or unbelted. Information necessary to service the system safely is included in the SRS and SB section of this Service Manual.

WARNING:

- To avoid rendering the SRS inoperative, which could increase the risk of personal injury or death in the event of a collision which would result in air bag inflation, all maintenance must be performed by an authorized NISSAN/INFINITI dealer.
- Improper maintenance, including incorrect removal and installation of the SRS, can lead to personal injury caused by unintentional activation of the system. For removal of Spiral Cable and Air Bag Module, see the SRS section.
- Do not use electrical test equipment on any circuit related to the SRS unless instructed to in this Service Manual. SRS wiring harnesses can be identified by yellow and/or orange harnesses or harness connectors.

Precautions For High-Voltage System

INFOID:000000001504906

Refer to [GI-24, "Precautions For High-Voltage System"](#).

Precaution for Procedure without Cowl Top Cover

INFOID:000000001504907

When performing the procedure after removing cowl top cover, cover the lower end of windshield with urethane, etc.

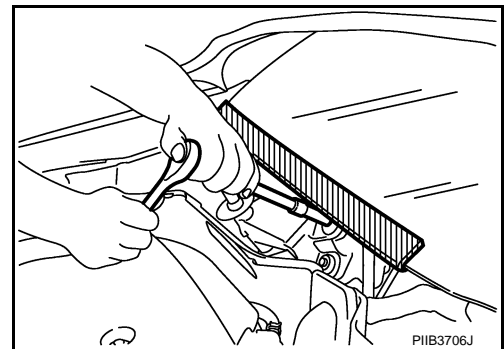

Precaution for Working with HFC-134a (R-134a)

INFOID:000000001504908

WARNING:

- CFC-12 (R-12) refrigerant and HFC-134a (R-134a) refrigerant are not compatible. If the refrigerants are mixed compressor failure is likely to occur. Refer to [HA-25, "Checking of Refrigerant Leaks"](#). To determine the purity of HFC-134a (R-134a) in the vehicle and recovery tank, use Refrigerant Recovery/Recycling Recharging equipment and Refrigerant Identifier.
- Use only specified oil for the HFC-134a (R-134a) A/C system and HFC-134a (R-134a) components. If oil other than that specified is used, compressor failure is likely to occur.
- The specified HFC-134a (R-134a) oil rapidly absorbs moisture from the atmosphere. The following handling precautions must be observed:
 - When removing refrigerant components from a vehicle, immediately cap (seal) the component to minimize the entry of moisture from the atmosphere.
 - When installing refrigerant components to a vehicle, do not remove the caps (unseal) until just before connecting the components. Connect all refrigerant loop components as quickly as possible to minimize the entry of moisture into system.
 - Only use the specified oil from a sealed container. Immediately reseal containers of oil. Without proper sealing, oil will become moisture saturated and should not be used.

PRECAUTIONS

< PRECAUTION >

[AUTOMATIC AIR CONDITIONER]

- Avoid breathing A/C refrigerant and oil vapor or mist. Exposure may irritate eyes, nose and throat. Remove HFC-134a (R-134a) from the A/C system using certified service equipment meeting requirements of SAE J2210 [HFC-134a (R-134a) recycling equipment], or J2209 [HFC-134a (R-134a) recycling equipment], If accidental system discharge occurs, ventilate work area before resuming service. Additional health and safety information may be obtained from refrigerant and oil manufacturers.
- Do not allow A/C oil to come in contact with styrofoam parts. Damage may result.

Contaminated Refrigerant

INFOID:000000001504909

If a refrigerant other than pure HFC-134a (R-134a) is identified in a vehicle, your options are:

- Explain to the customer that environmental regulations prohibit the release of contaminated refrigerant into the atmosphere.
- Explain that recovery of the contaminated refrigerant could damage your service equipment and refrigerant supply.
- Suggest the customer return the vehicle to the location of previous service where the contamination may have occurred.
- If you choose to perform the repair, recover the refrigerant using only **dedicated equipment and containers. Do not recover contaminated refrigerant into your existing service equipment.** If your facility does not have dedicated recovery equipment, you may contact a local refrigerant product retailer for available service. This refrigerant must be disposed of in accordance with all federal and local regulations. In addition, replacement of all refrigerant system components on the vehicle is recommended.
- If the vehicle is within the warranty period, the air conditioner warranty is void. Please contact NISSAN Customer Affairs for further assistance.

General Refrigerant Precaution

INFOID:000000001504910

WARNING:

- Do not release refrigerant into the air. Use approved recovery/recycling equipment to capture the refrigerant every time an air conditioning system is discharged.
- Always wear eye and hand protection (goggles and gloves) when working with any refrigerant or air conditioning system.
- Do not store or heat refrigerant containers above 52°C (125°F).
- Do not heat a refrigerant container with an open flame; if container warming is required, place the bottom of the container in a warm pail of water.
- Do not intentionally drop, puncture, or incinerate refrigerant containers.
- Keep refrigerant away from open flames: poisonous gas will be produced if refrigerant burns.
- Refrigerant will displace oxygen, therefore be certain to work in well ventilated areas to prevent suffocation.
- Do not pressure test or leak test HFC-134a (R-134a) service equipment and/or vehicle air conditioning systems with compressed air during repair. Some mixtures of air and HFC-134a (R-134a) have been shown to be combustible at elevated pressures. These mixtures, if ignited, may cause injury or property damage. Additional health and safety information may be obtained from refrigerant manufacturers.

Precaution for Leak Detection Dye

INFOID:000000001504911

- The A/C system does not contain a fluorescent leak detection dye.
- Do not use fluorescent leak detection dye in the A/C system.

A/C Identification Label

INFOID:000000001504912

Vehicles with factory installed A/C systems have this identification label on the underside of hood.

Precaution for Refrigerant Connection

INFOID:000000001504913

A new type refrigerant connection has been introduced to all refrigerant lines except the following locations.

- Expansion valve to cooling unit
- Evaporator pipes to evaporator (inside cooling unit)
- Refrigerant pressure sensor

FEATURES OF NEW TYPE REFRIGERANT CONNECTION

PRECAUTIONS

[AUTOMATIC AIR CONDITIONER]

< PRECAUTION >

- The O-ring has been relocated. It has also been provided with a groove for proper installation. This eliminates the chance of the O-ring being caught in, or damaged by, the mating part. The sealing direction of the O-ring is now set vertically in relation to the contacting surface of the mating part to improve sealing characteristics.
- The reaction force of the O-ring will not occur in the direction that causes the joint to pull out, thereby facilitating piping connections.

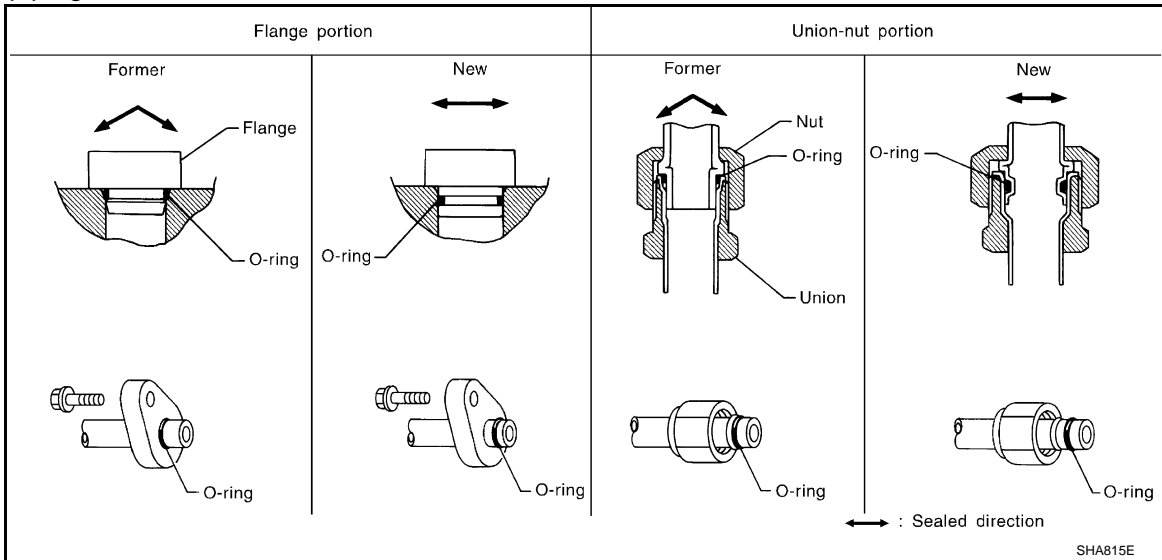

O-RING AND REFRIGERANT CONNECTION

PRECAUTIONS

< PRECAUTION >

[AUTOMATIC AIR CONDITIONER]

SEC. 214 • 270 • 274 • 276 • 278

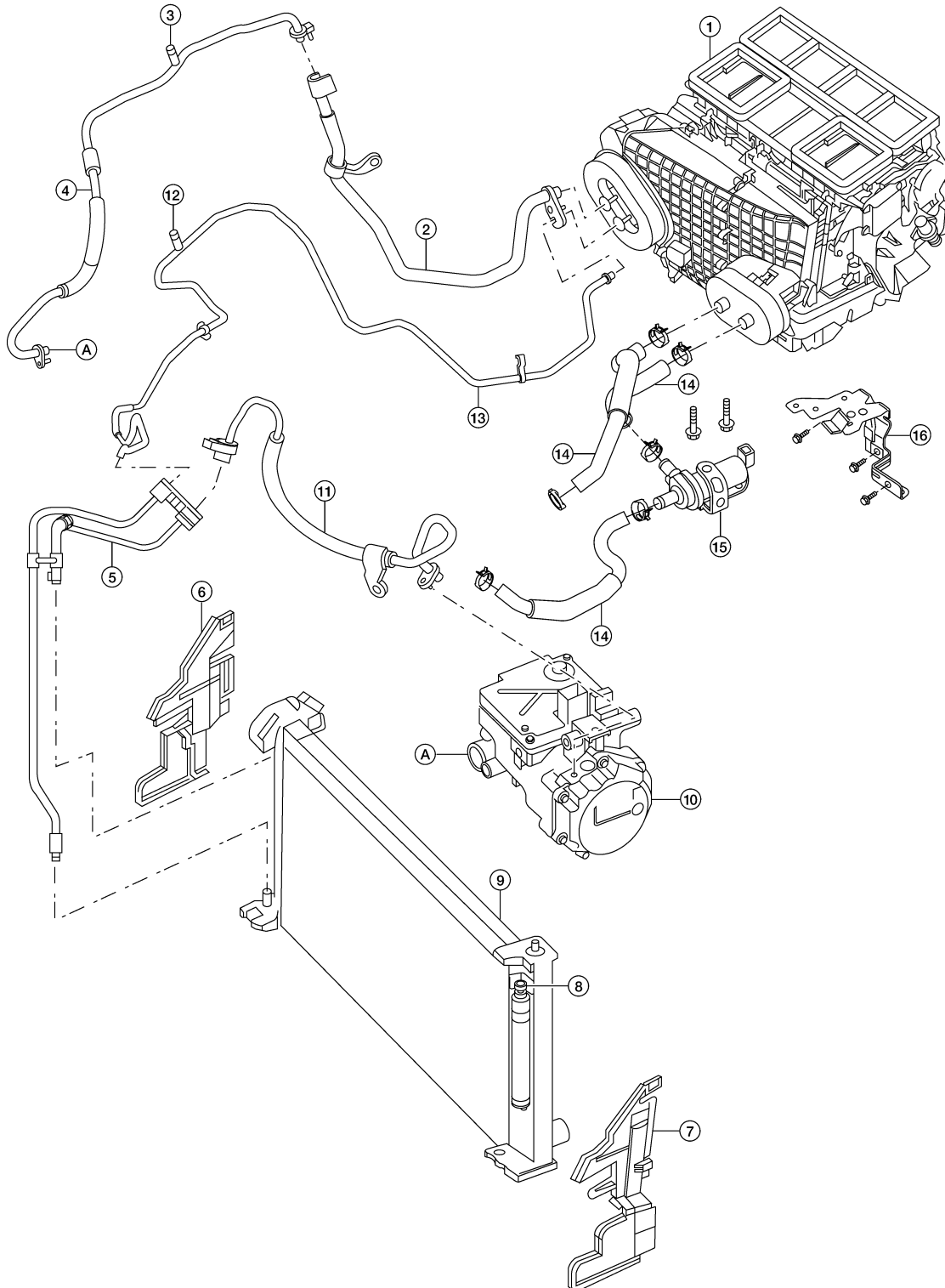

- | | | |
|-------------------------------------|---------------------------------|---|
| 1. Heater and cooling unit assembly | 2. Low-pressure pipe | 3. Low-pressure A/C service valve |
| 4. Low-pressure flexible hose | 5. Junction pipe | 6. Air deflector RH |
| 7. Air deflector LH | 8. Refrigerant pressure sensor | 9. Radiator, condenser and liquid tank assembly |
| 10. Electric compressor | 11. High-pressure flexible hose | 12. High-pressure A/C service valve |

ALIA0031ZZ

A
B
C
D
E
F
G
H
HAC
J
K
L
M
N
O
P

PRECAUTIONS

[AUTOMATIC AIR CONDITIONER]

< PRECAUTION >

- 13. High-pressure pipe
- 14. Heater hoses
- 15. Heater pump
- 16. Heater pump bracket
- A. Low-pressure flexible hose to electric compressor

CAUTION:

The new and former refrigerant connections use different O-ring configurations. Do not confuse O-rings since they are not interchangeable. If a wrong O-ring is installed, refrigerant will leak at, or around, the connection.

O-Ring Part Numbers and Specifications

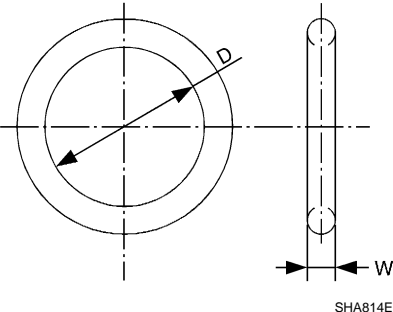
	Conne- tion type	O-ring size	Part number*	D mm (in)	W mm (in)
	New	8	92471 N8210	6.8 (0.268)	1.85 (0.0728)
Former	10	J2476 89956	9.25 (0.3642)	1.78 (0.0701)	
New	12	92472 N8210	10.9 (0.429)	2.43 (0.0957)	
Former		92475 71L00	11.0 (0.433)	2.4 (0.094)	
New	16	92473 N8210	13.6 (0.535)	2.43 (0.0957)	
Former		92475 72L00	14.3 (0.563)	2.3 (0.091)	
New	19	92474 N8210	16.5 (0.650)	2.43 (0.0957)	
Former		92477 N8200	17.12 (0.6740)	1.78 (0.0701)	
New	24	92195 AH300	21.8 (0.858)	2.4 (0.094)	

*: Always check with the Parts Department for the latest parts information.

WARNING:

Make sure all refrigerant is discharged into the recycling equipment and the pressure in the system is less than atmospheric pressure. Then gradually loosen the discharge side hose fitting and remove it.

CAUTION:

When replacing or cleaning refrigerant cycle components, observe the following.

- When the electric compressor is removed, store it in the same position as it is when mounted on the car. Failure to do so will cause electric compressor oil to enter the low pressure chamber.
- When connecting tubes, always use a torque wrench and a back-up wrench.
- After disconnecting tubes, immediately plug all openings to prevent entry of dirt and moisture.
- When installing an air conditioner in the vehicle, connect the pipes as the final stage of the operation. Do not remove the seal caps of pipes and other components until just before required for connection.
- Allow components stored in cool areas to warm to working area temperature before removing seal caps. This prevents condensation from forming inside A/C components.
- Thoroughly remove moisture from the refrigeration system before charging the refrigerant.
- Always replace used O-rings.
- When connecting tube, apply the specified electric compressor oil to circle of the O-rings. Be careful not to apply electric compressor oil to threaded portion.
- O-ring must be closely attached to dented portion of tube.
- When replacing the O-ring, be careful not to damage O-ring and tube.
- Connect tube until you hear it click, then tighten the nut or bolt by hand until snug. Make sure that the O-ring is installed to tube correctly.

PRECAUTIONS

[AUTOMATIC AIR CONDITIONER]

< PRECAUTION >

- After connecting line, conduct leak test and make sure that there is no leakage from connections. When the gas leaking point is found, disconnect that line and replace the O-ring. Then tighten connections of seal seat to the specified torque.

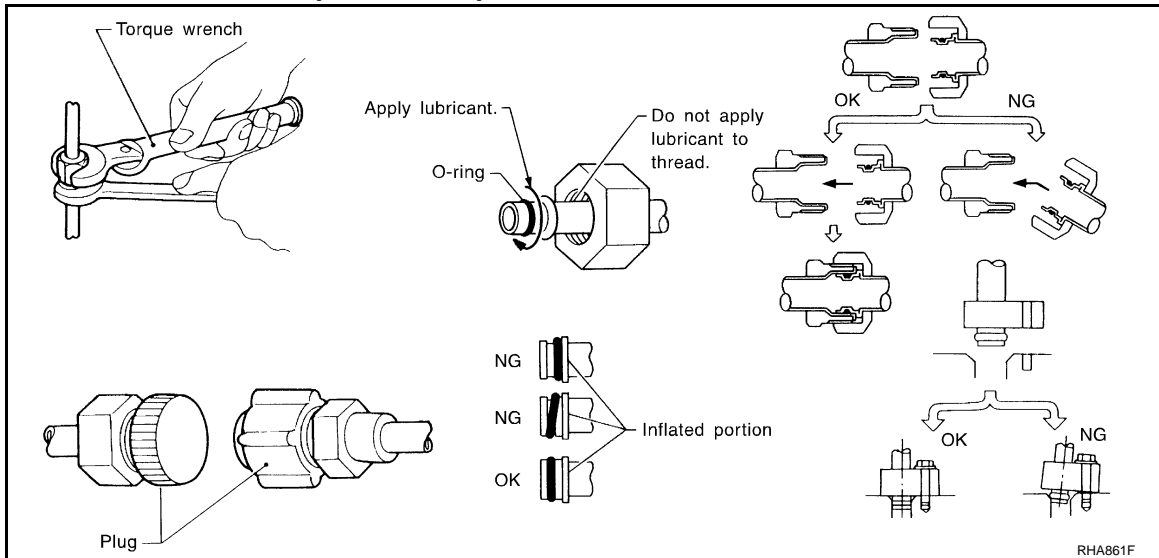

Precaution for Service of Electric Compressor

INFOID:000000001504914

- Plug all openings to prevent moisture and foreign matter from entering.
- When the electric compressor is removed, store it in the same position as it is when mounted on the car.
- When replacing or repairing electric compressor, refer to [HA-20, "Maintenance of Electric Compressor Oil Quantity in Electric Compressor"](#).
- After the electric compressor is installed, turn ignition switch (READY) and operate the electric compressor for more than two minutes.

Precaution for Service Equipment

INFOID:000000001504915

RECOVERY/RECYCLING EQUIPMENT

Follow the manufacturer's instructions for machine operation and machine maintenance. Never introduce any refrigerant other than that specified into the machine.

ELECTRONIC LEAK DETECTOR

Follow the manufacturer's instructions for tester operation and tester maintenance.

VACUUM PUMP

PRECAUTIONS

< PRECAUTION >

The oil contained inside the vacuum pump is not compatible with the specified oil for HFC-134a (R-134a) A/C systems. The vent side of the vacuum pump is exposed to atmospheric pressure so the vacuum pump oil may migrate out of the pump into the service hose. This is possible when the pump is switched off after evacuation (vacuuming) and hose is connected to it.

To prevent this migration, use a manual valve situated near the hose-to-pump connection, as follows.

- Usually vacuum pumps have a manual isolator valve as part of the pump. Close this valve to isolate the service hose from the pump.
- For pumps without an isolator, use a hose equipped with a manual shut-off valve near the pump end. Close the valve to isolate the hose from the pump.
- If the hose has an automatic shut off valve, disconnect the hose from the pump: as long as the hose is connected, the valve is open and lubricating oil may migrate.

Some one-way valves open when vacuum is applied and close under a no vacuum condition. Such valves may restrict the pump's ability to pull a deep vacuum and are not recommended.

[AUTOMATIC AIR CONDITIONER]

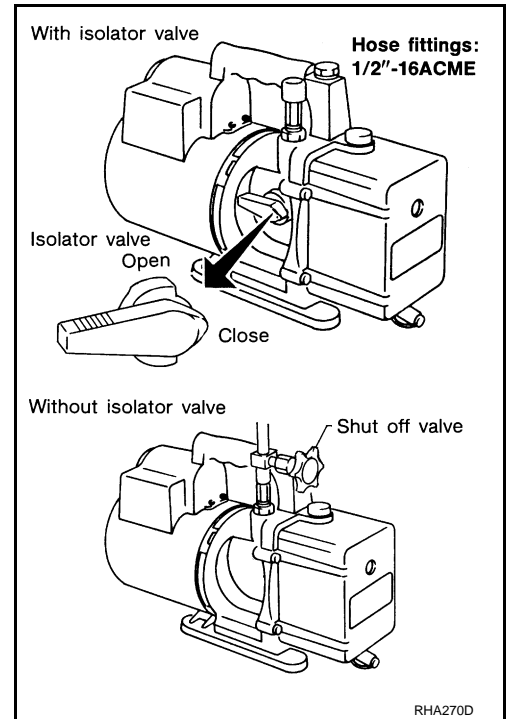

MANIFOLD GAUGE SET

Be certain that the gauge face indicates R-134a or 134a. Make sure the gauge set has 1/2"-16 ACME threaded connections for service hoses. Confirm the set has been used only with refrigerant HFC-134a (R-134a) along with specified oil.

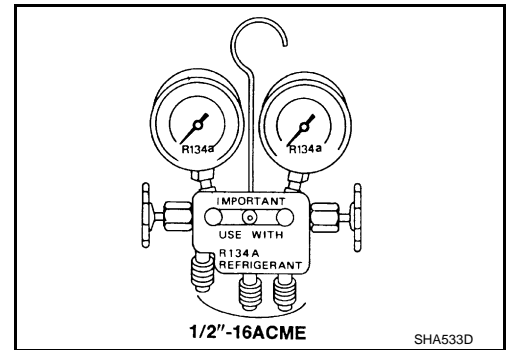

SERVICE HOSES

Be certain that the service hoses display the markings described (colored hose with black stripe). All hoses must include positive shut-off devices (either manual or automatic) near the end of the hoses opposite the manifold gauge.

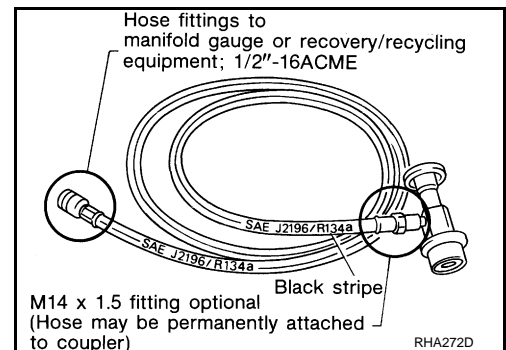

SERVICE COUPLERS

PRECAUTIONS

< PRECAUTION >

Never attempt to connect HFC-134a (R-134a) service couplers to a CFC-12 (R-12) A/C system. The HFC-134a (R-134a) couplers will not properly connect to the CFC-12 (R-12) system. However, if an improper connection is attempted, discharging and contamination may occur.

Shut-off valve rotation	A/C service valve
Clockwise	Open
Counterclockwise	Close

[AUTOMATIC AIR CONDITIONER]

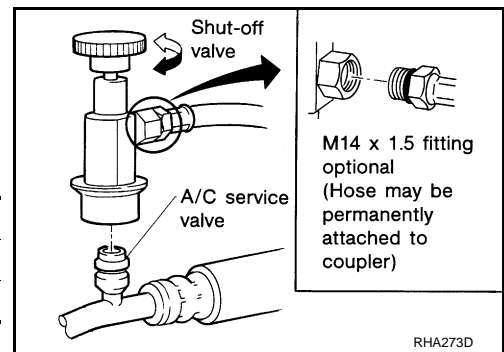

REFRIGERANT WEIGHT SCALE

Verify that no refrigerant other than HFC134a (R-134a) and specified oils have been used with the scale. If the scale controls refrigerant flow electronically, the hose fitting must be 1/2"-16 ACME.

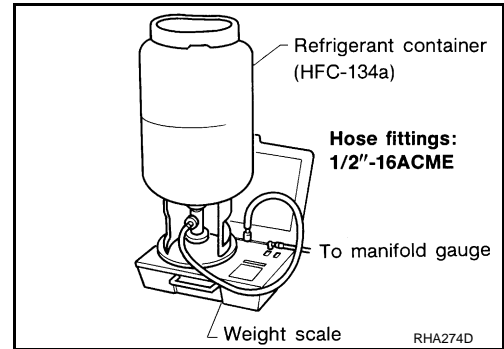

CHARGING CYLINDER

Using a charging cylinder is not recommended. Refrigerant may be vented into air from cylinder's top valve when filling the cylinder with refrigerant. Also, the accuracy of the cylinder is generally less than that of an electronic scale or of quality recycle/recharge equipment.

A
B
C
D
E
F
G
H
J
K
L
M
N
O
P

HAC