

SECTION **HRN**  
HORN

A  
B  
C  
D  
E  
F  
G  
H  
I  
J  
K  
M  
N  
O  
P

CONTENTS

<b>PRECAUTION</b> .....	2	<b>COMPONENT DIAGNOSIS</b> .....	3
<b>PRECAUTIONS</b> .....	2	<b>HORN</b> .....	3
Supplemental Restraint System (SRS) AIR BA		Wiring Diagram .....	3
G and SEAT BELT PRE-TENSIONER .....	2	<b>ON-VEHICLE REPAIR</b> .....	7
Precautions For High-Voltage System .....	2	<b>HORN</b> .....	7
Battery Service .....	2	Removal and Installation .....	7

HRN

# PRECAUTIONS

< PRECAUTION >

## PRECAUTION

### PRECAUTIONS

#### Supplemental Restraint System (SRS) AIR BAG and SEAT BELT PRE-TENSIONER

INFOID:000000001501551

The Supplemental Restraint System such as "AIR BAG" and "SEAT BELT PRE-TENSIONER", used along with a front seat belt, helps to reduce the risk or severity of injury to the driver and front passenger for certain types of collision. This system includes seat belt switch inputs and dual stage front air bag modules. The SRS system uses the seat belt switches to determine the front air bag deployment, and may only deploy one front air bag, depending on the severity of a collision and whether the front occupants are belted or unbelted. Information necessary to service the system safely is included in the SRS and SB section of this Service Manual.

#### **WARNING:**

- To avoid rendering the SRS inoperative, which could increase the risk of personal injury or death in the event of a collision which would result in air bag inflation, all maintenance must be performed by an authorized NISSAN/INFINITI dealer.
- Improper maintenance, including incorrect removal and installation of the SRS, can lead to personal injury caused by unintentional activation of the system. For removal of Spiral Cable and Air Bag Module, see the SRS section.
- Do not use electrical test equipment on any circuit related to the SRS unless instructed to in this Service Manual. SRS wiring harnesses can be identified by yellow and/or orange harnesses or harness connectors.

#### Precautions For High-Voltage System

INFOID:000000001501552

Refer to [GI-24, "Precautions For High-Voltage System"](#).

#### Battery Service

INFOID:000000001501553

# HORN

< COMPONENT DIAGNOSIS >

## COMPONENT DIAGNOSIS

### HORN

#### Wiring Diagram

INFOID:000000001501554

DATA LINE

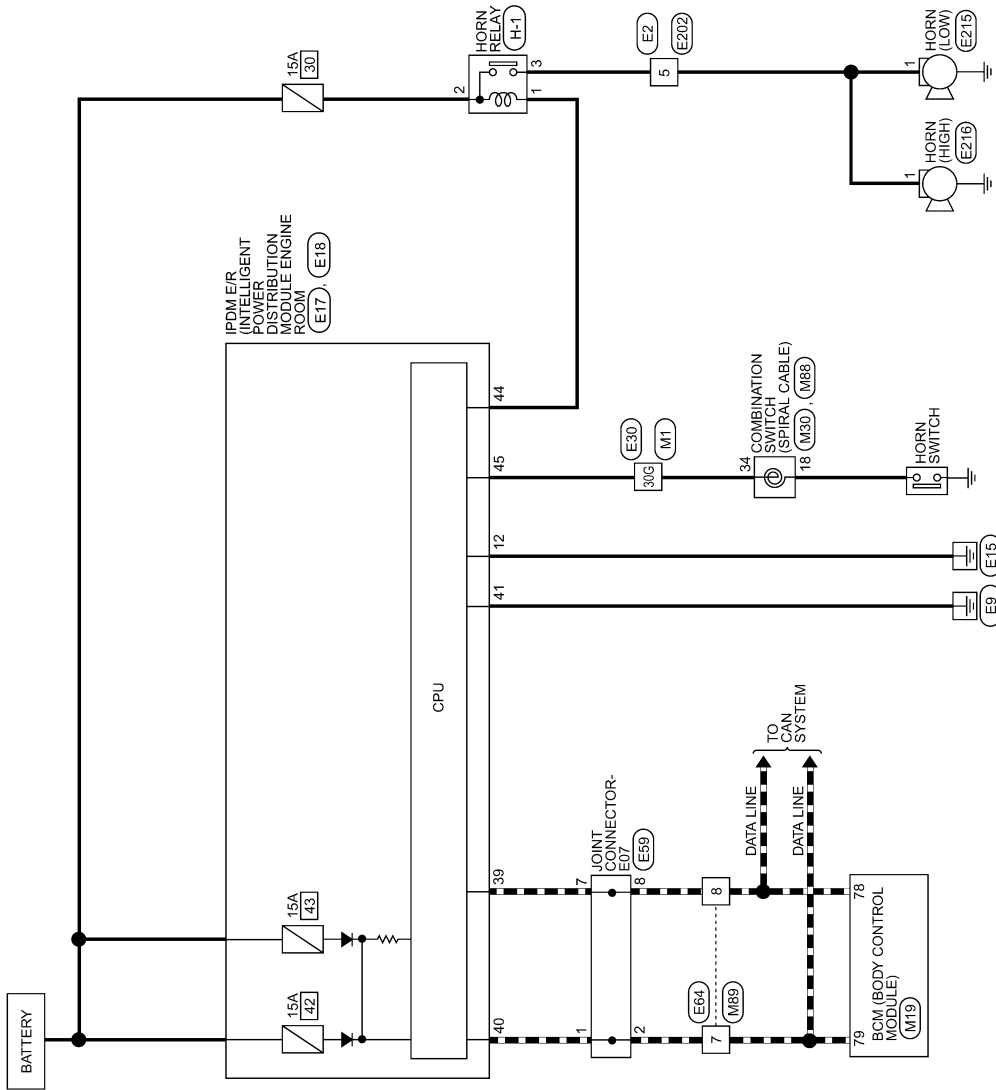

HORN

HRN-3

ALMWA0047GE

A  
B  
C  
D  
E  
F  
G  
H  
I  
J  
K  
HRN  
M  
N  
O  
P

## HORN CONNECTORS

Connector No.	M1
Connector Name	WIRE TO WIRE
Connector Color	WHITE

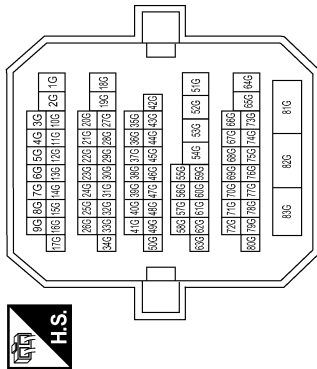

Terminal No.	30G	Color of Wire	L/W	Signal Name	—
--------------	-----	---------------	-----	-------------	---

Connector No.	M19
Connector Name	BCM (BODY CONTROL MODULE)
Connector Color	BLACK

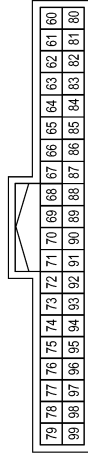

Terminal No.	78	Color of Wire	P	Signal Name	CAN-L
Terminal No.	79	Color of Wire	L	Signal Name	CAN-H

Connector No.	M30
Connector Name	COMBINATION SWITCH (SPIRAL CABLE)
Connector Color	GRAY

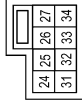

Terminal No.	34	Color of Wire	L/W	Signal Name	HORN
--------------	----	---------------	-----	-------------	------

Connector No.	M88
Connector Name	COMBINATION SWITCH (SPIRAL CABLE)
Connector Color	GRAY



Terminal No.	18	Color of Wire	G	Signal Name	HORN
--------------	----	---------------	---	-------------	------

Connector No.	M89
Connector Name	WIRE TO WIRE
Connector Color	WHITE



Terminal No.	7	Color of Wire	L	Signal Name	—
Terminal No.	8	Color of Wire	P	Signal Name	—

Connector No.	E2
Connector Name	WIRE TO WIRE
Connector Color	WHITE

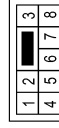

Terminal No.	5	Color of Wire	G	Signal Name	—
--------------	---	---------------	---	-------------	---

## < COMPONENT DIAGNOSIS >

Connector No.	E30
Connector Name	WIRE TO WIRE
Connector Color	WHITE

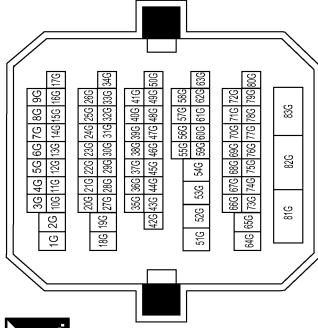

Terminal No.	30G	Color of Wire	L/W	Signal Name	—
--------------	-----	---------------	-----	-------------	---

Connector No.	E18
Connector Name	IPDM E/R (INTELLIGENT POWER DISTRIBUTION MODULE ENGINE ROOM)
Connector Color	WHITE

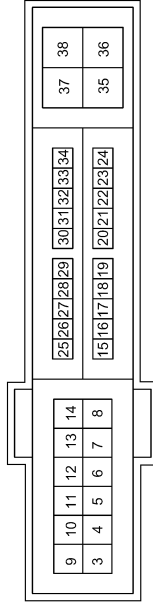

Terminal No.	12	Color of Wire	B	Signal Name	P-GND
--------------	----	---------------	---	-------------	-------

Connector No.	E17
Connector Name	IPDM E/R (INTELLIGENT POWER DISTRIBUTION MODULE ENGINE ROOM)
Connector Color	WHITE

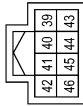

Terminal No.	Color of Wire	Signal Name
39	P	CAN-L
40	L	CAN-H
41	B	S-GND
44	G/W	HORN RLY
45	L/O	HORN_SW

Connector No.	E64
Connector Name	WIRE TO WIRE
Connector Color	WHITE



Terminal No.	7	Color of Wire	L	Signal Name	—
Terminal No.	8	Color of Wire	P	Signal Name	—

Connector No.	E59
Connector Name	JOINT CONNECTOR-E07
Connector Color	BLUE



Terminal No.	1	Color of Wire	L	Signal Name	—
Terminal No.	2	Color of Wire	L	Signal Name	—
Terminal No.	7	Color of Wire	P	Signal Name	—
Terminal No.	8	Color of Wire	P	Signal Name	—

ALMIA0116GB

A B C D E F G H I J K M N O P

HRN

## HORN CONNECTORS

Connector No.	E202
Connector Name	WIRE TO WIRE
Connector Color	WHITE

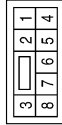

Terminal No.	Color of Wire	Signal Name
5	G	—

Connector No.	E215
Connector Name	HORN
Connector Color	BLACK



Terminal No.	Color of Wire	Signal Name
1	G	

Connector No.	E216
Connector Name	HORN
Connector Color	BLACK



Terminal No.	Color of Wire	Signal Name
1	G	

Connector No.	H-1
Connector Name	HORN RELAY
Connector Color	BLACK



Terminal No.	Color of Wire	Signal Name
1	G/W	—
2	G/B	—
3	G	—

# HORN

< ON-VEHICLE REPAIR >

## ON-VEHICLE REPAIR

### HORN

#### Removal and Installation

INFOID:000000001501555

#### REMOVAL

1. Position aside the front fender protector LH. Refer to [EXT-18. "Removal and Installation"](#).
2. Disconnect the horn connectors (A).
3. Remove the horn bracket bolt (B), and remove horn (2) and horn (1).

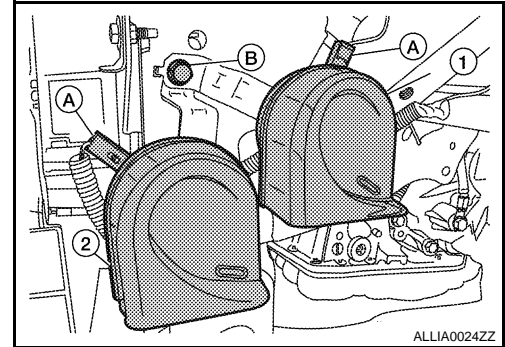

#### INSTALLATION

Installation is in the reverse order of removal.

A  
B  
C  
D  
E  
F  
G  
H  
I  
J  
K  
M  
N  
O  
P

HRN