

SECTION WCS

WARNING CHIME SYSTEM

A
B
C
D
E
F
G
H
I
J
K
L
M
O
P

CONTENTS

BASIC INSPECTION	3	PARKING BRAKE RELEASE WARNING CHIME : System Description	8	F
DIAGNOSIS AND REPAIR WORKFLOW	3	PARKING BRAKE RELEASE WARNING CHIME : Component Parts Location	8	G
Work Flow	3	PARKING BRAKE RELEASE WARNING CHIME : Component Description	8	
FUNCTION DIAGNOSIS	4	DIAGNOSIS SYSTEM (METER)	10	H
WARNING CHIME SYSTEM	4	CONSULT-III Function (METER)	10	
WARNING CHIME SYSTEM	4	DIAGNOSIS SYSTEM (BCM)	11	I
WARNING CHIME SYSTEM : System Diagram	4	BUZZER	11	
WARNING CHIME SYSTEM : System Description	4	BUZZER : CONSULT-III Function (BCM - BUZZ- ER)	11	J
WARNING CHIME SYSTEM : Component Parts Location	5	COMPONENT DIAGNOSIS	12	
WARNING CHIME SYSTEM : Component De- scription	6	POWER SUPPLY AND GROUND CIRCUIT	12	K
LIGHT REMINDER WARNING CHIME	6	COMBINATION METER	12	
LIGHT REMINDER WARNING CHIME : System Diagram	6	COMBINATION METER : Diagnosis Procedure	12	L
LIGHT REMINDER WARNING CHIME : System Description	6	BCM (BODY CONTROL MODULE)	12	
LIGHT REMINDER WARNING CHIME : Compo- nent Parts Location	7	BCM (BODY CONTROL MODULE) : Diagnosis Procedure	12	M
LIGHT REMINDER WARNING CHIME : Compo- nent Description	7	METER BUZZER CIRCUIT	13	
SEAT BELT WARNING CHIME	7	Description	13	
SEAT BELT WARNING CHIME : System Diagram	7	Component Function Check	13	
SEAT BELT WARNING CHIME : System Descrip- tion	7	Diagnosis Procedure	13	
SEAT BELT WARNING CHIME : Component Parts Location	7	SEAT BELT BUCKLE SWITCH SIGNAL CIR- CUIT	14	O
SEAT BELT WARNING CHIME : Component De- scription	7	Description	14	
PARKING BRAKE RELEASE WARNING CHIME	8	Component Function Check	14	
PARKING BRAKE RELEASE WARNING CHIME : System Diagram	8	Diagnosis Procedure	14	
		Component Inspection	14	P
		WARNING CHIME SYSTEM	16	
		Wiring Diagram	16	
		ECU DIAGNOSIS	23	

WCS

COMBINATION METER	23	Description	25
Reference Value	23	Diagnosis Procedure	25
Wiring Diagram	23		
Fail Safe	23		
DTC Index	23		
BCM (BODY CONTROL MODULE)	24	THE LIGHT REMINDER WARNING DOES NOT SOUND	26
Reference Value	24	Description	26
Wiring Diagram	24	Diagnosis Procedure	26
Fail Safe	24	THE SEAT BELT WARNING CONTINUES SOUNDING, OR DOES NOT SOUND	27
DTC Inspection Priority Chart	24	Description	27
DTC Index	24	Diagnosis Procedure	27
SYMPTOM DIAGNOSIS	25	PRECAUTION	28
THE PARKING BRAKE RELEASE WARNING CONTINUES SOUNDING, OR DOES NOT SOUND	25	PRECAUTIONS	28
		Supplemental Restraint System (SRS) "AIR BAG" and "SEAT BELT PRE-TENSIONER"	28

DIAGNOSIS AND REPAIR WORKFLOW

< BASIC INSPECTION >

BASIC INSPECTION

DIAGNOSIS AND REPAIR WORKFLOW

Work Flow

INFOID:000000000994976

DETAILED FLOW

1.OBTAIN INFORMATION ABOUT SYMPTOM

Interview the customer to obtain as much information as possible about the conditions and environment under which the malfunction occurred.

>> GO TO 2..

2.CHECK SYMPTOM

- Check the symptom based on the information obtained from the customer.
- Check to see if any other malfunctions are present.

>> GO TO 3..

3.CHECK CONSULT-III SELF-DIAGNOSIS RESULTS

Connect CONSULT-III and perform "SELF-DIAGNOSIS". Refer to [MWI-16. "CONSULT-III Function \(METER\)"](#).

Are self-diagnosis results normal?

YES >> GO TO 4..

NO >> Repair or replace the malfunctioning parts, GO TO 5..

4.NARROW DOWN MALFUNCTIONING PARTS THROUGH SYMPTOM DIAGNOSIS

Perform symptom diagnosis and repair or replace the identified malfunctioning parts.

>> GO TO 5..

5.FINAL CHECK

Check that the warning buzzer in the combination meter operates normally.

Does it operate normally?

YES >> Inspection End.

NO >> GO TO 1..

A
B
C
D
E
F
G
H
I
J
K
L
M
O
P

WCS

WARNING CHIME SYSTEM

< FUNCTION DIAGNOSIS >

FUNCTION DIAGNOSIS

WARNING CHIME SYSTEM

WARNING CHIME SYSTEM

WARNING CHIME SYSTEM : System Diagram

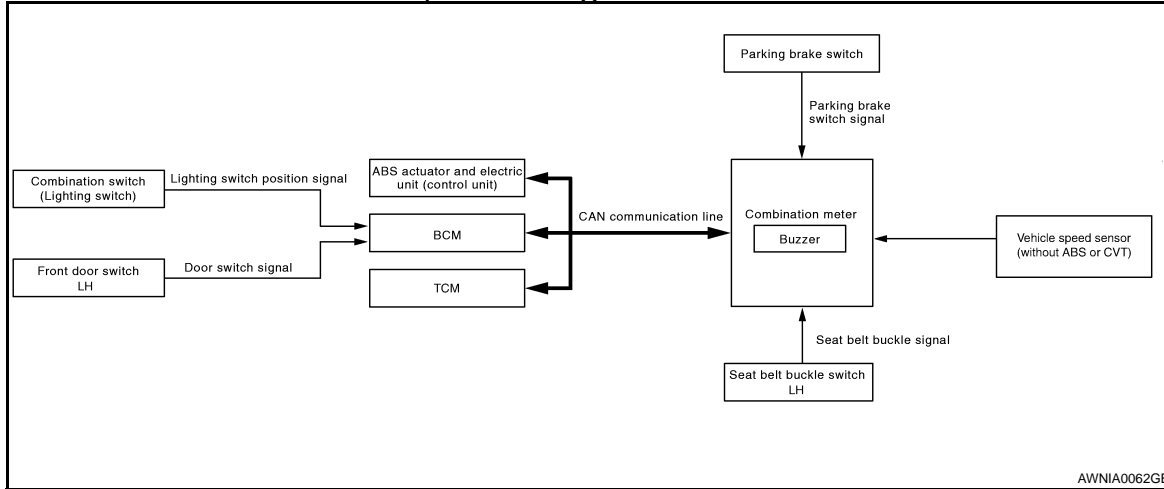

WARNING CHIME SYSTEM : System Description

INFOID:000000000994978

COMBINATION METER

- The buzzer (1) for warning chime system is installed in the combination meter.
- The buzzer sounds when the combination meter receives a buzzer output signal from each unit.

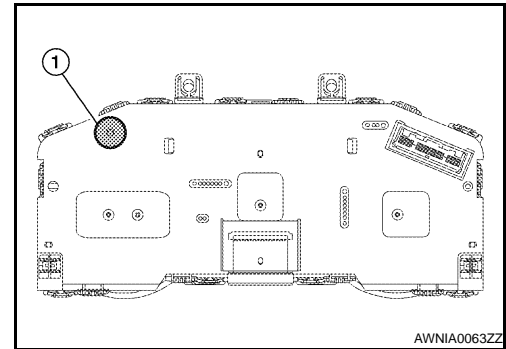

BCM

BCM receives signals from various units and transmits a buzzer output signal to the combination meter with CAN communication line if it judges that the warning buzzer should be activated.

BCM warning function list

Warning functions	Signal name
Light reminder warning chime	<ul style="list-style-type: none"> • Lighting switch position signal • Door switch signal
Seat belt warning chime	Seat belt buckle switch signal

WARNING CHIME SYSTEM

< FUNCTION DIAGNOSIS >

WARNING CHIME SYSTEM : Component Parts Location

INFOID:000000000994979

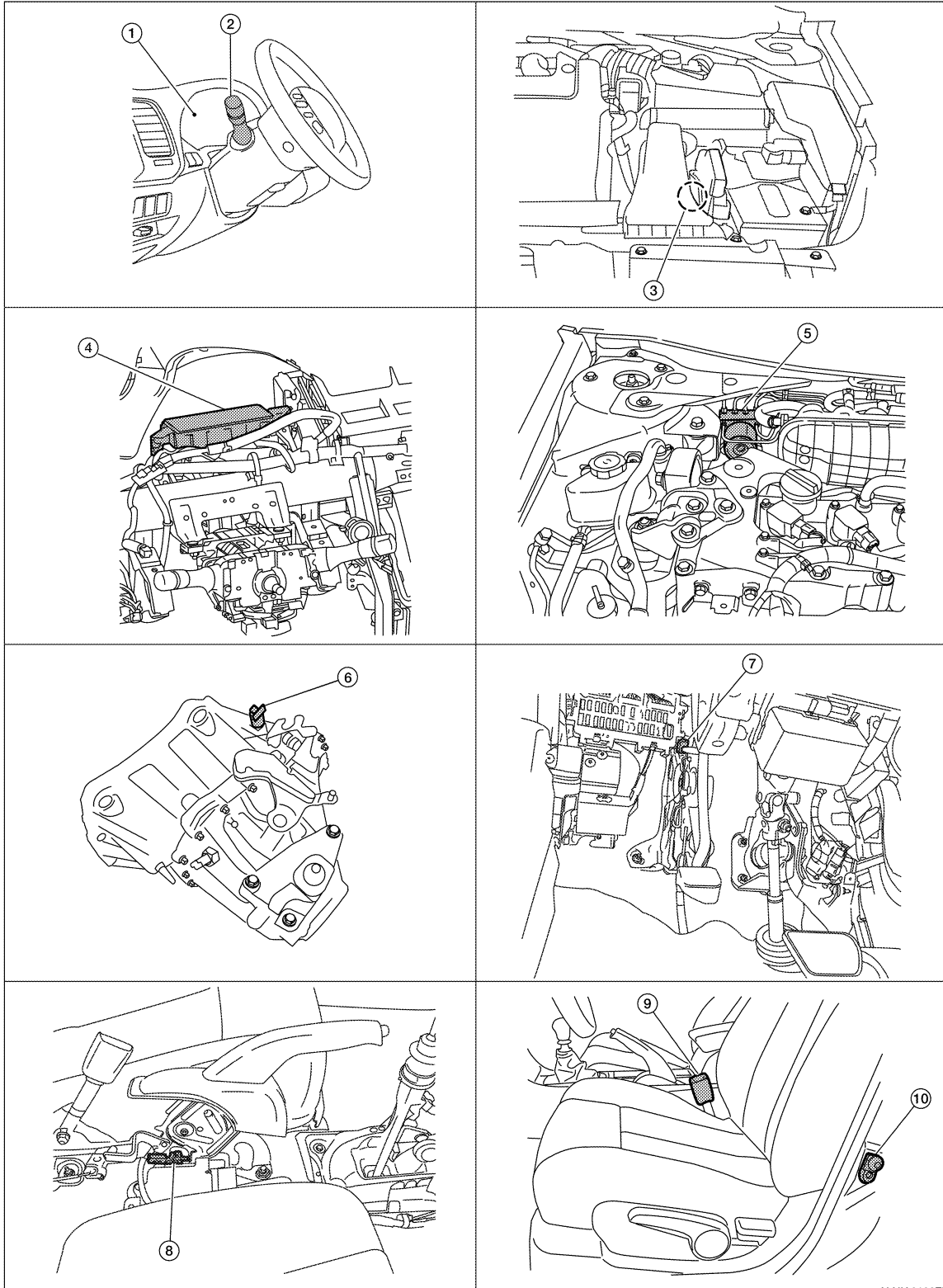

- | | | |
|--|---|---|
| 1. Combination meter M24 | 2. Combination switch (lighting switch) M28 | 3. TCM (vehicle speed signal) F16 (with CVT, without ABS) |
| 4. BCM M16, M17, M18, M19 (view with instrument panel removed) | 5. ABS actuator and electric unit (control unit) E26 (with ABS) | 6. Vehicle speed sensor F33 (without ABS or CVT) |

ALNIA0106ZZ

A
B
C
D
E
F
G
H
I
J
K
L
M
N
O
P

WCS

WARNING CHIME SYSTEM

< FUNCTION DIAGNOSIS >

7. Parking brake switch M73 (with CVT) (view with instrument lower cover LH removed)
8. Parking brake switch E35 (with M/T) (view with center console removed)
9. Seat belt buckle switch LH B202
10. Front door switch LH B8

WARNING CHIME SYSTEM : Component Description

INFOID:000000000994980

Unit	Description
Combination meter	<ul style="list-style-type: none"> Judges whether the parking brake is released using the vehicle speed signal and the parking brake switch signal, and sounds the buzzer if necessary. Receives the seat belt buckle switch signal from the seat belt buckle switch and transmits it to BCM with CAN communication line. Receives a buzzer output signal from BCM with CAN communication line.
BCM	Transmits signals provided by various units to the combination meter with CAN communication line.
ABS actuator and electric unit (control unit)	Transmits the vehicle speed signal to combination meter with CAN communication line. (with ABS)
TCM	Transmits the vehicle speed signal to combination meter with CAN communication line. (with CVT, without ABS)
Vehicle speed sensor	Transmits the vehicle speed signal to combination meter. (without ABS or CVT)
Seat belt buckle switch LH	Transmits a seat belt buckle switch signal to the combination meter.
Combination switch (Lighting switch)	Transmits the lighting switch position signal to BCM.
Front door switch LH	Transmits the door switch signal to BCM.
Parking brake switch	Transmits parking brake signal to combination meter.

LIGHT REMINDER WARNING CHIME

LIGHT REMINDER WARNING CHIME : System Diagram

INFOID:000000000994981

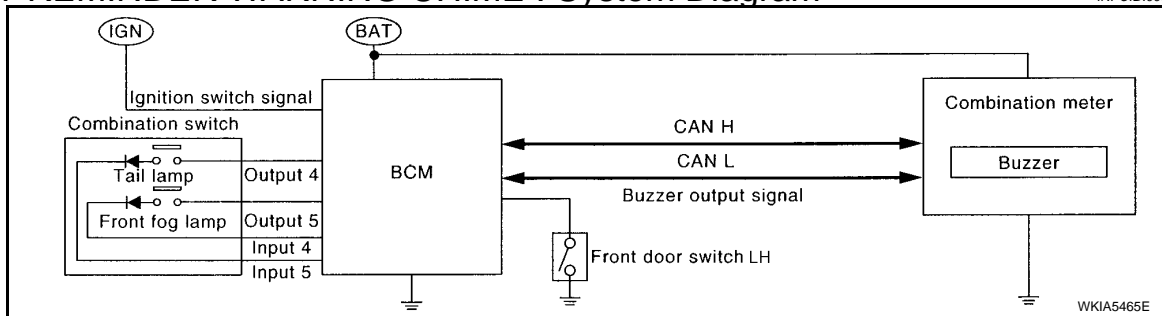

LIGHT REMINDER WARNING CHIME : System Description

INFOID:000000000994982

DESCRIPTION

With ignition switch in OFF or ACC position, driver door open, and lighting switch in 1ST or 2ND position, the light warning chime will sound.

- BCM detects ignition switch in OFF or ACC position, front door switch LH ON, and lighting switch in 1ST or 2ND position. And then transmits buzzer output signal (light reminder warning chime) to combination meter with CAN communication line.
- When combination meter receives buzzer output signal (light reminder warning chime), it sounds the buzzer.

WARNING OPERATION CONDITIONS

If all of the following conditions are fulfilled

- Lighting switch is at 1st or 2nd position
- Ignition switch is at OFF or ACC
- Front door switch LH is ON

WARNING CANCEL CONDITIONS

WARNING CHIME SYSTEM

< FUNCTION DIAGNOSIS >

Warning is canceled if any of the following conditions is fulfilled.

- Lighting switch OFF
- Ignition switch ON
- Front door switch LH is OFF

LIGHT REMINDER WARNING CHIME : Component Parts Location

INFOID:000000000994983

Refer to [WCS-5, "WARNING CHIME SYSTEM : Component Parts Location"](#).

LIGHT REMINDER WARNING CHIME : Component Description

INFOID:000000000994984

Unit	Description
Combination meter	Receives a buzzer output signal from BCM via CAN communication line and sounds the buzzer.
BCM	Judges the light warning conditions from the signals provided by various switches and transmits a buzzer output signal to the combination meter via CAN communication line if necessary.
Combination switch (Lighting switch)	Transmits the lighting switch position signal to BCM.
Front door switch LH	Transmits the door switch signal to BCM.

SEAT BELT WARNING CHIME

SEAT BELT WARNING CHIME : System Diagram

INFOID:000000000994985

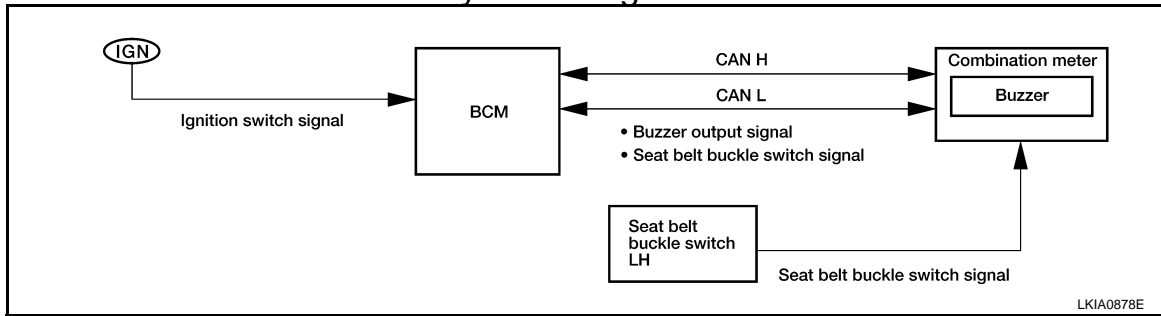

SEAT BELT WARNING CHIME : System Description

INFOID:000000000994986

DESCRIPTION

With ignition switch turned ON and driver seat belt unfastened, seat belt warning chime will sound for approximately 6 seconds.

- BCM receives seat belt buckle switch signal from combination meter with CAN communication line.
- BCM detects ignition switch turned ON and seat belt buckle switch LH ON. And then transmits buzzer output signal (seat belt warning chime) to combination meter with CAN communication line.
- When combination meter receives buzzer output signal (seat belt warning chime), it sounds the buzzer.

WARNING OPERATION CONDITIONS

If all of the following conditions are fulfilled

- Ignition switch OFF→ON
- Seat buckle switch LH is ON (driver seat belt not fastened)

WARNING CANCEL CONDITIONS

Cancels the warning if any of the following conditions is fulfilled.

- Ignition switch OFF
- Seat buckle switch LH is OFF (driver seat belt fastened)
- 90 seconds have passed since the start of the warning

SEAT BELT WARNING CHIME : Component Parts Location

INFOID:000000000994987

Refer to [WCS-5, "WARNING CHIME SYSTEM : Component Parts Location"](#).

SEAT BELT WARNING CHIME : Component Description

INFOID:000000000994988

WARNING CHIME SYSTEM

< FUNCTION DIAGNOSIS >

Unit	Description
Combination meter	<ul style="list-style-type: none"> Receives the seat belt buckle switch signal from the seat belt buckle switch and transmits it to BCM via CAN communication line. Receives a buzzer output signal from BCM via CAN communication line and sounds the buzzer.
BCM	Judges the seat belt warning condition from the seat belt buckle switch signal received from the combination meter and transmits a buzzer output signal to the combination meter via CAN communication line if necessary.
Seat belt buckle switch LH	Transmits seat belt buckle switch signal to combination meter.

PARKING BRAKE RELEASE WARNING CHIME

PARKING BRAKE RELEASE WARNING CHIME : System Diagram

INFOID:000000000994989

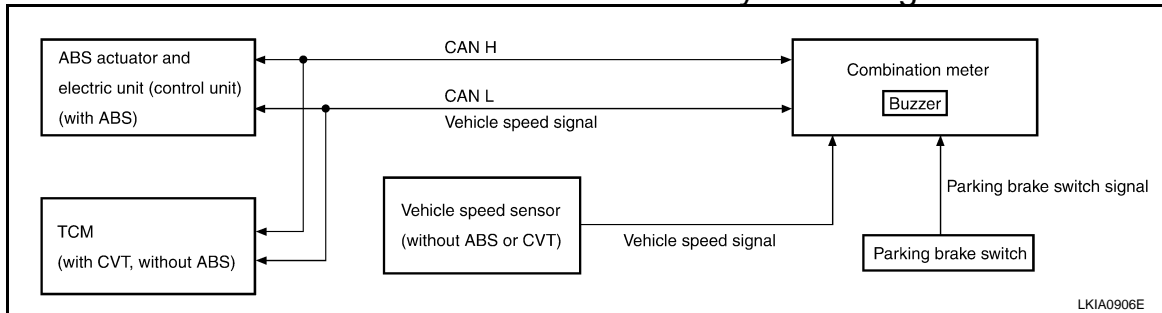

PARKING BRAKE RELEASE WARNING CHIME : System Description

INFOID:000000000994990

DESCRIPTION

- The combination meter receives the vehicle speed signal from the ABS actuator and electric unit (control unit) (with ABS), the TCM (with CVT, without ABS) or the vehicle speed sensor (without ABS or CVT).
- The combination meter judges whether the parking brake is released using the parking brake switch signal from the parking brake switch, and sounds the warning buzzer if necessary.

WARNING OPERATION CONDITIONS

If all of the following conditions are fulfilled

- Vehicle speed is approximately 7 km/h (4.3 MPH) or higher
- Parking brake switch ON

WARNING CANCEL CONDITIONS

Warning is canceled if any of the following conditions is fulfilled.

- Vehicle speed is approximately 3 km/h (1.9 MPH) or less
- Parking brake switch OFF

PARKING BRAKE RELEASE WARNING CHIME : Component Parts Location

INFOID:000000000994991

Refer to [WCS-5, "WARNING CHIME SYSTEM : Component Parts Location"](#).

PARKING BRAKE RELEASE WARNING CHIME : Component Description

INFOID:000000000994992

Unit	Description
Combination meter	<ul style="list-style-type: none"> Judges whether the parking brake is released using the parking brake switch signal from the parking brake switch, and sounds the buzzer if necessary. Receives a vehicle speed signal from ABS actuator and electric unit (control unit) (with ABS), the TCM (with CVT, without ABS) or the vehicle speed sensor (without ABS or CVT).
ABS actuator and electric unit (control unit)	Transmits the vehicle speed signal to combination meter via CAN communication line. (with ABS)
TCM	Transmits the vehicle speed signal to combination meter with CAN communication line. (with CVT, without ABS)

WARNING CHIME SYSTEM

< FUNCTION DIAGNOSIS >

Unit	Description
Vehicle speed sensor	Transmits the vehicle speed signal to combination meter. (without ABS or CVT)
Parking brake switch	Transmits parking brake switch signal to the combination meter.

A

B

C

D

E

F

G

H

I

J

K

L

M

WCS

O

P

DIAGNOSIS SYSTEM (METER)

< FUNCTION DIAGNOSIS >

DIAGNOSIS SYSTEM (METER)

CONSULT-III Function (METER)

INFOID:000000000994993

Refer to [MWI-16. "CONSULT-III Function \(METER\)".](#)

DIAGNOSIS SYSTEM (BCM)

< FUNCTION DIAGNOSIS >

DIAGNOSIS SYSTEM (BCM)

BUZZER

BUZZER : CONSULT-III Function (BCM - BUZZER)

INFOID:000000000994994

CONSULT-III APPLICATION ITEMS

Test item	Diagnosis mode	Description
BUZZER	Data Monitor	Displays BCM input data in real time.
	Active Test	Operation of electrical loads can be checked by sending driving signal to them.

DATA MONITOR

Display item [Unit]	Description
VEH SPEED 1 [Km/h]	Value of vehicle speed signal received from ABS actuator and electric unit (control unit) (with ABS), TCM (with CVT, without ABS) or vehicle speed sensor (without ABS or CVT).
PUSH SW [On/Off]	Status of push button ignition switch judged by BCM.
UNLK SEN-DR [On/Off]	Status of unlock sensor judged by BCM.
KEY SW-SLOT [On/Off]	Status of key slot judged by BCM.
TAIL LAMP SW [On/Off]	Status of each switch judged by BCM using the combination switch readout function.
FR FOG SW [On/Off]	Status of front fog lamp switch judged by BCM.
DOOR SW-DR [On/Off]	Status of driver side door switch judged by BCM.

ACTIVE TEST

Display item [Unit]	Description
IGN KEY WARN ALM	The key warning chime operation can be checked by operating the relevant function (On/Off).
SEAT BELT WARN TEST	The seat belt warning chime operation can be checked by operating the relevant function (On/Off).
ID REGIST WARNING	The ID regist warning chime operation can be checked by operating the relevant function (On/Off).
LIGHT WARN ALM	The light warning chime operation can be checked by operating the relevant function (On/Off).
RUN FLAT/T WARN BUZZER	The run-flat tire warning chime operation can be checked by operating the relevant function (On/Off).

A
B
C
D
E
F
G
H
I
J
K
L
M
O
P

WCS

POWER SUPPLY AND GROUND CIRCUIT

< COMPONENT DIAGNOSIS >

COMPONENT DIAGNOSIS

POWER SUPPLY AND GROUND CIRCUIT
COMBINATION METER

COMBINATION METER : Diagnosis Procedure

INFOID:000000000994995

Refer to [MWI-22. "COMBINATION METER : Diagnosis Procedure"](#).

BCM (BODY CONTROL MODULE)

BCM (BODY CONTROL MODULE) : Diagnosis Procedure

INFOID:000000000994996

Refer to [BCS-33. "Diagnosis Procedure"](#).

METER BUZZER CIRCUIT

< COMPONENT DIAGNOSIS >

METER BUZZER CIRCUIT

Description

INFOID:000000000994997

- The buzzer for warning chime system is installed in the combination meter.
- The combination meter sounds the alarm buzzer based on the signals transmitted from various units.

Component Function Check

INFOID:000000000994998

1.CHECK OPERATION OF METER BUZZER

1. Select "BUZZER" of "BCM" on CONSULT-III.
2. Perform "LIGHT WARN ALM" of "ACTIVE TEST".

Does meter buzzer activate?

- YES >> Inspection End.
NO >> Replace combination meter. Refer to [MWI-64. "Removal and Installation"](#).

Diagnosis Procedure

INFOID:000000000994999

1.CHECK POWER SUPPLY OF COMBINATION METER

Check power supply of combination meter. Refer to [MWI-22. "COMBINATION METER : Diagnosis Procedure"](#).

Is the inspection result normal?

- YES >> Inspection End.
NO >> Repair power supply circuit of combination meter.

A
B
C
D
E
F
G
H
I
J
K
L
M
O
P

WCS

SEAT BELT BUCKLE SWITCH SIGNAL CIRCUIT

< COMPONENT DIAGNOSIS >

SEAT BELT BUCKLE SWITCH SIGNAL CIRCUIT

Description

INFOID:000000000995000

Transmits a seat belt buckle switch signal to the combination meter.

Component Function Check

INFOID:000000000995001

1.CHECK COMBINATION METER INPUT SIGNAL

Select "DATA MONITOR" for "METER" and check the "BELT SW" monitor value.

BELT SW

When seat belt is fastened : OFF

When seat belt is unfastened : ON

>> Inspection End.

Diagnosis Procedure

INFOID:000000000995002

1.CHECK COMBINATION METER INPUT SIGNAL

-
1. Turn ignition switch ON.
 2. Check voltage between combination meter harness connector M24 terminal 35 and ground.

35 - Ground

When driver seat belt is fastened : Approx. 12V

When driver seat belt is unfastened : Approx. 0V

Is the inspection result normal?

YES >> Replace combination meter. Refer to [MWI-64, "Removal and Installation"](#).

NO >> GO TO 2..

2.CHECK SEAT BELT BUCKLE SWITCH CIRCUIT

-
1. Turn ignition switch OFF.
 2. Disconnect combination meter connector and seat belt buckle switch LH connector.
 3. Check continuity between combination meter harness connector M24 terminal 35 and seat belt buckle switch LH harness connector B202 terminal 1.

35 - 1 : Continuity should exist.

4. Check harness continuity between combination meter harness connector M24 terminal 35 and ground.

35 - Ground : Continuity should not exist.

Is the inspection result normal?

YES >> GO TO 3..

NO >> Repair harness or connector.

3.CHECK SEAT BELT BUCKLE SWITCH GROUND CIRCUIT

Check harness continuity between seat belt buckle switch LH harness connector B202 terminal 2 and ground.

2 - Ground : Continuity should exist.

Is the inspection result normal?

YES >> Inspection End.

NO >> Repair harness or connector.

Component Inspection

INFOID:000000000995003

SEAT BELT BUCKLE SWITCH SIGNAL CIRCUIT

< COMPONENT DIAGNOSIS >

1. CHECK SEAT BELT BUCKLE SWITCH

1. Turn ignition switch OFF.
2. Disconnect the seat belt buckle switch connector.
3. Check continuity between terminals 1 and 2.

1-2

When seat belt is fastened : Continuity should not exist.

When seat belt is unfastened : Continuity should exist.

Is the inspection result normal?

YES >> Inspection End.

NO >> Replace the seat belt buckle switch LH.

A

B

C

D

E

F

G

H

I

J

K

L

M

WCS

O

P

WARNING CHIME SYSTEM

< COMPONENT DIAGNOSIS >

WARNING CHIME SYSTEM

Wiring Diagram

INFOID:00000000995004

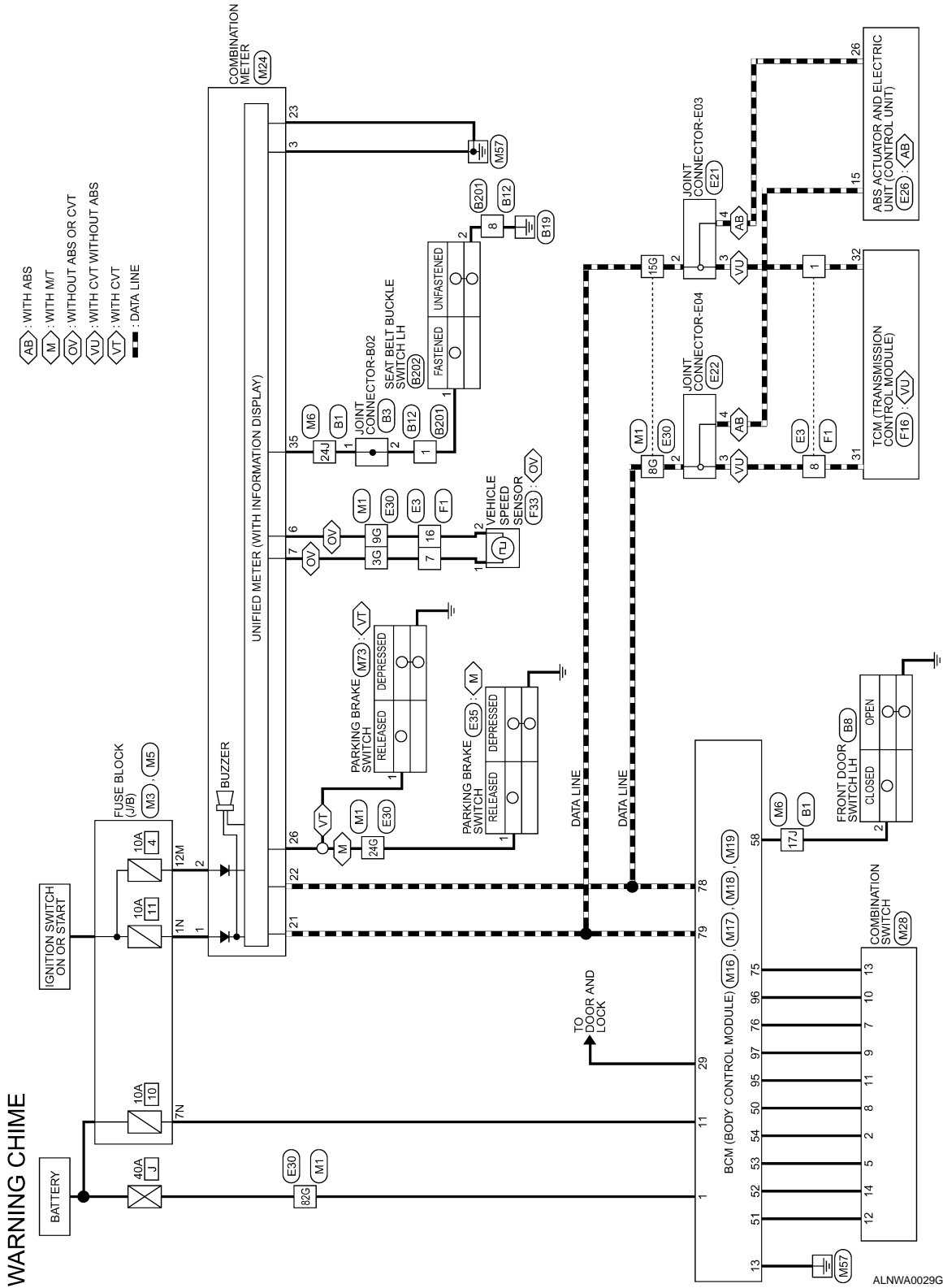

ALNWA0029GE

WARNING CHIME SYSTEM

< COMPONENT DIAGNOSIS >

WARNING CHIME CONNECTORS

Connector No.	M1
Connector Name	WIRE TO WIRE
Connector Color	WHITE

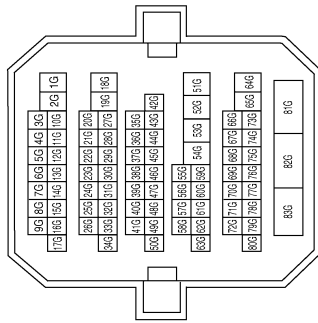

Terminal No.	Color of Wire	Signal Name
8G	P	—
15G	L	—
24G	G/R	—
82G	W/B	—

Connector No.	M3
Connector Name	FUSE BLOCK (J/B)
Connector Color	WHITE

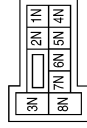

Terminal No.	Color of Wire	Signal Name
1N	W/L	—
7N	Y/R	—

Connector No.	M5
Connector Name	FUSE BLOCK (J/B)
Connector Color	WHITE

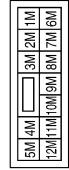

Connector No.	M6
Connector Name	WIRE TO WIRE
Connector Color	WHITE

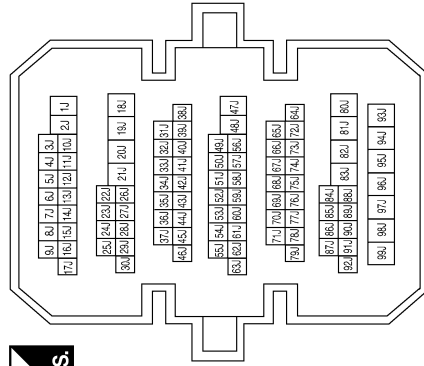

Terminal No.	12M
Color of Wire	P
Signal Name	—

WARNING CHIME SYSTEM

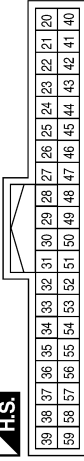

< COMPONENT DIAGNOSIS >

Connector No.	M18
Connector Name	BCM (BODY CONTROL MODULE)
Connector Color	GREEN



Terminal No.	Color of Wire	Signal Name
29	Y	FOB_IN_SW_1
50	LG/B	INPUT_5
51	LW	INPUT_1
52	G/B	INPUT_2
53	LG/R	INPUT_3
54	G/Y	INPUT_4
58	SB	DR_DOOR_SW

Connector No.	M17
Connector Name	BCM (BODY CONTROL MODULE)
Connector Color	WHITE

Terminal No.	Color of Wire	Signal Name
11	Y/R	BAT_BCM_FUSE
13	B	GND1

Connector No.	M16
Connector Name	BCM (BODY CONTROL MODULE)
Connector Color	BLACK

Terminal No.	Color of Wire	Signal Name
1	W/B	BAT_POWER_F/L

Connector No.	M24
Connector Name	COMBINATION METER
Connector Color	WHITE



Terminal No.	Color of Wire	Signal Name
1	W/L	BATT
2	O	IGN
3	B	GND
6	G/O	GND(SPEED SENSOR)
7	L/Y	SPEED SENSOR
21	L	CAN-H
22	P	CAN-L
23	B	GND
26	G/R	PKB
35	W/B	DR_BELT

Connector No.	M19
Connector Name	BCM (Body Control Module)
Connector Color	BLACK

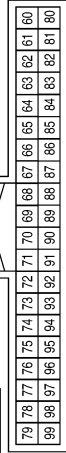
Terminal No.	Color of Wire	Signal Name
75	R/Y	OUTPUT_5
76	R/G	OUTPUT_3
78	P	CAN-L
79	L	CAN-H
95	R/W	OUTPUT_1
96	P/B	OUTPUT_4
97	R/B	OUTPUT_2

ALNIA0108GB

WARNING CHIME SYSTEM

< COMPONENT DIAGNOSIS >

Connector No.	E3
Connector Name	WIRE TO WIRE
Connector Color	WHITE

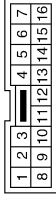

Terminal No.	Color of Wire	Signal Name
1	L	—
8	P	—

Connector No.	M7/3
Connector Name	PARKING BRAKE SWITCH (WITH M/T)
Connector Color	BLACK



Terminal No.	Color of Wire	Signal Name
1	G/R	—

Connector No.	M28
Connector Name	COMBINATION SWITCH
Connector Color	WHITE

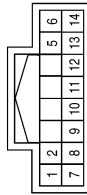

Terminal No.	Color of Wire	Signal Name
2	G/Y	OUTPUT_4
5	LG/R	OUTPUT_3
7	R/G	INPUT_3
8	LG/B	OUTPUT_5
9	R/B	INPUT_2
10	P/B	INPUT_4
11	R/W	INPUT_1
12	L/W	OUTPUT_1
13	R/Y	INPUT_5
14	G/B	OUTPUT_2

Connector No.	E28
Connector Name	ABS ACTUATOR AND ELECTRIC UNIT (CONTROL UNIT)
Connector Color	BLACK

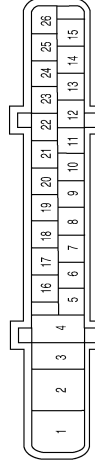

Terminal No.	Color of Wire	Signal Name
15	P	CAN-L
26	L	CAN-H

Connector No.	E22
Connector Name	JOINT CONNECTOR-E04
Connector Color	WHITE



Terminal No.	Color of Wire	Signal Name
2	P	—
3	P	—
4	P	—

Connector No.	E21
Connector Name	JOINT CONNECTOR-E03
Connector Color	WHITE



Terminal No.	Color of Wire	Signal Name
2	L	—
3	L	—
4	L	—

ALNIA0109GB

A
B
C
D
E
F
G
H
I
J
K
L
M
N
O
P

WARNING CHIME SYSTEM

< COMPONENT DIAGNOSIS >

Connector No.	E35
Connector Name	PARKING BRAKE SWITCH (WITH CVT)
Connector Color	BLACK



Terminal No.	Color of Wire	Signal Name
1	G/R	—

Terminal No.	Color of Wire	Signal Name
8G	P	—
15G	L	—
24G	G/R	—
82G	W/B	—

Connector No.	E30
Connector Name	WIRE TO WIRE
Connector Color	WHITE

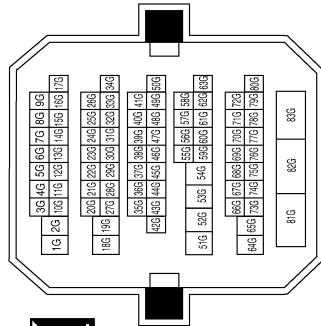

Connector No.	F16
Connector Name	TCM (TRANSMISSION CONTROL MODULE)
Connector Color	BLACK

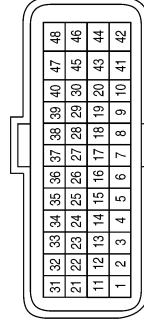

Terminal No.	Color of Wire	Signal Name
31	P	CAN-L
32	L	CAN-H

Connector No.	F1
Connector Name	WIRE TO WIRE
Connector Color	WHITE

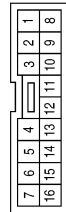

Terminal No.	Color of Wire	Signal Name
1	L	—
8	P	—

ALNIA0110GB

WARNING CHIME SYSTEM

< COMPONENT DIAGNOSIS >

Connector No.	B3
Connector Name	JOINT CONNECTOR-B02
Connector Color	WHITE



Terminal No.	Color of Wire	Signal Name
1	W/B	—
2	W/B	—

Terminal No.	Color of Wire	Signal Name
17J	SB	—
24J	W/B	—

Connector No.	B1
Connector Name	WIRE TO WIRE
Connector Color	WHITE

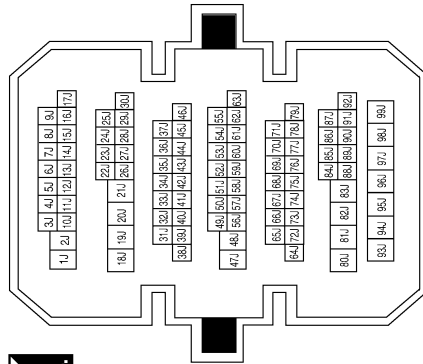

Connector No.	B201
Connector Name	WIRE TO WIRE
Connector Color	WHITE



Terminal No.	Color of Wire	Signal Name
1	W/B	—
8	B/Y	—

Connector No.	B12
Connector Name	WIRE TO WIRE
Connector Color	WHITE



Terminal No.	Color of Wire	Signal Name
1	W/B	—
8	B/Y	—

Connector No.	B8
Connector Name	FRONT DOOR SWITCH LH
Connector Color	WHITE

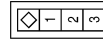

Terminal No.	Color of Wire	Signal Name
2	SB	DOOR SW(DR)

ALNIA0111GB

A
B
C
D
E
F
G
H
I
J
K
L
M
N
O
P

WARNING CHIME SYSTEM

< COMPONENT DIAGNOSIS >

Connector No.	B202
Connector Name	SEAT BELT BUCKLE SWITCH LH
Connector Color	WHITE



◇
1
2
3

Terminal No.	Color of Wire	Signal Name
1	W/B	BUCKLE SWITCH FR LH
2	B/Y	GND

ALNIA0112GB

COMBINATION METER

< ECU DIAGNOSIS >

ECU DIAGNOSIS

COMBINATION METER

Reference Value

INFOID:000000000995005

Refer to [MWI-31, "Reference Value"](#).

Wiring Diagram

INFOID:000000000995006

Refer to [MWI-33, "Wiring Diagram"](#).

Fail Safe

INFOID:000000000995007

Refer to [MWI-47, "Fail Safe"](#).

DTC Index

INFOID:000000000995008

Refer to [MWI-48, "DTC Index"](#).

A

B

C

D

E

F

G

H

I

J

K

L

M

WCS

O

P

BCM (BODY CONTROL MODULE)

< ECU DIAGNOSIS >

BCM (BODY CONTROL MODULE)

Reference Value

INFOID:000000000995009

Refer to [BCS-38, "Reference Value"](#).

Wiring Diagram

INFOID:000000000995010

Refer to [BCS-61, "Wiring Diagram"](#).

Fail Safe

INFOID:000000000995011

Refer to [BCS-69, "Fail Safe"](#).

DTC Inspection Priority Chart

INFOID:000000000995012

Refer to [BCS-71, "DTC Inspection Priority Chart"](#).

DTC Index

INFOID:000000000995013

Refer to [BCS-72, "DTC Index"](#).

THE PARKING BRAKE RELEASE WARNING CONTINUES SOUNDING, OR DOES NOT SOUND

< SYMPTOM DIAGNOSIS >

SYMPTOM DIAGNOSIS

THE PARKING BRAKE RELEASE WARNING CONTINUES SOUNDING, OR DOES NOT SOUND

Description

INFOID:000000000995014

- The parking brake warning buzzer sounds continuously during vehicle travel though the parking brake is released
- The parking brake warning buzzer does not sound at all even though driving the vehicle with the parking brake applied.

Diagnosis Procedure

INFOID:000000000995015

1. CHECK PARKING BRAKE WARNING LAMP

1. Start the engine.
2. Check the operation of the brake warning lamp by operating the parking brake.

Parking brake ON : ON
Parking brake OFF : OFF

Is the inspection result normal?

- YES >> Replace the combination meter. Refer to [MWI-64, "Removal and Installation"](#).
NO >> GO TO 2..

2. CHECK PARKING BRAKE SWITCH SIGNAL CIRCUIT

Perform inspection of the parking brake switch signal circuit. Refer to [MWI-28, "Diagnosis Procedure"](#).

Is the inspection result normal?

- YES >> GO TO 3..
NO >> Repair harness or connector.

3. CHECK PARKING BRAKE SWITCH UNIT

Perform a unit inspection for the parking brake switch. Refer to [MWI-28, "Component Inspection"](#).

Is the inspection result normal?

- YES >> Replace the combination meter. Refer to [MWI-64, "Removal and Installation"](#).
NO >> Replace the parking brake switch.

A
B
C
D
E
F
G
H
I
J
K
L
M
O
P

WCS

THE LIGHT REMINDER WARNING DOES NOT SOUND

< SYMPTOM DIAGNOSIS >

THE LIGHT REMINDER WARNING DOES NOT SOUND

Description

INFOID:000000000995016

Light reminder warning does not sound even though headlamp is illuminated.

Diagnosis Procedure

INFOID:000000000995017

1.CHECK COMBINATION SWITCH (LIGHT SWITCH) OPERATION

Check that the headlamps operate normally by operating the combination switch (light switch).

Do they operate normally?

YES >> GO TO 2..

NO >> Refer to [EXL-4, "Work Flow"](#).

2.CHECK FRONT DOOR SWITCH LH SIGNAL CIRCUIT

Perform inspection of the front door switch LH signal circuit. Refer to [DLK-47, "Diagnosis Procedure"](#).

Is the inspection result normal?

YES >> GO TO 3.

NO >> Repair harness or connector.

3.CHECK FRONT DOOR SWITCH LH

Perform a unit inspection for the front door switch LH. Refer to [DLK-49, "Component Inspection"](#).

Is the inspection result normal?

YES >> Replace the BCM. Refer to [BCS-76, "Removal and Installation"](#).

NO >> Replace the front door switch LH.

THE SEAT BELT WARNING CONTINUES SOUNDING, OR DOES NOT SOUND

< SYMPTOM DIAGNOSIS >

THE SEAT BELT WARNING CONTINUES SOUNDING, OR DOES NOT SOUND

Description

INFOID:000000000995018

- Seat belt warning does not sound even though driver seat belt is not fastened.
- Seat belt warning sounds even though driver seat belt is fastened.

Diagnosis Procedure

INFOID:000000000995019

1. CHECK WARNING CHIME OPERATION

1. With key removed from key switch and the front door LH open, turn lighting switch to 1st or 2nd position.
2. Return lighting switch to off position, and insert key into key switch.

Does warning chime sound for both steps?

YES >> GO TO 2..

NO >> Replace combination meter. Refer to [MWI-64. "Removal and Installation"](#).

2. CHECK SEAT BELT WARNING LAMP

1. Turn ignition switch ON.
2. Check the operation of the seat belt warning lamp in the combination meter.

Seat belt fastened : OFF

Seat belt not fastened : ON

Is the inspection result normal?

YES >> Replace BCM. Refer to [BCS-76. "Removal and Installation"](#).

NO >> GO TO 3..

3. CHECK SEAT BELT BUCKLE SWITCH CIRCUIT

Perform inspection of the seat belt buckle switch circuit. Refer to [WCS-14. "Diagnosis Procedure"](#).

Is the inspection result normal?

YES >> GO TO 4..

NO >> Repair harness or connector.

4. CHECK SEAT BELT BUCKLE SWITCH UNIT

Perform a unit inspection for the seat belt buckle switch. Refer to [WCS-14. "Component Inspection"](#).

Is the inspection result normal?

YES >> Replace the combination meter. Refer to [MWI-64. "Removal and Installation"](#).

NO >> Replace the seat belt buckle switch LH.

A
B
C
D
E
F
G
H
I
J
K
L
M
O
P

WCS

PRECAUTIONS

< PRECAUTION >

PRECAUTION

PRECAUTIONS

Supplemental Restraint System (SRS) "AIR BAG" and "SEAT BELT PRE-TENSIONER"

INFOID:000000000995020

The Supplemental Restraint System such as "AIR BAG" and "SEAT BELT PRE-TENSIONER", used along with a front seat belt, helps to reduce the risk or severity of injury to the driver and front passenger for certain types of collision. This system includes seat belt switch inputs and dual stage front air bag modules. The SRS system uses the seat belt switches to determine the front air bag deployment, and may only deploy one front air bag, depending on the severity of a collision and whether the front occupants are belted or unbelted. Information necessary to service the system safely is included in the SRS and SB section of this Service Manual.

WARNING:

- To avoid rendering the SRS inoperative, which could increase the risk of personal injury or death in the event of a collision which would result in air bag inflation, all maintenance must be performed by an authorized NISSAN/INFINITI dealer.
- Improper maintenance, including incorrect removal and installation of the SRS, can lead to personal injury caused by unintentional activation of the system. For removal of Spiral Cable and Air Bag Module, see the SRS section.
- Do not use electrical test equipment on any circuit related to the SRS unless instructed to in this Service Manual. SRS wiring harnesses can be identified by yellow and/or orange harnesses or harness connectors.