

Diagnosis Procedure	37	MALFUNCTION AREA CHART	68
A-BAG BRANCH LINE CIRCUIT	38	Main Line	68
Diagnosis Procedure	38	Branch Line	68
AV BRANCH LINE CIRCUIT	39	Short Circuit	68
Diagnosis Procedure	39	MAIN LINE BETWEEN EPS AND DLC CIR-	69
BCM BRANCH LINE CIRCUIT	40	CIRCUIT	69
Diagnosis Procedure	40	Diagnosis Procedure	69
DLC BRANCH LINE CIRCUIT	41	MAIN LINE BETWEEN DLC AND ABS CIR-	70
Diagnosis Procedure	41	CIRCUIT	70
HVAC BRANCH LINE CIRCUIT	42	Diagnosis Procedure	70
Diagnosis Procedure	42	ECM BRANCH LINE CIRCUIT	71
M&A BRANCH LINE CIRCUIT	43	Diagnosis Procedure	71
Diagnosis Procedure	43	EPS BRANCH LINE CIRCUIT	72
HV ECU BRANCH LINE CIRCUIT	44	Diagnosis Procedure	72
Diagnosis Procedure	44	DLC BRANCH LINE CIRCUIT	73
IPDM-E BRANCH LINE CIRCUIT	45	Diagnosis Procedure	73
Diagnosis Procedure	45	STRG BRANCH LINE CIRCUIT	74
CAN COMMUNICATION CIRCUIT	46	Diagnosis Procedure	74
Diagnosis Procedure	46	YAW BRANCH LINE CIRCUIT	75
HEV SYSTEM CAN		Diagnosis Procedure	75
HOW TO USE THIS MANUAL	48	ABS BRANCH LINE CIRCUIT	76
DESCRIPTION	48	Diagnosis Procedure	76
Description	48	HV ECU BRANCH LINE CIRCUIT	77
HOW TO USE THIS SECTION	50	Diagnosis Procedure	77
Caution	50	HEV SYSTEM CAN COMMUNICATION CIR-	78
Abbreviation List	50	CIRCUIT	78
PRECAUTION	51	Diagnosis Procedure	78
PRECAUTIONS	51	CAN SYSTEM (TYPE 13)	
Precautions For High-Voltage System	51	COMPONENT DIAGNOSIS	80
Precaution for Supplemental Restraint System		MAIN LINE BETWEEN DLC AND HV ECU	80
(SRS) "AIR BAG" and "SEAT BELT PRE-TEN-		CIRCUIT	80
SIONER"	51	Diagnosis Procedure	80
Precautions for Trouble Diagnosis	51	ECM BRANCH LINE CIRCUIT	81
Precautions for Harness Repair	51	Diagnosis Procedure	81
BASIC INSPECTION	53	A-BAG BRANCH LINE CIRCUIT	82
DIAGNOSIS AND REPAIR WORKFLOW	53	Diagnosis Procedure	82
Information Needed for Trouble Diagnosis	53	BCM BRANCH LINE CIRCUIT	83
Trouble Diagnosis Flow Chart	53	Diagnosis Procedure	83
Trouble Diagnosis Procedure	53	DLC BRANCH LINE CIRCUIT	84
Diagnosis Sheet	59	Diagnosis Procedure	84
DTC Related to HEV SYSTEM CAN List	59	HVAC BRANCH LINE CIRCUIT	85
COMPONENT DIAGNOSIS	63	Diagnosis Procedure	85
CAN COMMUNICATION SYSTEM	63	M&A BRANCH LINE CIRCUIT	86
Component Parts Location	63	Diagnosis Procedure	86
Wiring Diagram - HEV SYSTEM CAN -	64		

HV ECU BRANCH LINE CIRCUIT	87	AV BRANCH LINE CIRCUIT	94	
Diagnosis Procedure	87	Diagnosis Procedure	94	A
IPDM-E BRANCH LINE CIRCUIT	88	BCM BRANCH LINE CIRCUIT	95	
Diagnosis Procedure	88	Diagnosis Procedure	95	B
CAN COMMUNICATION CIRCUIT	89	DLC BRANCH LINE CIRCUIT	96	
Diagnosis Procedure	89	Diagnosis Procedure	96	C
CAN SYSTEM (TYPE 14)				
COMPONENT DIAGNOSIS	91	HVAC BRANCH LINE CIRCUIT	97	
		Diagnosis Procedure	97	
MAIN LINE BETWEEN DLC AND HV ECU CIRCUIT	91	M&A BRANCH LINE CIRCUIT	98	D
Diagnosis Procedure	91	Diagnosis Procedure	98	
ECM BRANCH LINE CIRCUIT	92	HV ECU BRANCH LINE CIRCUIT	99	E
Diagnosis Procedure	92	Diagnosis Procedure	99	
A-BAG BRANCH LINE CIRCUIT	93	IPDM-E BRANCH LINE CIRCUIT	100	F
Diagnosis Procedure	93	Diagnosis Procedure	100	
		CAN COMMUNICATION CIRCUIT	101	G
		Diagnosis Procedure	101	

LAN

N

O

P

HOW TO USE THIS MANUAL

DESCRIPTION

Description

INFOID:000000004219008

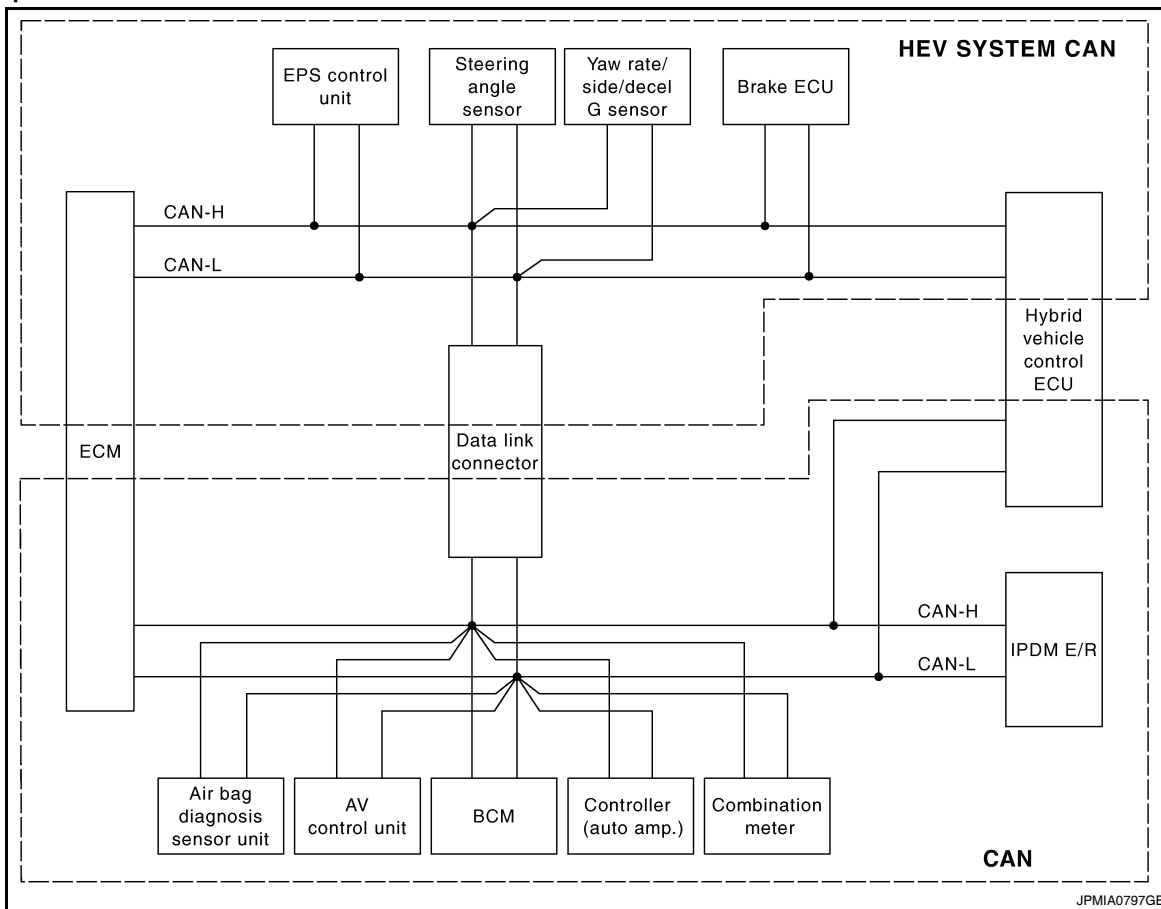

JPMIA0797GB

This vehicle has two types of CAN communication systems; CAN and HEV SYSTEM CAN. For starting the trouble diagnosis, refer to the following list.

NOTE:

- If the DTCs related to CAN and related to HEV SYSTEM CAN are displayed at the same time, diagnose CAN first.
- After the diagnosis of HEV SYSTEM CAN or CAN, erase the DTCs of unit connected to HEV SYSTEM CAN and CAN.

DESCRIPTION

< HOW TO USE THIS MANUAL >

[CAN FUNDAMENTAL]

Unit	DTC (INF code*) displayed on CONSULT-III	CAN communication system	Inspection
ECM	P0607, U1001, U1002, U1010, U0164	CAN	LAN-16. "Trouble Diagnosis Procedure"
	P0607, U0129, U0293, U1011, U1020, U1022	HEV SYSTEM CAN	
EPS control unit	C1608, U0129, U0293	HEV SYSTEM CAN	
Brake ECU	C1300, U0073, U0123, U0124, U0126, U0293	HEV SYSTEM CAN	LAN-53. "Trouble Diagnosis Procedure"
Hybrid vehicle control ECU	P0A1D (924), P0A1D (925), U0100, U0100 (211), U0100 (212), U0100 (530), U0129, U0129 (220), U0129 (222), U0129 (528), U0131, U0131 (433), U0131 (434)	HEV SYSTEM CAN	
	U1001, U1001 (146), U1001 (435), U1001 (594), U1001 (827), U1001 (919), U1001 (920)	CAN	
AV control unit	P0607, U1000, U1002, U1010	CAN	LAN-16. "Trouble Diagnosis Procedure"
BCM			
Controller (auto amp.)			
Combination meter			
IPDM E/R			

*: For the details, refer to [HBC-80. "Diagnosis Description"](#).

A
B
C
D
E
F
G
H
I
J
K
L
N
O
P

LAN

PRECAUTION

PRECAUTIONS

Precautions for Trouble Diagnosis

INFOID:000000004219009

CAUTION:

- Never apply 7.0 V or more to the measurement terminal.
- Use a tester with open terminal voltage of 7.0 V or less.
- Turn the ignition switch OFF and disconnect the battery cable from the negative terminal when checking the harness.

Precautions for Harness Repair

INFOID:000000004219010

- Solder the repaired area and wrap tape around the soldered area.

NOTE:

A fray of twisted lines must be within 110 mm (4.33 in).

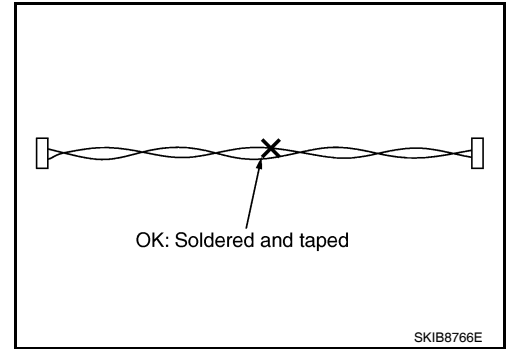

- Bypass connection is never allowed at the repaired area.

NOTE:

Bypass connection may cause CAN communication error. The spliced wire becomes separated and the characteristics of twisted line are lost.

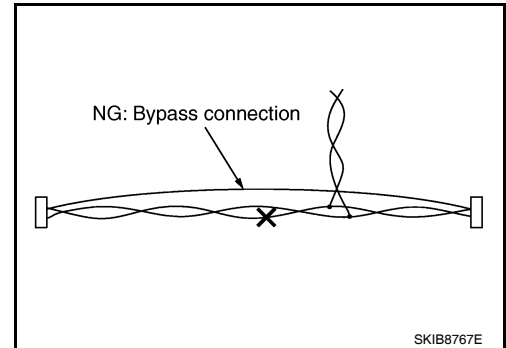

- Replace the applicable harness as an assembly if error is detected on the shield lines of CAN communication line.

FUNCTION DIAGNOSIS

CAN COMMUNICATION SYSTEM

System Description

INFOID:000000004219011

- CAN communication is a multiplex communication system. This enables the system to transmit and receive large quantities of data at high speed by connecting control units with two communication lines (CAN-H and CAN-L).
- Control units on the CAN network transmit signals using the CAN communication control circuit. They receive only necessary signals from other control units to operate various functions.
- CAN communication lines adopt twisted-pair line style (two lines twisted) for noise immunity.

System Diagram

INFOID:000000004219012

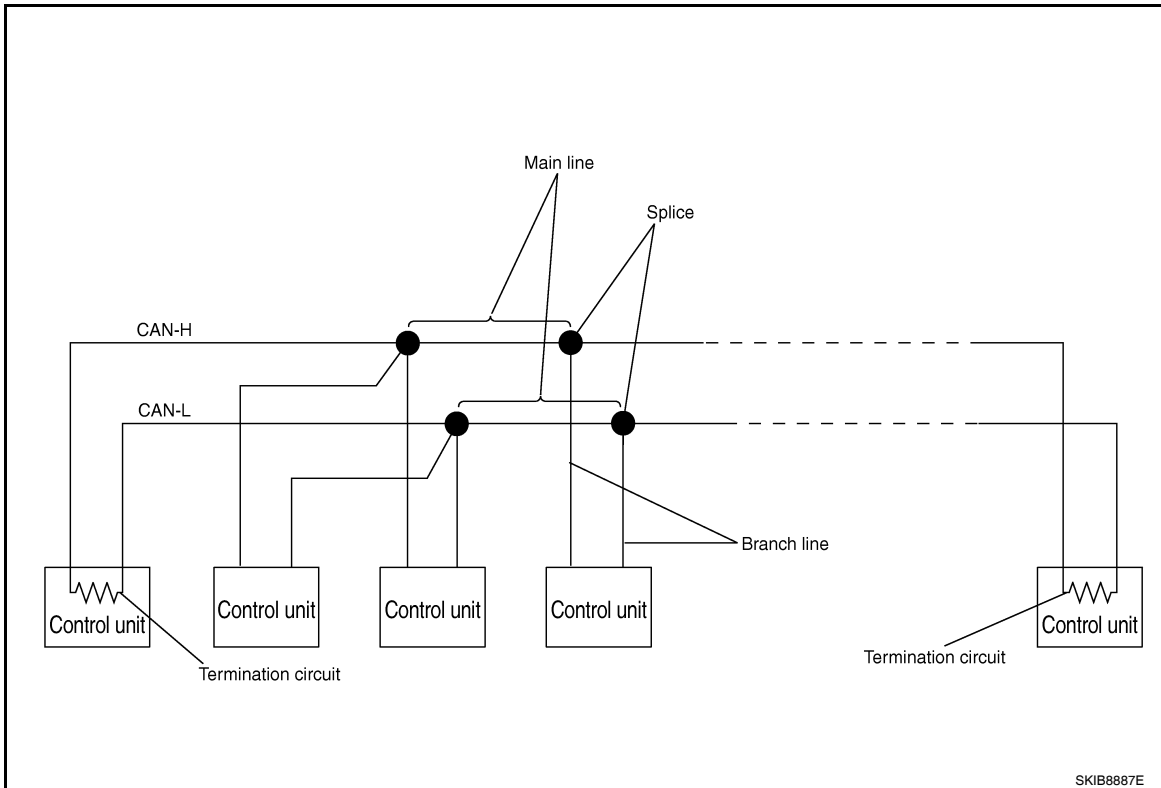

Each control unit passes an electric current to the termination circuits when transmitting CAN communication signal. The termination circuits produce an electrical potential difference between CAN-H and CAN-L. CAN communication system transmits and receives CAN communication signals by the potential difference.

LAN

Component	Description
Main line	CAN communication line between splices
Branch line	CAN communication line between splice and a control unit
Splice	A point connecting a branch line with a main line
Termination circuit	Refer to LAN-8. "CAN Communication Control Circuit" .

N

O

P

CAN COMMUNICATION SYSTEM

< FUNCTION DIAGNOSIS >

[CAN FUNDAMENTAL]

CAN Communication Control Circuit

INFOID:000000004219013

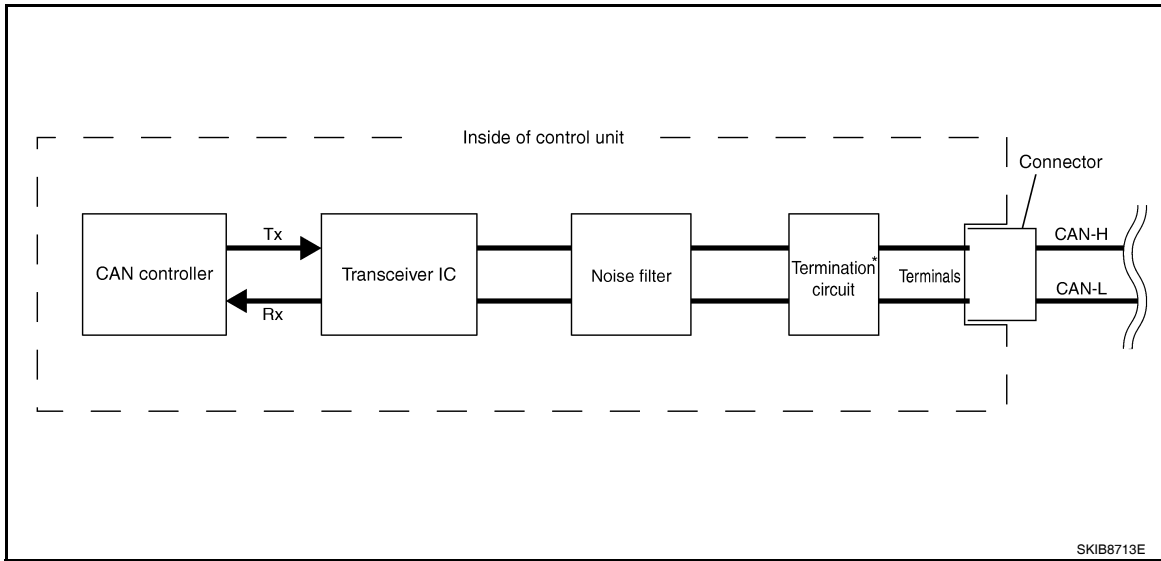

Component	System description
CAN controller	It controls CAN communication signal transmission and reception, error detection, etc.
Transceiver IC	It converts digital signal into CAN communication signal, and CAN communication signal into digital signal.
Noise filter	It eliminates noise of CAN communication signal.
Termination circuit* (Resistance of approx. 120 Ω)	It produces potential difference.

*: These are the only control units wired with both ends of CAN communication system.

DIAG ON CAN

Description

INFOID:000000004219014

“Diag on CAN” is a diagnosis using CAN communication instead of previous DDL1 and DDL2 communication lines, between control units and diagnosis unit.

System Diagram

INFOID:000000004219015

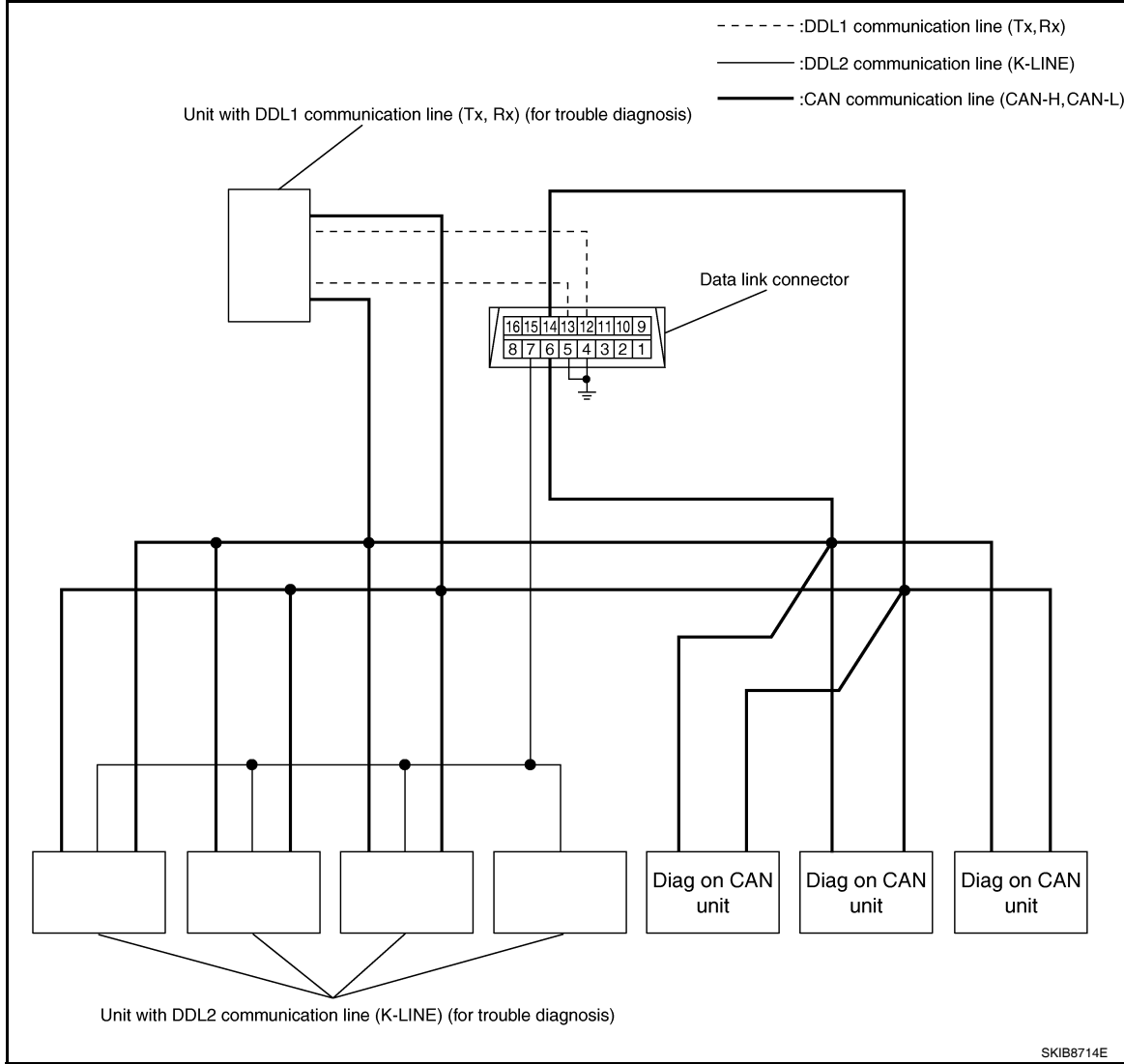

Name	Harness	Description
DDL1	Tx Rx	It is used for trouble diagnosis. (CAN-H and CAN-L are used for controlling)
DDL2	K-LINE	It is used for trouble diagnosis. (CAN-H and CAN-L are used for controlling)
Diag on CAN	CAN-H CAN-L	It is used for trouble diagnosis and control.

A
B
C
D
E
F
G
H
I
J
K
L

LAN

N
O
P

TROUBLE DIAGNOSIS

Condition of Error Detection

INFOID:000000004219016

“U1000” or “U1001” is indicated on SELF-DIAG RESULTS on CONSULT-III if CAN communication signal is not transmitted or received between units for 2 seconds or more.

CAN COMMUNICATION SYSTEM ERROR

- CAN communication line open (CAN-H, CAN-L, or both)
- CAN communication line short (ground, between CAN communication lines, other harnesses)
- Error of CAN communication control circuit of the unit connected to CAN communication line

WHEN “U1000” OR “U1001” IS INDICATED EVEN THOUGH CAN COMMUNICATION SYSTEM IS NORMAL

- Removal/installation of parts: Error may be detected when removing and installing CAN communication unit and related parts while turning the ignition switch ON. (A DTC except for CAN communication may be detected.)
- Fuse blown out (removed): CAN communication of the unit may cease.
- Voltage drop: Error may be detected if voltage drops due to discharged battery when turning the ignition switch ON (Depending on the control unit which carries out CAN communication).
- Error may be detected if the power supply circuit of the control unit, which carries out CAN communication, malfunctions (Depending on the control unit which carries out CAN communication).
- Error may be detected if reprogramming is not completed normally.

NOTE:

CAN communication system is normal if “U1000” or “U1001” is indicated on SELF-DIAG RESULTS of CONSULT-III under the above conditions. Erase the memory of the self-diagnosis of each unit.

Symptom When Error Occurs in CAN Communication System

INFOID:000000004219017

In CAN communication system, multiple units mutually transmit and receive signals. Each unit cannot transmit and receive signals if any error occurs on CAN communication line. Under this condition, multiple control units related to the root cause malfunction or go into fail-safe mode.

ERROR EXAMPLE

NOTE:

- Each vehicle differs in symptom of each unit under fail-safe mode and CAN communication line wiring.
- Refer to [LAN-23. "Abbreviation List"](#) for the unit abbreviation.

Example: TCM branch line open circuit

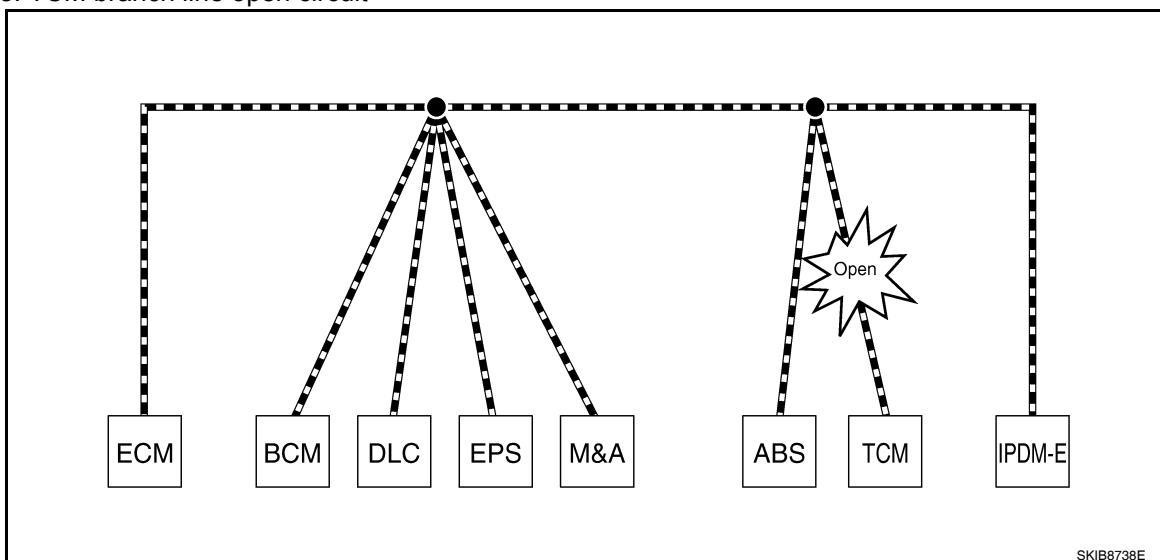

Unit name	Symptom
ECM	Engine torque limiting is affected, and shift harshness increases.
BCM	Reverse warning chime does not sound.

TROUBLE DIAGNOSIS

< FUNCTION DIAGNOSIS >

[CAN FUNDAMENTAL]

Unit name	Symptom
EPS control unit	Normal operation.
Combination meter	<ul style="list-style-type: none"> • Shift position indicator and OD OFF indicator turn OFF. • Warning lamps turn ON.
ABS actuator and electric unit (control unit)	Normal operation.
TCM	No impact on operation.
IPDM E/R	Normal operation.

Example: Data link connector branch line open circuit

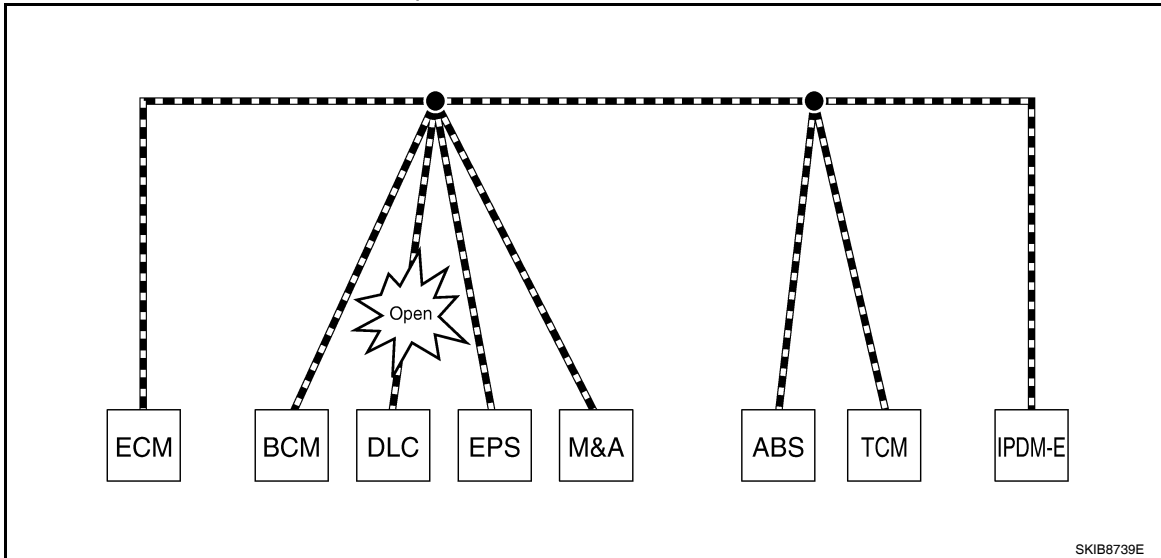

Unit name	Symptom
ECM	Normal operation.
BCM	
EPS control unit	
Combination meter	
ABS actuator and electric unit (control unit)	
TCM	
IPDM E/R	

NOTE:

- When data link connector branch line is open, transmission and reception of CAN communication signals are not affected. Therefore, no symptoms occur. However, be sure to repair malfunctioning circuit.
- The model (all units on CAN communication system are Diag on CAN) cannot perform CAN diagnosis with CONSULT-III if the following error occurs. The error is judged by the symptom.

Error	Difference of symptom
Data link connector branch line open circuit	Normal operation.
CAN-H, CAN-L harness short-circuit	Most of the units which are connected to the CAN communication system enter fail-safe mode or are deactivated.

A
B
C
D
E
F
G
H
I
J
K
L
N
O
P

LAN

TROUBLE DIAGNOSIS

< FUNCTION DIAGNOSIS >

[CAN FUNDAMENTAL]

Example: Main Line Between Data Link Connector and ABS Actuator and Electric Unit (Control Unit) Open Circuit

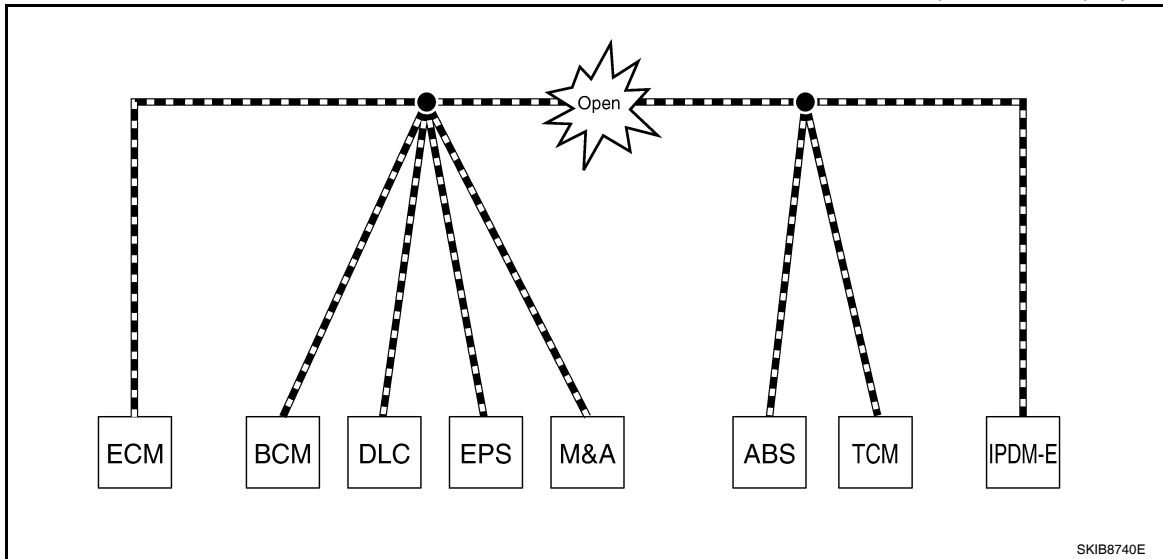

Unit name	Symptom
ECM	Engine torque limiting is affected, and shift harshness increases.
BCM	<ul style="list-style-type: none"> • Reverse warning chime does not sound. • The front wiper moves under continuous operation mode even though the front wiper switch being in the intermittent position.
EPS control unit	The steering effort increases.
Combination meter	<ul style="list-style-type: none"> • The shift position indicator and OD OFF indicator turn OFF. • The speedometer is inoperative. • The odo/trip meter stops.
ABS actuator and electric unit (control unit)	Normal operation.
TCM	No impact on operation.
IPDM E/R	When the ignition switch is ON, <ul style="list-style-type: none"> • The headlamps (Lo) turn ON. • The cooling fan continues to rotate.

Example: CAN-H, CAN-L Harness Short Circuit

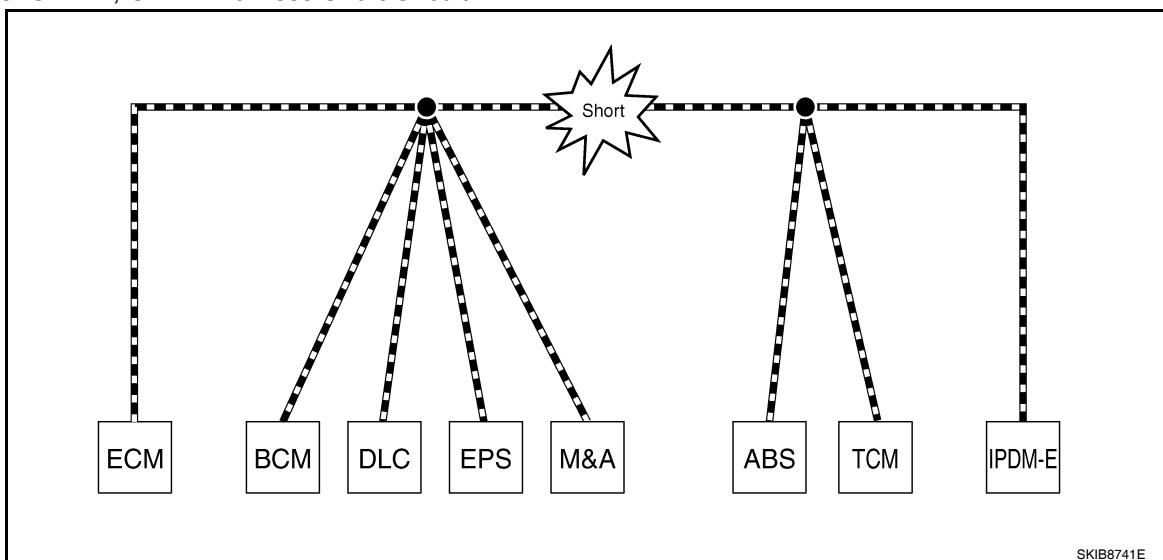

TROUBLE DIAGNOSIS

< FUNCTION DIAGNOSIS >

[CAN FUNDAMENTAL]

Unit name	Symptom
ECM	<ul style="list-style-type: none"> Engine torque limiting is affected, and shift harshness increases. Engine speed drops.
BCM	<ul style="list-style-type: none"> Reverse warning chime does not sound. The front wiper moves under continuous operation mode even though the front wiper switch being in the intermittent position. The room lamp does not turn ON. The engine does not start (if an error or malfunction occurs while turning the ignition switch OFF.) The steering lock does not release (if an error or malfunction occurs while turning the ignition switch OFF.)
EPS control unit	The steering effort increases.
Combination meter	<ul style="list-style-type: none"> The tachometer and the speedometer do not move. Warning lamps turn ON. Indicator lamps do not turn ON.
ABS actuator and electric unit (control unit)	Normal operation.
TCM	No impact on operation.
IPDM E/R	When the ignition switch is ON, <ul style="list-style-type: none"> The headlamps (Lo) turn ON. The cooling fan continues to rotate.

CAN Diagnosis with CONSULT-III

INFOID:000000004219018

CAN diagnosis on CONSULT-III extracts the root cause by receiving the following information.

- Response to the system call
- Control unit diagnosis information
- Self-diagnosis
- CAN diagnostic support monitor

Self-Diagnosis

INFOID:000000004219019

DTC	Self-diagnosis item (CONSULT-III indication)	DTC detection condition	Inspection/Action
U0164	LOST COMM (HVAC)	When ECM is not transmitting or receiving CAN communication signal of OBD (emission-related diagnosis) from A/C auto amp. for 2 seconds or more.	Start the inspection. Refer to the applicable section of the indicated control unit.
U1000	CAN COMM CIRCUIT	When a control unit (except for ECM) is not transmitting or receiving CAN communication signal for 2 seconds or more.	
U1001*	CAN COMM CIRCUIT	When ECM is not transmitting or receiving CAN communication signal other than OBD (emission-related diagnosis) for 2 seconds or more.	
		When hybrid vehicle control ECU is not transmitting or receiving CAN communication signal for 2 seconds or more.	
U1002	SYSTEM COMM	When a control unit is not transmitting or receiving CAN communication signal for 2 seconds or less.	
U1010	CONTROL UNIT(CAN)	When an error is detected during the initial diagnosis for CAN controller of each control unit.	
P0607	ECM		

*: Hybrid vehicle control ECU may display one or more DTCs listed as follows; U1001 (146), U1001 (435), U1001 (594), U1001 (827), U1001 (919), U1001 (920).

TROUBLE DIAGNOSIS

< FUNCTION DIAGNOSIS >

[CAN FUNDAMENTAL]

CAN Diagnostic Support Monitor

INFOID:000000004219020

MONITOR ITEM (CONSULT-III)

Example: CAN DIAG SUPPORT MNTR indication

Without PAST	With PAST
ECM	ECM
PRSENT PAST	PRSENT PAST
INITIAL DIAG OK	TRANSMIT DIAG OK OK
TRANSMIT DIAG OK	VDC/TCS/ABS - -
TCM OK	METER/M&A OK OK
VDC/TCS/ABS UNKWN	BCM/SEC OK OK
METER/M&A OK	ICC - -
ICC UNKWN	HVAC - -
BCM/SEC OK	TCM OK OK
IPDM E/R OK	EPS - -
	IPDM E/R OK OK
	e4WD - -
	AWD/4WD OK OK

JSMIA0015GB

Without PAST

Item	PRSENT	Description
Initial diagnosis	OK	Normal at present
	NG	Control unit error (Except for some control units)
Transmission diagnosis	OK	Normal at present
	UNKWN	Unable to transmit signals for 2 seconds or more. Diagnosis not performed
Control unit name (Reception diagnosis)	OK	Normal at present
	UNKWN	Unable to receive signals for 2 seconds or more. Diagnosis not performed
		No control unit for receiving signals. (No applicable optional parts)

With PAST

Item	PRSENT	PAST	Description
Transmission diagnosis	OK	OK	Normal at present and in the past
		1 – 39	Normal at present, but unable to transmit signals for 2 seconds or more in the past. (The number indicates the number of ignition switch cycles from OFF to ON.)
	UNKWN	0	Unable to transmit signals for 2 seconds or more at present.
Control unit name (Reception diagnosis)	OK	OK	Normal at present and in the past
		1 – 39	Normal at present, but unable to receive signals for 2 seconds or more in the past. (The number indicates the number of ignition switch cycles from OFF to ON.)
	UNKWN	0	Unable to receive signals for 2 seconds or more at present.
	-	-	Diagnosis not performed. No control unit for receiving signals. (No applicable optional parts)

MONITOR ITEM (ON-BOARD DIAGNOSIS)

NOTE:

For some models, CAN communication diagnosis result is received from the vehicle monitor.

TROUBLE DIAGNOSIS

[CAN FUNDAMENTAL]

< FUNCTION DIAGNOSIS >

Example: Vehicle Display

Item	Result indicated	Error counter	Description
CAN_COMM (Initial diagnosis)	OK	0	Normal at present
	NG	1 – 50	Control unit error (The number indicates how many times diagnosis has been run.)
CAN_CIRC_1 (Transmission diagnosis)	OK	0	Normal at present
	UNKWN	1 – 50	Unable to transmit for 2 seconds or more at present. (The number indicates how many times diagnosis has been run.)
CAN_CIRC_2 – 9 (Reception diagnosis of each unit)	OK	0	Normal at present
	UNKWN	1 – 50	Unable to transmit for 2 seconds or more at present. (The number indicates how many times diagnosis has been run.)
			Diagnosis not performed.
			No control unit for receiving signals. (No applicable optional parts)

How to Use CAN Communication Signal Chart

INFOID:000000004219021

The CAN communication signal chart lists the signals needed for trouble diagnosis. It is useful for detecting the root cause by finding a signal related to the symptom, and by checking transmission and reception unit.

Example: Tachometer does not move even though the engine rotates.

T: Transmit R: Receive

Signal name/Connecting unit	ECM	BCM	M&A	STRG	ABS	IPDM-E
A/C compressor feedback signal	T		R			
A/C compressor request signal	T					R
Accelerator pedal position signal	T				R	
Cooling fan motor operation signal	T					R
Engine coolant temperature signal	T		R			
Engine speed signal	T		R		R	
Fuel consumption monitor signal	T		R			
Malfunction indicator lamp signal	T		R			
A/C switch signal	R	T				
Ignition switch signal		T				R
Sleep/wake up signal		T	R			R

↓

It indicates that an error occurs between ECM and M&A (Shaded area).

CAN-H, CAN-L

SKIB8715E

BASIC INSPECTION

DIAGNOSIS AND REPAIR WORKFLOW

Trouble Diagnosis Flow Chart

INFOID:000000004219022

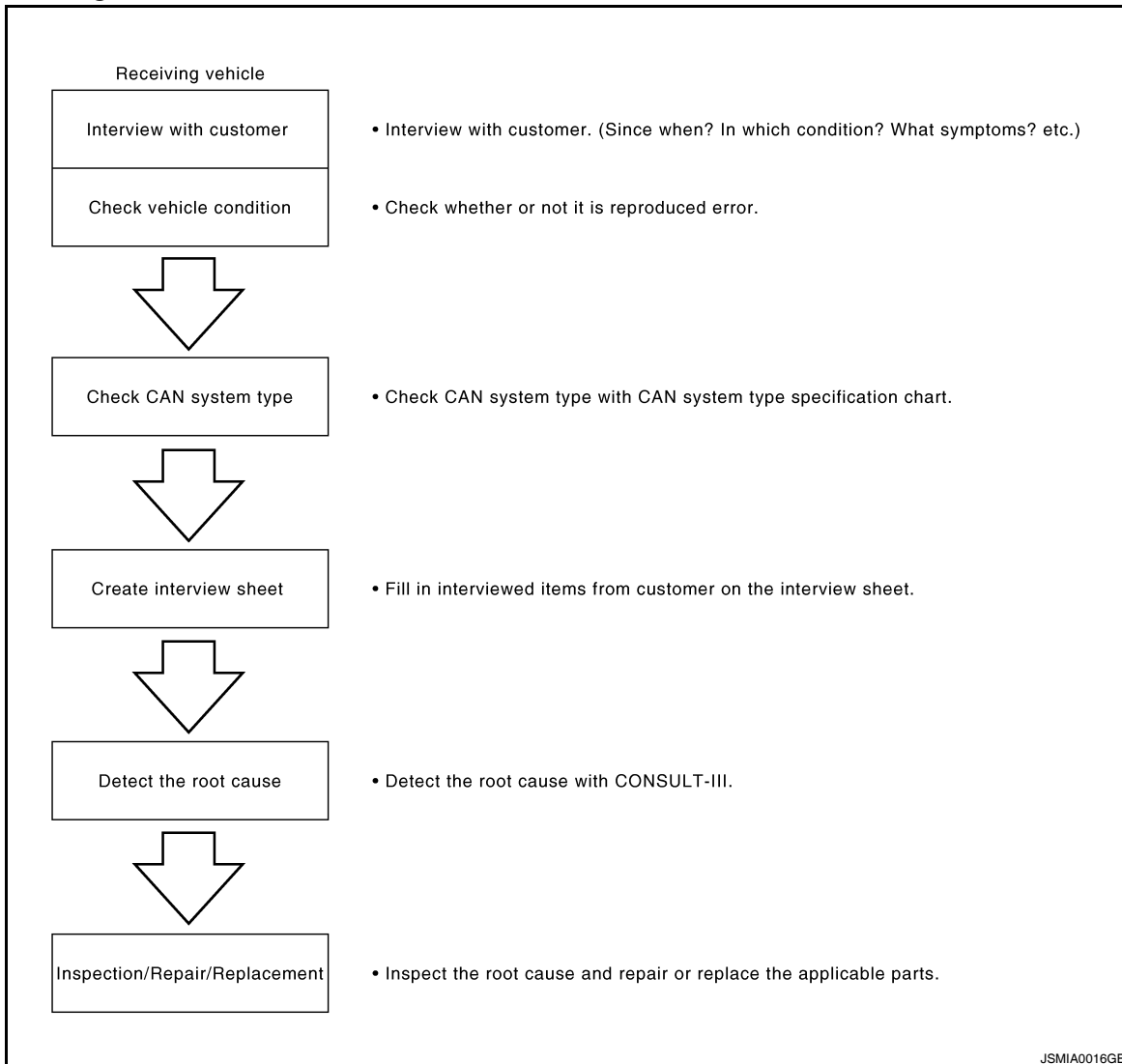

Trouble Diagnosis Procedure

INFOID:000000004219023

INTERVIEW WITH CUSTOMER

Interview with the customer is important to detect the root cause of CAN communication system errors and to understand vehicle condition and symptoms for proper trouble diagnosis.

Points in interview

- What: Parts name, system name
- When: Date, Frequency
- Where: Road condition, Place
- In what condition: Driving condition/environment
- Result: Symptom

NOTE:

- Check normal units as well as error symptoms.
- Example: Circuit between ECM and the combination meter is judged normal if the customer indicates tachometer functions normally.
- When a CAN communication system error is present, multiple control units may malfunction or go into fail-safe mode.

DIAGNOSIS AND REPAIR WORKFLOW

< BASIC INSPECTION >

[CAN FUNDAMENTAL]

- Indication of the combination meter is important to detect the root cause because it is the most obvious to the customer, and it performs CAN communication with many units.

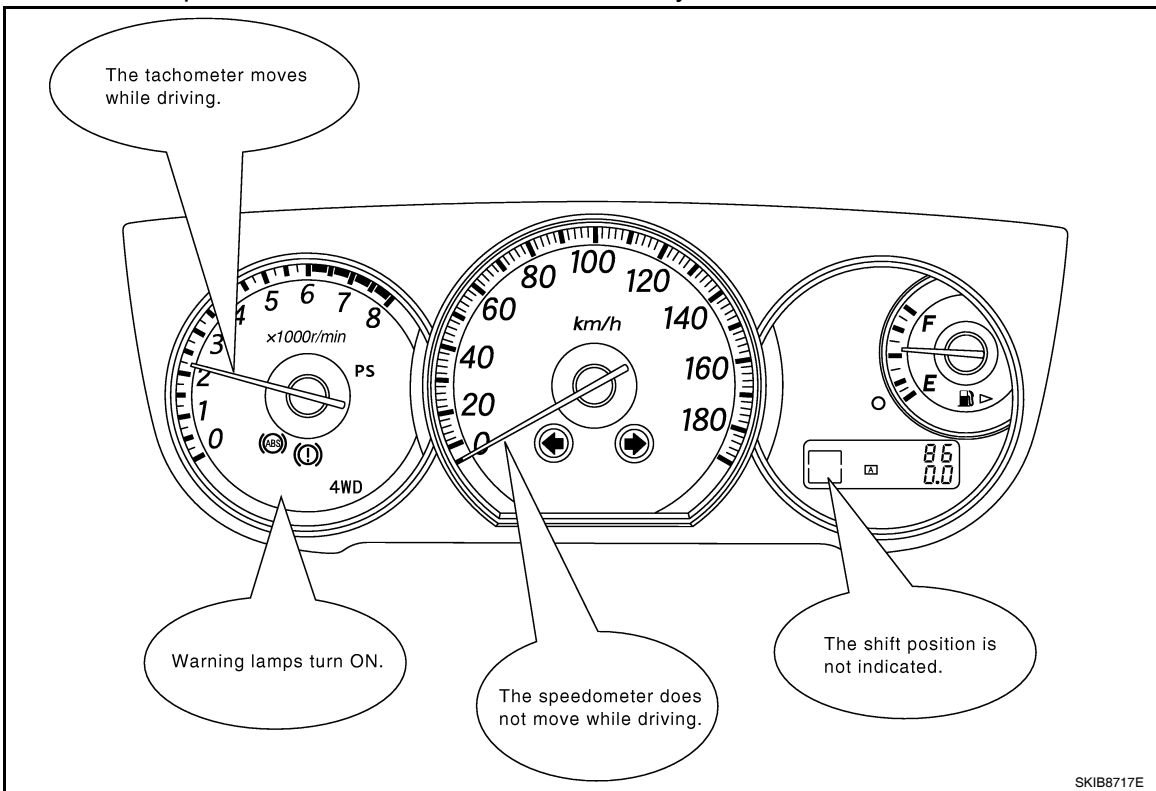

INSPECTION OF VEHICLE CONDITION

Check whether the symptom is reproduced or not.

NOTE:

Do not turn the ignition switch OFF or disconnect the battery cable while reproducing the error. The error may temporarily correct itself, making it difficult to determine the root cause.

CHECK OF CAN SYSTEM TYPE (HOW TO USE CAN SYSTEM TYPE SPECIFICATION CHART)

Determine CAN system type based on vehicle equipment.

NOTE:

- This chart is used if CONSULT-III does not automatically recognize CAN system type.
- There are two styles for CAN system type specification charts. Depending on the number of available system types, either style A or style B may be used.

CAN System Type Specification Chart (Style A)

NOTE:

A
B
C
D
E
F
G
H
I
J
K
L

LAN

DIAGNOSIS AND REPAIR WORKFLOW

< BASIC INSPECTION >

[CAN FUNDAMENTAL]

CAN system type is easily checked with the vehicle equipment identification information shown in the chart.

Example:
Vehicle is equipped as follows: Wagon, AWD, VQ35DE, CVT, VDC, and Intelligent Key system. (○ shows an example of CAN system type.)

CAN System Specification Chart
Determine CAN system type from the following specification chart.

Body type	Wagon					
Axle	2WD			AWD		
Engine	QR25DE		VQ35DE			
Transmission	A/T		CVT			
Brake control	ABS			VDC		
Intelligent Key system		X		X		X
CAN system type	1	2	3	4	5	6
CAN communication signal chart	XX-XX. "TYPE 1/TYPE 2"		XX-XX. "TYPE 3/TYPE 4"		XX-XX. "TYPE 5/TYPE 6"	

X : Applicable

VEHICLE EQUIPMENT IDENTIFICATION INFORMATION
NOTE:
Check CAN system type from the vehicle shape and equipment.

With VDC

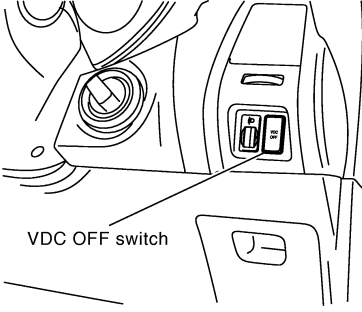

VDC OFF switch

With Intelligent Key system

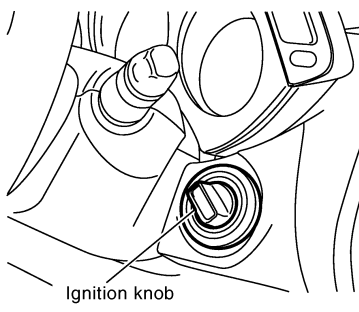

Ignition knob

In the above example,
• Checking VDC OFF switch leads to judge whether or not VDC is equipped.
• Checking the ignition knob leads to judge whether or not Intelligent Key system is equipped.

[For the above case, CAN system type is "6".]

JSMIA0017GB

CAN System Type Specification Chart (Style B)

NOTE:

DIAGNOSIS AND REPAIR WORKFLOW

< BASIC INSPECTION >

[CAN FUNDAMENTAL]

Interview Sheet (Example)

CAN Communication System Diagnosis Interview Sheet	
Date received:	3, Feb. 2006
Type: DBA-KG11	VIN No.: KG11-005040
Model: BDRARGZ397EDA-E-J-	
First registration: 10, Jan. 2001	Mileage: 62,140
CAN system type: Type 19	
Symptom (Results from interview with customer)	
<ul style="list-style-type: none">•Headlamps suddenly turn ON while driving the vehicle.•The engine does not restart after stopping the vehicle and turning the ignition switch OFF.•The cooling fan continues rotating while turning the ignition switch ON.	
Condition at inspection	
Error Symptom: Present / Past	
<p>The engine does not start. While turning the ignition switch ON,</p> <ul style="list-style-type: none">•The headlamps (Lo) turn ON, and the cooling fan continues rotating.•The interior lamp does not turn ON.	

JSMIA0019GB

DETECT THE ROOT CAUSE

CAN diagnosis function of CONSULT-III detects the root cause.

HOW TO USE THIS MANUAL

DESCRIPTION

Description

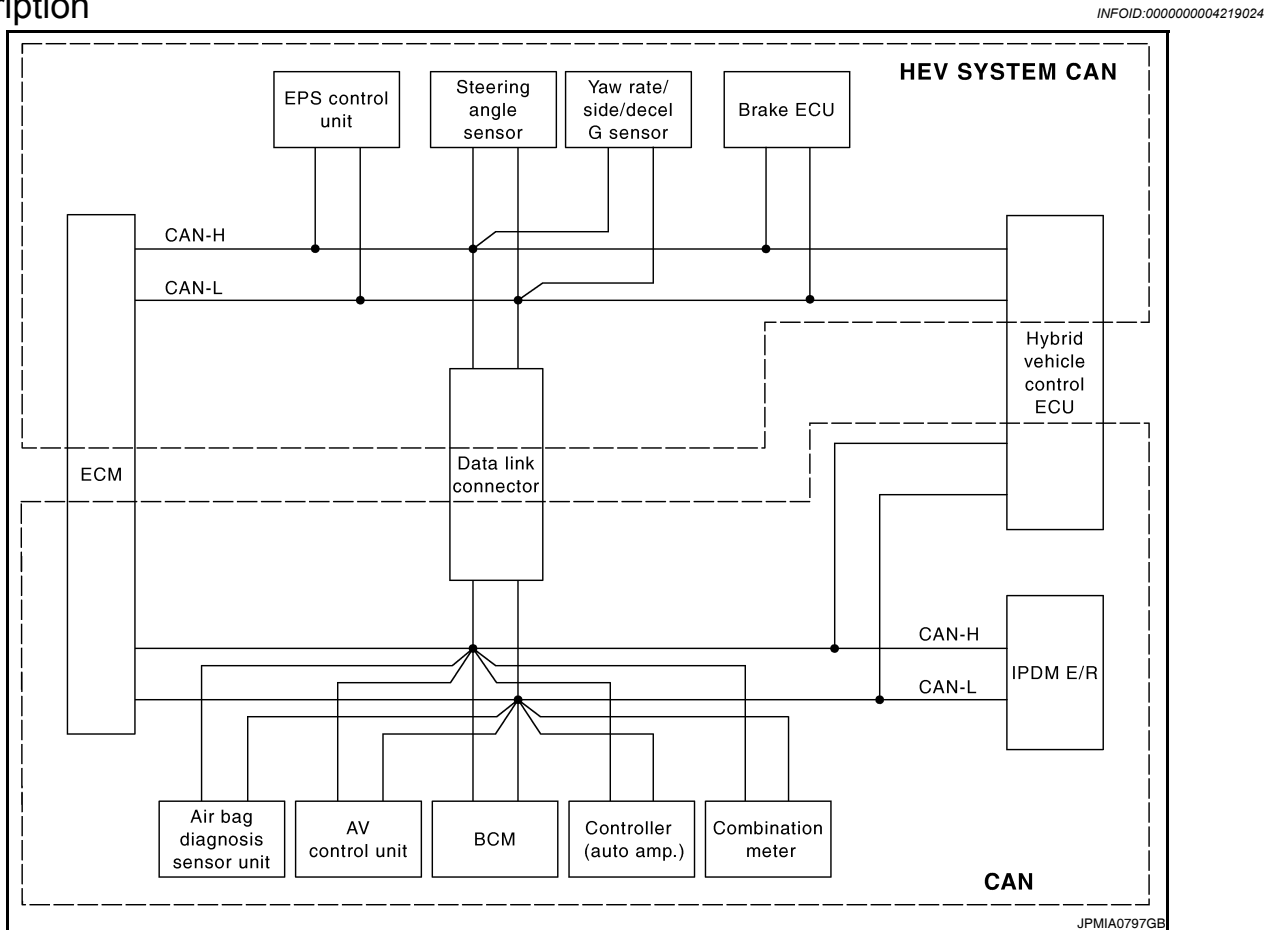

This vehicle has two types of CAN communication systems; CAN and HEV SYSTEM CAN. For starting the trouble diagnosis, refer to the following list.

NOTE:

- If the DTCs related to CAN and related to HEV SYSTEM CAN are displayed at the same time, diagnose CAN first.
- After the diagnosis of HEV SYSTEM CAN or CAN, erase the DTCs of unit connected to HEV SYSTEM CAN and CAN.

DESCRIPTION

< HOW TO USE THIS MANUAL >

[CAN]

Unit	DTC (INF code*) displayed on CONSULT-III	CAN communication system	Inspection
ECM	P0607, U1001, U0164	CAN	LAN-16. "Trouble Diagnosis Flow Chart"
	P0607, U0129, U0293, U1020, U1022	HEV SYSTEM CAN	
EPS control unit	C1608, U0129, U0293	HEV SYSTEM CAN	LAN-53. "Trouble Diagnosis Flow Chart"
Brake ECU	C1300, U0073, U0123, U0124, U0126, U0293	HEV SYSTEM CAN	
Hybrid vehicle control ECU	P0A1D (924), P0A1D (925), U0100, U0100 (211), U0100 (212), U0100 (530), U0129, U0129 (220), U0129 (222), U0129 (528), U0131, U0131 (433), U0131 (434)	HEV SYSTEM CAN	
	U1001, U1001 (146), U1001 (435), U1001 (594), U1001 (827), U1001 (919), U1001 (920)	CAN	
AV control unit	P0607, U1000, U1010	CAN	LAN-16. "Trouble Diagnosis Flow Chart"
BCM			
Controller (auto amp.)			
Combination meter			
IPDM E/R			

*: For the details, refer to [HBC-80. "Diagnosis Description"](#).

HOW TO USE THIS SECTION

< HOW TO USE THIS MANUAL >

[CAN]

HOW TO USE THIS SECTION

Caution

INFOID:000000004219025

- This section describes information peculiar to a vehicle and inspection procedures.
- For trouble diagnosis procedure, refer to [LAN-16. "Trouble Diagnosis Procedure"](#).

Abbreviation List

INFOID:000000004219026

Unit name abbreviations in CONSULT-III CAN diagnosis and in the description of CAN diagnosis in this section are as per the following list.

Abbreviation	Unit name
A-BAG	Air bag diagnosis sensor unit
AV	AV control unit
BCM	BCM
DLC	Data link connector
ECM	ECM
HVAC	Controller (auto amp.)
HV ECU	Hybrid vehicle control ECU
IPDM-E	IPDM E/R
M&A	Combination meter

A
B
C
D
E
F
G
H
I
J
K
L

LAN

N
O
P

PRECAUTION

PRECAUTIONS

Precautions For High-Voltage System

INFOID:000000004219027

Refer to [GI-24, "Precautions For High-Voltage System"](#).

Precaution for Supplemental Restraint System (SRS) "AIR BAG" and "SEAT BELT PRE-TENSIONER"

INFOID:000000004219028

The Supplemental Restraint System such as "AIR BAG" and "SEAT BELT PRE-TENSIONER", used along with a front seat belt, helps to reduce the risk or severity of injury to the driver and front passenger for certain types of collision. This system includes seat belt switch inputs and dual stage front air bag modules. The SRS system uses the seat belt switches to determine the front air bag deployment, and may only deploy one front air bag, depending on the severity of a collision and whether the front occupants are belted or unbelted. Information necessary to service the system safely is included in the "SRS AIRBAG" and "SEAT BELT" of this Service Manual.

WARNING:

- To avoid rendering the SRS inoperative, which could increase the risk of personal injury or death in the event of a collision which would result in air bag inflation, all maintenance must be performed by an authorized NISSAN/INFINITI dealer.
- Improper maintenance, including incorrect removal and installation of the SRS, can lead to personal injury caused by unintentional activation of the system. For removal of Spiral Cable and Air Bag Module, see the "SRS AIRBAG".
- Never use electrical test equipment on any circuit related to the SRS unless instructed to in this Service Manual. SRS wiring harnesses can be identified by yellow and/or orange harnesses or harness connectors.

Precautions for Trouble Diagnosis

INFOID:000000004219029

CAUTION:

- Never apply 7.0 V or more to the measurement terminal.
- Use a tester with open terminal voltage of 7.0 V or less.
- Turn the ignition switch OFF and disconnect the battery cable from the negative terminal when checking the harness.

Precautions for Harness Repair

INFOID:000000004219030

- Solder the repaired area and wrap tape around the soldered area.

NOTE:

A fray of twisted lines must be within 110 mm (4.33 in).

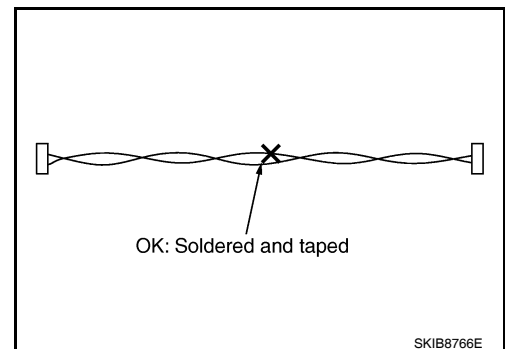

PRECAUTIONS

[CAN]

< PRECAUTION >

- Bypass connection is never allowed at the repaired area.

NOTE:

Bypass connection may cause CAN communication error. The spliced wire becomes separated and the characteristics of twisted line are lost.

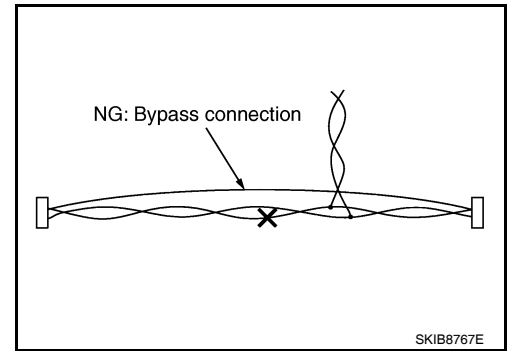

- Replace the applicable harness as an assembly if error is detected on the shield lines of CAN communication line.

LAN

N

O

P

BASIC INSPECTION

DIAGNOSIS AND REPAIR WORKFLOW

Interview Sheet

INFOID:000000004219031

CAN Communication System Diagnosis Interview Sheet

Date received:

Type:

VIN No.:

Model:

First registration:

Mileage:

CAN system type:

Symptom (Results from interview with customer)

Condition at inspection

Error symptom : Present / Past

SKIB8898E

CAN COMMUNICATION SYSTEM

< FUNCTION DIAGNOSIS >

[CAN]

FUNCTION DIAGNOSIS

CAN COMMUNICATION SYSTEM

CAN System Specification Chart

INFOID:000000004219032

Determine CAN system type from the following specification chart.

NOTE:

Refer to [LAN-16. "Trouble Diagnosis Procedure"](#) for how to use CAN system specification chart.

Body type	Sedan	
Axle	2WD	
Engine	QR25DE	
Transmission	e-CVT	
Brake control	VDC	
Navigation system		×
CAN system type	13	14

×: Applicable

VEHICLE EQUIPMENT IDENTIFICATION INFORMATION

NOTE:

Check CAN system type from the vehicle shape and equipment.

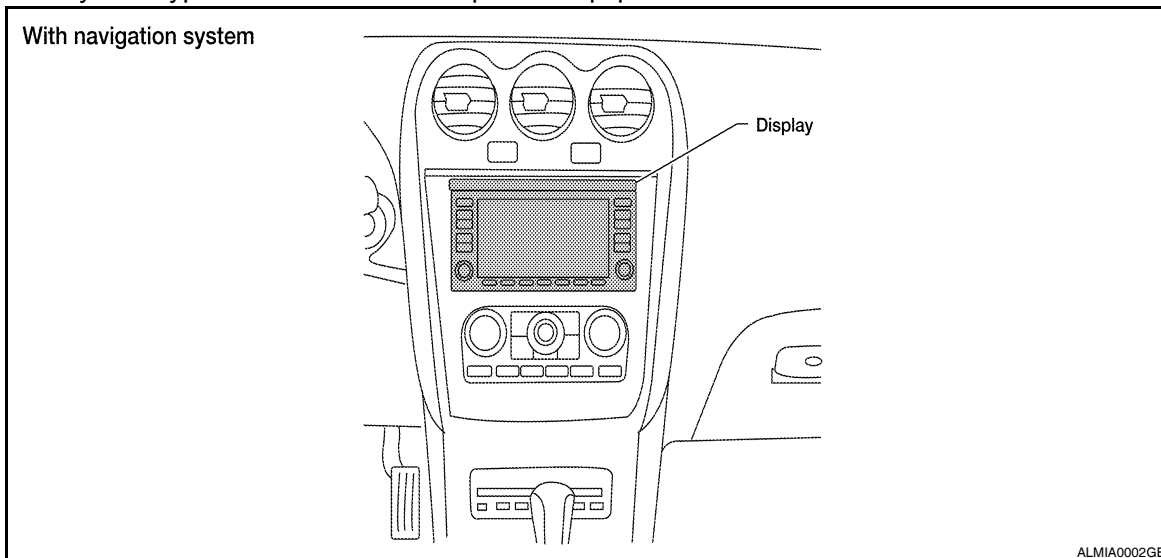

CAN Communication Signal Chart

INFOID:000000004219033

Refer to [LAN-15. "How to Use CAN Communication Signal Chart"](#) for how to use CAN communication signal chart.

NOTE:

Refer to [LAN-23. "Abbreviation List"](#) for the abbreviations of the connecting units.

T: Transmit R: Receive

Signal name/Connecting unit	ECM	AV	BCM	HVAC	M&A	HV ECU	IPDM-E
A/C cut request signal	T			R	R		
Cooling fan speed request signal	T						R
Engine coolant temperature signal	T			R	R		
Engine speed signal	T			R	R		
Engine status signal	T	R	R		R		

CAN COMMUNICATION SYSTEM

< FUNCTION DIAGNOSIS >

[CAN]

Signal name/Connecting unit	ECM	AV	BCM	HVAC	M&A	HV ECU	IPDM-E
Fuel consumption monitor signal	T	R			R		
Malfunctioning indicator lamp signal	T				R		
Buzzer output signal			T		R		
Day time running light request signal			T				R
Door switch signal		R	T		R	R	R
Front fog light request signal			T		R		R
Front wiper request signal			T				R
High beam request signal			T		R		R
Horn reminder signal			T				R
Ignition switch ON signal			T				R
			R				T
Interlock/PNP switch signal			T				R
			R				T
Key warning signal			T		R		
Low beam request signal			T				R
Meter display signal			T		R		
Oil pressure switch signal	R		R		R	R	T
					R	T	
			T		R		
Position light request signal			T		R		R
Rear window defogger switch signal			T				R
Sleep wake up signal			T		R		R
Steering lock relay signal			R				T
			T				R
Steering lock unit status signal			R				T
Theft warning horn request signal			T				R
Tire pressure data signal			T		R		
Trunk switch signal		R	T		R		
Turn indicator signal			T		R		
A/C evaporator temperature signal	R			T			
A/C switch signal	R			T			
Blower fan motor switch signal	R			T			
Target A/C evaporator temperature signal	R			T			
Distance to empty signal		R			T		
Fuel level low warning signal		R			T		
Fuel level sensor signal	R				T		
Market information signal		R			T		
Parking brake switch signal			R		T		
Seat belt buckle switch signal			R		T		
Vehicle speed signal	R	R	R		T		R
	R		R		R	T	
ABS warning lamp signal					R	T	
ASCD status signal					R	T	

CAN COMMUNICATION SYSTEM

< FUNCTION DIAGNOSIS >

[CAN]

Signal name/Connecting unit	ECM	AV	BCM	HVAC	M&A	HV ECU	IPDM-E
Brake warning lamp signal					R	T	
CHARGE lamp signal					R	T	
Energy flow status signal		R				T	
Engine off indicator signal					R	T	
EPS warning lamp signal					R	T	
HV battery warning lamp signal					R	T	
HV system warning lamp signal					R	T	
Master warning lamp signal					R	T	
NDB warning lamp signal					R	T	
P range signal	R		R		R	T	
READY lamp signal					R	T	
Regenerated power signal		R				T	
Shift position signal			R			T	
SLIP indicator lamp signal					R	T	
SOC signal		R			R	T	
Tire rotating direction signal		R				T	
Total power signal					R	T	
VDC warning indicator lamp signal					R	T	
AT device (detent switch) signal			R				T
Front wiper stop position signal			R				T
Hood switch signal			R				T
Push-button ignition switch status signal			R				T
Rear window defogger control signal	R						T

NOTE:

CAN data of the air bag diagnosis sensor unit is not used by usual service work, thus it is omitted.

LAN

COMPONENT DIAGNOSIS

CAN COMMUNICATION SYSTEM

Component Parts Location

INFOID:000000004219034

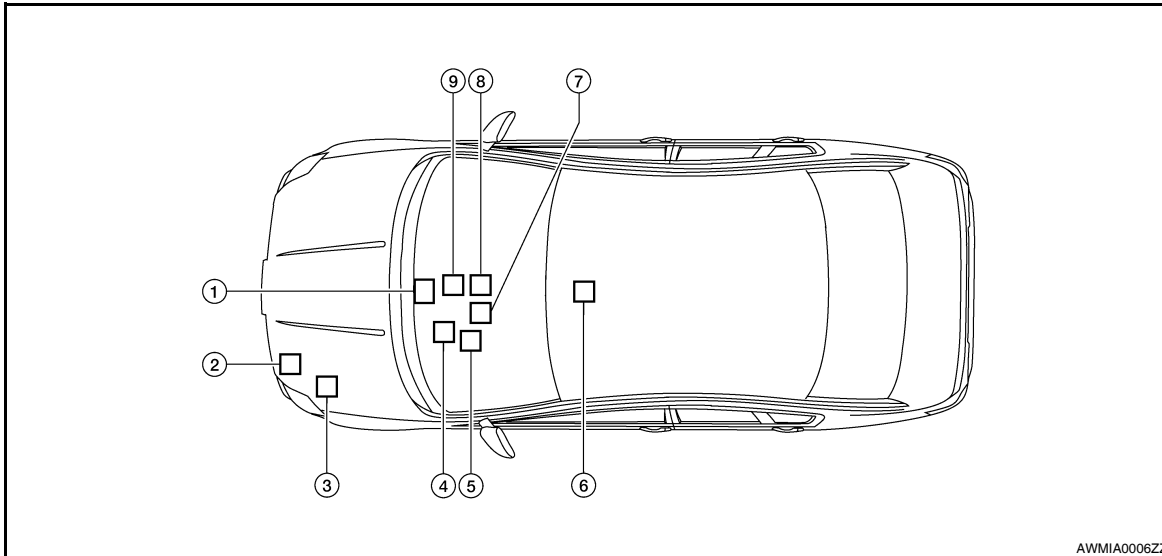

- | | | |
|-----------------------------------|-------------------------------|--------------------------------------|
| 1. Hybrid vehicle control ECU E66 | 2. ECM E10 | 3. IPDM E/R E17 |
| 4. BCM M19 | 5. Combination meter M24 | 6. Air bag diagnosis sensor unit M35 |
| 7. Data link connector M22 | 8. Controller (auto amp.) M37 | 9. AV control unit M46 |

CAN COMMUNICATION SYSTEM

< COMPONENT DIAGNOSIS >

[CAN]

Wiring Diagram - CAN SYSTEM -

INFOID:000000004219035

◊ NAV : WITH NAVI
 - - - : DATA LINE

CAN SYSTEM

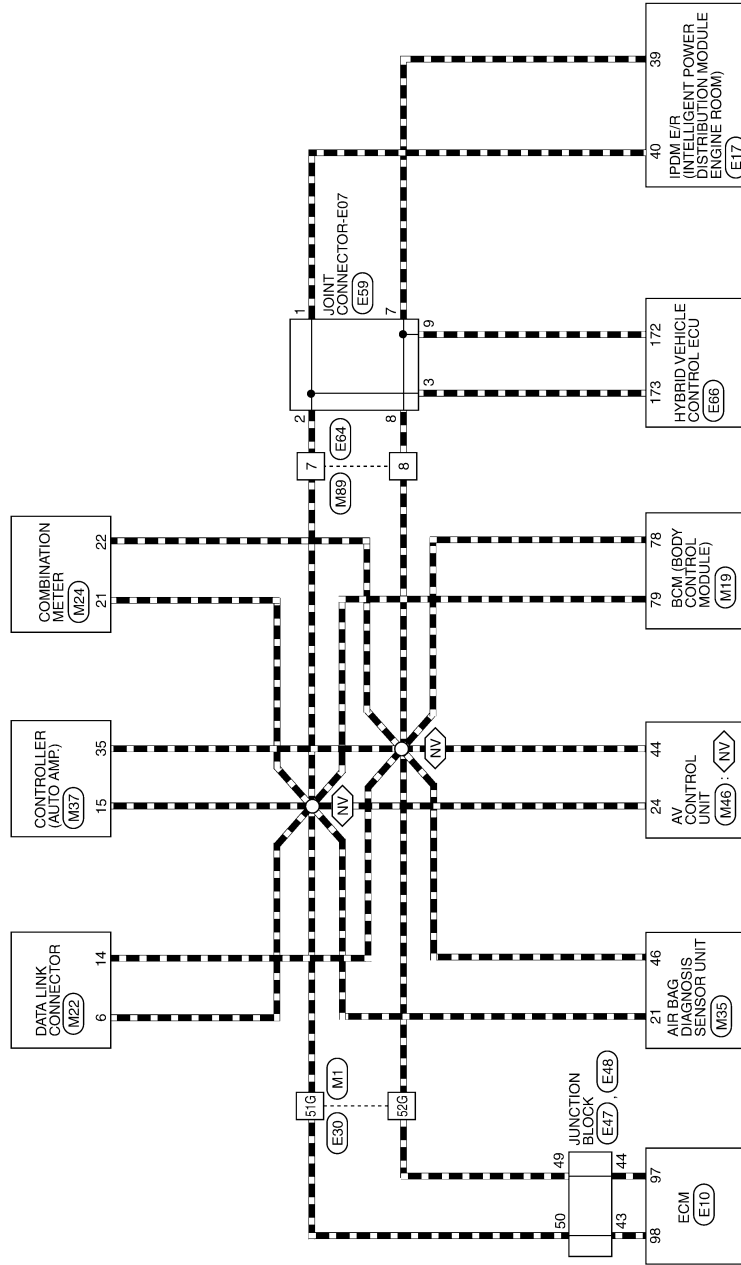

A
B
C
D
E
F
G
H
I
J
K
L
N
O
P

LAN

AWMWA0090G

CAN CONNECTORS

Connector No.	M1
Connector Name	WIRE TO WIRE
Connector Color	WHITE

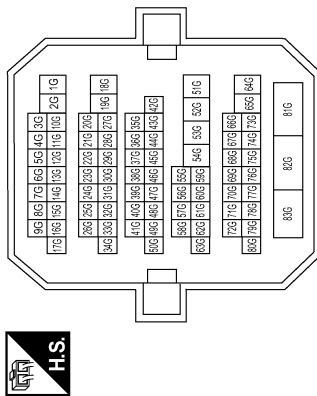

Terminal No.	Color of Wire	Signal Name
51G	L	---
52G	P	---

Connector No.	M19
Connector Name	BCM (BODY CONTROL MODULE)
Connector Color	BLACK

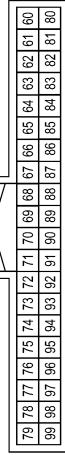

Terminal No.	Color of Wire	Signal Name
78	P	CAN-L
79	L	CAN-H

Connector No.	M22
Connector Name	DATA LINK CONNECTOR
Connector Color	WHITE

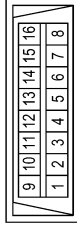

Terminal No.	Color of Wire	Signal Name
6	L	CAN-H
14	P	CAN-L

Connector No.	M24
Connector Name	COMBINATION METER
Connector Color	WHITE

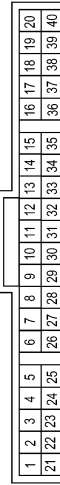

Terminal No.	Color of Wire	Signal Name
21	L	CAN-H
22	P	CAN-L

Connector No.	M35
Connector Name	AIR BAG DIAGNOSIS SENSOR UNIT
Connector Color	YELLOW

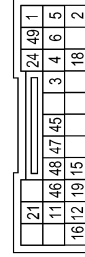

Terminal No.	Color of Wire	Signal Name
21	L	CAN-H
46	P	CAN-L

Connector No.	M37
Connector Name	CONTROLLER (AUTO AMP.)
Connector Color	WHITE

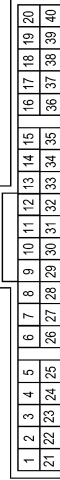

Terminal No.	Color of Wire	Signal Name
15	L	CAN-H
35	P	CAN-L

CAN COMMUNICATION SYSTEM

< COMPONENT DIAGNOSIS >

[CAN]

Connector No.	E10
Connector Name	ECM
Connector Color	BLACK

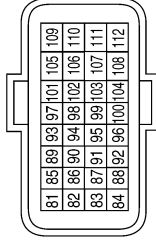

Terminal No.	Color of Wire	Signal Name
97	P	CAN-L
98	L	CAN-H

Connector No.	M89
Connector Name	WIRE TO WIRE
Connector Color	WHITE



Terminal No.	Color of Wire	Signal Name
7	L	—
8	P	—

Connector No.	M46
Connector Name	AV CONTROL UNIT
Connector Color	WHITE

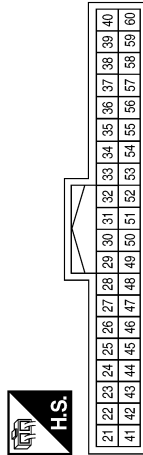

Terminal No.	Color of Wire	Signal Name
24	L	CAN H
44	P	CAN L

Connector No.	E48
Connector Name	JUNCTION BLOCK
Connector Color	WHITE

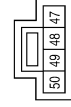

Terminal No.	Color of Wire	Signal Name
49	P	—
50	L	—

Connector No.	E47
Connector Name	JUNCTION BLOCK
Connector Color	WHITE



Terminal No.	Color of Wire	Signal Name
43	L	CAN-H
44	P	CAN-L

Connector No.	E17
Connector Name	IPDM E/R (INTELLIGENT POWER DISTRIBUTION MODULE ENGINE ROOM)
Connector Color	WHITE

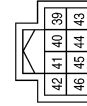

Terminal No.	Color of Wire	Signal Name
39	P	CAN-L
40	L	CAN-H

ALMIA0069GB

A
B
C
D
E
F
G
H
I
J
K
L
N
O
P

LAN

CAN COMMUNICATION SYSTEM

< COMPONENT DIAGNOSIS >

[CAN]

Connector No.	E64
Connector Name	WIRE TO WIRE
Connector Color	WHITE

1	2	3	4	5
6	7	8	9	10
11	12			



Terminal No.	Color of Wire	Signal Name
7	L	—
8	P	—

Connector No.	E59
Connector Name	JOINT CONNECTOR-E07
Connector Color	BLUE

12	11	10	9	8	7	6	5	4	3	2	1
----	----	----	---	---	---	---	---	---	---	---	---



Terminal No.	Color of Wire	Signal Name
1	L	—
2	L	—
3	L	—
7	P	—
8	P	—
9	P	—

Connector No.	E66
Connector Name	HYBRID VEHICLE CONTROL ECU
Connector Color	BLACK



168	167	166	165	164	163	77	76	75	74	73	72	71	70	69	68	67	66	65	64	63	62	61
174	173	172	171	170	169	111	110	109	108	107	106	105	104	103	102	101	100	99	98	97	96	95
180	179	178	177	176	175	128	127	126	125	124	123	122	121	120	119	118	117	116	115	114	113	112
186	185	184	183	182	181	145	144	143	142	141	140	139	138	137	136	135	134	133	132	131	130	129
						162	161	160	159	158	157	156	155	154	153	152	151	150	149	148	147	146

Terminal No.	Color of Wire	Signal Name
172	P	CAN-L
173	L	CAN-H

AWMIA0187GB

MALFUNCTION AREA CHART

< COMPONENT DIAGNOSIS >

[CAN]

MALFUNCTION AREA CHART

Main Line

INFOID:000000004219036

Malfunction Area	Reference
Main line between data link connector and hybrid vehicle control ECU	LAN-36, "Diagnosis Procedure"

Branch Line

INFOID:000000004219037

Malfunction Area	Reference
ECM branch line circuit	LAN-37, "Diagnosis Procedure"
Air bag diagnosis sensor unit branch line circuit	LAN-38, "Diagnosis Procedure"
AV control unit branch line circuit	LAN-39, "Diagnosis Procedure"
BCM branch line circuit	LAN-40, "Diagnosis Procedure"
Data link connector branch line circuit	LAN-41, "Diagnosis Procedure"
Controller (auto amp.) branch line circuit	LAN-42, "Diagnosis Procedure"
Combination meter branch line circuit	LAN-43, "Diagnosis Procedure"
Hybrid vehicle control ECU branch line circuit	LAN-44, "Diagnosis Procedure"
IPDM E/R branch line circuit	LAN-45, "Diagnosis Procedure"

Short Circuit

INFOID:000000004219038

Malfunction Area	Reference
CAN communication circuit	LAN-46, "Diagnosis Procedure"

A
B
C
D
E
F
G
H
I
J
K
L
N
O
P

LAN

MAIN LINE BETWEEN DLC AND HV ECU CIRCUIT

< COMPONENT DIAGNOSIS >

[CAN]

MAIN LINE BETWEEN DLC AND HV ECU CIRCUIT

Diagnosis Procedure

INFOID:000000004219039

INSPECTION PROCEDURE

1. CHECK CONNECTOR

1. Turn the ignition switch OFF.
2. Disconnect the battery cable from the negative terminal.
3. Check the following terminals and connectors for damage, bend and loose connection (connector side and harness side).
 - Harness connector M89
 - Harness connector E64

Is the inspection result normal?

YES >> GO TO 2.

NO >> Repair the terminal and connector.

2. CHECK HARNESS CONTINUITY (OPEN CIRCUIT)

1. Disconnect the harness connectors M89 and E64.
2. Check the continuity between the data link connector and the harness connector.

Data link connector		Harness connector		Continuity
Connector No.	Terminal No.	Connector No.	Terminal No.	
M22	6	M89	7	Existed
	14		8	Existed

Is the inspection result normal?

YES >> GO TO 3.

NO >> Repair the main line between the data link connector and the harness connector M89.

3. CHECK HARNESS CONTINUITY (OPEN CIRCUIT)

1. Disconnect the connector of hybrid vehicle control ECU.
2. Check the continuity between the harness connector and the hybrid vehicle control ECU harness connector.

Harness connector		Hybrid vehicle control ECU harness connector		Continuity
Connector No.	Terminal No.	Connector No.	Terminal No.	
E64	7	E66	173	Existed
	8		172	Existed

Is the inspection result normal?

YES (Present error)>>Check CAN system type decision again.

YES (Past error)>>Error was detected in the main line between the data link connector and the hybrid vehicle control ECU.

NO >> Repair the main line between the harness connector E64 and the hybrid vehicle control ECU.

ECM BRANCH LINE CIRCUIT

< COMPONENT DIAGNOSIS >

[CAN]

ECM BRANCH LINE CIRCUIT

Diagnosis Procedure

INFOID:000000004219040

1. CHECK CONNECTOR

1. Turn the ignition switch OFF.
2. Disconnect the battery cable from the negative terminal.
3. Check the following terminals and connectors for damage, bend and loose connection (unit side and connector side).
 - ECM
 - Harness connector E47
 - Harness connector E48
 - Junction block
 - Harness connector E30
 - Harness connector M1

Is the inspection result normal?

YES >> GO TO 2.

NO >> Repair the terminal and connector.

2. CHECK HARNESS FOR OPEN CIRCUIT

1. Disconnect the connector of ECM.
2. Check the resistance between the ECM harness connector terminals.

ECM harness connector		Resistance (Ω)
Connector No.	Terminal No.	
E10	98	Approx. 108 – 132
	97	

Is the measurement value within the specification?

YES >> GO TO 3.

NO >> Repair the ECM branch line.

3. CHECK POWER SUPPLY AND GROUND CIRCUIT

Check the power supply and the ground circuit of the ECM. Refer to [EC-114, "Diagnosis Procedure"](#).

Is the inspection result normal?

YES (Present error)>>Replace the ECM. Refer to [EC-14, "ADDITIONAL SERVICE WHEN REPLACING CONTROL UNIT : Special Repair Requirement"](#).

YES (Past error)>>Error was detected in the ECM branch line.

NO >> Repair the power supply and the ground circuit.

A
B
C
D
E
F
G
H
I
J
K
L

LAN

A-BAG BRANCH LINE CIRCUIT

< COMPONENT DIAGNOSIS >

[CAN]

A-BAG BRANCH LINE CIRCUIT

Diagnosis Procedure

INFOID:000000004219041

1. CHECK AIR BAG DIAGNOSIS SENSOR UNIT

Check the air bag diagnosis sensor unit. Refer to [SRC-3, "Work Flow"](#).

Is the inspection result normal?

YES >> Replace the main harness.

NO >> Replace parts whose air bag system has a malfunction.

AV BRANCH LINE CIRCUIT

< COMPONENT DIAGNOSIS >

[CAN]

AV BRANCH LINE CIRCUIT

Diagnosis Procedure

INFOID:000000004219042

1. CHECK CONNECTOR

1. Turn the ignition switch OFF.
2. Disconnect the battery cable from the negative terminal.
3. Check the terminals and connectors of the AV control unit for damage, bend and loose connection (unit side and connector side).

Is the inspection result normal?

- YES >> GO TO 2.
NO >> Repair the terminal and connector.

2. CHECK HARNESS FOR OPEN CIRCUIT

1. Disconnect the connector of AV control unit.
2. Check the resistance between the AV control unit harness connector terminals.

AV control unit harness connector			Resistance (Ω)
Connector No.	Terminal No.		
M46	24	44	Approx. 54 – 66

Is the measurement value within the specification?

- YES >> GO TO 3.
NO >> Repair the AV control unit branch line.

3. CHECK POWER SUPPLY AND GROUND CIRCUIT

Check the power supply and the ground circuit of the AV control unit. Refer to [AV-207, "AV CONTROL UNIT : Diagnosis Procedure"](#).

Is the inspection result normal?

- YES (Present error)>>Replace the AV control unit. Refer to [AV-278, "Removal and Installation"](#).
YES (Past error)>>Error was detected in the AV control unit branch line.
NO >> Repair the power supply and the ground circuit.

A
B
C
D
E
F
G
H
I
J
K
L

LAN

N
O
P

BCM BRANCH LINE CIRCUIT

< COMPONENT DIAGNOSIS >

[CAN]

BCM BRANCH LINE CIRCUIT

Diagnosis Procedure

INFOID:000000004219043

1.CHECK CONNECTOR

1. Turn the ignition switch OFF.
2. Disconnect the battery cable from the negative terminal.
3. Check the terminals and connectors of the BCM for damage, bend and loose connection (unit side and connector side).

Is the inspection result normal?

- YES >> GO TO 2.
NO >> Repair the terminal and connector.

2.CHECK HARNESS FOR OPEN CIRCUIT

1. Disconnect the connector of BCM.
2. Check the resistance between the BCM harness connector terminals.

BCM harness connector			Resistance (Ω)
Connector No.	Terminal No.		
M19	79	78	Approx. 54 – 66

Is the measurement value within the specification?

- YES >> GO TO 3.
NO >> Repair the BCM branch line.

3.CHECK POWER SUPPLY AND GROUND CIRCUIT

Check the power supply and the ground circuit of the BCM. Refer to [BCS-42, "Diagnosis Procedure"](#).

Is the inspection result normal?

- YES (Present error)>>Replace the BCM. Refer to [BCS-87, "Removal and Installation"](#).
YES (Past error)>>Error was detected in the BCM branch line.
NO >> Repair the power supply and the ground circuit.

DLC BRANCH LINE CIRCUIT

< COMPONENT DIAGNOSIS >

[CAN]

DLC BRANCH LINE CIRCUIT

Diagnosis Procedure

INFOID:000000004219044

1.CHECK CONNECTOR

1. Turn the ignition switch OFF.
2. Disconnect the battery cable from the negative terminal.
3. Check the terminals and connectors of the data link connector for damage, bend and loose connection (connector side and harness side).

Is the inspection result normal?

- YES >> GO TO 2.
NO >> Repair the terminal and connector.

2.CHECK HARNESS FOR OPEN CIRCUIT

Check the resistance between the data link connector terminals.

Data link connector			Resistance (Ω)
Connector No.	Terminal No.		
M22	6	14	Approx. 54 – 66

Is the measurement value within the specification?

- YES (Present error)>>Check CAN system type decision again.
YES (Past error)>>Error was detected in the data link connector branch line circuit.
NO >> Repair the data link connector branch line.

A
B
C
D
E
F
G
H
I
J
K
L
N
O
P

LAN

HVAC BRANCH LINE CIRCUIT

< COMPONENT DIAGNOSIS >

[CAN]

HVAC BRANCH LINE CIRCUIT

Diagnosis Procedure

INFOID:000000004219045

1. CHECK CONNECTOR

1. Turn the ignition switch OFF.
2. Disconnect the battery cable from the negative terminal.
3. Check the terminals and connectors of the controller (auto amp.) for damage, bend and loose connection (unit side and connector side).

Is the inspection result normal?

- YES >> GO TO 2.
NO >> Repair the terminal and connector.

2. CHECK HARNESS FOR OPEN CIRCUIT

1. Disconnect the connector of controller (auto amp.).
2. Check the resistance between the controller (auto amp.) harness connector terminals.

Controller (auto amp.) harness connector			Resistance (Ω)
Connector No.	Terminal No.		
M37	15	35	Approx. 54 – 66

Is the measurement value within the specification?

- YES >> GO TO 3.
NO >> Repair the controller (auto amp.) branch line.

3. CHECK POWER SUPPLY AND GROUND CIRCUIT

Check the power supply and the ground circuit of the controller (auto amp.). Refer to [HAC-86, "Diagnosis Procedure"](#).

Is the inspection result normal?

- YES (Present error)>>Replace the controller (auto amp.). Refer to [HAC-14, "Component Part Location"](#).
YES (Past error)>>Error was detected in the controller (auto amp.) branch line.
NO >> Repair the power supply and the ground circuit.

M&A BRANCH LINE CIRCUIT

< COMPONENT DIAGNOSIS >

[CAN]

M&A BRANCH LINE CIRCUIT

Diagnosis Procedure

INFOID:000000004219046

1. CHECK CONNECTOR

1. Turn the ignition switch OFF.
2. Disconnect the battery cable from the negative terminal.
3. Check the terminals and connectors of the combination meter for damage, bend and loose connection (unit side and connector side).

Is the inspection result normal?

- YES >> GO TO 2.
NO >> Repair the terminal and connector.

2. CHECK HARNESS FOR OPEN CIRCUIT

1. Disconnect the connector of combination meter.
2. Check the resistance between the combination meter harness connector terminals.

Combination meter harness connector			Resistance (Ω)
Connector No.	Terminal No.		
M24	21	22	Approx. 54 – 66

Is the measurement value within the specification?

- YES >> GO TO 3.
NO >> Repair the combination meter branch line.

3. CHECK POWER SUPPLY AND GROUND CIRCUIT

Check the power supply and the ground circuit of the combination meter. Refer to [MWI-40, "COMBINATION METER : Diagnosis Procedure"](#).

Is the inspection result normal?

- YES (Present error)>>Replace the combination meter. Refer to [MWI-135, "Removal and Installation"](#).
YES (Past error)>>Error was detected in the combination meter branch line.
NO >> Repair the power supply and the ground circuit.

A
B
C
D
E
F
G
H
I
J
K
L

LAN

N
O
P

HV ECU BRANCH LINE CIRCUIT

< COMPONENT DIAGNOSIS >

[CAN]

HV ECU BRANCH LINE CIRCUIT

Diagnosis Procedure

INFOID:000000004219047

1.CHECK DTC

Check whether or not the DTC related to HEV SYSTEM CAN indicated on All DTC Reading by CONSULT-III.

NOTE:

For DTCs related to HEV SYSTEM CAN, refer to [LAN-59. "DTC Related to HEV SYSTEM CAN List"](#).

Is the DTC related to HEV SYSTEM CAN displayed?

YES >> Inspect HEV SYSTEM CAN. Refer to [LAN-53. "Trouble Diagnosis Flow Chart"](#).

NO >> GO TO 2.

2.CHECK CONNECTOR

1. Turn the ignition switch OFF.
2. Disconnect the battery cable from the negative terminal.
3. Check the terminals and connectors of the hybrid vehicle control ECU for damage, bend and loose connection (unit side and connector side).

Is the inspection result normal?

YES >> GO TO 3.

NO >> Repair the terminal and connector.

3.CHECK HARNESS FOR OPEN CIRCUIT

1. Disconnect the connector of hybrid vehicle control ECU.
2. Check the resistance between the hybrid vehicle control ECU harness connector terminals.

Hybrid vehicle control ECU harness connector			Resistance (Ω)
Connector No.	Terminal No.		
E66	173	172	Approx. 54 – 66

Is the measurement value within the specification?

YES >> GO TO 4.

NO >> Repair the hybrid vehicle control ECU branch line.

4.CHECK POWER SUPPLY AND GROUND CIRCUIT

Check the power supply and the ground circuit of the hybrid vehicle control ECU. [HBC-600. "Wiring Diagram"](#).

Is the inspection result normal?

YES (Present error)>>Replace the hybrid vehicle control ECU. Refer to [HBC-644. "Exploded View"](#).

YES (Past error)>>Error was detected in the hybrid vehicle control ECU branch line.

NO >> Repair the power supply and the ground circuit.

IPDM-E BRANCH LINE CIRCUIT

< COMPONENT DIAGNOSIS >

[CAN]

IPDM-E BRANCH LINE CIRCUIT

Diagnosis Procedure

INFOID:000000004219048

1. CHECK CONNECTOR

1. Turn the ignition switch OFF.
2. Disconnect the battery cable from the negative terminal.
3. Check the terminals and connectors of the IPDM E/R for damage, bend and loose connection (unit side and connector side).

Is the inspection result normal?

- YES >> GO TO 2.
NO >> Repair the terminal and connector.

2. CHECK HARNESS FOR OPEN CIRCUIT

1. Disconnect the connector of IPDM E/R.
2. Check the resistance between the IPDM E/R harness connector terminals.

IPDM E/R harness connector			Resistance (Ω)
Connector No.	Terminal No.		
E17	40	39	Approx. 108 – 132

Is the measurement value within the specification?

- YES >> GO TO 3.
NO >> Repair the IPDM E/R branch line.

3. CHECK POWER SUPPLY AND GROUND CIRCUIT

Check the power supply and the ground circuit of the IPDM E/R. Refer to [PCS-22, "Diagnosis Procedure"](#).

Is the inspection result normal?

- YES (Present error)>>Replace the IPDM E/R. Refer to [PCS-39, "Removal and Installation"](#).
YES (Past error)>>Error was detected in the IPDM E/R branch line.
NO >> Repair the power supply and the ground circuit.

A
B
C
D
E
F
G
H
I
J
K
L

LAN

N
O
P

CAN COMMUNICATION CIRCUIT

[CAN]

< COMPONENT DIAGNOSIS >

CAN COMMUNICATION CIRCUIT

Diagnosis Procedure

INFOID:000000004219049

1. CONNECTOR INSPECTION

1. Turn the ignition switch OFF.
2. Disconnect the battery cable from the negative terminal.
3. Disconnect all the unit connectors on CAN communication system.
4. Check terminals and connectors for damage, bend and loose connection.

Is the inspection result normal?

- YES >> GO TO 2.
NO >> Repair the terminal and connector.

2. CHECK HARNESS CONTINUITY (SHORT CIRCUIT)

Check the continuity between the data link connector terminals.

Data link connector			Continuity
Connector No.	Terminal No.		
M22	6	14	Not existed

Is the inspection result normal?

- YES >> GO TO 3.
NO >> Check the harness and repair the root cause.

3. CHECK HARNESS CONTINUITY (SHORT CIRCUIT)

Check the continuity between the data link connector and the ground.

Data link connector		Ground	Continuity
Connector No.	Terminal No.		
M22	6		Not existed
	14		Not existed

Is the inspection result normal?

- YES >> GO TO 4.
NO >> Check the harness and repair the root cause.

4. CHECK ECM AND IPDM E/R TERMINATION CIRCUIT

1. Remove the ECM and the IPDM E/R.
2. Check the resistance between the ECM terminals.

ECM		Resistance (Ω)
Terminal No.		
98	97	Approx. 108 – 132

3. Check the resistance between the IPDM E/R terminals.

IPDM E/R		Resistance (Ω)
Terminal No.		
40	39	Approx. 108 – 132

Is the measurement value within the specification?

- YES >> GO TO 5.
NO >> Replace the ECM and/or the IPDM E/R.

5. CHECK SYMPTOM

Connect all the connectors. Check if the symptoms described in the "Symptom (Results from interview with customer)" are reproduced.

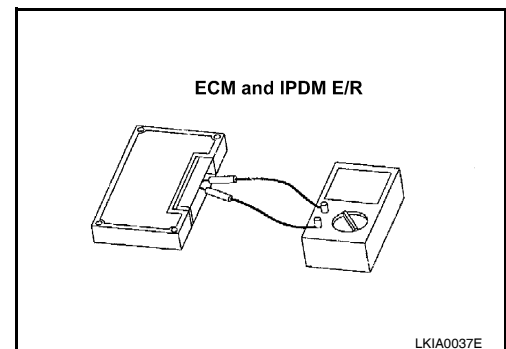

CAN COMMUNICATION CIRCUIT

< COMPONENT DIAGNOSIS >

[CAN]

Inspection result

Reproduced>>GO TO 6.

Non-reproduced>>Start the diagnosis again. Follow the trouble diagnosis procedure when past error is detected.

6.CHECK UNIT REPRODUCTION

Perform the reproduction test as per the following procedure for each unit.

1. Turn the ignition switch OFF.
2. Disconnect the battery cable from the negative terminal.
3. Disconnect one of the unit connectors of CAN communication system.

NOTE:

ECM and IPDM E/R have a termination circuit. Check other units first.

4. Connect the battery cable to the negative terminal. Check if the symptoms described in the "Symptom (Results from interview with customer)" are reproduced.

NOTE:

Although unit-related error symptoms occur, do not confuse them with other symptoms.

Inspection result

Reproduced>>Connect the connector. Check other units as per the above procedure.

Non-reproduced>>Replace the unit whose connector was disconnected.

A
B
C
D
E
F
G
H
I
J
K
L

LAN

N
O
P

< HOW TO USE THIS MANUAL >

HOW TO USE THIS MANUAL

DESCRIPTION

Description

INFOID:000000004219050

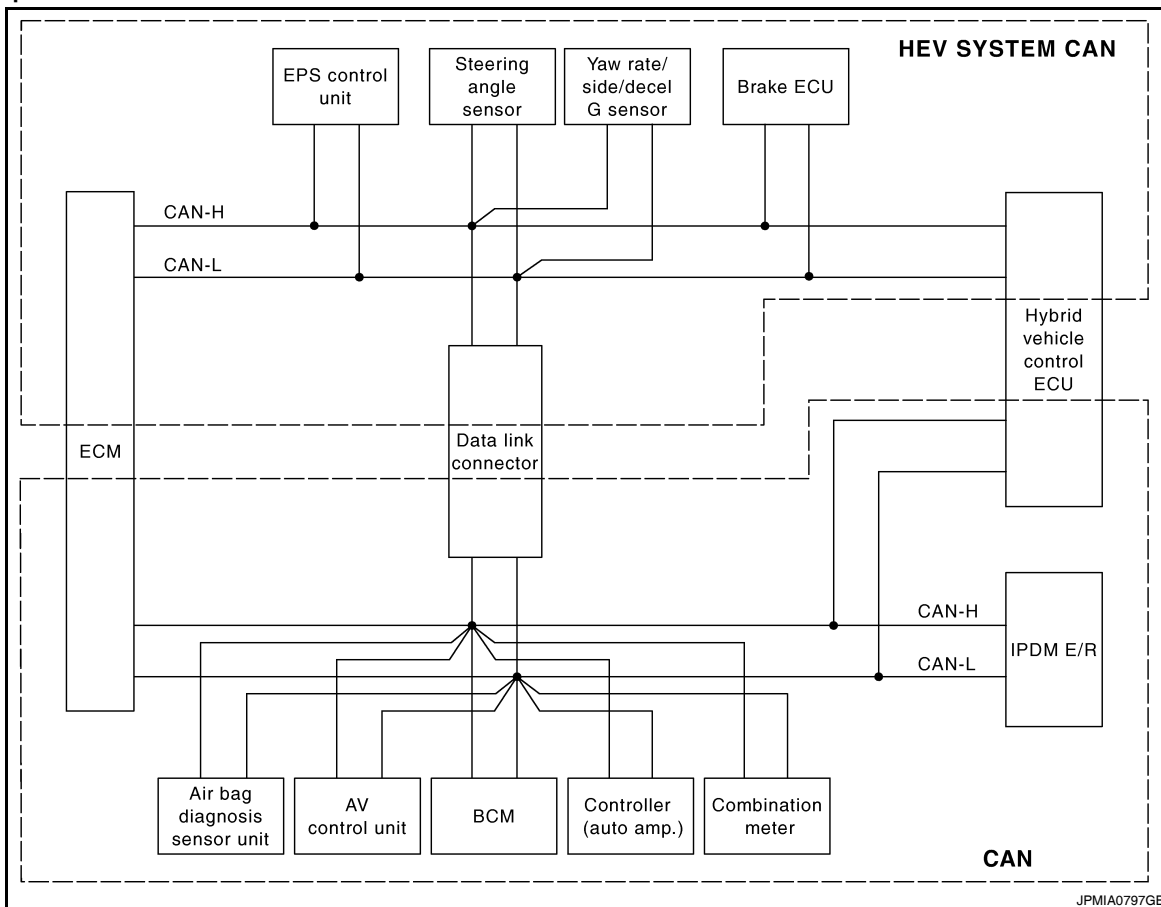

JPMIA0797GB

This vehicle has two types of CAN communication systems; CAN and HEV SYSTEM CAN. For starting the trouble diagnosis, refer to the following list.

NOTE:

- If the DTCs related to CAN and related to HEV SYSTEM CAN are displayed at the same time, diagnose CAN first.
- After the diagnosis of HEV SYSTEM CAN or CAN, erase the DTCs of unit connected to HEV SYSTEM CAN and CAN.

DESCRIPTION

< HOW TO USE THIS MANUAL >

[HEV SYSTEM CAN]

Unit	DTC (INF code [*]) displayed on CONSULT-III	CAN communication system	Inspection
ECM	P0607, U1001, U0164	CAN	LAN-16. "Trouble Diagnosis Flow Chart"
	P0607, U0129, U0293, U1020, U1022	HEV SYSTEM CAN	
EPS control unit	C1608, U0129, U0293	HEV SYSTEM CAN	
Brake ECU	C1300, U0073, U0123, U0124, U0126, U0293	HEV SYSTEM CAN	LAN-53. "Trouble Diagnosis Flow Chart"
Hybrid vehicle control ECU	P0A1D (924), P0A1D (925), U0100, U0100 (211), U0100 (212), U0100 (530), U0129, U0129 (220), U0129 (222), U0129 (528), U0131, U0131 (433), U0131 (434)	HEV SYSTEM CAN	
	U1001, U1001 (146), U1001 (435), U1001 (594), U1001 (827), U1001 (919), U1001 (920)	CAN	
AV control unit	P0607, U1000, U1010	CAN	LAN-16. "Trouble Diagnosis Flow Chart"
BCM			
Controller (auto amp.)			
Combination meter			
IPDM E/R			

*: For the details, refer to [HBC-80. "Diagnosis Description"](#).

A
B
C
D
E
F
G
H
I
J
K
L
N
O
P

LAN

HOW TO USE THIS SECTION

< HOW TO USE THIS MANUAL >

[HEV SYSTEM CAN]

HOW TO USE THIS SECTION

Caution

INFOID:000000004219051

For trouble diagnosis procedure, refer to [LAN-53. "Trouble Diagnosis Procedure"](#).

Abbreviation List

INFOID:000000004219052

Unit name abbreviations in HEV SYSTEM CAN diagnosis are as per the following list.

Abbreviation	Unit name	All DTC Reading (CONSULT-III)
ABS	Brake ECU	ABS
DLC	Data link connector	—
ECM	ECM	ENGINE
EPS	EPS control unit	EPS
HV ECU	Hybrid vehicle control ECU	HYBRID SYSTEM
STRG	Steering angle sensor	—
YAW	Yaw rate/side/decel G sensor	—

PRECAUTION

PRECAUTIONS

Precautions For High-Voltage System

INFOID:000000004219053

Refer to [GI-24, "Precautions For High-Voltage System"](#).

Precaution for Supplemental Restraint System (SRS) "AIR BAG" and "SEAT BELT PRE-TENSIONER"

INFOID:000000004219054

The Supplemental Restraint System such as "AIR BAG" and "SEAT BELT PRE-TENSIONER", used along with a front seat belt, helps to reduce the risk or severity of injury to the driver and front passenger for certain types of collision. This system includes seat belt switch inputs and dual stage front air bag modules. The SRS system uses the seat belt switches to determine the front air bag deployment, and may only deploy one front air bag, depending on the severity of a collision and whether the front occupants are belted or unbelted. Information necessary to service the system safely is included in the "SRS AIRBAG" and "SEAT BELT" of this Service Manual.

WARNING:

- To avoid rendering the SRS inoperative, which could increase the risk of personal injury or death in the event of a collision which would result in air bag inflation, all maintenance must be performed by an authorized NISSAN/INFINITI dealer.
- Improper maintenance, including incorrect removal and installation of the SRS, can lead to personal injury caused by unintentional activation of the system. For removal of Spiral Cable and Air Bag Module, see the "SRS AIRBAG".
- Never use electrical test equipment on any circuit related to the SRS unless instructed to in this Service Manual. SRS wiring harnesses can be identified by yellow and/or orange harnesses or harness connectors.

Precautions for Trouble Diagnosis

INFOID:000000004219055

CAUTION:

- Never apply 7.0 V or more to the measurement terminal.
- Use a tester with open terminal voltage of 7.0 V or less.
- Turn the ignition switch OFF and disconnect the battery cable from the negative terminal when checking the harness.

Precautions for Harness Repair

INFOID:000000004219056

- Solder the repaired area and wrap tape around the soldered area.

NOTE:

A fray of twisted lines must be within 110 mm (4.33 in).

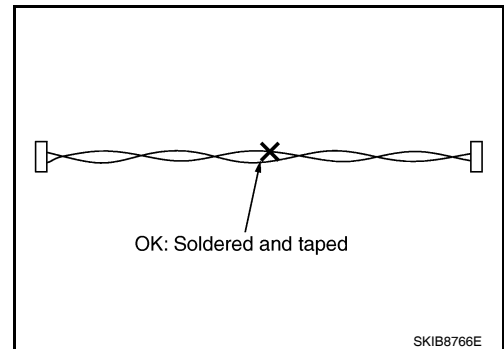

A
B
C
D
E
F
G
H
I
J
K
L
LAN
N
O
P

PRECAUTIONS

[HEV SYSTEM CAN]

< PRECAUTION >

- Bypass connection is never allowed at the repaired area.

NOTE:

Bypass connection may cause CAN communication error. The spliced wire becomes separated and the characteristics of twisted line are lost.

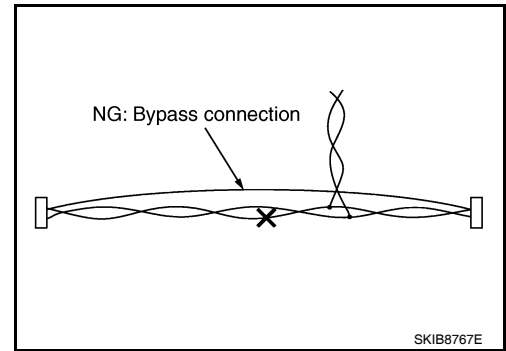

- Replace the applicable harness as an assembly if error is detected on the shield lines of HEV SYSTEMCAN communication line.

BASIC INSPECTION

DIAGNOSIS AND REPAIR WORKFLOW

Information Needed for Trouble Diagnosis

INFOID:000000004219057

HEV SYSTEM CAN performs trouble diagnosis with the following tools.

Tool	Usage
Diagnosis sheet	For detecting the root cause.
All DTC Reading (CONSULT-III)	For checking the condition of control units and the status of HEV SYSTEM CAN communication.
Abbreviation list	For checking abbreviations in diagnosis sheet.

Trouble Diagnosis Flow Chart

INFOID:000000004219058

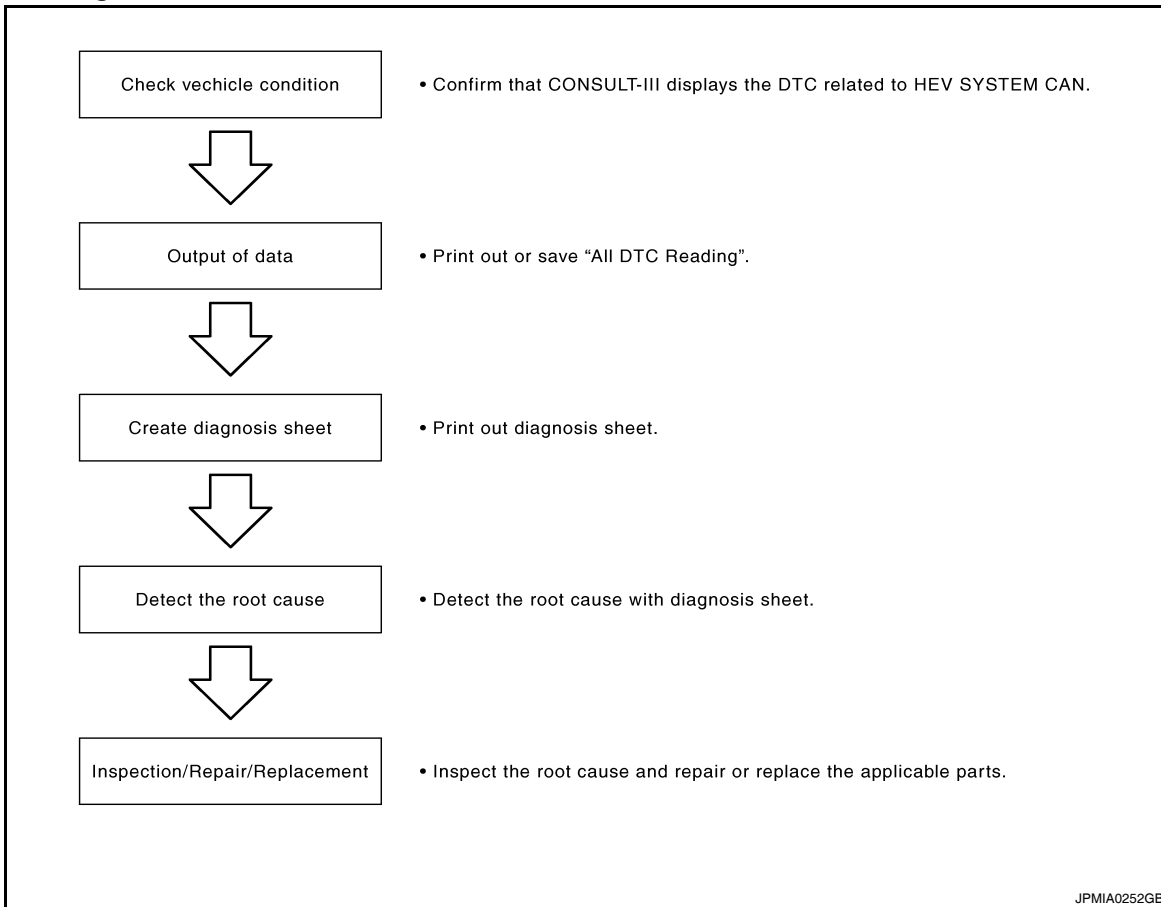

Trouble Diagnosis Procedure

INFOID:000000004219059

CHECK VEHICLE CONDITION

Check whether or not the DTC related to HEV SYSTEM CAN indicated on "All DTC Reading" by CONSULT-III.

NOTE:

Root cause cannot be detected using the procedure in this section if the DTC related to HEV SYSTEM CAN is not indicated. Refer to [LAN-59, "DTC Related to HEV SYSTEM CAN List"](#).

OUTPUT OF DATA

Print out or save "All DTC Reading".

CREATE DIAGNOSIS SHEET

Print out diagnosis sheet. Refer to [LAN-59, "Diagnosis Sheet"](#).

NOTE:

DIAGNOSIS AND REPAIR WORKFLOW

< BASIC INSPECTION >

[HEV SYSTEM CAN]

For abbreviations, refer to [LAN-50. "Abbreviation List"](#).

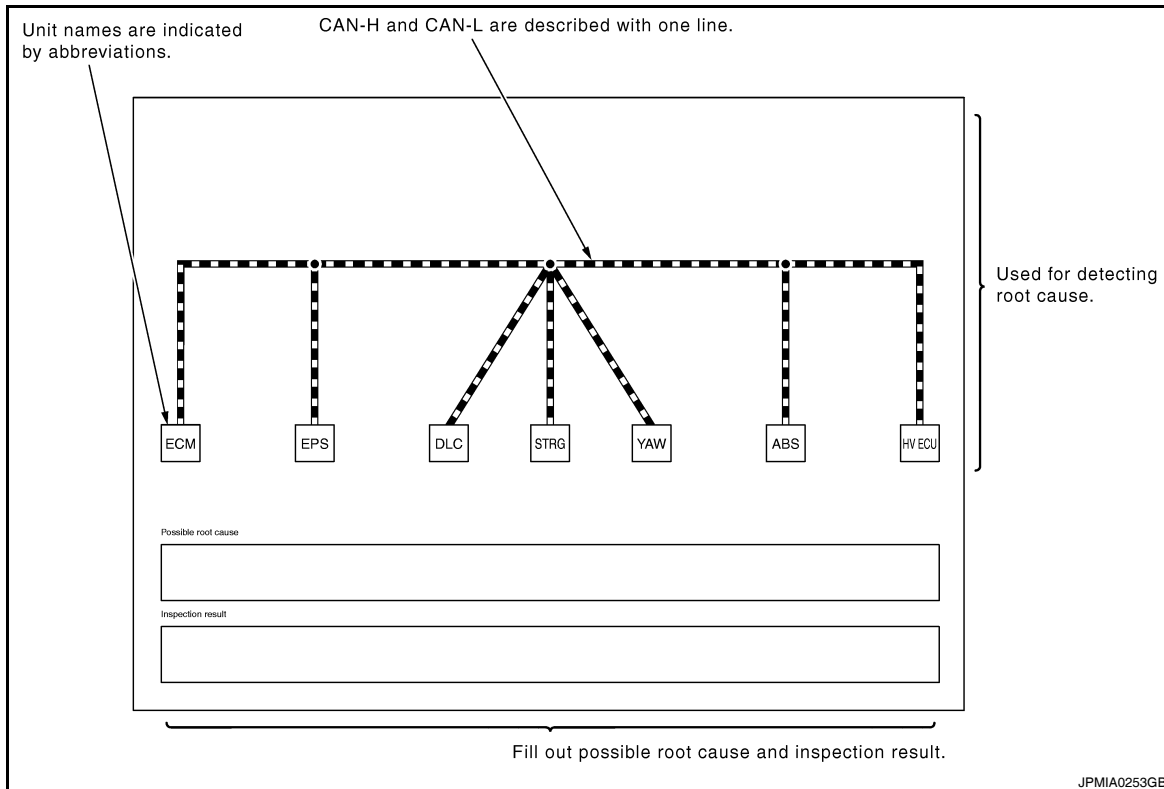

DETECT THE ROOT CAUSE

Description

To detect the root cause of HEV SYSTEM CAN, check for short circuit first. When there is no short circuit, check for open circuit.

Short Circuit

Check for short circuit, and DLC branch line open circuit.

When the symptoms listed below exist, a short circuit of the HEV SYSTEM CAN communication line or control unit is a possible cause.

Received data

Item (CONSULT-III)	Indication
The printed or saved All DTC Reading	<ul style="list-style-type: none"> The items of EPS and ABS are not displayed. U0129, U0293, U1020 and U1022 are displayed as the ENGINE items. U0100^{*1}, U0129^{*2} and U0131^{*3} are displayed as the HYBRID SYSTEM items.

- *1: Hybrid vehicle control ECU may display one or more DTCs (INF code) listed as follows; U0100 (211), U0100 (212), U0100 (530).
- *2: Hybrid vehicle control ECU may display one or more DTCs (INF code) listed as follows; U0129 (220), U0129 (222), U0129 (528).
- *3: Hybrid vehicle control ECU may display one or more DTCs (INF code) listed as follows; U0131 (433), U0131 (434).

Error symptom

- Most the units connected to the HEV SYSTEM CAN go into fail-safe mode or are deactivated.

Inspection procedure

DIAGNOSIS AND REPAIR WORKFLOW

< BASIC INSPECTION >

[HEV SYSTEM CAN]

- Refer to [LAN-68. "Short Circuit"](#).

(Example)

All DTC Reading			
DTC RESULTS	TIME	DTC RESULTS	TIME
IPDM E/R		No DTC is detected. Further testing may be required.	
HYBRID SYSTEM		No DTC is detected. Further testing may be required.	
U0100: LOST COMM [ECM]		U0131: LOST COMM [EPS]	
U0129: LOST COMM [BRAKE]		U0293: LOST COMM [HV ECU]	
		U0129: LOST COMM [BRAKE]	
		U01020: LOST COMM [HV ECU]	
		U01022: LOST COMM [BRAKE]	
		U0129: LOST COMM [BRAKE]	
		U0129: LOST COMM [BRAKE]	

DTC RESULTS	TIME	DTC RESULTS	TIME
REARVIEW CAMERA		No DTC is detected. Further testing may be required.	
AIR BAG		No DTC is detected. Further testing may be required.	
METER/M&A		No DTC is detected. Further testing may be required.	
B2205: SPEED METER		CRNT	
ENGINE		No DTC is detected. Further testing may be required.	
U0293: LOST COMM [HV ECU]		0	
U0129: LOST COMM [BRAKE]		0	

JPMIA0260GB

NOTE:

- DLC branch line circuit can be open when the following conditions are satisfied as All DTC Reading result;
- The DTCs related to HEV SYSTEM CAN are not displayed as ENGINE or HYBRID SYSTEM item.
 - The items of EPS and ABS are not displayed.

For the DLC branch line circuit inspection procedure, refer to [LAN-68. "Branch Line"](#).

Open Circuit

Draw a line on the diagnosis sheet to indicate the possible cause. Narrow the search.

NOTE:

- Color-code when drawing lines.
- Do not draw a line onto an existing line.
- When the root cause appears to be a branch line, be sure to check the control unit as well as the communication line.

1. Check each item on the printed or saved All DTC Reading. Draw a line on the diagnosis sheet to indicate the error circuit. Refer to [LAN-59. "DTC Related to HEV SYSTEM CAN List"](#).

a. Reception item of "HYBRID SYSTEM":

i. "U0100: LOST COMM [ECM]:211", "U0100: LOST COMM [ECM]:212" and "U0100: LOST COMM [ECM]:530" are indicated. This means HV ECU cannot receive the signal from ECM. Draw a line to indicate an error between HV ECU and ECM (line 1-a-i in the figure below).

A
B
C
D
E
F
G
H
I
J
K
L
N
O
P

LAN

DIAGNOSIS AND REPAIR WORKFLOW

< BASIC INSPECTION >

[HEV SYSTEM CAN]

- ii. “U0131:LOST COMM [EPS]:433” and “U0131:LOST COMM [EPS]:434” are indicated. This means HV ECU cannot receive the signal from EPS. Draw a line to indicate an error between HV ECU and EPS (line 1-a-ii in the figure below).

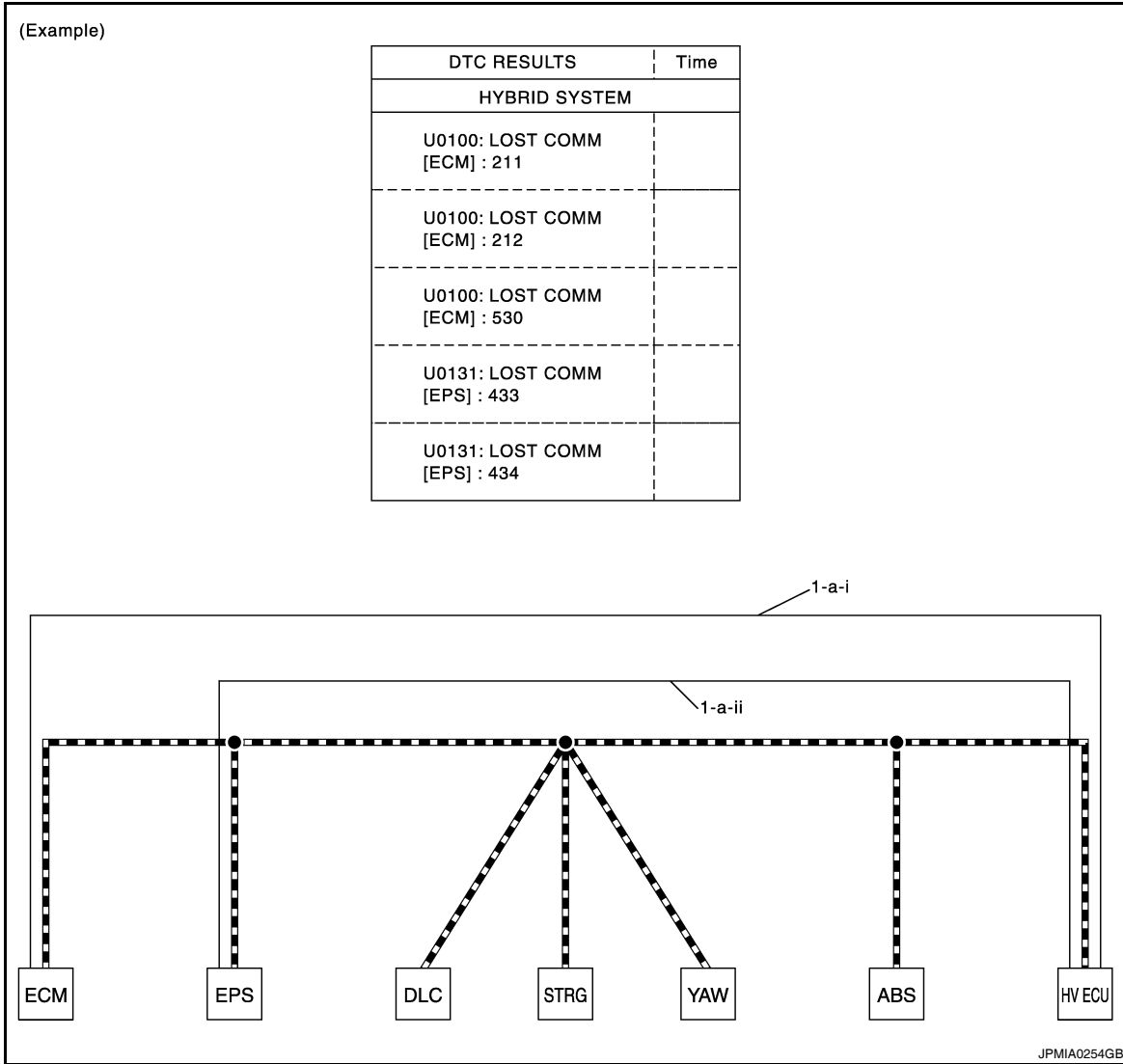

- b. Reception item of “ENGINE”:
- i. “U0293” and “U1020” are indicated. This means ECM cannot receive the signal from HV ECU. Draw a line to indicate an error between ECM and HV ECU (line 1-b-i in the figure below).

DIAGNOSIS AND REPAIR WORKFLOW

< BASIC INSPECTION >

[HEV SYSTEM CAN]

- ii. "U0129" and "U1022" are indicated. This means ECM cannot receive the signal from ABS. Draw a line to indicate an error between ECM and ABS (line 1-b-ii in the figure below).

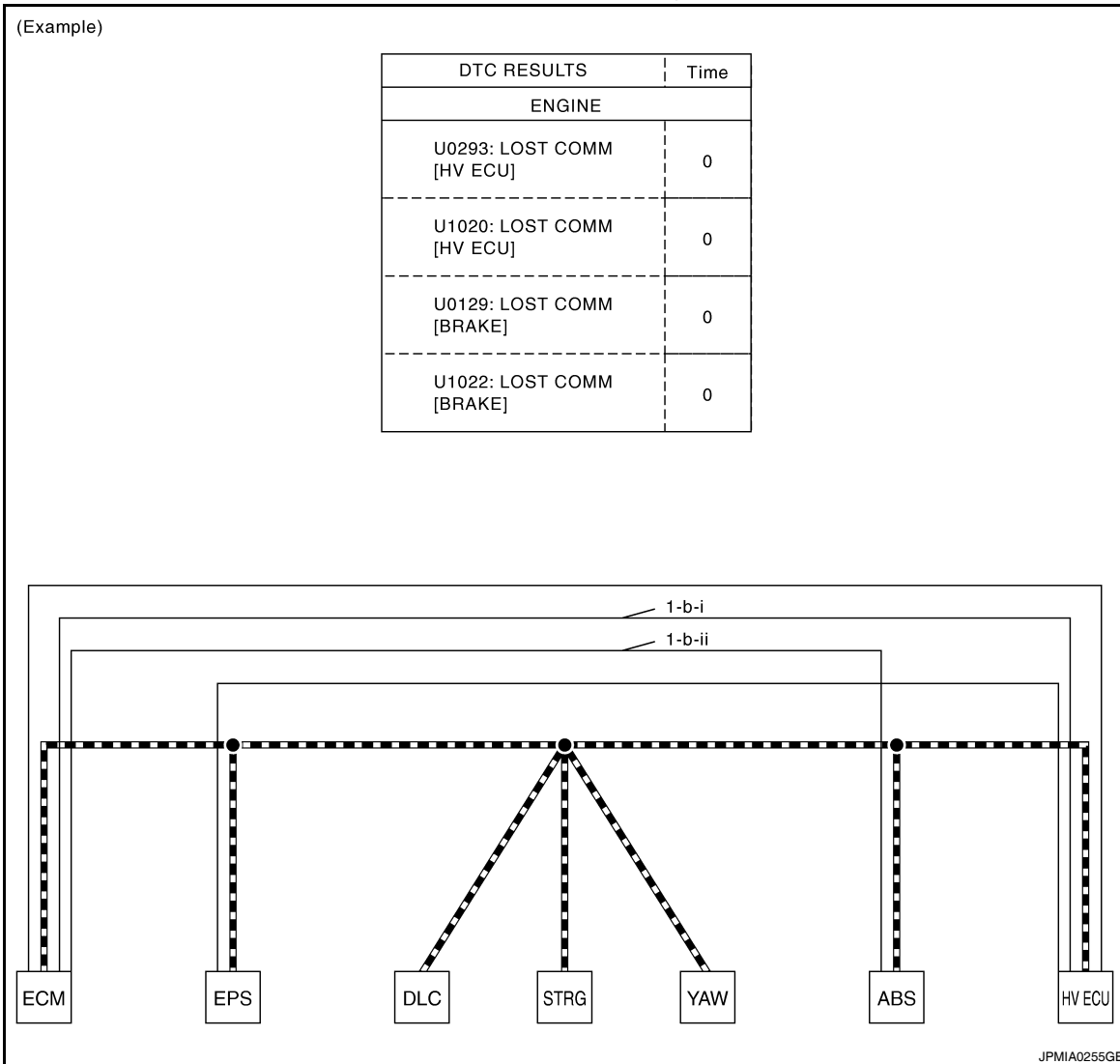

2. Based on information received from the printed or saved All DTC Reading, place a check mark on the known good HEV SYSTEM CAN communication line between ECM and HV ECU.
 - a. Through the previous procedure, the circuit between EPS splice and ABS splice has the most amount of lines (shade 2-a in the figure below).
 - b. Place a check mark on the known good lines to establish the error circuit.

A
B
C
D
E
F
G
H
I
J
K
L
N
O
P

LAN

DIAGNOSIS AND REPAIR WORKFLOW

< BASIC INSPECTION >

[HEV SYSTEM CAN]

Reception item of "ABS": "U0073", "U0123" and "U0124" are not indicated. ABS communicates normally with YAW. Put a check mark on the normal circuit between ABS and YAW (check mark 2-b in the figure below).

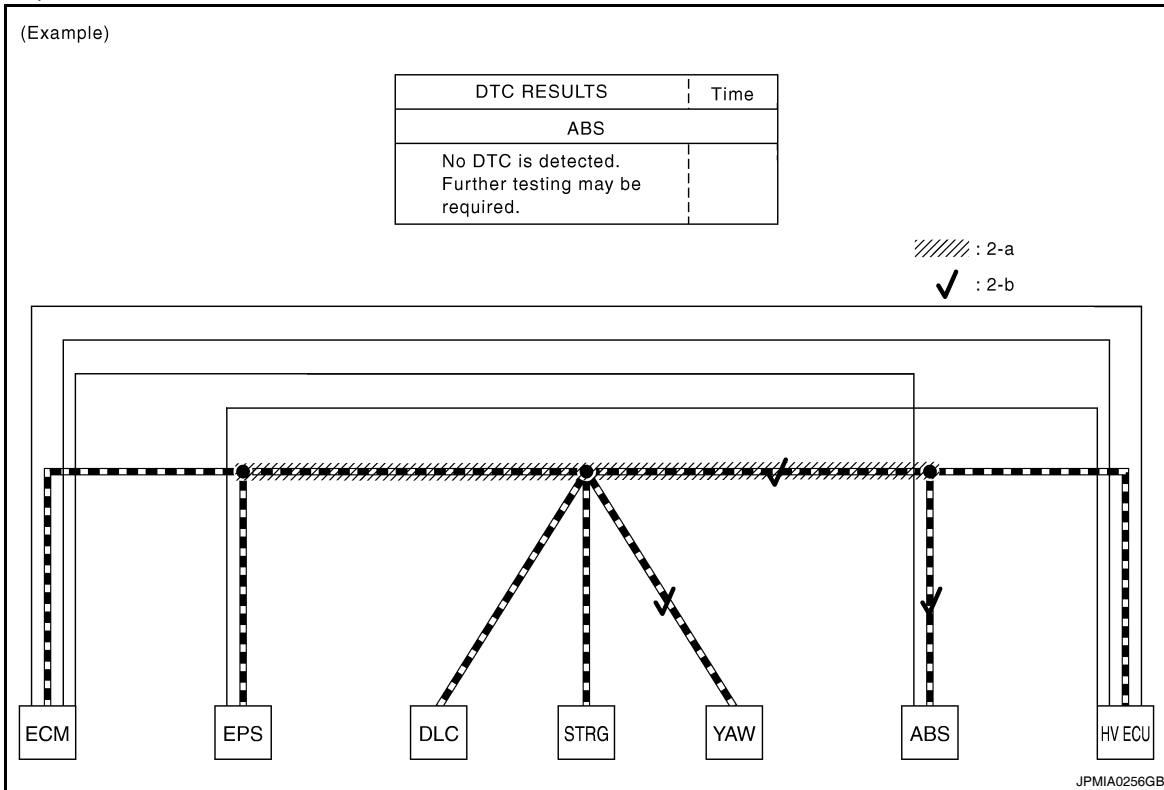

3. Through the above procedure, the error is detected in between EPS and DLC main line (shaded in the figure below).

NOTE:

For abbreviations, refer to [LAN-50, "Abbreviation List"](#).

4. Perform the inspection for the detected error circuit. For the inspection procedure, refer to [LAN-68, "Main Line"](#). (When the error is detected on branch line, refer to [LAN-68, "Branch Line"](#).)

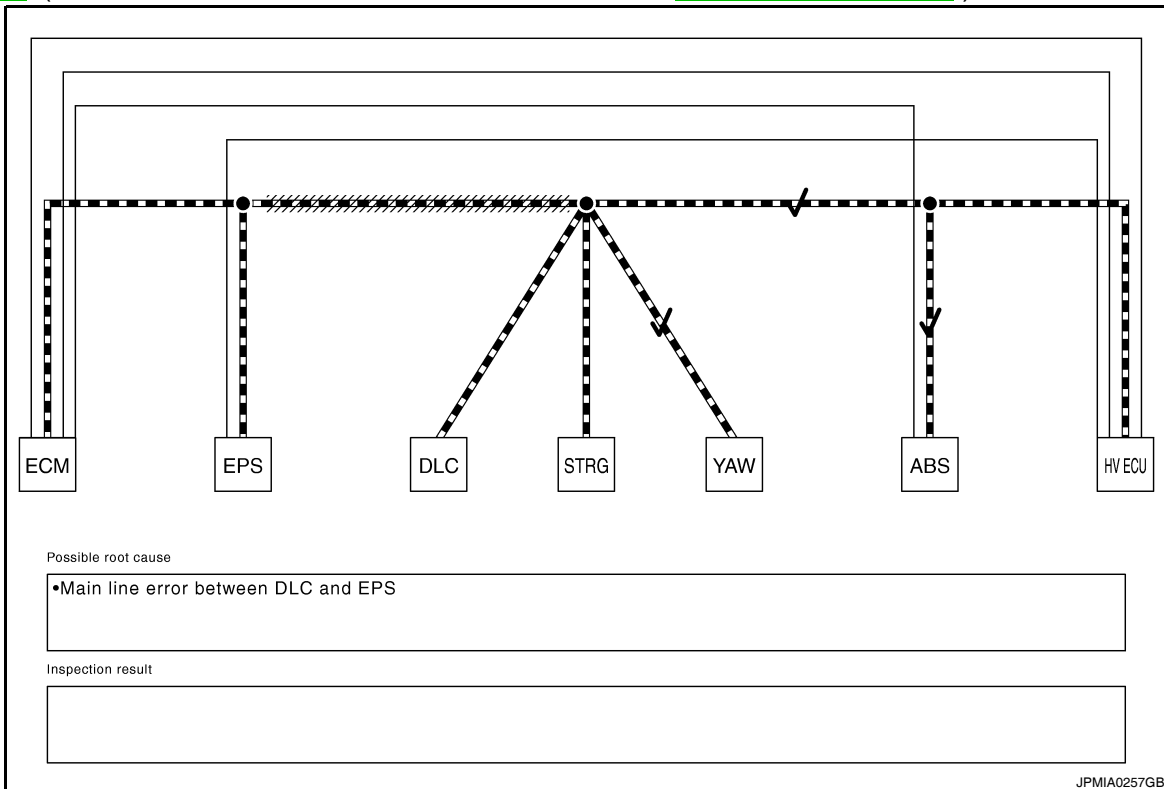

DIAGNOSIS AND REPAIR WORKFLOW

< BASIC INSPECTION >

[HEV SYSTEM CAN]

Diagnosis Sheet

INFOID:000000004219060

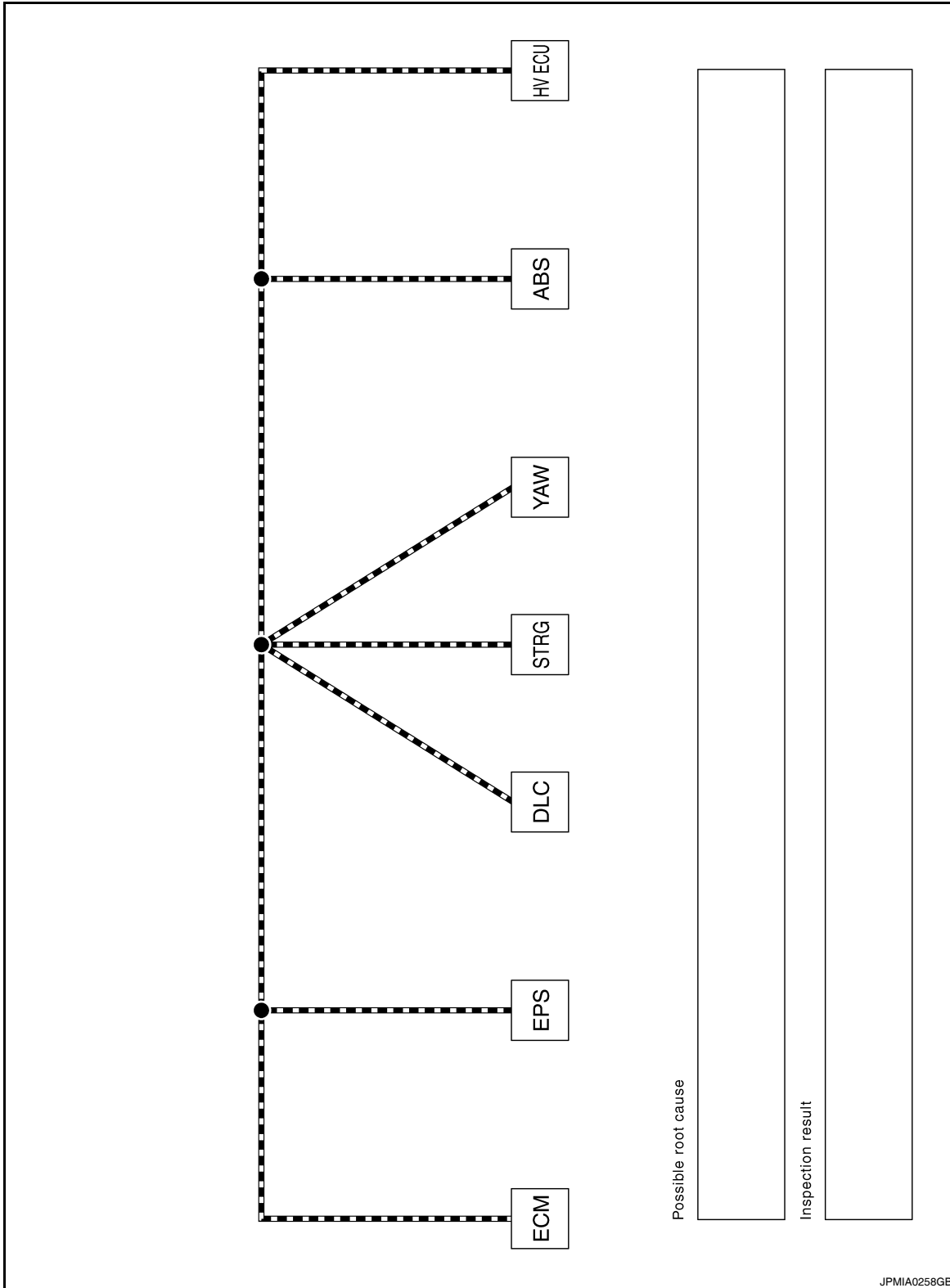

A
B
C
D
E
F
G
H
I
J
K
L
LAN
N
O
P

DTC Related to HEV SYSTEM CAN List

INFOID:000000004219061

DIAGNOSIS AND REPAIR WORKFLOW

< BASIC INSPECTION >

[HEV SYSTEM CAN]

Unit	DTC (INF code)	Diagnostic unit	Self-diagnosis item (CONSULT-III indication)	DTC detection logic	Possible cause
Hybrid vehicle control ECU	<ul style="list-style-type: none"> • P0A1D (924) • P0A1D (925) 	—	HV ECU	Hybrid vehicle control ECU malfunctions.	Hybrid vehicle control ECU
	<ul style="list-style-type: none"> • U0100 (211) • U0100 (530) 	ECM	LOST COMM [ECM]	CAN communication signal is not transmitted or received between ECM and hybrid vehicle control ECU for 1 second or more.	<ul style="list-style-type: none"> • HEV SYSTEM CAN communication line between ECM and hybrid vehicle control ECU • HEV SYSTEM CAN communication line short
	U0100 (212)	ECM	LOST COMM [ECM]	Malfunction signal of CAN communication line between ECM and hybrid vehicle control ECU is received.	<ul style="list-style-type: none"> • HEV SYSTEM CAN communication line between ECM and hybrid vehicle control ECU • HEV SYSTEM CAN communication line short
	<ul style="list-style-type: none"> • U0129 (220) • U0129 (528) 	ABS	LOST COMM [BRAKE]	CAN communication signal is not transmitted or received between brake ECU and hybrid vehicle control ECU for 2 seconds or more.	<ul style="list-style-type: none"> • HEV SYSTEM CAN communication line between brake ECU and hybrid vehicle control ECU • HEV SYSTEM CAN communication line short
	U0129 (222)	ABS	LOST COMM [BRAKE]	Malfunction signal of CAN communication line between brake ECU and hybrid vehicle control ECU is received.	<ul style="list-style-type: none"> • HEV SYSTEM CAN communication line between brake ECU and hybrid vehicle control ECU • HEV SYSTEM CAN communication line short
	<ul style="list-style-type: none"> • U0131 (433) • U0131 (434) 	EPS	LOST COMM [EPS]	CAN communication signal is not received between EPS control unit and hybrid vehicle control ECU for 1 second or more.	<ul style="list-style-type: none"> • HEV SYSTEM CAN communication line between EPS control unit and hybrid vehicle control ECU • HEV SYSTEM CAN communication line short

DIAGNOSIS AND REPAIR WORKFLOW

< BASIC INSPECTION >

[HEV SYSTEM CAN]

Unit	DTC (INF code)	Diagnostic unit	Self-diagnosis item (CONSULT-III indication)	DTC detection logic	Possible cause
Brake ECU	C1300	—	ECU	Brake ECU malfunctions.	Brake ECU
	U0073	• YAW • STRG	LOST COMM YAW/STRG	<ul style="list-style-type: none"> • CAN communication is stopped for more than 1 second. • The following phenomenon occur more than 10 times in 60 seconds. - CAN communication with yaw rate/side/decel G sensor or steering angle sensor is suspended more than 1 time per 5 seconds. 	<ul style="list-style-type: none"> • HEV SYSTEM CAN communication line between brake ECU and yaw rate/side/decel G sensor, steering angle sensor • HEV SYSTEM CAN communication line short
	U0123	• YAW • HV ECU	LOST COMM [YAW]	<ul style="list-style-type: none"> • CAN communication signal is not received between yaw rate/side/decel G sensor and brake ECU for 1 second or more. • The following phenomenon occur more than 10 times in 60 seconds. - CAN communication with hybrid vehicle control ECU is suspended more than 1 time per 5 seconds. 	<ul style="list-style-type: none"> • HEV SYSTEM CAN communication line between brake ECU and yaw rate/side/decel G sensor, hybrid vehicle control ECU • HEV SYSTEM CAN communication line short
	U0124	• YAW • HV ECU	LOST COMM [DECEL]		
	U0126	• STRG • HV ECU	LOST COMM [STRG]	<ul style="list-style-type: none"> • CAN communication signal is not received between steering angle sensor and brake ECU for 1 second or more. • The following phenomenon occur more than 10 times in 60 seconds. - CAN communication with hybrid vehicle control ECU is suspended more than 1 time per 5 seconds. 	<ul style="list-style-type: none"> • HEV SYSTEM CAN communication line between brake ECU and steering angle sensor, hybrid vehicle control ECU • HEV SYSTEM CAN communication line short
	U0293	HV ECU	LOST COMM [HV ECU]	<ul style="list-style-type: none"> • CAN communication signal is not received between hybrid vehicle control ECU and brake ECU for 2 seconds or more. • CAN communication signal from hybrid vehicle control ECU has error. • The following phenomenon occur more than 10 times in 60 seconds. - CAN communication with hybrid vehicle control ECU is suspended more than 1 time per 5 seconds. 	<ul style="list-style-type: none"> • HEV SYSTEM CAN communication line between brake ECU and hybrid vehicle control ECU • HEV SYSTEM CAN communication line short
	EPS control unit	C1608	—	CONTROL UNIT	EPS control unit malfunctions.
U0129		ABS	LOST COMM [BRAKE]	CAN communication signal is not received between brake ECU and EPS control unit for 2 seconds or more.	<ul style="list-style-type: none"> • HEV SYSTEM CAN communication line between brake ECU and EPS control unit • HEV SYSTEM CAN communication line short
U0293		HV ECU	LOST COMM [HV ECU]	CAN communication signal is not received between hybrid vehicle control ECU and EPS control unit for 2 seconds or more.	<ul style="list-style-type: none"> • HEV SYSTEM CAN communication line between hybrid vehicle control ECU and EPS control unit • HEV SYSTEM CAN communication line short

A
B
C
D
E
F
G
H
I
J
K
L

LAN

N
O
P

DIAGNOSIS AND REPAIR WORKFLOW

< BASIC INSPECTION >

[HEV SYSTEM CAN]

Unit	DTC (INF code)	Diagnostic unit	Self-diagnosis item (CONSULT-III indication)	DTC detection logic	Possible cause
ECM	P0607	—	ECM	ECM malfunctions.	ECM
	<ul style="list-style-type: none"> • U0293 • U1020 	HV ECU	LOST COMM [HV ECU]	CAN communication signal is not received between hybrid vehicle control ECU and ECM for 1 second or more.	<ul style="list-style-type: none"> • HEV SYSTEM CAN communication line between hybrid vehicle control ECU and ECM • HEV SYSTEM CAN communication line short
	<ul style="list-style-type: none"> • U0129 • U1022 	ABS	LOST COMM [BRAKE]	CAN communication signal is not received between brake ECU and ECM for 1 second or more.	<ul style="list-style-type: none"> • HEV SYSTEM CAN communication line between brake ECU and ECM • HEV SYSTEM CAN communication line short

COMPONENT DIAGNOSIS

CAN COMMUNICATION SYSTEM

Component Parts Location

INFOID:000000004219062

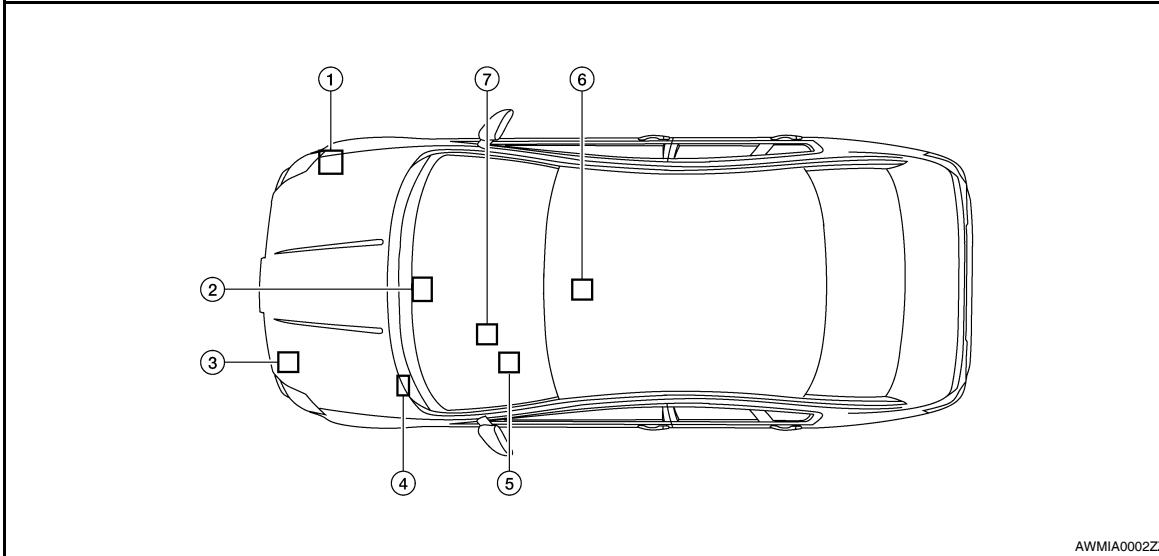

- | | | |
|----------------------------|-----------------------------------|-------------------------------------|
| 1. Brake ECU E61 | 2. Hybrid vehicle control ECU E66 | 3. ECM F13 |
| 4. EPS control unit E302 | 5. Steering angle sensor M53 | 6. Yaw rate/side/decel G sensor M55 |
| 7. Data link connector M22 | | |

A
B
C
D
E
F
G
H
I
J
K
L
N
O
P

LAN

CAN COMMUNICATION SYSTEM

< COMPONENT DIAGNOSIS >

[HEV SYSTEM CAN]

Wiring Diagram - HEV SYSTEM CAN -

INFOID:000000004219063

HEV SYSTEM CAN

--- : DATA LINE

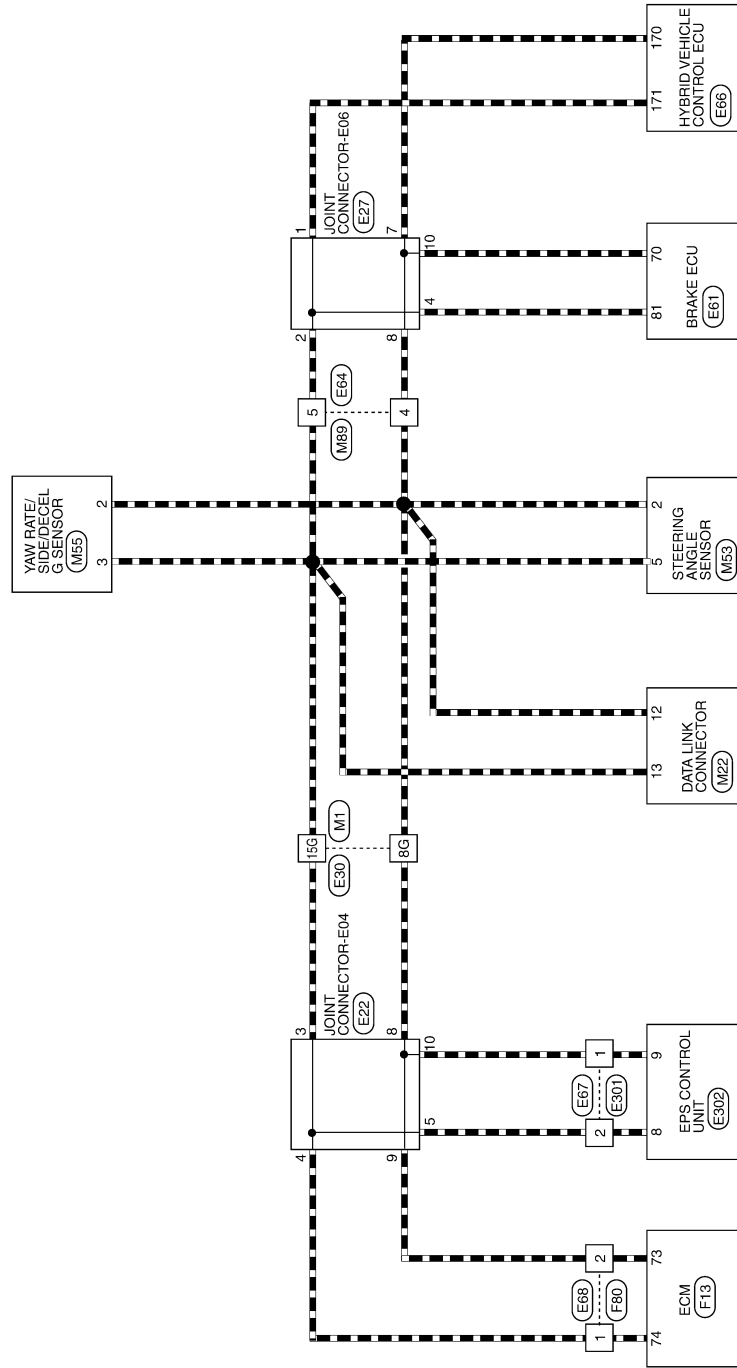

AWMWA0091G

CAN COMMUNICATION SYSTEM

< COMPONENT DIAGNOSIS >

[HEV SYSTEM CAN]

HEV SYSTEM CAN CONNECTORS

Connector No.	M1
Connector Name	WIRE TO WIRE
Connector Color	WHITE

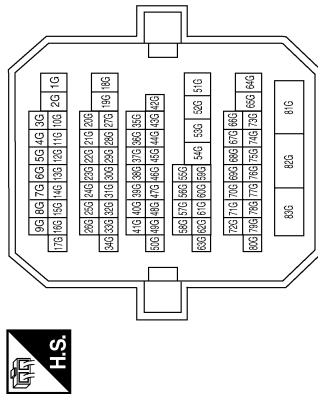

Terminal No.	Color of Wire	Signal Name
8G	BR	—
15G	Y	—

Connector No.	M55
Connector Name	YAW RATE/SIDE/DECEL G SENSOR
Connector Color	WHITE

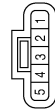

Terminal No.	Color of Wire	Signal Name
2	BR	CAN-L
3	Y	CAN-H

Connector No.	M22
Connector Name	DATA LINK CONNECTOR
Connector Color	WHITE

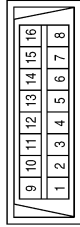

Terminal No.	Color of Wire	Signal Name
12	BR	CAN-L
13	Y	CAN-H

Connector No.	M89
Connector Name	WIRE TO WIRE
Connector Color	WHITE

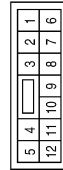

Terminal No.	Color of Wire	Signal Name
4	BR	—
5	Y	—

Connector No.	M53
Connector Name	STEERING ANGLE SENSOR
Connector Color	WHITE

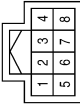

Terminal No.	Color of Wire	Signal Name
2	BR	CAN-L
5	Y	CAN-H

Connector No.	E22
Connector Name	JOINT CONNECTOR-E04
Connector Color	BLACK

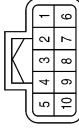

Terminal No.	Color of Wire	Signal Name
3	Y	—
4	Y	—
5	Y	—
8	BR	—
9	BR	—
10	BR	—

ALMIA0071GB

A
B
C
D
E
F
G
H
I
J
K
L
M
N
O
P

LAN

CAN COMMUNICATION SYSTEM

< COMPONENT DIAGNOSIS >

[HEV SYSTEM CAN]

Connector No.	E27
Connector Name	JOINT CONNECTOR-E06
Connector Color	BLUE

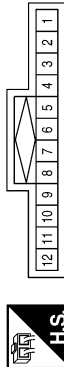

Terminal No.	Color of Wire	Signal Name
1	Y	—
2	Y	—
4	Y	—
7	BR	—
8	BR	—
10	BR	—

Connector No.	E30
Connector Name	WIRE TO WIRE
Connector Color	WHITE

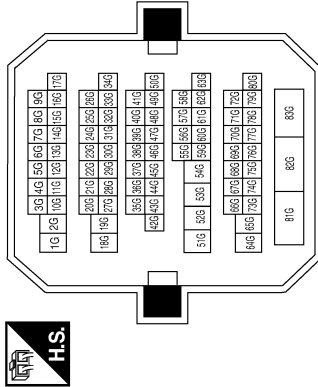

Terminal No.	Color of Wire	Signal Name
8G	BR	—
15G	Y	—

Connector No.	E61
Connector Name	BRAKE ECU
Connector Color	BLACK

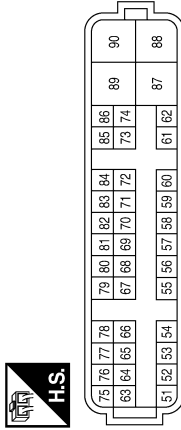

Terminal No.	Color of Wire	Signal Name
70	BR	CAN-L
81	Y	CAN-H

Connector No.	E64
Connector Name	WIRE TO WIRE
Connector Color	WHITE

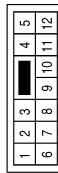

Terminal No.	Color of Wire	Signal Name
4	BR	—
5	Y	—

Connector No.	E66
Connector Name	HYBRID VEHICLE CONTROL ECU
Connector Color	BLACK

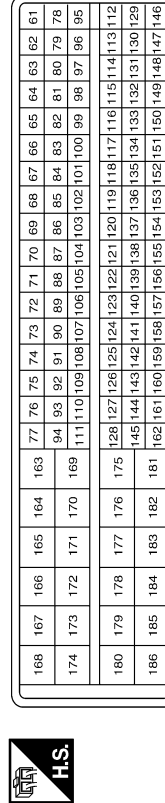

Terminal No.	Color of Wire	Signal Name
170	BR	CAN-L
171	Y	CAN-H

CAN COMMUNICATION SYSTEM

< COMPONENT DIAGNOSIS >

[HEV SYSTEM CAN]

Connector No.	E301
Connector Name	WIRE TO WIRE
Connector Color	BLACK

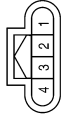

Terminal No.	Color of Wire	Signal Name
1	BR	—
2	Y	—

Connector No.	E68
Connector Name	WIRE TO WIRE
Connector Color	WHITE

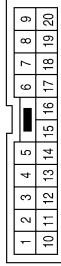

Terminal No.	Color of Wire	Signal Name
1	Y	—
2	BR	—

Connector No.	E67
Connector Name	WIRE TO WIRE
Connector Color	BLACK

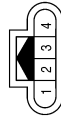

Terminal No.	Color of Wire	Signal Name
1	BR	—
2	Y	—

Connector No.	F80
Connector Name	WIRE TO WIRE
Connector Color	WHITE

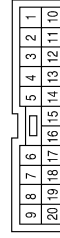

Terminal No.	Color of Wire	Signal Name
1	Y	—
2	BR	—

Connector No.	F13
Connector Name	ECM
Connector Color	BROWN

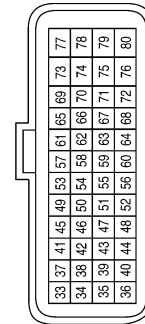

Terminal No.	Color of Wire	Signal Name
73	BR	CAN-L
74	Y	CAN-H

Connector No.	E302
Connector Name	EPS CONTROL UNIT
Connector Color	BLACK

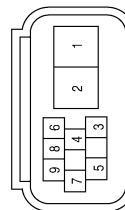

Terminal No.	Color of Wire	Signal Name
8	Y	CAN-H
9	BR	CAN-L

AWMIA0189GB

A
B
C
D
E
F
G
H
I
J
K
L
M
N
O
P

LAN

MALFUNCTION AREA CHART

< COMPONENT DIAGNOSIS >

[HEV SYSTEM CAN]

MALFUNCTION AREA CHART

Main Line

INFOID:000000004219064

Malfunction Area	Reference
Main line between EPS control unit and data link connector	LAN-69. "Diagnosis Procedure"
Main line between data link connector and brake ECU	LAN-70. "Diagnosis Procedure"

Branch Line

INFOID:000000004219065

Malfunction Area	Reference
ECM branch line circuit	LAN-71. "Diagnosis Procedure"
EPS control unit branch line circuit	LAN-72. "Diagnosis Procedure"
Data link connector branch line circuit	LAN-73. "Diagnosis Procedure"
Steering angle sensor branch line circuit	LAN-74. "Diagnosis Procedure"
Yaw rate/side/decel G sensor branch line circuit	LAN-75. "Diagnosis Procedure"
Brake ECU branch line circuit	LAN-76. "Diagnosis Procedure"
Hybrid vehicle control ECU branch line circuit	LAN-77. "Diagnosis Procedure"

Short Circuit

INFOID:000000004219066

Malfunction Area	Reference
CAN communication circuit	LAN-78. "Diagnosis Procedure"

MAIN LINE BETWEEN EPS AND DLC CIRCUIT

< COMPONENT DIAGNOSIS >

[HEV SYSTEM CAN]

MAIN LINE BETWEEN EPS AND DLC CIRCUIT

Diagnosis Procedure

INFOID:000000004219067

INSPECTION PROCEDURE

1. CHECK CONNECTOR

1. Turn the ignition switch OFF.
2. Disconnect the battery cable from the negative terminal.
3. Check the following terminals and connectors for damage, bend and loose connection (connector side and harness side).
 - Harness connector E30
 - Harness connector M1

Is the inspection result normal?

YES >> GO TO 2.

NO >> Repair the terminal and connector.

2. CHECK HARNESS CONTINUITY (OPEN CIRCUIT)

1. Disconnect the following harness connectors.
 - Harness connectors E301 and E67
 - Harness connectors E30 and M1
2. Check the continuity between the harness connectors.

Harness connector		Harness connector		Continuity
Connector No.	Terminal No.	Connector No.	Terminal No.	
E67	2	E30	15G	Existed
	1		8G	Existed

Is the inspection result normal?

YES >> GO TO 3.

NO >> Repair the main line between the harness connector E67 and E30.

3. CHECK HARNESS CONTINUITY (OPEN CIRCUIT)

Check the continuity between the harness connector and the data link connector.

Harness connector		Data link connector		Continuity
Connector No.	Terminal No.	Connector No.	Terminal No.	
M1	15G	M22	13	Existed
	8G		12	Existed

Is the inspection result normal?

YES >> GO TO 4.

NO >> Repair the main line between the harness connector M1 and the data link connector.

4. ERASE ALL DTC

1. Connect all the connectors.
2. Erase the DTCs of unit connected to HEV SYSTEM CAN and CAN.
3. Turn the ignition switch OFF.
4. Turn the ignition switch ON.
5. Perform All DTC Reading with CONSULT-III.

NOTE:

For DTCs related to HEV SYSTEM CAN, refer to [LAN-59. "DTC Related to HEV SYSTEM CAN List"](#).

Is the DTC related to HEV SYSTEM CAN displayed?

YES >> Reconfirm the procedure for detecting root cause.

NO >> Error was detected in the main line between the EPS control unit and the data link connector.

MAIN LINE BETWEEN DLC AND ABS CIRCUIT

< COMPONENT DIAGNOSIS >

[HEV SYSTEM CAN]

MAIN LINE BETWEEN DLC AND ABS CIRCUIT

Diagnosis Procedure

INFOID:000000004219068

INSPECTION PROCEDURE

1. CHECK CONNECTOR

1. Turn the ignition switch OFF.
2. Disconnect the battery cable from the negative terminal.
3. Check the following terminals and connectors for damage, bend and loose connection (connector side and harness side).
 - Harness connector M89
 - Harness connector E64

Is the inspection result normal?

YES >> GO TO 2.

NO >> Repair the terminal and connector.

2. CHECK HARNESS CONTINUITY (OPEN CIRCUIT)

1. Disconnect the harness connectors M89 and E64.
2. Check the continuity between the data link connector and the harness connector.

Data link connector		Harness connector		Continuity
Connector No.	Terminal No.	Connector No.	Terminal No.	
M22	13	M89	5	Existed
	12		4	Existed

Is the inspection result normal?

YES >> GO TO 3.

NO >> Repair the main line between the data link connector and the harness connector M89.

3. CHECK HARNESS CONTINUITY (OPEN CIRCUIT)

1. Disconnect the connector of brake ECU.
2. Check the continuity between the harness connector and the brake ECU harness connector.

Harness connector		Brake ECU harness connector		Continuity
Connector No.	Terminal No.	Connector No.	Terminal No.	
E64	5	E61	81	Existed
	4		70	Existed

Is the inspection result normal?

YES >> GO TO 4.

NO >> Repair the main line between the harness connector E64 and the brake ECU.

4. ERASE ALL DTC

1. Connect all the connectors.
2. Erase the DTCs of unit connected to HEV SYSTEM CAN and CAN.
3. Turn the ignition switch OFF.
4. Turn the ignition switch ON.
5. Perform All DTC Reading with CONSULT-III.

NOTE:

For DTCs related to HEV SYSTEM CAN, refer to [LAN-59, "DTC Related to HEV SYSTEM CAN List"](#).

Is the DTC related to HEV SYSTEM CAN displayed?

YES >> Reconfirm the procedure for detecting root cause.

NO >> Error was detected in the main line between the data link connector and the brake ECU.

ECM BRANCH LINE CIRCUIT

< COMPONENT DIAGNOSIS >

[HEV SYSTEM CAN]

ECM BRANCH LINE CIRCUIT

Diagnosis Procedure

INFOID:000000004219069

1. CHECK CONNECTOR

1. Turn the ignition switch OFF.
2. Disconnect the battery cable from the negative terminal.
3. Check the following terminals and connectors for damage, bend and loose connection (unit side and connector side).
 - ECM
 - Harness connector F80
 - Harness connector E68

Is the inspection result normal?

- YES >> GO TO 2.
NO >> Repair the terminal and connector.

2. CHECK HARNESS FOR OPEN CIRCUIT

1. Disconnect the connector of ECM.
2. Check the resistance between the ECM harness connector terminals.

ECM harness connector			Resistance (Ω)
Connector No.	Terminal No.		
F13	74	73	Approx. 108 – 132

Is the measurement value within the specification?

- YES >> GO TO 3.
NO >> Repair the ECM branch line.

3. CHECK POWER SUPPLY AND GROUND CIRCUIT

Check the power supply and the ground circuit of the ECM. Refer to [EC-114, "Diagnosis Procedure"](#).

Is the inspection result normal?

- YES >> GO TO 4.
NO >> Repair the power supply and the ground circuit.

4. ERASE ALL DTC

1. Connect the connector of ECM.
2. Erase the DTCs of unit connected to HEV SYSTEM CAN and CAN.
3. Turn the ignition switch OFF.
4. Turn the ignition switch ON.
5. Perform All DTC Reading with CONSULT-III.

NOTE:

For DTCs related to HEV SYSTEM CAN, refer to [LAN-59, "DTC Related to HEV SYSTEM CAN List"](#).

Is the DTC related to HEV SYSTEM CAN displayed?

- YES >> Replace the ECM. Refer to [EC-14, "ADDITIONAL SERVICE WHEN REPLACING CONTROL UNIT: Special Repair Requirement"](#).
NO >> Error was detected in the ECM branch line.

EPS BRANCH LINE CIRCUIT

Diagnosis Procedure

INFOID:000000004219070

1. CHECK CONNECTOR

1. Turn the ignition switch OFF.
2. Disconnect the battery cable from the negative terminal.
3. Check the following terminals and connectors for damage, bend and loose connection (unit side and connector side).
 - EPS control unit
 - Harness connector E301
 - Harness connector E67

Is the inspection result normal?

- YES >> GO TO 2.
 NO >> Repair the terminal and connector.

2. CHECK HARNESS FOR OPEN CIRCUIT

1. Disconnect the connector of EPS control unit.
2. Check the resistance between the EPS control unit harness connector terminals.

EPS control unit harness connector			Resistance (Ω)
Connector No.	Terminal No.		
E302	8	9	Approx. 54 – 66

Is the measurement value within the specification?

- YES >> GO TO 3.
 NO >> Repair the EPS control unit branch line.

3. CHECK POWER SUPPLY AND GROUND CIRCUIT

Check the power supply and the ground circuit of the EPS control unit. Refer to [STC-44, "Wiring Diagram — ELECTRONICALLY CONTROLLED POWER STEERING SYSTEM —"](#).

Is the inspection result normal?

- YES >> GO TO 4.
 NO >> Repair the power supply and the ground circuit.

4. ERASE ALL DTC

1. Connect the connector of EPS control unit.
2. Erase the DTCs of unit connected to HEV SYSTEM CAN and CAN.
3. Turn the ignition switch OFF.
4. Turn the ignition switch ON.
5. Perform All DTC Reading with CONSULT-III.

NOTE:

For DTCs related to HEV SYSTEM CAN, refer to [LAN-59, "DTC Related to HEV SYSTEM CAN List"](#).

Is the DTC related to HEV SYSTEM CAN displayed?

- YES >> Replace the EPS control unit. Refer to [STC-8, "Component Parts Location"](#).
 NO >> Error was detected in the EPS control unit branch line.

DLC BRANCH LINE CIRCUIT

< COMPONENT DIAGNOSIS >

[HEV SYSTEM CAN]

DLC BRANCH LINE CIRCUIT

Diagnosis Procedure

INFOID:000000004219071

1.CHECK CONNECTOR

1. Turn the ignition switch OFF.
2. Disconnect the battery cable from the negative terminal.
3. Check the terminals and connectors of the data link connector for damage, bend and loose connection (connector side and harness side).

Is the inspection result normal?

- YES >> GO TO 2.
NO >> Repair the terminal and connector.

2.CHECK HARNESS FOR OPEN CIRCUIT

Check the resistance between the data link connector terminals.

Data link connector			Resistance (Ω)
Connector No.	Terminal No.		
M22	13	12	Approx. 54 – 66

Is the measurement value within the specification?

- YES >> Reconfirm the procedure for detecting root cause.
NO >> Repair the data link connector branch line.

A
B
C
D
E
F
G
H
I
J
K
L

LAN

N
O
P

STRG BRANCH LINE CIRCUIT

< COMPONENT DIAGNOSIS >

[HEV SYSTEM CAN]

STRG BRANCH LINE CIRCUIT

Diagnosis Procedure

INFOID:000000004219072

1. CHECK CONNECTOR

1. Turn the ignition switch OFF.
2. Disconnect the battery cable from the negative terminal.
3. Check the terminals and connectors of the steering angle sensor for damage, bend and loose connection (unit side and connector side).

Is the inspection result normal?

- YES >> GO TO 2.
NO >> Repair the terminal and connector.

2. CHECK HARNESS FOR OPEN CIRCUIT

1. Disconnect the connector of steering angle sensor.
2. Check the resistance between the steering angle sensor harness connector terminals.

Steering angle sensor harness connector			Resistance (Ω)
Connector No.	Terminal No.		
M53	5	2	Approx. 54 – 66

Is the measurement value within the specification?

- YES >> GO TO 3.
NO >> Repair the steering angle sensor branch line.

3. CHECK POWER SUPPLY AND GROUND CIRCUIT

Check the power supply and the ground circuit of the steering angle sensor. Refer to [STC-44, "Wiring Diagram — ELECTRONICALLY CONTROLLED POWER STEERING SYSTEM —"](#).

Is the inspection result normal?

- YES >> GO TO 4.
NO >> Repair the power supply and the ground circuit.

4. ERASE ALL DTC

1. Connect the connector of steering angle sensor.
2. Erase the DTCs of unit connected to HEV SYSTEM CAN and CAN.
3. Turn the ignition switch OFF.
4. Turn the ignition switch ON.
5. Perform All DTC Reading with CONSULT-III.

NOTE:

For DTCs related to HEV SYSTEM CAN, refer to [LAN-59, "DTC Related to HEV SYSTEM CAN List"](#).

Is the DTC related to HEV SYSTEM CAN displayed?

- YES >> Replace the steering angle sensor. Refer to [STC-8, "Component Parts Location"](#).
NO >> Error was detected in the steering angle sensor branch line.

YAW BRANCH LINE CIRCUIT

< COMPONENT DIAGNOSIS >

[HEV SYSTEM CAN]

YAW BRANCH LINE CIRCUIT

Diagnosis Procedure

INFOID:000000004219073

1. CHECK CONNECTOR

1. Turn the ignition switch OFF.
2. Disconnect the battery cable from the negative terminal.
3. Check the terminals and connectors of the yaw rate/side/decel G sensor for damage, bend and loose connection (unit side and connector side).

Is the inspection result normal?

- YES >> GO TO 2.
NO >> Repair the terminal and connector.

2. CHECK HARNESS FOR OPEN CIRCUIT

1. Disconnect the connector of yaw rate/side/decel G sensor.
2. Check the resistance between the yaw rate/side/decel G sensor harness connector terminals.

Yaw rate/side/decel G sensor harness connector			Resistance (Ω)
Connector No.	Terminal No.		
M55	3	2	Approx. 54 – 66

Is the measurement value within the specification?

- YES >> GO TO 3.
NO >> Repair the yaw rate/side/decel G sensor branch line.

3. CHECK POWER SUPPLY AND GROUND CIRCUIT

Check the power supply and the ground circuit of the yaw rate/side/decel G sensor. Refer to [BRC-148, "Wiring Diagram - BRAKE CONTROL SYSTEM -"](#).

Is the inspection result normal?

- YES >> GO TO 4.
NO >> Repair the power supply and the ground circuit.

4. ERASE ALL DTC

1. Connect the connector of yaw rate/side/decel G sensor.
2. Erase the DTCs of unit connected to HEV SYSTEM CAN and CAN.
3. Turn the ignition switch OFF.
4. Turn the ignition switch ON.
5. Perform All DTC Reading with CONSULT-III.

NOTE:

For DTCs related to HEV SYSTEM CAN, refer to [LAN-59, "DTC Related to HEV SYSTEM CAN List"](#).

Is the DTC related to HEV SYSTEM CAN displayed?

- YES >> Replace the yaw rate/side/decel G sensor. Refer to [BRC-205, "Removal and Installation"](#).
NO >> Error was detected in the yaw rate/side/decel G sensor branch line.

A
B
C
D
E
F
G
H
I
J
K
L
N
O
P

LAN

ABS BRANCH LINE CIRCUIT

< COMPONENT DIAGNOSIS >

[HEV SYSTEM CAN]

ABS BRANCH LINE CIRCUIT

Diagnosis Procedure

INFOID:000000004219074

1. CHECK CONNECTOR

1. Turn the ignition switch OFF.
2. Disconnect the battery cable from the negative terminal.
3. Check the terminals and connectors of the brake ECU for damage, bend and loose connection (unit side and connector side).

Is the inspection result normal?

- YES >> GO TO 2.
NO >> Repair the terminal and connector.

2. CHECK HARNESS FOR OPEN CIRCUIT

1. Disconnect the connector of brake ECU.
2. Check the resistance between the brake ECU harness connector terminals.

Brake ECU harness connector			Resistance (Ω)
Connector No.	Terminal No.		
E61	81	70	Approx. 54 – 66

Is the measurement value within the specification?

- YES >> GO TO 3.
NO >> Repair the brake ECU branch line.

3. CHECK POWER SUPPLY AND GROUND CIRCUIT

Check the power supply and the ground circuit of the brake ECU. Refer to [BRC-148, "Wiring Diagram - BRAKE CONTROL SYSTEM -"](#).

Is the inspection result normal?

- YES >> GO TO 4.
NO >> Repair the power supply and the ground circuit.

4. ERASE ALL DTC

1. Connect the connector of brake ECU.
2. Erase the DTCs of unit connected to HEV SYSTEM CAN and CAN.
3. Turn the ignition switch OFF.
4. Turn the ignition switch ON.
5. Perform All DTC Reading with CONSULT-III.

NOTE:

For DTCs related to HEV SYSTEM CAN, refer to [LAN-59, "DTC Related to HEV SYSTEM CAN List"](#).

Is the DTC related to HEV SYSTEM CAN displayed?

- YES >> Replace the brake ECU. Refer to [BRC-198, "Exploded View"](#).
NO >> Error was detected in the brake ECU branch line.

HV ECU BRANCH LINE CIRCUIT

< COMPONENT DIAGNOSIS >

[HEV SYSTEM CAN]

HV ECU BRANCH LINE CIRCUIT

Diagnosis Procedure

INFOID:000000004219075

1. CHECK CONNECTOR

1. Turn the ignition switch OFF.
2. Disconnect the battery cable from the negative terminal.
3. Check the terminals and connectors of the hybrid vehicle control ECU for damage, bend and loose connection (unit side and connector side).

Is the inspection result normal?

- YES >> GO TO 2.
NO >> Repair the terminal and connector.

2. CHECK HARNESS FOR OPEN CIRCUIT

1. Disconnect the connector of hybrid vehicle control ECU.
2. Check the resistance between the hybrid vehicle control ECU harness connector terminals.

Hybrid vehicle control ECU harness connector			Resistance (Ω)
Connector No.	Terminal No.		
E66	171	170	Approx. 108 – 132

Is the measurement value within the specification?

- YES >> GO TO 3.
NO >> Repair the hybrid vehicle control ECU branch line.

3. CHECK POWER SUPPLY AND GROUND CIRCUIT

Check the power supply and the ground circuit of the hybrid vehicle control ECU. Refer to [HBC-600, "Wiring Diagram"](#).

Is the inspection result normal?

- YES >> GO TO 4.
NO >> Repair the power supply and the ground circuit.

4. ERASE ALL DTC

1. Connect the connector of hybrid vehicle control ECU.
2. Erase the DTCs of unit connected to HEV SYSTEM CAN and CAN.
3. Turn the ignition switch OFF.
4. Turn the ignition switch ON.
5. Perform All DTC Reading with CONSULT-III.

NOTE:

For DTCs related to HEV SYSTEM CAN, refer to [LAN-59, "DTC Related to HEV SYSTEM CAN List"](#).

Is the DTC related to HEV SYSTEM CAN displayed?

- YES >> Replace the hybrid vehicle control ECU. Refer to [HBC-644, "Exploded View"](#).
NO >> Error was detected in the hybrid vehicle control ECU branch line.

HEV SYSTEM CAN COMMUNICATION CIRCUIT

< COMPONENT DIAGNOSIS >

[HEV SYSTEM CAN]

HEV SYSTEM CAN COMMUNICATION CIRCUIT

Diagnosis Procedure

INFOID:000000004219076

1. CONNECTOR INSPECTION

1. Turn the ignition switch OFF.
2. Disconnect the battery cable from the negative terminal.
3. Disconnect all the unit connectors on HEV SYSTEM CAN.
4. Check terminals and connectors for damage, bend and loose connection.

Is the inspection result normal?

- YES >> GO TO 2.
NO >> Repair the terminal and connector.

2. CHECK HARNESS CONTINUITY (SHORT CIRCUIT)

Check the continuity between the data link connector terminals.

Data link connector		Continuity
Connector No.	Terminal No.	
M22	13	Not existed
	12	

Is the inspection result normal?

- YES >> GO TO 3.
NO >> Check the harness and repair the root cause.

3. CHECK HARNESS CONTINUITY (SHORT CIRCUIT)

Check the continuity between the data link connector and the ground.

Data link connector		Ground	Continuity
Connector No.	Terminal No.		
M22	13		Not existed
	12		Not existed

Is the inspection result normal?

- YES >> GO TO 4.
NO >> Check the harness and repair the root cause.

4. CHECK ECM AND HYBRID VEHICLE CONTROL ECU TERMINATION CIRCUIT

1. Remove the ECM and the hybrid vehicle control ECU.
2. Check the resistance between the ECM terminals.

ECM		Resistance (Ω)
Terminal No.		
74	73	Approx. 108 – 132

3. Check the resistance between the hybrid vehicle control ECU terminals.

Hybrid vehicle control ECU		Resistance (Ω)
Terminal No.		
171	170	Approx. 108 – 132

Is the measurement value within the specification?

- YES >> GO TO 5.
NO >> Replace the ECM and/or the hybrid vehicle control ECU.

5. CHECK DTC

1. Connect all the connectors.

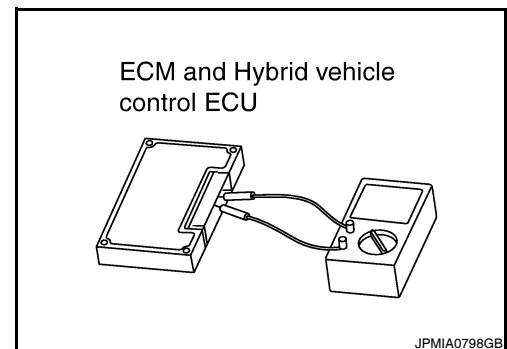

HEV SYSTEM CAN COMMUNICATION CIRCUIT

< COMPONENT DIAGNOSIS >

[HEV SYSTEM CAN]

2. Erase the DTCs of unit connected to HEV SYSTEM CAN and CAN.
3. Turn the ignition switch OFF.
4. Turn the ignition switch ON.
5. Perform All DTC Reading with CONSULT-III. Check if the symptoms listed below are reproduced.

Item (CONSULT-III)	Indication
The printed or saved All DTC Reading	<ul style="list-style-type: none">• The items of EPS and ABS are not displayed.• U0129, U0293, U1020 and U1022 are displayed as the ENGINE items.• U0100^{*1}, U0129^{*2} and U0131^{*3} are displayed as the HYBRID SYSTEM items.

- *1: Hybrid vehicle control ECU may display one or more DTCs (INF code) listed as follows; U0100 (211), U0100 (212), U0100 (530).
- *2: Hybrid vehicle control ECU may display one or more DTCs (INF code) listed as follows; U0129 (220), U0129 (222), U0129 (528).
- *3: Hybrid vehicle control ECU may display one or more DTCs (INF code) listed as follows; U0131 (433), U0131 (434).

Are the symptoms listed above reproduced?

YES >> GO TO 6.

NO >> Short circuit was detected in HEV SYSTEM CAN.

6. CHECK UNIT REPRODUCTION

Perform the reproduction test as per the following procedure for each unit.

1. Turn the ignition switch OFF.
2. Disconnect the battery cable from the negative terminal.
3. Disconnect one of the unit connectors of HEV SYSTEM CAN.

NOTE:

ECM and hybrid vehicle control ECU have a termination circuit. Check other units first.

4. Connect the battery cable to the negative terminal. Erase the DTCs of unit connected to HEV SYSTEM CAN and CAN.
5. Perform All DTC Reading with CONSULT-III. Check if the symptoms listed below are reproduced.

Item (CONSULT-III)	Indication
The printed or saved All DTC Reading	<ul style="list-style-type: none">• The items of EPS and ABS are not displayed.• U0129, U0293, U1020 and U1022 are displayed as the ENGINE items.• U0100^{*1}, U0129^{*2} and U0131^{*3} are displayed as the HYBRID SYSTEM items.

- *1: Hybrid vehicle control ECU may display one or more DTCs (INF code) listed as follows; U0100 (211), U0100 (212), U0100 (530).
- *2: Hybrid vehicle control ECU may display one or more DTCs (INF code) listed as follows; U0129 (220), U0129 (222), U0129 (528).
- *3: Hybrid vehicle control ECU may display one or more DTCs (INF code) listed as follows; U0131 (433), U0131 (434).

Are the symptoms listed above reproduced?

YES >> Connect the connector. Check other units as per the above procedure.

NO >> Replace the unit whose connector was disconnected.

A
B
C
D
E
F
G
H
I
J
K
L
N
O
P

LAN

MAIN LINE BETWEEN DLC AND HV ECU CIRCUIT

< COMPONENT DIAGNOSIS >

[CAN SYSTEM (TYPE 13)]

COMPONENT DIAGNOSIS

MAIN LINE BETWEEN DLC AND HV ECU CIRCUIT

Diagnosis Procedure

INFOID:000000004219077

INSPECTION PROCEDURE

1.CHECK CONNECTOR

1. Turn the ignition switch OFF.
2. Disconnect the battery cable from the negative terminal.
3. Check the following terminals and connectors for damage, bend and loose connection (connector side and harness side).
 - Harness connector M89
 - Harness connector E64

Is the inspection result normal?

YES >> GO TO 2.

NO >> Repair the terminal and connector.

2.CHECK HARNESS CONTINUITY (OPEN CIRCUIT)

1. Disconnect the harness connectors M89 and E64.
2. Check the continuity between the data link connector and the harness connector.

Data link connector		Harness connector		Continuity
Connector No.	Terminal No.	Connector No.	Terminal No.	
M22	6	M89	7	Existed
	14		8	Existed

Is the inspection result normal?

YES >> GO TO 3.

NO >> Repair the main line between the data link connector and the harness connector M89.

3.CHECK HARNESS CONTINUITY (OPEN CIRCUIT)

1. Disconnect the connector of hybrid vehicle control ECU.
2. Check the continuity between the harness connector and the hybrid vehicle control ECU harness connector.

Harness connector		Hybrid vehicle control ECU harness connector		Continuity
Connector No.	Terminal No.	Connector No.	Terminal No.	
E64	7	E66	173	Existed
	8		172	Existed

Is the inspection result normal?

YES (Present error)>>Check CAN system type decision again.

YES (Past error)>>Error was detected in the main line between the data link connector and the hybrid vehicle control ECU.

NO >> Repair the main line between the harness connector E64 and the hybrid vehicle control ECU.

ECM BRANCH LINE CIRCUIT

< COMPONENT DIAGNOSIS >

[CAN SYSTEM (TYPE 13)]

ECM BRANCH LINE CIRCUIT

Diagnosis Procedure

INFOID:000000004219078

1. CHECK CONNECTOR

1. Turn the ignition switch OFF.
2. Disconnect the battery cable from the negative terminal.
3. Check the following terminals and connectors for damage, bend and loose connection (unit side and connector side).
 - ECM
 - Harness connector E47
 - Harness connector E48
 - Junction block
 - Harness connector E30
 - Harness connector M1

Is the inspection result normal?

YES >> GO TO 2.

NO >> Repair the terminal and connector.

2. CHECK HARNESS FOR OPEN CIRCUIT

1. Disconnect the connector of ECM.
2. Check the resistance between the ECM harness connector terminals.

ECM harness connector		Resistance (Ω)
Connector No.	Terminal No.	
E10	98	Approx. 108 – 132
	97	

Is the measurement value within the specification?

YES >> GO TO 3.

NO >> Repair the ECM branch line.

3. CHECK POWER SUPPLY AND GROUND CIRCUIT

Check the power supply and the ground circuit of the ECM. Refer to [EC-114, "Diagnosis Procedure"](#).

Is the inspection result normal?

YES (Present error)>>Replace the ECM. Refer to [EC-14, "ADDITIONAL SERVICE WHEN REPLACING CONTROL UNIT : Special Repair Requirement"](#).

YES (Past error)>>Error was detected in the ECM branch line.

NO >> Repair the power supply and the ground circuit.

A
B
C
D
E
F
G
H
I
J
K
L

LAN

A-BAG BRANCH LINE CIRCUIT

< COMPONENT DIAGNOSIS >

[CAN SYSTEM (TYPE 13)]

A-BAG BRANCH LINE CIRCUIT

Diagnosis Procedure

INFOID:000000004219079

1. CHECK AIR BAG DIAGNOSIS SENSOR UNIT

Check the air bag diagnosis sensor unit. Refer to [SRC-3, "Work Flow"](#).

Is the inspection result normal?

YES >> Replace the main harness.

NO >> Replace parts whose air bag system has a malfunction.

BCM BRANCH LINE CIRCUIT

< COMPONENT DIAGNOSIS >

[CAN SYSTEM (TYPE 13)]

BCM BRANCH LINE CIRCUIT

Diagnosis Procedure

INFOID:000000004219080

1. CHECK CONNECTOR

1. Turn the ignition switch OFF.
2. Disconnect the battery cable from the negative terminal.
3. Check the terminals and connectors of the BCM for damage, bend and loose connection (unit side and connector side).

Is the inspection result normal?

- YES >> GO TO 2.
NO >> Repair the terminal and connector.

2. CHECK HARNESS FOR OPEN CIRCUIT

1. Disconnect the connector of BCM.
2. Check the resistance between the BCM harness connector terminals.

BCM harness connector			Resistance (Ω)
Connector No.	Terminal No.		
M19	79	78	Approx. 54 – 66

Is the measurement value within the specification?

- YES >> GO TO 3.
NO >> Repair the BCM branch line.

3. CHECK POWER SUPPLY AND GROUND CIRCUIT

Check the power supply and the ground circuit of the BCM. Refer to [BCS-42, "Diagnosis Procedure"](#).

Is the inspection result normal?

- YES (Present error)>>Replace the BCM. Refer to [BCS-87, "Removal and Installation"](#).
YES (Past error)>>Error was detected in the BCM branch line.
NO >> Repair the power supply and the ground circuit.

A
B
C
D
E
F
G
H
I
J
K
L

LAN

N
O
P

DLC BRANCH LINE CIRCUIT

< COMPONENT DIAGNOSIS >

[CAN SYSTEM (TYPE 13)]

DLC BRANCH LINE CIRCUIT

Diagnosis Procedure

INFOID:000000004219081

1. CHECK CONNECTOR

1. Turn the ignition switch OFF.
2. Disconnect the battery cable from the negative terminal.
3. Check the terminals and connectors of the data link connector for damage, bend and loose connection (connector side and harness side).

Is the inspection result normal?

YES >> GO TO 2.

NO >> Repair the terminal and connector.

2. CHECK HARNESS FOR OPEN CIRCUIT

Check the resistance between the data link connector terminals.

Data link connector			Resistance (Ω)
Connector No.	Terminal No.		
M22	6	14	Approx. 54 – 66

Is the measurement value within the specification?

YES (Present error)>>Check CAN system type decision again.

YES (Past error)>>Error was detected in the data link connector branch line circuit.

NO >> Repair the data link connector branch line.

HVAC BRANCH LINE CIRCUIT

< COMPONENT DIAGNOSIS >

[CAN SYSTEM (TYPE 13)]

HVAC BRANCH LINE CIRCUIT

Diagnosis Procedure

INFOID:000000004219082

1. CHECK CONNECTOR

1. Turn the ignition switch OFF.
2. Disconnect the battery cable from the negative terminal.
3. Check the terminals and connectors of the controller (auto amp.) for damage, bend and loose connection (unit side and connector side).

Is the inspection result normal?

- YES >> GO TO 2.
NO >> Repair the terminal and connector.

2. CHECK HARNESS FOR OPEN CIRCUIT

1. Disconnect the connector of controller (auto amp.).
2. Check the resistance between the controller (auto amp.) harness connector terminals.

Controller (auto amp.) harness connector			Resistance (Ω)
Connector No.	Terminal No.		
M37	15	35	Approx. 54 – 66

Is the measurement value within the specification?

- YES >> GO TO 3.
NO >> Repair the controller (auto amp.) branch line.

3. CHECK POWER SUPPLY AND GROUND CIRCUIT

Check the power supply and the ground circuit of the controller (auto amp.). Refer to [HAC-86, "Diagnosis Procedure"](#).

Is the inspection result normal?

- YES (Present error)>>Replace the controller (auto amp.). Refer to [HAC-14, "Component Part Location"](#).
YES (Past error)>>Error was detected in the controller (auto amp.) branch line.
NO >> Repair the power supply and the ground circuit.

A
B
C
D
E
F
G
H
I
J
K
L

LAN

N
O
P

M&A BRANCH LINE CIRCUIT

Diagnosis Procedure

INFOID:000000004219083

1. CHECK CONNECTOR

1. Turn the ignition switch OFF.
2. Disconnect the battery cable from the negative terminal.
3. Check the terminals and connectors of the combination meter for damage, bend and loose connection (unit side and connector side).

Is the inspection result normal?

- YES >> GO TO 2.
 NO >> Repair the terminal and connector.

2. CHECK HARNESS FOR OPEN CIRCUIT

1. Disconnect the connector of combination meter.
2. Check the resistance between the combination meter harness connector terminals.

Combination meter harness connector			Resistance (Ω)
Connector No.	Terminal No.		
M24	21	22	Approx. 54 – 66

Is the measurement value within the specification?

- YES >> GO TO 3.
 NO >> Repair the combination meter branch line.

3. CHECK POWER SUPPLY AND GROUND CIRCUIT

Check the power supply and the ground circuit of the combination meter. Refer to [MWI-40, "COMBINATION METER : Diagnosis Procedure"](#).

Is the inspection result normal?

- YES (Present error)>>Replace the combination meter. Refer to [MWI-135, "Removal and Installation"](#).
 YES (Past error)>>Error was detected in the combination meter branch line.
 NO >> Repair the power supply and the ground circuit.

HV ECU BRANCH LINE CIRCUIT

< COMPONENT DIAGNOSIS >

[CAN SYSTEM (TYPE 13)]

HV ECU BRANCH LINE CIRCUIT

Diagnosis Procedure

INFOID:000000004219084

1.CHECK DTC

Check whether or not the DTC related to HEV SYSTEM CAN indicated on All DTC Reading by CONSULT-III.

NOTE:

For DTCs related to HEV SYSTEM CAN, refer to [LAN-59. "DTC Related to HEV SYSTEM CAN List"](#).

Is the DTC related to HEV SYSTEM CAN displayed?

YES >> Inspect HEV SYSTEM CAN. Refer to [LAN-53. "Trouble Diagnosis Flow Chart"](#).

NO >> GO TO 2.

2.CHECK CONNECTOR

1. Turn the ignition switch OFF.
2. Disconnect the battery cable from the negative terminal.
3. Check the terminals and connectors of the hybrid vehicle control ECU for damage, bend and loose connection (unit side and connector side).

Is the inspection result normal?

YES >> GO TO 3.

NO >> Repair the terminal and connector.

3.CHECK HARNESS FOR OPEN CIRCUIT

1. Disconnect the connector of hybrid vehicle control ECU.
2. Check the resistance between the hybrid vehicle control ECU harness connector terminals.

Hybrid vehicle control ECU harness connector			Resistance (Ω)
Connector No.	Terminal No.		
E66	173	172	Approx. 54 – 66

Is the measurement value within the specification?

YES >> GO TO 4.

NO >> Repair the hybrid vehicle control ECU branch line.

4.CHECK POWER SUPPLY AND GROUND CIRCUIT

Check the power supply and the ground circuit of the hybrid vehicle control ECU. [HBC-600. "Wiring Diagram"](#).

Is the inspection result normal?

YES (Present error)>>Replace the hybrid vehicle control ECU. Refer to [HBC-644. "Exploded View"](#).

YES (Past error)>>Error was detected in the hybrid vehicle control ECU branch line.

NO >> Repair the power supply and the ground circuit.

A
B
C
D
E
F
G
H
I
J
K
L
N
O
P

LAN

IPDM-E BRANCH LINE CIRCUIT

< COMPONENT DIAGNOSIS >

[CAN SYSTEM (TYPE 13)]

IPDM-E BRANCH LINE CIRCUIT

Diagnosis Procedure

INFOID:000000004219085

1. CHECK CONNECTOR

1. Turn the ignition switch OFF.
2. Disconnect the battery cable from the negative terminal.
3. Check the terminals and connectors of the IPDM E/R for damage, bend and loose connection (unit side and connector side).

Is the inspection result normal?

- YES >> GO TO 2.
NO >> Repair the terminal and connector.

2. CHECK HARNESS FOR OPEN CIRCUIT

1. Disconnect the connector of IPDM E/R.
2. Check the resistance between the IPDM E/R harness connector terminals.

IPDM E/R harness connector			Resistance (Ω)
Connector No.	Terminal No.		
E17	40	39	Approx. 108 – 132

Is the measurement value within the specification?

- YES >> GO TO 3.
NO >> Repair the IPDM E/R branch line.

3. CHECK POWER SUPPLY AND GROUND CIRCUIT

Check the power supply and the ground circuit of the IPDM E/R. Refer to [PCS-22, "Diagnosis Procedure"](#).

Is the inspection result normal?

- YES (Present error)>>Replace the IPDM E/R. Refer to [PCS-39, "Removal and Installation"](#).
YES (Past error)>>Error was detected in the IPDM E/R branch line.
NO >> Repair the power supply and the ground circuit.

CAN COMMUNICATION CIRCUIT

< COMPONENT DIAGNOSIS >

[CAN SYSTEM (TYPE 13)]

CAN COMMUNICATION CIRCUIT

Diagnosis Procedure

INFOID:000000004219086

1.CONNECTOR INSPECTION

1. Turn the ignition switch OFF.
2. Disconnect the battery cable from the negative terminal.
3. Disconnect all the unit connectors on CAN communication system.
4. Check terminals and connectors for damage, bend and loose connection.

Is the inspection result normal?

- YES >> GO TO 2.
NO >> Repair the terminal and connector.

2.CHECK HARNESS CONTINUITY (SHORT CIRCUIT)

Check the continuity between the data link connector terminals.

Data link connector		Continuity
Connector No.	Terminal No.	
M22	6 14	Not existed

Is the inspection result normal?

- YES >> GO TO 3.
NO >> Check the harness and repair the root cause.

3.CHECK HARNESS CONTINUITY (SHORT CIRCUIT)

Check the continuity between the data link connector and the ground.

Data link connector		Ground	Continuity
Connector No.	Terminal No.		
M22	6		Not existed
	14		Not existed

Is the inspection result normal?

- YES >> GO TO 4.
NO >> Check the harness and repair the root cause.

4.CHECK ECM AND IPDM E/R TERMINATION CIRCUIT

1. Remove the ECM and the IPDM E/R.
2. Check the resistance between the ECM terminals.

ECM		Resistance (Ω)
Terminal No.		
98	97	Approx. 108 – 132

3. Check the resistance between the IPDM E/R terminals.

IPDM E/R		Resistance (Ω)
Terminal No.		
40	39	Approx. 108 – 132

Is the measurement value within the specification?

- YES >> GO TO 5.
NO >> Replace the ECM and/or the IPDM E/R.

5.CHECK SYMPTOM

Connect all the connectors. Check if the symptoms described in the "Symptom (Results from interview with customer)" are reproduced.

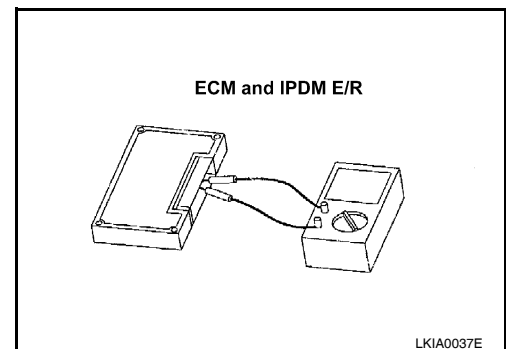

A
B
C
D
E
F
G
H
I
J
K
L
N
O
P

LAN

CAN COMMUNICATION CIRCUIT

< COMPONENT DIAGNOSIS >

[CAN SYSTEM (TYPE 13)]

Inspection result

Reproduced>>GO TO 6.

Non-reproduced>>Start the diagnosis again. Follow the trouble diagnosis procedure when past error is detected.

6.CHECK UNIT REPRODUCTION

Perform the reproduction test as per the following procedure for each unit.

1. Turn the ignition switch OFF.
2. Disconnect the battery cable from the negative terminal.
3. Disconnect one of the unit connectors of CAN communication system.

NOTE:

ECM and IPDM E/R have a termination circuit. Check other units first.

4. Connect the battery cable to the negative terminal. Check if the symptoms described in the "Symptom (Results from interview with customer)" are reproduced.

NOTE:

Although unit-related error symptoms occur, do not confuse them with other symptoms.

Inspection result

Reproduced>>Connect the connector. Check other units as per the above procedure.

Non-reproduced>>Replace the unit whose connector was disconnected.

MAIN LINE BETWEEN DLC AND HV ECU CIRCUIT

< COMPONENT DIAGNOSIS >

[CAN SYSTEM (TYPE 14)]

COMPONENT DIAGNOSIS

MAIN LINE BETWEEN DLC AND HV ECU CIRCUIT

Diagnosis Procedure

INFOID:000000004219087

INSPECTION PROCEDURE

1. CHECK CONNECTOR

1. Turn the ignition switch OFF.
2. Disconnect the battery cable from the negative terminal.
3. Check the following terminals and connectors for damage, bend and loose connection (connector side and harness side).
 - Harness connector M89
 - Harness connector E64

Is the inspection result normal?

YES >> GO TO 2.

NO >> Repair the terminal and connector.

2. CHECK HARNESS CONTINUITY (OPEN CIRCUIT)

1. Disconnect the harness connectors M89 and E64.
2. Check the continuity between the data link connector and the harness connector.

Data link connector		Harness connector		Continuity
Connector No.	Terminal No.	Connector No.	Terminal No.	
M22	6	M89	7	Existed
	14		8	Existed

Is the inspection result normal?

YES >> GO TO 3.

NO >> Repair the main line between the data link connector and the harness connector M89.

3. CHECK HARNESS CONTINUITY (OPEN CIRCUIT)

1. Disconnect the connector of hybrid vehicle control ECU.
2. Check the continuity between the harness connector and the hybrid vehicle control ECU harness connector.

Harness connector		Hybrid vehicle control ECU harness connector		Continuity
Connector No.	Terminal No.	Connector No.	Terminal No.	
E64	7	E66	173	Existed
	8		172	Existed

Is the inspection result normal?

YES (Present error)>>Check CAN system type decision again.

YES (Past error)>>Error was detected in the main line between the data link connector and the hybrid vehicle control ECU.

NO >> Repair the main line between the harness connector E64 and the hybrid vehicle control ECU.

A
B
C
D
E
F
G
H
I
J
K
L
LAN
N
O
P

ECM BRANCH LINE CIRCUIT

< COMPONENT DIAGNOSIS >

[CAN SYSTEM (TYPE 14)]

ECM BRANCH LINE CIRCUIT

Diagnosis Procedure

INFOID:000000004219088

1. CHECK CONNECTOR

1. Turn the ignition switch OFF.
2. Disconnect the battery cable from the negative terminal.
3. Check the following terminals and connectors for damage, bend and loose connection (unit side and connector side).
 - ECM
 - Harness connector E47
 - Harness connector E48
 - Junction block
 - Harness connector E30
 - Harness connector M1

Is the inspection result normal?

YES >> GO TO 2.

NO >> Repair the terminal and connector.

2. CHECK HARNESS FOR OPEN CIRCUIT

1. Disconnect the connector of ECM.
2. Check the resistance between the ECM harness connector terminals.

ECM harness connector		Resistance (Ω)
Connector No.	Terminal No.	
E10	98	Approx. 108 – 132
	97	

Is the measurement value within the specification?

YES >> GO TO 3.

NO >> Repair the ECM branch line.

3. CHECK POWER SUPPLY AND GROUND CIRCUIT

Check the power supply and the ground circuit of the ECM. Refer to [EC-114, "Diagnosis Procedure"](#).

Is the inspection result normal?

YES (Present error)>>Replace the ECM. Refer to [EC-14, "ADDITIONAL SERVICE WHEN REPLACING CONTROL UNIT : Special Repair Requirement"](#).

YES (Past error)>>Error was detected in the ECM branch line.

NO >> Repair the power supply and the ground circuit.

A-BAG BRANCH LINE CIRCUIT

< COMPONENT DIAGNOSIS >

[CAN SYSTEM (TYPE 14)]

A-BAG BRANCH LINE CIRCUIT

Diagnosis Procedure

INFOID:000000004219089

1. CHECK AIR BAG DIAGNOSIS SENSOR UNIT

Check the air bag diagnosis sensor unit. Refer to [SRC-3, "Work Flow"](#).

Is the inspection result normal?

YES >> Replace the main harness.

NO >> Replace parts whose air bag system has a malfunction.

A

B

C

D

E

F

G

H

I

J

K

L

LAN

N

O

P

AV BRANCH LINE CIRCUIT

< COMPONENT DIAGNOSIS >

[CAN SYSTEM (TYPE 14)]

AV BRANCH LINE CIRCUIT

Diagnosis Procedure

INFOID:000000004219090

1. CHECK CONNECTOR

1. Turn the ignition switch OFF.
2. Disconnect the battery cable from the negative terminal.
3. Check the terminals and connectors of the AV control unit for damage, bend and loose connection (unit side and connector side).

Is the inspection result normal?

- YES >> GO TO 2.
NO >> Repair the terminal and connector.

2. CHECK HARNESS FOR OPEN CIRCUIT

1. Disconnect the connector of AV control unit.
2. Check the resistance between the AV control unit harness connector terminals.

AV control unit harness connector			Resistance (Ω)
Connector No.	Terminal No.		
M46	24	44	Approx. 54 – 66

Is the measurement value within the specification?

- YES >> GO TO 3.
NO >> Repair the AV control unit branch line.

3. CHECK POWER SUPPLY AND GROUND CIRCUIT

Check the power supply and the ground circuit of the AV control unit. Refer to [AV-207, "AV CONTROL UNIT : Diagnosis Procedure"](#).

Is the inspection result normal?

- YES (Present error)>>Replace the AV control unit. Refer to [AV-278, "Removal and Installation"](#).
YES (Past error)>>Error was detected in the AV control unit branch line.
NO >> Repair the power supply and the ground circuit.

BCM BRANCH LINE CIRCUIT

< COMPONENT DIAGNOSIS >

[CAN SYSTEM (TYPE 14)]

BCM BRANCH LINE CIRCUIT

Diagnosis Procedure

INFOID:000000004219091

1.CHECK CONNECTOR

1. Turn the ignition switch OFF.
2. Disconnect the battery cable from the negative terminal.
3. Check the terminals and connectors of the BCM for damage, bend and loose connection (unit side and connector side).

Is the inspection result normal?

- YES >> GO TO 2.
NO >> Repair the terminal and connector.

2.CHECK HARNESS FOR OPEN CIRCUIT

1. Disconnect the connector of BCM.
2. Check the resistance between the BCM harness connector terminals.

BCM harness connector			Resistance (Ω)
Connector No.	Terminal No.		
M19	79	78	Approx. 54 – 66

Is the measurement value within the specification?

- YES >> GO TO 3.
NO >> Repair the BCM branch line.

3.CHECK POWER SUPPLY AND GROUND CIRCUIT

Check the power supply and the ground circuit of the BCM. Refer to [BCS-42, "Diagnosis Procedure"](#).

Is the inspection result normal?

- YES (Present error)>>Replace the BCM. Refer to [BCS-87, "Removal and Installation"](#).
YES (Past error)>>Error was detected in the BCM branch line.
NO >> Repair the power supply and the ground circuit.

A
B
C
D
E
F
G
H
I
J
K
L
N
O
P

LAN

DLC BRANCH LINE CIRCUIT

< COMPONENT DIAGNOSIS >

[CAN SYSTEM (TYPE 14)]

DLC BRANCH LINE CIRCUIT

Diagnosis Procedure

INFOID:000000004219092

1. CHECK CONNECTOR

1. Turn the ignition switch OFF.
2. Disconnect the battery cable from the negative terminal.
3. Check the terminals and connectors of the data link connector for damage, bend and loose connection (connector side and harness side).

Is the inspection result normal?

YES >> GO TO 2.

NO >> Repair the terminal and connector.

2. CHECK HARNESS FOR OPEN CIRCUIT

Check the resistance between the data link connector terminals.

Data link connector			Resistance (Ω)
Connector No.	Terminal No.		
M22	6	14	Approx. 54 – 66

Is the measurement value within the specification?

YES (Present error)>>Check CAN system type decision again.

YES (Past error)>>Error was detected in the data link connector branch line circuit.

NO >> Repair the data link connector branch line.

HVAC BRANCH LINE CIRCUIT

< COMPONENT DIAGNOSIS >

[CAN SYSTEM (TYPE 14)]

HVAC BRANCH LINE CIRCUIT

Diagnosis Procedure

INFOID:000000004219093

1. CHECK CONNECTOR

1. Turn the ignition switch OFF.
2. Disconnect the battery cable from the negative terminal.
3. Check the terminals and connectors of the controller (auto amp.) for damage, bend and loose connection (unit side and connector side).

Is the inspection result normal?

- YES >> GO TO 2.
NO >> Repair the terminal and connector.

2. CHECK HARNESS FOR OPEN CIRCUIT

1. Disconnect the connector of controller (auto amp.).
2. Check the resistance between the controller (auto amp.) harness connector terminals.

Controller (auto amp.) harness connector			Resistance (Ω)
Connector No.	Terminal No.		
M37	15	35	Approx. 54 – 66

Is the measurement value within the specification?

- YES >> GO TO 3.
NO >> Repair the controller (auto amp.) branch line.

3. CHECK POWER SUPPLY AND GROUND CIRCUIT

Check the power supply and the ground circuit of the controller (auto amp.). Refer to [HAC-86, "Diagnosis Procedure"](#).

Is the inspection result normal?

- YES (Present error)>>Replace the controller (auto amp.). Refer to [HAC-14, "Component Part Location"](#).
YES (Past error)>>Error was detected in the controller (auto amp.) branch line.
NO >> Repair the power supply and the ground circuit.

A
B
C
D
E
F
G
H
I
J
K
L

LAN

N
O
P

M&A BRANCH LINE CIRCUIT

Diagnosis Procedure

INFOID:000000004219094

1. CHECK CONNECTOR

1. Turn the ignition switch OFF.
2. Disconnect the battery cable from the negative terminal.
3. Check the terminals and connectors of the combination meter for damage, bend and loose connection (unit side and connector side).

Is the inspection result normal?

- YES >> GO TO 2.
 NO >> Repair the terminal and connector.

2. CHECK HARNESS FOR OPEN CIRCUIT

1. Disconnect the connector of combination meter.
2. Check the resistance between the combination meter harness connector terminals.

Combination meter harness connector			Resistance (Ω)
Connector No.	Terminal No.		
M24	21	22	Approx. 54 – 66

Is the measurement value within the specification?

- YES >> GO TO 3.
 NO >> Repair the combination meter branch line.

3. CHECK POWER SUPPLY AND GROUND CIRCUIT

Check the power supply and the ground circuit of the combination meter. Refer to [MWI-40, "COMBINATION METER : Diagnosis Procedure"](#).

Is the inspection result normal?

- YES (Present error)>>Replace the combination meter. Refer to [MWI-135, "Removal and Installation"](#).
 YES (Past error)>>Error was detected in the combination meter branch line.
 NO >> Repair the power supply and the ground circuit.

HV ECU BRANCH LINE CIRCUIT

< COMPONENT DIAGNOSIS >

[CAN SYSTEM (TYPE 14)]

HV ECU BRANCH LINE CIRCUIT

Diagnosis Procedure

INFOID:000000004219095

1.CHECK DTC

Check whether or not the DTC related to HEV SYSTEM CAN indicated on All DTC Reading by CONSULT-III.

NOTE:

For DTCs related to HEV SYSTEM CAN, refer to [LAN-59. "DTC Related to HEV SYSTEM CAN List"](#).

Is the DTC related to HEV SYSTEM CAN displayed?

YES >> Inspect HEV SYSTEM CAN. Refer to [LAN-53. "Trouble Diagnosis Flow Chart"](#).

NO >> GO TO 2.

2.CHECK CONNECTOR

1. Turn the ignition switch OFF.
2. Disconnect the battery cable from the negative terminal.
3. Check the terminals and connectors of the hybrid vehicle control ECU for damage, bend and loose connection (unit side and connector side).

Is the inspection result normal?

YES >> GO TO 3.

NO >> Repair the terminal and connector.

3.CHECK HARNESS FOR OPEN CIRCUIT

1. Disconnect the connector of hybrid vehicle control ECU.
2. Check the resistance between the hybrid vehicle control ECU harness connector terminals.

Hybrid vehicle control ECU harness connector			Resistance (Ω)
Connector No.	Terminal No.		
E66	173	172	Approx. 54 – 66

Is the measurement value within the specification?

YES >> GO TO 4.

NO >> Repair the hybrid vehicle control ECU branch line.

4.CHECK POWER SUPPLY AND GROUND CIRCUIT

Check the power supply and the ground circuit of the hybrid vehicle control ECU. [HBC-600. "Wiring Diagram"](#).

Is the inspection result normal?

YES (Present error)>>Replace the hybrid vehicle control ECU. Refer to [HBC-644. "Exploded View"](#).

YES (Past error)>>Error was detected in the hybrid vehicle control ECU branch line.

NO >> Repair the power supply and the ground circuit.

A
B
C
D
E
F
G
H
I
J
K
L
N
O
P

LAN

IPDM-E BRANCH LINE CIRCUIT

< COMPONENT DIAGNOSIS >

[CAN SYSTEM (TYPE 14)]

IPDM-E BRANCH LINE CIRCUIT

Diagnosis Procedure

INFOID:000000004219096

1. CHECK CONNECTOR

1. Turn the ignition switch OFF.
2. Disconnect the battery cable from the negative terminal.
3. Check the terminals and connectors of the IPDM E/R for damage, bend and loose connection (unit side and connector side).

Is the inspection result normal?

- YES >> GO TO 2.
NO >> Repair the terminal and connector.

2. CHECK HARNESS FOR OPEN CIRCUIT

1. Disconnect the connector of IPDM E/R.
2. Check the resistance between the IPDM E/R harness connector terminals.

IPDM E/R harness connector			Resistance (Ω)
Connector No.	Terminal No.		
E17	40	39	Approx. 108 – 132

Is the measurement value within the specification?

- YES >> GO TO 3.
NO >> Repair the IPDM E/R branch line.

3. CHECK POWER SUPPLY AND GROUND CIRCUIT

Check the power supply and the ground circuit of the IPDM E/R. Refer to [PCS-22, "Diagnosis Procedure"](#).

Is the inspection result normal?

- YES (Present error)>>Replace the IPDM E/R. Refer to [PCS-39, "Removal and Installation"](#).
YES (Past error)>>Error was detected in the IPDM E/R branch line.
NO >> Repair the power supply and the ground circuit.

CAN COMMUNICATION CIRCUIT

< COMPONENT DIAGNOSIS >

[CAN SYSTEM (TYPE 14)]

CAN COMMUNICATION CIRCUIT

Diagnosis Procedure

INFOID:000000004219097

1.CONNECTOR INSPECTION

1. Turn the ignition switch OFF.
2. Disconnect the battery cable from the negative terminal.
3. Disconnect all the unit connectors on CAN communication system.
4. Check terminals and connectors for damage, bend and loose connection.

Is the inspection result normal?

- YES >> GO TO 2.
NO >> Repair the terminal and connector.

2.CHECK HARNESS CONTINUITY (SHORT CIRCUIT)

Check the continuity between the data link connector terminals.

Data link connector		Continuity
Connector No.	Terminal No.	
M22	6 14	Not existed

Is the inspection result normal?

- YES >> GO TO 3.
NO >> Check the harness and repair the root cause.

3.CHECK HARNESS CONTINUITY (SHORT CIRCUIT)

Check the continuity between the data link connector and the ground.

Data link connector		Ground	Continuity
Connector No.	Terminal No.		
M22	6		Not existed
	14		Not existed

Is the inspection result normal?

- YES >> GO TO 4.
NO >> Check the harness and repair the root cause.

4.CHECK ECM AND IPDM E/R TERMINATION CIRCUIT

1. Remove the ECM and the IPDM E/R.
2. Check the resistance between the ECM terminals.

ECM		Resistance (Ω)
Terminal No.		
98	97	Approx. 108 – 132

3. Check the resistance between the IPDM E/R terminals.

IPDM E/R		Resistance (Ω)
Terminal No.		
40	39	Approx. 108 – 132

Is the measurement value within the specification?

- YES >> GO TO 5.
NO >> Replace the ECM and/or the IPDM E/R.

5.CHECK SYMPTOM

Connect all the connectors. Check if the symptoms described in the "Symptom (Results from interview with customer)" are reproduced.

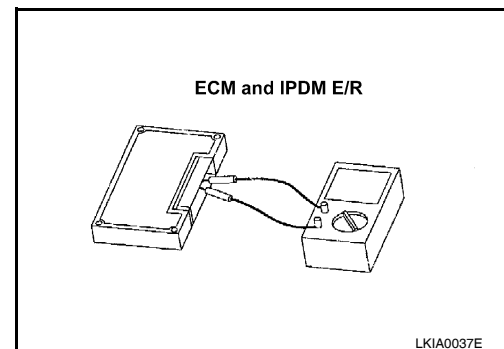

A
B
C
D
E
F
G
H
I
J
K
L
LAN
N
O
P

CAN COMMUNICATION CIRCUIT

< COMPONENT DIAGNOSIS >

[CAN SYSTEM (TYPE 14)]

Inspection result

Reproduced>>GO TO 6.

Non-reproduced>>Start the diagnosis again. Follow the trouble diagnosis procedure when past error is detected.

6.CHECK UNIT REPRODUCTION

Perform the reproduction test as per the following procedure for each unit.

1. Turn the ignition switch OFF.
2. Disconnect the battery cable from the negative terminal.
3. Disconnect one of the unit connectors of CAN communication system.

NOTE:

ECM and IPDM E/R have a termination circuit. Check other units first.

4. Connect the battery cable to the negative terminal. Check if the symptoms described in the "Symptom (Results from interview with customer)" are reproduced.

NOTE:

Although unit-related error symptoms occur, do not confuse them with other symptoms.

Inspection result

Reproduced>>Connect the connector. Check other units as per the above procedure.

Non-reproduced>>Replace the unit whose connector was disconnected.