

SECTION **WCS**

WARNING CHIME SYSTEM

A
B
C
D
E
F
G
H
I
J
K
L
M
O
P

CONTENTS

BASIC INSPECTION	3	PARKING BRAKE RELEASE WARNING CHIME	F
DIAGNOSIS AND REPAIR WORKFLOW	3	: System Description	10
Work Flow	3	PARKING BRAKE RELEASE WARNING CHIME	G
FUNCTION DIAGNOSIS	4	: Component Parts Location	11
WARNING CHIME SYSTEM	4	PARKING BRAKE RELEASE WARNING CHIME	
WARNING CHIME SYSTEM	4	: Component Description	11
WARNING CHIME SYSTEM : System Diagram	4	DIAGNOSIS SYSTEM (METER)	13
WARNING CHIME SYSTEM : System Description	4	Diagnosis Description	13
WARNING CHIME SYSTEM : Component Parts		CONSULT-III Function (METER/M&A)	13
Location	5	DIAGNOSIS SYSTEM (BCM)	16
WARNING CHIME SYSTEM : Component De-		BUZZER	16
scription	5	BUZZER : CONSULT-III Function (BCM - BUZZ-	J
LIGHT REMINDER WARNING CHIME	6	ER)	16
LIGHT REMINDER WARNING CHIME : System		COMPONENT DIAGNOSIS	17
Diagram	6	POWER SUPPLY AND GROUND CIRCUIT	17
LIGHT REMINDER WARNING CHIME : System		COMBINATION METER	17
Description	6	COMBINATION METER : Diagnosis Procedure	17
LIGHT REMINDER WARNING CHIME : Compo-		BCM (BODY CONTROL MODULE)	17
nent Parts Location	7	BCM (BODY CONTROL MODULE) : Diagnosis	M
LIGHT REMINDER WARNING CHIME : Compo-		Procedure	18
nent Description	7	BCM (BODY CONTROL MODULE) : Special Re-	
SEAT BELT WARNING CHIME	8	pair Requirement	18
SEAT BELT WARNING CHIME : System Diagram		METER BUZZER CIRCUIT	19
.....	8	Description	19
SEAT BELT WARNING CHIME : System Descrip-		Component Function Check	19
tion	8	Diagnosis Procedure	19
SEAT BELT WARNING CHIME : Component		SEAT BELT BUCKLE SWITCH SIGNAL CIR-	P
Parts Location	9	CUIT	20
SEAT BELT WARNING CHIME : Component De-		Description	20
scription	9	Component Function Check	20
PARKING BRAKE RELEASE WARNING CHIME	10	Diagnosis Procedure	20
PARKING BRAKE RELEASE WARNING CHIME		Component Inspection	21
: System Diagram	10	WARNING CHIME SYSTEM	22

WCS

Wiring Diagram	22	THE PARKING BRAKE RELEASE WARNING CONTINUES SOUNDING, OR DOES NOT SOUND	86
ECU DIAGNOSIS	29	Description	86
COMBINATION METER	29	Diagnosis Procedure	86
Reference Value	29	THE LIGHT REMINDER WARNING DOES NOT SOUND	87
Wiring Diagram	31	Description	87
Fail Safe	47	Diagnosis Procedure	87
DTC Index	48	THE SEAT BELT WARNING CONTINUES SOUNDING, OR DOES NOT SOUND	88
BCM (BODY CONTROL MODULE)	49	Description	88
Reference Value	49	Diagnosis Procedure	88
Terminal Layout	53	PRECAUTION	89
Physical Values	54	PRECAUTIONS	89
Wiring Diagram	72	Supplemental Restraint System (SRS) "AIR BAG" and "SEAT BELT PRE-TENSIONER"	89
Fail Safe	80		
DTC Inspection Priority Chart	82		
DTC Index	83		
SYMPTOM DIAGNOSIS	86		

DIAGNOSIS AND REPAIR WORKFLOW

< BASIC INSPECTION >

BASIC INSPECTION

DIAGNOSIS AND REPAIR WORKFLOW

Work Flow

INFOID:000000004219343

DETAILED FLOW

1.OBTAIN INFORMATION ABOUT SYMPTOM

Interview the customer to obtain as much information as possible about the conditions and environment under which the malfunction occurred.

>> GO TO 2

2.CHECK SYMPTOM

- Check the symptom based on the information obtained from the customer.
- Check to see if any other malfunctions are present.

>> GO TO 3

3.CHECK CONSULT-III SELF-DIAGNOSIS RESULTS

Connect CONSULT-III and perform "SELF-DIAGNOSIS". Refer to [MWI-35. "CONSULT-III Function \(METER/M&A\)".](#)

Are self-diagnosis results normal?

YES >> GO TO 4

NO >> Repair or replace the malfunctioning parts, GO TO 5

4.NARROW DOWN MALFUNCTIONING PARTS THROUGH SYMPTOM DIAGNOSIS

Perform symptom diagnosis and repair or replace the identified malfunctioning parts.

>> GO TO 5

5.FINAL CHECK

Check that the warning buzzer in the combination meter operates normally.

Does it operate normally?

YES >> Inspection End.

NO >> GO TO 1

A

B

C

D

E

F

G

H

I

J

K

L

M

WCS

O

P

WARNING CHIME SYSTEM

< FUNCTION DIAGNOSIS >

FUNCTION DIAGNOSIS

WARNING CHIME SYSTEM

WARNING CHIME SYSTEM

WARNING CHIME SYSTEM : System Diagram

INFOID:000000004219344

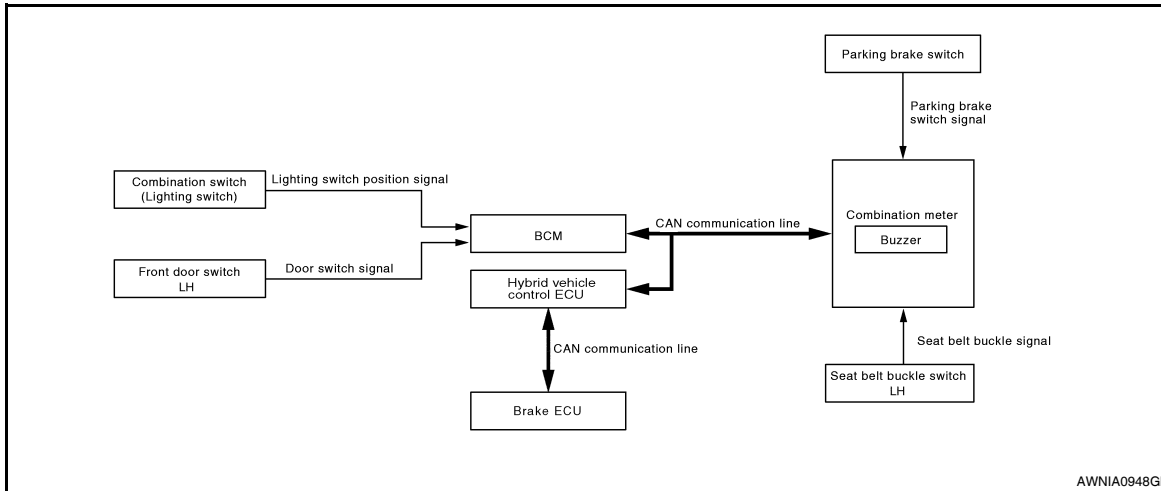

WARNING CHIME SYSTEM : System Description

INFOID:000000004219345

COMBINATION METER

- The buzzer (1) for warning chime system is installed in the combination meter.
- The buzzer sounds when the combination meter receives a buzzer output signal from each unit.

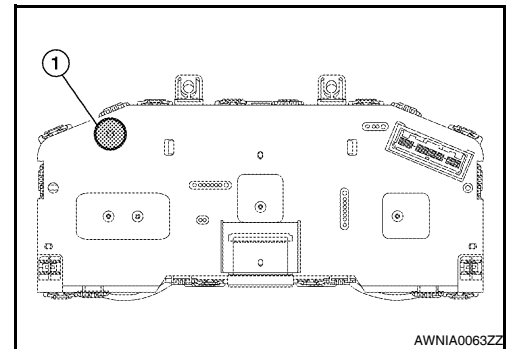

BCM

BCM receives signals from various units and transmits a buzzer output signal to the combination meter with CAN communication line if it judges that the warning buzzer should be activated.

BCM warning function list

Warning functions	Signal name
Light reminder warning chime	<ul style="list-style-type: none"> • Lighting switch position signal • Door switch signal
Seat belt warning chime	Seat belt buckle switch signal

WARNING CHIME SYSTEM

< FUNCTION DIAGNOSIS >

WARNING CHIME SYSTEM : Component Parts Location

INFOID:000000004219346

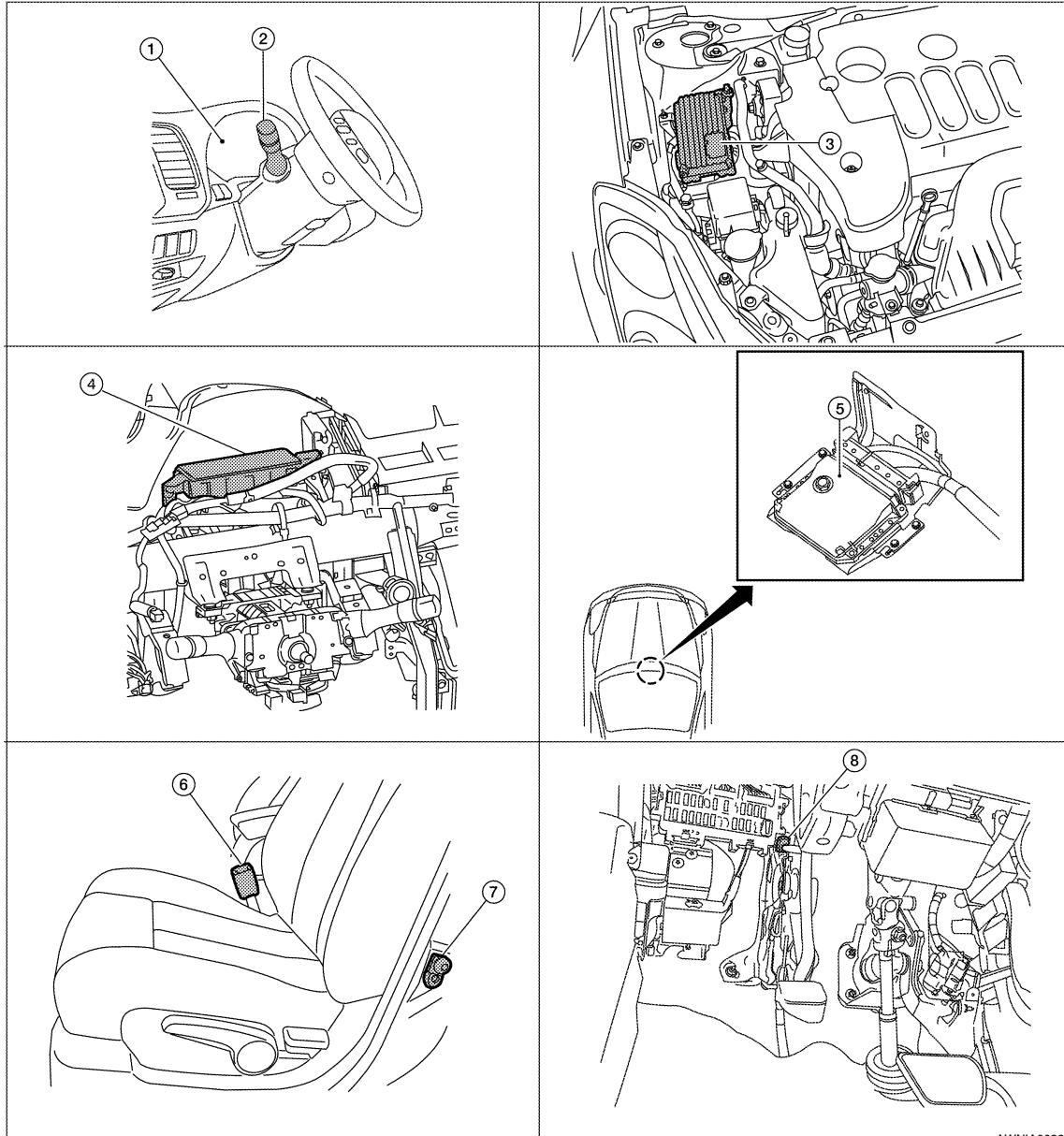

AWNIA0082ZZ

- | | | |
|--|---|------------------------------------|
| 1. Combination meter M24 | 2. Combination switch (lighting switch) M28 | 3. Brake ECU E61 |
| 4. BCM M16, M17, M18, M19 (view with instrument panel removed) | 5. Hybrid vehicle control ECU E66 | 6. Seat belt buckle switch LH B202 |
| 7. Front door switch LH B8 | 8. Parking brake switch E35 (view with instrument lower cover LH removed) | |

WARNING CHIME SYSTEM : Component Description

INFOID:000000004219347

Unit	Description
Combination meter	<ul style="list-style-type: none"> Judges whether the parking brake is released using the vehicle speed signal and the parking brake switch signal, and sounds the buzzer if necessary. Receives the seat belt buckle switch signal from the seat belt buckle switch and transmits it to BCM with CAN communication line. Receives a buzzer output signal from BCM with CAN communication line.
BCM	Transmits signals provided by various units to the combination meter with CAN communication line.

A
B
C
D
E
F
G
H
I
J
K
L
M
O
P

WARNING CHIME SYSTEM

< FUNCTION DIAGNOSIS >

Unit	Description
Hybrid vehicle control ECU	<ul style="list-style-type: none"> Receives vehicle speed signal from brake ECU with CAN communication line. Transmits the vehicle speed signal to combination meter with CAN communication line.
Brake ECU	Transmits the vehicle speed signal to hybrid vehicle control ECU with CAN communication line.
Seat belt buckle switch LH	Transmits a seat belt buckle switch signal to the combination meter.
Combination switch (Lighting switch)	Transmits the lighting switch position signal to BCM.
Front door switch LH	Transmits the door switch signal to BCM.
Parking brake switch	Transmits parking brake signal to combination meter.

LIGHT REMINDER WARNING CHIME

LIGHT REMINDER WARNING CHIME : System Diagram

INFOID:000000004219348

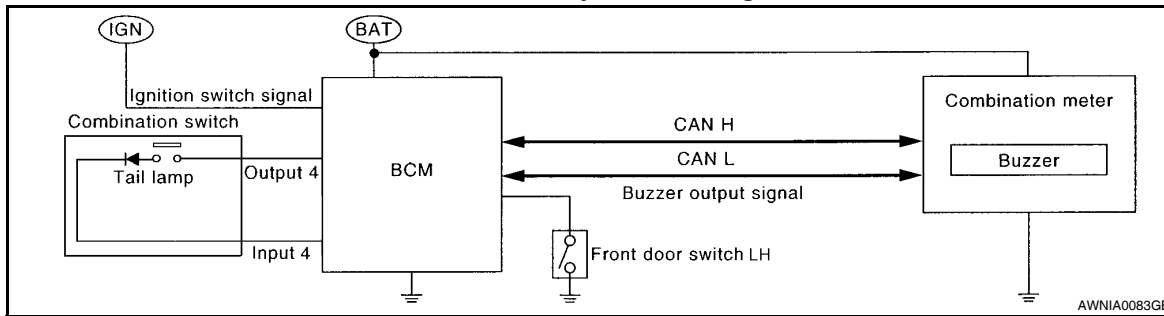

LIGHT REMINDER WARNING CHIME : System Description

INFOID:000000004219349

DESCRIPTION

With ignition switch in OFF or ACC position, driver door open, and lighting switch in 1ST or 2ND position, the light warning chime will sound.

- BCM detects ignition switch in OFF or ACC position, front door switch LH ON, and lighting switch in 1ST or 2ND position. And then transmits buzzer output signal (light reminder warning chime) to combination meter with CAN communication line.
- When combination meter receives buzzer output signal (light reminder warning chime), it sounds the buzzer.

WARNING OPERATION CONDITIONS

If all of the following conditions are fulfilled

- Lighting switch is at 1st or 2nd position
- Ignition switch is at OFF or ACC
- Front door switch LH is ON

WARNING CANCEL CONDITIONS

Warning is canceled if any of the following conditions is fulfilled.

- Lighting switch OFF
- Ignition switch ON
- Front door switch LH is OFF

WARNING CHIME SYSTEM

< FUNCTION DIAGNOSIS >

LIGHT REMINDER WARNING CHIME : Component Parts Location

INFOID:000000004490997

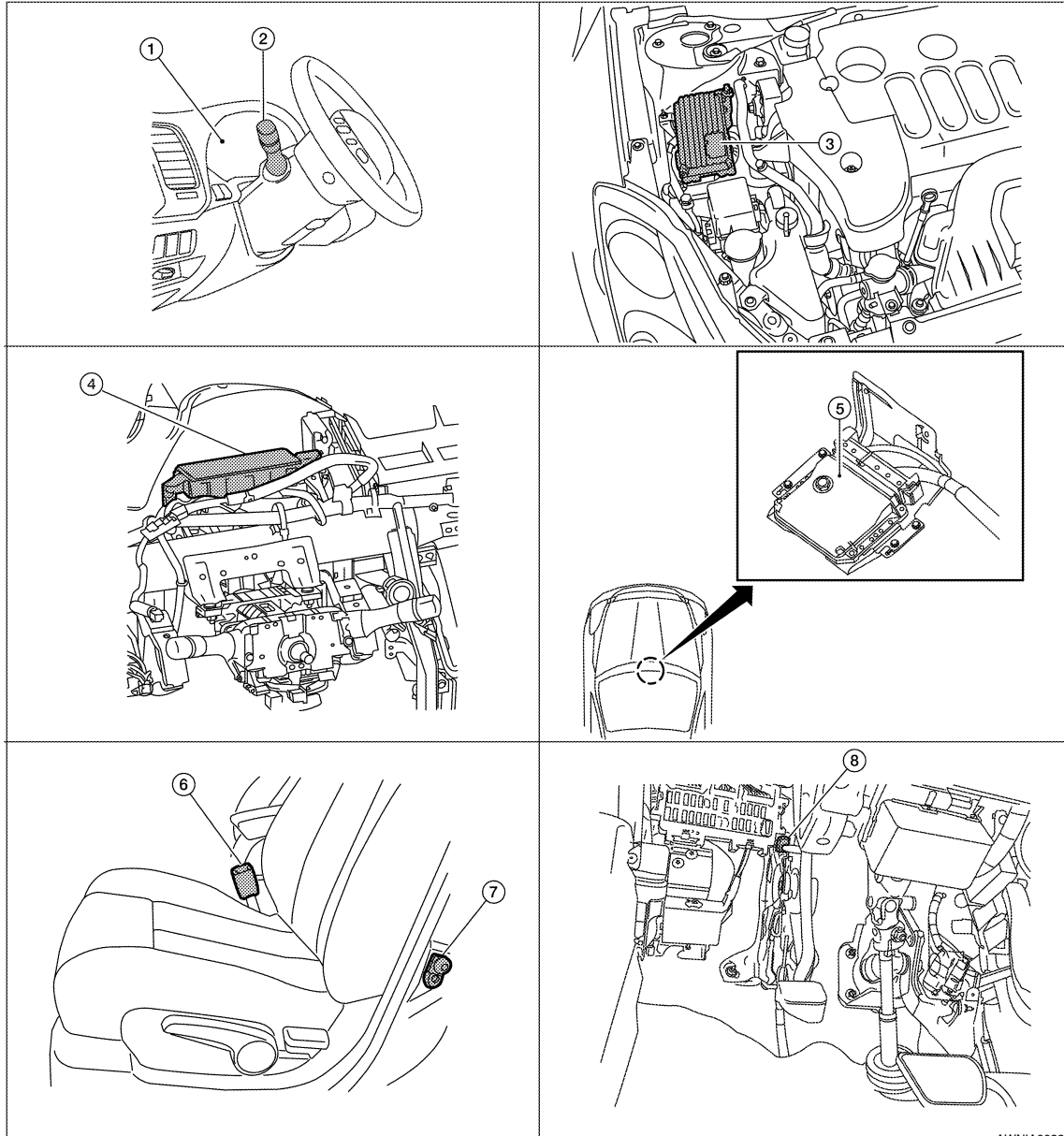

AWNIA0082ZZ

- | | | |
|--|---|------------------------------------|
| 1. Combination meter M24 | 2. Combination switch (lighting switch) M28 | 3. Brake ECU E61 |
| 4. BCM M16, M17, M18, M19 (view with instrument panel removed) | 5. Hybrid vehicle control ECU E66 | 6. Seat belt buckle switch LH B202 |
| 7. Front door switch LH B8 | 8. Parking brake switch E35 (view with instrument lower cover LH removed) | |

LIGHT REMINDER WARNING CHIME : Component Description

INFOID:000000004219351

Unit	Description
Combination meter	Receives a buzzer output signal from BCM via CAN communication line and sounds the buzzer.
BCM	Judges the light warning conditions from the signals provided by various switches and transmits a buzzer output signal to the combination meter via CAN communication line if necessary.
Combination switch (Lighting switch)	Transmits the lighting switch position signal to BCM.
Front door switch LH	Transmits the door switch signal to BCM.

A
B
C
D
E
F
G
H
I
J
K
L
M
O
P

WARNING CHIME SYSTEM

< FUNCTION DIAGNOSIS >

SEAT BELT WARNING CHIME

SEAT BELT WARNING CHIME : System Diagram

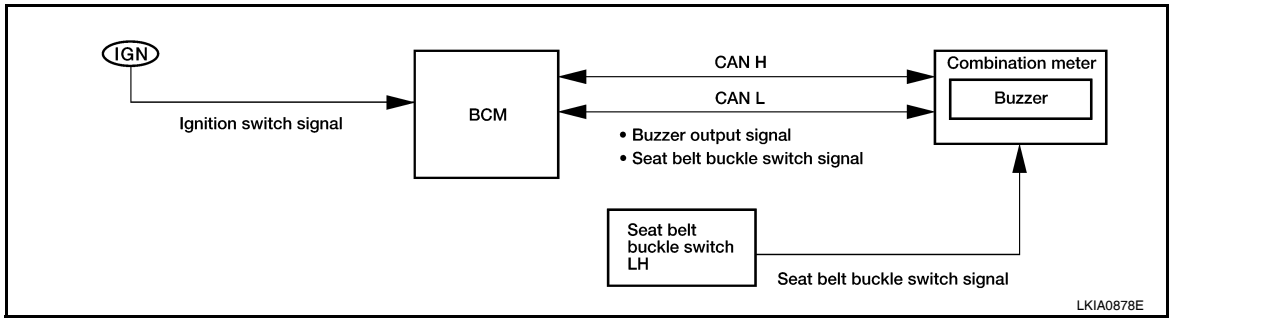

SEAT BELT WARNING CHIME : System Description

INFOID:000000004219353

DESCRIPTION

With ignition switch turned ON and driver seat belt unfastened, seat belt warning chime will sound for approximately 6 seconds.

- BCM receives seat belt buckle switch signal from combination meter with CAN communication line.
- BCM detects ignition switch turned ON and seat belt buckle switch LH ON. And then transmits buzzer output signal (seat belt warning chime) to combination meter with CAN communication line.
- When combination meter receives buzzer output signal (seat belt warning chime), it sounds the buzzer.

WARNING OPERATION CONDITIONS

If all of the following conditions are fulfilled

- Ignition switch OFF→ON
- Seat buckle switch LH is ON (driver seat belt not fastened)

WARNING CANCEL CONDITIONS

Cancels the warning if any of the following conditions is fulfilled.

- Ignition switch OFF
- Seat buckle switch LH is OFF (driver seat belt fastened)
- 90 seconds have passed since the start of the warning

WARNING CHIME SYSTEM

< FUNCTION DIAGNOSIS >

SEAT BELT WARNING CHIME : Component Parts Location

INFOID:000000004490998

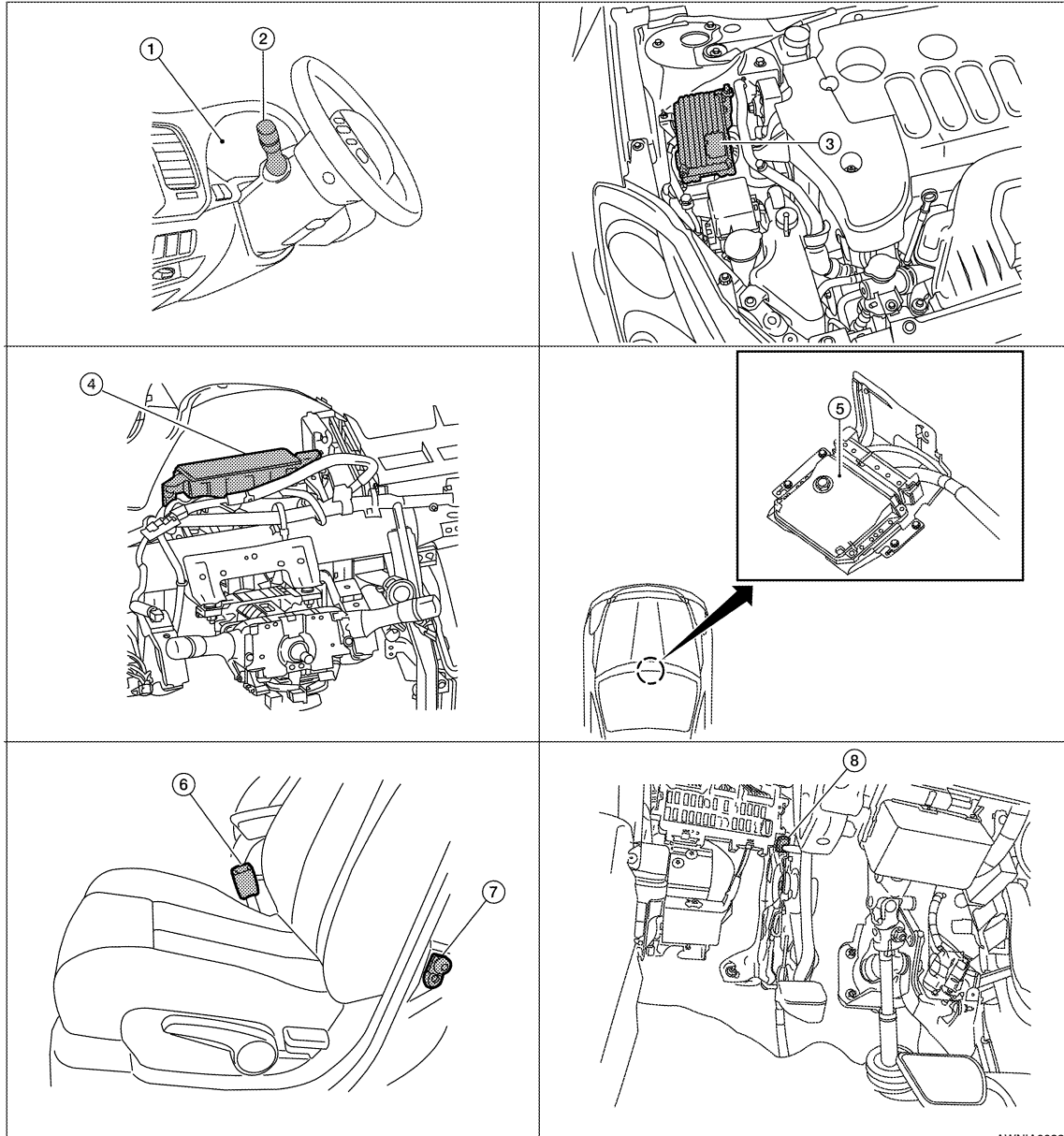

AWNIA0082ZZ

- | | | |
|--|---|------------------------------------|
| 1. Combination meter M24 | 2. Combination switch (lighting switch) M28 | 3. Brake ECU E61 |
| 4. BCM M16, M17, M18, M19 (view with instrument panel removed) | 5. Hybrid vehicle control ECU E66 | 6. Seat belt buckle switch LH B202 |
| 7. Front door switch LH B8 | 8. Parking brake switch E35 (view with instrument lower cover LH removed) | |

SEAT BELT WARNING CHIME : Component Description

INFOID:000000004219355

Unit	Description
Combination meter	<ul style="list-style-type: none"> • Receives the seat belt buckle switch signal from the seat belt buckle switch and transmits it to BCM via CAN communication line. • Receives a buzzer output signal from BCM via CAN communication line and sounds the buzzer.

A
B
C
D
E
F
G
H
I
J
K
L
M
O
P

WARNING CHIME SYSTEM

< FUNCTION DIAGNOSIS >

Unit	Description
BCM	Judges the seat belt warning condition from the seat belt buckle switch signal received from the combination meter and transmits a buzzer output signal to the combination meter via CAN communication line if necessary.
Seat belt buckle switch LH	Transmits seat belt buckle switch signal to combination meter.

PARKING BRAKE RELEASE WARNING CHIME

PARKING BRAKE RELEASE WARNING CHIME : System Diagram

INFOID:000000004219356

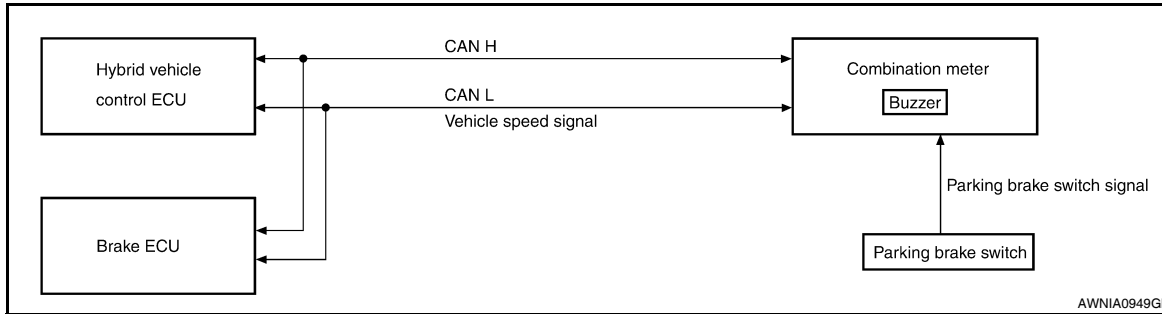

PARKING BRAKE RELEASE WARNING CHIME : System Description

INFOID:000000004219357

DESCRIPTION

- The brake ECU sends a vehicle speed signal to the hybrid vehicle control ECU via CAN communication. The hybrid vehicle control ECU then sends the vehicle speed signal to the combination meter via CAN communication.
- The combination meter judges whether the parking brake is released using the parking brake switch signal from the parking brake switch, and sounds the warning buzzer if necessary.

WARNING OPERATION CONDITIONS

If all of the following conditions are fulfilled

- Vehicle speed is approximately 7 km/h (4.3 MPH) or higher
- Parking brake switch ON

WARNING CANCEL CONDITIONS

Warning is canceled if any of the following conditions is fulfilled.

- Vehicle speed is approximately 3 km/h (1.9 MPH) or less
- Parking brake switch OFF

WARNING CHIME SYSTEM

< FUNCTION DIAGNOSIS >

PARKING BRAKE RELEASE WARNING CHIME : Component Parts Location

INFOID:000000004490999

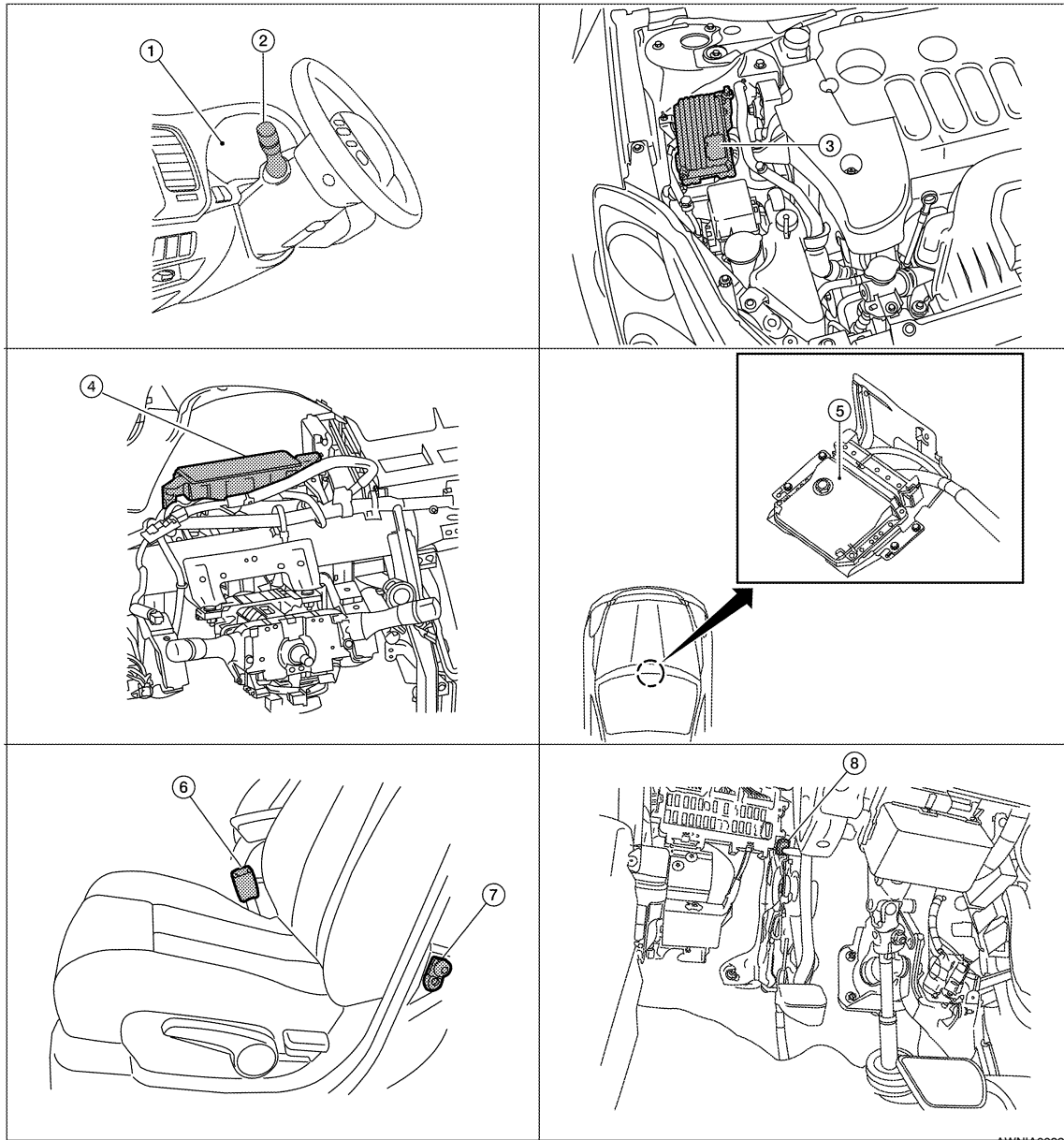

AWNIA0082ZZ

- | | | |
|--|---|------------------------------------|
| 1. Combination meter M24 | 2. Combination switch (lighting switch) M28 | 3. Brake ECU E61 |
| 4. BCM M16, M17, M18, M19 (view with instrument panel removed) | 5. Hybrid vehicle control ECU E66 | 6. Seat belt buckle switch LH B202 |
| 7. Front door switch LH B8 | 8. Parking brake switch E35 (view with instrument lower cover LH removed) | |

PARKING BRAKE RELEASE WARNING CHIME : Component Description

INFOID:000000004219359

Unit	Description
Combination meter	<ul style="list-style-type: none"> Judges whether the parking brake is released using the parking brake switch signal from the parking brake switch, and sounds the buzzer if necessary. Receives a vehicle speed signal from hybrid vehicle control ECU.
Hybrid vehicle control ECU	<ul style="list-style-type: none"> Receives vehicle speed signal from brake ECU with CAN communication line. Transmits the vehicle speed signal to combination meter with CAN communication line.

A
B
C
D
E
F
G
H
I
J
K
L
M
O
P

WCS

WARNING CHIME SYSTEM

< FUNCTION DIAGNOSIS >

Unit	Description
Brake ECU	Transmits the vehicle speed signal to the hybrid vehicle control ECU with CAN communication line.
Parking brake switch	Transmits parking brake switch signal to the combination meter.

DIAGNOSIS SYSTEM (METER)

< FUNCTION DIAGNOSIS >

DIAGNOSIS SYSTEM (METER)

Diagnosis Description

INFOID:000000004491000

SELF-DIAGNOSIS MODE

- Odo/trip meter and information display segment operation can be checked in self-diagnosis mode.
- Meters/gauges can be checked in self-diagnosis mode.

OPERATION PROCEDURE

1. Turn the ignition switch OFF.
2. While pushing the odo/trip meter switch, turn the ignition switch ON again.
3. Push the odo/trip meter switch at least 3 times within 7 seconds after the ignition switch is turned ON.
4. The unified meter control unit is turned to self-diagnosis mode.
 - All the segments on the odo/trip meter illuminate.

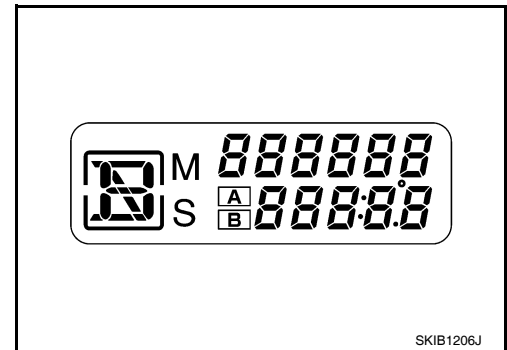

- Dots in all segments of information display LCD (1) flash alternately.

NOTE:

If any of the segments are not displayed, replace the combination meter. Refer to [MWI-135, "Removal and Installation"](#).

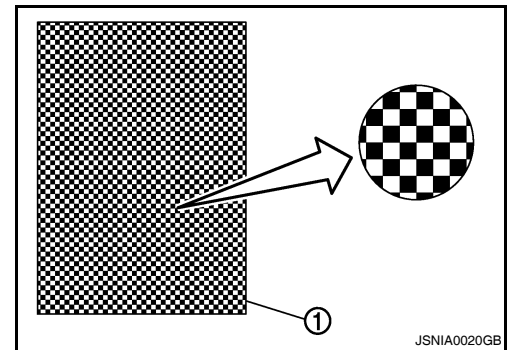

5. Push the odo/trip meter switch. Each meter/gauge should indicate as shown in the figure.

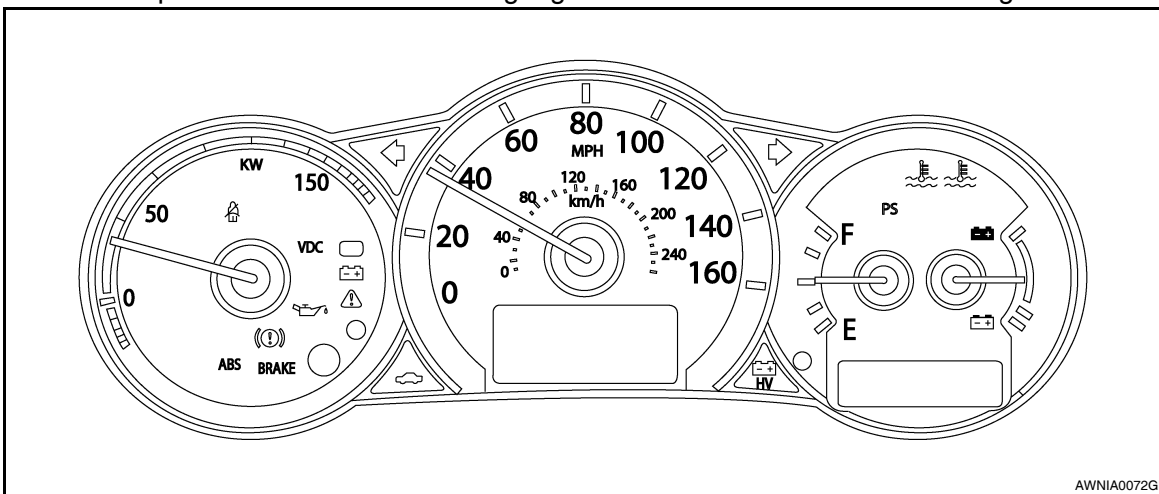

CONSULT-III Function (METER/M&A)

INFOID:000000004491001

CONSULT-III can display each diagnostic item using the diagnostic test modes shown following.

A
B
C
D
E
F
G
H
I
J
K
L
M
O
P

WCS

DIAGNOSIS SYSTEM (METER)

< FUNCTION DIAGNOSIS >

METER/M&A diagnosis mode	Description
SELF-DIAG RESULTS	Displays combination meter self-diagnosis results.
DATA MONITOR	Displays combination meter input/output data in real time.
CAN DIAG SUPPORT MNTR	The result of transmit/receive diagnosis of CAN communication can be read.

SELF-DIAG RESULTS

Display Item List

Refer to [MWI-72, "DTC Index"](#).

DATA MONITOR

Display Item List

X: Applicable

Display item [Unit]	MAIN SIGNALS	SELECTION FROM MENU	Description
SPEED METER [km/h] or [mph]	X	X	Displays the value of vehicle speed signal.
SPEED OUTPUT [km/h] or [mph]	X	X	Displays the value of vehicle speed signal, which is transmitted to each unit with CAN communication.
ODO OUTPUT		X	Displays the value, which is calculated by vehicle speed signal.
FUEL METER [lit.]	X	X	Displays the value, which processes a resistance signal from fuel gauge.
ABS W/L [ON/OFF]		X	Displays [ON/OFF] condition of ABS warning lamp.
VDC/TCS IND [ON/OFF]		X	Displays [ON/OFF] condition of VDC/TCS OFF indicator lamp.
SLIP IND [ON/OFF]		X	Displays [ON/OFF] condition of SLIP indicator lamp.
HEV BRAKE W/L [ON/OFF]		X	Displays [ON/OFF] condition of HEV brake warning lamp.*
DOOR W/L [ON/OFF]		X	Displays [ON/OFF] condition of door warning lamp.
TRUNK/GLAS-H [ON/OFF]		X	Displays [ON/OFF] condition of trunk warning lamp.
HI-BEAM IND [ON/OFF]		X	Displays [ON/OFF] condition of high beam indicator.
TURN IND [ON/OFF]		X	Displays [ON/OFF] condition of turn indicator.
OIL W/L [ON/OFF]		X	Displays [ON/OFF] condition of oil pressure warning lamp.
MIL [ON/OFF]		X	Displays [ON/OFF] condition of malfunction indicator lamp.
CRUISE IND [ON/OFF]		X	Displays [ON/OFF] condition of CRUISE indicator.
SET IND [ON/OFF]		X	Displays [ON/OFF] condition of SET indicator.
FUEL W/L [ON/OFF]		X	Displays [ON/OFF] condition of low-fuel warning lamp.
WASHER W/L [ON/OFF]		X	Displays [ON/OFF] condition of low-washer fluid warning lamp.
AIR PRES W/L [ON/OFF]		X	Displays [ON/OFF] condition of tire pressure warning lamp.
KEY G W/L [ON/OFF]		X	Displays [ON/OFF] condition of key warning lamp.
PUSH ENG IND		X	Displays the value of Intelligent Key system message indication.
SHIFT IND [P, R, N, D, L]		X	Displays [P, R, N, D, L] range position of ECVT.
PKB SW [ON/OFF]		X	Displays [ON/OFF] condition of parking brake switch.
BUCKLE SW [ON/OFF]		X	Displays [ON/OFF] condition of seat belt buckle switch LH.
DISTANCE [km] or [mile]		X	Displays the value, which is calculated by vehicle speed signal, fuel gauge and fuel consumption from ECM.
OUTSIDE TEMP [°C]		X	Displays the ambient air temperature, which is input from ambient sensor.
FUEL LOW SIG [ON/FF]		X	Displays [ON/OFF] condition of low-fuel warning signal.
BUZZER [ON/OFF]	X	X	Displays [ON/OFF] condition of buzzer.
ALL POWER METER [kw]		X	Displays the value of power meter.
SOC METER [%]		X	Displays the position of the high voltage battery status meter pointer.

DIAGNOSIS SYSTEM (METER)

< FUNCTION DIAGNOSIS >

Display item [Unit]	MAIN SIGNALS	SELECTION FROM MENU	Description	
EPS W/L [ON/OFF]		X	Displays [ON/OFF] condition of EPS warning lamp.	A
READY IND [ON/OFF]		X	Displays [ON/OFF] condition of READY indicator.	B
SYS FAIL W/L [ON/OFF]		X	Displays [ON/OFF] condition of hybrid system warning lamp.	B
SFT POSI W/L [ON/OFF]		X	Displays [ON/OFF] condition of shift position indicator.	
HV BAT W/L [ON/OFF]		X	Displays [ON/OFF] condition of high voltage battery warning lamp.	C
CHAGE W/L [ON/OFF]		X	Displays [ON/OFF] condition of charge warning lamp.	
LCD		X	Displays the value of Intelligent Key system message indication.	D
BRAKE OIL SW [ON/OFF]		X	Displays [ON/OFF] condition of brake fluid level switch.	D

NOTE:

Some items are not available due to vehicle specification.

A
B
C
D
E
F
G
H
I
J
K
L
M
O
P

WCS

DIAGNOSIS SYSTEM (BCM)

< FUNCTION DIAGNOSIS >

DIAGNOSIS SYSTEM (BCM)

BUZZER

BUZZER : CONSULT-III Function (BCM - BUZZER)

INFOID:000000004491002

DATA MONITOR

Display item [Unit]	Description
VEH SPEED 1 [Km/h]	Value of vehicle speed signal received from ABS actuator and electric unit (control unit) with CAN communication line.
PUSH SW [ON/OFF]	Status of push-button ignition switch judged by BCM.
UNLK SEN-DR [ON/OFF]	Status of front door lock assembly LH (door unlock sensor) judged by BCM.
KEY SW-SLOT [ON/OFF]	Status of key slot judged by BCM.
TAIL LAMP SW [ON/OFF]	Status of each switch judged by BCM using the combination SW readout function.
FR FOG SW [ON/OFF]	Status of front fog lamp switch judged by BCM.
DOOR SW-DR [ON/OFF]	Status of front door switch LH judged by BCM.

ACTIVE TEST

Display item [Unit]	Description
IGN KEY WARN ALM	The key warning chime operation can be checked by operating the relevant function (ON/OFF).
SEAT BELT WARN TEST	The seat belt warning chime operation can be checked by operating the relevant function (ON/OFF).
ID REGIST WARNING	The ID regist warning chime operation can be checked by operating the relevant function (ON/OFF).
LIGHT WARN ALM	The light warning chime operation can be checked by operating the relevant function (ON/OFF).

POWER SUPPLY AND GROUND CIRCUIT

< COMPONENT DIAGNOSIS >

COMPONENT DIAGNOSIS

POWER SUPPLY AND GROUND CIRCUIT COMBINATION METER

COMBINATION METER : Diagnosis Procedure

INFOID:000000004491003

1. CHECK FUSES

Check for blown combination meter fuses.

Unit	Power source	Fuse No.
Combination meter	Battery	11
	Ignition switch ON or START	4
	Ignition switch ACC or ON	19

Are any combination meter fuses blown?

- YES >> Eliminate cause of malfunction before installing new fuse.
 NO >> GO TO 2

2. POWER SUPPLY CIRCUIT CHECK

1. Disconnect combination meter connector.
2. Check voltage between combination meter harness connector M24 terminals 1, 2, 14 and ground.

Terminals		(-)	Ignition switch position			
(+)	Connector		Terminal	OFF	ACC	ON
M24	1	Ground	Battery voltage	Battery voltage	Battery voltage	Battery voltage
	2		0V	0V	Battery voltage	Battery voltage
	14		0V	Battery voltage	Battery voltage	0V

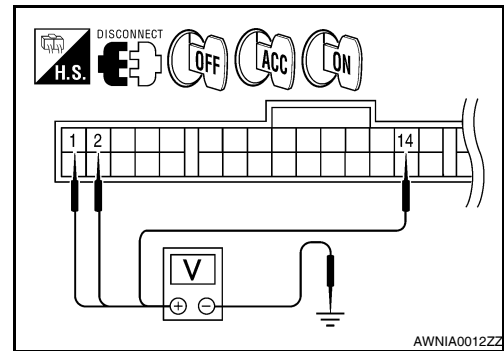

Do test results match chart?

- YES >> GO TO 3
 NO >> Check harness for open between combination meter and fuse.

3. GROUND CIRCUIT CHECK

1. Turn ignition switch OFF.
2. Check continuity between combination meter harness connector terminals 3, 4, 23 and ground.

Terminals		(-)	Continuity
(+)	Connector		
M24	3	Ground	Yes
	4		
	23		

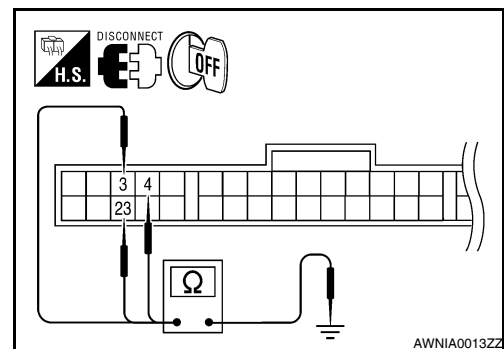

Do test results match chart?

- YES >> Inspection End.
 NO >> Check ground harness.

BCM (BODY CONTROL MODULE)

A
B
C
D
E
F
G
H
I
J
K
L
M
O
P

WCS

POWER SUPPLY AND GROUND CIRCUIT

< COMPONENT DIAGNOSIS >

BCM (BODY CONTROL MODULE) : Diagnosis Procedure

INFOID:000000004491004

1. CHECK FUSE AND FUSIBLE LINK

Check if the following BCM fuse or fusible link are blown.

Terminal No.	Signal name	Fuse and fusible link No.
1	Battery power supply	J
11		10

Is the fuse or fusible link blown?

- YES >> Replace the blown fuse or fusible link after repairing the affected circuit.
 NO >> GO TO 2

2. CHECK POWER SUPPLY CIRCUIT

- Turn ignition switch OFF.
- Disconnect BCM.
- Check voltage between BCM harness connector and ground.

Terminals		Voltage (Approx.)
(+)	(-)	
BCM		Ground
Connector	Terminal	
M16	1	
M17	11	
		Battery voltage

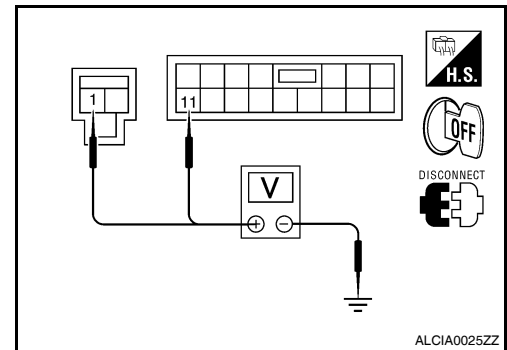

Is the measurement normal?

- YES >> GO TO 3
 NO >> Repair or replace harness.

3. CHECK GROUND CIRCUIT

Check continuity between BCM harness connector and ground.

BCM		Ground	Continuity
Connector	Terminal		Yes
M17	13		Yes

Does continuity exist?

- YES >> Inspection End.
 NO >> Repair or replace harness.

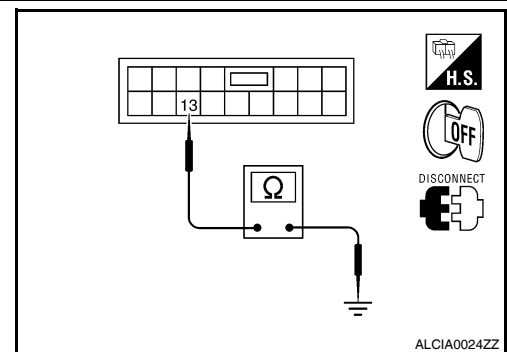

BCM (BODY CONTROL MODULE) : Special Repair Requirement

INFOID:000000004491005

1. REQUIRED WORK WHEN REPLACING BCM

Initialize control unit. Refer to CONSULT-III operation manual.

>> Work End.

METER BUZZER CIRCUIT

< COMPONENT DIAGNOSIS >

METER BUZZER CIRCUIT

Description

INFOID:000000004219364

- The buzzer for warning chime system is installed in the combination meter.
- The combination meter sounds the alarm buzzer based on the signals transmitted from various units.

Component Function Check

INFOID:000000004219365

1.CHECK OPERATION OF METER BUZZER

1. Select "BUZZER" of "BCM" on CONSULT-III.
2. Perform "LIGHT WARN ALM" of "ACTIVE TEST".

Does meter buzzer activate?

- YES >> Inspection End.
NO >> Replace combination meter. Refer to [MWI-135. "Removal and Installation"](#).

Diagnosis Procedure

INFOID:000000004219366

1.CHECK POWER SUPPLY OF COMBINATION METER

Check power supply of combination meter. Refer to [MWI-40. "COMBINATION METER : Diagnosis Procedure"](#).

Is the inspection result normal?

- YES >> Inspection End.
NO >> Repair power supply circuit of combination meter.

A
B
C
D
E
F
G
H
I
J
K
L
M
O
P

WCS

SEAT BELT BUCKLE SWITCH SIGNAL CIRCUIT

< COMPONENT DIAGNOSIS >

SEAT BELT BUCKLE SWITCH SIGNAL CIRCUIT

Description

INFOID:000000004219367

Transmits a seat belt buckle switch signal to the combination meter.

Component Function Check

INFOID:000000004219368

1.CHECK COMBINATION METER INPUT SIGNAL

Select "DATA MONITOR" for "METER/M&A" and check the "BELT SW" monitor value.

BELT SW

When seat belt is fastened : OFF

When seat belt is unfastened : ON

>> Inspection End.

Diagnosis Procedure

INFOID:000000004219369

1.CHECK COMBINATION METER INPUT SIGNAL

1. Turn ignition switch ON.
2. Check voltage between combination meter harness connector M24 terminal 35 and ground.

35 - Ground

When driver seat belt is fastened : Approx. 12V

When driver seat belt is unfastened : Approx. 0V

Is the inspection result normal?

YES >> Replace combination meter. Refer to [MWI-135](#), "Removal and Installation".

NO >> GO TO 2

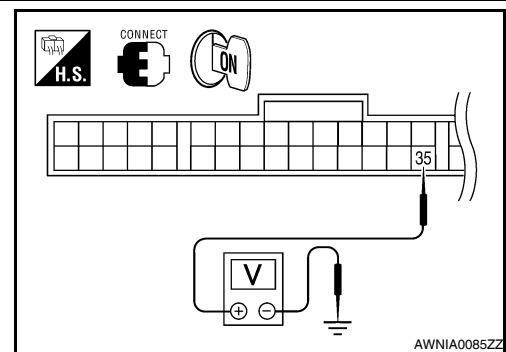

2.CHECK SEAT BELT BUCKLE SWITCH CIRCUIT

1. Turn ignition switch OFF.
2. Disconnect combination meter connector and seat belt buckle switch LH connector.
3. Check continuity between combination meter harness connector M24 terminal 35 and seat belt buckle switch LH harness connector B202 terminal 1.

35 - 1 : Continuity should exist.

4. Check harness continuity between combination meter harness connector M24 terminal 35 and ground.

35 - Ground : Continuity should not exist.

Is the inspection result normal?

YES >> GO TO 3

NO >> Repair harness or connector.

3.CHECK SEAT BELT BUCKLE SWITCH GROUND CIRCUIT

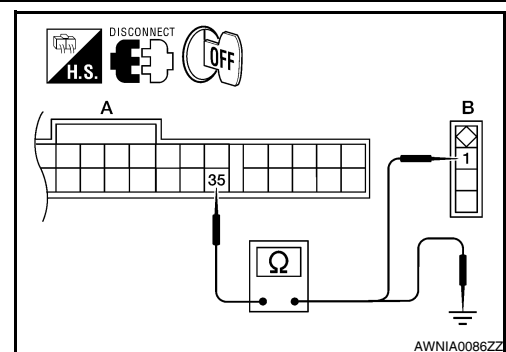

SEAT BELT BUCKLE SWITCH SIGNAL CIRCUIT

< COMPONENT DIAGNOSIS >

Check harness continuity between seat belt buckle switch LH harness connector B202 terminal 2 and ground.

2 - Ground : Continuity should exist.

Is the inspection result normal?

- YES >> Inspection End.
- NO >> Repair harness or connector.

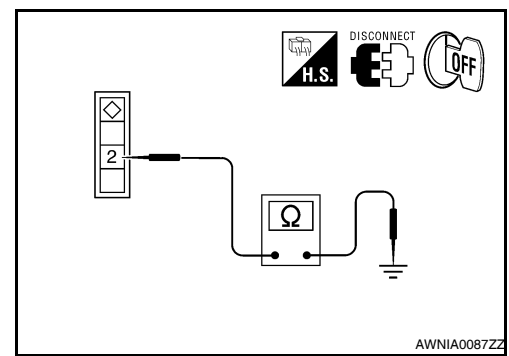

Component Inspection

1. CHECK SEAT BELT BUCKLE SWITCH

1. Turn ignition switch OFF.
2. Disconnect the seat belt buckle switch connector.
3. Check continuity between terminals 1 and 2.

1- 2

When seat belt is fastened : Continuity should not exist.

When seat belt is unfastened : Continuity should exist.

Is the inspection result normal?

- YES >> Inspection End.
- NO >> Replace the seat belt buckle switch LH.

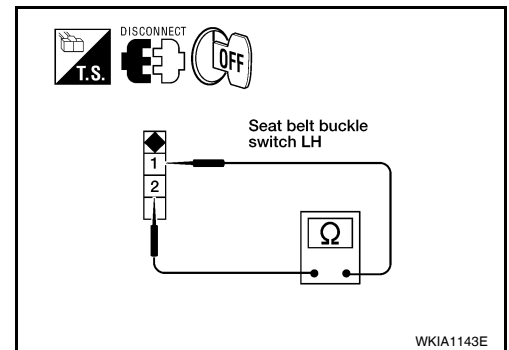

A
B
C
D
E
F
G
H
I
J
K
L
M
O
P

WCS

WARNING CHIME SYSTEM

< COMPONENT DIAGNOSIS >

WARNING CHIME SYSTEM

Wiring Diagram

INFOID:000000004219371

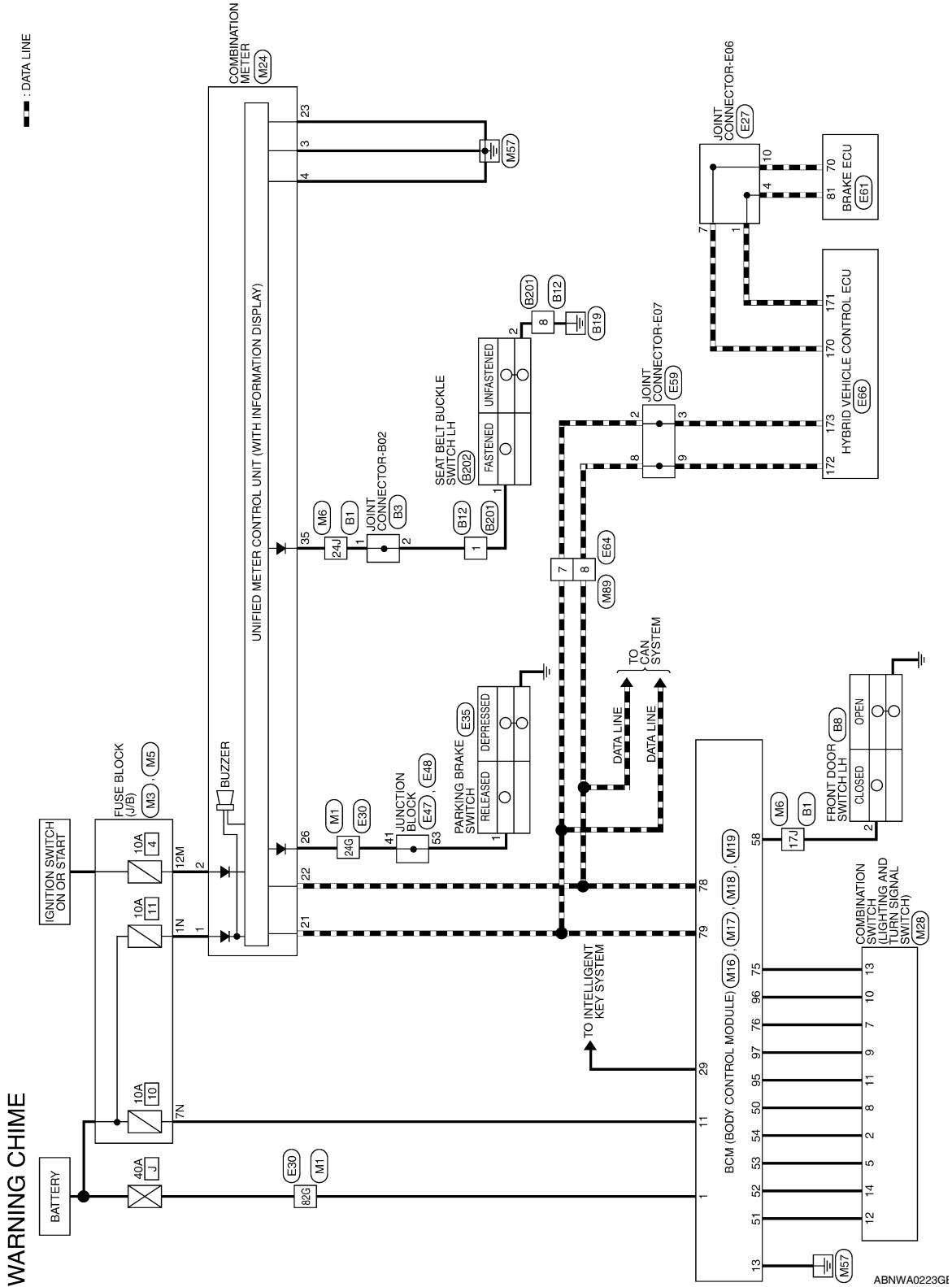

ABNWA0223Gi

WARNING CHIME SYSTEM

< COMPONENT DIAGNOSIS >

WARNING CHIME CONNECTORS

Connector No.	M1
Connector Name	WIRE TO WIRE
Connector Color	WHITE

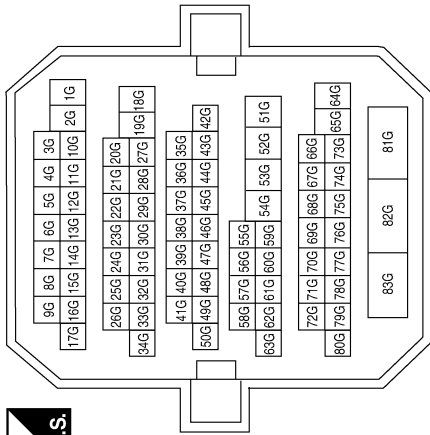

Terminal No.	Color of Wire	Signal Name
24G	G/R	-
82G	W/B	-

Connector No.	M3
Connector Name	FUSE BLOCK (J/B)
Connector Color	WHITE

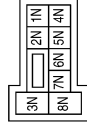

Terminal No.	Color of Wire	Signal Name
1N	W/L	-
7N	Y/R	-

Connector No.	M5
Connector Name	FUSE BLOCK (J/B)
Connector Color	WHITE

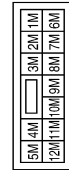

Terminal No.	Color of Wire	Signal Name
12M	P	-

A
B
C
D
E
F
G
H
I
J
K
L
M
N
O
P

WCS

WARNING CHIME SYSTEM

< COMPONENT DIAGNOSIS >

Connector No.	M6
Connector Name	WIRE TO WIRE
Connector Color	WHITE

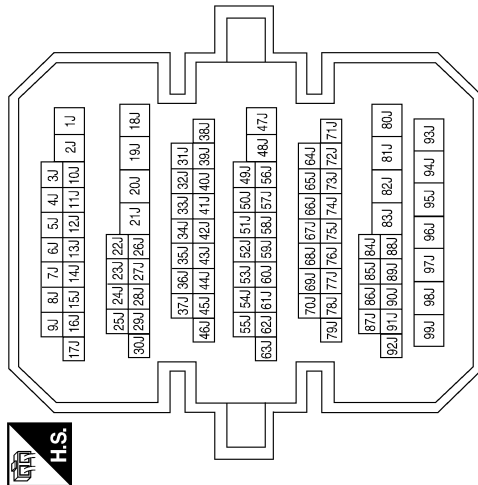

Terminal No.	Color of Wire	Signal Name
17J	SB	-
24J	W/B	-

Connector No.	M16
Connector Name	BCM (BODY CONTROL MODULE)
Connector Color	BLACK



Terminal No.	Color of Wire	Signal Name
1	W/B	BAT_POWER_F/L

Connector No.	M17
Connector Name	BCM (BODY CONTROL MODULE)
Connector Color	WHITE



Terminal No.	Color of Wire	Signal Name
11	Y/R	BAT_BCM_FUSE
13	B	GND1

Connector No.	M18
Connector Name	BCM (BODY CONTROL MODULE)
Connector Color	GREEN

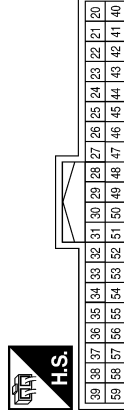

Terminal No.	Color of Wire	Signal Name
29	Y	FOB_IN_SW_1
50	LG/B	INPUT_5
51	L/W	INPUT_1
52	G/B	INPUT_2
53	LG/R	INPUT_3
54	G/Y	INPUT_4
58	SB	DR_DOOR_SW

WARNING CHIME SYSTEM

< COMPONENT DIAGNOSIS >

Connector No.	M28
Connector Name	COMBINATION SWITCH
Connector Color	WHITE

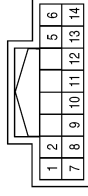

Terminal No.	Color of Wire	Signal Name
2	G/Y	OUTPUT_4
5	LG/R	OUTPUT_3
7	R/G	INPUT_3
8	LG/B	OUTPUT_5
9	R/B	INPUT_2
10	P/B	INPUT_4
11	R/W	INPUT_1
12	L/W	OUTPUT_1
13	R/Y	INPUT_5
14	G/B	OUTPUT_2

Connector No.	M24
Connector Name	COMBINATION METER
Connector Color	WHITE

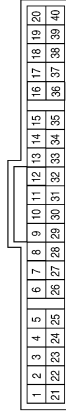

Terminal No.	Color of Wire	Signal Name
1	W/L	BATT
2	O	IGN
3	B	GND
4	B	GND
21	L	CAN-H
22	P	CAN-L
23	B	GND
26	G/R	PKB
35	W/B	DR_BELT

Connector No.	M19
Connector Name	BCM (BODY CONTROL MODULE)
Connector Color	BLACK

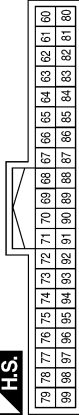

Terminal No.	Color of Wire	Signal Name
75	R/Y	OUTPUT_5
76	R/G	OUTPUT_3
78	P	CAN-L
79	L	CAN-H
95	R/W	OUTPUT_1
96	P/B	OUTPUT_4
97	R/B	OUTPUT_2

Connector No.	M89
Connector Name	WIRE TO WIRE
Connector Color	WHITE

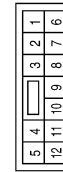

Terminal No.	Color of Wire	Signal Name
7	L	-
8	P	-

Connector No.	E27
Connector Name	JOINT CONNECTOR-E06
Connector Color	BLUE

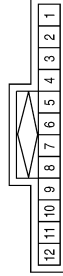

Terminal No.	Color of Wire	Signal Name
1	Y	-
4	Y	-
7	BR	-
10	BR	-

ABNIA0743GB

A
B
C
D
E
F
G
H
I
J
K
L
M
O
P

WARNING CHIME SYSTEM

< COMPONENT DIAGNOSIS >

Connector No.	E35
Connector Name	PARKING BRAKE SWITCH (WITH CVT)
Connector Color	BLACK

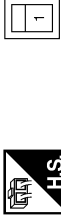

Terminal No.	Color of Wire	Signal Name
1	G/R	-

Terminal No.	Color of Wire	Signal Name
24G	G/R	-
82G	W/B	-

Connector No.	E30
Connector Name	WIRE TO WIRE
Connector Color	WHITE

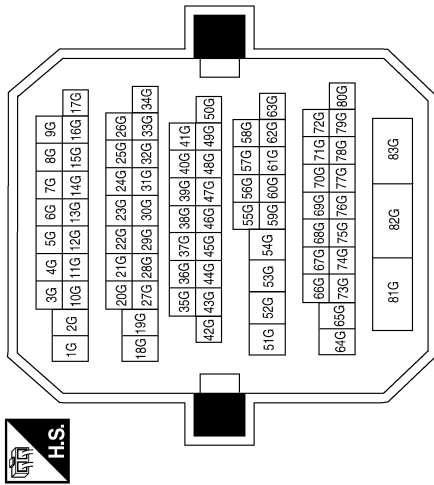

Connector No.	E59
Connector Name	JOINT CONNECTOR-E06
Connector Color	BLUE



Terminal No.	Color of wire	Signal Name
2	L	-
3	L	-
8	P	-
9	P	-

Connector No.	E48
Connector Name	JUNCTION BLOCK
Connector Color	WHITE

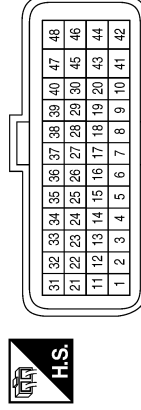

Terminal No.	Color of Wire	Signal Name
53	G/R	-

Connector No.	E47
Connector Name	JUNCTION BLOCK
Connector Color	WHITE



Terminal No.	Color of Wire	Signal Name
41	G/R	-

ABNIA0744GB

WARNING CHIME SYSTEM

< COMPONENT DIAGNOSIS >

Connector No.	E64
Connector Name	WIRE TO WIRE
Connector Color	WHITE

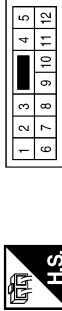

Terminal No.	Color of wire	Signal Name
7	L	-
8	P	-

Connector No.	E61
Connector Name	BRAKE ECU
Connector Color	BLACK



Terminal No.	Color of wire	Signal Name
70	BR	CAN-L
81	Y	CAN-H

Terminal No.	Color of wire	Signal Name
170	BR	CAN-L
171	Y	CAN-H
172	P	CAN-L
173	L	CAN-H

Connector No.	E66
Connector Name	HYBRID VEHICLE CONTROL ECU
Connector Color	BLACK



168	167	166	165	164	163	77	76	75	74	73	72	71	70	69	68	67	66	65	64	63	62	61
174	173	172	171	170	169	111	110	109	108	107	106	105	104	103	102	101	100	99	98	97	96	95
180	179	178	177	176	175	128	127	126	125	124	123	122	121	120	119	118	117	116	115	114	113	112
186	185	184	183	182	181	145	144	143	142	141	140	139	138	137	136	135	134	133	132	131	130	129
						162	161	160	159	158	157	156	155	154	153	152	151	150	149	148	147	146

ABNIA0745GB

WARNING CHIME SYSTEM

< COMPONENT DIAGNOSIS >

Connector No.	B1
Connector Name	WIRE TO WIRE
Connector Color	WHITE

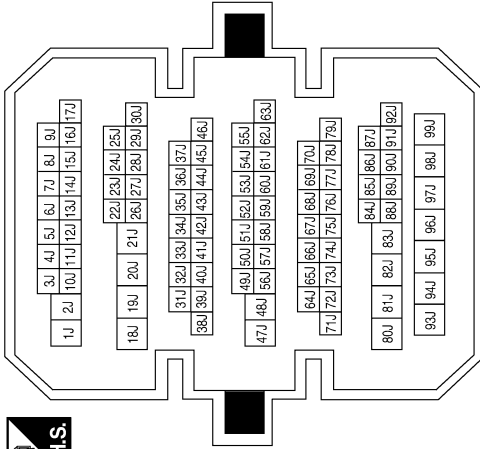

Terminal No.	Color of Wire	Signal Name
17J	SB	-
24J	W/B	-

Connector No.	B3
Connector Name	JOINT CONNECTOR-B02
Connector Color	WHITE



Terminal No.	Color of Wire	Signal Name
1	W/B	-
2	W/B	-

Connector No.	B8
Connector Name	FRONT DOOR SWITCH LH
Connector Color	WHITE



Terminal No.	Color of Wire	Signal Name
2	SB	DOOR SW(DR)

Connector No.	B12
Connector Name	WIRE TO WIRE
Connector Color	WHITE



Terminal No.	Color of Wire	Signal Name
1	W/B	-
8	B/Y	-

Connector No.	B201
Connector Name	WIRE TO WIRE
Connector Color	WHITE



Terminal No.	Color of Wire	Signal Name
1	W/B	-
8	B/Y	-

Connector No.	B202
Connector Name	SEAT BELT BUCKLE SWITCH LH
Connector Color	WHITE

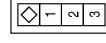

Terminal No.	Color of Wire	Signal Name
1	W/B	BUCKLE SWITCH FR LH
2	B/Y	GND

ABNIA0746GB

COMBINATION METER

< ECU DIAGNOSIS >

ECU DIAGNOSIS

COMBINATION METER

Reference Value

INFOID:000000004491006

TERMINAL LAYOUT

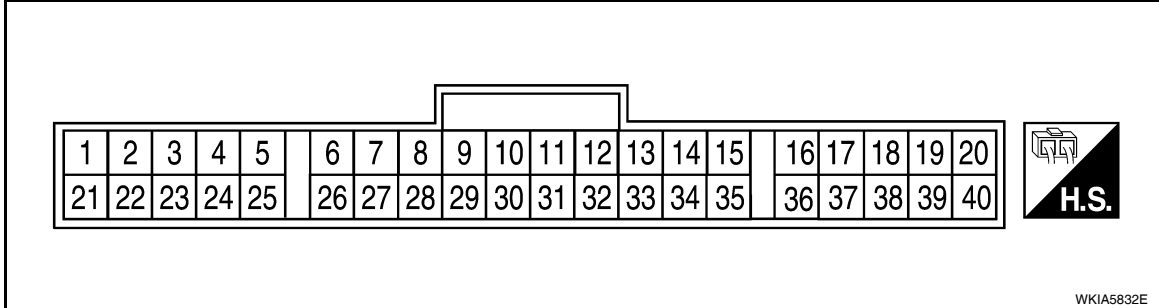

PHYSICAL VALUES

Terminal	Wire color	Item	Condition		Reference value (V) (Approx.)
			Ignition switch	Operation or condition	
1	W/L	Battery power supply	—	—	Battery voltage
2	O	Ignition switch ON or START	ON	—	Battery voltage
3	B	Ground (Power)	—	—	0
4	B	Ground (Illumination)			
5	R/Y	Illumination output	—	—	Refer to INL-9, "System Description" .
9	GR/W	Illumination switch power	—	—	Refer to INL-9, "System Description" .
10	O/L	Mode switch ground	ON	—	0
11	L/R	Mode switch A	ON	Switch pressed	0
				Switch released	5
12	B/R	Mode switch B	ON	Switch pressed	0
				Switch released	5
14	V/Y	Ignition switch ACC or ON	ON	—	Battery voltage
15	BR/W	Air bag warning lamp input	ON	Air bag warning lamp ON	3
				Air bag warning lamp OFF	0
18	O/B	Ambient sensor signal	ON	—	0 - 5 (Based on ambient temperature)
20	B/Y	Ambient sensor ground	ON	—	0
21	L	CAN-H	—	—	—
22	P	CAN-L	—	—	—
23	B	Ground (Circuit)	—	—	0
24	B/W	Fuel level sensor ground	ON	—	0
26	G/R	Parking brake switch	ON	Parking brake applied	0
				Parking brake released	Battery voltage
28	L/O	Security indicator input	OFF	Security indicator ON	0
				Security indicator OFF	Battery voltage

COMBINATION METER

< ECU DIAGNOSIS >

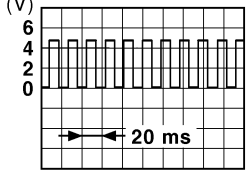
Terminal	Wire color	Item	Condition		Reference value (V) (Approx.)
			Ignition switch	Operation or condition	
29	R	Washer fluid level switch	ON	Washer fluid level low	0
				Washer fluid level normal	Battery voltage
30	L/B	Vehicle speed signal output (2-pulse)	ON	Speedometer operated [When vehicle speed is approx. 20 km/h (12 MPH)]	240 Hz
31	V/W	Vehicle speed signal output (8-pulse)	ON	Speedometer operated [When vehicle speed is approx. 40 km/h (25 MPH)]	<p>NOTE: Maximum voltage may be 12V due to specifications (connected units).</p>  <p style="text-align: right; font-size: small;">PKIC0643E</p>
34	G/B	Fuel level sensor signal	—	—	Refer to MWI-13. "FUEL GAUGE : System Description" .
35	W/B	Seat belt buckle switch LH	ON	Unfastened (ON)	0
				Fastened (OFF)	Battery voltage
36	L/W	Seat belt buckle switch RH	ON	Unfastened (ON)	0
				Fastened (OFF)	Battery voltage

COMBINATION METER

< ECU DIAGNOSIS >

Wiring Diagram

INFOID:000000004491007

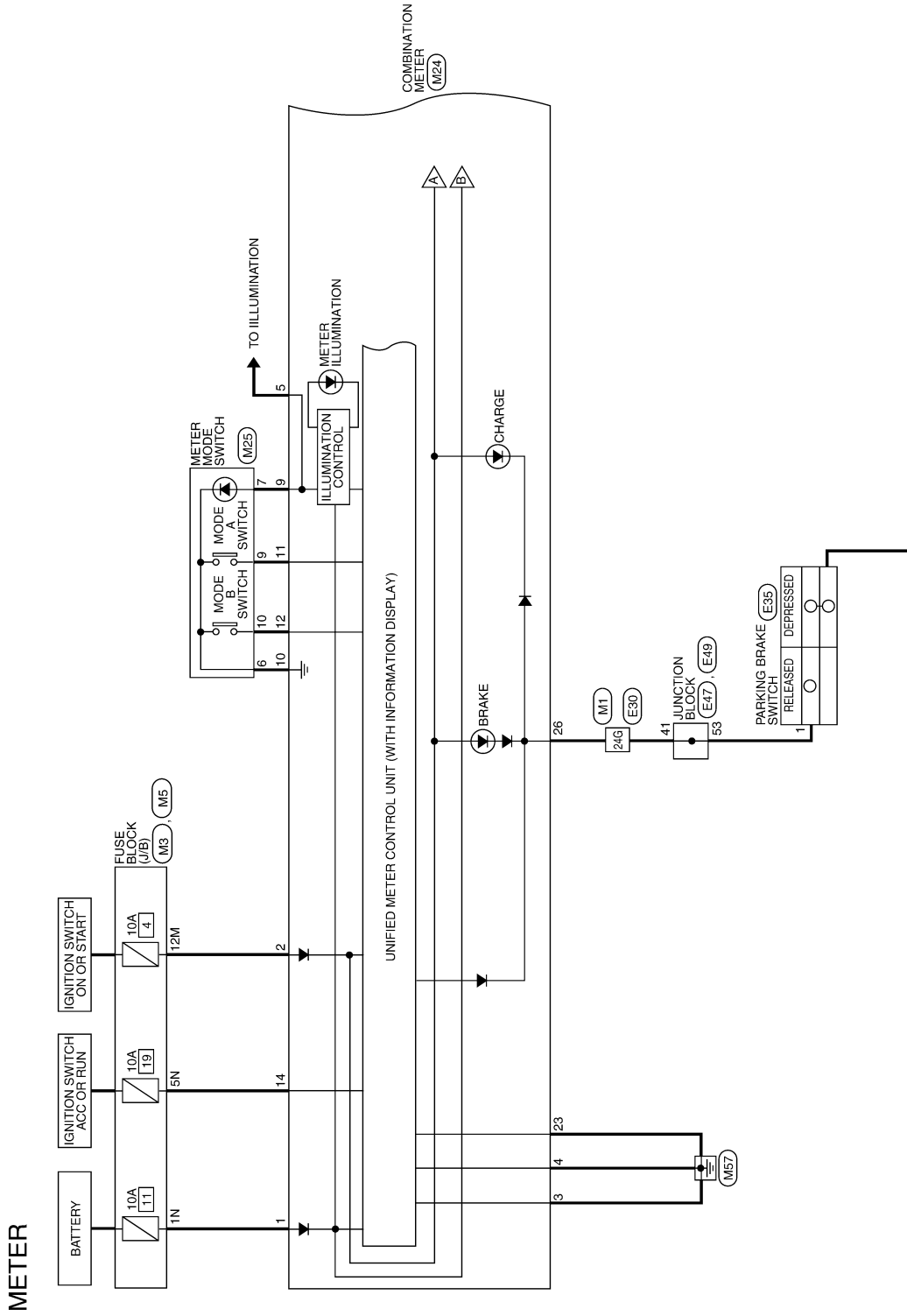

A
B
C
D
E
F
G
H
I
J
K
L
M
N
O
P

WCS

AWNWA0168G

COMBINATION METER

< ECU DIAGNOSIS >

--- : DATA LINE

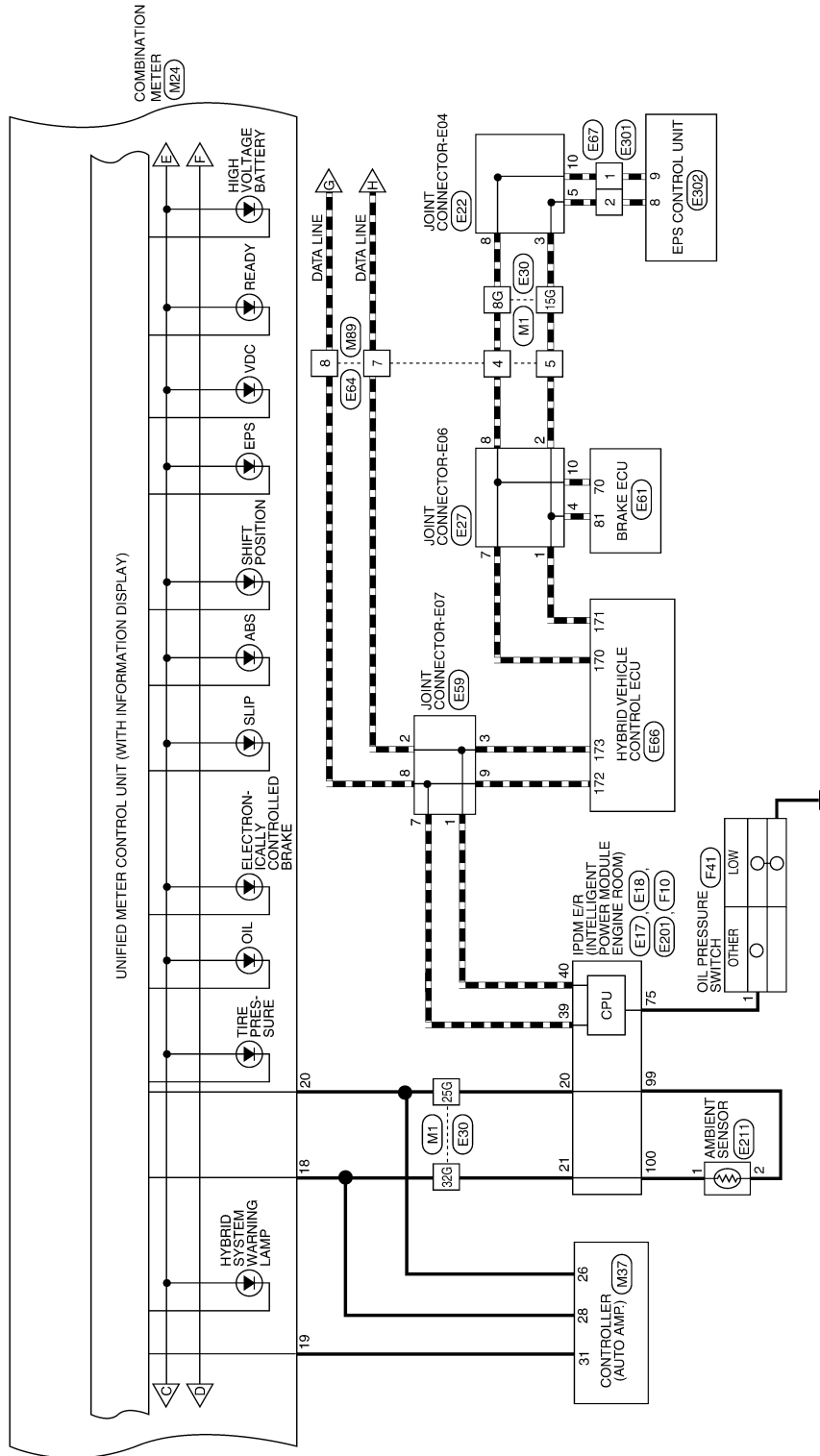

A
B
C
D
E
F
G
H
I
J
K
L
M
O
P

WCS

AWNWA0169G

COMBINATION METER

< ECU DIAGNOSIS >

--- : DATA LINE

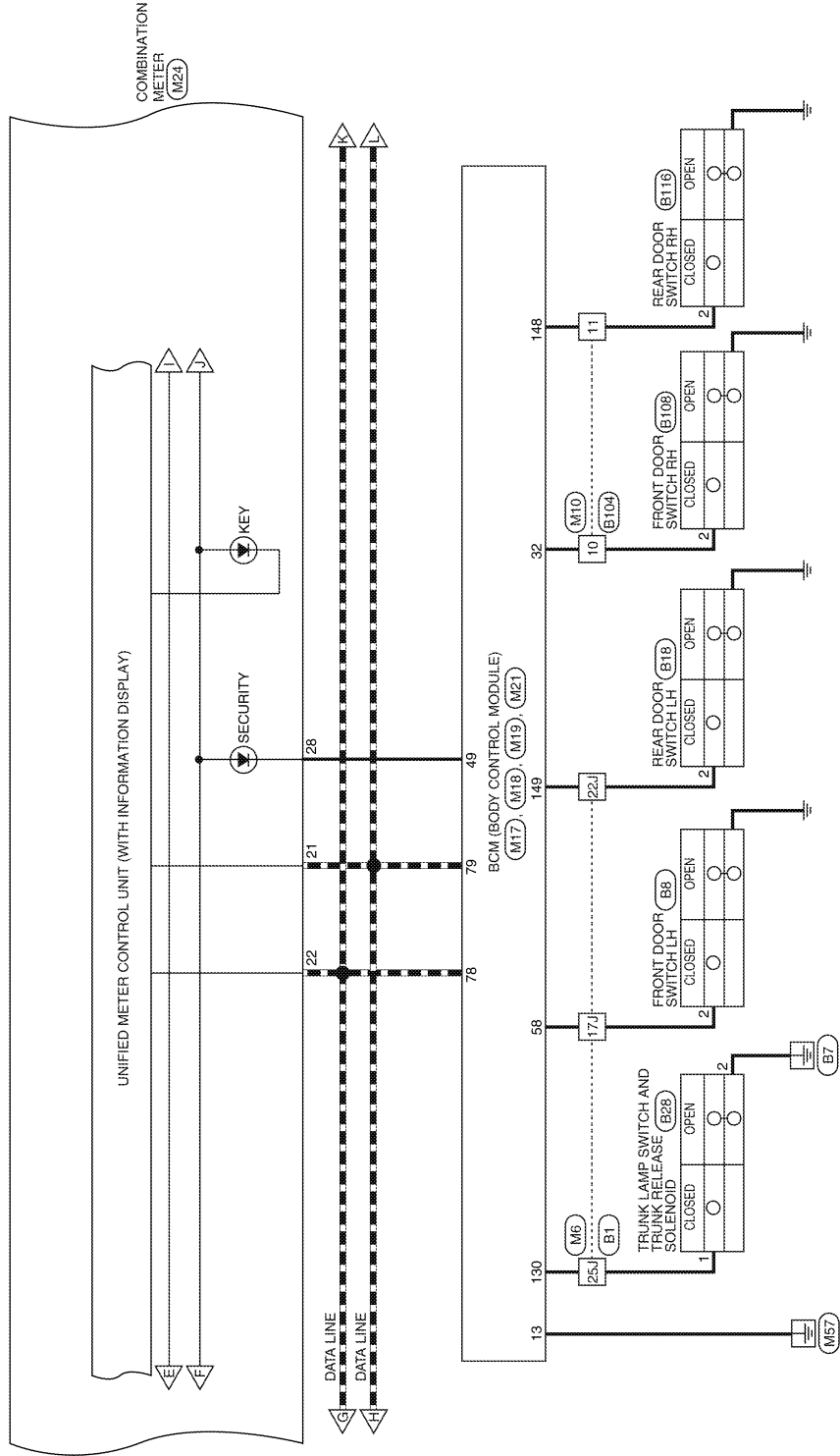

ALNWA0038GE

COMBINATION METER

< ECU DIAGNOSIS >

--- : DATA LINE

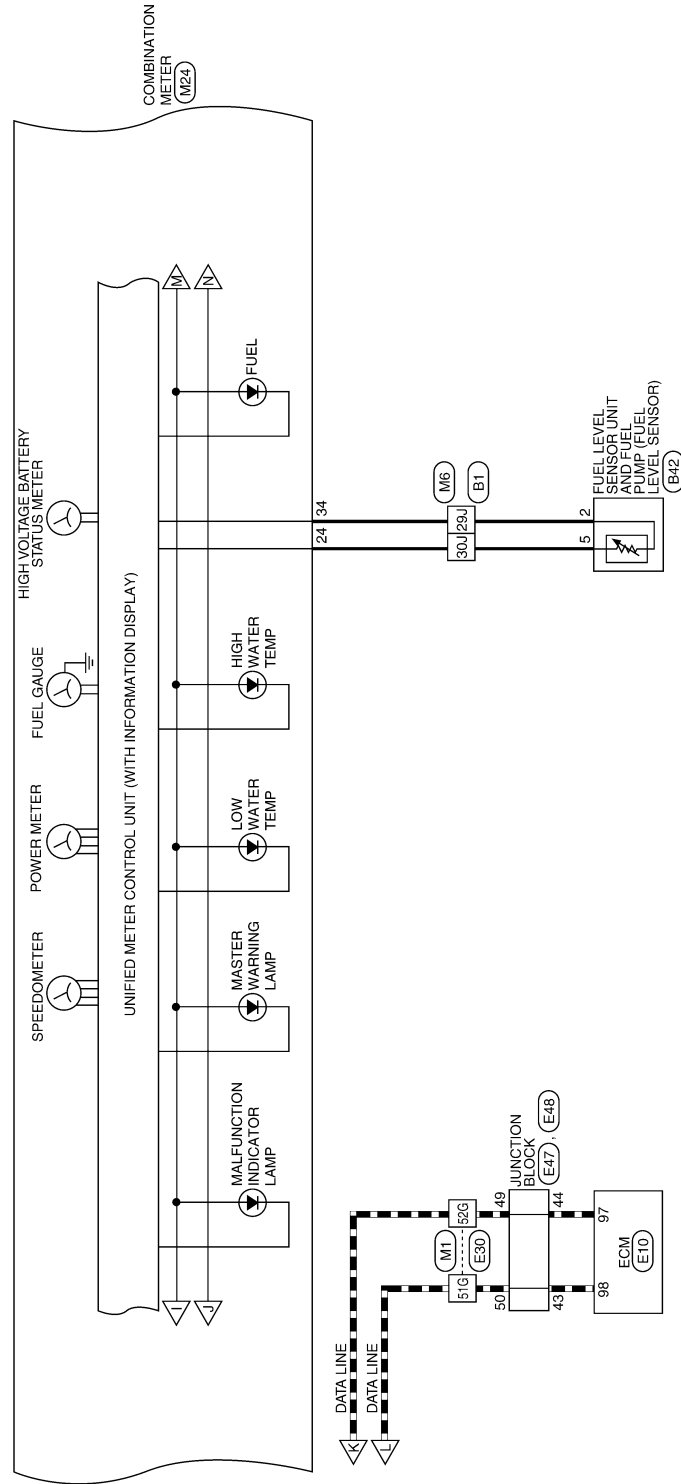

A
B
C
D
E
F
G
H
I
J
K
L
M
O
P

WCS

ALNWA0032GE

COMBINATION METER

< ECU DIAGNOSIS >

BE: WITH BLUETOOTH

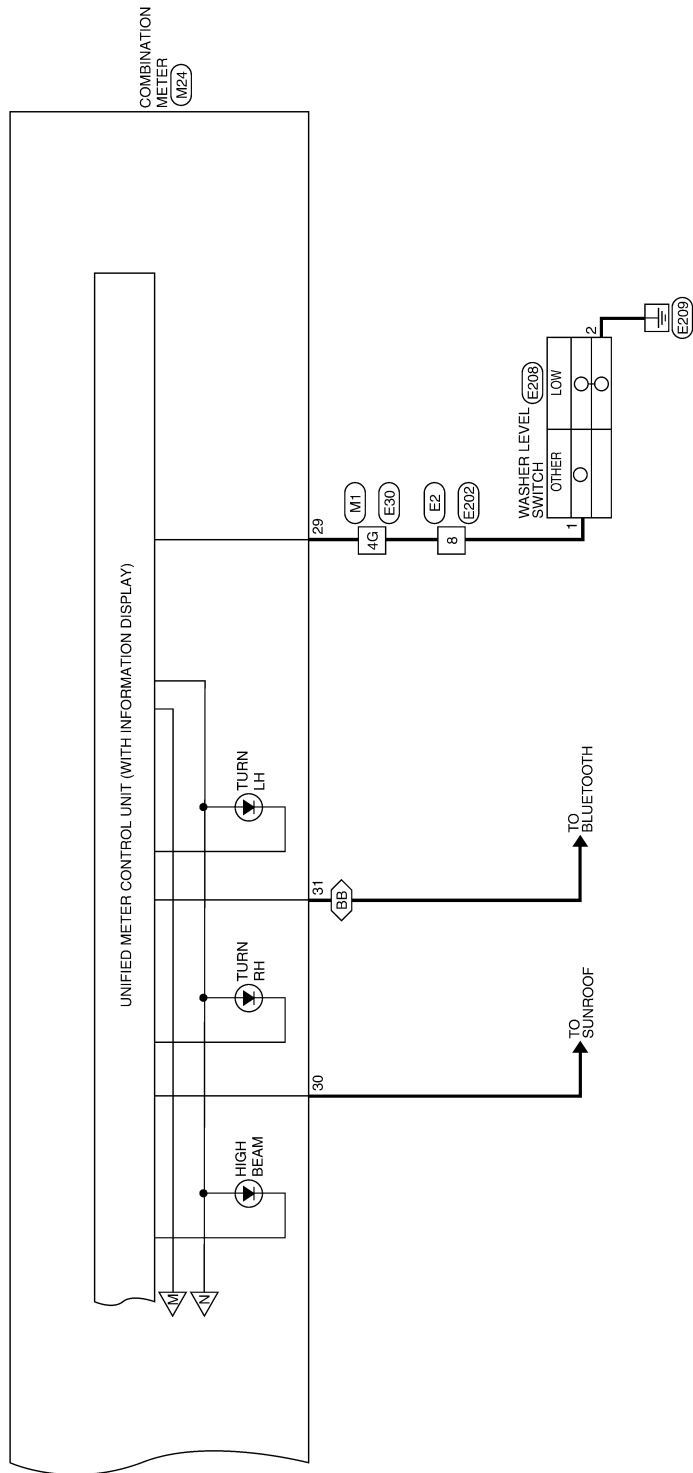

AWNWA0170G

COMBINATION METER

< ECU DIAGNOSIS >

METER CONNECTORS

Connector No.	M1
Connector Name	WIRE TO WIRE
Connector Color	WHITE

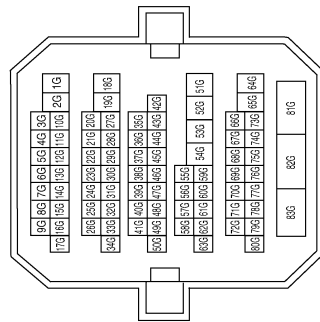

Terminal No.	Color of wire	Signal Name
4G	R	-
8G	BR	-
15G	Y	-
24G	G/R	-
25G	B/Y	-
32G	O/B	-
51G	L	-
52G	P	-

Connector No.	M3
Connector Name	FUSE BLOCK (J/B)
Connector Color	WHITE

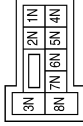

Terminal No.	Color of wire	Signal Name
1N	W/L	-
5N	V/Y	-

Connector No.	M5
Connector Name	FUSE BLOCK (J/B)
Connector Color	WHITE



Terminal No.	Color of wire	Signal Name
12M	O	-

Connector No.	M6
Connector Name	WIRE TO WIRE
Connector Color	WHITE

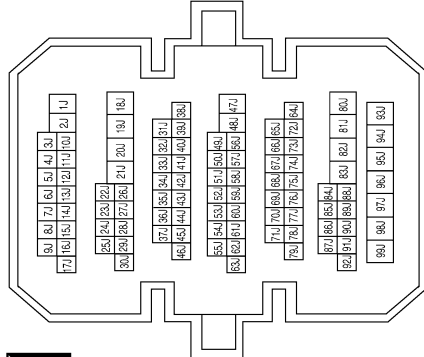

Terminal No.	Color of wire	Signal Name
17J	SB	-
22J	R/B	-
24J	W/B	-
25J	Y/G	-
29J	G/B	-
30J	B/W	-

ALNIA0150GB

A
B
C
D
E
F
G
H
I
J
K
L
M
O
P

WCS

COMBINATION METER

< ECU DIAGNOSIS >

Connector No.	M18
Connector Name	BCM (BODY CONTROL MODULE)
Connector Color	GREEN

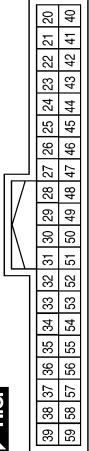
Terminal No.	Color of wire	Signal Name
32	R/B	AS_DOOR_SW
49	L/O	IMMO_LED
58	SB	DR_DOOR_SW

Connector No.	M17
Connector Name	BCM (BODY CONTROL MODULE)
Connector Color	WHITE

Terminal No.	Color of wire	Signal Name
13	B	GND1

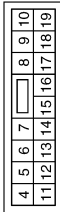
Connector No.	M10
Connector Name	WIRE TO WIRE
Connector Color	BROWN

Terminal No.	Color of wire	Signal Name
10	R/B	-
11	R/W	-

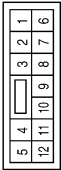
Connector No.	M21
Connector Name	BCM (BODY CONTROL MODULE)
Connector Color	GREY

Terminal No.	Color of wire	Signal Name
130	Y/G	TRUNK_SW
148	R/W	RR_DOOR_SW
149	R/B	RL_DOOR_SW

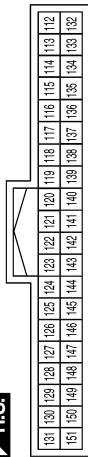
Connector No.	M19
Connector Name	BCM (BODY CONTROL MODULE)
Connector Color	BLACK

Terminal No.	Color of wire	Signal Name
78	P	CAN-L
79	L	CAN-H

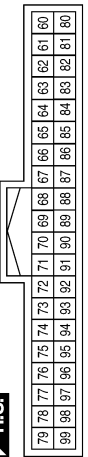
ALNIA0151GB

COMBINATION METER

< ECU DIAGNOSIS >

Connector No.	M24
Connector Name	COMBINATION METER
Connector Color	WHITE



1	2	3	4	5	6	7	8	9	10	11	12	13	14	15	16	17	18	19	20
21	22	23	24	25	26	27	28	29	30	31	32	33	34	35	36	37	38	39	40

Terminal No.	Color of Wire	Signal Name
1	W/L	BAT
2	O	IGN
3	B	GND (POWER)
4	B	GND (ILL)
5	R/Y	ILL OUTPUT
9	GR/W	SW ILL PWR
10	O/L	GND (SATELLITE SW)
11	L/R	MODE A SW
12	B/R	MODE B SW
14	V/Y	ACC
15	BR/W	AIR_BAG
18	O/B	OAT
19	P	OAT POWER
20	B/Y	GND (OAT SENSOR)

Terminal No.	Color of Wire	Signal Name
21	L	CAN-H
22	P	CAN-L
23	B	GND (CIRCUIT)
24	B/W	GND (FUEL SENSOR)
26	G/R	PKB
28	L/O	SECURITY
29	R	LOW WASH FLUID SW
30	L/B	2P/R OUT
31	V/W	8P/R OUT
34	G/B	FUEL SENSOR
35	W/B	DR_BELT
36	L/W	AS_BELT

Connector No.	M25
Connector Name	METER MODE SWITCH
Connector Color	WHITE



1	2	3	4	5
6	7	8	9	10

Terminal No.	Color of Wire	Signal Name
6	O/L	GND (SATELLITE SW)
7	R/L	SW ILL POWER
9	L/R	MODE A SW
10	B/R	MODE B SW

Connector No.	M35
Connector Name	AIR BAG DIAGNOSIS SENSOR UNIT
Connector Color	YELLOW



21	22	11	46	48	47	45	3	4	6	5	24	49	1
16	12	15					18				2		

Terminal No.	Color of Wire	Signal Name
15	BR/W	AIR BAG W/L
24	L/W	SEAT BELT REMINDER

Connector No.	M37
Connector Name	CONTROLLER (AUTO AMP.)
Connector Color	WHITE



1	2	3	4	5	6	7	8	9	10	11	12	13	14	15	16	17	18	19	20
21	22	23	24	25	26	27	28	29	30	31	32	33	34	35	36	37	38	39	40

Terminal No.	Color of Wire	Signal Name
26	B/Y	SENS GND
28	O/B	AMB SENS
31	P	AMB VDD

AWNIA0738GB

A
B
C
D
E
F
G
H
I
J
K
L
M
O
P

COMBINATION METER

< ECU DIAGNOSIS >

Connector No.	M89
Connector Name	WIRE TO WIRE
Connector Color	WHITE

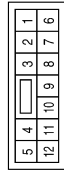

Terminal No.	Color of Wire	Signal Name
4	BR	-
5	Y	-
7	L	-
8	P	-

Connector No.	E2
Connector Name	WIRE TO WIRE
Connector Color	WHITE

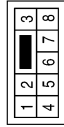

Terminal No.	Color of Wire	Signal Name
8	R	-

Connector No.	E10
Connector Name	ECM
Connector Color	BLACK

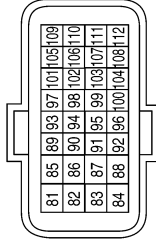

Terminal No.	Color of Wire	Signal Name
97	P	CAN-L
98	L	CAN-H

Connector No.	E17
Connector Name	IPDM E/R (INTELLIGENT POWER DISTRIBUTION MODULE ENGINE ROOM)
Connector Color	WHITE

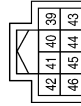

Terminal No.	Color of Wire	Signal Name
39	P	CAN-L
40	L	CAN-H

Connector No.	E18
Connector Name	IPDM E/R (INTELLIGENT POWER DISTRIBUTION MODULE ENGINE ROOM)
Connector Color	WHITE



Terminal No.	Color of Wire	Signal Name
20	B/Y	AMB_SENS_GND-E/R
21	O/B	AMB_SENS_SIG-E/R

Connector No.	E22
Connector Name	JOINT CONNECTOR-E04
Connector Color	BLACK

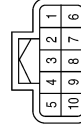

Terminal No.	Color of Wire	Signal Name
3	Y	-
5	Y	-
8	BR	-
10	BR	-

AWNIA0739GB

COMBINATION METER

< ECU DIAGNOSIS >

Connector No.	E27
Connector Name	JOINT CONNECTOR-E06
Connector Color	BLUE

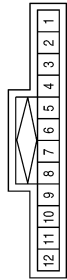

Terminal No.	Color of wire	Signal Name
1	Y	-
2	Y	-
4	Y	-
7	BR	-
8	BR	-
10	BR	-

Connector No.	E30
Connector Name	WIRE TO WIRE
Connector Color	WHITE

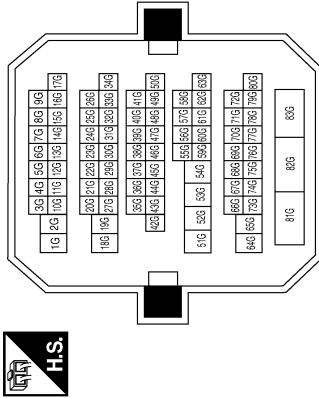

Terminal No.	Color of wire	Signal Name
4G	R	-
8G	P	-
15G	L	-
24G	G/R	-
25G	V	-
32G	O/B	-
51G	L	-
52G	P	-

Connector No.	E35
Connector Name	PARKING BRAKE SWITCH
Connector Color	BLACK



Terminal No.	Color of wire	Signal Name
1	G/R	-

Connector No.	E47
Connector Name	JUNCTION BLOCK
Connector Color	WHITE

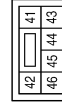

Terminal No.	Color of wire	Signal Name
41	G/R	-
43	L	-
44	P	-

Connector No.	E48
Connector Name	JUNCTION BLOCK
Connector Color	WHITE

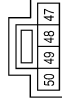

Terminal No.	Color of wire	Signal Name
49	P	-
50	L	-

ALNIA0154GB

A
B
C
D
E
F
G
H
I
J
K
L
M
N
O
P

COMBINATION METER

< ECU DIAGNOSIS >

Connector No.	E49
Connector Name	JUNCTION BLOCK
Connector Color	BROWN

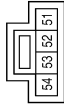

Terminal No.	Color of wire	Signal Name
53	G/R	-

Connector No.	E59
Connector Name	JOINT CONNECTOR-E06
Connector Color	BLUE

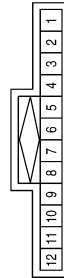

Terminal No.	Color of wire	Signal Name
1	L	-
2	L	-
3	L	-
7	P	-
8	P	-
9	P	-

Connector No.	E61
Connector Name	BRAKE ECU
Connector Color	BLACK

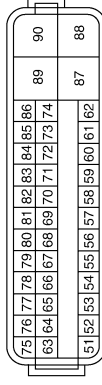

Terminal No.	Color of wire	Signal Name
70	BR	CAN-L
81	Y	CAN-H

Connector No.	E64
Connector Name	WIRE TO WIRE
Connector Color	WHITE

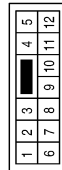

Terminal No.	Color of wire	Signal Name
4	BR	-
5	Y	-
7	L	-
8	P	-

Connector No.	E66
Connector Name	HIGH VOLTAGE ECU
Connector Color	BLACK

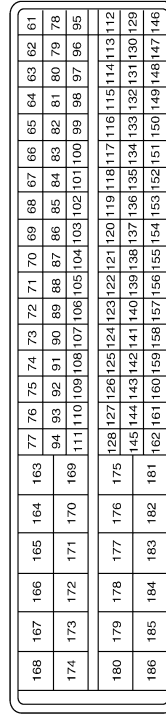

Terminal No.	Color of wire	Signal Name
170	BR	CAN-L
171	Y	CAN-H
172	P	CAN-L
173	L	CAN-H

ALNIA0155GB

COMBINATION METER

< ECU DIAGNOSIS >

Connector No.	E202
Connector Name	WIRE TO WIRE
Connector Color	WHITE

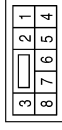

Terminal No.	Color of Wire	Signal Name
8	R	-

Connector No.	E201
Connector Name	IPDM E/R (INTELLIGENT POWER DISTRIBUTION MODULE ENGINE ROOM)
Connector Color	WHITE

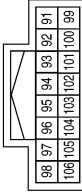

Terminal No.	Color of Wire	Signal Name
99	BR/W	AMB_SENS_GND-FEM
100	SB	AMB_SENS_SIG-FEM

Connector No.	E67
Connector Name	WIRE TO WIRE
Connector Color	BLACK

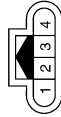

Terminal No.	Color of Wire	Signal Name
1	BR	-
2	Y	-

Connector No.	E301
Connector Name	WIRE TO WIRE
Connector Color	BLACK

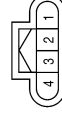

Terminal No.	Color of Wire	Signal Name
1	BR	-
2	Y	-

Connector No.	E211
Connector Name	AMBIENT SENSOR
Connector Color	BLACK



Terminal No.	Color of Wire	Signal Name
1	SB	AMB_SENS_SIG
2	BR/W	AMB_SENS_GND

Connector No.	E208
Connector Name	WASHER LEVEL SWITCH
Connector Color	WHITE



Terminal No.	Color of Wire	Signal Name
1	R	WASHER
2	B	GND

AWNIA0740GB

A
B
C
D
E
F
G
H
I
J
K
L
M
N
O
P

WCS

COMBINATION METER

< ECU DIAGNOSIS >

Connector No.	E302
Connector Name	EPS CONTROL UNIT
Connector Color	BLACK

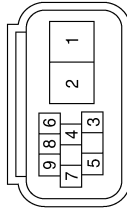

Terminal No.	Color of Wire	Signal Name
8	Y	CAN-H
9	BR	CAN-L

Connector No.	F10
Connector Name	IPDM E/R (INTELLIGENT POWER DISTRIBUTION MODULE ENGINE ROOM)
Connector Color	WHITE

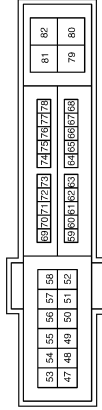

Terminal No.	Color of Wire	Signal Name
75	P/L	OIL_PRESSURE_SW

Connector No.	F41
Connector Name	OIL PRESSURE SWITCH
Connector Color	GRAY



Terminal No.	Color of Wire	Signal Name
1	P/L	-

Connector No.	B1
Connector Name	WIRE TO WIRE
Connector Color	WHITE

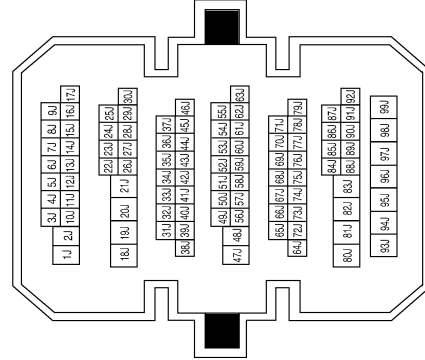



Terminal No.	Color of Wire	Signal Name
17J	SB	-
22J	R/B	-
24J	W/B	-
25J	Y/G	-
29J	G/B	-
30J	B/W	-

COMBINATION METER

< ECU DIAGNOSIS >

Connector No.	B3
Connector Name	JOINT CONNECTOR- B02
Connector Color	WHITE

Terminal No.	Color of Wire	Signal Name
1	W/B	-
2	W/B	-
3	W/B	-

Connector No.	B8
Connector Name	FRONT DOOR SWITCH LH
Connector Color	WHITE

Terminal No.	Color of Wire	Signal Name
2	SB	DOOR SW (DR)

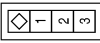
Connector No.	B9
Connector Name	AIR BAG DIAGNOSIS SENSOR UNIT
Connector Color	YELLOW

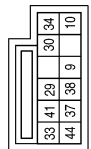

Terminal No.	Color of Wire	Signal Name
41	W/B	LH BUCKLE SW INPUT

Connector No.	B12
Connector Name	WIRE TO WIRE
Connector Color	WHITE

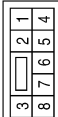

Terminal No.	Color of Wire	Signal Name
1	W/B	-
8	B	-

Connector No.	B18
Connector Name	REAR DOOR SWITCH LH
Connector Color	WHITE

Terminal No.	Color of Wire	Signal Name
2	R/B	DOOR SW (RL)

Connector No.	B28
Connector Name	TRUNK LAMP SWITCH AND TRUNK RELEASE SOLENOID
Connector Color	WHITE

Terminal No.	Color of Wire	Signal Name
1	Y/G	-
2	B	-

Connector No.	B42
Connector Name	FUEL LEVEL SENSOR UNIT AND FUEL PUMP
Connector Color	GRAY

Terminal No.	Color of Wire	Signal Name
2	G/B	FUEL_GND
5	B/W	FUEL_SIGNAL

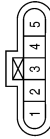
Connector No.	B104
Connector Name	WIRE TO WIRE
Connector Color	BROWN

Terminal No.	Color of Wire	Signal Name
10	R/G	-
11	R/W	-

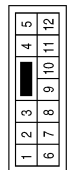
Connector No.	B105
Connector Name	WIRE TO WIRE
Connector Color	WHITE

Terminal No.	Color of Wire	Signal Name
1	L/B	-
8	B/Y	-

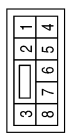
AWNIA0742GB

A
B
C
D
E
F
G
H
I
J
K
L
M
N
O
P

COMBINATION METER

< ECU DIAGNOSIS >

Connector No.	B116
Connector Name	REAR DOOR SWITCH RH
Connector Color	WHITE

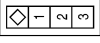
Terminal No.	Color of Wire	Signal Name
2	R/W	DOOR SW (RH)

Connector No.	B113
Connector Name	AIR BAG DIAGNOSIS SENSOR UNIT
Connector Color	YELLOW

Terminal No.	Color of Wire	Signal Name
25	L/B	RH BUCKLE SW INPUT

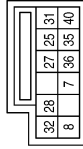
Connector No.	B108
Connector Name	FRONT DOOR SWITCH RH
Connector Color	WHITE

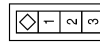

Terminal No.	Color of Wire	Signal Name
2	R/G	DOOR SW (AS)

Connector No.	B301
Connector Name	WIRE TO WIRE
Connector Color	WHITE

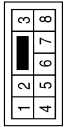
Terminal No.	Color of Wire	Signal Name
1	L	-
8	B	-

Connector No.	B202
Connector Name	SEAT BELT BUCKLE SWITCH LH
Connector Color	WHITE

Terminal No.	Color of Wire	Signal Name
1	W/B	SIGNAL
2	B	GND

Connector No.	B201
Connector Name	WIRE TO WIRE
Connector Color	WHITE

Terminal No.	Color of Wire	Signal Name
1	W/B	-
8	B	-

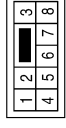
Terminal No.	Color of Wire	Signal Name
1	L	SIGNAL
2	B	GND

Connector No.	B302
Connector Name	SEAT BELT BUCKLE SWITCH RH
Connector Color	WHITE





Terminal No.	Color of Wire	Signal Name
1	L	SIGNAL
2	B	GND

AWNIA0743GB

COMBINATION METER

< ECU DIAGNOSIS >

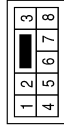
Connector No.	B201
Connector Name	WIRE TO WIRE
Connector Color	WHITE



Terminal No.	Color of Wire	Signal Name
1	W/B	-
8	B	-

Connector No.	B116
Connector Name	REAR DOOR SWITCH RH
Connector Color	WHITE



Terminal No.	Color of Wire	Signal Name
2	R/W	DOOR SW (RR)

Connector No.	B113
Connector Name	AIR BAG DIAGNOSIS SENSOR UNIT
Connector Color	YELLOW

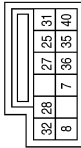

Terminal No.	Color of Wire	Signal Name
25	L/B	RH BUCKLE SW INPUT

Connector No.	B302
Connector Name	SEAT BELT BUCKLE SWITCH RH
Connector Color	WHITE

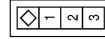

Terminal No.	Color of Wire	Signal Name
1	L	SIGNAL
2	B	GND

Connector No.	B301
Connector Name	WIRE TO WIRE
Connector Color	WHITE

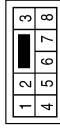

Terminal No.	Color of Wire	Signal Name
1	L	-
8	B	-

Connector No.	B202
Connector Name	SEAT BELT BUCKLE SWITCH LH
Connector Color	WHITE

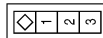

Terminal No.	Color of Wire	Signal Name
1	W/B	SIGNAL
2	B	GND

Fail Safe

The combination meter performs a fail-safe operation for the functions listed below when communication is lost.

ABNIA0752GB

INFOID:000000004491008

A
B
C
D
E
F
G
H
I
J
K
L
M
N
O
P

COMBINATION METER

< ECU DIAGNOSIS >

Function		Specifications
Speedometer		Zero indication.
Fuel gauge		
Power meter		
High voltage battery status meter		
Illumination control	Meter illumination	Change to nighttime mode when communication is lost.
Segment LCD	Odometer	Freeze current indication.
	ECVT position	Display turns off.
Buzzer		Buzzer turns off.
Warning lamp/indicator lamp	ABS warning lamp	Lamp turns on when communication is lost.
	Brake warning lamp	
	VDC OFF indicator lamp	
	SLIP indicator lamp	
	Oil pressure warning lamp	Lamp turns off when communication is lost.
	Malfunction indicator lamp	
	Master warning lamp	
	Air bag warning lamp	
	High beam indicator	
	Turn signal indicator lamp	
	Intelligent Key system warning lamp	Lamp turns off when disconnected.
	Driver and passenger seat belt warning lamp	
	Charge warning lamp	
	Security indicator lamp	
Low tire pressure warning lamp	Lamp will flash every second for 1 minute and then stay on continuously thereafter.	

DTC Index

INFOID:000000004491009

CONSULT-III display	Malfunction	Reference page
CAN COMM CIRC [U1000]	Malfunction is detected in CAN communication. CAUTION: Even when there is no malfunction on CAN communication system, malfunction may be misinterpreted when battery has low voltage (when maintaining 7 - 8 V for about 2 seconds) or 10A fuse [No. 19, located in the fuse block (J/B)] is disconnected.	MWI-38
VEHICLE SPEED CIRC [B2205]	Malfunction is detected when an erroneous speed signal is input. CAUTION: Even when there is no malfunction on speed signal system, malfunction may be misinterpreted when battery has low voltage (when maintaining 7 - 8 V for about 2 seconds).	MWI-39

NOTE:

“TIME” indicates the following.

- 0: Indicates that a malfunction is detected at present.
- 1-63: Indicates that a malfunction was detected in the past. (Displays number of ignition switch OFF → ON cycles after malfunction is detected. Self-diagnosis result is erased when “63” is exceeded.)

BCM (BODY CONTROL MODULE)

< ECU DIAGNOSIS >

BCM (BODY CONTROL MODULE)

Reference Value

INFOID:000000004491010

VALUES ON THE DIAGNOSIS TOOL

Monitor Item	Condition	Value/Status
FR WIPER HI	Other than front wiper switch HI	OFF
	Front wiper switch HI	ON
FR WIPER LOW	Other than front wiper switch LO	OFF
	Front wiper switch LO	ON
FR WASHER SW	Front washer switch OFF	OFF
	Front washer switch ON	ON
FR WIPER INT	Other than front wiper switch INT	OFF
	Front wiper switch INT	ON
FR WIPER STOP	Front wiper is not in STOP position	OFF
	Front wiper is in STOP position	ON
INT VOLUME	Wiper intermittent dial is in a dial position 1 - 7	Wiper intermittent dial position
TURN SIGNAL R	Other than turn signal switch RH	OFF
	Turn signal switch RH	ON
TURN SIGNAL L	Other than turn signal switch LH	OFF
	Turn signal switch LH	ON
TAIL LAMP SW	Other than lighting switch 1ST and 2ND	OFF
	Lighting switch 1ST or 2ND	ON
HI BEAM SW	Other than lighting switch HI	OFF
	Lighting switch HI	ON
HEAD LAMP SW 1	Other than lighting switch 2ND	OFF
	Lighting switch 2ND	ON
HEAD LAMP SW 2	Other than lighting switch 2ND	OFF
	Lighting switch 2ND	ON
PASSING SW	Other than lighting switch PASS	OFF
	Lighting switch PASS	ON
AUTO LIGHT SW	Other than lighting switch AUTO	OFF
	Lighting switch AUTO	ON
FR FOG SW	Front fog lamp switch OFF	OFF
	Front fog lamp switch ON	ON
DOOR SW-DR	Front door LH closed	OFF
	Front door LH opened	ON
DOOR SW-AS	Front door RH closed	OFF
	Front door RH opened	ON
DOOR SW-RR	Rear door RH closed	OFF
	Rear door RH opened	ON
DOOR SW-RL	Rear door LH closed	OFF
	Rear door LH opened	ON
DOOR SW-BK	NOTE: This item is displayed, but cannot be monitored.	OFF

A

B

C

D

E

F

G

H

I

J

K

L

M

WCS

O

P

BCM (BODY CONTROL MODULE)

< ECU DIAGNOSIS >

Monitor Item	Condition	Value/Status
CDL LOCK SW	Other than power door lock switch LOCK	OFF
	Door lock/unlock switch LOCK	ON
CDL UNLOCK SW	Other than door lock/unlock switch UNLOCK	OFF
	Door lock/unlock switch UNLOCK	ON
KEY CYL LK-SW	Other than front door LH key cylinder LOCK position	OFF
	Front door LH key cylinder LOCK position	ON
KEY CYL UN-SW	Other than front door LH key cylinder UNLOCK position	OFF
	Front door LH key cylinder UNLOCK position	ON
KEY CYL SW-TR	NOTE: This item is displayed, but cannot be monitored.	OFF
HAZARD SW	When hazard switch is not pressed	OFF
	When hazard switch is pressed	ON
REAR DEF SW	When rear window defogger switch is pressed	ON
FAN ON SIG	When AUTO switch or fan switch is pressed	ON
AIR COND SW	When A/C switch is pressed	ON
TR CANCEL SW	Trunk lid opener cancel switch OFF	OFF
	Trunk lid opener cancel switch ON	ON
TR/BD OPEN SW	Trunk lid opener switch OFF	OFF
	While the trunk lid opener switch is turned ON	ON
TRNK/HAT MNTR	Trunk lid closed	OFF
	Trunk lid opened	ON
RKE-LOCK	When LOCK button of Intelligent Key is not pressed	OFF
	When LOCK button of Intelligent Key is pressed	ON
RKE-UNLOCK	When UNLOCK button of Intelligent Key is not pressed	OFF
	When UNLOCK button of Intelligent Key is pressed	ON
RKE-TR/BD	When TRUNK OPEN button of Intelligent Key is not pressed	OFF
	When TRUNK OPEN button of Intelligent Key is pressed	ON
RKE-PANIC	When PANIC button of Intelligent Key is not pressed	OFF
	When PANIC button of Intelligent Key is pressed	ON
RKE-P/W OPEN	When UNLOCK button of Intelligent Key is not pressed and held	OFF
	When UNLOCK button of Intelligent Key is pressed and held	ON
RKE-MODE CHG	When LOCK/UNLOCK button of Intelligent Key is not pressed and held simultaneously	OFF
	When LOCK/UNLOCK button of Intelligent Key is pressed and held simultaneously	ON
OPTICAL SENSOR	When outside of the vehicle is bright	Close to 5 V
	When outside of the vehicle is dark	Close to 0 V
REQ SW-DR	When front door LH request switch is not pressed	OFF
	When front door LH request switch is pressed	ON
REQ SW-AS	When front door RH request switch is not pressed	OFF
	When front door RH request switch is pressed	ON
REQ SW-BD/TR	When trunk request switch is not pressed	OFF
	When trunk request switch is pressed	ON
PUSH SW	When push-button ignition switch is not pressed	OFF
	When push-button ignition switch is pressed	ON

BCM (BODY CONTROL MODULE)

< ECU DIAGNOSIS >

Monitor Item	Condition	Value/Status	
IGN RLY -F/B	Ignition switch OFF or ACC	OFF	A
	Ignition switch ON	ON	
ACC RLY -F/B	Ignition switch OFF	OFF	B
	Ignition switch ACC or ON	ON	
BRAKE SW 1	When the brake pedal is not depressed	ON	C
	When the brake pedal is depressed	OFF	
DETE/CANCL SW	When selector lever is in P position	OFF	D
	When selector lever is in any position other than P	ON	
SFT PN/N SW	When selector lever is in any position other than P or N	OFF	E
	When selector lever is in P or N position	ON	
S/L -LOCK	Electronic steering column lock LOCK status	OFF	F
	Electronic steering column lock UNLOCK status	ON	
S/L -UNLOCK	Electronic steering column lock UNLOCK status	OFF	G
	Electronic steering column lock LOCK status	ON	
S/L RELAY-F/B	Ignition switch OFF or ACC	OFF	H
	Ignition switch ON	ON	
UNLK SEN-DR	Front door LH UNLOCK status	OFF	I
	Front door LH LOCK status	ON	
PUSH SW -IPDM	When push-button ignition switch is not pressed (IPDM E/R sends via CAN)	OFF	J
	When push-button ignition switch is pressed (IPDM E/R sends via CAN)	ON	
IGN RLY1 F/B	Ignition switch OFF or ACC	OFF	K
	Ignition switch ON	ON	
DETE SW -IPDM	When selector lever is in P position (IPDM E/R sends via CAN)	OFF	L
	When selector lever is in any position other than P (IPDM E/R sends via CAN)	ON	
SFT PN -IPDM	When selector lever is in any position other than P or N (IPDM E/R sends via CAN)	OFF	M
	When selector lever is in P or N position (IPDM E/R sends via CAN)	ON	
SFT P -MET	When selector lever is in any position other than P (combination meter sends via CAN)	OFF	
	When selector lever is in P position (combination meter sends via CAN)	ON	
SFT N -MET	When selector lever is in any position other than N (combination meter sends via CAN)	OFF	WCS
	When selector lever is in N position (combination meter sends via CAN)	ON	
ENGINE STATE	Engine stopped	STOP	O
	While the engine stalls	STALL	
	At engine cranking	CRANK	
	Engine running	RUN	P
S/L LOCK-IPDM	Electronic steering column lock LOCK status (IPDM E/R sends via CAN)	OFF	
	Electronic steering column lock UNLOCK status (IPDM E/R sends via CAN)	ON	

BCM (BODY CONTROL MODULE)

< ECU DIAGNOSIS >

Monitor Item	Condition	Value/Status
S/L UNLCK-IPDM	Electronic steering column lock UNLOCK status (IPDM E/R sends via CAN)	OFF
	Electronic steering column lock LOCK status (IPDM E/R sends via CAN)	ON
S/L RELAY-REQ	Ignition switch OFF or ACC	OFF
	Ignition switch ON	ON
VEH SPEED 1	While driving	Equivalent to speedometer reading
VEH SPEED 2	While driving	Equivalent to speedometer reading
DR DOOR STATE	Front door LH LOCK status	LOCK
	Wait with selective UNLOCK operation (5 seconds)	READY
	Front door LH UNLOCK status	UNLK
AS DOOR STATE	Front door RH LOCK status	LOCK
	Wait with selective UNLOCK operation (5 seconds)	READY
	Front door RH UNLOCK status	UNLK
ID OK FLAG	Ignition switch ACC or ON	RESET
	Ignition switch OFF	SET
PRMT ENG STAT	When the hybrid system start is prohibited	RESET
	When the hybrid system start is permitted	SET
PRMT RKE STAT	NOTE: This item is displayed, but cannot be monitored.	RESET
KEY SW -SLOT	When Intelligent Key is not inserted into key slot	OFF
	When Intelligent Key is inserted into key slot	ON
RKE OPE COUN1	During the operation of Intelligent Key	Operation frequency of Intelligent Key
RKE OPE COUN2	NOTE: This item is displayed, but cannot be monitored.	Operation frequency of Intelligent Key
AIR PRESS FL	Ignition switch ON (only when the signal from the transmitter is received)	Air pressure of front LH tire
AIR PRESS FR	Ignition switch ON (only when the signal from the transmitter is received)	Air pressure of front RH tire
AIR PRESS RR	Ignition switch ON (only when the signal from the transmitter is received)	Air pressure of rear RH tire
AIR PRESS RL	Ignition switch ON (only when the signal from the transmitter is received)	Air pressure of rear LH tire
ID REGST FL1	When ID of front LH tire transmitter is registered (refer to WT-6, "ID Registration Procedure")	DONE
	When ID of front LH tire transmitter is not registered (refer to WT-6, "ID Registration Procedure")	YET
ID REGST FR1	When ID of front RH tire transmitter is registered (refer to WT-6, "ID Registration Procedure")	DONE
	When ID of front RH tire transmitter is not registered (refer to WT-6, "ID Registration Procedure")	YET
ID REGST RR1	When ID of rear RH tire transmitter is registered (refer to WT-6, "ID Registration Procedure")	DONE
	When ID of rear RH tire transmitter is not registered (refer to WT-6, "ID Registration Procedure")	YET
ID REGST RL1	When ID of rear LH tire transmitter is registered (refer to WT-6, "ID Registration Procedure")	DONE
	When ID of rear LH tire transmitter is not registered (refer to WT-6, "ID Registration Procedure")	YET

BCM (BODY CONTROL MODULE)

< ECU DIAGNOSIS >

Monitor Item	Condition	Value/Status
WARNING LAMP	Tire pressure indicator OFF	OFF
	Tire pressure indicator ON	ON

Terminal Layout

INFOID:000000004491011

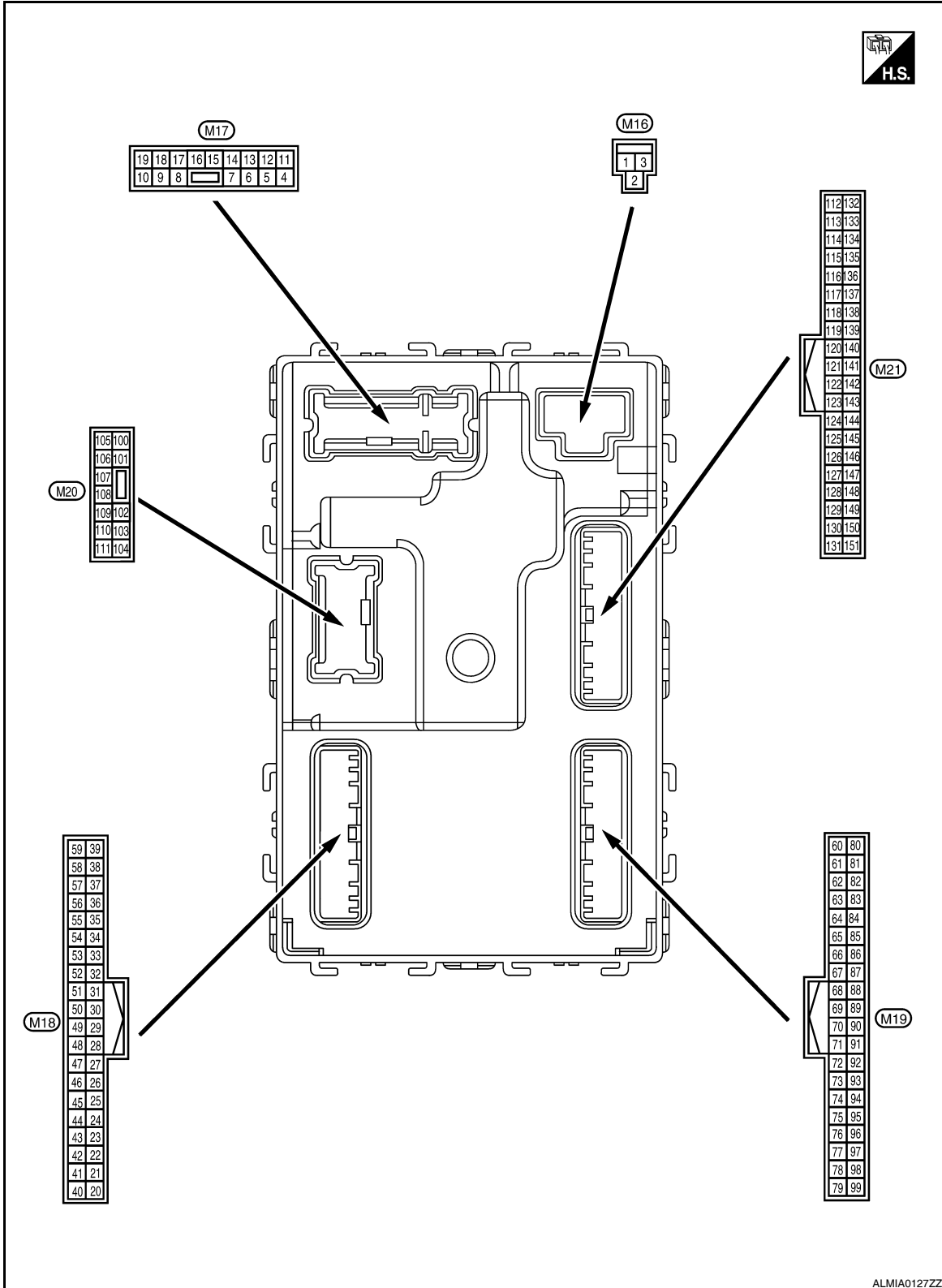

A
B
C
D
E
F
G
H
I
J
K
L
M
N
O
P

WCS

BCM (BODY CONTROL MODULE)

< ECU DIAGNOSIS >

Physical Values

INFOID:000000004491012

Terminal No. (Wire color)		Description		Condition		Value (Approx.)
		Signal name	Input/ Output			
(+)	(-)					
1 (W/B)	Ground	Battery power supply	Input	Ignition switch OFF		Battery voltage
2 (R/Y)	Ground	Battery power supply output	Output	Ignition switch OFF		Battery voltage
3 (L/W)	Ground	Ignition power supply output	Output	Ignition switch ON		Battery voltage
4 (P/W)	Ground	Interior room lamp power supply	Output	After passing the interior room lamp battery saver operation time		0V
				Any other time after passing the interior room lamp battery saver operation time		Battery voltage
5 (G/Y)	Ground	Front door RH UNLOCK	Output	Front door RH	UNLOCK (actuator is activated)	Battery voltage
					Other than UNLOCK (actuator is not activated)	0V
7 (R/W)	Ground	Step lamp	Output	Room lamp timer	ON	Battery voltage
					OFF	0V
8 (V)	Ground	All doors LOCK	Output	All doors	LOCK (actuator is activated)	Battery voltage
					Other than LOCK (actuator is not activated)	0V
9 (G)	Ground	Front door LH UNLOCK	Output	Front door LH	UNLOCK (actuator is activated)	Battery voltage
					Other than UNLOCK (actuator is not activated)	0V
10 (G/Y)	Ground	Rear door RH and rear door LH UNLOCK	Output	Rear door RH and rear door LH	UNLOCK (actuator is activated)	Battery voltage
					Other than UNLOCK (actuator is not activated)	0V
11 (Y/R)	Ground	Battery power supply	Input	Ignition switch OFF		Battery voltage
13 (B)	Ground	Ground	—	Ignition switch ON		0V
14 (R/Y)	Ground	Push-button ignition switch illumination ground	Input	Tail lamp	OFF	0V
					ON	
15 (Y/L)	Ground	ACC indicator lamp	Output	Ignition switch	OFF	Battery voltage
					ACC	0V

BCM (BODY CONTROL MODULE)

< ECU DIAGNOSIS >

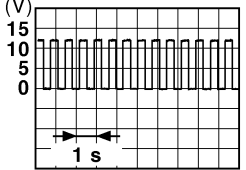
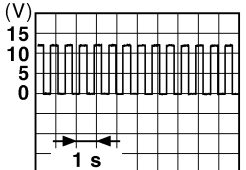
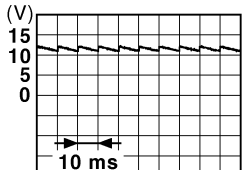
Terminal No. (Wire color)		Description		Condition		Value (Approx.)
(+)	(-)	Signal name	Input/ Output			
17 (G/B)	Ground	Turn signal (RH)	Output	Ignition switch ON	Turn signal switch OFF	0V
					Turn signal switch RH	 <p style="text-align: center;">6.5V</p>
18 (G/O)	Ground	Turn signal (LH)	Output	Ignition switch ON	Turn signal switch OFF	0V
					Turn signal switch LH	 <p style="text-align: center;">6.5V</p>
19 (Y)	Ground	Room lamp timer control	Output	Interior room lamp	Lamps fully OFF	Battery voltage
					Lamps fully ON	0V
21 (P/B)	Ground	Optical sensor signal	Input	Ignition switch ON	When outside of the vehi- cle is bright	Close to 5V
					When outside of the vehi- cle is dark	Close to 0V
24 (R/W)	Ground	Stop lamp switch 1	Input	—	Battery voltage	
26 (O/L)	Ground	Stop lamp switch 2	Input	Stop lamp switch	OFF (brake pedal is not de- pressed)	0V
					ON (brake pedal is de- pressed)	Battery voltage
27 (G/W)	Ground	Front door lock as- sembly LH (unlock sensor)	Input	Front door LH	LOCK status	 <p style="text-align: center;">11.8V</p>
					UNLOCK status	0V
29 (Y)	Ground	Key slot switch	Input	When Intelligent Key is inserted into key slot	Battery voltage	
				When Intelligent Key is not inserted into key slot	0V	
30 (V/Y)	Ground	ACC feedback signal	Input	Ignition switch	OFF	0
				ACC or ON	Battery voltage	
31 (G)	Ground	Ignition relay-2 feed- back signal	Input	Ignition switch	OFF	0V
				ON	Battery voltage	

A
B
C
D
E
F
G
H
I
J
K
L
M
O
P

WCS

BCM (BODY CONTROL MODULE)

< ECU DIAGNOSIS >

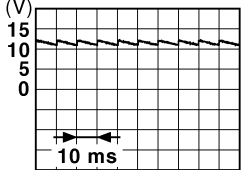
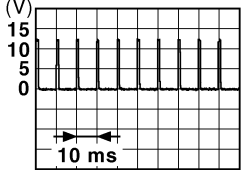
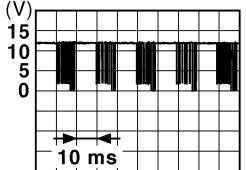
Terminal No. (Wire color)		Description		Condition		Value (Approx.)
(+)	(-)	Signal name	Input/ Output			
32 (R/B)	Ground	Front door RH switch	Input	Front door RH switch	OFF (when front door RH closes)	 <p style="text-align: right; font-size: small;">JPMIA0011GB</p> <p style="text-align: center;">11.8V</p>
					ON (when front door RH opens)	0V
33 (SB)	Ground	Compressor ON signal	Input	A/C switch	OFF	Battery voltage
					ON	0V
34* (L/R)	Ground	Front door lock assembly LH (key cylinder switch) (unlock)	Input	Front door lock assembly LH (key cylinder switch)	OFF (neutral)	Battery voltage
					ON (unlock)	0V
36* (GR)	Ground	Lock switch signal	Input	Door lock/unlock switch	Lock	Battery Voltage
					Unlock	0V
37 (O)	Ground	Trunk lid opener cancel switch	Input	Trunk lid opener cancel switch	CANCEL	 <p style="text-align: right; font-size: small;">JPMIA0012GB</p> <p style="text-align: center;">1.1V</p>
					ON	0V
38 (GR/W)	Ground	Rear window defogger ON signal	Input	Rear window defogger switch	OFF	Battery Voltage V
					ON	0V
39* (GR/R)	Ground	Unlock switch signal	Input	Door lock/unlock switch	Unlock	Battery Voltage
					Lock	0V
40* (Y/G)	Ground	Power window serial link	Input/ Output	Ignition switch ON	 <p style="text-align: right; font-size: small;">JPMIA0013GB</p> <p style="text-align: center;">10.2V</p>	
				Ignition switch OFF or ACC	0V	
41 (W)	Ground	Push-button ignition switch illumination	Output	Engine switch (push switch) illumination	ON	5.5V
					OFF	0V
42 (R)	Ground	LOCK indicator lamp	Output	LOCK indicator lamp	ON	0V
					OFF	Battery voltage
45 (P)	Ground	Receiver & sensor ground	Input	Ignition switch ON	0V	

BCM (BODY CONTROL MODULE)

< ECU DIAGNOSIS >

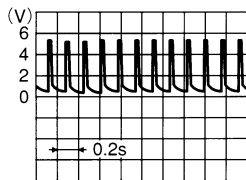
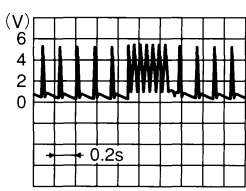
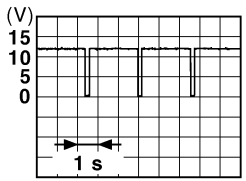
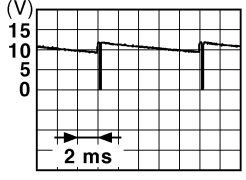
Terminal No. (Wire color)		Description		Condition	Value (Approx.)	
		Signal name	Input/ Output			
(+)	(-)					
46 (V/W)	Ground	Receiver & sensor power supply output	Output	Ignition switch	OFF	0V
					ACC or ON	5.0V
47 (G/O)	Ground	Tire pressure receiver signal	Input/ Output	Ignition switch ON	Standby state	 OCC3881D
					When receiving the signal from the transmitter	 OCC3880D
48 (R/B)	Ground	Selector lever P/N position signal	Input	Selector lever	P or N position	12.0V
					Except P and N positions	0V
49 (L/O)	Ground	Security indicator signal	Output	Security indicator	ON	0V
					Blinking	 JPMIA0014GB 11.3V
50 (LG/ B)	Ground	Combination switch OUTPUT 5	Output	Combination switch (Wiper intermittent dial 4)	All switch OFF	Battery voltage
					Lighting switch 1ST	 JPMIA0031GB 10.7V
					Lighting switch high-beam	
					Lighting switch 2ND	
Turn signal switch RH						
51 (L/W)	Ground	Combination switch OUTPUT 1	Output	Combination switch	All switch OFF (Wiper intermittent dial 4)	0V
					Front wiper switch HI (Wiper intermittent dial 4)	Any of the conditions below with all switch OFF
					<ul style="list-style-type: none"> • Wiper intermittent dial 1 • Wiper intermittent dial 2 • Wiper intermittent dial 3 • Wiper intermittent dial 6 • Wiper intermittent dial 7 	

A
B
C
D
E
F
G
H
I
J
K
L
M
O
P

WCS

BCM (BODY CONTROL MODULE)

< ECU DIAGNOSIS >

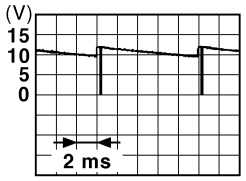
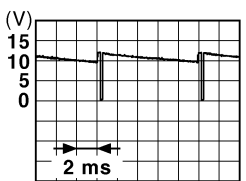
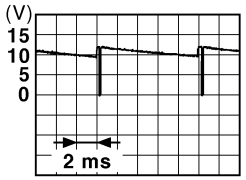
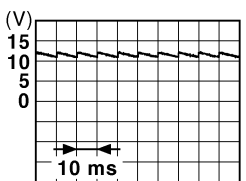
Terminal No. (Wire color)		Description		Condition	Value (Approx.)		
(+)	(-)	Signal name	Input/ Output				
52 (G/B)	Ground	Combination switch OUTPUT 2	Output	Combination switch	All switch OFF (Wiper intermittent dial 4)	0V	
					Front washer switch ON (Wiper intermittent dial 4)	 <p style="text-align: right; font-size: small;">JPMIA0033GB</p>	
					Any of the conditions below with all switch OFF		10.7V
53 (LG/ R)	Ground	Combination switch OUTPUT 3	Output	Combination switch (Wiper intermit- tent dial 4)	All switch OFF	0V	
					Front wiper switch INT	 <p style="text-align: right; font-size: small;">JPMIA0034GB</p>	
					Front wiper switch LO		10.7V
					Lighting switch AUTO		
54 (G/Y)	Ground	Combination switch OUTPUT 4	Output	Combination switch (Wiper intermit- tent dial 4)	All switch OFF	0V	
					Front fog lamp switch ON	 <p style="text-align: right; font-size: small;">JPMIA0035GB</p>	
					Lighting switch 2ND		10.7V
					Lighting switch flash-to- pass		
					Turn signal switch LH		
55 (BR/ W)	Ground	Front blower monitor	Input	Front blower mo- tor switch	ON	Battery voltage	
					OFF	0V	
56 (L/B)	Ground	Front door lock as- sembly LH (key cylin- der switch) (lock)	Input	Front door lock assembly LH (key cylinder switch)	OFF (neutral)	Battery voltage	
					ON (lock)	0V	
57 (W)	Ground	Tire pressure warn- ing check switch	Input	—	—	Battery voltage	
58 (SB)	Ground	Front door LH switch	Input	Front door LH switch	OFF (front door LH CLOSE)	 <p style="text-align: right; font-size: small;">JPMIA0011GB</p>	
					ON (front door LH OPEN)	0V	
59 (G/R)	Ground	Rear window defog- ger relay	Output	Rear window de- fogger	Active	Battery voltage	
					Not activated	0V	

BCM (BODY CONTROL MODULE)

< ECU DIAGNOSIS >

Terminal No. (Wire color)		Description		Condition	Value (Approx.)
(+)	(-)	Signal name	Input/ Output		
60 (B/R)	Ground	Front console antenna 2 (-)	Output	Ignition switch OFF	<p style="text-align: right; font-size: small;">JMKIA0062GB</p>
				When Intelligent Key is not in the passenger compartment	<p style="text-align: right; font-size: small;">JMKIA0063GB</p>
61 (W/R)	Ground	Center console antenna 2 (+)	Output	Ignition switch OFF	<p style="text-align: right; font-size: small;">JMKIA0062GB</p>
				When Intelligent Key is not in the passenger compartment	<p style="text-align: right; font-size: small;">JMKIA0063GB</p>
62 (B/Y)	Ground	Front outside handle RH antenna (-)	Output	When the front door RH request switch is operated with ignition switch OFF	<p style="text-align: right; font-size: small;">JMKIA0062GB</p>
				When Intelligent Key is not in the antenna detection area	<p style="text-align: right; font-size: small;">JMKIA0063GB</p>

A
B
C
D
E
F
G
H
I
J
K
L
M
O
P

WCS

BCM (BODY CONTROL MODULE)

< ECU DIAGNOSIS >

Terminal No. (Wire color)		Description		Condition	Value (Approx.)
(+)	(-)	Signal name	Input/ Output		
63 (LG)	Ground	Front outside handle RH antenna (+)	Output	When the front door RH request switch is operated with ignition switch OFF	<p style="text-align: right; font-size: small;">JMKIA0062GB</p>
				When Intelligent Key is not in the antenna detection area	<p style="text-align: right; font-size: small;">JMKIA0063GB</p>
64 (V)	Ground	Front outside handle LH antenna (-)	Output	When the front door LH request switch is operated with ignition switch OFF	<p style="text-align: right; font-size: small;">JMKIA0062GB</p>
				When Intelligent Key is not in the antenna detection area	<p style="text-align: right; font-size: small;">JMKIA0063GB</p>
65 (P)	Ground	Front outside handle LH antenna (+)	Output	When the front door LH request switch is operated with ignition switch OFF	<p style="text-align: right; font-size: small;">JMKIA0062GB</p>
				When Intelligent Key is not in the antenna detection area	<p style="text-align: right; font-size: small;">JMKIA0063GB</p>

BCM (BODY CONTROL MODULE)

< ECU DIAGNOSIS >





Terminal No. (Wire color)		Description		Condition	Value (Approx.)
(+)	(-)	Signal name	Input/ Output		
66 (R)	Ground	Instrument panel antenna (-)	Output	Ignition switch OFF	
				When Intelligent Key is not in the passenger compartment	
67 (G)	Ground	Instrument panel antenna (+)	Output	Ignition switch OFF	
				When Intelligent Key is not in the passenger compartment	
68 (G/O)	Ground	NATS antenna amp (built in key slot)	Input/ Output	During waiting	Just after pressing ignition switch. Pointer of tester should move.
69 (O)	Ground	NATS antenna amp (built in key slot)	Input/ Output	During waiting	Just after pressing ignition switch. Pointer of tester should move.
70 (R/B)	Ground	Ignition relay-2 control	Output	Ignition switch OFF or ACC	0V
				ON	Battery voltage

A
B
C
D
E
F
G
H
I
J
K
L
M
N
O
P

WCS

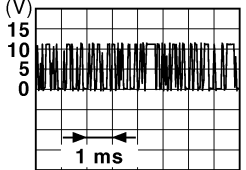
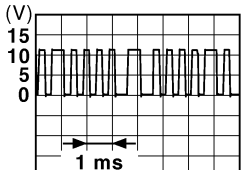

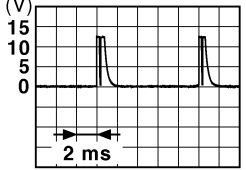
BCM (BODY CONTROL MODULE)

< ECU DIAGNOSIS >

Terminal No. (Wire color)		Description		Condition	Value (Approx.)
(+)	(-)	Signal name	Input/ Output		
71 (L/O)	Ground	Remote keyless entry receiver signal	Input/ Output	During waiting	 <p style="text-align: right; font-size: small;">JMKIA0064GB</p>
				When operating either button on Intelligent Key	 <p style="text-align: right; font-size: small;">JMKIA0065GB</p>
75 (R/Y)	Ground	Combination switch INPUT 5	Input	Combination switch	<p>All switch OFF (Wiper intermittent dial 4)</p>  <p style="text-align: right; font-size: small;">JPMIA0041GB</p> <p style="text-align: center;">1.4V</p>
				Combination switch	<p>Front fog lamp switch ON (Wiper intermittent dial 4)</p>  <p style="text-align: right; font-size: small;">JPMIA0037GB</p> <p style="text-align: center;">1.3V</p>
				Combination switch	<p>Any of the conditions below with all switch OFF</p> <ul style="list-style-type: none"> • Wiper intermittent dial 1 • Wiper intermittent dial 2 • Wiper intermittent dial 6 • Wiper intermittent dial 7  <p style="text-align: right; font-size: small;">JPMIA0040GB</p> <p style="text-align: center;">1.3V</p>

BCM (BODY CONTROL MODULE)

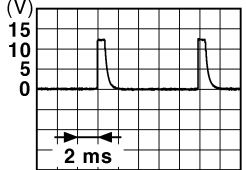
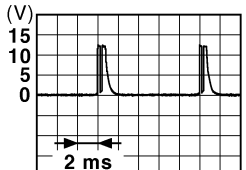
< ECU DIAGNOSIS >

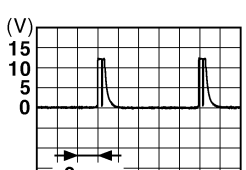
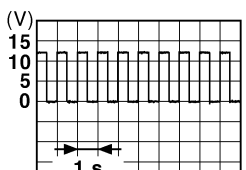
Terminal No. (Wire color)		Description		Condition	Value (Approx.)	
		Signal name	Input/ Output			
(+)	(-)					
76 (R/G)	Ground	Combination switch INPUT 3	Input	Combination switch	All switch OFF (Wiper intermittent dial 4)	 <p style="text-align: right; font-size: small;">JPMIA0041GB</p> <p style="text-align: center;">1.4V</p>
					Lighting switch high-beam (Wiper intermittent dial 4)	 <p style="text-align: right; font-size: small;">JPMIA0036GB</p> <p style="text-align: center;">1.3V</p>
					Lighting switch 2ND (Wiper intermittent dial 4)	 <p style="text-align: right; font-size: small;">JPMIA0037GB</p> <p style="text-align: center;">1.3V</p>
					Any of the conditions below with all switch OFF	<ul style="list-style-type: none"> • Wiper intermittent dial 1 • Wiper intermittent dial 2 • Wiper intermittent dial 3  <p style="text-align: right; font-size: small;">JPMIA0040GB</p> <p style="text-align: center;">1.3V</p>
77 (BR)	Ground	Push-button ignition switch	Input	Engine switch (push switch)	Pressed	0V
					Not pressed	Battery voltage
78 (P)	Ground	CAN-L	Input/ Output	—	—	
79 (L)	Ground	CAN-H	Input/ Output	—	—	
80 (R/L)	Ground	Key slot illumination	Output	Key slot illumina- tion	OFF	0V
					Blinking	 <p style="text-align: right; font-size: small;">JPMIA0015GB</p> <p style="text-align: center;">6.5V</p>
					ON	Battery voltage

A
B
C
D
E
F
G
H
I
J
K
L
M
O
P

WCS



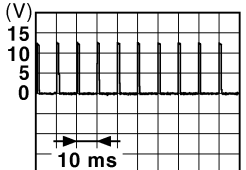
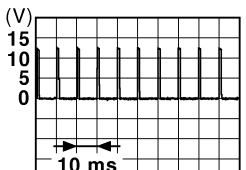

BCM (BODY CONTROL MODULE)

< ECU DIAGNOSIS >

Terminal No. (Wire color)		Description		Condition		Value (Approx.)
(+)	(-)	Signal name	Input/ Output			
81 (LG)	Ground	ON indicator lamp	Output	Ignition switch	OFF or ACC	Battery voltage
					ON	0V
83 (L)	Ground	ACC relay control	Output	Ignition switch	OFF	0V
					ACC or ON	Battery voltage
84 (Y/R)	Ground	ECTV device (detent switch)	Output	—		Battery voltage
85 (L/O)	Ground	Electronic steering column lock condition No. 1	Input	Electronic steering column lock	Lock status	0V
					Unlock status	Battery voltage
86 (G/R)	Ground	Electronic steering column lock condition No. 2	Input	Electronic steering column lock	Lock status	Battery voltage
					Unlock status	0V
87 (G/B)	Ground	ECTV device (detent switch)	Input	Selector lever	P position	0V
					Any position other than P	Battery voltage
88 (P/L)	Ground	Front door RH request switch	Input	Front door RH request switch	ON (pressed)	0V
					OFF (not pressed)	 <p style="text-align: right; font-size: small;">JPMIA0016GB 1.0V</p>
89 (B/W)	Ground	Front door LH request switch	Input	Front door LH request switch	ON (pressed)	0V
					OFF (not pressed)	 <p style="text-align: right; font-size: small;">JPMIA0016GB 1.0V</p>
90 (Y)	Ground	Front blower motor relay control	Output	Ignition switch	OFF or ACC	0V
					ON	Battery voltage
91 (L/R)	Ground	Remote keyless entry receiver power supply	Output	Ignition switch OFF		Battery voltage
94 (G/Y)	Ground	Electronic steering column lock CPU power supply	Output	Ignition switch	OFF or ACC	Battery voltage
					ON	0V

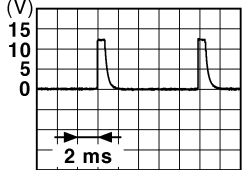
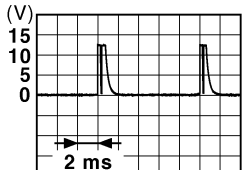
BCM (BODY CONTROL MODULE)

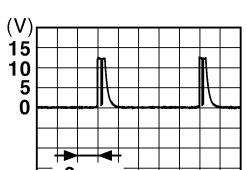
< ECU DIAGNOSIS >

Terminal No. (Wire color)		Description		Condition	Value (Approx.)
(+)	(-)	Signal name	Input/ Output		
95 (R/W)	Ground	Combination switch INPUT 1	Input	Combination switch (Wiper intermit- tent dial 4)	All switch OFF <div style="text-align: right;">  <p>1.4V</p> </div>
					Turn signal switch LH <div style="text-align: right;">  <p>1.3V</p> </div>
					Turn signal switch RH <div style="text-align: right;">  <p>1.3V</p> </div>
					Front wiper switch LO <div style="text-align: right;">  <p>1.3V</p> </div>
					Front washer switch ON <div style="text-align: right;">  <p>1.3V</p> </div>

A
B
C
D
E
F
G
H
I
J
K
L
M
O
P

WCS



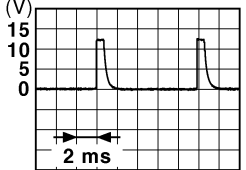
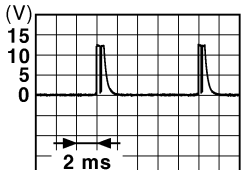
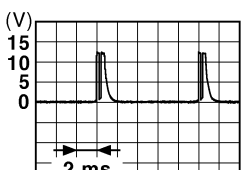
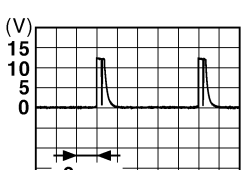

BCM (BODY CONTROL MODULE)

< ECU DIAGNOSIS >

Terminal No. (Wire color)		Description		Condition	Value (Approx.)
(+)	(-)	Signal name	Input/ Output		
96 (P/B)	Ground	Combination switch INPUT 4	Input	Combination switch	All switch OFF (Wiper intermittent dial 4)  <p style="text-align: right; font-size: small;">JPMIA0041GB</p> <p style="text-align: center;">1.4V</p>
					Lighting switch AUTO (Wiper intermittent dial 4)  <p style="text-align: right; font-size: small;">JPMIA0038GB</p> <p style="text-align: center;">1.3V</p>
					Lighting switch 1ST (Wiper intermittent dial 4)  <p style="text-align: right; font-size: small;">JPMIA0036GB</p> <p style="text-align: center;">1.3V</p>
					Any of the conditions below with all switch OFF <ul style="list-style-type: none"> • Wiper intermittent dial 1 • Wiper intermittent dial 5 • Wiper intermittent dial 6  <p style="text-align: right; font-size: small;">JPMIA0039GB</p> <p style="text-align: center;">1.3V</p>

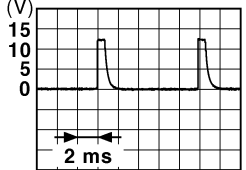
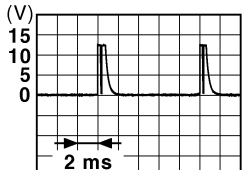
BCM (BODY CONTROL MODULE)

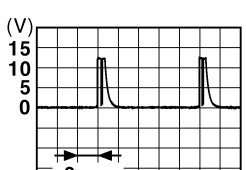
< ECU DIAGNOSIS >

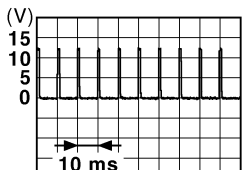
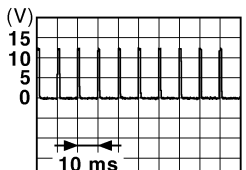
Terminal No. (Wire color)		Description		Condition	Value (Approx.)	
(+)	(-)	Signal name	Input/ Output			
97 (R/B)	Ground	Combination switch INPUT 2	Input	Combination switch (Wiper intermittent dial 4)	All switch OFF	 1.4V
					Lighting switch flash-to-pass	 1.3V
					Lighting switch 2ND	 1.3V
					Front wiper switch INT	 1.3V
					Front wiper switch HI	 1.3V
					Pressed	0 V
98 (G/R)	Ground	Hazard switch	Input	Hazard switch	 1.1V	
				Not pressed	 1.1V	

A
B
C
D
E
F
G
H
I
J
K
L
M
O
P

WCS

BCM (BODY CONTROL MODULE)

< ECU DIAGNOSIS >

Terminal No. (Wire color)		Description		Condition	Value (Approx.)	
(+)	(-)	Signal name	Input/ Output			
99 (L/Y)	Ground	Electronic steering column lock CPU communication	Input/ Output	Electronic steer- ing column lock	LOCK status	Battery voltage
					LOCK or UNLOCK	<p style="text-align: right; font-size: small;">JMKIA0066GB</p>
					For 15 seconds after UN- LOCK	Battery voltage
					15 seconds or later after UNLOCK	0V
103 (V)	Ground	Trunk lid opening	Output	Trunk lid	Open (trunk lid opener ac- tuator is activated)	Battery voltage
					Close (trunk lid opener ac- tuator is not activated)	0V
110 (V/W)	Ground	Trunk room lamp	Output	Trunk room lamp	ON	0V
					OFF	Battery voltage
114 (B)	Ground	Trunk room antenna 1 (-)	Output	Ignition switch OFF	When Intelligent Key is in the passenger compart- ment	<p style="text-align: right; font-size: small;">JMKIA0062GB</p>
					When Intelligent Key is not in the passenger compart- ment	<p style="text-align: right; font-size: small;">JMKIA0063GB</p>

BCM (BODY CONTROL MODULE)

< ECU DIAGNOSIS >

Terminal No. (Wire color)		Description		Condition	Value (Approx.)
(+)	(-)	Signal name	Input/ Output		
115 (W)	Ground	Trunk room antenna 1 (+)	Output	Ignition switch OFF	<p>JMKIA0062GB</p>
				When Intelligent Key is not in the passenger compart- ment	<p>JMKIA0063GB</p>
118 (L/O)	Ground	Rear bumper anten- na (-)	Output	When the trunk lid request switch is operated with ignition switch OFF	<p>JMKIA0062GB</p>
				When Intelligent Key is not in the antenna detection area	<p>JMKIA0063GB</p>
119 (BR/ W)	Ground	Rear bumper anten- na (+)	Output	When the trunk lid request switch is operated with ignition switch OFF	<p>JMKIA0062GB</p>
				When Intelligent Key is not in the antenna detection area	<p>JMKIA0063GB</p>

A
B
C
D
E
F
G
H
I
J
K
L
M
O
P

WCS

BCM (BODY CONTROL MODULE)

< ECU DIAGNOSIS >

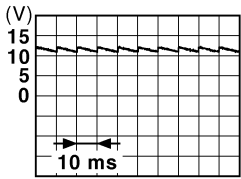
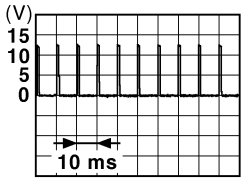
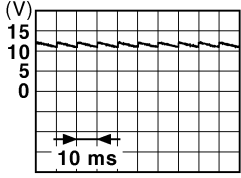
Terminal No. (Wire color)		Description		Condition	Value (Approx.)	
(+)	(-)	Signal name	Input/ Output			
127 (BR/ W)	Ground	Ignition relay (IPDM E/R) control	Output	Ignition switch	OFF or ACC	Battery voltage
					ON	0V
130 (Y/G)	Ground	Trunk room lamp switch	Input	Trunk room lamp switch	OFF (trunk is closed)	 <p style="text-align: right; font-size: small;">JPMIA0011GB</p> <p style="text-align: center;">11.8V</p>
					ON (trunk is open)	0V
132 (R)	Ground	Start signal	Output	Ignition switch ON	When selector lever is in P or N position and the brake peddle is not depressed	0V
					When selector lever is in P or N position and the brake peddle is depressed	Battery voltage
141 (G/R)	Ground	Trunk request switch	Input	Trunk request switch	ON (pressed)	0V
					OFF (not pressed)	 <p style="text-align: right; font-size: small;">JPMIA0016GB</p> <p style="text-align: center;">1.0V</p>
144 (GR)	Ground	Request switch buzzer	Output	Request switch buzzer	Sounding	0V
					Not sounding	Battery voltage
147 (L/R)	Ground	Trunk lid opener switch	Input	Trunk lid opener switch	Pressed	0V
					Not pressed	Battery voltage
148 (R/W)	Ground	Rear door RH switch	Input	Rear door RH switch	OFF (when rear door RH closes)	 <p style="text-align: right; font-size: small;">JPMIA0011GB</p> <p style="text-align: center;">11.8V</p>
					ON (when rear door RH opens)	0V

BCM (BODY CONTROL MODULE)

< ECU DIAGNOSIS >

Terminal No. (Wire color)		Description		Condition	Value (Approx.)
		Signal name	Input/ Output		
(+)	(-)				
149 (R/B)	Ground	Rear door LH switch	Input	Rear door LH switch	OFF (when rear door LH closes)
				ON (when rear door LH opens)	0V

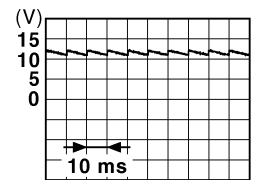

JPMIA0011GB

*: With LH and RH front window anti-pinch system

A
B
C
D
E
F
G
H
I
J
K
L
M
O
P

WCS

BCM (BODY CONTROL MODULE)

< ECU DIAGNOSIS >

Wiring Diagram

INFOID:00000000491013

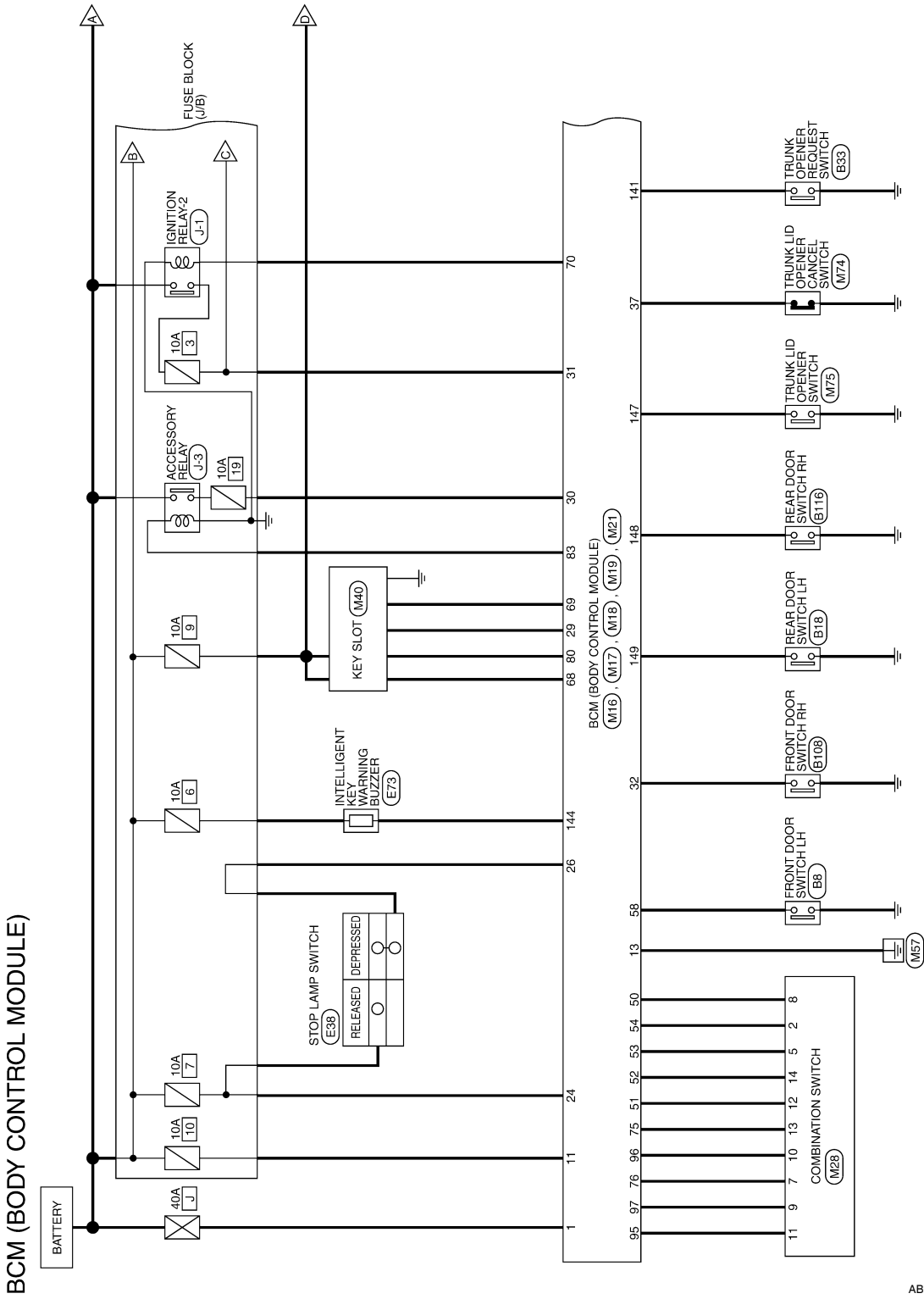

ABMWA0182GI

BCM (BODY CONTROL MODULE)

< ECU DIAGNOSIS >

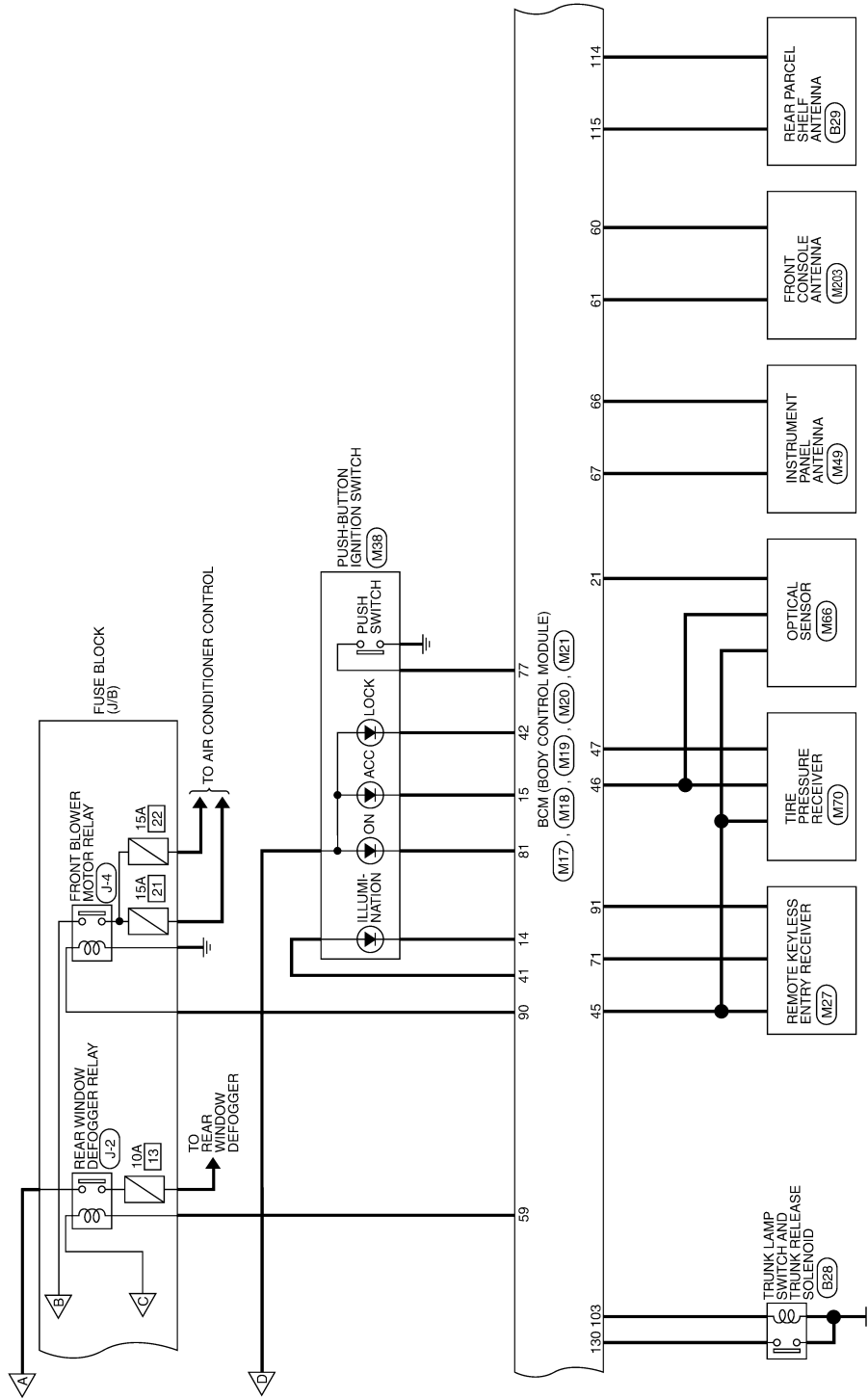

A
B
C
D
E
F
G
H
I
J
K
L
M
N
O
P

WCS

ABMWA0183GI

BCM (BODY CONTROL MODULE)

< ECU DIAGNOSIS >

--- : DATA LINE

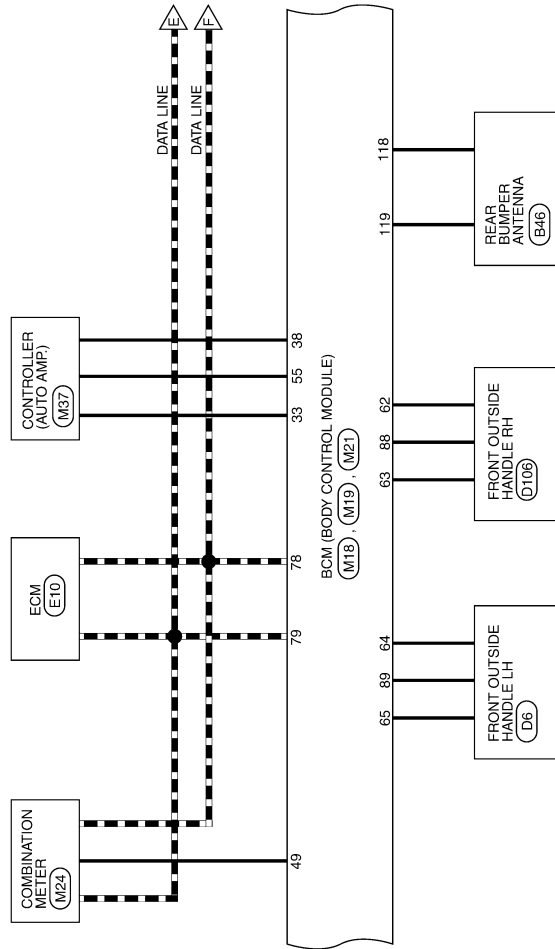

ALMWA0039Gf

BCM (BODY CONTROL MODULE)

< ECU DIAGNOSIS >

--- : DATA LINE

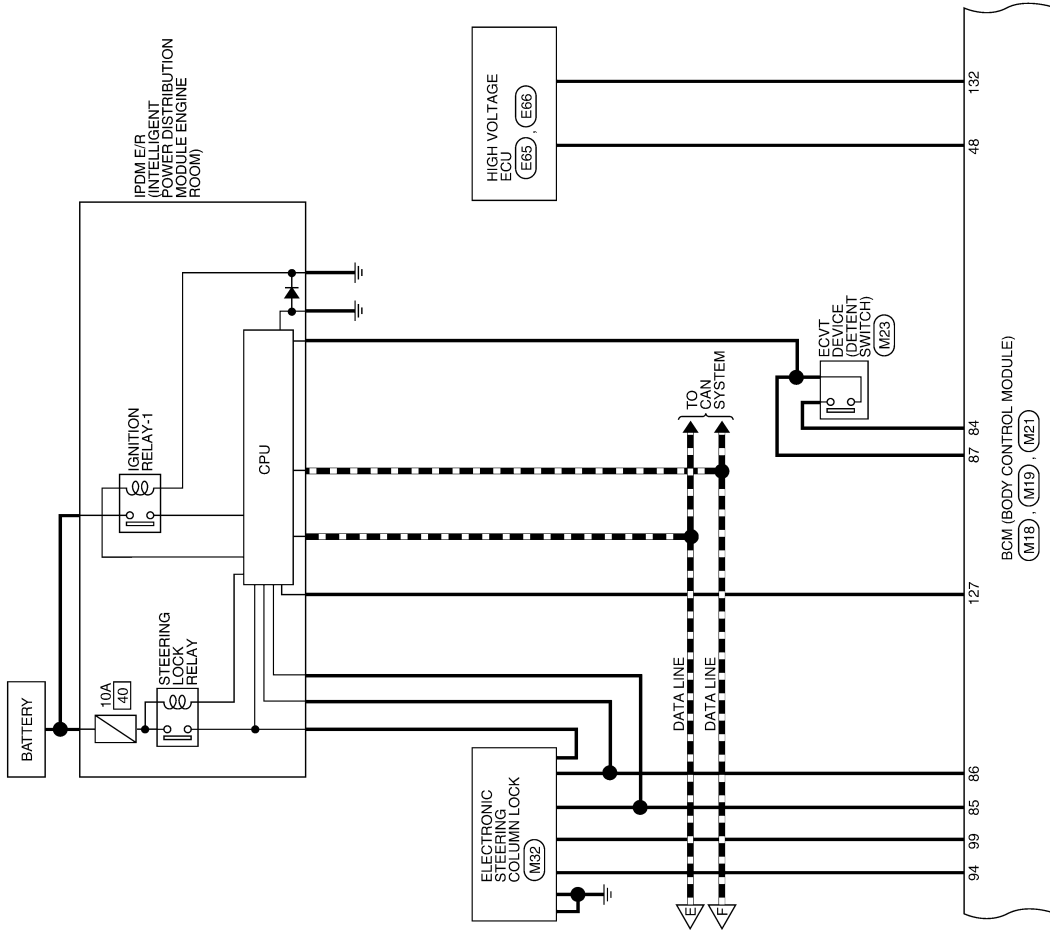

A
B
C
D
E
F
G
H
I
J
K
L
M

WCS

O
P

ALMWA0040G1

BCM (BODY CONTROL MODULE)

< ECU DIAGNOSIS >

<A1> : WITH LEFT FRONT ONLY POWER WINDOW ANTI-PINCH SYSTEM
 <A2> : WITH LEFT AND RIGHT FRONT POWER WINDOW ANTI-PINCH SYSTEM

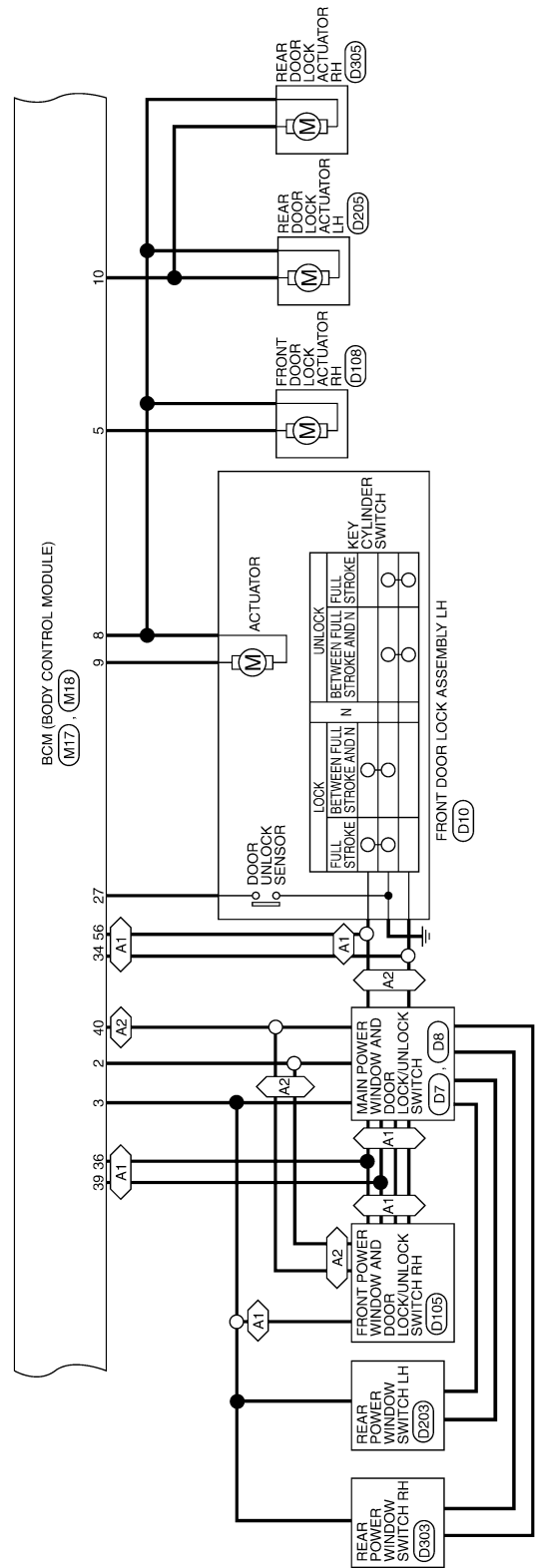

AAMWA0058GI

BCM (BODY CONTROL MODULE)

< ECU DIAGNOSIS >

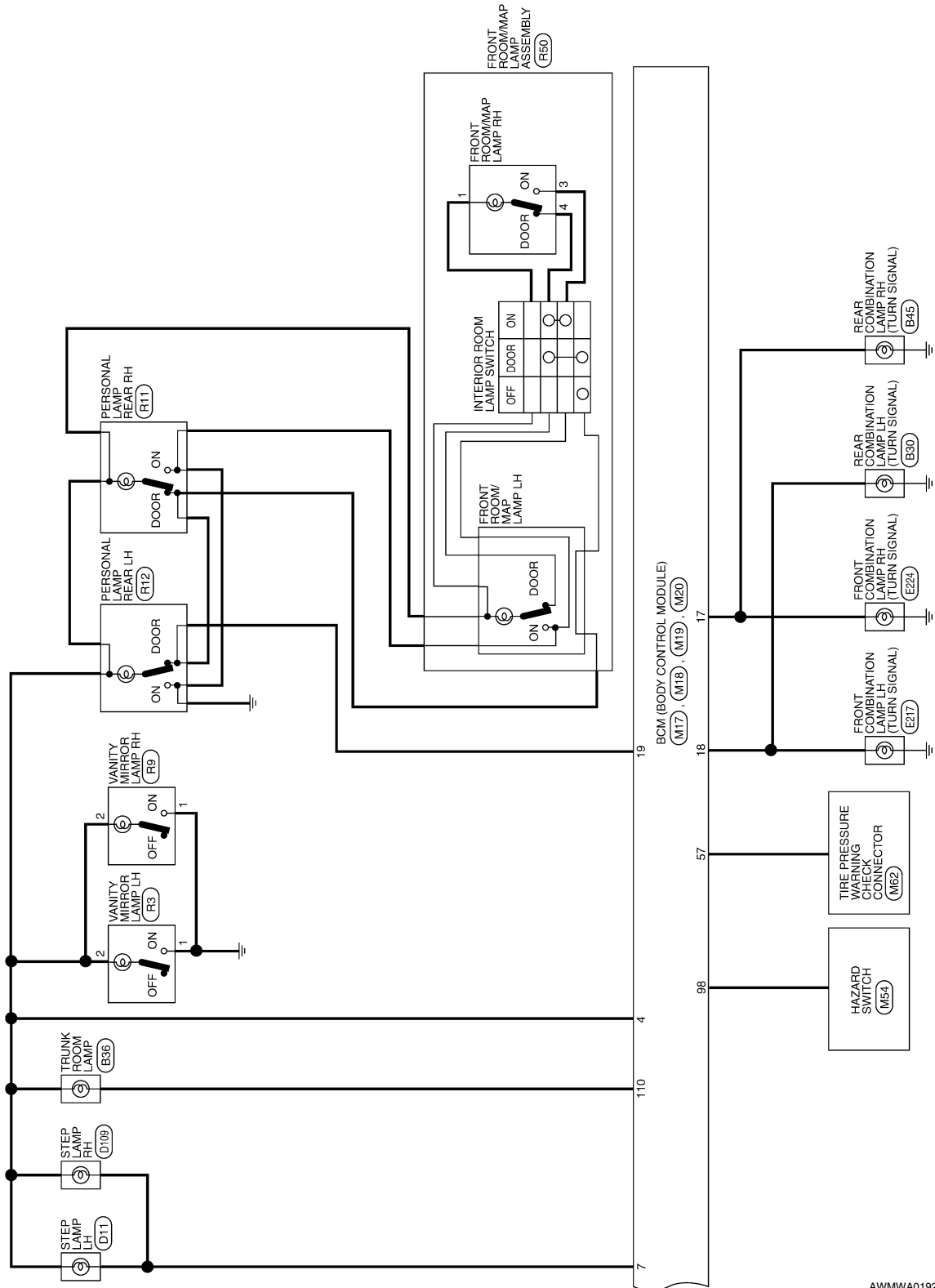

AWMWA0192G

A
B
C
D
E
F
G
H
I
J
K
L
M
N
O
P

WCS

BCM (BODY CONTROL MODULE)

< ECU DIAGNOSIS >

BCM (BODY CONTROL MODULE) CONNECTORS

Connector No.	M16
Connector Name	BCM (BODY CONTROL MODULE)
Connector Color	BLACK



Terminal No.	Color of Wire	Signal Name
1	W/B	BAT_POWER_F/L
2	R/Y	P/W_POWER_SUPPL Y_PERM
3	L/W	POWER_WINDOW_ POWER_SUPPLY (RAP)



Connector No.	M18
Connector Name	BCM (BODY CONTROL MODULE)
Connector Color	GREEN

39	37	36	35	34	33	32	31	30	29	28	27	26	25	24	23	22	21	20	
59	58	57	56	55	54	53	52	51	50	49	48	47	46	45	44	43	42	41	40

Terminal No.	Color of Wire	Signal Name
20	-	-
21	P/B	AUTO_LIGHT_SEN SOR_INPUT1
22	-	-
23	-	-
24	R/W	STOP_LAMP_LOW_SW
25	-	-
26	O/L	STOP_LAMP_HIGH_SW

Connector No.	M17
Connector Name	BCM (BODY CONTROL MODULE)
Connector Color	WHITE

4	5	6	7	8	9	10		
11	12	13	14	15	16	17	18	19



Terminal No.	Color of Wire	Signal Name
4	P/W	ROOM_LAMP_BAT_ SAVER
5	G/Y	CDL_AS
6	-	-
7	R/W	STEP_LAMP_OUTPUT
8	V	CDL_COMMON

Terminal No.	Color of Wire	Signal Name
9	G	CDL_DR/FL
10	G/Y	CDL_FR_RL_BA CK
11	Y/R	BAT_BCM_FUSE
12	-	-
13	B	GND1
14	R/Y	LOW_SIDE_PUSH_ LE D_OUTPUT
15	Y/L	ACC_LED
16	-	-
17	G/B	FR_FLASHER
18	G/O	FL_FLASHER
19	Y	ROOM_LAMP_OUTPUT

Terminal No.	Color of Wire	Signal Name
27	G/W	DOOR_LOCK_STATU S
28	-	-
29	Y	FOB_IN_SW_1
30	V/Y	ACC_F/B
31	G	IGN_F/B
32	R/B	AS_DOOR_SW
33	SB	AIRCON_SW
34	L/R	DOOR_KEY/C_ UNLOCK_SW
35	-	-
36	GR	CENTRAL_LOCK_SW
37	O	TRUNK_CANCEL_SW
38	GR/W	REAR_DEFOGGER_SW
39	GR/R	CENTRAL_UNLOCK_SW
40	Y/G	PW_K-LINE
41	W	PUSH_LED
42	R	S/L_LOCK_LED
43	-	-
44	-	-
45	P	GND_RF2_A/L
46	V/W	A/L_SEN S_KEYLESS_ TUNER_POWER_SUP PLY

Terminal No.	Color of Wire	Signal Name
47	G/O	KEYLESS_TUNER_SI
48	R/B	SHIFT_I/N/P
49	L/O	IMMO_LED
50	LG/B	INPUT_5
51	L/W	INPUT_1
52	G/B	INPUT_2
53	LG/R	INPUT_3
54	G/Y	INPUT_4
55	BR/W	BLOWER_FAN_SW
56	L/B	DOOR_KEY/C_ LOCK_SW
57	W	TPMS_MODE_TRIGG ER_SW
58	SB	DR_DOOR_SW
59	G/R	REAR_DEFOGGER_ RLY

AWMIA0392GB

BCM (BODY CONTROL MODULE)

< ECU DIAGNOSIS >

Connector No.	M19
Connector Name	BCM (BODY CONTROL MODULE)
Connector Color	BLACK



79	78	77	76	75	74	73	72	71	70	69	68	67	66	65	64	63	62	61	60
99	98	97	96	95	94	93	92	91	90	89	88	87	86	85	84	83	82	81	80

Terminal No.	Color of Wire	Signal Name
60	B/R	ROOM_ANT_2_B
61	W/R	ROOM_ANT_2_A

Terminal No.	Color of Wire	Signal Name
82	-	-
83	L	ACC_CONT
84	Y/R	AT_DEVICE_OUT
85	L/O	S/L_CONDITION_1
86	G/R	S/L_CONDITION_2
87	G/B	SHIFT_P
88	P/L	AS_REQUEST_SWITCH
89	B/W	DR_REQUEST_SWITCH
90	Y	IGN2_CONT
91	L/R	RF1_POWER_SUPPLY
92	-	-
93	-	-
94	G/Y	S/L_POWER_SUPPLY_12V
95	R/W	OUTPUT_1
96	P/B	OUTPUT_4
97	R/B	OUTPUT_2
98	G/R	HAZARD_SW
99	L/Y	S/L_K-LINE

Terminal No.	Color of Wire	Signal Name
62	B/Y	AS_DOOR_ANT_B
63	LG	AS_DOOR_ANT_A
64	V	DR_DOOR_ANT_B
65	P	DR_DOOR_ANT_A
66	R	ROOM_ANT_1_B
67	G	ROOM_ANT_1_A
68	G/O	FOB_READER_CLOCK
69	O	FOB_READER_DATA
70	R/B	IGN_ELEC_SIGNAL
71	L/O	RF1_TUNER_SIGNAL
72	-	-
73	-	-
75	R/Y	OUTPUT_5
76	R/G	OUTPUT_3
77	BR	ENG_START_SW
78	P	CAN-L
79	L	CAN-H
80	R/L	FOB_SLOT_ILLUMINATION
81	LG	IGN_ON_LED

Connector No.	M20
Connector Name	BCM (BODY CONTROL MODULE)
Connector Color	WHITE



100	101	102	103	104		
105	106	107	108	109	110	111

Terminal No.	Color of Wire	Signal Name
100	-	-
101	-	-
102	-	-
103	V	CDL_BACK_TRUNK
104	-	-
105	-	-
106	-	-
107	-	-
108	-	-
109	-	-
110	V/W	TRUNK_LAMP_OUTPUT
111	-	-

ALMIA0084GB

A
B
C
D
E
F
G
H
I
J
K
L
M
N
O
P

BCM (BODY CONTROL MODULE)

< ECU DIAGNOSIS >

Terminal No.	Color of Wire	Signal Name
138	-	-
139	-	-
140	-	-
141	G/R	TRUNK_REQUEST_SW
142	-	-
143	-	-
144	GR	BUZZER
145	-	-
146	-	-
147	L/R	BACK_TRUNK_OPENER
148	R/W	RR_DOOR_SW
149	R/B	RL_DOOR_SW
150	-	-
151	-	-

Terminal No.	Color of Wire	Signal Name
119	BR/W	BACK_DOOR_ANT_A
120	-	-
121	-	-
122	-	-
123	-	-
124	-	-
125	-	-
126	-	-
127	BR/W	IGN_USM_CONT1
128	-	-
129	-	-
130	Y/G	TRUNK_SW
131	-	-
132	R	ST_CONT_USM
133	-	-
134	-	-
135	-	-
136	-	-
137	-	-

Connector No.	M21
Connector Name	BCM (BODY CONTROL MODULE)
Connector Color	GRAY

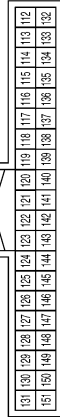

Terminal No.	Color of Wire	Signal Name
112	-	-
113	-	-
114	B	TRUNK_ANT_1_B
115	W	TRUNK_ANT_1_A
116	-	-
117	-	-
118	L/O	BACK_DOOR_ANT_B

Terminal No.	Color of Wire	Signal Name
8	LG/B	OUTPUT_5
9	R/B	INPUT_2
10	P/B	INPUT_4
11	R/W	INPUT_1
12	L/W	OUTPUT_1
13	R/Y	INPUT_5
14	G/B	OUTPUT_2
15	-	-
16	-	-

Connector No.	M28
Connector Name	COMBINATION SWITCH
Connector Color	WHITE

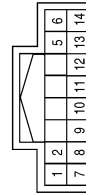

Terminal No.	Color of Wire	Signal Name
1	R/L	WASH_MTR
2	G/Y	OUTPUT_4
3	-	-
4	-	-
5	LG/R	OUTPUT_3
6	B	GND
7	R/G	INPUT_3

AWMIA0393GB

INFOID:000000004491014

Fail Safe

Display contents of CONSULT	Fail-safe	Cancellation
B2013: ID DISCORD BCM-S/L	Inhibit hybrid system cranking	Erase DTC
B2014: CHAIN OF S/L-BCM	Inhibit hybrid system cranking	Erase DTC

BCM (BODY CONTROL MODULE)

< ECU DIAGNOSIS >

Display contents of CONSULT	Fail-safe	Cancellation	
B2190: NATS ANTENNA AMP	Inhibit hybrid system cranking	Erase DTC	A
B2191: DIFFERENCE OF KEY	Inhibit hybrid system cranking	Erase DTC	B
B2192: ID DISCORD BCM-ECM	Inhibit hybrid system cranking	Erase DTC	C
B2193: CHAIN OF BCM-ECM	Inhibit hybrid system cranking	Erase DTC	D
B2195: ANTI-SCANNING	Inhibit hybrid system cranking	Erase DTC	E
B2557: VEHICLE SPEED	Inhibit electronic steering column lock	When normal vehicle speed signals have been received from brake ECU actuator and electric unit (control unit) for 500 ms	F
B2562: LOW VOLTAGE	<ul style="list-style-type: none"> • Inhibit hybrid system cranking • Inhibit electronic steering column lock 	100 ms after the power supply voltage increases to more than 8.8 V	G
B2563: HI VOLTAGE	<ul style="list-style-type: none"> • Inhibit hybrid system cranking • Inhibit electronic steering column lock 	500 ms after the power supply voltage decreases to less than 18 V	H
B2601: SHIFT POSITION	Inhibit electronic steering column lock	500 ms after the following signal reception status becomes consistent <ul style="list-style-type: none"> • Selector lever P position switch signal • P range signal (CAN) 	I
B2602: SHIFT POSITION	Inhibit electronic steering column lock	5 seconds after the following BCM recognition conditions are fulfilled <ul style="list-style-type: none"> • Ignition switch is in the ON position • Selector lever P position switch signal: Except P position (battery voltage) • Vehicle speed: 4 /h or more 	J
B2603: SHIFT POSI STATUS	Inhibit electronic steering column lock	500 ms after the following BCM recognition conditions are fulfilled <ul style="list-style-type: none"> • Ignition switch is in the ON position • Selector lever P position switch signal: Except P position (battery voltage) • Selector lever P/N position signal: Except P and N positions (0 V) 	K
B2604: PNP SW	Inhibit electronic steering column lock	500 ms after any of the following BCM recognition conditions is fulfilled <ul style="list-style-type: none"> • Status 1 <ul style="list-style-type: none"> - Ignition switch is in the ON position - Selector lever P/N position signal: P and N position (battery voltage) - P range signal or N range signal (CAN): ON • Status 2 <ul style="list-style-type: none"> - Ignition switch is in the ON position - Selector lever P/N position signal: Except P and N positions (0 V) - P range signal and N range signal (CAN): OFF 	L
B2605: PNP SW	Inhibit electronic steering column lock	500 ms after any of the following BCM recognition conditions is fulfilled <ul style="list-style-type: none"> • Ignition switch is in the ON position <ul style="list-style-type: none"> - Power position: IGN - Selector lever P/N position signal: Except P and N positions (0 V) - Interlock/PNP switch signal (CAN): OFF • Status 2 <ul style="list-style-type: none"> - Ignition switch is in the ON position - Selector lever P/N position signal: P or N position (battery voltage) - PNP switch signal (CAN): ON 	M

WCS

BCM (BODY CONTROL MODULE)

< ECU DIAGNOSIS >

Display contents of CONSULT	Fail-safe	Cancellation
B2606: S/L RELAY	Inhibit hybrid system cranking	500 ms after the following CAN signal communication status has become consistent <ul style="list-style-type: none"> • Electronic steering column lock relay signal (Request signal) • Electronic steering column lock relay signal (Condition signal)
B2607: S/L RELAY	Inhibit hybrid system cranking	500 ms after the following CAN signal communication status has become consistent <ul style="list-style-type: none"> • Electronic steering column lock relay signal (Request signal) • Electronic steering column lock relay signal (Condition signal)
B2609: S/L STATUS	<ul style="list-style-type: none"> • Inhibit hybrid system cranking • Inhibit electronic steering column lock 	When the following electronic steering column lock conditions agree <ul style="list-style-type: none"> • BCM electronic steering column lock control status • Electronic steering column lock condition No. 1 signal status • Electronic steering column lock condition No. 2 signal status
B260A: IGNITION RELAY	Inhibit hybrid system cranking	500 ms after the following conditions are fulfilled <ul style="list-style-type: none"> • IGN relay (IPDM E/R) control signal: OFF (Battery voltage) • Ignition ON signal (CAN to IPDM E/R): OFF (Request signal) • Ignition ON signal (CAN from IPDM E/R): OFF (Condition signal)
B260F: ENG STATE SIG LOST	Maintains the power supply position attained at the time of DTC detection	When any of the following conditions is fulfilled <ul style="list-style-type: none"> • Power position changes to ACC • Receives hybrid system status signal (CAN)
B2612: S/L STATUS	<ul style="list-style-type: none"> • Inhibit hybrid system cranking • Inhibit electronic steering column lock 	When any of the following conditions is fulfilled <ul style="list-style-type: none"> • Electronic steering column lock unit status signal (CAN) is received normally • The BCM electronic steering column lock control status matches the electronic steering column lock status recognized by the electronic steering column lock unit status signal (CAN from IPDM E/R)
B2617: STARTER RELAY CIRC	Inhibit hybrid system cranking	1 second after the starter motor relay control inside BCM becomes normal
B2618: BCM	Inhibit hybrid system cranking	1 second after the ignition relay (IPDM E/R) control inside BCM becomes normal
B2619: BCM	Inhibit hybrid system cranking	1 second after the electronic steering column lock unit power supply output control inside BCM becomes normal
B261E: VEHICLE TYPE	Inhibit hybrid system cranking	BCM initialization
B26E1: ENG STATE NO RECIV	Inhibit hybrid system cranking	When any of the following conditions is fulfilled <ul style="list-style-type: none"> • Power position changes to ACC • Receives hybrid system status signal (CAN)

DTC Inspection Priority Chart

INFOID:000000004491015

If some DTCs are displayed at the same time, perform inspections one by one based on the following priority chart.

Priority	DTC
1	<ul style="list-style-type: none"> • B2562: LOW VOLTAGE • B2563: HI VOLTAGE • B261E: VEHICLE TYPE
2	<ul style="list-style-type: none"> • U1000: CAN COMM CIRCUIT • U1010: CONTROL UNIT (CAN)
3	<ul style="list-style-type: none"> • B2190: NATS ANTENNA AMP • B2191: DIFFERENCE OF KEY • B2192: ID DISCORD BCM-ECM • B2193: CHAIN OF BCM-ECM

BCM (BODY CONTROL MODULE)

< ECU DIAGNOSIS >

Priority	DTC	A	
4	<ul style="list-style-type: none"> • B2013: ID DISCORD BCM-S/L • B2014: CHAIN OF S/L-BCM • B2553: IGNITION RELAY • B2555: STOP LAMP • B2556: PUSH-BTN IGN SW • B2557: VEHICLE SPEED • B2601: SHIFT POSITION • B2602: SHIFT POSITION • B2603: SHIFT POSI STATUS • B2604: PNP SW • B2605: PNP SW • B2606: S/L RELAY • B2607: S/L RELAY • B2609: S/L STATUS • B260A: IGNITION RELAY • B260B: STEERING LOCK UNIT • B260C: STEERING LOCK UNIT • B260D: STEERING LOCK UNIT • B260F: ENG STATE SIG LOST • B2611: ACC RELAY • B2612: S/L STATUS • B2614: ACC RELAY CIRC • B2615: BLOWER RELAY CIRC • B2616: IGN RELAY CIRC • B2617: STARTER RELAY CIRC • B2618: BCM • B2619: BCM • B261A: PUSH-BTN IGN SW • B26E1: ENG STATE NO RECIV • C1729: VHCL SPEED SIG ERR • U0415: VEHICLE SPEED SIG 	A B C D E F G H I	
	<ul style="list-style-type: none"> • C1704: LOW PRESSURE FL • C1705: LOW PRESSURE FR • C1706: LOW PRESSURE RR • C1707: LOW PRESSURE RL • C1708: [NO DATA] FL • C1709: [NO DATA] FR • C1710: [NO DATA] RR • C1711: [NO DATA] RL • C1712: [CHECKSUM ERR] FL • C1713: [CHECKSUM ERR] FR • C1714: [CHECKSUM ERR] RR • C1715: [CHECKSUM ERR] RL • C1716: [PRESSDATA ERR] FL • C1717: [PRESSDATA ERR] FR • C1718: [PRESSDATA ERR] RR • C1719: [PRESSDATA ERR] RL • C1720: [CODE ERR] FL • C1721: [CODE ERR] FR • C1722: [CODE ERR] RR • C1723: [CODE ERR] RL • C1724: [BATT VOLT LOW] FL • C1725: [BATT VOLT LOW] FR • C1726: [BATT VOLT LOW] RR • C1727: [BATT VOLT LOW] RL • C1734: CONTROL UNIT 	J K L M N O P	
	6	<ul style="list-style-type: none"> • B2621: INSIDE ANTENNA • B2622: INSIDE ANTENNA • B2623: INSIDE ANTENNA 	P

WCS

DTC Index

INFOID:000000004491016

NOTE:

Details of time display

BCM (BODY CONTROL MODULE)

< ECU DIAGNOSIS >

- CRNT: Displays when there is a malfunction now or after returning to the normal condition until turning ignition switch OFF → ON again.
- 1 - 39: Displayed if any previous malfunction is present when current condition is normal. It increases like 1 → 2 → 3...38 → 39 after returning to the normal condition whenever ignition switch OFF → ON. The counter remains at 39 even if the number of cycles exceeds it. It is counted from 1 again when turning ignition switch OFF → ON after returning to the normal condition if the malfunction is detected again.

CONSULT display	Fail-safe	Intelligent Key warning lamp ON	Tire pressure monitor warning lamp ON	Reference page
No DTC is detected. further testing may be required.	—	—	—	—
U1000: CAN COMM CIRCUIT	—	—	—	BCS-37
U1010: CONTROL UNIT (CAN)	—	—	—	BCS-38
U0415: VEHICLE SPEED SIG	—	—	—	BCS-39
B2013: ID DISCORD BCM-S/L	×	—	—	SEC-30
B2014: CHAIN OF S/L-BCM	×	—	—	SEC-31
B2190: NATS ANTENNA AMP	×	—	—	SEC-40
B2191: DIFFERENCE OF KEY	×	—	—	SEC-43
B2192: ID DISCORD BCM-ECM	×	—	—	SEC-44
B2193: CHAIN OF BCM-ECM	×	—	—	SEC-45
B2553: IGNITION RELAY	—	—	—	PCS-53
B2555: STOP LAMP	—	—	—	SEC-46
B2556: PUSH-BTN IGN SW	—	×	—	SEC-49
B2557: VEHICLE SPEED	×	×	—	SEC-51
B2562: LOW VOLTAGE	—	—	—	BCS-40
B2563: HI VOLTAGE	×	×	—	BCS-41
B2601: SHIFT POSITION	×	×	—	SEC-52
B2602: SHIFT POSITION	×	×	—	SEC-55
B2603: SHIFT POSI STATUS	×	×	—	SEC-57
B2604: PNP SW	×	×	—	SEC-60
B2607: S/L RELAY	×	×	—	SEC-62
B2609: S/L STATUS	×	×	—	SEC-64
B260A: IGNITION RELAY	×	×	—	PCS-55
B260B: STEERING LOCK UNIT	—	×	—	SEC-68
B260C: STEERING LOCK UNIT	—	×	—	SEC-69
B260D: STEERING LOCK UNIT	—	×	—	SEC-70
B260F: ENG STATE SIG LOST	×	×	—	SEC-71
B2611: ACC RELAY	—	—	—	PCS-56
B2612: S/L STATUS	×	×	—	SEC-72
B2614: ACC RELAY CIRC	—	×	—	PCS-58
B2615: BLOWER RELAY CIRC	—	×	—	PCS-61
B2616: IGN RELAY CIRC	—	×	—	PCS-64
B2617: STARTER RELAY CIRC	×	×	—	SEC-76
B2618: BCM	×	×	—	PCS-67
B2619: BCM	×	×	—	SEC-78
B261A: PUSH-BTN IGN SW	—	×	—	SEC-79

BCM (BODY CONTROL MODULE)

< ECU DIAGNOSIS >

CONSULT display	Fail-safe	Intelligent Key warning lamp ON	Tire pressure monitor warning lamp ON	Reference page	
B261E: VEHICLE TYPE	×	× (Turn ON for 15 seconds)	—	SEC-81	A
B2621: INSIDE ANTENNA	—	—	—	DLK-59	B
B2622: INSIDE ANTENNA	—	—	—	DLK-62	
B2623: INSIDE ANTENNA	—	—	—	DLK-65	C
C1704: LOW PRESSURE FL	—	—	×	WT-8	
C1705: LOW PRESSURE FR	—	—	×	WT-8	D
C1706: LOW PRESSURE RR	—	—	×	WT-8	
C1707: LOW PRESSURE RL	—	—	×	WT-8	
C1708: [NO DATA] FL	—	—	×	WT-14	E
C1709: [NO DATA] FR	—	—	×	WT-14	
C1710: [NO DATA] RR	—	—	×	WT-14	F
C1711: [NO DATA] RL	—	—	×	WT-14	
C1712: [CHECKSUM ERR] FL	—	—	×	WT-16	
C1713: [CHECKSUM ERR] FR	—	—	×	WT-16	G
C1714: [CHECKSUM ERR] RR	—	—	×	WT-16	
C1715: [CHECKSUM ERR] RL	—	—	×	WT-16	
C1716: [PRESSDATA ERR] FL	—	—	×	WT-18	H
C1717: [PRESSDATA ERR] FR	—	—	×	WT-18	
C1718: [PRESSDATA ERR] RR	—	—	×	WT-18	I
C1719: [PRESSDATA ERR] RL	—	—	×	WT-18	
C1720: [CODE ERR] FL	—	—	×	WT-16	J
C1721: [CODE ERR] FR	—	—	×	WT-16	
C1722: [CODE ERR] RR	—	—	×	WT-16	
C1723: [CODE ERR] RL	—	—	×	WT-16	K
C1724: [BATT VOLT LOW] FL	—	—	×	WT-16	
C1725: [BATT VOLT LOW] FR	—	—	×	WT-16	
C1726: [BATT VOLT LOW] RR	—	—	×	WT-16	L
C1727: [BATT VOLT LOW] RL	—	—	×	WT-16	
C1729: VHCL SPEED SIG ERR	—	—	×	WT-19	M
C1734: CONTROL UNIT	—	—	×	WT-20	

WCS

O

P

THE PARKING BRAKE RELEASE WARNING CONTINUES SOUNDING, OR DOES NOT SOUND

< SYMPTOM DIAGNOSIS >

SYMPTOM DIAGNOSIS

THE PARKING BRAKE RELEASE WARNING CONTINUES SOUNDING, OR DOES NOT SOUND

Description

INFOID:000000004219381

- The parking brake warning buzzer sounds continuously during vehicle travel though the parking brake is released
- The parking brake warning buzzer does not sound at all even though driving the vehicle with the parking brake applied.

Diagnosis Procedure

INFOID:000000004219382

1.CHECK PARKING BRAKE WARNING LAMP

1. Start the engine.
2. Check the operation of the brake warning lamp by operating the parking brake.

Parking brake ON : ON
Parking brake OFF : OFF

Is the inspection result normal?

- YES >> Replace the combination meter. Refer to [MWI-135, "Removal and Installation"](#).
NO >> GO TO 2

2.CHECK PARKING BRAKE SWITCH SIGNAL CIRCUIT

Perform inspection of the parking brake switch signal circuit. Refer to [MWI-46, "Diagnosis Procedure"](#).

Is the inspection result normal?

- YES >> GO TO 3
NO >> Repair harness or connector.

3.CHECK PARKING BRAKE SWITCH UNIT

Perform a unit inspection for the parking brake switch. Refer to [MWI-46, "Component Inspection"](#).

Is the inspection result normal?

- YES >> Replace the combination meter. Refer to [MWI-135, "Removal and Installation"](#).
NO >> Replace the parking brake switch.

THE LIGHT REMINDER WARNING DOES NOT SOUND

< SYMPTOM DIAGNOSIS >

THE LIGHT REMINDER WARNING DOES NOT SOUND

Description

INFOID:000000004219383

Light reminder warning does not sound even though headlamp is illuminated.

Diagnosis Procedure

INFOID:000000004219384

1.CHECK COMBINATION SWITCH (LIGHT SWITCH) OPERATION

Check that the headlamps operate normally by operating the combination switch (light switch).

Do they operate normally?

YES >> GO TO 2

NO >> Refer to [EXL-4, "Work Flow"](#).

2.CHECK FRONT DOOR SWITCH LH SIGNAL CIRCUIT

Perform inspection of the front door switch LH signal circuit. Refer to [DLK-69, "Description"](#).

Is the inspection result normal?

YES >> GO TO 3

NO >> Repair harness or connector.

3.CHECK FRONT DOOR SWITCH LH

Perform a unit inspection for the front door switch LH. Refer to [DLK-71, "Component Inspection"](#).

Is the inspection result normal?

YES >> Replace the BCM. Refer to [BCS-87, "Removal and Installation"](#).

NO >> Replace the front door switch LH.

A
B
C
D
E
F
G
H
I
J
K
L
M
O
P

WCS

THE SEAT BELT WARNING CONTINUES SOUNDING, OR DOES NOT SOUND

< SYMPTOM DIAGNOSIS >

THE SEAT BELT WARNING CONTINUES SOUNDING, OR DOES NOT SOUND

Description

INFOID:000000004219385

- Seat belt warning does not sound even though driver seat belt is not fastened.
- Seat belt warning sounds even though driver seat belt is fastened.

Diagnosis Procedure

INFOID:000000004219386

1. CHECK WARNING CHIME OPERATION

1. With key removed from key switch and the front door LH open, turn lighting switch to 1st or 2nd position.
2. Return lighting switch to off position, and insert key into key switch.

Does warning chime sound for both steps?

- YES >> GO TO 2
NO >> Replace combination meter. Refer to [MWI-135. "Removal and Installation"](#).

2. CHECK SEAT BELT WARNING LAMP

1. Turn ignition switch ON.
2. Check the operation of the seat belt warning lamp in the combination meter.

Seat belt fastened : OFF

Seat belt not fastened : ON

Is the inspection result normal?

- YES >> Replace BCM. Refer to [BCS-87. "Removal and Installation"](#).
NO >> GO TO 3

3. CHECK SEAT BELT BUCKLE SWITCH CIRCUIT

Perform inspection of the seat belt buckle switch circuit. Refer to [WCS-20. "Diagnosis Procedure"](#).

Is the inspection result normal?

- YES >> GO TO 4
NO >> Repair harness or connector.

4. CHECK SEAT BELT BUCKLE SWITCH UNIT

Perform a unit inspection for the seat belt buckle switch. Refer to [WCS-21. "Component Inspection"](#).

Is the inspection result normal?

- YES >> Replace the combination meter. Refer to [MWI-135. "Removal and Installation"](#).
NO >> Replace the seat belt buckle switch LH.

PRECAUTIONS

< PRECAUTION >

PRECAUTION

PRECAUTIONS

Supplemental Restraint System (SRS) "AIR BAG" and "SEAT BELT PRE-TENSIONER"

INFOID:000000004219387

The Supplemental Restraint System such as "AIR BAG" and "SEAT BELT PRE-TENSIONER", used along with a front seat belt, helps to reduce the risk or severity of injury to the driver and front passenger for certain types of collision. This system includes seat belt switch inputs and dual stage front air bag modules. The SRS system uses the seat belt switches to determine the front air bag deployment, and may only deploy one front air bag, depending on the severity of a collision and whether the front occupants are belted or unbelted. Information necessary to service the system safely is included in the SR and SB section of this Service Manual.

WARNING:

- To avoid rendering the SRS inoperative, which could increase the risk of personal injury or death in the event of a collision which would result in air bag inflation, all maintenance must be performed by an authorized NISSAN/INFINITI dealer.
- Improper maintenance, including incorrect removal and installation of the SRS, can lead to personal injury caused by unintentional activation of the system. For removal of Spiral Cable and Air Bag Module, see the SR section.
- Do not use electrical test equipment on any circuit related to the SRS unless instructed to in this Service Manual. SRS wiring harnesses can be identified by yellow and/or orange harnesses or harness connectors.

A
B
C
D
E
F
G
H
I
J
K
L
M
O
P

WCS