

SECTION **BCS**

BODY CONTROL SYSTEM

A
B
C
D
E
F
G
H
I
J
K
L

CONTENTS

BCM		
BASIC INSPECTION	3	
DIAGNOSIS AND REPAIR WORKFLOW	3	
Work Flow	3	
ADDITIONAL SERVICE WHEN REPLACING CONTROL UNIT	5	
ADDITIONAL SERVICE WHEN REPLACING CONTROL UNIT : Description	5	
ADDITIONAL SERVICE WHEN REPLACING CONTROL UNIT : Special Repair Requirement	5	
CONFIGURATION (BCM)	6	
CONFIGURATION (BCM) : Description	6	
CONFIGURATION (BCM) : Special Repair Requirement	6	
CONFIGURATION (BCM) : Configuration list	7	
FUNCTION DIAGNOSIS	8	
BODY CONTROL SYSTEM	8	
System Description	8	
Component Parts Location	9	
COMBINATION SWITCH READING SYSTEM	10	
System Diagram	10	
System Description	10	
SIGNAL BUFFER SYSTEM	14	
System Diagram	14	
System Description	14	
POWER CONSUMPTION CONTROL SYSTEM	15	
System Diagram	15	
System Description	15	
Component Parts Location	17	
DIAGNOSIS SYSTEM (BCM)	18	
COMMON ITEM	18	
COMMON ITEM : Diagnosis Description	18	
COMMON ITEM : CONSULT-III Function (BCM - COMMON ITEM)	18	
DOOR LOCK	19	
DOOR LOCK : CONSULT-III Function (BCM - DOOR LOCK)	19	
REAR WINDOW DEFOGGER	19	
REAR WINDOW DEFOGGER : CONSULT-III Function (BCM - REAR DEFOGGER)	19	
BUZZER	20	
BUZZER : CONSULT-III Function (BCM - BUZZER)	20	
INT LAMP	20	
INT LAMP : CONSULT-III Function (BCM - INT LAMP)	20	
HEADLAMP	22	
HEADLAMP : CONSULT-III Function (BCM - HEAD LAMP)	22	
WIPER	24	
WIPER : CONSULT - III Function (BCM - WIPER)	24	
FLASHER	24	
FLASHER : CONSULT-III Function (BCM - FLASHER)	24	
AIR CONDITIONER	25	
AIR CONDITIONER : CONSULT-III Function	25	
INTELLIGENT KEY	25	
INTELLIGENT KEY : CONSULT-III Function (BCM - INTELLIGENT KEY)	25	
COMB SW	28	
COMB SW : CONSULT-III Function (BCM - COMB SW)	28	
BCM	29	

BCS

N
O
P

BCM : CONSULT-III Function (BCM - BCM)	29	Special Repair Requirement	40
IMMU	29	POWER SUPPLY AND GROUND CIRCUIT	41
IMMU : CONSULT-III Function (BCM - IMMU)	29	Diagnosis Procedure	41
BATTERY SAVER	30	Special Repair Requirement	41
BATTERY SAVER : CONSULT-III Function (BCM - BATTERY SAVER)	30	COMBINATION SWITCH INPUT CIRCUIT	42
TRUNK	31	Diagnosis Procedure	42
TRUNK : CONSULT-III Function (BCM - TRUNK)..	31	Special Repair Requirement	43
THEFT ALM	31	COMBINATION SWITCH OUTPUT CIRCUIT... ..	44
THEFT ALM : CONSULT-III Function (BCM - THEFT)	31	Diagnosis Procedure	44
RETAINED PWR	32	Special Repair Requirement	45
RETAINED PWR : CONSULT-III Function (BCM - RETAINED PWR)	32	ECU DIAGNOSIS	46
SIGNAL BUFFER	32	BCM (BODY CONTROL MODULE)	46
SIGNAL BUFFER : CONSULT-III Function	32	Reference Value	46
AIR PRESSURE MONITOR	33	Terminal Layout	50
AIR PRESSURE MONITOR : Diagnosis Descrip- tion	33	Physical Values	50
AIR PRESSURE MONITOR : CONSULT-III Func- tion (BCM - AIR PRESSURE MONITOR)	34	Fail Safe	66
COMPONENT DIAGNOSIS	36	DTC Inspection Priority Chart	67
U1000 CAN COMM CIRCUIT	36	DTC Index	68
Description	36	WIRING DIAGRAM	71
DTC Logic	36	BCM (BODY CONTROL MODULE)	71
Diagnosis Procedure	36	Wiring Diagram	71
U1010 CONTROL UNIT (CAN)	37	SYMPTOM DIAGNOSIS	80
DTC Logic	37	COMBINATION SWITCH SYSTEM SYMP- TOMS	80
Diagnosis Procedure	37	Symptom Table	80
U0415 VEHICLE SPEED SIG	38	PRECAUTION	81
Description	38	PRECAUTIONS	81
DTC Logic	38	Precaution for Supplemental Restraint System (SRS) "AIR BAG" and "SEAT BELT PRE-TEN- SIONER"	81
Diagnosis Procedure	38	PREPARATION	82
B2562 LOW VOLTAGE	39	PREPARATION	82
DTC Logic	39	Commercial Service Tools	82
Diagnosis Procedure	39	ON-VEHICLE REPAIR	83
Special Repair Requirement	39	BCM (BODY CONTROL MODULE)	83
B2563 HI VOLTAGE	40	Removal and Installation	83
DTC Logic	40		
Diagnosis Procedure	40		

DIAGNOSIS AND REPAIR WORKFLOW

< BASIC INSPECTION >

[BCM]

BASIC INSPECTION

DIAGNOSIS AND REPAIR WORKFLOW

Work Flow

INFOID:000000005438890

OVERALL SEQUENCE

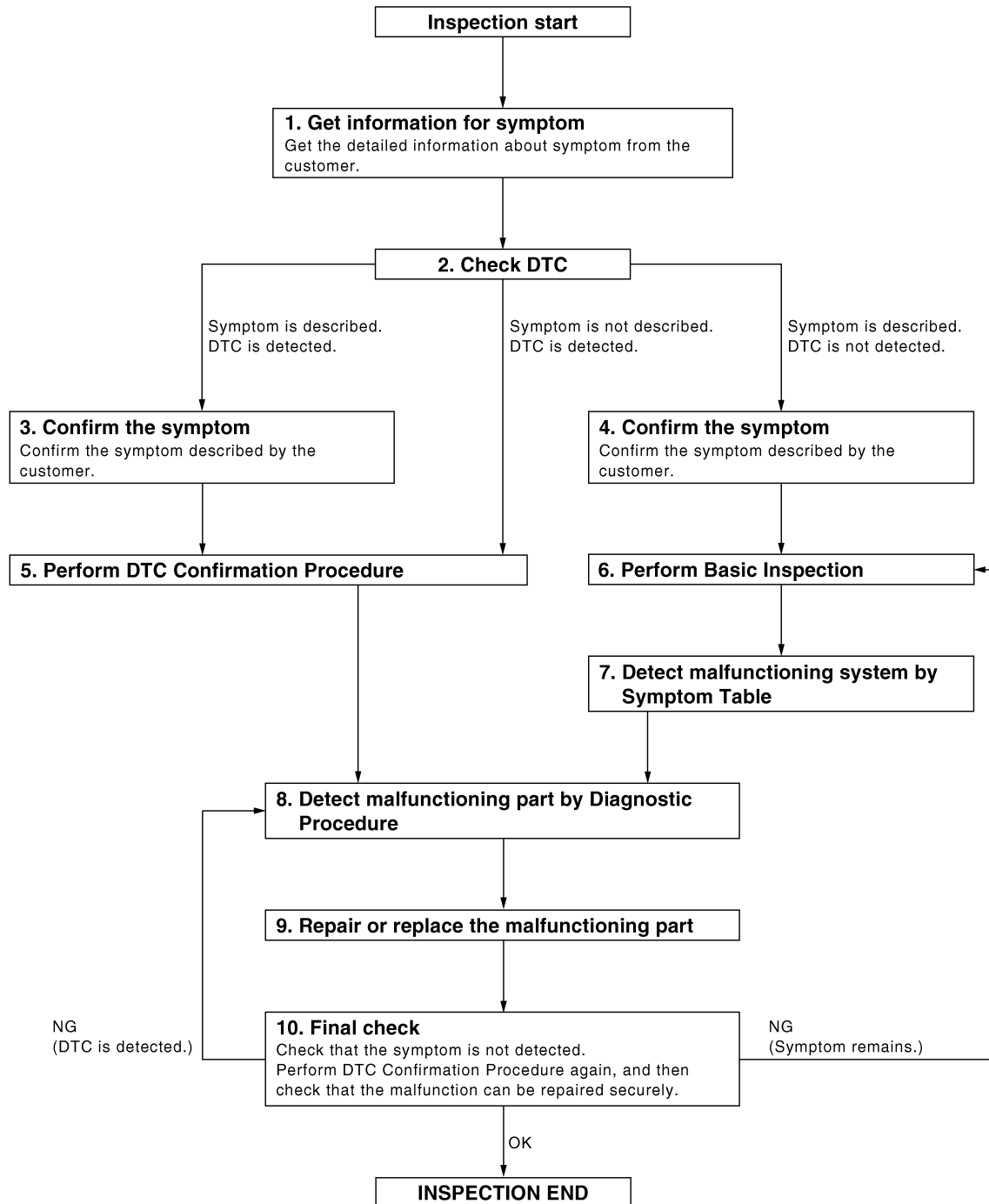

DETAILED FLOW

DIAGNOSIS AND REPAIR WORKFLOW

[BCM]

< BASIC INSPECTION >

1. GET INFORMATION FOR SYMPTOM

Get the detailed information from the customer about the symptom (the condition and the environment when the incident/malfunction occurred).

>> GO TO 2

2. CHECK DTC

1. Check DTC.
2. Perform the following procedure if DTC is displayed.
 - Record DTC and freeze frame data.
 - Erase DTC.
 - Study the relationship between the cause detected by DTC and the symptom described by the customer.
3. Check related service bulletins for information.

Is any symptom described and any DTC detected?

Symptom is described, DTC is detected>>GO TO 3

Symptom is described, DTC is not detected>>GO TO 4

Symptom is not described, DTC is detected>>GO TO 5

3. CONFIRM THE SYMPTOM

Confirm the symptom described by the customer.

Connect CONSULT-III to the vehicle in "DATA MONITOR" mode and check real time diagnosis results.

Verify relation between the symptom and the condition when the symptom is detected.

>> GO TO 5

4. CONFIRM THE SYMPTOM

Confirm the symptom described by the customer.

Connect CONSULT-III to the vehicle in "DATA MONITOR" mode and check real time diagnosis results.

Verify relation between the symptom and the condition when the symptom is detected.

>> GO TO 6

5. PERFORM DTC CONFIRMATION PROCEDURE

Perform DTC Confirmation Procedure for the displayed DTC, and then check that DTC is detected again.

At this time, always connect CONSULT-III to the vehicle, and check diagnostic results in real time.

If two or more DTCs are detected, refer to [BCS-67. "DTC Inspection Priority Chart"](#) and determine trouble diagnosis order.

NOTE:

- Freeze frame data is useful if the DTC is not detected.
- Perform Component Function Check if DTC Confirmation Procedure is not included in Service Manual. This simplified check procedure is an effective alternative though DTC cannot be detected during this check. If the result of Component Function Check is NG, it is the same as the detection of DTC by DTC Confirmation Procedure.

Is DTC detected?

YES >> GO TO 8

NO >> Refer to [BCS-68. "DTC Index"](#).

6. PERFORM BASIC INSPECTION

Perform [BCS-3. "Work Flow"](#).

Inspection End>>GO TO 7

7. DETECT MALFUNCTIONING SYSTEM BY SYMPTOM TABLE

Detect malfunctioning system according to [BCS-8. "System Description"](#) based on the confirmed symptom in step 4, and determine the trouble diagnosis order based on possible causes and symptom.

>> GO TO 8

DIAGNOSIS AND REPAIR WORKFLOW

< BASIC INSPECTION >

[BCM]

8. DETECT MALFUNCTIONING PART BY DIAGNOSTIC PROCEDURE

Inspect according to Diagnostic Procedure of the system.

NOTE:

The Diagnostic Procedure described based on open circuit inspection. A short circuit inspection is also required for the circuit check in the Diagnostic Procedure.

Is malfunctioning part detected?

YES >> GO TO 9

NO >> Check voltage of related BCM terminals using CONSULT-III.

9. REPAIR OR REPLACE THE MALFUNCTIONING PART

1. Repair or replace the malfunctioning part.
2. Reconnect parts or connectors disconnected during Diagnostic Procedure again after repair and replacement.
3. Check DTC. If DTC is displayed, erase it.

>> GO TO 10

10. FINAL CHECK

When DTC was detected in step 2, perform DTC Confirmation Procedure or Component Function Check again, and then check that the malfunction have been repaired securely.

When symptom was described from the customer, refer to confirmed symptom in step 3 or 4, and check that the symptom is not detected.

Does the symptom reappear?

YES (DTC is detected)>>GO TO 8

YES (Symptom remains)>>GO TO 6

NO >> Inspection End.

ADDITIONAL SERVICE WHEN REPLACING CONTROL UNIT

ADDITIONAL SERVICE WHEN REPLACING CONTROL UNIT : Description

INFOID:000000005438891

BEFORE REPLACEMENT

When replacing BCM, save or print current vehicle specification with CONSULT-III configuration before replacement.

NOTE:

If "READ CONFIGURATION" can not be used, use the "WRITE CONFIGURATION - Manual selection" after replacing BCM.

AFTER REPLACEMENT

CAUTION:

- When replacing BCM, you must perform "WRITE CONFIGURATION" with CONSULT-III.
- Complete the procedure of "WRITE CONFIGURATION" in order.
- If you set incorrect "WRITE CONFIGURATION", incidents might occur.
- Configuration is different for each vehicle model. Confirm configuration of each vehicle model.
- When replacing BCM, perform the system initialization (NATS).

ADDITIONAL SERVICE WHEN REPLACING CONTROL UNIT : Special Repair Requirement

INFOID:000000005438892

1. SAVING VEHICLE SPECIFICATION

CONSULT-III Configuration

Perform "READ CONFIGURATION" to save or print current vehicle specification. Refer to [BCS-6. "CONFIGURATION \(BCM\) : Description"](#).

NOTE:

If "READ CONFIGURATION" cannot be used, use the "WRITE CONFIGURATION - Manual selection" after replacing BCM.

DIAGNOSIS AND REPAIR WORKFLOW

[BCM]

< BASIC INSPECTION >

>> GO TO 2

2. REPLACE BCM

Replace BCM. Refer to [BCS-83, "Removal and Installation"](#).

>> GO TO 3

3. WRITING VEHICLE SPECIFICATION

ⓐCONSULT-III Configuration

Perform "WRITE CONFIGURATION - Config file" or "WRITE CONFIGURATION - Manual selection" to write vehicle specification. Refer to [BCS-6, "CONFIGURATION \(BCM\) : Special Repair Requirement"](#).

>> GO TO 4

4. INITIALIZE BCM (NATS)

Perform BCM initialization (NATS). Refer to CONSULT-III Operation Manual.

>> Inspection End.

CONFIGURATION (BCM)

CONFIGURATION (BCM) : Description

INFOID:000000005438893

Vehicle specification needs to be written with CONSULT-III because it is not written after replacing BCM. Configuration has three functions as follows

Function	Description
READ CONFIGURATION	<ul style="list-style-type: none">• Reads the vehicle configuration of current BCM.• Saves the read vehicle configuration.
WRITE CONFIGURATION - Manual selection	Writes the vehicle configuration with manual selection.
WRITE CONFIGURATION - Config file	Writes the vehicle configuration with saved data.

NOTE:

Manual setting item: Items which need selection by vehicle specifications

Automatic setting item: Items which are written in automatically (Setting cannot be changed)

CAUTION:

- When replacing BCM, you must perform "WRITE CONFIGURATION" with CONSULT-III.
- Complete the procedure of "WRITE CONFIGURATION" in order.
- If you set incorrect "WRITE CONFIGURATION", incidents might occur.
- Configuration is different for each vehicle model. Confirm configuration of each vehicle model.
- Never perform "WRITE CONFIGURATION" except for new BCM.

CONFIGURATION (BCM) : Special Repair Requirement

INFOID:000000005438894

1. WRITING MODE SELECTION

ⓐCONSULT-III Configuration

Select "CONFIGURATION" of BCM.

When writing saved data>>GO TO 2

When writing manually>>GO TO 3

2. PERFORM "WRITE CONFIGURATION - CONFIG FILE"

ⓐCONSULT-III Configuration

Perform "WRITE CONFIGURATION - Config File".

>> Inspection End.

DIAGNOSIS AND REPAIR WORKFLOW

< BASIC INSPECTION >

[BCM]

3. PERFORM "WRITE CONFIGURATION - MANUAL SELECTION"

CONSULT-III Configuration

1. Select "WRITE CONFIGURATION - Manual selection".
2. Identify the correct model and configuration list. Refer to [BCS-7, "CONFIGURATION \(BCM\) : Configuration list"](#).
3. Confirm and/or change setting value for each item.
4. Select "Setting change".

CAUTION:

Make sure to select "Setting change" even if the indicated configuration of brand new BCM is same as the desirable configuration. If not, configuration which is set automatically by selecting vehicle model cannot be memorized.

5. When "COMMAND FINISHED", select "END".

>> GO TO 4

4. OPERATION CHECK

Confirm that each function controlled by BCM operates normally.

>> Inspection End.

CONFIGURATION (BCM) : Configuration list

INFOID:000000005438895

MANUAL SETTING ITEM		NOTE
Items	Setting value	
AUTO LIGHT	WITH⇔WITHOUT	—
DTRL	WITH⇔WITHOUT	<ul style="list-style-type: none">• WITH: Canada• WITHOUT: Except Canada
TRANSMISSION	HEV	—
TR CANCEL SW	WITH⇔WITHOUT	—
TIRE PRESSURE	240 kPa	—

A
B
C
D
E
F
G
H
I
J
K
L

BCS

N
O
P

FUNCTION DIAGNOSIS

BODY CONTROL SYSTEM

System Description

INFOID:000000005438896

OUTLINE

- BCM (body control module) controls the various electrical components. It inputs the information required to the control from CAN communication and the signal received from each switch and sensor.
- BCM has combination switch reading function for reading the operation status of combination switches (light, turn signal, wiper and washer) in addition to a function for controlling the operation of various electrical components. It also has the signal transmission function as the passed point of signal and the power saving control function that reduces the power consumption with the ignition switch OFF.
- BCM is equipped with the diagnosis function that performs the diagnosis with CONSULT-III and various settings.

CAN communication control

In CAN communication, control units are connected with 2 communication lines (CAN-L, CAN-H) allowing a high rate of information transmission with less wiring. Each control unit transmits/receives the data but selectively reads required information only.

CAN communication signal

Refer to the [LAN-28, "CAN Communication Signal Chart"](#).

BCM control function list

System	Refer to
Combination switch reading system	BCS-10, "System Description"
Signal buffer system	BCS-14, "System Description"
Power consumption control system	BCS-15, "System Description"
Auto light system	EXL-12, "System Description"
Turn signal and hazard warning lamp system	EXL-15, "System Description"
Headlamp system	EXL-7, "System Description"
Exterior lamp battery saver system	PCS-11, "System Description"
Daytime running light system (Canada only)	EXL-9, "System Description"
Interior room lamp control system	INL-6, "System Description"
Step lamp system	
Interior room lamp battery saver system	BCS-15, "System Description"
Front wiper and washer system	WW-6, "System Description"
Warning chime system	WCS-4, "WARNING CHIME SYSTEM : System Description"
Door lock system	DLK-13, "DOOR LOCK AND UNLOCK SWITCH : System Description"
Trunk open system	DLK-26, "TRUNK LID OPENER SWITCH : System Description"
Nissan vehicle immobilizer system	SEC-15, "System Description"
Vehicle security system	SEC-18, "System Description"
Panic alarm	
Rear window defogger system	DEF-6, "System Description"

BODY CONTROL SYSTEM

[BCM]

< FUNCTION DIAGNOSIS >

System	Refer to
Intelligent Key system/hybrid system start	Door lock function <ul style="list-style-type: none"> • DLK-15, "DOOR REQUEST SWITCH : System Description" (door request switch) • SEC-10, "System Description" (Intelligent Key)
	Trunk open function <ul style="list-style-type: none"> • DLK-26, "TRUNK LID OPENER SWITCH : System Description" (trunk request switch) • SEC-10, "System Description" (Intelligent Key)
	Warning function <ul style="list-style-type: none"> • DLK-38, "System Description"
	Key reminder function <ul style="list-style-type: none"> • DLK-44, "System Description"
	Hybrid system start function <ul style="list-style-type: none"> • SEC-10, "System Description"
Power window system	<ul style="list-style-type: none"> • PWC-94, "System Description" (LH & RH front window anti-pinch) • PWC-11, "System Description" (LH front only window anti-pinch)
RAP (retained accessory power) system	RF-8, "System Description"
TPMS (tire pressure monitor system)	WT-8, "System Description"

Component Parts Location

INFOID:000000005438897

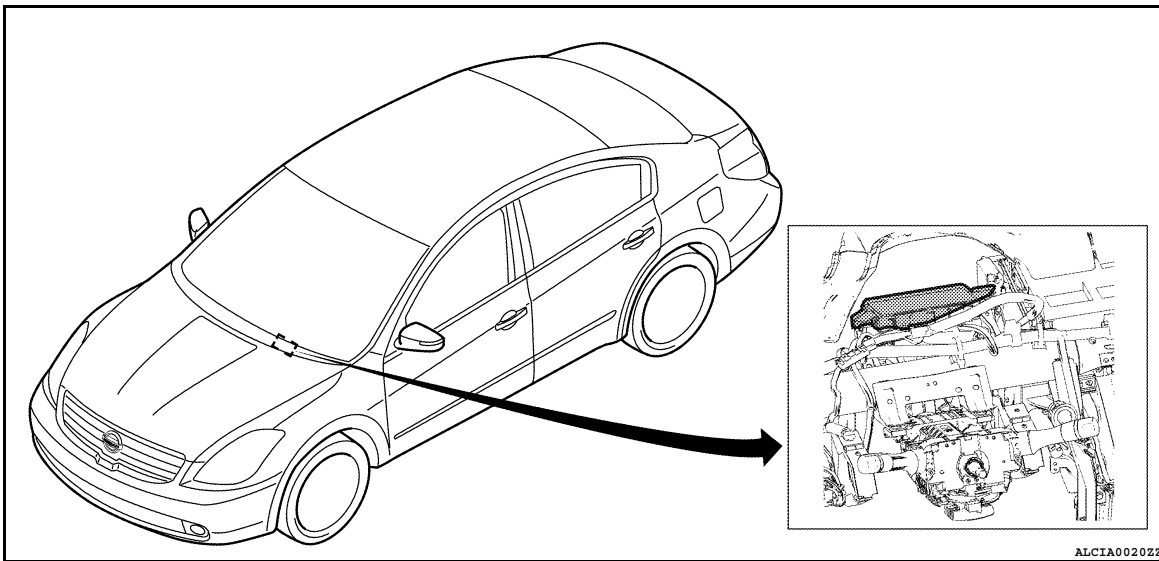

1. BCM M16, M17, M18, M19, M20, M21 (view with instrument panel removed)

BCS

COMBINATION SWITCH READING SYSTEM

< FUNCTION DIAGNOSIS >

[BCM]

COMBINATION SWITCH READING SYSTEM

System Diagram

INFOID:000000005438898

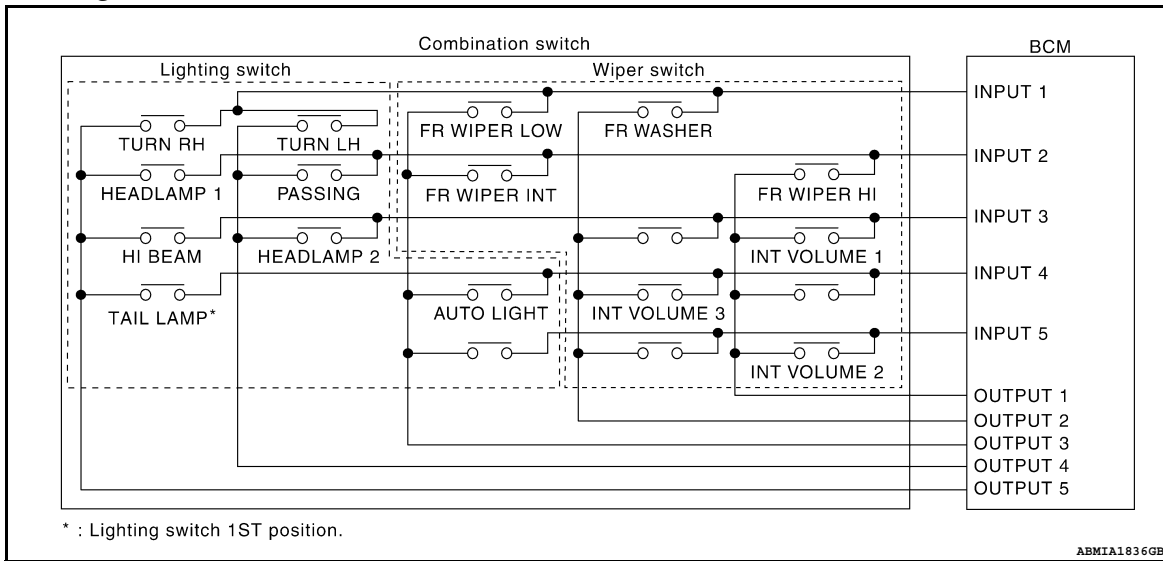

System Description

INFOID:000000005438899

OUTLINE

- BCM reads the status of the combination switch (light, turn signal, wiper and washer) and recognizes the status of each switch.
- BCM is a combination of 5 output terminals (OUTPUT 1 - 5) and 5 input terminals (INPUT 1 - 5). It reads a maximum of 20 switch status.

COMBINATION SWITCH MATRIX

Combination switch circuit

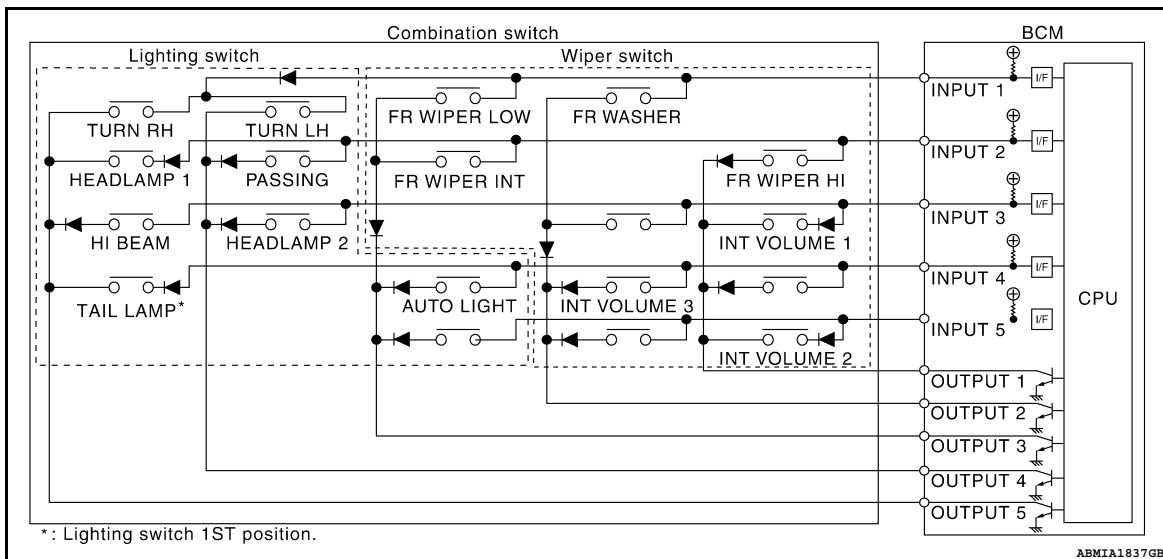

Combination switch INPUT-OUTPUT system list

System	OUTPUT 1	OUTPUT 2	OUTPUT 3	OUTPUT 4	OUTPUT 5
INPUT 1	—	FR WASHER	FR WIPER LOW	TURN LH	TURN RH
INPUT 2	FR WIPER HI	—	FR WIPER INT	PASSING	HEADLAMP 1
INPUT 3	INT VOLUME 1	—	—	HEADLAMP 2	HI BEAM

COMBINATION SWITCH READING SYSTEM

[BCM]

< FUNCTION DIAGNOSIS >

System	OUTPUT 1	OUTPUT 2	OUTPUT 3	OUTPUT 4	OUTPUT 5
INPUT 4	—	INT VOLUME 3	AUTO LIGHT	—	TAIL LAMP
INPUT 5	INT VOLUME 2	—	—	—	—

NOTE:

Headlamp has a dual system switch.

COMBINATION SWITCH READING FUNCTION

Description

- BCM reads the status of the combination switch at 10ms interval normally.

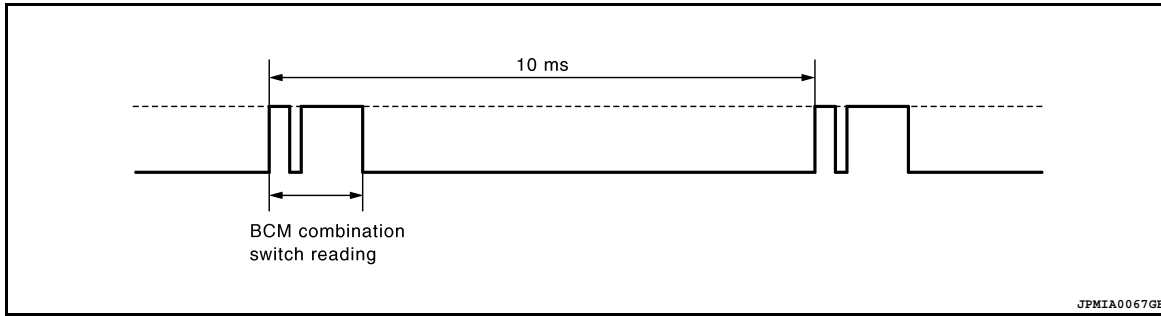

NOTE:

BCM reads the status of the combination switch at 60ms interval when BCM is controlled at low power consumption mode.

- BCM operates as follows and judges the status of the combination switch.
 - INPUT 1 - 5 outputs the voltage waveforms of 5 systems simultaneously.
 - It operates the transistor on OUTPUT side in the following order: OUTPUT 5→4→3→2→1.
 - The voltage waveform of INPUT corresponding to the formed circuit changes according to the operation of the transistor on OUTPUT side if any (1 or more) switches are ON.
 - It reads this change of the voltage as the status signal of the combination switch.

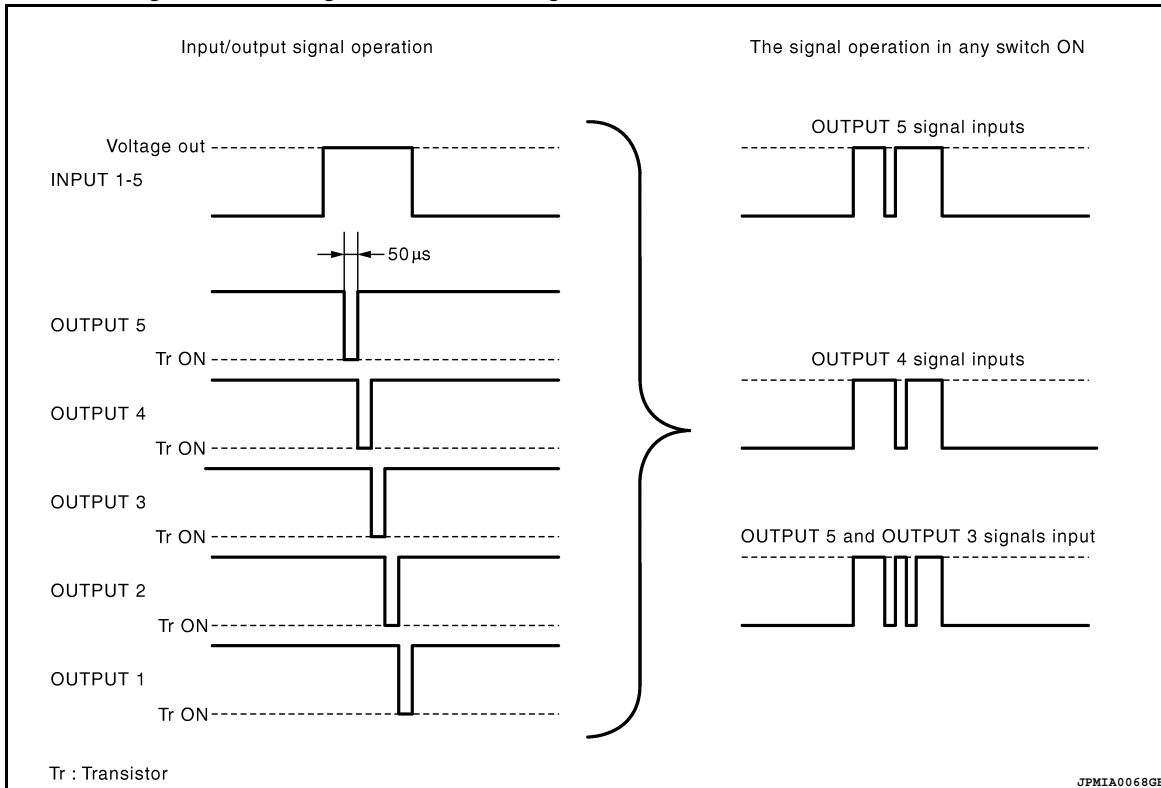

Operation Example

In the following operation example, the combination of the status signals of the combination switch is replaced as follows: INPUT 1 - 5 to "1 - 5" and OUTPUT 1 - 5 to "A - E".

A
B
C
D
E
F
G
H
I
J
K
L
N
O
P

BCS

COMBINATION SWITCH READING SYSTEM

[BCM]

< FUNCTION DIAGNOSIS >

Example 1: When a switch (TURN RH switch) is turned ON

- The circuit between INPUT 1 and OUTPUT 5 is formed when the TURN RH switch is turned ON.

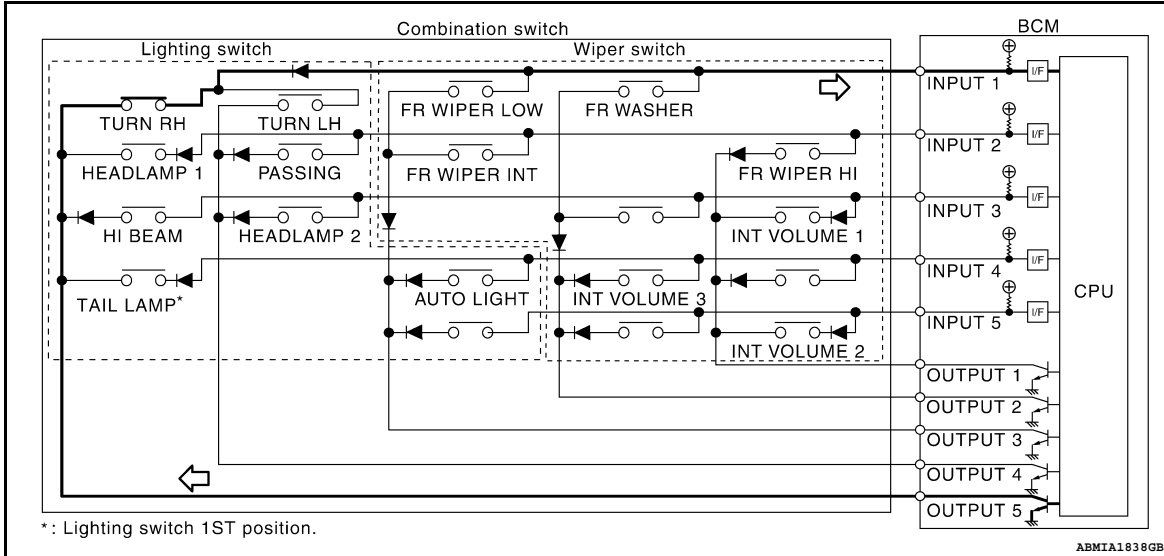

- BCM detects the combination switch status signal “1E” when the signal of OUTPUT 5 is input to INPUT 1.
- BCM judges that the TURN RH switch is ON when the signal “1E” is detected.

Example 2: When some switches (TURN RH switch, FR WIPER LOW switch) are turned ON

- The circuits between INPUT 1 and OUTPUT 5 and between INPUT 1 and OUTPUT 3 are formed when the TURN RH switch and FR WIPER LOW switch are turned ON.

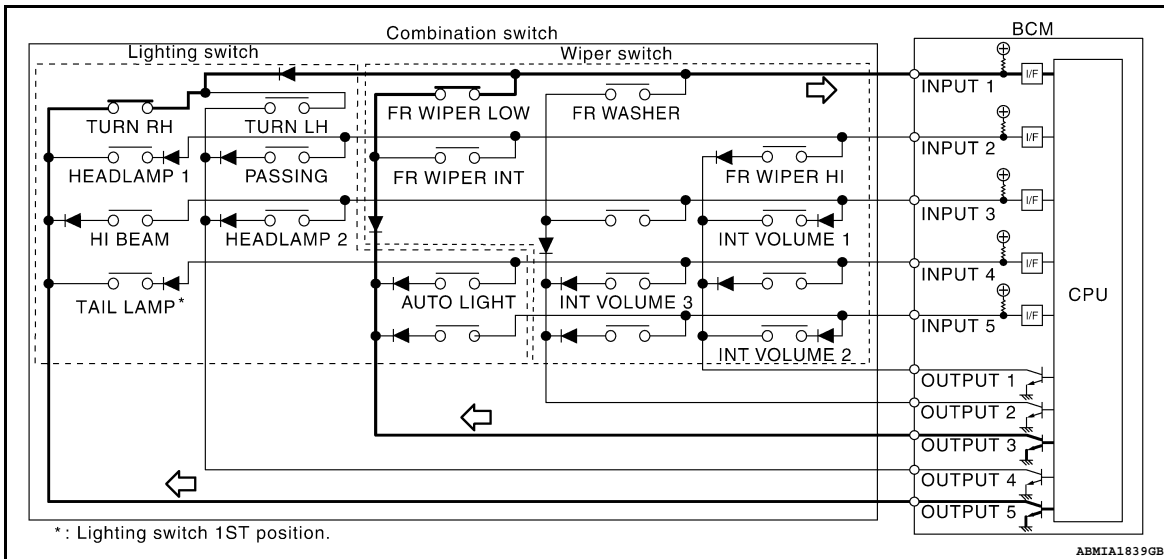

- BCM detects the combination switch status signal “1CE” when the signals of OUTPUT 3 and OUTPUT 5 are input to INPUT 1.
- BCM judges that the TURN RH switch and FR WIPER LOW switch are ON when the signal “1CE” is detected.

WIPER INTERMITTENT DIAL POSITION SETTING (FRONT WIPER INTERMITTENT OPERATION)

BCM judges the wiper intermittent dial 1 - 7 by the status of INT VOLUME 1, 2, and 3 switches.

COMBINATION SWITCH READING SYSTEM

< FUNCTION DIAGNOSIS >

[BCM]

Wiper intermittent dial position	Intermittent operation delay interval	INT VOLUME switch ON/OFF status		
		INT VOLUME 1 switch	INT VOLUME 2 switch	INT VOLUME 3 switch
1	Short ↑ ↓ Long	ON	ON	ON
2		ON	ON	OFF
3		ON	OFF	OFF
4		OFF	OFF	OFF
5		OFF	OFF	ON
6		OFF	ON	ON
7		OFF	ON	OFF

A
B
C
D
E
F
G
H
I
J
K
L

BCS

N
O
P

SIGNAL BUFFER SYSTEM

< FUNCTION DIAGNOSIS >

[BCM]

SIGNAL BUFFER SYSTEM

System Diagram

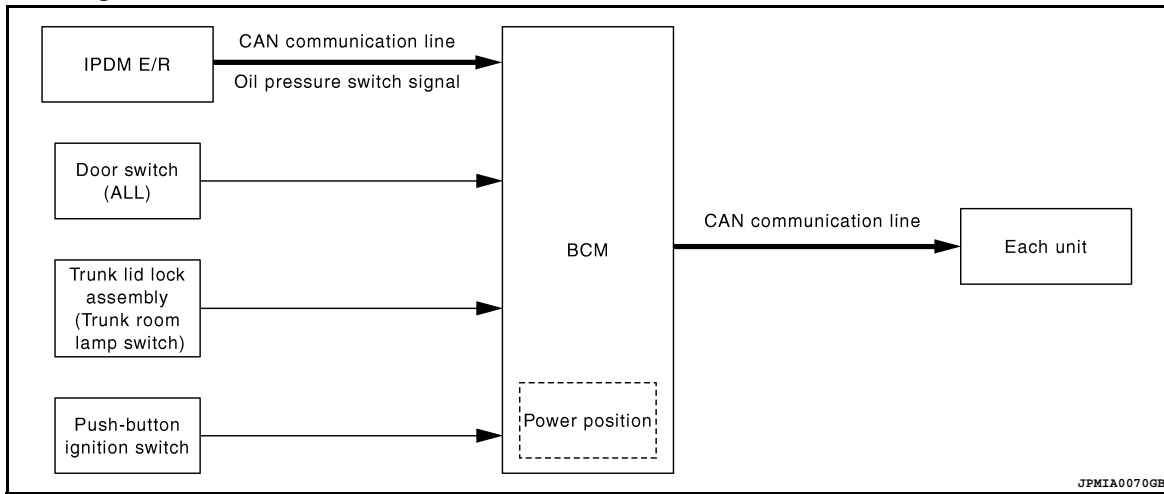

System Description

INFOID:000000005438901

OUTLINE

BCM has the signal transmission function that outputs/transmits each input/received signal to each unit.

Signal transmission function list

Signal name	Input	Output	Description
<ul style="list-style-type: none"> Ignition switch ON signal Ignition switch signal 	Push-button ignition switch	IPDM E/R (CAN)	Inputs the push-button ignition switch signal and transmits the ignition switch status judged with BCM via CAN communication.
Door switch signal	Any door switch	<ul style="list-style-type: none"> Combination meter (CAN) IPDM E/R (CAN) 	Inputs the door switch signal and transmits it via CAN communication.
Trunk switch signal	Trunk room lamp switch	Combination meter (CAN)	Inputs the trunk room lamp switch signal and transmits the trunk switch signal via CAN communication.
Oil pressure switch signal	IPDM E/R (CAN)	Combination meter (CAN)	Transmits the received oil pressure switch signal via CAN communication.

POWER CONSUMPTION CONTROL SYSTEM

System Diagram

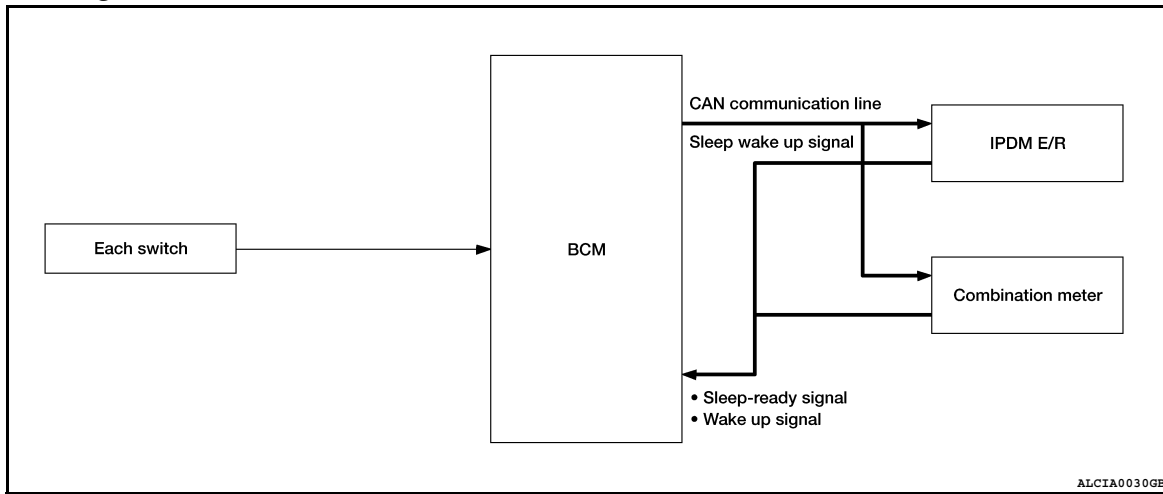

System Description

INFOID:000000005438903

OUTLINE

- BCM incorporates a power saving control function that reduces the power consumption according to the vehicle status.
- BCM switches the status (control mode) by itself with the power saving control function. It performs the sleep request to each unit (IPDM E/R and combination meter) that operates with the ignition switch OFF.

Normal mode (wake-up)

- CAN communication is normally performed with other units
- Each control with BCM is operating properly

CAN communication sleep mode (CAN sleep)

- CAN transmission is stopped
- Control with BCM only is operating

Low power consumption mode (BCM sleep)

- Low power consumption control is active
- CAN transmission is stopped

LOW POWER CONSUMPTION CONTROL WITH BCM

BCM reduces the power consumption with the following operation in the low power consumption mode.

- The reading interval of the each switches changes from 10ms interval to 60ms interval.

Sleep mode activation

- BCM receives the sleep-ready signal (ready) from IPDM E/R and combination meter via CAN communication.
- BCM transmits the sleep wake up signal (sleep) to each unit when all of the CAN sleep conditions are fulfilled.
- Each unit stops the transmission of CAN communication with the sleep wakeup signal. BCM is in CAN communication sleep mode.
- BCM is in the low power consumption mode and perform the low power consumption control when all of the BCM sleep conditions are fulfilled with CAN sleep condition.

A
B
C
D
E
F
G
H
I
J
K
L
N
O
P

BCS

POWER CONSUMPTION CONTROL SYSTEM

[BCM]

< FUNCTION DIAGNOSIS >

Sleep condition

CAN sleep condition	BCM sleep condition
<ul style="list-style-type: none"> Receiving the sleep-ready signal (ready) from all units Ignition switch: OFF Vehicle security system alarm and panic alarm : No operation Warning lamp: No operation Intelligent Key system buzzer: No operation Trunk room lamp switch status: No change Brake switch: OFF Key slot status: No change Turn signal indicator lamp: No operation Exterior lamp: OFF Door lock status: No change CONSULT-III communication status: No communication Meter display signal : No transmission Door switch status: No change Rear window defogger: OFF 	<ul style="list-style-type: none"> Interior room lamp battery saver: Time out RAP system: OFF Power window serial link communication: No transmission Push-button ignition switch illumination: OFF NATS: No operation Remote keyless entry receiver communication status: No communication Tire pressure monitor system: Stop

Wake-up operation

- BCM changes from the low power consumption mode to the CAN communication sleep mode when the any of the BCM wake-up conditions is fulfilled. Only the control with BCM is activated.
- BCM transmits the sleep wake up signal (wake up) to each unit when any of the CAN wake-up conditions is fulfilled. It changes from the low power consumption mode or the CAN communication sleep mode to the normal mode.
- Each unit starts the transmission of CAN communication with the sleep wake up signal. In addition, the combination meter transmits the wake up signal to BCM via CAN communication to report the CAN communication start.

Wake-up condition

BCM wake-up condition	CAN wake-up condition
<ul style="list-style-type: none"> Front door unlock sensor: OFF→ON, ON→OFF Front door lock assembly LH (key cylinder switch): Lock or unlock Door lock switch: OFF→ON Door unlock switch: OFF→ON Trunk lid opener switch: OFF→ON Power window serial link communication: Receiving Remote keyless entry receiver: Receiving valid keyfob 	<ul style="list-style-type: none"> Receiving the sleep-ready signal (Not-ready) from any units Key slot: OFF→ON, ON→OFF Push-button ignition switch: OFF→ON Hazard switch: OFF→ON PASSING switch: OFF→ON TAIL LAMP switch: OFF→ON Front door switch LH: OFF→ON, ON→OFF Front door switch RH: OFF→ON, ON→OFF Rear door switch LH: OFF→ON, ON→OFF Rear door switch RH: OFF→ON, OFF→ON Trunk room lamp switch: OFF→ON, ON→OFF Front door LH request switch: OFF→ON Front door RH request switch: OFF→ON Trunk request switch: OFF→ON Stop lamp switch 2 signal: ON Remote keyless entry receiver: Receiving valid keyfob

POWER CONSUMPTION CONTROL SYSTEM

< FUNCTION DIAGNOSIS >

[BCM]

Component Parts Location

INFOID:000000005438904

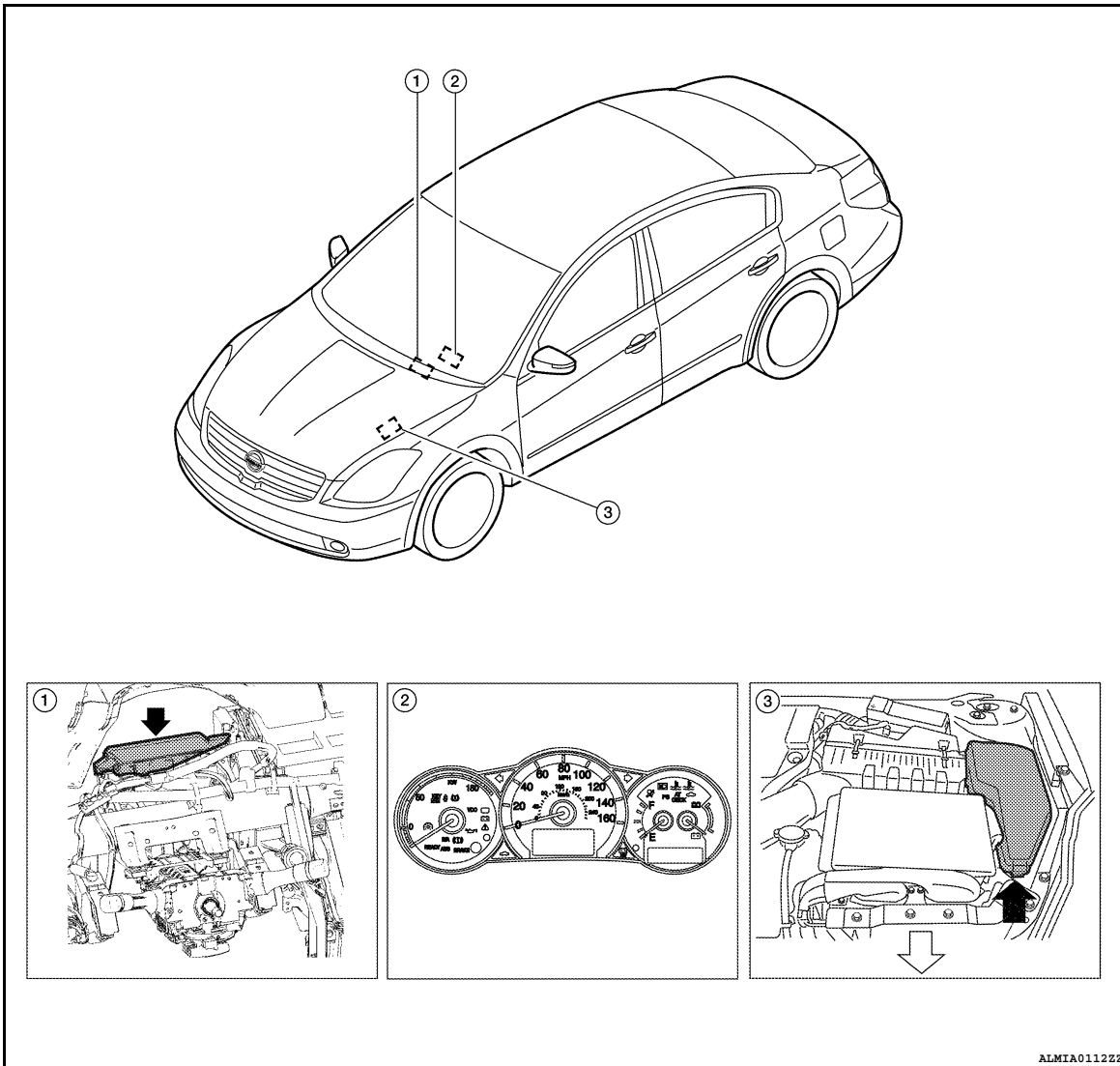

1. BCM M16, M17, M18, M19, M20, M21 (view with instrument panel removed)
2. Combination meter M24
3. IPDM E/R E16, E17, E18, E20, E21, F10

ALMIA0112ZZ

A
B
C
D
E
F
G
H
I
J
K
L

BCS

N
O
P

DIAGNOSIS SYSTEM (BCM)

[BCM]

< FUNCTION DIAGNOSIS >

DIAGNOSIS SYSTEM (BCM) COMMON ITEM

COMMON ITEM : Diagnosis Description

INFOID:000000005438905

BCM CONSULT-III FUNCTION

CONSULT-III performs the following functions via CAN communication with BCM.

Diagnosis mode	Function Description
WORK SUPPORT	Changes the setting for each system function.
SELF-DIAGNOSTIC RESULT	Displays the diagnosis results judged by BCM.
CAN DIAG SUPPORT MNTR	Monitors the reception status of CAN communication viewed from BCM.
DATA MONITOR	The BCM input/output signals are displayed.
ACTIVE TEST	The signals used to activate each device are forcibly supplied from BCM.
ECU IDENTIFICATION	The BCM part number is displayed.
CONFIGURATION	<ul style="list-style-type: none"> • Read and save the vehicle specification. • Write the vehicle specification when replacing BCM.

SYSTEM APPLICATION

BCM can perform the following functions for each system.

NOTE:

It can perform the diagnosis modes except the following for all sub system selection items.

System	Sub system selection item	Diagnosis mode		
		WORK SUPPORT	DATA MONITOR	ACTIVE TEST
Door lock	DOOR LOCK	×	×	×
Rear window defogger	REAR DEFOGGER		×	×
Warning chime	BUZZER		×	×
Interior room lamp timer	INT LAMP	×	×	×
Exterior lamp	HEAD LAMP	×	×	×
Wiper and washer	WIPER	×	×	×
Turn signal and hazard warning lamps	FLASHER	×	×	×
Air conditioner	AIR CONDITONER		×	
Intelligent Key system	INTELLIGENT KEY	×	×	×
Combination switch	COMB SW		×	
BCM	BCM	×		
Immobilizer	IMMU		×	×
Interior room lamp battery saver	BATTERY SAVER	×	×	×
Trunk open	TRUNK		×	×
Vehicle security system	THEFT ALM	×	×	×
RAP system	RETAINED PWR		×	
Signal buffer system	SIGNAL BUFFER		×	×
TPMS	AIR PRESSURE MONITOR	×	×	×

COMMON ITEM : CONSULT-III Function (BCM - COMMON ITEM)

INFOID:000000005438906

ECU IDENTIFICATION

Displays the BCM part No.

SELF-DIAG RESULT

Refer to [BCS-68, "DTC Index"](#).

DIAGNOSIS SYSTEM (BCM)

< FUNCTION DIAGNOSIS >

[BCM]

DOOR LOCK

DOOR LOCK : CONSULT-III Function (BCM - DOOR LOCK)

INFOID:000000005438907

WORK SUPPORT

Work item	Description
DOOR LOCK-UNLOCK SET	<ul style="list-style-type: none">• ON• OFF
AUTOMATIC DOOR LOCK SELECT	<ul style="list-style-type: none">• P RANGE• VH SPD
AUTOMATIC DOOR UNLOCK SELECT	<ul style="list-style-type: none">• MODE1• MODE2• MODE3• MODE4
AUTOMATIC LOCK/UNLOCK SELECT	<ul style="list-style-type: none">• LOCK/UNLOCK• LOCK ONLY• UNLOCK ONLY• OFF

DATA MONITOR

Monitor item	Contents
REQ SW-DR	Indicated [ON/OFF] condition of door request switch (driver side).
REQ SW-AS	Indicated [ON/OFF] condition of door request switch (passenger side).
REQ SW-BD/TR	Indicated [ON/OFF] condition of trunk lid opener request switch.
DOOR SW-DR	Indicated [ON/OFF] condition of driver side door switch.
DOOR SW-AS	Indicated [ON/OFF] condition of passenger side door switch.
DOOR SW-RR	Indicated [ON/OFF] condition of rear door switch RH.
DOOR SW-RL	Indicated [ON/OFF] condition of rear door switch LH.
CDL LOCK SW	Indicated [ON/OFF] condition of lock signal from door lock unlock switch.
CDL UNLOCK SW	Indicated [ON/OFF] condition of unlock signal from door lock unlock switch.
KEY CYL LK-SW	Indicated [ON/OFF] condition of lock signal from key cylinder.
KEY CYL UN-SW	Indicated [ON/OFF] condition of unlock signal from key cylinder.

ACTIVE TEST

Test item	Description
DOOR LOCK	This test is able to check door lock operation [OTR ULK / AS UNLK / DR UNLK / ALL UNLK / ALL LCK].

REAR WINDOW DEFOGGER

REAR WINDOW DEFOGGER : CONSULT-III Function (BCM - REAR DEFOGGER)

INFOID:000000005438908

DATA MONITOR

Monitor item [Unit]	Description
PUSH SW [ON/OFF]	Indicates condition of push switch
REAR DEF SW [ON/OFF]	Displays "Press (ON)/other (OFF)" status determined with the rear window defogger switch

ACTIVE TEST

DIAGNOSIS SYSTEM (BCM)

< FUNCTION DIAGNOSIS >

[BCM]

Test item	Description
REAR DEFOGGER	This test is able to check rear window defogger operation. Rear window defogger operates when "ON" on CONSULT-III screen is touched.

BUZZER

BUZZER : CONSULT-III Function (BCM - BUZZER)

INFOID:000000005438909

DATA MONITOR

Display item [Unit]	Description
VEH SPEED 1 [Km/h]	Value of vehicle speed signal received from ABS actuator and electric unit (control unit) with CAN communication line.
PUSH SW [ON/OFF]	Status of push-button ignition switch judged by BCM.
UNLK SEN-DR [ON/OFF]	Status of front door lock assembly LH (door unlock sensor) judged by BCM.
KEY SW-SLOT [ON/OFF]	Status of key slot judged by BCM.
TAIL LAMP SW [ON/OFF]	Status of each switch judged by BCM using the combination SW readout function.
DOOR SW-DR [ON/OFF]	Status of front door switch LH judged by BCM.

ACTIVE TEST

Display item [Unit]	Description
IGN KEY WARN ALM	The key warning chime operation can be checked by operating the relevant function (ON/OFF).
SEAT BELT WARN TEST	The seat belt warning chime operation can be checked by operating the relevant function (ON/OFF).
ID REGIST WARNING	The ID regist warning chime operation can be checked by operating the relevant function (ON/OFF).
LIGHT WARN ALM	The light warning chime operation can be checked by operating the relevant function (ON/OFF).

INT LAMP

INT LAMP : CONSULT-III Function (BCM - INT LAMP)

INFOID:000000005438910

WORK SUPPORT

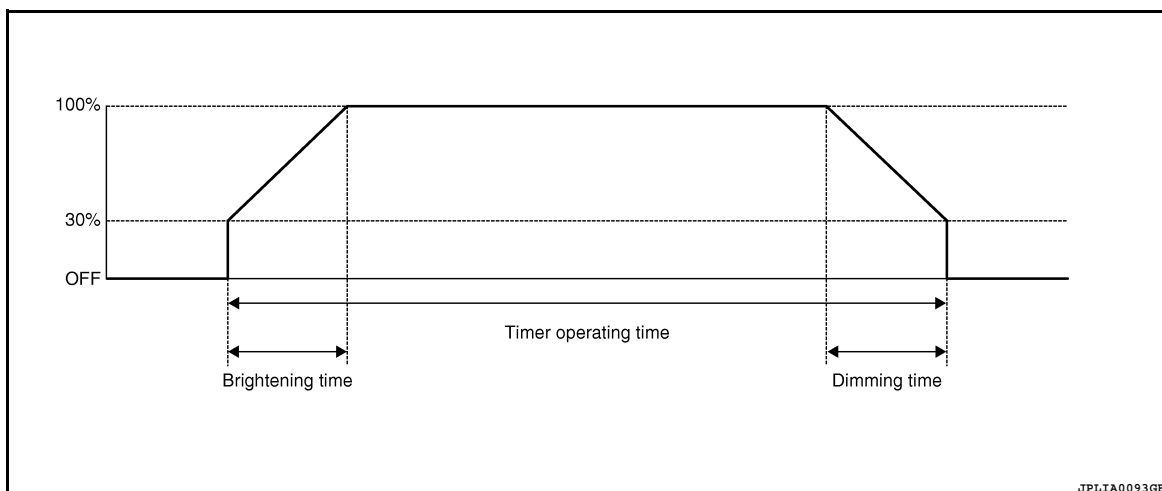

JPLIA0093GB

DIAGNOSIS SYSTEM (BCM)

< FUNCTION DIAGNOSIS >

[BCM]

Work Item	Setting item	Setting	
SET I/L D-UNLCK INTCON	ON*	With the interior room lamp timer function	
	OFF	Without the interior room lamp timer function	
ROOM LAMP TIMER SET	MODE2	7.5 sec.	Sets the interior room lamp ON time. (Timer operating time)
	MODE3*	15 sec.	
	MODE4	30 sec.	
ROOM LAMP ON TIME SET	MODE1	0.5 sec.	Sets the interior room lamp gradual brightening time.
	MODE2*	1 sec.	
	MODE3	2 sec.	
	MODE4	3 sec.	
	MODE5	0 sec.	
ROOM LAMP OFF TIME SET	MODE1	0.5 sec.	Sets the interior room lamp gradual dimming time.
	MODE2	1 sec.	
	MODE3	2 sec.	
	MODE4*	3 sec.	
	MODE5	0 sec.	
R LAMP TIMER LOGIC SET	MODE1*	Interior room lamp timer activates with synchronizing all doors.	
	MODE2	Interior room lamp timer activates with synchronizing the front door LH only.	

* : Initial setting

DATA MONITOR

Monitor item [Unit]	Description
REQ SW-DR [ON/OFF]	The switch status input from request switch (front LH)
REQ SW-AS [ON/OFF]	The switch status input from front request switch (front RH)
PUSH SW [ON/OFF]	The switch status input from push-button ignition switch
ACC RLY-F/B [ON/OFF]	Indicates [ON/OFF] condition of accessory relay.
UNLK SEN-DR [ON/OFF]	Indicates [ON/OFF] condition of driver door UNLOCK status.
KEY SW-SLOT [ON/OFF]	Key switch status input from key slot
DOOR SW-DR [ON/OFF]	The switch status input from front door switch LH
DOOR SW-AS [ON/OFF]	The switch status input from front door switch RH
DOOR SW-RR [ON/OFF]	The switch status input from rear door switch RH
DOOR SW- RL [ON/OFF]	The switch status input from rear door switch LH
CDL LOCK SW [ON/OFF]	Lock switch status received from door lock/unlock switch by power window serial link
CDL UNLOCK SW [ON/OFF]	Unlock switch status received from door lock/unlock switch by power window serial link
KEY CYL LK-SW [ON/OFF]	Lock switch status received from key cylinder switch by power window serial link

DIAGNOSIS SYSTEM (BCM)

< FUNCTION DIAGNOSIS >

[BCM]

Monitor item [Unit]	Description
KEY CYL UN-SW [ON/OFF]	Unlock switch status received from key cylinder switch by power window serial link
TRNK/HAT MNTR [ON/OFF]	The switch status input from trunk room lamp switch
RKE-LOCK [ON/OFF]	Lock signal status received from remote keyless entry receiver
RKE-UNLOCK [ON/OFF]	Unlock signal status received from remote keyless entry receiver

ACTIVE TEST

Test item	Operation	Description
INT LAMP	ON	Outputs the interior room lamp control signal to turn map lamp and personal lamp ON (Map lamp switch is in DOOR position).
	OFF	Stops the interior room lamp control signal to turn map lamp and personal lamp OFF.
STEP LAMP TEST	ON	Outputs the step lamp control signal to turn step lamp ON.
	OFF	Stops the step lamp control signal to turn step lamp OFF.
LUGGAGE LAMP TEST	ON	Outputs the luggage room lamp control signal to turn step lamp ON.
	OFF	Stops the luggage room lamp control signal to turn step lamp ON.

HEADLAMP

HEADLAMP : CONSULT-III Function (BCM - HEAD LAMP)

INFOID:000000005438911

WORK SUPPORT

Work item	Setting item	Setting	
CUSTOM A/LIGHT SETTING ²	MODE1 ¹	Normal	
	MODE2	More sensitive setting than normal setting (Turns ON earlier than normal operation.)	
	MODE3	More sensitive setting than MODE 2 (Turns ON earlier than MODE 2.)	
	MODE4	Less sensitive setting than normal setting (Turns ON later than normal operation.)	
BATTERY SAVER SET	ON ¹	With the exterior lamp battery saver function	
	OFF	Without the exterior lamp battery saver function	
ILL DELAY SET ²	MODE1 ¹	45 sec.	Sets delay timer function timer operation time (All doors closed)
	MODE2	Without the function	
	MODE3	30 sec.	
	MODE4	60 sec.	
	MODE5	90 sec.	
	MODE6	120 sec.	
	MODE7	150 sec.	
	MODE8	180 sec.	

1 : Initial setting

2 : With auto light system

DATA MONITOR

DIAGNOSIS SYSTEM (BCM)

< FUNCTION DIAGNOSIS >

[BCM]

Monitor item [Unit]	Description	A
PUSH SW [ON/OFF]	The switch status input from push-button ignition switch	A
ENGINE STATE [STOP/STALL/CRANK/RUN]	The engine status received from ECM with CAN communication	B
VEH SPEED 1 [km/h]	The value of the vehicle speed received from combination meter with CAN communication	C
KEY SW-SLOT [ON/OFF]	Key switch status input from key slot	D
TURN SIGNAL R [ON/OFF]	Each switch status that BCM judges from the combination switch reading function	E
TURN SIGNAL L [ON/OFF]		F
TAIL LAMP SW [ON/OFF]		G
HI BEAM SW [ON/OFF]		H
HEAD LAMP SW 1 [ON/OFF]		I
HEAD LAMP SW 2 [ON/OFF]		J
PASSING SW [ON/OFF]		K
AUTO LIGHT SW ¹ [ON/OFF]		L
DOOR SW-DR [ON/OFF]	The switch status input from front door switch LH	J
DOOR SW-AS [ON/OFF]	The switch status input from front door switch RH	K
DOOR SW-RR [ON/OFF]	The switch status input from rear door switch RH	L
DOOR SW-RL [ON/OFF]	The switch status input from rear door switch LH	L
OPTICAL SENSOR [V] ¹	The value of exterior brightness voltage input from the optical sensor	L

1: With auto light system

ACTIVE TEST

Test item	Operation	Description	N
TAIL LAMP	ON	Transmits the position light request signal to IPDM E/R with CAN communication to turn the tail lamp ON.	N
	OFF	Stops the tail lamp request signal transmission.	O
HEAD LAMP	HI	Transmits the high beam request signal with CAN communication to turn the headlamp (HI)	P
	LOW	Transmits the low beam request signal with CAN communication to turn the headlamp (LOW).	P
	OFF	Stops the high & low beam request signal transmission.	P
DAYTIME RUNNING LIGHT ¹	ON	Transmits the daytime running light system request signal to IPDM E/R	P
	OFF	Stops the daytime running light request signal transmission	P

DIAGNOSIS SYSTEM (BCM)

[BCM]

< FUNCTION DIAGNOSIS >

Test item	Operation	Description
ILL DIM SIGNAL	ON	Transmits the delay timer function timer operation time signal to IPDM E/R with CAN communication to turn the headlamps ON (All doors closed).
	OFF	Stops the delay timer function timer signal transmission.

1: With daytime running light system.

WIPER

WIPER : CONSULT - III Function (BCM - WIPER)

INFOID:000000005438912

WORK SUPPORT

Work item	Setting item	Description
WIPER SPEED SETTING	ON	With vehicle speed (Front wiper intermittent time linked with the vehicle speed and wiper dial position)
	OFF*	Without vehicle speed (Front wiper intermittent time linked with the wiper dial position)

* : Initial setting

DATA MONITOR

Monitor Item [Unit]	Description
PUSH SW [ON/OFF]	Displays the status of the push-button ignition switch judged by BCM.
VEH SPEED 1 [km/h]	Displays the value of the vehicle speed signal received from combination meter with CAN communication.
FR WIPER HI [OFF/ON]	Status of each switch judged by BCM using the combination switch reading function
FR WIPER LOW [OFF/ON]	
FR WASHER SW [OFF/ON]	
FR WIPER INT [OFF/ON]	
FR WIPER STOP [OFF/ON]	Displays the status of the front wiper auto stop signal received from IPDM E/R with CAN communication.
INT VOLUME [1 - 7]	Status of each switch judged by BCM using the combination switch reading function

ACTIVE TEST

Test item	Operation	Description
FR WIPER	INT	Transmits the front wiper request signal (INT) to IPDM E/R with CAN communication to operate the front wiper INT operation.
	LO	Transmits the front wiper request signal (LO) to IPDM E/R with CAN communication to operate the front wiper LO operation.
	HI	Transmits the front wiper request signal (HI) to IPDM E/R with CAN communication to operate the front wiper HI operation.
	OFF	Stops transmitting the front wiper request signal to stop the front wiper operation.

FLASHER

FLASHER : CONSULT-III Function (BCM - FLASHER)

INFOID:000000005438913

WORK SUPPORT

DIAGNOSIS SYSTEM (BCM)

< FUNCTION DIAGNOSIS >

[BCM]

Service item	Setting item	Setting	
HAZARD ANSWER BACK	LOCK ONLY	Activated when locking.	Sets the hazard warning lamp answer back activation when the door is lock/unlock with the request switch or the key fob.
	UNLOCK ONLY	Activated when unlocking.	
	LOCK/UNLOCK*	Activated when locking/unlocking	
	OFF	Not activated	

* : Initial setting

DATA MONITOR

Monitor item [Unit]	Description
REQ SW-DR [ON/OFF]	The switch status input from request switch (driver side)
REQ SW-AS [ON/OFF]	The switch status input from front request switch (passenger side)
PUSH SW [ON/OFF]	The switch status input from push-button ignition switch
TURN SIGNAL R [ON/OFF]	Each switch condition that BCM judges from the combination switch reading function
TURN SIGNAL L [ON/OFF]	
HAZARD SW [ON/OFF]	The switch status input from the hazard warning switch
RKE-LOCK [ON/OFF]	The lock signal status received from the keyless receiver
RKE-UNLOCK [ON/OFF]	The unlock signal status received from the keyless receiver
RKE-PANIC [ON/OFF]	The panic alarm signal status received from the keyless receiver

ACTIVE TEST

Test item	Operation	Description
FLASHER	OFF	Turns turn signal lamps (right and left) OFF.
	LH	Blinks left turn signal lamp.
	RH	Blinks right turn signal lamp.

AIR CONDITIONER

AIR CONDITIONER : CONSULT-III Function

INFOID:000000005804868

DATA MONITOR

Display Item List

Monitor Item [Unit]	Contents
FAN ON SIG [ON/OFF]	Displays [FAN (ON) / FAN (OFF)] status as judged from blower fan motor switch signal.
AIR COND SW [ON/OFF]	Displays [COMP (ON) / COMP (OFF)] status as judged from air conditioner switch signal.

INTELLIGENT KEY

INTELLIGENT KEY : CONSULT-III Function (BCM - INTELLIGENT KEY)

INFOID:000000005438914

WORK SUPPORT

A
B
C
D
E
F
G
H
I
J
K
L

BCS

N
O
P

DIAGNOSIS SYSTEM (BCM)

< FUNCTION DIAGNOSIS >

[BCM]

Monitor item	Description
CONFIRM KEY FOB ID	It can be checked whether Intelligent Key ID code is registered or not in this mode.
AUTO LOCK SET	Auto door lock time can be changed in this mode. <ul style="list-style-type: none"> • MODE1: 1 minute • MODE2: 5 minutes • MODE3: 30 seconds • MODE4: 2 minutes
LOCK/UNLOCK BY I-KEY	Door lock/unlock function by door request switch mode can be changed to operate (ON) or not operate (OFF) in this mode.
ENGINE START BY I-KEY	Engine start function mode can be changed to operate (ON) or not operate (OFF) with this mode.
TRUNK/GLASS HATCH OPEN	Buzzer reminder function mode by back door request switch can be changed to operate (ON) or not operate (OFF) with this mode.
PANIC ALARM SET	Panic alarm button pressing time on Intelligent Key remote control button can be selected from the following with this mode. <ul style="list-style-type: none"> • MODE1: 0.5 sec. • MODE2: Non-operation • MODE3: 1.5 sec.
PW DOWN SET	Unlock button pressing time on Intelligent Key button can be selected from the following with this mode. <ul style="list-style-type: none"> • MODE1: 3 sec. • MODE2: Non-operation • MODE3: 5 sec.
TRUNK OPEN DELAY	Trunk button pressing time on Intelligent Key button can be selected from the following with this mode. <ul style="list-style-type: none"> • MODE1: 0.5 sec. • MODE2: 1.5 sec. • MODE3: OFF: No delay
LO-BATT OF KEY FOB WARN	Intelligent Key low battery warning mode can be changed to operate (ON) or not operate (OFF) with this mode.
ANTI KEY LOCK IN FUNCTI	Key reminder function mode can be changed to operate (ON) or not operate (OFF) with this mode.
HAZARD ANSWER BACK	Hazard reminder function mode can be selected from the following with this mode. <ul style="list-style-type: none"> • LOCK ONLY: Door lock operation only • UNLOCK ONLY: Door unlock operation only • LOCK/UNLOCK: Lock/unlock operation • OFF: Non-operation
ANS BACK I-KEY LOCK	Buzzer reminder function (lock operation) mode by door request switch (driver side and passenger side) can be selected from the following with this mode. <ul style="list-style-type: none"> • Horn chirp: Sound horn • Buzzer: Sound Intelligent Key warning buzzer • OFF: Non-operation
ANS BACK I-KEY UNLOCK	Buzzer reminder function (unlock operation) mode by door request switch can be changed to operate (ON) or not operate (OFF) with this mode.
SHORT CRANKING OUTPUT	Starter motor can be forcibly activated.
INSIDE ANT DIAGNOSIS	This function allows inside key antenna self-diagnosis.
HORN WITH KEYLESS LOCK	Horn reminder function mode by Intelligent Key button can be changed to operate (ON) or not operate (OFF) with this mode.

SELF-DIAG RESULT

Refer to [BCS-68, "DTC Index"](#).

DATA MONITOR

Monitor Item	Condition
REQ SW -DR	Indicates [ON/OFF] condition of door request switch (driver side).
REQ SW -AS	Indicates [ON/OFF] condition of door request switch (passenger side).

DIAGNOSIS SYSTEM (BCM)

< FUNCTION DIAGNOSIS >

[BCM]

Monitor Item	Condition
REQ SW -BD/TR	Indicates [ON/OFF] condition of back door request switch.
PUSH SW	Indicates [ON/OFF] condition of push-button ignition switch.
IGN RLY2 -F/B	Indicates [ON/OFF] condition of ignition relay 2.
ACC RLY-F/B	Indicates [ON/OFF] condition of accessory relay.
BRAKE SW 1	Indicates [ON/OFF]* ¹ condition of brake switch power supply.
BRAKE SW 2	Indicates [ON/OFF] condition of brake switch.
DETE/CANCL SW	Indicates [ON/OFF] condition of P position.
SFT PN/N SW	Indicates [ON/OFF] condition of P or N position.
UNLK SEN -DR	Indicates [ON/OFF] condition of driver door UNLOCK status.
PUSH SW -IPDM	Indicates [ON/OFF] condition of push-button ignition switch.
IGN RLY1 -F/B	Indicates [ON/OFF] condition of ignition relay 1.
DETE SW -IPDM	Indicates [ON/OFF] condition of P position.
SFT PN -IPDM	Indicates [ON/OFF] condition of P or N position.
SFT P -MET	Indicates [ON/OFF] condition of P position.
SFT N -MET	Indicates [ON/OFF] condition of N position.
ENGINE STATE	Indicates [STOP/STALL/CRANK/RUN] condition of engine states.
VEH SPEED 1	Display the vehicle speed signal received from combination meter by numerical value [mph].
VEH SPEED 2	Display the vehicle speed signal received from ABS or VDC or TCM by numerical value [mph].
DOOR STAT-DR	Indicates [LOCK/READY/UNLK] condition of driver side door status.
DOOR STAT-AS	Indicates [LOCK/READY/UNLK] condition of passenger side door status.
ID OK FLAG	Indicates [SET/RESET] condition of key ID.
PRMT ENG STRT	Indicates [SET/RESET] condition of engine start possibility.
KEY SW -SLOT	Indicates [ON/OFF] condition of key slot.
TRNK/HAT MNTR	Indicates [ON/OFF] condition of trunk lid.
RKE-LOCK	Indicates [ON/OFF] condition of LOCK signal from Intelligent Key.
RKE-UNLOCK	Indicates [ON/OFF] condition of UNLOCK signal from Intelligent Key.
RKE-TR/BD	Indicates [ON/OFF] condition of TRUNK OPEN signal from Intelligent Key.
RKE-PANIC	Indicates [ON/OFF] condition of PANIC button of Intelligent Key.
RKE-P/W OPEN	Indicates [ON/OFF] condition of P/W DOWN signal from Intelligent Key.
RKE-MODE CHG	Indicates [ON/OFF] condition of MODE CHANGE signal from Intelligent Key.
RKE OPE COUN1	When remote keyless entry receiver receives the signal transmitted while operating on Intelligent Key, the numerical value start changing.
REVERSE SW	Indicates [ON/OFF] condition of R position.

*1: OFF is displayed when brake pedal is depressed while brake switch power supply is OFF.

ACTIVE TEST

Test item	Description
BATTERY SAVER	This test is able to check interior room lamp operation. The interior room lamp is activated after "ON" on CONSULT-III screen is touched.
PW REMOTO DOWN SET	This test is able to check power window down operation. The power window down is activated after "ON" on CONSULT-III screen is touched.
OUTSIDE BUZZER	This test is able to check Intelligent Key warning buzzer operation. The Intelligent Key warning buzzer is activated after "ON" on CONSULT-III screen is touched.

DIAGNOSIS SYSTEM (BCM)

< FUNCTION DIAGNOSIS >

[BCM]

Test item	Description
INSIDE BUZZER	This test is able to check warning chime in combination meter operation. <ul style="list-style-type: none"> • Take away warning chime sounds when "TAKE OUT" on CONSULT-III screen is touched. • Key warning chime sounds when "KEY" on CONSULT-III screen is touched. • OFF position warning chime sounds when "KNOB" on CONSULT-III screen is touched.
INDICATOR	This test is able to check warning lamp operation. <ul style="list-style-type: none"> • "KEY" Warning lamp illuminates when "KEY ON" on CONSULT-III screen is touched. • "KEY" Warning lamp blinks when "KEY IND" on CONSULT-III screen is touched.
INT LAMP	This test is able to check interior room lamp operation. The interior room lamp is activated after "ON" on CONSULT-III screen is touched.
LCD	This test is able to check meter display information <ul style="list-style-type: none"> • Engine start information displays when "BP N" on CONSULT-III screen is touched. • Engine start information displays when "BP I" on CONSULT-III screen is touched. • Key ID warning displays when "ID NG" on CONSULT-III screen is touched. • P position warning displays when "SFT P" on CONSULT-III screen is touched. • Intelligent Key insert information displays when "INSRT" on CONSULT-III screen is touched. • Intelligent Key low battery warning displays when "BATT" on CONSULT-III screen is touched. • Take away through window warning displays when "NO KY" on CONSULT-III screen is touched. • Take away warning display when "OUTKEY" on CONSULT-III screen is touched. • OFF position warning display when "LK WN" on CONSULT-III screen is touched.
FLASHER	This test is able to check hazard warning lamp operation. The hazard warning lamps are activated after "LH/RH/OFF" on CONSULT-III screen is touched.
HORN	This test is able to check horn operation. The horn is activated after "ON" on CONSULT-III screen is touched.
P RANGE	This test is able to check CVT shift selector power supply CVT shift selector power is supplied when "ON" on CONSULT-III screen is touched.
ENGINE SW ILLUMI	This test is able to check push-ignition switch illumination operation. Push-ignition switch illumination illuminates when "ON" on CONSULT-III screen is touched.
LOCK INDICATOR	This test is able to check LOCK indicator in push-ignition switch operation. LOCK indicator in push-ignition switch illuminates when "ON" on CONSULT-III screen is touched.
ACC INDICATOR	This test is able to check ACC indicator in push-ignition switch operation. ACC indicator in push-ignition switch illuminates when "ON" on CONSULT-III screen is touched.
IGNITION ON IND	This test is able to check ON indicator in push-ignition switch operation. ON indicator in push-ignition switch illuminates when "ON" on CONSULT-III screen is touched.
KEY SLOT ILLUMI	This test is able to check key slot illumination operation. Key slot illumination blinks when "ON" on CONSULT-III screen is touched.
TRUNK/BACK DOOR	This test is able to check back door opener actuator open operation. This actuator opens when "OPEN" on CONSULT-III screen is touched.

COMB SW

COMB SW : CONSULT-III Function (BCM - COMB SW)

INFOID:000000005438915

DATA MONITOR

Monitor item [UNIT]	Description
FR WIPER HI [OFF/ON]	Displays the status of the FR WIPER HI switch in combination switch judged by BCM with the combination switch reading function.
FR WIPER LOW [OFF/ON]	Displays the status of the FR WIPER LOW switch in combination switch judged by BCM with the combination switch reading function.
FR WASHER SW [OFF/ON]	Displays the status of the FR WASHER switch in combination switch judged by BCM with the combination switch reading function.

DIAGNOSIS SYSTEM (BCM)

[BCM]

< FUNCTION DIAGNOSIS >

Monitor item [UNIT]	Description
FR WIPER INT [OFF/ON]	Displays the status of the FR WIPER INT switch in combination switch judged by BCM with the combination switch reading function.
FR WIPER STOP [OFF/ON]	Displays the status of the front wiper stop position signal received from IPDM E/R via CAN communication.
INT VOLUME [1 - 7]	Displays the status of wiper intermittent dial position judged by BCM with the combination switch reading function.
TURN SIGNAL R [OFF/ON]	Displays the status of the TURN RH switch in combination switch judged by BCM with the combination switch reading function.
TURN SIGNAL L [OFF/ON]	Displays the status of the TURN LH switch in combination switch judged by BCM with the combination switch reading function.
TAIL LAMP SW [OFF/ON]	Displays the status of the TAIL LAMP switch in combination switch judged by BCM with the combination switch reading function.
HI BEAM SW [OFF/ON]	Displays the status of the HI BEAM switch in combination switch judged by BCM with the combination switch reading function.
HEAD LAMP SW 1 [OFF/ON]	Displays the status of the HEADLAMP 1 switch in combination switch judged by BCM with the combination switch reading function.
HEAD LAMP SW 2 [OFF/ON]	Displays the status of the HEADLAMP 2 switch in combination switch judged by BCM with the combination switch reading function.
PASSING SW [OFF/ON]	Displays the status of the PASSING switch in combination switch judged by BCM with the combination switch reading function.
AUTO LIGHT SW* [OFF/ON]	Displays the status of the AUTO LIGHT switch in combination switch judged by BCM with the combination switch reading function.

*: With auto light system

BCM

BCM : CONSULT-III Function (BCM - BCM)

INFOID:000000005438916

WORK SUPPORT

Work item	Description
RESET SETTING VALUE	Return a value set with Work Support of each system to a default value in factory shipment.

IMMU

IMMU : CONSULT-III Function (BCM - IMMU)

INFOID:000000005438917

DATA MONITOR

Monitor item	Content
CONFIRM ID ALL	Indicates [YET] at all time. Switch to [DONE] when a registered Intelligent Key is inserted into the key slot.
CONFIRM ID4	
CONFIRM ID3	
CONFIRM ID2	
CONFIRM ID1	
TP 4	Indicates the number of ID which has been registered.
TP 3	
TP 2	
TP 1	
PUSH SW	Indicates [ON/OFF] condition of push-button ignition switch.
KEY SW -SLOT	Indicates [ON/OFF] condition of key slot.

ACTIVE TEST

A
B
C
D
E
F
G
H
I
J
K
L

BCS

N
O
P

DIAGNOSIS SYSTEM (BCM)

< FUNCTION DIAGNOSIS >

[BCM]

Test item	Description
THEFT IND	This test is able to check security indicator lamp operation. The lamp will be turned on when "ON" on CONSULT-III screen touched.

BATTERY SAVER

BATTERY SAVER : CONSULT-III Function (BCM - BATTERY SAVER)

INFOID:000000005438918

WORK SUPPORT

Work item	Setting item	Setting	
ROOM LAMP BAT SAV SET	ON*	With the interior room lamp battery saver function	
	OFF	Without the interior room lamp battery saver function	
ROOM LAMP TIMER SET	MODE1*	30 min.	Sets the interior room lamp battery saver timer operating time.
	MODE2	60 min.	
BATTERY SAVER SET	ON*	With the exterior lamp battery saver function	
	OFF	Without the exterior lamp battery saver function	

* : Initial setting

DATA MONITOR

Monitor item [Unit]	Description
REQ SW-DR [ON/OFF]	The switch status input from request switch (front LH)
REQ SW-AS [ON/OFF]	The switch status input from front request switch (front RH)
PUSH SW [ON/OFF]	The switch status input from push-button ignition switch
ACC RLY-F/B [ON/OFF]	Indicates [ON/OFF] condition of accessory relay.
UNLK SEN-DR [ON/OFF]	Status of front door lock assembly LH (door unlock sensor)
KEY SW-SLOT [ON/OFF]	Key switch status input from key slot
DOOR SW-DR [ON/OFF]	The switch status input from front door switch LH
DOOR SW-AS [ON/OFF]	The switch status input from front door switch RH
DOOR SW-RR [ON/OFF]	The switch status input from rear door switch RH
DOOR SW-RL [ON/OFF]	The switch status input from rear door switch LH
CDL LOCK SW [ON/OFF]	Lock switch status received from door lock/unlock switch by power window serial link
CDL UNLOCK SW [ON/OFF]	Unlock switch status received from door lock/unlock switch by power window serial link
KEY CYL LK-SW [ON/OFF]	Lock switch status received from key cylinder switch by power window serial link
KEY CYL UN-SW [ON/OFF]	Unlock switch status received from key cylinder switch by power window serial link
TRNK/HAT MNTR [ON/OFF]	The switch status input from trunk room lamp switch

DIAGNOSIS SYSTEM (BCM)

[BCM]

< FUNCTION DIAGNOSIS >

Monitor item [Unit]	Description
RKE-LOCK [ON/OFF]	Lock signal status received from remote keyless entry receiver
RKE-UNLOCK [ON/OFF]	Unlock signal status received from remote keyless entry receiver

ACTIVE TEST

Test item	Operation	Description
BATTERY SAVER	OFF	Cuts the interior room lamp power supply to turn interior room lamp OFF.
	ON	Outputs the interior room lamp power supply to turn interior room lamp ON.*

* : Each lamp switch is in ON position.

TRUNK

TRUNK : CONSULT-III Function (BCM - TRUNK)

INFOID:000000005438919

DATA MONITOR

Monitor Item	Contents
PUSH SW	Indicates [ON/OFF] condition of push switch.
UNLK SEN -DR	Indicates [ON/OFF] condition of unlock sensor.
VEH SPEED 1	Indicates [Km/h] condition of vehicle speed signal from combination meter.
TR CANCEL SW	Indicates [ON/OFF] condition of trunk lid opener cancel switch.
TR/BD OPEN SW	Indicates [ON/OFF] condition of trunk lid opener switch.
TRNK/HAT MNTR	Indicates [ON/OFF] condition of trunk room lamp switch.
RKE-TR/BD	Indicates [ON/OFF] condition of trunk open signal from Intelligent Key remote controller button.

ACTIVE TEST

Test Item	Description
TRUNK/GLASS HATCH	This test is able to check trunk open operation. Trunk opens when "OPEN" on CONSULT-III screen is touched.

THEFT ALM

THEFT ALM : CONSULT-III Function (BCM - THEFT)

INFOID:000000005438920

WORK SUPPORT

Work item	Description
SECURITY ALARM SET	This mode is able to confirm and change security alarm ON-OFF setting.
THEFT ALM TRG	The switch which triggered vehicle security alarm is recorded. This mode is able to confirm and erase the record of vehicle security alarm. The trigger data can be erased by touching "CLEAR" on CONSULT-III screen.

DATA MONITOR

Monitor item	Description
REQ SW-DR	Indicates [ON/OFF] condition of door request switch (driver side).
REQ SW-AS	Indicates [ON/OFF] condition of door request switch (passenger side).
REQ SW-BD/TR	Indicates [ON/OFF] condition of trunk opener request switch.
PUSH SW	Indicates [ON/OFF] condition of push-button ignition switch

A
B
C
D
E
F
G
H
I
J
K
L

BCS

N
O
P

DIAGNOSIS SYSTEM (BCM)

[BCM]

< FUNCTION DIAGNOSIS >

Monitor item	Description
UNLK SEN-DR	Indicates [ON/OFF] condition of driver door UNLOCK status.
KEY SW -SLOT	Indicates [ON/OFF] condition of key slot.
DOOR SW-DR	Indicates [ON/OFF] condition of front door switch LH.
DOOR SW-AS	Indicates [ON/OFF] condition of front door switch RH.
DOOR SW-RR	Indicates [ON/OFF] condition of rear door switch RH.
DOOR SW-RL	Indicates [ON/OFF] condition of rear door switch LH.
CDL LOCK SW	Indicates [ON/OFF] condition of lock signal from door lock/unlock switch LH and RH.
CDL UNLOCK SW	Indicates [ON/OFF] condition of unlock signal from door lock/unlock switch LH and RH.
KEY CYL LK-SW	Indicates [ON/OFF] condition of lock signal from front door key cylinder switch.
KEY CYL UN-SW	Indicates [ON/OFF] condition of unlock signal from front door key cylinder switch.
TR/BD OPEN SW	Indicates [ON/OFF] condition of trunk lid opener switch.
TRNK/HAT MNTR	Indicates [ON/OFF] condition of trunk room lamp switch.
RKE-LOCK	Indicates [ON/OFF] condition of LOCK signal from Intelligent Key.
RKE-UNLOCK	Indicates [ON/OFF] condition of UNLOCK signal from Intelligent Key.
RKE-TR/BD	Indicates [ON/OFF] condition of TRUNK OPEN signal from Intelligent Key.

ACTIVE TEST

Test item	Operation	Description
THEFT IND		This test is able to check security indicator lamp operation. The lamp will be turned on when "ON" on CONSULT-III screen is touched.
VEHICLE SECURITY HORN		This test is able to check vehicle security horn operation. The horns will be activated for 0.5 seconds after "ON" on CONSULT-III screen is touched.
HEAD LAMP (HI)		This test is able to check vehicle security lamp operation. The headlamps will be activated for 0.5 seconds after "ON" on CONSULT-III screen is touched.
FLASHER	RH	Outputs the voltage to blink the right side turn signal lamps.
	LH	Outputs the voltage to blink the left side turn signal lamps.
	Off	Stops the voltage to turn the turn signal lamps OFF.

RETAINED PWR

RETAINED PWR : CONSULT-III Function (BCM - RETAINED PWR)

INFOID:000000005438921

DATA MONITOR

Monitor item	Description
DOOR SW-DR	Indicates [ON/OFF] condition of driver side door switch.
DOOR SW-AS	Indicates [ON/OFF] condition of passenger side door switch.

SIGNAL BUFFER

SIGNAL BUFFER : CONSULT-III Function

INFOID:000000005438922

DATA MONITOR

Monitor item [UNIT]	Description
PUSH SW [OFF/ON]	Displays the status of the push-button ignition switch judged by BCM.

ACTIVE TEST

Test item	Operation	Operation
OIL PRESSURE SW	OFF	OFF
	ON	BCM transmits the oil pressure switch signal to the combination meter via CAN communication, which illuminates the oil pressure warning lamp.

AIR PRESSURE MONITOR

AIR PRESSURE MONITOR : Diagnosis Description

INFOID:000000005438923

DESCRIPTION

During driving, the TPMS receives the signal transmitted from the transmitter installed in each wheel, when the tire pressure becomes low. The control unit (BCM) of this system has pressure judgment and trouble diagnosis functions.

When the TPMS detects low inflation pressure or another unusual symptom, the warning lamps in the combination meter comes on.

SELF DIAGNOSTIC PROCEDURE (WITH CONSULT-III)

With CONSULT-III

- Touch "SELF-DIAG RESULTS" display shows malfunction experienced since the last erasing operation. Refer to [BCS-68, "DTC Index"](#).

SELF DIAGNOSTIC PROCEDURE (WITHOUT CONSULT-III)

Without CONSULT-III

To start the self-diagnostic results mode, ground terminal of the tire pressure warning check connector. The malfunction location is indicated by the warning lamp flashing.

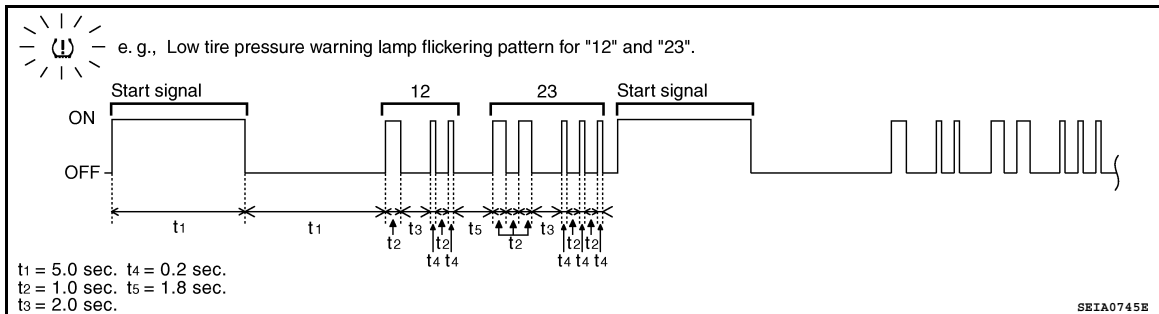

NOTE:

When the low tire warning lamp flashes 5 Hz and continues repeating it, the system is normal.

Flickering pattern	Items	Diagnostic items detected when...	Check item
15	Tire pressure value (Front LH)	Front LH tire pressure drops to 181 kPa (1.8 kg/cm, 25.25 psi) or less.	-
16	Tire pressure value (Front RH)	Front RH tire pressure drops to 181 kPa (1.8 kg/cm, 25.25 psi) or less.	
17	Tire pressure value (Rear RH)	Rear RH tire pressure drops to 181 kPa (1.8 kg/cm, 25.25 psi) or less.	
18	Tire pressure value (Rear LH)	Rear LH tire pressure drops to 181 kPa (1.8 kg/cm, 25.25 psi) or less.	
21	Transmitter no data (Front LH)	Data from front LH transmitter can not be received.	WT-43
22	Transmitter no data (Front RH)	Data from front RH transmitter can not be received.	
23	Transmitter no data (Rear RH)	Data from Rear RH transmitter can not be received.	
24	Transmitter no data (Rear LH)	Data from Rear LH transmitter can not be received.	

DIAGNOSIS SYSTEM (BCM)

[BCM]

< FUNCTION DIAGNOSIS >

Flickering pattern	Items	Diagnostic items detected when...	Check item
31	Transmitter checksum error (Front LH)	Checksum data from front LH transmitter is malfunctioning.	WT-43
32	Transmitter checksum error (Front RH)	Checksum data from front RH transmitter is malfunctioning.	
33	Transmitter checksum error (Rear RH)	Checksum data from rear RH transmitter is malfunctioning.	
34	Transmitter checksum error (Rear LH)	Checksum data from rear LH transmitter is malfunctioning.	
35	Transmitter pressure data error (Front LH)	Air pressure data from front LH transmitter is malfunction.	WT-43
36	Transmitter pressure data error (Front RH)	Air pressure data from front RH transmitter is malfunction.	
37	Transmitter pressure data error (Rear RH)	Air pressure data from rear RH transmitter is malfunction.	
38	Transmitter pressure data error (Rear LH)	Air pressure data from rear LH transmitter is malfunction.	
41	Transmitter function code error (Front LH)	Function code data from front LH transmitter is malfunction.	WT-43
42	Transmitter function code error (Front RH)	Function code data from front RH transmitter is malfunction.	
43	Transmitter function code error (Rear RH)	Function code data from rear RH transmitter is malfunction.	
44	Transmitter function code error (Rear LH)	Function code data from rear LH transmitter is malfunction.	
45	Transmitter battery voltage low (Front LH)	Battery voltage of front LH transmitter drops.	WT-43
46	Transmitter battery voltage low (Front RH)	Battery voltage of front RH transmitter drops.	
47	Transmitter battery voltage low (Rear RH)	Battery voltage of rear RH transmitter drops.	
48	Transmitter battery voltage low (Rear LH)	Battery voltage of rear LH transmitter drops.	
52	Vehicle speed signal error	Speed signal is not detected.	WT-43
53	BCM failure about TPMS	Tire pressure monitoring system malfunction in BCM	WT-43
No flickering	Tire pressure warning check switch	Tire pressure warning switch circuit is open.	-

ERASE SELF-DIAGNOSIS

With CONSULT-III

1. Perform applicable inspection of malfunctioning item and then repair or replace.
2. Turn ignition switch "ON" and select "SELF-DIAG RESULTS" mode for "AIR PRESSURE MONITOR" with CONSULT-III.
3. Touch "ERASE" on CONSULT-III screen to erase memory.

Without CONSULT-III

- In order to make it easier to find the cause of hard-to-duplicate malfunctions, malfunction information is stored into the control unit as necessary during use by the user. This memory is not erased no matter how many times the ignition switch is turned "ON" and "OFF".
- However, this information is erased by turning ignition switch "OFF" after performing self-diagnostic or by erasing the memory using the CONSULT-III.

AIR PRESSURE MONITOR : CONSULT-III Function (BCM - AIR PRESSURE MONI-

DIAGNOSIS SYSTEM (BCM)

[BCM]

< FUNCTION DIAGNOSIS >

TOR)

INFOID:000000005438924

WORK SUPPORT

ID Read

The registered ID number is displayed.

ID Regist

Refer to [WT-6](#).

SELF-DIAG RESULTS

Refer to [BCS-68. "DTC Index"](#).

DATA MONITOR

Screen of data monitor mode is displayed.

NOTE:

When malfunction is detected, CONSULT-III perform REAL-TIME DIAGNOSIS. Also, any malfunction detected while in this mode will be displayed at real time.

Display item list

Monitor	Condition	Specification
AIR PRESS FL AIR PRESS FR AIR PRESS RR AIR PRESS RL	<ul style="list-style-type: none"> Drive vehicle for a few minutes. or Ignition switch ON and activation tool is transmitting activation signals. 	Tire pressure (kPa, kg/cm ² or Psi)
ID REGST FL1 ID REGST FR1 ID REGST RR1 ID REGST RL1	Ignition switch ON	Registration ID: Green No registration: Red
WARNING LAMP		Low tire pressure warning lamp on: ON Low tire pressure warning lamp off: OFF
BUZZER		Buzzer in combination meter on: ON Buzzer in combination meter off: OFF

NOTE:

Before performing the self-diagnosis, be sure to register the ID, or erase the actual malfunction location may be different from that displayed on CONSULT-III.

ACTIVE TEST

NOTE:

Before performing the self-diagnosis, be sure to register the ID, or else the actual malfunction may be different from that displayed on CONSULT-III.

TEST ITEM LIST

Test item	Content
WARNING LAMP	This test is able to check warning lamp operation. The lamp will be turned on when "ON" on CONSULT-III screen is touched.
ID REGIST WARNING	This test is able to check to make sure that the buzzer sounds or the warning lamp turns on.
FLASHER	This test is able to check to make sure that each turn signal lamp turns on.
HORN	This test is able to check to make sure that the horn sounds.

A
B
C
D
E
F
G
H
I
J
K
L

BCS

N
O
P

COMPONENT DIAGNOSIS

U1000 CAN COMM CIRCUIT

Description

INFOID:000000005438925

Refer to [LAN-7, "System Description"](#).

DTC Logic

INFOID:000000005438926

DTC DETECTION LOGIC

CONSULT-III display description	DTC Detection Condition	Possible cause
CAN COMM CIRCUIT [U1000]	When any listed module cannot communicate CAN communication signal continuously for 2 seconds or more with ignition switch ON	In CAN communication system, any item (or items) of the following listed below is malfunctioning. <ul style="list-style-type: none"> • CVT • Receiving (ECM) • Receiving (VDC/TCS/ABS) • Receiving (METER/M&A) • Receiving (TCM) • Receiving (IPDM E/R)

Diagnosis Procedure

INFOID:000000005438927

1. PERFORM SELF DIAGNOSTIC

1. Turn ignition switch ON and wait for 2 seconds or more.
2. Check "SELF-DIAG RESULTS".

Is "CAN COMM CIRCUIT" displayed?

- YES >> Refer to [LAN-8, "CAN Communication Control Circuit"](#).
 NO >> Refer to [GI-42, "Intermittent Incident"](#).

U1010 CONTROL UNIT (CAN)

[BCM]

< COMPONENT DIAGNOSIS >

U1010 CONTROL UNIT (CAN)

DTC Logic

INFOID:000000005438928

DTC DETECTION LOGIC

CONSULT-III display description	DTC Detection Condition	Possible cause
CAN COMM CIRCUIT [U1010]	BCM detected internal CAN communication circuit malfunction.	BCM

Diagnosis Procedure

INFOID:000000005438929

1. REPLACE BCM

When DTC U1010 is detected, replace BCM.

>> Replace BCM. Refer to [BCS-83, "Removal and Installation"](#).

A
B
C
D
E
F
G
H
I
J
K
L

BCS

N
O
P

U0415 VEHICLE SPEED SIG

[BCM]

< COMPONENT DIAGNOSIS >

U0415 VEHICLE SPEED SIG

Description

INFOID:000000005438930

U0415 is displayed if any unusual condition is present in the reception status of the vehicle speed signal from the brake ECU.

DTC Logic

INFOID:000000005438931

DTC DETECTION LOGIC

DTC	Display contents of CONSULT-III	Diagnostic item is detected when ...	Probable malfunction location
U0415	VEHICLE SPEED SIG [U0415]	When the vehicle speed signal received from the brake ECU remains abnormal for 2 seconds or more.	<ul style="list-style-type: none">• Brake ECU• BCM

DTC CONFIRMATION PROCEDURE

1. DTC CONFIRMATION

1. Erase the DTC.
2. Turn ignition switch OFF.
3. Perform the "SELF-DIAG RESULTS" of CONSULT-III, when passed 2 seconds or more after the ignition switch is turned ON

Is any DTC detected?

- YES >> Refer to [BCS-68, "DTC Index"](#).
NO >> Inspection End.

Diagnosis Procedure

INFOID:000000005438932

1. BRAKE ECU SELF-DIAG RESULTS

Perform "SELF-DIAG RESULTS" of brake ECU with CONSULT-III. Refer to [BRC-40, "CONSULT-III Function"](#).

Is any DTC detected?

- YES >> Repair or replace the malfunctioning part.
NO >> Replace BCM. Refer to [BCS-83, "Removal and Installation"](#).

B2562 LOW VOLTAGE

[BCM]

< COMPONENT DIAGNOSIS >

B2562 LOW VOLTAGE

DTC Logic

INFOID:000000005438933

DTC DETECTION LOGIC

DTC	Display contents of CONSULT-III	Diagnostic item is detected when ...	Possible cause
B2562	LOW VOLTAGE	When the power supply voltage to BCM remains less than 8.8V for 1.5 seconds or more	Harness or connector (power supply circuit)

DTC CONFIRMATION PROCEDURE

1. DTC CONFIRMATION

1. Erase DTC.
2. Turn ignition switch OFF.
3. Perform the "SELF-DIAG RESULTS" of CONSULT-III, when passed 1.5 seconds or more after ignition switch is turned ON.

Is any DTC detected?

YES >> Refer to [BCS-39. "Diagnosis Procedure"](#).

NO >> Inspection End.

Diagnosis Procedure

INFOID:000000005438934

1. CHECK 12-VOLT BATTERY VOLTAGE

Check 12-volt battery voltage.

Is 12-volt battery voltage less than 8.8V?

Yes >> Charge battery and retest. Refer to [PG-72. "Battery"](#).

No >> GO TO 2

2. CHECK POWER SUPPLY CIRCUIT

Check BCM power supply circuit. Refer to [BCS-41. "Diagnosis Procedure"](#).

Is the circuit OK?

Yes >> Replace BCM. Refer to [BCS-83. "Removal and Installation"](#).

No >> Repair or replace the malfunctioning part.

Special Repair Requirement

INFOID:000000005438935

1. REQUIRED WORK WHEN REPLACING BCM

Initialize control unit. Refer to CONSULT-III operation manual.

>> Work End.

A
B
C
D
E
F
G
H
I
J
K
L
N
O
P

BCS

< COMPONENT DIAGNOSIS >

B2563 HI VOLTAGE**DTC Logic**

INFOID:000000005438936

DTC DETECTION LOGIC

DTC	Display contents of CONSULT-III	Diagnostic item is detected when ...	Possible cause
B2563	HI VOLTAGE	When the power supply voltage to BCM remains more than 18V for 90 seconds or more	Harness or connector (power supply circuit)

DTC CONFIRMATION PROCEDURE**1. DTC CONFIRMATION**

1. Erase DTC.
2. Turn ignition switch OFF.
3. Perform the "SELF-DIAG RESULTS" of CONSULT-III, when passed 90 seconds or more after the ignition switch is turned ON.

Is any DTC detected?

- YES >> Refer to [BCS-40. "Diagnosis Procedure"](#).
 NO >> Inspection End.

Diagnosis Procedure

INFOID:000000005438937

1. CHECK 12-VOLT BATTERY VOLTAGE

Check 12 volt battery voltage.

Is 12-volt battery voltage greater than 18V?

- Yes >> Check vehicle 12-volt battery charging system. Refer to [PG-72. "Battery"](#).
 No >> GO TO 2

2. CHECK POWER SUPPLY CIRCUITCheck BCM power supply circuit. Refer to [BCS-41. "Diagnosis Procedure"](#).**Is the circuit OK?**

- Yes >> Replace BCM. Refer to [BCS-83. "Removal and Installation"](#).
 No >> Repair or replace the malfunctioning part.

Special Repair Requirement

INFOID:000000005438938

1. REQUIRED WORK WHEN REPLACING BCM

Initialize control unit. Refer to CONSULT-III operation manual.

>> Work end.

POWER SUPPLY AND GROUND CIRCUIT

[BCM]

< COMPONENT DIAGNOSIS >

POWER SUPPLY AND GROUND CIRCUIT

Diagnosis Procedure

INFOID:000000005438939

Regarding Wiring Diagram information, refer to [BCS-71, "Wiring Diagram"](#).

1. CHECK FUSE AND FUSIBLE LINK

Check if the following BCM fuse or fusible link are blown.

Terminal No.	Signal name	Fuse and fusible link No.
1	Battery power supply	J
11		10

Is the fuse or fusible link blown?

- YES >> Replace the blown fuse or fusible link after repairing the affected circuit.
 NO >> GO TO 2

2. CHECK POWER SUPPLY CIRCUIT

- Turn ignition switch OFF.
- Disconnect BCM.
- Check voltage between BCM harness connector and ground.

Terminals		Voltage (Approx.)
(+)	(-)	
BCM		Ground
Connector	Terminal	
M16	1	
M17	11	
		Battery voltage

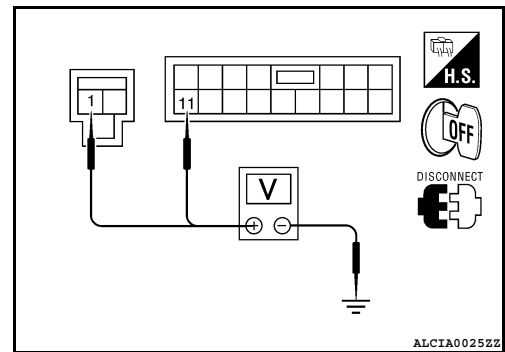

Is the measurement normal?

- YES >> GO TO 3
 NO >> Repair or replace harness.

3. CHECK GROUND CIRCUIT

Check continuity between BCM harness connector and ground.

BCM		Ground	Continuity
Connector	Terminal		
M17	13		Yes

Does continuity exist?

- YES >> Inspection End.
 NO >> Repair or replace harness.

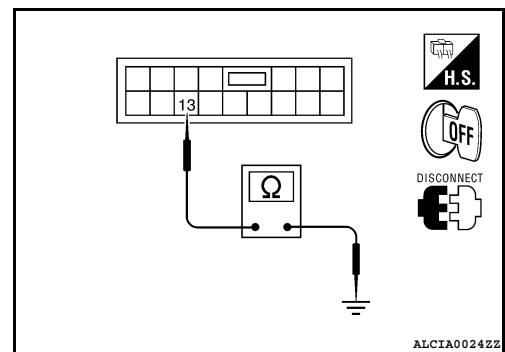

Special Repair Requirement

INFOID:000000005438940

1. REQUIRED WORK WHEN REPLACING BCM

Initialize control unit. Refer to CONSULT-III operation manual.

>> Work End.

A
B
C
D
E
F
G
H
I
J
K
L
M
N
O
P

BCS

COMBINATION SWITCH INPUT CIRCUIT

< COMPONENT DIAGNOSIS >

[BCM]

COMBINATION SWITCH INPUT CIRCUIT

Diagnosis Procedure

INFOID:000000005438941

Regarding Wiring Diagram information, refer to [BCS-71. "Wiring Diagram"](#).

1. CHECK INPUT 1 - 5 SYSTEM CIRCUIT FOR OPEN

1. Turn the ignition switch OFF.
2. Disconnect the BCM and combination switch.
3. Check continuity between BCM harness connector (A) and combination switch harness connector (B).

System	BCM		Combination switch		Continuity
	Connector	Terminal	Connector	Terminal	
INPUT 1	M19 (A)	95	M28 (B)	11	Yes
INPUT 2		97		9	
INPUT 3		76		7	
INPUT 4		96		10	
INPUT 5		75		13	

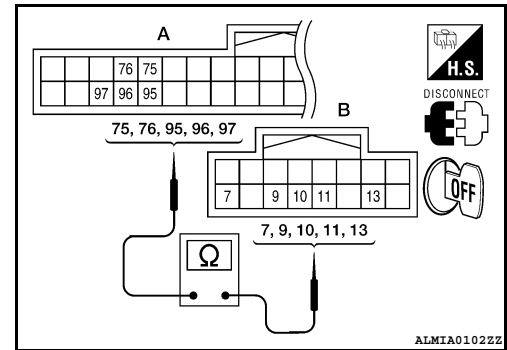

Does continuity exist?

- YES >> GO TO 2
 NO >> Repair or replace harness.

2. CHECK INPUT 1 - 5 SYSTEM CIRCUIT FOR SHORT

Check for continuity between BCM harness connector and ground.

System	BCM		Continuity
	Connector	Terminal	
INPUT 1	M19	95	No
INPUT 2		97	
INPUT 3		76	
INPUT 4		96	
INPUT 5		75	

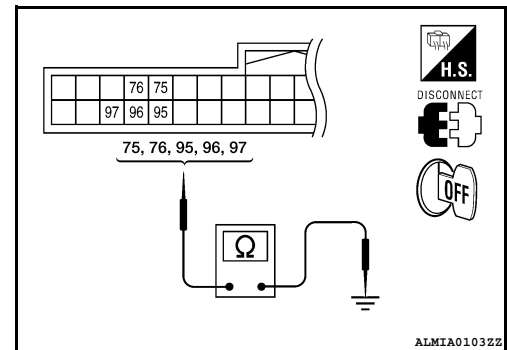

Does continuity exist?

- YES >> Repair or replace harness.
 NO >> GO TO 3

3. CHECK BCM OUTPUT VOLTAGE

1. Connect the BCM.
2. Check voltage between BCM harness connector and ground.

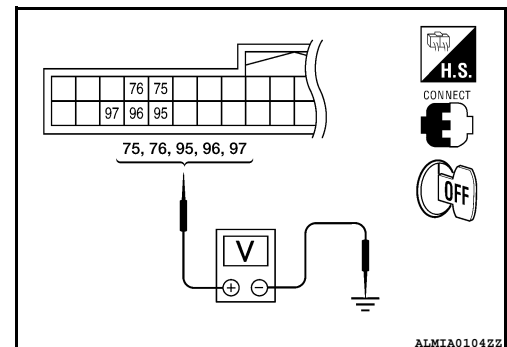

COMBINATION SWITCH INPUT CIRCUIT

< COMPONENT DIAGNOSIS >

[BCM]

System	Terminals		Voltage (Approx.)
	(+)	(-)	
	BCM		
	Connector	Terminal	
INPUT 1	M19	95	Ground
INPUT 2		97	
INPUT 3		76	
INPUT 4		96	
INPUT 5		75	

Refer to [BCS-50](#). "Physical Values".

Is the measurement normal?

YES >> GO TO 4

NO >> Replace BCM. Refer to [BCS-83](#). "Removal and Installation".

4. CHECK BCM INPUT SIGNAL

1. Connect the combination switch.
2. Turn ON any switch in the system that is malfunctioning.
3. Check voltage between BCM harness connector and ground.

System	Terminals		Voltage (Approx.)
	(+)	(-)	
	BCM		
	Connector	Terminal	
INPUT 1	M19	95	Ground
INPUT 2		97	
INPUT 3		76	
INPUT 4		96	
INPUT 5		75	

Refer to [BCS-50](#). "Physical Values".

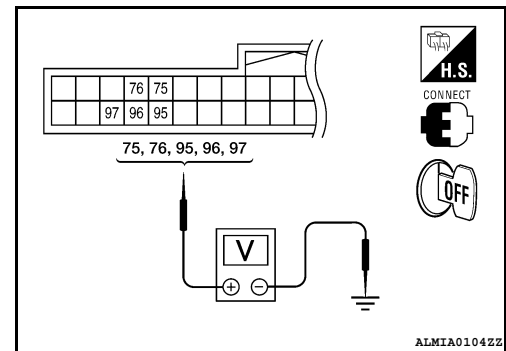

Is the measurement normal when any of the switches are turned ON?

YES >> Replace BCM. Refer to [BCS-83](#). "Removal and Installation".

NO >> Replace the combination switch. Refer to [EXL-156](#). "Removal and Installation".

Special Repair Requirement

INFOID:000000005438942

1. REQUIRED WORK WHEN REPLACING BCM

Initialize control unit. Refer to CONSULT-III operation manual.

>> Work End.

BCS

COMBINATION SWITCH OUTPUT CIRCUIT

[BCM]

< COMPONENT DIAGNOSIS >

COMBINATION SWITCH OUTPUT CIRCUIT

Diagnosis Procedure

INFOID:000000005438943

Regarding Wiring Diagram information, refer to [BCS-71. "Wiring Diagram"](#).

1. CHECK COMBINATION SWITCH OUTPUTS

Ⓟ With CONSULT-III perform combination switch "ACTIVE TEST" and operate combination switch outputs. Refer to [BCS-28. "COMB SW : CONSULT-III Function \(BCM - COMB SW\)"](#).

Do combination switch outputs function?

- YES >> Combination switch outputs are OK.
- NO >> GO TO 2

2. CHECK OUTPUT 1 - 5 SYSTEM CIRCUIT FOR OPEN

1. Turn the ignition switch OFF.
2. Disconnect the BCM and combination switch.
3. Check continuity between BCM harness connector (A) and combination switch harness connector (B).

System	BCM		Combination switch		Continuity
	Connector	Terminal	Connector	Terminal	
OUTPUT 1	M18 (A)	51	M28 (B)	12	Yes
OUTPUT 2		52		14	
OUTPUT 3		53		5	
OUTPUT 4		54		2	
OUTPUT 5		50		8	

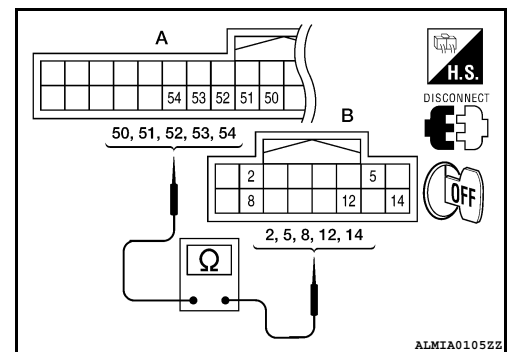

Does continuity exist?

- YES >> GO TO 3
- NO >> Repair or replace harness.

3. CHECK OUTPUT 1 - 5 SYSTEM CIRCUIT FOR SHORT

Check for continuity between BCM harness connector and ground.

System	BCM		Ground	Continuity
	Connector	Terminal		
OUTPUT 1	M18	51	Ground	No
OUTPUT 2		52		
OUTPUT 3		53		
OUTPUT 4		54		
OUTPUT 5		50		

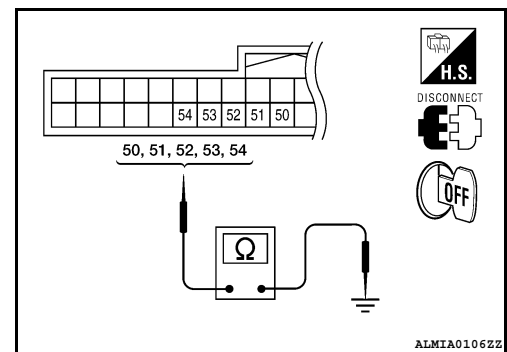

Does continuity exist?

- YES >> Repair or replace harness.
- NO >> GO TO 4

4. CHECK COMBINATION SWITCH OUTPUT VOLTAGE

COMBINATION SWITCH OUTPUT CIRCUIT

[BCM]

< COMPONENT DIAGNOSIS >

1. Connect BCM and combination switch.
2. Turn ON any switch in the system that is malfunctioning.
3. Check voltage between combination switch harness connector and ground.

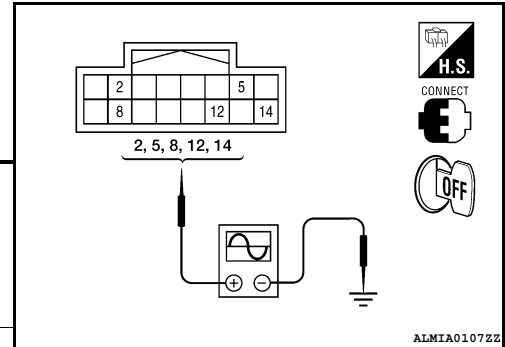

System	Terminals		Value (Approx.)	
	(+)			(-)
	Connector	Terminal		
OUTPUT 1	M28	12	Ground	
OUTPUT 2		14		
OUTPUT 3		5		
OUTPUT 4		2		
OUTPUT 5		8		

1.4V

Is the measurement normal when any of the switches is turned ON?

YES >> Replace BCM. Refer to [BCS-83. "Removal and Installation"](#).

NO >> Replace the combination switch. Refer to [EXL-156. "Removal and Installation"](#).

Special Repair Requirement

INFOID:000000005438944

1. REQUIRED WORK WHEN REPLACING BCM

Initialize control unit. Refer to CONSULT-III operation manual.

>> Work End.

A
B
C
D
E
F
G
H
I
J
K
L
N
O
P

BCS

BCM (BODY CONTROL MODULE)

< ECU DIAGNOSIS >

[BCM]

ECU DIAGNOSIS

BCM (BODY CONTROL MODULE)

Reference Value

INFOID:000000005438945

VALUES ON THE DIAGNOSIS TOOL

Monitor Item	Condition	Value/Status
FR WIPER HI	Other than front wiper switch HI	OFF
	Front wiper switch HI	ON
FR WIPER LOW	Other than front wiper switch LO	OFF
	Front wiper switch LO	ON
FR WASHER SW	Front washer switch OFF	OFF
	Front washer switch ON	ON
FR WIPER INT	Other than front wiper switch INT	OFF
	Front wiper switch INT	ON
FR WIPER STOP	Front wiper is not in STOP position	OFF
	Front wiper is in STOP position	ON
INT VOLUME	Wiper intermittent dial is in a dial position 1 - 7	Wiper intermittent dial position
TURN SIGNAL R	Other than turn signal switch RH	OFF
	Turn signal switch RH	ON
TURN SIGNAL L	Other than turn signal switch LH	OFF
	Turn signal switch LH	ON
TAIL LAMP SW	Other than lighting switch 1ST and 2ND	OFF
	Lighting switch 1ST or 2ND	ON
HI BEAM SW	Other than lighting switch HI	OFF
	Lighting switch HI	ON
HEAD LAMP SW 1	Other than lighting switch 2ND	OFF
	Lighting switch 2ND	ON
HEAD LAMP SW 2	Other than lighting switch 2ND	OFF
	Lighting switch 2ND	ON
PASSING SW	Other than lighting switch PASS	OFF
	Lighting switch PASS	ON
AUTO LIGHT SW	Other than lighting switch AUTO	OFF
	Lighting switch AUTO	ON
DOOR SW-DR	Front door LH closed	OFF
	Front door LH opened	ON
DOOR SW-AS	Front door RH closed	OFF
	Front door RH opened	ON
DOOR SW-RR	Rear door RH closed	OFF
	Rear door RH opened	ON
DOOR SW-RL	Rear door LH closed	OFF
	Rear door LH opened	ON
CDL LOCK SW	Other than power door lock switch LOCK	OFF
	Door lock/unlock switch LOCK	ON

BCM (BODY CONTROL MODULE)

< ECU DIAGNOSIS >

[BCM]

Monitor Item	Condition	Value/Status	
CDL UNLOCK SW	Other than door lock/unlock switch UNLOCK	OFF	A
	Door lock/unlock switch UNLOCK	ON	
KEY CYL LK-SW	Other than front door LH key cylinder LOCK position	OFF	B
	Front door LH key cylinder LOCK position	ON	
KEY CYL UN-SW	Other than front door LH key cylinder UNLOCK position	OFF	C
	Front door LH key cylinder UNLOCK position	ON	
HAZARD SW	When hazard switch is not pressed	OFF	D
	When hazard switch is pressed	ON	
REAR DEF SW	When rear window defogger switch is pressed	ON	
FAN ON SIG	When AUTO switch or fan switch is pressed	ON	
AIR COND SW	When A/C switch is pressed	ON	E
TR CANCEL SW	Trunk lid opener cancel switch OFF	OFF	F
	Trunk lid opener cancel switch ON	ON	
TR/BD OPEN SW	Trunk lid opener switch OFF	OFF	G
	While the trunk lid opener switch is turned ON	ON	
TRNK/HAT MNTR	Trunk lid closed	OFF	H
	Trunk lid opened	ON	
RKE-LOCK	When LOCK button of Intelligent Key is not pressed	OFF	I
	When LOCK button of Intelligent Key is pressed	ON	
RKE-UNLOCK	When UNLOCK button of Intelligent Key is not pressed	OFF	J
	When UNLOCK button of Intelligent Key is pressed	ON	
RKE-TR/BD	When TRUNK OPEN button of Intelligent Key is not pressed	OFF	K
	When TRUNK OPEN button of Intelligent Key is pressed	ON	
RKE-PANIC	When PANIC button of Intelligent Key is not pressed	OFF	L
	When PANIC button of Intelligent Key is pressed	ON	
RKE-P/W OPEN	When UNLOCK button of Intelligent Key is not pressed and held	OFF	BCS
	When UNLOCK button of Intelligent Key is pressed and held	ON	
RKE-MODE CHG	When LOCK/UNLOCK button of Intelligent Key is not pressed and held simultaneously	OFF	N
	When LOCK/UNLOCK button of Intelligent Key is pressed and held simultaneously	ON	
OPTICAL SENSOR	When outside of the vehicle is bright	Close to 5 V	O
	When outside of the vehicle is dark	Close to 0 V	
REQ SW-DR	When front door LH request switch is not pressed	OFF	P
	When front door LH request switch is pressed	ON	
REQ SW-AS	When front door RH request switch is not pressed	OFF	
	When front door RH request switch is pressed	ON	
REQ SW-BD/TR	When trunk request switch is not pressed	OFF	
	When trunk request switch is pressed	ON	
PUSH SW	When push-button ignition switch is not pressed	OFF	
	When push-button ignition switch is pressed	ON	
IGN RLY -F/B	Ignition switch OFF or ACC	OFF	
	Ignition switch ON	ON	
ACC RLY -F/B	Ignition switch OFF	OFF	
	Ignition switch ACC or ON	ON	

BCM (BODY CONTROL MODULE)

< ECU DIAGNOSIS >

[BCM]

Monitor Item	Condition	Value/Status
BRAKE SW 1	When the brake pedal is not depressed	ON
	When the brake pedal is depressed	OFF
DETE/CANCL SW	When selector lever is in P position	OFF
	When selector lever is in any position other than P	ON
SFT PN/N SW	When selector lever is in any position other than P or N	OFF
	When selector lever is in P or N position	ON
UNLK SEN-DR	Front door LH UNLOCK status	OFF
	Front door LH LOCK status	ON
PUSH SW -IPDM	When push-button ignition switch is not pressed (IPDM E/R sends via CAN)	OFF
	When push-button ignition switch is pressed (IPDM E/R sends via CAN)	ON
IGN RLY1 F/B	Ignition switch OFF or ACC	OFF
	Ignition switch ON	ON
DETE SW -IPDM	When selector lever is in P position (IPDM E/R sends via CAN)	OFF
	When selector lever is in any position other than P (IPDM E/R sends via CAN)	ON
SFT PN -IPDM	When selector lever is in any position other than P or N (IPDM E/R sends via CAN)	OFF
	When selector lever is in P or N position (IPDM E/R sends via CAN)	ON
SFT P -MET	When selector lever is in any position other than P (combination meter sends via CAN)	OFF
	When selector lever is in P position (combination meter sends via CAN)	ON
SFT N -MET	When selector lever is in any position other than N (combination meter sends via CAN)	OFF
	When selector lever is in N position (combination meter sends via CAN)	ON
ENGINE STATE	Engine stopped	STOP
	While the engine stalls	STALL
	At engine cranking	CRANK
	Engine running	RUN
VEH SPEED 1	While driving	Equivalent to speedometer reading
VEH SPEED 2	While driving	Equivalent to speedometer reading
DR DOOR STATE	Front door LH LOCK status	LOCK
	Wait with selective UNLOCK operation (5 seconds)	READY
	Front door LH UNLOCK status	UNLK
AS DOOR STATE	Front door RH LOCK status	LOCK
	Wait with selective UNLOCK operation (5 seconds)	READY
	Front door RH UNLOCK status	UNLK
ID OK FLAG	Ignition switch ACC or ON	RESET
	Ignition switch OFF	SET
PRMT ENG STAT	When the hybrid system start is prohibited	RESET
	When the hybrid system start is permitted	SET
KEY SW -SLOT	When Intelligent Key is not inserted into key slot	OFF
	When Intelligent Key is inserted into key slot	ON
RKE OPE COUN1	During the operation of Intelligent Key	Operation frequency of Intelligent Key

BCM (BODY CONTROL MODULE)

< ECU DIAGNOSIS >

[BCM]

Monitor Item	Condition	Value/Status	
AIR PRESS FL	Ignition switch ON (only when the signal from the transmitter is received)	Air pressure of front LH tire	A
AIR PRESS FR	Ignition switch ON (only when the signal from the transmitter is received)	Air pressure of front RH tire	B
AIR PRESS RR	Ignition switch ON (only when the signal from the transmitter is received)	Air pressure of rear RH tire	C
AIR PRESS RL	Ignition switch ON (only when the signal from the transmitter is received)	Air pressure of rear LH tire	C
ID REGST FL1	When ID of front LH tire transmitter is registered (refer to WT-6. "ID Registration Procedure")	DONE	D
	When ID of front LH tire transmitter is not registered (refer to WT-6. "ID Registration Procedure")	YET	D
ID REGST FR1	When ID of front RH tire transmitter is registered (refer to WT-6. "ID Registration Procedure")	DONE	E
	When ID of front RH tire transmitter is not registered (refer to WT-6. "ID Registration Procedure")	YET	F
ID REGST RR1	When ID of rear RH tire transmitter is registered (refer to WT-6. "ID Registration Procedure")	DONE	G
	When ID of rear RH tire transmitter is not registered (refer to WT-6. "ID Registration Procedure")	YET	G
ID REGST RL1	When ID of rear LH tire transmitter is registered (refer to WT-6. "ID Registration Procedure")	DONE	H
	When ID of rear LH tire transmitter is not registered (refer to WT-6. "ID Registration Procedure")	YET	H
WARNING LAMP	Tire pressure indicator OFF	OFF	I
	Tire pressure indicator ON	ON	I
BUZZER	Tire pressure warning alarm is not sounding	OFF	J
	Tire pressure warning alarm is sounding	ON	J

A
B
C
D
E
F
G
H
I
J
K
L

BCS

N
O
P

BCM (BODY CONTROL MODULE)

< ECU DIAGNOSIS >

[BCM]

Terminal Layout

INFOID:000000005438946

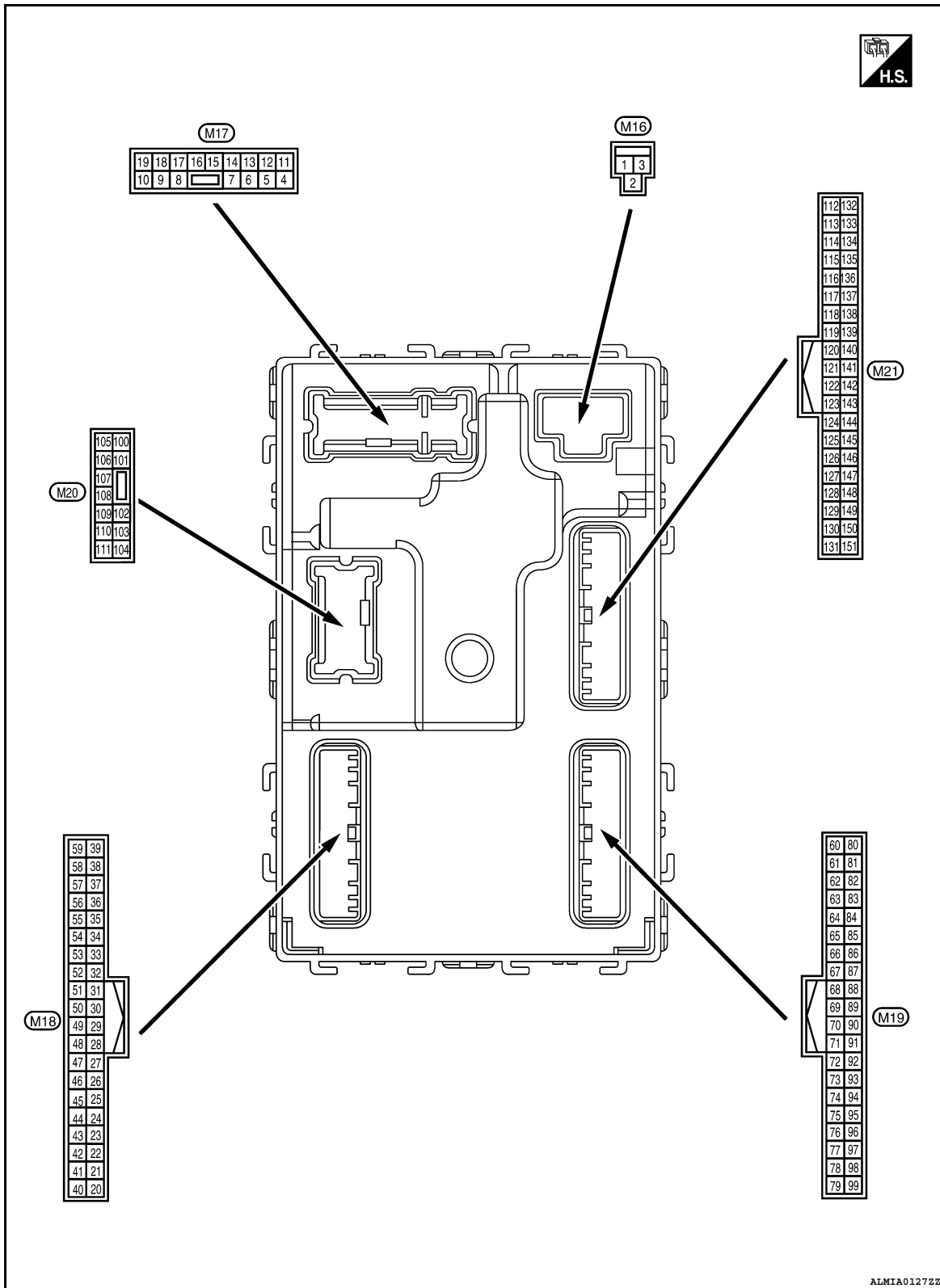

Physical Values

INFOID:000000005438947

BCM (BODY CONTROL MODULE)

< ECU DIAGNOSIS >

[BCM]

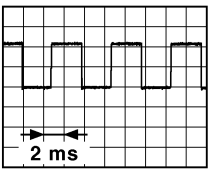
Terminal No. (Wire color)		Description		Condition		Value (Approx.)
(+)	(-)					
1 (W/B)	Ground	Battery power supply	Input	Ignition switch OFF		Battery voltage
2 (R/Y)	Ground	Battery power supply output	Output	Ignition switch OFF		Battery voltage
3 (L/W)	Ground	Ignition power supply output	Output	Ignition switch ON		Battery voltage
4 (P/W)	Ground	Interior room lamp power supply	Output	After passing the interior room lamp battery saver operation time		0V
				Any other time after passing the interior room lamp battery saver operation time		Battery voltage
5 (G/Y)	Ground	Front door RH UNLOCK	Output	Front door RH	UNLOCK (actuator is activated)	Battery voltage
					Other than UNLOCK (actuator is not activated)	0V
7 (R/W)	Ground	Step lamp	Output	Room lamp timer	ON	Battery voltage
					OFF	0V
8 (V)	Ground	All doors LOCK	Output	All doors	LOCK (actuator is activated)	Battery voltage
					Other than LOCK (actuator is not activated)	0V
9 (G)	Ground	Front door LH UNLOCK	Output	Front door LH	UNLOCK (actuator is activated)	Battery voltage
					Other than UNLOCK (actuator is not activated)	0V
10 (G/Y)	Ground	Rear door RH and rear door LH UNLOCK	Output	Rear door RH and rear door LH	UNLOCK (actuator is activated)	Battery voltage
					Other than UNLOCK (actuator is not activated)	0V
11 (Y/R)	Ground	Battery power supply	Input	Ignition switch OFF		Battery voltage
13 (B)	Ground	Ground	—	Ignition switch ON		0V
14 (R/Y)	Ground	Push-button ignition switch illumination ground	Input	Tail lamp	OFF	0V
					ON	<p>NOTE: When the illumination brightening/dimming level is in the neutral position</p>  <p style="text-align: right; font-size: small;">JSN1A0010GB</p>
15 (Y/L)	Ground	ACC indicator lamp	Output	Ignition switch	OFF	Battery voltage
					ACC	0V

A
B
C
D
E
F
G
H
I
J
K
L
N
O
P

BCS

BCM (BODY CONTROL MODULE)

< ECU DIAGNOSIS >

[BCM]

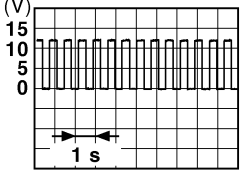
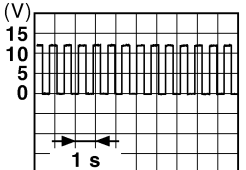
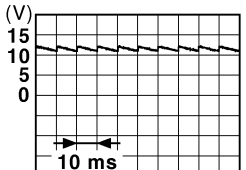
Terminal No. (Wire color)		Description		Condition		Value (Approx.)
(+)	(-)	Signal name	Input/ Output			
17 (G/B)	Ground	Turn signal (RH)	Output	Ignition switch ON	Turn signal switch OFF	0V
					Turn signal switch RH	 <p style="text-align: center;">6.5V</p>
18 (G/Y)	Ground	Turn signal (LH)	Output	Ignition switch ON	Turn signal switch OFF	0V
					Turn signal switch LH	 <p style="text-align: center;">6.5V</p>
19 (Y)	Ground	Room lamp timer control	Output	Interior room lamp	Lamps fully OFF	Battery voltage
					Lamps fully ON	0V
21 (P/B)	Ground	Optical sensor signal	Input	Ignition switch ON	When outside of the vehi- cle is bright	Close to 5V
					When outside of the vehi- cle is dark	Close to 0V
24 (R/W)	Ground	Stop lamp switch 1	Input	—	Battery voltage	
26 (O/L)	Ground	Stop lamp switch 2	Input	Stop lamp switch	OFF (brake pedal is not de- pressed)	0V
					ON (brake pedal is de- pressed)	Battery voltage
27 (G/W)	Ground	Front door lock as- sembly LH (unlock sensor)	Input	Front door LH	LOCK status	 <p style="text-align: center;">11.8V</p>
					UNLOCK status	0V
29 (Y)	Ground	Key slot switch	Input	When Intelligent Key is inserted into key slot	Battery voltage	
				When Intelligent Key is not inserted into key slot	0V	
30 (V/Y)	Ground	ACC feedback signal	Input	Ignition switch	OFF	0
				ACC or ON	Battery voltage	
31 (G)	Ground	Ignition relay-2 feed- back signal	Input	Ignition switch	OFF	0V
				ON	Battery voltage	

BCM (BODY CONTROL MODULE)

< ECU DIAGNOSIS >

[BCM]

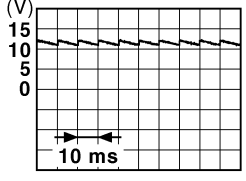
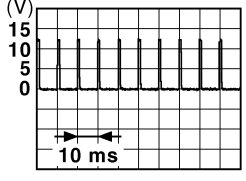
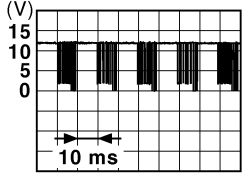
Terminal No. (Wire color)		Description		Condition		Value (Approx.)
(+)	(-)	Signal name	Input/ Output			
32 (R/B)	Ground	Front door RH switch	Input	Front door RH switch	OFF (when front door RH closes)	 <p style="text-align: right;">11.8V</p>
					ON (when front door RH opens)	0V
33 (SB)	Ground	Compressor ON signal	Input	A/C switch	OFF	Battery voltage
					ON	0V
34* (L/R)	Ground	Front door lock assembly LH (key cylinder switch) (unlock)	Input	Front door lock assembly LH (key cylinder switch)	OFF (neutral)	Battery voltage
					ON (unlock)	0V
36* (GR)	Ground	Lock switch signal	Input	Door lock/unlock switch	Lock	Battery Voltage
					Unlock	0V
37 (O)	Ground	Trunk lid opener cancel switch	Input	Trunk lid opener cancel switch	CANCEL	 <p style="text-align: right;">1.1V</p>
					ON	0V
38 (GR/W)	Ground	Rear window defogger ON signal	Input	Rear window defogger switch	OFF	Battery Voltage V
					ON	0V
39* (GR/R)	Ground	Unlock switch signal	Input	Door lock/unlock switch	Unlock	Battery Voltage
					Lock	0V
40* (Y/G)	Ground	Power window serial link	Input/ Output	Ignition switch ON	 <p style="text-align: right;">10.2V</p>	
				Ignition switch OFF or ACC	0V	
41 (W)	Ground	Push-button ignition switch illumination	Output	Engine switch (push switch) illumination	ON	5.5V
					OFF	0V
42 (R)	Ground	LOCK indicator lamp	Output	LOCK indicator lamp	ON	0V
					OFF	Battery voltage
45 (P)	Ground	Receiver & sensor ground	Input	Ignition switch ON	0V	

A
B
C
D
E
F
G
H
I
J
K
L



BCS

N
O
P

BCM (BODY CONTROL MODULE)

[BCM]

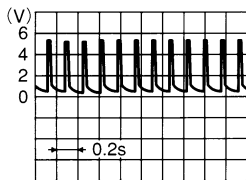
< ECU DIAGNOSIS >

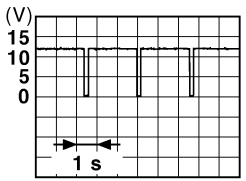
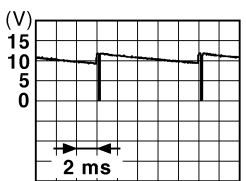
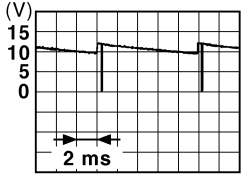
Terminal No. (Wire color)		Description		Condition	Value (Approx.)	
		Signal name	Input/ Output			
(+)	(-)					
46 (V/W)	Ground	Receiver & sensor power supply output	Output	Ignition switch	OFF	0V
					ACC or ON	5.0V
47 (G/O)	Ground	Tire pressure receiver signal	Input/ Output	Ignition switch ON	Standby state	 OCC3881D
					When receiving the signal from the transmitter	 OCC3880D
48 (R/B)	Ground	Selector lever P/N position signal	Input	Selector lever	P or N position	12.0V
					Except P and N positions	0V
49 (L/O)	Ground	Security indicator signal	Output	Security indicator	Blinking	 JPMIA0014GB 11.3V
					OFF	Battery voltage
50 (LG/ B)	Ground	Combination switch OUTPUT 5	Output	Combination switch (Wiper intermittent dial 4)	All switch OFF	 JPMIA0031GB 10.7V
					Lighting switch 1ST	
					Lighting switch high-beam	
					Lighting switch 2ND	
				Turn signal switch RH		
51 (L/W)	Ground	Combination switch OUTPUT 1	Output	Combination switch	All switch OFF (Wiper intermittent dial 4)	 JPMIA0032GB 10.7V
					Front wiper switch HI (Wiper intermittent dial 4)	
					Any of the conditions below with all switch OFF <ul style="list-style-type: none"> • Wiper intermittent dial 1 • Wiper intermittent dial 2 • Wiper intermittent dial 3 • Wiper intermittent dial 6 • Wiper intermittent dial 7 	

BCM (BODY CONTROL MODULE)

< ECU DIAGNOSIS >

[BCM]

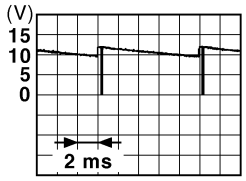
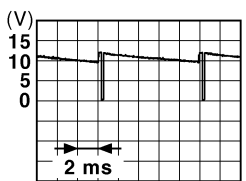
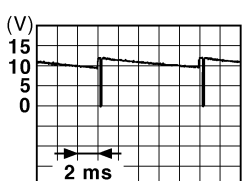
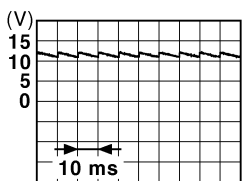
Terminal No. (Wire color)		Description		Condition	Value (Approx.)
(+)	(-)	Signal name	Input/ Output		
52 (G/B)	Ground	Combination switch OUTPUT 2	Output	Combination switch	All switch OFF (Wiper intermittent dial 4)
				Combination switch	Front washer switch ON (Wiper intermittent dial 4)
				Combination switch	Any of the conditions below with all switch OFF <ul style="list-style-type: none"> • Wiper intermittent dial 1 • Wiper intermittent dial 5 • Wiper intermittent dial 6
					 <p style="text-align: right; margin-right: 50px;">10.7V</p>
53 (LG/R)	Ground	Combination switch OUTPUT 3	Output	Combination switch (Wiper intermittent dial 4)	All switch OFF
				Combination switch (Wiper intermittent dial 4)	Front wiper switch INT
				Combination switch (Wiper intermittent dial 4)	Front wiper switch LO
				Combination switch (Wiper intermittent dial 4)	Lighting switch AUTO
					 <p style="text-align: right; margin-right: 50px;">10.7V</p>
54 (G/Y)	Ground	Combination switch OUTPUT 4	Output	Combination switch (Wiper intermittent dial 4)	All switch OFF
				Combination switch (Wiper intermittent dial 4)	Lighting switch flash-to-pass
				Combination switch (Wiper intermittent dial 4)	Turn signal switch LH
					 <p style="text-align: right; margin-right: 50px;">10.7V</p>
55 (BR/W)	Ground	Front blower monitor	Input	Front blower motor switch	ON
				Front blower motor switch	OFF
					Battery voltage
56 (L/B)	Ground	Front door lock assembly LH (key cylinder switch) (lock)	Input	Front door lock assembly LH (key cylinder switch)	OFF (neutral)
				Front door lock assembly LH (key cylinder switch)	ON (lock)
					Battery voltage
57 (W)	Ground	Tire pressure warning check switch	Input	—	Battery voltage
58 (SB)	Ground	Front door LH switch	Input	Front door LH switch	OFF (front door LH CLOSE)
				Front door LH switch	ON (front door LH OPEN)
					 <p style="text-align: right; margin-right: 50px;">11.8V</p>
59 (G/R)	Ground	Rear window defogger relay	Output	Rear window defogger	Active
				Rear window defogger	Not activated
					Battery voltage
					0V

A
B
C
D
E
F
G
H
I
J
K
L
N
O
P

BCS

BCM (BODY CONTROL MODULE)

< ECU DIAGNOSIS >

[BCM]

Terminal No. (Wire color)		Description		Condition	Value (Approx.)
(+)	(-)	Signal name	Input/ Output		
60 (B/R)	Ground	Front console antenna 2 (-)	Output	Ignition switch OFF	<p style="text-align: right; font-size: small;">JMKIA0062GB</p>
				When Intelligent Key is not in the passenger compartment	<p style="text-align: right; font-size: small;">JMKIA0063GB</p>
61 (W/R)	Ground	Center console antenna 2 (+)	Output	Ignition switch OFF	<p style="text-align: right; font-size: small;">JMKIA0062GB</p>
				When Intelligent Key is not in the passenger compartment	<p style="text-align: right; font-size: small;">JMKIA0063GB</p>
62 (B/Y)	Ground	Front outside handle RH antenna (-)	Output	When the front door RH request switch is operated with ignition switch OFF	<p style="text-align: right; font-size: small;">JMKIA0062GB</p>
				When Intelligent Key is not in the antenna detection area	<p style="text-align: right; font-size: small;">JMKIA0063GB</p>

BCM (BODY CONTROL MODULE)

< ECU DIAGNOSIS >

[BCM]

Terminal No. (Wire color)		Description		Condition	Value (Approx.)
(+)	(-)	Signal name	Input/ Output		
63 (LG)	Ground	Front outside handle RH antenna (+)	Output	When Intelligent Key is in the antenna detection area	
				When the front door RH request switch is operat- ed with ignition switch OFF	
64 (V)	Ground	Front outside handle LH antenna (-)	Output	When Intelligent Key is in the antenna detection area	
				When the front door LH request switch is operat- ed with ignition switch OFF	
65 (P)	Ground	Front outside handle LH antenna (+)	Output	When Intelligent Key is in the antenna detection area	
				When the front door LH request switch is operat- ed with ignition switch OFF	

A
B
C
D
E
F
G
H
I
J
K
L

BCS

N
O
P

BCM (BODY CONTROL MODULE)

< ECU DIAGNOSIS >

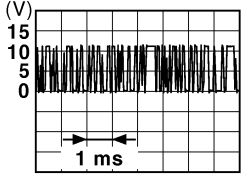
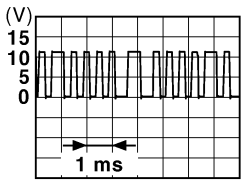
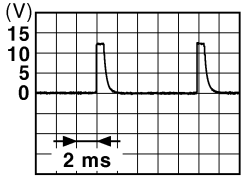
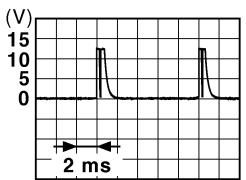
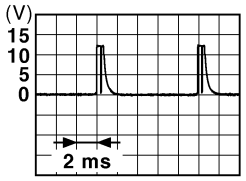

[BCM]

Terminal No. (Wire color)		Description		Condition		Value (Approx.)
(+)	(-)	Signal name	Input/ Output			
68 (G/O)	Ground	NATS antenna amp (built in key slot)	Input/ Output	During waiting	Ignition switch is pressed while inserting the Intelli- gent Key into the key slot.	Just after pressing ignition switch. Pointer of tester should move.
69 (O)	Ground	NATS antenna amp (built in key slot)	Input/ Output	During waiting	Ignition switch is pressed while inserting the Intelli- gent Key into the key slot.	Just after pressing ignition switch. Pointer of tester should move.
70 (R/B)	Ground	Ignition relay-2 con- trol	Output	Ignition switch	OFF or ACC ON	0V Battery voltage
71 (L/O)	Ground	Remote keyless entry receiver signal	Input/ Output	During waiting		 <p style="text-align: right; font-size: small;">JMKIA0064GB</p>
				When operating either button on Intelligent Key		 <p style="text-align: right; font-size: small;">JMKIA0065GB</p>
75 (R/Y)	Ground	Combination switch INPUT 5	Input	Combination switch	All switch OFF (Wiper intermittent dial 4)	 <p style="text-align: right; font-size: small;">JPMIA0041GB</p> <p style="text-align: center;">1.4V</p>
					Wiper intermittent dial 4	 <p style="text-align: right; font-size: small;">JPMIA0037GB</p> <p style="text-align: center;">1.3V</p>
					Any of the conditions below with all switch OFF • Wiper intermittent dial 1 • Wiper intermittent dial 2 • Wiper intermittent dial 6 • Wiper intermittent dial 7	 <p style="text-align: right; font-size: small;">JPMIA0040GB</p> <p style="text-align: center;">1.3V</p>

BCM (BODY CONTROL MODULE)

< ECU DIAGNOSIS >

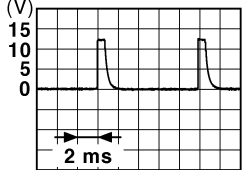
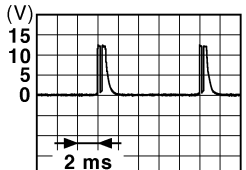
[BCM]

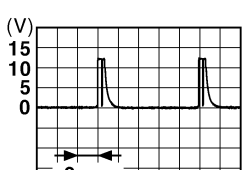
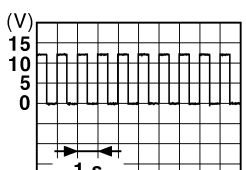
Terminal No. (Wire color)		Description		Condition	Value (Approx.)
(+)	(-)	Signal name	Input/ Output		
76 (R/G)	Ground	Combination switch INPUT 3	Input	Combination switch	All switch OFF (Wiper intermittent dial 4) <div style="text-align: right;">  <p style="font-size: small; margin: 0;">JPMIA0041GB</p> <p style="margin: 0;">1.4V</p> </div>
				Lighting switch high-beam (Wiper intermittent dial 4)	<div style="text-align: right;">  <p style="font-size: small; margin: 0;">JPMIA0036GB</p> <p style="margin: 0;">1.3V</p> </div>
				Lighting switch 2ND (Wiper intermittent dial 4)	<div style="text-align: right;">  <p style="font-size: small; margin: 0;">JPMIA0037GB</p> <p style="margin: 0;">1.3V</p> </div>
				Any of the conditions below with all switch OFF	<div style="text-align: right;">  <p style="font-size: small; margin: 0;">JPMIA0040GB</p> <p style="margin: 0;">1.3V</p> </div> <ul style="list-style-type: none"> • Wiper intermittent dial 1 • Wiper intermittent dial 2 • Wiper intermittent dial 3
78 (P)	Ground	CAN-L	Input/ Output	—	—
79 (L)	Ground	CAN-H	Input/ Output	—	—
80 (R/L)	Ground	Key slot illumination	Output	Key slot illumina- tion	OFF Blinking <div style="text-align: right;">  <p style="font-size: small; margin: 0;">JPMIA0015GB</p> <p style="margin: 0;">6.5V</p> </div>
				ON	Battery voltage
81 (LG)	Ground	ON indicator lamp	Output	Ignition switch	OFF or ACC ON
				ON	0V

A
B
C
D
E
F
G
H
I
J
K
L
N
O
P

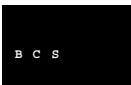

BCM (BODY CONTROL MODULE)

< ECU DIAGNOSIS >



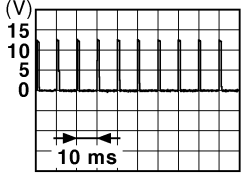
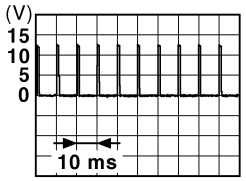

[BCM]

Terminal No. (Wire color)		Description		Condition		Value (Approx.)
		Signal name	Input/ Output			
(+)	(-)					
83 (L)	Ground	ACC relay control	Output	Ignition switch	OFF	0V
					ACC or ON	Battery voltage
84 (Y/R)	Ground	CTV shift selector (detent switch)	Output	—		Battery voltage
87 (G/B)	Ground	CTV shift selector (detent switch)	Input	Selector lever	P position	0V
					Any position other than P	Battery voltage
88 (P/L)	Ground	Front door RH re- quest switch	Input	Front door RH re- quest switch	ON (pressed)	0V
					OFF (not pressed)	 <p style="text-align: right; margin-right: 50px;">1.0V</p> <p style="text-align: right; font-size: small;">JPMIA0016GB</p>
89 (B/W)	Ground	Front door LH re- quest switch	Input	Front door LH re- quest switch	ON (pressed)	0V
					OFF (not pressed)	 <p style="text-align: right; margin-right: 50px;">1.0V</p> <p style="text-align: right; font-size: small;">JPMIA0016GB</p>
90 (Y)	Ground	Front blower motor relay control	Output	Ignition switch	OFF or ACC	0V
					ON	Battery voltage
91 (L/R)	Ground	Remote keyless entry receiver power sup- ply	Output	Ignition switch OFF		Battery voltage

BCM (BODY CONTROL MODULE)

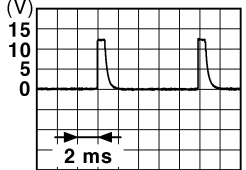
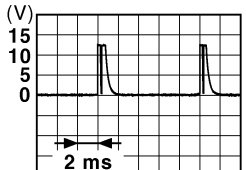
< ECU DIAGNOSIS >

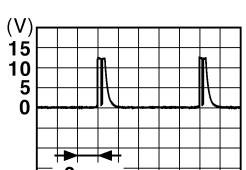
[BCM]

Terminal No. (Wire color)		Description		Condition	Value (Approx.)
(+)	(-)	Signal name	Input/ Output		
95 (R/W)	Ground	Combination switch INPUT 1	Input	All switch OFF	 1.4V
				Turn signal switch LH	 1.3V
				Turn signal switch RH	 1.3V
				Front wiper switch LO	 1.3V
				Front washer switch ON	 1.3V

A
B
C
D
E
F
G
H
I
J
K
L
N
O
P

BCS

BCM (BODY CONTROL MODULE)

< ECU DIAGNOSIS >



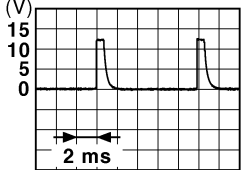
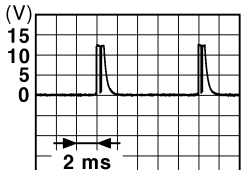
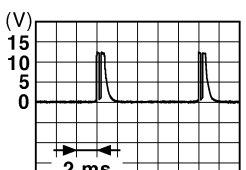
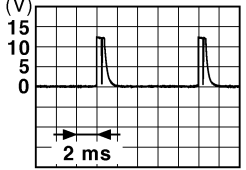

[BCM]

Terminal No. (Wire color)		Description		Condition	Value (Approx.)
(+)	(-)	Signal name	Input/ Output		
96 (P/B)	Ground	Combination switch INPUT 4	Input	Combination switch	All switch OFF (Wiper intermittent dial 4)  <p style="text-align: right; font-size: small;">JPMIA0041GB</p> <p style="text-align: center;">1.4V</p>
					Lighting switch AUTO (Wiper intermittent dial 4)  <p style="text-align: right; font-size: small;">JPMIA0038GB</p> <p style="text-align: center;">1.3V</p>
					Lighting switch 1ST (Wiper intermittent dial 4)  <p style="text-align: right; font-size: small;">JPMIA0036GB</p> <p style="text-align: center;">1.3V</p>
					Any of the conditions below with all switch OFF <ul style="list-style-type: none"> • Wiper intermittent dial 1 • Wiper intermittent dial 5 • Wiper intermittent dial 6  <p style="text-align: right; font-size: small;">JPMIA0039GB</p> <p style="text-align: center;">1.3V</p>

BCM (BODY CONTROL MODULE)

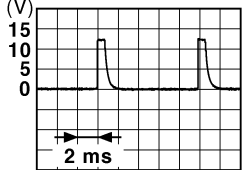
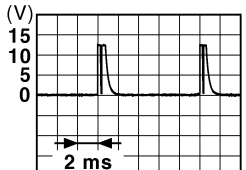
< ECU DIAGNOSIS >

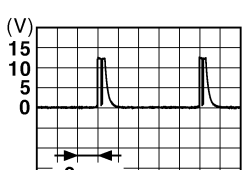
[BCM]

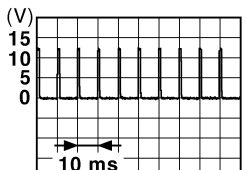
Terminal No. (Wire color)		Description		Condition	Value (Approx.)	
(+)	(-)	Signal name	Input/ Output			
97 (R/B)	Ground	Combination switch INPUT 2	Input	Combination switch (Wiper intermittent dial 4)	All switch OFF	 1.4V
					Lighting switch flash-to-pass	 1.3V
					Lighting switch 2ND	 1.3V
					Front wiper switch INT	 1.3V
					Front wiper switch HI	 1.3V
					Pressed	0 V
98 (G/O)	Ground	Hazard switch	Input	Hazard switch	Not pressed	 1.1V

A
B
C
D
E
F
G
H
I
J
K
L
N
O
P

BCS

BCM (BODY CONTROL MODULE)

< ECU DIAGNOSIS >

[BCM]

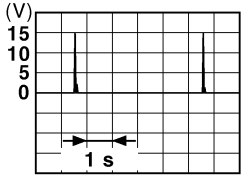
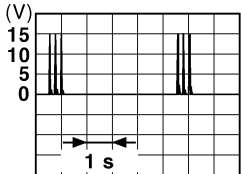
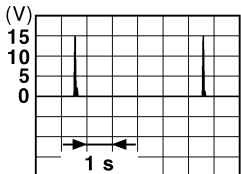
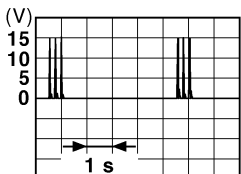
Terminal No. (Wire color)		Description		Condition		Value (Approx.)
(+)	(-)	Signal name	Input/ Output			
103 (V)	Ground	Trunk lid opening	Output	Trunk lid	Open (trunk lid opener actuator is activated)	Battery voltage
					Close (trunk lid opener actuator is not activated)	0V
110 (V/W)	Ground	Trunk room lamp	Output	Trunk room lamp	ON	0V
					OFF	Battery voltage
114 (B)	Ground	Trunk room antenna 1 (-)	Output	Ignition switch OFF	When Intelligent Key is in the passenger compartment	 <p style="text-align: right; font-size: small;">JMKIA0062GB</p>
					When Intelligent Key is not in the passenger compartment	 <p style="text-align: right; font-size: small;">JMKIA0063GB</p>
115 (W)	Ground	Trunk room antenna 1 (+)	Output	Ignition switch OFF	When Intelligent Key is in the passenger compartment	 <p style="text-align: right; font-size: small;">JMKIA0062GB</p>
					When Intelligent Key is not in the passenger compartment	 <p style="text-align: right; font-size: small;">JMKIA0063GB</p>

BCM (BODY CONTROL MODULE)

< ECU DIAGNOSIS >

[BCM]

Terminal No. (Wire color)		Description		Condition	Value (Approx.)	
		Signal name	Input/ Output			
(+)	(-)					
118 (L/O)	Ground	Rear bumper antenna (-)	Output	When the trunk lid request switch is operated with ignition switch OFF	When Intelligent Key is in the antenna detection area	<p style="text-align: right; font-size: small;">JMKIA0062GB</p>
				When Intelligent Key is not in the antenna detection area	<p style="text-align: right; font-size: small;">JMKIA0063GB</p>	
119 (BR/W)	Ground	Rear bumper antenna (+)	Output	When the trunk lid request switch is operated with ignition switch OFF	When Intelligent Key is in the antenna detection area	<p style="text-align: right; font-size: small;">JMKIA0062GB</p>
				When Intelligent Key is not in the antenna detection area	<p style="text-align: right; font-size: small;">JMKIA0063GB</p>	
127 (BR/W)	Ground	Ignition relay (IPDM E/R) control	Output	Ignition switch	OFF or ACC	Battery voltage
					ON	0V
130 (Y/G)	Ground	Trunk room lamp switch	Input	Trunk room lamp switch	OFF (trunk is closed)	<p style="text-align: right; font-size: small;">JPMIA0011GB</p> <p style="text-align: center;">11.8V</p>
					ON (trunk is open)	0V
132 (R)	Ground	Start signal	Output	Ignition switch ON	When selector lever is in P or N position and the brake peddle is not depressed	0V
					When selector lever is in P or N position and the brake peddle is depressed	Battery voltage

A
B
C
D
E
F
G
H
I
J
K
L

BCS

N
O
P

BCM (BODY CONTROL MODULE)

< ECU DIAGNOSIS >

[BCM]

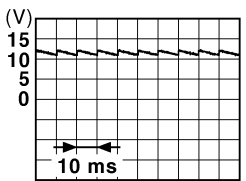
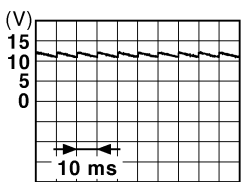
Terminal No. (Wire color)		Description		Condition	Value (Approx.)	
		Signal name	Input/ Output			
(+)	(-)					
140 (BR)	Ground	Push-button ignition switch	Input	Engine switch (push switch)	Pressed	0V
					Not pressed	Battery voltage
141 (G/R)	Ground	Trunk request switch	Input	Trunk request switch	ON (pressed)	0V
						OFF (not pressed)
144 (GR)	Ground	Request switch buzzer	Output	Request switch buzzer	Sounding	0V
					Not sounding	Battery voltage
147 (L/R)	Ground	Trunk lid opener switch	Input	Trunk lid opener switch	Pressed	0V
						Not pressed
148 (R/W)	Ground	Rear door RH switch	Input	Rear door RH switch	OFF (when rear door RH closes)	 <p style="text-align: center;">11.8V</p>
						ON (when rear door RH opens)
149 (R/B)	Ground	Rear door LH switch	Input	Rear door LH switch	OFF (when rear door LH closes)	 <p style="text-align: center;">11.8V</p>
						ON (when rear door LH opens)

*: With LH and RH front window anti-pinch system

Fail Safe

INFOID:000000005438949

Display contents of CONSULT	Fail-safe	Cancellation
B2190: NATS ANTENNA AMP	Inhibit hybrid system cranking	Erase DTC
B2191: DIFFERENCE OF KEY	Inhibit hybrid system cranking	Erase DTC
B2192: ID DISCORD BCM-ECM	Inhibit hybrid system cranking	Erase DTC
B2193: CHAIN OF BCM-ECM	Inhibit hybrid system cranking	Erase DTC

BCM (BODY CONTROL MODULE)

< ECU DIAGNOSIS >

[BCM]

Display contents of CONSULT	Fail-safe	Cancellation
B2195: ANTI-SCANNING	Inhibit hybrid system cranking	Erase DTC
B2562: LOW VOLTAGE	Inhibit hybrid system cranking	100 ms after the power supply voltage increases to more than 8.8 V
B2563: HI VOLTAGE	Inhibit hybrid system cranking	500 ms after the power supply voltage decreases to less than 18 V
B260A: IGNITION RELAY	Inhibit hybrid system cranking	500 ms after the following conditions are fulfilled <ul style="list-style-type: none"> IGN relay (IPDM E/R) control signal: OFF (Battery voltage) Ignition ON signal (CAN to IPDM E/R): OFF (Request signal) Ignition ON signal (CAN from IPDM E/R): OFF (Condition signal)
B260F: ENG STATE SIG LOST	Maintains the power supply position attained at the time of DTC detection	When any of the following conditions is fulfilled <ul style="list-style-type: none"> Power position changes to ACC Receives hybrid system status signal (CAN)
B2617: STARTER RELAY CIRC	Inhibit hybrid system cranking	1 second after the starter motor relay control inside BCM becomes normal
B2618: BCM	Inhibit hybrid system cranking	1 second after the ignition relay (IPDM E/R) control inside BCM becomes normal
B261E: VEHICLE TYPE	Inhibit hybrid system cranking	BCM initialization
B26E1: ENG STATE NO RECIV	Inhibit hybrid system cranking	When any of the following conditions is fulfilled <ul style="list-style-type: none"> Power position changes to ACC Receives hybrid system status signal (CAN)

DTC Inspection Priority Chart

INFOID:000000005438950

If some DTCs are displayed at the same time, perform inspections one by one based on the following priority chart.

Priority	DTC
1	<ul style="list-style-type: none"> B2562: LOW VOLTAGE B2563: HI VOLTAGE B261E: VEHICLE TYPE
2	<ul style="list-style-type: none"> U1000: CAN COMM CIRCUIT U1010: CONTROL UNIT (CAN)
3	<ul style="list-style-type: none"> B2190: NATS ANTENNA AMP B2191: DIFFERENCE OF KEY B2192: ID DISCORD BCM-ECM B2193: CHAIN OF BCM-ECM B2195: ANTI SCANNING

BCS

BCM (BODY CONTROL MODULE)

< ECU DIAGNOSIS >

[BCM]

Priority	DTC
4	<ul style="list-style-type: none"> • B2553: IGNITION RELAY • B2555: STOP LAMP • B2556: PUSH-BTN IGN SW • B2557: VEHICLE SPEED • B2601: SHIFT POSITION • B2602: SHIFT POSITION • B2603: SHIFT POSI STATUS • B2604: TRANSMISSION RANGE SWITCH • B260A: IGNITION RELAY • B260F: ENG STATE SIG LOST • B2611: ACC RELAY • B2614: ACC RELAY CIRC • B2615: BLOWER RELAY CIRC • B2616: IGN RELAY CIRC • B2617: STARTER RELAY CIRC • B2618: BCM • B261A: PUSH-BTN IGN SW • B261E: VEHICLE TYPE • B26E1: ENG STATE NO RECIV • B26EA: KEY REGISTRATION • C1729: VHCL SPEED SIG ERR • U0415: VEHICLE SPEED SIG
5	<ul style="list-style-type: none"> • C1704: LOW PRESSURE FL • C1705: LOW PRESSURE FR • C1706: LOW PRESSURE RR • C1707: LOW PRESSURE RL • C1708: [NO DATA] FL • C1709: [NO DATA] FR • C1710: [NO DATA] RR • C1711: [NO DATA] RL • C1712: [CHECKSUM ERR] FL • C1713: [CHECKSUM ERR] FR • C1714: [CHECKSUM ERR] RR • C1715: [CHECKSUM ERR] RL • C1716: [PRESSDATA ERR] FL • C1717: [PRESSDATA ERR] FR • C1718: [PRESSDATA ERR] RR • C1719: [PRESSDATA ERR] RL • C1720: [CODE ERR] FL • C1721: [CODE ERR] FR • C1722: [CODE ERR] RR • C1723: [CODE ERR] RL • C1724: [BATT VOLT LOW] FL • C1725: [BATT VOLT LOW] FR • C1726: [BATT VOLT LOW] RR • C1727: [BATT VOLT LOW] RL • C1734: CONTROL UNIT
6	<ul style="list-style-type: none"> • B2622: INSIDE ANTENNA • B2623: INSIDE ANTENNA

DTC Index

INFOID:000000005438951

NOTE:

- Details of time display
- CRNT: Displays when there is a malfunction now or after returning to the normal condition until turning ignition switch OFF → ON again.
- 1 - 39: Displayed if any previous malfunction is present when current condition is normal. It increases like 1 → 2 → 3...38 → 39 after returning to the normal condition whenever ignition switch OFF → ON. The counter remains at 39 even if the number of cycles exceeds it. It is counted from 1 again when turning ignition switch OFF → ON after returning to the normal condition if the malfunction is detected again.

BCM (BODY CONTROL MODULE)

< ECU DIAGNOSIS >

[BCM]

CONSULT display	Fail-safe	Intelligent Key warning lamp ON	Tire pressure monitor warning lamp ON	Reference page	
No DTC is detected. further testing may be required.	—	—	—	—	A
U1000: CAN COMM CIRCUIT	—	—	—	BCS-36	B
U1010: CONTROL UNIT (CAN)	—	—	—	BCS-37	C
U0415: VEHICLE SPEED SIG	—	—	—	BCS-38	D
B2190: NATS ANTENNA AMP	×	—	—	SEC-30	E
B2191: DIFFERENCE OF KEY	×	—	—	SEC-33	F
B2192: ID DISCORD BCM-ECM	×	—	—	SEC-34	G
B2193: CHAIN OF BCM-ECM	×	—	—	SEC-35	H
B2195: ANTI SCANNING	×	—	—	SEC-36	I
B2553: IGNITION RELAY	—	—	—	PCS-50	J
B2555: STOP LAMP	—	—	—	SEC-37	K
B2556: PUSH-BTN IGN SW	—	×	—	SEC-40	L
B2557: VEHICLE SPEED	×	×	—	SEC-42	BCS
B2562: LOW VOLTAGE	—	—	—	BCS-39	N
B2563: HI VOLTAGE	×	×	—	BCS-40	O
B2601: SHIFT POSITION	×	×	—	SEC-43	P
B2602: SHIFT POSITION	×	×	—	SEC-46	
B2603: SHIFT POSI STATUS	×	×	—	SEC-49	
B2604: TRANSMISSION RANGE SWITCH	×	×	—	SEC-52	
B260A: IGNITION RELAY	×	×	—	PCS-52	
B260F: ENG STATE SIG LOST	×	×	—	SEC-54	
B2611: ACC RELAY	—	—	—	PCS-53	
B2614: ACC RELAY CIRC	—	×	—	PCS-55	
B2615: BLOWER RELAY CIRC	—	×	—	PCS-58	
B2616: IGN RELAY CIRC	—	×	—	PCS-61	
B2617: STARTER RELAY CIRC	×	×	—	SEC-56	
B2618: BCM	×	×	—	PCS-64	
B261A: PUSH-BTN IGN SW	—	×	—	SEC-58	
B261E: VEHICLE TYPE	×	× (Turn ON for 15 seconds)	—	SEC-60	
B2622: INSIDE ANTENNA	—	—	—	DLK-55	
B2623: INSIDE ANTENNA	—	—	—	DLK-58	
B26EA: KEY REGISTRATION	×	× (Turn ON for 15 seconds)	—	SEC-55. "Description"	
C1704: LOW PRESSURE FL	—	—	×	WT-8	
C1705: LOW PRESSURE FR	—	—	×	WT-8	
C1706: LOW PRESSURE RR	—	—	×	WT-8	
C1707: LOW PRESSURE RL	—	—	×	WT-8	
C1708: [NO DATA] FL	—	—	×	WT-14	
C1709: [NO DATA] FR	—	—	×	WT-14	
C1710: [NO DATA] RR	—	—	×	WT-14	
C1711: [NO DATA] RL	—	—	×	WT-14	

BCM (BODY CONTROL MODULE)

< ECU DIAGNOSIS >

[BCM]

CONSULT display	Fail-safe	Intelligent Key warning lamp ON	Tire pressure monitor warning lamp ON	Reference page
C1712: [CHECKSUM ERR] FL	—	—	×	WT-16
C1713: [CHECKSUM ERR] FR	—	—	×	WT-16
C1714: [CHECKSUM ERR] RR	—	—	×	WT-16
C1715: [CHECKSUM ERR] RL	—	—	×	WT-16
C1716: [PRESSDATA ERR] FL	—	—	×	WT-18
C1717: [PRESSDATA ERR] FR	—	—	×	WT-18
C1718: [PRESSDATA ERR] RR	—	—	×	WT-18
C1719: [PRESSDATA ERR] RL	—	—	×	WT-18
C1720: [CODE ERR] FL	—	—	×	WT-16
C1721: [CODE ERR] FR	—	—	×	WT-16
C1722: [CODE ERR] RR	—	—	×	WT-16
C1723: [CODE ERR] RL	—	—	×	WT-16
C1724: [BATT VOLT LOW] FL	—	—	×	WT-16
C1725: [BATT VOLT LOW] FR	—	—	×	WT-16
C1726: [BATT VOLT LOW] RR	—	—	×	WT-16
C1727: [BATT VOLT LOW] RL	—	—	×	WT-16
C1729: VHCL SPEED SIG ERR	—	—	×	WT-19
C1734: CONTROL UNIT	—	—	×	WT-20

BCM (BODY CONTROL MODULE)

[BCM]

< WIRING DIAGRAM >

WIRING DIAGRAM

BCM (BODY CONTROL MODULE)

Wiring Diagram

INFOID:000000005804719

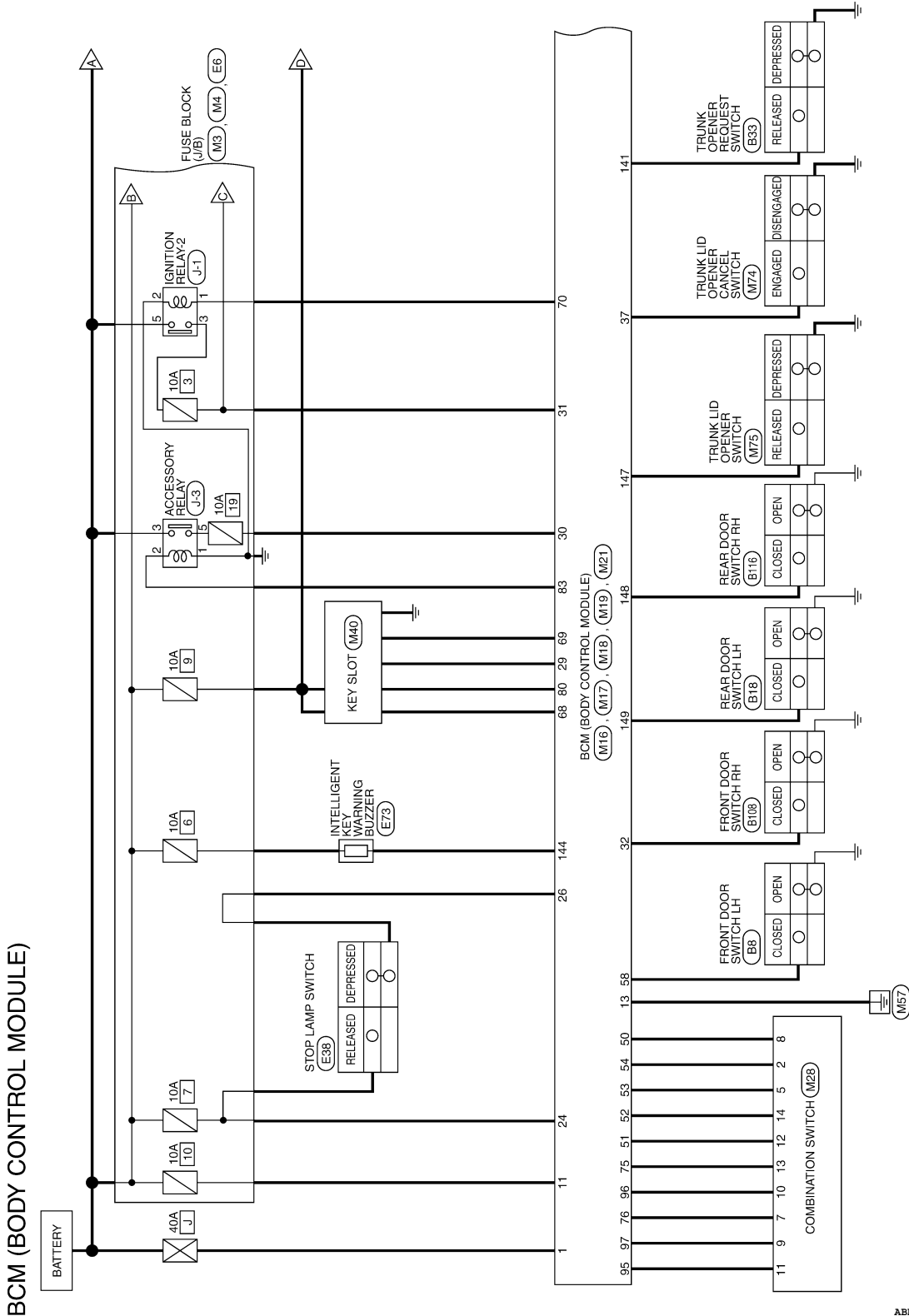

A
B
C
D
E
F
G
H
I
J
K
L
M
N
O
P

BCS

BCM (BODY CONTROL MODULE)

< WIRING DIAGRAM >

[BCM]

AL: WITH AUTO LIGHT SYSTEM

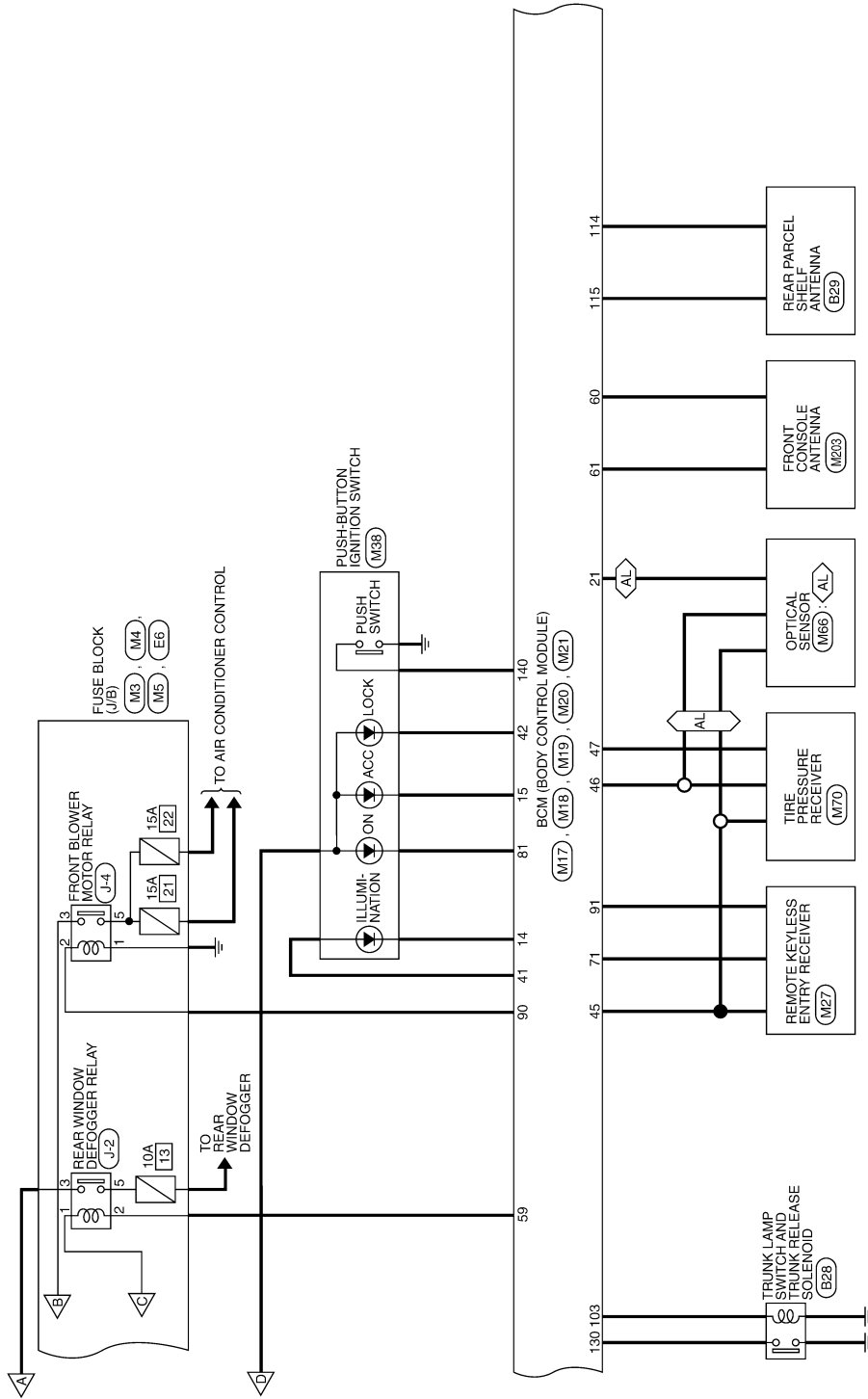

ABMWA0663GB

BCM (BODY CONTROL MODULE)

< WIRING DIAGRAM >

[BCM]

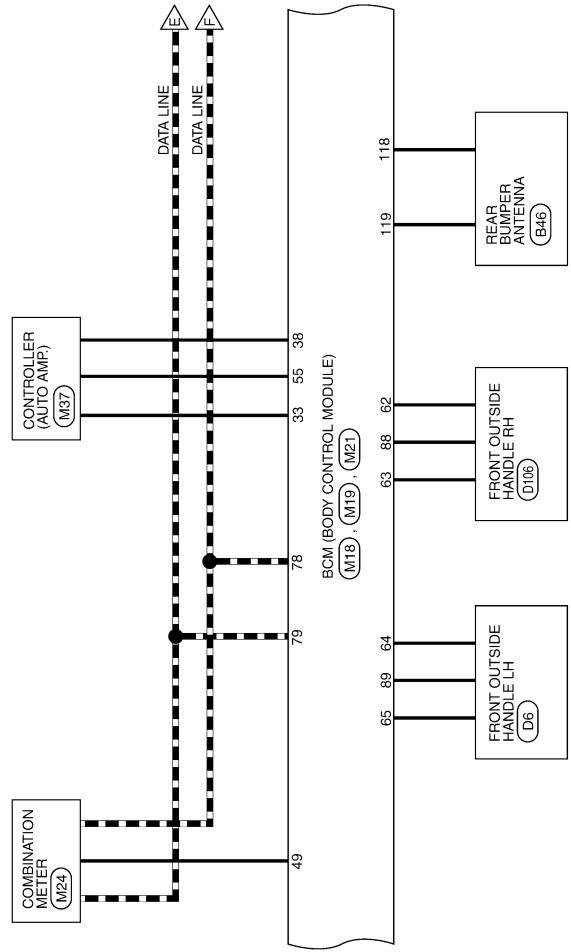

A
B
C
D
E
F
G
H
I
J
K
L
N
O
P

BCS

ABMWA0664GB

BCM (BODY CONTROL MODULE)

< WIRING DIAGRAM >

[BCM]

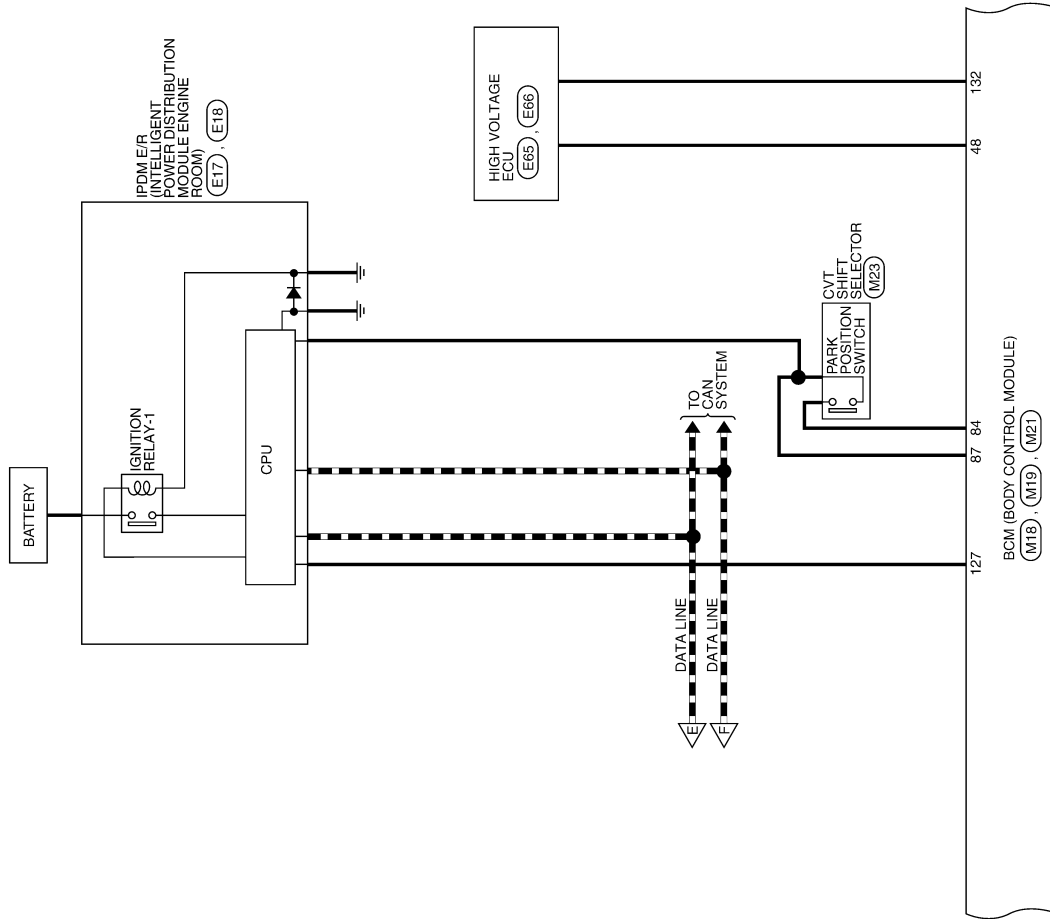

ABMWA0665GB

BCM (BODY CONTROL MODULE)

< WIRING DIAGRAM >

[BCM]

<A1> : WITH LEFT FRONT ONLY POWER WINDOW ANTI-PINCH SYSTEM
 <A2> : WITH LEFT AND RIGHT FRONT POWER WINDOW ANTI-PINCH SYSTEM

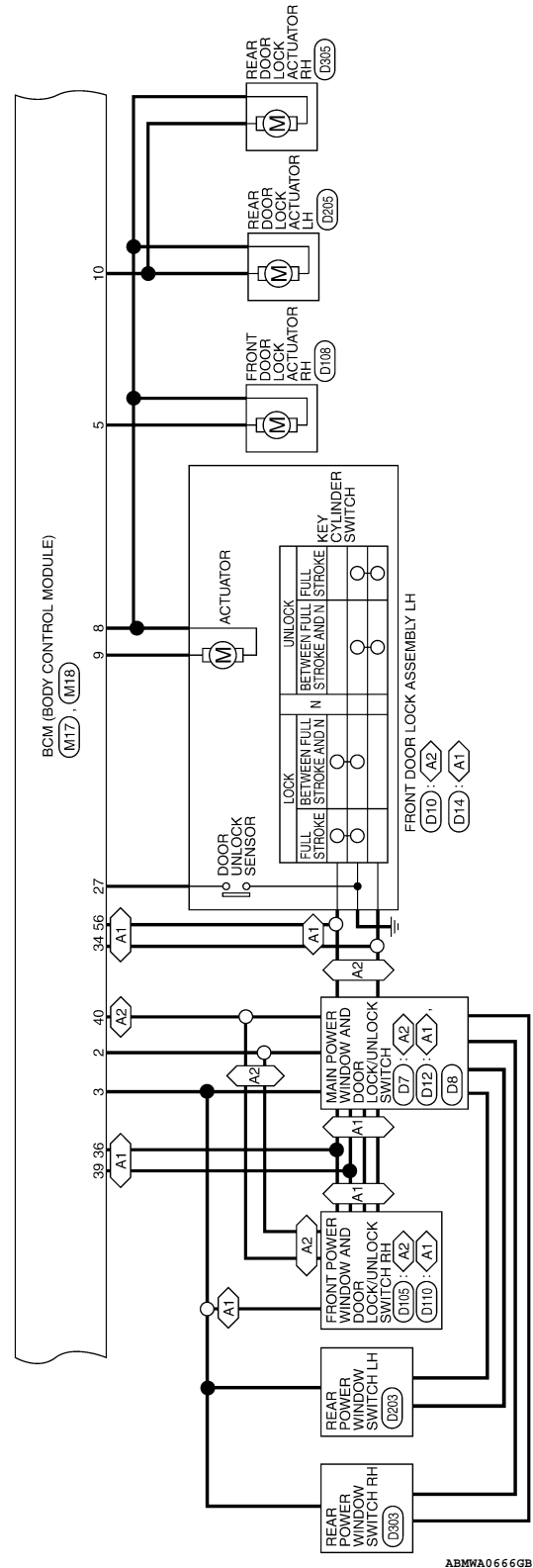

ABMWA0666GB

A
B
C
D
E
F
G
H
I
J
K
L
BCS
N
O
P

BCM (BODY CONTROL MODULE)

< WIRING DIAGRAM >

[BCM]

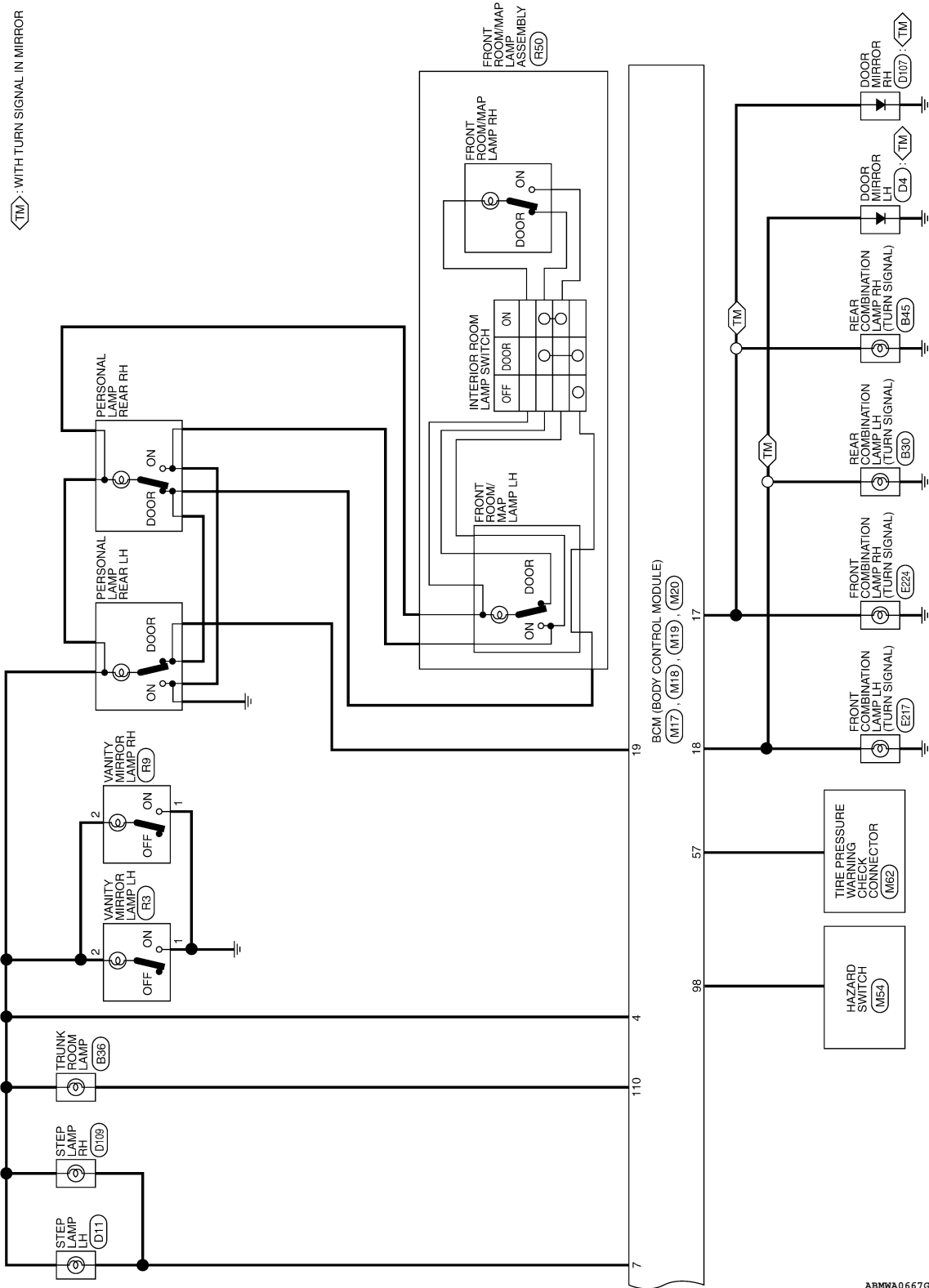

ABMWA0667GB

BCM (BODY CONTROL MODULE)

< WIRING DIAGRAM >

[BCM]

BCM (BODY CONTROL MODULE) CONNECTORS

Connector No.	M16
Connector Name	BCM (BODY CONTROL MODULE)
Connector Color	BLACK



Terminal No.	Color of Wire	Signal Name
1	W/B	BAT_POWER_F/L
2	R/Y	P/W_POWER_SUPPLY_PERM
3	L/W	POWER_WINDOW_POWER_SUPPLY (RAP)

Connector No.	M17
Connector Name	BCM (BODY CONTROL MODULE)
Connector Color	WHITE

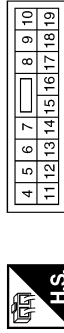

Terminal No.	Color of Wire	Signal Name
4	P/W	ROOM_LAMP_BAT_SAVER
5	G/Y	CDL_AS
6	-	-
7	G/W	STEP_LAMP_OUTPUT
8	V	CDL_COMMON

Terminal No.	Color of Wire	Signal Name
9	G	CDL_DR/FL
10	G/Y	CDL_RR_RL_BACK
11	Y/R	BAT_BCM_FUSE
12	-	-
13	B	GND1
14	R/Y	LOW_SIDE_PUSH_LED_OUTPUT
15	Y/L	ACC_LED
16	-	-
17	G/B	FR_FLASHER
18	G/Y	FL_FLASHER
19	Y	ROOM_LAMP_OUTPUT

Connector No.	M18
Connector Name	BCM (BODY CONTROL MODULE)
Connector Color	GREEN

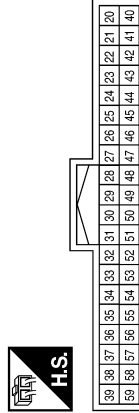

Terminal No.	Color of Wire	Signal Name
20	-	-
21	P/B	AUTO_LIGHT_SENSOR_INPUT1
22	-	-
23	-	-
24	R/W	STOP_LAMP_LOW_SW
25	-	-
26	O/L	STOP_LAMP_HIGH_SW
27	G/W	DOOR_LOCK_STATUS

Terminal No.	Color of Wire	Signal Name
28	-	-
29	Y	FOB_IN_SW_1
30	V/Y	ACC_F/B
31	G	IGN_F/B
32	R/B	AS_DOOR_SW
33	SB	AIRCON_SW
34	L/R	DOOR_KEY/C_UNLOCK_SW
35	-	-
36	GR	CENTRAL_LOCK_SW
37	O	TRUNK_CANCEL_SW
38	GR/W	REAR_DEFOGGER_SW
39	GR/R	CENTRAL_UNLOCK_SW
40	Y/G	PW_K-LINE
41	W	PUSH_LED
42	R	S/L_LOCK_LED
43	-	-
44	-	-
45	P	GND_RF2_A/L

Terminal No.	Color of Wire	Signal Name
46	V/W	A/L_SENS_KEYLESS_TUNER_POWER_SUPPLY
47	G/O	KEYLESS_TUNER_SI
48	R/B	SHIFT_N/P
49	L/O	IMMO_LED
50	LG/B	INPUT_5
51	L/W	INPUT_1
52	G/B	INPUT_2
53	LG/R	INPUT_3
54	G/Y	INPUT_4
55	BR/W	BLOWER_FAN_SW
56	L/B	DOOR_KEY/C_LOCK_SW
57	W	TPMS_MODE_TRIGGER_SW
58	SB	DR_DOOR_SW
59	G/R	REAR_DEFOGGER_RLY

A
B
C
D
E
F
G
H
I
J
K
L
M
N
O
P

BCS

ABMIA1745GB

BCM (BODY CONTROL MODULE)

< WIRING DIAGRAM >

[BCM]

Terminal No.	Color of Wire	Signal Name
82	-	-
83	L	ACC_CONT
84	Y/R	AT_DEVICE_OUT
85	-	-
86	-	-
87	G/B	SHIFT_P
88	P/L	AS_REQUEST SWITCH
89	B/W	DR_REQUEST SWITCH
90	Y	IGN2_CONT
91	L/R	RF1_POWER_SUPPLY
92	-	-
93	-	-
94	-	-
95	R/W	OUTPUT_1
96	P/B	OUTPUT_4
97	R/B	OUTPUT_2
98	G/O	HAZARD_SW
99	-	-

Terminal No.	Color of Wire	Signal Name
62	B/Y	AS_DOOR_ANT_B
63	LG	AS_DOOR_ANT_A
64	V	DR_DOOR_ANT_B
65	P	DR_DOOR_ANT_A
66	-	-
67	-	-
68	G/O	FOB_READER_CLOCK
69	O	FOB_READER_DATA
70	R/B	IGN_ELEC_CONT
71	L/O	RF1_TUNER_SIGNAL
72	-	-
73	-	-
75	R/Y	OUTPUT_5
76	R/G	OUTPUT_3
77	-	-
78	P	CAN-L
79	L	CAN-H
80	R/L	FOB_SLOT_ILLUMINATION
81	LG	IGN_ON_LED

Terminal No.	Color of Wire	Signal Name
100	-	-
101	-	-
102	-	-
103	V	CDL_BACK_TRUNK
104	-	-
105	-	-
106	-	-
107	-	-
108	-	-
109	-	-
110	V/W	TRUNK_LAMP_OUTPUT
111	-	-

Connector No.	M19
Connector Name	BCM (BODY CONTROL MODULE)
Connector Color	BLACK



79	78	77	76	75	74	73	72	71	70	69	68	67	66	65	64	63	62	61	60
99	98	97	96	95	94	93	92	91	90	89	88	87	86	85	84	83	82	81	80

Terminal No.	Color of Wire	Signal Name
60	B/R	ROOM_ANT_2_B
61	W/R	ROOM_ANT_2_A

Connector No.	M20
Connector Name	BCM (BODY CONTROL MODULE)
Connector Color	WHITE



100	101	102	103	104		
105	106	107	108	109	110	111

BCM (BODY CONTROL MODULE)

< WIRING DIAGRAM >

[BCM]

Connector No.	M21
Connector Name	BCM (BODY CONTROL MODULE)
Connector Color	GRAY

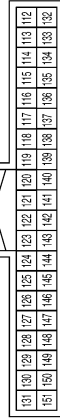

Terminal No.	Color of Wire	Signal Name
112	-	-
113	-	-
114	B	TRUNK_ANT_1_B
115	W	TRUNK_ANT_1_A
116	-	-
117	-	-
118	L/O	BACK_DOOR_ANT_B

Terminal No.	Color of Wire	Signal Name
119	BR/W	BACK_DOOR_ANT_A
120	-	-
121	-	-
122	-	-
123	-	-
124	-	-
125	-	-
126	-	-
127	BR/W	IGN_USM_CONT1
128	-	-
129	-	-
130	Y/G	TRUNK_SW
131	-	-
132	R	ST_CONT_USM
133	-	-
134	-	-
135	-	-
136	-	-
137	-	-

Terminal No.	Color of Wire	Signal Name
138	-	-
139	-	-
140	BR	ENG_START_SW_W/O_ESCL
141	G/R	TRUNK_REQUEST_SW
142	-	-
143	-	-
144	GR	BUZZER
145	-	-
146	-	-
147	L/R	BACK_TRUNK_OPENER
148	R/W	RR_DOOR_SW
149	R/B	RL_DOOR_SW
150	-	-
151	-	-

Connector No.	M28
Connector Name	COMBINATION SWITCH
Connector Color	WHITE

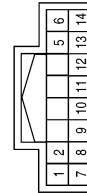

Terminal No.	Color of Wire	Signal Name
1	R/L	WASH_MTR
2	G/Y	OUTPUT_4
5	LG/R	OUTPUT_3
6	B	GND
7	R/G	INPUT_3

Terminal No.	Color of Wire	Signal Name
8	LG/B	OUTPUT_5
9	R/B	INPUT_2
10	P/B	INPUT_4
11	R/W	INPUT_1
12	L/W	OUTPUT_1
13	R/Y	INPUT_5
14	G/B	OUTPUT_2

A
B
C
D
E
F
G
H
I
J
K
L
N
O
P

BCS

COMBINATION SWITCH SYSTEM SYMPTOMS

< SYMPTOM DIAGNOSIS >

[BCM]

SYMPTOM DIAGNOSIS

COMBINATION SWITCH SYSTEM SYMPTOMS

Symptom Table

INFOID:000000005438952

1. Perform the data monitor of CONSULT-III to check for any malfunctioning item.
2. Check the malfunction combinations.

Malfunction item: ×

Malfunction combination	Data monitor item												
	FR WIPER HI	FR WIPER LOW	FR WASHER SW	FR WIPER INT	INT VOLUME	TURN SIGNAL R	TURN SIGNAL L	TAIL LAMP SW	HI BEAM SW	HEAD LAMP SW 1	HEAD LAMP SW 2	PASSING SW	AUTO LIGHT SW
A		×	×			×	×						
B	×			×						×		×	
C					×				×		×		
D					×			×					×
E					×								
F	×				×								
G			×		×								
H		×		×									×
I							×				×	×	
J						×		×	×	×			
K	All Items												
L	If only one item is detected or the item is not applicable to the combinations A to K												

3. Identify the malfunctioning part from the agreed combination and repair or replace the part.

Malfunction combination	Malfunctioning part	Repair or replace
A	Combination switch INPUT 1 circuit	Inspect the combination switch input circuit applicable to the malfunctioning part. BCS-42. "Diagnosis Procedure"
B	Combination switch INPUT 2 circuit	
C	Combination switch INPUT 3 circuit	
D	Combination switch INPUT 4 circuit	
E	Combination switch INPUT 5 circuit	
F	Combination switch OUTPUT 1 circuit	Inspect the combination switch output circuit applicable to the malfunctioning part. BCS-44. "Diagnosis Procedure"
G	Combination switch OUTPUT 2 circuit	
H	Combination switch OUTPUT 3 circuit	
I	Combination switch OUTPUT 4 circuit	
J	Combination switch OUTPUT 5 circuit	
K	BCM	Replace BCM. Refer to BCS-83. "Removal and Installation" .
L	Combination switch	Replace the combination switch. Refer to EXL-156. "Removal and Installation" .

PRECAUTION

PRECAUTIONS

Precaution for Supplemental Restraint System (SRS) "AIR BAG" and "SEAT BELT PRE-TENSIONER"

INFOID:000000005806123

The Supplemental Restraint System such as "AIR BAG" and "SEAT BELT PRE-TENSIONER", used along with a front seat belt, helps to reduce the risk or severity of injury to the driver and front passenger for certain types of collision. This system includes seat belt switch inputs and dual stage front air bag modules. The SRS system uses the seat belt switches to determine the front air bag deployment, and may only deploy one front air bag, depending on the severity of a collision and whether the front occupants are belted or unbelted. Information necessary to service the system safely is included in the SR and SB section of this Service Manual.

WARNING:

- To avoid rendering the SRS inoperative, which could increase the risk of personal injury or death in the event of a collision which would result in air bag inflation, all maintenance must be performed by an authorized NISSAN/INFINITI dealer.
- Improper maintenance, including incorrect removal and installation of the SRS, can lead to personal injury caused by unintentional activation of the system. For removal of Spiral Cable and Air Bag Module, see the SR section.
- Do not use electrical test equipment on any circuit related to the SRS unless instructed to in this Service Manual. SRS wiring harnesses can be identified by yellow and/or orange harnesses or harness connectors.

PRECAUTIONS WHEN USING POWER TOOLS (AIR OR ELECTRIC) AND HAMMERS

WARNING:

- When working near the Airbag Diagnosis Sensor Unit or other Airbag System sensors with the Ignition ON or engine running, DO NOT use air or electric power tools or strike near the sensor(s) with a hammer. Heavy vibration could activate the sensor(s) and deploy the air bag(s), possibly causing serious injury.
- When using air or electric power tools or hammers, always switch the Ignition OFF, disconnect the battery, and wait at least 3 minutes before performing any service.

A
B
C
D
E
F
G
H
I
J
K
L

BCS

N
O
P

PREPARATION

< PREPARATION >

[BCM]

PREPARATION

PREPARATION

Commercial Service Tools

INFOID:000000005438954

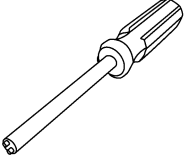
Tool name	Description
<p data-bbox="159 415 279 441">Power tools</p>  <p data-bbox="797 632 873 646">PIIB1407E</p>	<p data-bbox="1008 415 1344 441">Loosening bolts, nuts and screws</p>
<p data-bbox="159 665 402 716">One-way screw removal tool</p>  <p data-bbox="797 884 889 898">ALMIA0486ZZ</p>	<p data-bbox="1008 665 1279 690">Removing one-way screws</p>

ON-VEHICLE REPAIR

BCM (BODY CONTROL MODULE)

Removal and Installation

INFOID:000000005806134

REMOVAL

CAUTION:

Before replacing BCM, perform "READ CONFIGURATION" to save or print current vehicle specification. Refer to [BCS-6, "CONFIGURATION \(BCM\) : Special Repair Requirement"](#).

1. Disconnect the 12-volt battery negative terminal.
2. Remove the combination meter. Refer to [MWI-117, "Removal and Installation"](#).
3. Remove the BCM screws (A) using a suitable tool, and pull out the BCM (1).
4. Disconnect the BCM connector and remove the BCM (1).

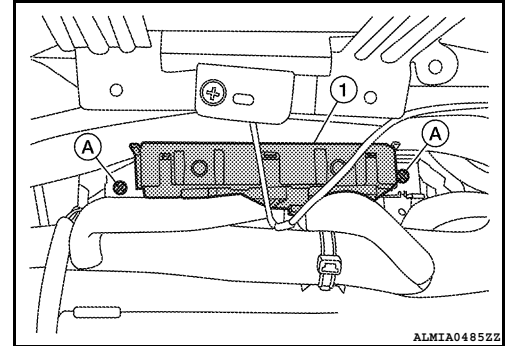

INSTALLATION

Installation is in the reverse order of removal.

CAUTION:

- When replacing BCM, perform "WRITE CONFIGURATION". Refer to [BCS-6, "CONFIGURATION \(BCM\) : Special Repair Requirement"](#).
- When replacing BCM, perform the system initialization (NATS). Refer to the CONSULT-III operation manual for the initialization procedure.
- When replacing BCM, if new BCM does not come with keyfobs attached, all existing keyfobs must be re-registered. Refer to the CONSULT-III operation manual for the initialization procedure.

A
B
C
D
E
F
G
H
I
J
K
L

BCS