

SECTION **INT**
INTERIOR

A
B
C
D
E
F
G
H
I
INT
K
L
M
N
O
P

CONTENTS

SYMPTOM DIAGNOSIS	2	DOOR FINISHER	12
SQUEAK AND RATTLE TROUBLE DIAG- NOSES	2	Exploded View	12
Work Flow	2	Removal and Installation	13
Generic Squeak and Rattle Troubleshooting	4	BODY SIDE TRIM	18
Diagnostic Worksheet	6	Exploded View	18
Clip and Fastener	7	Removal and Installation	19
PRECAUTION	10	REAR PARCEL SHELF FINISHER	22
PRECAUTIONS	10	Exploded View	22
Precaution for Supplemental Restraint System (SRS) "AIR BAG" and "SEAT BELT PRE-TEN- SIONER"	10	Removal and Installation	22
Precautions For High-Voltage System	10	FLOOR TRIM	24
Precautions	10	Exploded View	24
PREPARATION	11	Removal and Installation	24
PREPARATION	11	HEADLINING	26
Special Service Tools	11	Exploded View	26
Commercial Service Tools	11	Removal and Installation	26
ON-VEHICLE REPAIR	12	TRUNK ROOM TRIM & TRUNK LID FINISH- ER	29
		Exploded View	29
		Removal and Installation	30

SQUEAK AND RATTLE TROUBLE DIAGNOSES

< SYMPTOM DIAGNOSIS >

SYMPTOM DIAGNOSIS

SQUEAK AND RATTLE TROUBLE DIAGNOSES

Work Flow

INFOID:000000005440088

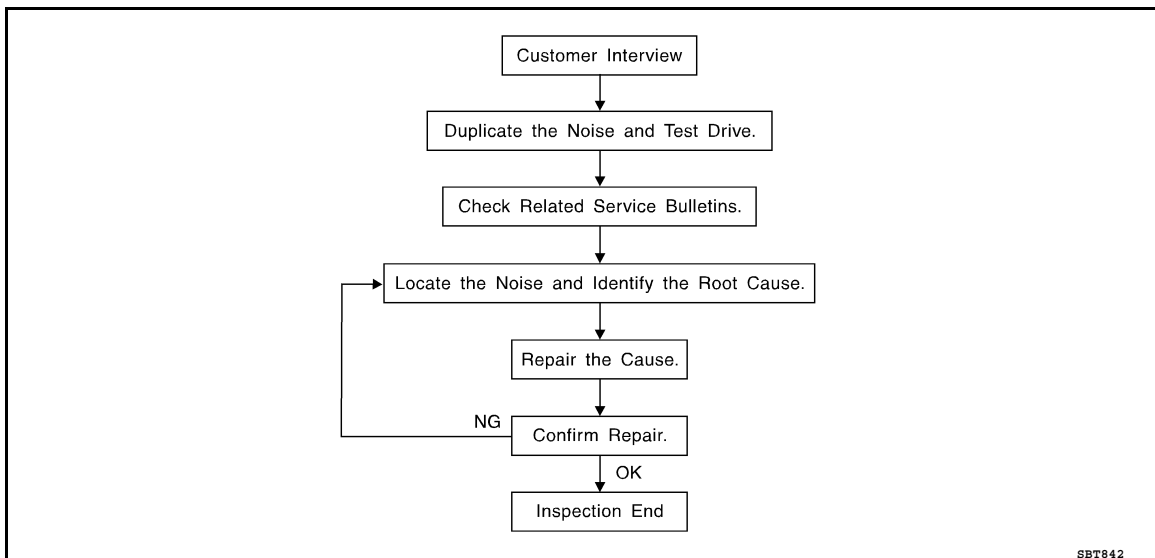

CUSTOMER INTERVIEW

Interview the customer if possible, to determine the conditions that exist when the noise occurs. Use the Diagnostic Worksheet during the interview to document the facts and conditions when the noise occurs and any customer's comments. This information is necessary to duplicate the conditions that exist when the noise occurs.

- The customer may not be able to provide a detailed descriptions or the location of the noise. Attempt to obtain all the facts and conditions that exist when the noise occurs (or does not occur).
- If there is more than one noise in the vehicle, be sure to diagnose and repair the noise that the customer is concerned about. This can be accomplished by test driving the vehicle with the customer.
- After identifying the type of noise, isolate the noise in terms of its characteristics. The noise characteristics are provided so the customer, service adviser and technician are all speaking the same language when defining the noise.
- Squeak —(Like tennis shoes on a clean floor)
Squeak characteristics include the light contact/fast movement/brought on by road conditions/hard surfaces = higher pitch noise/softer surfaces = lower pitch noises/edge to surface = chirping
- Creak—(Like walking on an old wooden floor)
Creak characteristics include firm contact/slow movement/twisting with a rotational movement/pitch dependent on materials/often brought on by activity.
- Rattle—(Like shaking a baby rattle)
Rattle characteristics include the fast repeated contact/vibration or similar movement/loose parts/missing clip or fastener/incorrect clearance.
- Knock —(Like a knock on a door)
Knock characteristics include hollow sounding/sometimes repeating/often brought on by driver action.
- Tick—(Like a clock second hand)
Tick characteristics include gentle contacting of light materials/loose components/can be caused by driver action or road conditions.
- Thump—(Heavy, muffled knock noise)
Thump characteristics include softer knock/dead sound often brought on by activity.
- Buzz—(Like a bumble bee)
Buzz characteristics include high frequency rattle/firm contact.
- Often the degree of acceptable noise level will vary depending upon the person. A noise that you may judge as acceptable may be very irritating to the customer.
- Weather conditions, especially humidity and temperature, may have a great effect on noise level.

DUPLICATE THE NOISE AND TEST DRIVE

SQUEAK AND RATTLE TROUBLE DIAGNOSES

< SYMPTOM DIAGNOSIS >

If possible, drive the vehicle with the customer until the noise is duplicated. Note any additional information on the Diagnostic Worksheet regarding the conditions or location of the noise. This information can be used to duplicate the same conditions when you confirm the repair.

If the noise can be duplicated easily during the test drive, to help identify the source of the noise, try to duplicate the noise with the vehicle stopped by doing one or all of the following:

- 1) Close a door.
 - 2) Tap or push/pull around the area where the noise appears to be coming from.
 - 3) Rev the engine.
 - 4) Use a floor jack to recreate vehicle "twist".
 - 5) At idle, apply engine load (electrical load, drive position on CVT models).
 - 6) Raise the vehicle on a hoist and hit a tire with a rubber hammer.
- Drive the vehicle and attempt to duplicate the conditions the customer states exist when the noise occurs.
 - If it is difficult to duplicate the noise, drive the vehicle slowly on an undulating or rough road to stress the vehicle body.

CHECK RELATED SERVICE BULLETINS

After verifying the customer concern or symptom, check ASIST for Technical Service Bulletins (TSBs) related to that concern or symptom.

If a TSB relates to the symptom, follow the procedure to repair the noise.

LOCATE THE NOISE AND IDENTIFY THE ROOT CAUSE

1. Narrow down the noise to a general area. To help pinpoint the source of the noise, use a listening tool (Chassis Ear: J-39570, Engine Ear and mechanics stethoscope).
2. Narrow down the noise to a more specific area and identify the cause of the noise by:
 - Removing the components in the area that you suspect the noise is coming from.
Do not use too much force when removing clips and fasteners, otherwise clips and fastener can be broken or lost during the repair, resulting in the creation of new noise.
 - Tapping or pushing/pulling the component that you suspect is causing the noise.
Do not tap or push/pull the component with excessive force, otherwise the noise will be eliminated only temporarily.
 - Feeling for a vibration with your hand by touching the component(s) that you suspect is (are) causing the noise.
 - Placing a piece of paper between components that you suspect are causing the noise.
 - Looking for loose components and contact marks.

REPAIR THE CAUSE

- If the cause is a loose component, tighten the component securely.
- If the cause is insufficient clearance between components:
 - separate components by repositioning or loosening and retightening the component, if possible.
 - insulate components with a suitable insulator such as urethane pads, foam blocks, felt cloth tape or urethane tape. A Nissan Squeak and Rattle Kit (J-43980) is available through your authorized Nissan Parts Department.

CAUTION:

Do not use excessive force as many components are constructed of plastic and may be damaged.

NOTE:

Always check with the Parts Department for the latest parts information.

The following materials are contained in the Nissan Squeak and Rattle Kit (J-43980). Each item can be ordered separately as needed.

URETHANE PADS [1.5 mm (0.059 in) thick]

Insulates connectors, harness, etc.

76268-9E005: 100 × 135 mm (3.94 × 5.31 in)/76884-71L01: 60 × 85 mm (2.36 × 3.35 in)/76884-

71L02: 15 × 25 mm (0.59 × 0.98 in)

INSULATOR (Foam blocks)

Insulates components from contact. Can be used to fill space behind a panel.

73982-9E000: 45 mm (1.77 in) thick, 50 × 50 mm (1.97 × 1.97 in)/73982-

50Y00: 10 mm (0.39 in) thick, 50 × 50 mm (1.97 × 1.97 in)

INSULATOR (Light foam block)

80845-71L00: 30 mm (1.18 in) thick, 30 × 50 mm (1.18 × 1.97in)

FELT CLOTHTAPE

Used to insulate where movement does not occur. Ideal for instrument panel applications.

68370-4B000: 15 × 25 mm (0.59 × 0.98 in) pad/68239-13E00: 5 mm (0.20 in) wide tape roll

SQUEAK AND RATTLE TROUBLE DIAGNOSES

< SYMPTOM DIAGNOSIS >

The following materials, not found in the kit, can also be used to repair squeaks and rattles.

UHMW (TEFLON) TAPE

Insulates where slight movement is present. Ideal for instrument panel applications.

SILICONE GREASE

Used in place of UHMW tape that will be visible or not fit. Will only last a few months.

SILICONE SPRAY

Use when grease cannot be applied.

DUCT TAPE

Use to eliminate movement.

CONFIRM THE REPAIR

Confirm that the cause of a noise is repaired by test driving the vehicle. Operate the vehicle under the same conditions as when the noise originally occurred. Refer to the notes on the Diagnostic Worksheet.

Generic Squeak and Rattle Troubleshooting

INFOID:000000005440089

Refer to Table of Contents for specific component removal and installation information.

INSTRUMENT PANEL

Most incidents are caused by contact and movement between:

1. Acrylic lens and combination meter housing
2. Instrument panel to front pillar finishers
3. Instrument panel to windshield
4. Instrument panel mounting pins
5. Wiring harnesses behind the combination meter
6. A/C defroster duct and duct joint

These incidents can usually be located by tapping or moving the components to duplicate the noise or by pressing on the components while driving to stop the noise. Most of these incidents can be repaired by applying felt cloth tape or silicon spray (in hard to reach areas). Urethane pads can be used to insulate wiring harness.

CAUTION:

Do not use silicone spray to isolate a squeak or rattle. If you saturate the area with silicone, you will not be able to recheck the repair.

CENTER CONSOLE

Components to pay attention to include:

1. Shifter assembly cover to finisher
2. A/C control unit and cluster lid C
3. Wiring harnesses behind audio and A/C control unit

The instrument panel repair and isolation procedures also apply to the center console.

DOORS

Pay attention to the:

1. Finisher and inner panel making a slapping noise
2. Inside handle escutcheon to door finisher
3. Wiring harnesses tapping
4. Door striker out of alignment causing a popping noise on starts and stops

Tapping or moving the components or pressing on them while driving to duplicate the conditions can isolate many of these incidents. You can usually insulate the areas with felt cloth tape or insulator foam blocks from the Nissan Squeak and Rattle Kit (J-43980) to repair the noise.

TRUNK

Trunk noises are often caused by a loose jack or loose items put into the trunk by the owner.

In addition look for:

1. Trunk lid bumpers out of adjustment
2. Trunk lid striker out of adjustment
3. The trunk lid torsion bars knocking together
4. A loose license plate or bracket

SQUEAK AND RATTLE TROUBLE DIAGNOSES

< SYMPTOM DIAGNOSIS >

Most of these incidents can be repaired by adjusting, securing or insulating the item(s) or component(s) causing the noise.

SUNROOF/HEADLINING

Noises in the sunroof/headlining area can often be traced to one of the following:

1. Sunroof lid, rail, linkage or seals making a rattle or light knocking noise
2. Sunvisor shaft shaking in the holder
3. Front or rear windshield touching headlining and squeaking

Again, pressing on the components to stop the noise while duplicating the conditions can isolate most of these incidents. Repairs usually consist of insulating with felt cloth tape.

OVERHEAD CONSOLE (FRONT AND REAR)

Overhead console noises are often caused by the console panel clips not being engaged correctly. Most of these incidents are repaired by pushing up on the console at the clip locations until the clips engage.

In addition, look for:

1. Loose harness or harness connectors.
2. Front console map/reading lamp lens loose.
3. Loose screws at console attachment points.

SEATS

When isolating seat noise it's important to note the position the seat is in and the load placed on the seat when the noise is present. These conditions should be duplicated when verifying and isolating the cause of the noise.

Cause of seat noise include:

1. Headrest rods and holder
2. A squeak between the seat pad cushion and frame
3. The rear seatback lock and bracket

These noises can be isolated by moving or pressing on the suspected components while duplicating the conditions under which the noise occurs. Most of these incidents can be repaired by repositioning the component or applying urethane tape to the contact area.

UNDERHOOD

Some interior noise may be caused by components under the hood or on the engine wall. The noise is then transmitted into the passenger compartment.

Causes of transmitted underhood noise include:

1. Any component mounted to the engine wall
2. Components that pass through the engine wall
3. Engine wall mounts and connectors
4. Loose radiator mounting pins
5. Hood bumpers out of adjustment
6. Hood striker out of adjustment

These noises can be difficult to isolate since they cannot be reached from the interior of the vehicle. The best method is to secure, move or insulate one component at a time and test drive the vehicle. Also, engine RPM or load can be changed to isolate the noise. Repairs can usually be made by moving, adjusting, securing, or insulating the component causing the noise.

A
B
C
D
E
F
G
H
I
INT
K
L
M
N
O
P

SQUEAK AND RATTLE TROUBLE DIAGNOSES

< SYMPTOM DIAGNOSIS >

Diagnostic Worksheet

INFOID:000000005440090

Dear Customer:

We are concerned about your satisfaction with your vehicle. Repairing a squeak or rattle sometimes can be very difficult. To help us fix your vehicle right the first time, please take a moment to note the area of the vehicle where the squeak or rattle occurs and under what conditions. You may be asked to take a test drive with a service advisor or technician to ensure we confirm the noise you are hearing.

SQUEAK & RATTLE DIAGNOSTIC WORKSHEET

I. WHERE DOES THE NOISE COME FROM? (circle the area of the vehicle)

The illustrations are for reference only, and may not reflect the actual configuration of your vehicle.

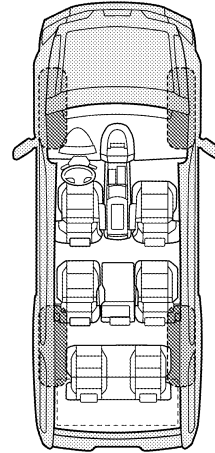
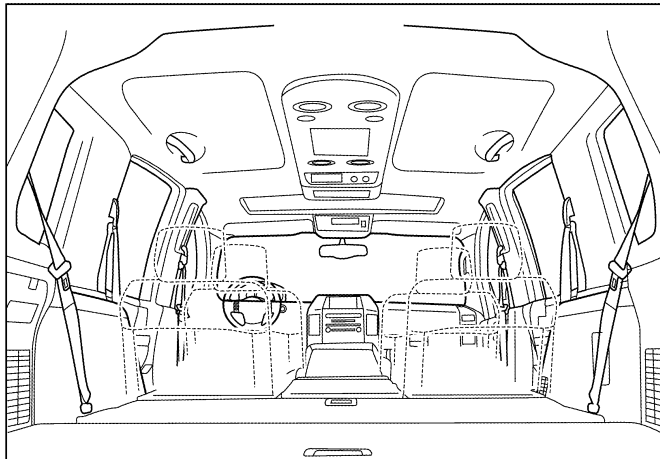
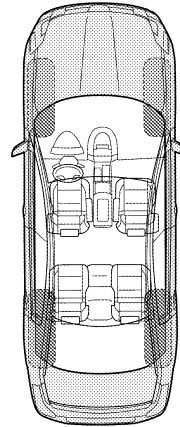
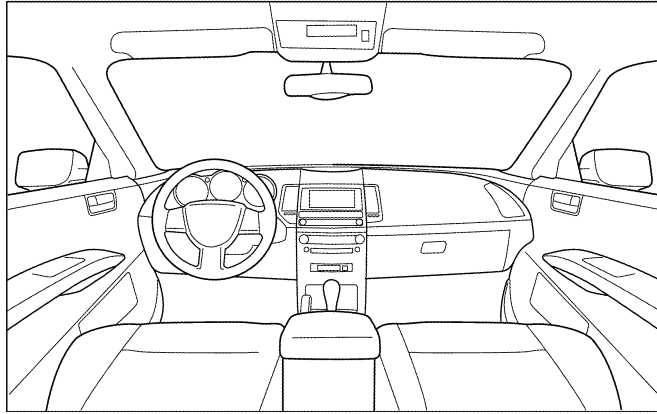

Continue to page 2 of the worksheet and briefly describe the location of the noise or rattle. In addition, please indicate the conditions which are present when the noise occurs.

SQUEAK AND RATTLE TROUBLE DIAGNOSES

< SYMPTOM DIAGNOSIS >

SQUEAK & RATTLE DIAGNOSTIC WORKSHEET - page 2

Briefly describe the location where the noise occurs:

II. WHEN DOES IT OCCUR? (please check the boxes that apply)

- | | |
|---|--|
| <input type="checkbox"/> Anytime | <input type="checkbox"/> After sitting out in the rain |
| <input type="checkbox"/> 1st time in the morning | <input type="checkbox"/> When it is raining or wet |
| <input type="checkbox"/> Only when it is cold outside | <input type="checkbox"/> Dry or dusty conditions |
| <input type="checkbox"/> Only when it is hot outside | <input type="checkbox"/> Other: |

III. WHEN DRIVING:

- Through driveways
- Over rough roads
- Over speed bumps
- Only about ____ mph
- On acceleration
- Coming to a stop
- On turns: left, right or either (circle)
- With passengers or cargo
- Other: _____
- After driving ____ miles or ____ minutes

IV. WHAT TYPE OF NOISE

- Squeak (like tennis shoes on a clean floor)
- Creak (like walking on an old wooden floor)
- Rattle (like shaking a baby rattle)
- Knock (like a knock at the door)
- Tick (like a clock second hand)
- Thump (heavy muffled knock noise)
- Buzz (like a bumble bee)

TO BE COMPLETED BY DEALERSHIP PERSONNEL

Test Drive Notes:

	YES	NO	Initials of person performing
Vehicle test driven with customer	<input type="checkbox"/>	<input type="checkbox"/>	_____
- Noise verified on test drive	<input type="checkbox"/>	<input type="checkbox"/>	_____
- Noise source located and repaired	<input type="checkbox"/>	<input type="checkbox"/>	_____
- Follow up test drive performed to confirm repair	<input type="checkbox"/>	<input type="checkbox"/>	_____

VIN: _____ Customer Name _____

W.O.# _____ Date: _____

This form must be attached to Work Order

LATA0071E











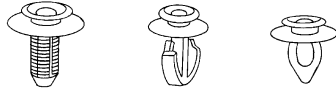

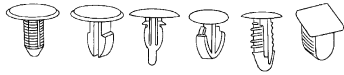
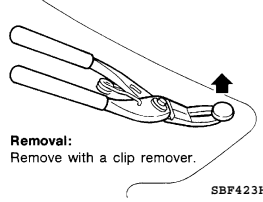
INFOID:000000005440091

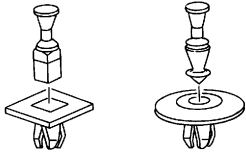
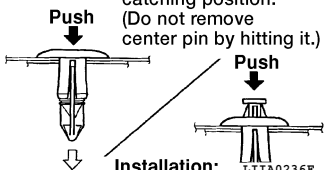
Clip and Fastener

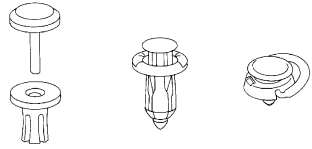
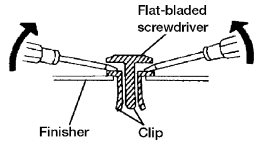
- Clips and fasteners in EXT section correspond to the following numbers and symbols.
- Replace any clips and/or fasteners which are damaged during removal or installation.

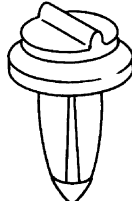
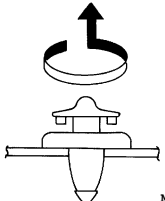

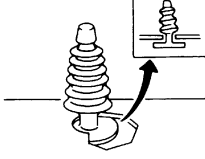
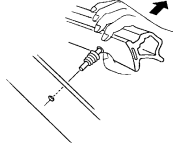

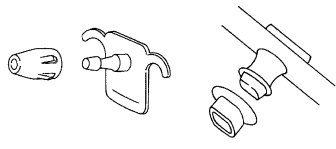
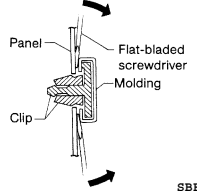





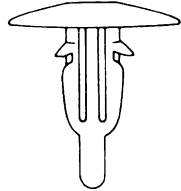
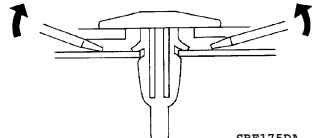

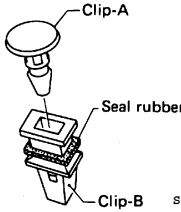
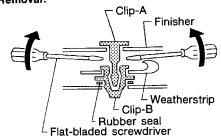
SQUEAK AND RATTLE TROUBLE DIAGNOSES

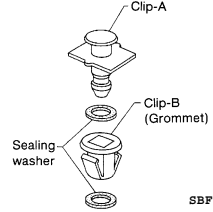
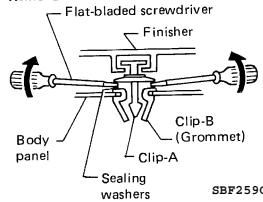
< SYMPTOM DIAGNOSIS >

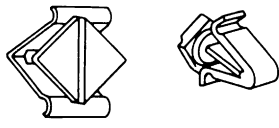
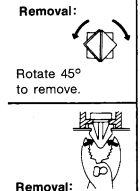
Symbol No.	Shapes	Removal & Installation
<p>C101</p> 	 <p style="text-align: center;">SBF302H</p>	<p>Removal: Remove by bending up with flat-bladed screwdrivers or clip remover.</p>  <p style="text-align: right;">SBF367BA</p>
<p>C103</p> 	 <p style="text-align: center;">SBT095</p>	 <p>Removal: Remove with a clip remover.</p> <p style="text-align: right;">SBF423H</p>
<p>C203</p> 	 <p style="text-align: center;">SBF258G</p>	<p>Push center pin to catching position. (Do not remove center pin by hitting it.)</p>  <p>Installation: L11A0236E</p>
<p>C205</p> 	 <p style="text-align: center;">MBT080A</p>	<p>Removal:</p>  <p style="text-align: right;">SBF638CA</p>
<p>C206</p> 	 <p style="text-align: center;">MBF519B</p>	 <p style="text-align: right;">MBF520B</p>
<p>CE103</p> 	 <p style="text-align: center;">SBF104B</p>	<p>Removal:</p>  <p style="text-align: right;">SBF147B</p>
<p>CE107</p> 	 <p style="text-align: center;">SBF411H</p>	 <p style="text-align: right;">SBF767B</p>

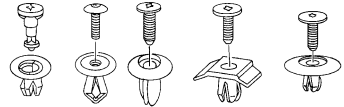
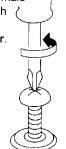
SQUEAK AND RATTLE TROUBLE DIAGNOSES

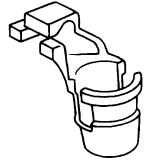
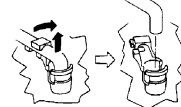
< SYMPTOM DIAGNOSIS >

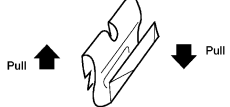
Symbol No.	Shapes	Removal & Installation	
CE117 	 SBF174D	Removal: Remove by bending up with a flat-bladed screwdriver or pliers.  SBF175DA	A B C
CF110 	 SBF648B	Removal:  SBF649B	D E F
CF118 	 SBF151D	Removal:  SBF259G	G H
CG101 	 SBF145B	Removal: Rotate 45° to remove.  Installation:  SBF085B	I INT
CS101 	 SBF078B	Removal: 1. Screw out with a Phillips screwdriver. 2. Remove female portion with flat-bladed screwdriver.  SBF992G	K L M
CR103 	 SBF768B	Removal: Holder portion of clip must be spread out to remove rod.  SBF770B	N O
Metal Clip 	 WBT072	Removal:  WBT073	P

PRECAUTIONS

< PRECAUTION >

PRECAUTION

PRECAUTIONS

Precaution for Supplemental Restraint System (SRS) "AIR BAG" and "SEAT BELT PRE-TENSIONER"

INFOID:000000005818879

The Supplemental Restraint System such as "AIR BAG" and "SEAT BELT PRE-TENSIONER", used along with a front seat belt, helps to reduce the risk or severity of injury to the driver and front passenger for certain types of collision. This system includes seat belt switch inputs and dual stage front air bag modules. The SRS system uses the seat belt switches to determine the front air bag deployment, and may only deploy one front air bag, depending on the severity of a collision and whether the front occupants are belted or unbelted. Information necessary to service the system safely is included in the SR and SB section of this Service Manual.

WARNING:

- To avoid rendering the SRS inoperative, which could increase the risk of personal injury or death in the event of a collision which would result in air bag inflation, all maintenance must be performed by an authorized NISSAN/INFINITI dealer.
- Improper maintenance, including incorrect removal and installation of the SRS, can lead to personal injury caused by unintentional activation of the system. For removal of Spiral Cable and Air Bag Module, see the SR section.
- Do not use electrical test equipment on any circuit related to the SRS unless instructed to in this Service Manual. SRS wiring harnesses can be identified by yellow and/or orange harnesses or harness connectors.

PRECAUTIONS WHEN USING POWER TOOLS (AIR OR ELECTRIC) AND HAMMERS

WARNING:

- When working near the Airbag Diagnosis Sensor Unit or other Airbag System sensors with the Ignition ON or engine running, DO NOT use air or electric power tools or strike near the sensor(s) with a hammer. Heavy vibration could activate the sensor(s) and deploy the air bag(s), possibly causing serious injury.
- When using air or electric power tools or hammers, always switch the Ignition OFF, disconnect the battery, and wait at least 3 minutes before performing any service.

Precautions For High-Voltage System

INFOID:000000005440094

Refer to [GI-24, "Precautions For High-Voltage System"](#).

Precautions

INFOID:000000005440095

- After removing and installing any opening/closing parts, make sure to perform all adjustments for proper operation.
- Check the lubrication level, damage, and wear of each part. If necessary, grease or replace it.
- When removing or disassembling any part, be careful not to damage or deform it. Protect parts which may get in the way with cloth.
- When removing parts with a screw driver or other tool, protect parts by wrapping them with vinyl or tape.
- Keep removed parts protected with cloth.
- If a clip is deformed or damaged, replace it.
- If a non reuseable part is removed, replace it with a new one.
- Tighten bolts and nuts firmly to the specified torque.
- After re-assembly has been completed, make sure each part functions correctly.
- Remove stains in the following manner:

Water-Soluble stains	Oil stains
Dip a cloth in warm water, and squeeze tightly. After wiping the stain, wipe with a soft dry cloth.	Dissolve a synthetic detergent in warm water (density of 2 to 3% or less), dip the cloth, then clean off the stain with the cloth. Next, dip the cloth in fresh water, then squeeze tightly. Clean off detergent completely, then wipe entire area with a soft dry cloth.
Do not use any organic solvent, such as a thinner or benzene to remove stains	

PREPARATION

< PREPARATION >



PREPARATION

PREPARATION

Special Service Tools

INFOID:000000005440096

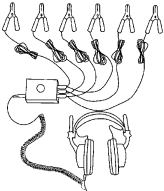
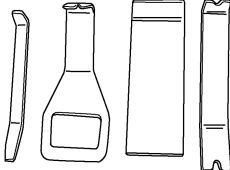
The actual shapes of Kent-Moore tools may differ from those of special service tools illustrated here.

Tool number (Kent-Moore No.) Tool name	Description
(J-39570) Chassis ear  SIIA0993E	Locating the noise
— (J-46534) Trim Tool Set  AWJIA0483ZZ	Removing trim components
(J-43980) NISSAN Squeak and Rattle Kit  SIIA0994E	Repairing the cause of noise

Commercial Service Tools

INFOID:000000005440097

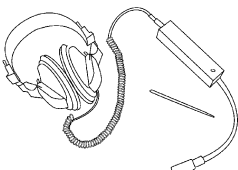
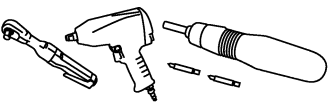
Tool name	Description
Engine ear  SIIA0995E	Locating the noise
Power tools  PIIB1407E	Loosening bolts, nuts and screws

DOOR FINISHER

< ON-VEHICLE REPAIR >

ON-VEHICLE REPAIR

DOOR FINISHER

Exploded View

INFOID:000000005440098

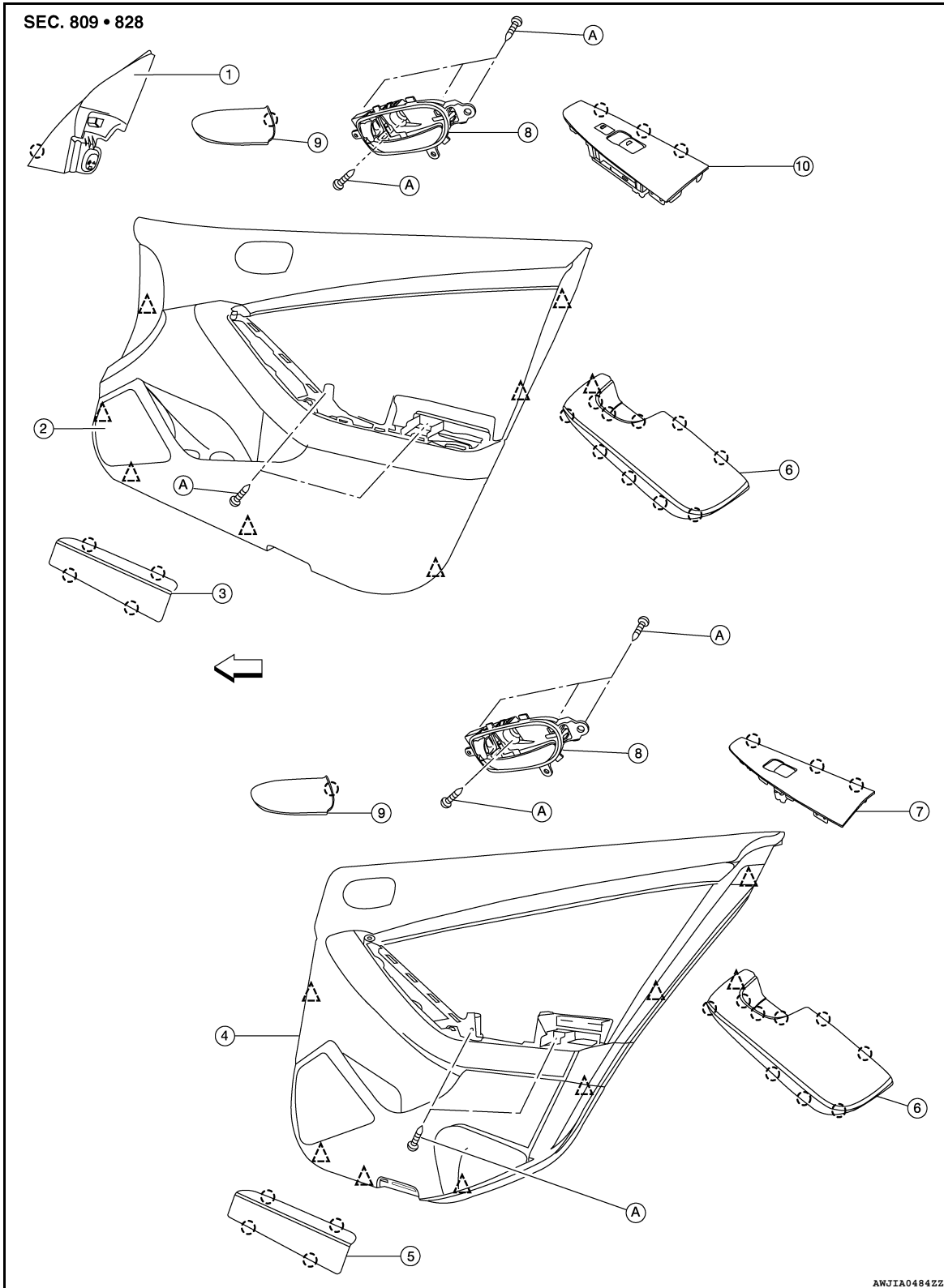

DOOR FINISHER

< ON-VEHICLE REPAIR >

- | | | |
|--|---------------------------------|---|
| 1. Mirror cover | 2. Front door finisher | 3. Step lamp lens |
| 4. Rear door finisher | 5. Step lamp lens (if equipped) | 6. Arm rest finisher |
| 7. Rear door power window switch finisher | 8. Inside release handle | 9. Inside release handle escutcheon |
| 10. Front door power window and door lock/unlock switch finisher | A. Screw |  Clip C101 |

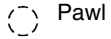

Removal and Installation

INFOID:000000005440099

FRONT DOOR FINISHER

Removal

1. Release the pawls and remove step lamp lens, then disconnect the connector.
 2. Release the pawls at the rear edge and remove inside release handle escutcheon, then remove the screw.
 3. Remove the armrest finisher as follows:
CAUTION:
If not removed properly, the door armrest finisher clips may be damaged: making it hard to properly reinstall the part.
- a. Insert the trim stick and twist, while gently lifting up at rear of armrest finisher to release outboard clips (A).

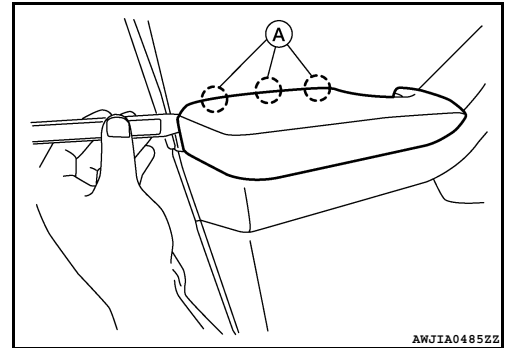

- b. Gently lift up on the rear of the armrest finisher to release the inboard clips (B).

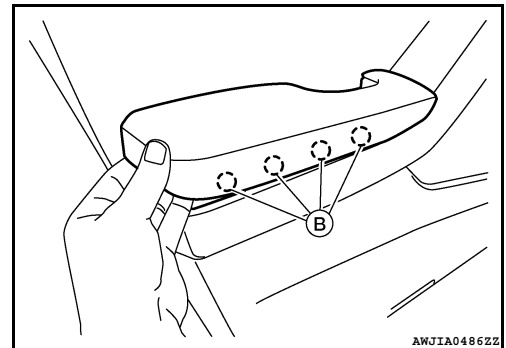

- c. Gently lift up on the front of the armrest finisher to release the inboard clips (B).

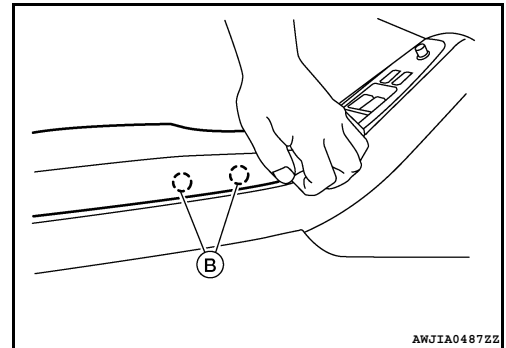

A
B
C
D
E
F
G
H
I
INT
K
L
M
N
O
P

DOOR FINISHER

< ON-VEHICLE REPAIR >

- d. Support the armrest finisher at the pull grip part of the armrest finisher while gently lifting the armrest finisher straight up to release the pull grip clips (C), then remove the armrest finisher (1).

CAUTION:

Do not twist, pull the armrest straight up to remove.

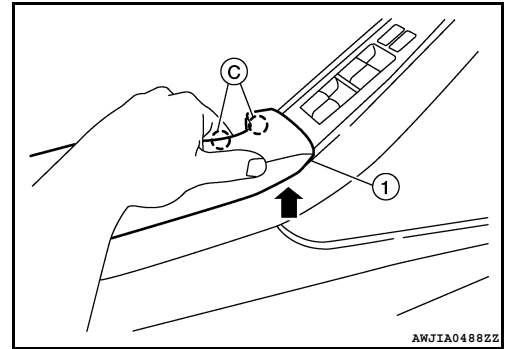

4. Lift power window and door lock/unlock switch finisher upward to remove, then disconnect the connectors.
 - Remove the front door finisher screws beneath power window and door lock/unlock switch finisher.
5. Release the clips around outer edge, then remove front door finisher.
6. Disconnect inside release handle and lock knob cables from back of front door finisher.
7. Release the pawls and remove mirror cover.

Installation

1. Align the mirror cover pawls and install the mirror cover.
2. Connect the inside release handle and lock knob cables on the back of the front door finisher.
3. Align the front door finisher clips around the outer edge, then install the front door finisher.
4. Install the front door finisher screws beneath power window and door lock/unlock switch finisher.
 - Connect the door lock/unlock switch connector and install the door lock/unlock switch finisher.
5. Install the armrest finisher as follows:

- a. Align and press the armrest finisher cover datum clip (D) and inboard clip (B), into the front door finisher.

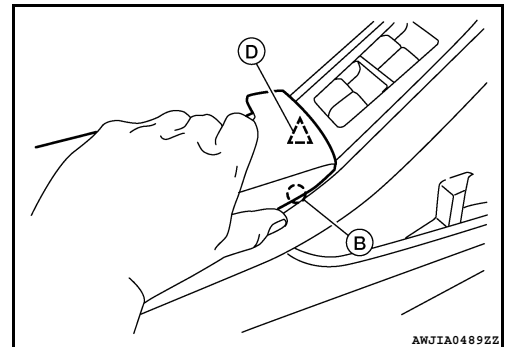

- b. Align and press out and down to seat the inboard clips.

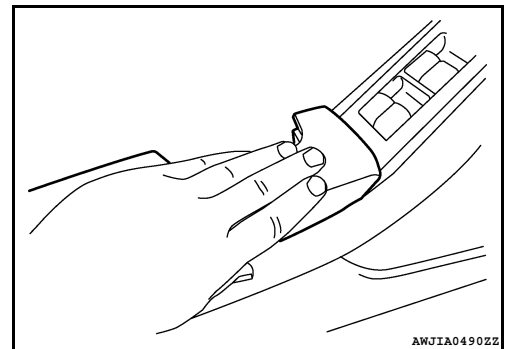

DOOR FINISHER

< ON-VEHICLE REPAIR >

- c. Align and press down to seat the outboard clips.

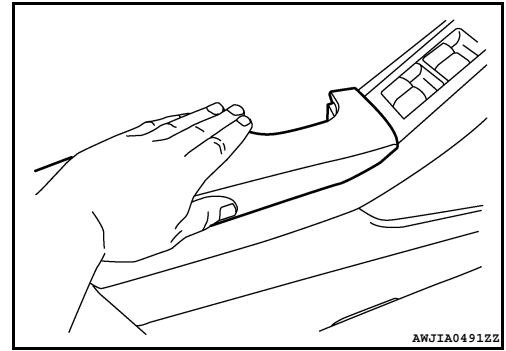

6. Align the inside release handle escutcheon pawls, then install the inside release handle escutcheon
7. Connect the step lamp lens connector, align the step lamp lens pawls and install the step lamp lens.

REAR DOOR FINISHER

Removal

1. Release the pawls and remove the step lamp/reflector lens, then disconnect the connector (if equipped).
2. Release the pawls at the rear edge and remove inside release handle escutcheon, then remove the screw.
3. Remove the armrest finisher as follows:
CAUTION:
If not removed properly, the door armrest finisher clips may be damaged: making it hard to properly reinstall the part.
- a. Insert the trim stick and twist, gently lift up at rear of armrest finisher to release outboard clips (A).

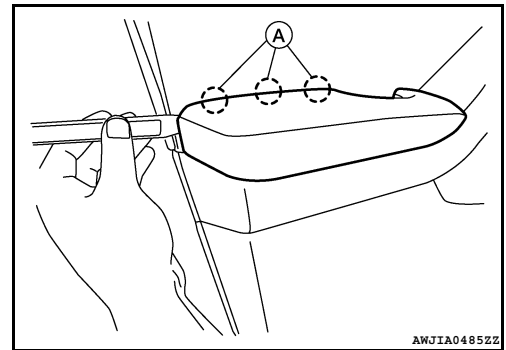

- b. Gently lift up on the rear of the armrest finisher to release the inboard clips (B).

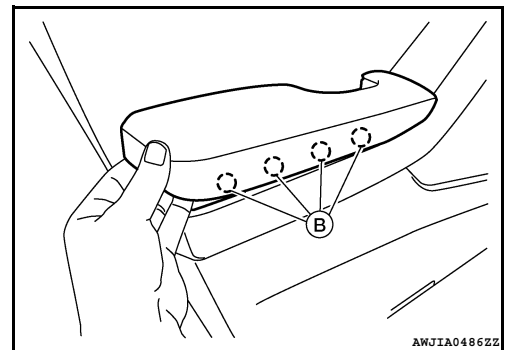

A
B
C
D
E
F
G
H
I
INT
K
L
M
N
O
P

DOOR FINISHER

< ON-VEHICLE REPAIR >

- c. Gently lift up on the front of the armrest finisher to release the inboard clips (B).

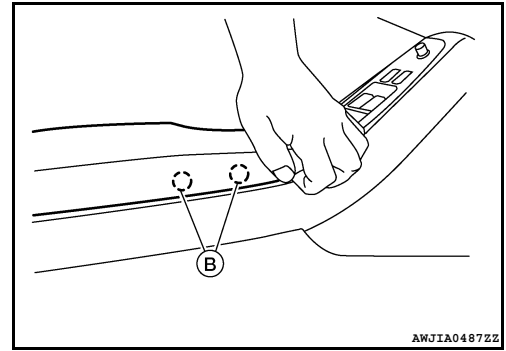

- d. Support the armrest finisher at the pull grip part of the armrest finisher while gently lifting the armrest finisher straight up to release the pull grip clips (C), then remove the armrest finisher (1).

CAUTION:

Do not twist, pull the armrest straight up to remove.

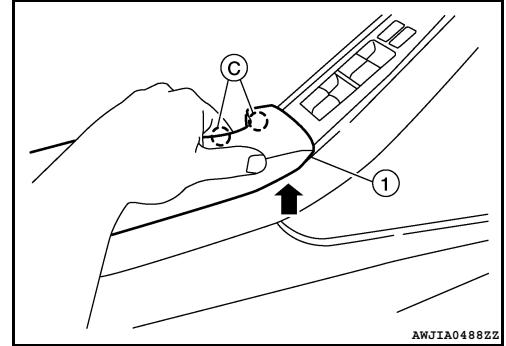

4. Lift power window switch finisher upward to remove, then disconnect the connector.
• Remove the rear door finisher screws beneath power window switch finisher.
5. Release the clips around outer edge, then remove rear door finisher.
6. Disconnect inside release handle and lock knob cables from the back of rear door finisher.

Installation

Installation is in the reverse order of removal.

NOTE:

When installing the armrest finisher, perform the following:

1. Align and press the armrest finisher cover datum clip (D) and inboard clip (B), into the front door finisher.

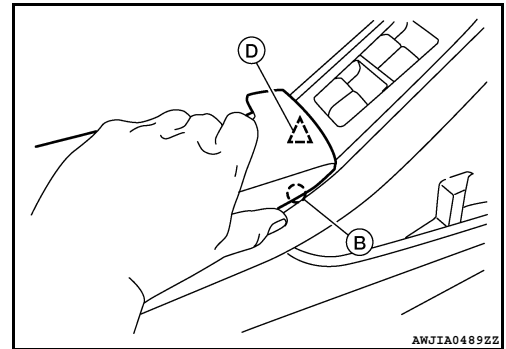

2. Align and press out and down to seat the inboard clips.

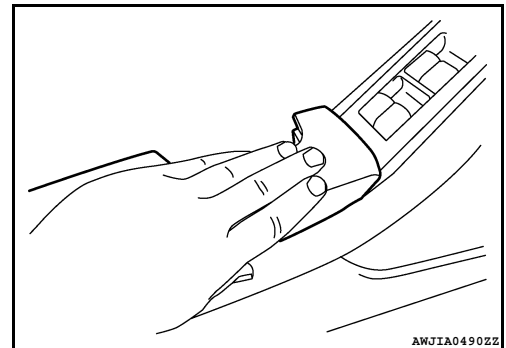

DOOR FINISHER

< ON-VEHICLE REPAIR >

3. Align and press down to seat the outboard clips.

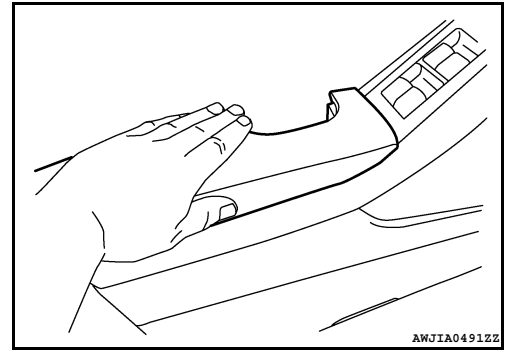

A

B

C

D

E

F

G

H

I

INT

K

L

M

N

O

P

BODY SIDE TRIM

< ON-VEHICLE REPAIR >

BODY SIDE TRIM

Exploded View

INFOID:000000005440100

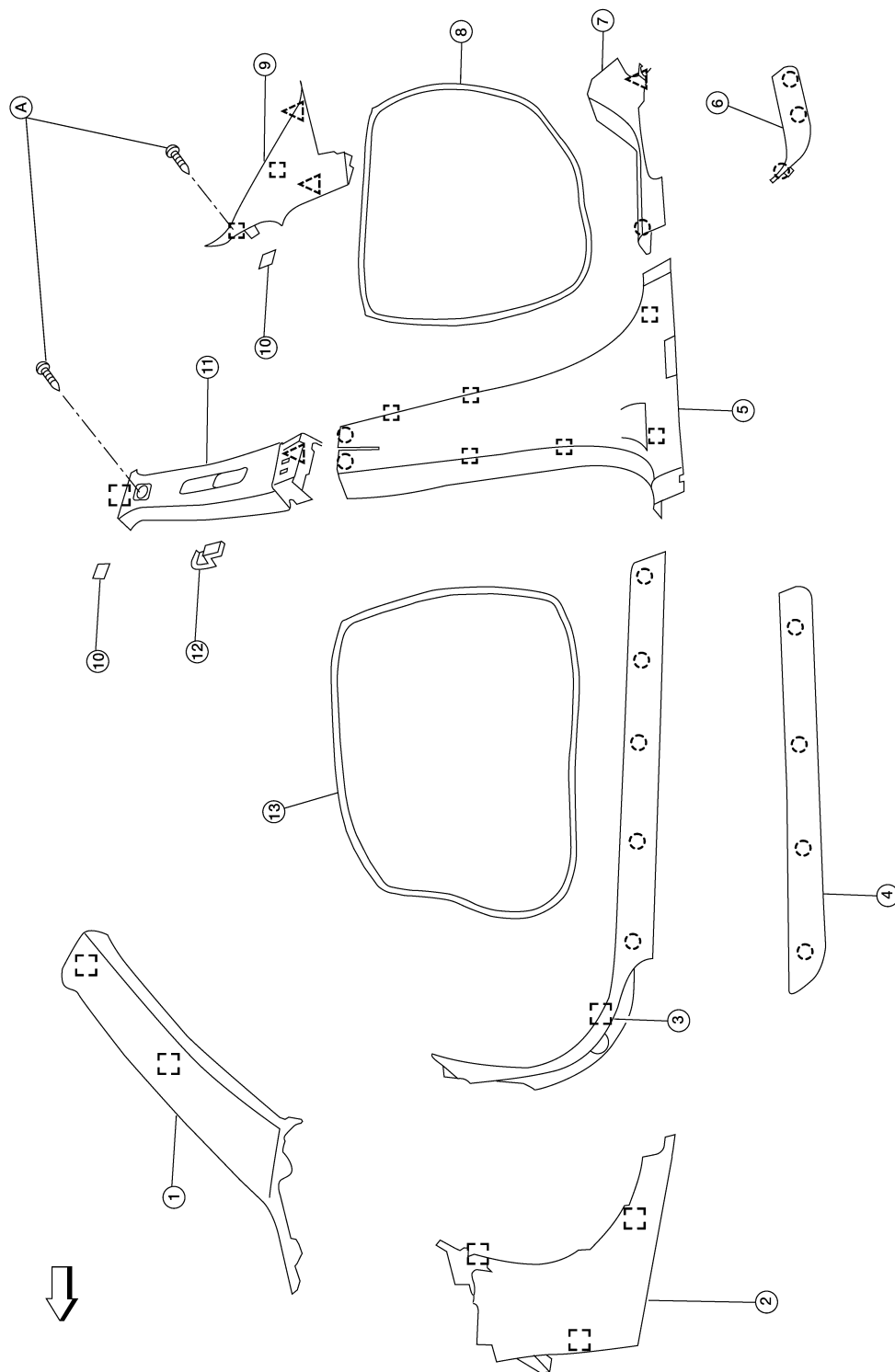

SEC. 769

ALJ1A0002ZZ



- | | | |
|--------------------------|---------------------------------|-------------------------|
| 1. Front pillar finisher | 2. Dash side lower finisher | 3. Front kicking plate |
| 4. Front sill cover | 5. Center pillar lower finisher | 6. Rear sill cover |
| 7. Rear kicking plate | 8. Rear body side welt | 9. Rear pillar finisher |

BODY SIDE TRIM

< ON-VEHICLE REPAIR >

- 10. Screw cover
- 13. Front body side welt
-  Pawl

- 11. Center pillar upper finisher
- A. Screw
-  Metal clip

- 12. Front seat belt adjuster cover
-  Clip C101
-  Vehicle front

Removal and Installation

INFOID:000000005440101

CAUTION:

- Wrap the tip of flat-bladed screwdriver with a cloth when removing metal clips from garnishes.
- When removing, always use suitable tool made of plastic.
- When removing or installing body side welts, do not allow butyl seal to come in contact with pillar finishers.

FRONT PILLAR FINISHER

Removal

1. Partially remove front body side welt.

CAUTION:

Insert a suitable clip removing tool wrapped with a shop cloth inserted into the part shown by the arrow (between the clip and the body side panel), then release the clip.

2. Release the clips, then remove front pillar finisher.

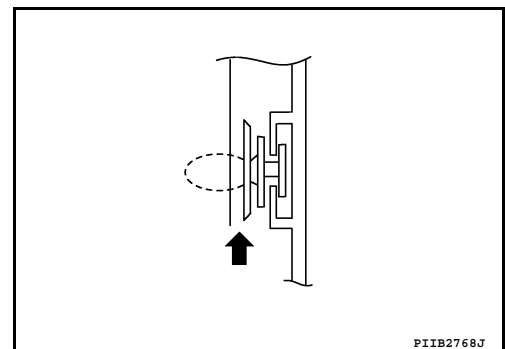

Installation

Installation is in the reverse order of removal.

CAUTION:

Make sure that clips are fully aligned with panel holes on body when installing, then press them in completely.

DASH SIDE LOWER FINISHER

Removal

1. Remove front kicking plate.
2. Release the clips, then remove dash side lower finisher.

Installation

Installation is in the reverse order of removal.

CAUTION:

Make sure that clips are fully aligned with panel holes on body when installing, then press them in completely.

FRONT KICKING PLATE

Removal

Release the clip and pawls, then remove front kicking plate.

Installation

Installation is in the reverse order of removal.

CAUTION:

Make sure that clips are fully aligned with panel holes on body when installing, then press them in completely.

FRONT BODY SIDE WELT

Removal

1. Remove front kicking plate.
2. Release welt from the body opening, then remove front body side welt.

A
B
C
D
E
F
G
H
I

INT

K
L
M
N
O
P

BODY SIDE TRIM

< ON-VEHICLE REPAIR >

Installation

Installation is in the reverse order of removal.

CAUTION:

Make sure that clips are fully aligned with panel holes on body when installing, then press them in completely.

CENTER PILLAR LOWER FINISHER

Removal

1. Remove front and rear kicking plate.
2. Partially remove front and rear body side welts.
3. Release the clips and pawls, then remove center pillar lower finisher.

Installation

Installation is in the reverse order of removal.

CAUTION:

Make sure that clips are fully aligned with panel holes on body when installing, then press them in completely.

CENTER PILLAR UPPER FINISHER

Removal

1. Partially remove front and rear body side welts.
2. Remove screw cover, then remove the screw.
3. Remove front seat belt adjuster cover and shoulder anchor bolt. Refer to [SB-6, "Exploded View"](#).
4. Remove center pillar lower finisher.
5. Release the clips, then remove center pillar upper finisher.

Installation

Installation is in the reverse order of removal.

CAUTION:

Make sure that clips are fully aligned with panel holes on body when installing, then press them in completely.

REAR KICKING PLATE

Removal

Release the clip and pawl, then remove rear kicking plate.

Installation

Installation is in the reverse order of removal.

CAUTION:

Make sure that clips are fully aligned with panel holes on body when installing, then press them in completely.

REAR BODY SIDE WELT

Removal

1. Remove rear kicking plate.
2. Release the welt from the body opening, then remove rear body side welt.

Installation

Installation is in the reverse order of removal.

CAUTION:

Make sure that clips are fully aligned with panel holes on body when installing, then press them in completely.

REAR PILLAR FINISHER

Removal

1. Partially remove rear body side welts.
2. Remove screw cover, then remove the screw.
3. Release the clips, then remove rear pillar finisher.

BODY SIDE TRIM

< ON-VEHICLE REPAIR >

Installation

Installation is in the reverse order of removal.

CAUTION:

Make sure that clips are fully aligned with panel holes on body when installing, then press them in completely.

SILL PLATE COVER (FRONT/REAR)

Removal

Release the pawls, then remove the sill plate cover.

Installation

Installation is in the reverse order of removal.

CAUTION:

Make sure that clips are fully aligned with panel holes on body when installing, then press them in completely.

A

B

C

D

E

F

G

H

I

INT

K

L

M

N

O

P

REAR PARCEL SHELF FINISHER

< ON-VEHICLE REPAIR >

REAR PARCEL SHELF FINISHER

Exploded View

INFOID:000000005440102

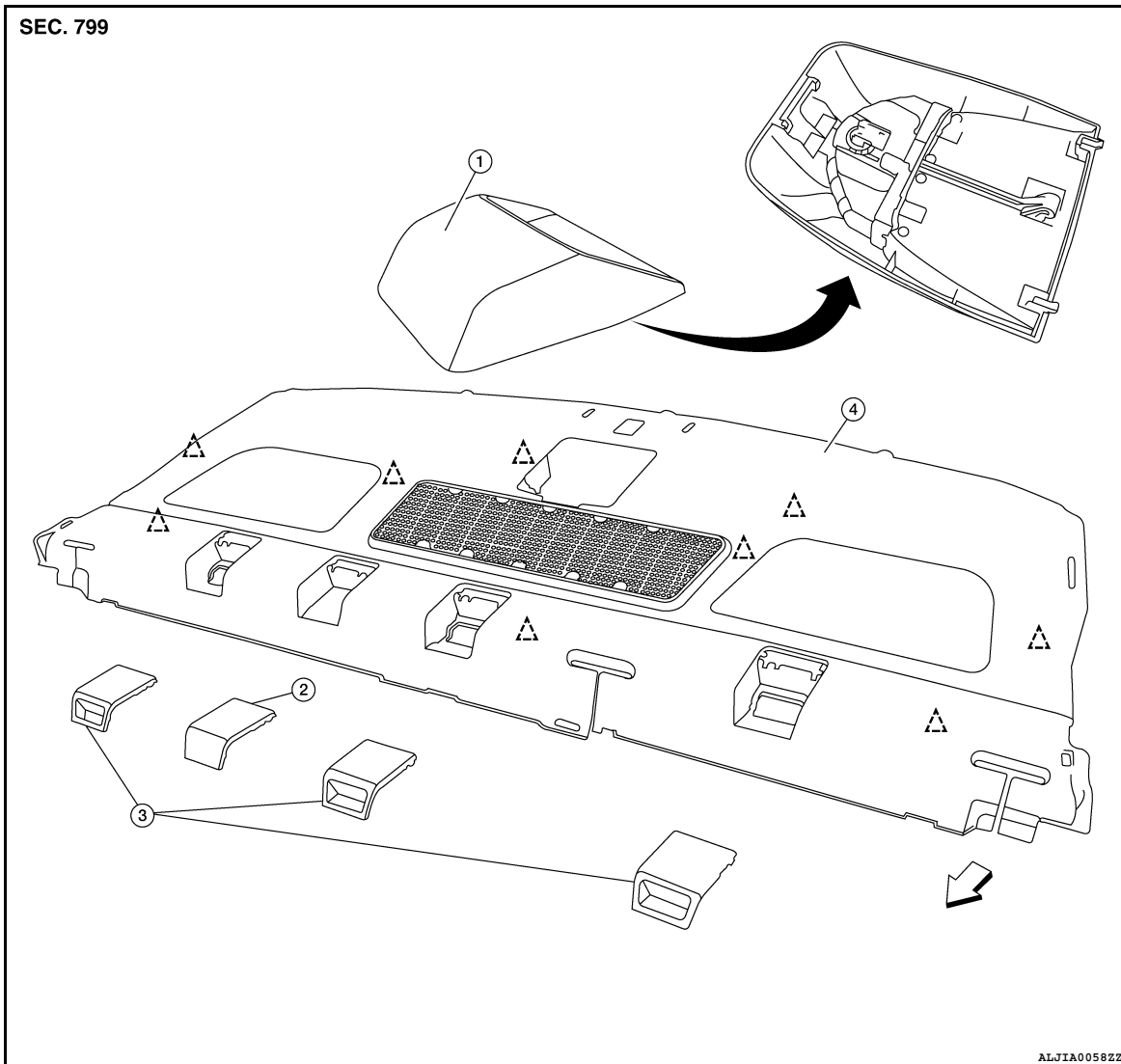

1. High mounted stop lamp (if equipped) 2. Cover 3. Child anchor cover
4. Rear parcel shelf finisher ← Front △ Clip C101

Removal and Installation

INFOID:000000005440103

REMOVAL

1. Remove the rear seat. Refer to [SE-24, "Removal and Installation"](#).
2. Remove high mounted stop lamp (if equipped). Refer to [EXL-152, "Removal and Installation"](#).
3. Remove rear pillar finisher RH/LH. Refer to [INT-19, "Removal and Installation"](#).
4. Thread the rear seat belt RH/LH/Center through vertical opening and release from rear parcel shelf finisher.
5. Remove the clips, then remove rear parcel shelf finisher.

INSTALLATION

Installation is in the reverse order of removal.

CAUTION:

REAR PARCEL SHELF FINISHER

< ON-VEHICLE REPAIR >

Make sure that clips are fully aligned with panel holes on body when installing, then press them in completely.

A

B

C

D

E

F

G

H

I

INT

K

L

M

N

O

P

FLOOR TRIM

< ON-VEHICLE REPAIR >

FLOOR TRIM

Exploded View

INFOID:000000005440104

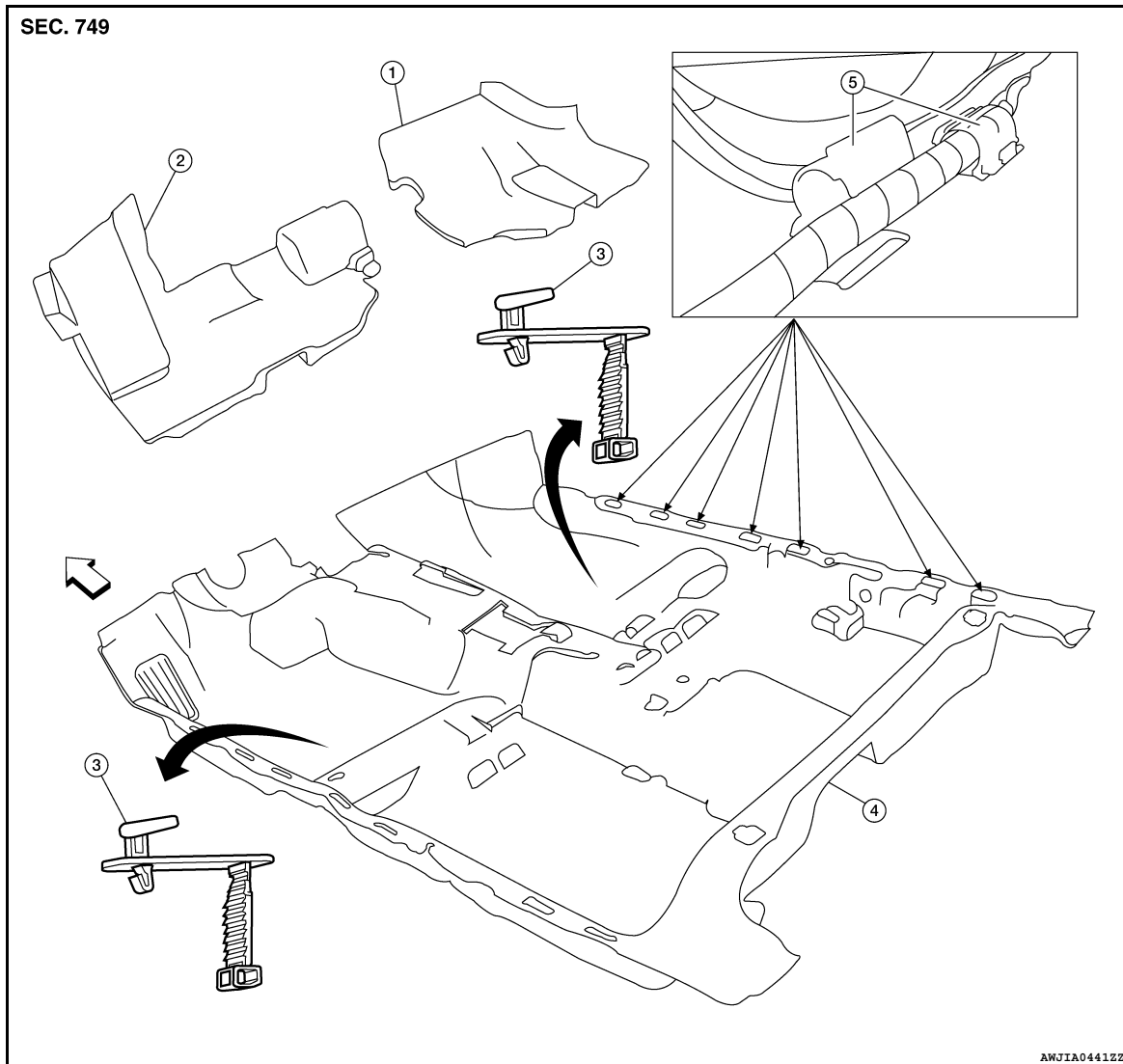

1. Spacer (RH)

2. Spacer (LH)

3. Floor mat hooks

4. Floor carpet

5. Harness clamp

↔ Vehicle front

Removal and Installation

INFOID:000000005440105

REMOVAL

1. Remove front seat (RH/LH) and rear seat cushion. Refer to [SE-22, "Removal and Installation"](#) (front seat) and [SE-24, "Removal and Installation"](#) (rear seat).
2. Remove lower body side trim. Refer to [INT-19, "Removal and Installation"](#).
3. Remove center console. Refer to [IP-17, "Exploded View"](#).

FLOOR TRIM

< ON-VEHICLE REPAIR >

4. Remove the connector duct (RH/LH) (2) and the center connector duct (1) from heater and cooling unit. Refer to [VTL-12. "Removal and Installation"](#).
 - ⇐ Vehicle front
5. Remove the bracket bolt, then position the parking brake cable aside.
6. Disconnect the drain hose (4) from the heater and cooling unit, then set aside.
7. Remove the HV ECU. Refer to [HBC-641. "Removal and Installation"](#).
8. Remove the three bolts (A) and one nut, then remove the bracket (3).
9. Remove the diagnosis sensor unit. Refer to [SR-15. "Removal and Installation"](#).
10. Remove the parking brake cable nuts (A), then position the parking brake cables (2) aside.
 - ⇐ Vehicle front
11. Remove the bracket nuts (B), then remove extension bracket (1) and center console rear bracket (3).

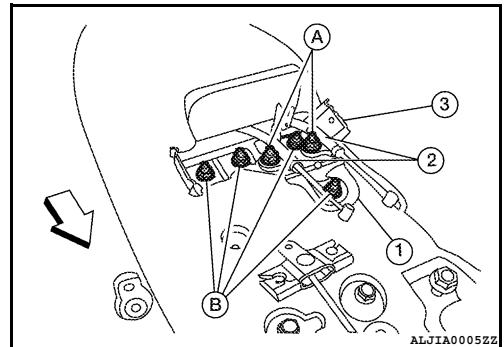
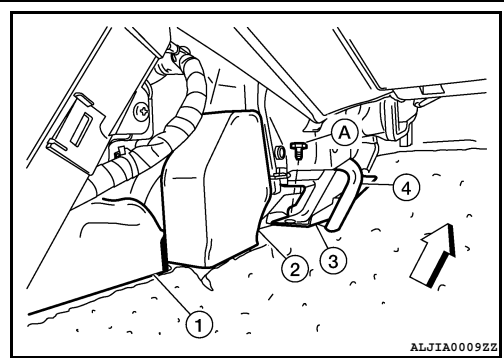

12. Remove front seat belt floor anchor bolt (RH/LH). Refer to [SB-6. "Exploded View"](#).
13. Release the tab, then remove floor mat hooks.
14. Release the tabs and open harness clamps (seven - RH and seven - LH). Position harness and floor carpet cut-out areas outside of harness clamps.
15. Fold corners toward center, then remove floor carpet.

INSTALLATION

Installation is in the reverse order of removal.

A
B
C
D
E
F
G
H
I
INT
K
L
M
N
O
P

HEADLINING

< ON-VEHICLE REPAIR >

HEADLINING

Exploded View

INFOID:000000005440106

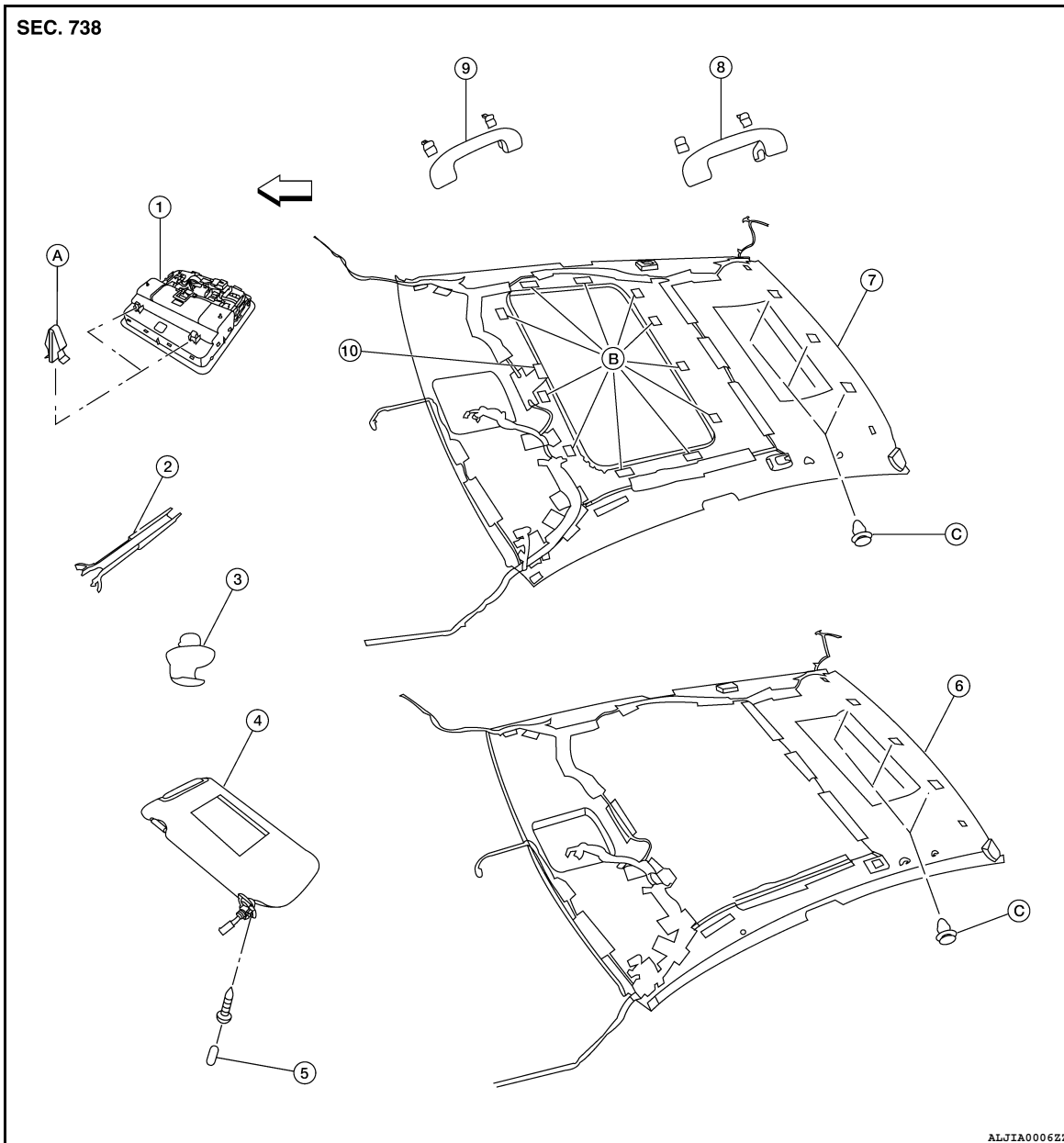

- | | | |
|---------------------------------------|-------------------------|--|
| 1. Map lamp assembly | 2. Mirror harness cover | 3. Sunvisor holder |
| 4. Sunvisor | 5. Sunvisor cover | 6. Headlining assembly (without sunroof) |
| 7. Headlining assembly (with sunroof) | 8. Rear assist grip | 9. Front assist grip |
| 10. Sunroof clip | A. Metal clip | B. Dual lock fastener |
| C. Clip C101 | ← Vehicle front | |

Removal and Installation

INFOID:000000005440107

CAUTION:

- Disconnect the 12-volt negative and positive battery terminals.
- Be careful not to bend headlining during removal or installation.

NOTE:

The following components are integral to the headliner and are repaired only as an assembly:

HEADLINING

< ON-VEHICLE REPAIR >

- Personal lamp (LH/RH).
- Roof harness assembly.
- Antenna feeder assembly.

REMOVAL

1. Recline the front seats to the fully reclined position.
2. Disconnect the 12-volt battery negative and positive terminals.
3. Remove front pillar finisher (RH/LH). Refer to [INT-19, "Removal and Installation"](#).
4. Disconnect headlining harness and antenna feeder connectors.
5. Remove center pillar upper and rear pillar finishers. Refer to [INT-19, "Removal and Installation"](#).
6. Disconnect antenna amplifier and rear window defogger connectors.
7. Release the molded clip, then remove front and rear assist grips.

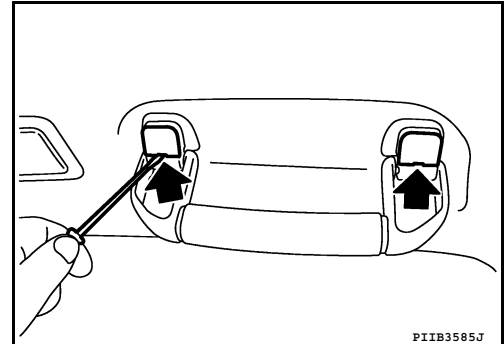

8. Disconnect rear view mirror harness connector.
9. Remove the sunvisor covers and screws, and then remove sunvisors (RH/LH).
 - If equipped, disconnect vanity mirror illumination harness connector.
10. Insert a suitable thin tool into the sunvisor holder notch and press in to release the locking tab.
 - Rotate sunvisor holder 90 degrees and pull away from headlining to remove.

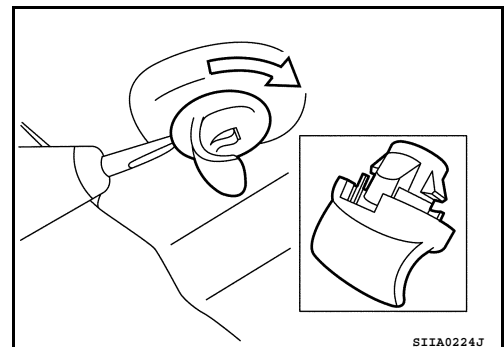

11. Remove room/map lamp assembly.
 - For sunroof equipped vehicles: Release the pawls and lower room/map lamp assembly away from headliner. Disconnect the room/map lamp and sunroof switch connectors, then remove the room/map lamp assembly.
12. For sunroof equipped vehicles, use a suitable tool to release dual lock fastener(s) around the sunroof opening and release the sunroof clip.
13. Release the three hidden clips near the rear edge of headliner using a suitable clip removal tool.
14. Drop headlining down and carefully rotate into position. Remove headlining through rear door opening.

CAUTION:

- **When removing, two workers are required. (one for each front and rear of headlining)**
- **Cover center console finisher upper surface with a shop cloth to prevent damage.**

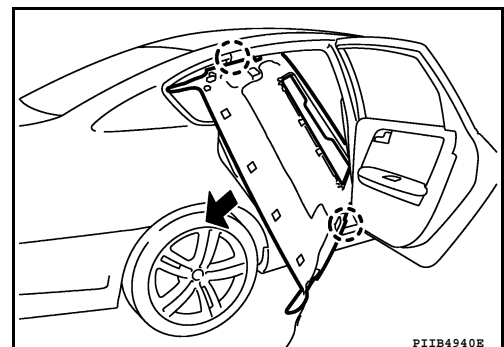

HEADLINING

< ON-VEHICLE REPAIR >

INSTALLATION

Installation is in the reverse order of removal.

TRUNK ROOM TRIM & TRUNK LID FINISHER

< ON-VEHICLE REPAIR >

TRUNK ROOM TRIM & TRUNK LID FINISHER

Exploded View

INFOID:000000005440108

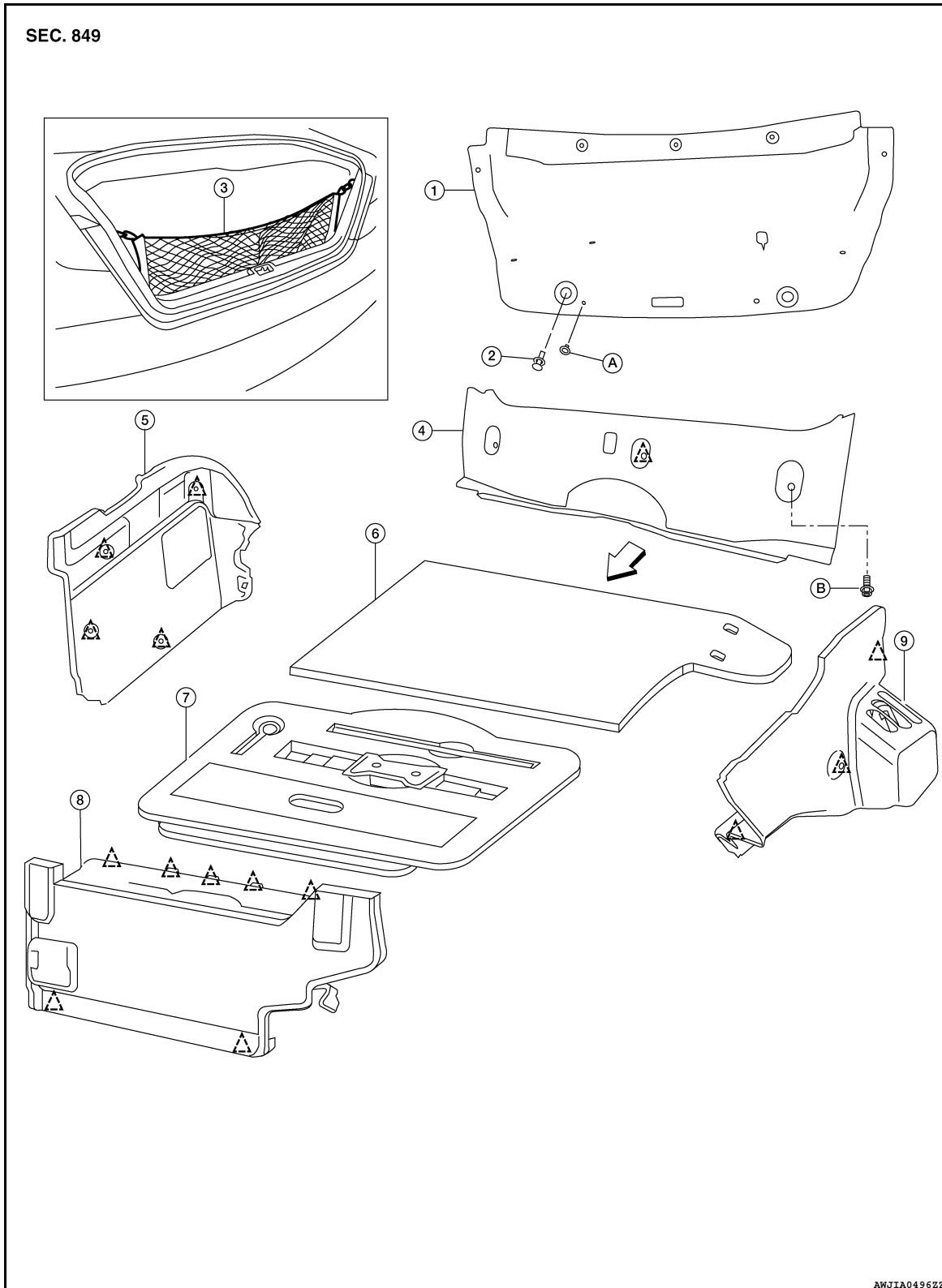

TRUNK ROOM TRIM



A
B
C
D
E
F
G
H
I
INT
K
L
M
N
O
P

TRUNK ROOM TRIM & TRUNK LID FINISHER

< ON-VEHICLE REPAIR >

- | | | |
|------------------------|-----------------------------|--|
| 1. Trunk lid finisher | 2. Trunk lid rubber bumper | 3. Trunk net rear |
| 4. Trunk rear finisher | 5. Trunk side finisher (RH) | 6. Trunk floor carpet |
| 7. Spare tire cover | 8. Trunk front finisher | 9. Trunk side finisher (LH) |
| A. Clip C205 | B. Clip - hook type |  Clip |
-  Vehicle front

Removal and Installation

INFOID:000000005440109

REMOVAL

1. Remove trunk net rear and trunk net side (if equipped).
2. Remove trunk floor carpet.
3. Remove trunk front finisher.
4. Release the clips, then remove trunk rear finisher.
5. Release the clips, then remove trunk side finisher (RH/LH).
6. Remove spare tire cover.
7. Remove the trunk lid rubber bumper (RH/LH), then release the clips and remove trunk lid finisher.

INSTALLATION

Installation is in the reverse order of removal.

CAUTION:

Make sure that clips are fully aligned with panel holes on body when installing, then press them in completely.