

# SECTION **SEC**

## SECURITY CONTROL SYSTEM

A  
B  
C  
D  
E  
F  
G  
H  
I  
J  
L  
M  
N  
O  
P

### CONTENTS

<b>INTELLIGENT KEY SYSTEM</b>	
<b>BASIC INSPECTION</b> .....	4
<b>DIAGNOSIS AND REPAIR WORKFLOW</b> .....	4
Work Flow .....	4
<b>PRE-INSPECTION FOR DIAGNOSTIC</b> .....	7
Basic Inspection .....	7
Vehicle Security Operation Check .....	7
<b>INSPECTION AND ADJUSTMENT</b> .....	9
<b>ECM RE-COMMUNICATING FUNCTION</b> .....	9
ECM RE-COMMUNICATING FUNCTION : De- scription .....	9
ECM RE-COMMUNICATING FUNCTION : Spe- cial Repair Requirement .....	9
<b>FUNCTION DIAGNOSIS</b> .....	10
<b>INTELLIGENT KEY SYSTEM/ENGINE</b>	
<b>START FUNCTION</b> .....	10
System Diagram .....	10
System Description .....	10
Component Parts Location .....	13
Component Description .....	14
<b>NVIS (NISSAN VEHICLE IMMOBILIZER SYS- TEM-NATS)</b> .....	15
System Diagram .....	15
System Description .....	15
Component Parts Location .....	16
Component Description .....	16
<b>VEHICLE SECURITY SYSTEM</b> .....	18
System Diagram .....	18
System Description .....	18
Component Parts Location .....	20
Component Description .....	21
<b>DIAGNOSIS SYSTEM (BCM)</b> .....	22
<b>COMMON ITEM</b> .....	22
COMMON ITEM : Diagnosis Description .....	22
COMMON ITEM : CONSULT-III Function (BCM - COMMON ITEM) .....	22
<b>INTELLIGENT KEY</b> .....	23
INTELLIGENT KEY : CONSULT-III Function (BCM - INTELLIGENT KEY) .....	23
<b>THEFT ALM</b> .....	25
THEFT ALM : CONSULT-III Function (BCM - THEFT) .....	25
<b>IMMU</b> .....	26
IMMU : CONSULT-III Function (BCM - IMMU) .....	26
<b>COMPONENT DIAGNOSIS</b> .....	28
<b>U1000 CAN COMM CIRCUIT</b> .....	28
Description .....	28
DTC Logic .....	28
Diagnosis Procedure .....	28
<b>U1010 CONTROL UNIT (CAN)</b> .....	29
DTC Logic .....	29
Diagnosis Procedure .....	29
<b>B2190, P1614 NATS ANTENNA AMP.</b> .....	30
Description .....	30
DTC Logic .....	30
Diagnosis Procedure .....	30
<b>B2191, P1615 DIFFERENCE OF KEY</b> .....	33
Description .....	33
DTC Logic .....	33
Diagnosis Procedure .....	33
<b>B2192, P1611 ID DISCORD, IMMU-ECM</b> .....	34
Description .....	34
DTC Logic .....	34
Diagnosis Procedure .....	34
<b>B2193, P1612 CHAIN OF ECM-IMMU</b> .....	35

SEC

Description .....	35	<b>B261A PUSH-BUTTON IGNITION SWITCH ....</b>	<b>58</b>
DTC Logic .....	35	Description .....	58
Diagnosis Procedure .....	35	DTC Logic .....	58
<b>B2195 ANTI-SCANNING .....</b>	<b>36</b>	Diagnosis Procedure .....	58
Description .....	36	<b>B261E VEHICLE TYPE .....</b>	<b>60</b>
DTC Logic .....	36	Description .....	60
Diagnosis Procedure .....	36	DTC Logic .....	60
<b>B2555 STOP LAMP .....</b>	<b>37</b>	Diagnosis Procedure .....	60
Description .....	37	<b>POWER SUPPLY AND GROUND CIRCUIT ....</b>	<b>61</b>
DTC Logic .....	37	<b>BCM .....</b>	<b>61</b>
Diagnosis Procedure .....	37	BCM : Diagnosis Procedure .....	61
Component Inspection .....	39	BCM : Special Repair Requirement .....	61
<b>B2556 PUSH-BUTTON IGNITION SWITCH ....</b>	<b>40</b>	<b>IPDM E/R (INTELLIGENT POWER DISTRIBUTION MODULE ENGINE ROOM) .....</b>	<b>62</b>
Description .....	40	IPDM E/R (INTELLIGENT POWER DISTRIBUTION MODULE ENGINE ROOM) : Diagnosis Procedure .....	62
DTC Logic .....	40	<b>KEY SLOT .....</b>	<b>63</b>
Diagnosis Procedure .....	40	Diagnosis Procedure .....	63
Component Inspection .....	41	<b>KEY SLOT ILLUMINATION .....</b>	<b>64</b>
<b>B2557 VEHICLE SPEED .....</b>	<b>42</b>	Description .....	64
Description .....	42	Component Function Check .....	64
DTC Logic .....	42	Diagnosis Procedure .....	64
Diagnosis Procedure .....	42	<b>KEY CYLINDER SWITCH .....</b>	<b>66</b>
<b>B2601 SHIFT POSITION .....</b>	<b>43</b>	Description .....	66
Description .....	43	Component Function Check .....	66
DTC Logic .....	43	Diagnosis Procedure (With LH and RH Anti-Pinch) .....	66
Diagnosis Procedure .....	43	Diagnosis Procedure (With LH Anti-Pinch Only) ....	68
Component Inspection .....	45	Component Inspection .....	69
<b>B2602 SHIFT POSITION .....</b>	<b>46</b>	<b>HORN .....</b>	<b>70</b>
Description .....	46	Description .....	70
DTC Logic .....	46	Component Function Check .....	70
Diagnosis Procedure .....	46	Diagnosis Procedure .....	70
<b>B2603 SHIFT POSITION STATUS .....</b>	<b>49</b>	<b>HEADLAMP .....</b>	<b>72</b>
Description .....	49	Description .....	72
DTC Logic .....	49	Component Function Check .....	72
Diagnosis Procedure .....	49	Diagnosis Procedure .....	72
<b>B2604 TRANSMISSION RANGE SWITCH .....</b>	<b>52</b>	<b>WARNING LAMP .....</b>	<b>73</b>
Description .....	52	Description .....	73
DTC Logic .....	52	Component Function Check .....	73
Diagnosis Procedure .....	52	Diagnosis Procedure .....	73
<b>B260F ENGINE STATUS .....</b>	<b>54</b>	<b>VEHICLE SECURITY INDICATOR .....</b>	<b>74</b>
Description .....	54	Description .....	74
DTC Logic .....	54	Component Function Check .....	74
Diagnosis Procedure .....	54	Diagnosis Procedure .....	74
<b>B26EA KEY REGISTRATION .....</b>	<b>55</b>	<b>ECU DIAGNOSIS .....</b>	<b>75</b>
Description .....	55	<b>BCM (BODY CONTROL MODULE) .....</b>	<b>75</b>
DTC Logic .....	55	Reference Value .....	75
Diagnosis Procedure .....	55		
<b>B2617 STARTER RELAY CIRCUIT .....</b>	<b>56</b>		
Description .....	56		
DTC Logic .....	56		
Diagnosis Procedure .....	56		

Terminal Layout .....	79	<b>INTELLIGENT KEY SYSTEM/ENGINE</b>	
Physical Values .....	79	<b>START FUNCTION SYMPTOMS .....</b>	<b>147</b>
Fail Safe .....	95	Symptom Table .....	147
DTC Inspection Priority Chart .....	96	<b>VEHICLE SECURITY SYSTEM SYMPTOMS .</b>	<b>148</b>
DTC Index .....	97	Symptom Table .....	148
<b>IPDM E/R (INTELLIGENT POWER DISTRI-</b>		<b>NISSAN VEHICLE IMMOBILIZER SYSTEM-</b>	
<b>BUTION MODULE ENGINE ROOM) .....</b>	<b>100</b>	<b>NATS SYMPTOMS .....</b>	<b>149</b>
Reference Value .....	100	Symptom Table .....	149
Terminal Layout .....	101	<b>PRECAUTION .....</b>	<b>150</b>
Physical Values .....	101	<b>PRECAUTIONS .....</b>	<b>150</b>
Wiring Diagram .....	105	Precaution for Supplemental Restraint System	
Fail Safe .....	110	(SRS) "AIR BAG" and "SEAT BELT PRE-TEN-	
DTC Index .....	112	SIONER" .....	150
<b>WIRING DIAGRAM .....</b>	<b>113</b>	Precautions For High-Voltage System .....	150
<b>INTELLIGENT KEY SYSTEM/ENGINE</b>		<b>PREPARATION .....</b>	<b>151</b>
<b>START FUNCTION .....</b>	<b>113</b>	<b>PREPARATION .....</b>	<b>151</b>
Wiring Diagram .....	113	Special Service Tool .....	151
<b>VEHICLE SECURITY SYSTEM .....</b>	<b>125</b>	<b>ON-VEHICLE REPAIR .....</b>	<b>152</b>
Wiring Diagram .....	125	<b>KEY SLOT .....</b>	<b>152</b>
<b>NVIS (NISSAN VEHICLE IMMOBILIZER SYS-</b>		Removal and Installation .....	152
<b>TEM-NATS) .....</b>	<b>138</b>	<b>PUSH BUTTON IGNITION SWITCH .....</b>	<b>153</b>
Wiring Diagram .....	138	Removal and Installation .....	153
<b>SYMPTOM DIAGNOSIS .....</b>	<b>147</b>		

A  
B  
C  
D  
E  
F  
G  
H  
I  
J

**SEC**

L  
M  
N  
O  
P

**BASIC INSPECTION**

DIAGNOSIS AND REPAIR WORKFLOW

Work Flow

INFOID:000000005439802

OVERALL SEQUENCE

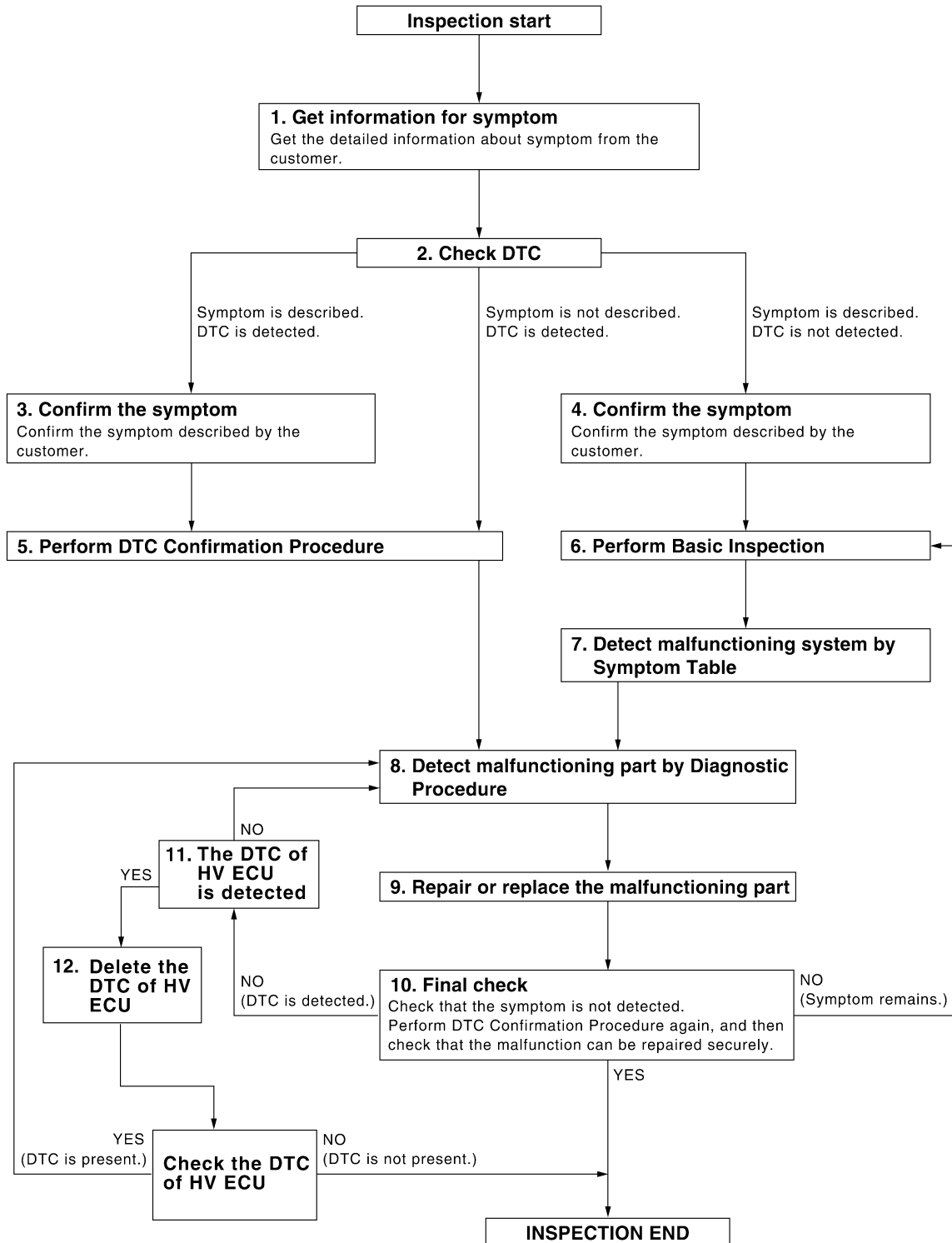

ALKITA1389GB

DETAILED FLOW

# DIAGNOSIS AND REPAIR WORKFLOW

< BASIC INSPECTION >

[INTELLIGENT KEY SYSTEM]

## 1.GET INFORMATION FOR SYMPTOM

Get the detailed information from the customer about the symptom (the condition and the environment when the incident/malfunction occurred).

>> GO TO 2

## 2.CHECK DTC WITH BCM AND IPDM E/R

1. Check "Self Diagnostic Result" with CONSULT-III.
2. Perform the following procedure if DTC is displayed.
  - Record DTC and freeze frame data (Print them out with CONSULT-III.)
  - Erase DTC.
  - Study the relationship between the cause detected by DTC and the symptom described by the customer.
3. Check related service bulletins for information.

Is any symptom described and any DTC detected?

Symptom is described, DTC is displayed>>GO TO 3

Symptom is described, DTC is not displayed>>GO TO 4

Symptom is not described, DTC is displayed>>GO TO 5

## 3.CONFIRM THE SYMPTOM

Confirm the symptom described by the customer.

Connect CONSULT-III to the vehicle in "Data Monitor" mode and check real time diagnosis results.

Verify relation ship between the symptom and the condition when the symptom is detected.

>> GO TO 5

## 4.CONFIRM THE SYMPTOM

Confirm the symptom described by the customer.

Connect CONSULT-III to the vehicle in "Data Monitor" mode and check real time diagnosis results.

Verify relation ship between the symptom and the condition when the symptom is detected.

>> GO TO 6

## 5.PERFORM DTC CONFIRMATION PROCEDURE

Perform DTC Confirmation Procedure for the displayed DTC, and then check that DTC is detected again.

At this time, always keep CONSULT-III connected to the vehicle, and check diagnostic results in real time.

If two or more DTCs are detected, refer to [SEC-96. "DTC Inspection Priority Chart"](#) and determine trouble diagnosis order.

**NOTE:**

- Freeze frame data is useful if the DTC is not detected.
- Perform Component Function Check if DTC Confirmation Procedure is not included in Service Manual. This simplified check procedure is an effective alternative though DTC cannot be detected during this check. If the result of Component Function Check is NG, it is the same as the detection of DTC by DTC Confirmation Procedure.

Is DTC detected?

YES >> GO TO 8

NO >> Refer to [GI-42. "Intermittent Incident"](#).

## 6.PERFORM BASIC INSPECTION

Perform [SEC-7. "Basic Inspection"](#).

>> GO TO 7

## 7.DETECT MALFUNCTIONING SYSTEM BY SYMPTOM TABLE

Detect malfunctioning system according to following symptom tables based on the confirmed symptom in step 4, and determine the trouble diagnosis order based on possible causes and symptoms.

- Intelligent Key system/hybrid system start function: [SEC-147. "Symptom Table"](#).
- Vehicle security system: [SEC-148. "Symptom Table"](#).

# DIAGNOSIS AND REPAIR WORKFLOW

< BASIC INSPECTION >

[INTELLIGENT KEY SYSTEM]

- Nissan vehicle immobilizer system-NATS: [SEC-149. "Symptom Table"](#).

>> GO TO 8

## 8. DETECT MALFUNCTIONING PART BY DIAGNOSTIC PROCEDURE

---

Inspect according to Diagnostic Procedure of the system.

### NOTE:

The Diagnostic Procedure described based on open circuit inspection. A short circuit inspection is also required for the circuit check in the Diagnostic Procedure.

Is malfunctioning part detected?

YES >> GO TO 9

NO >> Check voltage of related BCM terminals using CONSULT-III.

## 9. REPAIR OR REPLACE THE MALFUNCTIONING PART

---

1. Repair or replace the malfunctioning part.
2. Reconnect parts or connectors disconnected during Diagnostic Procedure again after repair or replacement.
3. Check DTC. If DTC is displayed, erase it.

>> GO TO 10

## 10. FINAL CHECK

---

When DTC was detected in step 2, perform DTC Confirmation Procedure or Component Function Check again, and then check that the malfunction have been fully repaired.

When symptom was described from the customer, refer to confirmed symptom in step 3 or 4, and check that the symptom has been repaired.

YES or NO

NO (DTC is detected) >>GO TO 11

NO (Symptom remains) >>GO TO 6

YES >> Inspection End.

## 11. CHECK DTC WITH HV ECU

---

Check hybrid vehicle control ECU (HV ECU) "Self Diagnostic Result" with CONSULT-III.

Is any DTC detected?

YES >> GO TO 12

NO >> GO TO 8

## 12. RECHECK DTC WITH HV ECU

---

1. Erase HV ECU DTCs.
2. Check hybrid vehicle control ECU (HV ECU) "Self Diagnostic Result" with CONSULT-III.

Is any DTC detected?

YES >> GO TO 8

NO >> Inspection End.

## PRE-INSPECTION FOR DIAGNOSTIC

## Basic Inspection

INFOID:000000005439803

The hybrid system start function, door lock function, power distribution system and NATS-NVIS in the Intelligent Key system are closely related to each other regarding control. Narrow down the functional area in question by performing basic inspection to identify which function is malfunctioning. The vehicle security function can operate only when the door lock and power distribution system are operating normally. Therefore, it is easy to identify any factor unique to the vehicle security system by performing the vehicle security operation check after basic inspection.

**1.CHECK DOOR LOCK OPERATION**

Check the door lock for normal operation with the Intelligent Key and door request switch. Successful door lock operation with the Intelligent Key and request switch indicates that the remote keyless entry receiver and inside key antenna required for engine start are functioning normally. Identify the malfunctioning point by referring to the DLK section if the door cannot be unlocked.

Can the door be locked with the Intelligent Key and door request switch?

YES >> GO TO 2

NO >> Refer to [DLK-180. "Symptom Table"](#).

**2.CHECK HYBRID SYSTEM STARTING**

Check that the hybrid system starts when operating with the Intelligent Key inserted into the key slot.

Does the hybrid system start?

YES >> GO TO 3

NO >> Refer to [SEC-147. "Symptom Table"](#).

**3.CHECK POWER SUPPLY INDICATOR SWITCHING**

Press push-button ignition switch and position indicator will switch from LOCK, ACC to ON. Check that the position indicator is illuminated at different positions.

Is each position indicator illuminating?

YES >> GO TO 4

NO >> Refer to [PCS-70. "Component Function Check"](#).

**4.CHECK VEHICLE SECURITY SYSTEM**

Check the vehicle security system for normal operation.

The vehicle security function can operate only when the door lock and power distribution functions are operating normally.

Therefore, it is easy to identify any factor unique to the vehicle security by performing the vehicle security operation check after this basic inspection.

>> Refer to [SEC-7. "Vehicle Security Operation Check"](#).

## Vehicle Security Operation Check

INFOID:000000005439804

**1.INSPECTION START**

Turn ignition switch "OFF" and remove Intelligent Key from key slot.

**NOTE:**

Before starting operation check, open front windows.

>> GO TO 2

**2.CHECK SECURITY INDICATOR LAMP**

1. Lock doors using Intelligent Key or mechanical key.
2. Check that security indicator lamp illuminates for 30 seconds.

Does the security indicator lamp illuminate?

YES >> GO TO 3

NO >> Perform diagnosis and repair. Refer to [SEC-74. "Component Function Check"](#).

A

B

C

D

E

F

G

H

I

J

SEC

L

M

N

O

P

## PRE-INSPECTION FOR DIAGNOSTIC

< BASIC INSPECTION >

[INTELLIGENT KEY SYSTEM]

---

### 3. CHECK ALARM FUNCTION

---

1. After 30 seconds, security indicator lamp will start to blink.
2. Open any door before unlocking with Intelligent Key or mechanical key, or open trunk lid without Intelligent Key or mechanical key.

Does the alarm function properly?

YES >> GO TO 4

NO >> Check the following.

- The vehicle security system does not phase in alarm mode. Refer to [SEC-148. "Symptom Table"](#).
- Alarm (horn, headlamp and hazard lamp) do not operate. Refer to [SEC-148. "Symptom Table"](#).

### 4. CHECK ALARM CANCEL OPERATION

---

Unlock any door or open trunk lid using Intelligent Key or mechanical key.

Does the alarm (horn, headlamp and hazard lamp) stop?

YES >> Inspection End.

NO >> Check door lock function. Refer to [DLK-20. "INTELLIGENT KEY : System Description"](#).



INSPECTION AND ADJUSTMENT  
ECM RE-COMMUNICATING FUNCTION

A

ECM RE-COMMUNICATING FUNCTION : Description

INFOID:000000005439805

B

Performing following procedure can automatically perform re-communication of ECM and BCM, but only when the ECM has been replaced with a new one (\*1).

\*1: New one means an ECM which has never been energized on-board.  
(In this step, initialization procedure by CONSULT-III is not necessary)

C

**NOTE:**

- When registering new Key IDs or replacing the ECM that is not brand new, refer to CONSULT-III Operation Manual NATS-IVIS/NVIS.
- If multiple keys are attached to the key holder, separate them before work.
- Distinguish keys with unregistered key ID from those with registered ID.

D

ECM RE-COMMUNICATING FUNCTION : Special Repair Requirement

INFOID:000000005439806

E

**1.**PERFORM ECM RE-COMMUNICATING FUNCTION

F

1. Install ECM.
2. Insert the registered Intelligent Key (\*2), turn ignition switch to "ON".  
\*2: To perform this step, use the key that has been used before performing ECM replacement.
3. Maintain ignition switch in "ON" position for at least 5 seconds.
4. Turn ignition switch to "OFF".
5. Start engine.

G

Can engine be started?

H

- YES >> Procedure is completed.  
NO >> Initialize control unit.Refer to CONSULT-III Operation Manual.

I

J

SEC

L

M

N

O

P

FUNCTION DIAGNOSIS

INTELLIGENT KEY SYSTEM/ENGINE START FUNCTION

System Diagram

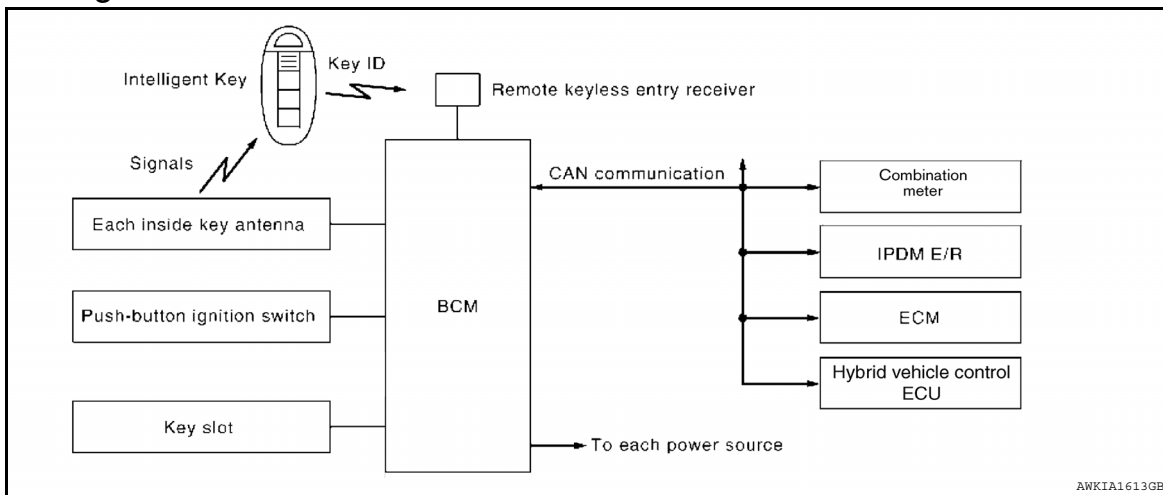

INFOID:000000005439807

AWKIA1613GB

System Description

INFOID:000000005439808

INPUT/OUTPUT SIGNAL CHART

Switch	Input signal to BCM	BCM function	Actuator
Push-button ignition switch	Push switch	Engine start function	• KEY warning lamp
CVT shift selector	P range		
Transmission range switch	N, P range		
Stop lamp switch	Brake ON/OFF		
Each inside key antenna	Request signal		
Remote keyless entry receiver	Key ID		
Each door switch	Door open/close		
ECM	Engine status signal		

SYSTEM DESCRIPTION

- The engine start function of Intelligent Key system is a system that makes it possible to start and stop the engine without removing the key. It verifies the electronic ID using two-way communications when pressing the push-button ignition switch while carrying the Intelligent Key, which operates based on the results of electronic ID verification for Intelligent Key using two-way communications between the Intelligent Key and the vehicle.

NOTE:

The driver should carry the Intelligent Key at all times.

- Intelligent Key has 2 IDs [for Intelligent Key and for NVIS (NATS)]. It can perform the door lock/unlock operation and the push-button ignition switch operation when the registered Intelligent Key is carried.
- When the Intelligent Key battery is discharged, it can be used as emergency back-up by inserting the Intelligent Key to the key slot. At that time, perform the NVIS (NATS) ID verification. If it is used when the Intelligent Key is carried, perform the Intelligent Key ID verification.
- If the ID is successfully verified, and when push-button ignition switch is pressed, starting the hybrid system will be possible.
- If the door lock/unlock operation is performed when the Intelligent Key battery is discharged, all doors lock/unlock can be performed by operating the driver door key cylinder using the mechanical key set in the Intelligent Key.
- Intelligent Key can be registered with up to 4 keys on request from the owner.

NOTE:

# INTELLIGENT KEY SYSTEM/ENGINE START FUNCTION

< FUNCTION DIAGNOSIS >

[INTELLIGENT KEY SYSTEM]

- Refer to [DLK-20. "INTELLIGENT KEY : System Description"](#) for any functions other than hybrid system start function of Intelligent Key system.

## PRECAUTIONS FOR INTELLIGENT KEY SYSTEM

- **In the Intelligent Key system of model L32, the transponder [the chip for NVIS (NATS) ID verification] is integrated into the Intelligent Key. (For vehicles without Intelligent Key, it is integrated into the mechanical key.) Therefore, the mechanical key cannot perform the ID verification, and thus it cannot start the hybrid system. Instead, the NVIS (NATS) ID verification can be performed by inserting the Intelligent Key into the key slot, and then it can start the hybrid system.**

## OPERATION WHEN INTELLIGENT KEY IS CARRIED

1. When the push-button ignition switch is pressed and brake pedal depressed, the BCM signals the inside key antenna and transmits the request signal to the Intelligent Key.
2. The Intelligent Key receives the request signal and transmits the Intelligent Key ID signal to the BCM via the remote keyless entry receiver.
3. The BCM receives the Intelligent Key ID signal and verifies it with the registered ID.
4. BCM turns ACC relay ON and transmits the ignition power supply ON signal to IPDM E/R.
5. IPDM E/R turns the ignition relay ON and starts the ignition power supply.
6. BCM confirms that the shift position is P.
7. BCM transmits the hybrid system start request signal via hardwire to Hybrid Vehicle Control ECU. If BCM judges that the hybrid system start condition is satisfied.

### CAUTION:

**If a malfunction is detected in the Intelligent Key system, the "KEY" warning lamp in the combination meter illuminates. At that time, the engine cannot be started.**

\*: For the hybrid system start condition, refer to "PUSH-BUTTON IGNITION SWITCH OPERATION PROCEDURE".

## OPERATION RANGE

Hybrid system can be started when Intelligent Key is inside the vehicle. However, sometimes hybrid system might not start when Intelligent Key is on instrument panel or in glove box.

## OPERATION WHEN KEY SLOT IS USED

When the Intelligent Key battery is discharged, it performs the NVIS (NATS) ID verification between the integrated transponder and BCM by inserting the Intelligent Key into the key slot, and then the hybrid system can be started.

For details relating to starting the hybrid system using key slot, refer to [SEC-15. "System Description"](#).

## BATTERY SAVER SYSTEM

When all the following conditions are met for 60 minutes, the battery saver system will cut off the power supply to prevent battery discharge.

- The ignition switch is in the ACC position
- All doors are closed
- CVT selector lever is in the P position
- No Intelligent Key malfunctions (Intelligent Key warning indicator is not ON)

### Reset Condition of Battery Saver System

In order to prevent the battery from discharging, the battery saver system will cut off the power supply when all doors are closed, the selector lever is on P position and the ignition switch is left on ACC position for 1 hour. If any of the following conditions are met the battery saver system is released and the steering will change automatically to lock position from OFF position.

- Opening any door
  - Operating with request switch on door lock
  - Operating with Intelligent Key on door lock
- Press push-button ignition switch will change to ACC position from OFF position.

## PUSH-BUTTON IGNITION SWITCH OPERATION PROCEDURE

The power supply position changing operation can be performed with the following operations.

### NOTE:

- When an Intelligent Key is within the detection area of inside key antenna or when it is inserted to the key slot, it is equivalent to the operations below.
- When starting the engine, the BCM monitors under the hybrid system start conditions,

# INTELLIGENT KEY SYSTEM/ENGINE START FUNCTION

< FUNCTION DIAGNOSIS >

[INTELLIGENT KEY SYSTEM]

- Brake pedal operating condition
- CVT selector lever position
- Vehicle speed
- Engine status
- Unless each condition is fulfilled, the hybrid system will not respond regardless of how many times the hybrid system switch is pressed. At that time, illumination repeats the position in the order of LOCK→ACC→ON→OFF.

Power supply position	Hybrid system start/stop condition		Push-button ignition switch operation frequency
	Brake pedal	CVT selector lever position	
LOCK → ACC	Not depressed	Any position	1
LOCK → ACC → ON	Not depressed	Any position	2
LOCK → ACC → ON → OFF	Not depressed	Any position	3
LOCK → START ACC → START ON → START (Engine start)	Depressed	P(*1)	1 [If the switch is pressed once, the engine starts from any power supply position (LOCK, ACC, and ON)]
Engine is running → OFF (Engine stop)	—	Any position (vehicle speed < 4 km/h)	1
Engine is running → ACC (Engine stop)	—	Any position other than P (*2)	1
Engine stall return operation while driving	—	P position	1

\*1: When the CVT selector lever position is N position, the engine start condition is different according to the vehicle speed.

- At vehicle speed of 4 km/h or less, the engine can start only when the brake pedal is depressed.
- At vehicle speed of 4 km/h or more, the engine can start even if the brake pedal is not depressed. (It is the same as “Engine stall return operation while driving”.)

\*2: When the CVT selector lever position is in any position other than P position and when the vehicle speed is 5 km/h or more, the engine stop condition is different.

- Press and hold the push-button ignition switch for 2 seconds or more. (When the push-button ignition switch is pressed for too short a time, the operation may be invalid, so properly press and hold to prevent an incorrect operation.)
- Press the push-button ignition switch 3 times or more within 1.5 seconds. (Emergency stop operation)

# INTELLIGENT KEY SYSTEM/ENGINE START FUNCTION

< FUNCTION DIAGNOSIS >

[INTELLIGENT KEY SYSTEM]

## Component Parts Location

INFOID:000000005439809

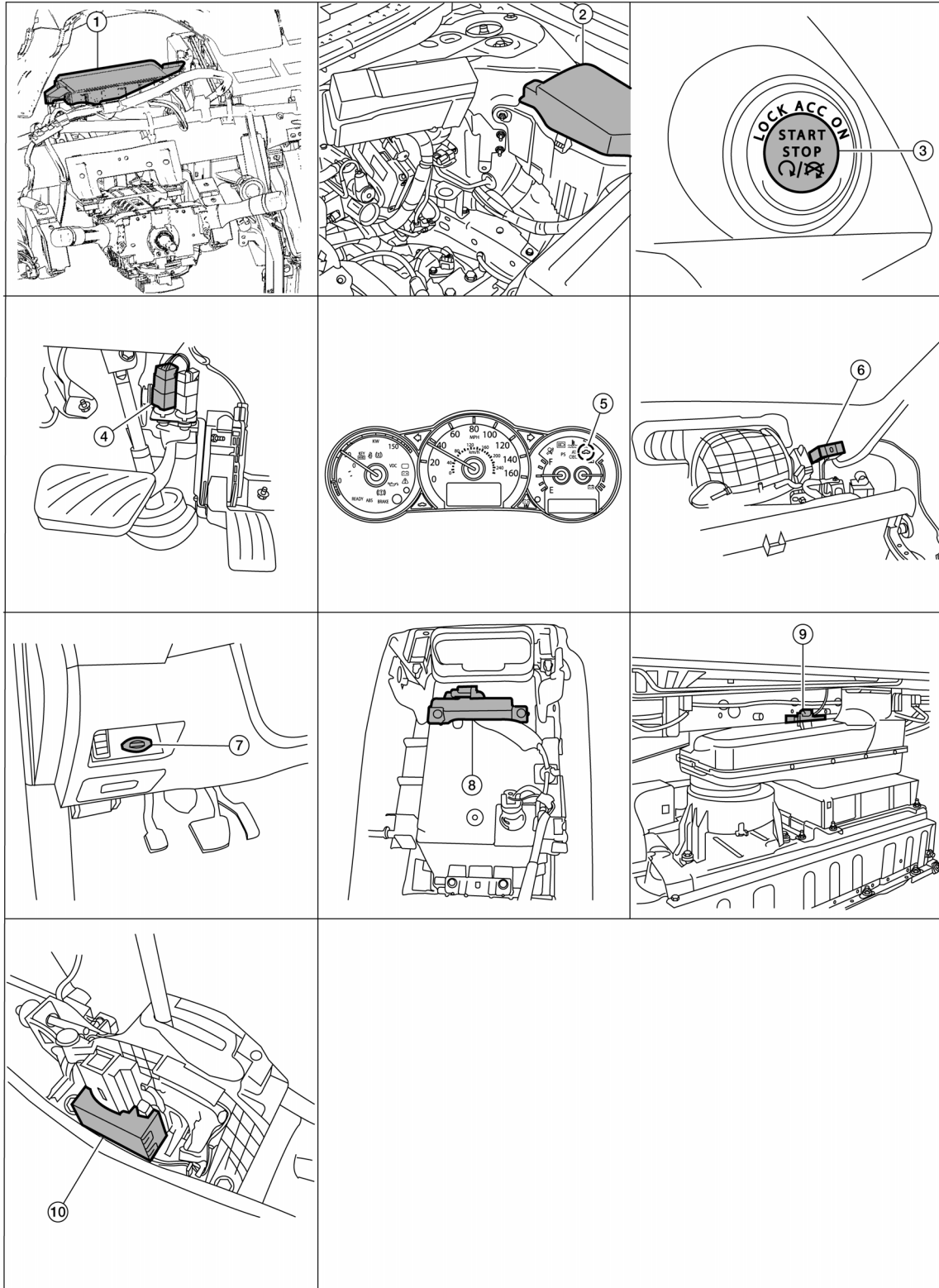

A  
B  
C  
D  
E  
F  
G  
H  
I  
J  
K  
L  
M  
N  
O  
P

SEC

← Front

- 1. BCM M16, M17, M18, M19, M21 (view with instrument panel removed)
- 2. IPDM E/R E17, E18
- 3. Push button ignition switch M38
- 4. Stop lamp switch E38 (view with instrument lower cover LH removed)
- 5. Security indicator lamp

AWKIA1614ZZ

# INTELLIGENT KEY SYSTEM/ENGINE START FUNCTION

< FUNCTION DIAGNOSIS >

[INTELLIGENT KEY SYSTEM]

- |  |                            |   |
|--|----------------------------|---|
| 6. Remote keyless entry receiver M27<br>(view with instrument panel removed) | 7. Key slot M40            | 8. Front console antenna M203<br>(bottom view of console) |
| 9. Rear parcel shelf antenna B29   | 10. CVT shift selector M23 |   |

## Component Description

INFOID:000000005439810

Component	Reference
Push-button ignition switch	<a href="#">SEC-58</a>
Door switch	<a href="#">DLK-62</a>
CVT shift selector	<a href="#">SEC-43</a>
Inside key antenna	<a href="#">DLK-55</a>
Remote keyless entry receiver	<a href="#">DLK-107</a>
Stop lamp switch	<a href="#">SEC-37</a>
Transmission range switch	<a href="#">SEC-52</a>
Security indicator	<a href="#">SEC-74</a>
Key warning lamp	<a href="#">SEC-73</a>

# NVIS (NISSAN VEHICLE IMMOBILIZER SYSTEM-NATS)

< FUNCTION DIAGNOSIS >

[INTELLIGENT KEY SYSTEM]

## NVIS (NISSAN VEHICLE IMMOBILIZER SYSTEM-NATS)

### System Diagram

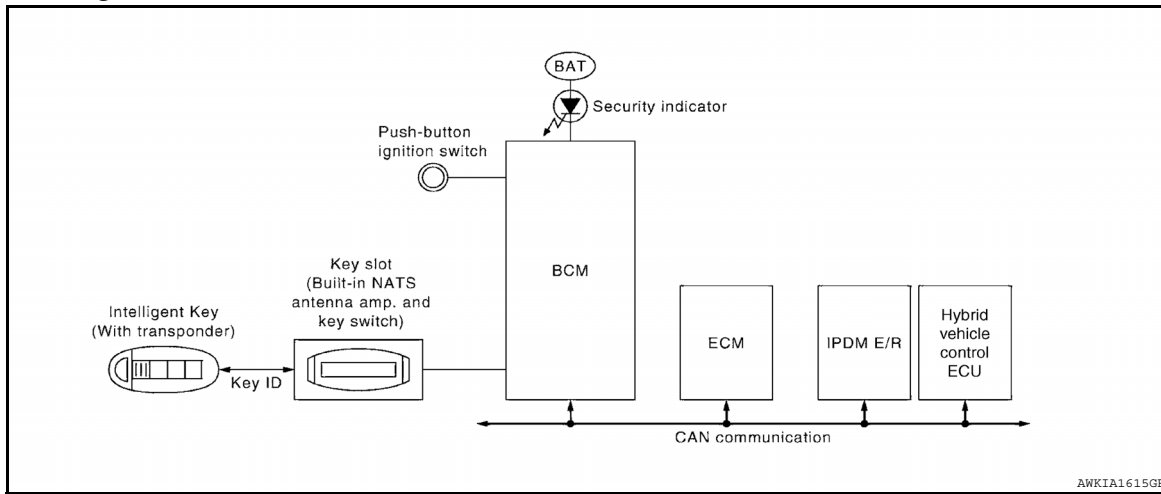

### System Description

INFOID:000000005439812

### INPUT/OUTPUT SIGNAL CHART

Switch	Input signal to BCM	BCM function	Actuator
Push-button ignition switch	Push switch	NVIS (NATS)	<ul style="list-style-type: none"> <li>KEY warning lamp</li> <li>Security indicator lamp</li> </ul>
CVT shift selector	P range		
Transmission range switch	N, P range		
Stop lamp switch	Brake ON/OFF		
Key slot	Key ID		
Each door switch	Door open/close		
ECM	Engine status signal		

### SYSTEM DESCRIPTION

- The NVIS (NATS) is an anti-theft system by registering an Intelligent Key ID in to the vehicle and prevents the hybrid system being started by an unregistered Intelligent Key. It has a higher protection against auto thefts that duplicate mechanical key.
- It performs the ID verification when starting the hybrid system in the same way as the Intelligent Key system. But, it performs the NVIS (NATS) ID verification when inserting the Intelligent Key and performs the Intelligent Key ID verification when carrying the Intelligent Key.
- The Intelligent Key system of L32 is not the same as the conventional models. The mechanical key integrated in the Intelligent Key cannot start the hybrid system. When the Intelligent Key battery is discharged, the NVIS (NATS) ID verification memorized to the transponder integrated with Intelligent Key is performed by inserting the Intelligent Key into the key slot. If the verification results are OK, the hybrid system start operation can be performed by the push-button ignition switch operation.
- The security indicator always blinks when the Intelligent Key is removed from the key slot and when the push-button ignition switch is in LOCK position.
- Intelligent Key can be registered with up to 4 keys on request from the owner.
- The specified registration is required when replacing ECM, BCM or Intelligent Key. The registration procedure for NVIS (NATS) and registration procedure for Intelligent Key when installing the BCM, refer to CONSULT-III Operation Manual NATS-IVIS/NVIS.
- Possible symptom of NVIS (NATS) malfunction is "hybrid system cannot start". In L32, the hybrid system can be started with the Intelligent Key system and NVIS (NATS). Identify the possible causes according to "Work Flow", Refer to [SEC-4, "Work Flow"](#).
- If ECM other than Genuine NISSAN part is installed, the hybrid system cannot be started. For ECM replacement procedure, refer to [SEC-9, "ECM RE-COMMUNICATING FUNCTION : Special Repair Requirement"](#).

### PRECAUTIONS FOR KEY REGISTRATION

A  
B  
C  
D  
E  
F  
G  
H  
I  
J  
L  
M  
N  
O  
P

SEC

# NVIS (NISSAN VEHICLE IMMOBILIZER SYSTEM-NATS)

[INTELLIGENT KEY SYSTEM]

## < FUNCTION DIAGNOSIS >

- The key registration is a procedure that erases the current NVIS (NATS) ID once, and then re-registers a new ID operation. Therefore the registered Intelligent Key is necessary for this procedure. Before starting the registration operation collect all registered Intelligent Keys from the customer
- When registering the Intelligent Key, performs only one procedure to register simultaneously both ID (NVIS "NATS" ID registration and Intelligent Key ID registration).

The NVIS (NATS) ID registration is the procedure that registers the ID stored into the transponder (integrated in Intelligent Key) to BCM.

The Intelligent key ID registration is the procedure that registers the ID to BCM.

- When performing the Intelligent Key system registration only, the hybrid system cannot be started by inserting the key into the key slot. When performing the NVIS (NATS) registration only, the hybrid system cannot be started by the operation when carrying the key. The registration of both systems should be performed.

## SECURITY INDICATOR

- Warns that the vehicle is equipped with NVIS (NATS).
- The security indicator always blinks when the Intelligent Key is removed from the key slot and when the ignition switch is in LOCK position.

### NOTE:

Because security indicator is highly efficient, the battery is barely affected.

## Component Parts Location

INFOID:000000005439813

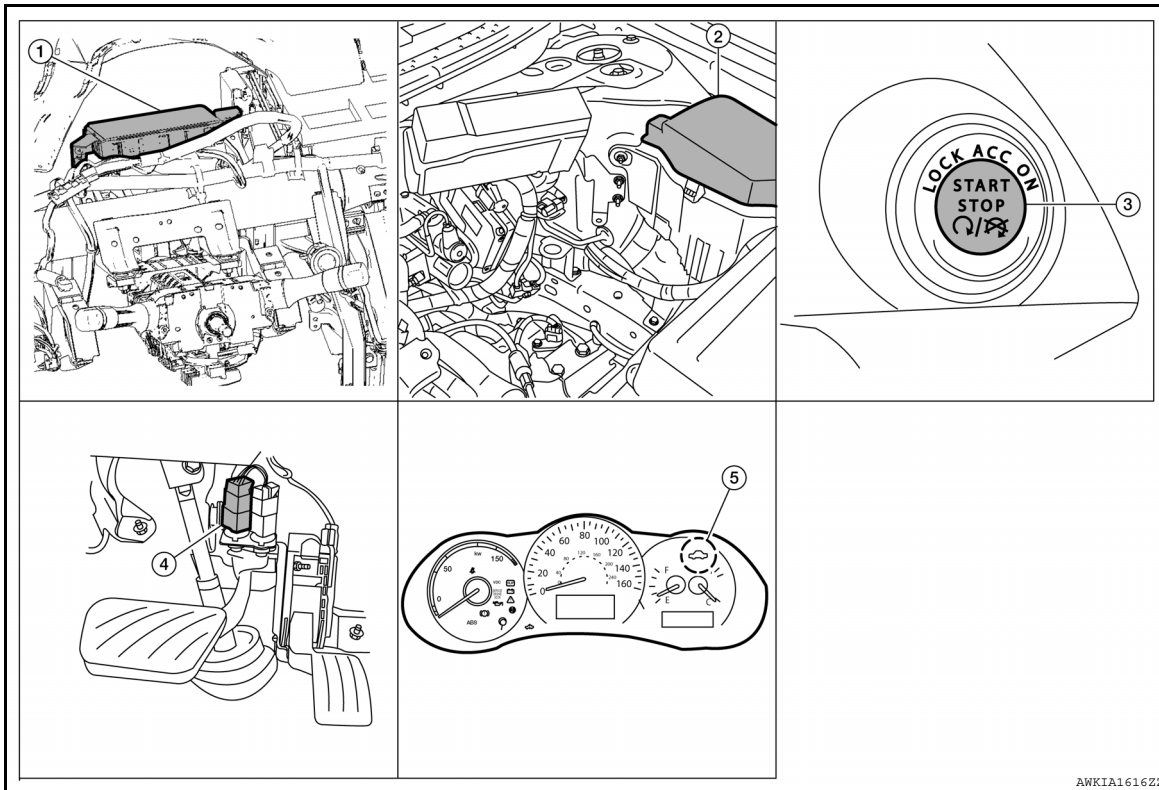

AWKIA1616ZZ

← Front

- |   |   |  |
|---|---|--|
| <p>3. Push-button ignition switch M38</p> | <p>1. BCM M16, M17, M18, M19, M21<br/>(view with instrument panel removed)</p> <p>4. Stop lamp switch E38<br/>(view with instrument lower cover LH removed)</p> | <p>2. IPDM E/R E17, E18</p> <p>5. Security indicator lamp.</p> |
|---|---|--|

## Component Description

INFOID:000000005439814

Component	Reference
Push-button ignition switch	<a href="#">SEC-58</a>
Door switch	<a href="#">DLK-62</a>



# NVIS (NISSAN VEHICLE IMMOBILIZER SYSTEM-NATS)

< FUNCTION DIAGNOSIS >

[INTELLIGENT KEY SYSTEM]

Component	Reference
CVT shift selector	<a href="#">SEC-43</a>
Inside key antenna	<a href="#">DLK-55</a>
Remote keyless entry receiver	<a href="#">DLK-107</a>
Stop lamp switch	<a href="#">SEC-37</a>
Transmission range switch	<a href="#">SEC-52</a>
Key warning lamp	<a href="#">SEC-73</a>

A  
B  
C

D

E

F

G

H

I

J

SEC

L

M

N

O

P

# VEHICLE SECURITY SYSTEM

< FUNCTION DIAGNOSIS >

[INTELLIGENT KEY SYSTEM]

## VEHICLE SECURITY SYSTEM

### System Diagram

INFOID:000000005439815

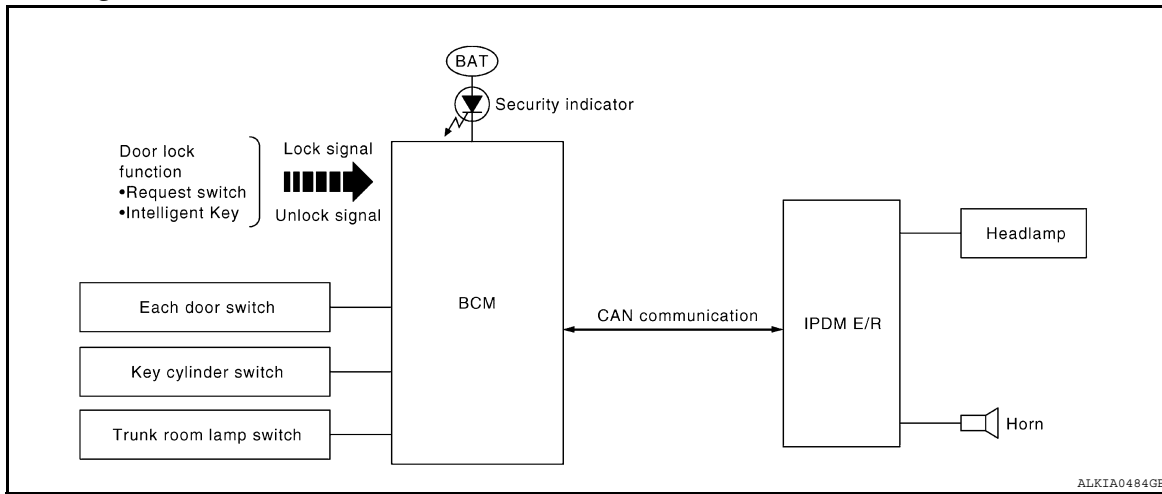

ALKIA0484GB

### System Description

INFOID:000000005439816

### INPUT/OUTPUT SIGNAL CHART

Switch	Input signal to BCM	BCM system	Actuator
All door switch	Open or close	Vehicle security system	<ul style="list-style-type: none"> <li>IPDM E/R</li> <li>Head lamp</li> <li>Horn</li> <li>Security indicator lamp</li> </ul>
Trunk room lamp switch			
Door key cylinder switch	Lock or unlock		
Door lock and unlock switch			
Door request switch			
Intelligent Key	Lock or unlock		
	Panic alarm		

### OPERATION FLOW

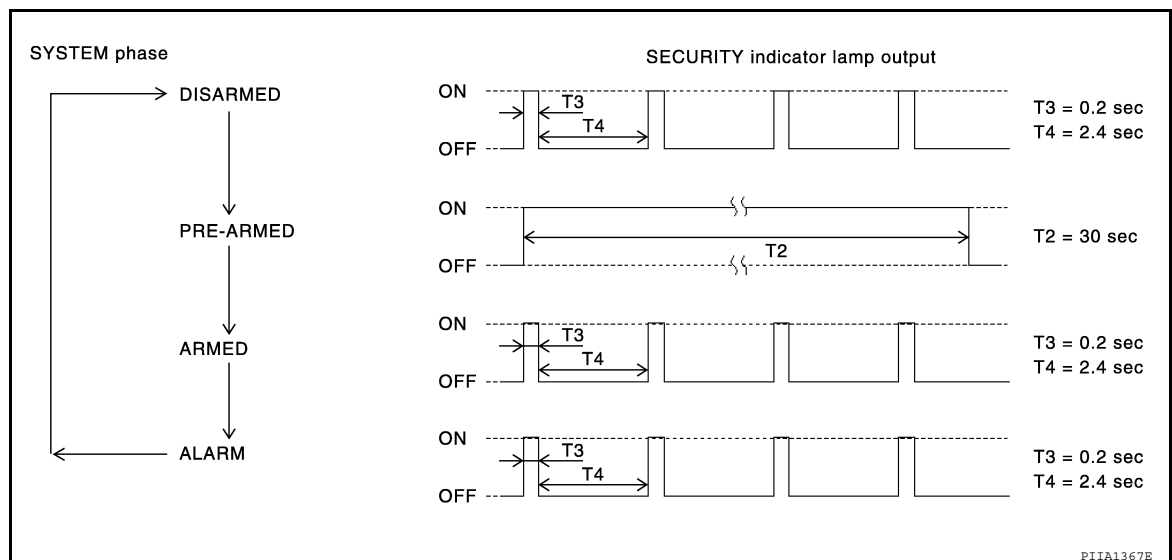

PIIA1367E

### SETTING THE VEHICLE SECURITY SYSTEM

#### Initial Condition

- Ignition switch is in OFF position.

#### Disarmed Phase

# VEHICLE SECURITY SYSTEM

## < FUNCTION DIAGNOSIS >

## [INTELLIGENT KEY SYSTEM]

- When doors or trunk is open, the vehicle security system is set in the disarmed phase on the assumption that the owner is inside or near the vehicle. A
- When the vehicle security system is in the disarmed phase, the security indicator lamp blinks every 2.4 seconds. B

### Pre-armed Phase and Armed Phase

When the following operation 1 or 2 is performed, the vehicle security system turns into the “pre-armed” phase. (The security indicator lamp illuminates.)

1. BCM receives LOCK signal from front door key cylinder switch or Intelligent Key, after trunk and all doors are closed. C
2. Trunk and all doors are closed after front doors are locked by key or door lock and unlock switch. The security indicator lamp illuminates for 30 seconds. Then, the system automatically shifts into the “armed” phase. D

### CANCELING THE SET VEHICLE SECURITY SYSTEM

When one of the following operations is performed, the armed phase is canceled. E

1. Unlock the doors with the key or Intelligent Key.
2. Turn ignition switch “ON” or “ACC” position. F

### CANCELING THE ALARM OPERATION OF THE VEHICLE SECURITY SYSTEM

When unlocking the door with the key or Intelligent Key the alarm operation is canceled. G

### ACTIVATING THE ALARM OPERATION OF THE VEHICLE SECURITY SYSTEM

Check that the system is in the armed phase. (The security indicator lamp blinks every 2.4 seconds.)

When the following operation 1 or 2 is performed, the system sounds the horns and flashes the headlamps for about 50 seconds. H

1. Trunk or any door is opened during armed phase.
2. Disconnecting and connecting the battery connector before canceling armed phase. I

### PANIC ALARM OPERATION

Intelligent Key system will not operate vehicle security system (horn and headlamps) if the ignition switch is in the ACC or ON position. J

When the Intelligent Key system is triggered, ground is supplied intermittently to both headlamp relay and horn relay.

When headlamp relay and horn relay are energized, then power is supplied to headlamps (LH and RH) and horns (HIGH and LOW).

The headlamp flashes and the horn sounds intermittently.

The alarm automatically turns off after 50 seconds or when BCM receives any signal from Intelligent Key. L

SEC

L

M

N

O

P

# VEHICLE SECURITY SYSTEM

< FUNCTION DIAGNOSIS >

[INTELLIGENT KEY SYSTEM]

## Component Parts Location

INFOID:000000005439817

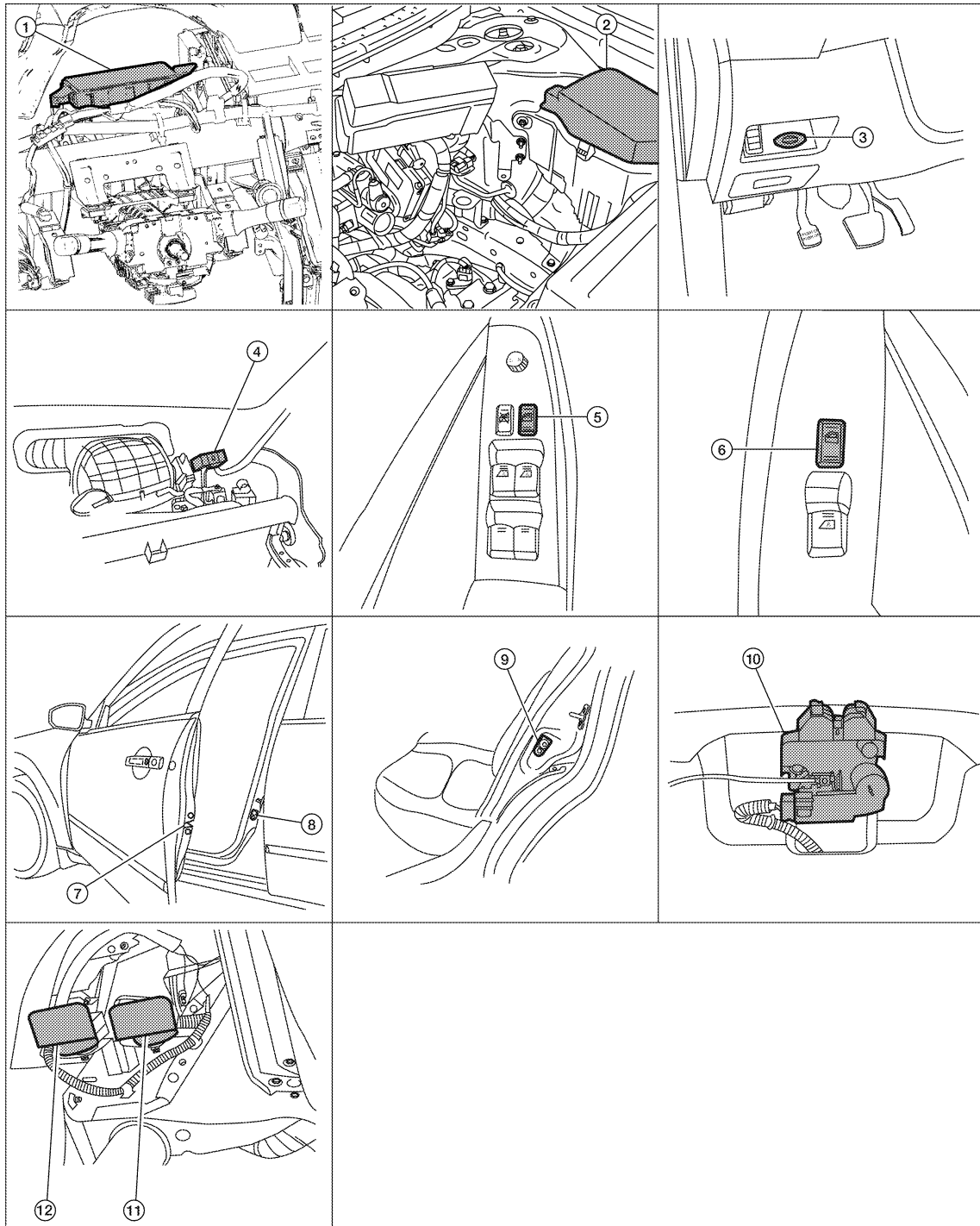

ALKIA0239ZZ

- |  |  |   |
|--|--|---|
| 1. BCM M16, M17, M18, M19, M21<br>(view with instrument panel removed)       | 2. IPDM E/R E17, E18   | 3. Key slot M40   |
| 4. Remote keyless entry receiver M27<br>(view with instrument panel removed) | 5. Main power window and door lock/unlock switch D8 (with left and right front power window anti-pinch system) D8, D12 (with left front only power window anti-pinch system) | 6. Power window and door lock/unlock switch RH D110 (with left front only power window anti-pinch system) D105 (with left and right front power window anti-pinch system) |

# VEHICLE SECURITY SYSTEM

## < FUNCTION DIAGNOSIS >

## [INTELLIGENT KEY SYSTEM]

- |   |  |                                    |
|---|--|------------------------------------|
| 7. Front door lock assembly LH (key cylinder switch) D10 (with left and right front power window anti-pinch system) D14 (with left front only power window anti-pinch system) | 8. Front door switch LH B8 RH B108                                 | 9. Rear door switch LH B18 RH B116 |
| 10. Trunk lamp switch and trunk release solenoid B28 (view with trunk lid inner trim panel removed)   | 11. Horn (high) E216 (view with front fender protector LH removed) | 12. Horn (low) E215                |

A  
B  
C

## Component Description

INFOID:000000005439818

Component	Reference
BCM	<a href="#">SEC-18</a>
Horn relay	<a href="#">SEC-70</a>
Security indicator	<a href="#">SEC-74</a>
Door switch	<a href="#">DLK-62</a>
Door lock actuator	<a href="#">DLK-95</a>
Trunk lid lock assembly	<a href="#">DLK-100</a>
Door key cylinder switch	<a href="#">DLK-74</a>
Door lock and unlock switch (driver)	<a href="#">DLK-65</a>
Door lock and unlock switch (passenger)	<a href="#">DLK-68</a>

D  
E  
F  
G  
H  
I  
J  
L  
M  
N  
O  
P

SEC

# DIAGNOSIS SYSTEM (BCM)

< FUNCTION DIAGNOSIS >

[INTELLIGENT KEY SYSTEM]

## DIAGNOSIS SYSTEM (BCM)

### COMMON ITEM

#### COMMON ITEM : Diagnosis Description

INFOID:000000005804812

#### BCM CONSULT-III FUNCTION

CONSULT-III performs the following functions via CAN communication with BCM.

Diagnosis mode	Function Description
WORK SUPPORT	Changes the setting for each system function.
SELF-DIAGNOSTIC RESULT	Displays the diagnosis results judged by BCM.
CAN DIAG SUPPORT MNTR	Monitors the reception status of CAN communication viewed from BCM.
DATA MONITOR	The BCM input/output signals are displayed.
ACTIVE TEST	The signals used to activate each device are forcibly supplied from BCM.
ECU IDENTIFICATION	The BCM part number is displayed.
CONFIGURATION	<ul style="list-style-type: none"> <li>Read and save the vehicle specification.</li> <li>Write the vehicle specification when replacing BCM.</li> </ul>

#### SYSTEM APPLICATION

BCM can perform the following functions for each system.

#### NOTE:

It can perform the diagnosis modes except the following for all sub system selection items.

System	Sub system selection item	Diagnosis mode		
		WORK SUPPORT	DATA MONITOR	ACTIVE TEST
Door lock	DOOR LOCK	×	×	×
Rear window defogger	REAR DEFOGGER		×	×
Warning chime	BUZZER		×	×
Interior room lamp timer	INT LAMP	×	×	×
Exterior lamp	HEAD LAMP	×	×	×
Wiper and washer	WIPER	×	×	×
Turn signal and hazard warning lamps	FLASHER	×	×	×
Air conditioner	AIR CONDITONER		×	
Intelligent Key system	INTELLIGENT KEY	×	×	×
Combination switch	COMB SW		×	
BCM	BCM	×		
Immobilizer	IMMU		×	×
Interior room lamp battery saver	BATTERY SAVER	×	×	×
Trunk open	TRUNK		×	×
Vehicle security system	THEFT ALM	×	×	×
RAP system	RETAINED PWR		×	
Signal buffer system	SIGNAL BUFFER		×	×
TPMS	AIR PRESSURE MONITOR	×	×	×

#### COMMON ITEM : CONSULT-III Function (BCM - COMMON ITEM)

INFOID:000000005804813

#### ECU IDENTIFICATION

Displays the BCM part No.

#### SELF-DIAG RESULT

Refer to [SEC-97, "DTC Index"](#).

# DIAGNOSIS SYSTEM (BCM)

[INTELLIGENT KEY SYSTEM]

< FUNCTION DIAGNOSIS >

## INTELLIGENT KEY

### INTELLIGENT KEY : CONSULT-III Function (BCM - INTELLIGENT KEY)

INFOID:000000005804814

#### WORK SUPPORT

Monitor item	Description
CONFIRM KEY FOB ID	It can be checked whether Intelligent Key ID code is registered or not in this mode.
AUTO LOCK SET	Auto door lock time can be changed in this mode. <ul style="list-style-type: none"> <li>• MODE1: 1 minute</li> <li>• MODE2: 5 minutes</li> <li>• MODE3: 30 seconds</li> <li>• MODE4: 2 minutes</li> </ul>
LOCK/UNLOCK BY I-KEY	Door lock/unlock function by door request switch mode can be changed to operate (ON) or not operate (OFF) in this mode.
ENGINE START BY I-KEY	Engine start function mode can be changed to operate (ON) or not operate (OFF) with this mode.
TRUNK/GLASS HATCH OPEN	Buzzer reminder function mode by back door request switch can be changed to operate (ON) or not operate (OFF) with this mode.
PANIC ALARM SET	Panic alarm button pressing time on Intelligent Key remote control button can be selected from the following with this mode. <ul style="list-style-type: none"> <li>• MODE1: 0.5 sec.</li> <li>• MODE2: Non-operation</li> <li>• MODE3: 1.5 sec.</li> </ul>
PW DOWN SET	Unlock button pressing time on Intelligent Key button can be selected from the following with this mode. <ul style="list-style-type: none"> <li>• MODE1: 3 sec.</li> <li>• MODE2: Non-operation</li> <li>• MODE3: 5 sec.</li> </ul>
TRUNK OPEN DELAY	Trunk button pressing time on Intelligent Key button can be selected from the following with this mode. <ul style="list-style-type: none"> <li>• MODE1: 0.5 sec.</li> <li>• MODE2: 1.5 sec.</li> <li>• MODE3: OFF: No delay</li> </ul>
LO-BATT OF KEY FOB WARN	Intelligent Key low battery warning mode can be changed to operate (ON) or not operate (OFF) with this mode.
ANTI KEY LOCK IN FUNCTI	Key reminder function mode can be changed to operate (ON) or not operate (OFF) with this mode.
HAZARD ANSWER BACK	Hazard reminder function mode can be selected from the following with this mode. <ul style="list-style-type: none"> <li>• LOCK ONLY: Door lock operation only</li> <li>• UNLOCK ONLY: Door unlock operation only</li> <li>• LOCK/UNLOCK: Lock/unlock operation</li> <li>• OFF: Non-operation</li> </ul>
ANS BACK I-KEY LOCK	Buzzer reminder function (lock operation) mode by door request switch (driver side and passenger side) can be selected from the following with this mode. <ul style="list-style-type: none"> <li>• Horn chirp: Sound horn</li> <li>• Buzzer: Sound Intelligent Key warning buzzer</li> <li>• OFF: Non-operation</li> </ul>
ANS BACK I-KEY UNLOCK	Buzzer reminder function (unlock operation) mode by door request switch can be changed to operate (ON) or not operate (OFF) with this mode.
SHORT CRANKING OUTPUT	Starter motor can be forcibly activated.
INSIDE ANT DIAGNOSIS	This function allows inside key antenna self-diagnosis.
HORN WITH KEYLESS LOCK	Horn reminder function mode by Intelligent Key button can be changed to operate (ON) or not operate (OFF) with this mode.

#### SELF-DIAG RESULT

Refer to [SEC-97, "DTC Index"](#).

# DIAGNOSIS SYSTEM (BCM)

[INTELLIGENT KEY SYSTEM]

< FUNCTION DIAGNOSIS >

## DATA MONITOR

Monitor Item	Condition
REQ SW -DR	Indicates [ON/OFF] condition of door request switch (driver side).
REQ SW -AS	Indicates [ON/OFF] condition of door request switch (passenger side).
REQ SW -BD/TR	Indicates [ON/OFF] condition of back door request switch.
PUSH SW	Indicates [ON/OFF] condition of push-button ignition switch.
IGN RLY2 -F/B	Indicates [ON/OFF] condition of ignition relay 2.
ACC RLY-F/B	Indicates [ON/OFF] condition of accessory relay.
BRAKE SW 1	Indicates [ON/OFF]* <sup>1</sup> condition of brake switch power supply.
BRAKE SW 2	Indicates [ON/OFF] condition of brake switch.
DETE/CANCL SW	Indicates [ON/OFF] condition of P position.
SFT PN/N SW	Indicates [ON/OFF] condition of P or N position.
UNLK SEN -DR	Indicates [ON/OFF] condition of driver door UNLOCK status.
PUSH SW -IPDM	Indicates [ON/OFF] condition of push-button ignition switch.
IGN RLY1 -F/B	Indicates [ON/OFF] condition of ignition relay 1.
DETE SW -IPDM	Indicates [ON/OFF] condition of P position.
SFT PN -IPDM	Indicates [ON/OFF] condition of P or N position.
SFT P -MET	Indicates [ON/OFF] condition of P position.
SFT N -MET	Indicates [ON/OFF] condition of N position.
ENGINE STATE	Indicates [STOP/STALL/CRANK/RUN] condition of engine states.
VEH SPEED 1	Display the vehicle speed signal received from combination meter by numerical value [mph].
VEH SPEED 2	Display the vehicle speed signal received from ABS or VDC or TCM by numerical value [mph].
DOOR STAT-DR	Indicates [LOCK/READY/UNLK] condition of driver side door status.
DOOR STAT-AS	Indicates [LOCK/READY/UNLK] condition of passenger side door status.
ID OK FLAG	Indicates [SET/RESET] condition of key ID.
PRMT ENG STRT	Indicates [SET/RESET] condition of engine start possibility.
KEY SW -SLOT	Indicates [ON/OFF] condition of key slot.
TRNK/HAT MNTR	Indicates [ON/OFF] condition of trunk lid.
RKE-LOCK	Indicates [ON/OFF] condition of LOCK signal from Intelligent Key.
RKE-UNLOCK	Indicates [ON/OFF] condition of UNLOCK signal from Intelligent Key.
RKE-TR/BD	Indicates [ON/OFF] condition of TRUNK OPEN signal from Intelligent Key.
RKE-PANIC	Indicates [ON/OFF] condition of PANIC button of Intelligent Key.
RKE-P/W OPEN	Indicates [ON/OFF] condition of P/W DOWN signal from Intelligent Key.
RKE-MODE CHG	Indicates [ON/OFF] condition of MODE CHANGE signal from Intelligent Key.
RKE OPE COUN1	When remote keyless entry receiver receives the signal transmitted while operating on Intelligent Key, the numerical value start changing.
REVERSE SW	Indicates [ON/OFF] condition of R position.

\*1: OFF is displayed when brake pedal is depressed while brake switch power supply is OFF.

## ACTIVE TEST

Test item	Description
BATTERY SAVER	This test is able to check interior room lamp operation. The interior room lamp is activated after "ON" on CONSULT-III screen is touched.
PW REMOTO DOWN SET	This test is able to check power window down operation. The power window down is activated after "ON" on CONSULT-III screen is touched.



# DIAGNOSIS SYSTEM (BCM)

**[INTELLIGENT KEY SYSTEM]**

< FUNCTION DIAGNOSIS >

Test item	Description
OUTSIDE BUZZER	This test is able to check Intelligent Key warning buzzer operation. The Intelligent Key warning buzzer is activated after "ON" on CONSULT-III screen is touched.
INSIDE BUZZER	This test is able to check warning chime in combination meter operation. <ul style="list-style-type: none"> <li>• Take away warning chime sounds when "TAKE OUT" on CONSULT-III screen is touched.</li> <li>• Key warning chime sounds when "KEY" on CONSULT-III screen is touched.</li> <li>• OFF position warning chime sounds when "KNOB" on CONSULT-III screen is touched.</li> </ul>
INDICATOR	This test is able to check warning lamp operation. <ul style="list-style-type: none"> <li>• "KEY" Warning lamp illuminates when "KEY ON" on CONSULT-III screen is touched.</li> <li>• "KEY" Warning lamp blinks when "KEY IND" on CONSULT-III screen is touched.</li> </ul>
INT LAMP	This test is able to check interior room lamp operation. The interior room lamp is activated after "ON" on CONSULT-III screen is touched.
LCD	This test is able to check meter display information <ul style="list-style-type: none"> <li>• Engine start information displays when "BP N" on CONSULT-III screen is touched.</li> <li>• Engine start information displays when "BP I" on CONSULT-III screen is touched.</li> <li>• Key ID warning displays when "ID NG" on CONSULT-III screen is touched.</li> <li>• P position warning displays when "SFT P" on CONSULT-III screen is touched.</li> <li>• Intelligent Key insert information displays when "INSRT" on CONSULT-III screen is touched.</li> <li>• Intelligent Key low battery warning displays when "BATT" on CONSULT-III screen is touched.</li> <li>• Take away through window warning displays when "NO KY" on CONSULT-III screen is touched.</li> <li>• Take away warning display when "OUTKEY" on CONSULT-III screen is touched.</li> <li>• OFF position warning display when "LK WN" on CONSULT-III screen is touched.</li> </ul>
FLASHER	This test is able to check hazard warning lamp operation. The hazard warning lamps are activated after "LH/RH/OFF" on CONSULT-III screen is touched.
HORN	This test is able to check horn operation. The horn is activated after "ON" on CONSULT-III screen is touched.
P RANGE	This test is able to check CVT shift selector power supply CVT shift selector power is supplied when "ON" on CONSULT-III screen is touched.
ENGINE SW ILLUMI	This test is able to check push-ignition switch illumination operation. Push-ignition switch illumination illuminates when "ON" on CONSULT-III screen is touched.
LOCK INDICATOR	This test is able to check LOCK indicator in push-ignition switch operation. LOCK indicator in push-ignition switch illuminates when "ON" on CONSULT-III screen is touched.
ACC INDICATOR	This test is able to check ACC indicator in push-ignition switch operation. ACC indicator in push-ignition switch illuminates when "ON" on CONSULT-III screen is touched.
IGNITION ON IND	This test is able to check ON indicator in push-ignition switch operation. ON indicator in push-ignition switch illuminates when "ON" on CONSULT-III screen is touched.
KEY SLOT ILLUMI	This test is able to check key slot illumination operation. Key slot illumination blinks when "ON" on CONSULT-III screen is touched.
TRUNK/BACK DOOR	This test is able to check back door opener actuator open operation. This actuator opens when "OPEN" on CONSULT-III screen is touched.

A  
B  
C  
D  
E  
F  
G  
H  
I  
J  
L  
M  
N  
O  
P

SEC

## THEFT ALM

### THEFT ALM : CONSULT-III Function (BCM - THEFT)

INFOID:000000005804815

#### WORK SUPPORT

Work item	Description
SECURITY ALARM SET	This mode is able to confirm and change security alarm ON-OFF setting.
THEFT ALM TRG	The switch which triggered vehicle security alarm is recorded. This mode is able to confirm and erase the record of vehicle security alarm. The trigger data can be erased by touching "CLEAR" on CONSULT-III screen.

# DIAGNOSIS SYSTEM (BCM)

< FUNCTION DIAGNOSIS >

[INTELLIGENT KEY SYSTEM]

## DATA MONITOR

Monitor item	Description
REQ SW-DR	Indicates [ON/OFF] condition of door request switch (driver side).
REQ SW-AS	Indicates [ON/OFF] condition of door request switch (passenger side).
REQ SW-BD/TR	Indicates [ON/OFF] condition of trunk opener request switch.
PUSH SW	Indicates [ON/OFF] condition of push-button ignition switch
UNLK SEN-DR	Indicates [ON/OFF] condition of driver door UNLOCK status.
KEY SW -SLOT	Indicates [ON/OFF] condition of key slot.
DOOR SW-DR	Indicates [ON/OFF] condition of front door switch LH.
DOOR SW-AS	Indicates [ON/OFF] condition of front door switch RH.
DOOR SW-RR	Indicates [ON/OFF] condition of rear door switch RH.
DOOR SW-RL	Indicates [ON/OFF] condition of rear door switch LH.
CDL LOCK SW	Indicates [ON/OFF] condition of lock signal from door lock/unlock switch LH and RH.
CDL UNLOCK SW	Indicates [ON/OFF] condition of unlock signal from door lock/unlock switch LH and RH.
KEY CYL LK-SW	Indicates [ON/OFF] condition of lock signal from front door key cylinder switch.
KEY CYL UN-SW	Indicates [ON/OFF] condition of unlock signal from front door key cylinder switch.
TR/BD OPEN SW	Indicates [ON/OFF] condition of trunk lid opener switch.
TRNK/HAT MNTR	Indicates [ON/OFF] condition of trunk room lamp switch.
RKE-LOCK	Indicates [ON/OFF] condition of LOCK signal from Intelligent Key.
RKE-UNLOCK	Indicates [ON/OFF] condition of UNLOCK signal from Intelligent Key.
RKE-TR/BD	Indicates [ON/OFF] condition of TRUNK OPEN signal from Intelligent Key.

## ACTIVE TEST

Test item	Operation	Description
THEFT IND		This test is able to check security indicator lamp operation. The lamp will be turned on when "ON" on CONSULT-III screen is touched.
VEHICLE SECURITY HORN		This test is able to check vehicle security horn operation. The horns will be activated for 0.5 seconds after "ON" on CONSULT-III screen is touched.
HEAD LAMP (HI)		This test is able to check vehicle security lamp operation. The headlamps will be activated for 0.5 seconds after "ON" on CONSULT-III screen is touched.
FLASHER	RH	Outputs the voltage to blink the right side turn signal lamps.
	LH	Outputs the voltage to blink the left side turn signal lamps.
	Off	Stops the voltage to turn the turn signal lamps OFF.

## IMMU

### IMMU : CONSULT-III Function (BCM - IMMU)

INFOID:000000005804816

## DATA MONITOR

Monitor item	Content
CONFIRM ID ALL	Indicates [YET] at all time. Switch to [DONE] when a registered Intelligent Key is inserted into the key slot.
CONFIRM ID4	
CONFIRM ID3	
CONFIRM ID2	
CONFIRM ID1	

# DIAGNOSIS SYSTEM (BCM)

< FUNCTION DIAGNOSIS >

[INTELLIGENT KEY SYSTEM]

Monitor item	Content
TP 4	Indicates the number of ID which has been registered.
TP 3	
TP 2	
TP 1	
PUSH SW	Indicates [ON/OFF] condition of push-button ignition switch.
KEY SW -SLOT	Indicates [ON/OFF] condition of key slot.

## ACTIVE TEST

Test item	Description
THEFT IND	This test is able to check security indicator lamp operation. The lamp will be turned on when "ON" on CONSULT-III screen touched.

A  
B  
C  
D  
E  
F  
G  
H  
I  
J  
L  
M  
N  
O  
P

SEC

## COMPONENT DIAGNOSIS

### U1000 CAN COMM CIRCUIT

#### Description

INFOID:000000005439824

CAN (Controller Area Network) is a serial communication line for real time applications. It is an on-vehicle multiplex communication line with high data communication speed and excellent error detection ability. Modern vehicle is equipped with many electronic control unit, and each control unit shares information and links with other control units during operation (not independent). In CAN communication, control units are connected with 2 communication lines (CAN-H line, CAN-L line) allowing a high rate of information transmission with less wiring. Each control unit transmits/receives data but selectively reads required data only. CAN Communication Signal Chart, refer to [LAN-28, "CAN Communication Signal Chart"](#).

#### DTC Logic

INFOID:000000005439825

#### DTC DETECTION LOGIC

CONSULT-III display description	DTC Detection Condition	Possible cause
CAN COMM CIRCUIT [U1000]	When BCM cannot communicate CAN communication signal continuously for 2 seconds or more	In CAN communication system, any item (or items) of the following listed below is malfunctioning. <ul style="list-style-type: none"> <li>• CVT</li> <li>• Receiving (ECM)</li> <li>• Receiving (VDC/TCS/ABS)</li> <li>• Receiving (METER/M&amp;A)</li> <li>• Receiving (MULTI AV)</li> <li>• Receiving (IPDM E/R)</li> </ul>

#### Diagnosis Procedure

INFOID:000000005439826

### 1. PERFORM SELF DIAGNOSTIC

1. Turn ignition switch ON and wait for 2 second or more.
2. Check "Self Diagnostic Result".

#### Is "CAN COMM CIRCUIT" displayed?

- YES >> Refer to [LAN-8, "CAN Communication Control Circuit"](#).
- NO >> Refer to [GI-42, "Intermittent Incident"](#).

# U1010 CONTROL UNIT (CAN)

< COMPONENT DIAGNOSIS >

[INTELLIGENT KEY SYSTEM]

## U1010 CONTROL UNIT (CAN)

### DTC Logic

INFOID:000000005439827

### DTC DETECTION LOGIC

CONSULT-III display description	DTC Detection Condition	Possible cause
CAN COMM CIRCUIT [U1010]	BCM detected internal CAN communication circuit malfunction.	BCM

### Diagnosis Procedure

INFOID:000000005439828

#### 1. REPLACE BCM

When DTC U1010 is detected, replace BCM.

>> Replace BCM. Refer to [BCS-83, "Removal and Installation"](#).

A  
B  
C  
D  
E  
F  
G  
H  
I  
J  
L  
M  
N  
O  
P

SEC

# B2190, P1614 NATS ANTENNA AMP.

< COMPONENT DIAGNOSIS >

[INTELLIGENT KEY SYSTEM]

## B2190, P1614 NATS ANTENNA AMP.

### Description

INFOID:000000005439844

Performs ID verification through BCM and Intelligent Key when push-button ignition switch is pressed. Prohibits starting of the engine when an unregistered ID of Intelligent Key is used.

### DTC Logic

INFOID:000000005439845

### DTC DETECTION LOGIC

DTC No.	Trouble diagnosis name	DTC detecting condition	Possible cause
B2190	NATS ANTENNA AMP	Inactive communication between key slot and BCM.	<ul style="list-style-type: none"><li>• Harness or connectors (The key slot circuit is open or shorted)</li><li>• Key slot</li><li>• BCM</li></ul>
P1614			

### DTC CONFIRMATION PROCEDURE

#### 1. PERFORM DTC CONFIRMATION PROCEDURE

1. Insert Intelligent Key into the key slot.
2. Check "Self diagnostic result" with CONSULT-III.

#### Is DTC detected?

- YES >> Refer to [SEC-30, "Diagnosis Procedure"](#).  
NO >> GO TO 2

#### 2. PERFORM DTC CONFIRMATION PROCEDURE

1. Press the push-button ignition switch.
2. Check "Self diagnostic result" with CONSULT-III.

#### Is DTC detected?

- YES >> Refer to [SEC-30, "Diagnosis Procedure"](#).  
NO >> Inspection End.

### Diagnosis Procedure

INFOID:000000005439846

Regarding Wiring Diagram information, refer to [SEC-138, "Wiring Diagram"](#).

#### 1. INSPECTION START

Check the case in which DTC is detected.

- Case1: It is detected when Intelligent Key is inserted into key slot.
- Case2: It is detected after Intelligent Key is inserted into key slot and push-button ignition switch is pressed.

#### In which case is DTC detected?

- Case1. >> GO TO 2  
Case2. >> GO TO 4

#### 2. CHECK KEY SLOT INPUT SIGNAL

1. Turn ignition switch OFF.
2. Disconnect key slot harness connector.

# B2190, P1614 NATS ANTENNA AMP.

[INTELLIGENT KEY SYSTEM]

## < COMPONENT DIAGNOSIS >

3. Check voltage between key slot harness connector and ground.

Key slot		Ground	Voltage [V] (approx.)
Connector	Terminal		
M40	2	Ground	Battery voltage

Is the inspection result normal?

YES >> Replace key slot. Refer to [SEC-152. "Removal and Installation"](#).

NO >> GO TO 3

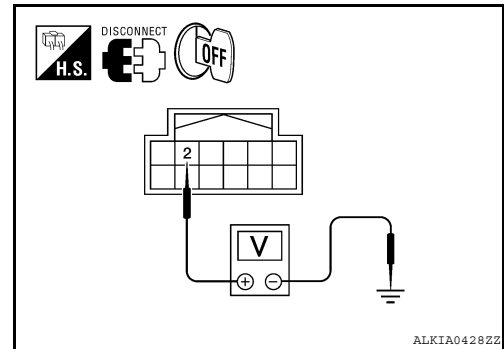

### 3.CHECK KEY SLOT CIRCUIT

1. Disconnect BCM harness connector.
2. Check continuity between key slot harness connector M40 (A) terminal 2 and BCM harness connector M19 (B) terminal 68.

Key slot		BCM		Continuity
Connector	Terminal	Connector	Terminal	
A: M40	2	B: M19	68	Yes

3. Check continuity between key slot harness connector M40 (A) terminal 2 and ground.

Key slot		Ground	Continuity
Connector	Terminal		
A: M40	2	Ground	No

Is the inspection result normal?

YES >> GO TO 8

NO >> Repair harness or connector.

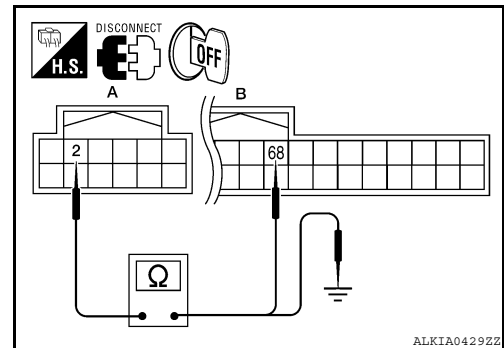

### 4.CHECK PUSH-IGNITION SWITCH OPERATION

Press push-button ignition switch and check if it turns ON.

Does ignition switch turn to ON?

YES >> GO TO 5

NO >> GO TO 7

### 5.CHECK KEY SLOT COMMUNICATION SIGNAL

1. Turn ignition switch OFF.
2. Disconnect key slot harness connector.
3. Check voltage between key slot harness connector and ground.

Key slot		Ground	Continuity
Connector	Terminal		
M40	3	Ground	Yes

Is the inspection result normal?

YES >> Replace key slot. Refer to [SEC-152. "Removal and Installation"](#).

NO >> GO TO 6

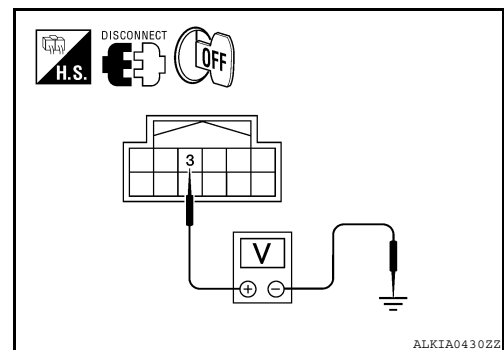

### 6.CHECK KEY SLOT COMMUNICATION SIGNAL CIRCUIT

1. Disconnect BCM harness connector.

A  
B  
C  
D  
E  
F  
G  
H  
I  
J  
L  
M  
N  
O  
P

SEC

## B2190, P1614 NATS ANTENNA AMP.

[INTELLIGENT KEY SYSTEM]

### < COMPONENT DIAGNOSIS >

- Check continuity between key slot harness connector M40 (A) terminal 3 and BCM harness connector M19 (B) terminal 69.

Key slot		BCM		Continuity
Connector	Terminal	Connector	Terminal	
A: M40	3	B: M19	69	Yes

- Check continuity between key slot harness connector M40 (A) terminal 3 and ground.

Key slot		Ground	Continuity
Connector	Terminal		
A: M40	3	Ground	No

Is the inspection result normal?

YES >> GO TO 8

NO >> Repair harness or connector.

### 7. CHECK KEY SLOT GROUND CIRCUIT

- Turn ignition switch OFF.
- Disconnect key slot harness connector.
- Check continuity between key slot harness connector and ground.

Key slot		Ground	Continuity
Connector	Terminal		
M40	7	Ground	Yes

Is the inspection result normal?

YES >> GO TO 8

NO >> Repair harness or connector.

### 8. CHECK INTERMITTENT INCIDENT

Refer to [GI-42, "Intermittent Incident"](#).

>> Inspection End.

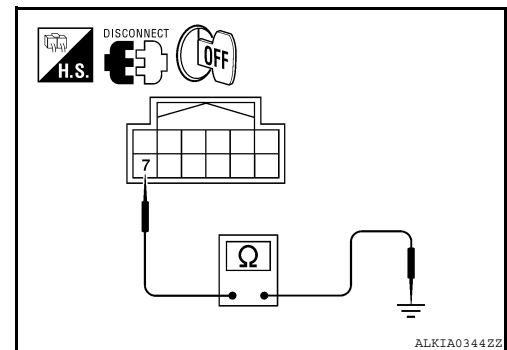
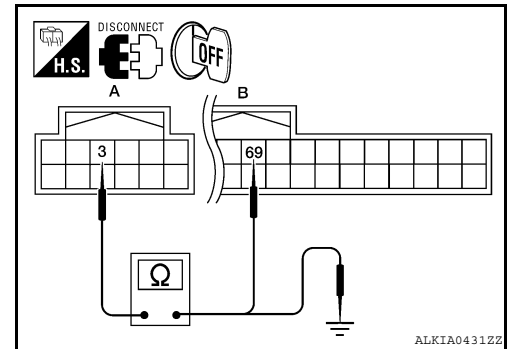



# B2191, P1615 DIFFERENCE OF KEY

< COMPONENT DIAGNOSIS >

[INTELLIGENT KEY SYSTEM]

## B2191, P1615 DIFFERENCE OF KEY

### Description

INFOID:000000005439847

Performs ID verification through BCM and Intelligent Key when push-button ignition switch is pressed. Prohibits starting of the engine when an unregistered ID of Intelligent Key is used.

### DTC Logic

INFOID:000000005439848

### DTC DETECTION LOGIC

DTC No.	Trouble diagnosis name	DTC detecting condition	Possible cause
B2191 P1615	DIFFERENCE OF KEY	The ID verification results between BCM and Intelligent Key are NG. The registration is necessary.	<ul style="list-style-type: none"> <li>Intelligent Key</li> </ul>

### DTC CONFIRMATION PROCEDURE

#### 1. PERFORM DTC CONFIRMATION PROCEDURE

1. Press the push-button ignition switch
2. Check "Self diagnostic result" with CONSULT-III.

#### Is DTC detected?

- YES >> Refer to [SEC-33. "Diagnosis Procedure"](#).  
 NO >> Inspection End.

### Diagnosis Procedure

INFOID:000000005439849

#### 1. PERFORM INITIALIZATION

Perform initialization with CONSULT-III. Re-register all Intelligent Keys. For initialization and registration of Intelligent Key. Refer to "CONSULT-III Operation Manual NATS-IVIS/NVIS".

#### Can the system be initialized and can the engine be started with re-registered Intelligent Key?

- YES >> Intelligent Key was unregistered.  
 NO >> BCM is malfunctioning.
  - Replace BCM. Refer to [BCS-83. "Removal and Installation"](#).
  - Perform initialization again

SEC

# B2192, P1611 ID DISCORD, IMMUECM

< COMPONENT DIAGNOSIS >

[INTELLIGENT KEY SYSTEM]

## B2192, P1611 ID DISCORD, IMMUECM

### Description

INFOID:000000005439850

BCM performs the ID verification with hybrid vehicle control ECU that allows the hybrid system to start. Start the hybrid system if the ID is OK. hybrid vehicle control ECU prevents the hybrid system from starting if the ID is not registered. BCM starts the communication with hybrid vehicle control ECU if ignition switch is turned ON.

### DTC Logic

INFOID:000000005439851

#### DTC DETECTION LOGIC

##### NOTE:

- If DTC B2192 is displayed with DTC U1000, first perform the trouble diagnosis for DTC U1000. Refer to [SEC-28, "DTC Logic"](#).
- If DTC B2192 is displayed with DTC U1010, first perform the trouble diagnosis for DTC U1010. Refer to [SEC-29, "DTC Logic"](#).

DTC No.	Trouble diagnosis name	DTC detecting condition	Possible cause
B2192	ID DISCORD, IMMUECM	The ID verification results between BCM and hybrid vehicle control ECU are NG. The registration is necessary.	<ul style="list-style-type: none"><li>• BCM</li><li>• hybrid vehicle control ECU</li></ul>
P1611			

#### DTC CONFIRMATION PROCEDURE

##### 1.PERFORM DTC CONFIRMATION PROCEDURE

1. Turn ignition switch ON under the following conditions.
  - CVT selector lever is in the P or N position
  - Do not depress the brake pedal
2. Check "Self diagnostic result" with CONSULT-III.

##### Is DTC detected?

- YES >> Refer to [SEC-34, "Diagnosis Procedure"](#).  
NO >> Inspection End.

### Diagnosis Procedure

INFOID:000000005439852

##### 1.PERFORM INITIALIZATION

Perform initialization with CONSULT-III. Re-register all Intelligent Keys.

For initialization and registration of Intelligent Key. Refer to "CONSULT-III Operation Manual".

Can the system be initialized and can the hybrid system be started with re-registered Intelligent Key?

- YES >> ID was unregistered.  
NO >> BCM is malfunctioning.
  - Replace BCM. Refer to [BCS-83, "Removal and Installation"](#).
  - Perform initialization again
  - Replace hybrid vehicle control ECU

# B2193, P1612 CHAIN OF ECM-IMMU

< COMPONENT DIAGNOSIS >

[INTELLIGENT KEY SYSTEM]

## B2193, P1612 CHAIN OF ECM-IMMU

### Description

INFOID:000000005439853

BCM performs the ID verification with hybrid vehicle control ECU that allows the hybrid system to start. Start the hybrid system if the ID is OK. Hybrid vehicle control ECU prevents the hybrid system from starting if the ID is not registered. BCM starts the communication with hybrid vehicle control ECU if ignition switch is turned ON.

### DTC Logic

INFOID:000000005439854

### DTC DETECTION LOGIC

#### NOTE:

- If DTC B2193 is displayed with DTC U1000, first perform the trouble diagnosis for DTC U1000. Refer to [SEC-28, "DTC Logic"](#).
- If DTC B2193 is displayed with DTC U1010, first perform the trouble diagnosis for DTC U1010. Refer to [SEC-29, "DTC Logic"](#).

DTC No.	Trouble diagnosis name	DTC detecting condition	Possible cause
B2193	CHAIN OF ECM-IMMU	Inactive communication between hybrid vehicle control ECU and BCM	<ul style="list-style-type: none"><li>• Harness or connectors (The CAN communication line is open or shorted)</li><li>• BCM</li><li>• hybrid vehicle control ECU</li></ul>
P1612			

### DTC CONFIRMATION PROCEDURE

#### 1. PERFORM DTC CONFIRMATION PROCEDURE

1. Turn ignition switch ON under the following conditions.
  - CVT selector lever is in the P or N position.
  - Do not depress brake pedal.
2. Check "Self diagnostic result" with CONSULT-III.

#### Is DTC detected?

- YES >> Refer to [SEC-35, "Diagnosis Procedure"](#).  
NO >> Inspection End.

### Diagnosis Procedure

INFOID:000000005439855

#### 1. REPLACE BCM

1. Replace BCM. Refer to [BCS-83, "Removal and Installation"](#).
2. Perform initialization with CONSULT-III.  
For initialization, refer to "CONSULT-III Operation Manual".

#### Does the hybrid system start?

- YES >> BCM is malfunctioning.
  - Replace BCM. Refer to [BCS-83, "Removal and Installation"](#).
  - Perform initialization again and delete the DTC of hybrid vehicle control ECU.

NO >> Hybrid vehicle control ECU is malfunctioning.
  - Replace hybrid vehicle control ECU.
  - Perform re-communicating function.

**B2195 ANTI-SCANNING**

**Description**

INFOID:000000005804833

When ignition switch is turned ON, BCM performs ID verification with ECM. If ID verification that is out of the specified specification is detected, BCM prohibits further ID verification and engine cranking.

**DTC Logic**

INFOID:000000005804834

**DTC DETECTION LOGIC**

DTC No.	Trouble diagnosis name	DTC detecting condition	Possible cause
B2195	ANTI-SCANNING	ID verification between BCM and ECM that is out of the specified specification is detected	ID verification request out of the specified specification

**DTC CONFIRMATION PROCEDURE**

**1. PERFORM DTC CONFIRMATION PROCEDURE**

1. Turn ignition switch ON under the following conditions.
  - Selector lever is in the P or N position
  - Do not depress brake pedal
2. Check "Self-diagnostic result" using CONSULT-III.

Is DTC detected?

- YES >> Refer to [SEC-36. "Diagnosis Procedure"](#).
- NO >> Inspection End.

**Diagnosis Procedure**

INFOID:000000005804835

**1. CHECK SELF-DIAGNOSTIC RESULT-1**

1. Perform "Self-diagnostic result" of BCM using CONSULT-III.
2. Erase DTC.
3. Perform DTC Confirmation Procedure. Refer to [SEC-36. "DTC Logic"](#).

Is DTC B2195 detected?

- YES >> GO TO 2.
- NO >> Inspection End

**2. CHECK EQUIPMENT OF THE VEHICLE**

Check that unspecified accessory part related to engine start is not installed.

Is unspecified accessory part related to engine start installed?

- YES >> GO TO 3.
- NO >> Replace BCM. Refer to [BCS-83. "Removal and Installation"](#).

**3. CHECK SELF-DIAGNOSTIC RESULT-2**

1. Obtain the customers approval to remove unspecified accessory part related to engine start, and then remove it.
2. Perform "Self-diagnostic result" of BCM using CONSULT-III.
3. Erase DTC.
4. Perform DTC Confirmation Procedure. Refer to [SEC-36. "DTC Logic"](#).

Is DTC B2195 detected?

- YES >> Replace BCM. Refer to [BCS-83. "Removal and Installation"](#).
- NO >> Inspection End

# B2555 STOP LAMP

< COMPONENT DIAGNOSIS >

[INTELLIGENT KEY SYSTEM]

## B2555 STOP LAMP

### Description

INFOID:000000005439856

BCM detects the stop lamp status and confirms the stop lamp switch ON/OFF status. BCM confirms the engine start condition according to the stop lamp switch ON/OFF status.

### DTC Logic

INFOID:000000005439857

### DTC DETECTION LOGIC

DTC No.	Trouble diagnosis name	DTC detecting condition	Possible cause
B2555	STOP LAMP	BCM makes a comparison between the upper voltage and lower voltage of stop lamp switch. It judges from their values to detect the malfunctioning circuit.	<ul style="list-style-type: none"> <li>Harness or connectors (stop lamp switch circuit is open or shorted)</li> <li>Stop lamp switch</li> <li>Fuse</li> </ul>

### DTC CONFIRMATION PROCEDURE

#### 1. PERFORM DTC CONFIRMATION PROCEDURE

- Depress the brake pedal and wait for at least 1 second.
- Check "Self diagnostic result" with CONSULT-III.

Is DTC detected?

- YES >> Refer to [SEC-37, "Diagnosis Procedure"](#).  
 NO >> Inspection End.

### Diagnosis Procedure

INFOID:000000005439858

Regarding Wiring Diagram information, refer to [SEC-138, "Wiring Diagram"](#).

#### 1. CHECK STOP LAMP SWITCH INPUT SIGNAL

- Turn ignition switch OFF.
- Disconnect BCM harness connector.
- Check voltage between BCM harness connector and ground.

BCM		Ground	Stop lamp switch position	Voltage [V]
Connector	Terminal			
M18	26	Ground	Depressed	Battery voltage
			Released	0

Is the inspection result normal?

- YES >> GO TO 2  
 NO >> GO TO 3

#### 2. CHECK BCM INPUT SIGNAL

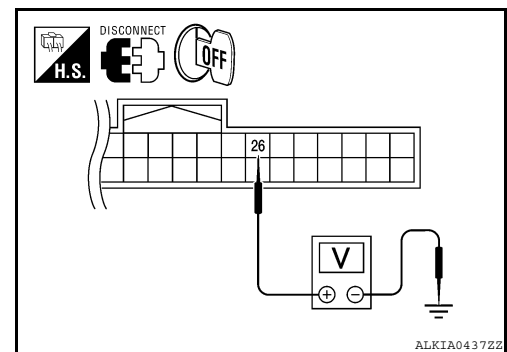

SEC

# B2555 STOP LAMP

[INTELLIGENT KEY SYSTEM]

## < COMPONENT DIAGNOSIS >

Check voltage between BCM harness connector M18 terminal 24 and ground.

BCM		Ground	Voltage [V]
Connector	Terminal		
M18	24	Ground	Battery voltage

Is the inspection result normal?

- YES >> Stop lamp switch circuit is OK.
- NO >> Repair harness or fuse.

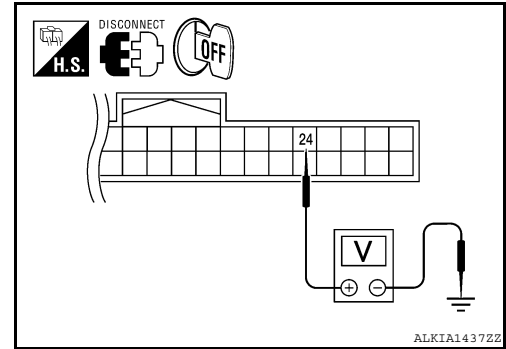

ALKIA1437ZZ

### 3. CHECK STOP LAMP SWITCH POWER SUPPLY CIRCUIT

1. Disconnect stop lamp switch harness connector.
2. Check voltage between stop lamp harness connector and ground.

Stop lamp switch		Ground	Voltage [V]
Connector	Terminal		
E38	1	Ground	Battery voltage

Is the inspection result normal?

- YES >> GO TO 4
- NO >> Check harness for open or short between stop lamp switch and fuse.

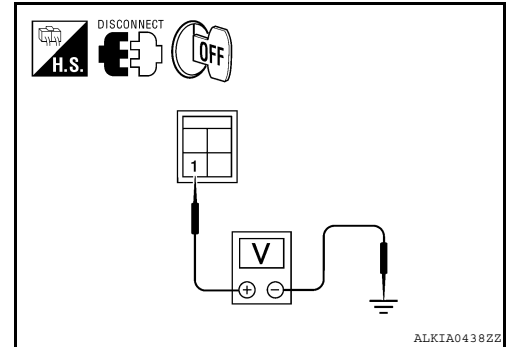

ALKIA0438ZZ

### 4. CHECK STOP LAMP SWITCH CIRCUIT

1. Check continuity between stop lamp switch harness connector E38 (A) terminal 2 and BCM harness connector M18 (B) terminal 26.

Stop lamp switch		BCM		Continuity
Connector	Terminal	Connector	Terminal	
A: E38	2	B: M18	26	Yes

2. Check continuity between stop lamp switch harness connector E38 (A) terminal 2 and ground.

Stop lamp switch		Ground	Continuity
Connector	Terminal		
A: E38	2	Ground	No

Is the inspection result normal?

- YES >> GO TO 5
- NO >> Repair harness or connector.

### 5. CHECK STOP LAMP SWITCH

Refer to [SEC-39, "Component Inspection"](#).

Is the inspection result normal?

- YES >> GO TO 6
- NO >> Replace stop lamp switch.

### 6. CHECK INTERMITTENT INCIDENT

Refer to [GI-42, "Intermittent Incident"](#).

>> Inspection End.

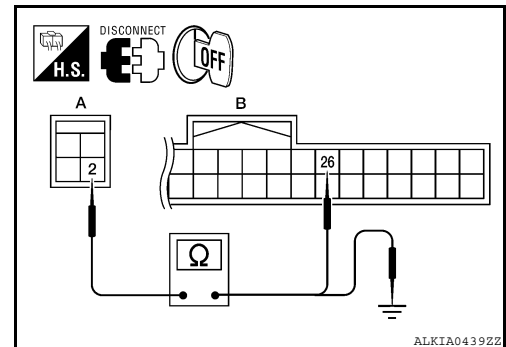

ALKIA0439ZZ

# B2555 STOP LAMP

< COMPONENT DIAGNOSIS >

[INTELLIGENT KEY SYSTEM]

## Component Inspection

INFOID:000000005439859

### 1. CHECK STOP LAMP SWITCH

1. Turn ignition switch OFF.
2. Disconnect stop lamp switch harness connector.
3. Check continuity between stop lamp switch terminals under the following conditions.

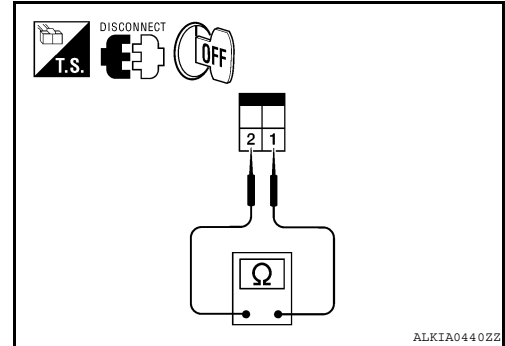

Stop lamp switch		Condition	Continuity	
Terminal				
1	2	Brake pedal	Not depressed	No
			Depressed	Yes

Is the inspection result normal?

- YES >> Inspection End.  
NO >> Replace stop lamp switch.

A  
B  
C  
D  
E  
F  
G  
H  
I  
J  
L  
M  
N  
O  
P

SEC

# B2556 PUSH-BUTTON IGNITION SWITCH

< COMPONENT DIAGNOSIS >

[INTELLIGENT KEY SYSTEM]

## B2556 PUSH-BUTTON IGNITION SWITCH

### Description

INFOID:000000005439860

The switch that changes the power supply position. BCM maintains the power supply position status. BCM changes the power supply position with the operation of the push-button ignition switch.

### DTC Logic

INFOID:000000005439861

### DTC DETECTION LOGIC

DTC No.	Trouble diagnosis name	DTC detecting condition	Possible cause
B2556	PUSH-BUTTON IGNITION SWITCH	BCM detects the push-button ignition switch stuck to ON for 100 seconds or more	<ul style="list-style-type: none"><li>• Harness or connectors (Push-button ignition switch circuit is shorted.)</li><li>• Push-button ignition switch</li></ul>

### DTC CONFIRMATION PROCEDURE

#### 1. PERFORM DTC CONFIRMATION PROCEDURE

1. Start the engine and wait for at least 100 seconds.
2. Check "Self diagnostic result" with CONSULT-III.

#### Is DTC detected?

- YES >> Refer to [SEC-40, "Diagnosis Procedure"](#).  
NO >> Inspection End.

### Diagnosis Procedure

INFOID:000000005439862

Regarding Wiring Diagram information, refer to [SEC-138, "Wiring Diagram"](#).

#### 1. CHECK PUSH-BUTTON IGNITION SWITCH INPUT SIGNAL

1. Turn ignition switch OFF.
2. Disconnect push-button ignition switch harness connector.
3. Check voltage between push-button ignition switch harness connector and ground.

Push-button ignition switch		Ground	Voltage [V]
Connector	Terminal		
M38	4	Ground	Battery voltage

#### Is the inspection result normal?

- YES >> GO TO 2  
NO >> GO TO 4

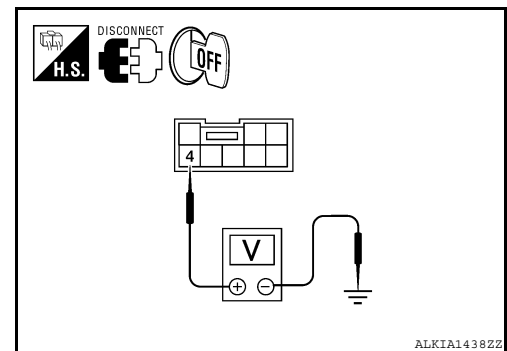

#### 2. CHECK PUSH-BUTTON IGNITION SWITCH

Refer to [SEC-41, "Component Inspection"](#).

#### Is the inspection result normal?

- YES >> GO TO 3  
NO >> Replace push-button ignition switch. Refer to [SEC-153, "Removal and Installation"](#).

#### 3. CHECK INTERMITTENT INCIDENT

Refer to [GI-42, "Intermittent Incident"](#).

>> Inspection End.



# B2556 PUSH-BUTTON IGNITION SWITCH

[INTELLIGENT KEY SYSTEM]

< COMPONENT DIAGNOSIS >

## 4. CHECK PUSH-BUTTON IGNITION SWITCH CIRCUIT FOR SHORT

1. Disconnect BCM harness connector and IPDM E/R harness connector.
2. Check continuity between push-button ignition switch harness connector and ground.

Push-button ignition switch		Ground	Continuity
Connector	Terminal		
M38	4	Ground	No

Is the inspection result normal?

- YES >> Replace BCM. Refer to [BCS-83, "Removal and Installation"](#).
- NO >> Repair harness or connector.

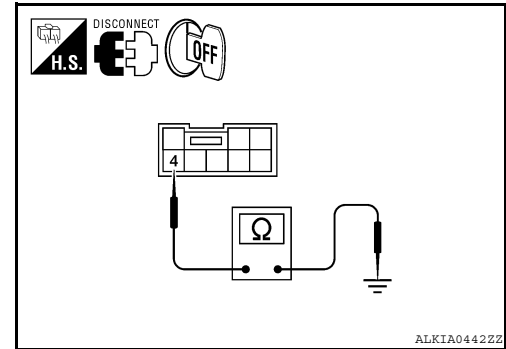

INFOID:000000005439863

## Component Inspection

### 1. CHECK PUSH-BUTTON IGNITION SWITCH

1. Turn ignition switch OFF.
2. Disconnect push-button ignition switch harness connector.
3. Check continuity between push-button ignition switch terminals under the following conditions.

Push-button ignition switch		Condition	Continuity
Terminal			
1	4	Pressed	Yes
		Not pressed	No

Is the inspection result normal?

- YES >> Inspection End.
- NO >> Replace push-button ignition switch. Refer to [SEC-153, "Removal and Installation"](#).

A  
B  
C  
D  
E  
F  
G  
H  
I  
J  
L  
M  
N  
O  
P

SEC

## B2557 VEHICLE SPEED

### Description

INFOID:000000005439864

BCM receives the 2 vehicle speed signals via CAN communication. 1 signal is transmitted by the combination meter. Another signal is transmitted by HV ECU. BCM compares both signals to detect the vehicle speed.

### DTC Logic

INFOID:000000005439865

#### DTC DETECTION LOGIC

**NOTE:**

- If DTC B2557 is displayed with DTC U1000, first perform the trouble diagnosis for DTC U1000. Refer to [SEC-28, "DTC Logic"](#).
- If DTC B2557 is displayed with DTC U1010, first perform the trouble diagnosis for DTC U1010. Refer to [SEC-29, "DTC Logic"](#).

DTC	Self-diagnosis name	DTC detecting condition	Possible causes
B2557	VEHICLE SPEED	BCM detects the following difference between the vehicle speed from "unified meter" and the one from HV ECU for 10 seconds continuously <ul style="list-style-type: none"> <li>• One is 10km/h or more and the other is 4km/h or less.</li> </ul>	<ul style="list-style-type: none"> <li>• Wheel sensor</li> <li>• Combination meter</li> <li>• HV ECU</li> </ul>

#### DTC CONFIRMATION PROCEDURE

##### 1. PERFORM DTC CONFIRMATION PROCEDURE

1. Drive the vehicle at the vehicle speed of 10 km/h or more and wait for at least 10 seconds.
2. Check "Self diagnostic result" with CONSULT-III.

Is DTC detected?

- YES >> Refer to [SEC-42, "Diagnosis Procedure"](#).  
 NO >> Inspection End.

#### Diagnosis Procedure

INFOID:000000005439866

##### 1. CHECK DTC WITH HV ECU

Check "Self diagnostic result" with CONSULT-III. Refer to [BRC-143, "DTC Index"](#).

Is the inspection result normal?

- YES >> GO TO 2  
 NO >> Repair or replace malfunctioning parts.

##### 2. CHECK COMBINATION METER.

Check combination meter. Refer to [MWI-4, "Work Flow"](#).

>> Inspection End.

# B2601 SHIFT POSITION

< COMPONENT DIAGNOSIS >

[INTELLIGENT KEY SYSTEM]

## B2601 SHIFT POSITION

### Description

INFOID:000000005439867

BCM confirms the shift position with the following 2 signals.

- CVT selector lever
- P position signal from IPDM E/R.

### DTC Logic

INFOID:000000005439868

### DTC DETECTION LOGIC

#### NOTE:

- If DTC B2601 is displayed with DTC U1000, first perform the trouble diagnosis for DTC U1000. Refer to [SEC-28, "DTC Logic"](#).
- If DTC B2601 is displayed with DTC U1010, first perform the trouble diagnosis for DTC U1010. Refer to [SEC-29, "DTC Logic"](#).

DTC No.	Trouble diagnosis name	DTC detecting condition	Possible cause
B2601	SHIFT POSITION	BCM detects when a difference between the shift P input signal and the shift position signal received from IPDM E/R continues for 2 seconds or more	<ul style="list-style-type: none"> <li>• Harness or connectors (CVT shift selector circuit is open or shorted.)</li> <li>• CVT shift selector</li> </ul>

### DTC CONFIRMATION PROCEDURE

#### 1. PERFORM DTC CONFIRMATION PROCEDURE

1. Turn ignition switch ON under the following conditions, and wait for at least 2 seconds.
  - CVT selector lever is in the P position.
  - Do not depress the brake pedal.
2. Check "Self diagnostic result" with CONSULT-III.
3. Turn ignition switch ON under the following conditions, and wait for at least 2 seconds.
  - CVT selector lever is in other than P position.
  - Do not depress the brake pedal.
4. Check "Self diagnostic result" with CONSULT-III.

#### Is DTC detected?

- YES >> Refer to [SEC-43, "Diagnosis Procedure"](#).  
 NO >> Inspection End.

### Diagnosis Procedure

INFOID:000000005439869

Regarding Wiring Diagram information, refer to [SEC-138, "Wiring Diagram"](#).

#### 1. CHECK CVT SHIFT SELECTOR POWER SUPPLY

1. Turn ignition switch to ACC.
2. Disconnect CVT shift selector harness connector.
3. Check voltage between CVT shift selector harness connector and ground.

CVT shift selector		Ground	Voltage [V]
Connector	Terminal		
M23	8	Ground	Battery voltage

#### Is the inspection result normal?

- YES >> GO TO 3  
 NO >> GO TO 2

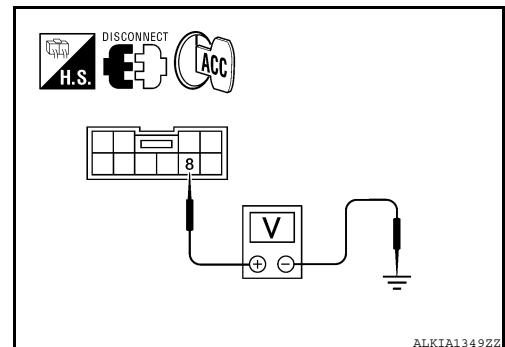

### < COMPONENT DIAGNOSIS >

## 2. CHECK CVT SHIFT SELECTOR POWER SUPPLY CIRCUIT

1. Disconnect BCM harness connector.
2. Check continuity between BCM harness connector M19 (A) terminal 84 and CVT shift selector harness connector M23 (B) terminal 8.

BCM		CVT shift selector		Continuity
Connector	Terminal	Connector	Terminal	
A: M19	84	B: M23	8	Yes

3. Check continuity between BCM harness connector M19 (A) terminal 84 and ground.

BCM		Ground	Continuity
Connector	Terminal		
A: M19	84	Ground	No

Is the inspection result normal?

- YES >> Replace BCM. Refer to [BCS-83, "Removal and Installation"](#).  
 NO >> Repair harness or connector.

## 3. CHECK CVT SHIFT SELECTOR CIRCUIT (BCM)

1. Disconnect BCM harness connector and IPDM E/R harness connector.
2. Check continuity between BCM harness connector M19 (A) terminal 87 and CVT shift selector harness connector M23 (B) terminal 9.

BCM		CVT shift selector		Continuity
Connector	Terminal	Connector	Terminal	
A: M19	87	B: M23	9	Yes

3. Check continuity between BCM harness connector M19 (A) terminal 87 and ground.

BCM		Ground	Continuity
Connector	Terminal		
A: M19	87	Ground	No

Is the inspection result normal?

- YES >> GO TO 4  
 NO >> Repair harness or connector.

## 4. CHECK CVT SHIFT SELECTOR CIRCUIT (IPDM E/R)

1. Disconnect BCM harness connector.
2. Check continuity between CVT shift selector harness connector M23 (A) terminal 9 and IPDM E/R harness connector E17 (B) terminal 43.

CVT shift selector		IPDM E/R		Continuity
Connector	Terminal	Connector	Terminal	
A: M23	9	B: E17	43	Yes

3. Check continuity between CVT shift selector harness connector M23 (A) terminal 9 and ground.

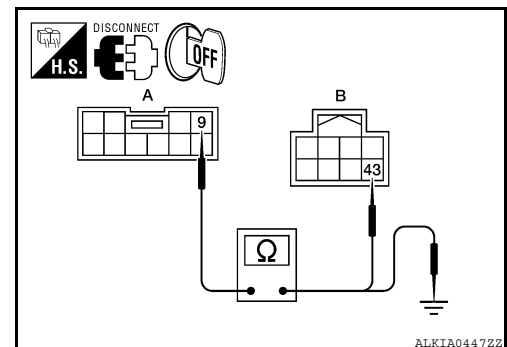
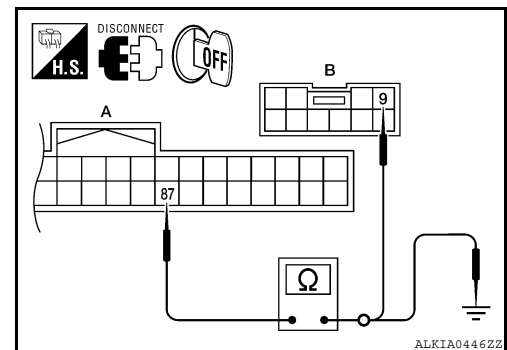
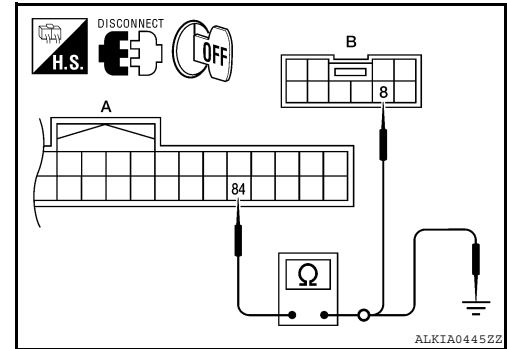

# B2601 SHIFT POSITION

[INTELLIGENT KEY SYSTEM]

< COMPONENT DIAGNOSIS >

CVT shift selector		Ground	Continuity
Connector	Terminal		
A: M23	9	Ground	No

Is the inspection result normal?

- YES >> GO TO 5
- NO >> Repair harness or connector.

## 5.CHECK CVT SHIFT SELECTOR

Refer to [SEC-45. "Component Inspection"](#).

Is the inspection result normal?

- YES >> GO TO 6
- NO >> Replace CVT shift selector. Refer to [TM-26. "Removal and Installation"](#).

## 6.CHECK INTERMITTENT INCIDENT

Refer to [GI-42. "Intermittent Incident"](#).

>> Inspection End.

## Component Inspection

INFOID:000000005439870

## 1.CHECK CVT SHIFT SELECTOR

1. Turn ignition switch OFF.
2. Disconnect CVT shift selector harness connector.
3. Check continuity between CVT shift selector terminals as follows.

CVT shift selector			Condition		Continuity
Connector	Terminal		CVT selector lever	P position	No
M137	8	9		Other than above	Yes

Is the inspection result normal?

- YES >> Inspection End.
- NO >> Replace CVT shift selector. Refer to [TM-26. "Removal and Installation"](#).

A  
B  
C  
D  
E  
F  
G  
H  
I  
J  
L  
M  
N  
O  
P

SEC

## B2602 SHIFT POSITION

### Description

INFOID:000000005439871

BCM confirms the shift position with the following 2 signals.

- CVT selector lever
- Speed signal from combination meter

### DTC Logic

INFOID:000000005439872

### DTC DETECTION LOGIC

**NOTE:**

- If DTC B2602 is displayed with DTC U1000, first perform the trouble diagnosis for DTC U1000. Refer to [SEC-28, "DTC Logic"](#).
- If DTC B2602 is displayed with DTC U1010, first perform the trouble diagnosis for DTC U1010. Refer to [SEC-29, "DTC Logic"](#).

DTC No.	Trouble diagnosis name	DTC detecting condition	Possible cause
B2602	SHIFT POSITION	BCM detects the following status for 10 seconds. <ul style="list-style-type: none"> <li>• Shift position is in P position</li> <li>• Vehicle speed is 4km/h or more</li> <li>• Ignition switch is in the ON position</li> </ul>	<ul style="list-style-type: none"> <li>• Harness or connectors (CVT drive circuit is open or shorted)</li> <li>• CVT shift selector</li> <li>• Combination meter</li> </ul>

### DTC CONFIRMATION PROCEDURE

#### 1. PERFORM DTC CONFIRMATION PROCEDURE

1. Start the engine under the following conditions and wait for at least 10 seconds.
  - CVT selector lever is in the P or N position
  - Depress the brake pedal.
2. Drive the vehicle for at least 10 seconds at a speed greater than 4 km/h.
3. Check "Self diagnostic result" with CONSULT-III.

Is DTC detected?

- YES >> Refer to [SEC-46, "Diagnosis Procedure"](#).  
 NO >> Inspection End.

### Diagnosis Procedure

INFOID:000000005439873

Regarding Wiring Diagram information, refer to [SEC-138, "Wiring Diagram"](#).

#### 1. CHECK DTC WITH COMBINATION METER

Check "Self diagnostic result" with CONSULT-III. Refer to [MWI-53, "DTC Index"](#).

Is the inspection result normal?

- YES >> GO TO 2  
 NO >> Repair or replace malfunctioning parts.

#### 2. CHECK CVT SHIFT SELECTOR POWER SUPPLY

1. Turn ignition switch to ACC.
2. Disconnect CVT shift selector harness connector.

# B2602 SHIFT POSITION

[INTELLIGENT KEY SYSTEM]

## < COMPONENT DIAGNOSIS >

- Check voltage between CVT shift selector harness connector and ground.

CVT shift selector		Ground	Voltage [V]
Connector	Terminal		
M23	8	Ground	Battery voltage

Is the inspection result normal?

- YES >> GO TO 4  
NO >> GO TO 3

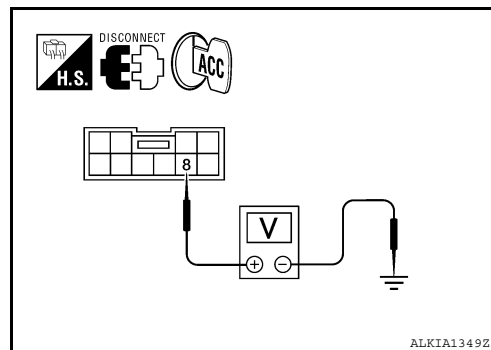

### 3. CHECK CVT SHIFT SELECTOR POWER SUPPLY CIRCUIT

- Disconnect BCM harness connector.
- Check continuity between BCM harness connector M19 (A) terminal 84 and CVT shift selector harness connector M23 (B) terminal 8.

BCM		CVT shift selector		Continuity
Connector	Terminal	Connector	Terminal	
A: M19	84	B: M23	8	Yes

- Check continuity between BCM harness connector M19 (A) terminal 84 and ground.

BCM		Ground	Continuity
Connector	Terminal		
A: M19	84	Ground	No

Is the inspection result normal?

- YES >> Replace BCM. Refer to [BCS-83. "Removal and Installation"](#).  
NO >> Repair harness or connector.

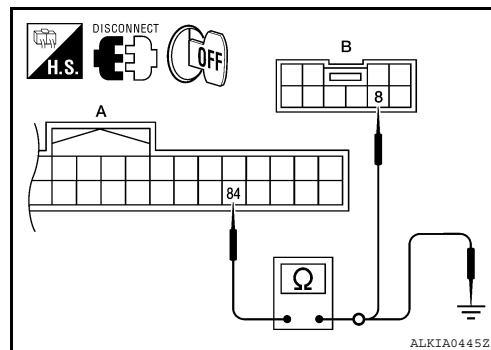

### 4. CHECK CVT SHIFT SELECTOR CIRCUIT

- Disconnect BCM harness connector.
- Check continuity between CVT shift selector harness connector and BCM harness connector.

BCM		CVT shift selector		Continuity
Connector	Terminal	Connector	Terminal	
A: M19	87	B: M23	9	Yes

- Check continuity between CVT shift selector harness connector and ground.

BCM		Ground	Continuity
Connector	Terminal		
A: M19	87	Ground	No

Is the inspection result normal?

- YES >> GO TO 5  
NO >> Repair harness or connector.

### 5. CHECK CVT SHIFT SELECTOR

Refer to [SEC-45. "Component Inspection"](#).

Is the inspection result normal?

- YES >> GO TO 6

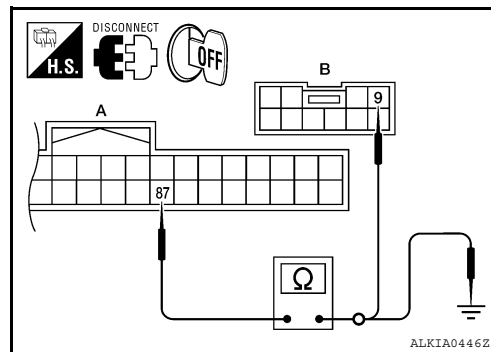

A  
B  
C  
D  
E  
F  
G  
H  
I  
J  
L  
M  
N  
O  
P

SEC

## B2602 SHIFT POSITION

[INTELLIGENT KEY SYSTEM]

< COMPONENT DIAGNOSIS >

---

NO >> Replace CVT shift selector. Refer to [TM-26, "Removal and Installation"](#).

### 6.CHECK INTERMITTENT INCIDENT

---

Refer to [GI-42, "Intermittent Incident"](#).

>> Inspection End.



# B2603 SHIFT POSITION STATUS

< COMPONENT DIAGNOSIS >

[INTELLIGENT KEY SYSTEM]

## B2603 SHIFT POSITION STATUS

### Description

INFOID:000000005439874

BCM confirms the shift position with the following 2 signals.

- CVT selector lever
- Transmission range switch

### DTC Logic

INFOID:000000005439875

### DTC DETECTION LOGIC

DTC	Self-diagnosis name	DTC detecting condition	Possible causes
B2603	SHIFT POSITION STATUS	BCM detects the followings status for 500 ms or more when shift is in P position and, ignition switch is in ON position. <ul style="list-style-type: none"><li>• Transmission range switch: approx. 0V</li><li>• CVT shift selector: approx 0V</li></ul>	<ul style="list-style-type: none"><li>• Harness or connector (CVT shift selector circuit is open or shorted.)</li><li>• Harness or connectors [Transmission range switch circuit is open or shorted.]</li><li>• CVT shift selector</li><li>• Transmission range switch</li></ul>

### DTC CONFIRMATION PROCEDURE

#### 1. PERFORM DTC CONFIRMATION PROCEDURE

1. Start the engine under the following conditions and wait for at least 1 second.
  - CVT selector lever is in the P position.
  - Do not depress the brake pedal.
2. Shift to N and wait for at least 1 second.
3. Shift to any other gear other than P and wait for at least 1 second.
4. Check "Self diagnostic result" with CONSULT-III.

#### Is DTC detected?

- YES >> Refer to [SEC-49, "Diagnosis Procedure"](#).  
NO >> Inspection End.

### Diagnosis Procedure

INFOID:000000005439876

Regarding Wiring Diagram information, refer to [SEC-113, "Wiring Diagram"](#).

#### 1. CHECK DTC WITH IPDM E/R

Check "Self diagnostic result" with CONSULT-III. Refer to [SEC-49, "DTC Logic"](#).

#### Is the inspection result normal?

- YES >> GO TO 2  
NO >> Repair or replace malfunctioning parts.

#### 2. CHECK DTC WITH HV ECU

Check "Self diagnostic result" with CONSULT-III. Refer to [SEC-49, "DTC Logic"](#).

#### Is the inspection result normal?

- YES >> GO TO 3  
NO >> Repair or replace malfunctioning parts.

#### 3. CHECK TRANSMISSION RANGE SWITCH CIRCUIT

1. Turn ignition switch OFF.
2. Disconnect hybrid vehicle control ECU harness connector and BCM harness connector.

## B2603 SHIFT POSITION STATUS

[INTELLIGENT KEY SYSTEM]

### < COMPONENT DIAGNOSIS >

- Check continuity between hybrid vehicle control ECU harness connector E65 (A) terminal 37 and BCM harness connector M18 (B) terminal 48.

Hybrid vehicle control ECU		BCM		Continuity
Connector	Terminal	Connector	Terminal	
A: E65	37	B: M18	48	Yes

- Check continuity between hybrid vehicle control ECU harness connector E65 (A) terminal 37 and ground.

Hybrid vehicle control ECU		Ground	Continuity
Connector	Terminal		
A: E65	37	Ground	No

Is the inspection result normal?

YES >> GO TO 4

NO >> Repair harness or connector.

### 4. CHECK CVT SHIFT SELECTOR POWER SUPPLY

- Turn ignition switch OFF.
- Disconnect CVT shift selector harness connector.
- Check voltage between CVT shift selector harness connector and ground.

CVT shift selector		Ground	Voltage [V]
Connector	Terminal		
M23	8	Ground	Battery voltage

Is the inspection result normal?

YES >> GO TO 6

NO >> GO TO 5

### 5. CHECK CVT SHIFT SELECTOR POWER SUPPLY CIRCUIT

- Disconnect BCM harness connector.
- Check continuity between BCM harness connector M19 (A) terminal 84 and CVT shift selector harness connector M23 (B) terminal 8.

BCM		CVT shift selector		Continuity
Connector	Terminal	Connector	Terminal	
A: M19	84	B: M23	8	Yes

- Check continuity between BCM harness connector M19 (A) terminal 84 and ground.

BCM		Ground	Continuity
Connector	Terminal		
A: M19	84	Ground	No

Is the inspection result normal?

YES >> Replace BCM. Refer to [BCS-83, "Removal and Installation"](#).

NO >> Repair harness or connector.

### 6. CHECK CVT SHIFT SELECTOR CIRCUIT

- Disconnect BCM harness connector.

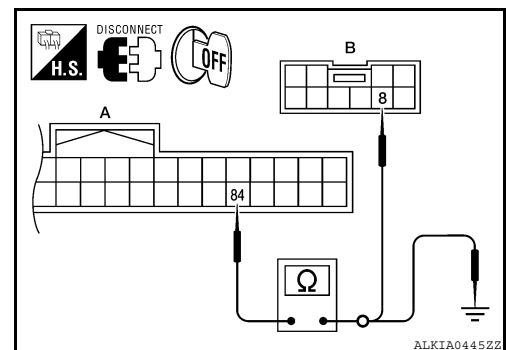
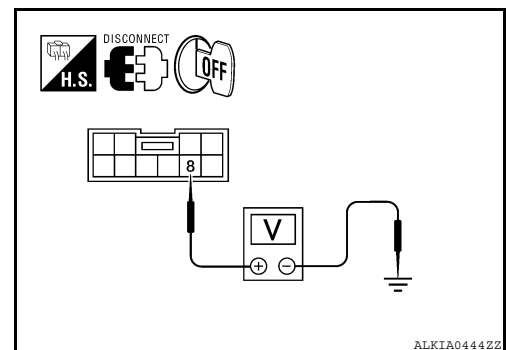
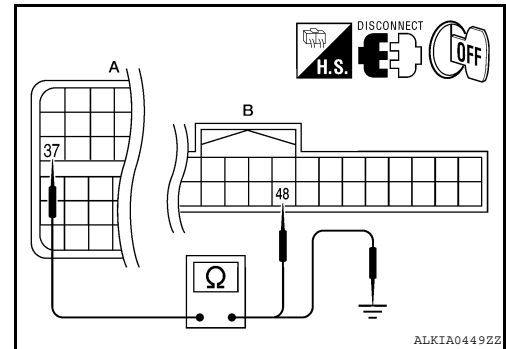

# B2603 SHIFT POSITION STATUS

[INTELLIGENT KEY SYSTEM]

## < COMPONENT DIAGNOSIS >

- Check continuity between BCM harness connector M19 (A) terminal 87 and CVT shift selector harness connector M23 (B) terminal 9.

BCM		CVT shift selector		Continuity
Connector	Terminal	Connector	Terminal	
A: M19	87	B: M23	9	Yes

- Check continuity between BCM harness connector M19 (A) terminal 87 and ground.

BCM		Ground	Continuity
Connector	Terminal		
A: M19	87	Ground	No

Is the inspection result normal?

- YES >> GO TO 7
- NO >> Repair harness or connector.

### 7. CHECK CVT SHIFT SELECTOR

Refer to [SEC-45. "Component Inspection"](#).

Is the inspection result normal?

- YES >> GO TO 8
- NO >> Replace CVT shift selector. Refer to [TM-26. "Removal and Installation"](#).

### 8. CHECK INTERMITTENT INCIDENT

Refer to [GI-42. "Intermittent Incident"](#).

>> Inspection End.

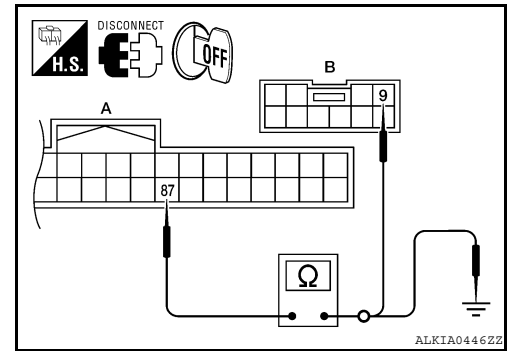

A  
B  
C  
D  
E  
F  
G  
H  
I  
J

SEC

L  
M  
N  
O  
P

# B2604 TRANSMISSION RANGE SWITCH

< COMPONENT DIAGNOSIS >

[INTELLIGENT KEY SYSTEM]

## B2604 TRANSMISSION RANGE SWITCH

### Description

INFOID:000000005439877

BCM confirms the shift position with the following 3 signals.

- CVT selector lever
- Transmission range switch
- P position signal from hybrid vehicle control ECU

### DTC Logic

INFOID:000000005439878

### DTC DETECTION LOGIC

#### NOTE:

- If DTC B2604 is displayed with DTC U1000, first perform the trouble diagnosis for DTC U1000. Refer to [SEC-28, "DTC Logic"](#).
- If DTC B2604 is displayed with DTC U1010, first perform the trouble diagnosis for DTC U1010. Refer to [SEC-29, "DTC Logic"](#).

DTC No.	Trouble diagnosis name	DTC detecting condition	Possible cause
B2604	TRANSMISSION RANGE SWITCH	BCM detects the following status for 500 ms or more when the ignition switch is in the ON position. <ul style="list-style-type: none"><li>• N position input signal exists. Shift position signal from hybrid vehicle control ECU does not exist.</li><li>• N position input signal does not exist. Shift position signal from hybrid vehicle control ECU exists.</li></ul>	<ul style="list-style-type: none"><li>• Harness or connectors [The transmission range switch circuit is open or shorted.]</li><li>• Transmission range switch</li><li>• HV ECU</li></ul>

### DTC CONFIRMATION PROCEDURE

#### 1. PERFORM DTC CONFIRMATION PROCEDURE

1. Start the hybrid system under the following conditions and wait for at least 1 second.
  - CVT selector lever is in the P position
  - Do not depress the brake pedal
  - Use CVT selector lever to select each gear, one at a time. Wait at each gear position for at least 1 second.
2. Check "Self diagnostic result" with CONSULT-III.

#### Is DTC detected?

- YES >> Refer to [SEC-52, "Diagnosis Procedure"](#).  
NO >> Inspection End.

### Diagnosis Procedure

INFOID:000000005439879

Regarding Wiring Diagram information, refer to [SEC-113, "Wiring Diagram"](#).

#### 1. CHECK DTC WITH HV ECU

Check "Self diagnostic result" with CONSULT-III. Refer to [HBC-597, "DTC Index"](#).

#### Is the inspection result normal?

- YES >> GO TO 2  
NO >> Repair or replace malfunctioning parts.

#### 2. CHECK TRANSMISSION RANGE SWITCH CIRCUIT

1. Turn ignition switch OFF.
2. Disconnect hybrid vehicle control ECU harness connector and BCM harness connector.

# B2604 TRANSMISSION RANGE SWITCH

[INTELLIGENT KEY SYSTEM]

## < COMPONENT DIAGNOSIS >

3. Check continuity between hybrid vehicle control ECU harness connector and BCM harness connector.

Hybrid vehicle control ECU		BCM		Continuity
Connector	Terminal	Connector	Terminal	
A: E65	37	B: M18	48	Yes

4. Check continuity between hybrid vehicle control ECU harness connector and ground.

Hybrid vehicle control ECU		Ground	Continuity
Connector	Terminal		
A: E65	37	Ground	No

Is the inspection result normal?

YES >> GO TO 3

NO >> Repair harness or connector.

## 3. CHECK INTERMITTENT INCIDENT

Refer to [GI-42. "Intermittent Incident"](#).

>> Inspection End.

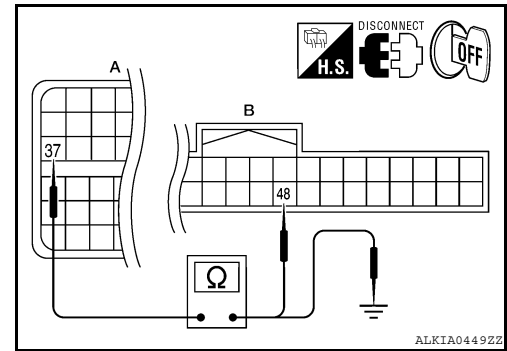

A  
B  
C  
D  
E  
F  
G  
H  
I  
J

SEC

L  
M  
N  
O  
P

## B260F ENGINE STATUS

### Description

INFOID:000000005439895

BCM receives the hybrid system status signal from hybrid vehicle control ECU via CAN communication.

### DTC Logic

INFOID:000000005439896

#### DTC DETECTION LOGIC

**NOTE:**

- If DTC B260F is displayed with DTC U1000, first perform the trouble diagnosis for DTC U1000. Refer to [SEC-28, "DTC Logic"](#).
- If DTC B260F is displayed with DTC U1010, first perform the trouble diagnosis for DTC U1010. Refer to [SEC-29, "DTC Logic"](#).

DTC No.	Trouble diagnosis name	DTC detecting condition	Possible cause
B260F	INTERRUPTION OF ENGINE STATUS SIGNAL	BCM is not yet received the hybrid system status signal from hybrid vehicle control ECU when ignition switch is in ON position	<ul style="list-style-type: none"> <li>• Hybrid vehicle control ECU</li> </ul>

#### DTC CONFIRMATION PROCEDURE

##### 1. PERFORM DTC CONFIRMATION PROCEDURE

1. Turn ignition switch ON under the following conditions.
  - CVT selector lever is in the P position.
  - Do not depress the brake pedal.
2. Check "Self diagnostic result" with CONSULT-III.

Is DTC detected?

- YES >> Refer to [SEC-54, "Diagnosis Procedure"](#).  
 NO >> Inspection End.

#### Diagnosis Procedure

INFOID:000000005439897

##### 1. INSPECTION START

1. Turn ignition switch ON.
2. Check "Self diagnostic result" with CONSULT-III.
3. Touch "ERASE".
4. **Perform DTC Confirmation Procedure.**  
See [SEC-54, "DTC Logic"](#).

Is the DTC B260F displayed again?

- YES >> GO TO 2  
 NO >> Inspection End.

##### 2. REPLACE HV ECU

1. Replace hybrid vehicle control ECU. Refer to [HBC-641, "Precaution for replacing hybrid vehicle control ECU"](#).
2. Refer to [HBC-641, "Removal and Installation"](#).

>> Inspection End.

## B26EA KEY REGISTRATION

### Description

INFOID:000000005804836

When the registered Intelligent Key is carried, the door lock/unlock operation and the push-button ignition switch operation become possible.

### DTC Logic

INFOID:000000005804837

### DTC DETECTION LOGIC

DTC No.	Trouble diagnosis name	DTC detecting condition	Possible cause
B26EA	KEY REGISTRATION	Intelligent Key is not registered successfully.	<ul style="list-style-type: none"><li>Improper registration operation</li><li>Intelligent Key</li><li>BCM</li></ul>

### DTC CONFIRMATION PROCEDURE

#### 1. PERFORM DTC CONFIRMATION PROCEDURE

1. Perform initialization using CONSULT-III. Reregister all Intelligent Keys.  
For initialization and registration of Intelligent Key, refer to CONSULT-III Operation Manual.
2. Check "Self-diagnostic result" using CONSULT-III.

#### Is DTC detected?

- YES >> Refer to [SEC-55. "Diagnosis Procedure"](#).  
NO >> Inspection End.

### Diagnosis Procedure

INFOID:000000005804838

#### 1. PERFORM INITIALIZATION

1. Perform initialization using CONSULT-III. Reregister all Intelligent Keys.  
For initialization and registration of Intelligent Key, refer to CONSULT-III Operation Manual.
2. Check "Self-diagnostic result" using CONSULT-III.

#### Is DTC detected?

- YES >> GO TO 2.  
NO >> Inspection End.

#### 2. REPLACE INTELLIGENT KEY

1. Replace Intelligent Key. Reregister all Intelligent Keys.
2. Perform initialization using CONSULT-III. For initialization, refer to CONSULT-III Operation Manual.
3. Check "Self-diagnostic result" using CONSULT-III.

#### Is DTC detected?

- YES >> Replace BCM. Refer to [BCS-83. "Removal and Installation"](#).  
NO >> Inspection End.

A  
B  
C  
D  
E  
F  
G  
H  
I  
J  
L  
M  
N  
O  
P

SEC

# B2617 STARTER RELAY CIRCUIT

< COMPONENT DIAGNOSIS >

[INTELLIGENT KEY SYSTEM]

## B2617 STARTER RELAY CIRCUIT

### Description

INFOID:000000005439901

The hybrid system start enabling condition is located in the BCM. BCM transmits the starting signal to HV ECU via hardwire. HV ECU responds with hybrid system status.

### DTC Logic

INFOID:000000005439902

### DTC DETECTION LOGIC

#### NOTE:

- If DTC B2617 is displayed with DTC U1000, first perform the trouble diagnosis for DTC U1000. Refer to [SEC-28, "DTC Logic"](#).
- If DTC B2617 is displayed with DTC U1010, first perform the trouble diagnosis for DTC U1010. Refer to [SEC-29, "DTC Logic"](#).

DTC No.	Trouble diagnosis name	DTC detecting condition	Possible cause
B2617	STARTER RELAY CIRCUIT	An immediate operation of hybrid starting system is requested by BCM, but there is no response for more than 1 second.	<ul style="list-style-type: none"><li>• Harness or connectors (hybrid starting system circuit is open or shorted.)</li><li>• Hybrid vehicle control ECU</li></ul>

### DTC CONFIRMATION PROCEDURE

#### 1. PERFORM DTC CONFIRMATION PROCEDURE

1. Press the push-button ignition switch under the following conditions.
  - CVT selector lever is in the P position.
  - Depress the brake pedal.
2. Check "Self diagnostic result" with CONSULT-III.

#### Is DTC detected?

- YES >> Refer to [SEC-56, "Diagnosis Procedure"](#).  
NO >> Inspection End.

### Diagnosis Procedure

INFOID:000000005439903

Regarding Wiring Diagram information, refer to [SEC-113, "Wiring Diagram"](#).

#### 1. CHECK STARTER RELAY

1. Turn ignition switch ON.
2. Check voltage between BCM harness connector and ground under the following condition.

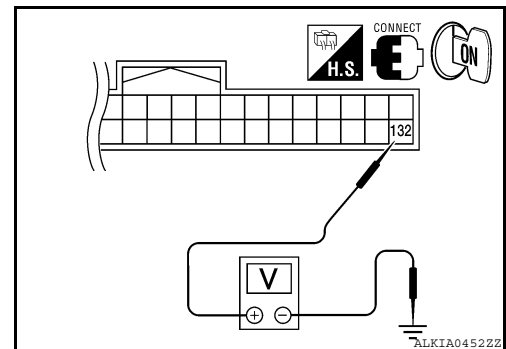



# B2617 STARTER RELAY CIRCUIT

< COMPONENT DIAGNOSIS >

[INTELLIGENT KEY SYSTEM]

BCM		Ground	Condition	Voltage (V)
Connector	Terminal			
M21	132	Ground	Ignition switch	Battery voltage
			Cranking or request to start (selector lever in P position)	0
			Other than above	0

Is the measurement value within the specification?

- YES >> GO TO 3
- NO >> GO TO 2

## 2. CHECK HV ECU CIRCUIT

1. Turn ignition switch OFF.
2. Disconnect BCM harness connector M121 and hybrid vehicle control ECU harness connector E66.
3. Check continuity between hybrid vehicle control ECU harness connector E66 (A) terminal 167 and BCM harness connector M21 (B) terminal 132.

Hybrid vehicle control ECU		BCM		Continuity
Connector	Terminal	Connector	Terminal	
E66	167	M21	132	Yes

4. Check continuity between hybrid vehicle control ECU harness connector E66 (A) terminal 167 and ground.

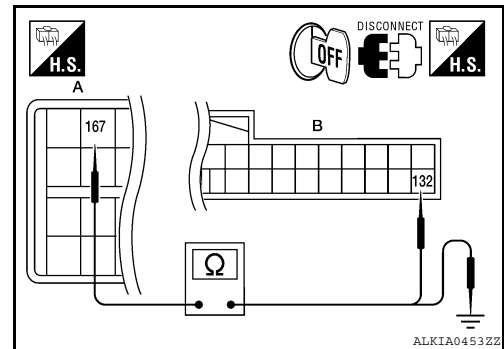

Hybrid vehicle control ECU		Ground	Continuity
Connector	Terminal		
E66	167	Ground	No

Is the inspection result normal?

- YES >> Replace BCM. Refer to [BCS-83. "Removal and Installation"](#).
- NO >> Repair harness or connector.

## 3. CHECK INTERMITTENT INCIDENT

Refer to [GI-42. "Intermittent Incident"](#).

>> Inspection End.

A  
B  
C  
D  
E  
F  
G  
H  
I  
J  
L  
M  
N  
O  
P

SEC

# B261A PUSH-BUTTON IGNITION SWITCH

< COMPONENT DIAGNOSIS >

[INTELLIGENT KEY SYSTEM]

## B261A PUSH-BUTTON IGNITION SWITCH

### Description

INFOID:000000005439907

IPDM E/R transmits the push-button ignition switch status via CAN communication to BCM. BCM receives push-button status by hardwire input. BCM compares the 2 signals for mismatch.

### DTC Logic

INFOID:000000005439908

### DTC DETECTION LOGIC

#### NOTE:

- If DTC B261A is displayed with DTC U1000, first perform the trouble diagnosis for DTC U1000. Refer to [SEC-28, "DTC Logic"](#).
- If DTC B261A is displayed with DTC U1010, first perform the trouble diagnosis for DTC U1010. Refer to [SEC-29, "DTC Logic"](#).

DTC No.	Trouble diagnosis name	DTC detecting condition	Possible cause
B261A	PUSH-BUTTON IGNITION SWITCH	BCM detects the mismatch between the following for 1 second or more <ul style="list-style-type: none"><li>• Push-button ignition switch status</li><li>• Push-button ignition switch status from IPDM E/R (CAN)</li></ul>	<ul style="list-style-type: none"><li>• Harness or connectors (Push-button ignition switch circuit is open or shorted)</li><li>• Between BCM and push-button ignition switch</li><li>• Between IPDM E/R and push-button ignition switch</li></ul>

### DTC CONFIRMATION PROCEDURE

#### 1. PERFORM DTC CONFIRMATION PROCEDURE

1. Press the push-button ignition switch under the following conditions and wait for at least 1 second.
  - CVT selector lever is in the P position
  - Do not depress brake pedal.
2. Check "Self diagnostic result" with CONSULT-III.

#### Is DTC detected?

YES >> Refer to [SEC-58, "Diagnosis Procedure"](#).

NO >> Inspection End.

### Diagnosis Procedure

INFOID:000000005439909

Regarding Wiring Diagram information, refer to [SEC-138, "Wiring Diagram"](#).

#### 1. CHECK PUSH-BUTTON IGNITION SWITCH OUTPUT SIGNAL 1

1. Turn ignition switch OFF.
2. Disconnect push-button ignition switch harness connector and IPDM E/R harness connector.
3. Check voltage between push-button ignition switch harness connector and ground.

Push-button ignition switch		Ground	Voltage (V)
Connector	Terminal		
M38	4	Ground	Battery voltage

#### Is the inspection result normal?

YES >> GO TO 3

NO >> GO TO 2

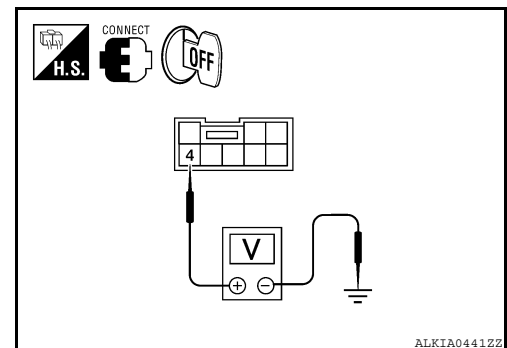

#### 2. CHECK PUSH-BUTTON IGNITION SWITCH CIRCUIT

## B261A PUSH-BUTTON IGNITION SWITCH

[INTELLIGENT KEY SYSTEM]

### < COMPONENT DIAGNOSIS >

1. Disconnect BCM harness connector.
2. Check continuity between push-button ignition switch harness connector M38 terminal 4 and BCM harness connector M21 terminal 140.

Push-button ignition switch		BCM		Continuity
Connector	Terminal	Connector	Terminal	
M38	4	M21	140	Yes

3. Check continuity between push-button ignition switch harness connector M38 terminal 4 and ground.

Push-button ignition switch		Ground	Continuity
Connector	Terminal		
M38	4	Ground	No

Is the inspection result normal?

YES >> GO TO 3

NO >> Repair harness or connector.

### 3. CHECK PUSH-BUTTON IGNITION SWITCH

1. Disconnect IPDM E/R harness connector.
2. Check continuity between push-button ignition switch harness connector M38 (A) terminal 4 and IPDM E/R harness connector E18 (B) terminal 28.

Push-button ignition switch		IPDM E/R		Continuity
Connector	Terminal	Connector	Terminal	
A: M38	4	B: E18	28	Yes

3. Check continuity between push-button ignition switch harness connector and ground.

Push-button ignition switch		Ground	Continuity
Connector	Terminal		
A: M38	4	Ground	No

Is the inspection result normal?

YES >> GO TO 4

NO >> Repair harness or connector.

### 4. CHECK INTERMITTENT INCIDENT

Refer to [GI-42. "Intermittent Incident"](#).

>> Inspection End.

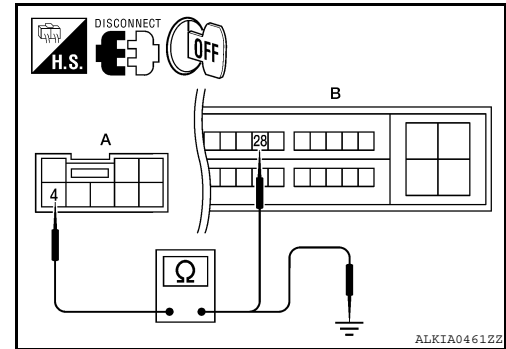

A  
B  
C  
D  
E  
F  
G  
H  
I  
J  
L  
M  
N  
O  
P

SEC

## B261E VEHICLE TYPE

### Description

INFOID:000000005439910

There are two types of vehicles.

- HEV
- Conventional

### DTC Logic

INFOID:000000005439911

#### DTC DETECTION LOGIC

**NOTE:**

- If DTC B261E is displayed with DTC U1000, first perform the trouble diagnosis for DTC U1000. Refer to [SEC-28, "DTC Logic"](#).
- If DTC B261E is displayed with DTC U1010, first perform the trouble diagnosis for DTC U1010. Refer to [SEC-29, "DTC Logic"](#).

DTC No.	Trouble diagnosis name	DTC detecting condition	Possible cause
B261E	VEHICLE TYPE	Difference of BCM configuration	<ul style="list-style-type: none"> <li>• BCM</li> </ul>

#### DTC CONFIRMATION PROCEDURE

### 1. PERFORM DTC CONFIRMATION PROCEDURE

1. Turn ignition switch ON.
2. Check "Self diagnostic result" with CONSULT-III.

Is DTC detected?

- YES >> Refer to [SEC-60, "Diagnosis Procedure"](#).  
 NO >> Inspection End.

### Diagnosis Procedure

INFOID:000000005439912

### 1. INSPECTION START

1. Turn ignition switch ON.
2. Check "Self diagnostic result" with CONSULT-III.
3. Touch "ERASE".
4. **Perform DTC Confirmation Procedure.**  
See [SEC-60, "DTC Logic"](#).

Is the 1st trip DTC B261E displayed again?

- YES >> Perform BCM configuration. Refer to Consult-III Operation Manual.  
 NO >> Inspection End.

# POWER SUPPLY AND GROUND CIRCUIT

[INTELLIGENT KEY SYSTEM]

< COMPONENT DIAGNOSIS >

## POWER SUPPLY AND GROUND CIRCUIT

### BCM

#### BCM : Diagnosis Procedure

INFOID:000000005804817

Regarding Wiring Diagram information, refer to [BCS-71, "Wiring Diagram"](#).

### 1. CHECK FUSE AND FUSIBLE LINK

Check if the following BCM fuse or fusible link are blown.

Terminal No.	Signal name	Fuse and fusible link No.
1	Battery power supply	J
11		10

Is the fuse or fusible link blown?

YES >> Replace the blown fuse or fusible link after repairing the affected circuit.

NO >> GO TO 2

### 2. CHECK POWER SUPPLY CIRCUIT

1. Turn ignition switch OFF.
2. Disconnect BCM.
3. Check voltage between BCM harness connector and ground.

Terminals		Voltage (Approx.)
(+)	(-)	
BCM		Ground
Connector	Terminal	
M16	1	
M17	11	Battery voltage

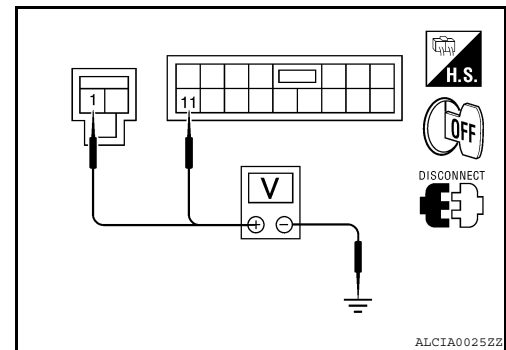

Is the measurement normal?

YES >> GO TO 3

NO >> Repair or replace harness.

### 3. CHECK GROUND CIRCUIT

Check continuity between BCM harness connector and ground.

BCM		Ground	Continuity
Connector	Terminal		
M17	13		Yes

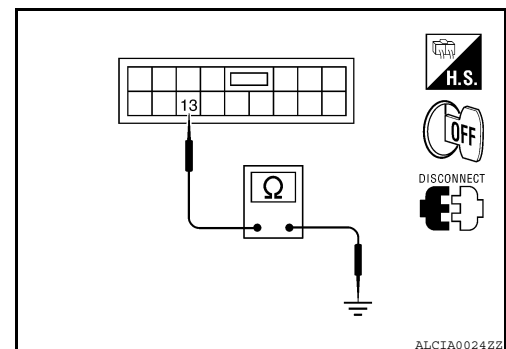

Does continuity exist?

YES >> Inspection End.

NO >> Repair or replace harness.

#### BCM : Special Repair Requirement

INFOID:000000005804818

### 1. REQUIRED WORK WHEN REPLACING BCM

Initialize control unit. Refer to CONSULT-III operation manual.

>> Work End.

# POWER SUPPLY AND GROUND CIRCUIT

< COMPONENT DIAGNOSIS >

[INTELLIGENT KEY SYSTEM]

## IPDM E/R (INTELLIGENT POWER DISTRIBUTION MODULE ENGINE ROOM)

## IPDM E/R (INTELLIGENT POWER DISTRIBUTION MODULE ENGINE ROOM) : Diagnosis Procedure

INFOID:000000005804819

Regarding Wiring Diagram information, refer to [PCS-29. "Wiring Diagram"](#).

### 1. CHECK FUSES AND FUSIBLE LINK

Check that the following IPDM E/R fuses or fusible link are not blown.

Terminal No.	Signal name	Fuses and fusible link No.
1, 2	Battery power supply	D, E, F
—		42
—		43

Is the fuse blown?

YES >> Replace the blown fuse or fusible link after repairing the affected circuit.

NO >> GO TO 2

### 2. CHECK POWER SUPPLY CIRCUIT

1. Turn ignition switch OFF.
2. Disconnect IPDM E/R.
3. Check voltage between IPDM E/R harness connector and ground.

Terminals		Voltage (V) (Approx.)
(+)	(-)	
IPDM E/R		Ground
Connector	Terminal	
E16	1	
	2	
		Battery voltage

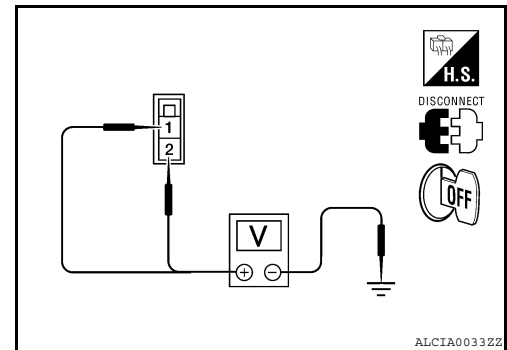

Is the measurement value normal?

YES >> GO TO 3

NO >> Repair or replace harness.

### 3. CHECK GROUND CIRCUIT

Check continuity between IPDM E/R harness connectors and ground.

IPDM E/R		Ground	Continuity
Connector	Terminal		
E18 (A)	12	Ground	Yes
E17 (B)	41		

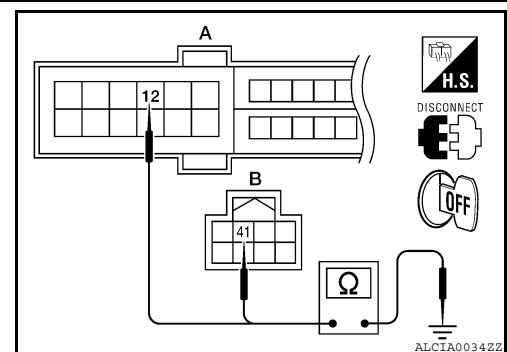

Does continuity exist?

YES >> Inspection End.

NO >> Repair or replace harness.

# KEY SLOT

< COMPONENT DIAGNOSIS >

[INTELLIGENT KEY SYSTEM]

## KEY SLOT

### Diagnosis Procedure

INFOID:000000005439916

Regarding Wiring Diagram information, refer to [SEC-138. "Wiring Diagram"](#).

#### 1. CHECK KEY SLOT POWER SUPPLY CIRCUIT

1. Turn ignition switch OFF.
2. Disconnect key slot connector.
3. Check voltage between slot connector and ground.

Key slot		Ground	Voltage (V) (Approx.)
Connector	Terminal		
M40	1	Ground	Battery voltage
	5		

Is the inspection result normal?

YES >> GO TO 2

NO >> Repair or replace key slot power supply circuit.

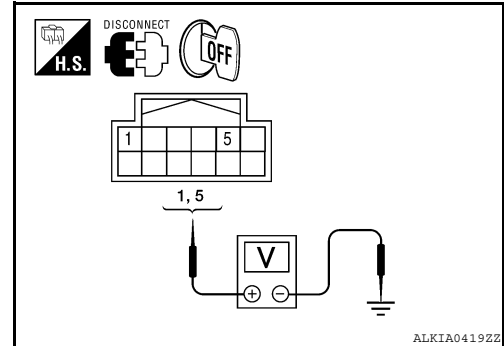

#### 2. CHECK KEY SLOT GROUND CIRCUIT

Check continuity between key slot connector and ground.

Key slot		Ground	Continuity
Connector	Terminal		
M40	7	Ground	Yes

Is the inspection result normal?

YES >> GO TO 3

NO >> Repair or replace key slot ground circuit.

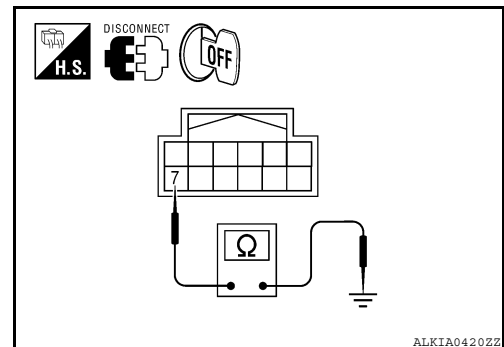

#### 3. CHECK INTERMITTENT INCIDENT

Refer to [GI-42. "Intermittent Incident"](#).

>> Inspection End.

A  
B  
C  
D  
E  
F  
G  
H  
I  
J  
L  
M  
N  
O  
P

SEC

# KEY SLOT ILLUMINATION

< COMPONENT DIAGNOSIS >

[INTELLIGENT KEY SYSTEM]

## KEY SLOT ILLUMINATION

### Description

INFOID:000000005439917

Blinks when Intelligent Key insertion is required.

### Component Function Check

INFOID:000000005439918

## 1. CHECK FUNCTION

### With CONSULT-III

Check key slot illumination ("KEY SLOT ILLUMI") Active Test mode.

#### Is the inspection result normal?

- YES >> Key slot function is OK.
- NO >> Refer to [SEC-64, "Diagnosis Procedure"](#).

### Diagnosis Procedure

INFOID:000000005439919

Regarding Wiring Diagram information, refer to [SEC-138, "Wiring Diagram"](#).

## 1. CHECK KEY SLOT ILLUMINATION OUTPUT SIGNAL

Check voltage between key slot connector and ground.

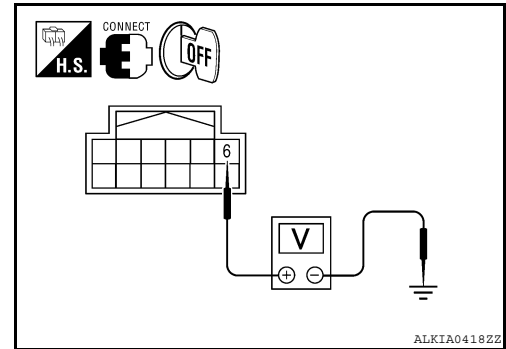

Terminals			Condition	Key slot illumination	Voltage (V) (Approx.)
(+)		(-)			
Key slot connector	Terminal				
M40	6	Ground	Intelligent Key inserted	OFF	Battery voltage
			Intelligent Key removed	ON	0

#### Is the inspection result normal?

- YES >> GO TO 6
- NO >> GO TO 2

## 2. CHECK KEY SLOT POWER SUPPLY CIRCUIT

1. Turn ignition switch OFF.
2. Disconnect key slot connector.



# KEY SLOT ILLUMINATION

[INTELLIGENT KEY SYSTEM]

## < COMPONENT DIAGNOSIS >

3. Check voltage between slot connector and ground.

Terminals		Voltage (V) (Approx.)
(+)	(-)	
Key slot connector	Terminal	Ground
M40	1	
	5	Battery voltage

Is the inspection result normal?

- YES >> GO TO 3
- NO >> Repair or replace key slot power supply circuit.

### 3.CHECK KEY SLOT GROUND CIRCUIT

Check continuity between key slot connector and ground.

Key slot connector	Terminal	Ground	Continuity
M40	7		Yes

Is the inspection result normal?

- YES >> GO TO 4
- NO >> Repair or replace key slot ground circuit.

### 4.CHECK KEY SLOT CIRCUIT

1. Turn ignition switch OFF.
2. Disconnect BCM and key slot connector.
3. Check continuity between BCM connector and key slot connector.

BCM connector	Terminal	Key slot connector	Terminal	Continuity
A: M19	80	B: M40	6	Yes

4. Check continuity between BCM connector and ground.

BCM connector	Terminal	Ground	Continuity
A: M19	80		No

Is the inspection result normal?

- YES >> GO TO 5
- NO >> Repair or replace harness between BCM and key slot.

### 5.CHECK KEY SLOT

Refer to [DLK-73, "Component Inspection"](#).

Is the inspection result normal?

- YES >> GO TO 6
- NO >> Replace key slot. Refer to [SEC-152, "Removal and Installation"](#).

### 6.CHECK INTERMITTENT INCIDENT

Refer to [GI-42, "Intermittent Incident"](#).

>> Inspection End.

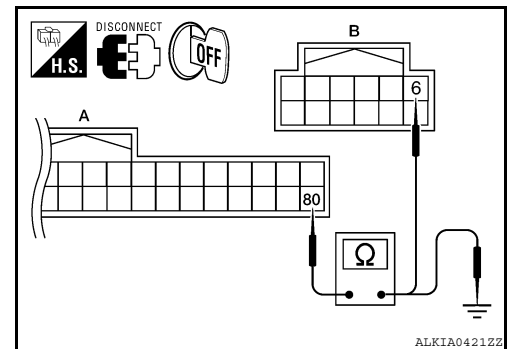
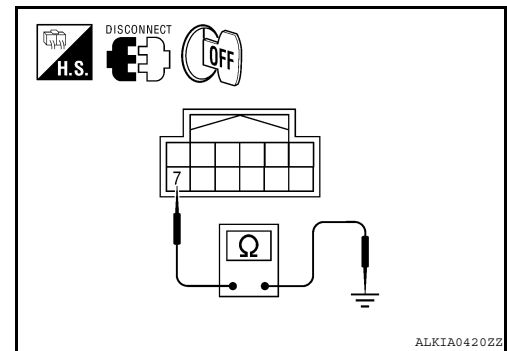
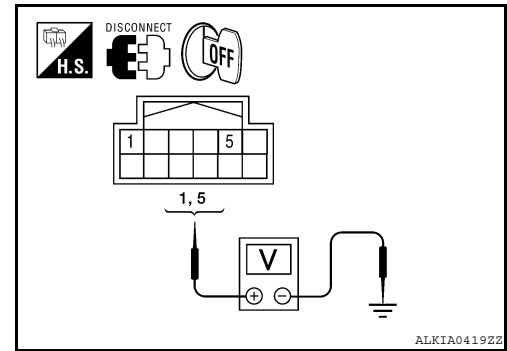

A  
B  
C  
D  
E  
F  
G  
H  
I  
J  
L  
M  
N  
O  
P

SEC

# KEY CYLINDER SWITCH

< COMPONENT DIAGNOSIS >

[INTELLIGENT KEY SYSTEM]

## KEY CYLINDER SWITCH

### Description

INFOID:000000005439920

For vehicles equipped with LH and RH anti-pinch system, the main power window and door lock/unlock switch detects condition of the door key cylinder switch and transmits to BCM as the LOCK or UNLOCK signal.

For vehicles equipped with LH anti-pinch system only, the front door lock assembly LH (key cylinder switch) transmits the LOCK or UNLOCK signal directly to the BCM.

### Component Function Check

INFOID:000000005439921

## 1. CHECK DOOR KEY CYLINDER SWITCH INPUT SIGNAL

Check KEY CYL UN-SW, KEY CYL UN-SW in "DATA MONITOR" mode for "POWER DOOR LOCK SYSTEM" with CONSULT-III. Refer to [DLK-5. "Work Flow"](#).

Monitor item	Condition
KEY CYL LK-SW	Lock : ON
	Neutral / Unlock : OFF
KEY CYL UN-SW	Unlock : ON
	Neutral / Lock : OFF

Is the inspection result normal?

YES >> Key cylinder switch is OK.

NO >> With LH and RH anti-pinch, refer to [SEC-66. "Diagnosis Procedure \(With LH and RH Anti-Pinch\)"](#).

NO >> With LH anti-pinch only, refer to [SEC-68. "Diagnosis Procedure \(With LH Anti-Pinch Only\)"](#).

### Diagnosis Procedure (With LH and RH Anti-Pinch)

INFOID:000000005439922

Regarding Wiring Diagram information, refer to [SEC-125. "Wiring Diagram"](#).

## 1. CHECK DOOR KEY CYLINDER SWITCH INPUT SIGNAL

1. Turn ignition switch ON.
2. Check voltage between main power window and door lock/unlock switch connector and ground.

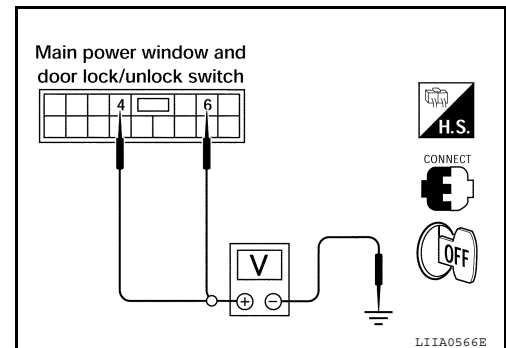

# KEY CYLINDER SWITCH

< COMPONENT DIAGNOSIS >

[INTELLIGENT KEY SYSTEM]

Terminals		Key position	Voltage (V) (Approx.)
(+)	(-)		
Main power window and door lock/unlock switch connector	Terminal		
D7	4	Lock	0
	6	Neutral / Unlock	Battery voltage
		Unlock	0
		Neutral / Lock	Battery voltage

Is the inspection result normal?

YES >> Replace main power window and door lock/unlock switch. Refer to [PWC-187, "Removal and Installation"](#).

NO >> GO TO 2

## 2. CHECK DOOR KEY CYLINDER SIGNAL CIRCUIT

- Turn ignition switch OFF.
- Disconnect main power window and door lock/unlock switch connector and front door lock assembly LH (key cylinder switch) connector.
- Check continuity between main power window and door lock/unlock switch connector and front door lock assembly LH (key cylinder switch) connector.

Main power window and door lock/unlock switch connector	Terminal	Front door lock assembly LH (key cylinder switch) connector	Terminal	Continuity
A: D7	4	B: D10	6	Yes
	6		5	

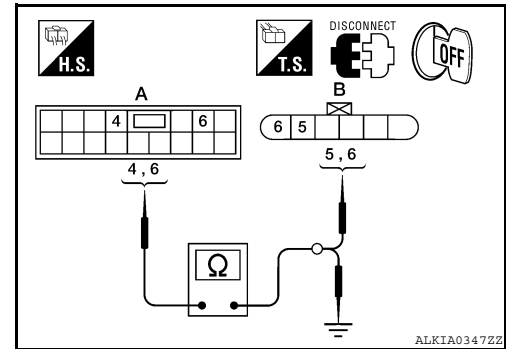

- Check continuity between main power window and door lock/unlock switch connector and ground.

Power window main switch connector	Terminal	Ground	Continuity
A: D7	4	Ground	No
	6		

Is the inspection result normal?

YES >> GO TO 3

NO >> Repair or replace harness.

## 3. CHECK DOOR KEY CYLINDER SWITCH GROUND CIRCUIT

Check continuity between front door lock assembly LH connector and ground.

Front door lock assembly LH connector	Terminal	Ground	Continuity
D10	4	Ground	Yes

Is the inspection result normal?

YES >> GO TO 4

NO >> Repair or replace harness.

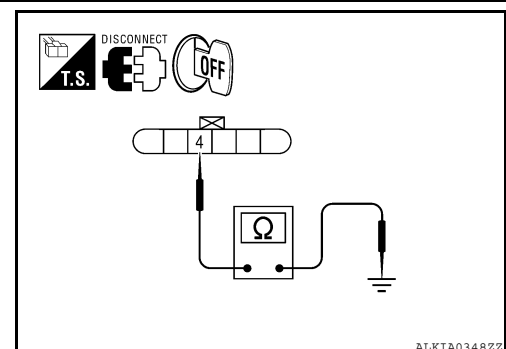

## 4. CHECK DOOR KEY CYLINDER SWITCH

Check door key cylinder switch.

Refer to [SEC-69, "Component Inspection"](#).

# KEY CYLINDER SWITCH

[INTELLIGENT KEY SYSTEM]

< COMPONENT DIAGNOSIS >

Is the inspection result normal?

- YES >> Check intermittent incident. Refer to [GI-42, "Intermittent Incident"](#).
- NO >> Replace front door lock assembly LH (key cylinder switch). Refer to [DLK-217, "FRONT DOOR LOCK : Removal and Installation"](#).

## Diagnosis Procedure (With LH Anti-Pinch Only)

INFOID:000000005439923

Regarding Wiring Diagram information, refer to [SEC-125, "Wiring Diagram"](#).

### 1. CHECK DOOR KEY CYLINDER SWITCH INPUT SIGNAL

1. Turn ignition switch ON.
2. Check voltage between BCM connector and ground.

Terminals		Key position	Voltage (V) (Approx.)
(+)	(-)		
BCM connector	Terminal		
M18	56	Lock	0
		Neutral / Unlock	Battery voltage
	34	Unlock	0
		Neutral / Lock	Battery voltage

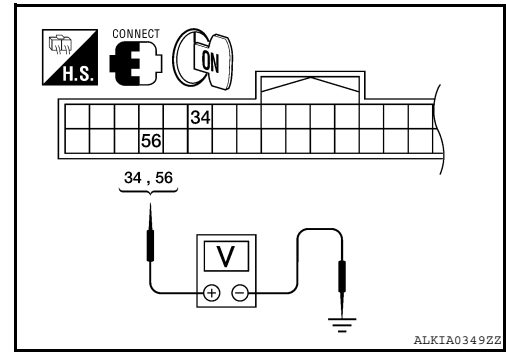

Is the inspection result normal?

- YES >> Replace main power window and door lock/unlock switch. Refer to [PWC-87, "Removal and Installation"](#).
- NO >> GO TO 2

### 2. CHECK DOOR KEY CYLINDER SWITCH GROUND CIRCUIT

1. Turn ignition switch OFF.
2. Disconnect front door lock assembly LH (key cylinder switch) connector.
3. Check continuity between front door lock assembly LH (key cylinder switch) connector and ground.

Front door lock assembly LH connector	Terminal	Ground	Continuity
D14	4		Yes

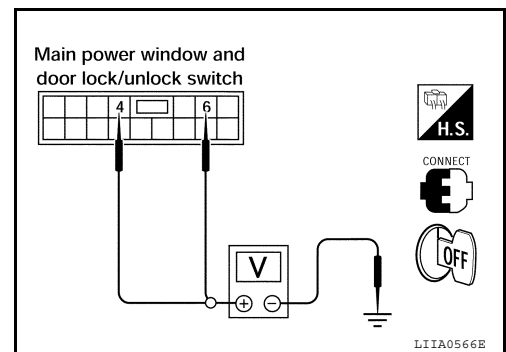

Is the inspection result normal?

- YES >> GO TO 3
- NO >> Repair or replace harness.

### 3. CHECK DOOR KEY CYLINDER SIGNAL CIRCUIT

1. Disconnect BCM connector M18.
2. Check continuity between front door lock assembly LH (key cylinder switch) connector D14 terminals 5, 6 and BCM connector M18 (B) terminals 34, 35.

Front door lock assembly LH connector	Terminal	BCM connector	Terminal	Continuity
A: D14	5	B: M18	34	Yes
	6		56	

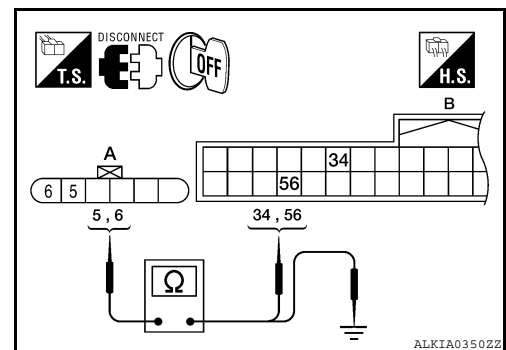

3. Check continuity between front door lock assembly LH (key cylinder switch) connector D14 (A) terminals 5, 6 and ground.

# KEY CYLINDER SWITCH

< COMPONENT DIAGNOSIS >

[INTELLIGENT KEY SYSTEM]

Front door lock assembly LH connector	Terminal	Ground	Continuity
A: D14	5		Ground
	6		

Is the inspection result normal?

YES >> GO TO 4

NO >> Repair or replace harness.

## 4. CHECK DOOR KEY CYLINDER SWITCH

Check door key cylinder switch.

Refer to [SEC-69, "Component Inspection"](#).

Is the inspection result normal?

YES >> Check intermittent incident. Refer to [GI-42, "Intermittent Incident"](#).

NO >> Replace front door lock assembly LH (key cylinder switch). Refer to [DLK-217, "FRONT DOOR LOCK : Removal and Installation"](#).

## Component Inspection

INFOID:000000005439924

### COMPONENT INSPECTION

#### 1. CHECK DOOR KEY CYLINDER SWITCH

Check front door lock assembly LH (key cylinder switch).

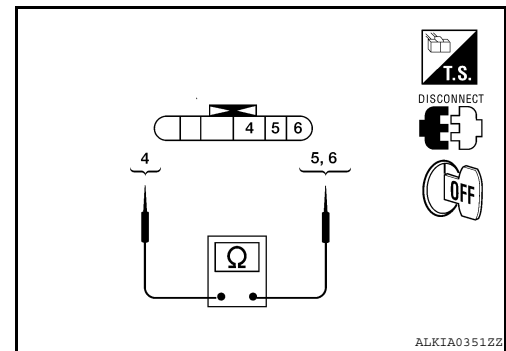

Terminal		Key position	Continuity
Front door lock assembly LH (key cylinder switch)			
5	4	Unlock	Yes
		Neutral / Lock	No
6		Lock	Yes
		Neutral / Unlock	No

Is the inspection result normal?

YES >> Key cylinder switch is OK.

NO >> Replace front door lock assembly LH (key cylinder switch). Refer to [DLK-217, "FRONT DOOR LOCK : Removal and Installation"](#).

# HORN

< COMPONENT DIAGNOSIS >

[INTELLIGENT KEY SYSTEM]

## HORN

### Description

INFOID:000000005439925

Horn (high/low) is located inside of front bumper and operates when theft warning system is in alarm phase.

### Component Function Check

INFOID:000000005439926

#### 1.CHECK FUNCTION

1. Select HORN in "ACTIVE TEST" mode with CONSULT-III.
2. Check the horn (high/low) operation.

Test item		Description	
HORN	ON	Horn relay	ON (for 20 ms)

Is the operation normal?

- YES >> Inspection End.  
 NO >> Refer to [SEC-70. "Diagnosis Procedure"](#).

### Diagnosis Procedure

INFOID:000000005439927

Regarding Wiring Diagram information, refer to [SEC-125. "Wiring Diagram"](#).

#### 1.CHECK HORN FUNCTION

Check horn function with horn switch

Do the horns sound?

- YES >> GO TO 2  
 NO >> Refer to [HRN-3. "Wiring Diagram"](#).

#### 2.CHECK HORN RELAY POWER SUPPLY

1. Turn ignition switch ON.
2. Perform "ACTIVE TEST" ("HORN") with CONSULT-III.
3. Using an analog voltmeter or an oscilloscope, check voltage between IPDM E/R connector E17 terminal 44 and ground.

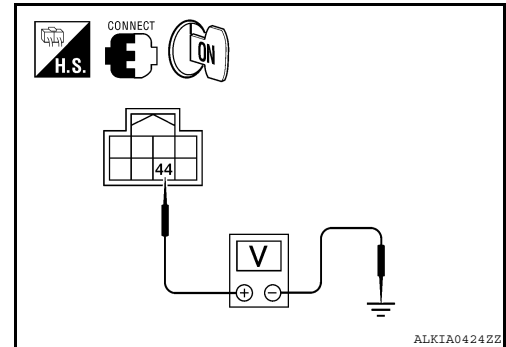

ALKIA0424ZZ

IPDM E/R		Ground	Test item	Voltage (V) (Approx.)	
Connector	Terminal				
E17	44	Ground	HORN	ON	Battery voltage → 0 → Battery voltage
				Other than above	Battery voltage

Is the inspection result normal?

- YES >> GO TO 4  
 NO >> GO TO 3

#### 3.CHECK HORN RELAY CIRCUIT

1. Turn ignition switch OFF.

# HORN

[INTELLIGENT KEY SYSTEM]

< COMPONENT DIAGNOSIS >

2. Disconnect IPDM E/R and horn relay connector.
3. Check continuity between IPDM E/R harness connector and horn relay harness connector.

IPDM E/R		Horn relay		Continuity
Connector	Terminal	Connector	Terminal	
A: E17	44	B: H-1	1	Yes

4. Check continuity between IPDM E/R harness connector and ground.

IPDM E/R		Ground	Continuity
Connector	Terminal		
A: E17	44	Ground	No

Is the inspection result normal?

- YES >> GO TO 4
- NO >> Repair or replace harness.

## 4. CHECK INTERMITTENT INCIDENT

Refer to [GI-42. "Intermittent Incident"](#).

Is the inspection result normal?

- YES >> Replace IPDM E/R. Refer to [PCS-36. "Removal and Installation"](#).
- NO >> Repair or replace the malfunctioning part.

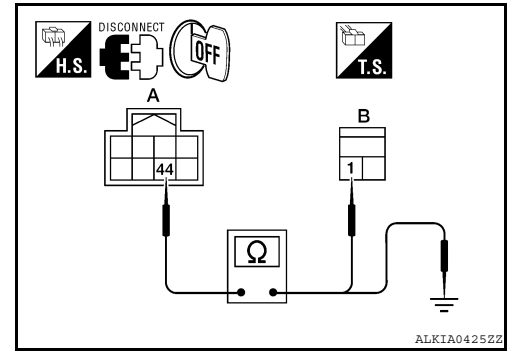

A  
B  
C  
D  
E  
F  
G  
H  
I  
J  
L  
M  
N  
O  
P

SEC

## HEADLAMP

### Description

INFOID:000000005439928

Headlamp lighting when theft warning system is alarm phase.

### Component Function Check

INFOID:000000005439929

#### 1.CHECK HEADLAMP OPERATION

---

Check if headlamp operate by lighting switch.

Does headlamp come on when turning switch "ON"?

YES >> Headlamp circuit is OK.

NO >> Check headlamp system. Refer to [SEC-72, "Diagnosis Procedure"](#).

### Diagnosis Procedure

INFOID:000000005439930

#### 1.CHECK HEADLAMP OPERATION

---

Refer to [EXL-36, "Diagnosis Procedure"](#).

Is the inspection result normal?

YES >> GO TO 2

NO >> Repair or replace malfunctioning parts.

#### 2.CHECK INTERMITTENT INCIDENT

---

Refer to [GI-42, "Intermittent Incident"](#).

Is the inspection result normal?

>> Inspection End.



# WARNING LAMP

< COMPONENT DIAGNOSIS >

[INTELLIGENT KEY SYSTEM]

## WARNING LAMP

### Description

INFOID:000000005439931

- Warning lamp is built in combination meter.
- Intelligent Key system malfunction is reported to the driver by the warning lamp illumination.

### Component Function Check

INFOID:000000005439932

#### 1.CHECK FUNCTION

1. Perform "INDICATOR" in the "Active Test" mode with CONSULT-III.
2. Check warning lamp operation.

Test item		Description	
INDICATOR	ON	Warning lamp	ON
	OFF		OFF

#### Is the inspection result normal?

- YES >> Inspection End.  
NO >> Refer to [SEC-73, "Diagnosis Procedure"](#).

### Diagnosis Procedure

INFOID:000000005439933

#### 1.CHECK COMBINATION METER

Check combination meter function. Refer to [MWI-4, "Work Flow"](#).

#### Is the inspection result is normal?

- YES >> GO TO 2  
NO >> Repair or replace the malfunctioning parts.

#### 2.CHECK INTERMITTENT INCIDENT

Refer to [GI-42, "Intermittent Incident"](#).

>> Inspection End.

A  
B  
C  
D  
E  
F  
G  
H  
I  
J  
L  
M  
N  
O  
P

SEC

# VEHICLE SECURITY INDICATOR

< COMPONENT DIAGNOSIS >

[INTELLIGENT KEY SYSTEM]

## VEHICLE SECURITY INDICATOR

### Description

INFOID:000000005439934

- Vehicle security indicator is built in combination meter.
- NVIS (Nissan Vehicle Immobilizer System-NATS) and vehicle security system conditions are indicated by blink or illumination of vehicle security indicator.

### Component Function Check

INFOID:000000005439935

#### 1.CHECK FUNCTION

1. Perform "THEFT IND" in the "ACTIVE TEST" mode with CONSULT-III.
2. Check vehicle security indicator operation.

Test item		Description	
THEFT IND	ON	Vehicle security indicator	ON
	OFF		OFF

#### Is the inspection result normal?

- YES >> Inspection End.  
NO >> Refer to [SEC-74, "Diagnosis Procedure"](#).

### Diagnosis Procedure

INFOID:000000005439936

#### 1.CHECK COMBINATION METER FUNCTION

Check combination meter. Refer to [MWI-4, "Work Flow"](#).

#### Is the inspection result is normal?

- YES >> GO TO 2  
NO >> Repair or replace the malfunctioning parts.

#### 2.CHECK INTERMITTENT INCIDENT

Refer to [GI-42, "Intermittent Incident"](#).

>> Inspection End.

# BCM (BODY CONTROL MODULE)

< ECU DIAGNOSIS >

[INTELLIGENT KEY SYSTEM]

## ECU DIAGNOSIS

### BCM (BODY CONTROL MODULE)

Reference Value

INFOID:000000005804820

#### VALUES ON THE DIAGNOSIS TOOL

Monitor Item	Condition	Value/Status
FR WIPER HI	Other than front wiper switch HI	OFF
	Front wiper switch HI	ON
FR WIPER LOW	Other than front wiper switch LO	OFF
	Front wiper switch LO	ON
FR WASHER SW	Front washer switch OFF	OFF
	Front washer switch ON	ON
FR WIPER INT	Other than front wiper switch INT	OFF
	Front wiper switch INT	ON
FR WIPER STOP	Front wiper is not in STOP position	OFF
	Front wiper is in STOP position	ON
INT VOLUME	Wiper intermittent dial is in a dial position 1 - 7	Wiper intermittent dial position
TURN SIGNAL R	Other than turn signal switch RH	OFF
	Turn signal switch RH	ON
TURN SIGNAL L	Other than turn signal switch LH	OFF
	Turn signal switch LH	ON
TAIL LAMP SW	Other than lighting switch 1ST and 2ND	OFF
	Lighting switch 1ST or 2ND	ON
HI BEAM SW	Other than lighting switch HI	OFF
	Lighting switch HI	ON
HEAD LAMP SW 1	Other than lighting switch 2ND	OFF
	Lighting switch 2ND	ON
HEAD LAMP SW 2	Other than lighting switch 2ND	OFF
	Lighting switch 2ND	ON
PASSING SW	Other than lighting switch PASS	OFF
	Lighting switch PASS	ON
AUTO LIGHT SW	Other than lighting switch AUTO	OFF
	Lighting switch AUTO	ON
DOOR SW-DR	Front door LH closed	OFF
	Front door LH opened	ON
DOOR SW-AS	Front door RH closed	OFF
	Front door RH opened	ON
DOOR SW-RR	Rear door RH closed	OFF
	Rear door RH opened	ON
DOOR SW-RL	Rear door LH closed	OFF
	Rear door LH opened	ON
CDL LOCK SW	Other than power door lock switch LOCK	OFF
	Door lock/unlock switch LOCK	ON

# BCM (BODY CONTROL MODULE)

< ECU DIAGNOSIS >

[INTELLIGENT KEY SYSTEM]

Monitor Item	Condition	Value/Status
CDL UNLOCK SW	Other than door lock/unlock switch UNLOCK	OFF
	Door lock/unlock switch UNLOCK	ON
KEY CYL LK-SW	Other than front door LH key cylinder LOCK position	OFF
	Front door LH key cylinder LOCK position	ON
KEY CYL UN-SW	Other than front door LH key cylinder UNLOCK position	OFF
	Front door LH key cylinder UNLOCK position	ON
HAZARD SW	When hazard switch is not pressed	OFF
	When hazard switch is pressed	ON
REAR DEF SW	When rear window defogger switch is pressed	ON
FAN ON SIG	When AUTO switch or fan switch is pressed	ON
AIR COND SW	When A/C switch is pressed	ON
TR CANCEL SW	Trunk lid opener cancel switch OFF	OFF
	Trunk lid opener cancel switch ON	ON
TR/BD OPEN SW	Trunk lid opener switch OFF	OFF
	While the trunk lid opener switch is turned ON	ON
TRNK/HAT MNTR	Trunk lid closed	OFF
	Trunk lid opened	ON
RKE-LOCK	When LOCK button of Intelligent Key is not pressed	OFF
	When LOCK button of Intelligent Key is pressed	ON
RKE-UNLOCK	When UNLOCK button of Intelligent Key is not pressed	OFF
	When UNLOCK button of Intelligent Key is pressed	ON
RKE-TR/BD	When TRUNK OPEN button of Intelligent Key is not pressed	OFF
	When TRUNK OPEN button of Intelligent Key is pressed	ON
RKE-PANIC	When PANIC button of Intelligent Key is not pressed	OFF
	When PANIC button of Intelligent Key is pressed	ON
RKE-P/W OPEN	When UNLOCK button of Intelligent Key is not pressed and held	OFF
	When UNLOCK button of Intelligent Key is pressed and held	ON
RKE-MODE CHG	When LOCK/UNLOCK button of Intelligent Key is not pressed and held simultaneously	OFF
	When LOCK/UNLOCK button of Intelligent Key is pressed and held simultaneously	ON
OPTICAL SENSOR	When outside of the vehicle is bright	Close to 5 V
	When outside of the vehicle is dark	Close to 0 V
REQ SW-DR	When front door LH request switch is not pressed	OFF
	When front door LH request switch is pressed	ON
REQ SW-AS	When front door RH request switch is not pressed	OFF
	When front door RH request switch is pressed	ON
REQ SW-BD/TR	When trunk request switch is not pressed	OFF
	When trunk request switch is pressed	ON
PUSH SW	When push-button ignition switch is not pressed	OFF
	When push-button ignition switch is pressed	ON
IGN RLY -F/B	Ignition switch OFF or ACC	OFF
	Ignition switch ON	ON
ACC RLY -F/B	Ignition switch OFF	OFF
	Ignition switch ACC or ON	ON

# BCM (BODY CONTROL MODULE)

< ECU DIAGNOSIS >

[INTELLIGENT KEY SYSTEM]

Monitor Item	Condition	Value/Status	
BRAKE SW 1	When the brake pedal is not depressed	ON	A
	When the brake pedal is depressed	OFF	
DETE/CANCL SW	When selector lever is in P position	OFF	B
	When selector lever is in any position other than P	ON	
SFT PN/N SW	When selector lever is in any position other than P or N	OFF	C
	When selector lever is in P or N position	ON	
UNLK SEN-DR	Front door LH UNLOCK status	OFF	D
	Front door LH LOCK status	ON	
PUSH SW -IPDM	When push-button ignition switch is not pressed (IPDM E/R sends via CAN)	OFF	E
	When push-button ignition switch is pressed (IPDM E/R sends via CAN)	ON	
IGN RLY1 F/B	Ignition switch OFF or ACC	OFF	F
	Ignition switch ON	ON	
DETE SW -IPDM	When selector lever is in P position (IPDM E/R sends via CAN)	OFF	G
	When selector lever is in any position other than P (IPDM E/R sends via CAN)	ON	
SFT PN -IPDM	When selector lever is in any position other than P or N (IPDM E/R sends via CAN)	OFF	H
	When selector lever is in P or N position (IPDM E/R sends via CAN)	ON	
SFT P -MET	When selector lever is in any position other than P (combination meter sends via CAN)	OFF	I
	When selector lever is in P position (combination meter sends via CAN)	ON	
SFT N -MET	When selector lever is in any position other than N (combination meter sends via CAN)	OFF	J
	When selector lever is in N position (combination meter sends via CAN)	ON	
ENGINE STATE	Engine stopped	STOP	SEC
	While the engine stalls	STALL	
	At engine cranking	CRANK	L
	Engine running	RUN	
VEH SPEED 1	While driving	Equivalent to speedometer reading	M
VEH SPEED 2	While driving	Equivalent to speedometer reading	
DR DOOR STATE	Front door LH LOCK status	LOCK	N
	Wait with selective UNLOCK operation (5 seconds)	READY	
	Front door LH UNLOCK status	UNLK	
AS DOOR STATE	Front door RH LOCK status	LOCK	O
	Wait with selective UNLOCK operation (5 seconds)	READY	
	Front door RH UNLOCK status	UNLK	
ID OK FLAG	Ignition switch ACC or ON	RESET	P
	Ignition switch OFF	SET	
PRMT ENG STAT	When the hybrid system start is prohibited	RESET	
	When the hybrid system start is permitted	SET	
KEY SW -SLOT	When Intelligent Key is not inserted into key slot	OFF	
	When Intelligent Key is inserted into key slot	ON	
RKE OPE COUN1	During the operation of Intelligent Key	Operation frequency of Intelligent Key	

# BCM (BODY CONTROL MODULE)

< ECU DIAGNOSIS >

[INTELLIGENT KEY SYSTEM]

Monitor Item	Condition	Value/Status
AIR PRESS FL	Ignition switch ON (only when the signal from the transmitter is received)	Air pressure of front LH tire
AIR PRESS FR	Ignition switch ON (only when the signal from the transmitter is received)	Air pressure of front RH tire
AIR PRESS RR	Ignition switch ON (only when the signal from the transmitter is received)	Air pressure of rear RH tire
AIR PRESS RL	Ignition switch ON (only when the signal from the transmitter is received)	Air pressure of rear LH tire
ID REGST FL1	When ID of front LH tire transmitter is registered (refer to <a href="#">WT-6, "ID Registration Procedure"</a> )	DONE
	When ID of front LH tire transmitter is not registered (refer to <a href="#">WT-6, "ID Registration Procedure"</a> )	YET
ID REGST FR1	When ID of front RH tire transmitter is registered (refer to <a href="#">WT-6, "ID Registration Procedure"</a> )	DONE
	When ID of front RH tire transmitter is not registered (refer to <a href="#">WT-6, "ID Registration Procedure"</a> )	YET
ID REGST RR1	When ID of rear RH tire transmitter is registered (refer to <a href="#">WT-6, "ID Registration Procedure"</a> )	DONE
	When ID of rear RH tire transmitter is not registered (refer to <a href="#">WT-6, "ID Registration Procedure"</a> )	YET
ID REGST RL1	When ID of rear LH tire transmitter is registered (refer to <a href="#">WT-6, "ID Registration Procedure"</a> )	DONE
	When ID of rear LH tire transmitter is not registered (refer to <a href="#">WT-6, "ID Registration Procedure"</a> )	YET
WARNING LAMP	Tire pressure indicator OFF	OFF
	Tire pressure indicator ON	ON
BUZZER	Tire pressure warning alarm is not sounding	OFF
	Tire pressure warning alarm is sounding	ON

# BCM (BODY CONTROL MODULE)

[INTELLIGENT KEY SYSTEM]

< ECU DIAGNOSIS >

## Terminal Layout

INFOID:000000005804821

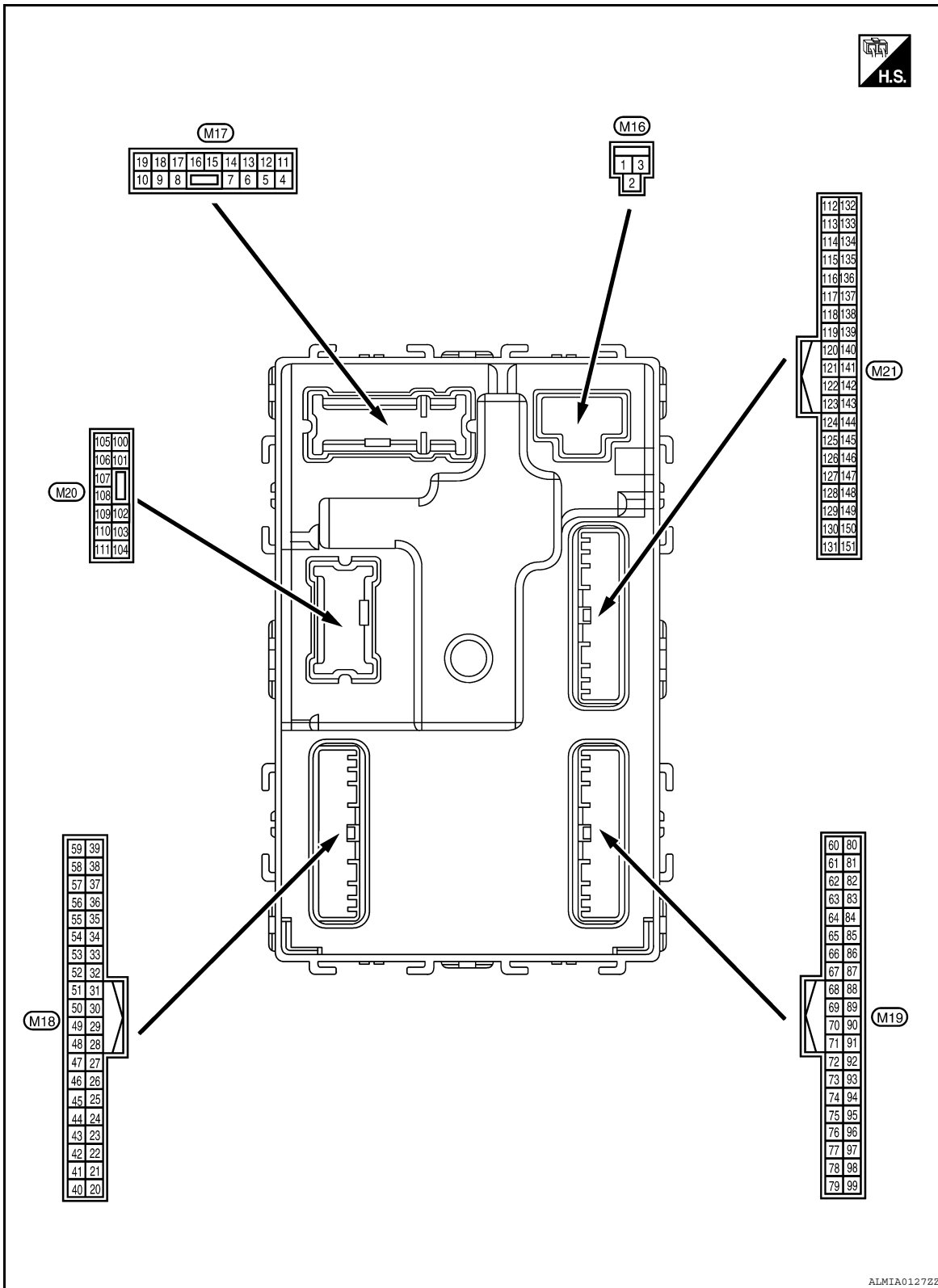

## Physical Values

INFOID:000000005804822

# BCM (BODY CONTROL MODULE)

< ECU DIAGNOSIS >

[INTELLIGENT KEY SYSTEM]

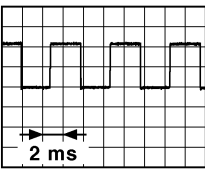
Terminal No. (Wire color)		Description		Condition		Value (Approx.)
		Signal name	Input/ Output			
(+)	(-)					
1 (W/B)	Ground	Battery power supply	Input	Ignition switch OFF		Battery voltage
2 (R/Y)	Ground	Battery power supply output	Output	Ignition switch OFF		Battery voltage
3 (L/W)	Ground	Ignition power supply output	Output	Ignition switch ON		Battery voltage
4 (P/W)	Ground	Interior room lamp power supply	Output	After passing the interior room lamp battery saver operation time		0V
				Any other time after passing the interior room lamp battery saver operation time		Battery voltage
5 (G/Y)	Ground	Front door RH UNLOCK	Output	Front door RH	UNLOCK (actuator is activated)	Battery voltage
					Other than UNLOCK (actuator is not activated)	0V
7 (R/W)	Ground	Step lamp	Output	Room lamp timer	ON	Battery voltage
					OFF	0V
8 (V)	Ground	All doors LOCK	Output	All doors	LOCK (actuator is activated)	Battery voltage
					Other than LOCK (actuator is not activated)	0V
9 (G)	Ground	Front door LH UNLOCK	Output	Front door LH	UNLOCK (actuator is activated)	Battery voltage
					Other than UNLOCK (actuator is not activated)	0V
10 (G/Y)	Ground	Rear door RH and rear door LH UNLOCK	Output	Rear door RH and rear door LH	UNLOCK (actuator is activated)	Battery voltage
					Other than UNLOCK (actuator is not activated)	0V
11 (Y/R)	Ground	Battery power supply	Input	Ignition switch OFF		Battery voltage
13 (B)	Ground	Ground	—	Ignition switch ON		0V
14 (R/Y)	Ground	Push-button ignition switch illumination ground	Input	Tail lamp	OFF	0V
					ON	<p><b>NOTE:</b> When the illumination brightening/dimming level is in the neutral position</p>  <p style="text-align: right; font-size: small;">JSNIA0010GB</p>
15 (Y/L)	Ground	ACC indicator lamp	Output	Ignition switch	OFF	Battery voltage
					ACC	0V



# BCM (BODY CONTROL MODULE)

## [INTELLIGENT KEY SYSTEM]

< ECU DIAGNOSIS >

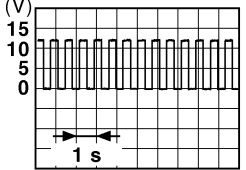
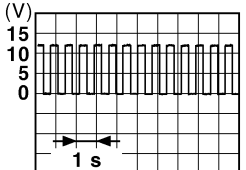
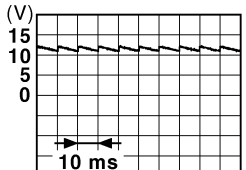
Terminal No. (Wire color)		Description		Condition		Value (Approx.)
(+)	(-)	Signal name	Input/ Output			
17 (G/B)	Ground	Turn signal (RH)	Output	Ignition switch ON	Turn signal switch OFF	0V
					Turn signal switch RH	 <p style="text-align: center;">6.5V</p>
18 (G/Y)	Ground	Turn signal (LH)	Output	Ignition switch ON	Turn signal switch OFF	0V
					Turn signal switch LH	 <p style="text-align: center;">6.5V</p>
19 (Y)	Ground	Room lamp timer control	Output	Interior room lamp	Lamps fully OFF	Battery voltage
					Lamps fully ON	0V
21 (P/B)	Ground	Optical sensor signal	Input	Ignition switch ON	When outside of the vehi- cle is bright	Close to 5V
					When outside of the vehi- cle is dark	Close to 0V
24 (R/W)	Ground	Stop lamp switch 1	Input	—	Battery voltage	
26 (O/L)	Ground	Stop lamp switch 2	Input	Stop lamp switch	OFF (brake pedal is not de- pressed)	0V
					ON (brake pedal is de- pressed)	Battery voltage
27 (G/W)	Ground	Front door lock as- sembly LH (unlock sensor)	Input	Front door LH	LOCK status	 <p style="text-align: center;">11.8V</p>
					UNLOCK status	0V
29 (Y)	Ground	Key slot switch	Input	When Intelligent Key is inserted into key slot	Battery voltage	
				When Intelligent Key is not inserted into key slot	0V	
30 (V/Y)	Ground	ACC feedback signal	Input	Ignition switch	OFF	0
				ACC or ON	Battery voltage	
31 (G)	Ground	Ignition relay-2 feed- back signal	Input	Ignition switch	OFF	0V
				ON	Battery voltage	

A  
B  
C  
D  
E  
F  
G  
H  
I  
J  
L  
M  
N  
O  
P

SEC

# BCM (BODY CONTROL MODULE)

[INTELLIGENT KEY SYSTEM]

< ECU DIAGNOSIS >

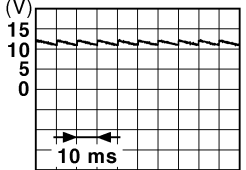
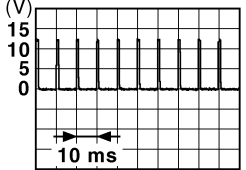
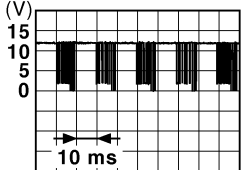
Terminal No. (Wire color)		Description		Condition	Value (Approx.)	
		Signal name	Input/ Output			
(+)	(-)					
32 (R/B)	Ground	Front door RH switch	Input	Front door RH switch	OFF (when front door RH closes)  ON (when front door RH opens)	 <small>JPMIA0011GB</small> 11.8V
						0V
33 (SB)	Ground	Compressor ON signal	Input	A/C switch	OFF ON	Battery voltage 0V
34* (L/R)	Ground	Front door lock assembly LH (key cylinder switch) (unlock)	Input	Front door lock assembly LH (key cylinder switch)	OFF (neutral) ON (unlock)	Battery voltage 0V
36* (GR)	Ground	Lock switch signal	Input	Door lock/unlock switch	Lock Unlock	Battery Voltage 0V
37 (O)	Ground	Trunk lid opener cancel switch	Input	Trunk lid opener cancel switch	CANCEL	 <small>JPMIA0012GB</small> 1.1V
						0V
38 (GR/W)	Ground	Rear window defogger ON signal	Input	Rear window defogger switch	OFF ON	Battery Voltage V 0V
39* (GR/R)	Ground	Unlock switch signal	Input	Door lock/unlock switch	Unlock Lock	Battery Voltage 0V
40* (Y/G)	Ground	Power window serial link	Input/ Output	Ignition switch ON		 <small>JPMIA0013GB</small> 10.2V
						Ignition switch OFF or ACC
41 (W)	Ground	Push-button ignition switch illumination	Output	Engine switch (push switch) illumination	ON OFF	5.5V 0V
42 (R)	Ground	LOCK indicator lamp	Output	LOCK indicator lamp	ON OFF	0V Battery voltage
45 (P)	Ground	Receiver & sensor ground	Input	Ignition switch ON		0V

# BCM (BODY CONTROL MODULE)

< ECU DIAGNOSIS >

[INTELLIGENT KEY SYSTEM]

Terminal No. (Wire color)		Description		Condition	Value (Approx.)	
		Signal name	Input/ Output			
(+)	(-)					
46 (V/W)	Ground	Receiver & sensor power supply output	Output	Ignition switch	OFF	0V
					ACC or ON	5.0V
47 (G/O)	Ground	Tire pressure receiver signal	Input/ Output	Ignition switch ON	Standby state	
					When receiving the signal from the transmitter	
48 (R/B)	Ground	Selector lever P/N position signal	Input	Selector lever	P or N position	12.0V
					Except P and N positions	0V
49 (L/O)	Ground	Security indicator signal	Output	Security indicator	Blinking	
					OFF	Battery voltage
50 (LG/ B)	Ground	Combination switch OUTPUT 5	Output	Combination switch (Wiper intermittent dial 4)	All switch OFF	0V
					Lighting switch 1ST	
					Lighting switch high-beam	
					Lighting switch 2ND	
Turn signal switch RH	10.7V					
51 (L/W)	Ground	Combination switch OUTPUT 1	Output	Combination switch	All switch OFF (Wiper intermittent dial 4)	0V
					Front wiper switch HI (Wiper intermittent dial 4)	
Any of the conditions below with all switch OFF					10.7V	
<ul style="list-style-type: none"> <li>• Wiper intermittent dial 1</li> <li>• Wiper intermittent dial 2</li> <li>• Wiper intermittent dial 3</li> <li>• Wiper intermittent dial 6</li> <li>• Wiper intermittent dial 7</li> </ul>						

A  
B  
C  
D  
E  
F  
G  
H  
I  
J  
L  
M  
N  
O  
P

SEC

# BCM (BODY CONTROL MODULE)

< ECU DIAGNOSIS >

[INTELLIGENT KEY SYSTEM]

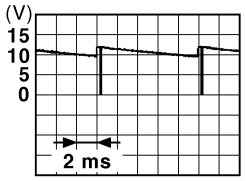
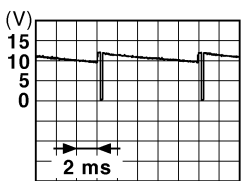
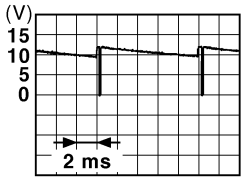
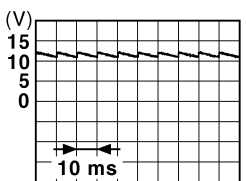
Terminal No. (Wire color)		Description		Condition		Value (Approx.)
(+)	(-)	Signal name	Input/ Output			
52 (G/B)	Ground	Combination switch OUTPUT 2	Output	Combination switch	All switch OFF (Wiper intermittent dial 4)	0V
					Front washer switch ON (Wiper intermittent dial 4)	 <p style="text-align: right; font-size: small;">JPMIA0033GB</p>
					Any of the conditions below with all switch OFF <ul style="list-style-type: none"> <li>• Wiper intermittent dial 1</li> <li>• Wiper intermittent dial 5</li> <li>• Wiper intermittent dial 6</li> </ul>	
53 (LG/ R)	Ground	Combination switch OUTPUT 3	Output	Combination switch (Wiper intermit- tent dial 4)	All switch OFF	0V
					Front wiper switch INT	 <p style="text-align: right; font-size: small;">JPMIA0034GB</p>
					Lighting switch AUTO	
54 (G/Y)	Ground	Combination switch OUTPUT 4	Output	Combination switch (Wiper intermit- tent dial 4)	All switch OFF	0V
					Lighting switch flash-to- pass	 <p style="text-align: right; font-size: small;">JPMIA0035GB</p>
					Turn signal switch LH	
55 (BR/ W)	Ground	Front blower monitor	Input	Front blower mo- tor switch	ON	Battery voltage
					OFF	0V
56 (L/B)	Ground	Front door lock as- sembly LH (key cylin- der switch) (lock)	Input	Front door lock assembly LH (key cylinder switch)	OFF (neutral)	Battery voltage
					ON (lock)	0V
57 (W)	Ground	Tire pressure warn- ing check switch	Input	—	—	Battery voltage
58 (SB)	Ground	Front door LH switch	Input	Front door LH switch	OFF (front door LH CLOSE)	 <p style="text-align: right; font-size: small;">JPMIA0011GB</p>
					ON (front door LH OPEN)	
59 (G/R)	Ground	Rear window defog- ger relay	Output	Rear window de- fogger	Active	Battery voltage
					Not activated	0V

# BCM (BODY CONTROL MODULE)

< ECU DIAGNOSIS >

[INTELLIGENT KEY SYSTEM]

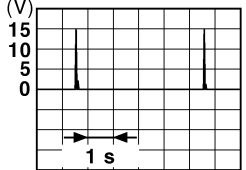
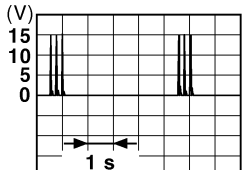
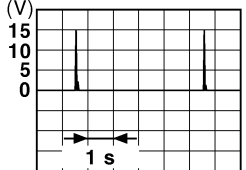
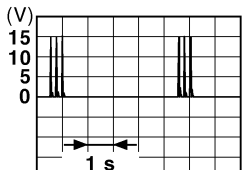
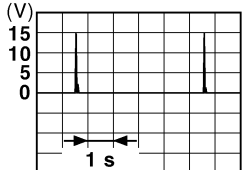
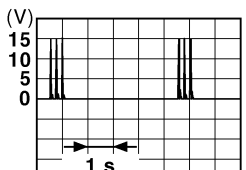
Terminal No. (Wire color)		Description		Condition	Value (Approx.)
(+)	(-)	Signal name	Input/ Output		
60 (B/R)	Ground	Front console antenna 2 (-)	Output	Ignition switch OFF	 <p style="text-align: right; font-size: small;">JMKIA0062GB</p>
				When Intelligent Key is not in the passenger compartment	 <p style="text-align: right; font-size: small;">JMKIA0063GB</p>
61 (W/R)	Ground	Center console antenna 2 (+)	Output	Ignition switch OFF	 <p style="text-align: right; font-size: small;">JMKIA0062GB</p>
				When Intelligent Key is not in the passenger compartment	 <p style="text-align: right; font-size: small;">JMKIA0063GB</p>
62 (B/Y)	Ground	Front outside handle RH antenna (-)	Output	When the front door RH request switch is operated with ignition switch OFF	 <p style="text-align: right; font-size: small;">JMKIA0062GB</p>
				When Intelligent Key is not in the antenna detection area	 <p style="text-align: right; font-size: small;">JMKIA0063GB</p>

A  
B  
C  
D  
E  
F  
G  
H  
I  
J  
L  
M  
N  
O  
P

SEC

# BCM (BODY CONTROL MODULE)

< ECU DIAGNOSIS >

[INTELLIGENT KEY SYSTEM]

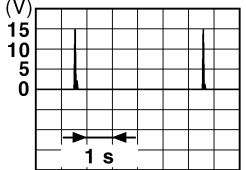
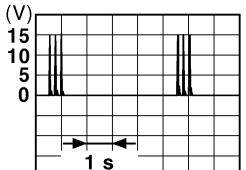
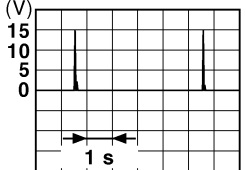
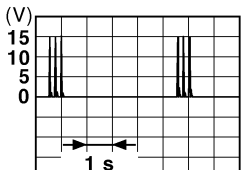
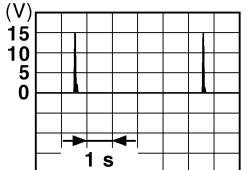
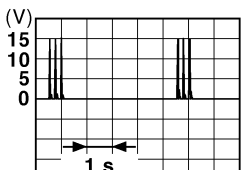
Terminal No. (Wire color)		Description		Condition	Value (Approx.)
(+)	(-)	Signal name	Input/ Output		
63 (LG)	Ground	Front outside handle RH antenna (+)	Output	When the front door RH request switch is operat- ed with ignition switch OFF	When Intelligent Key is in the antenna detection area  <small>JMKIA0062GB</small>
				When Intelligent Key is not in the antenna detection area	 <small>JMKIA0063GB</small>
64 (V)	Ground	Front outside handle LH antenna (-)	Output	When the front door LH request switch is operat- ed with ignition switch OFF	When Intelligent Key is in the antenna detection area  <small>JMKIA0062GB</small>
				When Intelligent Key is not in the antenna detection area	 <small>JMKIA0063GB</small>
65 (P)	Ground	Front outside handle LH antenna (+)	Output	When the front door LH request switch is operat- ed with ignition switch OFF	When Intelligent Key is in the antenna detection area  <small>JMKIA0062GB</small>
				When Intelligent Key is not in the antenna detection area	 <small>JMKIA0063GB</small>

# BCM (BODY CONTROL MODULE)

< ECU DIAGNOSIS >

[INTELLIGENT KEY SYSTEM]

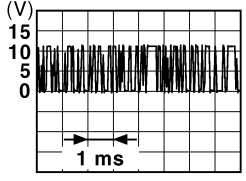
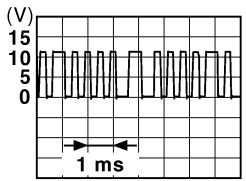
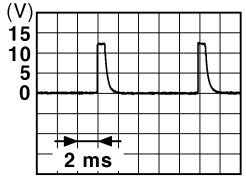
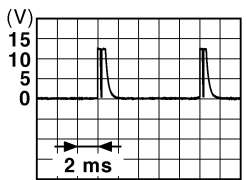
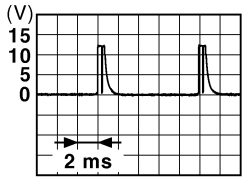
Terminal No. (Wire color)		Description		Condition		Value (Approx.)
(+)	(-)	Signal name	Input/ Output			
68 (G/O)	Ground	NATS antenna amp (built in key slot)	Input/ Output	During waiting	Ignition switch is pressed while inserting the Intelli- gent Key into the key slot.	Just after pressing ignition switch. Pointer of tester should move.
69 (O)	Ground	NATS antenna amp (built in key slot)	Input/ Output	During waiting	Ignition switch is pressed while inserting the Intelli- gent Key into the key slot.	Just after pressing ignition switch. Pointer of tester should move.
70 (R/B)	Ground	Ignition relay-2 con- trol	Output	Ignition switch	OFF or ACC ON	0V Battery voltage
71 (L/O)	Ground	Remote keyless entry receiver signal	Input/ Output	During waiting		 <p style="text-align: right; font-size: small;">JMKIA0064GB</p>
				When operating either button on Intelligent Key		 <p style="text-align: right; font-size: small;">JMKIA0065GB</p>
75 (R/Y)	Ground	Combination switch INPUT 5	Input	Combination switch	All switch OFF (Wiper intermittent dial 4)	 <p style="text-align: right; font-size: small;">JPMIA0041GB</p> <p style="text-align: center;">1.4V</p>
					Wiper intermittent dial 4	 <p style="text-align: right; font-size: small;">JPMIA0037GB</p> <p style="text-align: center;">1.3V</p>
					Any of the conditions below with all switch OFF • Wiper intermittent dial 1 • Wiper intermittent dial 2 • Wiper intermittent dial 6 • Wiper intermittent dial 7	 <p style="text-align: right; font-size: small;">JPMIA0040GB</p> <p style="text-align: center;">1.3V</p>



A  
B  
C  
D  
E  
F  
G  
H  
I  
J  
L  
M  
N  
O  
P

SEC

# BCM (BODY CONTROL MODULE)

< ECU DIAGNOSIS >

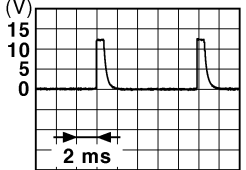
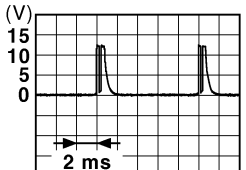
[INTELLIGENT KEY SYSTEM]

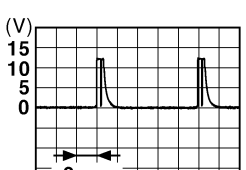
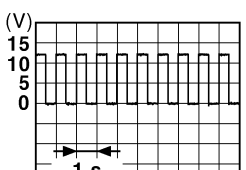
Terminal No. (Wire color)		Description		Condition	Value (Approx.)	
(+)	(-)	Signal name	Input/ Output			
76 (R/G)	Ground	Combination switch INPUT 3	Input	Combination switch	All switch OFF (Wiper intermittent dial 4)	 <small>JPMIA0041GB</small> 1.4V
				Combination switch	Lighting switch high-beam (Wiper intermittent dial 4)	 <small>JPMIA0036GB</small> 1.3V
				Combination switch	Lighting switch 2ND (Wiper intermittent dial 4)	 <small>JPMIA0037GB</small> 1.3V
				Combination switch	Any of the conditions below with all switch OFF <ul style="list-style-type: none"> <li>• Wiper intermittent dial 1</li> <li>• Wiper intermittent dial 2</li> <li>• Wiper intermittent dial 3</li> </ul>	 <small>JPMIA0040GB</small> 1.3V
78 (P)	Ground	CAN-L	Input/ Output	—	—	
79 (L)	Ground	CAN-H	Input/ Output	—	—	
80 (R/L)	Ground	Key slot illumination	Output	Key slot illumina- tion	OFF	0V
				Key slot illumina- tion	Blinking	 <small>JPMIA0015GB</small> 6.5V
81 (LG)	Ground	ON indicator lamp	Output	Ignition switch	OFF or ACC	Battery voltage
				Ignition switch	ON	0V



# BCM (BODY CONTROL MODULE)

< ECU DIAGNOSIS >

[INTELLIGENT KEY SYSTEM]

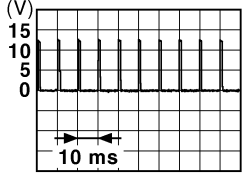
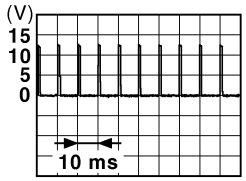
Terminal No. (Wire color)		Description		Condition		Value (Approx.)
		Signal name	Input/ Output			
(+)	(-)					
83 (L)	Ground	ACC relay control	Output	Ignition switch	OFF	0V
					ACC or ON	Battery voltage
84 (Y/R)	Ground	CTV shift selector (detent switch)	Output	—		Battery voltage
87 (G/B)	Ground	CTV shift selector (detent switch)	Input	Selector lever	P position	0V
					Any position other than P	Battery voltage
88 (P/L)	Ground	Front door RH re- quest switch	Input	Front door RH re- quest switch	ON (pressed)	0V
					OFF (not pressed)	 <p style="text-align: center;">1.0V</p>
89 (B/W)	Ground	Front door LH re- quest switch	Input	Front door LH re- quest switch	ON (pressed)	0V
					OFF (not pressed)	 <p style="text-align: center;">1.0V</p>
90 (Y)	Ground	Front blower motor relay control	Output	Ignition switch	OFF or ACC	0V
					ON	Battery voltage
91 (L/R)	Ground	Remote keyless entry receiver power sup- ply	Output	Ignition switch OFF		Battery voltage



A  
B  
C  
D  
E  
F  
G  
H  
I  
J  
L  
M  
N  
O  
P

SEC

# BCM (BODY CONTROL MODULE)

< ECU DIAGNOSIS >

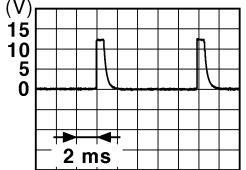
[INTELLIGENT KEY SYSTEM]

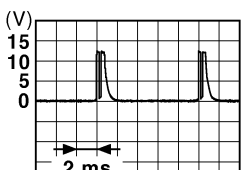
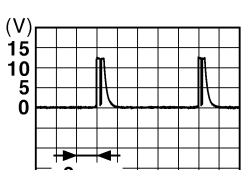
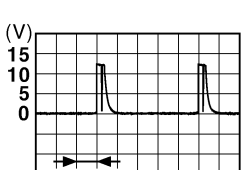
Terminal No. (Wire color)		Description		Condition	Value (Approx.)
(+)	(-)	Signal name	Input/ Output		
95 (R/W)	Ground	Combination switch INPUT 1	Input	All switch OFF	 1.4V
				Turn signal switch LH	 1.3V
				Turn signal switch RH	 1.3V
				Front wiper switch LO	 1.3V
				Front washer switch ON	 1.3V

# BCM (BODY CONTROL MODULE)

[INTELLIGENT KEY SYSTEM]

< ECU DIAGNOSIS >

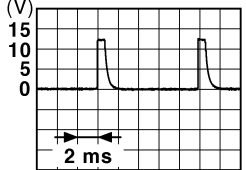
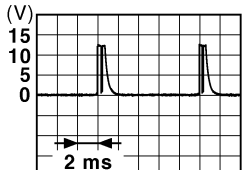
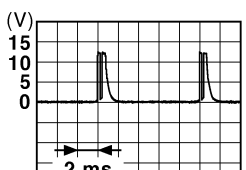
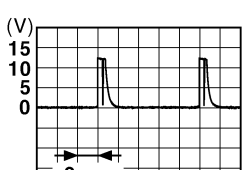
Terminal No. (Wire color)		Description		Condition	Value (Approx.)
(+)	(-)	Signal name	Input/ Output		
96 (P/B)	Ground	Combination switch INPUT 4	Input	Combination switch	All switch OFF (Wiper intermittent dial 4) <div style="text-align: right;">  <p style="font-size: small; margin: 0;">JPMIA0041GB</p> <p style="margin: 0;">1.4V</p> </div>
				Lighting switch AUTO (Wiper intermittent dial 4)	Lighting switch AUTO (Wiper intermittent dial 4) <div style="text-align: right;">  <p style="font-size: small; margin: 0;">JPMIA0038GB</p> <p style="margin: 0;">1.3V</p> </div>
				Lighting switch 1ST (Wiper intermittent dial 4)	Lighting switch 1ST (Wiper intermittent dial 4) <div style="text-align: right;">  <p style="font-size: small; margin: 0;">JPMIA0036GB</p> <p style="margin: 0;">1.3V</p> </div>
				Any of the conditions below with all switch OFF	Any of the conditions below with all switch OFF <ul style="list-style-type: none"> <li>Wiper intermittent dial 1</li> <li>Wiper intermittent dial 5</li> <li>Wiper intermittent dial 6</li> </ul> <div style="text-align: right;">  <p style="font-size: small; margin: 0;">JPMIA0039GB</p> <p style="margin: 0;">1.3V</p> </div>

A  
B  
C  
D  
E  
F  
G  
H  
I  
J  
L  
M  
N  
O  
P

SEC

# BCM (BODY CONTROL MODULE)

[INTELLIGENT KEY SYSTEM]

< ECU DIAGNOSIS >

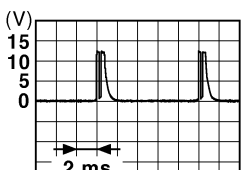
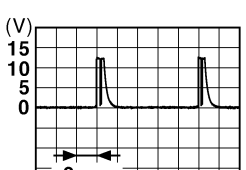
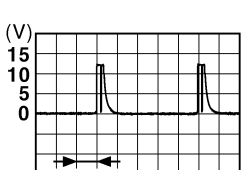
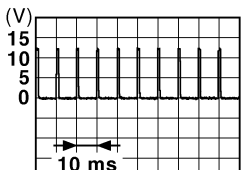
Terminal No. (Wire color)		Description		Condition	Value (Approx.)	
(+)	(-)	Signal name	Input/ Output			
97 (R/B)	Ground	Combination switch INPUT 2	Input			Combination switch (Wiper intermittent dial 4)
				Lighting switch flash-to-pass	 <small>JPMIA0037GB</small> 1.3V	
				Lighting switch 2ND	 <small>JPMIA0036GB</small> 1.3V	
				Front wiper switch INT	 <small>JPMIA0038GB</small> 1.3V	
				Front wiper switch HI	 <small>JPMIA0040GB</small> 1.3V	
				Pressed	0 V	
98 (G/O)	Ground	Hazard switch	Input	Hazard switch	Not pressed  <small>JPMIA0012GB</small> 1.1V	

# BCM (BODY CONTROL MODULE)

## [INTELLIGENT KEY SYSTEM]

### < ECU DIAGNOSIS >

Terminal No. (Wire color)		Description		Condition	Value (Approx.)	
		Signal name	Input/ Output			
(+)	(-)					
103 (V)	Ground	Trunk lid opening	Output	Trunk lid	Open (trunk lid opener actuator is activated)	Battery voltage
					Close (trunk lid opener actuator is not activated)	0V
110 (V/W)	Ground	Trunk room lamp	Output	Trunk room lamp	ON	0V
					OFF	Battery voltage
114 (B)	Ground	Trunk room antenna 1 (-)	Output	Ignition switch OFF	When Intelligent Key is in the passenger compartment	<p style="text-align: right; font-size: small;">JMKIA0062GB</p>
					When Intelligent Key is not in the passenger compartment	<p style="text-align: right; font-size: small;">JMKIA0063GB</p>
115 (W)	Ground	Trunk room antenna 1 (+)	Output	Ignition switch OFF	When Intelligent Key is in the passenger compartment	<p style="text-align: right; font-size: small;">JMKIA0062GB</p>
					When Intelligent Key is not in the passenger compartment	<p style="text-align: right; font-size: small;">JMKIA0063GB</p>

A  
B  
C  
D  
E  
F  
G  
H  
I  
J  
L  
M  
N  
O  
P

SEC

# BCM (BODY CONTROL MODULE)

< ECU DIAGNOSIS >

[INTELLIGENT KEY SYSTEM]

Terminal No. (Wire color)		Description		Condition	Value (Approx.)
(+)	(-)	Signal name	Input/ Output		
118 (L/O)	Ground	Rear bumper antenna (-)	Output	When the trunk lid request switch is operated with ignition switch OFF	When Intelligent Key is in the antenna detection area
				When Intelligent Key is not in the antenna detection area	When Intelligent Key is not in the antenna detection area
119 (BR/W)	Ground	Rear bumper antenna (+)	Output	When the trunk lid request switch is operated with ignition switch OFF	When Intelligent Key is in the antenna detection area
				When Intelligent Key is not in the antenna detection area	When Intelligent Key is not in the antenna detection area
127 (BR/W)	Ground	Ignition relay (IPDM E/R) control	Output	Ignition switch	OFF or ACC
					ON
130 (Y/G)	Ground	Trunk room lamp switch	Input	Trunk room lamp switch	OFF (trunk is closed)
					ON (trunk is open)
132 (R)	Ground	Start signal	Output	Ignition switch ON	When selector lever is in P or N position and the brake peddle is not depressed
					When selector lever is in P or N position and the brake peddle is depressed

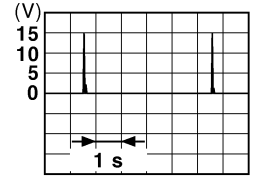

JMKIA0062GB

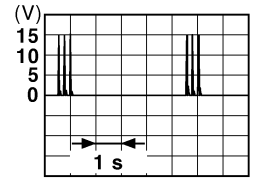

JMKIA0063GB

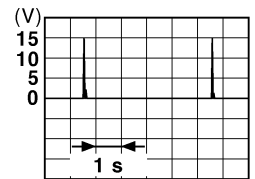

JMKIA0062GB

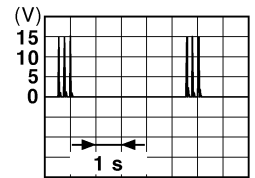

JMKIA0063GB

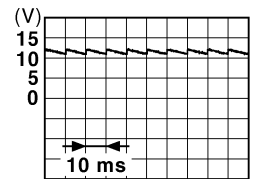

JPMIA0011GB

11.8V

# BCM (BODY CONTROL MODULE)

< ECU DIAGNOSIS >

[INTELLIGENT KEY SYSTEM]

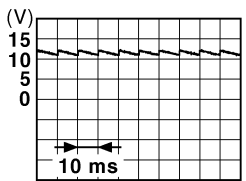
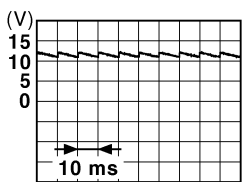
Terminal No. (Wire color)		Description		Condition	Value (Approx.)	
		Signal name	Input/ Output			
(+)	(-)					
140 (BR)	Ground	Push-button ignition switch	Input	Engine switch (push switch)	Pressed	0V
					Not pressed	Battery voltage
141 (G/R)	Ground	Trunk request switch	Input	Trunk request switch	ON (pressed)	0V
						OFF (not pressed)
144 (GR)	Ground	Request switch buzzer	Output	Request switch buzzer	Sounding	0V
					Not sounding	Battery voltage
147 (L/R)	Ground	Trunk lid opener switch	Input	Trunk lid opener switch	Pressed	0V
					Not pressed	Battery voltage
148 (R/W)	Ground	Rear door RH switch	Input	Rear door RH switch	OFF (when rear door RH closes)	 <p style="text-align: center;">11.8V</p>
						ON (when rear door RH opens)
149 (R/B)	Ground	Rear door LH switch	Input	Rear door LH switch	OFF (when rear door LH closes)	 <p style="text-align: center;">11.8V</p>
						ON (when rear door LH opens)

\*: With LH and RH front window anti-pinch system

## Fail Safe

INFOID:000000005804823

Display contents of CONSULT	Fail-safe	Cancellation
B2190: NATS ANTENNA AMP	Inhibit hybrid system cranking	Erase DTC
B2191: DIFFERENCE OF KEY	Inhibit hybrid system cranking	Erase DTC
B2192: ID DISCORD BCM-ECM	Inhibit hybrid system cranking	Erase DTC
B2193: CHAIN OF BCM-ECM	Inhibit hybrid system cranking	Erase DTC

# BCM (BODY CONTROL MODULE)

< ECU DIAGNOSIS >

[INTELLIGENT KEY SYSTEM]

Display contents of CONSULT	Fail-safe	Cancellation
B2195: ANTI-SCANNING	Inhibit hybrid system cranking	Erase DTC
B2562: LOW VOLTAGE	Inhibit hybrid system cranking	100 ms after the power supply voltage increases to more than 8.8 V
B2563: HI VOLTAGE	Inhibit hybrid system cranking	500 ms after the power supply voltage decreases to less than 18 V
B260A: IGNITION RELAY	Inhibit hybrid system cranking	500 ms after the following conditions are fulfilled <ul style="list-style-type: none"> <li>IGN relay (IPDM E/R) control signal: OFF (Battery voltage)</li> <li>Ignition ON signal (CAN to IPDM E/R): OFF (Request signal)</li> <li>Ignition ON signal (CAN from IPDM E/R): OFF (Condition signal)</li> </ul>
B260F: ENG STATE SIG LOST	Maintains the power supply position attained at the time of DTC detection	When any of the following conditions is fulfilled <ul style="list-style-type: none"> <li>Power position changes to ACC</li> <li>Receives hybrid system status signal (CAN)</li> </ul>
B2617: STARTER RELAY CIRC	Inhibit hybrid system cranking	1 second after the starter motor relay control inside BCM becomes normal
B2618: BCM	Inhibit hybrid system cranking	1 second after the ignition relay (IPDM E/R) control inside BCM becomes normal
B261E: VEHICLE TYPE	Inhibit hybrid system cranking	BCM initialization
B26E1: ENG STATE NO RECIV	Inhibit hybrid system cranking	When any of the following conditions is fulfilled <ul style="list-style-type: none"> <li>Power position changes to ACC</li> <li>Receives hybrid system status signal (CAN)</li> </ul>

## DTC Inspection Priority Chart

INFOID:000000005804824

If some DTCs are displayed at the same time, perform inspections one by one based on the following priority chart.

Priority	DTC
1	<ul style="list-style-type: none"> <li>B2562: LOW VOLTAGE</li> <li>B2563: HI VOLTAGE</li> <li>B261E: VEHICLE TYPE</li> </ul>
2	<ul style="list-style-type: none"> <li>U1000: CAN COMM CIRCUIT</li> <li>U1010: CONTROL UNIT (CAN)</li> </ul>
3	<ul style="list-style-type: none"> <li>B2190: NATS ANTENNA AMP</li> <li>B2191: DIFFERENCE OF KEY</li> <li>B2192: ID DISCORD BCM-ECM</li> <li>B2193: CHAIN OF BCM-ECM</li> <li>B2195: ANTI SCANNING</li> </ul>



# BCM (BODY CONTROL MODULE)

< ECU DIAGNOSIS >

[INTELLIGENT KEY SYSTEM]

Priority	DTC			
4	<ul style="list-style-type: none"> <li>• B2553: IGNITION RELAY</li> <li>• B2555: STOP LAMP</li> <li>• B2556: PUSH-BTN IGN SW</li> <li>• B2557: VEHICLE SPEED</li> <li>• B2601: SHIFT POSITION</li> <li>• B2602: SHIFT POSITION</li> <li>• B2603: SHIFT POSI STATUS</li> <li>• B2604: TRANSMISSION RANGE SWITCH</li> <li>• B260A: IGNITION RELAY</li> <li>• B260F: ENG STATE SIG LOST</li> <li>• B2611: ACC RELAY</li> <li>• B2614: ACC RELAY CIRC</li> <li>• B2615: BLOWER RELAY CIRC</li> <li>• B2616: IGN RELAY CIRC</li> <li>• B2617: STARTER RELAY CIRC</li> <li>• B2618: BCM</li> <li>• B261A: PUSH-BTN IGN SW</li> <li>• B261E: VEHICLE TYPE</li> <li>• B26E1: ENG STATE NO RECIV</li> <li>• B26EA: KEY REGISTRATION</li> <li>• C1729: VHCL SPEED SIG ERR</li> <li>• U0415: VEHICLE SPEED SIG</li> </ul>	A B C D E F		
	5	<ul style="list-style-type: none"> <li>• C1704: LOW PRESSURE FL</li> <li>• C1705: LOW PRESSURE FR</li> <li>• C1706: LOW PRESSURE RR</li> <li>• C1707: LOW PRESSURE RL</li> <li>• C1708: [NO DATA] FL</li> <li>• C1709: [NO DATA] FR</li> <li>• C1710: [NO DATA] RR</li> <li>• C1711: [NO DATA] RL</li> <li>• C1712: [CHECKSUM ERR] FL</li> <li>• C1713: [CHECKSUM ERR] FR</li> <li>• C1714: [CHECKSUM ERR] RR</li> <li>• C1715: [CHECKSUM ERR] RL</li> <li>• C1716: [PRESSDATA ERR] FL</li> <li>• C1717: [PRESSDATA ERR] FR</li> <li>• C1718: [PRESSDATA ERR] RR</li> <li>• C1719: [PRESSDATA ERR] RL</li> <li>• C1720: [CODE ERR] FL</li> <li>• C1721: [CODE ERR] FR</li> <li>• C1722: [CODE ERR] RR</li> <li>• C1723: [CODE ERR] RL</li> <li>• C1724: [BATT VOLT LOW] FL</li> <li>• C1725: [BATT VOLT LOW] FR</li> <li>• C1726: [BATT VOLT LOW] RR</li> <li>• C1727: [BATT VOLT LOW] RL</li> <li>• C1734: CONTROL UNIT</li> </ul>	G H I J L M	
		6	<ul style="list-style-type: none"> <li>• B2622: INSIDE ANTENNA</li> <li>• B2623: INSIDE ANTENNA</li> </ul>	N

SEC

## DTC Index

INFOID:000000005804825

**NOTE:**

- Details of time display
- CRNT: Displays when there is a malfunction now or after returning to the normal condition until turning ignition switch OFF → ON again.
- 1 - 39: Displayed if any previous malfunction is present when current condition is normal. It increases like 1 → 2 → 3...38 → 39 after returning to the normal condition whenever ignition switch OFF → ON. The counter remains at 39 even if the number of cycles exceeds it. It is counted from 1 again when turning ignition switch OFF → ON after returning to the normal condition if the malfunction is detected again.

# BCM (BODY CONTROL MODULE)

< ECU DIAGNOSIS >

[INTELLIGENT KEY SYSTEM]

CONSULT display	Fail-safe	Intelligent Key warning lamp ON	Tire pressure monitor warning lamp ON	Reference page
No DTC is detected. further testing may be required.	—	—	—	—
U1000: CAN COMM CIRCUIT	—	—	—	<a href="#">BCS-36</a>
U1010: CONTROL UNIT (CAN)	—	—	—	<a href="#">BCS-37</a>
U0415: VEHICLE SPEED SIG	—	—	—	<a href="#">BCS-38</a>
B2190: NATS ANTENNA AMP	×	—	—	<a href="#">SEC-30</a>
B2191: DIFFERENCE OF KEY	×	—	—	<a href="#">SEC-33</a>
B2192: ID DISCORD BCM-ECM	×	—	—	<a href="#">SEC-34</a>
B2193: CHAIN OF BCM-ECM	×	—	—	<a href="#">SEC-35</a>
B2195: ANTI SCANNING	×	—	—	<a href="#">SEC-36</a>
B2553: IGNITION RELAY	—	—	—	<a href="#">PCS-50</a>
B2555: STOP LAMP	—	—	—	<a href="#">SEC-37</a>
B2556: PUSH-BTN IGN SW	—	×	—	<a href="#">SEC-40</a>
B2557: VEHICLE SPEED	×	×	—	<a href="#">SEC-42</a>
B2562: LOW VOLTAGE	—	—	—	<a href="#">BCS-39</a>
B2563: HI VOLTAGE	×	×	—	<a href="#">BCS-40</a>
B2601: SHIFT POSITION	×	×	—	<a href="#">SEC-43</a>
B2602: SHIFT POSITION	×	×	—	<a href="#">SEC-46</a>
B2603: SHIFT POSI STATUS	×	×	—	<a href="#">SEC-49</a>
B2604: TRANSMISSION RANGE SWITCH	×	×	—	<a href="#">SEC-52</a>
B260A: IGNITION RELAY	×	×	—	<a href="#">PCS-52</a>
B260F: ENG STATE SIG LOST	×	×	—	<a href="#">SEC-54</a>
B2611: ACC RELAY	—	—	—	<a href="#">PCS-53</a>
B2614: ACC RELAY CIRC	—	×	—	<a href="#">PCS-55</a>
B2615: BLOWER RELAY CIRC	—	×	—	<a href="#">PCS-58</a>
B2616: IGN RELAY CIRC	—	×	—	<a href="#">PCS-61</a>
B2617: STARTER RELAY CIRC	×	×	—	<a href="#">SEC-56</a>
B2618: BCM	×	×	—	<a href="#">PCS-64</a>
B261A: PUSH-BTN IGN SW	—	×	—	<a href="#">SEC-58</a>
B261E: VEHICLE TYPE	×	× (Turn ON for 15 seconds)	—	<a href="#">SEC-60</a>
B2622: INSIDE ANTENNA	—	—	—	<a href="#">DLK-55</a>
B2623: INSIDE ANTENNA	—	—	—	<a href="#">DLK-58</a>
B26EA: KEY REGISTRATION	×	× (Turn ON for 15 seconds)	—	<a href="#">SEC-55. "Description"</a>
C1704: LOW PRESSURE FL	—	—	×	<a href="#">WT-8</a>
C1705: LOW PRESSURE FR	—	—	×	<a href="#">WT-8</a>
C1706: LOW PRESSURE RR	—	—	×	<a href="#">WT-8</a>
C1707: LOW PRESSURE RL	—	—	×	<a href="#">WT-8</a>
C1708: [NO DATA] FL	—	—	×	<a href="#">WT-14</a>
C1709: [NO DATA] FR	—	—	×	<a href="#">WT-14</a>
C1710: [NO DATA] RR	—	—	×	<a href="#">WT-14</a>
C1711: [NO DATA] RL	—	—	×	<a href="#">WT-14</a>

# BCM (BODY CONTROL MODULE)

< ECU DIAGNOSIS >

[INTELLIGENT KEY SYSTEM]

CONSULT display	Fail-safe	Intelligent Key warning lamp ON	Tire pressure monitor warning lamp ON	Reference page
C1712: [CHECKSUM ERR] FL	—	—	×	<a href="#">WT-16</a>
C1713: [CHECKSUM ERR] FR	—	—	×	<a href="#">WT-16</a>
C1714: [CHECKSUM ERR] RR	—	—	×	<a href="#">WT-16</a>
C1715: [CHECKSUM ERR] RL	—	—	×	<a href="#">WT-16</a>
C1716: [PRESSDATA ERR] FL	—	—	×	<a href="#">WT-18</a>
C1717: [PRESSDATA ERR] FR	—	—	×	<a href="#">WT-18</a>
C1718: [PRESSDATA ERR] RR	—	—	×	<a href="#">WT-18</a>
C1719: [PRESSDATA ERR] RL	—	—	×	<a href="#">WT-18</a>
C1720: [CODE ERR] FL	—	—	×	<a href="#">WT-16</a>
C1721: [CODE ERR] FR	—	—	×	<a href="#">WT-16</a>
C1722: [CODE ERR] RR	—	—	×	<a href="#">WT-16</a>
C1723: [CODE ERR] RL	—	—	×	<a href="#">WT-16</a>
C1724: [BATT VOLT LOW] FL	—	—	×	<a href="#">WT-16</a>
C1725: [BATT VOLT LOW] FR	—	—	×	<a href="#">WT-16</a>
C1726: [BATT VOLT LOW] RR	—	—	×	<a href="#">WT-16</a>
C1727: [BATT VOLT LOW] RL	—	—	×	<a href="#">WT-16</a>
C1729: VHCL SPEED SIG ERR	—	—	×	<a href="#">WT-19</a>
C1734: CONTROL UNIT	—	—	×	<a href="#">WT-20</a>

A  
B  
C  
D  
E  
F  
G  
H  
I  
J  
L  
M  
N  
O  
P

SEC

# IPDM E/R (INTELLIGENT POWER DISTRIBUTION MODULE ENGINE ROOM)

< ECU DIAGNOSIS >

[INTELLIGENT KEY SYSTEM]

## IPDM E/R (INTELLIGENT POWER DISTRIBUTION MODULE ENGINE ROOM)

Reference Value

INFOID:000000005804826

### VALUES ON THE DIAGNOSIS TOOL

Monitor Item	Condition		Value/Status
RADFAN REQ	Engine idle speed	Changes depending on engine coolant temperature, air conditioner operation status, vehicle speed, etc.	0 - 100 %
TAIL&CLR REQ	Lighting switch OFF		OFF
	Lighting switch 1ST, 2ND, HI or AUTO (Light is illuminated)		ON
HL LO REQ	Lighting switch OFF		OFF
	Lighting switch 2ND HI or AUTO (Light is illuminated)		ON
HL HI REQ	Lighting switch OFF		OFF
	Lighting switch HI		ON
FR WIP REQ	Ignition switch ON	Front wiper switch OFF	STOP
		Front wiper switch INT	1LOW
		Front wiper switch LO	LOW
		Front wiper switch HI	HI
WIP AUTO STOP	Ignition switch ON	Front wiper stop position	STOP P
		Any position other than front wiper stop position	ACT P
WIP PROT	Ignition switch ON	Front wiper operates normally	OFF
		Front wiper stops at fail-safe operation	BLOCK
IGN RLY1 -REQ	Ignition switch OFF or ACC		OFF
	Ignition switch ON		ON
IGN RLY	Ignition switch OFF or ACC		OFF
	Ignition switch ON		ON
PUSH SW	Release the push-button ignition switch		OFF
	Press the push-button ignition switch		ON
DETENT SW	Ignition switch ON	<ul style="list-style-type: none"> <li>Press the selector button with CVT selector lever in P position</li> <li>CVT selector lever in any position other than P</li> </ul>	OFF
		Release the CVT selector button with CVT selector lever in P position	
DTRL REQ	DTRL OFF		Off
	DTRL ON		On
OIL P SW	Ignition switch OFF, ACC or engine running		OPEN
	Ignition switch ON		CLOSE
THFT HRN REQ	Not operated		OFF
	<ul style="list-style-type: none"> <li>Panic alarm is activated</li> <li>Horn is activated with VEHICLE SECURITY (THEFT WARNING) SYSTEM</li> </ul>		ON
HORN CHIRP	Not operated		OFF
	Door locking with Intelligent Key (horn chirp mode)		ON

# IPDM E/R (INTELLIGENT POWER DISTRIBUTION MODULE ENGINE ROOM)

< ECU DIAGNOSIS >

[INTELLIGENT KEY SYSTEM]

## Terminal Layout

INFOID:000000005804827

### TERMINAL LAYOUT

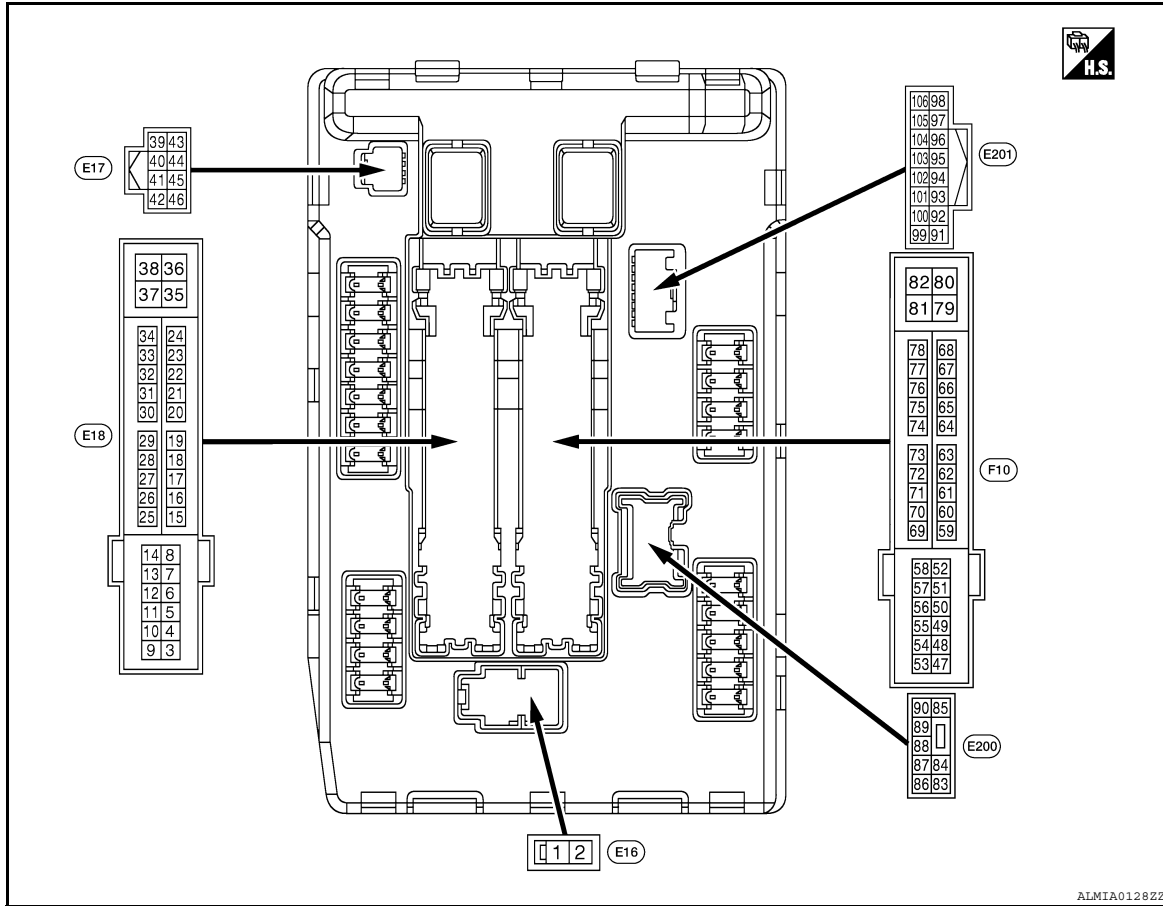

### Physical Values

INFOID:000000005804828

### PHYSICAL VALUES

SEC

Terminal No. (Wire color)		Description		Condition		Value (Approx.)
+	-	Signal name	Input/ Output			
1 (R)	Ground	Battery power supply	Input	Ignition switch OFF		Battery voltage
2 (L)	Ground	Battery power supply	Input	Ignition switch OFF		Battery voltage
4 (LG)	Ground	Front wiper LO	Output	Ignition switch ON	Front wiper switch OFF	0V
					Front wiper switch LO	Battery voltage
5 (Y)	Ground	Front wiper HI	Output	Ignition switch ON	Front wiper switch OFF	0V
					Front wiper switch HI	Battery voltage
6 (SB)	Ground	Daytime light relay power supply (Canada models only)	Output	Ignition switch OFF		Battery voltage
7 (GR)	Ground	Tail, license plate lamps & interior lamps	Output	Ignition switch ON	Lighting switch OFF	0V
					Lighting switch 1ST	Battery voltage

# IPDM E/R (INTELLIGENT POWER DISTRIBUTION MODULE ENGINE ROOM)

< ECU DIAGNOSIS >

[INTELLIGENT KEY SYSTEM]

Terminal No. (Wire color)		Description		Condition	Value (Approx.)
+	-	Signal name	Input/ Output		
10 (BR)	Ground	ECM relay power supply	Output	Ignition switch OFF (For a few seconds after turning ignition switch OFF)	0V
				<ul style="list-style-type: none"> <li>• Ignition switch ON</li> <li>• Ignition switch OFF (More than a few seconds after turning ignition switch OFF)</li> </ul>	Battery voltage
12 (B)	Ground	Ground	—	Ignition switch ON	0V
13 (SB)	Ground	Fuel pump power supply	Output	Approximately 1 second or more after turning the ignition switch ON	0V
				<ul style="list-style-type: none"> <li>• Approximately 1 second after turning the ignition switch ON</li> <li>• Engine running</li> </ul>	Battery voltage
15 (V)	Ground	Ignition relay-1 power supply	Output	Ignition switch OFF	0V
				Ignition switch ON	Battery voltage
16 (L/Y)	Ground	Front wiper auto stop	Input	Ignition switch ON	0V
				Front wiper stop position Any position other than front wiper stop position	Battery voltage
19 (Y)	Ground	Ignition relay-1 power supply	Output	Ignition switch OFF	0V
				Ignition switch ON	Battery voltage
20 (L)	Ground	Ambient sensor ground	—	Ignition switch ON	0V
21 (LG)	Ground	Ambient sensor	—	Ignition switch ON	5V
22 (W/R)	Ground	Refrigerant pressure sensor ground	—	Ignition switch ON	0V
23 (B/R)	Ground	Refrigerant pressure sensor	—	<ul style="list-style-type: none"> <li>• Ignition switch ON (READY)</li> <li>• Both A/C switch and blower motor switch ON (electric compressor operates)</li> </ul>	1.0 - 4.0V
24 (BR/W)	Ground	Refrigerant pressure sensor power supply	—	Ignition switch ON	5V
25 (R)	Ground	Ignition relay-1 power supply	Output	Ignition switch OFF	0V
				Ignition switch ON	Battery voltage
27 (W)	Ground	Ignition relay monitor	Input	Ignition switch OFF or ACC	Battery voltage
				Ignition switch ON	0V
28 (SB)	Ground	Push-button ignition switch	Input	Press the push-button ignition switch	0V
				Release the push-button ignition switch	Battery voltage
31 (B)	Ground	Ignition relay power supply	Output	Ignition switch OFF	0V
				Ignition switch ON	Battery voltage
39 (P)	—	CAN-L	Input/ Output	—	—
40 (L)	—	CAN-H	Input/ Output	—	—
41 (B)	Ground	Ground	—	Ignition switch ON	0V
42 (SB)	Ground	Cooling fan relay-1 control	Input	Ignition switch OFF or ACC	0V
				Ignition switch ON	0.7V

# IPDM E/R (INTELLIGENT POWER DISTRIBUTION MODULE ENGINE ROOM)

< ECU DIAGNOSIS >

[INTELLIGENT KEY SYSTEM]

Terminal No. (Wire color)		Description		Condition		Value (Approx.)
+	-	Signal name	Input/ Output			
43 (G/B)	Ground	CVT shift selector (Detention switch)	Input	Ignition switch ON	Press the CVT selector button (CVT selector lever P)	Battery voltage
					<ul style="list-style-type: none"> <li>• CVT selector lever in any position other than P</li> <li>• Release the CVT selec- tor button (CVT selector lever P)</li> </ul>	0V
44 (G/W)	Ground	Horn relay control	Input	The horn is deactivated		Battery voltage
				The horn is activated		0V
45 (L/O)	Ground	Anti theft horn relay control	Input	The horn is deactivated		Battery voltage
				The horn is activated		0V
48 (R)	Ground	Heater pump relay power supply	Output	Engine running	Heater pump OFF	0V
					Heater pump ON (Heater pump is operating)	Battery voltage
49 (v)	Ground	ECM relay power supply	Output	Ignition switch OFF (For a few seconds after turning ignition switch OFF)		0V
				<ul style="list-style-type: none"> <li>• Ignition switch ON</li> <li>• Ignition switch OFF (More than a few seconds after turn- ing ignition switch OFF)</li> </ul>		Battery voltage
51 (SB)	Ground	Ignition relay power supply	Output	Ignition switch OFF		0V
				Ignition switch ON		Battery voltage
53 (V)	Ground	ECM relay power supply	Output	Ignition switch OFF (For a few seconds after turning ignition switch OFF)		0V
				<ul style="list-style-type: none"> <li>• Ignition switch ON</li> <li>• Ignition switch OFF (More than a few seconds after turn- ing ignition switch OFF)</li> </ul>		Battery voltage
54 (GR)	Ground	Throttle control motor re- lay power supply	Output	Ignition switch OFF (For a few seconds after turning ignition switch OFF)		0V
				<ul style="list-style-type: none"> <li>• Ignition switch ON</li> <li>• Ignition switch OFF (More than a few seconds after turn- ing ignition switch OFF)</li> </ul>		Battery voltage
55 (LG)	Ground	ECM power supply	Output	Ignition switch OFF		Battery voltage
56 (R)	Ground	Ignition relay power supply	Output	Ignition switch OFF		0V
				Ignition switch ON		Battery voltage
57 (O)	Ground	Ignition relay power supply	Output	Ignition switch OFF		0V
				Ignition switch ON		Battery voltage
69 (SB)	Ground	ECM relay control	Output	Ignition switch OFF (For a few seconds after turning ignition switch OFF)		Battery voltage
				<ul style="list-style-type: none"> <li>• Ignition switch ON</li> <li>• Ignition switch OFF (More than a few seconds after turn- ing ignition switch OFF)</li> </ul>		0 - 1.5V

A  
B  
C  
D  
E  
F  
G  
H  
I  
J  
L  
M  
N  
O  
P

SEC

# IPDM E/R (INTELLIGENT POWER DISTRIBUTION MODULE ENGINE ROOM)

< ECU DIAGNOSIS >

[INTELLIGENT KEY SYSTEM]

Terminal No. (Wire color)		Description		Condition		Value (Approx.)
+	-	Signal name	Input/ Output			
70 (G)	Ground	Throttle control motor re- lay control	Output	Ignition switch ON → OFF		0 -1.0V ↓ Battery voltage ↓ 0V
				Ignition switch ON		0 - 1.0V
75 (LG)	Ground	Oil pressure switch	Input	Ignition switch ON	Engine stopped	0V
					Engine running	Battery voltage
77 (GR)	Ground	Fuel pump relay control	Output	<ul style="list-style-type: none"> <li>• Approximately 1 second after turning the ignition switch ON</li> <li>• Engine running</li> </ul>		0 - 1.0V
				Approximately 1 second or more after turning the ignition switch ON		Battery voltage
83 (R/Y)	Ground	Headlamp LO (RH)	Output	Ignition switch ON	Lighting switch OFF	0V
					Lighting switch 2ND	Battery voltage
84 (L)	Ground	Headlamp LO (LH)	Output	Ignition switch ON	Lighting switch OFF	0V
					Lighting switch 2ND	Battery voltage
88 (R/W)	Ground	Washer pump power supply	Output	Ignition switch ON		Battery voltage
89 (L/W)	Ground	Headlamp HI (RH)	Output	Ignition switch ON	<ul style="list-style-type: none"> <li>• Lighting switch HI</li> <li>• Lighting switch PASS</li> </ul>	Battery voltage
					Lighting switch OFF	0V
90 (G)	Ground	Headlamp HI (LH)	Output	Ignition switch ON	<ul style="list-style-type: none"> <li>• Lighting switch HI</li> <li>• Lighting switch PASS</li> </ul>	Battery voltage
					Lighting switch OFF	0V
91 (LG/R)	Ground	Parking lamp (RH)	Output	Ignition switch ON	Lighting switch 1ST	Battery voltage
					Lighting switch OFF	0V
92 (LG/B)	Ground	Parking lamp (LH)	Output	Ignition switch ON	Lighting switch 1ST	Battery voltage
					Lighting switch OFF	0V
97 (V)	Ground	Cooling fan control	Output	Engine idling		0-5V
99 (BR/W)	Ground	Ambient sensor ground	—	Ignition switch ON		0V
100 (SB)	Ground	Ambient sensor	—	Ignition switch ON		5V
101 (W)	Ground	Refrigerant pressure sensor ground	—	Ignition switch ON		0V
102 (R)	Ground	Refrigerant pressure sensor	—	<ul style="list-style-type: none"> <li>• Ignition switch ON (READY)</li> <li>• Both A/C switch and blower motor switch ON (electric compressor operates)</li> </ul>		1.0 - 4.0V
103 (P)	Ground	Refrigerant pressure sensor power supply	—	Ignition switch ON		5V
105 (V)	Ground	Daytime light relay control (Canada only)	Output	Ignition switch ON	Daytime light system active	Battery voltage
				Ignition switch ON	Daytime light system inactive	0V



# IPDM E/R (INTELLIGENT POWER DISTRIBUTION MODULE ENGINE ROOM)

< ECU DIAGNOSIS >

[INTELLIGENT KEY SYSTEM]

## Wiring Diagram

INFOID:000000005804829

### IPDM E/R (INTELLIGENT POWER DISTRIBUTION MODULE ENGINE ROOM)

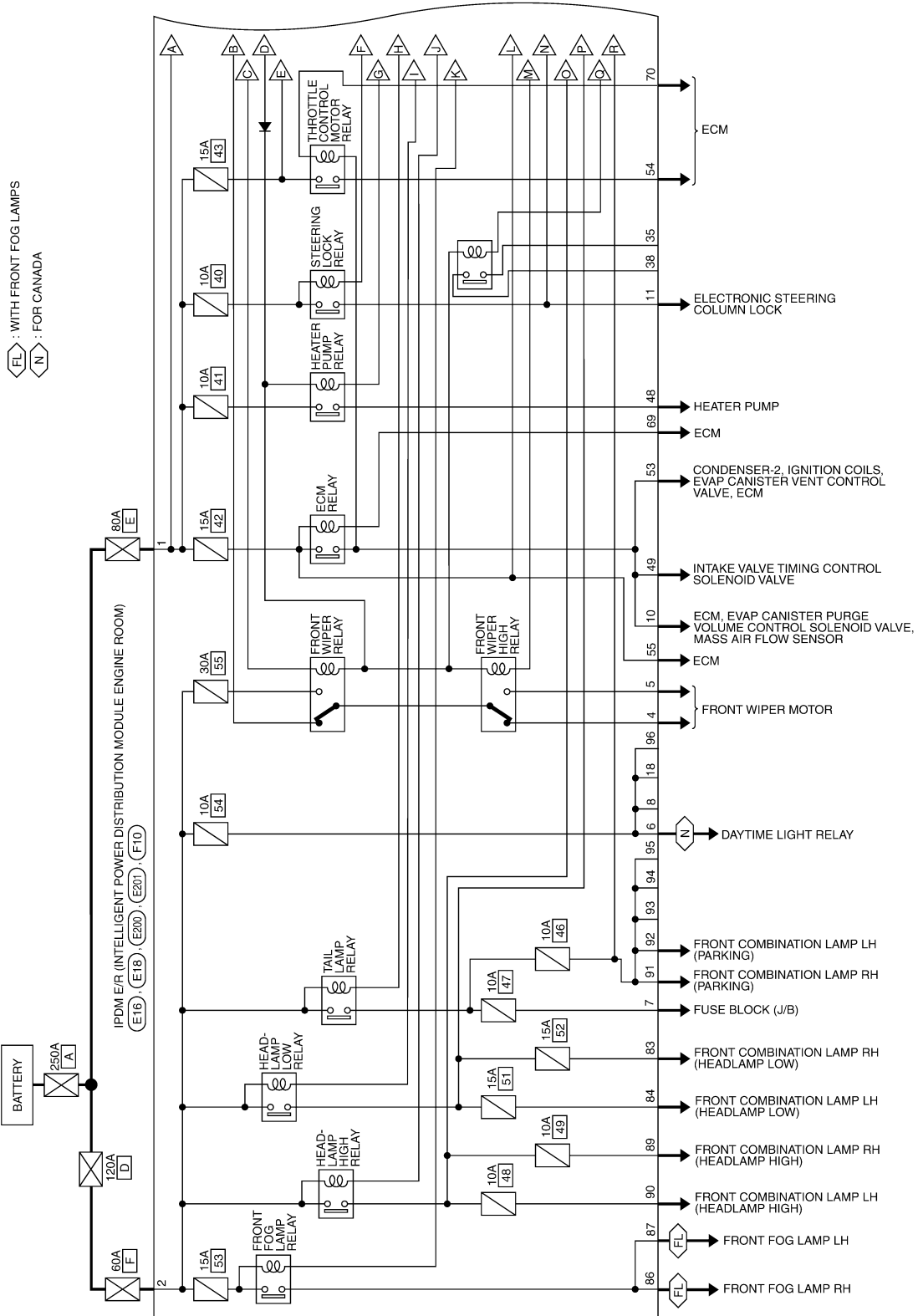

ABMWA0191GB

A  
B  
C  
D  
E  
F  
G  
H  
I  
J  
K  
L  
M  
N  
O  
P

SEC

# IPDM E/R (INTELLIGENT POWER DISTRIBUTION MODULE ENGINE ROOM)

< ECU DIAGNOSIS >

[INTELLIGENT KEY SYSTEM]

 : DATA LINE  
 : FOR CANADA

IPDM E/R (INTELLIGENT POWER DISTRIBUTION MODULE ENGINE ROOM)

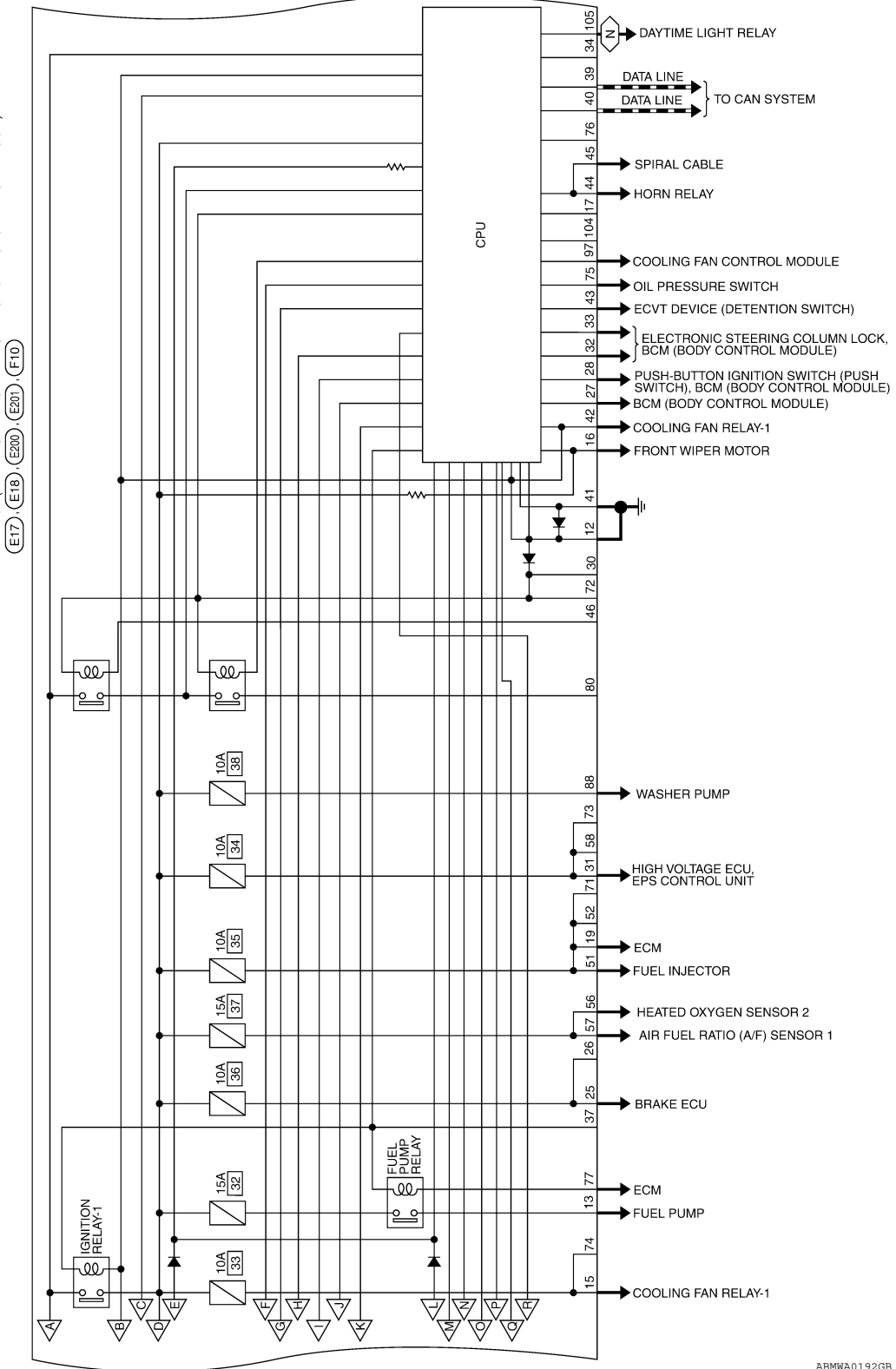

ABMWA0192GB

A  
B  
C  
D  
E  
F  
G  
H  
I  
J  
L  
M  
N  
O  
P

IPDM E/R  
(INTELLIGENT POWER  
DISTRIBUTION MODULE  
ENGINE ROOM)  
(E18) (E20)

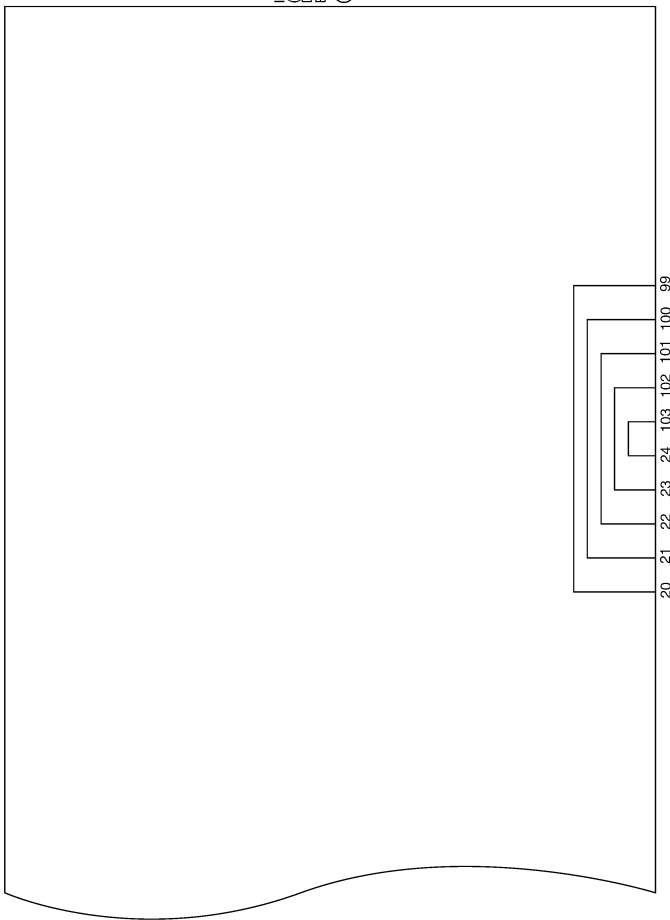

**SEC**

ALMWA0033GB

## IPDM E/R (INTELLIGENT POWER DISTRIBUTION MODULE ENGINE ROOM) CONNECTORS

Connector No.	E16
Connector Name	IPDM E/R (INTELLIGENT POWER DISTRIBUTION MODULE ENGINE ROOM)
Connector Color	BLACK



Terminal No.	Color of Wire	Signal Name
1	R	F/L_MAIN
2	B/Y	F/L_USM

Connector No.	E17
Connector Name	IPDM E/R (INTELLIGENT POWER DISTRIBUTION MODULE ENGINE ROOM)
Connector Color	WHITE

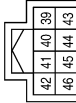

Terminal No.	Color of Wire	Signal Name
39	P	CAN-L
40	L	CAN-H
41	B	GND (SIGNAL)
42	SB	MOTOR_FAN_RLY_MID
43	G/B	DETENT_SW
44	G/W	HORN_RLY
45	L/O	HORN_SW
46	-	-

Connector No.	E18
Connector Name	IPDM E/R (INTELLIGENT POWER DISTRIBUTION MODULE ENGINE ROOM)
Connector Color	WHITE

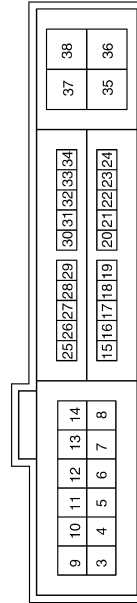

Terminal No.	Color of Wire	Signal Name
8	-	-
9	-	-
10	R/B	ECM_VB
11	P/L	ESCL
12	B	GND (POWER)
13	W	FUEL_PUMP
14	-	-
15	BR	START_IG-E/R
16	L/Y	WIPER_AUTOSTOP
17	-	-
18	-	-
19	L/Y	BCM_IGNSW
20	B/Y	AMB_SENS_GND-E/R
21	O/B	AMB_SENS_SIG-E/R
22	W/R	PD_SENS_GND-E/R

Terminal No.	Color of Wire	Signal Name
23	B/R	PD_SENS_SIG-E/R
24	BR/W	PD_SENS_PWR-E/R
25	G/R	ABS_ECU
26	-	-
27	BR/W	IGN_SIGNAL
28	BR	PUSH_START_SW
29	-	-
30	-	-
31	G/W	REV_RLY
32	LG	SL_CONDITION_1
33	W	SL_CONDITION_2
34	-	-
35	-	-
36	-	-
37	-	-
38	-	-

Terminal No.	Color of Wire	Signal Name
3	-	-
4	L/R	FR_WIPER_LO
5	L/B	FR_WIPER_HI
6	SB	DTRL
7	R/L	TAIL/ILLUMI

ABM1A0566GB

A  
B  
C  
D  
E  
F  
G  
H  
I  
J  
L  
M  
N  
O  
P

Connector No.	E201
Connector Name	IPDM E/R (INTELLIGENT POWER DISTRIBUTION MODULE ENGINE ROOM)
Connector Color	WHITE

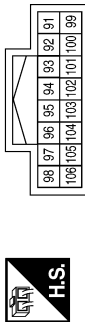

Terminal No.	Color of Wire	Signal Name
91	LG/R	CLEARANCE_RH
92	LG/B	CLEARANCE_LH
93	-	-
94	-	-
95	-	-
96	-	-
97	V	MOTOR_FAN_PWM
98	-	-
99	BR/W	AMB_SENS_GND-FEM
100	SB	AMB_SENS_SIG-FEM
101	W	PD_SENS_GND-FEM
102	R	PD_SENS_SIG-FEM
103	P	PD_SENS_PWR-FEM
104	-	-
105	V	DTRL_RLY
106	-	-

Connector No.	E200
Connector Name	IPDM E/R (INTELLIGENT POWER DISTRIBUTION MODULE ENGINE ROOM)
Connector Color	WHITE



Terminal No.	Color of Wire	Signal Name
83	R/Y	HEADLAMP_LO_RH
84	L	HEADLAMP_LO_LH
85	-	-
86	W/R	FR_FOG_LAMP_RH
87	L/Y	FR_FOG_LAMP_LH
88	R/W	WASHER_MTR
89	L/W	HEADLAMP_HI_RH
90	G	HEADLAMP_HI_LH

SEC

ALMIA0077GB

Terminal No.	Color of Wire	Signal Name
64	-	-
65	-	-
66	-	-
67	-	-
68	-	-
69	W/B	SSOF
70	O	MOTRLY
71	-	-
72	-	-
73	-	-
74	-	-
75	P/L	OIL_PRESSURE_SW
76	-	-
77	B/R	FPR
78	-	-
79	-	-
80	-	-
81	-	-
82	-	-

Terminal No.	Color of Wire	Signal Name
47	-	-
48	R	ENG_SOL
49	B/R	ENG_SOL
50	-	-
51	LG	INJECTOR_#1
52	-	-
53	R/W	IGN_COIL
54	G/W	ETC
55	W/L	ECM_BAT
56	R/Y	O2_SENS_#1
57	O	O2_SENS_#2
58	-	-
59	-	-
60	-	-
61	-	-
62	-	-
63	-	-

Connector No.	F10
Connector Name	IPDM E/R (INTELLIGENT POWER DISTRIBUTION MODULE ENGINE ROOM)
Connector Color	WHITE

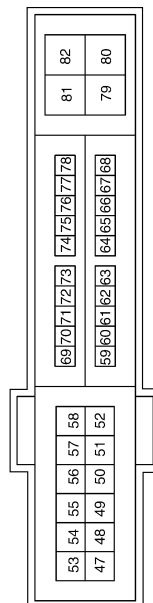

ALMIA0078GB

INFOID:000000005804830

## Fail Safe

### CAN COMMUNICATION CONTROL

When CAN communication with ECM and BCM is impossible, IPDM E/R performs fail-safe control. After CAN communication recovers normally, it also returns to normal control.

If No CAN Communication Is Available With ECM

# IPDM E/R (INTELLIGENT POWER DISTRIBUTION MODULE ENGINE ROOM)

< ECU DIAGNOSIS >

[INTELLIGENT KEY SYSTEM]

Control part	Fail-safe in operation
Cooling fan	<ul style="list-style-type: none"> <li>• Signals cooling fans ON when the ignition switch is turned ON</li> <li>• Signals cooling fans OFF when the ignition switch is turned OFF</li> </ul>
Heater pump	Heater pump relay OFF

If No CAN Communication Is Available With BCM

Control part	Fail-safe in operation
Headlamp	<ul style="list-style-type: none"> <li>• Turns ON the headlamp low relay when the ignition switch is turned ON</li> <li>• Turns OFF the headlamp low relay when the ignition switch is turned OFF</li> <li>• Headlamp high relay OFF</li> </ul>
<ul style="list-style-type: none"> <li>• Parking lamps</li> <li>• Side marker lamps</li> <li>• License plate lamps</li> <li>• Illuminations</li> <li>• Tail lamps</li> </ul>	<ul style="list-style-type: none"> <li>• Turns ON the tail lamp relay when the ignition switch is turned ON</li> <li>• Turns OFF the tail lamp relay when the ignition switch is turned OFF</li> </ul>
Front wiper	<ul style="list-style-type: none"> <li>• The status just before activation of fail-safe control is maintained until the ignition switch is turned OFF while the front wiper is operating at LO or HI speed.</li> <li>• The wiper is operated at LO speed until the ignition switch is turned OFF if the fail-safe control is activated while the front wiper is set in the INT mode and the front wiper motor is operating.</li> </ul>
Horn	Horn OFF
Ignition relay	The status just before activation of fail-safe is maintained.

## IGNITION RELAY MALFUNCTION DETECTION FUNCTION

- IPDM E/R monitors the voltage at the contact circuit and excitation coil circuit of the ignition relay inside it.
- IPDM E/R judges the ignition relay error if the voltage differs between the contact circuit and the excitation coil circuit.
- If the ignition relay cannot turn OFF due to contact seizure, it activates the tail lamp relay for 10 minutes to alert the user to the ignition relay malfunction when the ignition switch is turned OFF.

DTC	Ignition switch	Ignition relay	Tail lamp relay
—	ON	ON	—
—	OFF	OFF	—
B2098: IGN RELAY ON	OFF	ON	ON (10 minutes)
B2099: IGN RELAY OFF	ON	OFF	—

### NOTE:

The tail lamp turns OFF when the ignition switch is turned ON.

## FRONT WIPER CONTROL

IPDM E/R detects front wiper stop position by a front wiper auto stop signal.

When a front wiper auto stop signal is in the conditions listed below, IPDM E/R stops power supply to wiper after repeating a front wiper 10 second activation and 20 second stop five times.

Ignition switch	Front wiper switch	Auto stop signal
ON	OFF	Front wiper stop position signal cannot be input 10 seconds.
	ON	The signal does not change for 10 seconds.

### NOTE:

This operation status can be confirmed on the IPDM E/R “Data Monitor” that displays “BLOCK” for the item “WIP PROT” while the wiper is stopped.

## STARTER MOTOR PROTECTION FUNCTION

IPDM E/R turns OFF the starter control relay to protect the starter motor when the starter control relay remains active for 90 seconds.

A  
B  
C  
D  
E  
F  
G  
H  
I  
J  
L  
M  
N  
O  
P

SEC

# IPDM E/R (INTELLIGENT POWER DISTRIBUTION MODULE ENGINE ROOM)

< ECU DIAGNOSIS >

[INTELLIGENT KEY SYSTEM]

## DTC Index

INFOID:000000005804831

CONSULT-III display	Fail-safe	TIME <sup>NOTE</sup>		Refer to
No DTC is detected. further testing may be required.	—	—	—	—
U1000: CAN COMM CIRCUIT	×	CRNT	1 – 39	<a href="#">PCS-18</a>
B2098: IGN RELAY ON	×	CRNT	1 – 39	<a href="#">PCS-19</a>
B2099: IGN RELAY OFF	—	CRNT	1 – 39	<a href="#">PCS-20</a>

### NOTE:

The details of TIME display are as follows.

- CRNT: The malfunctions that are detected now
- 1 - 39: The number is indicated when it is normal at present and a malfunction was detected in the past. It increases like 0 → 1 → 2 ... 38 → 39 after returning to the normal condition whenever IGN OFF → ON. It is fixed to 39 until the self-diagnosis results are erased if it is over 39. It returns to 0 when a malfunction is detected again in the process.



# INTELLIGENT KEY SYSTEM/ENGINE START FUNCTION

< WIRING DIAGRAM >

[INTELLIGENT KEY SYSTEM]

## WIRING DIAGRAM

### INTELLIGENT KEY SYSTEM/ENGINE START FUNCTION

Wiring Diagram

INFOID:000000005806160

#### INTELLIGENT KEY SYSTEM/ENGINE START FUNCTION

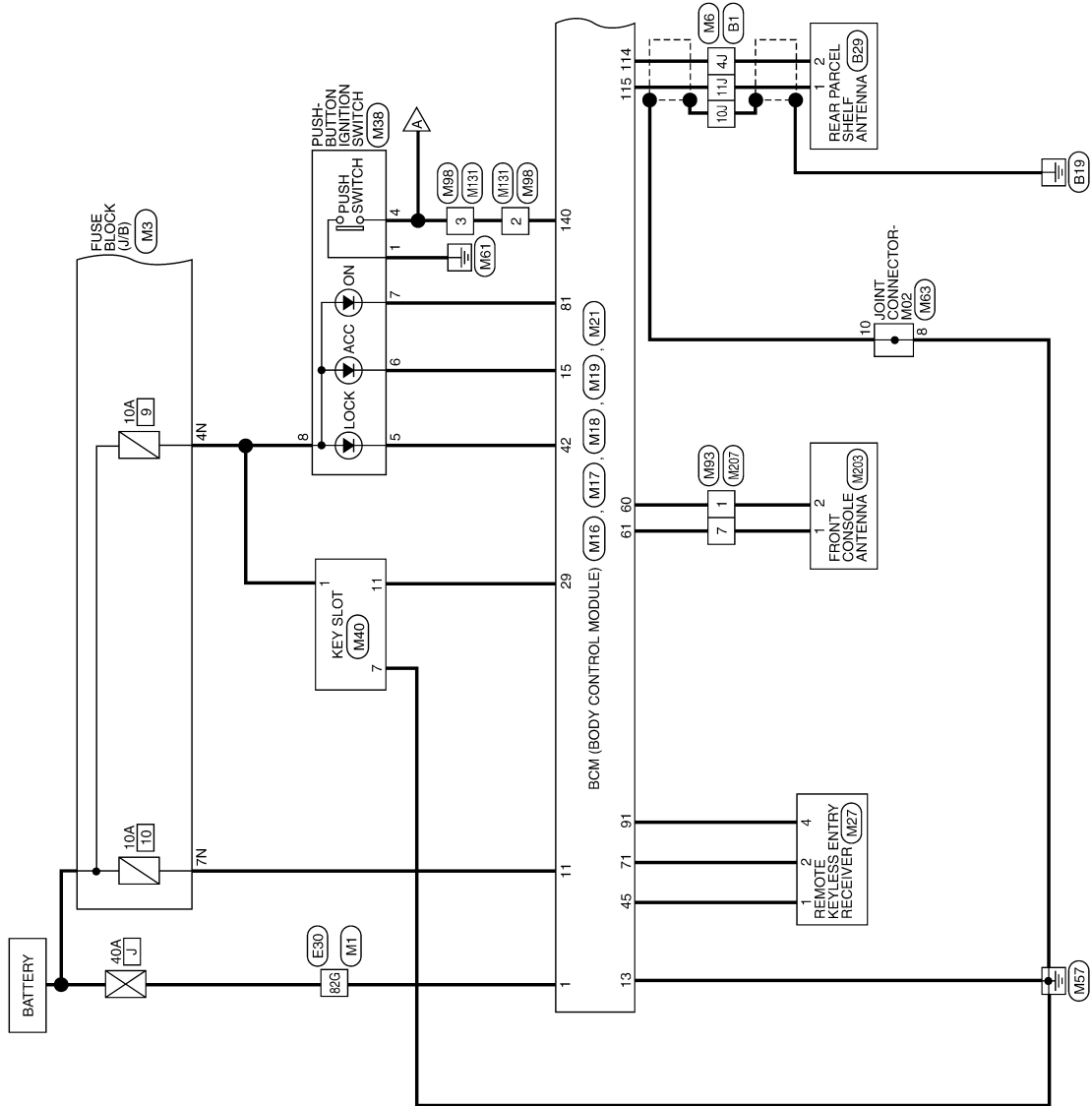

A  
B  
C  
D  
E  
F  
G  
H  
I  
J  
L  
M  
N  
O  
P

SEC

# INTELLIGENT KEY SYSTEM/ENGINE START FUNCTION

< WIRING DIAGRAM >

[INTELLIGENT KEY SYSTEM]

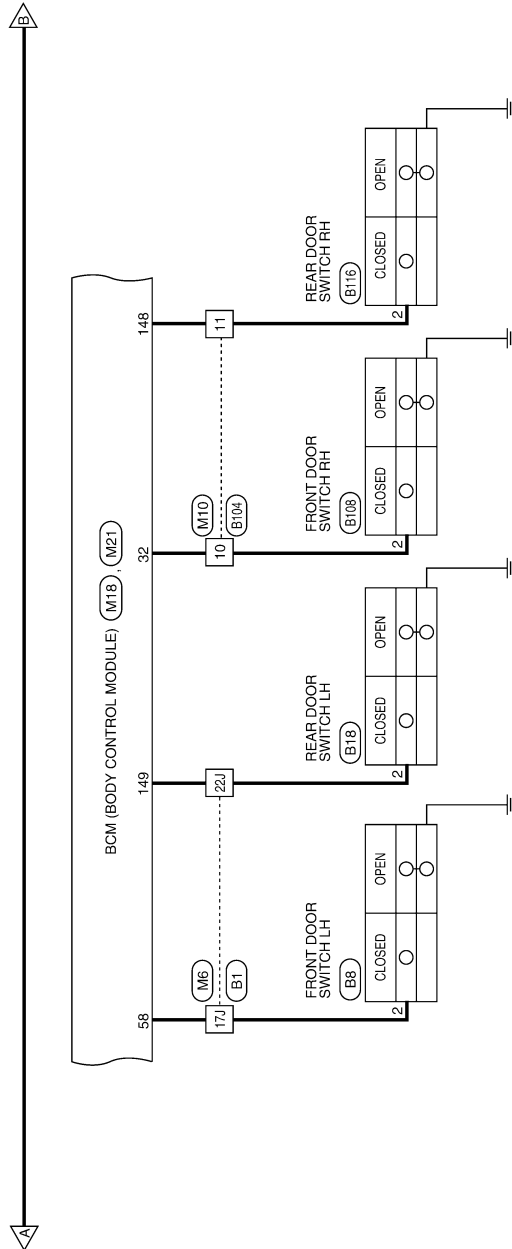

ABKWA0800GB

# INTELLIGENT KEY SYSTEM/ENGINE START FUNCTION

< WIRING DIAGRAM >

[INTELLIGENT KEY SYSTEM]

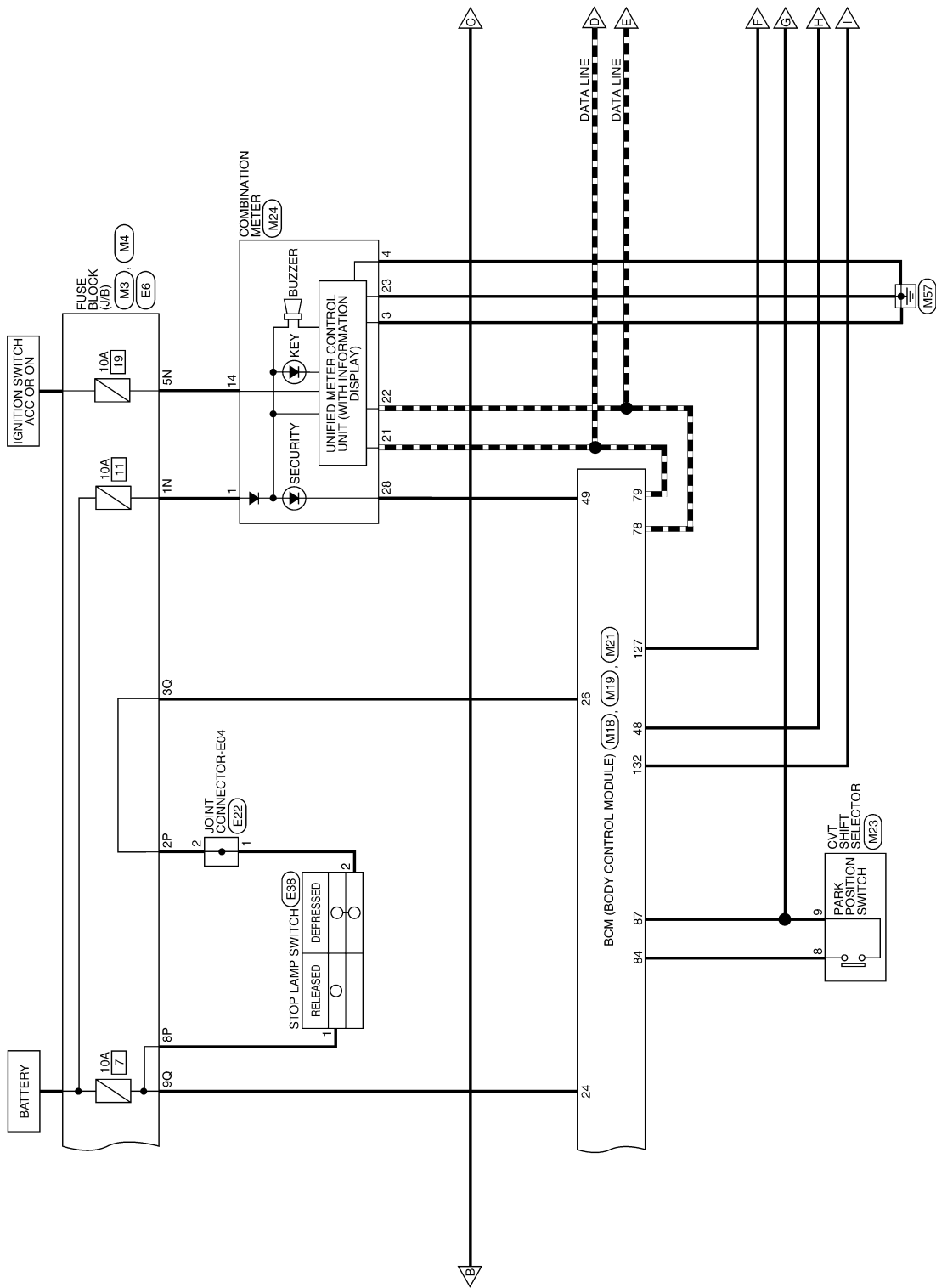

A  
B  
C  
D  
E  
F  
G  
H  
I  
J  
K  
L  
M  
N  
O  
P

SEC

ABKWA0801GB

# INTELLIGENT KEY SYSTEM/ENGINE START FUNCTION

< WIRING DIAGRAM >

[INTELLIGENT KEY SYSTEM]

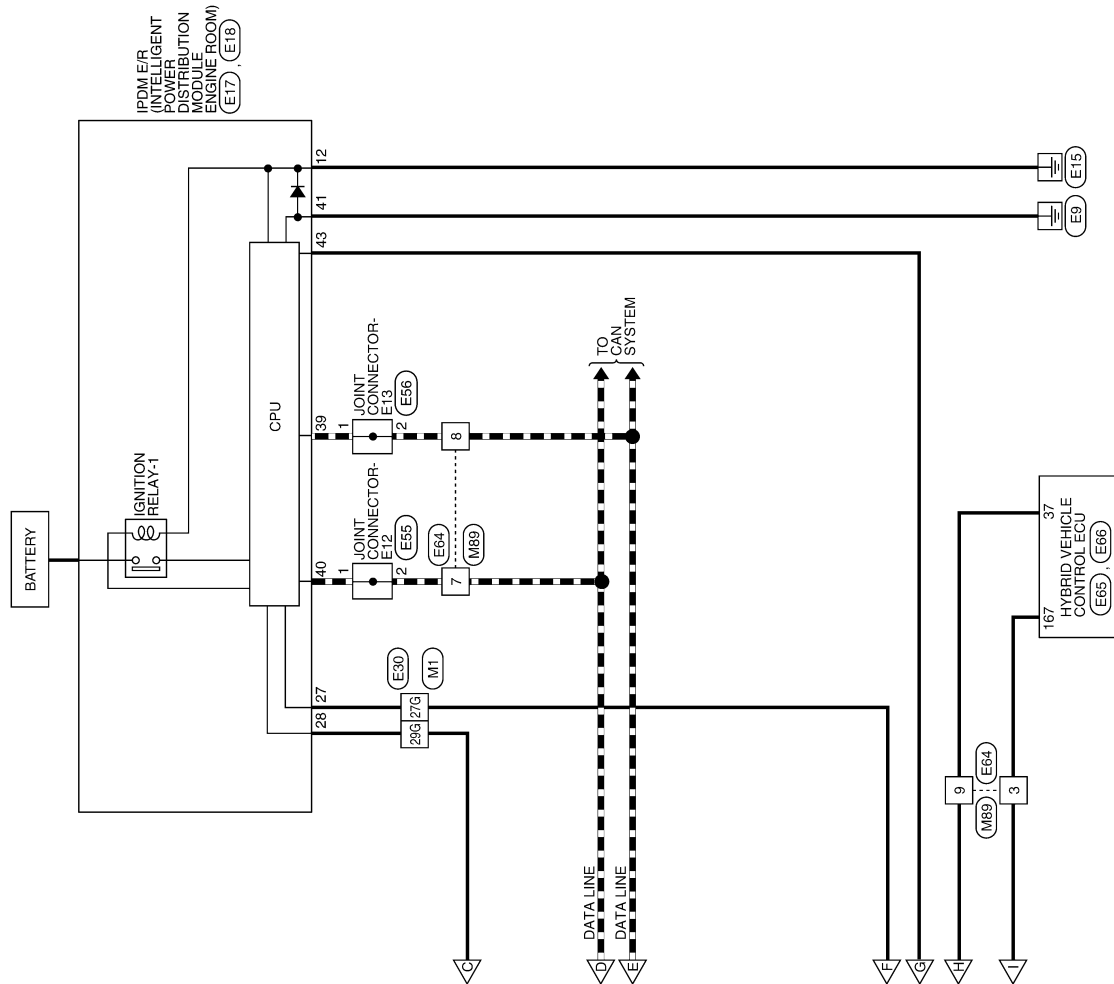

ABKWA0802GB

# INTELLIGENT KEY SYSTEM/ENGINE START FUNCTION

< WIRING DIAGRAM >

[INTELLIGENT KEY SYSTEM]

## INTELLIGENT KEY SYSTEM/ENGINE START FUNCTION CONNECTORS

Connector No.	M1
Connector Name	WIRE TO WIRE
Connector Color	WHITE

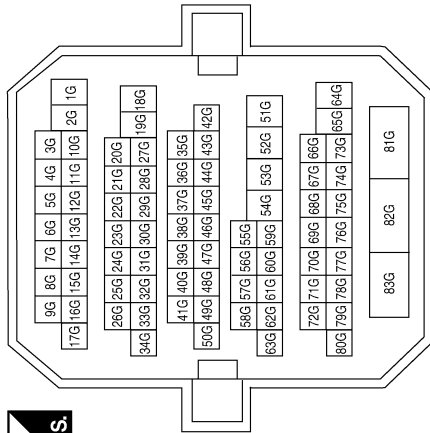

Terminal No.	Color of Wire	Signal Name
27G	BR/W	-
29G	BR	-
82G	W/B	-

Connector No.	M3
Connector Name	FUSE BLOCK (J/B)
Connector Color	WHITE

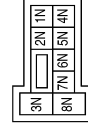

Terminal No.	Color of Wire	Signal Name
1N	W/L	-
4N	G/Y	-
5N	V/Y	-
7N	Y/R	-

Connector No.	M4
Connector Name	FUSE BLOCK (J/B)
Connector Color	WHITE



Terminal No.	Color of Wire	Signal Name
3Q	O/L	-
9Q	R/W	-

Connector No.	M6
Connector Name	WIRE TO WIRE
Connector Color	WHITE

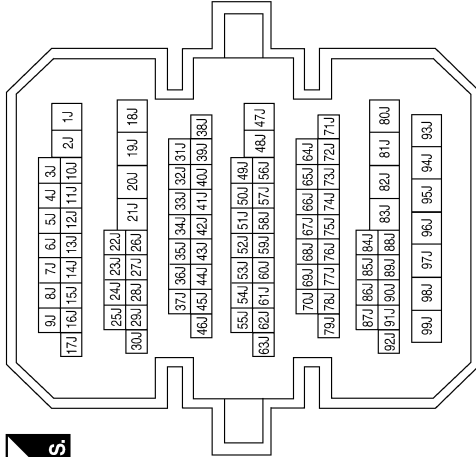

Terminal No.	Color of Wire	Signal Name
4J	B	-
10J	SHIELD	-
11J	W	-
17J	SB	-
22J	R/B	-

A  
B  
C  
D  
E  
F  
G  
H  
I  
J  
K  
L  
M  
N  
O  
P

SEC

ABK1A2256GB

# INTELLIGENT KEY SYSTEM/ENGINE START FUNCTION

< WIRING DIAGRAM >

[INTELLIGENT KEY SYSTEM]

Connector No.	M17
Connector Name	BCM (BODY CONTROL MODULE)
Connector Color	WHITE

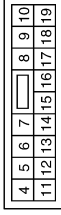

Terminal No.	Color of Wire	Signal Name
11	Y/R	BAT_BCM_FUSE
13	B	GND1
15	Y/L	ACC_LED

Connector No.	M16
Connector Name	BCM (BODY CONTROL MODULE)
Connector Color	BLACK



Terminal No.	Color of Wire	Signal Name
1	W/B	BAT_POWER_F/L

Connector No.	M10
Connector Name	WIRE TO WIRE
Connector Color	BROWN

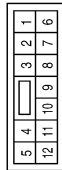

Terminal No.	Color of Wire	Signal Name
10	R/B	-
11	R/W	-

Terminal No.	Color of Wire	Signal Name
71	L/O	RF1 TUNER SIGNAL
78	P	CAN-L
79	L	CAN-H
81	LG	IGN ON LED
84	Y/R	AT DEVICE OUT
87	G/B	SHIFT P
91	L/R	RF1 POWER SUPPLY

Connector No.	M19
Connector Name	BCM (BODY CONTROL MODULE)
Connector Color	BLACK

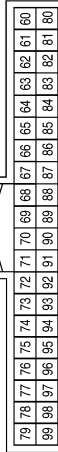

Terminal No.	Color of Wire	Signal Name
60	B/R	ROOM_ANT_2_B
61	W/R	ROOM_ANT_2_A

Connector No.	M18
Connector Name	BCM (BODY CONTROL MODULE)
Connector Color	GREEN

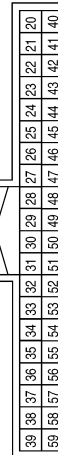

Terminal No.	Color of Wire	Signal Name
24	R/W	STOP LAMP LOW SW
26	O/L	STOP LAMP HIGH SW
29	Y	FOB IN SW
32	R/B	AS DOOR SW
42	R	S/L LOCK LED
45	P	GND RF2 A/L
48	R/B	SHIFT N/P
49	L/O	IMMO LED
58	SB	DR_DOOR SW

ABK1A2257GB

# INTELLIGENT KEY SYSTEM/ENGINE START FUNCTION

< WIRING DIAGRAM >

[INTELLIGENT KEY SYSTEM]

Connector No.	M24
Connector Name	COMBINATION METER
Connector Color	WHITE

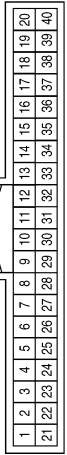

Terminal No.	Color of Wire	Signal Name
1	W/L	BAT
3	B	GND (POWER)
4	B	GND (ILL)
14	V/Y	ACC
21	L	CAN-H
22	P	CAN-L
23	B	GND (CIRCUIT)
28	L/O	SECURITY

Connector No.	M23
Connector Name	CVT SHIFT SELECTOR
Connector Color	WHITE



Terminal No.	Color of Wire	Signal Name
8	Y/R	DETENT_KEY_SW
9	G/B	DETENT_KEY_SW

Connector No.	M21
Connector Name	BCM (BODY CONTROL MODULE)
Connector Color	GRAY

Terminal No.	Color of Wire	Signal Name
114	B	TRUNK_ANT_1_B
115	W	TRUNK_ANT_1_A
127	BR/W	IGN_USM_CONT1
132	R	ST CONT USM
140	BR	ENG_START_SW W/O ESCL
148	R/W	RR_DOOR_SW
149	R/B	RL_DOOR_SW

Connector No.	M40
Connector Name	KEY SLOT
Connector Color	WHITE



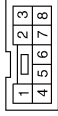

Terminal No.	Color of Wire	Signal Name
1	G/Y	B+
7	B	GND
11	Y	CARD_SW_1

Connector No.	M38
Connector Name	PUSH-BUTTON IGNITION SWITCH
Connector Color	BROWN

Terminal No.	Color of Wire	Signal Name
1	B	GND
4	BR	START_SW
5	R	LOCK
6	Y/L	ACC
7	LG	ON
8	G/Y	B+

Connector No.	M27
Connector Name	REMOTE KEY-LESS ENTRY RECEIVER
Connector Color	BLACK

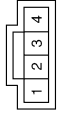
Terminal No.	Color of Wire	Signal Name
1	P	GND
2	L/O	SIGNAL
4	L/R	12V

ABK1A2258GB

A  
B  
C  
D  
E  
F  
G  
H  
I  
J  
K  
L  
M  
N  
O  
P

SEC

# INTELLIGENT KEY SYSTEM/ENGINE START FUNCTION

< WIRING DIAGRAM >

[INTELLIGENT KEY SYSTEM]

Connector No.	M93
Connector Name	WIRE TO WIRE
Connector Color	WHITE

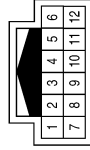

Terminal No.	Color of Wire	Signal Name
1	B/R	-
7	W/R	-

Connector No.	M89
Connector Name	WIRE TO WIRE
Connector Color	GRAY

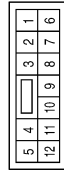

Terminal No.	Color of Wire	Signal Name
3	R	-
7	L	-
8	P	-
9	R/B	-

Connector No.	M63
Connector Name	JOINT CONNECTOR-M02
Connector Color	BLUE

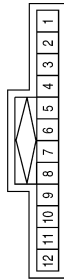

Terminal No.	Color of Wire	Signal Name
8	B	-
10	GR	-

Connector No.	M203
Connector Name	FRONT CONSOLE ANTENNA
Connector Color	GRAY



Terminal No.	Color of Wire	Signal Name
1	W/R	ANT+
2	B/R	ANT-

Connector No.	M131
Connector Name	WIRE TO WIRE
Connector Color	WHITE

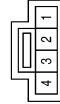

Terminal No.	Color of Wire	Signal Name
2	BR	-
3	BR	-

Connector No.	M98
Connector Name	WIRE TO WIRE
Connector Color	WHITE



Terminal No.	Color of Wire	Signal Name
2	BR	-
3	BR	-

ABK1A2259GB



# INTELLIGENT KEY SYSTEM/ENGINE START FUNCTION

< WIRING DIAGRAM >

[INTELLIGENT KEY SYSTEM]

Connector No.	E17
Connector Name	IPDM E/R (INTELLIGENT POWER DISTRIBUTION MODULE ENGINE ROOM)
Connector Color	WHITE

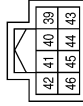

Terminal No.	Color of Wire	Signal Name
39	P	CAN-L
40	L	CAN-H
41	B	GND (SIGNAL)
43	G/B	DETENT_SW

Connector No.	E6
Connector Name	FUSE BLOCK (J/B)
Connector Color	WHITE



Terminal No.	Color of Wire	Signal Name
2P	P	-
8P	R	-

Connector No.	M207
Connector Name	WIRE TO WIRE
Connector Color	WHITE

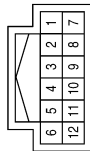

Terminal No.	Color of Wire	Signal Name
1	B/R	-
7	W/R	-

Connector No.	E22
Connector Name	JOINT CONNECTOR-E04
Connector Color	BLACK

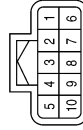

Terminal No.	Color of Wire	Signal Name
1	P	-
2	P	-

Terminal No.	Color of Wire	Signal Name
12	B	GND (POWER)
27	W	IGN_SIGNAL
28	SB	PUSH_START_SW

Connector No.	E18
Connector Name	IPDM E/R (INTELLIGENT POWER DISTRIBUTION MODULE ENGINE ROOM)
Connector Color	WHITE

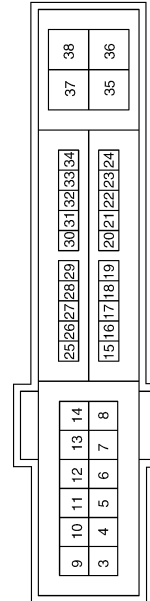

ABK1A2260GB

A  
B  
C  
D  
E  
F  
G  
H  
I  
J  
L  
M  
N  
O  
P

SEC

# INTELLIGENT KEY SYSTEM/ENGINE START FUNCTION

< WIRING DIAGRAM >

[INTELLIGENT KEY SYSTEM]

Connector No.	E38
Connector Name	STOP LAMP SWITCH
Connector Color	WHITE



Terminal No.	Color of Wire	Signal Name
1	R	-
2	P	-

Terminal No.	Color of Wire	Signal Name
27G	W	-
29G	SB	-
82G	LG	-

Connector No.	E30
Connector Name	WIRE TO WIRE
Connector Color	WHITE

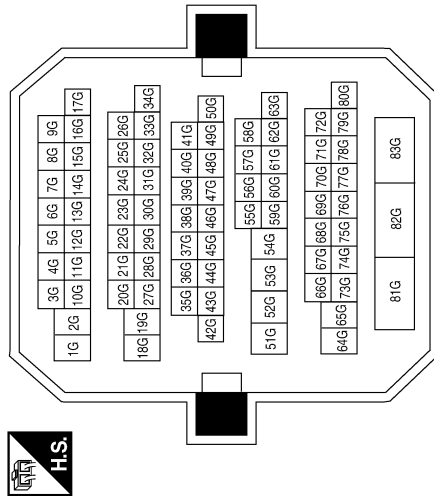

Connector No.	E64
Connector Name	WIRE TO WIRE
Connector Color	WHITE

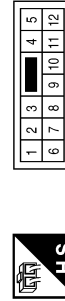

Terminal No.	Color of Wire	Signal Name
3	R	-
7	L	-
8	P	-
9	R/B	-

Connector No.	E56
Connector Name	JOINT CONNECTOR-E13
Connector Color	WHITE



Terminal No.	Color of Wire	Signal Name
1	P	-
2	P	-

Connector No.	E55
Connector Name	JOINT CONNECTOR-E12
Connector Color	WHITE



Terminal No.	Color of Wire	Signal Name
1	L	-
2	L	-

ABK1A2261GB

# INTELLIGENT KEY SYSTEM/ENGINE START FUNCTION

< WIRING DIAGRAM >

[INTELLIGENT KEY SYSTEM]

Terminal No.	Color of Wire	Signal Name
167	R	ST2

Connector No.	E66
Connector Name	HYBRID VEHICLE CONTROL ECU
Connector Color	BLACK



168	167	166	165	164	163	77	76	75	74	73	72	71	70	69	68	67	66	65	64	63	62	61
174	173	172	171	170	169	111	110	109	108	107	106	105	104	103	102	101	100	99	98	97	96	95
180	179	178	177	176	175	128	127	126	125	124	123	122	121	120	119	118	117	116	115	114	113	112
186	185	184	183	182	181	148	144	143	142	141	140	139	138	137	136	135	134	133	132	131	130	129
						162	161	160	159	158	157	156	155	154	153	152	151	150	149	148	147	146

Connector No.	E65
Connector Name	HYBRID VEHICLE CONTROL ECU
Connector Color	BLACK



53	54	55	56	57	58	59	60	3	2	1
45	46	47	48	49	50	51	52	6	5	4
37	38	39	40	41	42	43	44			
29	30	31	32	33	34	35	36	9	8	7
21	22	23	24	25	26	27	28	12	11	10
13	14	15	16	17	18	19	20			

Terminal No.	Color of Wire	Signal Name
37	O	SHNP

Connector No.	B8
Connector Name	FRONT DOOR SWITCH LH
Connector Color	WHITE



1
2
3

Terminal No.	Color of Wire	Signal Name
4J	BR	-
10J	SHIELD	-
11J	Y	-
17J	SB	-
22J	BR	-

Connector No.	B1
Connector Name	WIRE TO WIRE
Connector Color	WHITE

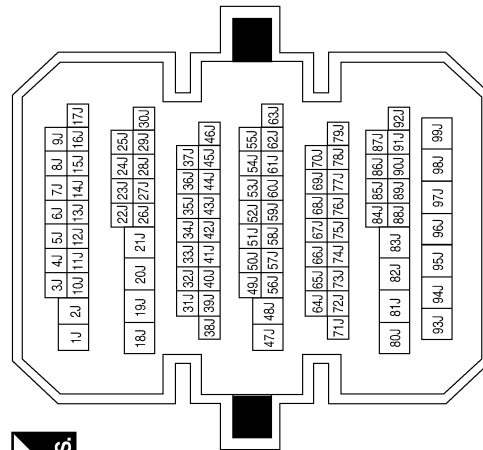

ABK1A2262GB

A  
B  
C  
D  
E  
F  
G  
H  
I  
J  
L  
M  
N  
O  
P

SEC

# INTELLIGENT KEY SYSTEM/ENGINE START FUNCTION

< WIRING DIAGRAM >

[INTELLIGENT KEY SYSTEM]

Connector No.	B104
Connector Name	WIRE TO WIRE
Connector Color	BROWN

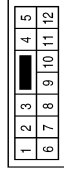

Terminal No.	Color of Wire	Signal Name
10	GR	-
11	B	-

Connector No.	B29
Connector Name	REAR PARCEL SHELF ANTENNA
Connector Color	GRAY



Terminal No.	Color of Wire	Signal Name
1	Y	ANT+
2	BR	ANT-

Connector No.	B18
Connector Name	REAR DOOR SWITCH LH
Connector Color	WHITE



Terminal No.	Color of Wire	Signal Name
2	BR	DOOR SW (RL)

Connector No.	B116
Connector Name	REAR DOOR SWITCH RH
Connector Color	WHITE

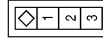

Terminal No.	Color of Wire	Signal Name
2	B	DOOR SW (RR)

Connector No.	B108
Connector Name	FRONT DOOR SWITCH RH
Connector Color	WHITE

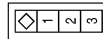

Terminal No.	Color of Wire	Signal Name
2	GR	DOOR SW (AS)

ABK1A2263GB

# VEHICLE SECURITY SYSTEM

[INTELLIGENT KEY SYSTEM]

< WIRING DIAGRAM >

## VEHICLE SECURITY SYSTEM

### Wiring Diagram

INFOID:000000005806161

### VEHICLE SECURITY SYSTEM

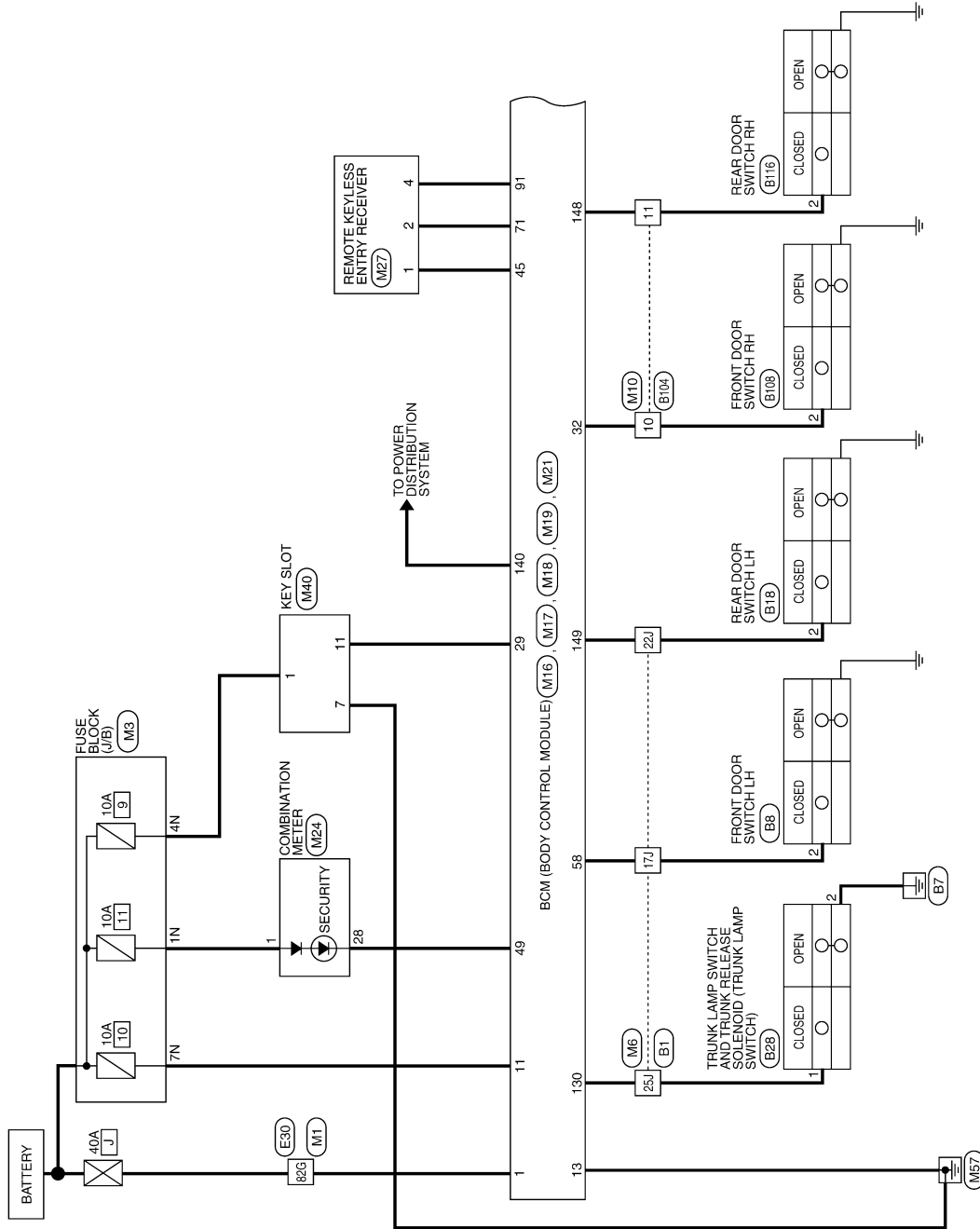

ABKWA0803GB

A  
B  
C  
D  
E  
F  
G  
H  
I  
J  
K  
L  
M  
N  
O  
P

SEC

# VEHICLE SECURITY SYSTEM

< WIRING DIAGRAM >

[INTELLIGENT KEY SYSTEM]

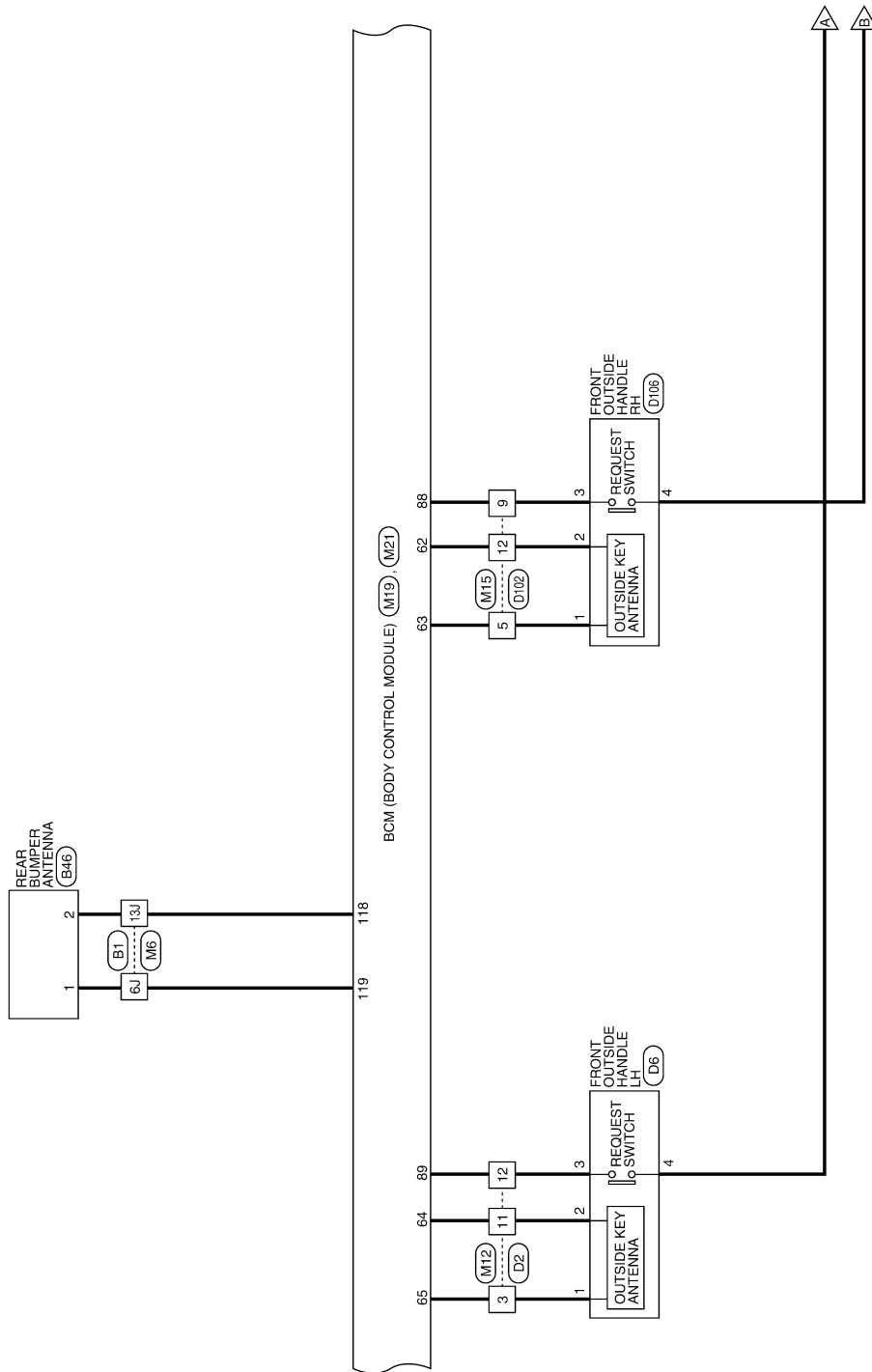

ABKWA0804GB

# VEHICLE SECURITY SYSTEM

[INTELLIGENT KEY SYSTEM]

< WIRING DIAGRAM >

A1 : WITH LEFT FRONT ONLY POWER WINDOW ANTI-PINCH SYSTEM  
 A2 : WITH LEFT AND RIGHT FRONT POWER WINDOW ANTI-PINCH SYSTEM

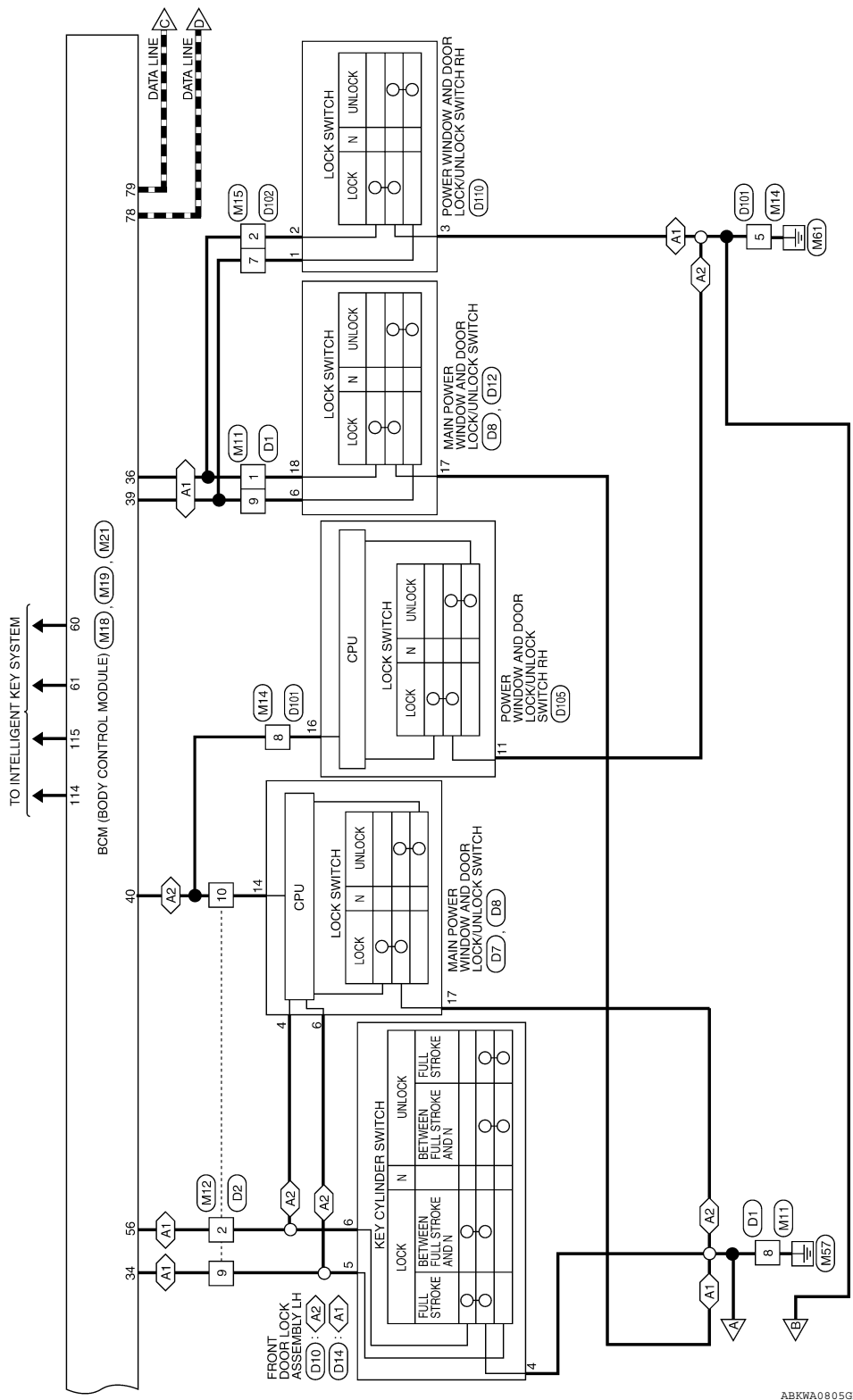

ABKWA0805GB

A  
B  
C  
D  
E  
F  
G  
H  
I  
J  
K  
L  
M  
N  
O  
P

SEC

# VEHICLE SECURITY SYSTEM

[INTELLIGENT KEY SYSTEM]

< WIRING DIAGRAM >

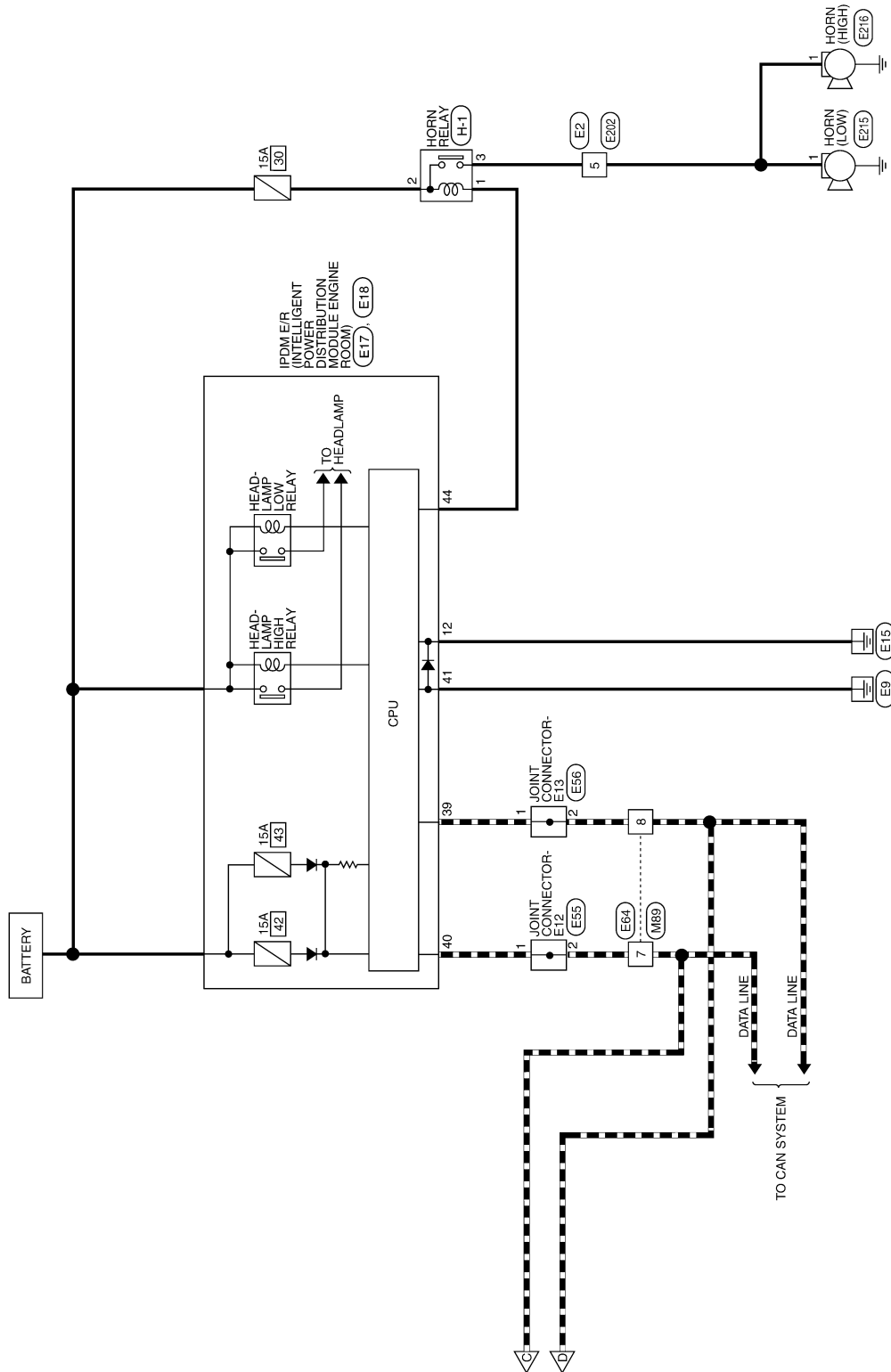

ABKWA0806GB



# VEHICLE SECURITY SYSTEM

[INTELLIGENT KEY SYSTEM]

< WIRING DIAGRAM >

## VEHICLE SECURITY SYSTEM CONNECTORS

Connector No.	M1
Connector Name	WIRE TO WIRE
Connector Color	WHITE

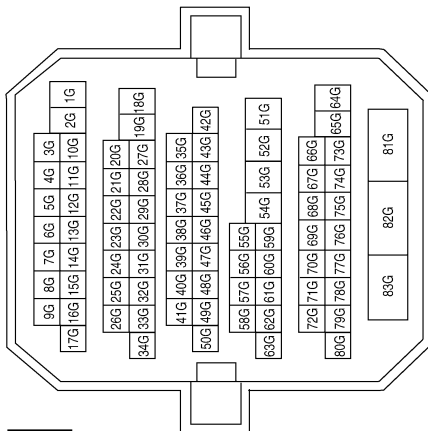

Terminal No.	Color of Wire	Signal Name
82G	W/B	-

Connector No.	M3
Connector Name	FUSE BLOCK (J/B)
Connector Color	WHITE

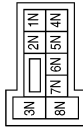

Terminal No.	Color of Wire	Signal Name
1N	W/L	-
4N	G/Y	-
7N	Y/R	-

Connector No.	M6
Connector Name	WIRE TO WIRE
Connector Color	WHITE

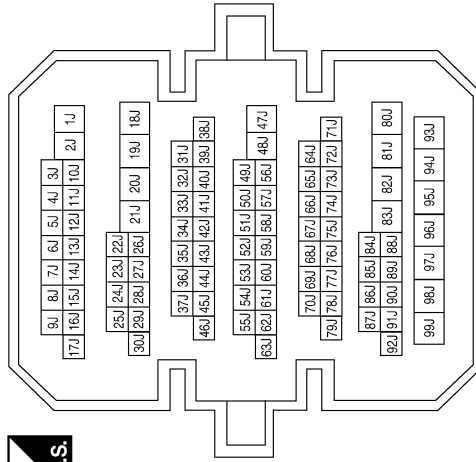

Terminal No.	Color of Wire	Signal Name
6J	BR/W	-
13J	L/O	-
17J	SB	-
22J	R/B	-
25J	Y/G	-

Connector No.	M10
Connector Name	WIRE TO WIRE
Connector Color	BROWN

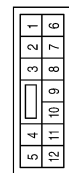

Terminal No.	Color of Wire	Signal Name
10	R/B	-
11	R/W	-

ABK1A2265GB

A B C D E F G H I J L M N O P

SEC

# VEHICLE SECURITY SYSTEM

[INTELLIGENT KEY SYSTEM]

< WIRING DIAGRAM >

Connector No.	M14
Connector Name	WIRE TO WIRE
Connector Color	WHITE

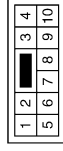

Terminal No.	Color of Wire	Signal Name
5	B	-
8	Y/G	-

Connector No.	M12
Connector Name	WIRE TO WIRE
Connector Color	WHITE



Terminal No.	Color of Wire	Signal Name
2	L/B	-
3	P	-
9	L/R	-
10	Y/G	-
11	V	-
12	B/W	-

Connector No.	M11
Connector Name	WIRE TO WIRE
Connector Color	WHITE

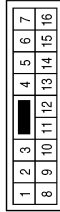

Terminal No.	Color of Wire	Signal Name
1	GR	-
8	B	-
9	GR/R	-

Connector No.	M17
Connector Name	BCM (BODY CONTROL MODULE)
Connector Color	WHITE



Terminal No.	Color of Wire	Signal Name
11	Y/R	BAT_BCM_FUSE
13	B	GND1

Connector No.	M16
Connector Name	BCM (BODY CONTROL MODULE)
Connector Color	BLACK



Terminal No.	Color of Wire	Signal Name
1	W/B	BAT_POWER_F/L

Connector No.	M15
Connector Name	WIRE TO WIRE
Connector Color	WHITE

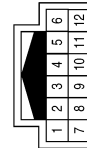

Terminal No.	Color of Wire	Signal Name
2	G/R	-
5	LG	-
7	GR/R	-
9	P/L	-
12	B/Y	-

ABK1A2266GB

# VEHICLE SECURITY SYSTEM

## [INTELLIGENT KEY SYSTEM]

< WIRING DIAGRAM >

Connector No.	M18
Connector Name	BCM (BODY CONTROL MODULE)
Connector Color	GREEN



39	38	37	36	35	34	33	32	31	30	29	28	27	26	25	24	23	22	21	20
59	58	57	56	55	54	53	52	51	50	49	48	47	46	45	44	43	42	41	40

Terminal No.	Color of Wire	Signal Name
29	Y	FOB_IN_SW_1
32	R/B	AS_DOOR_SW
34	L/R	DOOR_KEY/C_UNLOCK_SW
36	GR	CENTRAL_LOCK_SW
39	GR/R	CENTRAL_UNLOCK_SW
40	Y/G	PW_K-LINE
45	P	GND_RF2_A/L
49	L/O	IMMO_LED
56	L/B	DOOR_KEY/C_LOCK_SW
58	SB	DR_DOOR_SW

Connector No.	M19
Connector Name	BCM (BODY CONTROL MODULE)
Connector Color	BLACK



79	78	77	76	75	74	73	72	71	70	69	68	67	66	65	64	63	62	61	60
99	98	97	96	95	94	93	92	91	90	89	88	87	86	85	84	83	82	81	80

Terminal No.	Color of Wire	Signal Name
60	B/R	ROOM_ANT_2_B
61	W/R	ROOM_ANT_2_A
62	B/Y	AS_DOOR_ANT_B
63	LG	AS_DOOR_ANT_A
64	V	DR_DOOR_ANT_B
65	P	DR_DOOR_ANT_A
71	L/O	RF1_TUNER_SIGNAL
78	P	CAN_L
79	L	CAN_H
88	P/L	AS_REQUEST_SWITCH
89	B/W	DR_REQUEST_SWITCH
91	L/R	RF1_POWER_SUPPLY

Connector No.	M21
Connector Name	BCM (BODY CONTROL MODULE)
Connector Color	GRAY



131	130	129	128	127	126	125	124	123	122	121	120	119	118	117	116	115	114	113	112
151	150	149	148	147	146	145	144	143	142	141	140	139	138	137	136	135	134	133	132

Terminal No.	Color of Wire	Signal Name
114	B	TRUNK_ANT_1_B
115	W	TRUNK_ANT_1_A
118	L/O	BACK_DOOR_ANT_B
119	BR/W	BACK_DOOR_ANT_A
130	Y/G	TRUNK_SW
140	BR	ENG_START_SW_W/O_ESCL
148	R/W	RR_DOOR_SW
149	R/B	RL_DOOR_SW

Connector No.	M24
Connector Name	COMBINATION METER
Connector Color	WHITE



1	2	3	4	5	6	7	8	9	10	11	12	13	14	15	16	17	18	19	20
21	22	23	24	25	26	27	28	29	30	31	32	33	34	35	36	37	38	39	40

Terminal No.	Color of Wire	Signal Name
1	W/L	BAT
28	L/O	SECURITY

Connector No.	M27
Connector Name	REMOTE KEYLESS ENTRY RECEIVER
Connector Color	BLACK



1	2	3	4
---	---	---	---

Terminal No.	Color of Wire	Signal Name
1	P	GND
2	L/O	SIGNAL
4	L/R	12V

Connector No.	M40
Connector Name	KEY SLOT
Connector Color	WHITE



1	2	3	4	5	6
7	8	9	10	11	12

Terminal No.	Color of Wire	Signal Name
1	G/Y	B+
7	B	GND
11	Y	CARD SW 1

# VEHICLE SECURITY SYSTEM

## [INTELLIGENT KEY SYSTEM]

< WIRING DIAGRAM >

Connector No.	E17
Connector Name	IPDM E/R (INTELLIGENT POWER DISTRIBUTION MODULE ENGINE ROOM)
Connector Color	WHITE

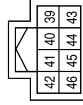

Terminal No.	Color of Wire	Signal Name
39	P	CAN-L
40	L	CAN-H
41	B	GND (SIGNAL)
44	G/W	HORN_RLY

Connector No.	E2
Connector Name	WIRE TO WIRE
Connector Color	WHITE

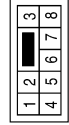

Terminal No.	Color of Wire	Signal Name
5	G	-

Connector No.	M89
Connector Name	WIRE TO WIRE
Connector Color	WHITE

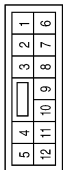

Terminal No.	Color of Wire	Signal Name
7	L	-
8	P	-

Terminal No.	82G	Color of Wire	LG	Signal Name	-
--------------	-----	---------------	----	-------------	---

Connector No.	E30
Connector Name	WIRE TO WIRE
Connector Color	WHITE

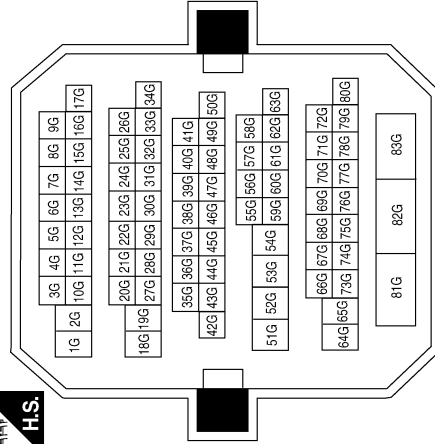

Connector No.	E18
Connector Name	IPDM E/R (INTELLIGENT POWER DISTRIBUTION MODULE ENGINE ROOM)
Connector Color	WHITE

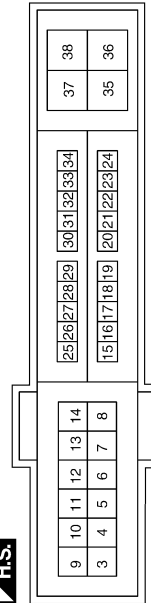

Terminal No.	Color of Wire	Signal Name
12	B	GND (POWER)

ABK1A2268GB

# VEHICLE SECURITY SYSTEM

< WIRING DIAGRAM >

[INTELLIGENT KEY SYSTEM]

Connector No.	E64
Connector Name	WIRE TO WIRE
Connector Color	WHITE

1	2	3	4	5
6	7	8	9	10 11 12



Terminal No.	Color of Wire	Signal Name
7	L	--
8	P	--

Connector No.	E56
Connector Name	JOINT CONNECTOR-E13
Connector Color	WHITE

4	3	2	1
---	---	---	---



Terminal No.	Color of Wire	Signal Name
1	P	--
2	P	--

Connector No.	E55
Connector Name	JOINT CONNECTOR-E12
Connector Color	WHITE

4	3	2	1
---	---	---	---



Terminal No.	Color of Wire	Signal Name
1	L	--
2	L	--

Connector No.	E216
Connector Name	HORN (HIGH)
Connector Color	BLACK



1
---

Terminal No.	Color of Wire	Signal Name
1	G	--

Connector No.	E215
Connector Name	HORN (LOW )
Connector Color	BLACK



1
---

Terminal No.	Color of Wire	Signal Name
1	G	--

Connector No.	E202
Connector Name	WIRE TO WIRE
Connector Color	WHITE



3	2	1
8	7	6 5 4

Terminal No.	Color of Wire	Signal Name
5	G	--

ABK1A2269GB

A  
B  
C  
D  
E  
F  
G  
H  
I  
J  
L  
M  
N  
O  
P

SEC

# VEHICLE SECURITY SYSTEM

< WIRING DIAGRAM >

[INTELLIGENT KEY SYSTEM]

Connector No.	B1
Connector Name	WIRE TO WIRE
Connector Color	WHITE

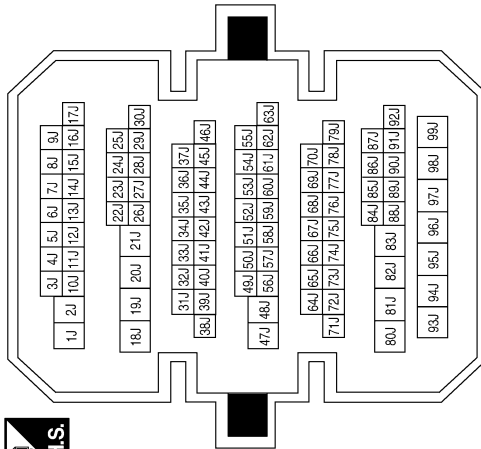

Connector No.	B18
Connector Name	REAR DOOR SWITCH LH
Connector Color	WHITE

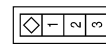

Terminal No.	2	Color of Wire	BR	Signal Name	DOOR SW (RL)
--------------	---	---------------	----	-------------	--------------

Terminal No.	Color of Wire	Signal Name
6J	L	-
13J	LG	-
17J	SB	-
22J	BR	-
25J	W	-

Connector No.	B8
Connector Name	FRONT DOOR SWITCH LH
Connector Color	WHITE

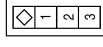

Terminal No.	2	Color of Wire	SB	Signal Name	DOOR SW (DR)
--------------	---	---------------	----	-------------	--------------

Connector No.	B28
Connector Name	TRUNK LAMP SWITCH AND TRUNK RELEASE SOLENOID
Connector Color	WHITE



Terminal No.	Color of Wire	Signal Name
1	W	-
2	B	-

Connector No.	B46
Connector Name	REAR BUMPER ANTENNA
Connector Color	GRAY



Terminal No.	Color of Wire	Signal Name
1	L	ANT+
2	LG	ANT-

# VEHICLE SECURITY SYSTEM

< WIRING DIAGRAM >

[INTELLIGENT KEY SYSTEM]

Connector No.	B116
Connector Name	REAR DOOR SWITCH RH
Connector Color	WHITE

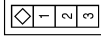

Terminal No.	Color of Wire	Signal Name
2	B	DOOR SW (RR)

Connector No.	B108
Connector Name	FRONT DOOR SWITCH RH
Connector Color	WHITE

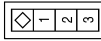

Terminal No.	Color of Wire	Signal Name
2	GR	DOOR SW (AS)

Connector No.	B104
Connector Name	WIRE TO WIRE
Connector Color	BROWN

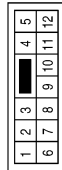

Terminal No.	Color of Wire	Signal Name
10	GR	-
11	B	-

Connector No.	D6
Connector Name	FRONT OUTSIDE HANDLE LH
Connector Color	BLACK

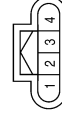

Terminal No.	Color of Wire	Signal Name
1	P	ANT+
2	V	ANT-
3	GR	SW+
4	B	SW-

Connector No.	D2
Connector Name	WIRE TO WIRE
Connector Color	WHITE

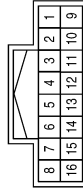

Terminal No.	Color of Wire	Signal Name
2	L/B	-
3	P	-
9	L/R	-
10	BR	-
11	V	-
12	GR	-

Connector No.	D1
Connector Name	WIRE TO WIRE
Connector Color	WHITE

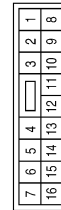

Terminal No.	Color of Wire	Signal Name
1	GR	-
8	B	-
9	GR/R	-

ABKIA2271GB

A  
B  
C  
D  
E  
F  
G  
H  
I  
J  
L  
M  
N  
O  
P

SEC

# VEHICLE SECURITY SYSTEM

[INTELLIGENT KEY SYSTEM]

< WIRING DIAGRAM >

Connector No.	D10
Connector Name	FRONT DOOR LOCK ASSEMBLY LH (WITH LEFT AND RIGHT POWER WINDOW ANTI-PINCH SYSTEM)
Connector Color	GRAY

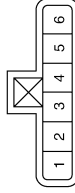

Terminal No.	Color of Wire	Signal Name
4	B	GND
5	L/R	DOOR_KEY/C_UNLOCK_SW
6	L/B	DOOR_KEY/C_LOCK_SW

Connector No.	D8
Connector Name	MAIN POWER WINDOW AND DOOR LOCK/UNLOCK SWITCH
Connector Color	WHITE

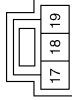

Terminal No.	Color of Wire	Signal Name
17	B	GND
18	GR	LOCK

Connector No.	D7
Connector Name	MAIN POWER WINDOW AND DOOR LOCK/UNLOCK SWITCH (WITH LEFT AND RIGHT FRONT POWER WINDOW ANTI-PINCH SYSTEM)
Connector Color	WHITE

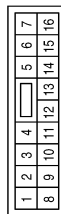

Terminal No.	Color of Wire	Signal Name
4	L/B	LOCK
6	L/R	UNLOCK
14	BR	COM

Connector No.	D101
Connector Name	WIRE TO WIRE
Connector Color	WHITE

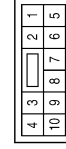

Terminal No.	Color of Wire	Signal Name
5	B	-
8	R	-

Connector No.	D14
Connector Name	FRONT DOOR LOCK ASSEMBLY LH (WITH LEFT FRONT ONLY POWER WINDOW ANTI-PINCH SYSTEM)
Connector Color	GRAY

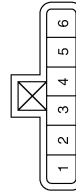

Terminal No.	Color of Wire	Signal Name
4	B	GND
5	L/R	DOOR_KEY/C_UNLOCK_SW
6	L/B	DOOR_KEY/C_LOCK_SW

Connector No.	D12
Connector Name	MAIN POWER WINDOW AND DOOR LOCK/UNLOCK SWITCH (WITH LEFT FRONT ONLY POWER WINDOW ANTI-PINCH SYSTEM)
Connector Color	WHITE



Terminal No.	Color of Wire	Signal Name
6	GR/R	UNLOCK

ABK1A2272GB



# VEHICLE SECURITY SYSTEM

## [INTELLIGENT KEY SYSTEM]

< WIRING DIAGRAM >

Connector No.	D106
Connector Name	FRONT OUTSIDE HANDLE RH
Connector Color	BLACK

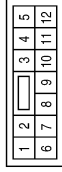

Terminal No.	Color of Wire	Signal Name
1	R	ANT+
2	L	ANT-
3	GR	SW+
4	B	SW-

Connector No.	D105
Connector Name	POWER WINDOW AND DOOR LOCK/UNLOCK SWITCH RH (WITH LEFT AND RIGHT FRONT POWER WINDOW ANTI-PINCH SYSTEM)
Connector Color	WHITE

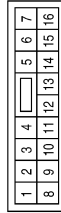

Terminal No.	Color of Wire	Signal Name
11	B	GND
16	R	COM

Connector No.	D102
Connector Name	WIRE TO WIRE
Connector Color	WHITE

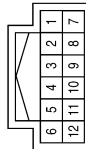

Terminal No.	Color of Wire	Signal Name
2	GR	-
5	R	-
7	GR/R	-
9	GR	-
12	L	-

Terminal No.	Color of Wire	Signal Name
1	W	-
2	SB	-
3	O	-

Connector No.	H-1
Connector Name	FUSE AND FUSIBLE LINK BOX (HORN RELAY)
Connector Color	-

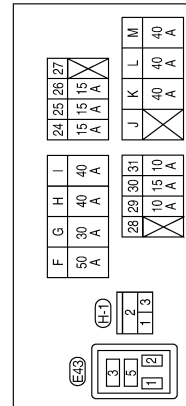

Connector No.	D110
Connector Name	POWER WINDOW AND DOOR LOCK/UNLOCK SWITCH RH (WITH LEFT FRONT ONLY POWER WINDOW ANTI-PINCH SYSTEM)
Connector Color	WHITE

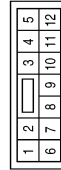

Terminal No.	Color of Wire	Signal Name
1	GR	LOCK
2	GR/R	UNLOCK
3	B	GND

ABK1A2273GB

A  
B  
C  
D  
E  
F  
G  
H  
I  
J  
K  
L  
M  
N  
O  
P

SEC

# NVIS (NISSAN VEHICLE IMMOBILIZER SYSTEM-NATS)

< WIRING DIAGRAM >

[INTELLIGENT KEY SYSTEM]

## NVIS (NISSAN VEHICLE IMMOBILIZER SYSTEM-NATS)

### Wiring Diagram

INFOID:000000005806162

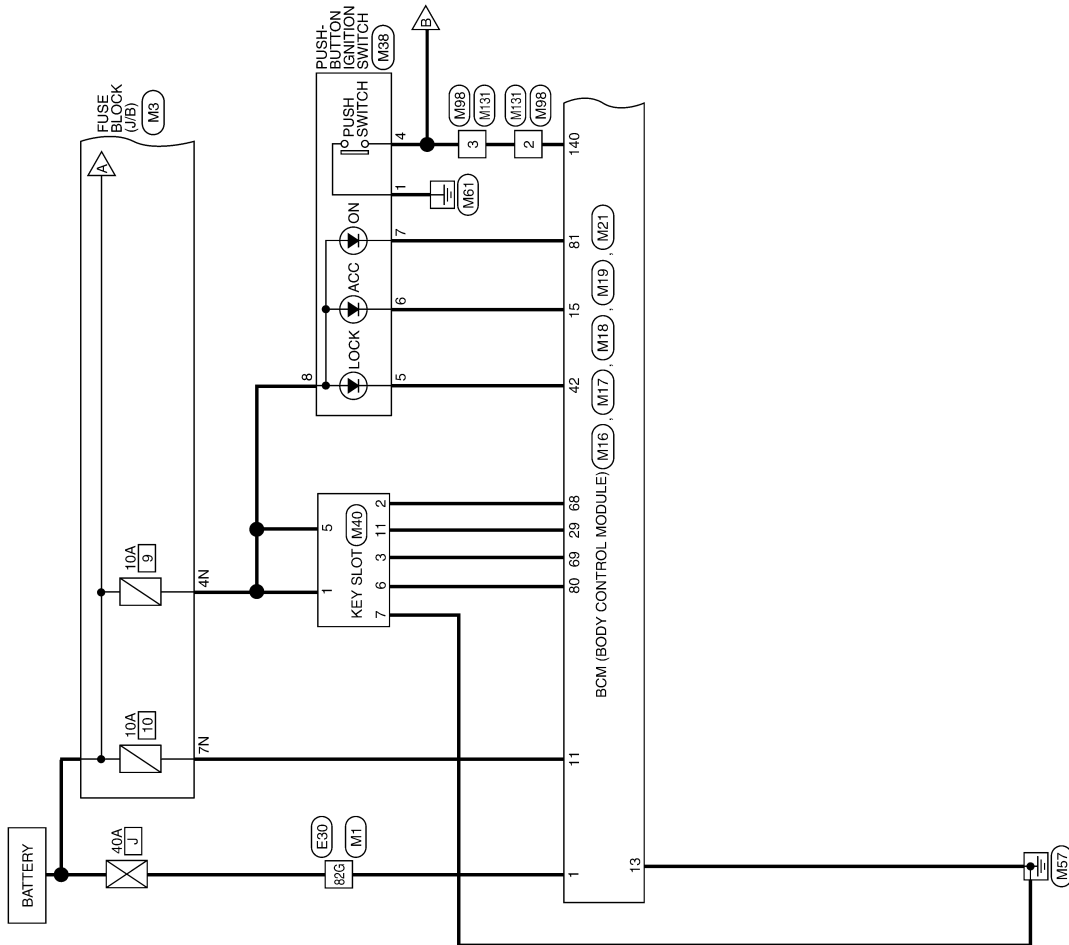

NVIS

ABKWA0807GB

# NVIS (NISSAN VEHICLE IMMOBILIZER SYSTEM-NATS)

< WIRING DIAGRAM >

[INTELLIGENT KEY SYSTEM]

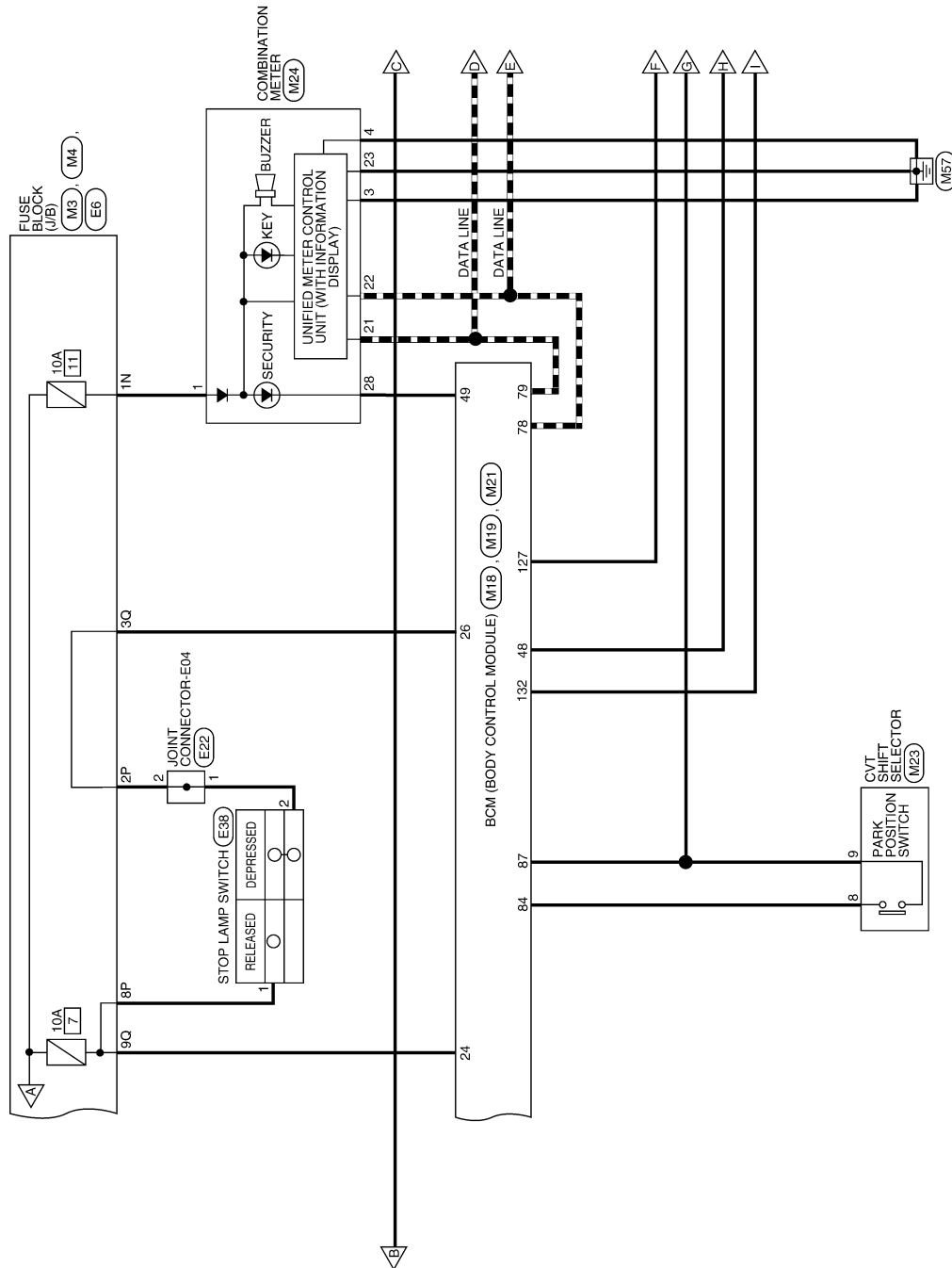

ABKWA0808GB

A  
B  
C  
D  
E  
F  
G  
H  
I  
J  
K  
L  
M  
N  
O  
P

SEC

# NVIS (NISSAN VEHICLE IMMOBILIZER SYSTEM-NATS)

< WIRING DIAGRAM >

[INTELLIGENT KEY SYSTEM]

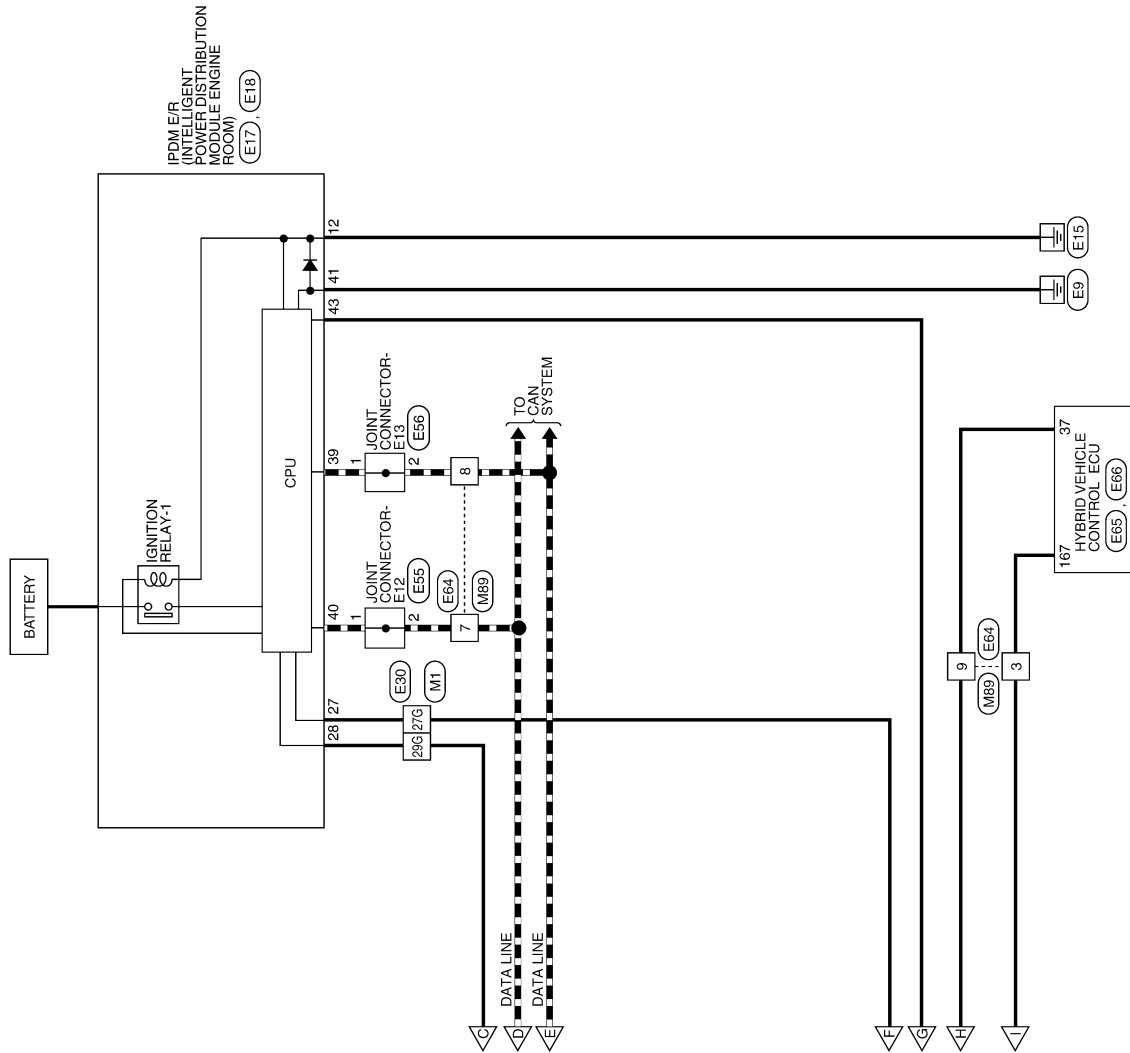

ABKWA0809GB

# NVIS (NISSAN VEHICLE IMMOBILIZER SYSTEM-NATS)

[INTELLIGENT KEY SYSTEM]

< WIRING DIAGRAM >

## NVIS CONNECTORS

Connector No.	M1
Connector Name	WIRE TO WIRE
Connector Color	WHITE

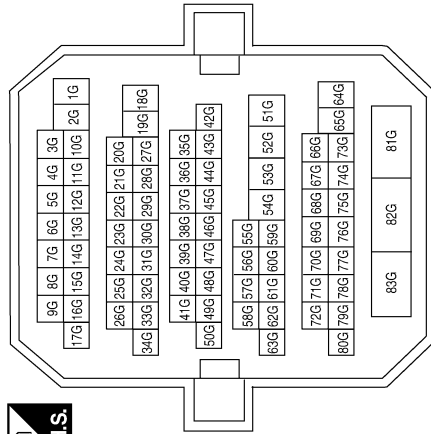

Terminal No.	Color of Wire	Signal Name
27G	BR/W	-
29G	BR	-
82G	W/B	-

Connector No.	M3
Connector Name	FUSE BLOCK (J/B)
Connector Color	WHITE

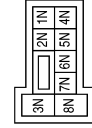

Terminal No.	Color of Wire	Signal Name
1N	W/L	-
4N	G/Y	-
7N	Y/R	-

Connector No.	M4
Connector Name	FUSE BLOCK (J/B)
Connector Color	WHITE

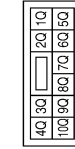

Terminal No.	Color of Wire	Signal Name
3Q	O/L	-
9Q	R/W	-

Connector No.	M16
Connector Name	BCM (BODY CONTROL MODULE)
Connector Color	BLACK



Terminal No.	Color of Wire	Signal Name
1	W/B	BAT_POWER_F/L

Connector No.	M17
Connector Name	BCM (BODY CONTROL MODULE)
Connector Color	WHITE

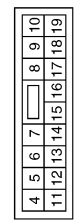

Terminal No.	Color of Wire	Signal Name
11	Y/R	BAT_BCM_FUSE
13	B	GND1
15	Y/L	ACC_LED

A  
B  
C  
D  
E  
F  
G  
H  
I  
J  
K  
L  
M  
N  
O  
P

SEC

# NVIS (NISSAN VEHICLE IMMOBILIZER SYSTEM-NATS)

## [INTELLIGENT KEY SYSTEM]

< WIRING DIAGRAM >

Terminal No.	Color of Wire	Signal Name
78	P	CAN-L
79	L	CAN-H
80	R/L	FOB_SLOT ILLUMINATION
81	LG	IGN_ON_LED
84	Y/R	AT_DEVICE_OUT
87	G/B	SHIFT_P

Connector No.	M19
Connector Name	BCM (BODY CONTROL MODULE)
Connector Color	BLACK



79	78	77	76	75	74	73	72	71	70	69	68	67	66	65	64	63	62	61	60
59	58	57	56	55	54	53	52	51	50	49	48	47	46	45	44	43	42	41	40
39	38	37	36	35	34	33	32	31	30	29	28	27	26	25	24	23	22	21	20

Terminal No.	Color of Wire	Signal Name
68	G/O	FOB_READER_CLOCK
69	O	FOB_READER_DATA

Connector No.	M18
Connector Name	BCM (BODY CONTROL MODULE)
Connector Color	GREEN



39	38	37	36	35	34	33	32	31	30	29	28	27	26	25	24	23	22	21	20
59	58	57	56	55	54	53	52	51	50	49	48	47	46	45	44	43	42	41	40

Terminal No.	Color of Wire	Signal Name
24	R/W	STOP_LAMP_LOW_SW
26	O/L	STOP_LAMP_HIGH_SW
29	Y	FOB_IN_SW_1
42	R	S/L_LOCK_LED
48	R/G	SHIFT_N/P
49	L/O	IMMO_LED

Connector No.	M24
Connector Name	COMBINATION METER
Connector Color	WHITE



1	2	3	4	5	6	7	8	9	10	11	12	13	14	15	16	17	18	19	20
21	22	23	24	25	26	27	28	29	30	31	32	33	34	35	36	37	38	39	40

Terminal No.	Color of Wire	Signal Name
1	W/L	BAT
3	B	GND (POWER)
4	B	GND (ILL)
21	L	CAN-H
22	P	CAN-L
23	B	GND (CIRCUIT)
28	L/O	SECURITY

Connector No.	M23
Connector Name	CVT SHIFT SELECTOR
Connector Color	WHITE



1	3	7	9		
2	4	5	6	8	10

Terminal No.	Color of Wire	Signal Name
8	Y/R	DETENT_KEY_SW
9	G/B	DETENT_KEY_SW

Connector No.	M21
Connector Name	BCM (BODY CONTROL MODULE)
Connector Color	GRAY



131	130	129	128	127	126	125	124	123	122	121	120	119	118	117	116	115	114	113	112
151	150	149	148	147	146	145	144	143	142	141	140	139	138	137	136	135	134	133	132

Terminal No.	Color of Wire	Signal Name
127	BR/W	IGN_USM_CONT1
132	R	ST CONT USM
140	BR	ENG START SW W/O ESCL

ABK1A2275GB

# NVIS (NISSAN VEHICLE IMMOBILIZER SYSTEM-NATS)

## [INTELLIGENT KEY SYSTEM]

< WIRING DIAGRAM >

Connector No.	M89
Connector Name	WIRE TO WIRE
Connector Color	GRAY

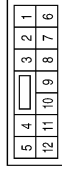

Terminal No.	Color of Wire	Signal Name
3	R	-
7	L	-
8	P	-
9	R/B	-

Connector No.	M40
Connector Name	KEY SLOT
Connector Color	WHITE

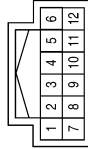

Terminal No.	Color of Wire	Signal Name
1	G/Y	B+
2	G/O	CLOCK
3	O	DATA
5	G/Y	LIGHT_BAT+
6	R/L	LIGHT_A
7	B	GND
11	Y	CARD_SW_1

Connector No.	M38
Connector Name	PUSH-BUTTON IGNITION SWITCH
Connector Color	BROWN

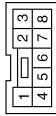

Terminal No.	Color of Wire	Signal Name
1	B	GND
4	BR	START_SW
5	R	LOCK
6	Y/L	ACC
7	LG	ON
8	G/Y	B+

Connector No.	E6
Connector Name	FUSE BLOCK (J/B)
Connector Color	WHITE



Terminal No.	Color of Wire	Signal Name
2P	P	-
8P	R	-

Connector No.	M131
Connector Name	WIRE TO WIRE
Connector Color	WHITE

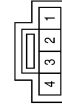

Terminal No.	Color of Wire	Signal Name
2	BR	-
3	BR	-

Connector No.	M98
Connector Name	WIRE TO WIRE
Connector Color	WHITE

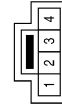

Terminal No.	Color of Wire	Signal Name
2	BR	-
3	BR	-

ABK1A2276GB

A  
B  
C  
D  
E  
F  
G  
H  
I  
J  
L  
M  
N  
O  
P

SEC

# NVIS (NISSAN VEHICLE IMMOBILIZER SYSTEM-NATS)

## [INTELLIGENT KEY SYSTEM]

< WIRING DIAGRAM >

Terminal No.	Color of Wire	Signal Name
12	B	GND (POWER)
27	W	IGN_SIGNAL
28	SB	PUSH_START_SW

Connector No.	E18
Connector Name	IPDM E/R (INTELLIGENT POWER DISTRIBUTION MODULE ENGINE ROOM)
Connector Color	WHITE

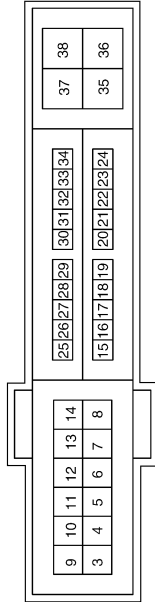

Connector No.	E17
Connector Name	IPDM E/R (INTELLIGENT POWER DISTRIBUTION MODULE ENGINE ROOM)
Connector Color	WHITE



Terminal No.	Color of Wire	Signal Name
39	P	CAN-L
40	L	CAN-H
41	B	GND (SIGNAL)
43	G/B	DETENT_SW

Terminal No.	Color of Wire	Signal Name
27G	W	-
29G	SB	-
82G	LG	-

Connector No.	E30
Connector Name	WIRE TO WIRE
Connector Color	WHITE

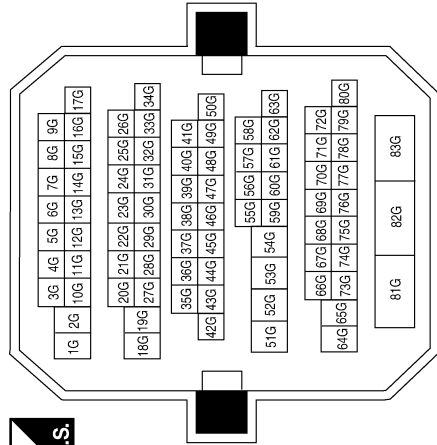

Connector No.	E22
Connector Name	JOINT CONNECTOR-E04
Connector Color	BLACK

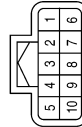

Terminal No.	Color of Wire	Signal Name
1	P	-
2	P	-

ABK1A2277GB



# NVIS (NISSAN VEHICLE IMMOBILIZER SYSTEM-NATS)

< WIRING DIAGRAM >

[INTELLIGENT KEY SYSTEM]

Connector No.	E38
Connector Name	STOP LAMP SWITCH
Connector Color	WHITE



Terminal No.	Color of Wire	Signal Name
1	R	-
2	P	-

Connector No.	E55
Connector Name	JOINT CONNECTOR-E12
Connector Color	WHITE



Terminal No.	Color of Wire	Signal Name
1	L	-
2	L	-

Connector No.	E56
Connector Name	JOINT CONNECTOR-E13
Connector Color	WHITE



Terminal No.	Color of Wire	Signal Name
1	P	-
2	P	-

Connector No.	E64
Connector Name	WIRE TO WIRE
Connector Color	WHITE

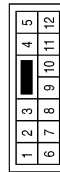

Terminal No.	Color of Wire	Signal Name
3	R	-
7	L	-
8	P	-
9	R/B	-

Connector No.	E65
Connector Name	HYBRID VEHICLE CONTROL ECU
Connector Color	BLACK

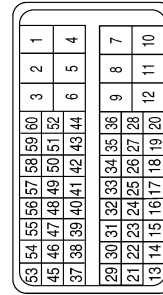

Terminal No.	Color of Wire	Signal Name
37	O	SHNP

A  
B  
C  
D  
E  
F  
G  
H  
I  
J  
L  
M  
N  
O  
P

SEC

# NVIS (NISSAN VEHICLE IMMOBILIZER SYSTEM-NATS)

< WIRING DIAGRAM >

[INTELLIGENT KEY SYSTEM]

Terminal No.	Color of Wire	Signal Name
167	R	ST2

Connector No.	E66	
Connector Name	HYBRID VEHICLE CONTROL ECU	
Connector Color	BLACK	



168	167	166	165	164	163	77	76	75	74	73	72	71	70	69	68	67	66	65	64	63	62	61
174	173	172	171	170	169	111	110	109	108	107	106	105	104	103	102	101	100	99	98	97	96	95
180	179	178	177	176	175	128	127	126	125	124	123	122	121	120	119	118	117	116	115	114	113	112
186	185	184	183	182	181	146	144	143	142	141	140	139	138	137	136	135	134	133	132	131	130	129
						162	161	160	159	158	157	156	155	154	153	152	151	150	149	148	147	146

ABK1A2279GB

# INTELLIGENT KEY SYSTEM/ENGINE START FUNCTION SYMPTOMS

< SYMPTOM DIAGNOSIS >

[INTELLIGENT KEY SYSTEM]

## SYMPTOM DIAGNOSIS

### INTELLIGENT KEY SYSTEM/ENGINE START FUNCTION SYMPTOMS

#### Symptom Table

INFOID:000000005439952

Hybrid system can not be started with all Intelligent Keys.

#### CAUTION:

- Follow Trouble Diagnosis Flowchart referring to “[SEC-4, "Work Flow"](#)”. Determine malfunctioning condition before performing this diagnosis.
- Check that vehicle is under the condition shown in “Conditions of vehicle” before starting diagnosis.
- Check systems shown in the “Diagnosis/service procedure” column in this order.

#### CONDITIONS OF VEHICLE (OPERATING CONDITIONS)

- Engine start function is ON when setting on CONSULT-III.
- Use Intelligent Key with registered Intelligent Key ID.
- One or more of Intelligent Keys with registered Intelligent Key ID is in the passenger compartment.

Diagnosis/service procedure		Reference page
1. Check power supply and ground circuit	BCM	<a href="#">BCS-41</a>
	IPDM E/R	<a href="#">PCS-21</a>
2. Check push button ignition switch		<a href="#">PCS-70</a>
3. Check Intermittent Incident		<a href="#">GI-42</a>

A  
B  
C  
D  
E  
F  
G  
H  
I  
J  
L  
M  
N  
O  
P

SEC

# VEHICLE SECURITY SYSTEM SYMPTOMS

< SYMPTOM DIAGNOSIS >

[INTELLIGENT KEY SYSTEM]

## VEHICLE SECURITY SYSTEM SYMPTOMS

### Symptom Table

INFOID:000000005439953

Procedure		Diagnostic procedure	Refer to page
Symptom			
1	Vehicle security system cannot be set by ....	Door switch	Check door switch <a href="#">DLK-62</a>
		Trunk	Check trunk room lamp switch <a href="#">DLK-86</a>
		Door outside key	Check key cylinder switch (with LH and RH anti-pinch) <a href="#">SEC-66</a>
			Check key cylinder switch (with LH anti-pinch only) <a href="#">SEC-66</a>
		Intelligent Key	Check Intelligent Key battery and function <a href="#">DLK-111</a>
	Check Intermittent Incident <a href="#">GI-42</a>		
	Security indicator does not turn ON.		Check vehicle security indicator <a href="#">SEC-74</a>
		Check Intermittent Incident <a href="#">GI-42</a>	
2	* Vehicle security system does not sound alarm when ....	Any door is opened.	Check door switch <a href="#">DLK-62</a>
			Check Intermittent Incident <a href="#">GI-42</a>
3	Vehicle security alarm does not activate.	Horn alarm	Check horn <a href="#">SEC-70</a>
			Check Intermittent Incident <a href="#">GI-42</a>
	Head lamp alarm	Check head lamp alarm <a href="#">SEC-72</a>	
		Check Intermittent Incident <a href="#">GI-42</a>	
4	Vehicle security system cannot be canceled by ....	Door outside key	Check key cylinder switch (with LH and RH anti-pinch) <a href="#">SEC-66</a>
			Check key cylinder switch (with LH anti-pinch only) <a href="#">SEC-68</a>
		Check Intermittent Incident <a href="#">GI-42</a>	
	Intelligent Key	Check Intelligent Key battery and function <a href="#">DLK-111</a>	
		Check Intermittent Incident <a href="#">GI-42</a>	

\*: Check the system is in the armed phase.

# NISSAN VEHICLE IMMOBILIZER SYSTEM-NATS SYMPTOMS

< SYMPTOM DIAGNOSIS >

[INTELLIGENT KEY SYSTEM]

## NISSAN VEHICLE IMMOBILIZER SYSTEM-NATS SYMPTOMS

### Symptom Table

INFOID:000000005439954

Security indicator does not turn ON or flash.

**CAUTION:**

- Follow Trouble Diagnosis Flowchart referring to “[SEC-4, "Work Flow"](#)”. Determine malfunctioning condition before performing this diagnosis.
- Check that vehicle is under the condition shown in “Conditions of vehicle” before starting diagnosis.
- Check systems shown in the “Action” column in this order.

#### CONDITIONS OF VEHICLE (OPERATING CONDITIONS)

- Intelligent Key is not inserted into key slot.
- Engine switch is not depressed.

Action	Reference page
1. Check vehicle security indicator	<a href="#">SEC-74</a>
2. Check Intermittent Incident	<a href="#">GI-42</a>

A  
B  
C  
D  
E  
F  
G  
H  
I  
J  
L  
M  
N  
O  
P

SEC

## PRECAUTION

### PRECAUTIONS

#### Precaution for Supplemental Restraint System (SRS) "AIR BAG" and "SEAT BELT PRE-TENSIONER"

INFOID:000000005804832

The Supplemental Restraint System such as "AIR BAG" and "SEAT BELT PRE-TENSIONER", used along with a front seat belt, helps to reduce the risk or severity of injury to the driver and front passenger for certain types of collision. This system includes seat belt switch inputs and dual stage front air bag modules. The SRS system uses the seat belt switches to determine the front air bag deployment, and may only deploy one front air bag, depending on the severity of a collision and whether the front occupants are belted or unbelted. Information necessary to service the system safely is included in the SR and SB section of this Service Manual.

**WARNING:**

- To avoid rendering the SRS inoperative, which could increase the risk of personal injury or death in the event of a collision which would result in air bag inflation, all maintenance must be performed by an authorized NISSAN/INFINITI dealer.
- Improper maintenance, including incorrect removal and installation of the SRS, can lead to personal injury caused by unintentional activation of the system. For removal of Spiral Cable and Air Bag Module, see the SR section.
- Do not use electrical test equipment on any circuit related to the SRS unless instructed to in this Service Manual. SRS wiring harnesses can be identified by yellow and/or orange harnesses or harness connectors.

#### PRECAUTIONS WHEN USING POWER TOOLS (AIR OR ELECTRIC) AND HAMMERS

**WARNING:**

- When working near the Airbag Diagnosis Sensor Unit or other Airbag System sensors with the Ignition ON or engine running, DO NOT use air or electric power tools or strike near the sensor(s) with a hammer. Heavy vibration could activate the sensor(s) and deploy the air bag(s), possibly causing serious injury.
- When using air or electric power tools or hammers, always switch the Ignition OFF, disconnect the battery, and wait at least 3 minutes before performing any service.

#### Precautions For High-Voltage System

INFOID:000000005439956

Refer to [GI-24, "Precautions For High-Voltage System"](#).

# PREPARATION

< PREPARATION >

[INTELLIGENT KEY SYSTEM]

## PREPARATION

### PREPARATION

#### Special Service Tool

INFOID:000000005817151

The actual shapes of Kent-Moore tools may differ from those of special service tools illustrated here.

Tool number (Kent-Moore No.) Tool name	Description
— (J-46534) Trim Tool Set	Removing trim components

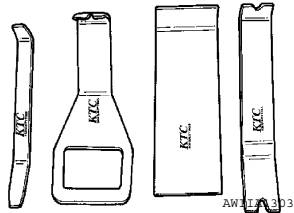

A  
B  
C  
D  
E  
F  
G  
H  
I  
J  
L  
M  
N  
O  
P

SEC

## ON-VEHICLE REPAIR

### KEY SLOT

#### Removal and Installation

INFOID:000000005439958

#### REMOVAL

1. Remove the instrument lower cover (LH). Refer to [IP-11. "Removal and Installation"](#).
2. Disconnect the key slot connector.
3. Remove the key slot screw (A), and then remove the key slot (1) from the instrument lower cover (LH) (2).

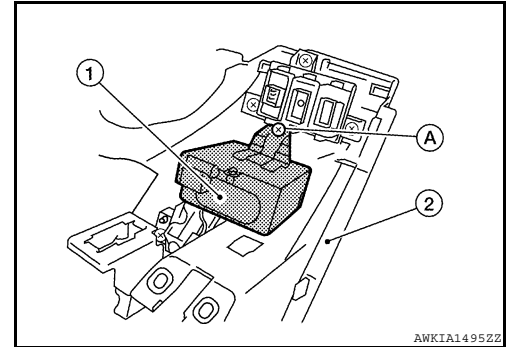

#### INSTALLATION

Installation is in the reverse order of removal.



# PUSH BUTTON IGNITION SWITCH

< ON-VEHICLE REPAIR >

[INTELLIGENT KEY SYSTEM]

## PUSH BUTTON IGNITION SWITCH

### Removal and Installation

INFOID:000000005439959

#### REMOVAL

1. Remove push-button ignition switch from cluster lid A using Tool.

**Tool number** : — (J-46534)

2. Disconnect electrical harness connector from push-button ignition switch.

#### INSTALLATION

Installation is in the reverse order of removal.

A

B

C

D

E

F

G

H

I

J

SEC

L

M

N

O

P