

SECTION **MIR**
MIRRORS

A
B
C
D
E
F
G
H
I
J
K
MIR
M
N
O
P

CONTENTS

PRECAUTION	2	SQUEAK AND RATTLE TROUBLE DIAG- NOSES	13
PRECAUTIONS	2	Work Flow	13
Precaution for Supplemental Restraint System (SRS) "AIR BAG" and "SEAT BELT PRE-TEN- SIONER"	2	Generic Squeak and Rattle Troubleshooting	14
Precaution for Work	2	Diagnostic Worksheet	17
PREPARATION	3	REMOVAL AND INSTALLATION	19
PREPARATION	3	INSIDE MIRROR	19
Special Service Tools	3	Exploded View	19
Commercial Service Tools	3	Removal and Installation	19
WIRING DIAGRAM	4	DOOR MIRROR	20
INSIDE MIRROR	4	Exploded View	20
Wiring Diagram - With Homelink Universal Trans- ceiver	4	Removal and Installation	20
Wiring Diagram - Without Homelink Universal Transceiver	6	DOOR MIRROR GLASS	22
DOOR MIRROR	8	Removal and Installation	22
Wiring Diagram	8	DOOR MIRROR REAR FINISHER	23
SYMPTOM DIAGNOSIS	13	Removal and Installation	23
		DOOR MIRROR ACTUATOR	24
		Removal and Installation	24
		DOOR MIRROR REMOTE CONTROL SWITCH	25
		Removal and Installation	25

PRECAUTIONS

< PRECAUTION >

PRECAUTION

PRECAUTIONS

Precaution for Supplemental Restraint System (SRS) "AIR BAG" and "SEAT BELT PRE-TENSIONER"

INFOID:000000009951574

The Supplemental Restraint System such as "AIR BAG" and "SEAT BELT PRE-TENSIONER", used along with a front seat belt, helps to reduce the risk or severity of injury to the driver and front passenger for certain types of collision. Information necessary to service the system safely is included in the SR and SB section of this Service Manual.

WARNING:

- To avoid rendering the SRS inoperative, which could increase the risk of personal injury or death in the event of a collision which would result in air bag inflation, all maintenance must be performed by an authorized NISSAN/INFINITI dealer.
- Improper maintenance, including incorrect removal and installation of the SRS, can lead to personal injury caused by unintentional activation of the system. For removal of Spiral Cable and Air Bag Module, see the SR section.
- Do not use electrical test equipment on any circuit related to the SRS unless instructed to in this Service Manual. SRS wiring harnesses can be identified by yellow and/or orange harnesses or harness connectors.

PRECAUTIONS WHEN USING POWER TOOLS (AIR OR ELECTRIC) AND HAMMERS

WARNING:

- When working near the Airbag Diagnosis Sensor Unit or other Airbag System sensors with the Ignition ON or engine running, DO NOT use air or electric power tools or strike near the sensor(s) with a hammer. Heavy vibration could activate the sensor(s) and deploy the air bag(s), possibly causing serious injury.
- When using air or electric power tools or hammers, always switch the Ignition OFF, disconnect the battery and wait at least three minutes before performing any service.

Precaution for Work

INFOID:000000009463520

- When removing or disassembling each component, be careful not to damage or deform it. If a component may be subject to interference, be sure to protect it with a shop cloth.
- When removing (disengaging) components with a screwdriver or similar tool, be sure to wrap the component with a shop cloth or vinyl tape to protect it.
- Protect the removed parts with a shop cloth and prevent them from being dropped.
- Replace a deformed or damaged clip.
- If a part is specified as a non-reusable part, always replace it with a new one.
- Be sure to tighten bolts and nuts securely to the specified torque.
- After installation is complete, be sure to check that each part works properly.
- Follow the steps below to clean components:
 - Water soluble dirt:
 - Dip a soft cloth into lukewarm water, wring the water out of the cloth and wipe the dirty area.
 - Then rub with a soft, dry cloth.
 - Oily dirt:
 - Dip a soft cloth into lukewarm water with mild detergent (concentration: within 2 to 3%) and wipe the dirty area.
 - Then dip a cloth into fresh water, wring the water out of the cloth and wipe the detergent off.
 - Then rub with a soft, dry cloth.
 - Do not use organic solvent such as thinner, benzene, alcohol or gasoline.
 - For genuine leather seats, use a genuine leather seat cleaner.

PREPARATION

< PREPARATION >



PREPARATION

PREPARATION

Special Service Tools

INFOID:000000009895301

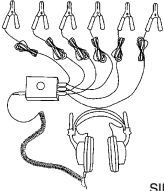
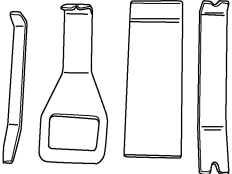
The actual shapes of the tools may differ from those illustrated here.

Tool number (TechMate No.) Tool name	Description
— (J-39570) Chassis Ear  SIA0993E	Locating the noise
— (J-46534) Trim Tool Set  AWJIA0483ZZ	Removing trim components
— (J-50397) NISSAN Squeak and Rattle Kit  ALJIA1232ZZ	Repairing the cause of noise

Commercial Service Tools

INFOID:000000009463522

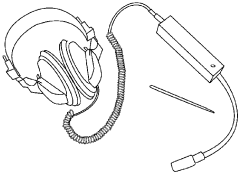
(TechMate No.) Tool name	Description
(J-39565) Engine Ear  SIA0995E	Locating the noise

A
B
C
D
E
F
G
H
I
J
K
MIR
M
N
O
P

INSIDE MIRROR

< WIRING DIAGRAM >

WIRING DIAGRAM

INSIDE MIRROR

Wiring Diagram - With Homelink Universal Transceiver

INFOID:000000009463523

INSIDE MIRROR - WITH HOMELINK UNIVERSAL TRANSCEIVER

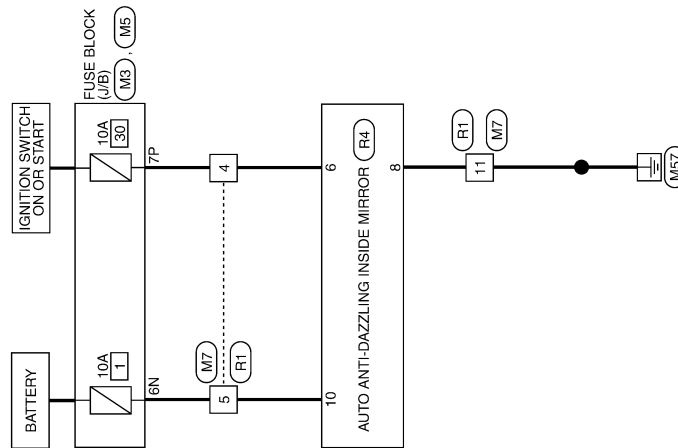

AALWA0465GB

INSIDE MIRROR

< WIRING DIAGRAM >

INSIDE MIRROR CONNECTORS - WITH HOMELINK UNIVERSAL TRANSCEIVER

Connector No.	M3
Connector Name	FUSE BLOCK (J/B)
Connector Color	WHITE

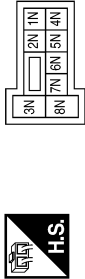

Terminal No.	Color of Wire	Signal Name
6N	W	-

Connector No.	M5
Connector Name	FUSE BLOCK (J/B)
Connector Color	WHITE



Terminal No.	Color of Wire	Signal Name
7P	G	-

Connector No.	M7
Connector Name	WIRE TO WIRE
Connector Color	WHITE

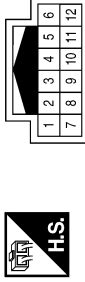

Terminal No.	Color of Wire	Signal Name
4	G	-
5	W	-
11	GR	-

Connector No.	R1
Connector Name	WIRE TO WIRE
Connector Color	WHITE

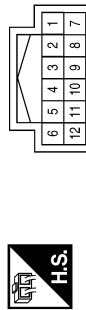

Terminal No.	Color of Wire	Signal Name
4	B/R	-
5	B/Y	-
11	B	-

Connector No.	R4
Connector Name	AUTO ANTI-DAZZLING INSIDE MIRROR (WITH HOMELINK UNIVERSAL TRANSCEIVER)
Connector Color	BLACK

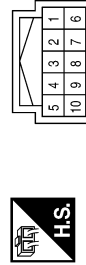

Terminal No.	Color of Wire	Signal Name
6	B/R	-
8	B	-
10	B/Y	-

ABLIA5190GB

A
B
C
D
E
F
G
H
I
J
K
M
N
O
P

MIR

INSIDE MIRROR

< WIRING DIAGRAM >

Wiring Diagram - Without Homelink Universal Transceiver

INFOID:000000009463524

INSIDE MIRROR - WITHOUT HOMELINK UNIVERSAL TRANSCEIVER

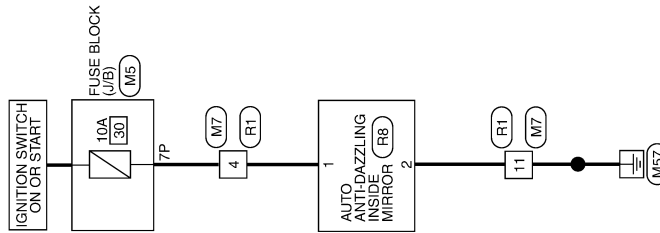

AALWA0464GB

INSIDE MIRROR

< WIRING DIAGRAM >

INSIDE MIRROR CONNECTORS - WITHOUT HOMELINK UNIVERSAL TRANSCIEVER

Connector No.	M5
Connector Name	FUSE BLOCK (J/B)
Connector Color	WHITE



Terminal No.	Color of Wire	Signal Name
7P	G	-

Connector No.	M7
Connector Name	WIRE TO WIRE
Connector Color	WHITE

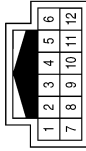

Terminal No.	Color of Wire	Signal Name
4	G	-
11	GR	-

Connector No.	R1
Connector Name	WIRE TO WIRE
Connector Color	WHITE

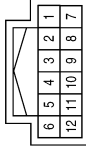

Terminal No.	Color of Wire	Signal Name
4	B/R	-
11	B	-

Connector No.	R8
Connector Name	AUTO ANTI-DAZZLING INSIDE MIRROR (WITHOUT HOMELINK UNIVERSAL TRANSCIEVER)
Connector Color	BLACK

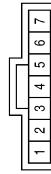

Terminal No.	Color of Wire	Signal Name
1	B/R	-
2	B	-

ABLIA5191GB

A
B
C
D
E
F
G
H
I
J
K
M
N
O
P

MIR

DOOR MIRROR

< WIRING DIAGRAM >

DOOR MIRROR

Wiring Diagram

INFOID:000000009463525

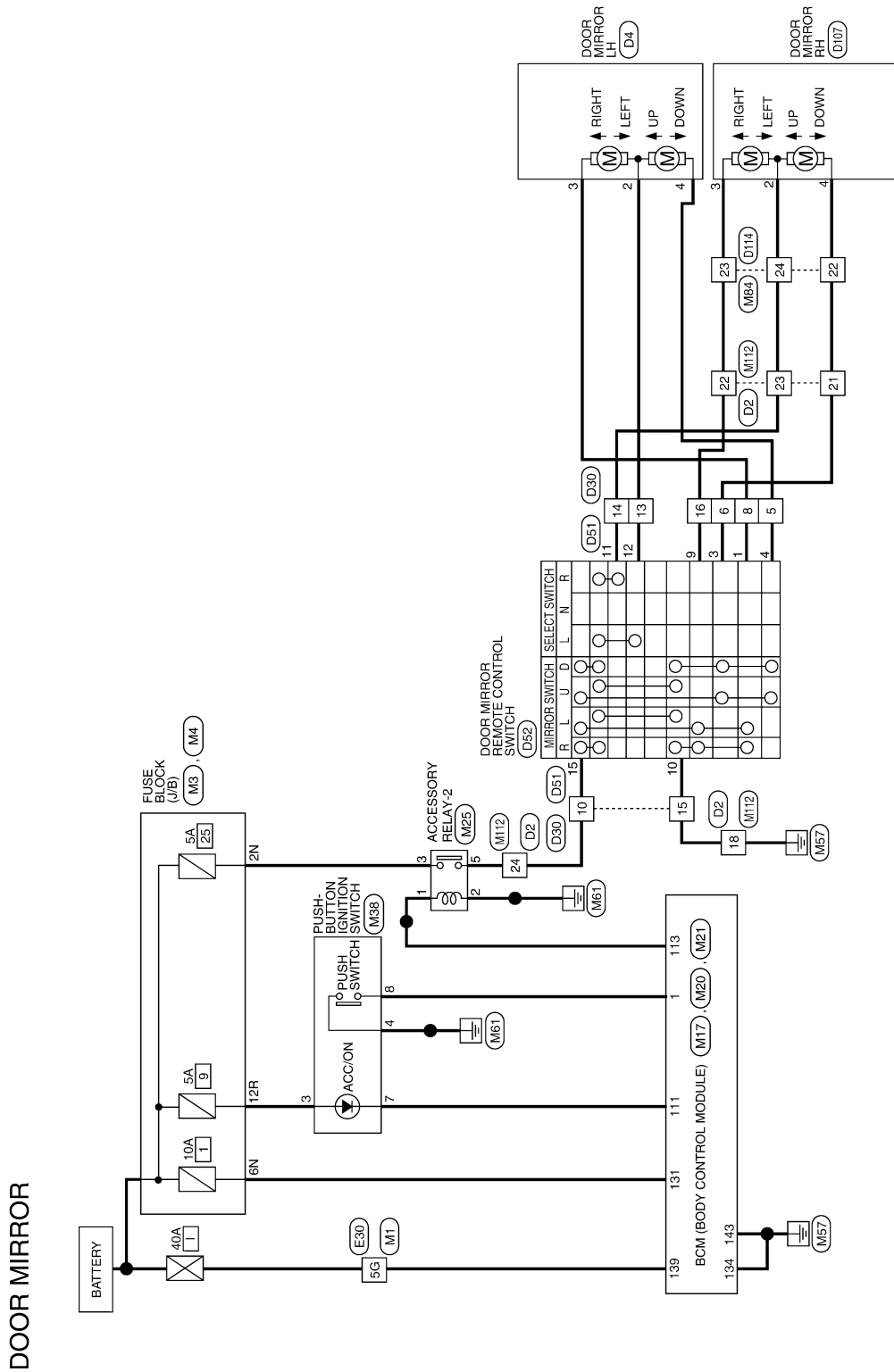

ABLWA2248GB

DOOR MIRROR

< WIRING DIAGRAM >

DOOR MIRROR CONNECTORS

Connector No.	M1
Connector Name	WIRE TO WIRE
Connector Color	WHITE

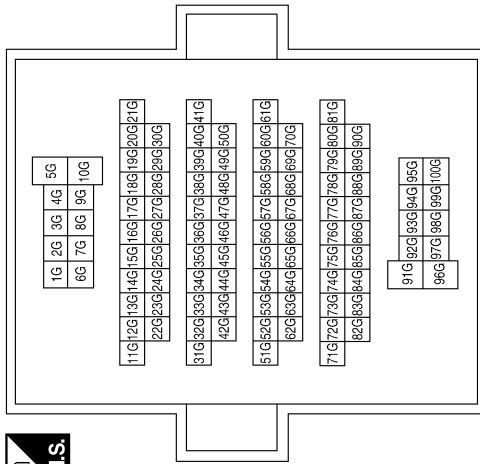

Terminal No.	5G	W	Signal Name	-
--------------	----	---	-------------	---

Connector No.	M3
Connector Name	FUSE BLOCK (J/B)
Connector Color	WHITE

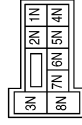

Terminal No.	Color of Wire	Signal Name
2N	LG	-
6N	W	-

Connector No.	M4
Connector Name	FUSE BLOCK (J/B)
Connector Color	BROWN



Connector No.	M17
Connector Name	BCM (BODY CONTROL MODULE)
Connector Color	GREEN

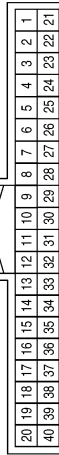

Terminal No.	12R	W	Signal Name	-
--------------	-----	---	-------------	---

Connector No.	M20
Connector Name	BCM (BODY CONTROL MODULE)
Connector Color	BLACK

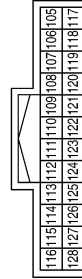

Terminal No.	111	Y	Signal Name	ACC LED
Terminal No.	113	P	Signal Name	ACC RELAY OUT

ABLIA5202GB

DOOR MIRROR

< WIRING DIAGRAM >

Connector No.	M21
Connector Name	BCM (BODY CONTROL MODULE)
Connector Color	WHITE

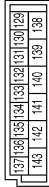

Terminal No.	Color of Wire	Signal Name
131	W	BAT BCM FUSE
134	B	GND2
139	W	BAT POWER F/L
143	B	GND1

Connector No.	M25
Connector Name	ACCESSORY RELAY-2
Connector Color	BLUE



Terminal No.	Color of Wire	Signal Name
1	W	-
2	B	-
3	LG	-
5	P	-

Connector No.	M38
Connector Name	PUSH-BUTTON IGNITION SWITCH
Connector Color	WHITE

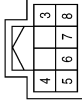

Terminal No.	Color of Wire	Signal Name
3	W	-
4	B	-
7	Y	-
8	R	-

Connector No.	M84
Connector Name	WIRE TO WIRE
Connector Color	WHITE

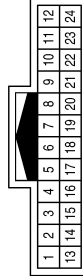

Terminal No.	Color of Wire	Signal Name
22	W	-
23	G	-
24	BG	-

Connector No.	M112
Connector Name	WIRE TO WIRE
Connector Color	WHITE

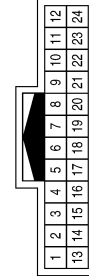

Terminal No.	Color of Wire	Signal Name
18	B	-
21	W	-
22	G	-
23	BG	-
24	P	-

DOOR MIRROR

< WIRING DIAGRAM >

Connector No.	D2
Connector Name	WIRE TO WIRE
Connector Color	WHITE

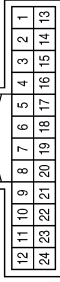

Terminal No.	Color of Wire	Signal Name
18	B	-
21	BG	-
22	P	-
23	W	-
24	G	-

Terminal No.	Color of Wire	Signal Name
5G	P	-

Connector No.	E30
Connector Name	WIRE TO WIRE
Connector Color	WHITE

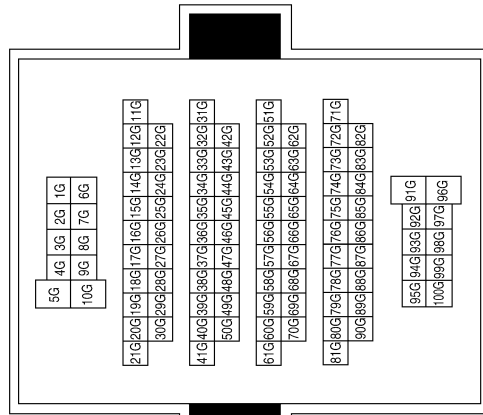

Terminal No.	Color of Wire	Signal Name
5	R	-
6	BG	-
8	W	-
10	G	-
13	P	-
14	W	-
15	B	-
16	P	-

Connector No.	D30
Connector Name	WIRE TO WIRE
Connector Color	WHITE

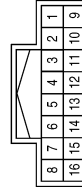

Connector No.	D4
Connector Name	DOOR MIRROR LH
Connector Color	WHITE

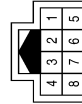

Terminal No.	Color of Wire	Signal Name
2	P	-
3	W	-
4	R	-

ABLIA5203GB

A B C D E F G H I J K M N O P



DOOR MIRROR

< WIRING DIAGRAM >

Connector No.	D51
Connector Name	WIRE TO WIRE
Connector Color	WHITE

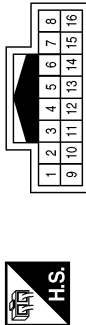

Terminal No.	Color of Wire	Signal Name
5	R	-
6	BR	-
8	W	-
10	G	-
13	P	-
14	W	-
15	B	-
16	GR	-

Connector No.	D52
Connector Name	DOOR MIRROR REMOTE CONTROL SWITCH
Connector Color	WHITE

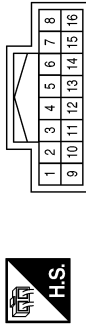

Terminal No.	Color of Wire	Signal Name
1	W	-
3	BR	-
4	R	-
9	GR	-
10	B	-
11	W	-
12	P	-
15	G	-

Connector No.	D107
Connector Name	DOOR MIRROR RH
Connector Color	WHITE



Terminal No.	Color of Wire	Signal Name
2	R	-
3	W	-
4	P	-

Connector No.	D114
Connector Name	WIRE TO WIRE
Connector Color	WHITE

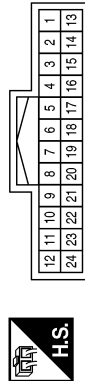

Terminal No.	Color of Wire	Signal Name
22	P	-
23	W	-
24	R	-

ABLIA5193GB

SQUEAK AND RATTLE TROUBLE DIAGNOSES

< SYMPTOM DIAGNOSIS >

SYMPTOM DIAGNOSIS

SQUEAK AND RATTLE TROUBLE DIAGNOSES

Work Flow

INFOID:000000009895302

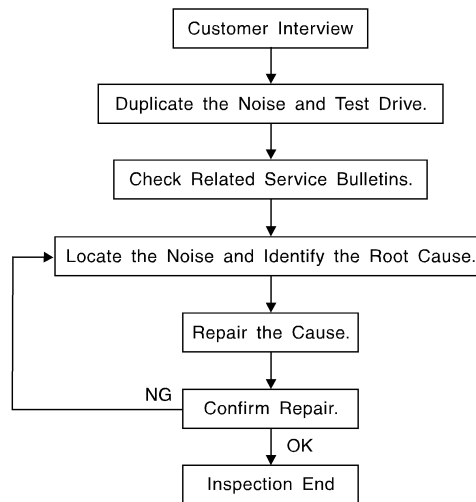

SBT842

CUSTOMER INTERVIEW

Interview the customer if possible, to determine the conditions that exist when the noise occurs. Use the Diagnostic Worksheet during the interview to document the facts and conditions when the noise occurs and any customer's comments; refer to [MIR-17. "Diagnostic Worksheet"](#). This information is necessary to duplicate the conditions that exist when the noise occurs.

- The customer may not be able to provide a detailed description or the location of the noise. Attempt to obtain all the facts and conditions that exist when the noise occurs (or does not occur).
- If there is more than one noise in the vehicle, be sure to diagnose and repair the noise that the customer is concerned about. This can be accomplished by test driving the vehicle with the customer.
- After identifying the type of noise, isolate the noise in terms of its characteristics. The noise characteristics are provided so the customer, service adviser and technician are all speaking the same language when defining the noise.
- Squeak —(Like tennis shoes on a clean floor)
Squeak characteristics include the light contact/fast movement/brought on by road conditions/hard surfaces = higher pitch noise/softer surfaces = lower pitch noises/edge to surface = chirping.
- Creak—(Like walking on an old wooden floor)
Creak characteristics include firm contact/slow movement/twisting with a rotational movement/pitch dependent on materials/often brought on by activity.
- Rattle—(Like shaking a baby rattle)
Rattle characteristics include the fast repeated contact/vibration or similar movement/loose parts/missing clip or fastener/incorrect clearance.
- Knock —(Like a knock on a door)
Knock characteristics include hollow sounding/sometimes repeating/often brought on by driver action.
- Tick—(Like a clock second hand)
Tick characteristics include gentle contacting of light materials/loose components/can be caused by driver action or road conditions.
- Thump—(Heavy, muffled knock noise)
Thump characteristics include softer knock/dead sound often brought on by activity.
- Buzz—(Like a bumble bee)
Buzz characteristics include high frequency rattle/firm contact.
- Often the degree of acceptable noise level will vary depending upon the person. A noise that you may judge as acceptable may be very irritating to the customer.
- Weather conditions, especially humidity and temperature, may have a great effect on noise level.

DUPLICATE THE NOISE AND TEST DRIVE

SQUEAK AND RATTLE TROUBLE DIAGNOSES

< SYMPTOM DIAGNOSIS >

If possible, drive the vehicle with the customer until the noise is duplicated. Note any additional information on the Diagnostic Worksheet regarding the conditions or location of the noise. This information can be used to duplicate the same conditions when you confirm the repair.

If the noise can be duplicated easily during the test drive, to help identify the source of the noise, try to duplicate the noise with the vehicle stopped by doing one or all of the following:

- 1) Close a door.
 - 2) Tap or push/pull around the area where the noise appears to be coming from.
 - 3) Rev the engine.
 - 4) Use a floor jack to recreate vehicle "twist".
 - 5) At idle, apply engine load (electrical load, half-clutch on M/T model, drive position on CVT and A/T models).
 - 6) Raise the vehicle on a hoist and hit a tire with a rubber hammer.
- Drive the vehicle and attempt to duplicate the conditions the customer states exist when the noise occurs.
 - If it is difficult to duplicate the noise, drive the vehicle slowly on an undulating or rough road to stress the vehicle body.

CHECK RELATED SERVICE BULLETINS

After verifying the customer concern or symptom, check ASIST for Technical Service Bulletins (TSBs) related to that concern or symptom.

If a TSB relates to the symptom, follow the procedure to repair the noise.

LOCATE THE NOISE AND IDENTIFY THE ROOT CAUSE

1. Narrow down the noise to a general area. To help pinpoint the source of the noise, use a listening tool (Chassis Ear: J-39570, Engine Ear: J-39565 and mechanic's stethoscope).
2. Narrow down the noise to a more specific area and identify the cause of the noise by:
 - removing the components in the area that you suspect the noise is coming from.
Do not use too much force when removing clips and fasteners, otherwise clips and fasteners can be broken or lost during the repair, resulting in the creation of new noise.
 - tapping or pushing/pulling the component that you suspect is causing the noise.
Do not tap or push/pull the component with excessive force, otherwise the noise will be eliminated only temporarily.
 - feeling for a vibration with your hand by touching the component(s) that you suspect is (are) causing the noise.
 - placing a piece of paper between components that you suspect are causing the noise.
 - looking for loose components and contact marks.
Refer to [MIR-14, "Generic Squeak and Rattle Troubleshooting"](#).

REPAIR THE CAUSE

- If the cause is a loose component, tighten the component securely.
- If the cause is insufficient clearance between components:
 - separate components by repositioning or loosening and retightening the component, if possible.
 - insulate components with a suitable insulator such as urethane pads, foam blocks, felt cloth tape or urethane tape. A NISSAN Squeak and Rattle Kit (J-50397) is available through your authorized NISSAN Parts Department.

CAUTION:

Do not use excessive force as many components are constructed of plastic and may be damaged.

NOTE:

- Always check with the Parts Department for the latest parts information.
- The materials contained in the NISSAN Squeak and Rattle Kit (J-50397) are listed on the inside cover of the kit; and can each be ordered separately as needed.
- The following materials not found in the kit can also be used to repair squeaks and rattles.
 - SILICONE GREASE: Use instead of UHMW tape that will be visible or does not fit. The silicone grease will only last a few months.
 - SILICONE SPRAY: Use when grease cannot be applied.
 - DUCT TAPE: Use to eliminate movement.

CONFIRM THE REPAIR

Confirm that the cause of a noise is repaired by test driving the vehicle. Operate the vehicle under the same conditions as when the noise originally occurred. Refer to the notes on the Diagnostic Worksheet.

Generic Squeak and Rattle Troubleshooting

INFOID:000000009895303

Refer to Table of Contents for specific component removal and installation information.

SQUEAK AND RATTLE TROUBLE DIAGNOSES

< SYMPTOM DIAGNOSIS >

INSTRUMENT PANEL

Most incidents are caused by contact and movement between:

1. Cluster lid A and the instrument panel
2. Acrylic lens and combination meter housing
3. Instrument panel to front pillar finisher
4. Instrument panel to windshield
5. Instrument panel pins
6. Wiring harnesses behind the combination meter
7. A/C defroster duct and duct joint

These incidents can usually be located by tapping or moving the components to duplicate the noise or by pressing on the components while driving to stop the noise. Most of these incidents can be repaired by applying felt cloth tape or silicone spray (in hard to reach areas). Urethane pads can be used to insulate wiring harness.

CAUTION:

Do not use silicone spray to isolate a squeak or rattle. If you saturate the area with silicone, you will not be able to recheck the repair.

CENTER CONSOLE

Components to pay attention to include:

1. Shift selector assembly cover to finisher
2. A/C control unit and cluster lid C
3. Wiring harnesses behind audio and A/C control unit

The instrument panel repair and isolation procedures also apply to the center console.

DOORS

Pay attention to the:

1. Finisher and inner panel making a slapping noise
2. Inside handle escutcheon to door finisher
3. Wiring harnesses tapping
4. Door striker out of alignment causing a popping noise on starts and stops

Tapping or moving the components or pressing on them while driving to duplicate the conditions can isolate many of these incidents. You can usually insulate the areas with felt cloth tape or insulator foam blocks from the NISSAN Squeak and Rattle Kit (J-50397) to repair the noise.

TRUNK

Trunk noises are often caused by a loose jack or loose items put into the trunk by the owner.

In addition look for:

1. Trunk lid bumpers out of adjustment
2. Trunk lid striker out of adjustment
3. The trunk lid torsion bars knocking together
4. A loose license plate or bracket

Most of these incidents can be repaired by adjusting, securing or insulating the item(s) or component(s) causing the noise.

SUNROOF/HEADLINING

Noises in the sunroof/headlining area can often be traced to one of the following:

1. Sunroof lid, rail, linkage or seals making a rattle or light knocking noise
2. Sun visor shaft shaking in the holder
3. Front or rear windshield touching headlining and squeaking

Again, pressing on the components to stop the noise while duplicating the conditions can isolate most of these incidents. Repairs usually consist of insulating with felt cloth tape.

OVERHEAD CONSOLE (FRONT AND REAR)

Overhead console noises are often caused by the console panel clips not being engaged correctly. Most of these incidents are repaired by pushing up on the console at the clip locations until the clips engage.

In addition look for:

A

B

C

D

E

F

G

H

I

J

K

MIR

M

N

O

P

SQUEAK AND RATTLE TROUBLE DIAGNOSES

< SYMPTOM DIAGNOSIS >

1. Loose harness or harness connectors.
2. Front console map/reading lamp lens loose.
3. Loose screws at console attachment points.

SEATS

When isolating seat noise it's important to note the position the seat is in and the load placed on the seat when the noise is present. These conditions should be duplicated when verifying and isolating the cause of the noise.

Cause of seat noise include:

1. Headrest rods and holder
2. A squeak between the seat pad cushion and frame
3. The rear seatback lock and bracket

These noises can be isolated by moving or pressing on the suspected components while duplicating the conditions under which the noise occurs. Most of these incidents can be repaired by repositioning the component or applying urethane tape to the contact area.

UNDERHOOD

Some interior noise may be caused by components under the hood or on the engine wall. The noise is then transmitted into the passenger compartment.

Causes of transmitted underhood noise include:

1. Any component installed to the engine wall
2. Components that pass through the engine wall
3. Engine wall mounts and connectors
4. Loose radiator installation pins
5. Hood bumpers out of adjustment
6. Hood striker out of adjustment

These noises can be difficult to isolate since they cannot be reached from the interior of the vehicle. The best method is to secure, move or insulate one component at a time and test drive the vehicle. Also, engine rpm or load can be changed to isolate the noise. Repairs can usually be made by moving, adjusting, securing, or insulating the component causing the noise.

SQUEAK AND RATTLE TROUBLE DIAGNOSES

< SYMPTOM DIAGNOSIS >

Diagnostic Worksheet

INFOID:000000009895304

Dear Customer:

We are concerned about your satisfaction with your vehicle. Repairing a squeak or rattle sometimes can be very difficult. To help us fix your vehicle right the first time, please take a moment to note the area of the vehicle where the squeak or rattle occurs and under what conditions. You may be asked to take a test drive with a service advisor or technician to ensure we confirm the noise you are hearing.

SQUEAK & RATTLE DIAGNOSTIC WORKSHEET

I. WHERE DOES THE NOISE COME FROM? (circle the area of the vehicle)

The illustrations are for reference only, and may not reflect the actual configuration of your vehicle.

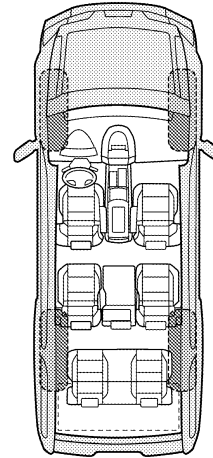
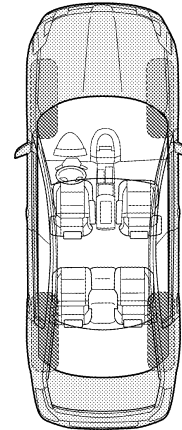
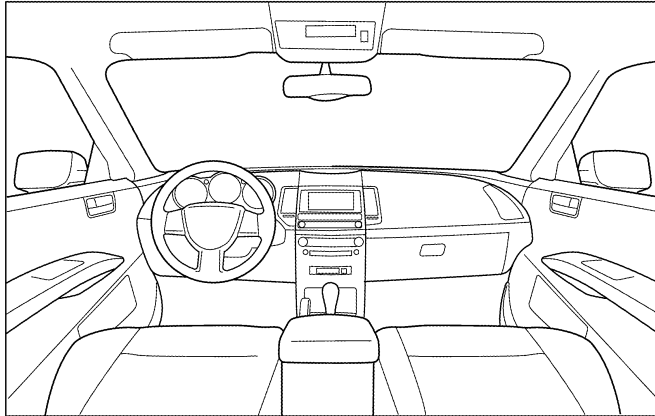

Continue to page 2 of the worksheet and briefly describe the location of the noise or rattle. In addition, please indicate the conditions which are present when the noise occurs.

A
B
C
D
E
F
G
H
I
J
K
M
N
O
P

MIR

SQUEAK AND RATTLE TROUBLE DIAGNOSES

< SYMPTOM DIAGNOSIS >

SQUEAK & RATTLE DIAGNOSTIC WORKSHEET - page 2

Briefly describe the location where the noise occurs:

II. WHEN DOES IT OCCUR? (please check the boxes that apply)

- | | |
|-------------------------------------------------------|--------------------------------------------------------|
| <input type="checkbox"/> Anytime | <input type="checkbox"/> After sitting out in the rain |
| <input type="checkbox"/> 1st time in the morning | <input type="checkbox"/> When it is raining or wet |
| <input type="checkbox"/> Only when it is cold outside | <input type="checkbox"/> Dry or dusty conditions |
| <input type="checkbox"/> Only when it is hot outside | <input type="checkbox"/> Other: |

III. WHEN DRIVING:

- Through driveways
- Over rough roads
- Over speed bumps
- Only about ____ mph
- On acceleration
- Coming to a stop
- On turns: left, right or either (circle)
- With passengers or cargo
- Other: _____
- After driving ____ miles or ____ minutes

IV. WHAT TYPE OF NOISE

- Squeak (like tennis shoes on a clean floor)
- Creak (like walking on an old wooden floor)
- Rattle (like shaking a baby rattle)
- Knock (like a knock at the door)
- Tick (like a clock second hand)
- Thump (heavy muffled knock noise)
- Buzz (like a bumble bee)

TO BE COMPLETED BY DEALERSHIP PERSONNEL

Test Drive Notes:

	YES	NO	Initials of person performing
Vehicle test driven with customer	<input type="checkbox"/>	<input type="checkbox"/>	_____
- Noise verified on test drive	<input type="checkbox"/>	<input type="checkbox"/>	_____
- Noise source located and repaired	<input type="checkbox"/>	<input type="checkbox"/>	_____
- Follow up test drive performed to confirm repair	<input type="checkbox"/>	<input type="checkbox"/>	_____

VIN: _____ Customer Name _____

W.O.# _____ Date: _____

This form must be attached to Work Order

LAI0071E

INSIDE MIRROR

< REMOVAL AND INSTALLATION >

REMOVAL AND INSTALLATION

INSIDE MIRROR

Exploded View

INFOID:000000009463529

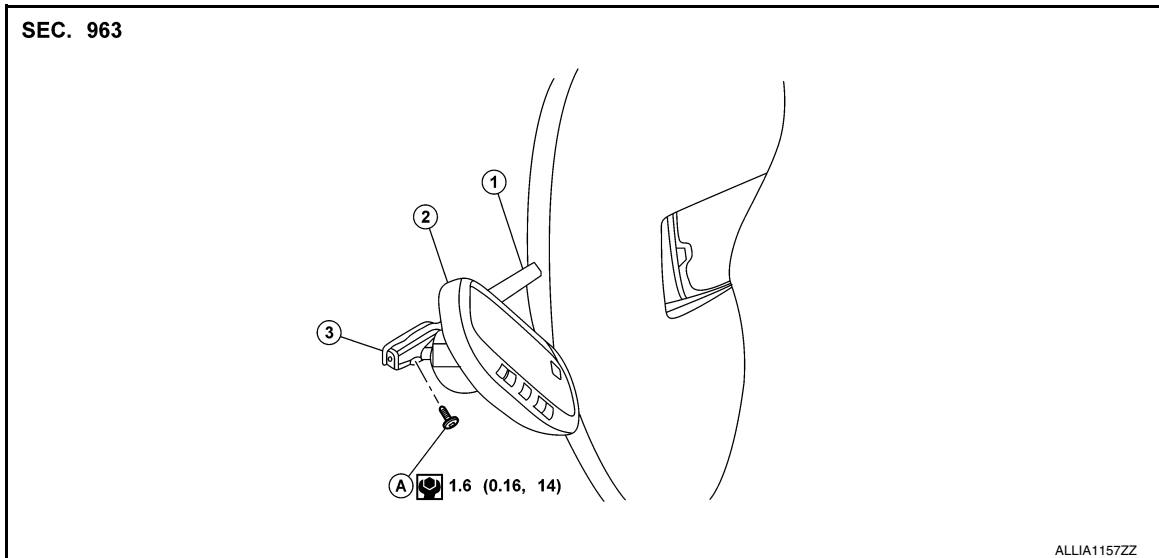

1. Inside mirror harness 2. Inside mirror 3. Mirror base
A. Screw

Removal and Installation

INFOID:000000009463530

REMOVAL

1. Remove the inside mirror base screw.
2. Disconnect the harness connector from the inside mirror.
3. Slide the inside mirror upward and remove.

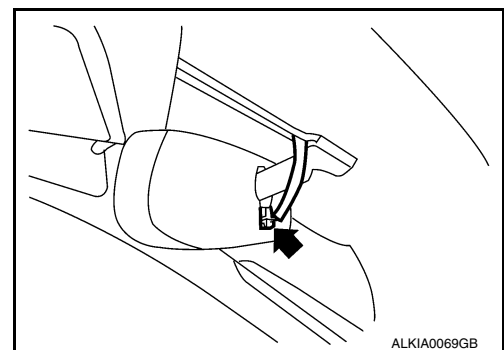

INSTALLATION

Installation is in the reverse order of removal.

CAUTION:

Apply Genuine Mirror Adhesive or equivalent to bonding surface of mirror base. Refer to [GI-21, "Recommended Chemical Products and Sealants"](#).

A
B
C
D
E
F
G
H
I
J
K
M
N
O
P

MIR

DOOR MIRROR

< REMOVAL AND INSTALLATION >

DOOR MIRROR

Exploded View

INFOID:000000009463531

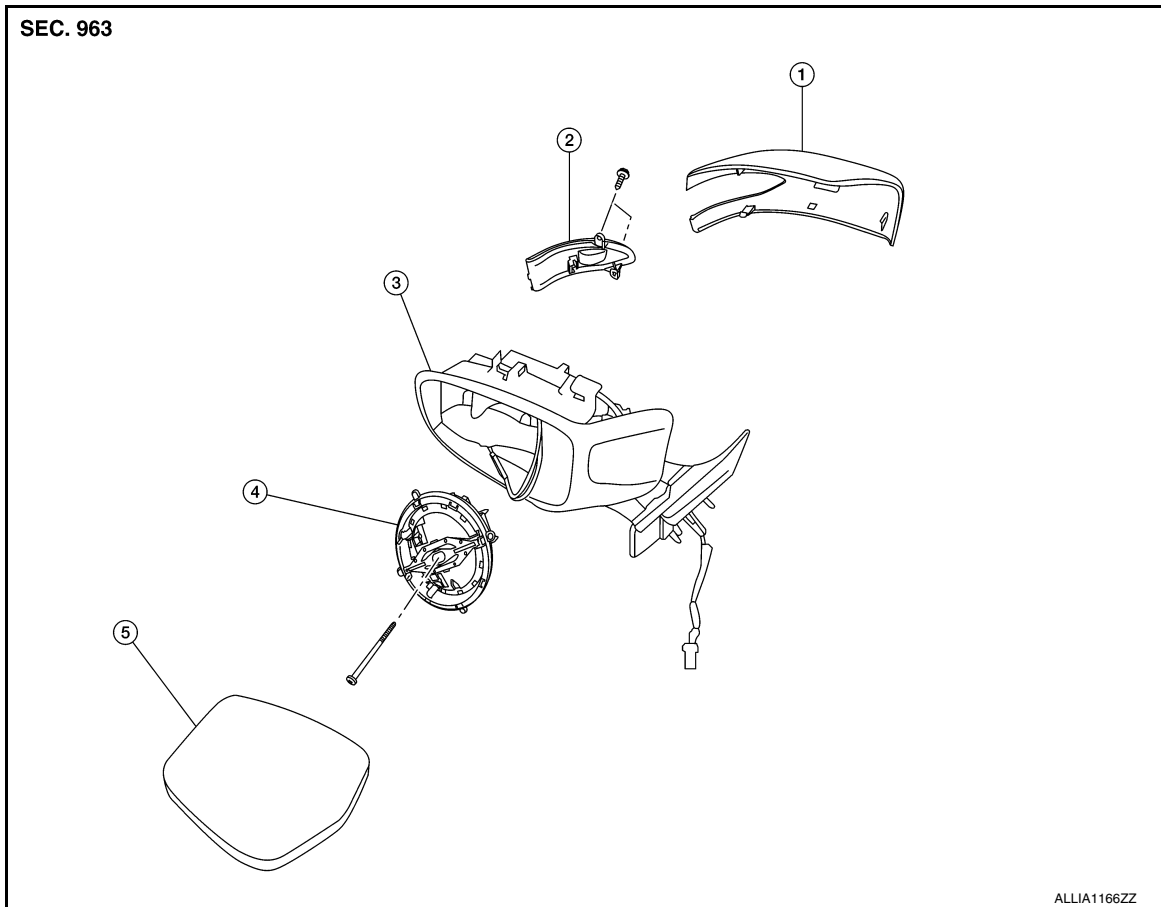

- | | | |
|-------------------------|----------------------------------------|---------------------------------|
| 1. Door mirror cover | 2. Side turn signal lamp (if equipped) | 3. Door mirror housing assembly |
| 4. Door mirror actuator | 5. Door mirror glass and holder | |

Removal and Installation

INFOID:000000009463532

REMOVAL

1. Remove the front door finisher. Refer to [INT-15, "Removal and Installation"](#).
2. Disconnect the harness connectors (A) from the door mirror corner finisher.
3. Release the clips and pawls using a suitable tool and remove the door mirror corner finisher (1).
 - Push suitable trim tool underneath finisher, and then pry outward as shown. Move tool further up near upper fastened area, and then pry outward again.

- △: Clip
- : Pawl

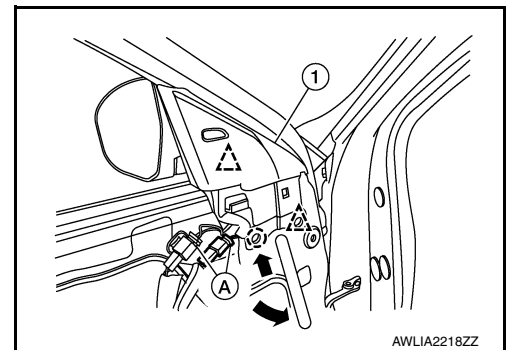

DOOR MIRROR

< REMOVAL AND INSTALLATION >

4. Remove the door mirror nuts (A) and the door mirror assembly (1).

Door mirror nut: : 5.1 N·m (0.5 kg-m, 4 ft-lb)

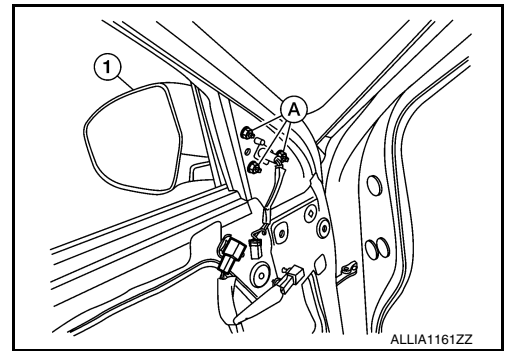

INSTALLATION

Installation is in the reverse order of removal.

A
B
C
D
E
F
G
H
I
J
K
M
N
O
P

MIR

DOOR MIRROR GLASS

< REMOVAL AND INSTALLATION >

DOOR MIRROR GLASS

Removal and Installation

INFOID:000000009463533

REMOVAL

1. Position the door mirror glass surface upward.
2. Apply protective tape (A) to mirror housing.
3. Insert a suitable tool (B) as shown and gently release the door mirror glass (1) from the door mirror actuator.

CAUTION:

Do not use excessive force or damage or breakage of the door mirror glass could occur.

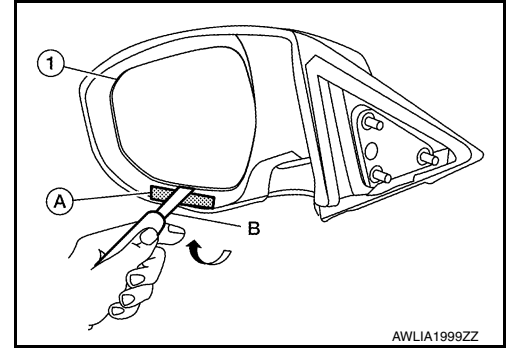

INSTALLATION

Installation is in the reverse order of removal.

DOOR MIRROR REAR FINISHER

< REMOVAL AND INSTALLATION >

DOOR MIRROR REAR FINISHER

Removal and Installation

INFOID:000000009463534

REMOVAL

1. Remove the door mirror glass. Refer to [MIR-22. "Removal and Installation"](#).
2. Release the door mirror rear finisher pawls (A) using a suitable tool.

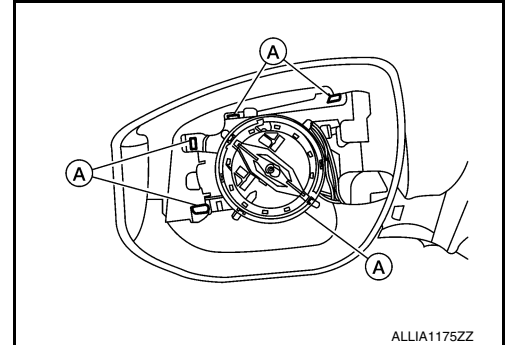

3. Remove the door mirror rear finisher.

INSTALLATION

Installation is in the reverse order of removal.

CAUTION:

After installation, check that pawls are securely engaged.

A
B
C
D
E
F
G
H
I
J
K
M
N
O
P

MIR

DOOR MIRROR ACTUATOR

< REMOVAL AND INSTALLATION >

DOOR MIRROR ACTUATOR

Removal and Installation

INFOID:000000009463535

REMOVAL

1. Remove the door mirror glass. Refer to [MIR-22, "Removal and Installation"](#).
2. Remove the mirror actuator screw (A).
3. Release the door mirror actuator pawls (A) using a suitable tool.
○: Pawl
4. Disconnect the harness connector from the door mirror actuator (1) and remove.

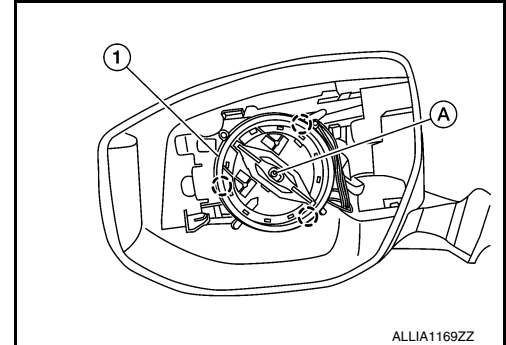

ALLIA1169ZZ

INSTALLATION

Installation is in the reverse order of removal.

DOOR MIRROR REMOTE CONTROL SWITCH

< REMOVAL AND INSTALLATION >

DOOR MIRROR REMOTE CONTROL SWITCH

Removal and Installation

INFOID:00000009463536

REMOVAL

1. Release the pawls and remove the front door pull handle outer finisher. Refer to [INT-15. "Exploded View"](#).
2. Disconnect the harness connector from the door mirror remote control switch.
3. Release the pawls and remove the door mirror remote control switch from the front door finisher.

INSTALLATION

Installation is in the reverse order of removal.

A
B
C
D
E
F
G
H
I
J
K
M
N
O
P

MIR