

SECTION **DEF**  
**DEFOGGER**

A  
B  
C

CONTENTS

<b>PRECAUTION</b> .....	3	<b>BASIC INSPECTION</b> .....	16	F
<b>PRECAUTIONS</b> .....	3	<b>DIAGNOSIS AND REPAIR WORKFLOW</b> .....	16	G
Precaution for Supplemental Restraint System (SRS) "AIR BAG" and "SEAT BELT PRE-TENSIONER" .....	3	Work Flow .....	16	
Precaution for Work .....	3	<b>DTC/CIRCUIT DIAGNOSIS</b> .....	19	H
<b>PREPARATION</b> .....	4	<b>REAR WINDOW DEFOGGER SWITCH</b> .....	19	
<b>PREPARATION</b> .....	4	<b>WITH MANUAL A/C</b> .....	19	I
Special Service Tool .....	4	WITH MANUAL A/C : Description .....	19	
<b>SYSTEM DESCRIPTION</b> .....	5	WITH MANUAL A/C : Component Function Check .....	19	J
<b>COMPONENT PARTS</b> .....	5	WITH MANUAL A/C : Diagnosis Procedure .....	19	
Component Parts Location .....	5	<b>WITH AUTO A/C</b> .....	22	K
Component Description .....	5	WITH AUTO A/C : Description .....	22	
<b>SYSTEM</b> .....	7	WITH AUTO A/C : Component Function Check .....	22	
System Diagram .....	7	WITH AUTO A/C : Diagnosis Procedure .....	22	
System Description .....	7	<b>REAR WINDOW DEFOGGER RELAY</b> .....	26	DEF
<b>DIAGNOSIS SYSTEM (BCM)</b> .....	8	Description .....	26	
<b>COMMON ITEM</b> .....	8	Component Function Check .....	26	M
COMMON ITEM : CONSULT Function (BCM - COMMON ITEM) .....	8	Diagnosis Procedure .....	26	
<b>REAR DEFOGGER</b> .....	9	Component Inspection .....	27	
REAR DEFOGGER : CONSULT Function (BCM - REAR DEFOGGER) .....	9	<b>REAR WINDOW DEFOGGER POWER SUPPLY AND GROUND CIRCUIT</b> .....	28	N
<b>ECU DIAGNOSIS INFORMATION</b> .....	10	Description .....	28	
<b>BCM (BODY CONTROL MODULE)</b> .....	10	Component Function Check .....	28	
List of ECU Reference .....	10	Diagnosis Procedure .....	28	O
<b>WIRING DIAGRAM</b> .....	11	Component Inspection .....	29	
<b>REAR WINDOW DEFOGGER SYSTEM</b> .....	11	<b>DRIVER SIDE DOOR MIRROR DEFOGGER</b> ...	30	P
Wiring Diagram .....	11	Description .....	30	
		Component Function Check .....	30	
		Diagnosis Procedure .....	30	
		Component Inspection .....	31	
		<b>PASSENGER SIDE DOOR MIRROR DEFOGGER</b> .....	32	
		Description .....	32	

Component Function Check .....	32	<b>DRIVER SIDE DOOR MIRROR DEFOGGER DOES NOT OPERATE.</b> .....	38
Diagnosis Procedure .....	32	Diagnosis Procedure .....	38
Component Inspection .....	33	<b>PASSENGER SIDE DOOR MIRROR DEFOGGER DOES NOT OPERATE.</b> .....	39
<b>SYMPTOM DIAGNOSIS</b> .....	34	Diagnosis Procedure .....	39
<b>DEFOGGER SYSTEM SYMPTOMS</b> .....	34	<b>REAR WINDOW DEFOGGER SWITCH DOES NOT LIGHT, BUT REAR WINDOW DEFOGGER OPERATES</b> .....	40
Symptom Table .....	34	Diagnosis Procedure .....	40
<b>REAR WINDOW DEFOGGER AND DOOR MIRROR DEFOGGER DO NOT OPERATE.</b> ....	35	<b>REMOVAL AND INSTALLATION</b> .....	41
Diagnosis Procedure .....	35	<b>FILAMENT</b> .....	41
<b>REAR WINDOW DEFOGGER DOES NOT OPERATE BUT BOTH OF DOOR MIRROR DEFOGGER OPERATE.</b> .....	36	Inspection and Repair .....	41
Diagnosis Procedure .....	36	<b>CONDENSER</b> .....	43
<b>BOTH DOORS MIRROR DEFOGGER DON'T OPERATE BUT REAR WINDOW DEFOGGER OPERATES</b> .....	37	Removal and Installation .....	43
Diagnosis Procedure .....	37		

# PRECAUTIONS

< PRECAUTION >

## PRECAUTION

### PRECAUTIONS

#### Precaution for Supplemental Restraint System (SRS) "AIR BAG" and "SEAT BELT PRE-TENSIONER"

INFOID:000000010480821

The Supplemental Restraint System such as "AIR BAG" and "SEAT BELT PRE-TENSIONER", used along with a front seat belt, helps to reduce the risk or severity of injury to the driver and front passenger for certain types of collision. Information necessary to service the system safely is included in the SR and SB section of this Service Manual.

#### **WARNING:**

- To avoid rendering the SRS inoperative, which could increase the risk of personal injury or death in the event of a collision which would result in air bag inflation, all maintenance must be performed by an authorized NISSAN/INFINITI dealer.
- Improper maintenance, including incorrect removal and installation of the SRS, can lead to personal injury caused by unintentional activation of the system. For removal of Spiral Cable and Air Bag Module, see the SR section.
- Do not use electrical test equipment on any circuit related to the SRS unless instructed to in this Service Manual. SRS wiring harnesses can be identified by yellow and/or orange harnesses or harness connectors.

#### PRECAUTIONS WHEN USING POWER TOOLS (AIR OR ELECTRIC) AND HAMMERS

#### **WARNING:**

- When working near the Airbag Diagnosis Sensor Unit or other Airbag System sensors with the Ignition ON or engine running, DO NOT use air or electric power tools or strike near the sensor(s) with a hammer. Heavy vibration could activate the sensor(s) and deploy the air bag(s), possibly causing serious injury.
- When using air or electric power tools or hammers, always switch the Ignition OFF, disconnect the battery and wait at least three minutes before performing any service.

#### Precaution for Work

INFOID:000000010480822

- When removing or disassembling each component, be careful not to damage or deform it. If a component may be subject to interference, be sure to protect it with a shop cloth.
- When removing (disengaging) components with a screwdriver or similar tool, be sure to wrap the component with a shop cloth or vinyl tape to protect it.
- Protect the removed parts with a shop cloth and prevent them from being dropped.
- Replace a deformed or damaged clip.
- If a part is specified as a non-reusable part, always replace it with a new one.
- Be sure to tighten bolts and nuts securely to the specified torque.
- After installation is complete, be sure to check that each part works properly.
- Follow the steps below to clean components:
  - Water soluble dirt:
    - Dip a soft cloth into lukewarm water, wring the water out of the cloth and wipe the dirty area.
    - Then rub with a soft, dry cloth.
  - Oily dirt:
    - Dip a soft cloth into lukewarm water with mild detergent (concentration: within 2 to 3%) and wipe the dirty area.
    - Then dip a cloth into fresh water, wring the water out of the cloth and wipe the detergent off.
    - Then rub with a soft, dry cloth.
  - Do not use organic solvent such as thinner, benzene, alcohol or gasoline.
  - For genuine leather seats, use a genuine leather seat cleaner.

# PREPARATION

< PREPARATION >

## PREPARATION

### PREPARATION

#### Special Service Tool

INFOID:000000010480823

The actual shapes of the tools may differ from those illustrated here.

Tool number (TechMate No.) Tool name	Description
— (J-46534) Trim Tool Set	Removing trim components

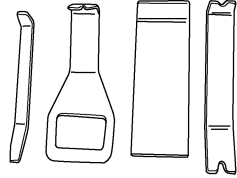

AWJIA0483ZZ

# COMPONENT PARTS

< SYSTEM DESCRIPTION >

## SYSTEM DESCRIPTION

### COMPONENT PARTS

#### Component Parts Location

INFOID:000000010480824

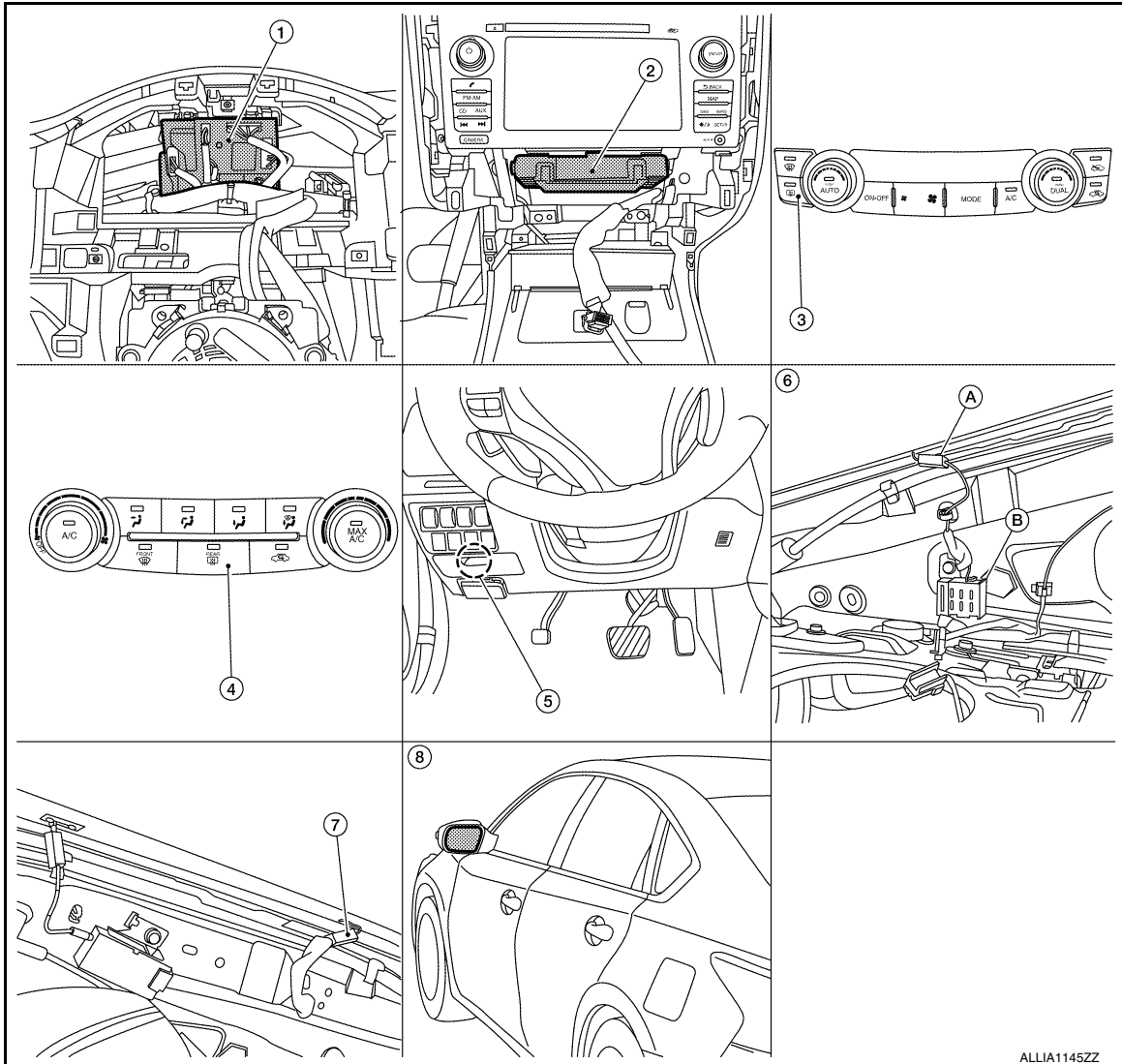

1. BCM (view with combination meter removed)
2. A/C auto amp. (with auto A/C) (view with A/C switch assembly removed)
3. A/C switch assembly (rear window defogger switch) (with auto A/C)
4. Front air control (rear window defogger switch) (with manual A/C)
5. Rear window defogger relay
6. A. Rear window defogger power connector  
B. Condenser (view with rear pillar finisher LH removed)
7. Rear window defogger ground connector (view with rear pillar finisher RH removed)
8. Door mirror LH (door mirror defogger, if equipped) (RH similar)

#### Component Description

INFOID:000000010480825

Component	Description
BCM	<ul style="list-style-type: none"> <li>• Operates the rear window defogger with the operation of rear window defogger switch.</li> <li>• Performs the timer control of rear window defogger.</li> </ul>
Rear window defogger relay	<ul style="list-style-type: none"> <li>• Operates the rear window defogger and the door mirror defogger with the control signal from BCM.</li> </ul>

## COMPONENT PARTS

### < SYSTEM DESCRIPTION >

Component	Description
A/C auto amp <sup>1</sup>	<ul style="list-style-type: none"><li>Displays the rear window defogger ON to the display when detecting the operation of the rear window defogger.</li></ul>
A/C switch assembly <sup>1</sup> (rear window defogger switch)	<ul style="list-style-type: none"><li>The rear window defogger switch is turned ON.</li></ul>
Front air control <sup>2</sup> (rear window defogger switch)	<ul style="list-style-type: none"><li>The rear window defogger switch is turned ON.</li><li>Turns the indicator lamp ON when detecting the operation of rear window defogger.</li></ul>
Rear window defogger	<ul style="list-style-type: none"><li>Heats the heating wire with the power supply from the rear window defogger relay to prevent the rear window from fogging up.</li></ul>
Door mirror defogger <sup>3</sup>	<ul style="list-style-type: none"><li>Heats the heating wire with the power supply from the rear window defogger relay to prevent the door mirror from fogging up.</li></ul>

1: With auto A/C

2: With manual A/C

3: With heated mirrors

# SYSTEM

< SYSTEM DESCRIPTION >

## SYSTEM

### System Diagram

INFOID:000000010480826

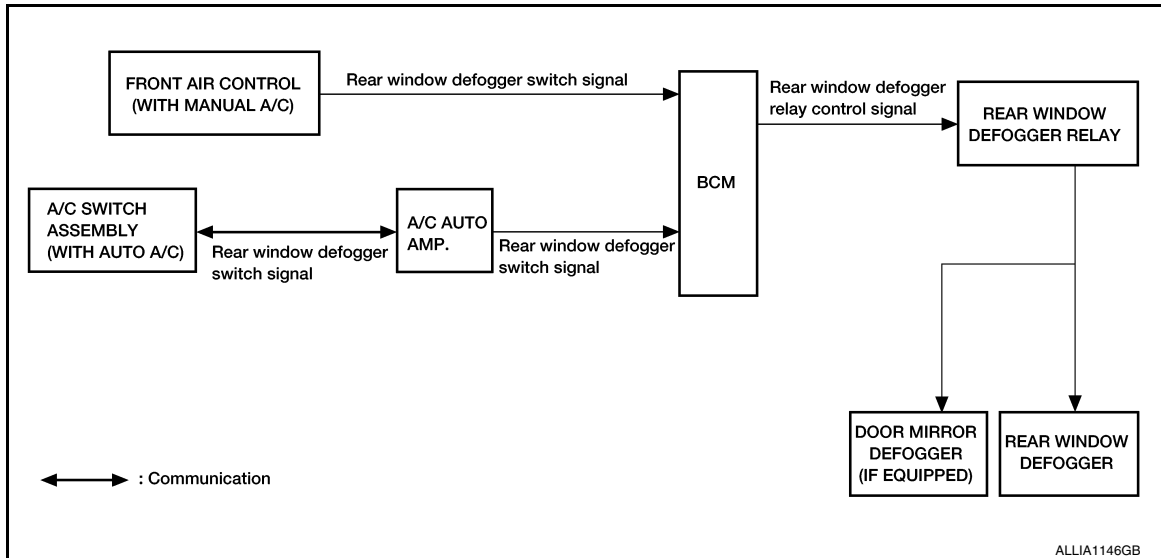

### System Description

INFOID:000000010480827

#### Operation Description

- When rear window defogger switch is turned ON while ignition switch is ON, the rear window defogger switch transmits rear window defogger switch signal to BCM.
- BCM turns rear window defogger relay ON when rear window defogger switch signal is received.
- Rear window defogger and door mirror defogger (with door mirror defogger) are supplied with power and operate when rear window defogger relay turns ON.
- Rear window defogger ON is displayed when front air control (manual A/C) or A/C switch assembly (auto A/C) receives signals.

#### Timer function

- BCM turns rear window defogger relay ON for approximately 15 minutes when rear window defogger switch is turned ON while ignition switch is ON. It makes rear window defogger and door mirror defogger (with door mirror defogger) operate.
- Timer is canceled after pressing rear window defogger switch again during timer operation. Then BCM turns rear window defogger relay OFF. The same reaction also occurs during timer operation, if the ignition switch is turned OFF.

### INPUT/OUTPUT SIGNAL CHART

Switch	Input signal to BCM	BCM function	Actuator
Rear window defogger switch	Defogger switch signal	Rear window defogger and door mirror defogger* control	Rear window defogger
Push button ignition switch	Ignition signal		Door mirror defogger*

\*: With door mirror defogger

# DIAGNOSIS SYSTEM (BCM)

< SYSTEM DESCRIPTION >

## DIAGNOSIS SYSTEM (BCM)

### COMMON ITEM

COMMON ITEM : CONSULT Function (BCM - COMMON ITEM)

INFOID:000000011009050

#### CAUTION:

After disconnecting the CONSULT vehicle interface (VI) from the data link connector, the ignition must be cycled OFF → ON (for at least 5 seconds) → OFF. If this step is not performed, the BCM may not go to "sleep mode", potentially causing a discharged battery and a no-start condition.

### APPLICATION ITEM

CONSULT performs the following functions via CAN communication with BCM.

Direct Diagnostic Mode	Description
Ecu Identification	The BCM part number is displayed.
Self Diagnostic Result	The BCM self diagnostic results are displayed.
Data Monitor	The BCM input/output data is displayed in real time.
Active Test	The BCM activates outputs to test components.
Work support	The settings for BCM functions can be changed.
Configuration	<ul style="list-style-type: none"> <li>The vehicle specification can be read and saved.</li> <li>The vehicle specification can be written when replacing BCM.</li> </ul>
CAN Diag Support Mntr	The result of transmit/receive diagnosis of CAN communication is displayed.

### SYSTEM APPLICATION

BCM can perform the following functions.

System	Sub System	Direct Diagnostic Mode						
		Ecu Identification	Self Diagnostic Result	Data Monitor	Active Test	Work support	Configuration	CAN Diag Support Mntr
Door lock	DOOR LOCK		×	×	×	×		
Rear window defogger	REAR DEFOGGER			×	×	×		
Warning chime	BUZZER			×	×			
Interior room lamp timer	INT LAMP			×	×	×		
Remote keyless entry system	MULTI REMOTE ENT			×	×	×		
Exterior lamp	HEADLAMP			×	×	×		
Wiper and washer	WIPER			×	×	×		
Turn signal and hazard warning lamps	FLASHER			×	×			
Air conditioner	AIR CONDITIONER			×				
Intelligent Key system	INTELLIGENT KEY		×	×	×	×		
Combination switch	COMB SW			×				
BCM	BCM	×	×			×	×	×
Immobilizer	IMMU		×	×	×			
Interior room lamp battery saver	BATTERY SAVER			×	×			
Trunk open	TRUNK			×				
Vehicle security system	THEFT ALM			×	×	×		



# DIAGNOSIS SYSTEM (BCM)

## < SYSTEM DESCRIPTION >

System	Sub System	Direct Diagnostic Mode						
		Ecu Identification	Self Diagnostic Result	Data Monitor	Active Test	Work support	Configuration	CAN Diag Support Mntr
RAP system	RETAINED PWR			×				
Signal buffer system	SIGNAL BUFFER			×				
TPMS	AIR PRESSURE MONITOR		×	×	×	×		

## REAR DEFOGGER

### REAR DEFOGGER : CONSULT Function (BCM - REAR DEFOGGER)

INFOID:0000000011009051

#### **CAUTION:**

After disconnecting the CONSULT vehicle interface (VI) from the data link connector, the ignition must be cycled OFF → ON (for at least 5 seconds) → OFF. If this step is not performed, the BCM may not go to "sleep mode", potentially causing a discharged battery and a no-start condition.

## DATA MONITOR

Monitor Item [Unit]	Description
PUSH SW [On/Off]	Indicates condition of push-button ignition switch.
REAR DEF SW [On/Off]	Indicates condition of rear window defogger switch.

## ACTIVE TEST

Test Item	Description
REAR DEFOGGER	This test is able to check rear window defogger operation [Off/On].

## WORK SUPPORT

Support Item	Setting	Description
SET R-DEF TIMER	MODE3	Rear defogger turns OFF after 1 minute.
	MODE2	Rear defogger remains ON until turned OFF.
	MODE1*	Rear defogger turns OFF after 15 minutes.

\* : Initial setting

# BCM (BODY CONTROL MODULE)

< ECU DIAGNOSIS INFORMATION >

## ECU DIAGNOSIS INFORMATION

### BCM (BODY CONTROL MODULE)

List of ECU Reference

INFOID:0000000010480830

ECU	Reference
BCM	<a href="#">BCS-32. "Reference Value"</a>
	<a href="#">BCS-51. "Fail Safe"</a>
	<a href="#">BCS-52. "DTC Inspection Priority Chart"</a>
	<a href="#">BCS-53. "DTC Index"</a>



# REAR WINDOW DEFOGGER SYSTEM

< WIRING DIAGRAM >

## REAR WINDOW DEFOGGER CONNECTORS

Connector No.	M1
Connector Name	WIRE TO WIRE
Connector Color	WHITE

Terminal No.	5G	Color of Wire	W	Signal Name	-
--------------	----	---------------	---	-------------	---

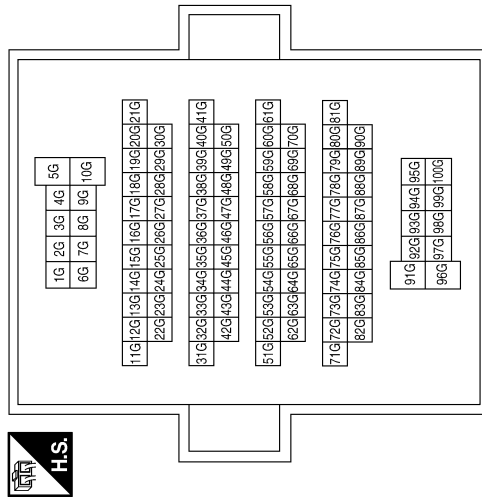

Connector No.	M3
Connector Name	FUSE BLOCK (J/B)
Connector Color	WHITE



Terminal No.	6N	Color of Wire	W	Signal Name	-
--------------	----	---------------	---	-------------	---

Connector No.	M5
Connector Name	FUSE BLOCK (J/B)
Connector Color	WHITE



Terminal No.	4P	Color of Wire	P	Signal Name	-
5P	BG	-	-	-	-
6P	Y	-	-	-	-
7P	G	-	-	-	-

Connector No.	M14
Connector Name	WIRE TO WIRE
Connector Color	WHITE



Terminal No.	4	Color of Wire	GR	Signal Name	-
--------------	---	---------------	----	-------------	---

Connector No.	M17
Connector Name	BCM (BODY CONTROL MODULE)
Connector Color	GREEN

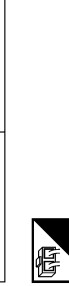

Terminal No.	32	Color of Wire	Y	Signal Name	REAR DEFOGGER SW
--------------	----	---------------	---	-------------	------------------

# REAR WINDOW DEFOGGER SYSTEM

< WIRING DIAGRAM >

Connector No.	M37
Connector Name	FRONT AIR CONTROL
Connector Color	WHITE

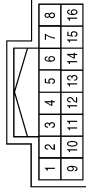

Terminal No.	Color of Wire	Signal Name
2	G	IGN
9	B	GND
10	Y	RR DEF ON
15	P	RR DEF F/B

Connector No.	M21
Connector Name	BCM (BODY CONTROL MODULE)
Connector Color	WHITE

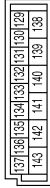

Terminal No.	Color of Wire	Signal Name
131	W	BAT BCM FUSE
134	B	GND2
139	W	BAT POWER F/L
143	B	GND1

Connector No.	M18
Connector Name	BCM (BODY CONTROL MODULE)
Connector Color	BLACK

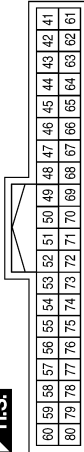

Terminal No.	Color of Wire	Signal Name
59	P	CAN-L
60	L	CAN-H
61	Y	REAR DEFOGGER RELAY OUT

Connector No.	M112
Connector Name	WIRE TO WIRE
Connector Color	WHITE



Terminal No.	Color of Wire	Signal Name
5	BG	-
18	B	-

Connector No.	M84
Connector Name	WIRE TO WIRE
Connector Color	WHITE

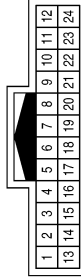

Terminal No.	Color of Wire	Signal Name
5	BG	-

Connector No.	M79
Connector Name	A/C SWITCH ASSEMBLY
Connector Color	WHITE

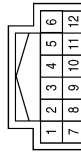

Terminal No.	Color of Wire	Signal Name
1	B	-
9	BR	-
10	V	-
12	G	-

AALIA2813GB

A  
B  
C  
D  
E  
F  
G  
H  
I  
J  
K  
DEF  
M  
N  
O  
P

# REAR WINDOW DEFOGGER SYSTEM

< WIRING DIAGRAM >

Connector No.	B13
Connector Name	FUSE BLOCK (J/B)
Connector Color	WHITE

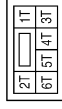

Terminal No.	Color of Wire	Signal Name
3T	Y	-
5T	Y	-

Connector No.	E30
Connector Name	WIRE TO WIRE
Connector Color	WHITE

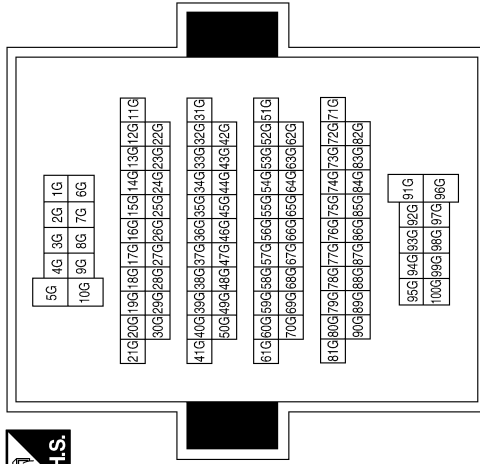

Terminal No.	Color of Wire	Signal Name
5G	P	-

Connector No.	M152
Connector Name	A/C AUTO AMP.
Connector Color	WHITE

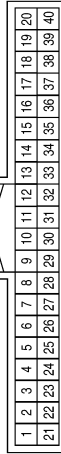

Terminal No.	Color of Wire	Signal Name
2	B	GND
4	BR	TX FR
15	Y	RR DEF SW
22	B	P GND
23	G	IGN
24	V	RX FR
35	P	RR DEF F/B

Connector No.	B54
Connector Name	REAR WINDOW DEFOGGER
Connector Color	BLACK



Terminal No.	Color of Wire	Signal Name
2	B	-

Connector No.	B53
Connector Name	REAR WINDOW DEFOGGER
Connector Color	BLACK



Terminal No.	Color of Wire	Signal Name
1	B	-

Connector No.	B52
Connector Name	CONDENSER
Connector Color	WHITE



Terminal No.	Color of Wire	Signal Name
1	Y	-

AALIA2819GB

# REAR WINDOW DEFOGGER SYSTEM

< WIRING DIAGRAM >

Connector No.	D101
Connector Name	WIRE TO WIRE
Connector Color	WHITE

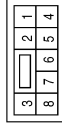

Terminal No.	Color of Wire	Signal Name
4	B	-

Connector No.	D4
Connector Name	DOOR MIRROR LH
Connector Color	WHITE

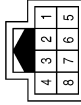

Terminal No.	Color of Wire	Signal Name
1	BG	-
5	B	-

Connector No.	D2
Connector Name	WIRE TO WIRE
Connector Color	WHITE

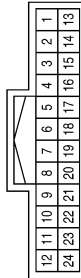

Terminal No.	Color of Wire	Signal Name
5	BG	-
18	B	-

Connector No.	J-2
Connector Name	FUSE BLOCK (J/B) (REAR WINDOW DEFOGGER RELAY)
Connector Color	-

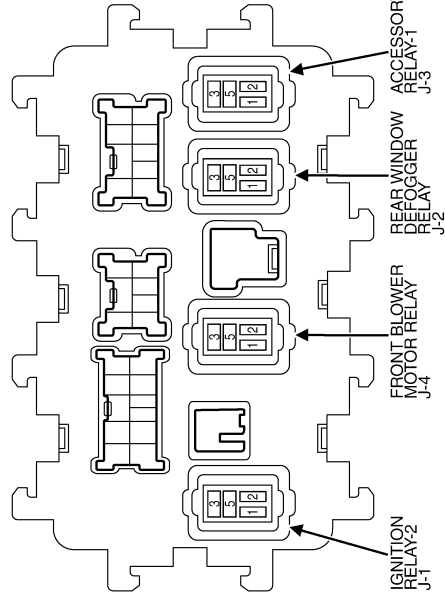

Connector No.	D114
Connector Name	WIRE TO WIRE
Connector Color	WHITE

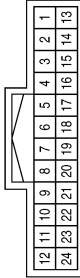

Terminal No.	Color of Wire	Signal Name
5	BG	-

Connector No.	D107
Connector Name	DOOR MIRROR RH
Connector Color	WHITE

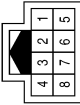

Terminal No.	Color of Wire	Signal Name
1	BG	-
5	B	-

ABLIA5177GB

A  
B  
C  
D  
E  
F  
G  
H  
I  
J  
K  
DEF  
M  
N  
O  
P

# DIAGNOSIS AND REPAIR WORKFLOW

< BASIC INSPECTION >

## BASIC INSPECTION

### DIAGNOSIS AND REPAIR WORKFLOW

Work Flow

INFOID:0000000010480832

OVERALL SEQUENCE

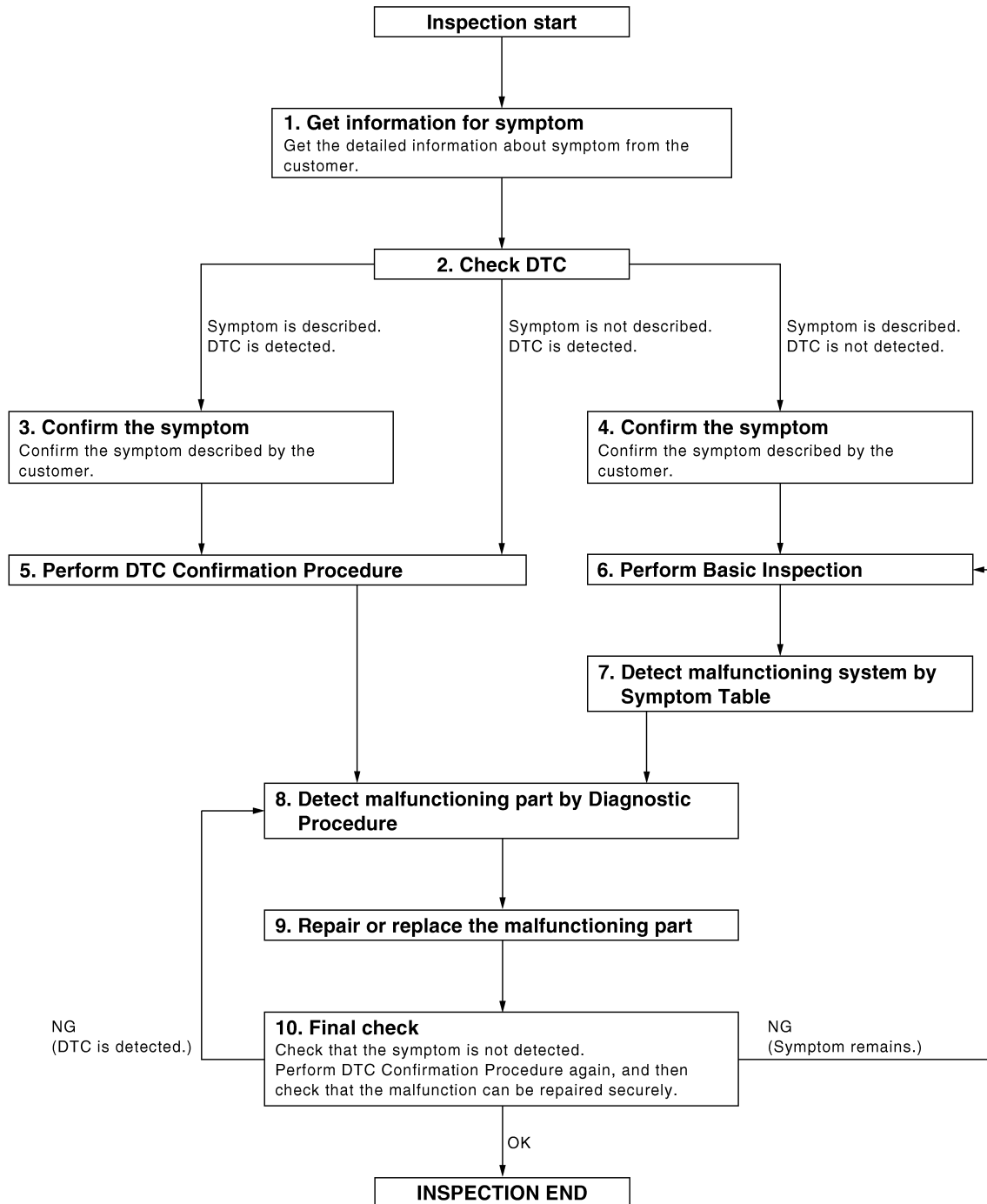

DETAILED FLOW

Revision: May 2014

DEF-16

JMKIA0101GB

2015 Altima Sedan



# DIAGNOSIS AND REPAIR WORKFLOW

## < BASIC INSPECTION >

### 1. GET INFORMATION FOR SYMPTOM

Get the detailed information from the customer about the symptom (the condition and the environment when the incident/malfunction occurred).

>> GO TO 2.

### 2. CHECK DTC

1. Check DTC.
2. Perform the following procedure if DTC is displayed.
  - Record DTC and freeze frame data (Print them out with CONSULT.)
  - Erase DTC.
  - Study the relationship between the cause detected by DTC and the symptom described by the customer.
3. Check related service bulletins for information.

#### Is any symptom described and any DTC detected?

- Symptom is described, DTC is displayed>>GO TO 3.
- Symptom is described, DTC is not displayed>>GO TO 4.
- Symptom is not described, DTC is displayed>>GO TO 5.

### 3. CONFIRM THE SYMPTOM

Confirm the symptom described by the customer.  
Connect CONSULT to the vehicle in "Data Monitor" mode and check real time diagnosis results.  
Verify relation between the symptom and the condition when the symptom is detected.

>> GO TO 5.

### 4. CONFIRM THE SYMPTOM

Confirm the symptom described by the customer.  
Connect CONSULT to the vehicle in "Data Monitor" mode and check real time diagnosis results.  
Verify relation between the symptom and the condition when the symptom is detected.

>> GO TO 6.

### 5. PERFORM DTC CONFIRMATION PROCEDURE

Perform DTC Confirmation Procedure for the displayed DTC, and then check that DTC is detected again.  
At this time, always connect CONSULT to the vehicle, and check diagnostic results in real time.  
If two or more DTCs are detected, refer to [BCS-52. "DTC Inspection Priority Chart"](#) and determine trouble diagnosis order.

#### **NOTE:**

- Freeze frame data is useful if the DTC is not detected.
- Perform Component Function Check if DTC Confirmation Procedure is not included in Service Manual. This simplified check procedure is an effective alternative though DTC cannot be detected during this check.  
If the result of Component Function Check is NG, it is the same as the detection of DTC by DTC Confirmation Procedure.

#### Is DTC detected?

- YES >> GO TO 8.
- NO >> Refer to [GI-44. "Intermittent Incident"](#).

### 6. PERFORM BASIC INSPECTION

Perform [DEF-16. "Work Flow"](#).

>> GO TO 7.

### 7. DETECT MALFUNCTIONING SYSTEM BY SYMPTOM TABLE

Detect malfunctioning system according to [DEF-7. "System Description"](#) based on the confirmed symptom in step 4, and determine the trouble diagnosis order based on possible causes and symptom.

>> GO TO 8.

A  
B  
C  
D  
E  
F  
G  
H  
I  
J  
K  
DEF  
M  
N  
O  
P

# DIAGNOSIS AND REPAIR WORKFLOW

< BASIC INSPECTION >

---

## 8. DETECT MALFUNCTIONING PART BY DIAGNOSTIC PROCEDURE

---

Inspect according to Diagnostic Procedure of the system.

**NOTE:**

The Diagnostic Procedure described based on open circuit inspection. A short circuit inspection is also required for the circuit check in the Diagnostic Procedure.

Is malfunctioning part detected?

YES >> GO TO 9.

NO >> Check voltage of related BCM terminals using CONSULT.

## 9. REPAIR OR REPLACE THE MALFUNCTIONING PART

---

1. Repair or replace the malfunctioning part.
2. Reconnect parts or connectors disconnected during Diagnostic Procedure again after repair and replacement.
3. Check DTC. If DTC is displayed, erase it.

>> GO TO 10.

## 10. FINAL CHECK

---

When DTC was detected in step 2, perform DTC Confirmation Procedure or Component Function Check again, and then check that the malfunction have been repaired securely.

When symptom was described from the customer, refer to confirmed symptom in step 3 or 4, and check that the symptom is not detected.

Does the symptom reappear?

YES (DTC is detected)>>GO TO 8.

YES (Symptom remains)>>GO TO 6.

NO >> Inspection End.

# REAR WINDOW DEFOGGER SWITCH

< DTC/CIRCUIT DIAGNOSIS >

## DTC/CIRCUIT DIAGNOSIS

### REAR WINDOW DEFOGGER SWITCH WITH MANUAL A/C

#### WITH MANUAL A/C : Description

INFOID:000000010480833

- The rear window defogger is operated by pressing the rear window defogger switch ON.
- The indicator lamp in the rear window defogger switch illuminates while the rear window defogger is ON.

#### WITH MANUAL A/C : Component Function Check

INFOID:000000010480834

#### 1. CHECK REAR WINDOW DEFOGGER SWITCH FUNCTION

1. Push ignition switch to ON.
2. Press rear window defogger switch.
3. Check that the indicator lamp of the rear window defogger switch illuminates.
4. Press rear window defogger switch.
5. Check that the indicator lamp of the rear window defogger switch extinguishes.

##### Is the inspection result normal?

- YES >> Rear window defogger switch function is OK.  
NO >> Refer to [DEF-19, "WITH MANUAL A/C : Diagnosis Procedure"](#).

#### WITH MANUAL A/C : Diagnosis Procedure

INFOID:000000010480835

Regarding Wiring Diagram information, refer to [DEF-11, "Wiring Diagram"](#).

#### 1. CHECK REAR WINDOW DEFOGGER RELAY OPERATION

1. Push the ignition switch to ON.
2. Check that an operation noise of rear window defogger relay [located in fuse block (J/B)] can be heard when pressing the rear window defogger switch ON and OFF.

##### Is the inspection result normal?

- YES >> GO TO 2.  
NO >> GO TO 5.

#### 2. CHECK FUSE

Check if Fuse 22 from the rear window defogger relay output is blown.

##### Is the fuse blown?

- YES >> Replace the blown fuse after repairing the affected circuit.  
NO >> GO TO 3.

#### 3. CHECK FOR VOLTAGE FROM THE REAR WINDOW DEFOGGER RELAY

1. Connect a voltmeter between Fuse block (J/B) and ground.
2. While pressing the rear window defogger switch ON and OFF, check for voltage between Fuse block (J/B) and ground.

(+)		(-)	Condition	Voltage (V) (Approx.)	
Fuse block (J/B)					
Connector	Terminal				
M5	4P	Ground	Rear window defogger switch	ON	Battery voltage
			OFF	0	

##### Is the inspection result normal?

- YES >> GO TO 4.  
NO >> Perform rear window defogger relay diagnosis. Refer to [DEF-26, "Diagnosis Procedure"](#).

A  
B  
C  
D  
E  
F  
G  
H  
I  
J  
K  
DEF  
M  
N  
O  
P

## REAR WINDOW DEFOGGER SWITCH

< DTC/CIRCUIT DIAGNOSIS >

### 4. CHECK REAR WINDOW DEFOGGER SWITCH INDICATOR CIRCUIT

1. Press rear window defogger switch.
2. Check for voltage between front air control connector and ground.

(+)		(-)	Condition	Voltage (V) (Approx.)	
Front air control					
Connector	Terminal				
M37	15	Ground	Rear window defogger switch	ON	Battery voltage
				OFF	0

Is the inspection result normal?

- YES >> Replace front air control. Refer to [HAC-162, "Removal and Installation"](#).  
 NO >> Repair or replace harness.

### 5. CHECK FRONT AIR CONTROL (REAR WINDOW DEFOGGER SWITCH) FUNCTION

1. Check "REAR DEF SW" in "Data Monitor" in "REAR DEFOGGER" of "BCM" using CONSULT.
2. Operate rear window defogger switch and check the status on CONSULT screen.

Monitor Item	Condition		status
REAR DEF SW	Rear window defogger switch	Pressed	On
		Released	Off

Is the inspection result normal?

- YES >> GO TO 8.  
 NO >> GO TO 6.

### 6. CHECK REAR WINDOW DEFOGGER ON SIGNAL CIRCUIT

Check voltage between BCM connector and ground.

(+)		(-)	Condition	Voltage (V) (Approx.)	
BCM					
Connector	Terminal				
M17	32	Ground	Rear window defogger switch	ON	0
				OFF	5

Is the inspection result normal?

- YES >> Replace BCM. Refer to [BCS-81, "Removal and Installation"](#).  
 NO >> GO TO 7.

### 7. CHECK HARNESS CONTINUITY

1. Push ignition switch to OFF.
2. Disconnect BCM and front air control.
3. Check continuity between BCM connector and front air control connector.

BCM		Front air control		Continuity
Connector	Terminal	Connector	Terminal	
M17	32	M37	10	Yes

4. Check continuity between BCM harness connector and ground.

BCM		Ground	Continuity
Connector	Terminal		
M17	32		No

Is the inspection result normal?

# REAR WINDOW DEFOGGER SWITCH

## < DTC/CIRCUIT DIAGNOSIS >

- YES >> Replace front air control. Refer to [HAC-162, "Removal and Installation"](#).  
 NO >> Repair or replace harness.

### 8. CHECK REAR WINDOW DEFOGGER RELAY GROUND CIRCUIT

#### CONSULT

1. Select "Active Test" in "REAR DEFOGGER" of "BCM".
2. Turn "REAR DEFOGGER" active test ON and OFF.
3. Check voltage between fuse block (J/B) connector and ground.

(+)		(-)	Condition	Voltage (V) (Approx.)	
Fuse block (J/B)					
Connector	Terminal				
M5	6P	Ground	Rear window defogger active test	ON	0
			OFF	Battery voltage	

#### Is the inspection result normal?

- YES >> GO TO 11.  
 NO >> GO TO 9.

### 9. CHECK REAR WINDOW DEFOGGER RELAY CIRCUIT

Check voltage between fuse block (J/B) connector and ground.

(+)		(-)	Condition	Voltage (V) (Approx.)	
Fuse block (J/B)					
Connector	Terminal				
M5	6P	Ground	Rear window defogger switch	ON	0
			OFF	Battery voltage	

#### Is the inspection result normal?

- YES >> Replace rear window defogger relay.  
 NO >> GO TO 10.

### 10. CHECK HARNESS CONTINUITY

1. Push ignition switch to OFF.
2. Disconnect BCM and fuse block (J/B).
3. Check continuity between BCM connector and fuse block (J/B) connector.

BCM		Fuse block (J/B)		Continuity
Connector	Terminal	Connector	Terminal	
M18	61	M5	6P	Yes

4. Check continuity between fuse block (J/B) connector M5 terminal 6P and ground.

Fuse block (J/B)		Ground	Continuity
Connector	Terminal		
M5	6P		No

#### Is the inspection result normal?

- YES >> Perform rear window defogger relay component inspection. Refer to [DEF-27, "Component Inspection"](#). If OK, replace BCM. Refer to [BCS-81, "Removal and Installation"](#).  
 NO >> Repair or replace harness.

### 11. CHECK REAR WINDOW DEFOGGER RELAY

Check rear window defogger relay.  
 Refer to [DEF-27, "Component Inspection"](#).

#### Is the inspection result normal?

# REAR WINDOW DEFOGGER SWITCH

## < DTC/CIRCUIT DIAGNOSIS >

---

- YES >> GO TO 12.  
NO >> Replace rear window defogger relay.

## 12. CHECK INTERMITTENT INCIDENT

---

Check intermittent incident.

Refer to [GI-44, "Intermittent Incident"](#).

Is the inspection result normal?

- YES >> Check the following.
- Battery power supply circuit.
  - Fuse block (J/B).
- NO >> Repair or replace the malfunctioning parts.

## WITH AUTO A/C

### WITH AUTO A/C : Description

INFOID:0000000010480836

- The rear window defogger is operated by pressing the rear window defogger switch ON.
- The indicator lamp in the rear window defogger switch illuminates while the rear window defogger is ON.

### WITH AUTO A/C : Component Function Check

INFOID:0000000010480837

## 1. CHECK REAR WINDOW DEFOGGER SWITCH FUNCTION

---

1. Push ignition switch to ON.
2. Press rear window defogger switch.
3. Check that the indicator lamp of the rear window defogger switch illuminates.
4. Press rear window defogger switch.
5. Check that the indicator lamp of the rear window defogger switch extinguishes.

Is the inspection result normal?

- YES >> Rear window defogger switch function is OK.  
NO >> Refer to [DEF-22, "WITH AUTO A/C : Diagnosis Procedure"](#).

## WITH AUTO A/C : Diagnosis Procedure

INFOID:0000000010480838

Regarding Wiring Diagram information, refer to [DEF-11, "Wiring Diagram"](#).

## 1. CHECK REAR WINDOW DEFOGGER RELAY OPERATION

---

1. Push the ignition switch to ON.
2. Check that an operation noise of rear window defogger relay [located in fuse block (J/B)] can be heard when pressing the rear window defogger switch ON and OFF.

Is the inspection result normal?

- YES >> GO TO 2.  
NO >> GO TO 5.

## 2. CHECK FUSE

---

Check if Fuse 22 from the rear window defogger relay output is blown.

Is the fuse blown?

- YES >> Replace the blown fuse after repairing the affected circuit.  
NO >> GO TO 3.

## 3. CHECK FOR VOLTAGE FROM THE REAR WINDOW DEFOGGER RELAY

---

1. Connect a voltmeter between Fuse block (J/B) and ground.
2. While pressing the rear window defogger switch ON and OFF, check for voltage between Fuse block (J/B) and ground.

# REAR WINDOW DEFOGGER SWITCH

## < DTC/CIRCUIT DIAGNOSIS >

(+)		(-)	Condition	Voltage (V) (Approx.)	
Fuse block (J/B)					
Connector	Terminal				
M5	4P	Ground	Rear window defogger switch	ON	Battery voltage
			OFF	0	

Is the inspection result normal?

YES >> GO TO 4.

NO >> Perform rear window defogger relay diagnosis. Refer to [DEF-26, "Diagnosis Procedure"](#).

### 4. CHECK REAR WINDOW DEFOGGER SWITCH INDICATOR CIRCUIT

1. Press rear window defogger switch.
2. Check for voltage between A/C auto amp. connector and ground.

(+)		(-)	Condition	Voltage (V) (Approx.)	
A/C auto amp.					
Connector	Terminal				
M152	35	Ground	Rear window defogger switch	ON	Battery voltage
			OFF	0	

Is the inspection result normal?

YES >> Replace A/C auto amp. Refer to [HAC-102, "Removal and Installation"](#).

NO >> Repair or replace harness.

### 5. CHECK A/C AUTO AMP. (REAR WINDOW DEFOGGER SWITCH) FUNCTION

1. Check "REAR DEF SW" in "Data Monitor in "REAR DEFOGGER" of "BCM" using CONSULT.
2. Operate rear window defogger switch and check the status on CONSULT screen.

Monitor Item	Condition		status
REAR DEF SW	Rear window defogger switch	Pressed	On
		Released	Off

Is the inspection result normal?

YES >> GO TO 8.

NO >> GO TO 6.

### 6. CHECK REAR WINDOW DEFOGGER ON SIGNAL CIRCUIT

Check voltage between BCM connector and ground.

(+)		(-)	Condition	Voltage (V) (Approx.)	
BCM					
Connector	Terminal				
M17	32	Ground	Rear window defogger switch	ON	0
			OFF	5	

Is the inspection result normal?

YES >> Replace BCM. Refer to [BCS-81, "Removal and Installation"](#).

NO >> GO TO 7.

### 7. CHECK HARNESS CONTINUITY

1. Push ignition switch to OFF.
2. Disconnect BCM and front air control.
3. Check continuity between BCM connector and A/C auto amp.

# REAR WINDOW DEFOGGER SWITCH

## < DTC/CIRCUIT DIAGNOSIS >

BCM		A/C auto amp.		Continuity
Connector	Terminal	Connector	Terminal	
M17	32	M152	15	Yes

4. Check continuity between BCM harness connector and ground.

BCM		Ground	Continuity
Connector	Terminal		
M17	32		No

Is the inspection result normal?

YES >> Replace A/C auto amp. Refer to [HAC-102. "Removal and Installation"](#).

NO >> Repair or replace harness.

## 8. CHECK REAR WINDOW DEFOGGER RELAY GROUND CIRCUIT

### CONSULT

1. Select "REAR DEFOGGER" in "Active Test" of "BCM."
2. Turn "REAR DEFOGGER" active test ON and OFF.
3. Check voltage between fuse block (J/B) connector and ground.

(+)		(-)	Condition	Voltage (V) (Approx.)	
Fuse block (J/B)					
Connector	Terminal				
M5	6P	Ground	Rear window defogger active test	ON	0
			OFF	Battery voltage	

Is the inspection result normal?

YES >> GO TO 11.

NO >> GO TO 9.

## 9. CHECK REAR WINDOW DEFOGGER RELAY CIRCUIT

Check voltage between fuse block (J/B) connector and ground.

(+)		(-)	Condition	Voltage (V) (Approx.)	
Fuse block (J/B)					
Connector	Terminal				
M5	6P	Ground	Rear window defogger switch	ON	0
			OFF	Battery voltage	

Is the inspection result normal?

YES >> Replace rear window defogger relay.

NO >> GO TO 10.

## 10. CHECK HARNESS CONTINUITY

1. Push ignition switch to OFF.
2. Disconnect BCM and fuse block (J/B).
3. Check continuity between BCM connector and fuse block (J/B) connector.

BCM		Fuse block (J/B)		Continuity
Connector	Terminal	Connector	Terminal	
M18	61	M5	6P	Yes

4. Check continuity between fuse block (J/B) connector M5 terminal 6P and ground.



# REAR WINDOW DEFOGGER SWITCH

## < DTC/CIRCUIT DIAGNOSIS >

Fuse block (J/B)		Ground	Continuity
Connector	Terminal		
M5	6P		No

Is the inspection result normal?

YES >> Perform rear window defogger relay component inspection. Refer to [DEF-27. "Component Inspection"](#). If OK, replace BCM. Refer to [BCS-81. "Removal and Installation"](#).

NO >> Repair or replace harness.

### 11. CHECK REAR WINDOW DEFOGGER RELAY

Check rear window defogger relay.

Refer to [DEF-27. "Component Inspection"](#).

Is the inspection result normal?

YES >> GO TO 12.

NO >> Replace rear window defogger relay.

### 12. CHECK INTERMITTENT INCIDENT

Check intermittent incident.

Refer to [GI-44. "Intermittent Incident"](#).

Is the inspection result normal?

YES >> Check the following.

- Battery power supply circuit.
- Fuse block (J/B).

NO >> Repair or replace the malfunctioning parts.

A  
B  
C  
D  
E  
F  
G  
H  
I  
J  
K  
M  
N  
O  
P

DEF

# REAR WINDOW DEFOGGER RELAY

< DTC/CIRCUIT DIAGNOSIS >

## REAR WINDOW DEFOGGER RELAY

### Description

INFOID:000000010480839

Power is supplied to the rear window defogger with BCM control.

### Component Function Check

INFOID:000000010480840

#### 1. CHECK REAR WINDOW DEFOGGER RELAY POWER SUPPLY CIRCUIT

Check that an operation noise of rear window defogger relay [located in fuse block (J/B)] can be heard when turning the rear window defogger switch ON.

Is the inspection result normal?

- YES >> Rear window defogger relay power supply circuit is OK.
- NO >> Refer to [DEF-26, "Diagnosis Procedure"](#).

### Diagnosis Procedure

INFOID:000000010480841

Regarding Wiring Diagram information, refer to [DEF-11, "Wiring Diagram"](#).

#### 1. CHECK REAR WINDOW DEFOGGER RELAY GROUND CIRCUIT

1. Turn ignition switch ON.
2. Check voltage between BCM connector and ground.

(+)		(-)	Condition	Voltage (V) (Approx.)	
BCM					
Connector	Terminal				
M18	61	Ground	Rear window defogger switch	ON	0
				OFF	Battery voltage

Is the inspection result normal?

- YES >> Rear window defogger power supply circuit is OK.
- NO >> GO TO 2.

#### 2. CHECK HARNESS CONTINUITY

1. Turn ignition switch OFF.
2. Disconnect BCM and fuse block (J/B).
3. Check continuity between BCM connector and fuse block (J/B) connector.

BCM		Fuse block (J/B)		Continuity
Connector	Terminal	Connector	Terminal	
M18	61	M5	6P	Yes

Is the inspection result normal?

- YES >> GO TO 3.
- NO >> Repair or replace harness.

#### 3. CHECK REAR WINDOW DEFOGGER RELAY

Check rear window defogger relay.  
Refer to [DEF-27, "Component Inspection"](#).

Is the inspection result normal?

- YES >> Check intermittent incident. Refer to [GI-44, "Intermittent Incident"](#)
- NO >> Replace rear window defogger relay.

# REAR WINDOW DEFOGGER RELAY

< DTC/CIRCUIT DIAGNOSIS >

## Component Inspection

INFOID:000000010480842

### 1. CHECK REAR WINDOW DEFOGGER RELAY

Check rear window defogger relay.

Terminal		Condition	Continuity
Rear window defogger relay			
3	5	12V direct current supply between terminals 1 and 2.	Yes
		No current supply	No

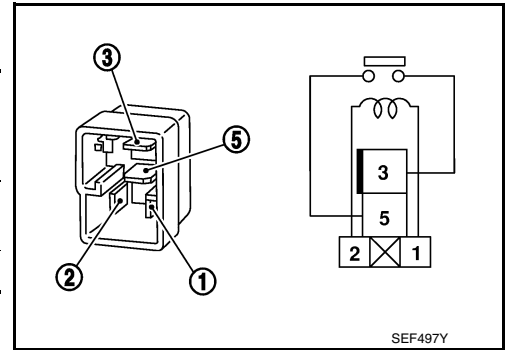

Is the inspection result normal?

- YES >> Inspection End.
- NO >> Replace rear window defogger relay.

A  
B  
C  
D  
E  
F  
G  
H  
I  
J  
K  
DEF  
M  
N  
O  
P

# REAR WINDOW DEFOGGER POWER SUPPLY AND GROUND CIRCUIT

< DTC/CIRCUIT DIAGNOSIS >

## REAR WINDOW DEFOGGER POWER SUPPLY AND GROUND CIRCUIT

### Description

INFOID:000000010480843

Heats the heating wire with the power supply from the rear window defogger relay to prevent the rear window from fogging up.

### Component Function Check

INFOID:000000010480844

## 1. CHECK REAR WINDOW DEFOGGER

Check that the heating wire of rear window defogger is heated when turning the rear window defogger switch ON.

### Is the inspection result normal?

- YES >> Rear window defogger is OK.
- NO >> Refer to [DEF-28, "Diagnosis Procedure"](#).

## Diagnosis Procedure

INFOID:000000010480845

Regarding Wiring Diagram information, refer to [DEF-11, "Wiring Diagram"](#).

## 1. CHECK FUSES

Check if any of the following fuses in fuse block (J/B) are blown.

COMPONENT PARTS	AMPERE	FUSE NO.
Fuse block (J/B)	15A	23
	15A	24

### Is the inspection result normal?

- YES >> GO TO 2.
- NO >> Replace the blown fuse after repairing the affected circuit.

## 2. CHECK REAR WINDOW DEFOGGER POWER SUPPLY CIRCUIT

1. Turn ignition switch ON.
2. Check voltage between fuse block (J/B) connector and ground.

(+)		(-)	Condition	Voltage (V) (Approx.)	
Connector	Terminal				
B13	3T, 5T	Ground	Rear window defogger switch	ON	Battery voltage
			OFF	0	

### Is the inspection result normal?

- YES >> GO TO 3.
- NO >> Perform rear window defogger diagnosis. Refer to [DEF-26, "Diagnosis Procedure"](#).

## 3. CHECK POWER SUPPLY CIRCUIT

1. Turn ignition switch ON.
2. Check voltage between rear window defogger connector and ground.

# REAR WINDOW DEFOGGER POWER SUPPLY AND GROUND CIRCUIT

< DTC/CIRCUIT DIAGNOSIS >

(+)		(-)	Condition		Voltage (V) (Approx.)
Rear window defogger					
Connector	Terminal				
B53	1	Ground	Rear window defogger switch	ON	Battery voltage
				OFF	0

Is the inspection result normal?

YES >> GO TO 4.

NO >> GO TO 5.

## 4. CHECK GROUND CIRCUIT

1. Turn ignition switch OFF.
2. Disconnect rear window defogger.
3. Check continuity between rear window defogger connector and ground.

Rear window defogger		Ground	Continuity
Connector	Terminal		
B54	2		Yes

Is the inspection result normal?

YES >> GO TO 6.

NO >> Repair or replace harness.

## 5. CHECK HARNESS CONTINUITY

1. Turn ignition switch OFF.
2. Disconnect fuse block (J/B).
3. Check continuity between fuse block (J/B) connector and condenser connector.

Fuse block (J/B)		Condenser		Continuity
Connector	Terminal	Connector	Terminal	
B13	3T	B52	1	Yes
	5T			

Is the inspection result normal?

YES >> Replace condenser. Refer to [DEF-43, "Removal and Installation"](#).

NO >> Replace or repair harness.

## 6. CHECK FILAMENT

Check filament.

Refer to [DEF-29, "Component Inspection"](#).

Is the inspection result normal?

YES >> Refer to [GI-44, "Intermittent Incident"](#).

NO >> Repair filament. Refer to [DEF-41, "Inspection and Repair"](#).

## Component Inspection

INFOID:0000000010480846

### 1. CHECK FILAMENT

Check the filament for damage or open circuits.

Refer to [DEF-41, "Inspection and Repair"](#).

Is the inspection result normal?

YES >> Inspection End.

NO >> Repair filament. Refer to [DEF-41, "Inspection and Repair"](#).

# DRIVER SIDE DOOR MIRROR DEFOGGER

< DTC/CIRCUIT DIAGNOSIS >

## DRIVER SIDE DOOR MIRROR DEFOGGER

### Description

INFOID:000000010480847

Heats the heating wire with the power supply from the rear window defogger relay to prevent the door mirror from fogging up.

### Component Function Check

INFOID:000000010480848

#### 1. CHECK DOOR MIRROR DEFOGGER LH

Check that heating wire of door mirror defogger LH is heated when turning the rear window defogger switch ON.

Is the inspection result normal?

- YES >> Door mirror defogger is OK.
- NO >> Refer to [DEF-30, "Diagnosis Procedure"](#).

### Diagnosis Procedure

INFOID:000000010480849

Regarding Wiring Diagram information, refer to [DEF-11, "Wiring Diagram"](#).

#### 1. CHECK POWER SUPPLY CIRCUIT

1. Turn ignition switch OFF.
2. Disconnect door mirror LH.
3. Turn ignition switch ON.
4. Check voltage between door mirror LH connector and ground.

(+)		(-)	Condition	Voltage (V) (Approx.)
Connector	Terminal			
D4	1	Ground	Rear window defogger switch	ON
			OFF	Battery voltage
				0

Is the inspection result normal?

- YES >> GO TO 2.
- NO >> Repair or replace harness.

#### 2. CHECK GROUND CIRCUIT

1. Turn ignition switch OFF.
2. Check continuity between door mirror LH connector and ground.

Door mirror LH		Ground	Continuity
Connector	Terminal		
D4	5		Yes

Is the inspection result normal?

- YES >> GO TO 3.
- NO >> Repair or replace harness.

#### 3. CHECK DOOR MIRROR DEFOGGER LH

Check door mirror defogger LH.  
Refer to [DEF-31, "Component Inspection"](#).

Is the inspection result normal?

- YES >> GO TO 4.
- NO >> Replace door mirror. Refer to [MIR-22, "Removal and Installation"](#).

# DRIVER SIDE DOOR MIRROR DEFOGGER

< DTC/CIRCUIT DIAGNOSIS >

## 4. CHECK INTERMITTENT INCIDENT

Check intermittent incident.

Refer to [GI-44, "Intermittent Incident"](#).

Is the inspection result normal?

- YES >> Check the following.
- Battery power supply circuit.
  - Fuse block (J/B).
- NO >> Repair or replace the malfunctioning parts.

## Component Inspection

INFOID:000000010480850

## 1. CHECK DOOR MIRROR DEFOGGER LH

1. Turn ignition switch OFF.
2. Disconnect door mirror LH.
3. Check continuity between door mirror terminals.

Terminal		Continuity
1	5	Yes

Is the inspection result normal?

- YES >> Inspection End.
- NO >> Replace door mirror LH. Refer to [MIR-22, "Removal and Installation"](#).

A  
B  
C  
D  
E  
F  
G  
H  
I  
J  
K  
DEF  
M  
N  
O  
P

# PASSENGER SIDE DOOR MIRROR DEFOGGER

< DTC/CIRCUIT DIAGNOSIS >

## PASSENGER SIDE DOOR MIRROR DEFOGGER

### Description

INFOID:000000010480851

Heats the heating wire with the power supply from the rear window defogger relay to prevent the door mirror from fogging up.

### Component Function Check

INFOID:000000010480852

#### 1. CHECK DOOR MIRROR DEFOGGER RH

Check that the heating wire of door mirror defogger RH is heated when turning the rear window defogger switch ON.

Is the inspection result normal?

- YES >> Door mirror defogger RH is OK.
- NO >> Refer to [DEF-32, "Diagnosis Procedure"](#).

### Diagnosis Procedure

INFOID:000000010480853

Regarding Wiring Diagram information, refer to [DEF-11, "Wiring Diagram"](#).

#### 1. CHECK POWER SUPPLY CIRCUIT

1. Turn ignition switch OFF.
2. Disconnect door mirror RH.
3. Turn ignition switch ON.
4. Check voltage between door mirror RH connector and ground.

(+)		(-)	Condition		Voltage (V) (Approx.)
Connector	Terminal				
D107	1	Ground	Rear window defogger switch	ON	Battery voltage
				OFF	0

Is the inspection result normal?

- YES >> GO TO 2.
- NO >> Repair or replace harness.

#### 2. CHECK GROUND CIRCUIT

1. Turn ignition switch OFF.
2. Check continuity between door mirror RH connector and ground.

Door mirror RH		Ground	Continuity
Connector	Terminal		
D107	5		Yes

Is the inspection result normal?

- YES >> GO TO 3.
- NO >> Repair or replace harness.

#### 3. CHECK PASSENGER SIDE DOOR MIRROR DEFOGGER

Check door mirror defogger RH.  
Refer to [DEF-33, "Component Inspection"](#).

Is the inspection result normal?

- YES >> GO TO 4.
- NO >> Replace door mirror RH. Refer to [MIR-22, "Removal and Installation"](#).



# PASSENGER SIDE DOOR MIRROR DEFOGGER

< DTC/CIRCUIT DIAGNOSIS >

## 4. CHECK INTERMITTENT INCIDENT

Check intermittent incident.

Refer to [GI-44, "Intermittent Incident"](#).

Is the inspection result normal?

- YES >> Check the following.
- Battery power supply circuit.
  - Fuse block (J/B).
- NO >> Repair or replace the malfunctioning parts.

## Component Inspection

INFOID:000000010480854

## 1. CHECK DOOR MIRROR DEFOGGER RH

1. Turn ignition switch OFF.
2. Disconnect door mirror RH.
3. Check continuity between door mirror terminals.

Terminal		Continuity
1	5	Yes

Is the inspection result normal?

- YES >> Inspection End.
- NO >> Replace door mirror RH. Refer to [MIR-22, "Removal and Installation"](#).

A  
B  
C  
D  
E  
F  
G  
H  
I  
J  
K  
DEF  
M  
N  
O  
P

# DEFOGGER SYSTEM SYMPTOMS

< SYMPTOM DIAGNOSIS >

## SYMPTOM DIAGNOSIS

### DEFOGGER SYSTEM SYMPTOMS

#### Symptom Table

INFOID:000000010480855

Symptom	Reference page
Rear window defogger and door mirror defoggers* do not operate.	Refer to <a href="#">DEF-35, "Diagnosis Procedure"</a> .
Rear window defogger does not operate but both of the door mirror defoggers* operate.	Refer to <a href="#">DEF-36, "Diagnosis Procedure"</a> .
Both door mirror defoggers* don't operate but rear window defogger operates.	Refer to <a href="#">DEF-37, "Diagnosis Procedure"</a> .
Driver side door mirror defogger* does not operate.	Refer to <a href="#">DEF-38, "Diagnosis Procedure"</a> .
Passenger side door mirror defogger* does not operate.	Refer to <a href="#">DEF-39, "Diagnosis Procedure"</a> .
Rear window defogger switch does not light, but rear window defogger operates.	Refer to <a href="#">DEF-40, "Diagnosis Procedure"</a> .

\*:if equipped

# REAR WINDOW DEFOGGER AND DOOR MIRROR DEFOGGER DO NOT OPERATE.

< SYMPTOM DIAGNOSIS >

## REAR WINDOW DEFOGGER AND DOOR MIRROR DEFOGGER DO NOT OPERATE.

### Diagnosis Procedure

INFOID:000000010480856

Regarding Wiring Diagram information, refer to [DEF-11, "Wiring Diagram"](#).

#### 1. CHECK REAR WINDOW DEFOGGER SWITCH

Check rear window defogger switch.

Refer to [DEF-19, "WITH MANUAL A/C : Component Function Check"](#).

Is the inspection result normal?

YES >> GO TO 2.

NO >> Repair or replace the malfunctioning parts.

#### 2. CHECK REAR WINDOW DEFOGGER RELAY

Check rear window defogger relay.

Refer to [DEF-26, "Component Function Check"](#).

Is the inspection result normal?

YES >> GO TO 3.

NO >> Repair or replace the malfunctioning parts.

#### 3. CHECK REAR WINDOW DEFOGGER POWER SUPPLY AND GROUND CIRCUIT

Check rear window defogger power supply and ground circuit.

Refer to [DEF-28, "Component Function Check"](#).

Is the inspection result normal?

YES >> GO TO 4.

NO >> Repair or replace the malfunctioning parts.

#### 4. CHECK DOOR MIRROR DEFOGGER POWER SUPPLY

1. Turn ignition switch ON.

2. Check voltage between fuse block (J/B) connector M5 and ground.

(+)		(-)	Condition	Voltage (V) (Approx.)	
Fuse block (J/B)					
Connector	Terminal				
M5	5P	Ground	Rear window defogger switch	ON	Battery voltage
				OFF	0

Is the inspection result normal?

YES >> GO TO 5.

NO >> Replace fuse block (J/B).

#### 5. CHECK BOTH DOOR MIRROR DEFOGGER

1. Check door mirror LH. Refer to [DEF-30, "Component Function Check"](#).

2. Check door mirror RH. Refer to [DEF-32, "Component Function Check"](#).

Is the inspection result normal?

YES >> Check intermittent incident. Refer to [GI-44, "Intermittent Incident"](#).

NO >> Repair or replace the malfunctioning parts.

# REAR WINDOW DEFOGGER DOES NOT OPERATE BUT BOTH OF DOOR MIRROR DEFOGGER OPERATE.

< SYMPTOM DIAGNOSIS >

---

REAR WINDOW DEFOGGER DOES NOT OPERATE BUT BOTH OF DOOR MIRROR DEFOGGER OPERATE.

## Diagnosis Procedure

INFOID:000000010480857

### 1. CHECK REAR WINDOW DEFOGGER POWER SUPPLY AND GROUND CIRCUIT

---

Check rear window defogger power supply and ground circuit.

Refer to [DEF-28, "Component Function Check"](#).

Is the inspection result normal?

YES >> Refer to [GI-44, "Intermittent Incident"](#).

NO >> Repair or replace the malfunctioning parts.

# BOTH DOORS MIRROR DEFOGGER DON'T OPERATE BUT REAR WINDOW DEFOGGER OPERATES

< SYMPTOM DIAGNOSIS >

## BOTH DOORS MIRROR DEFOGGER DON'T OPERATE BUT REAR WINDOW DEFOGGER OPERATES

### Diagnosis Procedure

INFOID:000000010480858

Regarding Wiring Diagram information, refer to [DEF-11, "Wiring Diagram"](#).

### 1. CHECK DOOR MIRROR DEFOGGER FUSE

Check if the following fuse in fuse block (J/B) is blown.

COMPONENT PARTS	AMPERE	FUSE NO.
Fuse block (J/B)	10A	22

Is the inspection result normal?

YES >> GO TO 2.

NO >> Replace the blown fuse after repairing the affected circuit.

### 2. CHECK DOOR MIRROR DEFOGGER POWER SUPPLY CIRCUIT

1. Turn ignition switch ON.
2. Check voltage between fuse block (J/B) harness connector and ground.

(+)		(-)	Condition	Voltage (V) (Approx.)
Fuse block (J/B)				
Connector	Terminal			
M5	5P	Ground	Rear window defogger switch	ON OFF
				Battery voltage 0

Is the inspection result normal?

YES >> GO TO 3.

NO >> Replace fuse block (J/B).

### 3. CHECK BOTH DOOR MIRROR DEFOGGER

1. Check door mirror LH. Refer to [DEF-30, "Component Function Check"](#).
2. Check door mirror RH. Refer to [DEF-32, "Component Function Check"](#).

Is the inspection result normal?

YES >> Check intermittent incident. Refer to [GI-44, "Intermittent Incident"](#).

NO >> Repair or replace the malfunctioning parts.

A  
B  
C  
D  
E  
F  
G  
H  
I  
J  
K  
DEF  
M  
N  
O  
P

## DRIVER SIDE DOOR MIRROR DEFOGGER DOES NOT OPERATE.

< SYMPTOM DIAGNOSIS >

---

## DRIVER SIDE DOOR MIRROR DEFOGGER DOES NOT OPERATE.

### Diagnosis Procedure

INFOID:000000010480859

#### 1. CHECK DOOR MIRROR DEFOGGER LH

---

Check door mirror defogger LH.

Refer to [DEF-30, "Component Function Check"](#).

Is the inspection result normal?

YES >> Refer to [GI-44, "Intermittent Incident"](#).

NO >> Repair or replace the malfunctioning parts.

# PASSENGER SIDE DOOR MIRROR DEFOGGER DOES NOT OPERATE.

< SYMPTOM DIAGNOSIS >

## PASSENGER SIDE DOOR MIRROR DEFOGGER DOES NOT OPERATE.

### Diagnosis Procedure

INFOID:000000010480860

#### 1. CHECK DOOR MIRROR DEFOGGER RH

Check door mirror defogger RH.

Refer to [DEF-32, "Component Function Check"](#).

Is the inspection result normal?

YES >> Refer to [GI-44, "Intermittent Incident"](#).

NO >> Repair or replace the malfunctioning parts.

A  
B  
C  
D  
E  
F  
G  
H  
I  
J  
K  
DEF  
M  
N  
O  
P

# REAR WINDOW DEFOGGER SWITCH DOES NOT LIGHT, BUT REAR WINDOW DEFOGGER OPERATES

< SYMPTOM DIAGNOSIS >

---

## REAR WINDOW DEFOGGER SWITCH DOES NOT LIGHT, BUT REAR WINDOW DEFOGGER OPERATES

### Diagnosis Procedure

INFOID:000000010480861

#### 1. CHECK REAR WINDOW DEFOGGER SWITCH

---

Check that the rear window defogger switch is operating normally.

Is the inspection result normal?

YES >> Refer to [GI-44, "Intermittent Incident"](#).

NO >> Refer to [DEF-19, "WITH MANUAL A/C : Diagnosis Procedure"](#) or [DEF-22, "WITH AUTO A/C : Diagnosis Procedure"](#).



# FILAMENT

< REMOVAL AND INSTALLATION >

## REMOVAL AND INSTALLATION

### FILAMENT

#### Inspection and Repair

INFOID:000000010480862

#### INSPECTION

1. When measuring voltage, wrap tin foil around the top of the negative probe. Then press the foil against the wire with your finger.

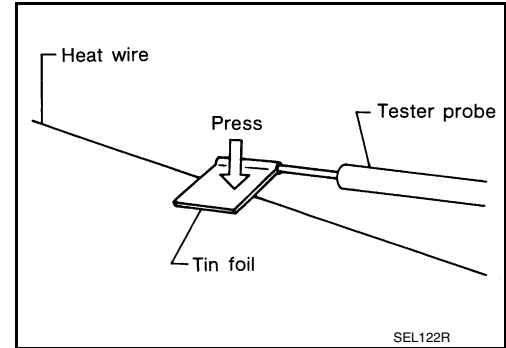

2. Attach probe circuit tester (in Volt range) to middle portion of each filament.

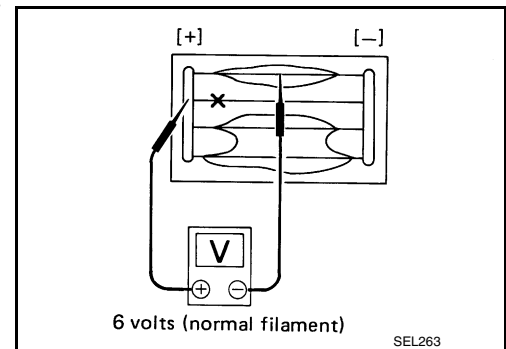

3. If a filament is burned out, circuit tester registers 0 or battery voltage.
4. To locate burned out point, move probe to left and right along filament. Test needle will swing abruptly when probe passes the point.

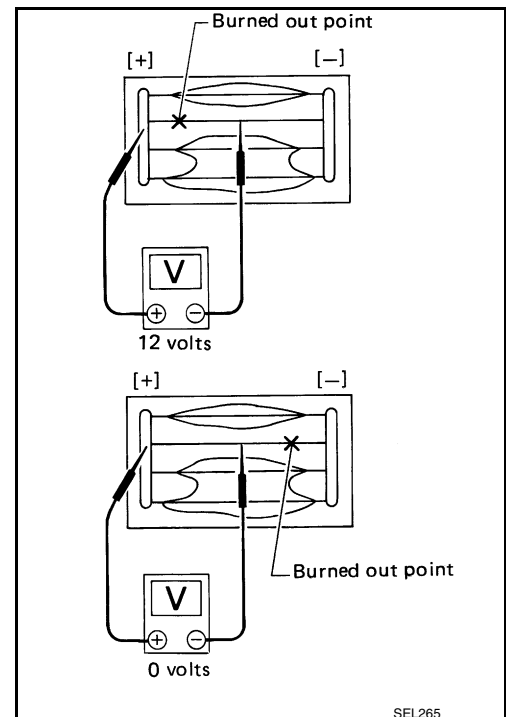

#### REPAIR

##### REPAIR EQUIPMENT

- Conductive silver composition (Dupont No. 4817 or equivalent)

A  
B  
C  
D  
E  
F  
G  
H  
I  
J  
K  
DEF  
M  
N  
O  
P

# FILAMENT

## < REMOVAL AND INSTALLATION >

- Ruler 30 cm (11.8 in) long
- Drawing pen
- Heat gun
- Alcohol
- Cloth

### REPAIRING PROCEDURE

1. Wipe broken heat wire and its surrounding area clean with a cloth dampened in alcohol.
2. Apply a small amount of conductive silver composition to tip of drawing pen.

**NOTE:**

Shake silver composition container before use.

3. Place ruler on glass along broken line. Deposit conductive silver composition on break with drawing pen. Slightly overlap existing heat wire on both sides [preferably 5 mm (0.20 in)] of the break.

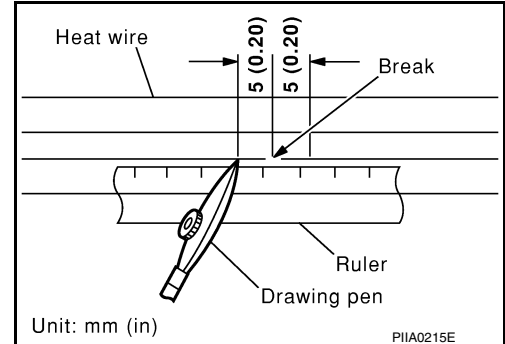

4. After repair has been completed, check repaired wire for continuity. This check should be conducted 10 minutes after silver composition is deposited.

**CAUTION:**

**Do not touch repaired area while test is being conducted.**

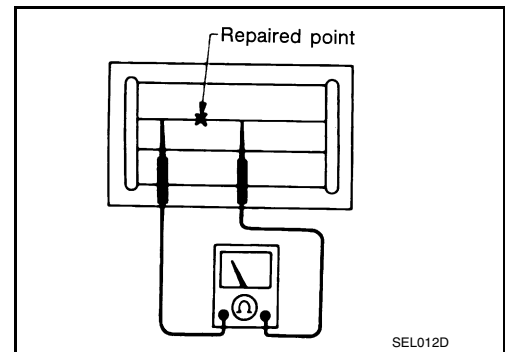

5. Apply a constant stream of hot air directly to the repaired area for approximately 20 minutes with a heat gun. A minimum distance of 3 cm (1.2 in) should be kept between repaired area and hot air outlet.

**NOTE:**

If a heat gun is not available, let the repaired area dry for 24 hours.

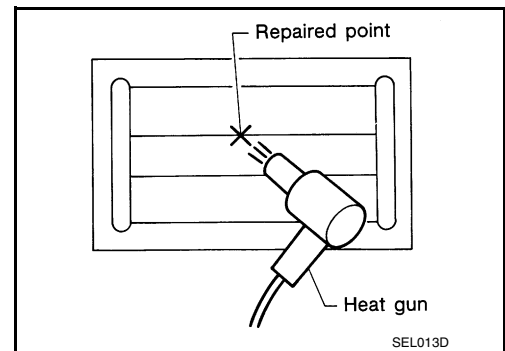

# CONDENSER

< REMOVAL AND INSTALLATION >

## CONDENSER

### Removal and Installation

INFOID:000000010480863

#### REMOVAL

1. Remove the rear pillar finisher. Refer to [INT-25, "REAR PILLAR FINISHER : Removal and Installation"](#).
2. Disconnect the harness connector from the condenser.
3. Remove the bolt (A) and the condenser (1).

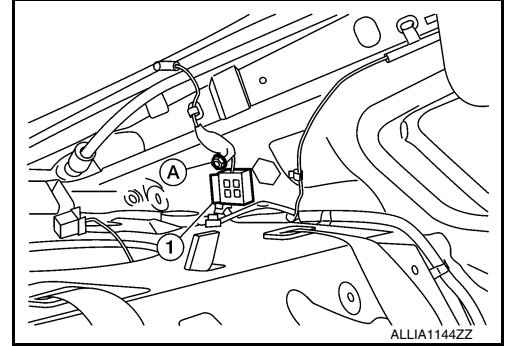

#### INSTALLATION

Installation is in the reverse order of removal.

A  
B  
C  
D  
E  
F  
G  
H  
I  
J  
K  
DEF  
M  
N  
O  
P