

SECTION **MIR**
MIRRORS

A
B
C
D
E
F
G
H
I
J
K
M
N
O
P

CONTENTS

WIRING DIAGRAM	2	SYMPTOM DIAGNOSIS	14
DOOR MIRROR	2	SQUEAK AND RATTLE TROUBLE DIAG- NOSES	14
Wiring Diagram - Power Fold System	2	Work Flow	14
Wiring Diagram - Without Power Fold System	5	Generic Squeak and Rattle Troubleshooting	16
INSIDE MIRROR	8	Diagnostic Worksheet	18
Wiring Diagram	8	UNIT REMOVAL AND INSTALLATION	20
PREPARATION	11	INSIDE MIRROR	20
PREPARATION	11	Removal and Installation	20
Special Service Tool	11	DOOR MIRROR	21
PRECAUTION	12	Door Mirror Assembly	21
PRECAUTIONS	12	Door Mirror Glass	21
Precaution for Supplemental Restraint System (SRS) "AIR BAG" and "SEAT BELT PRE-TEN- SIONER"	12	UNIT DISASSEMBLY AND ASSEMBLY ...	23
Precaution Necessary for Steering Wheel Rota- tion After Battery Disconnect	12	DOOR MIRROR	23
Precaution for Work	13	Mirror Actuator	23

MIR

DOOR MIRROR

< WIRING DIAGRAM >

WIRING DIAGRAM

DOOR MIRROR

Wiring Diagram - Power Fold System

INFOID:000000006658840

DOOR MIRROR - POWER FOLD SYSTEM

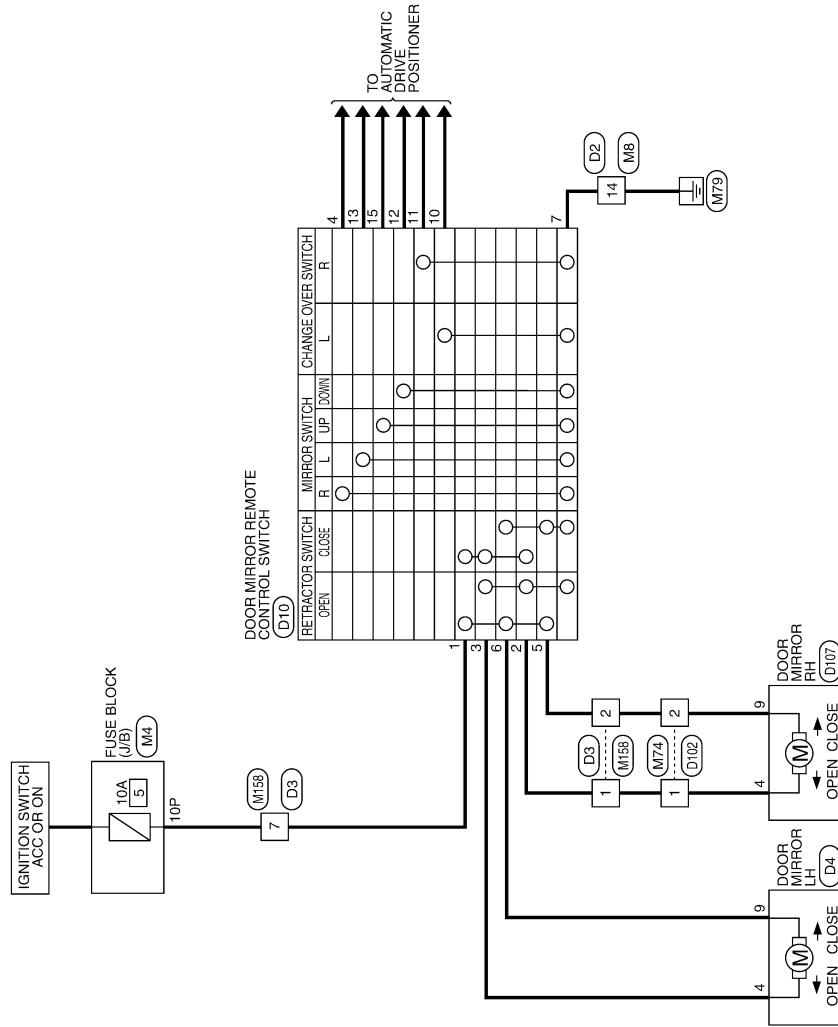

ABLWA1157GB

DOOR MIRROR

< WIRING DIAGRAM >

DOOR MIRROR CONNECTORS - POWER FOLD SYSTEM

Connector No.	M4
Connector Name	FUSE BLOCK (J/B)
Connector Color	WHITE



Terminal No.	10P	Color of Wire	O	Signal Name	-
--------------	-----	---------------	---	-------------	---

Connector No.	M8
Connector Name	WIRE TO WIRE
Connector Color	WHITE

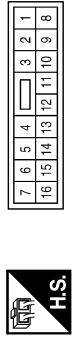

Terminal No.	14	Color of Wire	B	Signal Name	-
--------------	----	---------------	---	-------------	---

Connector No.	M74
Connector Name	WIRE TO WIRE
Connector Color	BROWN

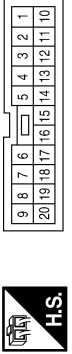

Terminal No.	1	Color of Wire	Y/L	Signal Name	-
Terminal No.	2	Color of Wire	R	Signal Name	-

Connector No.	M158
Connector Name	WIRE TO WIRE
Connector Color	WHITE

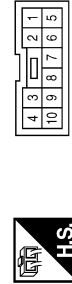

Terminal No.	1	Color of Wire	Y/L	Signal Name	-
Terminal No.	2	Color of Wire	R	Signal Name	-
Terminal No.	7	Color of Wire	O	Signal Name	-

Connector No.	D2
Connector Name	WIRE TO WIRE
Connector Color	WHITE

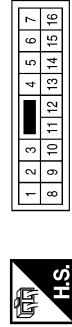

Terminal No.	14	Color of Wire	B	Signal Name	-
--------------	----	---------------	---	-------------	---

Connector No.	D3
Connector Name	WIRE TO WIRE
Connector Color	WHITE

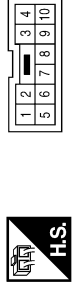

Terminal No.	1	Color of Wire	Y/L	Signal Name	-
Terminal No.	2	Color of Wire	R	Signal Name	-
Terminal No.	7	Color of Wire	O	Signal Name	-

ABLIA0127GB

A
B
C
D
E
F
G
H
I
J
K
M
N
O
P

MIR

DOOR MIRROR

< WIRING DIAGRAM >

Terminal No.	Color of Wire	Signal Name
1	O	-
2	Y/L	-
3	L	-
4	GR	-
5	R	-
6	G	-
7	B	-
10	BRW	-
11	LG	-
12	SB	-
13	V/W	-
15	Y/B	-

Connector No.	D10
Connector Name	DOOR MIRROR REMOTE CONTROL SWITCH (WITH AUTOMATIC DRIVE POSITIONER)
Connector Color	BROWN

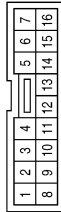

Connector No.	D4
Connector Name	DOOR MIRROR LH (WITH AUTOMATIC DRIVE POSITIONER)
Connector Color	WHITE

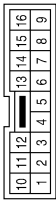

Terminal No.	Color of Wire	Signal Name
4	L	-
9	G	-

Connector No.	D107
Connector Name	DOOR MIRROR RH (WITH AUTOMATIC DRIVE POSITIONER)
Connector Color	WHITE



Connector No.	D102
Connector Name	WIRE TO WIRE
Connector Color	BROWN

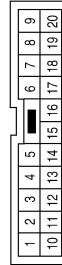

Terminal No.	Color of Wire	Signal Name
4	Y/L	-
9	R	-

Terminal No.	Color of Wire	Signal Name
1	Y/L	-
2	R	-

ABLIA1324GB

DOOR MIRROR

< WIRING DIAGRAM >

Wiring Diagram - Without Power Fold System

INFOID:000000006418435

DOOR MIRROR-WITHOUT POWER FOLD SYSTEM

DOOR MIRROR - WITHOUT POWER FOLD SYSTEM

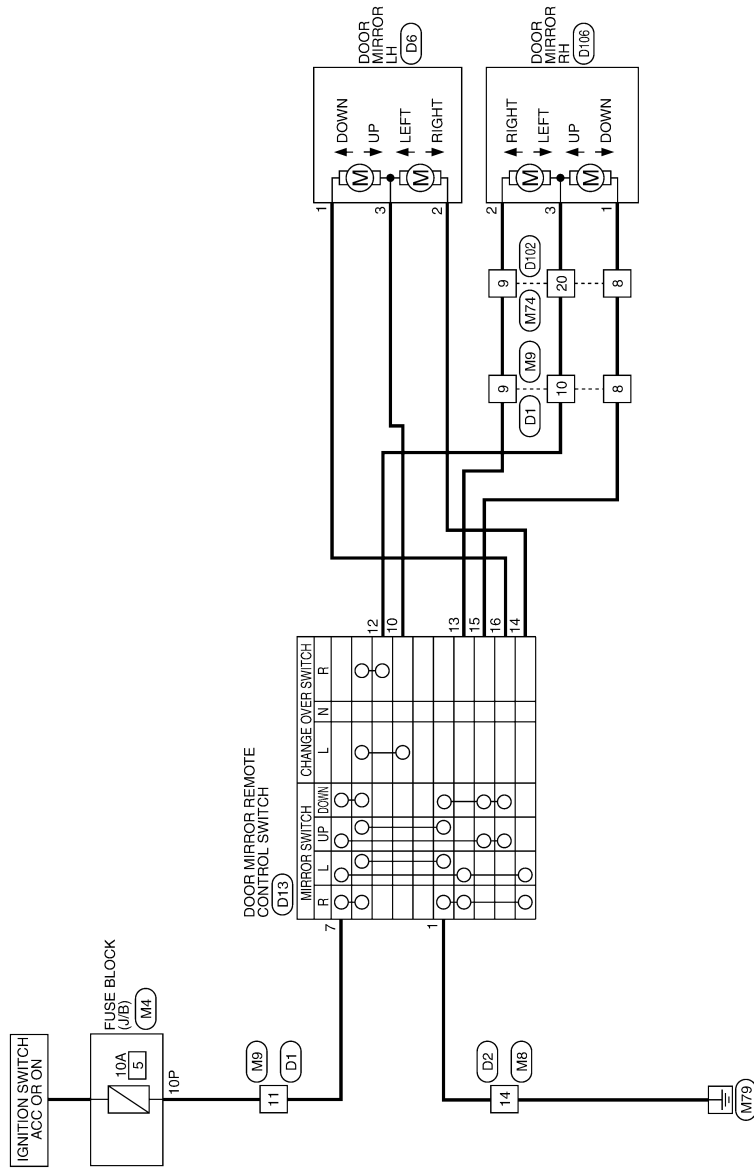

A
B
C
D
E
F
G
H
I
J
K
L
M
N
O
P

MIR

ABLWA1158GB

DOOR MIRROR

< WIRING DIAGRAM >

DOOR MIRROR CONNECTORS - WITHOUT POWER FOLD SYSTEM

Connector No.	M4
Connector Name	FUSE BLOCK (J/B)
Connector Color	WHITE



Terminal No.	Color of Wire	Signal Name
10P	O	-

Connector No.	M8
Connector Name	WIRE TO WIRE
Connector Color	WHITE

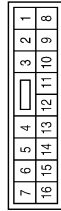

Terminal No.	Color of Wire	Signal Name
14	B	-

Connector No.	M9
Connector Name	WIRE TO WIRE
Connector Color	BROWN

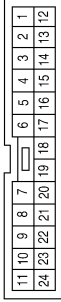

Terminal No.	Color of Wire	Signal Name
8	SB	-
9	Y/B	-
10	V/W	-
11	GR	-

Connector No.	M74
Connector Name	WIRE TO WIRE
Connector Color	BROWN



Terminal No.	Color of Wire	Signal Name
8	SB	-(WITHOUT AUTOMATIC DRIVE POSITIONER)
9	Y/B	-(WITHOUT AUTOMATIC DRIVE POSITIONER)
20	V/W	-(WITHOUT AUTOMATIC DRIVE POSITIONER)

Connector No.	D1
Connector Name	WIRE TO WIRE
Connector Color	BROWN

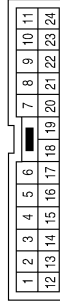

Terminal No.	Color of Wire	Signal Name
8	SB	-
9	Y/B	-
10	V/W	-
11	G/R	-(WITHOUT AUTOMATIC DRIVE POSITIONER)

Connector No.	D2
Connector Name	WIRE TO WIRE
Connector Color	WHITE

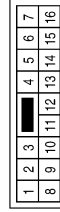

Terminal No.	Color of Wire	Signal Name
14	B	-

DOOR MIRROR

< WIRING DIAGRAM >

Connector No.	D102
Connector Name	WIRE TO WIRE
Connector Color	BROWN

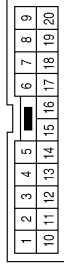

Terminal No.	Color of Wire	Signal Name
8	SB	-(WITHOUT AUTOMATIC DRIVE POSITIONER)
9	Y/B	-(WITHOUT AUTOMATIC DRIVE POSITIONER)
20	V/W	-(WITHOUT AUTOMATIC DRIVE POSITIONER)

Connector No.	D13
Connector Name	DOOR MIRROR REMOTE CONTROL SWITCH (WITHOUT AUTOMATIC DRIVE POSITIONER)
Connector Color	WHITE

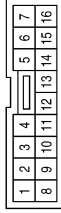

Terminal No.	Color of Wire	Signal Name
1	B	-
7	G/R	-
10	P	-
12	V/W	-
13	Y/B	-
14	Y/R	-
15	SB	-
16	L/R	-

Connector No.	D6
Connector Name	DOOR MIRROR LH (WITHOUT AUTOMATIC DRIVE POSITIONER)
Connector Color	WHITE



Terminal No.	Color of Wire	Signal Name
1	L/R	-
2	Y/R	-
3	P	-

Connector No.	D106
Connector Name	DOOR MIRROR RH (WITHOUT AUTOMATIC DRIVE POSITIONER)
Connector Color	WHITE



Terminal No.	Color of Wire	Signal Name
1	SB	-
2	Y/B	-
3	V/W	-

ABLIA2686GB

A
B
C
D
E
F
G
H
I
J
K
L
M
N
O
P

MIR

INSIDE MIRROR

< WIRING DIAGRAM >

INSIDE MIRROR

Wiring Diagram

INSIDE MIRROR

INFOID:000000006418434

EC WITH AUTO DIMMING OUTSIDE MIRRORS

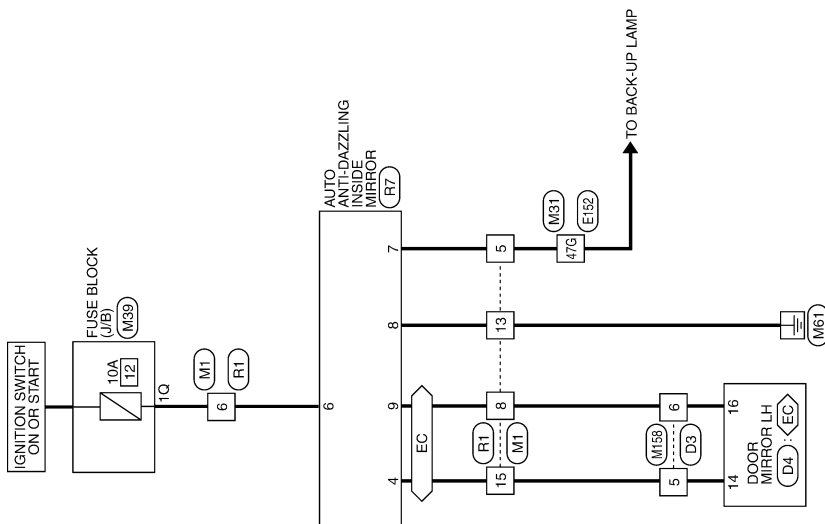

INSIDE MIRROR

ABLWA1159GB

INSIDE MIRROR

< WIRING DIAGRAM >

INSIDE MIRROR CONNECTORS

Connector No.	M1
Connector Name	WIRE TO WIRE
Connector Color	WHITE

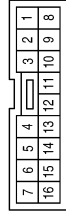

Terminal No.	Color of Wire	Signal Name
5	G/W	-
6	G/R	-
8	Y/V	-
13	B	-
15	LG/B	-

Connector No.	M31
Connector Name	WIRE TO WIRE
Connector Color	WHITE

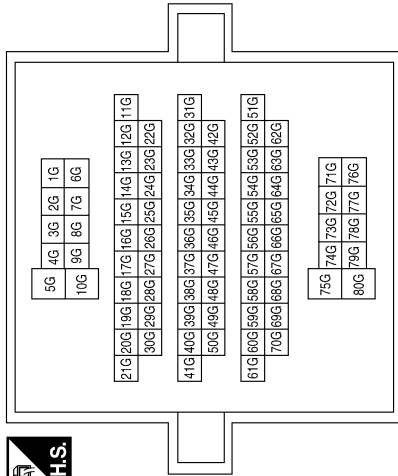

Terminal No.	Color of Wire	Signal Name
47G	G/W	-

Connector No.	M39
Connector Name	FUSE BLOCK (J/B)
Connector Color	WHITE

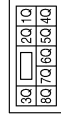

Terminal No.	Color of Wire	Signal Name
1Q	G/R	-

Connector No.	M158
Connector Name	WIRE TO WIRE
Connector Color	WHITE

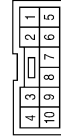

Terminal No.	Color of Wire	Signal Name
5	LG/B	-
6	Y/V	-

ABLIA0128GB

A
B
C
D
E
F
G
H
I
J
K
M
N
O
P

MIR

INSIDE MIRROR

< WIRING DIAGRAM >

Connector No.	R1
Connector Name	WIRE TO WIRE
Connector Color	WHITE

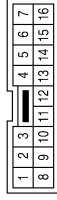

Terminal No.	Color of Wire	Signal Name
5	G/W	-
6	G/R	-
8	Y/V	-
13	B	-
15	LG/B	-

Terminal No.	47G	Color of Wire	G/W	Signal Name	-
--------------	-----	---------------	-----	-------------	---

Connector No.	E152
Connector Name	WIRE TO WIRE
Connector Color	WHITE

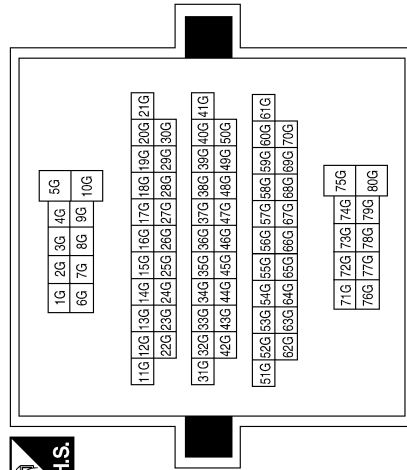

Connector No.	D4
Connector Name	DOOR MIRROR LH (WITH AUTOMATIC DRIVE POSITIONER)
Connector Color	WHITE



Terminal No.	Color of Wire	Signal Name
14	LG/B	EC FEED
16	Y/V	EC RETURN

Connector No.	D3	Connector Name	WIRE TO WIRE	Connector Color	WHITE
---------------	----	----------------	--------------	-----------------	-------



Terminal No.	Color of Wire	Signal Name
5	LG/B	-
6	Y/V	-

Connector No.	R7
Connector Name	AUTO ANTI-DAZZLING INSIDE MIRROR
Connector Color	GRAY

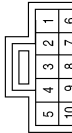

Terminal No.	Color of Wire	Signal Name
4	LG/B	-
6	G/R	ING
7	G/W	REV
8	B	GND
9	Y/V	-

ABLIA0129GB

PREPARATION

< PREPARATION >

PREPARATION

PREPARATION

Special Service Tool

INFOID:000000006635745

The actual shapes of Kent-Moore tools may differ from those of special service tools illustrated here.

Tool number (Kent-Moore No.) Tool name	Description
— (J-46534) Trim tool set	For removing trim

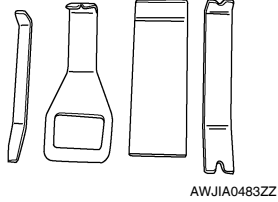

A
B
C
D
E
F
G
H
I
J
K
M
N
O
P

MIR

PRECAUTIONS

< PRECAUTION >

PRECAUTION

PRECAUTIONS

Precaution for Supplemental Restraint System (SRS) "AIR BAG" and "SEAT BELT PRE-TENSIONER"

INFOID:000000006146216

The Supplemental Restraint System such as "AIR BAG" and "SEAT BELT PRE-TENSIONER", used along with a front seat belt, helps to reduce the risk or severity of injury to the driver and front passenger for certain types of collision. This system includes seat belt switch inputs and dual stage front air bag modules. The SRS system uses the seat belt switches to determine the front air bag deployment, and may only deploy one front air bag, depending on the severity of a collision and whether the front occupants are belted or unbelted. Information necessary to service the system safely is included in the SR and SB section of this Service Manual.

WARNING:

- To avoid rendering the SRS inoperative, which could increase the risk of personal injury or death in the event of a collision which would result in air bag inflation, all maintenance must be performed by an authorized NISSAN/INFINITI dealer.
- Improper maintenance, including incorrect removal and installation of the SRS, can lead to personal injury caused by unintentional activation of the system. For removal of Spiral Cable and Air Bag Module, see the SR section.
- Do not use electrical test equipment on any circuit related to the SRS unless instructed to in this Service Manual. SRS wiring harnesses can be identified by yellow and/or orange harnesses or harness connectors.

PRECAUTIONS WHEN USING POWER TOOLS (AIR OR ELECTRIC) AND HAMMERS

WARNING:

- When working near the Airbag Diagnosis Sensor Unit or other Airbag System sensors with the Ignition ON or engine running, DO NOT use air or electric power tools or strike near the sensor(s) with a hammer. Heavy vibration could activate the sensor(s) and deploy the air bag(s), possibly causing serious injury.
- When using air or electric power tools or hammers, always switch the Ignition OFF, disconnect the battery, and wait at least 3 minutes before performing any service.

Precaution Necessary for Steering Wheel Rotation After Battery Disconnect

INFOID:000000006146217

NOTE:

- This Procedure is applied only to models with Intelligent Key system and NATS (NISSAN ANTI-THEFT SYSTEM).
- Remove and install all control units after disconnecting both battery cables with the ignition knob in the "LOCK" position.
- Always use CONSULT-III to perform self-diagnosis as a part of each function inspection after finishing work. If DTC is detected, perform trouble diagnosis according to self-diagnostic results.

For models equipped with the Intelligent Key system and NATS, an electrically controlled steering lock mechanism is adopted on the key cylinder.

For this reason, if the battery is disconnected or if the battery is discharged, the steering wheel will lock and steering wheel rotation will become impossible.

If steering wheel rotation is required when battery power is interrupted, follow the procedure below before starting the repair operation.

OPERATION PROCEDURE

1. Connect both battery cables.

NOTE:

Supply power using jumper cables if battery is discharged.

2. Use the Intelligent Key or mechanical key to turn the ignition switch to the "ACC" position. At this time, the steering lock will be released.
3. Disconnect both battery cables. The steering lock will remain released and the steering wheel can be rotated.
4. Perform the necessary repair operation.

PRECAUTIONS

< PRECAUTION >

5. When the repair work is completed, return the ignition switch to the "LOCK" position before connecting the battery cables. (At this time, the steering lock mechanism will engage.)
6. Perform a self-diagnosis check of all control units using CONSULT-III.

Precaution for Work

INFOID:000000006635747

- When removing or disassembling each component, be careful not to damage or deform it. If a component may be subject to interference, be sure to protect it with a shop cloth.
- When removing (disengaging) components with a screwdriver or similar tool, be sure to wrap the component with a shop cloth or vinyl tape to protect it.
- Protect the removed parts with a shop cloth and prevent them from being dropped.
- Replace a deformed or damaged clip.
- If a part is specified as a non-reusable part, always replace it with new one.
- Be sure to tighten bolts and nuts securely to the specified torque.
- After installation is complete, be sure to check that each part works properly.
- Follow the steps below to clean components.
 - Water soluble dirt: Dip a soft cloth into lukewarm water, and wring the water out of the cloth to wipe the dirty area.
Then rub with a soft and dry cloth.
 - Oily dirt: Dip a soft cloth into lukewarm water with mild detergent (concentration: within 2 to 3%), and wipe the dirty area.
Then dip a cloth into fresh water, and wring the water out of the cloth to wipe the detergent off. Then rub with a soft and dry cloth.
- Do not use organic solvent such as thinner, benzene, alcohol, or gasoline.
- For genuine leather seats, use a genuine leather seat cleaner.

A

B

C

D

E

F

G

H

I

J

K

MIR

M

N

O

P

SQUEAK AND RATTLE TROUBLE DIAGNOSES

< SYMPTOM DIAGNOSIS >

SYMPTOM DIAGNOSIS

SQUEAK AND RATTLE TROUBLE DIAGNOSES

Work Flow

INFOID:000000006146218

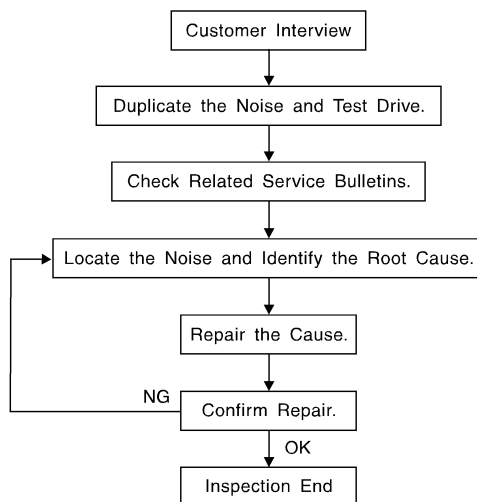

SBT842

CUSTOMER INTERVIEW

Interview the customer if possible, to determine the conditions that exist when the noise occurs. Use the Diagnostic Worksheet during the interview to document the facts and conditions when the noise occurs and any customer's comments; refer to [MIR-18, "Diagnostic Worksheet"](#). This information is necessary to duplicate the conditions that exist when the noise occurs.

- The customer may not be able to provide a detailed description or the location of the noise. Attempt to obtain all the facts and conditions that exist when the noise occurs (or does not occur).
- If there is more than one noise in the vehicle, be sure to diagnose and repair the noise that the customer is concerned about. This can be accomplished by test driving the vehicle with the customer.
- After identifying the type of noise, isolate the noise in terms of its characteristics. The noise characteristics are provided so the customer, service adviser and technician are all speaking the same language when defining the noise.
- Squeak —(Like tennis shoes on a clean floor)
Squeak characteristics include the light contact/fast movement/brought on by road conditions/hard surfaces = higher pitch noise/softer surfaces = lower pitch noises/edge to surface = chirping.
- Creak—(Like walking on an old wooden floor)
Creak characteristics include firm contact/slow movement/twisting with a rotational movement/pitch dependent on materials/often brought on by activity.
- Rattle—(Like shaking a baby rattle)
Rattle characteristics include the fast repeated contact/vibration or similar movement/loose parts/missing clip or fastener/incorrect clearance.
- Knock —(Like a knock on a door)
Knock characteristics include hollow sounding/sometimes repeating/often brought on by driver action.
- Tick—(Like a clock second hand)
Tick characteristics include gentle contacting of light materials/loose components/can be caused by driver action or road conditions.
- Thump—(Heavy, muffled knock noise)
Thump characteristics include softer knock/dead sound often brought on by activity.
- Buzz—(Like a bumble bee)
Buzz characteristics include high frequency rattle/firm contact.
- Often the degree of acceptable noise level will vary depending upon the person. A noise that you may judge as acceptable may be very irritating to the customer.
- Weather conditions, especially humidity and temperature, may have a great effect on noise level.

DUPLICATE THE NOISE AND TEST DRIVE

SQUEAK AND RATTLE TROUBLE DIAGNOSES

< SYMPTOM DIAGNOSIS >

If possible, drive the vehicle with the customer until the noise is duplicated. Note any additional information on the Diagnostic Worksheet regarding the conditions or location of the noise. This information can be used to duplicate the same conditions when you confirm the repair.

If the noise can be duplicated easily during the test drive, to help identify the source of the noise, try to duplicate the noise with the vehicle stopped by doing one or all of the following:

- 1) Close a door.
 - 2) Tap or push/pull around the area where the noise appears to be coming from.
 - 3) Rev the engine.
 - 4) Use a floor jack to recreate vehicle "twist".
 - 5) At idle, apply engine load (electrical load, drive position).
 - 6) Raise the vehicle on a hoist and hit a tire with a rubber hammer.
- Drive the vehicle and attempt to duplicate the conditions the customer states exist when the noise occurs.
 - If it is difficult to duplicate the noise, drive the vehicle slowly on an undulating or rough road to stress the vehicle body.

CHECK RELATED SERVICE BULLETINS

After verifying the customer concern or symptom, check ASIST for Technical Service Bulletins (TSBs) related to that concern or symptom.

If a TSB relates to the symptom, follow the procedure to repair the noise.

LOCATE THE NOISE AND IDENTIFY THE ROOT CAUSE

1. Narrow down the noise to a general area. To help pinpoint the source of the noise, use a listening tool (Chassis Ear: J-39570, Engine Ear: J-39565 and mechanic's stethoscope).
2. Narrow down the noise to a more specific area and identify the cause of the noise by:
 - removing the components in the area that you suspect the noise is coming from.
Do not use too much force when removing clips and fasteners, otherwise clips and fasteners can be broken or lost during the repair, resulting in the creation of new noise.
 - tapping or pushing/pulling the component that you suspect is causing the noise.
Do not tap or push/pull the component with excessive force, otherwise the noise will be eliminated only temporarily.
 - feeling for a vibration with your hand by touching the component(s) that you suspect is (are) causing the noise.
 - placing a piece of paper between components that you suspect are causing the noise.
 - looking for loose components and contact marks.
Refer to [MIR-16. "Generic Squeak and Rattle Troubleshooting"](#).

REPAIR THE CAUSE

- If the cause is a loose component, tighten the component securely.
- If the cause is insufficient clearance between components:
 - separate components by repositioning or loosening and retightening the component, if possible.
 - insulate components with a suitable insulator such as urethane pads, foam blocks, felt cloth tape or urethane tape. A NISSAN Squeak and Rattle Kit (J-43980) is available through your authorized NISSAN Parts Department.

CAUTION:

Do not use excessive force as many components are constructed of plastic and may be damaged.

Always check with the Parts Department for the latest parts information.

The following materials are contained in the NISSAN Squeak and Rattle Kit (J-43980). Each item can be ordered separately as needed.

URETHANE PADS [1.5 mm (0.059 in) thick]

Insulates connectors, harness, etc.

76268-9E005: 100×135 mm (3.94×5.31 in)/76884-71L01: 60×85 mm (2.36×3.35 in)/76884-71L02: 15×25 mm (0.59×0.98 in)

INSULATOR (Foam blocks)

Insulates components from contact. Can be used to fill space behind a panel.

73982-9E000: 45 mm (1.77 in) thick, 50×50 mm (1.97×1.97 in)/73982-50Y00: 10 mm (0.39 in) thick, 50×50 mm (1.97×1.97 in)

INSULATOR (Light foam block)

80845-71L00: 30 mm (1.18 in) thick, 30×50 mm (1.18×1.97 in)

FELT CLOTH TAPE

Used to insulate where movement does not occur. Ideal for instrument panel applications.

SQUEAK AND RATTLE TROUBLE DIAGNOSES

< SYMPTOM DIAGNOSIS >

68370-4B000: 15×25 mm (0.59×0.98 in) pad/68239-13E00: 5 mm (0.20 in) wide tape roll. The following materials not found in the kit can also be used to repair squeaks and rattles.

UHMW (TEFLON) TAPE

Insulates where slight movement is present. Ideal for instrument panel applications.

SILICONE GREASE

Used instead of UHMW tape that will be visible or not fit.

Note: Will only last a few months.

SILICONE SPRAY

Use when grease cannot be applied.

DUCT TAPE

Use to eliminate movement.

CONFIRM THE REPAIR

Confirm that the cause of a noise is repaired by test driving the vehicle. Operate the vehicle under the same conditions as when the noise originally occurred. Refer to the notes on the Diagnostic Worksheet.

Generic Squeak and Rattle Troubleshooting

INFOID:000000006146219

Refer to Table of Contents for specific component removal and installation information.

INSTRUMENT PANEL

Most incidents are caused by contact and movement between:

1. The cluster lid A and instrument panel
2. Acrylic lens and combination meter housing
3. Instrument panel to front pillar garnish
4. Instrument panel to windshield
5. Instrument panel mounting pins
6. Wiring harnesses behind the combination meter
7. A/C defroster duct and duct joint

These incidents can usually be located by tapping or moving the components to duplicate the noise or by pressing on the components while driving to stop the noise. Most of these incidents can be repaired by applying felt cloth tape or silicone spray (in hard to reach areas). Urethane pads can be used to insulate wiring harness.

CAUTION:

Do not use silicone spray to isolate a squeak or rattle. If you saturate the area with silicone, you will not be able to recheck the repair.

CENTER CONSOLE

Components to pay attention to include:

1. Shift selector cover to finisher
2. A/C control unit and cluster lid C
3. Wiring harnesses behind audio and A/C control unit

The instrument panel repair and isolation procedures also apply to the center console.

DOORS

Pay attention to the:

1. Finisher and inner panel making a slapping noise
2. Inside handle escutcheon to door finisher
3. Wiring harnesses tapping
4. Door striker out of alignment causing a popping noise on starts and stops

Tapping or moving the components or pressing on them while driving to duplicate the conditions can isolate many of these incidents. You can usually insulate the areas with felt cloth tape or insulator foam blocks from the NISSAN Squeak and Rattle Kit (J-43980) to repair the noise.

TRUNK

Trunk noises are often caused by a loose jack or loose items put into the trunk by the owner.

In addition look for:

1. Trunk lid bumpers out of adjustment

SQUEAK AND RATTLE TROUBLE DIAGNOSES

< SYMPTOM DIAGNOSIS >

2. Trunk lid striker out of adjustment
3. The trunk lid torsion bars knocking together
4. A loose license plate or bracket

Most of these incidents can be repaired by adjusting, securing or insulating the item(s) or component(s) causing the noise.

SUNROOF/HEADLINING

Noises in the sunroof/headlining area can often be traced to one of the following:

1. Sunroof lid, rail, linkage or seals making a rattle or light knocking noise
2. Sun visor shaft shaking in the holder
3. Front or rear windshield touching headliner and squeaking

Again, pressing on the components to stop the noise while duplicating the conditions can isolate most of these incidents. Repairs usually consist of insulating with felt cloth tape.

OVERHEAD CONSOLE (FRONT AND REAR)

Overhead console noises are often caused by the console panel clips not being engaged correctly. Most of these incidents are repaired by pushing up on the console at the clip locations until the clips engage.

In addition look for:

1. Loose harness or harness connectors.
2. Front console map/reading lamp lense loose.
3. Loose screws at console attachment points.

SEATS

When isolating seat noise it's important to note the position the seat is in and the load placed on the seat when the noise is present. These conditions should be duplicated when verifying and isolating the cause of the noise.

Cause of seat noise include:

1. Headrest rods and holder
2. A squeak between the seat pad cushion and frame
3. The rear seatback lock and bracket

These noises can be isolated by moving or pressing on the suspected components while duplicating the conditions under which the noise occurs. Most of these incidents can be repaired by repositioning the component or applying urethane tape to the contact area.

UNDERHOOD

Some interior noise may be caused by components under the hood or on the engine wall. The noise is then transmitted into the passenger compartment.

Causes of transmitted underhood noise include:

1. Any component mounted to the engine wall
2. Components that pass through the engine wall
3. Engine wall mounts and connectors
4. Loose radiator mounting pins
5. Hood bumpers out of adjustment
6. Hood striker out of adjustment

These noises can be difficult to isolate since they cannot be reached from the interior of the vehicle. The best method is to secure, move or insulate one component at a time and test drive the vehicle. Also, engine RPM or load can be changed to isolate the noise. Repairs can usually be made by moving, adjusting, securing, or insulating the component causing the noise.

A
B
C
D
E
F
G
H
I
J
K
M
N
O
P

MIR

SQUEAK AND RATTLE TROUBLE DIAGNOSES

< SYMPTOM DIAGNOSIS >

Diagnostic Worksheet

INFOID:000000006146220

Dear Customer:

We are concerned about your satisfaction with your vehicle. Repairing a squeak or rattle sometimes can be very difficult. To help us fix your vehicle right the first time, please take a moment to note the area of the vehicle where the squeak or rattle occurs and under what conditions. You may be asked to take a test drive with a service advisor or technician to ensure we confirm the noise you are hearing.

SQUEAK & RATTLE DIAGNOSTIC WORKSHEET

I. WHERE DOES THE NOISE COME FROM? (circle the area of the vehicle)

The illustrations are for reference only, and may not reflect the actual configuration of your vehicle.

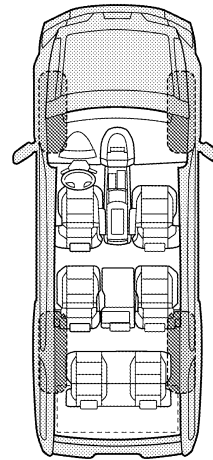
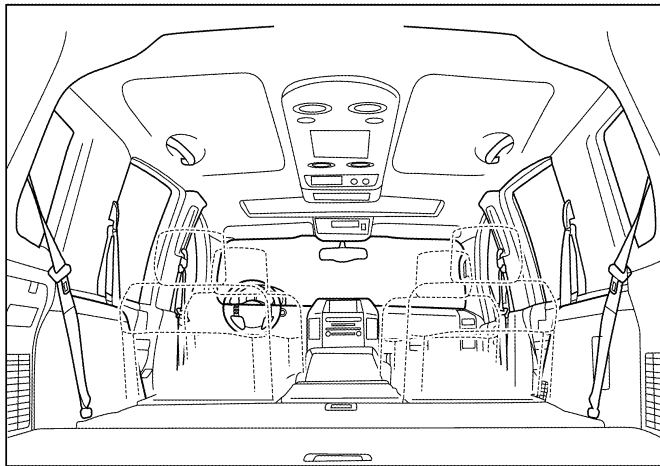
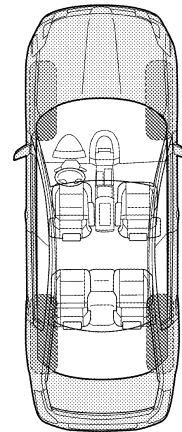
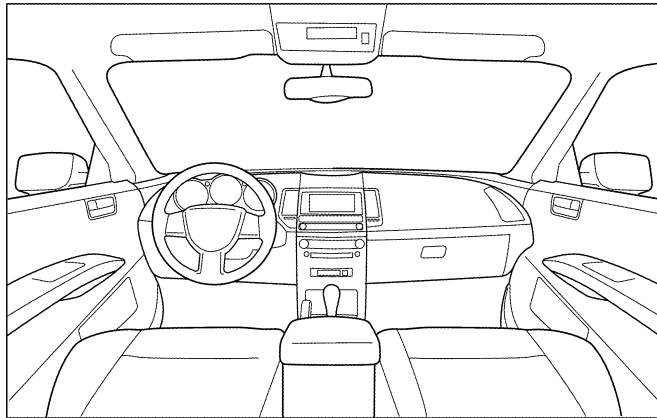

Continue to page 2 of the worksheet and briefly describe the location of the noise or rattle. In addition, please indicate the conditions which are present when the noise occurs.

SQUEAK AND RATTLE TROUBLE DIAGNOSES

< SYMPTOM DIAGNOSIS >

SQUEAK & RATTLE DIAGNOSTIC WORKSHEET - page 2

Briefly describe the location where the noise occurs:

II. WHEN DOES IT OCCUR? (please check the boxes that apply)

- | | |
|---|--|
| <input type="checkbox"/> Anytime | <input type="checkbox"/> After sitting out in the rain |
| <input type="checkbox"/> 1st time in the morning | <input type="checkbox"/> When it is raining or wet |
| <input type="checkbox"/> Only when it is cold outside | <input type="checkbox"/> Dry or dusty conditions |
| <input type="checkbox"/> Only when it is hot outside | <input type="checkbox"/> Other: |

III. WHEN DRIVING:

- Through driveways
- Over rough roads
- Over speed bumps
- Only about ____ mph
- On acceleration
- Coming to a stop
- On turns: left, right or either (circle)
- With passengers or cargo
- Other: _____
- After driving ____ miles or ____ minutes

IV. WHAT TYPE OF NOISE

- Squeak (like tennis shoes on a clean floor)
- Creak (like walking on an old wooden floor)
- Rattle (like shaking a baby rattle)
- Knock (like a knock at the door)
- Tick (like a clock second hand)
- Thump (heavy muffled knock noise)
- Buzz (like a bumble bee)

TO BE COMPLETED BY DEALERSHIP PERSONNEL

Test Drive Notes:

	YES	NO	Initials of person performing
Vehicle test driven with customer	<input type="checkbox"/>	<input type="checkbox"/>	_____
- Noise verified on test drive	<input type="checkbox"/>	<input type="checkbox"/>	_____
- Noise source located and repaired	<input type="checkbox"/>	<input type="checkbox"/>	_____
- Follow up test drive performed to confirm repair	<input type="checkbox"/>	<input type="checkbox"/>	_____

VIN: _____ Customer Name _____
W.O.# _____ Date: _____

This form must be attached to Work Order

LAIA0071E

A
B
C
D
E
F
G
H
I
J
K
M
N
O
P

MIR

INSIDE MIRROR

< UNIT REMOVAL AND INSTALLATION >

UNIT REMOVAL AND INSTALLATION

INSIDE MIRROR

Removal and Installation

INFOID:000000006146221

INSIDE MIRROR

Removal

1. Remove inside mirror finisher.
2. Remove the inside mirror screw and slide the mirror upward to remove.
3. Disconnect the connector.

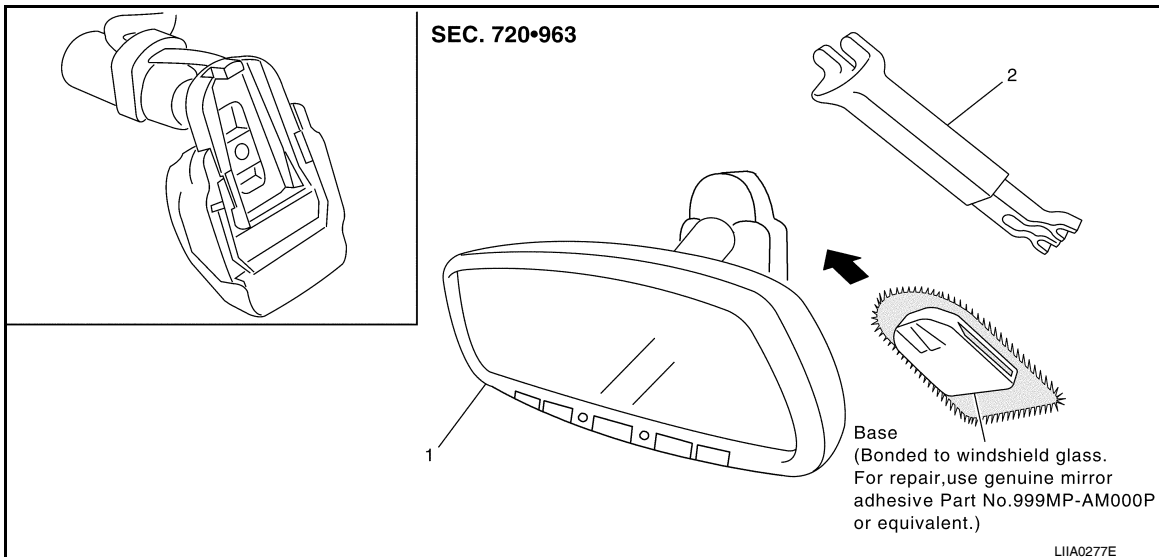

1. Inside mirror

2. Inside mirror finisher

Installation

Installation is in the reverse order of removal.

- Calibrate the compass as necessary. Ref to [MWI-24, "Description"](#).

DOOR MIRROR

< UNIT REMOVAL AND INSTALLATION >

DOOR MIRROR

Door Mirror Assembly

INFOID:000000006146222

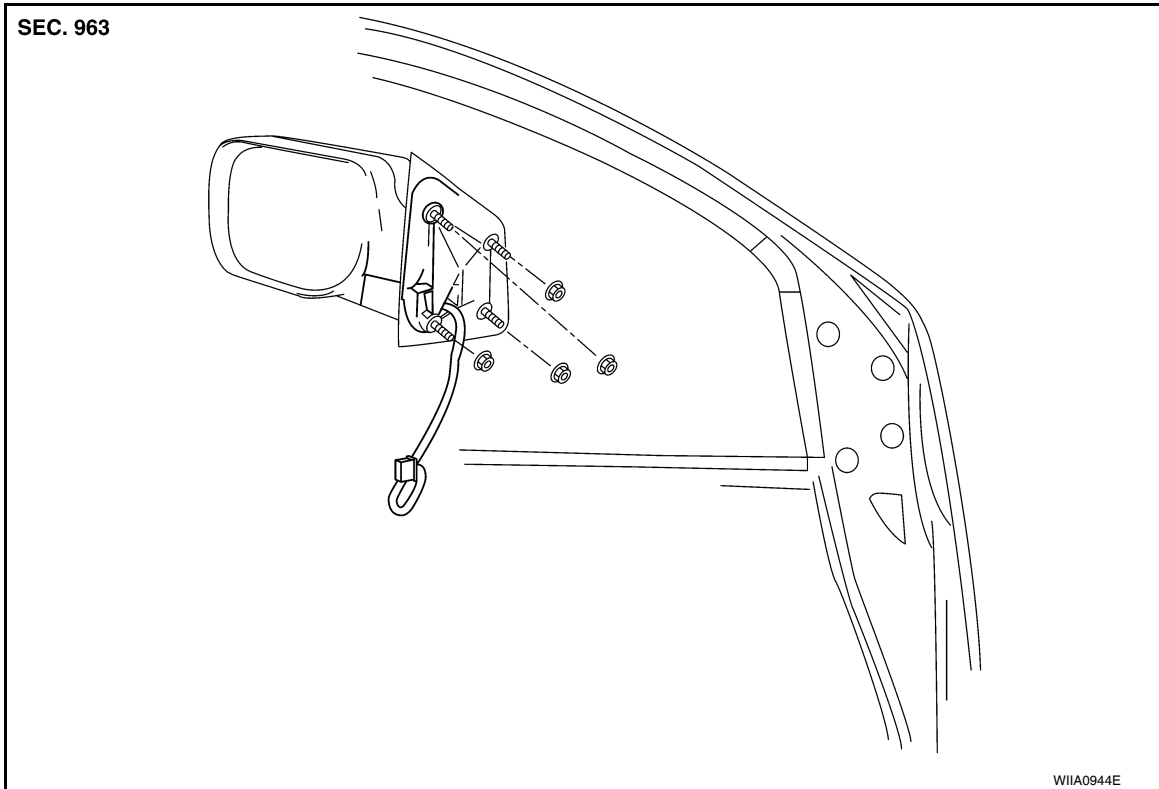

REMOVAL

NOTE:

Be careful not to damage the mirror bodies.

1. Remove the front door finisher. Refer to [INT-11, "Removal and Installation"](#)
2. Remove the adhesive front door sash cover.
3. Disconnect the door mirror harness connector.
4. Remove the door mirror nuts and the door mirror assembly.

INSTALLATION

Installation is in the reverse order of removal.

Door Mirror Glass

INFOID:000000006146223

REMOVAL

A
B
C
D
E
F
G
H
I
J
K
M
N
O
P

MIR

DOOR MIRROR

< UNIT REMOVAL AND INSTALLATION >

1. Set mirror assembly mirror glass in the upward position.
2. Apply protective tape to mirror housing edge.
3. Insert a suitable tool under tab (1) and gently twist to release mirror glass and holder from mirror bracket (2). Remove mirror glass and holder by hand to fully disengage from holder bracket.
4. Disconnect two electrical connectors (3), (4) from mirror glass and holder.

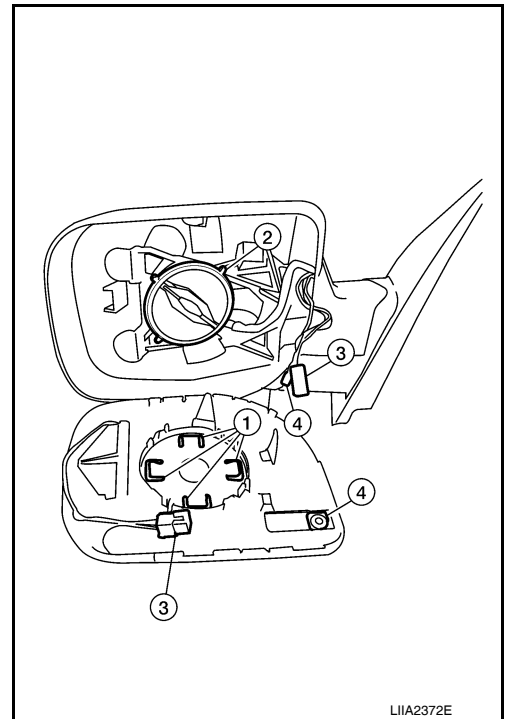

INSTALLATION

1. Set mirror holder bracket and mirror glass and holder in the horizontal position. Ensure that metal dampener blades (1) on mirror glass are aligned with ramps (2) inside plastic mirror case.
2. Connect two electrical connectors (4), (3) to the back of the mirror holder.
3. Align mirror glass and holder with mirror holder bracket and push mirror glass and holder onto mirror holder bracket.
4. Rotate mirror to ensure proper installation.

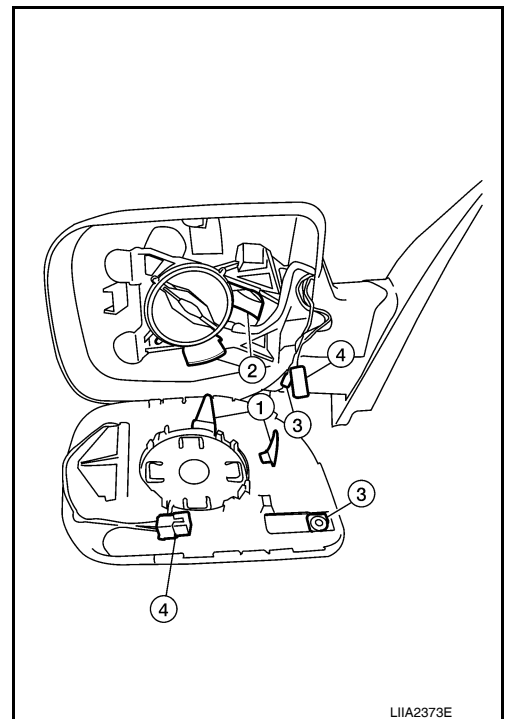

DOOR MIRROR

< UNIT DISASSEMBLY AND ASSEMBLY >

UNIT DISASSEMBLY AND ASSEMBLY

DOOR MIRROR

Mirror Actuator

INFOID:000000006146224

DISASSEMBLY AND ASSEMBLY

Disassembly

1. Remove the mirror glass. Refer to [MIR-21, "Door Mirror Glass"](#).
2. Remove the center screw (A) and release the actuator hooks from housing (B).

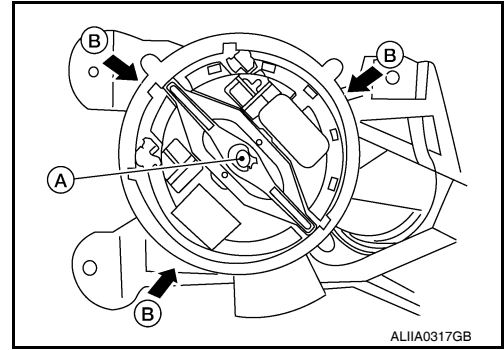

3. Disconnect the connector (A) and remove the actuator (1).

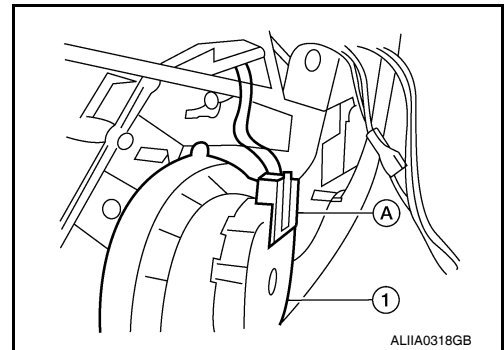

Assembly

Assembly is the reverse order of disassembly.

A
B
C
D
E
F
G
H
I
J
K
M
N
O
P

MIR