

SECTION **SBC**

SEAT BELT CONTROL SYSTEM

A
B
C
D
E
F
G
SBC
I
J
K
L
M
N
O
P

CONTENTS

<p>BASIC INSPECTION 2</p> <p>DIAGNOSIS AND REPAIR WORK FLOW 2</p> <p style="padding-left: 20px;">Work Flow2</p> <p>SYSTEM DESCRIPTION 3</p> <p>SEAT BELT WARNING SYSTEM 3</p> <p style="padding-left: 20px;">System Diagram3</p> <p style="padding-left: 20px;">System Description3</p> <p style="padding-left: 20px;">Component Parts Location4</p> <p style="padding-left: 20px;">Component Description4</p> <p>DTC/CIRCUIT DIAGNOSIS 5</p> <p>SEAT BELT BUCKLE SWITCH 5</p> <p>DRIVER SIDE5</p> <p style="padding-left: 20px;">DRIVER SIDE : Description5</p> <p style="padding-left: 20px;">DRIVER SIDE : Component Function Check5</p> <p style="padding-left: 20px;">DRIVER SIDE : Diagnosis Procedure5</p> <p style="padding-left: 20px;">DRIVER SIDE : Component Inspection (Seat Belt Buckle Switch)6</p> <p>PASSENGER SIDE6</p> <p style="padding-left: 20px;">PASSENGER SIDE : Description6</p> <p style="padding-left: 20px;">PASSENGER SIDE : Component Function Check6</p>	<p>PASSENGER SIDE : Diagnosis Procedure 7</p> <p>PASSENGER SIDE : Component Inspection (Seat Belt Buckle Switch) 8</p> <p>SEAT BELT WARNING LAMP CIRCUIT 9</p> <p style="padding-left: 20px;">Diagnosis Procedure 9</p> <p>SEAT BELT WARNING SYSTEM10</p> <p style="padding-left: 20px;">Wiring Diagram - SEAT BELT WARNING SYSTEM -10</p> <p>SYMPTOM DIAGNOSIS13</p> <p>SEAT BELT WARNING LAMP DOES NOT TURN OFF13</p> <p style="padding-left: 20px;">Diagnosis Procedure13</p> <p>SEAT BELT WARNING LAMP DOES NOT TURN ON14</p> <p style="padding-left: 20px;">Diagnosis Procedure14</p> <p>PRECAUTION15</p> <p>PRECAUTIONS15</p> <p style="padding-left: 20px;">Precaution for Supplemental Restraint System (SRS) "AIR BAG" and "SEAT BELT PRE-TENSIONER"15</p>
--	--

DIAGNOSIS AND REPAIR WORK FLOW

< BASIC INSPECTION >

BASIC INSPECTION

DIAGNOSIS AND REPAIR WORK FLOW

Work Flow

INFOID:000000005491814

DETAILED FLOW

1.OBTAIN INFORMATION ABOUT SYMPTOM

Interview the customer to obtain as much malfunction information (conditions and environment when the malfunction occurs) as possible when the customer brings the vehicle in.

>> GO TO 2.

2.REPRODUCE THE MALFUNCTION INFORMATION

Check the malfunction on the vehicle that the customer describes.
Inspect the relation of the symptoms and the condition when the symptoms occur.

>> GO TO 3.

3.IDENTIFY THE MALFUNCTIONING SYSTEM WITH "SYMPTOM DIAGNOSIS"

Use "Symptom diagnosis" from the symptom inspection result in step 2 and then identify where to start performing the diagnosis based on possible causes and symptoms.

>> GO TO 4.

4.IDENTIFY THE MALFUNCTIONING PARTS WITH "COMPONENT DIAGNOSIS"

Perform the diagnosis with "Component diagnosis" of the applicable system.

>> GO TO 5.

5.REPAIR OR REPLACE THE MALFUNCTIONING PARTS

Repair or replace the specified malfunctioning parts.

>> GO TO 6.

6.FINAL CHECK

Check that the malfunction is not reproduced, referring to the symptom inspection result in step 2.

Are the malfunctions corrected?

YES >> INSPECTION END
NO >> GO TO 3.

SEAT BELT WARNING SYSTEM

< SYSTEM DESCRIPTION >

SYSTEM DESCRIPTION

SEAT BELT WARNING SYSTEM

System Diagram

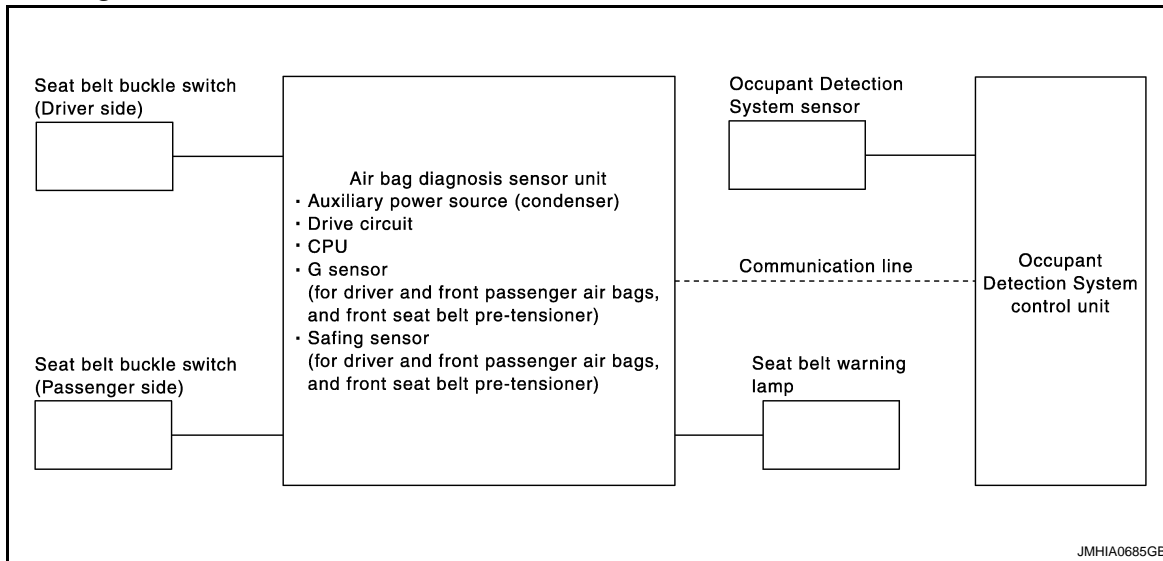

System Description

INFOID:000000005491816

SBC

- Turns ON seat belt warning lamp, when the Occupant Detection System judges adult or child in the front passenger seat and the passenger seat belt buckle switch is OFF.
- Operation of air bag diagnosis sensor unit when air bag diagnosis sensor unit receives information from Occupant Detection System.
- In addition, seat belt warning lamp illuminates, when the driver side seat belt is not fasten. This does not relate to the air bag diagnosis sensor unit.
- For driver seat belt function, refer to [MWI-6. "METER SYSTEM : System Diagram"](#)

Status (front passenger seat)	Seat belt warning lamp (When front passenger seat is unbuckled)
Empty	OFF
An object	OFF
Child/ child-seat	ON
Adult	ON
Malfunction	OFF

SEAT BELT WARNING SYSTEM

< SYSTEM DESCRIPTION >

Component Parts Location

INFOID:000000005491817

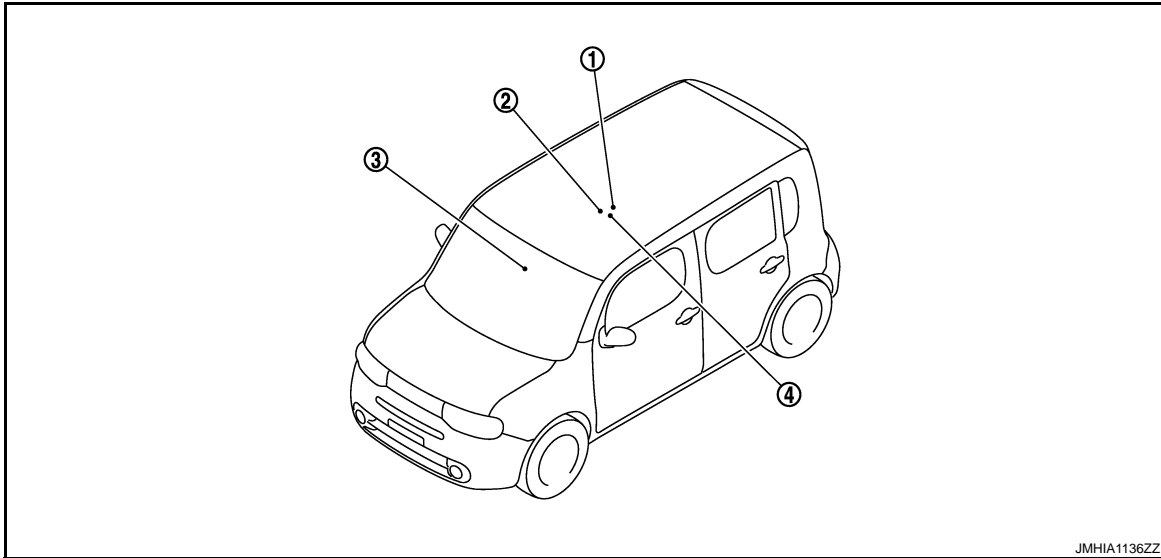

JMHIA1136ZZ

1. Air bag diagnosis sensor unit B13, B14, M59
Refer to [SRC-12. "Component Parts Location"](#)
2. Seat belt buckle switch (passenger side) B23
3. Occupant Detection System control unit B12
Refer to [SRC-12. "Component Parts Location"](#)
4. Seat belt buckle switch (driver side) B22

Component Description

INFOID:000000005491818

Component parts	Outline of function
Seat belt buckle switch (Driver side)	Detects if the seat belt buckle switch (driver side) is fastened or unfastened
Seat belt buckle switch (Passenger side)	Detects if the seat belt buckle switch (passenger side) is fastened or unfastened
Seat belt warning lamp	Turns the seat belt warning lamp ON when the seat belt is unfastened
Occupant Detection System control unit	Judges the passenger seat condition based on the information from Occupant Detection System control unit
Occupant Detection System seat sensor	Detects if the passenger seat is empty or occupied
Air bag diagnosis sensor unit	Turns ON seat belt warning lamp based on the information from Occupant Detection System control unit
Front passenger air bag OFF indicator	Turns the front passenger air bag OFF indicator lamp ON when the front passenger seat is occupied by a child or a child seat

SEAT BELT BUCKLE SWITCH

< DTC/CIRCUIT DIAGNOSIS >

DTC/CIRCUIT DIAGNOSIS

SEAT BELT BUCKLE SWITCH DRIVER SIDE

DRIVER SIDE : Description

INFOID:000000005491819

- Detects whether or not the seat belt is fastened when the ignition switch turns ON. If the seat belt is not fastened, it illuminates the seat belt warning lamp on the combination meter.
- The seat belt buckle switch is installed in the seat belt buckle.

DRIVER SIDE : Component Function Check

INFOID:000000005491820

1.CHECK SEAT BELT BUCKLE SWITCH

Ⓜ With CONSULT-III

When checking "BUCKLE SW" in DATA MONITOR in METER/M&A, check that ON/OFF display changes synchronized with the insertion operation to the seat belt buckle.

Monitor item	Condition
BUCKLE SW	When driver side seat belt is not fastened: ON
	When driver side seat belt is fastened: OFF

Is the inspection result normal?

- YES >> Seat belt buckle switch (driver side) circuit is normal.
NO >> Refer to [SBC-5, "DRIVER SIDE : Diagnosis Procedure"](#).

SBC

DRIVER SIDE : Diagnosis Procedure

INFOID:000000005491821

1.CHECK SEAT BELT BUCKLE SWITCH (DRIVER SIDE) CIRCUIT

1. Turn ignition switch OFF.
2. Disconnect seat belt buckle switch (driver side) connector.
3. Turn ignition switch ON.
4. Check voltage between seat belt buckle switch (driver side) harness connector and ground.

(+)		(-)	Condition	Voltage (V) (Approx.)
Seat belt buckle switch (driver side) Connector	Terminal			
B22	1	Ground	When driver side seat belt is fastened	Battery voltage
			When driver side seat belt is not fastened	0

Is the inspection result normal?

- YES >> GO TO 3.
NO >> GO TO 2.

2.CHECK SEAT BELT BUCKLE SWITCH (DRIVER SIDE) CIRCUIT

1. Turn ignition switch OFF.
2. Disconnect combination meter connector.
3. Check continuity between combination meter harness connector and seat belt buckle switch (driver side) harness connector.

Combination meter		Seat belt buckle switch (driver side)		Continuity
Connector	Terminal	Connector	Terminal	
M34	9	B22	1	Existed

4. Check continuity between combination meter harness connector and ground.

SEAT BELT BUCKLE SWITCH

< DTC/CIRCUIT DIAGNOSIS >

Combination meter		Ground	Continuity
Connector	Terminal		
M34	9		Not existed

Is the inspection result normal?

YES >> Replace combination meter. Refer to [MWI-97, "Removal and Installation"](#).

NO >> Repair or replace harness.

3.CHECK SEAT BELT BUCKLE SWITCH GROUND CIRCUIT

Check continuity between seat belt buckle switch (driver side) harness connector and ground.

Seat belt buckle switch (driver side)		Ground	Continuity
Connector	Terminal		
B22	2		Existed

Is the inspection result normal?

YES >> GO TO 4.

NO >> Repair or replace harness.

4.CHECK SEAT BELT BUCKLE SWITCH (DRIVER SIDE)

Check seat belt buckle switch (driver side). Refer to [SBC-6, "DRIVER SIDE : Component Inspection \(Seat Belt Buckle Switch\)"](#).

Is the inspection result normal?

YES >> INSPECTION END

NO >> Replace seat belt buckle (driver side). Refer to [SB-8, "SEAT BELT BUCKLE : Removal and Installation"](#).

DRIVER SIDE : Component Inspection (Seat Belt Buckle Switch)

INFOID:000000005491822

1.CHECK SEAT BELT BUCKLE SWITCH (DRIVER SIDE)

1. Turn ignition switch OFF
2. Disconnect seat belt buckle switch connector.
3. Check continuity between seat belt buckle switch (driver side).

Seat belt buckle switch (driver side)		Condition	Continuity
Terminal			
1	2	When driver side seat belt is not fastened	Existed
		When driver side seat belt is fastened	Not existed

Is the inspection result normal?

YES >> INSPECTION END

NO >> Replace seat belt buckle (driver side). Refer to [SB-8, "SEAT BELT BUCKLE : Exploded View"](#)

PASSENGER SIDE

PASSENGER SIDE : Description

INFOID:000000005491823

- Detects whether or not the seat belt is fastened when the ignition switch turns ON. If the seat belt switch is not fastened, it illuminates the seat belt warning lamp on the combination meter.
- The seat belt buckle switch is installed in the seat belt buckle.

PASSENGER SIDE : Component Function Check

INFOID:000000005491824

1.CHECK SEAT BELT WARNING FUNCTION

1. Sit down in passenger seat.
2. Check that seat belt warning lamp turns OFF when passenger seat belt is fastened, and then turns ON when passenger seat belt is unfastened.

Is the inspection result normal?

SEAT BELT BUCKLE SWITCH

< DTC/CIRCUIT DIAGNOSIS >

- YES >> Seat belt buckle switch (passenger side) circuit is normal.
 NO >> Refer to [SBC-7, "PASSENGER SIDE : Diagnosis Procedure"](#).

PASSENGER SIDE : Diagnosis Procedure

INFOID:000000005491825

1. CHECK SEAT BELT BUCKLE SWITCH (PASSENGER SIDE) CIRCUIT

1. Turn ignition switch OFF.
2. Disconnect seat belt buckle switch (passenger side) connector.
3. Turn ignition switch ON.
4. Check that voltage between seat belt buckle switch (passenger side) and ground.

(+)		(-)	Condition	Voltage (V) (Approx.)
Seat belt buckle switch (passenger side)				
Connector	Terminal			
B23	1	Ground	When passenger side seat belt is fastened	Battery voltage
			When passenger side seat belt is not fastened	0

Is the inspection result normal?

- YES >> GO TO 3.
 NO >> GO TO 2.

2. CHECK SEAT BELT BUCKLE SWITCH (PASSENGER SIDE) CIRCUIT

1. Turn ignition switch OFF.
2. Disconnect air bag diagnosis sensor unit connector.
3. Check continuity between air bag diagnosis sensor unit harness connector and seat belt buckle switch (passenger side) harness connector.

Air bag diagnosis sensor unit		Seat belt buckle switch (passenger side)		Continuity
Connector	Terminal	Connector	Terminal	
B14	29	B23	1	Existed

4. Check continuity between air bag diagnosis sensor unit harness connector and ground.

Air bag diagnosis sensor unit		Ground	Continuity
Connector	Terminal		
B14	29		Not existed

Is the inspection result normal?

- YES >> Replace air bag diagnosis sensor unit. Refer to [SR-26, "Removal and Installation"](#).
 NO >> Repair or replace harness between air bag diagnosis sensor unit and seat belt buckle switch (passenger side).

3. CHECK SEAT BELT BUCKLE SWITCH GROUND CIRCUIT

Check continuity between seat belt buckle switch (passenger side) harness connector and ground.

Seat belt buckle switch (passenger side)		Ground	Continuity
Connector	Terminal		
B23	2		Existed

Is the inspection result normal?

- YES >> GO TO 4.
 NO >> Repair or replace harness.

4. CHECK SEAT BELT BUCKLE SWITCH (PASSENGER SIDE)

Check seat belt buckle switch (passenger side). Refer to [SBC-8, "PASSENGER SIDE : Component Inspection \(Seat Belt Buckle Switch\)"](#).

Is the inspection result normal?

- YES >> INSPECTION END

A
B
C
D
E
F
G
I
J
K
L
M
N
O
P

SBC

SEAT BELT BUCKLE SWITCH

< DTC/CIRCUIT DIAGNOSIS >

NO >> Replace seat belt buckle (passenger side). Refer to [SB-8, "SEAT BELT BUCKLE : Removal and Installation"](#).

PASSENGER SIDE : Component Inspection (Seat Belt Buckle Switch)

INFOID:000000005491826

1. CHECK SEAT BELT BUCKLE SWITCH (PASSENGER SIDE)

1. Turn ignition switch OFF.
2. Disconnect seat belt buckle switch connector.
3. Check continuity between seat belt buckle switch (passenger side).

Seat belt buckle switch (passenger side)		Condition	Continuity
Terminal			
1	2	When passenger side seat belt is not fastened	Existed
		When passenger side seat belt is fastened	Not existed

Is the inspection result normal?

YES >> INSPECTION END

NO >> Replace seat belt buckle switch (passenger side). Refer to [SB-8, "SEAT BELT BUCKLE : Removal and Installation"](#).

SEAT BELT WARNING LAMP CIRCUIT

< DTC/CIRCUIT DIAGNOSIS >

SEAT BELT WARNING LAMP CIRCUIT

Diagnosis Procedure

INFOID:000000005491827

1. CHECK SEAT BELT WARNING LAMP CIRCUIT

1. Turn ignition switch OFF.
2. Disconnect combination meter connector.
3. Turn ignition switch ON.
4. Check voltage between combination meter harness connector and ground.

Combination meter		Ground	Voltage (V) (Approx.)
Connector	Terminal		
M34	29		12

Is the inspection result normal?

YES >> GO TO 2.

NO >> Repair or replace combination meter. Refer to [MWI-97, "Removal and Installation"](#).

2. CHECK SEAT BELT WARNING LAMP CIRCUIT

1. Turn ignition switch OFF.
2. Disconnect air bag diagnosis sensor unit connector.
3. Check continuity between combination meter harness connector and air bag diagnosis sensor unit harness connector.

Combination meter		Air bag diagnosis sensor unit		Continuity
Connector	Terminal	Connector	Terminal	
M34	29	M59	24	Existed

4. Check continuity between combination meter and ground.

Combination meter		Ground	Continuity
Connector	Terminal		
M34	29		Not existed

Is the inspection result normal?

YES >> Replace air bag diagnosis sensor unit. Refer to [SR-26, "Removal and Installation"](#).

NO >> Repair or replace harness.

A
B
C
D
E
F
G
I
J
K
L
M
N
O
P

SBC

SEAT BELT WARNING SYSTEM

< DTC/CIRCUIT DIAGNOSIS >

SEAT BELT WARNING SYSTEM

Wiring Diagram - SEAT BELT WARNING SYSTEM -

INFOID:000000005491828

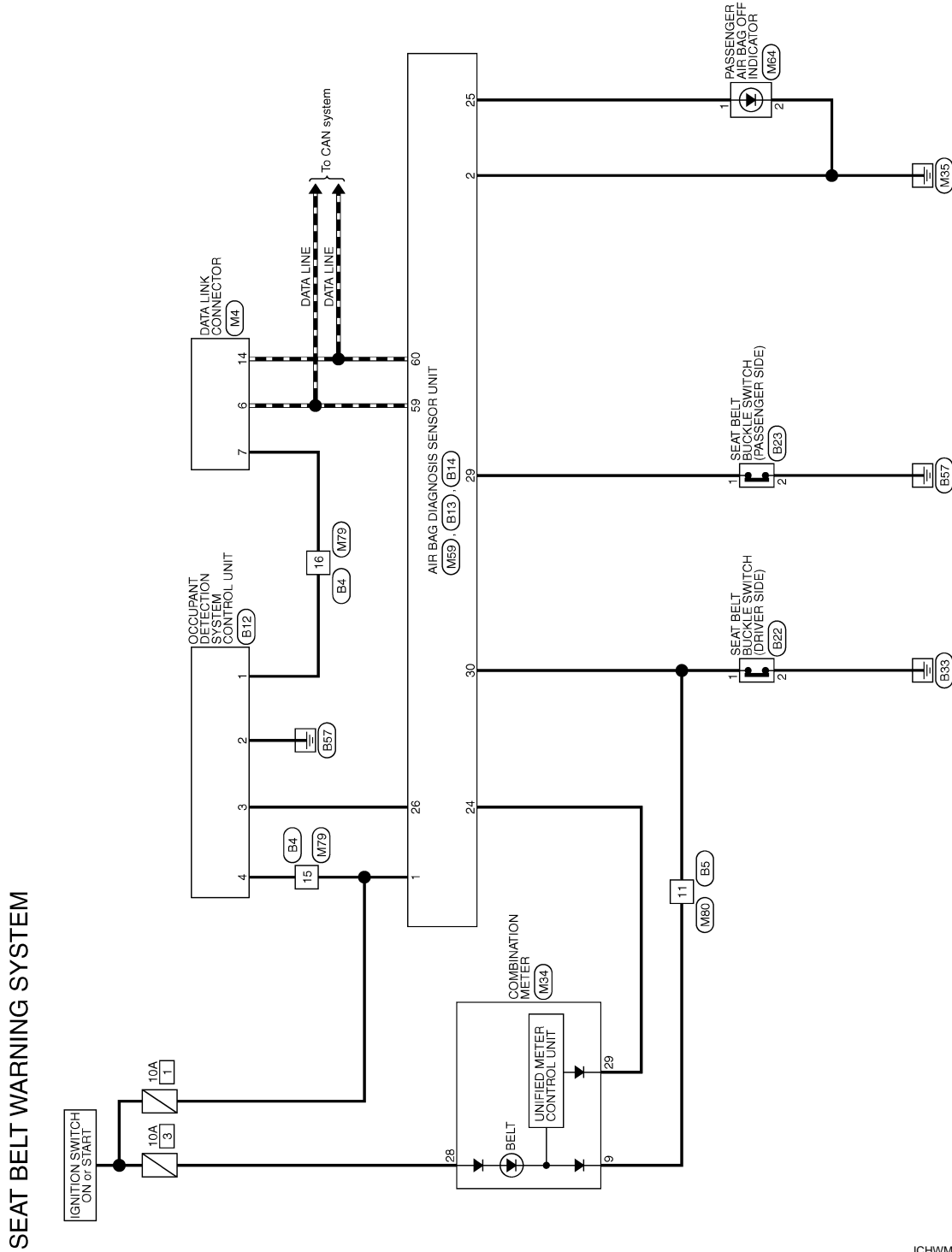

2009/10/02

JCHWM0541GI

SEAT BELT WARNING SYSTEM

< DTC/CIRCUIT DIAGNOSIS >

SEAT BELT WARNING SYSTEM

Connector No.	B4
Connector Name	WIRE TO WIRE
Connector Type	TH24MW-NH

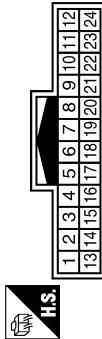

Terminal No.	Color of Wire	Signal Name [Specification]
1	W	-
2	V	-
3	O	-
4	P	-
5	W	-
6	W	-
7	P	-
8	SB	-
11	G	-
12	SB	-
13	L	-
15	R	-
16	GR	-
17	BR	-
18	L	-
19	Y	-
20	LG	-
22	Y	-
23	BR	-
24	O	-

Connector No.	B5
Connector Name	WIRE TO WIRE
Connector Type	TH16MW-NH

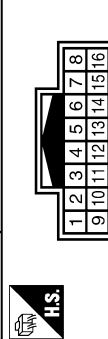

Terminal No.	Color of Wire	Signal Name [Specification]
1	V	-
2	GR	-

5	V	-
6	W	-
8	LG	-
9	R	-
11	O	-
13	GR	-
14	P	-
16	W	-

Connector No.	B12
Connector Name	OCCUPANT DETECTION SYSTEM CONTROL UNIT
Connector Type	TH40FW-NH

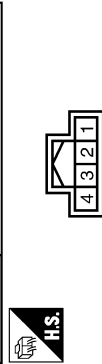

Terminal No.	Color of Wire	Signal Name [Specification]
1	GR	-
2	B	-
3	V	-
4	R	-

Connector No.	B13
Connector Name	AIR BAG DIAGNOSIS SENSOR UNIT
Connector Type	NH22FY-1V-EX

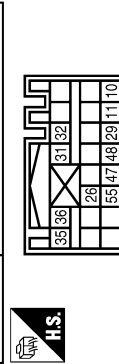

Terminal No.	Color of Wire	Signal Name [Specification]
10	Y	PRH (+)
11	Y	PRH (-)
26	V	ODS INPUT
29	LG	RH BUCKLE SW INPUT
31	Y	SRH (+)
32	Y	SRH (-)
35	P	GRH (+)
36	L	GRH (-)

47	G	SATELLITE RH (+)
48	R	SATELLITE RH (-)
55	SHIELD	GND

Connector No.	B14
Connector Name	AIR BAG DIAGNOSIS SENSOR UNIT
Connector Type	NH22FY-2V-EX

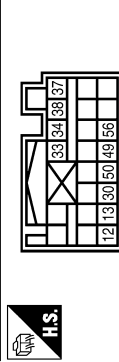

Terminal No.	Color of Wire	Signal Name [Specification]
12	Y	PLH (+)
13	Y	PLH (-)
30	O	LH BUCKLE SW INPUT
33	Y	SLH (+)
34	Y	SLH (-)
37	G	CLH (+)
38	R	CLH (-)
49	P	SATELLITE LH (+)
50	L	SATELLITE LH (-)
56	SHIELD	GND

Connector No.	B22
Connector Name	SEAT BELT BUCKLE SWITCH (DRIVER SIDE)
Connector Type	A03FW

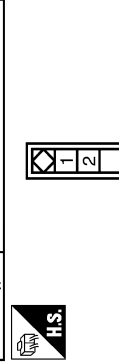

Terminal No.	Color of Wire	Signal Name [Specification]
1	O	-
2	B	-

Connector No.	B23
Connector Name	SEAT BELT BUCKLE SWITCH (PASSENGER SIDE)
Connector Type	A03FW

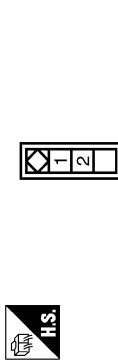

Terminal No.	Color of Wire	Signal Name [Specification]
1	LG	-
2	B	-

Connector No.	M4
Connector Name	DATA LINK CONNECTOR
Connector Type	BD16FW

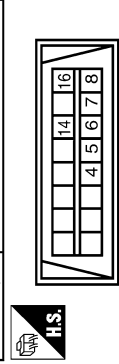

Terminal No.	Color of Wire	Signal Name [Specification]
4	B	-
5	B	-
6	L	-
7	GR/R	-
8	O	-
14	P	-
16	LG/R	-

A
B
C
D
E
F
G
H
I
J
K
L
M
N
O
P

SBC

SEAT BELT WARNING SYSTEM

< DTC/CIRCUIT DIAGNOSIS >

SEAT BELT WARNING SYSTEM

Connector No.	M34
Connector Name	COMBINATION METER
Connector Type	TH40FW-NH

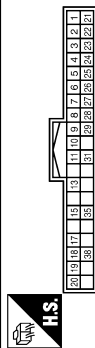

Terminal No.	Color of Wire	Signal Name [Specification]
1	L	CAN-H
2	P	CAN-L
3	V	VEHICLE SPEED SIGNAL (2-PULSE)
4	L	VEHICLE SPEED SIGNAL (8-PULSE)
6	BR/Y	FUEL LEVEL SENSOR SIGNAL
7	R/G	AIR BAG SIGNAL
8	P	OVERDRIVE CONTROL SWITCH SIGNAL
9	O	SEAT BELT BUCKLE SWITCH SIGNAL (DRIVER SIDE)
10	SB	PARKING BRAKE SWITCH SIGNAL
11	G/R	BRAKE FLUID LEVEL SWITCH SIGNAL
13	B/R	ILLUMINATION CONTROL SIGNAL
15	L/Y	ACC POWER SUPPLY
17	G	WASHER LEVEL SWITCH SIGNAL
18	R/Y	SECURITY SIGNAL
19	V/W	AMBIENT SENSOR SIGNAL
20	R/W	AMBIENT SENSOR GROUND
21	B	GROUND
22	B	GROUND
23	B	GROUND
24	V	FUEL LEVEL SENSOR GROUND
25	B	VDC GROUND
27	LG	BATTERY POWER SUPPLY
28	GR	IGNITION SIGNAL
29	BR	PASSENGER SEAT BELT WARNING SIGNAL
31	R	A/C AUTO AMP-CONNECTION RECOGNITION SIGNAL
35	BR	ENGINE COOLANT TEMPERATURE SIGNAL
38	GR	ALTERNATOR SIGNAL

Connector No.	M59
Connector Name	AIR BAG DIAGNOSIS SENSOR UNIT
Connector Type	NH2BFY-EX

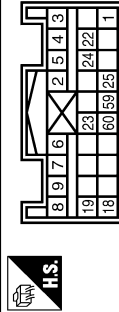

Terminal No.	Color of Wire	Signal Name [Specification]
1	R/L	IGN
2	B	GND
3	Y	DR1 (+)
4	Y/R	DR1 (-) DR2 (-)
5	L/Y	DR2 (+)
6	Y/G	AST (+)
7	Y/B	AST (-)
8	Y/L	ASZ (+)
9	G/Y	ASZ (-)
18	LG	ECZS (+)
19	V	ECZS (-)
22	SHIELD	SHIELD
23	R/G	AIR BAG W/L
24	BR	SEAT BELT W/L
25	R/B	OUTOFF TELLTALE
59	L	CAN-H
60	P	CAN-L

Connector No.	M64
Connector Name	PASSENGER AIR BAG OFF INDICATOR
Connector Type	JA805FB

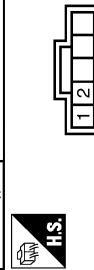

Terminal No.	Color of Wire	Signal Name [Specification]
2	B	-

Connector No.	M79
Connector Name	WIRE TO WIRE
Connector Type	TH24FW-NH

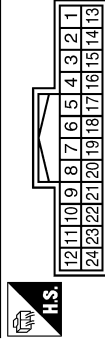

Terminal No.	Color of Wire	Signal Name [Specification]
1	W/G	-
2	L/Y	-
3	R	-
4	P/B	-
5	W	-
6	W/G	-
7	R/B	-
8	SB	-
11	G/B	-
12	G/R	-
13	R/G	-
15	R/L	-
16	GR/R	-
17	BR/Y	-
18	Y	-
19	Y	-
20	GR/L	-
22	L	-
23	Y/L	-
24	G/W	-

Connector No.	M80
Connector Name	WIRE TO WIRE
Connector Type	TH16FW-NH

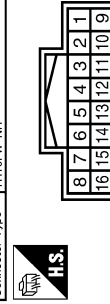

Terminal No.	Color of Wire	Signal Name [Specification]
1	L/B	-
2	GR/L	-

5	W	-
6	W/L	-
8	BR/Y	-
9	R/Y	-
11	O	-
13	BR/W	-
14	W/B	-
16	W/G	-

SEAT BELT WARNING LAMP DOES NOT TURN OFF

< SYMPTOM DIAGNOSIS >

SYMPTOM DIAGNOSIS

SEAT BELT WARNING LAMP DOES NOT TURN OFF

Diagnosis Procedure

INFOID:000000005491831

1. CHECK SEAT BELT BUCKLE SWITCH (DRIVER SIDE)

Check seat belt buckle switch (driver side). Refer to [SBC-5. "DRIVER SIDE : Component Function Check"](#)

Is the inspection result normal?

YES >> GO TO 2.

NO >> Repair or replace the malfunctioning parts.

2. CHECK SEAT BELT BUCKLE SWITCH (PASSENGER SIDE)

Check seat belt buckle switch (passenger side). Refer to [SBC-6. "PASSENGER SIDE : Component Function Check"](#)

NOTE:

Except for Mexico

Is the inspection result normal?

YES >> GO TO 3.

NO >> Repair or replace the malfunctioning parts.

3. CHECK SEAT BELT WARNING LAMP CIRCUIT

Check seat belt warning lamp circuit. Refer to [SBC-9. "Diagnosis Procedure"](#)

Is the inspection result normal?

YES >> GO TO 4.

NO >> Repair or replace the malfunctioning parts.

4. CONFIRM THE OPERATION

Confirm the operation again.

Is the inspection result normal?

YES >> Check intermittent incident. Refer to [GI-35. "Intermittent Incident"](#).

NO >> GO TO 1.

A
B
C
D
E
F
G
I
J
K
L
M
N
O
P

SBC

SEAT BELT WARNING LAMP DOES NOT TURN ON

< SYMPTOM DIAGNOSIS >

SEAT BELT WARNING LAMP DOES NOT TURN ON

Diagnosis Procedure

INFOID:000000005491832

1.CHECK SELF-DIAGNOSIS RESULT

Perform "COMBINATION METER" self-diagnosis result. Refer to [MWI-30, "CONSULT-III Function \(METER/M&A\)"](#)

Is DTC detected?

- YES >> Repair or replace the malfunctioning parts.
- NO >> GO TO 2.

2.CHECK POWER SUPPLY

Check that fuses are not blown.

Check ignition power supply of combination meter. Refer to [MWI-39, "COMBINATION METER : Diagnosis Procedure"](#)

Is the inspection result normal?

- YES >> GO TO 3.
- NO >> Repair or replace the malfunctioning parts.

3.CHECK SEAT BELT BUCKLE SWITCH (DRIVER SIDE)

Check seat belt buckle switch (driver side). Refer to [SBC-5, "DRIVER SIDE : Component Function Check"](#)

Is the inspection result normal?

- YES >> GO TO 4.
- NO >> Repair or replace the malfunctioning parts.

4..CHECK SEAT BELT BUCKLE SWITCH (PASSENGER SIDE)

Check seat belt buckle switch (passenger side). Refer to [SBC-6, "PASSENGER SIDE : Component Function Check"](#)

NOTE:

Except for Mexico

Is the inspection result normal?

- YES >> GO TO 5.
- NO >> Repair or replace the malfunctioning parts.

5..CHECK SEAT BELT WARNING LAMP CIRCUIT

Check seat belt warning lamp circuit. Refer to [SBC-9, "Diagnosis Procedure"](#)

Is the inspection result normal?

- YES >> GO TO 6.
- NO >> Repair or replace the malfunctioning parts.

6.CONFIRM THE OPERATION

Confirm the operation again.

Is the inspection result normal?

- YES >> Check intermittent incident. Refer to [GI-35, "Intermittent Incident"](#).
- NO >> GO TO 1.

PRECAUTIONS

< PRECAUTION >

PRECAUTION

PRECAUTIONS

Precaution for Supplemental Restraint System (SRS) "AIR BAG" and "SEAT BELT PRE-TENSIONER"

INFOID:000000005790720

The Supplemental Restraint System such as "AIR BAG" and "SEAT BELT PRE-TENSIONER", used along with a front seat belt, helps to reduce the risk or severity of injury to the driver and front passenger for certain types of collision. This system includes seat belt switch inputs and dual stage front air bag modules. The SRS system uses the seat belt switches to determine the front air bag deployment, and may only deploy one front air bag, depending on the severity of a collision and whether the front occupants are belted or unbelted. Information necessary to service the system safely is included in the "SRS AIR BAG" and "SEAT BELT" of this Service Manual.

WARNING:

- To avoid rendering the SRS inoperative, which could increase the risk of personal injury or death in the event of a collision which would result in air bag inflation, all maintenance must be performed by an authorized NISSAN/INFINITI dealer.
- Improper maintenance, including incorrect removal and installation of the SRS, can lead to personal injury caused by unintentional activation of the system. For removal of Spiral Cable and Air Bag Module, see the "SRS AIR BAG".
- Do not use electrical test equipment on any circuit related to the SRS unless instructed to in this Service Manual. SRS wiring harnesses can be identified by yellow and/or orange harnesses or harness connectors.

PRECAUTIONS WHEN USING POWER TOOLS (AIR OR ELECTRIC) AND HAMMERS

WARNING:

- When working near the Air Bag Diagnosis Sensor Unit or other Air Bag System sensors with the ignition ON or engine running, DO NOT use air or electric power tools or strike near the sensor(s) with a hammer. Heavy vibration could activate the sensor(s) and deploy the air bag(s), possibly causing serious injury.
- When using air or electric power tools or hammers, always switch the ignition OFF, disconnect the battery, and wait at least 3 minutes before performing any service.

A
B
C
D
E
F
G
SBC
I
J
K
L
M
N
O
P