

SECTION **PWC**

POWER WINDOW CONTROL SYSTEM

A
B
C
D
E
F
G
H
I
J
L
M
N
O
P

CONTENTS

<p>BASIC INSPECTION 4</p> <p>DIAGNOSIS AND REPAIR WORK FLOW 4 WorkFlow4</p> <p>INSPECTION AND ADJUSTMENT 5</p> <p>ADDITIONAL SERVICE WHEN REMOVING BATTERY NEGATIVE TERMINAL5 ADDITIONAL SERVICE WHEN REMOVING BATTERY NEGATIVE TERMINAL : Description5 ADDITIONAL SERVICE WHEN REMOVING BATTERY NEGATIVE TERMINAL : Special Repair Requirement5</p> <p>ADDITIONAL SERVICE WHEN REPLACING CONTROL UNIT5 ADDITIONAL SERVICE WHEN REPLACING CONTROL UNIT : Description5 ADDITIONAL SERVICE WHEN REPLACING CONTROL UNIT : Special Repair Requirement6</p> <p>SYSTEM DESCRIPTION 7</p> <p>POWER WINDOW SYSTEM 7 System Diagram7 System Description7 Component Parts Location9 Component Description9</p> <p>DIAGNOSIS SYSTEM (BCM) (WITH INTELLIGENT KEY SYSTEM)11</p> <p>COMMON ITEM11 COMMON ITEM : CONSULT-III Function (BCM - COMMON ITEM) 11</p> <p>RETAINED PWR12 RETAINED PWR : CONSULT-III Function (BCM - RETAINED PWR)12</p> <p>DIAGNOSIS SYSTEM (BCM) (WITHOUT INTELLIGENT KEY SYSTEM)14</p>	<p>COMMON ITEM14 COMMON ITEM : CONSULT-III Function (BCM - COMMON ITEM)14</p> <p>RETAINED PWR14 RETAINED PWR : CONSULT-III Function (BCM - RETAINED PWR)15</p> <p>DTC/CIRCUIT DIAGNOSIS16</p> <p>POWER SUPPLY AND GROUND CIRCUIT16</p> <p>POWER WINDOW MAIN SWITCH16 POWER WINDOW MAIN SWITCH : Diagnosis Procedure16</p> <p>FRONT POWER WINDOW SWITCH (PASSENGER SIDE)17 FRONT POWER WINDOW SWITCH (PASSENGER SIDE) : Diagnosis Procedure17</p> <p>REAR POWER WINDOW SWITCH17 REAR POWER WINDOW SWITCH : Diagnosis Procedure17</p> <p>FRONT POWER WINDOW SWITCH (PASSENGER SIDE)19 Description19 Component Function Check19 Diagnosis Procedure19 Component Inspection20</p> <p>REAR POWER WINDOW SWITCH21 Description21 Component Function Check21 Diagnosis Procedure21 Component Inspection22</p> <p>POWER WINDOW MOTOR23</p> <p>DRIVER SIDE23 DRIVER SIDE : Description23 DRIVER SIDE : Component Function Check23</p>
---	--



DRIVER SIDE : Diagnosis Procedure	23	FRONT PASSENGER SIDE POWER WINDOW DOES NOT OPERATE	92
PASSENGER SIDE	24	WITH BOTH POWER WINDOW MAIN SWITCH AND FRONT PASSENGER SIDE POWER WINDOW SWITCH	92
PASSENGER SIDE : Description	24	WITH BOTH POWER WINDOW MAIN SWITCH AND FRONT PASSENGER SIDE POWER WINDOW SWITCH : Diagnosis Procedure	92
PASSENGER SIDE : Component Function Check	24	WITH FRONT POWER WINDOW SWITCH ONLY	92
PASSENGER SIDE : Diagnosis Procedure	24	WITH FRONT POWER WINDOW SWITCH ONLY : Diagnosis Procedure	92
REAR LH	25	REAR LH SIDE POWER WINDOW DOES NOT OPERATE	93
REAR LH : Description	25	WITH BOTH POWER WINDOW MAIN SWITCH AND REAR POWER WINDOW SWITCH LH	93
REAR LH : Component Function Check	25	WITH BOTH POWER WINDOW MAIN SWITCH AND REAR POWER WINDOW SWITCH LH : Diagnosis Procedure	93
REAR LH : Diagnosis Procedure	25	WITH REAR POWER WINDOW SWITCH LH ONLY	93
REAR RH	26	WITH REAR POWER WINDOW SWITCH LH ONLY : Diagnosis Procedure	93
REAR RH : Description	26	REAR RH SIDE POWER WINDOW DOES NOT OPERATE	94
REAR RH : Component Function Check	26	WITH BOTH POWER WINDOW MAIN SWITCH AND REAR POWER WINDOW SWITCH RH	94
REAR RH : Diagnosis Procedure	26	WITH BOTH POWER WINDOW MAIN SWITCH AND REAR POWER WINDOW SWITCH RH : Diagnosis Procedure	94
ENCODER CIRCUIT	28	WITH REAR POWER WINDOW SWITCH RH ONLY	94
Description	28	WITH REAR POWER WINDOW SWITCH RH ONLY : Diagnosis Procedure	94
Component Function Check	28	ANTI-PINCH SYSTEM DOES NOT OPERATE NORMALLY (DRIVER SIDE)	95
Diagnosis Procedure	28	Diagnosis Procedure	95
ECU DIAGNOSIS INFORMATION	31	POWER WINDOW RETAINED POWER OPERATION DOES NOT OPERATE PROPERLY	96
BCM (BODY CONTROL MODULE)	31	Diagnosis Procedure	96
WITH INTELLIGENT KEY	31	AUTO OPERATION DOES NOT OPERATE BUT MANUAL OPERATE NORMALLY (DRIVER SIDE)	97
WITH INTELLIGENT KEY : Reference Value	31	Diagnosis Procedure	97
WITH INTELLIGENT KEY : Wiring Diagram - BCM -	51	POWER WINDOW LOCK SWITCH DOES NOT FUNCTION	98
WITH INTELLIGENT KEY : Fail-safe	55	Diagnosis Procedure	98
WITH INTELLIGENT KEY : DTC Inspection Priority Chart	56	PRECAUTION	99
WITH INTELLIGENT KEY : DTC Index	57		
WITHOUT INTELLIGENT KEY	59		
WITHOUT INTELLIGENT KEY : Reference Value..	59		
WITHOUT INTELLIGENT KEY : Wiring Diagram - BCM -	74		
WITHOUT INTELLIGENT KEY : Fail-safe	77		
WITHOUT INTELLIGENT KEY : DTC Inspection Priority Chart	78		
WITHOUT INTELLIGENT KEY : DTC Index	78		
POWER WINDOW MAIN SWITCH	80		
Reference Value	80		
Wiring Diagram - POWER WINDOW CONTROL SYSTEM -	82		
Fail Safe	88		
SYMPTOM DIAGNOSIS	90		
NONE OF THE POWER WINDOWS CAN BE OPERATED USING ANY SWITCH	90		
Diagnosis Procedure	90		
DRIVER SIDE POWER WINDOW DOES NOT OPERATE	91		
Diagnosis Procedure	91		

PRECAUTIONS	99	REMOVAL AND INSTALLATION	100
Precaution for Supplemental Restraint System (SRS) "AIR BAG" and "SEAT BELT PRE-TEN- SIONER"	99	POWER WINDOW MAIN SWITCH	100
		Removal and Installation	100

A
B
C
D
E
F
G
H
I
J
L
M
N
O
P

PWC

DIAGNOSIS AND REPAIR WORK FLOW

< BASIC INSPECTION >

BASIC INSPECTION

DIAGNOSIS AND REPAIR WORK FLOW

WorkFlow

INFOID:000000006504964

DETAILED FLOW

1.OBTAIN INFORMATION ABOUT SYMPTOM

Interview the customer to obtain the malfunction information (conditions and environment when the malfunction occurred) as much as possible when the customer brings the vehicle in.

>> GO TO 2.

2.REPRODUCE THE MALFUNCTION INFORMATION

Check the malfunction on the vehicle that the customer describes.
Inspect the relation of the symptoms and the condition when the symptoms occur.

>> GO TO 3.

3.IDENTIFY THE MALFUNCTIONING SYSTEM WITH "SYMPTOM DIAGNOSIS"

Use "Symptom diagnosis" from the symptom inspection result in step 2 and then identify where to start performing the diagnosis based on possible causes and symptoms.

>> GO TO 4.

4.IDENTIFY THE MALFUNCTIONING PARTS WITH "COMPONENT DIAGNOSIS"

Perform the diagnosis with "Component diagnosis" of the applicable system.

>> GO TO 5.

5.REPAIR OR REPLACE THE MALFUNCTIONING PARTS

Repair or replace the specified malfunctioning parts.

>> GO TO 6.

6.FINAL CHECK

Check that malfunctions are not reproduced when obtaining the malfunction information from the customer, referring to the symptom inspection result in step 2.

Are the malfunctions corrected?

YES >> INSPECTION END

NO >> GO TO 3.

INSPECTION AND ADJUSTMENT

< BASIC INSPECTION >

INSPECTION AND ADJUSTMENT

ADDITIONAL SERVICE WHEN REMOVING BATTERY NEGATIVE TERMINAL

ADDITIONAL SERVICE WHEN REMOVING BATTERY NEGATIVE TERMINAL : Description

INFOID:000000006918034

If any of the following work has been done Initial setting is necessary.

- Power supply to the power window main switch or power window motor is cut off by the removal of battery terminal or the battery fuse is blown.
- Disconnection and connection of power window main switch harness connector.
- Removal and installation of motor from regulator assembly.
- Operation of regulator assembly as an independent unit.
- Removal and installation of glass.
- Removal and installation of door glass run.

NOTE:

The following specified operations can not be performed under the non-initialized condition.

- Auto-up operation
- Anti-pinch function
- Retained power operation

Refer to [PWC-5, "ADDITIONAL SERVICE WHEN REMOVING BATTERY NEGATIVE TERMINAL : Special Repair Requirement"](#).

ADDITIONAL SERVICE WHEN REMOVING BATTERY NEGATIVE TERMINAL : Special Repair Requirement

INFOID:000000006918035

INITIALIZATION PROCEDURE

1. Disconnect battery minus terminal or power window main switch connector. Reconnect it after a minute or more.
2. Turn ignition switch ON.
3. Operate power window switch to fully open the window. (This operation is unnecessary if the window is already fully open)
4. Continue pulling the power window switch UP (AUTO-UP operation). Even after glass stops at fully closed position, keep pulling the switch for 2 seconds or more.
5. Initializing procedure is completely.
6. Inspect anti-pinch function.

CHECK ANTI-PINCH FUNCTION

1. Fully open the door window.
 2. Place a piece of wood near fully closed position.
 3. Close door glass completely with AUTO-UP.
- Check that glass lowers for approximately 150 mm (5.9 in) without pinching piece of wood and stops.
 - Check that glass does not rise when operating the power window main switch while lowering.

CAUTION:

- Perform initial setting when auto-up operation or anti-pinch function does not operate normally.
- Check that AUTO-UP operates before inspection when system initialization is performed.
- Do not check with hands and other body parts because they may be pinched. Do not get pinched.
- It may switch to fail-safe mode if open/close operation is performed continuously without full close. Perform initial setting in that situation. Refer to [PWC-88, "Fail Safe"](#)
- Finish initial setting. Otherwise, next operation cannot be done.

1. Auto-up operation
2. Anti-pinch function
3. Retained power operation

ADDITIONAL SERVICE WHEN REPLACING CONTROL UNIT

ADDITIONAL SERVICE WHEN REPLACING CONTROL UNIT : Description

INFOID:000000006918036

Refer to [PWC-5, "ADDITIONAL SERVICE WHEN REMOVING BATTERY NEGATIVE TERMINAL : Description"](#).

A
B
C
D
E
F
G
H
I
J
L
M
N
O
P



INSPECTION AND ADJUSTMENT

< BASIC INSPECTION >

ADDITIONAL SERVICE WHEN REPLACING CONTROL UNIT : Special Repair Requirement

INFOID:000000006918037

Refer to [PWC-5, "ADDITIONAL SERVICE WHEN REMOVING BATTERY NEGATIVE TERMINAL : Special Repair Requirement"](#) for initialization procedure and check anti-pinch function.

POWER WINDOW SYSTEM

< SYSTEM DESCRIPTION >

SYSTEM DESCRIPTION

POWER WINDOW SYSTEM

System Diagram

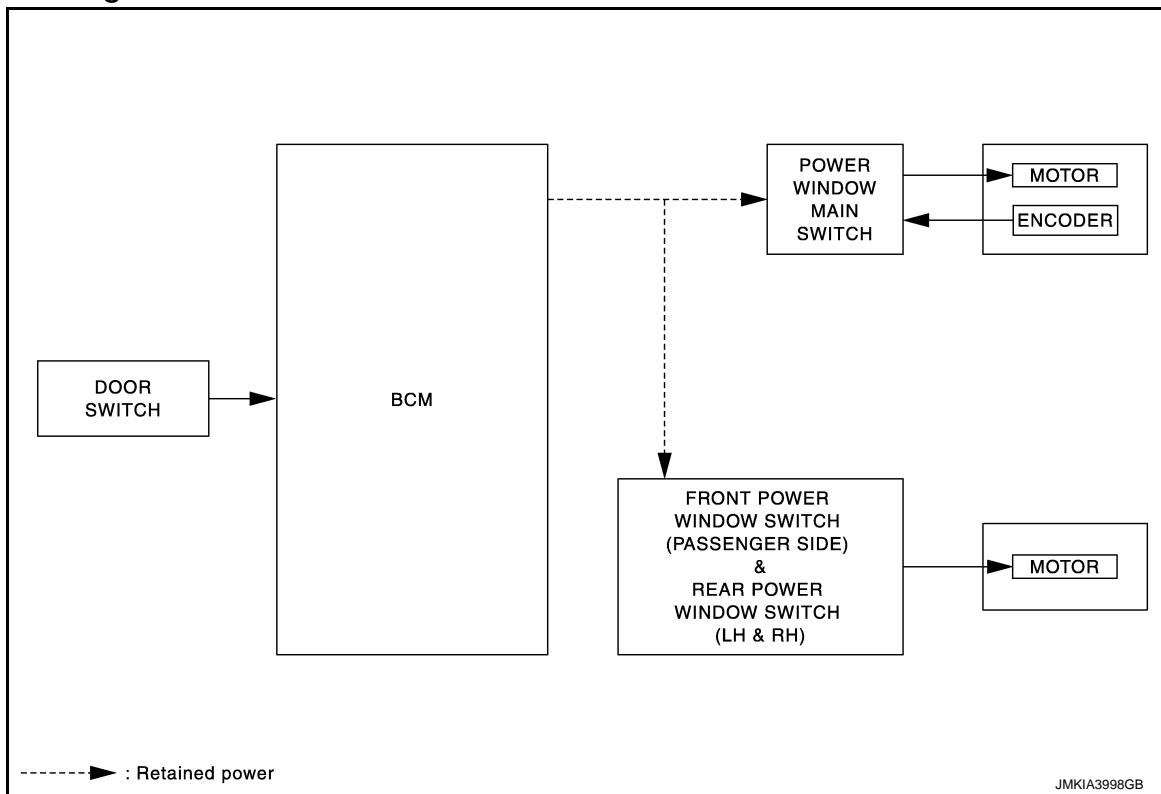

System Description

INFOID:000000006917751

- Power window system is activated by power window switch when ignition switch turns ON, or during the retained power operation after ignition switch turns OFF.
- Power window main switch opens/closes all door glass.
- Front and rear power window switch opens/closes the corresponding door glass.
- AUTO UP/DOWN operation can be performed when power window main switch turns to AUTO.
- Power window lock switch can lock all power windows other than driver seat.
- If door glass receives resistance that is the specified value or more while power window of driver seat is in AUTO-UP operation, power window of driver seat operates in the reverse direction.

POWER WINDOW AUTO-OPERATION (FRONT DRIVER SIDE)

- AUTO UP/DOWN operation can be performed when power window main switch turns to AUTO.
- Encoder continues detecting the movement of power window motor and transmits to power window switch as the encoder pulse signal while power window motor is operating.
- Power window switch reads the changes of encoder signal and stops AUTO operation when door glass is at fully opened/closed position.
- Power window motor is operable in case encoder is malfunctioning.

RETAINED POWER OPERATION (FRONT DRIVER SIDE)

Retained power operation is an additional power supply function that enables power window system to operate for 45 seconds even when ignition switch is turned OFF.

Retained Power Cancel Conditions

- Front door CLOSE (door switch OFF) → OPEN (door switch ON).
- When ignition switch is ON again.
- When timer time passes (45 seconds).

POWER WINDOW LOCK

A
B
C
D
E
F
G
H
I
J
L
M
N
O
P

PWC

POWER WINDOW SYSTEM

< SYSTEM DESCRIPTION >

Ground circuit inside power window main switch shuts off when power window lock switch is ON. This inhibits each power window switch operation except the power window main switch.

ANTI-PINCH SYSTEM (FRONT DRIVER SIDE)

- Pinch foreign material in the door glass during AUTO-UP operation, and it is the anti-pinch function that lowers the door glass 150 mm (5.9 in) when detected.
- Encoder continues detecting the movement of front power window motor (driver side) and transmits to power window main switch as the encoder pulse signal while front power window motor (driver side) is operating.
- Resistance is applied to the front power window motor (driver side) rotation that changes the frequency of encoder pulse signal if foreign material is trapped in the door glass.
- Power window main switch controls to lower the window glass for 150 mm (5.9 in) after it detects encoder pulse signal frequency change.

Operation Condition

When front door glass (driver side) AUTO-UP operation is performed (anti-pinch function does not operate just before the door glass closes and is fully closed).

NOTE:

Depending on environment and driving conditions, if a similar impact or load is applied to the door glass, it may lower.

POWER WINDOW SYSTEM

< SYSTEM DESCRIPTION >

Component Parts Location

INFOID:000000006504971

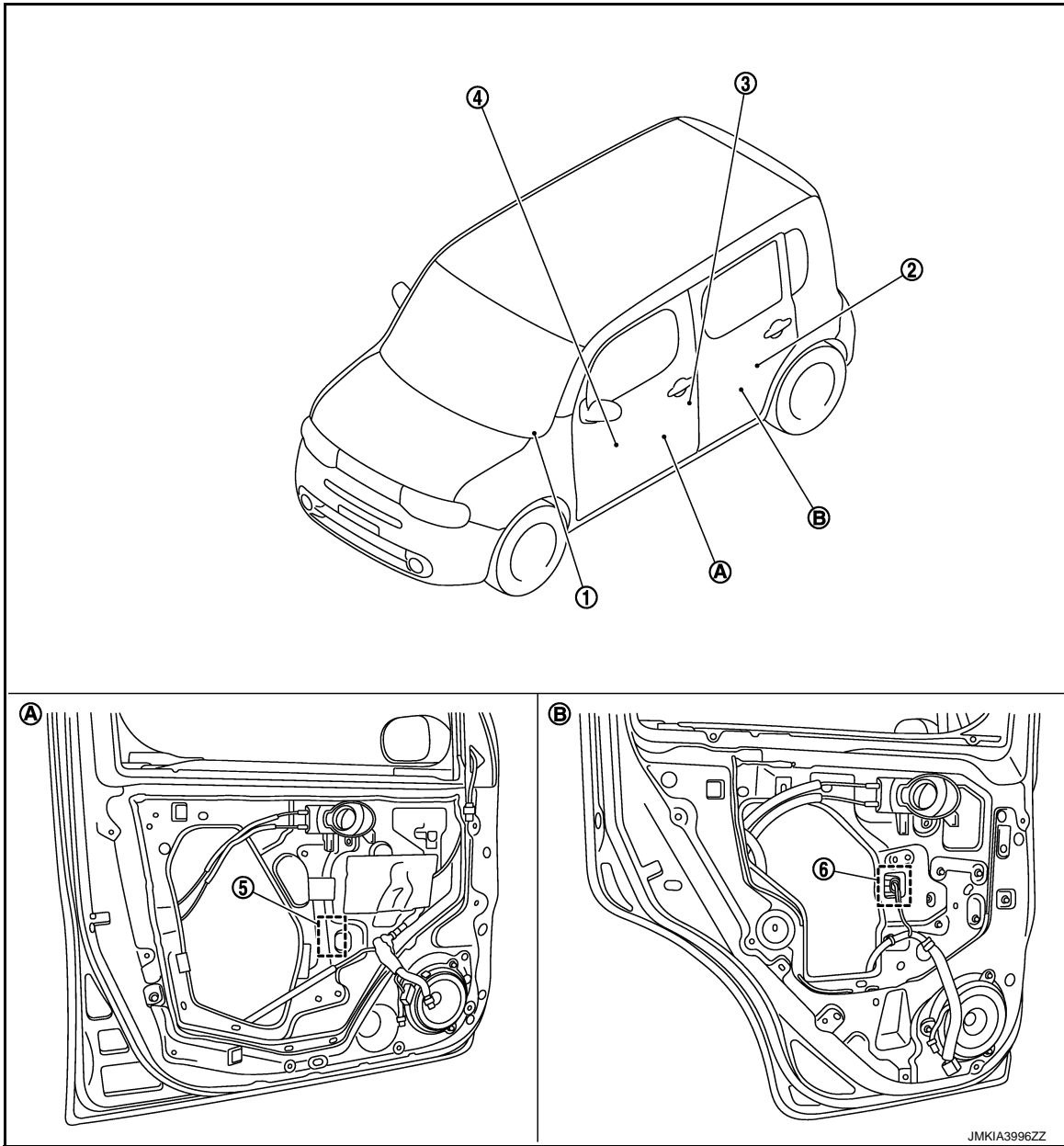

- | | | |
|--|---|------------------------------------|
| 1. BCM Refer to BCS-9, "Component Parts Location" (With Intelligent Key) or BCS-84, "Component Parts Location" (Without Intelligent Key) | 2. Rear power window switch LH | 3. Front door switch (driver side) |
| 4. Power window main switch | 5. Front power window motor (driver side) | 6. Rear power window motor LH |
| A. View with front door finisher removed. | B. View with rear door finisher removed. | |

Component Description

INFOID:000000006917750

Component parts	Description
BCM	<ul style="list-style-type: none"> Supplies power supply to power window switch. Controls retained power.
Power window main switch	<ul style="list-style-type: none"> Directly controls all power window motor of all doors. Controls anti-pinch operation of power window.

POWER WINDOW SYSTEM

< SYSTEM DESCRIPTION >

Component parts	Description
Front power window switch (passenger side)	Controls power window motor of front passenger side door.
Rear power window switch (LH & RH)	Controls power window motor of rear door (LH & RH).
Front power window motor (driver side)	<ul style="list-style-type: none">• Integrates the encoder and power window motor.• Operates with signals from power window main switch.• Transmits front power window motor (driver side) rotation as a pulse signal to power window main switch.
Front power window motor (passenger side)	Operates with signals from power window main switch and front power window switch (passenger side).
Rear power window motor (LH & RH)	Operates with signals from power window main switch and rear power window switch (LH & RH).
Encoder	Detects condition of the front power window motor (driver side) operation and transmits to power window main switch as pulse signal.
Front door switch	Detects door open/close condition and transmits to BCM.

DIAGNOSIS SYSTEM (BCM) (WITH INTELLIGENT KEY SYSTEM)

< SYSTEM DESCRIPTION >

DIAGNOSIS SYSTEM (BCM) (WITH INTELLIGENT KEY SYSTEM) COMMON ITEM

COMMON ITEM : CONSULT-III Function (BCM - COMMON ITEM)

INFOID:000000006949448

APPLICATION ITEM

CONSULT-III performs the following functions via CAN communication with BCM.

Diagnosis mode	Function Description
Work Support	Changes the setting for each system function.
Self Diagnostic Result	Displays the diagnosis results judged by BCM.
CAN Diag Support Monitor	Monitors the reception status of CAN communication viewed from BCM. Refer to CONSULT-III operation manual.
Data Monitor	The BCM input/output signals are displayed.
Active Test	The signals used to activate each device are forcibly supplied from BCM.
Ecu Identification	The BCM part number is displayed.
Configuration	<ul style="list-style-type: none"> Read and save the vehicle specification. Write the vehicle specification when replacing BCM.

SYSTEM APPLICATION

BCM can perform the following functions for each system.

NOTE:

It can perform the diagnosis modes except the following for all sub system selection items.

x: Applicable item

System	Sub system selection item	Diagnosis mode		
		Work Support	Data Monitor	Active Test
Door lock	DOOR LOCK	x	x	x
Rear window defogger	REAR DEFOGGER		x	x
Warning chime	BUZZER		x	x
Interior room lamp timer	INT LAMP	x	x	x
Exterior lamp	HEAD LAMP	x	x	x
Wiper and washer	WIPER	x	x	x
Turn signal and hazard warning lamps	FLASHER	x	x	x
Automatic air conditioner	AIR CONDITONER		x	x
<ul style="list-style-type: none"> Intelligent Key system Engine start system 	INTELLIGENT KEY	x	x	x
Combination switch	COMB SW		x	
Body control system	BCM	x		
NVIS - NATS	IMMU	x	x	x
Interior room lamp battery saver	BATTERY SAVER	x	x	x
Back door	TRUNK		x	
Vehicle security system	THEFT ALM	x	x	x
RAP system	RETAINED PWR		x	
Signal buffer system	SIGNAL BUFFER		x	x
TPMS	TPMS (AIR PRESSURE MONITOR)	x	x	x

FREEZE FRAME DATA (FFD)

The BCM records the following vehicle condition at the time a particular DTC is detected, and displays on CONSULT-III.

DIAGNOSIS SYSTEM (BCM) (WITH INTELLIGENT KEY SYSTEM)

< SYSTEM DESCRIPTION >

CONSULT screen item	Indication/Unit	Description	
Vehicle Speed	km/h	Vehicle speed of the moment a particular DTC is detected	
Odo/Trip Meter	km	Total mileage (Odometer value) of the moment a particular DTC is detected	
Vehicle Condition	SLEEP>LOCK	Power position status of the moment a particular DTC is detected	While turning BCM status from low power consumption mode to normal mode (Power supply position is "LOCK"*)
	SLEEP>OFF		While turning BCM status from low power consumption mode to normal mode (Power supply position is "OFF".)
	LOCK>ACC		While turning power supply position from "LOCK"* to "ACC"
	ACC>ON		While turning power supply position from "ACC" to "IGN"
	RUN>ACC		While turning power supply position from "RUN" to "ACC" (Vehicle is stopping and selector lever is except P position.)
	CRANK>RUN		While turning power supply position from "CRANKING" to "RUN" (From cranking up the engine to run it)
	RUN>URGENT		While turning power supply position from "RUN" to "ACC" (Emergency stop operation)
	ACC>OFF		While turning power supply position from "ACC" to "OFF"
	OFF>LOCK		While turning power supply position from "OFF" to "LOCK"*
	OFF>ACC		While turning power supply position from "OFF" to "ACC"
	ON>CRANK		While turning power supply position from "IGN" to "CRANKING"
	OFF>SLEEP		While turning BCM status from normal mode (Power supply position is "OFF".) to low power consumption mode
	LOCK>SLEEP		While turning BCM status from normal mode (Power supply position is "LOCK"*.) to low power consumption mode
	LOCK		Power supply position is "LOCK"*
	OFF		Power supply position is "OFF" (Ignition switch OFF)
	ACC		Power supply position is "ACC" (Ignition switch ACC)
	ON		Power supply position is "IGN" (Ignition switch ON with engine stopped)
	ENGINE RUN		Power supply position is "RUN" (Ignition switch ON with engine running)
CRANKING	Power supply position is "CRANKING" (At engine cranking)		
IGN Counter	0 - 39	The number of times that ignition switch is turned ON after DTC is detected <ul style="list-style-type: none"> • The number is 0 when a malfunction is detected now. • The number increases like 1 → 2 → 3...38 → 39 after returning to the normal condition whenever ignition switch OFF → ON. • The number is fixed to 39 until the self-diagnosis results are erased if it is over 39. 	

NOTE:

*: Power position shifts to "LOCK" from "OFF", when ignition switch is in the OFF position, selector lever is in the P position (CVT models), and any of the following conditions are met.

- Closing door
- Opening door
- Door is locked using door request switch
- Door is locked using Intelligent Key

The power position shifts to "ACC" when the push-button ignition switch (push switch) is pushed at "LOCK".

RETAINED PWR

RETAINED PWR : CONSULT-III Function (BCM - RETAINED PWR)

INFOID:0000000006504974

Data monitor

DIAGNOSIS SYSTEM (BCM) (WITH INTELLIGENT KEY SYSTEM)

< SYSTEM DESCRIPTION >

Monitor Item	Description
DOOR SW-DR	Indicates [ON/OFF] condition of driver side door switch.
DOOR SW-AS	Indicates [ON/OFF] condition of passenger side door switch.

A

B

C

D

E

F

G

H

I

J

PWC

L

M

N

O

P

DIAGNOSIS SYSTEM (BCM) (WITHOUT INTELLIGENT KEY SYSTEM)

< SYSTEM DESCRIPTION >

DIAGNOSIS SYSTEM (BCM) (WITHOUT INTELLIGENT KEY SYSTEM) COMMON ITEM

COMMON ITEM : CONSULT-III Function (BCM - COMMON ITEM)

INFOID:000000006949450

APPLICATION ITEM

CONSULT-III performs the following functions via CAN communication with BCM.

Diagnosis mode	Function Description
Work Support	Changes the setting for each system function.
Self Diagnostic Result	Displays the diagnosis results judged by BCM.
CAN Diag Support Monitor	Monitors the reception status of CAN communication viewed from BCM. Refer to CONSULT-III operation manual.
Data Monitor	The BCM input/output signals are displayed.
Active Test	The signals used to activate each device are forcibly supplied from BCM.
Ecu Identification	The BCM part number is displayed.
Configuration	<ul style="list-style-type: none"> Read and save the vehicle specification. Write the vehicle specification when replacing BCM.

SYSTEM APPLICATION

BCM can perform the following functions for each system.

NOTE:

It can perform the diagnosis modes except the following for all sub system selection items.

×: Applicable item

System	Sub system selection item	Diagnosis mode		
		Work Support	Data Monitor	Active Test
Door lock	DOOR LOCK	×	×	×
Rear window defogger	REAR DEFOGGER		×	×
Warning chime	BUZZER		×	×
Interior room lamp control	INT LAMP	×	×	×
Remote keyless entry system	MULTI REMOTE ENT	×	×	×
Exterior lamp	HEAD LAMP	×	×	×
Wiper and washer	WIPER	×	×	×
Turn signal and hazard warning lamps	FLASHER		×	×
<ul style="list-style-type: none"> Automatic air conditioner Manual air conditioner 	AIR CONDITONER		×	×
Combination switch	COMB SW		×	
Body control system	BCM	×		
NVIS - NATS	IMMU	×	×	×
Interior room lamp battery saver	BATTERY SAVER	×	×	×
Back door	TRUNK		×	
Vehicle security system	THEFT ALM	×	×	×
RAP system	RETAINED PWR		×	×
Signal buffer system	SIGNAL BUFFER		×	×
TPMS	TPMS (AIR PRESSURE MONITOR)	×	×	×
Panic alarm system	PANIC ALARM			×

RETAINED PWR

DIAGNOSIS SYSTEM (BCM) (WITHOUT INTELLIGENT KEY SYSTEM)

< SYSTEM DESCRIPTION >

RETAINED PWR : CONSULT-III Function (BCM - RETAINED PWR)

INFOID:000000006928462

Data monitor

Monitor Item	Description
DOOR SW-DR	Indicates [ON/OFF] condition of driver side door switch.
DOOR SW-AS	Indicates [ON/OFF] condition of passenger side door switch.

A
B
C
D
E
F
G
H
I
J
L
M
N
O
P

PWC

POWER SUPPLY AND GROUND CIRCUIT

< DTC/CIRCUIT DIAGNOSIS >

DTC/CIRCUIT DIAGNOSIS

POWER SUPPLY AND GROUND CIRCUIT

POWER WINDOW MAIN SWITCH

POWER WINDOW MAIN SWITCH : Diagnosis Procedure

INFOID:000000006504976

1. CHECK POWER SUPPLY CIRCUIT

1. Turn ignition OFF.
2. Disconnect power window main switch connector.
3. Turn ignition switch ON.
4. Check voltage between power window main switch harness connector and ground.

(+)		(-)	Voltage (V) (Approx.)
Power window main switch			
Connector	Terminal	Ground	Battery voltage
D5	10		
D6	19		

Is the inspection result normal?

YES >> GO TO 2.

NO >> GO TO 3.

2. CHECK GROUND CIRCUIT

1. Turn ignition switch OFF.
2. Check continuity between power window main switch harness connector and ground.

Power window main switch		Ground	Continuity
Connector	Terminal		
D6	17		Existed

Is the inspection result normal?

YES >> INSPECTION END

NO >> Repair or replace harness.

3. CHECK HARNESS CONTINUITY

1. Turn ignition switch OFF.
2. Disconnect BCM connector.
3. Check continuity between BCM harness connector and power window main switch harness connector.

BCM		Power window main switch		Continuity
Connector	Terminal	Connector	Terminal	
M67	68	D5	10	Existed
	69	D6	19	

4. Check continuity between BCM harness connector and ground.

BCM		Ground	Continuity
Connector	Terminal		
M67	68		Not existed
	69		

Is the inspection result normal?

YES >> Replace BCM. Refer to [BCS-78. "Removal and Installation"](#) (With Intelligent Key). Refer [BCS-141. "Removal and Installation"](#) (Without Intelligent Key).

NO >> Repair or replace harness.

POWER SUPPLY AND GROUND CIRCUIT

< DTC/CIRCUIT DIAGNOSIS >

FRONT POWER WINDOW SWITCH (PASSENGER SIDE)

FRONT POWER WINDOW SWITCH (PASSENGER SIDE) : Diagnosis Procedure

INFOID:000000006504977

1. CHECK POWER SUPPLY CIRCUIT

1. Turn ignition switch OFF.
2. Disconnect front power window switch (passenger side) connector.
3. Turn ignition switch ON.
4. Check voltage between front power window switch (passenger side) harness connector and ground.

(+)		(-)	Condition	Voltage (V) (Approx.)
Front power window switch (passenger side)				
Connector	Terminal			
D25	8	Ground	Ignition switch ON	Battery voltage

Is the inspection result normal?

YES >> INSPECTION END

NO >> GO TO 2.

2. CHECK HARNESS CONTINUITY

1. Turn ignition switch OFF.
2. Disconnect BCM connector.
3. Check continuity between BCM harness connector and front power window switch (passenger side) harness connector.

BCM		Front power window switch (passenger side)		Continuity
Connector	Terminal	Connector	Terminal	
M67	68	D25	8	Existed

4. Check continuity between BCM harness connector and ground.

BCM		Ground	Continuity
Connector	Terminal		
M67	68		Not existed

Is the inspection result normal?

YES >> Replace BCM. Refer to [BCS-78, "Removal and Installation"](#) (With Intelligent Key). Refer to [BCS-78, "Removal and Installation"](#) (Without Intelligent Key).

NO >> Repair or replace harness.

REAR POWER WINDOW SWITCH

REAR POWER WINDOW SWITCH : Diagnosis Procedure

INFOID:000000006504978

1. CHECK POWER SUPPLY CIRCUIT

1. Turn ignition switch OFF.
2. Disconnect rear power window switch connector.
3. Turn ignition switch ON.
4. Check voltage between rear power window switch harness connector and ground.

(+)		(-)	Condition	Voltage (V) (Approx.)
Rear power window switch				
Connector	Terminal			
LH	D63	Ground	Ignition switch ON	Battery voltage
RH	D43			

Is the inspection result normal?

A
B
C
D
E
F
G
H
I
J
L
M
N
O
P

PWC

POWER SUPPLY AND GROUND CIRCUIT

< DTC/CIRCUIT DIAGNOSIS >

YES >> INSPECTION END

NO >> GO TO 2.

2.CHECK HARNESS CONTINUITY

1. Turn ignition switch OFF.
2. Disconnect BCM connector.
3. Check continuity between BCM harness connector and rear power window switch harness connector.

BCM		Rear power window switch		Continuity	
Connector	Terminal	Connector	Terminal		
M67	68	LH	D63	1	Existed
		RH	D43		

4. Check continuity between BCM harness connector and ground.

BCM		Ground	Continuity
Connector	Terminal		
M67	68		Not existed

Is the inspection result normal?

YES >> Replace BCM. Refer to [BCS-78. "Removal and Installation"](#) (With Intelligent Key). Refer to [BCS-141. "Removal and Installation"](#) (Without Intelligent Key).

NO >> Repair or replace harness.

FRONT POWER WINDOW SWITCH (PASSENGER SIDE)

< DTC/CIRCUIT DIAGNOSIS >

FRONT POWER WINDOW SWITCH (PASSENGER SIDE)

Description

INFOID:000000006504979

Front power window motor (passenger side) will be operated if front power window switch (passenger side) is operated.

Component Function Check

INFOID:000000006504980

1. CHECK FRONT POWER WINDOW SWITCH (PASSENGER SIDE) FUNCTION

Check front power window motor (passenger side) operation with front power window switch (passenger side).

Is the inspection result normal?

YES >> Front power window switch (passenger side) is OK.

NO >> Refer to [PWC-19, "Diagnosis Procedure"](#).

Diagnosis Procedure

INFOID:000000006504981

1. CHECK FRONT POWER WINDOW SWITCH (PASSENGER SIDE) INPUT SIGNAL

1. Turn ignition switch OFF.
2. Disconnect front power window switch (passenger side) connector.
3. Turn ignition switch ON.
4. Check voltage between front power window switch (passenger side) harness connector and ground.

(+)		(-)	Condition	Voltage (V) (Approx.)
Connector	Terminal			
D25	12	Ground	Power window main switch (passenger side) UP	Battery voltage
			DOWN	0
	11		UP	0
			DOWN	Battery voltage

Is the inspection result normal?

YES >> GO TO 2.

NO >> GO TO 3.

2. CHECK FRONT POWER WINDOW SWITCH (PASSENGER SIDE)

Check front power window switch (passenger side).

Refer to [PWC-20, "Component Inspection"](#).

Is the inspection result normal?

YES >> GO TO 4.

NO >> Replace front power window switch (passenger side). Refer to [PWC-100, "Removal and Installation"](#).

3. CHECK FRONT WINDOW SWITCH (PASSENGER SIDE) CIRCUIT

1. Turn ignition switch OFF.
2. Disconnect power window main switch connector.
3. Check continuity between power window main switch harness connector and front power window switch (passenger side) harness connector.

Power window main switch		Front power window switch (passenger side)		Continuity
Connector	Terminal	Connector	Terminal	
D5	16	D25	12	Existed
	12		11	

4. Check continuity between power window main switch harness connector and ground.

A
B
C
D
E
F
G
H
I
J
L
M
N
O
P

PWC

FRONT POWER WINDOW SWITCH (PASSENGER SIDE)

< DTC/CIRCUIT DIAGNOSIS >

Power window main switch		Ground	Continuity
Connector	Terminal		
D5	16		Not existed
	12		

Is the inspection result normal?

YES >> Replace power window main switch. Refer to [PWC-100, "Removal and Installation"](#).

NO >> Repair or replace harness.

4.CHECK INTERMITTENT INCIDENT

Refer to [GI-41, "Intermittent Incident"](#).

>> INSPECTION END

Component Inspection

INFOID:000000006504982

1.CHECK FRONT POWER WINDOW SWITCH (PASSENGER SIDE)

1. Turn ignition OFF.
2. Disconnect front power window switch (passenger side) connector.
3. Check front power window switch (passenger side).

Front power window switch (passenger side)		Front power window switch condition	Continuity
Terminal			
8	7	UP	Existed
11	6		
11	6	NEUTRAL	
12	7		
8	6	DOWN	
12	7		

Is the inspection result normal?

YES >> INSPECTION END

NO >> Replace front power window switch (passenger side). Refer to [PWC-100, "Removal and Installation"](#).

REAR POWER WINDOW SWITCH

< DTC/CIRCUIT DIAGNOSIS >

REAR POWER WINDOW SWITCH

Description

INFOID:000000006504983

Rear power window motor will be operated if rear power window switch is operated.

Component Function Check

INFOID:000000006504984

1. CHECK REAR POWER WINDOW SWITCH FUNCTION

Check rear power window motor operation with rear power window switch.

Is the inspection result normal?

- YES >> Rear power window switch is OK.
- NO >> Refer to [PWC-21, "Diagnosis Procedure"](#).

Diagnosis Procedure

INFOID:000000006504985

1. CHECK REAR POWER WINDOW SWITCH INPUT SIGNAL

1. Turn ignition switch OFF.
2. Disconnect rear power window switch connector.
3. Turn ignition switch ON.
4. Check voltage between rear power window switch harness connector and ground.

(+)		(-)	Condition	Voltage (V) (Approx.)	
Connector	Terminal				
LH: D63	2	Ground	Power window main switch: LH	UP	Battery voltage
				DOWN	0
	3		UP	0	
			DOWN	Battery voltage	
RH: D43	2		Power window main switch: RH	UP	Battery voltage
				DOWN	0
	3			UP	0
				DOWN	Battery voltage

Is the inspection result normal?

- YES >> GO TO 2.
- NO >> GO TO 3.

2. CHECK REAR POWER WINDOW SWITCH

Check rear power window switch.

Refer to [PWC-22, "Component Inspection"](#).

Is the inspection result normal?

- YES >> GO TO 4.
- NO >> Replace rear power window switch. Refer to [PWC-100, "Removal and Installation"](#).

3. CHECK REAR POWER WINDOW SWITCH CIRCUIT

1. Turn ignition switch OFF.
2. Disconnect power window main switch connector.
3. Check continuity between power window main switch harness connector and rear power window switch harness connector.

A
B
C
D
E
F
G
H
I
J
L
M
N
O
P

PWC

REAR POWER WINDOW SWITCH

< DTC/CIRCUIT DIAGNOSIS >

Power window main switch		Rear power window switch			Continuity
Connector	Terminal	Connector		Terminal	
D5	1	LH	D63	2	Existed
	3			3	
	5	RH	D43	3	
	7			2	

4. Check continuity between power window main switch harness connector and ground.

Power window main switch		Ground	Continuity
Connector	Terminal		
D5	1	Ground	Not existed
	3		
	5		
	7		

Is the inspection result normal?

YES >> Replace power window main switch. Refer to [PWC-100, "Removal and Installation"](#) .

NO >> Repair or replace harness.

4.CHECK INTERMITTENT INCIDENT

Refer to [GI-41, "Intermittent Incident"](#).

>> INSPECTION END

Component Inspection

INFOID:000000006504986

1.CHECK REAR POWER WINDOW SWITCH

1. Turn ignition switch OFF.
2. Disconnect rear power window switch connector.
3. Check rear power window switch.

Rear power window switch		Rear power window switch condition	Continuity
Terminal			
1	5	UP	Existed
3	4		
3	4	NEUTRAL	
2	5		
1	4	DOWN	
2	5		

Is the inspection result normal?

YES >> INSPECTION END

NO >> Replace rear power window switch. Refer to [PWC-100, "Removal and Installation"](#).

POWER WINDOW MOTOR

< DTC/CIRCUIT DIAGNOSIS >

POWER WINDOW MOTOR DRIVER SIDE

DRIVER SIDE : Description

INFOID:000000006504987

Door glass moves UP/DOWN by receiving the signal from power window main switch.

DRIVER SIDE : Component Function Check

INFOID:000000006504988

1. CHECK FRONT POWER WINDOW MOTOR (DRIVER SIDE) OPERATION

Check front power window motor (driver side) operation with power window main switch.

Is the inspection result normal?

- YES >> Front power window motor (driver side) is OK.
 NO >> Refer to [PWC-23. "DRIVER SIDE : Diagnosis Procedure"](#).

DRIVER SIDE : Diagnosis Procedure

INFOID:000000006504989

1. CHECK POWER WINDOW MOTOR (DRIVER SIDE) INPUT SIGNAL

1. Turn ignition switch OFF.
2. Disconnect front power window motor (driver side) connector.
3. Turn ignition switch ON.
4. Check voltage between power window motor (driver side) harness connector and ground.

(+)		(-)	Condition	Voltage (V) (Approx.)
Connector	Terminal			
D7	1	Ground	Power window main switch UP	Battery voltage
			Power window main switch DOWN	0
	3		Power window main switch UP	0
			Power window main switch DOWN	Battery voltage

Is the inspection result normal?

- YES >> Replace power window motor (driver side). Refer to [GW-21. "Removal and Installation"](#).
 NO >> GO TO 2.

2. CHECK POWER WINDOW MOTOR CIRCUIT

1. Turn ignition switch OFF.
2. Disconnect power window main switch connector.
3. Check continuity between power window main switch harness connector and front power window motor (driver side) harness connector.

Power window main switch		Front power window motor (driver side)		Continuity
Connector	Terminal	Connector	Terminal	
D5	8	D7	1	Existed
	11		3	

4. Check continuity between power window main switch harness connector and ground.

Power window main switch		Ground	Continuity
Connector	Terminal		
D5	8		Not existed
	11		

Is the inspection result normal?

- YES >> Replace power window main switch. Refer to [PWC-100. "Removal and Installation"](#).
 NO >> Repair or replace harness.

A
B
C
D
E
F
G
H
I
J
L
M
N
O
P

PWC

POWER WINDOW MOTOR

< DTC/CIRCUIT DIAGNOSIS >

PASSENGER SIDE

PASSENGER SIDE : Description

INFOID:000000006504990

Door glass moves UP/DOWN by receiving the signal from power window main switch or front power window switch (passenger side).

PASSENGER SIDE : Component Function Check

INFOID:000000006504991

1. CHECK FRONT POWER WINDOW MOTOR (PASSENGER SIDE) OPERATION

Check front power window motor (passenger side) operation with power window main switch or front power window switch (passenger side).

Is the inspection result normal?

- YES >> Power window motor (passenger side) is OK.
 NO >> Refer to [PWC-24. "PASSENGER SIDE : Diagnosis Procedure"](#).

PASSENGER SIDE : Diagnosis Procedure

INFOID:000000006504992

1. CHECK FRONT POWER WINDOW MOTOR (PASSENGER SIDE) INPUT SIGNAL

1. Turn ignition switch OFF.
2. Disconnect front power window motor (passenger side) connector.
3. Turn ignition switch ON.
4. Check voltage between front power window motor (passenger side) harness connector and ground.

(+)		(-)	Condition	Voltage (V) (Approx.)
Connector	Terminal			
D27	2	Ground	UP	Battery voltage
			DOWN	0
	1		UP	0
			DOWN	Battery voltage

Is the inspection result normal?

- YES >> Replace front power window motor (passenger side). Refer to [GW-21. "Removal and Installation"](#).
 NO >> GO TO 2.

2. CHECK FRONT POWER WINDOW MOTOR (PASSENGER SIDE) CIRCUIT

1. Turn ignition switch OFF.
2. Disconnect front power window switch (passenger side) connector.
3. Check continuity between front power window switch (passenger side) harness connector and front power window motor (passenger side) harness connector.

Front power window switch (passenger side)		Front power window motor (passenger side)		Continuity
Connector	Terminal	Connector	Terminal	
D25	6	D27	1	Existed
	7		2	

4. Check continuity between front power window switch (passenger side) harness connector and ground.

Front power window switch (passenger side)		Ground	Continuity
Connector	Terminal		
D25	6		Not existed
	7		

Is the inspection result normal?

- YES >> Replace front power window switch (passenger side). [PWC-100. "Removal and Installation"](#).

POWER WINDOW MOTOR

< DTC/CIRCUIT DIAGNOSIS >

NO >> Repair or replace harness.

REAR LH

REAR LH : Description

INFOID:000000006504993

Door glass moves UP/DOWN by receiving the signal from power window main switch or rear power window switch LH.

REAR LH : Component Function Check

INFOID:000000006504994

1.CHECK REAR POWER WINDOW MOTOR LH OPERATION

Check rear power window motor LH operation with power window main switch or rear power window switch LH.

Is the inspection result normal?

YES >> Rear power window motor LH is OK.

NO >> Refer to [PWC-25. "REAR LH : Diagnosis Procedure"](#)

REAR LH : Diagnosis Procedure

INFOID:000000006504995

1.CHECK REAR POWER WINDOW MOTOR LH INPUT SIGNAL

1. Turn ignition switch OFF.
2. Disconnect rear power window motor LH connector.
3. Turn ignition switch ON.
4. Check voltage between rear power window motor LH harness connector and ground.

(+)		(-)	Condition	Voltage (V) (Approx.)
Connector	Terminal			
D97	1	Ground	UP	Battery voltage
			DOWN	0
	2		UP	0
			DOWN	Battery voltage

Is the inspection result normal?

YES >> Replace rear power window motor LH. Refer to [GW-25. "Removal and Installation"](#).

NO >> GO TO 2.

2.CHECK REAR POWER WINDOW MOTOR LH CIRCUIT

1. Turn ignition switch OFF.
2. Disconnect rear power window switch LH connector.
3. Check continuity between rear power window switch LH harness connector and rear power window motor LH harness connector.

Rear power window switch LH		Rear power window motor LH		Continuity
Connector	Terminal	Connector	Terminal	
D63	4	D67	2	Existed
	5		1	

4. Check continuity between rear power window switch LH connector and ground.

Rear power window switch LH		Ground	Continuity
Connector	Terminal		
D83	4		Not existed
	5		

Is the inspection result normal?

POWER WINDOW MOTOR

< DTC/CIRCUIT DIAGNOSIS >

- YES >> Replace rear power window switch LH. Refer to [PWC-100. "Removal and Installation"](#).
 NO >> Repair or replace harness.

REAR RH

REAR RH : Description

INFOID:000000006504996

Door glass moves UP/DOWN by receiving the signal from power window main switch or rear power window switch RH.

REAR RH : Component Function Check

INFOID:000000006504997

1. CHECK REAR POWER WINDOW MOTOR RH OPERATION

Check rear power window motor RH operation with power window main switch or rear power window switch RH.

Is the inspection result normal?

- YES >> Rear power window motor RH is OK.
 NO >> Refer to [PWC-26. "REAR RH : Diagnosis Procedure"](#).

REAR RH : Diagnosis Procedure

INFOID:000000006504998

1. CHECK REAR POWER WINDOW MOTOR RH INPUT SIGNAL

1. Turn ignition switch OFF.
2. Disconnect rear power window motor RH connector.
3. Turn ignition switch ON.
4. Check voltage between rear power window motor RH harness connector and ground.

(+)		(-)	Condition	Voltage (V) (Approx.)
Connector	Terminal			
D47	1	Ground	UP	Battery voltage
			DOWN	0
	2		UP	0
			DOWN	Battery voltage

Is the inspection result normal?

- YES >> Replace rear power window motor RH. Refer to [GW-25. "Removal and Installation"](#).
 NO >> GO TO 2.

2. CHECK REAR POWER WINDOW MOTOR RH CIRCUIT

1. Turn ignition switch OFF.
2. Disconnect rear power window switch RH connector.
3. Check continuity between rear power window switch RH harness connector and rear power window motor RH harness connector.

Rear power window switch RH		Rear power window motor RH		Continuity
Connector	Terminal	Connector	Terminal	
D43	4	D47	2	Existed
	5		1	

4. Check continuity between rear power window switch RH harness connector and ground.

Rear power window switch RH		Ground	Continuity
Connector	Terminal		
D43	4		Not existed
	5		

Is the inspection result normal?

POWER WINDOW MOTOR

< DTC/CIRCUIT DIAGNOSIS >

YES >> Replace rear power window switch RH. Refer to [PWC-100. "Removal and Installation"](#).
NO >> Repair or replace harness.

A

B

C

D

E

F

G

H

I

J

PWC

L

M

N

O

P

ENCODER CIRCUIT

< DTC/CIRCUIT DIAGNOSIS >

ENCODER CIRCUIT

Description

INFOID:000000006504999

Detects condition of the front power window motor (driver side) operation and transmits to power window main switch as pulse signal.

Component Function Check

INFOID:000000006505000

1.CHECK ENCODER OPERATION

Check front driver side door glass perform AUTO open/close operation normally when power window main switch.

Is the inspection result normal?

- YES >> Encoder operation is OK.
- NO >> Refer to [PWC-28. "Diagnosis Procedure"](#)

Diagnosis Procedure

INFOID:000000006505001

Encoder Circuit Check

1.CHECK ENCODER OPERATION

1. Turn ignition switch ON.
2. Check signal between power window main switch harness connector and ground with oscilloscope.

(+)		(-)	Signal (Reference value)
Power window main switch			
Connector	Terminal	Ground	Refer to following signal
D5	9		
	13		

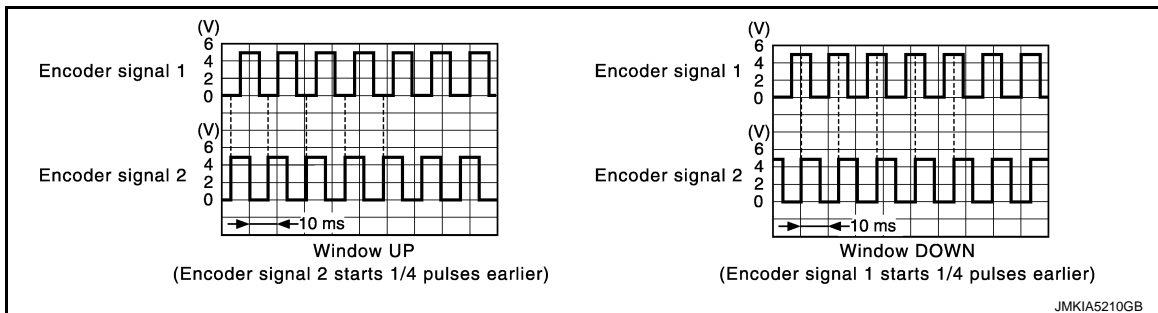

Is the inspection result normal?

- YES >> GO TO 7.
- NO >> GO TO 2.

2.CHECK ENCODER SIGNAL CIRCUIT

1. Turn ignition switch OFF.
2. Disconnect power window main switch connector and front power window motor (driver side) connector.
3. Check continuity between power window main switch harness connector and front power window motor (driver side) harness connector.

Power window main switch		Front power window motor (driver side)		Continuity
Connector	Terminal	Connector	Terminal	
D5	9	D7	6	Existed
	13		5	

4. Check continuity between power window main switch harness connector and ground.

ENCODER CIRCUIT

< DTC/CIRCUIT DIAGNOSIS >

Power window main switch		Ground	Continuity
Connector	Terminal		
D5	9		
	13		Not existed

Is the inspection result normal?

YES >> GO TO 3.

NO >> Repair or replace harness.

3.CHECK ENCODER POWER SUPPLY CIRCUIT

1. Connect power window main switch connector.
2. Turn ignition switch ON.
3. Check voltage between front power window motor (driver side) harness connector and ground.

(+)		(-)	Voltage (V) (Approx.)
Front power window motor (driver side)			
Connector	Terminal		
D7	2	Ground	Battery voltage

Is the inspection result normal?

YES >> GO TO 4.

NO >> GO TO 5.

4.CHECK GROUND CIRCUIT

1. Turn ignition switch OFF.
2. Check continuity between front power window motor (driver side) harness connector and ground.

Front power window motor (driver side)		Ground	Continuity
Connector	Terminal		
D7	4		

Is the inspection result normal?

YES >> GO TO 7.

NO >> GO TO 6.

5.CHECK HARNESS CONTINUITY 1

1. Turn ignition switch OFF.
2. Check continuity between power window main switch harness connector and front power window motor (driver side) harness connector.

Power window main switch		Front power window motor (driver side)		Continuity
Connector	Terminal	Connector	Terminal	
D5	15	D7	2	Existed

3. Check continuity between power window main switch harness connector and ground.

Power window main switch		Ground	Continuity
Connector	Terminal		
D5	15		

Is the inspection result normal?

YES >> Replace power window main switch. Refer to [PWC-100, "Removal and Installation"](#).

NO >> Repair or replace harness.

6.CHECK HARNESS CONTINUITY 2

1. Disconnect power window main switch connector.

A
B
C
D
E
F
G
H
I
J
L
M
N
O
P

PWC

ENCODER CIRCUIT

< DTC/CIRCUIT DIAGNOSIS >

2. Check continuity between power window main switch harness connector and front power window motor (driver side) harness connector.

Power window main switch		Front power window motor (driver side)		Continuity
Connector	Terminal	Connector	Terminal	
D5	2	D7	4	Existed

Is the inspection result normal?

- YES >> Replace power window main switch. Refer to [PWC-100, "Removal and Installation"](#).
NO >> Repair or replace harness.

7. CHECK INTERMITTENT INCIDENT

Refer to [GI-41, "Intermittent Incident"](#).

>> INSPECTION END

BCM (BODY CONTROL MODULE)

< ECU DIAGNOSIS INFORMATION >

ECU DIAGNOSIS INFORMATION

BCM (BODY CONTROL MODULE)

WITH INTELLIGENT KEY

WITH INTELLIGENT KEY : Reference Value

INFOID:000000006949437

VALUES ON THE DIAGNOSIS TOOL

CONSULT-III MONITOR ITEM

Monitor Item	Condition	Value/Status
FR WIPER HI	Other than front wiper switch HI	Off
	Front wiper switch HI	On
FR WIPER LOW	Other than front wiper switch LO	Off
	Front wiper switch LO	On
FR WASHER SW	Front washer switch OFF	Off
	Front washer switch ON	On
FR WIPER INT	Other than front wiper switch INT/AUTO	Off
	Front wiper switch INT/AUTO	On
FR WIPER STOP	Front wiper is not in STOP position	Off
	Front wiper is in STOP position	On
INT VOLUME	Wiper intermittent dial is in a dial position 1 - 7	Wiper intermittent dial position
RR WIPER ON	Other than rear wiper switch ON	Off
	Rear wiper switch ON	On
RR WIPER INT	Other than rear wiper switch INT	Off
	Rear wiper switch INT	On
RR WASHER SW	Rear washer switch OFF	Off
	Rear washer switch ON	On
RR WIPER STOP	Rear wiper is in STOP position	Off
	Rear wiper is not in STOP position	On
TURN SIGNAL R	Other than turn signal switch RH	Off
	Turn signal switch RH	On
TURN SIGNAL L	Other than turn signal switch LH	Off
	Turn signal switch LH	On
TAIL LAMP SW	Other than lighting switch 1ST and 2ND	Off
	Lighting switch 1ST or 2ND	On
HI BEAM SW	Other than lighting switch HI	Off
	Lighting switch HI	On
HEAD LAMP SW 1	Other than lighting switch 2ND	Off
	Lighting switch 2ND	On
HEAD LAMP SW 2	Other than lighting switch 2ND	Off
	Lighting switch 2ND	On
PASSING SW	Other than lighting switch PASS	Off
	Lighting switch PASS	On
AUTO LIGHT SW	Other than lighting switch AUTO	Off
	Lighting switch AUTO	On

A
B
C
D
E
F
G
H
I
J
L
M
N
O
P

PWC

BCM (BODY CONTROL MODULE)

< ECU DIAGNOSIS INFORMATION >

Monitor Item	Condition	Value/Status
FR FOG SW	Front fog lamp switch OFF	Off
	Front fog lamp switch ON	On
DOOR SW-DR	Driver door closed	Off
	Driver door opened	On
DOOR SW-AS	Passenger door closed	Off
	Passenger door opened	On
DOOR SW-RR	Rear RH door closed	Off
	Rear RH door opened	On
DOOR SW-RL	Rear LH door closed	Off
	Rear LH door opened	On
DOOR SW-BK	Back door closed	Off
	Back door opened	On
CDL LOCK SW	Other than power door lock switch LOCK	Off
	Power door lock switch LOCK	On
CDL UNLOCK SW	Other than power door lock switch UNLOCK	Off
	Power door lock switch UNLOCK	On
KEY CYL LK-SW	Other than driver door key cylinder LOCK position	Off
	Driver door key cylinder LOCK position	On
KEY CYL UN-SW	Other than driver door key cylinder UNLOCK position	Off
	Driver door key cylinder UNLOCK position	On
HAZARD SW	Hazard switch is OFF	Off
	Hazard switch is ON	On
REAR DEF SW	Rear window defogger switch OFF	Off
	Rear window defogger switch ON	On
TR/BD OPEN SW	NOTE: The item is indicated, but not monitored.	Off
TRNK/HAT MNTR	NOTE: The item is indicated, but not monitored.	Off
FAN ON SIG	Blower fan OFF	Off
	Blower fan ON	On
AIR COND SW	Air conditioner OFF (A/C switch indicator OFF)	Off
	Air conditioner ON (A/C switch indicator ON)	On
RKE-LOCK	LOCK button of the key is not pressed	Off
	LOCK button of the key is pressed	On
RKE-UNLOCK	UNLOCK button of the key is not pressed	Off
	UNLOCK button of the key is pressed	On
RKE-TR/BD	BACK DOOR OPEN button of the key is not pressed	Off
	BACK DOOR OPEN button of the key is pressed	On
RKE-PANIC	PANIC button of the key is not pressed	Off
	PANIC button of the key is pressed	On
RKE-MODE CHG	LOCK/UNLOCK button of the key is not pressed and held simultaneously	Off
	LOCK/UNLOCK button of the key is pressed and held simultaneously	On
OPTI SEN (DTCT)	Bright outside of the vehicle	Close to 5 V
	Dark outside of the vehicle	Close to 0 V

BCM (BODY CONTROL MODULE)

< ECU DIAGNOSIS INFORMATION >

Monitor Item	Condition	Value/Status	
OPTI SEN (FILT)	Bright outside of the vehicle (Lighting switch AUTO)	Close to 5 V	A
	Dark outside of the vehicle (Lighting switch AUTO)	Close to 1.50 V	
OPTICAL SENSOR	NOTE: The item is indicated, but not monitored.	Off	B
RAIN SENSOR	NOTE: The item is indicated, but not monitored.	Off	C
REQ SW -DR	Driver door request switch is not pressed	Off	D
	Driver door request switch is pressed	On	
REQ SW -AS	Passenger door request switch is not pressed	Off	E
	Passenger door request switch is pressed	On	
REQ SW -RR	NOTE: The item is indicated, but not monitored.	Off	F
REQ SW -RL	NOTE: The item is indicated, but not monitored.	Off	G
REQ SW -BD/TR	Back door request switch is not pressed	Off	H
	Back door request switch is pressed	On	
PUSH SW	Push-button ignition switch (push switch) is not pressed	Off	I
	Push-button ignition switch (push switch) is pressed	On	
CLUCH SW	NOTE: The item is indicated, but not monitored.	Off	J
BRAKE SW 1	The brake pedal is not depressed	Off	K
	The brake pedal is depressed	On	
BRAKE SW 2	The brake pedal is depressed when No. 9 fuse is blown	Off	L
	The brake pedal is not depressed when No. 9 fuse is blown, or No. 9 fuse is normal	On	
DETE/CANCL SW	Selector lever in P position	Off	M
	Selector lever in any position other than P	On	
SFT PN/N SW	Selector lever in any position other than P and N	Off	N
	Selector lever in P or N position	On	
S/L -LOCK	NOTE: The item is indicated, but not monitored.	Off	O
S/L -UNLOCK	NOTE: The item is indicated, but not monitored.	Off	P
S/L RELAY-F/B	NOTE: The item is indicated, but not monitored.	Off	
UNLK SEN -DR	Driver door is locked	Off	Q
	Driver door is unlocked	On	
PUSH SW -IPDM	Push-button ignition switch (push-switch) is not pressed	Off	R
	Push-button ignition switch (push-switch) is pressed	On	
IGN RLY1 -F/B	Ignition switch in OFF or ACC position	Off	S
	Ignition switch in ON position	On	
DETE SW -IPDM	Selector lever in any position other than P	Off	T
	Selector lever in P position	On	
SFT PN -IPDM	Selector lever in any position other than P and N	Off	U
	Selector lever in P or N position	On	
SFT P -MET	Selector lever in any position other than P	Off	V
	Selector lever in P position	On	

BCM (BODY CONTROL MODULE)

< ECU DIAGNOSIS INFORMATION >

Monitor Item	Condition	Value/Status
SFT N -MET	Selector lever in any position other than N	Off
	Selector lever in N position	On
ENGINE STATE	Engine stopped	Stop
	While the engine stalls	Stall
	At engine cranking	Crank
	Engine running	Run
S/L LOCK-IPDM	NOTE: The item is indicated, but not monitored.	Off
S/L UNLK-IPDM	NOTE: The item is indicated, but not monitored.	Off
S/L RELAY-REQ	NOTE: The item is indicated, but not monitored.	Off
VEH SPEED 1	While driving	Equivalent to speedometer reading
VEH SPEED 2	While driving	Equivalent to speedometer reading
DOOR STAT-DR	Driver door is locked	LOCK
	Wait with selective UNLOCK operation (5 seconds)	READY
	Driver door is unlocked	UNLOCK
DOOR STAT-AS	Passenger door is locked	LOCK
	Wait with selective UNLOCK operation (5 seconds)	READY
	Passenger door is unlocked	UNLOCK
ID OK FLAG	Driver side door is open after ignition switch is turned OFF (Selector lever is in the P position except for M/T models)	Reset
	Ignition switch ON	Set
PRMT ENG STRT	The engine start is prohibited	Reset
	The engine start is permitted	Set
PRMT RKE STRT	NOTE: The item is indicated, but not monitored.	Reset
RKE OPE COUN1	During the operation of the key	Operation frequency of the key
RKE OPE COUN2	NOTE: The item is indicated, but not monitored.	—
CONFIRM ID ALL	The key ID that the key slot receives is not recognized by any key ID registered to BCM.	Yet
	The key ID that the key slot receives is recognized by any key ID registered to BCM.	Done
CONFIRM ID4	The key ID that the key slot receives is not recognized by the fourth key ID registered to BCM.	Yet
	The key ID that the key slot receives is recognized by the fourth key ID registered to BCM.	Done
CONFIRM ID3	The key ID that the key slot receives is not recognized by the third key ID registered to BCM.	Yet
	The key ID that the key slot receives is recognized by the third key ID registered to BCM.	Done
CONFIRM ID2	The key ID that the key slot receives is not recognized by the second key ID registered to BCM.	Yet
	The key ID that the key slot receives is recognized by the second key ID registered to BCM.	Done

BCM (BODY CONTROL MODULE)

< ECU DIAGNOSIS INFORMATION >

Monitor Item	Condition	Value/Status	
CONFIRM ID1	The key ID that the key slot receives is not recognized by the first key ID registered to BCM.	Yet	A
	The key ID that the key slot receives is recognized by the first key ID registered to BCM.	Done	B
NOT REGISTERED	BCM detects registered key ID, or BCM does not detect key ID.	ID OK	C
	BCM detects non-registration key ID.	ID NG	
TP 4	The ID of fourth key is not registered to BCM	Yet	D
	The ID of fourth key is registered to BCM	Done	
TP 3	The ID of third key is not registered to BCM	Yet	E
	The ID of third key is registered to BCM	Done	
TP 2	The ID of second key is not registered to BCM	Yet	F
	The ID of second key is registered to BCM	Done	
TP 1	The ID of first key is not registered to BCM	Yet	G
	The ID of first key is registered to BCM	Done	
AIR PRESS FL	Ignition switch ON (Only when the signal from the transmitter is received)	Air pressure of front LH tire	H
AIR PRESS FR	Ignition switch ON (Only when the signal from the transmitter is received)	Air pressure of front RH tire	I
AIR PRESS RR	Ignition switch ON (Only when the signal from the transmitter is received)	Air pressure of rear RH tire	J
AIR PRESS RL	Ignition switch ON (Only when the signal from the transmitter is received)	Air pressure of rear LH tire	
ID REGST FL1	ID of front LH tire transmitter is registered	Done	PWC
	ID of front LH tire transmitter is not registered	Yet	
ID REGST FR1	ID of front RH tire transmitter is registered	Done	L
	ID of front RH tire transmitter is not registered	Yet	
ID REGST RR1	ID of rear RH tire transmitter is registered	Done	M
	ID of rear RH tire transmitter is not registered	Yet	
ID REGST RL1	ID of rear LH tire transmitter is registered	Done	N
	ID of rear LH tire transmitter is not registered	Yet	
WARNING LAMP	Tire pressure indicator OFF	Off	O
	Tire pressure indicator ON	On	
BUZZER	Tire pressure warning alarm is not sounding	Off	P
	Tire pressure warning alarm is sounding	On	

BCM (BODY CONTROL MODULE)

< ECU DIAGNOSIS INFORMATION >

TERMINAL LAYOUT

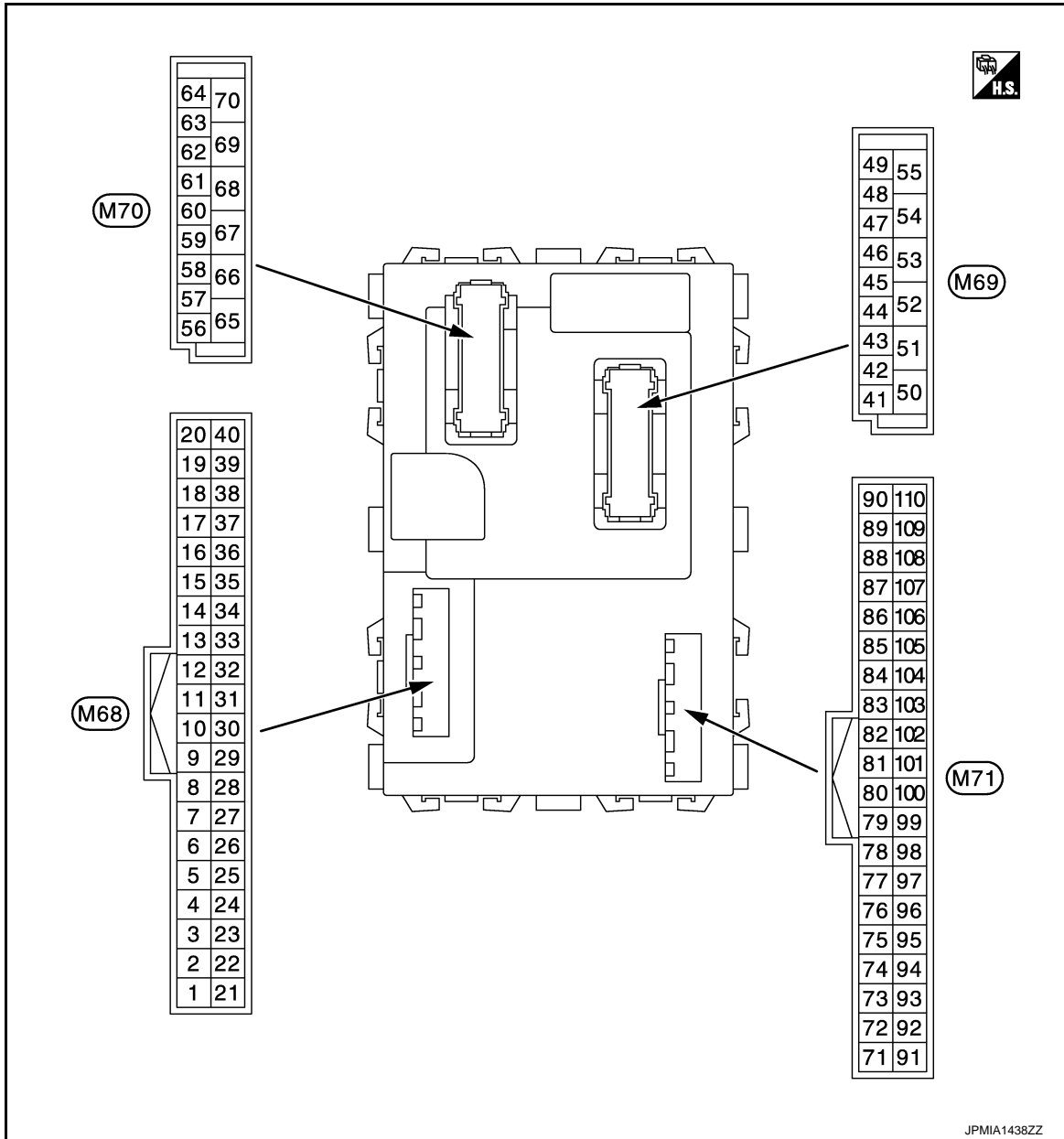

NOTE:

- Connector color
- M68, M70: Black
- M69, M71: White

PHYSICAL VALUES

BCM (BODY CONTROL MODULE)

< ECU DIAGNOSIS INFORMATION >

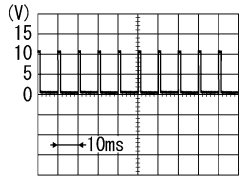
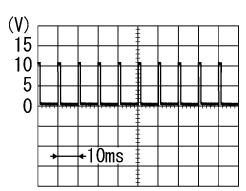
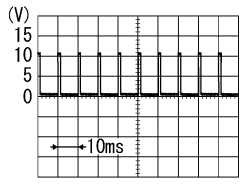
Terminal No. (Wire color)		Description		Condition	Value (Approx.)	
		Signal name	Input/ Output			
+	-					
2 (BR/W)	Ground	Combination switch INPUT 5	Input	Combination switch (Wiper intermit- tent dial 4)	All switch OFF	0 V
					Turn signal switch RH	
					Lighting switch HI	
					Lighting switch 1ST	
					Lighting switch 2ND	
3 (GR)	Ground	Combination switch INPUT 4	Input	Combination switch (Wiper intermit- tent dial 4)	All switch OFF	0 V
					Turn signal switch LH	
					Lighting switch PASS	
					Lighting switch 2ND	
					Front fog lamp switch ON	
4 (L/Y)	Ground	Combination switch INPUT 3	Input	Combination switch (Wiper intermit- tent dial 4)	All switch OFF	0 V
					Front wiper switch LO	
					Front wiper switch MIST	
					Front wiper switch INT	
					Lighting switch AUTO	

A
B
C
D
E
F
G
H
I
J
L
M
N
O
P

PWC

BCM (BODY CONTROL MODULE)

< ECU DIAGNOSIS INFORMATION >

Terminal No. (Wire color)		Description		Condition	Value (Approx.)	
+	-	Signal name	Input/ Output			
5 (G)	Ground	Combination switch INPUT 2	Input	Combination switch	All switch OFF (Wiper intermittent dial 4)	0 V
					Front washer switch (Wiper intermittent dial 4)	
					Rear washer ON (Wiper intermittent dial 4)	
					Any of the condition below with all switch OFF <ul style="list-style-type: none"> • Wiper intermittent dial 1 • Wiper intermittent dial 5 • Wiper intermittent dial 6 	
Rear wiper switch ON (Wiper intermittent dial 4)		0.8 V				
6 (L/R)	Ground	Combination switch INPUT 1	Input	Combination switch	All switch OFF (Wiper intermittent dial 4)	0 V
					Front wiper switch HI (Wiper intermittent dial 4)	
					Rear wiper switch INT (Wiper intermittent dial 4)	
					Wiper intermittent dial 3 (All switch OFF)	
					Any of the condition below with all switch OFF <ul style="list-style-type: none"> • Wiper intermittent dial 1 • Wiper intermittent dial 2 	
Any of the condition below with all switch OFF <ul style="list-style-type: none"> • Wiper intermittent dial 6 • Wiper intermittent dial 7 		0.8 V				

BCM (BODY CONTROL MODULE)

< ECU DIAGNOSIS INFORMATION >

Terminal No. (Wire color)		Description		Condition	Value (Approx.)
+	-	Signal name	Input/ Output		
7 (W/R)	Ground	Door key cylinder switch UNLOCK	Input	Door key cylinder switch	NEUTRAL position
				UNLOCK position	8.0 - 8.5 V
8 (W/B)	Ground	Door key cylinder switch LOCK	Input	Door key cylinder switch	NEUTRAL position
				LOCK position	0 V
9 (R)	Ground	Stop lamp switch 1	Input	Stop lamp switch	OFF (Brake pedal is not depressed)
				ON (Brake pedal is de- pressed)	Battery voltage
12 (GR)	Ground	Door lock and unlock switch LOCK	Input	Door lock and unlock switch	NEUTRAL position
				LOCK position	0 V
13 (BR)	Ground	Door lock and unlock switch UNLOCK	Input	Door lock and unlock switch	NEUTRAL position
				UNLOCK position	0 V
14 (L/B)	Ground	Optical sensor	Input	Ignition switch ON	When bright outside of the vehicle
				When dark outside of the vehicle	Close to 0 V
15 (W/L)	Ground	Rear window defog- ger switch	Input	Rear window defogger switch	Not pressed
				Pressed	0 V
17 (R/G)	Ground	Optical sensor pow- er supply	Output	Ignition switch	OFF, ACC
				ON	5 V

A
B
C
D
E
F
G
H
I
J
L
M
N
O
P

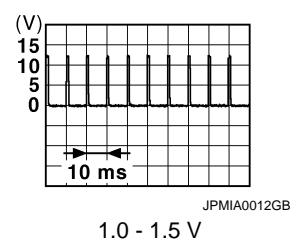
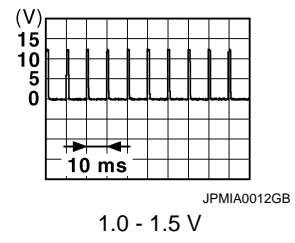
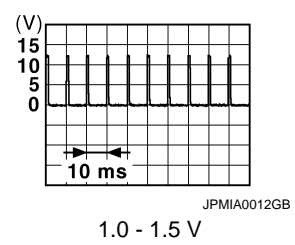
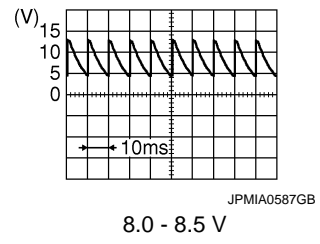

PWC

BCM (BODY CONTROL MODULE)

< ECU DIAGNOSIS INFORMATION >

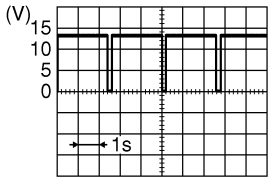
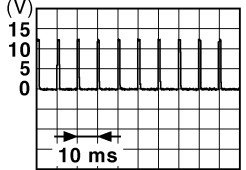
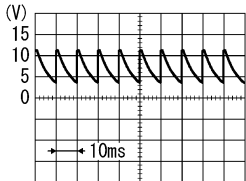
Terminal No. (Wire color)		Description		Condition		Value (Approx.)
		Signal name	Input/ Output			
+	-					
18 (V)	Ground	Sensor ground	Input	Ignition switch ON		0 V
21 (P/L)	Ground	NATS antenna amp.	Input/ Output	During waiting	Ignition switch is pressed while inserting the key into the key slot.	Just after pressing ignition switch. Pointer of tester should move.
23 (R/Y)	Ground	Security indicator lamp	Output	Security indicator	ON	0 V
					Blinking (Ignition switch OFF)	 <p style="text-align: right; font-size: small;">JPMIA0590GB</p>
					OFF	Battery voltage
24* (GR/R)	Ground	Dongle link	Input/ Output	Ignition switch OFF		5 V
25 (LG)	Ground	NATS antenna amp.	Input/ Output	During waiting	Ignition switch is pressed while inserting the key into the key slot.	Just after pressing ignition switch. Pointer of tester should move.
27 (Y/G)	Ground	A/C switch	Input	Air conditioner	OFF (A/C switch indicator: OFF)	 <p style="text-align: right; font-size: small;">JPMIA0012GB</p>
					ON (A/C switch indicator: ON)	0 V
28 (G/W)	Ground	Blower fan switch	Input	Blower fan	OFF	0 V
					ON	 <p style="text-align: right; font-size: small;">PKIB4960J</p>
29 (L/W)	Ground	Hazard switch	Input	Hazard switch	OFF	12 V
					ON	0 V

BCM (BODY CONTROL MODULE)

< ECU DIAGNOSIS INFORMATION >

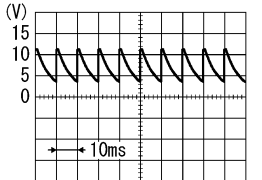
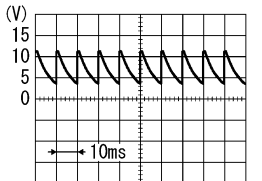
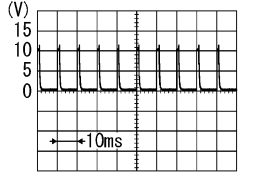
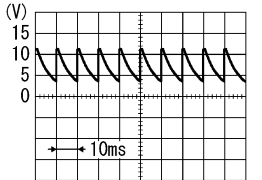
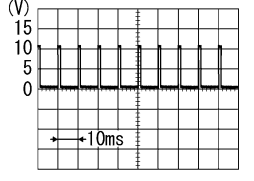
Terminal No. (Wire color)		Description		Condition	Value (Approx.)	
		Signal name	Input/ Output			
+	-					
31 (G/B)	Ground	Front door lock as- sembly driver side (Unlock sensor)	Input	Driver door	LOCK status (Unlock sen- sor switch OFF)	 <small>PKIB4960J</small> 7.0 - 8.0 V
					UNLOCK status (Unlock sensor switch ON)	0 V
32 (LG)	Ground	Combination switch OUTPUT 5	Output	Combination switch	All switch OFF (Wiper intermittent dial 4)	 <small>PKIB4960J</small> 7.0 - 8.0 V
					Front fog lamp switch ON (Wiper intermittent dial 4)	 <small>PKIB4956J</small> 1.0 V
					Rear wiper switch ON (Wiper intermittent dial 4)	
					Any of the condition below with all switch OFF <ul style="list-style-type: none"> • Wiper intermittent dial 1 • Wiper intermittent dial 2 • Wiper intermittent dial 6 • Wiper intermittent dial 7 	
33 (Y/L)	Ground	Combination switch OUTPUT 4	Output	Combination switch	All switch OFF (Wiper intermittent dial 4)	 <small>PKIB4960J</small> 7.0 - 8.0 V
					Lighting switch 1ST (Wiper intermittent dial 4)	 <small>PKIB4958J</small> 1.2 V
					Lighting switch AUTO (Wiper intermittent dial 4)	
					Rear wiper switch INT (Wiper intermittent dial 4)	
Any of the condition below with all switch OFF <ul style="list-style-type: none"> • Wiper intermittent dial 1 • Wiper intermittent dial 5 • Wiper intermittent dial 6 						

A
B
C
D
E
F
G
H
I
J
L
M
N
O
P

PWC

BCM (BODY CONTROL MODULE)

< ECU DIAGNOSIS INFORMATION >

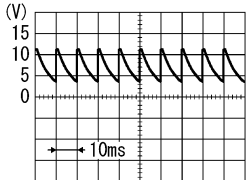
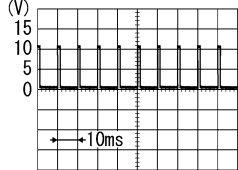
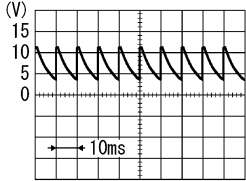
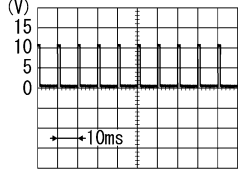
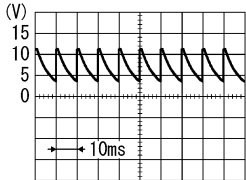
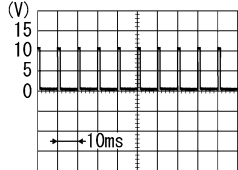
Terminal No. (Wire color)		Description		Condition	Value (Approx.)	
+	-	Signal name	Input/ Output			
34 (W)	Ground	Combination switch OUTPUT 3	Output	Combination switch	All switch OFF (Wiper intermittent dial 4)	 <p style="text-align: right; font-size: small;">PKIB4960J</p> <p style="text-align: center;">7.0 - 8.0 V</p>
					Lighting switch 2ND (Wiper intermittent dial 4)	 <p style="text-align: right; font-size: small;">PKIB4958J</p> <p style="text-align: center;">1.2 V</p>
					Lighting switch HI (Wiper intermittent dial 4)	
					Rear washer switch ON (Wiper intermittent dial 4)	
Any of the condition below with all switch OFF						
<ul style="list-style-type: none"> • Wiper intermittent dial 1 • Wiper intermittent dial 2 • Wiper intermittent dial 3 						
35 (R/L)	Ground	Combination switch OUTPUT 2	Output	Combination switch (Wiper intermit- tent dial 4)	All switch OFF	 <p style="text-align: right; font-size: small;">PKIB4960J</p> <p style="text-align: center;">7.0 - 8.0 V</p>
					Lighting switch 2ND	 <p style="text-align: right; font-size: small;">PKIB4958J</p> <p style="text-align: center;">1.2 V</p>
					Lighting switch PASS	
					Front wiper switch INT	
Front wiper switch HI						
36 (L/O)	Ground	Combination switch OUTPUT 1	Output	Combination switch (Wiper intermit- tent dial 4)	All switch OFF	 <p style="text-align: right; font-size: small;">PKIB4960J</p> <p style="text-align: center;">7.0 - 8.0 V</p>
					Turn signal switch RH	 <p style="text-align: right; font-size: small;">PKIB4958J</p> <p style="text-align: center;">1.2 V</p>
					Turn signal switch LH	
					Front wiper switch LO (Front wiper switch MIST)	
Front washer switch ON						

BCM (BODY CONTROL MODULE)

< ECU DIAGNOSIS INFORMATION >

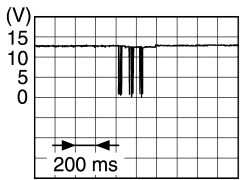
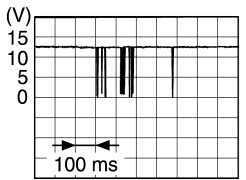
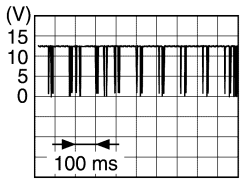
Terminal No. (Wire color)		Description		Condition	Value (Approx.)	
+	-	Signal name	Input/ Output			
37 (G/O)	Ground	Selector lever P position switch	Input	Selector lever	P position 0 V	
				Any position other than P 12 V		
38 (G/Y)	Ground	Receiver communication	Input/ Output	Waiting	~12 V	
				Ignition switch OFF (Remote keyless entry communication)	When operating either button on Intelligent Key	 JMMIA0572GB
				Ignition switch ON (TPMS communication)	Waiting	 JMMIA0573GB
				When receiving signal from tire pressure sensor	 JMMIA0574GB	
39 (L)	Ground	CAN-H	Input/ Output	—	—	
40 (P)	Ground	CAN-L	Input/ Output	—	—	
43 (W)	Ground	Back door switch	Input	Back door switch	OFF (When back door closed)	
				ON (When back door opened)	0 V	
44 (LG)	Ground	Rear wiper stop position	Input	Ignition switch ON	Rear wiper stop position 12 V	
				Any position other than rear wiper stop position 0 V		

A
B
C
D
E
F
G
H
I
J
L
M
N
O
P

PWC

BCM (BODY CONTROL MODULE)

< ECU DIAGNOSIS INFORMATION >

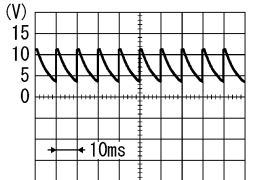
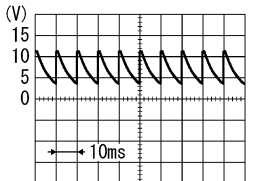
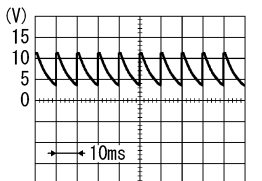
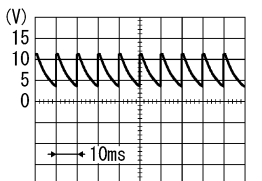
Terminal No. (Wire color)		Description		Condition	Value (Approx.)	
+	-	Signal name	Input/ Output			
45 (SB)	Ground	Passenger door switch	Input	Passenger door switch	OFF (When passenger door closed)	 7.0 - 8.0 V
				Passenger door switch	ON (When passenger door opened)	0 V
46 (GR/L)	Ground	Rear RH door switch	Input	Rear RH door switch	OFF (When rear RH door closed)	 7.0 - 8.0 V
				Rear RH door switch	ON (When rear RH door opened)	0 V
47 (BR/Y)	Ground	Driver door switch	Input	Driver door switch	OFF (When driver door closed)	 7.0 - 8.0 V
				Driver door switch	ON (When driver door opened)	0 V
48 (W/G)	Ground	Rear LH door switch	Input	Rear LH door switch	OFF (When rear LH door closed)	 7.0 - 8.0 V
				Rear LH door switch	ON (When rear door LH opened)	0 V
50 (R/W)	Ground	Back door lock actuator relay control	Output	Back door	LOCK (Actuator is activated)	0 V
				Back door	Other than LOCK (Actuator is not activated)	Battery voltage
51 (W)	Ground	Back door request switch	Input	Back door request switch	ON (Pressed)	0 V
					Back door request switch	OFF (Not pressed)
54 (L/W)	Ground	Rear wiper	Output	Rear wiper	OFF (Stopped)	0 V
					Rear wiper	ON (Activated)

BCM (BODY CONTROL MODULE)

< ECU DIAGNOSIS INFORMATION >

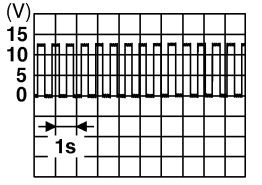
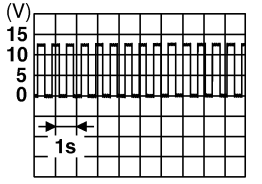
Terminal No. (Wire color)		Description		Condition		Value (Approx.)
		Signal name	Input/ Output			
+	-					
55 (G)	Ground	Rear door UNLOCK	Output	Rear door	UNLOCK (Actuator is activated)	12 V
					Other then UNLOCK (Actuator is not activated)	0 V
56 (L)	Ground	Interior room lamp power supply	Output		Interior room lamp battery saver is activated. (Cuts the interior room lamp power supply)	0 V
					Interior room lamp battery saver is not activated. (Outputs the interior room lamp power supply)	12 V
57 (Y)	Ground	Battery power supply	Input	Ignition switch OFF		Battery voltage
59 (G)	Ground	Passenger door UNLOCK	Output	Passenger door	UNLOCK (Actuator is activated)	12 V
					Other then UNLOCK (Actuator is not activated)	0 V
60 (W/B)	Ground	Turn signal LH	Output	Ignition switch ON	Turn signal switch OFF	0 V
					Turn signal switch LH	 6.0 V
61 (W/L)	Ground	Turn signal RH	Output	Ignition switch ON	Turn signal switch OFF	0 V
					Turn signal switch RH	 6.0 V
63 (BR)	Ground	Interior room lamp timer control	Output	Interior room lamp	OFF	12 V
					ON	0 V
65 (V)	Ground	All doors LOCK	Output	All doors	LOCK (Actuator is activated)	12 V
					Other then LOCK (Actuator is not activated)	0 V
66 (L/B)	Ground	Driver door UNLOCK	Output	Driver door	UNLOCK (Actuator is activated)	12 V
					Other then UNLOCK (Actuator is not activated)	0 V
67 (B)	Ground	Ground	Output	Ignition switch ON		0 V
68 (L)	Ground	P/W power supply (IGN)	Output	Ignition switch ON		12 V
69 (L/W)	Ground	P/W power supply (BAT)	Output	Ignition switch OFF		12 V

A
B
C
D
E
F
G
H
I
J
L
M
N
O
P

PWC

BCM (BODY CONTROL MODULE)

< ECU DIAGNOSIS INFORMATION >

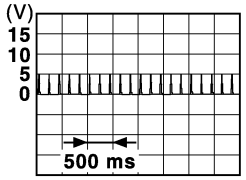
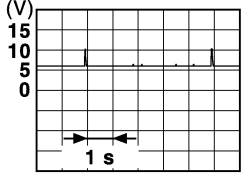
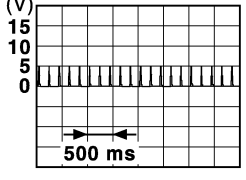
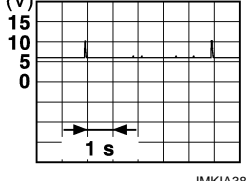
Terminal No. (Wire color)		Description		Condition	Value (Approx.)
		Signal name	Input/ Output		
+	-				
70 (Y)	Ground	Battery power supply	Input	Ignition switch OFF	Battery voltage
75 (SB)	Ground	Driver door request switch	Input	Driver door request switch	ON (Pressed) 0 V
				OFF (Not pressed) 12 V	
76 (L/O)	Ground	Push-button ignition switch (push switch)	Input	Push-button ignition switch (push switch)	Pressed 0 V
				Not pressed 12 V	
78 (LG)	Ground	Driver door antenna (+)	Output	When the driver door request switch is operated with ignition switch OFF	When Intelligent Key is not in the antenna detection area  JMkia3838GB
				When Intelligent Key is in the antenna detection area  JMkia3839GB	
79 (V)	Ground	Driver door antenna (-)	Output	When the driver door request switch is operated with ignition switch OFF	When Intelligent Key is not in the antenna detection area  JMkia3838GB
				When Intelligent Key is in the antenna detection area  JMkia3839GB	

BCM (BODY CONTROL MODULE)

< ECU DIAGNOSIS INFORMATION >

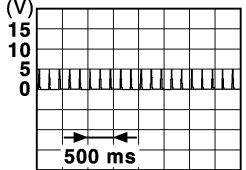
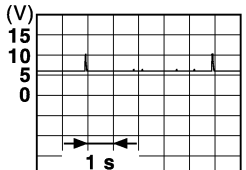
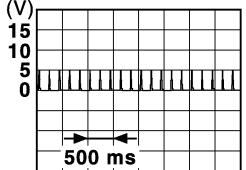
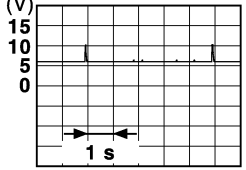
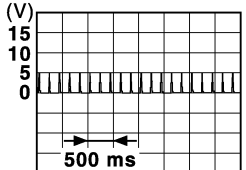
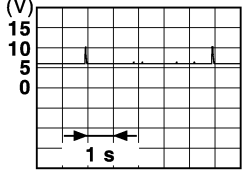
Terminal No. (Wire color)		Description		Condition	Value (Approx.)
+	-	Signal name	Input/ Output		
80 (BR/Y)	Ground	Passenger door antenna (+)	Output	When Intelligent Key is not in the antenna detection area	 <small>JMKIA3838GB</small>
				When the passenger door request switch is operated with ignition switch OFF	 <small>JMKIA3839GB</small>
81 (L/Y)	Ground	Passenger door antenna (-)	Output	When Intelligent Key is not in the antenna detection area	 <small>JMKIA3838GB</small>
				When the passenger door request switch is operated with ignition switch OFF	 <small>JMKIA3839GB</small>
82 (W/B)	Ground	Back door antenna (+)	Output	When Intelligent Key is not in the antenna detection area	 <small>JMKIA3838GB</small>
				When the back door request switch is operated with ignition switch OFF	 <small>JMKIA3839GB</small>

A
B
C
D
E
F
G
H
I
J
L
M
N
O
P

PWC

BCM (BODY CONTROL MODULE)

< ECU DIAGNOSIS INFORMATION >

Terminal No. (Wire color)		Description		Condition	Value (Approx.)
+	-	Signal name	Input/ Output		
83 (B/W)	Ground	Back door antenna (-)	Output	When the back door request switch is operated with ignition switch OFF	<p style="text-align: right;">JMkia3838GB</p>
				When Intelligent Key is in the antenna detection area	<p style="text-align: right;">JMkia3839GB</p>
84 (Y/G)	Ground	Room antenna (+) (Instrument panel)	Output	Ignition switch OFF	<p style="text-align: right;">JMkia3838GB</p>
				When Intelligent Key is in the antenna detection area	<p style="text-align: right;">JMkia3839GB</p>
85 (Y/L)	Ground	Room antenna (-) (Instrument panel)	Output	Ignition switch OFF	<p style="text-align: right;">JMkia3838GB</p>
				When Intelligent Key is in the antenna detection area	<p style="text-align: right;">JMkia3839GB</p>

BCM (BODY CONTROL MODULE)

< ECU DIAGNOSIS INFORMATION >

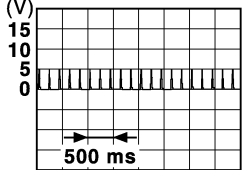
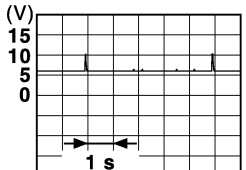
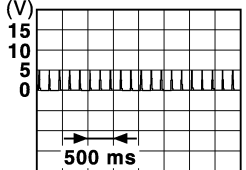
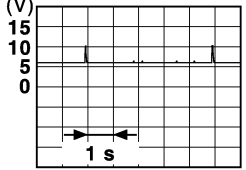
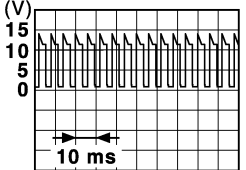
Terminal No. (Wire color)		Description		Condition	Value (Approx.)
+	-	Signal name	Input/ Output		
86 (P)	Ground	Luggage room antenna (+)	Output	Ignition switch OFF	 <p style="text-align: right; font-size: small;">JMkia3838GB</p>
				When Intelligent Key is in the antenna detection area	 <p style="text-align: right; font-size: small;">JMkia3839GB</p>
87 (L)	Ground	Luggage room antenna (-)	Output	Ignition switch OFF	 <p style="text-align: right; font-size: small;">JMkia3838GB</p>
				When Intelligent Key is in the antenna detection area	 <p style="text-align: right; font-size: small;">JMkia3839GB</p>
90 (W/L)	Ground	Push-button ignition switch illumination	Output	Push-button ignition switch illumination	ON 12 V OFF 0 V
91 (Y)	Ground	ACC/ON indicator lamp	Output	Ignition switch OFF	Battery voltage
				ACC or ON	0.5 V
92 (BR/R)	Ground	Push-button ignition switch illumination ground	Output	Tail lamp OFF	0 V
				ON	NOTE: When the illumination brightening/dimming level is in the neutral position  <p style="text-align: right; font-size: small;">JPMIA1554GB</p> 6.0 - 7.0 V

A
B
C
D
E
F
G
H
I
J
L
M
N
O
P

PWC

BCM (BODY CONTROL MODULE)

< ECU DIAGNOSIS INFORMATION >

Terminal No. (Wire color)		Description		Condition		Value (Approx.)
+	-	Signal name	Input/ Output			
93 (GR/W)	Ground	Intelligent Key warn- ing buzzer	Output	Intelligent Key warning buzzer	Sounding	0 V
					Not sounding	12 V
96 (BR/W)	Ground	ACC relay control	Output	Ignition switch	OFF	0 V
					ACC or ON	12 V
97 (L/R)	Ground	Starter relay control	Output	Ignition switch ON	When selector lever is in P or N position	Battery voltage
					When selector lever is not in P or N position	0 V
98 (BR)	Ground	Ignition relay (IPDM E/R) control	Output	Ignition switch	OFF or ACC	12 V
					ON	0 V
99 (W/R)	Ground	Ignition relay control	Output	Ignition switch	OFF or ACC	0 V
					ON	12 V
100 (G)	Ground	Passenger door re- quest switch	Input	Passenger door request switch	ON (Pressed)	0 V
					OFF (Not pressed)	12 V
102 (G)	Ground	Selector lever P/N position	Input	Selector lever	P or N position	Battery voltage
					Except P and N positions	0 V
104 (Y/R)	Ground	CVT shift selector (detention switch) power supply	Output	Ignition switch ON		12 V
105 (B/O)	Ground	Stop lamp switch 2	Input	Ignition switch OFF		Battery voltage
106 (Y/B)	Ground	Blower fan motor re- lay control	Output	Ignition switch	OFF or ACC	0 V
					ON	12 V

*: For Canada

BCM (BODY CONTROL MODULE)

< ECU DIAGNOSIS INFORMATION >

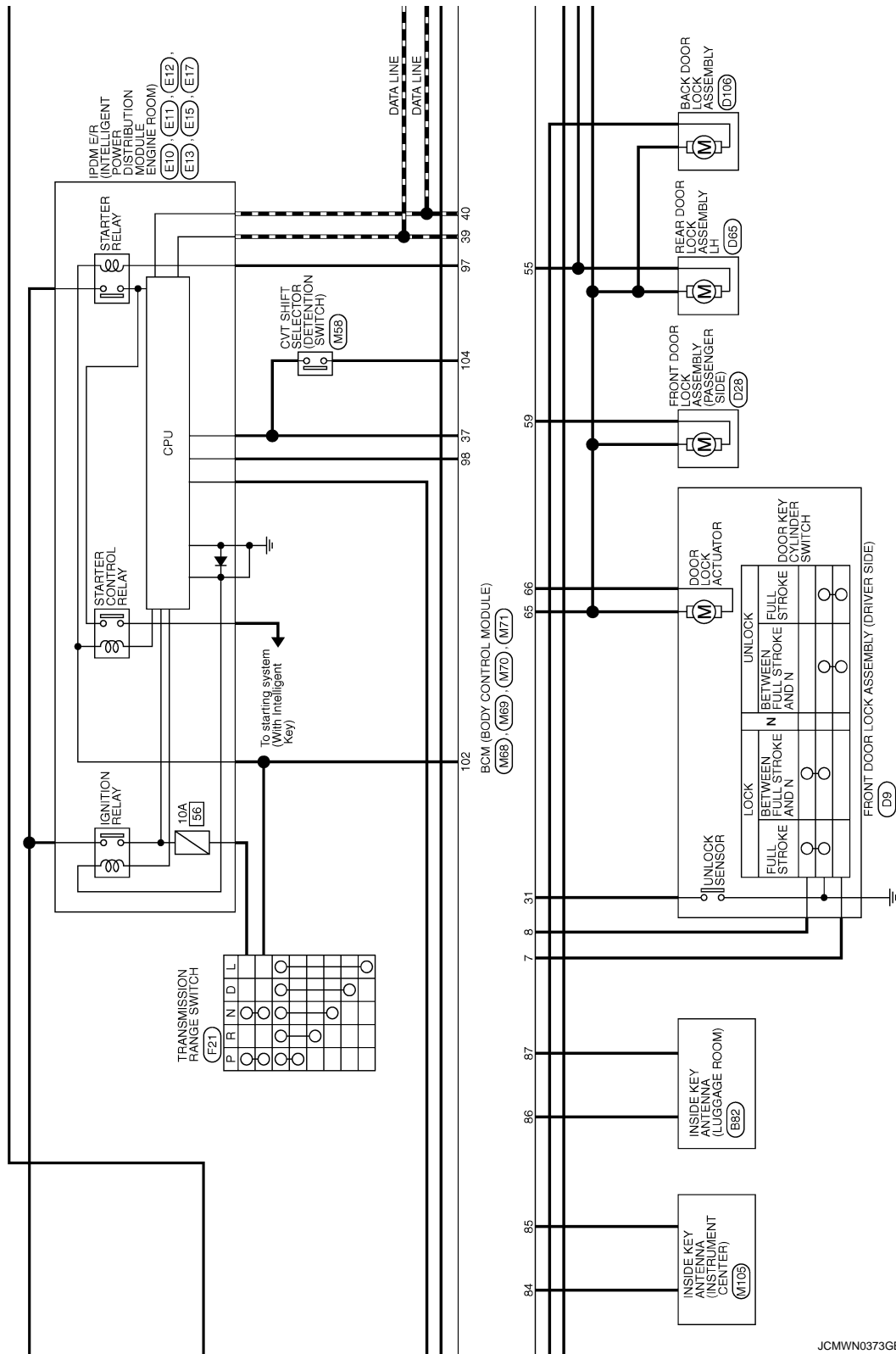

JCMWN0373GB

BCM (BODY CONTROL MODULE)

< ECU DIAGNOSIS INFORMATION >

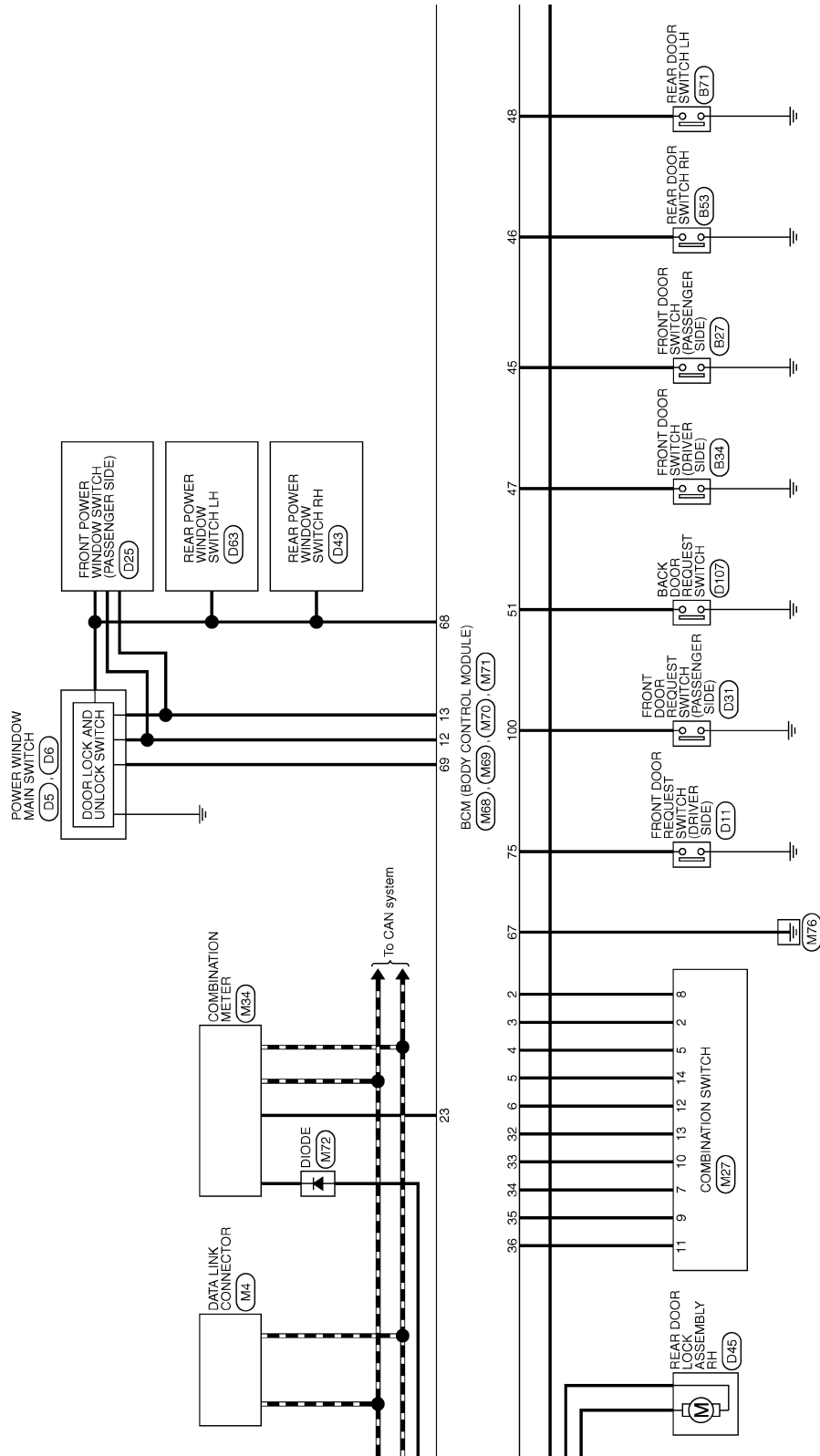

JCMWN0374GB

A
B
C
D
E
F
G
H
I
J
PWC
L
M
N
O
P

BCM (BODY CONTROL MODULE)

< ECU DIAGNOSIS INFORMATION >

 For Canada

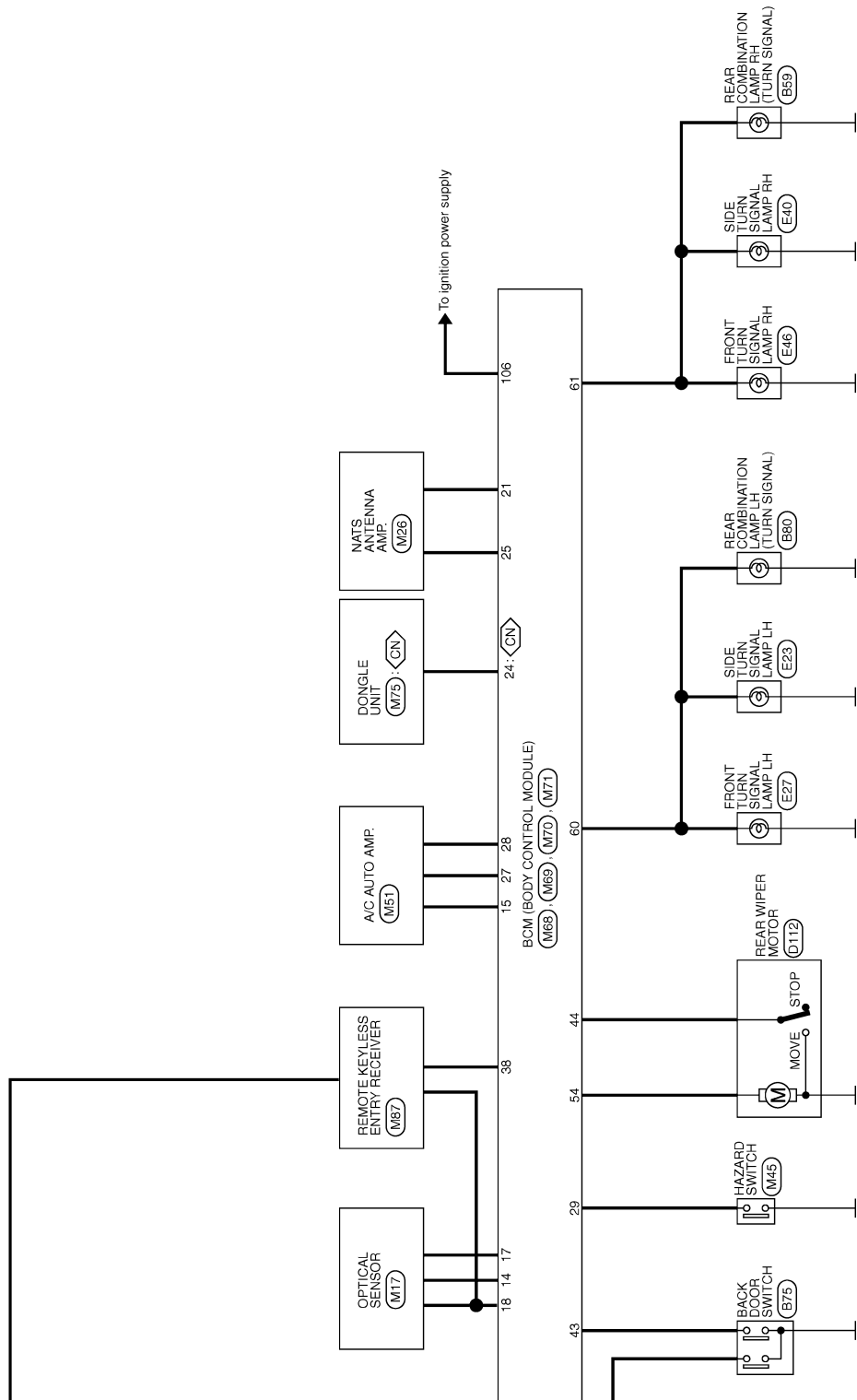

JCMWN0375GB

BCM (BODY CONTROL MODULE)

< ECU DIAGNOSIS INFORMATION >

86	P	LUGGAGE ROOM ANT-
87	L	LUGGAGE ROOM ANT-
90	W/L	PUSH-BUTTON IGNITION SW ILL POWER
91	Y	ACC ON IND
92	BR/R	PUSH-BUTTON IGNITION SW ILL GND
93	GR/W	1-KEY WARN BUZZER
96	BR/W	ACC RELAY CONT
97	L/R	STARTER RELAY CONT
98	BR	IGN RELAY (IPDM E/R) CONT
99	W/R	IGN RELAY CONT
100	G	PASSENGER DOOR REQUEST SW
102	G	SHIFT N/P
104	Y/R	CVT SHIFT SELECTOR POWER SUPPLY
105	B/O	STOP LAMP SW 2
106	Y/B	BLOWER FAN MOTOR RELAY CONT

Connector No.	M70
Connector Name	BCM (BODY CONTROL MODULE)
Connector Type	FEA09FW-FHA6-SA

65	66	67	68	69	70
----	----	----	----	----	----

Terminal No.	Color of Wire	Signal Name [Specification]
56	L	INTERIOR ROOM LAMP POWER SUPPLY
57	Y	BAT (FUSE)
59	G	PASSENGER DOOR UNLOCK OUTPUT
60	W/B	TURN SIGNAL LH OUTPUT
61	W/L	TURN SIGNAL RH OUTPUT
63	BR	ROOM LAMP TIMER CONTROL
65	V	ALL DOOR LOCK OUTPUT
66	L/B	DRIVER DOOR UNLOCK OUTPUT
67	B	GND
68	L	POWER WINDOW POWER SUPPLY (IGN)
69	L/W	POWER WINDOW POWER SUPPLY (BAT)
70	Y	BAT (F/L)

Connector No.	M71
Connector Name	BCM (BODY CONTROL MODULE)
Connector Type	TH40FW-NH

71	72	73	74	75	76	77	78	79	80	81	82	83	84	85	86	87	88	89	90
----	----	----	----	----	----	----	----	----	----	----	----	----	----	----	----	----	----	----	----

Terminal No.	Color of Wire	Signal Name [Specification]
75	SB	DRIVER DOOR REQUEST SW
76	L/O	PUSH SW
78	LG	DRIVER DOOR ANT-
79	V	DRIVER DOOR ANT-
80	BR/Y	PASSENGER DOOR ANT-
81	L/Y	PASSENGER DOOR ANT-
82	W/B	BACK DOOR ANT-
83	B/W	BACK DOOR ANT-
84	Y/G	ROOM ANT-
85	Y/L	ROOM ANT-

BCM (BODY CONTROL MODULE) (WITH INTELLIGENT KEY)

12	GR	CENTRAL DOOR LOCK SW
13	BR	CENTRAL DOOR UNLOCK SW
14	L/B	OPTICAL SENSOR
15	W/L	REAR WINDOW DEFROGGER SW
17	R/G	OPTICAL SENSOR POWER SUPPLY
18	V	SENSOR GND
21	P/L	NATS ANTENNA AMP
23	R/Y	SECURITY INDICATOR LAMP
24	GR/R	DONGLE LINK
25	LG	NATS ANTENNA AMP
27	Y/G	A/G SW
28	G/W	BLOWER FAN SW
29	L/W	HAZARD SW
31	G/B	DR DOOR UNLOCK SENSOR
32	LG	COMBI SW OUTPUT 5
33	Y/L	COMBI SW OUTPUT 4
34	W	COMBI SW OUTPUT 3
35	R/L	COMBI SW OUTPUT 2
36	L/O	COMBI SW OUTPUT 1
37	G/O	SHIFT P
38	G/Y	RECEIVER COM1
39	L	CAN-H
40	P	CAN-L

Connector No.	M27
Connector Name	COMBINATION SWITCH
Connector Type	TH16FW-NH

1	2	3	4	5	6		
7	8	9	10	11	12	13	14

Terminal No.	Color of Wire	Signal Name [Specification]
1	O	WASHER (RR)
2	GR	OUTPUT 4
3	L	WASHER (FR)
4	W	IGN
5	L/Y	OUTPUT 3
8	B	GND
9	W	INPUT 3
7	BR/W	OUTPUT 5
9	R/L	INPUT 2
10	Y/L	INPUT 4
11	L/O	INPUT 1
12	L/R	OUTPUT 1
13	LG	INPUT 5
14	G	OUTPUT 2

Connector No.	M68
Connector Name	BCM (BODY CONTROL MODULE)
Connector Type	TH40FB-NH

1	2	3	4	5	6	7	8	9	10	11	12	13	14	15	16	17	18	19	20
---	---	---	---	---	---	---	---	---	----	----	----	----	----	----	----	----	----	----	----

Terminal No.	Color of Wire	Signal Name [Specification]
2	BR/W	COMBI SW INPUT 5
3	GR	COMBI SW INPUT 4
4	L/Y	COMBI SW INPUT 3
5	G	COMBI SW INPUT 2
6	L/R	COMBI SW INPUT 1
7	W/R	KEY CYL UNLOCK SW
8	W/B	KEY CYL LOCK SW
9	R	STOP LAMP SW 1

Connector No.	M69
Connector Name	BCM (BODY CONTROL MODULE)
Connector Type	FEA09FB-FHA6-SA

41	42	43	44	45	46	47	48	49
50	51	52	53	54	55			

Terminal No.	Color of Wire	Signal Name [Specification]
43	W	BACK DOOR SW
44	LG	REAR WIPER STOP POSITION
45	SB	PASSENGER DOOR SW
46	GR/L	REAR RH DOOR SW
47	BR/Y	DRIVER DOOR SW
48	W/G	REAR LH DOOR SW
50	R/W	BK DR LOCK ACT RELAY CONT
51	W	BACK DOOR REQUEST SW
54	L/W	REAR WIPER OUTPUT
55	G	REAR DOOR UNLOCK OUTPUT

WITH INTELLIGENT KEY : Fail-safe

FAIL-SAFE CONTROL BY DTC

BCM performs fail-safe control when any DTC are detected.

JCMWN0376GB

INFOID:00000000694939

A
B
C
D
E
F
G
H
I
J
K
L
M
N
O
P

PWC

BCM (BODY CONTROL MODULE)

< ECU DIAGNOSIS INFORMATION >

Display contents of CONSULT	Fail-safe	Cancellation
B2192: ID DISCORD BCM-ECM	Inhibit engine cranking	Erase DTC
B2193: CHAIN OF BCM-ECM	Inhibit engine cranking	Erase DTC
B2195: ANTI-SCANNING	Inhibit engine cranking	Ignition switch ON → OFF
B2196: DONGLE NG	Inhibit engine cranking	Erase DTC
B2198: NATS ANTENNA AMP	Inhibit engine cranking	Erase DTC
B2608: STARTER RELAY	Inhibit engine cranking	500 ms after the following signal communication status becomes consistent <ul style="list-style-type: none"> • Starter relay control signal • Starter relay status signal (CAN)
B260F: ENG STATE SIG LOST	Inhibit engine cranking	When any of the following conditions are fulfilled <ul style="list-style-type: none"> • Power position changes to ACC • Receives engine status signal (CAN)
B26F1: IGN RELAY OFF	Inhibit engine cranking	When the following conditions are fulfilled <ul style="list-style-type: none"> • Ignition switch ON signal (CAN: Transmitted from BCM): ON • Ignition switch ON signal (CAN: Transmitted from IPDM E/R): ON
B26F2: IGN RELAY ON	Inhibit engine cranking	When the following conditions are fulfilled <ul style="list-style-type: none"> • Ignition switch ON signal (CAN: Transmitted from BCM): OFF • Ignition switch ON signal (CAN: Transmitted from IPDM E/R): OFF
B26F3: START CONT RLY ON	Inhibit engine cranking	When the following conditions are fulfilled <ul style="list-style-type: none"> • Starter control relay signal (CAN: Transmitted from BCM): OFF • Starter control relay signal (CAN: Transmitted from IPDM E/R): OFF
B26F4: START CONT RLY OFF	Inhibit engine cranking	When the following conditions are fulfilled <ul style="list-style-type: none"> • Starter control relay signal (CAN: Transmitted from BCM): ON • Starter control relay signal (CAN: Transmitted from IPDM E/R): ON
B26F7: BCM	Inhibit engine cranking by Intelligent Key system	When room antenna and luggage room antenna functions normally

REAR WIPER MOTOR PROTECTION

BCM detects the rear wiper stopping position according to the rear wiper stop position signal.

When the rear wiper stop position signal does not change for more than 5 seconds while driving the rear wiper, BCM stops power supply to protect the rear wiper motor.

Condition of cancellation

1. More than 1 minute is passed after the rear wiper stop.
2. Turn rear wiper switch OFF.
3. Operate the rear wiper switch or rear washer switch.

WITH INTELLIGENT KEY : DTC Inspection Priority Chart

INFOID:000000006949440

If some DTCs are displayed at the same time, perform inspections one by one based on the following priority chart.

Priority	DTC
1	B2562: LOW VOLTAGE
2	<ul style="list-style-type: none"> • U1000: CAN COMM CIRCUIT • U1010: CONTROL UNIT (CAN)
3	<ul style="list-style-type: none"> • B2192: ID DISCORD BCM-ECM • B2193: CHAIN OF BCM-ECM • B2195: ANTI-SCANNING • B2196: DONGLE NG • B2198: NATS ANTENNA AMP

BCM (BODY CONTROL MODULE)

< ECU DIAGNOSIS INFORMATION >

Priority	DTC	
4	• B2555: STOP LAMP	A
	• B2556: PUSH-BTN IGN SW	
	• B2557: VEHICLE SPEED	B
	• B2601: SHIFT POSITION	
	• B2602: SHIFT POSITION	
	• B2603: SHIFT POSI STATUS	C
	• B2604: PNP/CLUTCH SW	
	• B2605: PNP/CLUTCH SW	
	• B2608: STARTER RELAY	D
	• B260F: ENG STATE SIG LOST	
	• B2614: BCM	
	• B2615: BCM	
	• B2616: BCM	E
	• B2618: BCM	
	• B261A: PUSH-BTN IGN SW	
	• B26F1: IGN RELAY OFF	F
	• B26F2: IGN RELAY ON	
	• B26F3: START CONT RLY ON	
	• B26F4: START CONT RLY OFF	G
	• B26F6: BCM	
• B26F7: BCM		
• B26F8: BCM		
• B26FC: KEY REGISTRATION		
• C1729: VHCL SPEED SIG ERR	H	
• U0415: VEHICLE SPEED		
5	• C1704: LOW PRESSURE FL	I
	• C1705: LOW PRESSURE FR	
	• C1706: LOW PRESSURE RR	
	• C1707: LOW PRESSURE RL	J
	• C1708: [NO DATA] FL	
	• C1709: [NO DATA] FR	
	• C1710: [NO DATA] RR	
	• C1711: [NO DATA] RL	
	• C1716: [PRESSDATA ERR] FL	
	• C1717: [PRESSDATA ERR] FR	
• C1718: [PRESSDATA ERR] RR		
• C1719: [PRESSDATA ERR] RL		
6	• B2621: INSIDE ANTENNA	
	• B2622: INSIDE ANTENNA	
7	• B2626: OUTSIDE ANTENNA	
	• B2627: OUTSIDE ANTENNA	
	• B2628: OUTSIDE ANTENNA	

PWC

WITH INTELLIGENT KEY : DTC Index

INFOID:000000006949441

NOTE:

The details of time display are as follows.

- CRNT: A malfunction is detected now.
- PAST: A malfunction was detected in the past.

IGN counter is displayed on Freeze Frame Data. For details of Freeze Frame Data, refer to [BCS-18. "COMMON ITEM : CONSULT-III Function \(BCM - COMMON ITEM\)"](#).

CONSULT display	Fail-safe	Freeze Frame Data •Vehicle Speed •Odo/Trip Meter •Vehicle Condition	Intelligent Key warning lamp ON	Tire pressure monitor warning lamp ON	Reference page
No DTC is detected. further testing may be required.	—	—	—	—	—
U1000: CAN COMM	—	—	—	—	BCS-38

BCM (BODY CONTROL MODULE)

< ECU DIAGNOSIS INFORMATION >

CONSULT display	Fail-safe	Freeze Frame Data •Vehicle Speed •Odo/Trip Meter •Vehicle Condition	Intelligent Key warning lamp ON	Tire pressure monitor warning lamp ON	Reference page
U1010: CONTROL UNIT (CAN)	—	—	—	—	BCS-39
U0415: VEHICLE SPEED	—	—	×	—	BCS-40
B2192: ID DISCORD BCM-ECM	×	—	—	—	SEC-37
B2193: CHAIN OF BCM-ECM	×	—	—	—	SEC-39
B2195: ANTI-SCANNING	×	—	—	—	SEC-40
B2196: DONGLE NG	×	—	—	—	SEC-41
B2198: NATS ANTENNA AMP	×	—	—	—	SEC-43
B2555: STOP LAMP	—	×	×	—	SEC-47
B2556: PUSH-BTN IGN SW	—	×	×	—	SEC-49
B2557: VEHICLE SPEED	—	×	×	—	SEC-51
B2562: LOW VOLTAGE	—	×	—	—	BCS-41
B2601: SHIFT POSITION	—	×	×	—	SEC-52
B2602: SHIFT POSITION	—	×	×	—	SEC-55
B2603: SHIFT POSI STATUS	—	×	×	—	SEC-58
B2604: PNP/CLUTCH SW	—	×	×	—	SEC-63
B2605: PNP/CLUTCH SW	—	×	×	—	SEC-66
B2608: STARTER RELAY	×	×	×	—	SEC-68
B260F: ENG STATE SIG LOST	×	×	×	—	SEC-70
B2614: BCM	—	×	×	—	PCS-77
B2615: BCM	—	×	×	—	PCS-80
B2616: BCM	—	×	×	—	PCS-83
B2618: BCM	—	×	×	—	PCS-86
B261A: PUSH-BTN IGN SW	—	×	×	—	PCS-87
B2621: INSIDE ANTENNA	—	×	—	—	DLK-44
B2622: INSIDE ANTENNA	—	×	—	—	DLK-46
B2626: OUTSIDE ANTENNA	—	×	—	—	DLK-50
B2627: OUTSIDE ANTENNA	—	×	—	—	DLK-48
B2628: OUTSIDE ANTENNA	—	×	—	—	DLK-52
B26F1: IGN RELAY OFF	×	×	×	—	PCS-89
B26F2: IGN RELAY ON	×	×	×	—	PCS-91
B26F3: START CONT RLY ON	×	×	×	—	SEC-71
B26F4: START CONT RLY OFF	×	×	×	—	SEC-72
B26F6: BCM	—	×	×	—	PCS-93
B26F7: BCM	×	×	×	—	SEC-74
B26F8: BCM	—	×	×	—	SEC-75
B26FC: KEY REGISTRATION	—	×	×	—	SEC-76
C1704: LOW PRESSURE FL	—	—	—	×	WT-25
C1705: LOW PRESSURE FR	—	—	—	×	
C1706: LOW PRESSURE RR	—	—	—	×	
C1707: LOW PRESSURE RL	—	—	—	×	

BCM (BODY CONTROL MODULE)

< ECU DIAGNOSIS INFORMATION >

CONSULT display	Fail-safe	Freeze Frame Data •Vehicle Speed •Odo/Trip Meter •Vehicle Condition	Intelligent Key warning lamp ON	Tire pressure monitor warning lamp ON	Reference page
C1708: [NO DATA] FL	—	—	—	×	WT-27
C1709: [NO DATA] FR	—	—	—	×	
C1710: [NO DATA] RR	—	—	—	×	
C1711: [NO DATA] RL	—	—	—	×	
C1716: [PRESSDATA ERR] FL	—	—	—	×	WT-30
C1717: [PRESSDATA ERR] FR	—	—	—	×	
C1718: [PRESSDATA ERR] RR	—	—	—	×	
C1719: [PRESSDATA ERR] RL	—	—	—	×	
C1729: VHCL SPEED SIG ERR	—	—	—	×	WT-32

WITHOUT INTELLIGENT KEY

WITHOUT INTELLIGENT KEY : Reference Value

INFOID:000000006949442

VALUES ON THE DIAGNOSIS TOOL

Monitor Item	Condition	Value/Status
IGN ON SW	Ignition switch OFF or ACC	Off
	Ignition switch ON	On
KEY ON SW	Mechanical key is removed from key cylinder	Off
	Mechanical key is inserted to key cylinder	On
CDL LOCK SW	Door lock/unlock switch does not operate	Off
	Press door lock/unlock switch to the lock side	On
CDL UNLOCK SW	Door lock/unlock switch does not operate	Off
	Press door lock/unlock switch to the unlock side	On
DOOR SW-DR	Driver's door closed	Off
	Driver's door opened	On
DOOR SW-AS	Passenger door closed	Off
	Passenger door opened	On
DOOR SW-RR	Rear RH door closed	Off
	Rear RH door opened	On
DOOR SW-RL	Rear LH door closed	Off
	Rear LH door opened	On
BACK DOOR SW	Back door closed	Off
	Back door opened	On
LOCK STATUS	NOTE: The item is indicated, but not monitored.	Off
ACC ON SW	Ignition switch OFF	Off
	Ignition switch ACC or ON	On
KEYLESS LOCK	"LOCK" button of key fob is not pressed	Off
	"LOCK" button of key fob is pressed	On
KEYLESS UNLOCK	"UNLOCK" button of key fob is not pressed	Off
	"UNLOCK" button of key fob is pressed	On

BCM (BODY CONTROL MODULE)

< ECU DIAGNOSIS INFORMATION >

Monitor Item	Condition	Value/Status
SHOCK SENSOR	NOTE: The item is indicated, but not monitored.	NORMAL
KEY CYL LK-SW	Other than driver door key cylinder LOCK position	Off
	Driver door key cylinder LOCK position	On
KEY CYL UN-SW	Other than driver door key cylinder UNLOCK position	Off
	Driver door key cylinder UNLOCK position	On
VEHICLE SPEED	While driving	Equivalent to speedometer reading
REAR DEF SW	Rear window defogger switch OFF	Off
	Rear window defogger switch ON	On
REVERSE SW CAN	NOTE: The item is indicated, but not used.	Off
		On
TAIL LAMP SW	Lighting switch OFF	Off
	Lighting switch 1ST	On
FR FOG SW	Front fog lamp switch OFF	Off
	Front fog lamp switch ON	On
BUCKLE SW	The seat belt (driver side) is fastened. [Seat belt switch (driver side) OFF]	Off
	The seat belt (driver side) is unfastened. [Seat belt switch (driver side) ON]	On
TRNK/HAT MNTR	NOTE: The item is indicated, but not monitored.	Off
ACC SW	Ignition switch OFF	Off
	Ignition switch ACC or ON	On
KYLS TRNK/HAT	NOTE: The item is indicated, but not monitored.	Off
KEYLESS PANIC	PANIC button of key fob is not pressed	Off
	PANIC button of key fob is pressed	On
HI BEAM SW	Lighting switch OFF	Off
	Lighting switch HI	On
HEAD LAMP SW 1	Lighting switch OFF	Off
	Lighting switch 2ND	On
HEAD LAMP SW 2	Lighting switch OFF	Off
	Lighting switch 2ND	On
AUTO LIGHT SW	Lighting switch OFF	Off
	Lighting switch AUTO	On
PASSING SW	Other than lighting switch PASS	Off
	Lighting switch PASS	On
RR FOG SW	NOTE: The item is indicated, but not monitored.	Off
TURN SIGNAL R	Turn signal switch OFF	Off
	Turn signal switch RH	On
TURN SIGNAL L	Turn signal switch OFF	Off
	Turn signal switch LH	On
PKB SW	Parking brake switch is OFF	Off
	Parking brake switch is ON	On
ENGINE RUN	Engine stopped	Off
	Engine running	On

BCM (BODY CONTROL MODULE)

< ECU DIAGNOSIS INFORMATION >

Monitor Item	Condition	Value/Status	
OPTI SEN (DTCT)	Bright outside of the vehicle	Close to 5 V	A
	Dark outside of the vehicle	Close to 0 V	
OPTI SEN (FILT)	Bright outside of the vehicle (Lighting switch AUTO)	Close to 5 V	B
	Dark outside of the vehicle (Lighting switch AUTO)	Close to 1.50 V	
LIG SEN COND	NOTE: The item is indicated, but not monitored.	OFF	C
IGN SW CAN	Ignition switch OFF or ACC	Off	
	Ignition switch ON	On	
FR WIPER HI	Front wiper switch OFF	Off	D
	Front wiper switch HI	On	
FR WIPER LOW	Front wiper switch OFF	Off	E
	Front wiper switch LO	On	
FR WIPER INT	Front wiper switch OFF	Off	
	Front wiper switch INT	On	F
FR WASHER SW	Front washer switch OFF	Off	
	Front washer switch ON	On	G
INT VOLUME	Wiper intermittent dial is in a dial position 1 - 7	1 - 7	
FR WIPER STOP	Any position other than front wiper stop position	Off	
	Front wiper stop position	On	H
RR WIPER ON	Rear wiper switch OFF	Off	
	Rear wiper switch ON	On	I
RR WIPER INT	Rear wiper switch OFF	Off	
	Rear wiper switch INT	On	
RR WASHER SW	Rear washer switch OFF	Off	J
	Rear washer switch ON	On	
RR WIPER STOP	Rear wiper stop position	Off	
	Other than rear wiper stop position	On	PWC
RAIN SENSOR	NOTE: The item is indicated, but not monitored.	Off	
HAZARD SW	Hazard switch OFF	Off	L
	Hazard switch ON	On	
FAN ON SIG	Blower control dial OFF	Off	M
	Other than blower control dial OFF	On	
AIR COND SW	<ul style="list-style-type: none"> • Air conditioner OFF (A/C switch indicator OFF) (Automatic air conditioner) • A/C switch OFF (Manual air conditioner) 	Off	N
	<ul style="list-style-type: none"> • Air conditioner ON (A/C switch indicator ON) (Automatic air conditioner) • A/C switch ON (Manual air conditioner) 	On	
THERMO AMP NOTE: At models with automatic air conditioner this item is not monitored.	Ignition switch ON	Off	O
	Evaporator is extremely low temperature	On	P
FR DEF SW	Other than A/C mode defroster ON position	Off	
	A/C mode defroster ON position	On	
KEYLESS TRUNK	NOTE: The item is indicated, but not monitored.	Off	
TRNK OPNR SW	NOTE: The item is indicated, but not monitored.	Off	

BCM (BODY CONTROL MODULE)

< ECU DIAGNOSIS INFORMATION >

Monitor Item	Condition	Value/Status
TRNK OPN MNTR	NOTE: The item is indicated, but not monitored.	Off
HOOD SW	Close the hood	Off
	Open the hood	On
TRANSPONDER	Other than the ignition switch is ON by key registered to BCM.	Off
	The ignition switch is ON by key registered to BCM.	On
INTELLI KEY	NOTE: The item is indicated, but not used.	Off
AUTO RELOCK	NOTE: The item is indicated, but not monitored.	Off
OIL PRESS SW	<ul style="list-style-type: none">Ignition switch OFF or ACCEngine running	Off
	Ignition switch ON	On
BRAKE SW	Brake pedal is not depressed	Off
	Brake pedal is depressed	On

BCM (BODY CONTROL MODULE)

< ECU DIAGNOSIS INFORMATION >

TERMINAL LAYOUT

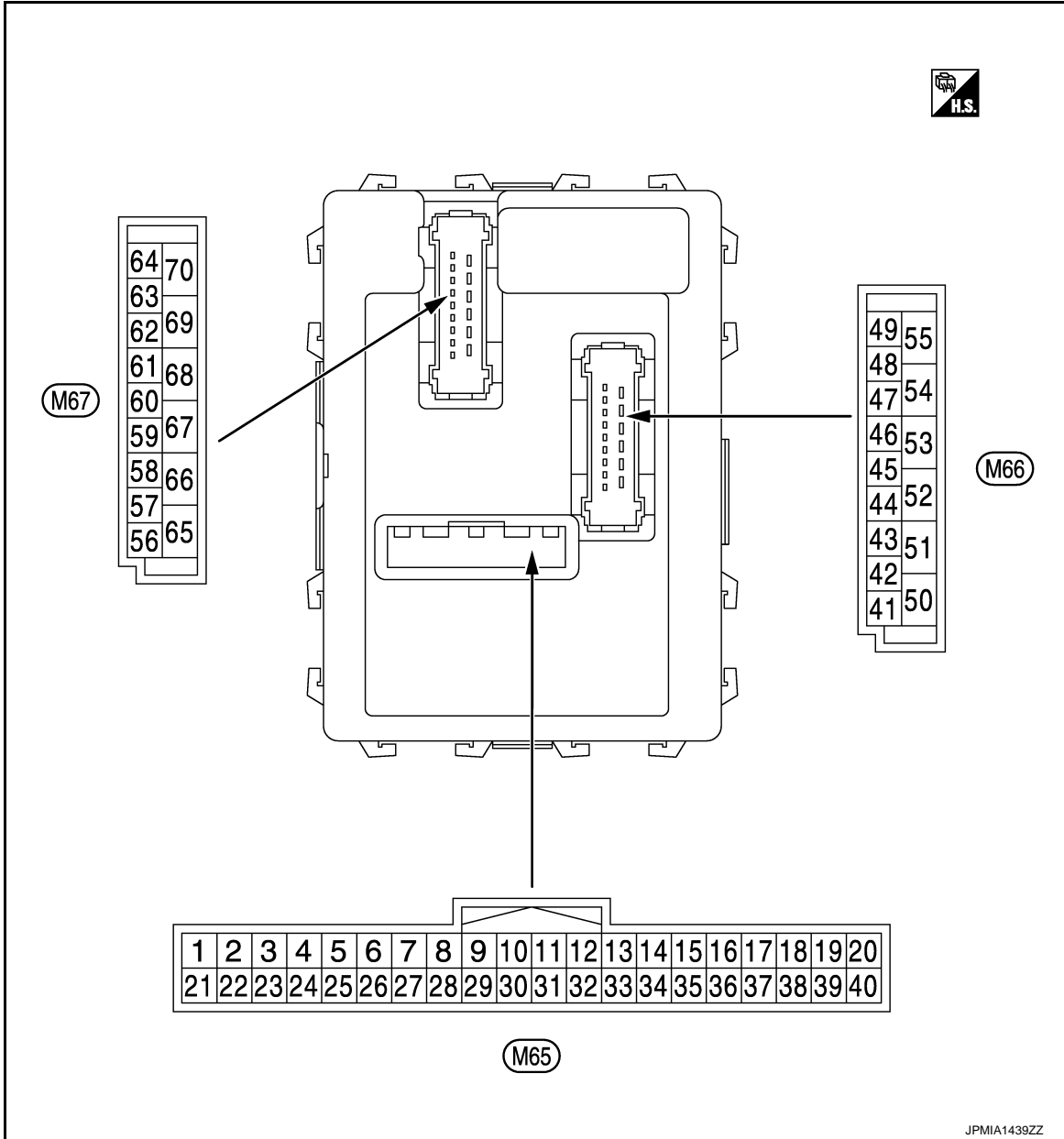

NOTE:

- M65, M66: White
- M67: Black

PHYSICAL VALUES

A
B
C
D
E
F
G
H
I
J
L
M
N
O
P

PWC

BCM (BODY CONTROL MODULE)

< ECU DIAGNOSIS INFORMATION >

Terminal No. (Wire color)		Description		Condition	Value (Approx.)		
		Signal name	Input/ Output				
+	-						
2 (BR/W)	Ground	Combination switch INPUT 5	Input	Combination switch (Wiper intermit- tent dial 4)	All switch OFF	0 V	
					Turn signal switch RH	<p style="text-align: right; font-size: small;">PKIB4958J</p>	
					Lighting switch HI		
					Lighting switch 1ST		1.0 V
					Lighting switch 2ND	<p style="text-align: right; font-size: small;">JPMIA0342JP</p>	2.0 V
3 (GR)	Ground	Combination switch INPUT 4	Input	Combination switch (Wiper intermit- tent dial 4)	All switch OFF	0 V	
					Turn signal switch LH	<p style="text-align: right; font-size: small;">PKIB4958J</p>	
					Lighting switch PASS		
					Lighting switch 2ND		1.0 V
					Front fog lamp switch ON	<p style="text-align: right; font-size: small;">PKIB4956J</p>	0.8 V
4 (L/Y)	Ground	Combination switch INPUT 3	Input	Combination switch (Wiper intermit- tent dial 4)	All switch OFF	0 V	
					Front wiper switch LO	<p style="text-align: right; font-size: small;">PKIB4958J</p>	
					Front wiper switch MIST		
					Front wiper switch INT		
					Lighting switch AUTO		1.0 V

BCM (BODY CONTROL MODULE)

< ECU DIAGNOSIS INFORMATION >

Terminal No. (Wire color)		Description		Condition	Value (Approx.)	
+	-	Signal name	Input/ Output			
5 (G)	Ground	Combination switch INPUT 2	Input	Combination switch	All switch OFF (Wiper intermittent dial 4)	0 V
					Front washer switch (Wiper intermittent dial 4)	
					Rear washer switch ON (Wiper intermittent dial 4)	
					Any of the condition below with all switch OFF <ul style="list-style-type: none"> • Wiper intermittent dial 1 • Wiper intermittent dial 5 • Wiper intermittent dial 6 	
Rear wiper switch ON (Wiper intermittent dial 4)		0.8 V				
6 (L/R)	Ground	Combination switch INPUT 1	Input	Combination switch	All switch OFF (Wiper intermittent dial 4)	0 V
					Front wiper switch HI (Wiper intermittent dial 4)	
					Rear wiper switch INT (Wiper intermittent dial 4)	
					Wiper intermittent dial 3 (All switch OFF)	
					Any of the condition below with all switch OFF <ul style="list-style-type: none"> • Wiper intermittent dial 1 • Wiper intermittent dial 2 	
Any of the condition below with all switch OFF <ul style="list-style-type: none"> • Wiper intermittent dial 6 • Wiper intermittent dial 7 		0.8 V				

A
B
C
D
E
F
G
H
I
J
L
M
N
O
P

PWC

BCM (BODY CONTROL MODULE)

< ECU DIAGNOSIS INFORMATION >

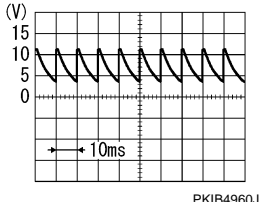
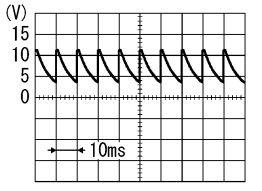
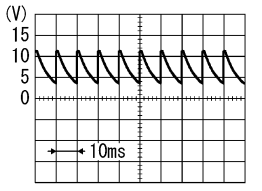
Terminal No. (Wire color)		Description		Condition		Value (Approx.)
+	-	Signal name	Input/ Output			
7 (W/R)	Ground	Door key cylinder switch UNLOCK	Input	Door key cylin- der switch	NEUTRAL position	 7.0 - 8.0 V
					UNLOCK position	0 V
8 (W/B)	Ground	Door key cylinder switch LOCK	Input	Door key cylin- der switch	NEUTRAL position	12 V
					LOCK position	0 V
9 (R)	Ground	Stop lamp switch	Input	Stop lamp switch	OFF (Brake pedal is not depressed)	0 V
					ON (Brake pedal is de- pressed)	Battery voltage
10 (W/L)	Ground	Rear window defog- ger switch	Input	Rear window defogger switch	OFF (Not pressed)	12 V
					ON (Pressed)	0 V
11 (L/Y)	Ground	Ignition switch ACC	Input	Ignition switch OFF	0 V	
				Ignition switch ACC or ON	Battery voltage	
12 (SB)	Ground	Passenger door switch	Input	Passenger door switch	OFF (When passenger door closed)	 7.0 - 8.0 V
					ON (When passenger door opened)	0 V
13 (GR/L)	Ground	Rear RH door switch	Input	Rear RH door switch	OFF (When rear RH door closed)	 7.0 - 8.0 V
					ON (When rear RH door opened)	0 V
14 (L/B)	Ground	Optical sensor	Input	Ignition switch ON	When bright outside of the vehicle	Close to 5 V
					When dark outside of the vehicle	Close to 0 V
17 (R/G)	Ground	Optical sensor pow- er supply	Output	Ignition switch	OFF, ACC	0 V
					ON	5 V
18 (V)	Ground	Receiver and sensor ground	Input	Ignition switch ON	0 V	

BCM (BODY CONTROL MODULE)

< ECU DIAGNOSIS INFORMATION >

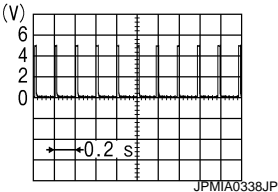
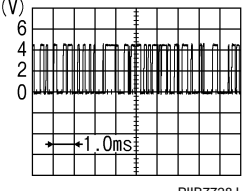
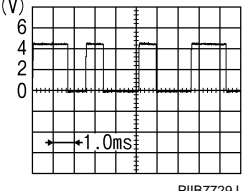
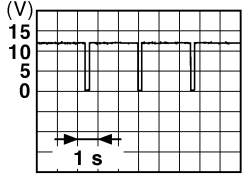
Terminal No. (Wire color)		Description		Condition	Value (Approx.)
+	-	Signal name	Input/ Output		
19 (BR)	Ground	Remote keyless entry receiver power supply	Input	Ignition switch OFF	0 V
				Insert mechanical key into ignition key cylinder	5 V
				Remove mechanical key from ignition key cylinder (Any door opened)	
				Remove mechanical key from ignition key cylinder (Any door closed)	
20 (G/Y)	Ground	Remote keyless entry receiver communication	Input	Ignition switch OFF	0 V
				Insert mechanical key into ignition key cylinder	
				Waiting	
				Signal receiving	
21 (P/L)	Ground	Immobilizer antenna (Clock)	Input/Output	During waiting	Ignition switch is pressed while inserting the key into the key slot. Just after pressing ignition switch. Pointer of tester should move.
23 (R/Y)	Ground	Security indicator	Input	Security indicator	0 V
				ON	
				Blinking (Ignition switch OFF)	
				OFF	12 V
24 (GR/R)	Ground	Dongle link	Input/Output	Ignition switch OFF	5 V
25 (LG)	Ground	Immobilizer antenna (Rx, Tx)	Input/Output	During waiting	Ignition switch is pressed while inserting the key into the key slot. Just after pressing ignition switch. Pointer of tester should move.
26*1 (GR)	Ground	Thermo control amp.	Input	Ignition switch ON	0 V
				Evaporator is extremely low temperature	12 V

A
B
C
D
E
F
G
H
I
J
L
M
N
O
P

PWC

BCM (BODY CONTROL MODULE)

< ECU DIAGNOSIS INFORMATION >

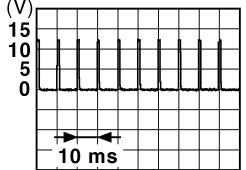
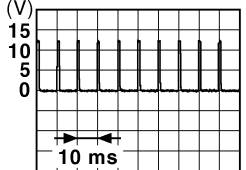
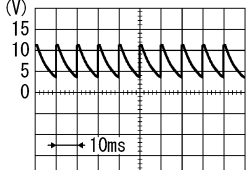
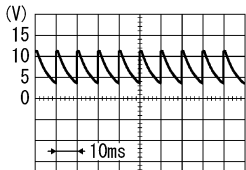
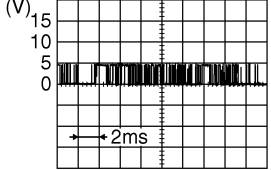
Terminal No. (Wire color)		Description		Condition	Value (Approx.)	
		Signal name	Input/ Output			
+	-					
27 (Y/G)*2 (Y/R)*3	Ground	A/C switch (Auto- matic air condition- er)	Input	A/C	OFF (A/C switch indicator: OFF)	 1.0 - 1.5 V
					ON (A/C switch indicator: ON)	0 V
		A/C switch (Manual c air conditioner)	Input	A/C switch	OFF	 1.0 - 1.5 V
					ON	0 V
28 (G/W)	Ground	Blower fan switch (Automatic air condi- tioner)	Input	Fan switch	Blower fan switch OFF	0 V
					Blower fan switch ON	 7.0 - 8.0 V
		Blower fan switch (Manual air condi- tioner)	Input	Fan switch	Blower fan switch OFF	 7.0 - 8.0 V
					Blower fan switch ON	0 V
29 (L/W)	Ground	Hazard switch	Input	Hazard switch	OFF	Battery voltage
					ON	0 V
31 (G/Y)	Ground	Front defroster switch	Input	Ignition switch ON	A/C mode defroster ON position	0 V
					Other than A/C mode de- froster ON position	 8.0 - 9.0 V

BCM (BODY CONTROL MODULE)

< ECU DIAGNOSIS INFORMATION >

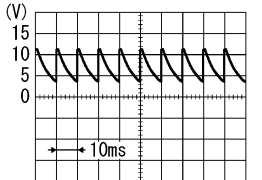
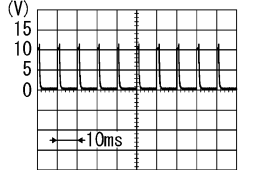
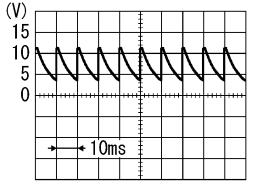
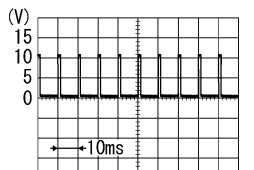
Terminal No. (Wire color)		Description		Condition	Value (Approx.)	
		Signal name	Input/ Output			
+	-					
32 (LG)	Ground	Combination switch OUTPUT 5	Output	Combination switch	All switch OFF (Wiper intermittent dial 4)	 <p style="text-align: right; font-size: small;">PKIB4960J</p> <p style="text-align: center;">7.0 - 8.0 V</p>
					Front fog lamp switch ON (Wiper intermittent dial 4)	 <p style="text-align: right; font-size: small;">PKIB4966J</p> <p style="text-align: center;">1.0 V</p>
					Rear wiper switch ON (Wiper intermittent dial 4)	
					Any of the condition below with all switch OFF	
33 (Y/L)	Ground	Combination switch OUTPUT 4	Output	Combination switch	All switch OFF (Wiper intermittent dial 4)	 <p style="text-align: right; font-size: small;">PKIB4960J</p> <p style="text-align: center;">7.0 - 8.0 V</p>
					Lighting switch 1ST (Wiper intermittent dial 4)	 <p style="text-align: right; font-size: small;">PKIB4958J</p> <p style="text-align: center;">1.2 V</p>
					Lighting switch AUTO (Wiper intermittent dial 4)	
					Rear wiper switch INT (Wiper intermittent dial 4)	

A
B
C
D
E
F
G
H
I
J
L
M
N
O
P

PWC

BCM (BODY CONTROL MODULE)

< ECU DIAGNOSIS INFORMATION >

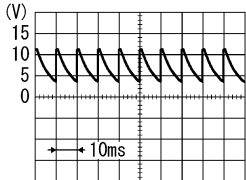
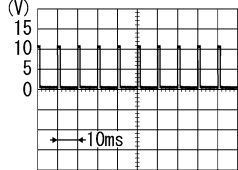
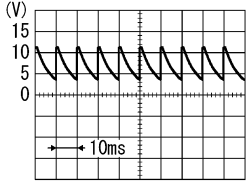
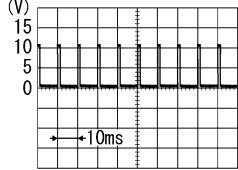
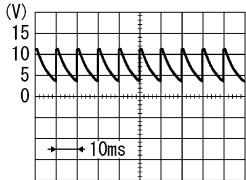
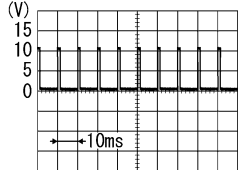
Terminal No. (Wire color)		Description		Condition	Value (Approx.)	
+	-	Signal name	Input/ Output			
34 (W)	Ground	Combination switch OUTPUT 3	Output	Combination switch	All switch OFF (Wiper intermittent dial 4)	 <small>PKIB4960J</small> 7.0 - 8.0 V
					Lighting switch 2ND (Wiper intermittent dial 4)	 <small>PKIB4958J</small> 1.2 V
					Lighting switch HI (Wiper intermittent dial 4)	
					Rear washer switch ON (Wiper intermittent dial 4)	
Any of the condition below with all switch OFF <ul style="list-style-type: none"> • Wiper intermittent dial 1 • Wiper intermittent dial 2 • Wiper intermittent dial 3 						
35 (R/L)	Ground	Combination switch OUTPUT 2	Output	Combination switch (Wiper intermit- tent dial 4)	All switch OFF	 <small>PKIB4960J</small> 7.0 - 8.0 V
					Lighting switch 2ND	 <small>PKIB4958J</small> 1.2 V
					Lighting switch PASS	
					Front wiper switch INT	
Front wiper switch HI						
36 (L/O)	Ground	Combination switch OUTPUT 1	Output	Combination switch (Wiper intermit- tent dial 4)	All switch OFF	 <small>PKIB4960J</small> 7.0 - 8.0 V
					Turn signal switch RH	 <small>PKIB4958J</small> 1.2 V
					Turn signal switch LH	
					Front wiper switch LO (Front wiper switch MIST)	
Front washer switch ON						

BCM (BODY CONTROL MODULE)

< ECU DIAGNOSIS INFORMATION >

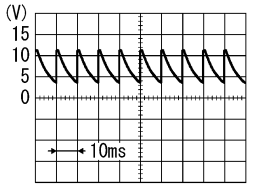
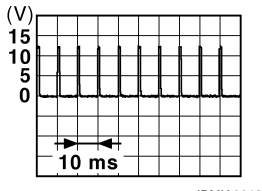
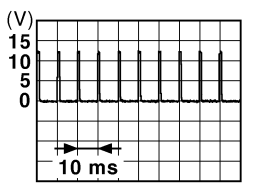
Terminal No. (Wire color)		Description		Condition	Value (Approx.)
+	-	Signal name	Input/ Output		
37 (R/W)	Ground	Key switch	Input	Insert mechanical key into ignition key cylinder	Battery voltage
				Remove mechanical key from ignition key cylinder	0 V
38 (O)	Ground	Ignition switch ON	Input	Ignition switch OFF or ACC	0 V
				Ignition switch ON	Battery voltage
39 (L)	Ground	CAN-H	Input/ Output	—	—
40 (P)	Ground	CAN-L	Input/ Output	—	—
43 (W)	Ground	Back door switch	Input	Back door switch OFF (When back door closed)	 7.0 - 8.0 V
				ON (When back door opened)	0 V
44 (LG)	Ground	Rear wiper stop position	Input	Ignition switch ON Rear wiper stop position	12 V
				Any position other than rear wiper stop position	0 V
45 (GR)	Ground	Door lock and unlock switch LOCK	Input	Door lock and unlock switch NEUTRAL position	 1.0 - 1.5 V
				LOCK position	0 V
46 (BR)	Ground	Door lock and unlock switch UNLOCK	Input	Door lock and unlock switch NEUTRAL position	 1.0 - 1.5 V
				UNLOCK position	0 V

A
B
C
D
E
F
G
H
I
J
L
M
N
O
P

PWC

BCM (BODY CONTROL MODULE)

< ECU DIAGNOSIS INFORMATION >

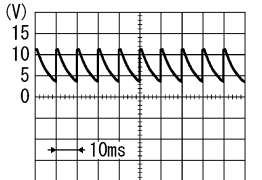
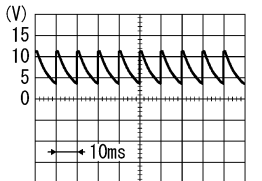
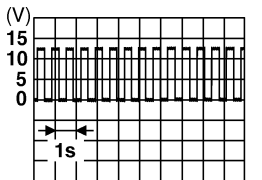
Terminal No. (Wire color)		Description		Condition		Value (Approx.)
+	-	Signal name	Input/ Output			
47 (BR/Y)	Ground	Driver door switch	Input	Driver door switch	OFF (When driver door closed)	 <p style="text-align: right; font-size: small;">PKIB4960J</p> <p style="text-align: center;">7.0 - 8.0 V</p>
					ON (When driver door opened)	0 V
48 (W/G)	Ground	Rear LH door switch	Input	Rear LH door switch	OFF (When rear LH door closed)	 <p style="text-align: right; font-size: small;">PKIB4960J</p> <p style="text-align: center;">7.0 - 8.0 V</p>
					ON (When rear LH door opened)	0 V
50*1 (SB)	Ground	A/C indicator	Output	A/C indicator	OFF	12 V
					ON	0 V
54 (L/W)	Ground	Rear wiper	Output	Ignition switch ON	Rear wiper switch OFF	0 V
					Rear wiper switch ON	12 V
56 (L)	Ground	Interior room lamp power supply	Output	Interior room lamp battery saver is activated. (Cuts the interior room lamp power supply)	0 V	
					Interior room lamp battery saver is not activated. (Outputs the interior room lamp power supply)	12 V
57 (Y)	Ground	Battery power supply	Input	Ignition switch OFF	Battery voltage	
59 (L/B)	Ground	Driver door UNLOCK	Output	Driver door	UNLOCK (Actuator is activated)	12 V
					Other than UNLOCK (Actuator is not activated)	0 V
60 (W/B)	Ground	Turn signal LH	Output	Ignition switch ON	Turn signal switch OFF	0 V
					Turn signal switch LH	 <p style="text-align: right; font-size: small;">PKIC6370E</p> <p style="text-align: center;">6.0 V</p>

BCM (BODY CONTROL MODULE)

< ECU DIAGNOSIS INFORMATION >

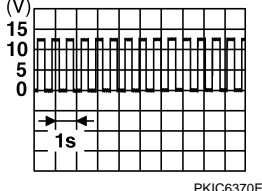
Terminal No. (Wire color)		Description		Condition	Value (Approx.)	
+	-	Signal name	Input/ Output			
61 (W/L)	Ground	Turn signal RH	Output	Ignition switch OFF	0 V	
				Ignition switch ON	Turn signal switch RH	 6.0 V
63 (BR)	Ground	Interior room lamp timer control	Output	Interior room lamp	OFF	12 V
				ON	0 V	
65 (V)	Ground	All doors LOCK	Output	All doors	LOCK (Actuator is activated)	12 V
				Other then LOCK (Actuator is not activated)	0 V	
66 (G)	Ground	Passenger door and rear door UNLOCK	Output	Passenger door and rear door	UNLOCK (Actuator is activated)	12 V
				Other then UNLOCK (Actuator is not activated)	0 V	
67 (B)	Ground	Ground	Output	Ignition switch ON	0 V	
68 (L)	Ground	P/W power supply (IGN)	Output	Ignition switch ON	12 V	
69 (L/W)	Ground	P/W power supply (BAT)	Output	Ignition switch OFF	12 V	
70 (Y)	Ground	Battery power supply	Input	Ignition switch OFF	Battery voltage	

- *1: Only manual air conditioner
- *2: Automatic air conditioner
- *3: Manual air conditioner

PWC

L

M

N

O

P

BCM (BODY CONTROL MODULE)

< ECU DIAGNOSIS INFORMATION >

WITHOUT INTELLIGENT KEY : Wiring Diagram - BCM -

INFOID:000000006949443

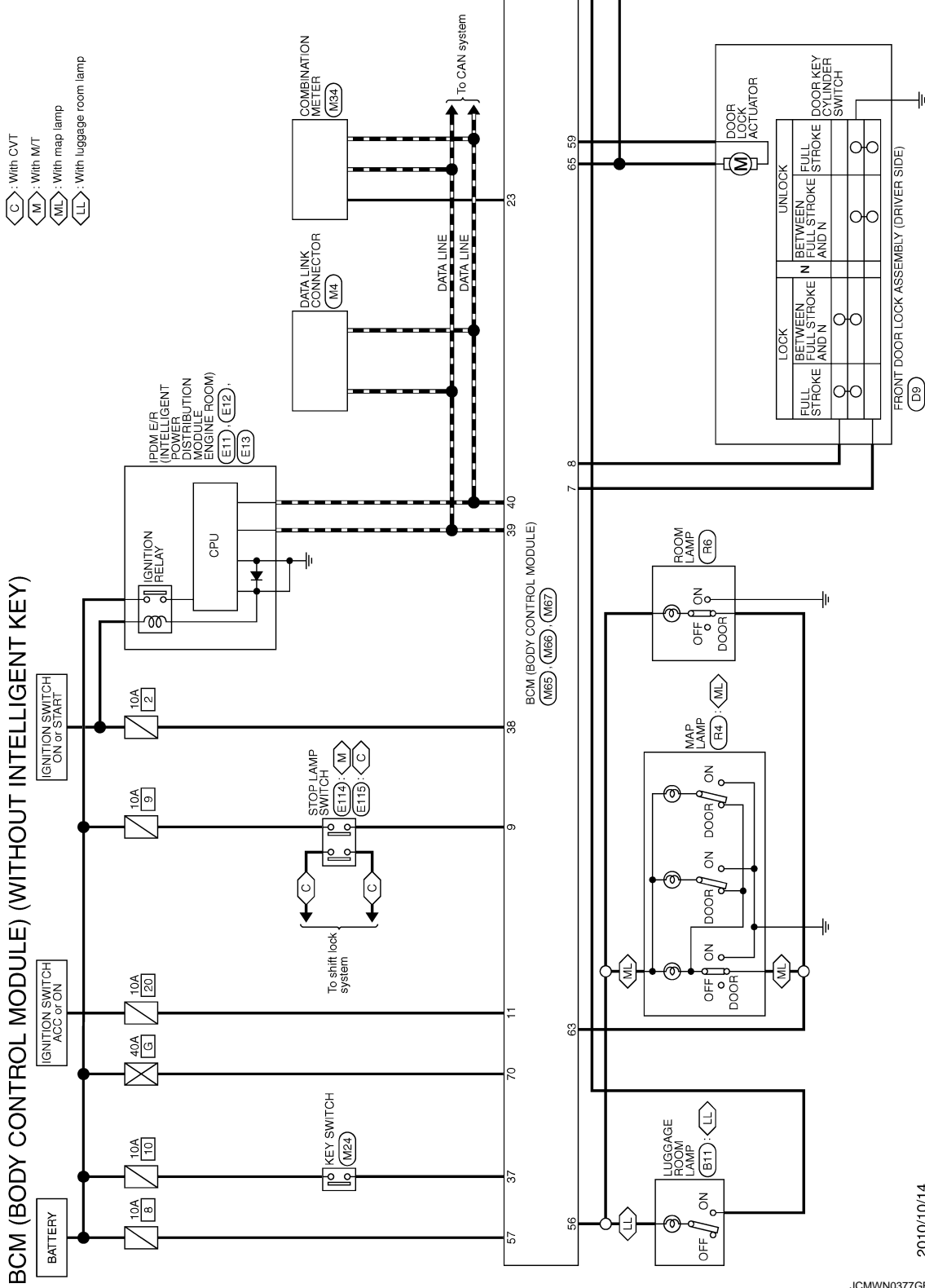

BCM (BODY CONTROL MODULE)

< ECU DIAGNOSIS INFORMATION >

AA: With auto A/C
 MA: With manual A/C
 AL: With auto light system

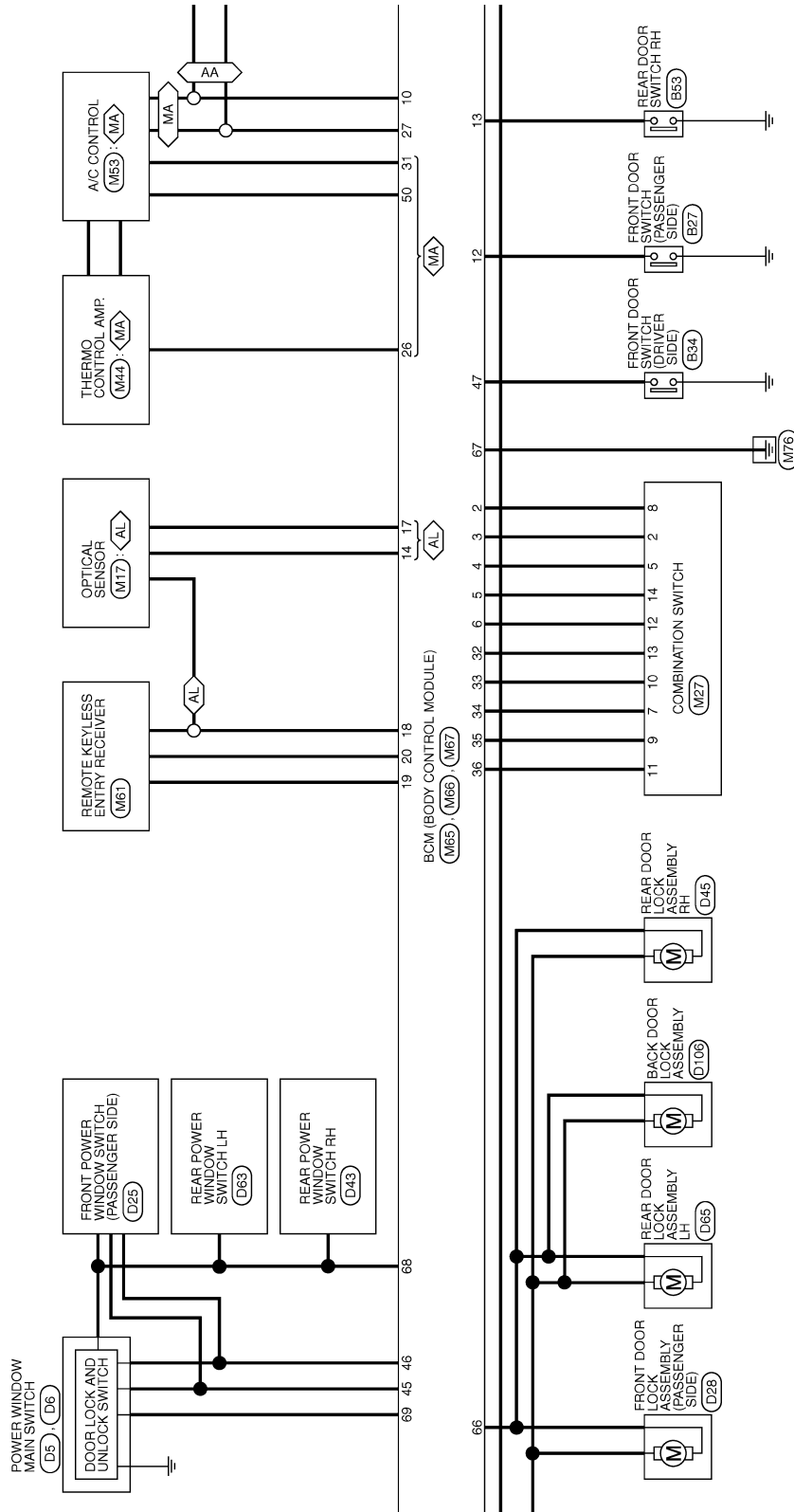

JCMWN0378GB

A
B
C
D
E
F
G
H
I
J
L
M
N
O
P

PWC

BCM (BODY CONTROL MODULE)

< ECU DIAGNOSIS INFORMATION >

- : For Canada
- : With auto A/C
- : With manual A/C
- : With luggage room lamp

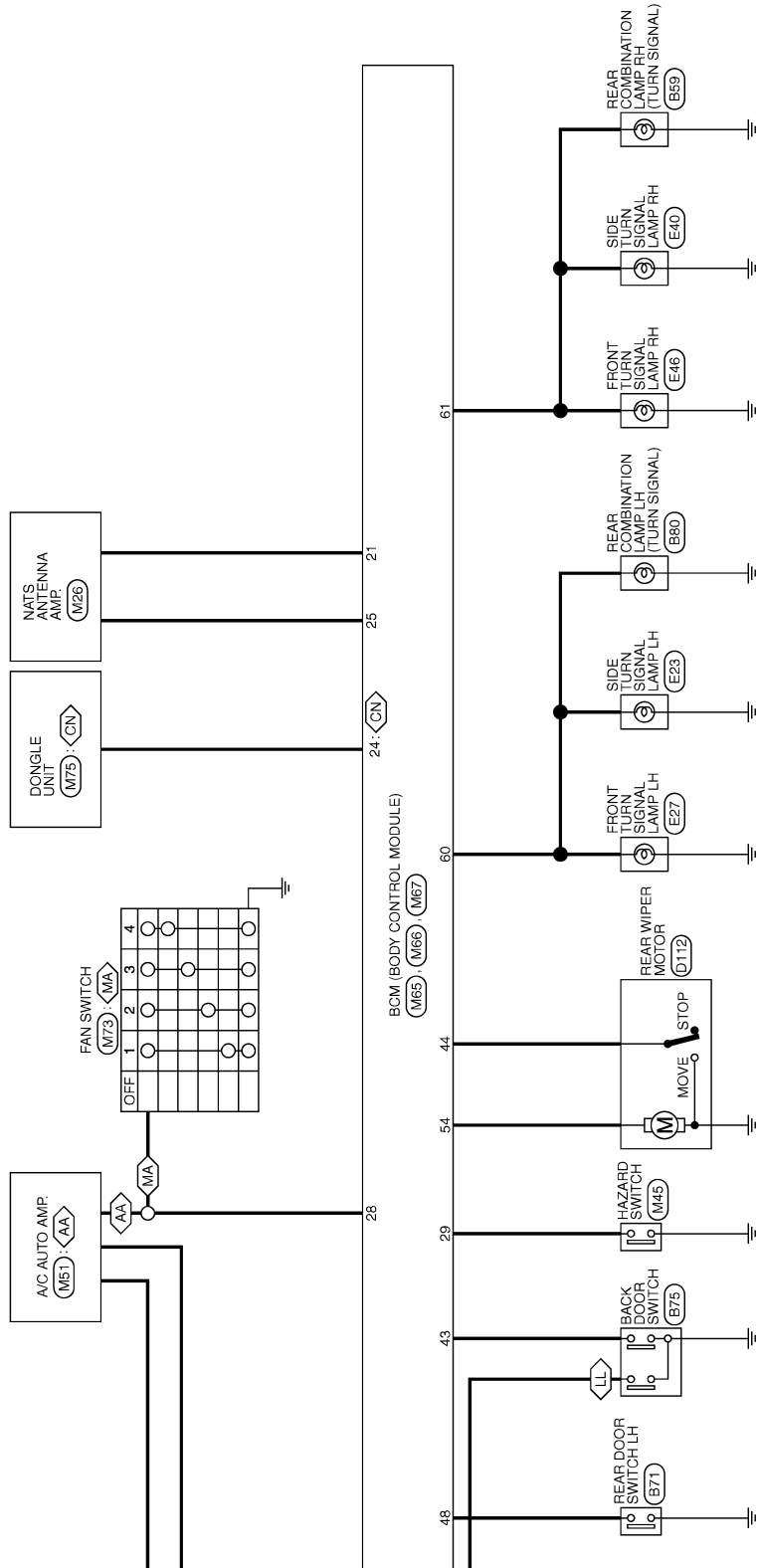

JCMWN0379GB

BCM (BODY CONTROL MODULE)

< ECU DIAGNOSIS INFORMATION >

BCM (BODY CONTROL MODULE) (WITHOUT INTELLIGENT KEY)		
Connector No.	M27	
Connector Name	COMBINATION SWITCH	
Connector Type	TH16PV-NH	
Terminal No.	1	Signal Name [Specification]
2	WASHER (RR)	WASHER (RR)
3	OUTPUT 4	WASHER (FR)
4	WASHER (FR)	IGN
5	L/W	OUTPUT 3
6	L/Y	OUTPUT 3
7	B	GND
8	BR/W	INPUT 3
9	R/L	OUTPUT 5
10	Y/L	INPUT 2
11	L/O	INPUT 4
12	L/R	INPUT 1
13	LG	OUTPUT 1
14	G	OUTPUT 2

BCM (BODY CONTROL MODULE) (WITHOUT INTELLIGENT KEY)		
Connector No.	M27	
Connector Name	BCM (BODY CONTROL MODULE)	
Connector Type	FEA03FB-FH4C-SA	
Terminal No.	56	Signal Name [Specification]
57	Y	INTERIOR ROOM LAMP POWER SUPPLY
58	L	BAT (FUSE)
59	L/B	DRIVER DOOR UNLOCK OUTPUT
60	W/B	TURN SIGNAL LH OUTPUT
61	W/L	TURN SIGNAL RH OUTPUT
62	BR	ROOM LAMP TIMER CONTROL
63	V	ALL DOOR LOCK OUTPUT
64	G	PASSENGER DOOR-REAR DOOR UNLOCK OUTPUT
65	B	GND
66	L	POWER WINDOW POWER SUPPLY (IGN)
67	L/W	POWER WINDOW POWER SUPPLY (BAT)
68	Y	BAT (F/L)
69	Y	BAT (F/L)
70	Y	BAT (F/L)

BCM (BODY CONTROL MODULE) (WITHOUT INTELLIGENT KEY)		
Connector No.	M67	
Connector Name	BCM (BODY CONTROL MODULE)	
Connector Type	FEA03FB-FH4C-SA	
Terminal No.	10	Signal Name [Specification]
11	W/L	REAR WINDOW DEFOGGER SW
12	L/Y	ACC
13	SB	PASSENGER DOOR SW
14	GR/L	REAR RH DOOR SW
15	L/B	OPTICAL SENSOR
16	R/G	OPTICAL SENSOR POWER SUPPLY
17	R/G	RECEIVER / SENSOR GND
18	V	KEYLESS ENTRY RECEIVER POWER SUPPLY
19	BR	KEYLESS ENTRY RECEIVER COMM
20	G/Y	KEYLESS ENTRY RECEIVER COMM
21	P/L	NATS ANTENNA AMP
22	R/Y	SECURITY INDICATOR LAMP
23	GR/R	DONGLE LINK
24	LG	NATS ANTENNA AMP
25	GR	THERMO CONTROL AMP
26	GR	A/C SW (With auto A/C)
27	Y/G	A/C SW (With manual A/C)
28	G/W	BLOWER FAN SW
29	L/W	HAZARD SW
30	G/Y	FR DEFROSTER SW
31	LG	COMBI SW OUTPUT 5
32	Y/L	COMBI SW OUTPUT 4
33	W	COMBI SW OUTPUT 3
34	R/L	COMBI SW OUTPUT 2
35	L/O	COMBI SW OUTPUT 1
36	R/W	KEY SWITCH
37	O	IGN
38	L	CAN-H
39	L	CAN-L
40	P	CAN-L

BCM (BODY CONTROL MODULE) (WITHOUT INTELLIGENT KEY)		
Connector No.	M65	
Connector Name	BCM (BODY CONTROL MODULE)	
Connector Type	TH40PV-NH	
Terminal No.	2	Signal Name [Specification]
3	GR	COMBI SW INPUT 5
4	L/Y	COMBI SW INPUT 4
5	G	COMBI SW INPUT 3
6	L/R	COMBI SW INPUT 2
7	W/B	COMBI SW INPUT 1
8	W/B	KEY CYL UNLOCK SW
9	R	STOP LAMP SW

BCM (BODY CONTROL MODULE)		
Connector No.	M66	
Connector Name	BCM (BODY CONTROL MODULE)	
Connector Type	FEA08FW-FH4G-SA	
Terminal No.	41	Signal Name [Specification]
42	W	BACK DOOR SW
43	LG	REAR WIPER STOP POSITION
44	GR	CENTRAL DOOR LOCK SW
45	GR	CENTRAL DOOR UNLOCK SW
46	BR/Y	DRIVER DOOR SW
47	W/G	REAR LH DOOR SW
48	SB	A/C INDICATOR OUTPUT
49	L/W	REAR WIPER OUTPUT

WITHOUT INTELLIGENT KEY : Fail-safe

FAIL-SAFE CONTROL BY DTC
BCM performs fail-safe control when any DTC are detected.

JCMWN0380GB

INFOID:000000006949444

A
B
C
D
E
F
G
H
I
J
PWC
L
M
N
O
P

BCM (BODY CONTROL MODULE)

< ECU DIAGNOSIS INFORMATION >

Display contents of CONSULT	Fail-safe	Cancellation
B2190: NATS ANTENNA AMP	Inhibit engine cranking	Erase DTC
B2191: DIFFERENCE OF KEY	Inhibit engine cranking	Erase DTC
B2192: ID DISCORD BCM-ECM	Inhibit engine cranking	Erase DTC
B2193: CHAIN OF BCM-ECM	Inhibit engine cranking	Erase DTC
B2195: ANTI SCANNING	Inhibit engine cranking	Ignition switch ON → OFF
B2196: DONGLE NG	Inhibit engine cranking	Erase DTC

REAR WIPER MOTOR PROTECTION

BCM detects the rear wiper stopping position according to the rear wiper auto stop signal.

When the rear wiper auto stop signal does not change more than 5 seconds while driving the rear wiper, BCM stops power supply to protect the rear wiper motor.

Condition of cancellation

1. Pass more than 1 minute after the rear wiper stop.
2. Turn rear wiper switch OFF.
3. Operate the rear wiper switch or rear washer switch.

WITHOUT INTELLIGENT KEY : DTC Inspection Priority Chart

INFOID:000000006949445

If some DTCs are displayed at the same time, perform inspections one by one based on the following priority chart.

Priority	DTC
1	<ul style="list-style-type: none"> • U1000: CAN COMM • U1010: CONTROL UNIT (CAN)
2	<ul style="list-style-type: none"> • B2190: NATS ANTENNA AMP • B2191: DIFFERENCE OF KEY • B2192: ID DISCORD BCM-ECM • B2193: CHAIN OF BCM-ECM • B2195: ANTI SCANNING • B2196: DONGLE NG
3	C1735: IGN CIRCUIT OPEN
4	<ul style="list-style-type: none"> • C1704: LOW PRESSURE FL • C1705: LOW PRESSURE FR • C1706: LOW PRESSURE RR • C1707: LOW PRESSURE RL • C1708: [NO DATA] FL • C1709: [NO DATA] FR • C1710: [NO DATA] RR • C1711: [NO DATA] RL • C1716: [PRESSDATA ERR] FL • C1717: [PRESSDATA ERR] FR • C1718: [PRESSDATA ERR] RR • C1719: [PRESSDATA ERR] RL • C1729: VHCL SPEED SIG ERR

WITHOUT INTELLIGENT KEY : DTC Index

INFOID:000000006949446

NOTE:

Details of time display

- CRNT: Displays when there is a malfunction now or after returning to the normal condition until turning ignition switch OFF → ON again.
- 1 - 39: Displayed if any previous malfunction is present when current condition is normal. It increases like 1 → 2 → 3...38 → 39 after returning to the normal condition whenever ignition switch OFF → ON. The counter remains at 39 even if the number of cycles exceeds it. It is counted from 1 again when turning ignition switch OFF → ON after returning to the normal condition if the malfunction is detected again.

BCM (BODY CONTROL MODULE)

< ECU DIAGNOSIS INFORMATION >

CONSULT display	Fail-safe	Tire pressure monitor warn- ing lamp ON	Reference
U1000: CAN COMM	—	—	BCS-111
U1010: CONTROL UNIT (CAN)	—	—	BCS-112
B2190: NATS ANTENNA AMP	×	—	SEC-192
B2191: DIFFERENCE OF KEY	×	—	SEC-195
B2192: ID DISCORD BCM-ECM	×	—	SEC-196
B2193: CHAIN OF BCM-ECM	×	—	SEC-198
B2195: ANTI SCANNING	×	—	SEC-199
B2196: DONGLE NG	×	—	SEC-200
C1704: LOW PRESSURE FL	—	×	WT-25
C1705: LOW PRESSURE FR	—	×	
C1706: LOW PRESSURE RR	—	×	
C1707: LOW PRESSURE RL	—	×	WT-27
C1708: [NO DATA] FL	—	×	
C1709: [NO DATA] FR	—	×	
C1710: [NO DATA] RR	—	×	
C1711: [NO DATA] RL	—	×	WT-30
C1716: [PRESS DATA ERR] FL	—	×	
C1717: [PRESS DATA ERR] FR	—	×	
C1718: [PRESS DATA ERR] RR	—	×	
C1719: [PRESS DATA ERR] RL	—	×	WT-32
C1729: VHCL SPEED SIG ERR	—	×	
C1735: IGN CIRCUIT OPEN	—	—	BCS-113

A
B
C
D
E
F
G
H
I
J
L
M
N
O
P

PWC

POWER WINDOW MAIN SWITCH

< ECU DIAGNOSIS INFORMATION >

POWER WINDOW MAIN SWITCH

Reference Value

INFOID:000000006505012

TERMINAL LAYOUT

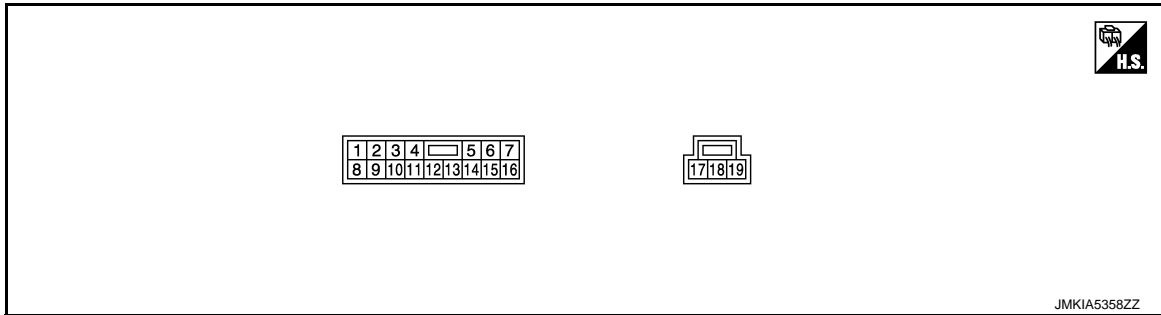

PHYSICAL VALUES

Terminal No. (Wire color)		Description		Condition	Voltage [V] (Approx.)
+	-	Signal name	Input/ Output		
1 (R)	Ground	Rear power window motor LH UP signal	Output	When rear LH switch in power window main switch is in UP operation.	Battery voltage
2 (LG)	Ground	Encoder ground	—	—	0
3 (O)	Ground	Rear power window motor LH DOWN signal	Output	When rear LH switch in power window main switch is in DOWN operation.	Battery voltage
5 (Y)	Ground	Rear power window motor RH DOWN signal	Output	When rear RH switch in power window main switch is in DOWN operation.	Battery voltage
7 (LG)	Ground	Rear power window motor RH UP signal	Output	When rear RH switch in power window main switch is in UP operation.	Battery voltage
8 (BR)	Ground	Front power window motor (driver side) UP signal	Output	When front LH switch in power window main switch is in UP operation.	Battery voltage
9 (V)	Ground	Encoder pulse signal 2	Input	When front power window motor (driver side) operates.	
10 (L)	Ground	Ignition switch power supply	Input	Ignition switch ON	Battery voltage
				Other than above	0
11 (GR)	Ground	Front power window motor (driver side) DOWN signal	Output	When front LH switch in power window main switch is in DOWN operation.	Battery voltage
12 (SB)	Ground	Front power window motor (passenger side) DOWN signal	Output	When front RH switch in power window main switch is in DOWN operation.	Battery voltage

JMKIA0070GB

POWER WINDOW MAIN SWITCH

< ECU DIAGNOSIS INFORMATION >

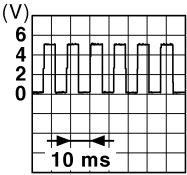
Terminal No. (Wire color)		Description		Condition	Voltage [V] (Approx.)
+	-	Signal name	Input/ Output		
13 (W)	Ground	Encoder pulse signal 1	Input	When front power window motor (driver side) operates.	 <p style="text-align: right; font-size: small;">JMKIA0070GB</p>
15 (G)	Ground	Encoder power supply	Output	Ignition switch ON.	Battery voltage
16 (W)	Ground	Front power window motor (passenger side) UP signal	Output	When front RH switch in power window main switch is in UP operation.	Battery voltage
17 (B)	Ground	Ground	—	—	0
19 (P)	Ground	Battery power supply	Input	Ignition switch OFF	Battery voltage

A
B
C
D
E
F
G
H
I
J
L
M
N
O
P

PWC

POWER WINDOW MAIN SWITCH

< ECU DIAGNOSIS INFORMATION >

Wiring Diagram - POWER WINDOW CONTROL SYSTEM -

INFOID:000000006505013

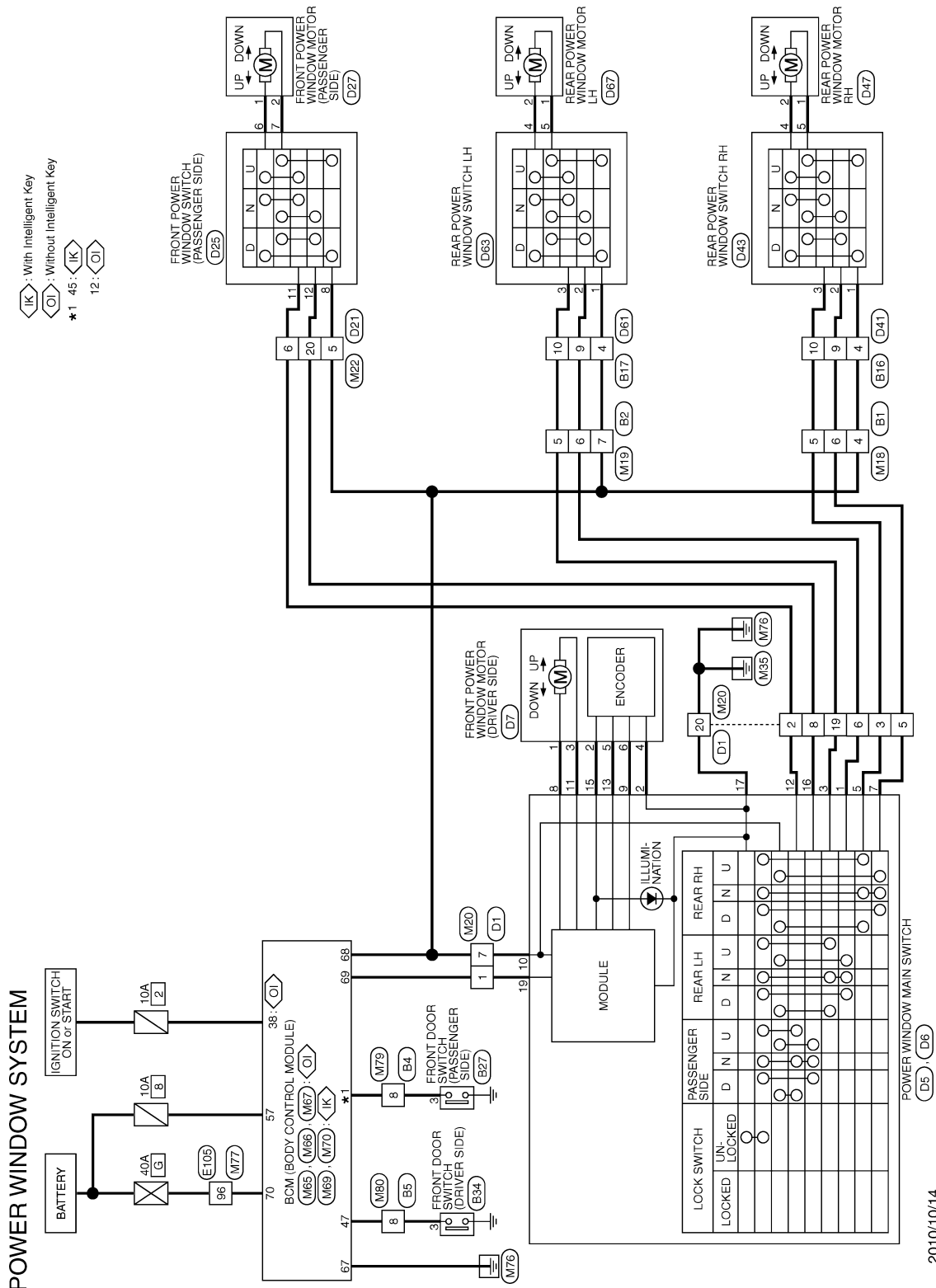

POWER WINDOW MAIN SWITCH

< ECU DIAGNOSIS INFORMATION >

POWER WINDOW SYSTEM

Connector No.	B1
Connector Name	WIRE TO WIRE
Connector Type	NS16MW-CS

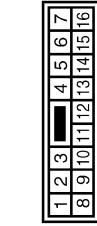

Terminal No.	Color of Wire	Signal Name [Specification]
1	G	
3	V	
4	L	
5	Y	
6	W	
7	LG	
8	GR	
9	SB	
10	W	
11	G	
12	V	
13	BR	
15	R	
16	GR	

Connector No.	B2
Connector Name	WIRE TO WIRE
Connector Type	NS16MW-CS

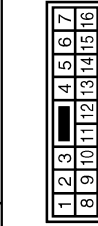

Terminal No.	Color of Wire	Signal Name [Specification]
1	V	
2	W	
3	O	
5	O	
6	R	
7	L	
8	L	
9	G	

10	V	
11	P	
12	LG	
14	R	
15	Y	
16	B	

Connector No.	B4
Connector Name	WIRE TO WIRE
Connector Type	TH24MW-NH

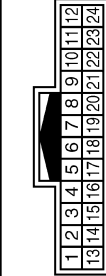

Terminal No.	Color of Wire	Signal Name [Specification]
1	W	
2	V	
3	O	
4	P	
5	W	
8	SB	
9	GR	
10	SB	
11	G	
12	SB	
13	L	
15	R	
16	GR	
17	BR	
18	L	
20	LG	
22	Y	
23	BR	
24	O	

Connector No.	B5
Connector Name	WIRE TO WIRE
Connector Type	TH16MW-NH

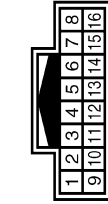

Terminal No.	Color of Wire	Signal Name [Specification]
1	V	
2	GR	
5	V	
6	W	
8	LG	
9	R	
11	O	
13	GR	
14	P	
16	W	

Connector No.	B16
Connector Name	WIRE TO WIRE
Connector Type	NS10FW-CS

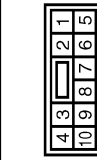

Terminal No.	Color of Wire	Signal Name [Specification]
1	V	
4	L	
5	G	
7	GR	
8	LG	
9	W	
10	Y	

Connector No.	B17
Connector Name	WIRE TO WIRE
Connector Type	NS10FW-CS

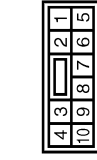

Terminal No.	Color of Wire	Signal Name [Specification]
1	V	
4	L	
5	G	
7	L	
8	V	
9	R	
10	O	

Connector No.	B27
Connector Name	FRONT DOOR SWITCH (PASSENGER SIDE)
Connector Type	TH104FW-NH

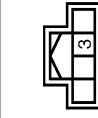

Terminal No.	Color of Wire	Signal Name [Specification]
3	SB	

JCKWM5377GB

A
B
C
D
E
F
G
H
I
J
L
M
N
O
P

PWC

POWER WINDOW MAIN SWITCH

< ECU DIAGNOSIS INFORMATION >

POWER WINDOW SYSTEM

Connector No.	B34
Connector Name	FRONT DOOR SWITCH (DRIVER SIDE)
Connector Type	TH4DFV-NH



Terminal No.	Color of Wire	Signal Name [Specification]
3	LG	-

Connector No.	D1
Connector Name	WIRE TO WIRE
Connector Type	NH1DFV-CS10

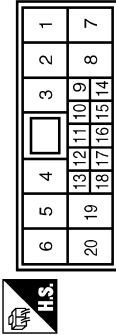

Terminal No.	Color of Wire	Signal Name [Specification]
1	P	-
2	SB	-
3	Y	-
5	LG	-
6	R	-
7	L	-
8	W	-
9	BR	-
10	P	-
12	GR	-
13	W	-
14	G	-
15	V	-
17	R	-
18	L	-
19	O	-
20	B	-

Connector No.	D5
Connector Name	POWER WINDOW MAIN SWITCH
Connector Type	NS12FW-CS

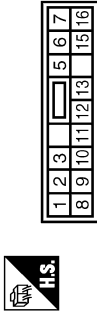

Terminal No.	Color of Wire	Signal Name [Specification]
1	R	-
2	LG	-
3	O	-
5	Y	-
6	R	-
7	LG	-
8	BR	-
9	V	-
10	L	-
11	GR	-
12	SB	-
13	W	-
15	G	-
16	W	-

Connector No.	D6
Connector Name	POWER WINDOW MAIN SWITCH
Connector Type	NS32FW-CS



Terminal No.	Color of Wire	Signal Name [Specification]
17	B	-
18	GR	-
19	P	-

Connector No.	D7
Connector Name	FRONT POWER WINDOW MOTOR (DRIVER SIDE)
Connector Type	RS38FG



Terminal No.	Color of Wire	Signal Name [Specification]
1	BR	-
2	G	-
3	GR	-
4	LG	-
5	W	-
6	V	-

Connector No.	D21
Connector Name	WIRE TO WIRE
Connector Type	NH1DFV-CS10

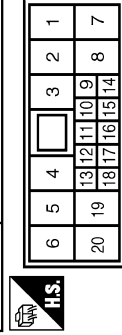

Terminal No.	Color of Wire	Signal Name [Specification]
1	G	-
2	Y	-
4	B	-
5	L	-
6	SB	-
7	R	-
8	V	-
9	R	-
10	W	-
11	L	-
12	LG	-
13	P	-
14	B	-
15	G	-
16	GR	-
17	BR	-

18	V	-
20	W	-

Connector No.	D25
Connector Name	FRONT POWER WINDOW SWITCH (PASSENGER SIDE)
Connector Type	NS12FW-CS



Terminal No.	Color of Wire	Signal Name [Specification]
1	GR	-
2	BR	-
3	B	-
6	Y	-
7	R	-
8	L	-
11	SB	-
12	W	-

Connector No.	D27
Connector Name	FRONT POWER WINDOW MOTOR (PASSENGER SIDE)
Connector Type	RS38FG



Terminal No.	Color of Wire	Signal Name [Specification]
1	Y	-
2	R	-

JCKWM5378GB

POWER WINDOW MAIN SWITCH

< ECU DIAGNOSIS INFORMATION >

POWER WINDOW SYSTEM

Connector No.	D41
Connector Name	WIRE TO WIRE
Connector Type	NS10MW-CS



Terminal No.	Color of Wire	Signal Name [Specification]
1	W	-
4	L	-
5	P	-
7	GR	-
8	LG	-
9	BR	-
10	O	-

Connector No.	D43
Connector Name	REAR POWER WINDOW SWITCH RH
Connector Type	NS08FW-CS

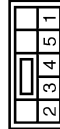

Terminal No.	Color of Wire	Signal Name [Specification]
1	L	-
2	BR	-
3	O	-
4	G	-
5	R	-

Connector No.	D47
Connector Name	REAR POWER WINDOW MOTOR RH
Connector Type	RS08FG



Terminal No.	Color of Wire	Signal Name [Specification]
1	R	-
2	G	-

Connector No.	D61
Connector Name	WIRE TO WIRE
Connector Type	NS10MW-CS

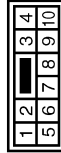

Terminal No.	Color of Wire	Signal Name [Specification]
1	V	-
4	L	-
5	G	-
7	GR	-
8	LG	-
9	BR	-
10	O	-

Connector No.	D63
Connector Name	REAR POWER WINDOW SWITCH LH
Connector Type	NS08FW-CS

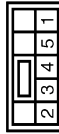

Terminal No.	Color of Wire	Signal Name [Specification]
1	L	-
2	BR	-
3	O	-
4	G	-
5	R	-

Connector No.	D67
Connector Name	REAR POWER WINDOW MOTOR LH
Connector Type	RS08FG



Terminal No.	Color of Wire	Signal Name [Specification]
1	R	-
2	G	-

JCKWM5379GB

A
B
C
D
E
F
G
H
I
J
PWC
L
M
N
O
P

POWER WINDOW MAIN SWITCH

< ECU DIAGNOSIS INFORMATION >

POWER WINDOW SYSTEM

Connector No.	E105
Connector Name	WIRE TO WIRE
Connector Type	THB0MW-CS16-TM4



Terminal No.	Color of Wire	Signal Name [Specification]
1	V	-
2	W	-
3	SB	-
4	G	-
5	P	-
6	L	- [With NAVI]
7	R	- [Without NAVI]
8	Y	-
9	O	-
10	W	-
11	SB	-
12	V	-
13	R	-
14	GR	-
15	P	-
16	Y	-
17	BR	-
18	SB	-
19	R	-
20	V	-
21	P	-
22	L	-
23	GR	-
24	W	-
25	G	-
26	Y	-
27	BR	-
28	SB	-
29	R	-
30	V	-
31	P	-
32	L	-
33	GR	-
34	W	-
35	G	-
36	Y	-
37	BR	-
38	SB	-
39	R	-
40	V	-
41	P	-
42	L	-
43	GR	-
44	W	-
45	G	-
46	Y	-
47	BR	-
48	SB	-
49	R	-
50	V	-
51	P	-
52	L	-
53	GR	-
54	W	-
55	G	-
56	Y	-
57	BR	-
58	SB	-
59	R	-
60	V	-
61	P	-
62	L	-
63	GR	-
64	W	-
65	G	-
66	Y	-
67	BR	-
68	SB	-
69	R	-
70	V	-
71	P	-

72	LG	-
73	P	-
74	V	-
75	Y	-
76	LG	-
77	O	-
78	G	-
79	P	-
80	L	-
81	L	-
82	W	-
83	BR	-
84	B	-
87	GR	-
91	W	-
92	Y	-
93	Y	-
94	R	-
95	V	-
96	LG	-
97	R	-
98	SB	-
99	G	-
100	P	-

Connector No.	M18
Connector Name	WIRE TO WIRE
Connector Type	NS16FY-CS



Terminal No.	Color of Wire	Signal Name [Specification]
1	G/R	-
3	L/W	-
4	L	-
5	Y	-
6	L/B	-
7	LG	-
8	GR	-
9	SB	-
10	W/L	-
11	G	-
12	V	-
13	L	-
15	L	-

16	GR	-
----	----	---



Connector No.	M19
Connector Name	WIRE TO WIRE
Connector Type	NS16FY-CS



Terminal No.	Color of Wire	Signal Name [Specification]
1	V	-
2	W	-
3	O	-
4	L/R	-
5	R	-
6	L	-
7	R/B	-
8	L	-
9	G	-
10	V	-
11	L/W	-
12	LG	-
14	R	-
15	Y/R	-
16	B/R	-

Connector No.	M20
Connector Name	WIRE TO WIRE
Connector Type	NH10MW-CS10

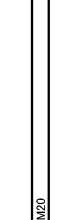

Terminal No.	Color of Wire	Signal Name [Specification]
1	L/W	-
2	W/R	-
3	Y	-
5	L/B	-
6	R	-

7	L	-
8	Y/R	-
9	SB	-
10	LG	-
12	GR	-
13	W/B	-
14	G/B	-
15	V	-
17	BR	-
18	W/R	-
19	L/R	-
20	B	-

Connector No.	M22
Connector Name	WIRE TO WIRE
Connector Type	NH10MW-CS10



Terminal No.	Color of Wire	Signal Name [Specification]
1	G	-
2	G	-
4	B	-
5	L	-
6	W/R	-
7	R	-
8	V	-
9	G/R	-
10	LG	-
11	R	-
12	G	-
13	BR/Y	-
14	B	-
15	G/B	-
16	GR	-
17	BR	-
18	L/Y	-
20	Y/R	-

JCKWM5380GB

POWER WINDOW MAIN SWITCH

< ECU DIAGNOSIS INFORMATION >

POWER WINDOW SYSTEM

Connector No.	M65
Connector Name	BCM (BODY CONTROL MODULE)
Connector Type	TH40PV-NH



1	2	3	4	5	6	7	8	9	10	11	12	13	14	15	16	17	18	19	20
---	---	---	---	---	---	---	---	---	----	----	----	----	----	----	----	----	----	----	----

Terminal No.	Color of Wire	Signal Name [Specification]
2	BR/W	COMBI SW INPUT 5
3	GR	COMBI SW INPUT 4
4	L/Y	COMBI SW INPUT 3
5	G	COMBI SW INPUT 2
6	L/R	COMBI SW INPUT 1
7	W/R	KEY CYL UNLOCK SW
8	W/B	KEY CYL LOCK SW
9	R	STOP LAMP SW
10	W/L	REAR WINDOW DEFOGGER SW
11	L/Y	ACC
12	SB	PASSENGER DOOR SW
13	GR/L	REAR RH DOOR SW
14	L/B	OPTICAL SENSOR
17	R/G	OPTICAL SENSOR POWER SUPPLY
18	V	RECEIVER / SENSOR GND
19	BR	KEYLESS ENTRY RECEIVER POWER SUPPLY
20	G/Y	KEYLESS ENTRY RECEIVER COMM
21	P/L	NATS ANTENNA AMP
23	R/Y	SECURITY INDICATOR LAMP
24	GR/R	DONGLE LINK
25	LG	NATS ANTENNA AMP
26	GR	THERMO CONTROL AMP
27	Y/G	A/C SW [With auto A/C]
27	Y/R	A/C SW [With manual A/C]
28	G/W	BLOWER FAN SW
29	L/W	HAZARD SW
31	G/Y	FR DEFROSTER SW
32	LG	COMBI SW OUTPUT 5
33	Y/L	COMBI SW OUTPUT 4
34	W	COMBI SW OUTPUT 3
35	R/L	COMBI SW OUTPUT 2
36	L/O	COMBI SW OUTPUT 1
37	R/W	KEY SWITCH
38	O	IGN
39	L	CAN-H
40	P	CAN-L

Connector No.	M66
Connector Name	BCM (BODY CONTROL MODULE)
Connector Type	FEA09FW-FHA6-SA



41	42	43	44	45	46	47	48	49
----	----	----	----	----	----	----	----	----

Terminal No.	Color of Wire	Signal Name [Specification]
43	W	BACK DOOR SW
44	LG	REAR WIPER STOP POSITION
45	GR	CENTRAL DOOR LOCK SW
46	BR	CENTRAL DOOR UNLOCK SW
47	RP/Y	DRIVER DOOR SW
48	W/G	REAR LH DOOR SW
50	SB	A/C INDICATOR OUTPUT
54	L/W	REAR WIPER OUTPUT

Connector No.	M67
Connector Name	BCM (BODY CONTROL MODULE)
Connector Type	FEA09FB-FHA6-SA



56	57	58	59	60	61	62	63	64
----	----	----	----	----	----	----	----	----

Terminal No.	Color of Wire	Signal Name [Specification]
56	L	INTERIOR ROOM LAMP POWER SUPPLY
57	Y	BAT (FUSE)
58	L/B	DRIVER DOOR UNLOCK OUTPUT
60	W/B	TURN SIGNAL LH OUTPUT
61	W/L	TURN SIGNAL RH OUTPUT
63	BR	ROOM LAMP TIMER CONTROL
65	V	ALL DOOR LOCK OUTPUT
66	G	PASSENGER DOOR REAR DOOR UNLOCK OUTPUT
67	B	GND
68	L/W	POWER WINDOW POWER SUPPLY (IGN)
69	L/W	POWER WINDOW POWER SUPPLY (BAT)
70	Y	BAT (F/L)

Connector No.	M69
Connector Name	BCM (BODY CONTROL MODULE)
Connector Type	FEA09FB-FHA6-SA



41	42	43	44	45	46	47	48	49
----	----	----	----	----	----	----	----	----

Terminal No.	Color of Wire	Signal Name [Specification]
43	W	BACK DOOR SW
44	LG	REAR WIPER STOP POSITION
45	SB	PASSENGER DOOR SW
46	GR/L	REAR RH DOOR SW
47	BR/Y	DRIVER DOOR SW
48	W/G	REAR LH DOOR SW
50	R/W	BK DR LOCK ACT RELAY CONT
51	W	BACK DOOR REQUEST SW
54	L/W	REAR WIPER OUTPUT
55	G	REAR DOOR UNLOCK OUTPUT

Connector No.	M70
Connector Name	BCM (BODY CONTROL MODULE)
Connector Type	FEA09FW-FHA6-SA



56	57	58	59	60	61	62	63	64
----	----	----	----	----	----	----	----	----

Terminal No.	Color of Wire	Signal Name [Specification]
56	L	INTERIOR ROOM LAMP POWER SUPPLY
57	Y	BAT (FUSE)
59	G	PASSENGER DOOR UNLOCK OUTPUT
60	W/B	TURN SIGNAL LH OUTPUT
61	W/L	TURN SIGNAL RH OUTPUT
63	BR	ROOM LAMP TIMER CONTROL
65	V	ALL DOOR LOCK OUTPUT
66	L/B	DRIVER DOOR UNLOCK OUTPUT
67	B	GND
68	L	POWER WINDOW POWER SUPPLY (IGN)
69	L/W	POWER WINDOW POWER SUPPLY (BAT)
70	Y	BAT (F/L)

A
B
C
D
E
F
G
H
I
J
L
M
N
O
P

POWER WINDOW MAIN SWITCH

< ECU DIAGNOSIS INFORMATION >

POWER WINDOW SYSTEM

Connector No.	M77
Connector Name	WIRE TO WIRE
Connector Type	TH80FW-CS16-TM4

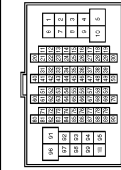

Terminal No.	Color of Wire	Signal Name [Specification]
1	B/O	-
2	R	-
3	G/R	-
4	G/B	-
5	L	-
6	L	-
7	W/R	-
8	G/W	-
9	Y/L	-
10	W	-
31	GR/L	-
32	L/B	-
33	R/Y	-
34	SB	-
35	BR	-
36	G	-
39	L/R	-
44	G/O	-
45	LG/R	-
46	GR/W	-
48	L/O	-
51	B/W	-
52	R/L	-
54	O	-
57	GR	-
59	V	-
60	R/W	-
61	V/W	-
62	W/L	-
63	W/B	-
67	Y/R	-
69	LG	-
70	SHIELD	-
71	P/B	-
72	R/G	-
73	R	-
74	L/Y	-
76	W/G	-

77	GR/R	-
78	O	-
79	LS	-
80	P	-
81	L	-
82	GR	-
83	G/R	-
84	B	-
87	G	-
91	R	-
92	O	-
93	Y	-
94	R/B	-
95	L/W	-
96	Y	-
97	L	-
98	BR/W	-
99	W	-
100	G/R	-

Connector No.	M79
Connector Name	WIRE TO WIRE
Connector Type	TH22FW-NH

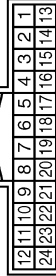

Terminal No.	Color of Wire	Signal Name [Specification]
1	W/G	-
2	L/Y	-
3	R	-
4	P/B	-
5	W	-
8	SB	-
9	L/G	-
10	GR/B	-
11	G/B	-
12	G/R	-
13	R/G	-
15	R/L	-
16	GR/R	-
17	BR/Y	-
18	V	-
20	GR/L	-
22	L	-

23	Y/L	-
24	G/W	-

Connector No.	M80
Connector Name	WIRE TO WIRE
Connector Type	TH16FW-NH

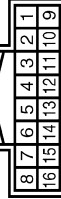

Terminal No.	Color of Wire	Signal Name [Specification]
1	L/B	-
2	GR/L	-
5	W	-
6	W/L	-
8	BR/Y	-
9	R/Y	-
11	O	-
13	BR/W	-
14	W/B	-
16	W/G	-

JCKWM5382GB

INFOID:000000006505014

Fail Safe

FAIL-SAFE CONTROL

Switches to fail-safe control when malfunction is detected in encoder signal that detects up/down speed and direction of door glass. Switches to fail-safe control when error beyond regulation value is detected between the fully closed position and the actual position of the glass.

POWER WINDOW MAIN SWITCH

< ECU DIAGNOSIS INFORMATION >

Error	Error condition
Pulse sensor malfunction	When only one side of pulse signal is being detected for more than the specified value.
Both pulse sensors malfunction	When both pulse signals have not been detected for more than the specified value during glass open/close operation.
Pulse direction malfunction	When the pulse signal that is detected during glass open/close operation detects the opposite condition of power window motor operating direction.
Glass recognition position malfunction 1	When it detects the error between glass fully closed position in power window switch memory and actual fully closed position during glass open/close operation is more than the specified value.
Glass recognition position malfunction 2	When it detects pulse count more than the value of glass full stroke during glass open/close operation.
Malfunction of not yet updated closed position of glass	When glass open/close operation is continuously performed without fully closing more than the specified value (approximately 10 strokes).

It changes to condition before initialization and the following functions do not operate when switched to fail-safe control.

- Auto-up operation
- Anti-pinch function

Perform initial operation to recover when switched to fail-safe mode. However, it switches back to fail-safe control when malfunction is found in power window main switch or front power window motor (driver side).

A
B
C
D
E
F
G
H
I
J
L
M
N
O
P

PWC

NONE OF THE POWER WINDOWS CAN BE OPERATED USING ANY SWITCH

< SYMPTOM DIAGNOSIS >

SYMPTOM DIAGNOSIS

NONE OF THE POWER WINDOWS CAN BE OPERATED USING ANY SWITCH

Diagnosis Procedure

INFOID:000000006505015

1. CHECK BCM POWER SUPPLY AND GROUND CIRCUIT

Check BCM power supply and ground circuit. Refer to the following.

- With Intelligent Key: Refer to [BCS-42, "Diagnosis Procedure"](#).
- Without Intelligent Key: Refer to [BCS-114, "Diagnosis Procedure"](#).

Is the inspection result normal?

YES >> GO TO 2.

NO >> Repair or replace the malfunctioning parts.

2. CONFIRM THE OPERATION

Confirm the operation again.

Is the result normal?

YES >> Check intermittent incident. Refer to [GI-41, "Intermittent Incident"](#).

NO >> GO TO 1.

DRIVER SIDE POWER WINDOW DOES NOT OPERATE

< SYMPTOM DIAGNOSIS >

DRIVER SIDE POWER WINDOW DOES NOT OPERATE

Diagnosis Procedure

INFOID:000000006505016

1.CHECK POWER WINDOW MAIN SWITCH POWER SUPPLY AND GROUND CIRCUIT

Check power window main switch power supply and ground circuit
Refer to [PWC-16, "POWER WINDOW MAIN SWITCH : Diagnosis Procedure"](#).

Is the inspection result normal?

- YES >> GO TO 2.
- NO >> Repair or replace the malfunctioning parts.

2.CHECK FRONT POWER WINDOW MOTOR (DRIVER SIDE)

Check power window motor.
Refer to [PWC-23, "DRIVER SIDE : Component Function Check"](#).

Is the inspection result normal?

- YES >> GO TO 3.
- NO >> Repair or replace the malfunctioning parts.

3.CONFIRM THE OPERATION

Confirm the operation again.

Is the result normal?

- YES >> Check intermittent incident. Refer to [GI-41, "Intermittent Incident"](#).
- NO >> GO TO 1.

A
B
C
D
E
F
G
H
I
J
L
M
N
O
P

PWC

FRONT PASSENGER SIDE POWER WINDOW DOES NOT OPERATE

< SYMPTOM DIAGNOSIS >

FRONT PASSENGER SIDE POWER WINDOW DOES NOT OPERATE WITH BOTH POWER WINDOW MAIN SWITCH AND FRONT PASSENGER SIDE POWER WINDOW SWITCH

WITH BOTH POWER WINDOW MAIN SWITCH AND FRONT PASSENGER SIDE
POWER WINDOW SWITCH : Diagnosis Procedure

INFOID:000000006505017

1. CHECK FRONT POWER WINDOW SWITCH (PASSENGER SIDE)

Check front power window switch (passenger side).

Refer to [PWC-19, "Component Function Check"](#).

Is the inspection result normal?

YES >> GO TO 2.

NO >> Repair or replace the malfunctioning parts

2. CHECK FRONT POWER WINDOW MOTOR (PASSENGER SIDE)

Check front power window motor (passenger side).

Refer to [PWC-24, "PASSENGER SIDE : Component Function Check"](#).

Is the inspection result normal?

YES >> GO TO 3.

NO >> Repair or replace the malfunctioning parts.

3. CONFIRM THE OPERATION

Confirm the operation again.

Is the result normal?

YES >> Check intermittent incident. Refer to [GI-41, "Intermittent Incident"](#).

NO >> GO TO 1.

WITH FRONT POWER WINDOW SWITCH ONLY

WITH FRONT POWER WINDOW SWITCH ONLY : Diagnosis Procedure

INFOID:000000006505018

1. CHECK FRONT POWER WINDOW SWITCH (PASSENGER SIDE) POWER SUPPLY AND GROUND CIRCUIT

Check front power window switch (passenger side) power supply and ground circuit.

Refer to [PWC-17, "FRONT POWER WINDOW SWITCH \(PASSENGER SIDE\) : Diagnosis Procedure"](#).

Is the inspection result normal?

YES >> GO TO 2.

NO >> Repair or replace the malfunctioning parts.

2. CHECK FRONT POWER WINDOW SWITCH (PASSENGER SIDE)

Check front power window switch (passenger side).

Refer to [PWC-19, "Component Function Check"](#).

Is the inspection result normal?

YES >> GO TO 3.

NO >> Repair or replace the malfunctioning parts

3. CONFIRM THE OPERATION

Confirm the operation again.

Is the result normal?

YES >> Check intermittent incident. Refer to [GI-41, "Intermittent Incident"](#).

NO >> GO TO 1.

REAR LH SIDE POWER WINDOW DOES NOT OPERATE

< SYMPTOM DIAGNOSIS >

REAR LH SIDE POWER WINDOW DOES NOT OPERATE
WITH BOTH POWER WINDOW MAIN SWITCH AND REAR POWER WINDOW SWITCH LH

WITH BOTH POWER WINDOW MAIN SWITCH AND REAR POWER WINDOW SWITCH LH : Diagnosis Procedure

INFOID:000000006505019

1.CHECK REAR POWER WINDOW SWITCH

Check rear power window switch.
Refer to [PWC-21, "Component Function Check"](#).

Is the inspection result normal?

- YES >> GO TO 2.
- NO >> Repair or replace the malfunctioning parts.

2.CHECK REAR POWER WINDOW MOTOR LH

Check rear power window motor LH.
Refer to [PWC-25, "REAR LH : Component Function Check"](#).

Is the inspection result normal?

- YES >> GO TO 3.
- NO >> Repair or replace the malfunctioning parts.

3.CONFIRM THE OPERATION

Confirm the operation again.

Is the result normal?

- YES >> Check intermittent incident. Refer to [GI-41, "Intermittent Incident"](#).
- NO >> GO TO 1.

WITH REAR POWER WINDOW SWITCH LH ONLY

WITH REAR POWER WINDOW SWITCH LH ONLY : Diagnosis Procedure

INFOID:000000006505020

1.CHECK REAR POWER WINDOW SWITCH POWER SUPPLY AND GROUND CIRCUIT

Check rear power window switch power supply and ground circuit.
Refer to [PWC-17, "REAR POWER WINDOW SWITCH : Diagnosis Procedure"](#).

Is the inspection result normal?

- YES >> GO TO 2.
- NO >> Repair or replace the malfunctioning parts.

2.CHECK REAR POWER WINDOW SWITCH

Check rear power window switch.
Refer to [PWC-21, "Component Function Check"](#).

Is the inspection result normal?

- YES >> GO TO 3.
- NO >> Repair or replace the malfunctioning parts.

3.CONFIRM THE OPERATION

Confirm the operation again.

Is the result normal?

- YES >> Check intermittent incident. Refer to [GI-41, "Intermittent Incident"](#).
- NO >> GO TO 1.

A
B
C
D
E
F
G
H
I
J
L
M
N
O
P

PWC

REAR RH SIDE POWER WINDOW DOES NOT OPERATE

< SYMPTOM DIAGNOSIS >

REAR RH SIDE POWER WINDOW DOES NOT OPERATE WITH BOTH POWER WINDOW MAIN SWITCH AND REAR POWER WINDOW SWITCH RH

WITH BOTH POWER WINDOW MAIN SWITCH AND REAR POWER WINDOW
SWITCH RH : Diagnosis Procedure

INFOID:000000006505021

1.CHECK REAR POWER WINDOW SWITCH

Check rear power window switch.

Refer to [PWC-21, "Component Function Check"](#).

Is the inspection result normal?

YES >> GO TO 2.

NO >> Repair or replace the malfunctioning parts.

2.CHECK REAR POWER WINDOW MOTOR RH

Check rear power window motor RH.

Refer to [PWC-26, "REAR RH : Component Function Check"](#).

Is the inspection result normal?

YES >> GO TO 3.

NO >> Repair or replace the malfunctioning parts.

3.CONFIRM THE OPERATION

Confirm the operation again.

Is the result normal?

YES >> Check intermittent incident. Refer to [GI-41, "Intermittent Incident"](#).

NO >> GO TO 1.

WITH REAR POWER WINDOW SWITCH RH ONLY

WITH REAR POWER WINDOW SWITCH RH ONLY : Diagnosis Procedure

INFOID:000000006505022

1.CHECK REAR POWER WINDOW SWITCH POWER SUPPLY AND GROUND CIRCUIT

Check rear power window switch power supply and ground circuit.

Refer to [PWC-17, "REAR POWER WINDOW SWITCH : Diagnosis Procedure"](#).

Is the inspection result normal?

YES >> GO TO 2.

NO >> Repair or replace the malfunctioning parts.

2.CHECK REAR POWER WINDOW SWITCH

Check rear power window switch.

Refer to [PWC-21, "Component Function Check"](#).

Is the inspection result normal?

YES >> GO TO 3.

NO >> Repair or replace the malfunctioning parts.

3.CONFIRM THE OPERATION

Confirm the operation again.

Is the result normal?

YES >> Check intermittent incident. Refer to [GI-41, "Intermittent Incident"](#).

NO >> GO TO 1.

ANTI-PINCH SYSTEM DOES NOT OPERATE NORMALLY (DRIVER SIDE)

< SYMPTOM DIAGNOSIS >

ANTI-PINCH SYSTEM DOES NOT OPERATE NORMALLY (DRIVER SIDE)

Diagnosis Procedure

INFOID:000000006505023

1.CHECK POWER WINDOW AUTO OPERATION

Check AUTO operation when anti-pinch function does not operate.

Is the inspection result normal?

YES >> GO TO 2.

NO >> Refer to [PWC-97, "Diagnosis Procedure"](#).

2.CONFIRM THE OPERATION

Confirm the operation again.

Is the result normal?

YES >> Check intermittent incident. Refer to [GI-41, "Intermittent Incident"](#).

NO >> GO TO 1.

A
B
C
D
E
F
G
H
I
J
L
M
N
O
P

PWC

POWER WINDOW RETAINED POWER OPERATION DOES NOT OPERATE PROPERLY

< SYMPTOM DIAGNOSIS >

POWER WINDOW RETAINED POWER OPERATION DOES NOT OPERATE PROPERLY

Diagnosis Procedure

INFOID:000000006505024

1. CHECK FRONT DOOR SWITCH

Check front door switch. Refer to the following.

- With Intelligent Key: Refer to [DLK-55. "Component Function Check"](#).
- Without Intelligent Key: Refer to [DLK-239. "Component Function Check"](#).

Is the inspection result normal?

YES >> GO TO 2.

NO >> Repair or replace the malfunctioning parts.

2. CONFIRM THE OPERATION

Confirm the operation again.

Is the result normal?

YES >> Check intermittent incident. Refer to [GI-41. "Intermittent Incident"](#).

NO >> GO TO 1.

AUTO OPERATION DOES NOT OPERATE BUT MANUAL OPERATE NORMALLY (DRIVER SIDE)

< SYMPTOM DIAGNOSIS >

AUTO OPERATION DOES NOT OPERATE BUT MANUAL OPERATE NORMALLY (DRIVER SIDE)

Diagnosis Procedure

INFOID:000000006505025

1.PERFORM INITIALIZATION PROCEDURE

Initialization procedure is executed and operation is confirmed.

Refer to [PWC-5, "ADDITIONAL SERVICE WHEN REMOVING BATTERY NEGATIVE TERMINAL : Special Repair Requirement"](#).

Is the inspection result normal?

YES >> INSPECTION END
NO >> GO TO 2.

2.CHECK ENCODER

Check encoder.

Refer to [PWC-28, "Component Function Check"](#).

Is the inspection result normal?

YES >> GO TO 3.
NO >> Repair or replace the malfunctioning parts.

3.REPLACE POWER WINDOW MAIN SWITCH

Replace power window main switch.

Refer to [PWC-100, "Removal and Installation"](#).

Is the inspection result normal?

YES >> INSPECTION END
NO >> GO TO 4.

4.CONFIRM THE OPERATION

Confirm the operation again.

Is the result normal?

YES >> Check intermittent incident. Refer to [GI-41, "Intermittent Incident"](#).
NO >> GO TO 1.

A
B
C
D
E
F
G
H
I
J
L
M
N
O
P

PWC

POWER WINDOW LOCK SWITCH DOES NOT FUNCTION

< SYMPTOM DIAGNOSIS >

POWER WINDOW LOCK SWITCH DOES NOT FUNCTION

Diagnosis Procedure

INFOID:000000006505026

1. REPLACE POWER WINDOW MAIN SWITCH

Replace power window main switch.

>> Refer to [PWC-100. "Removal and Installation"](#).

PRECAUTIONS

< PRECAUTION >

PRECAUTION

PRECAUTIONS

Precaution for Supplemental Restraint System (SRS) "AIR BAG" and "SEAT BELT PRE-TENSIONER"

INFOID:000000006505027

The Supplemental Restraint System such as "AIR BAG" and "SEAT BELT PRE-TENSIONER", used along with a front seat belt, helps to reduce the risk or severity of injury to the driver and front passenger for certain types of collision. This system includes seat belt switch inputs and dual stage front air bag modules. The SRS system uses the seat belt switches to determine the front air bag deployment, and may only deploy one front air bag, depending on the severity of a collision and whether the front occupants are belted or unbelted. Information necessary to service the system safely is included in the "SRS AIR BAG" and "SEAT BELT" of this Service Manual.

WARNING:

Always observe the following items for preventing accidental activation.

- To avoid rendering the SRS inoperative, which could increase the risk of personal injury or death in the event of a collision that would result in air bag inflation, all maintenance must be performed by an authorized NISSAN/INFINITI dealer.
- Improper maintenance, including incorrect removal and installation of the SRS, can lead to personal injury caused by unintentional activation of the system. For removal of Spiral Cable and Air Bag Module, see "SRS AIR BAG".
- Never use electrical test equipment on any circuit related to the SRS unless instructed to in this Service Manual. SRS wiring harnesses can be identified by yellow and/or orange harnesses or harness connectors.

PRECAUTIONS WHEN USING POWER TOOLS (AIR OR ELECTRIC) AND HAMMERS

WARNING:

Always observe the following items for preventing accidental activation.

- When working near the Air Bag Diagnosis Sensor Unit or other Air Bag System sensors with the ignition ON or engine running, never use air or electric power tools or strike near the sensor(s) with a hammer. Heavy vibration could activate the sensor(s) and deploy the air bag(s), possibly causing serious injury.
- When using air or electric power tools or hammers, always switch the ignition OFF, disconnect the battery, and wait at least 3 minutes before performing any service.

A
B
C
D
E
F
G
H
I
J
L
M
N
O
P

PWC

POWER WINDOW MAIN SWITCH

< REMOVAL AND INSTALLATION >

REMOVAL AND INSTALLATION

POWER WINDOW MAIN SWITCH

Removal and Installation

INFOID:000000006505029

REMOVAL

1. Remove the power window main switch finisher (2). Refer to [INT-12. "Removal and Installation"](#).
2. Power window main switch (1) is removed from power window main switch finisher (2) using flat-head screw driver (A) etc.

 : Pawl

CAUTION:

Never fold the pawl of power window main switch finisher.

NOTE:

The same procedure is also performed for front power window switch (passenger side) and rear power window switch (LH & RH).

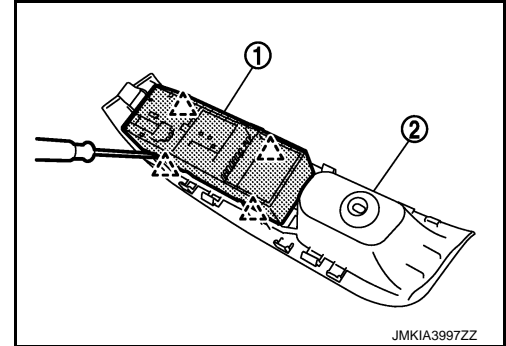

INSTALLATION

Install in the reverse order of removal.

NOTE:

Power window main switch is exchanged or is detached it is necessary to do the initialization procedure.

Refer to [PWC-5. "ADDITIONAL SERVICE WHEN REMOVING BATTERY NEGATIVE TERMINAL : Special Repair Requirement"](#).