

SECTION **RAX**
REAR AXLE

A
B
C

RAX

CONTENTS

E

SYMPTOM DIAGNOSIS	2	REMOVAL AND INSTALLATION	5	F
NOISE, VIBRATION AND HARSHNESS (NVH) TROUBLESHOOTING	2	REAR WHEEL HUB	5	G
NVH Troubleshooting Chart	2	Exploded View	5	
PREPARATION	3	Removal and Installation	5	
PREPARATION	3	Inspection	5	
Commercial Service Tool	3	SERVICE DATA AND SPECIFICATIONS (SDS)	6	H
PERIODIC MAINTENANCE	4	SERVICE DATA AND SPECIFICATIONS (SDS)	6	I
REAR WHEEL HUB	4	Wheel Bearing	6	J
Inspection	4			

J

K

L

M

N

O

P

NOISE, VIBRATION AND HARSHNESS (NVH) TROUBLESHOOTING

< SYMPTOM DIAGNOSIS >

SYMPTOM DIAGNOSIS

NOISE, VIBRATION AND HARSHNESS (NVH) TROUBLESHOOTING

NVH Troubleshooting Chart

INFOID:000000006502692

Use chart below to find the cause of the symptom. If necessary, repair or replace these parts.

Reference		RAX-5	—	RAX-4	NVH in RAX and RSU sections	NVH in WT section	NVH in WT section	NVH in BR section
Possible cause and SUSPECTED PARTS		Improper installation, looseness	Parts interference	Wheel bearing damage	REAR AXLE AND REAR SUSPENSION	TIRE	ROAD WHEEL	BRAKE
Symptom	REAR AXLE	Noise	x	x	x	x	x	x
		Shake	x	x	x	x	x	x
		Vibration	x	x	x	x		
		Shimmy	x	x		x	x	x
		Judder	x			x	x	x
		Poor quality ride or handling	x	x		x	x	x

x: Applicable

PREPARATION

< PREPARATION >

PREPARATION

PREPARATION

Commercial Service Tool

INFOID:0000000006502693

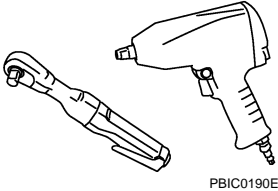
Tool name	Description
<p data-bbox="167 415 277 441">Power tool</p>  <p data-bbox="867 632 938 646">PBIC0190E</p>	<p data-bbox="1062 415 1317 441">Loosening bolts and nuts</p>

A

B

C

RAX

E

F

G

H

I

J

K

L

M

N

O

P

REAR WHEEL HUB

< PERIODIC MAINTENANCE >

PERIODIC MAINTENANCE

REAR WHEEL HUB

Inspection

INFOID:000000006502694

COMPONENT PART

Check the mounting conditions (looseness, back lash) of each component and component conditions (wear, damage) are normal.

WHEEL HUB AND BEARING ASSEMBLY

Check the following items, and replace the part it necessary.

- Move wheel hub and bearing assembly in the axial direction by hand. Check there is no looseness of wheel bearing.

Axial end play : Refer to [RAX-6. "Wheel Bearing"](#).

- Rotate wheel hub and bearing assembly and check there is no unusual noise or other irregular conditions. If there is any of irregular conditions, replace wheel hub and bearing assembly.

REAR WHEEL HUB

< REMOVAL AND INSTALLATION >

REMOVAL AND INSTALLATION

REAR WHEEL HUB

Exploded View

INFOID:0000000006502695

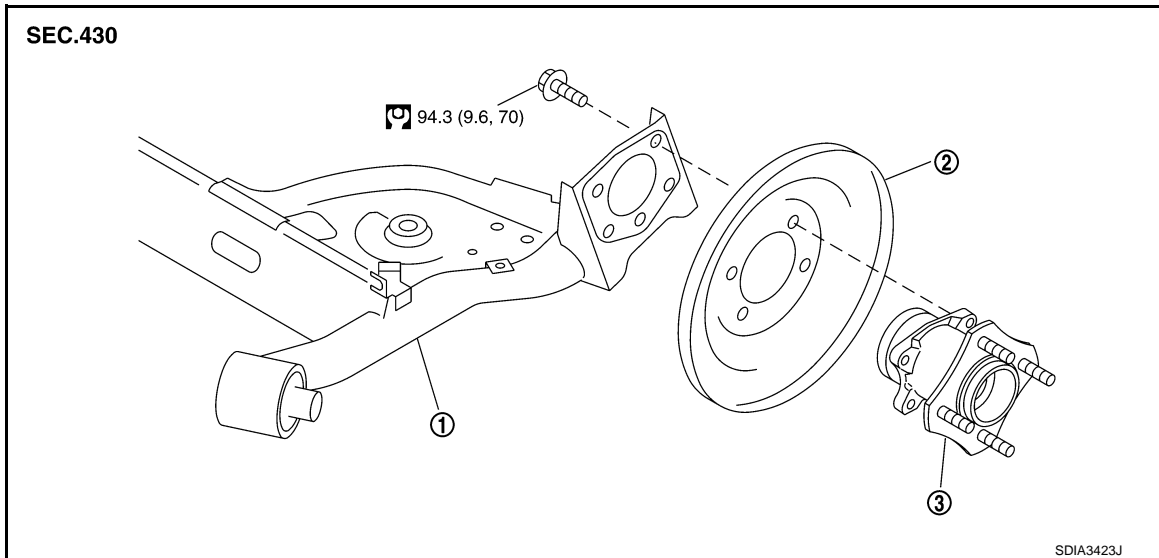

1. Rear suspension beam
2. Back plate
3. Wheel hub and bearing assembly

Refer to [GI-4, "Components"](#) for symbols in the figure.

Removal and Installation

INFOID:0000000006502696

REMOVAL

1. Remove tires with power tool. Refer to [WT-45, "Exploded View"](#).
2. Remove wheel sensor and sensor harness. Refer to [BRC-110, "REAR WHEEL SENSOR : Exploded View"](#).
3. Remove brake drum. Refer to [BR-39, "Exploded View"](#).
NOTE:
Keep back plate and brake assembly not falling down without removing them.
4. Remove wheel hub and bearing assembly.

INSTALLATION

Install in the reverse order of removal.

Inspection

INFOID:0000000006502697

INSPECTION AFTER REMOVAL

Check the wheel hub and bearing assembly for wear, cracks, and damage. Replace if necessary.

INSPECTION AFTER INSTALLATION

1. Check wheel sensor harness for proper connection. Refer to [BRC-110, "REAR WHEEL SENSOR : Exploded View"](#).
2. Adjust parking brake operation (stroke). Refer to [PB-3, "Inspection and Adjustment"](#).
3. Check wheel alignment. Refer to [RSU-6, "Inspection"](#).

A
B
C
RAX
E
F
G
H
I
J
K
L
M
N
O
P

SERVICE DATA AND SPECIFICATIONS (SDS)

< SERVICE DATA AND SPECIFICATIONS (SDS)

SERVICE DATA AND SPECIFICATIONS (SDS)

SERVICE DATA AND SPECIFICATIONS (SDS)

Wheel Bearing

INFOID:000000006502698

Item	Standard
Axial end play	0.05 mm (0.002 in) or less