

SECTION **IP**
INSTRUMENT PANEL

A
B
C
D
E
F
G
H
I
IP
K
L
M
N
O
P

CONTENTS

PRECAUTION	2	SYMPTOM DIAGNOSIS	6
PRECAUTIONS	2	SQUEAK AND RATTLE TROUBLE DIAG- NOSES	6
Precaution for Supplemental Restraint System (SRS) "AIR BAG" and "SEAT BELT PRE-TEN- SIONER"	2	Work Flow	6
Service	2	Inspection Procedure	8
PREPARATION	3	Diagnostic Worksheet	10
PREPARATION	3	REMOVAL AND INSTALLATION	12
Special Service Tools	3	INSTRUMENT PANEL ASSEMBLY	12
Commercial Service Tools	3	Exploded View	12
CLIP LIST	5	Removal and Installation	13
Clip List	5	CENTER CONSOLE ASSEMBLY	22
		Exploded View	22
		Removal and Installation	22

PRECAUTIONS

< PRECAUTION >

PRECAUTION

PRECAUTIONS

Precaution for Supplemental Restraint System (SRS) "AIR BAG" and "SEAT BELT PRE-TENSIONER"

INFOID:000000007772062

The Supplemental Restraint System such as "AIR BAG" and "SEAT BELT PRE-TENSIONER", used along with a front seat belt, helps to reduce the risk or severity of injury to the driver and front passenger for certain types of collision. This system includes seat belt switch inputs and dual stage front air bag modules. The SRS system uses the seat belt switches to determine the front air bag deployment, and may only deploy one front air bag, depending on the severity of a collision and whether the front occupants are belted or unbelted. Information necessary to service the system safely is included in the "SRS AIR BAG" and "SEAT BELT" of this Service Manual.

WARNING:

Always observe the following items for preventing accidental activation.

- To avoid rendering the SRS inoperative, which could increase the risk of personal injury or death in the event of a collision that would result in air bag inflation, all maintenance must be performed by an authorized NISSAN/INFINITI dealer.
- Improper maintenance, including incorrect removal and installation of the SRS, can lead to personal injury caused by unintentional activation of the system. For removal of Spiral Cable and Air Bag Module, see "SRS AIR BAG".
- Never use electrical test equipment on any circuit related to the SRS unless instructed to in this Service Manual. SRS wiring harnesses can be identified by yellow and/or orange harnesses or harness connectors.

PRECAUTIONS WHEN USING POWER TOOLS (AIR OR ELECTRIC) AND HAMMERS

WARNING:

Always observe the following items for preventing accidental activation.

- When working near the Air Bag Diagnosis Sensor Unit or other Air Bag System sensors with the ignition ON or engine running, never use air or electric power tools or strike near the sensor(s) with a hammer. Heavy vibration could activate the sensor(s) and deploy the air bag(s), possibly causing serious injury.
- When using air or electric power tools or hammers, always switch the ignition OFF, disconnect the battery, and wait at least 3 minutes before performing any service.

Service

INFOID:000000007772063

- Disconnect battery negative terminal in advance.
- Disconnect air bag system line in advance.
- Never tamper with or force air bag lid open, as this may adversely affect air bag performance.
- Be careful not to scratch pad and other parts.
- When removing or disassembling any part, be careful not to damage or deform it. Protect parts, that may get in the way with a shop cloth.
- When removing parts with a screwdriver or other tool, cover the tool surface with vinyl tape to protect parts.
- Keep removed parts protected with a shop cloth.
- If a clip is deformed or damaged, replace it.
- If an un reusable part is removed, replace it with a new one.
- Tighten bolts and nuts firmly to the specified torque.
- After reassembly is complete, check that each part functions correctly.
- Remove stains via the following procedure.

Water-soluble stains:

Dip a soft cloth in warm water, and then squeeze it tightly. After wiping off the stain, wipe with a soft dry cloth.

Oil stain:

Dissolve a synthetic detergent in warm water (density of 2 to 3%), dip the cloth, then wipe off the stain with the cloth. Next, dip the cloth in fresh water and squeeze it tightly. Then wipe off the detergent completely. Then wipe the area with a soft dry cloth.

- Never use any organic solvent, such as thinner or benzine.

PREPARATION

< PREPARATION >

PREPARATION

PREPARATION

Special Service Tools

INFOID:000000007772064

The actual shapes of Kent-Moore tools may differ from those of special service tools illustrated here.

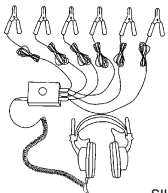
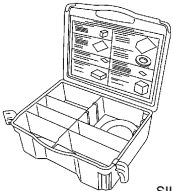
Tool number (Kent-Moore No.) Tool name	Description
<p>(J-39570) Chassis ear</p>  <p>SIIA0993E</p>	<p>Locates the noise</p>
<p>(J-43980) NISSAN Squeak and Rattle Kit</p>  <p>SIIA0994E</p>	<p>Repairs the cause of noise</p>

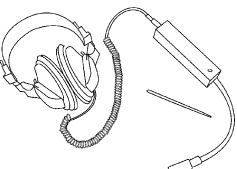
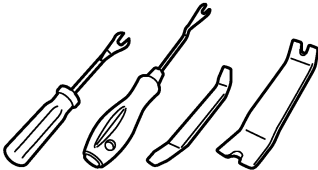

Commercial Service Tools

INFOID:000000007772065

Tool name	Description
<p>Engine ear</p>  <p>SIIA0995E</p>	<p>Locates the noise</p>
<p>Remover tool</p>  <p>JMKIA3050ZZ</p>	<p>Removes clips, pawls, and metal clips</p>

PREPARATION

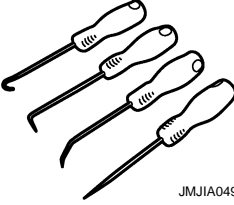
< PREPARATION >

Tool name	Description
<p data-bbox="164 302 350 327">Hook and pick tool</p>  <p data-bbox="821 417 906 434">JMJA0490ZZ</p>	<p data-bbox="1057 302 1344 327">Removes rear console cover</p>
<p data-bbox="164 554 272 579">Power tool</p>  <p data-bbox="821 667 889 684">PIIB1407E</p>	

CLIP LIST

< PREPARATION >

CLIP LIST

Clip List

INFOID:000000007772066

Shapes	Removal & Installation	Shapes	Removal & Installation
	<p>Removal: Remove by bending up with flat-bladed screwdrivers or clip remover.</p>	<p>Clip A Clip B</p>	<p>Removal:</p> <p>Finisher Clip A Flat-bladed screwdriver Clip B</p>
	<p>Removal: Remove with a clip remover.</p>	<p>Clip A Clip B (Grommet)</p>	<p>Removal:</p> <p>Flat-bladed screwdriver Finisher Body panel Clip A Clip B (Grommet)</p>
	<p>Removal: Push center pin to catching position. (Do not remove center pin by hitting it.)</p> <p>Installation:</p>		<p>Removal: Holder portion of clip must be spread out to remove rod.</p>
	<p>Removal: Remove by bending up with flat-bladed screwdrivers or clip remover.</p> <p>Clip Finisher</p>		<p>Removal:</p> <ol style="list-style-type: none"> Screw out with a Phillips screwdriver. Remove female portion with flat-bladed screwdriver.
	<p>Removal:</p>		<p>Removal:</p> <p>Rotate 45° to remove.</p> <p>Installation:</p>
	<p>Removal:</p>		<p>Removal:</p>

JMJIA3734GB

A
B
C
D
E
F
G
H
I
IP
K
L
M
N
O
P

SQUEAK AND RATTLE TROUBLE DIAGNOSES

< SYMPTOM DIAGNOSIS >

SYMPTOM DIAGNOSIS

SQUEAK AND RATTLE TROUBLE DIAGNOSES

Work Flow

INFOID:000000007772067

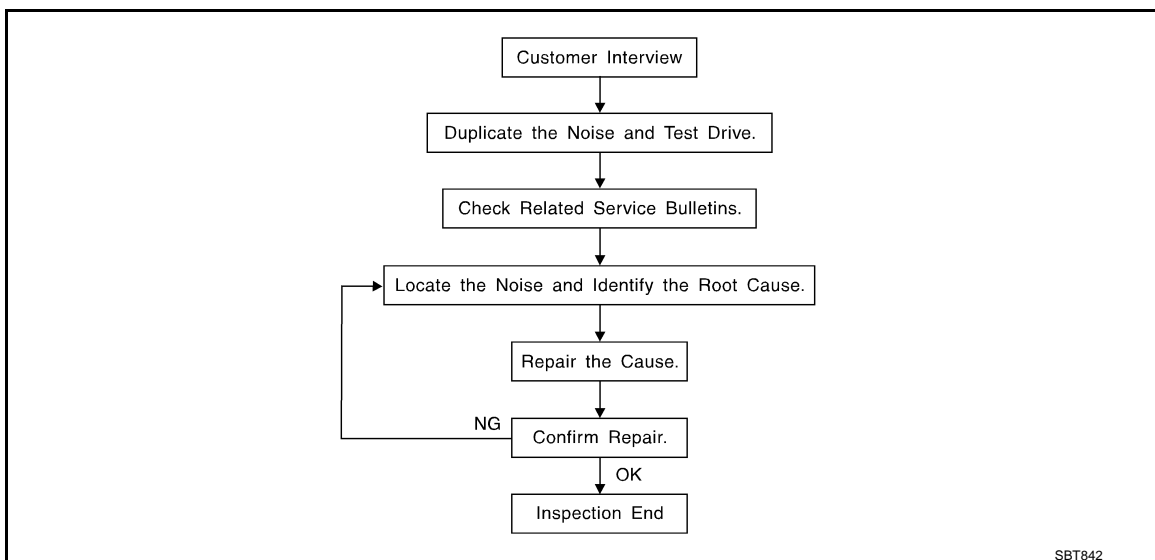

CUSTOMER INTERVIEW

Interview the customer if possible, to determine the conditions that exist when the noise occurs. Use the Diagnostic Worksheet during the interview to document the facts and conditions when the noise occurs and any customer comments. Refer to [IP-10. "Diagnostic Worksheet"](#). This information is necessary to duplicate the conditions that exist when the noise occurs.

- The customer may not be able to provide a detailed description or the location of the noise. Attempt to obtain all the facts and conditions that exist when the noise occurs (or does not occur).
- If there is more than one noise in the vehicle, perform a diagnosis and repair the noise that the customer is concerned about. This can be accomplished by performing a test drive with the customer.
- After identifying the type of noise, isolate the noise in terms of its characteristics. The noise characteristics are provided so that the customer, service adviser, and technician use the same language when describing the noise.
- Squeak – (Like tennis shoes on a clean floor)
Squeak characteristics include the light contact / fast movement / brought on by road conditions / hard surfaces = high-pitched noise / softer surfaces = low-pitched noises / edge to surface = chirping
- Creak – (Like walking on an old wooden floor)
Creak characteristics include firm contact / slow movement/twisting with a rotational movement / pitch dependent on materials / often brought on by activity.
- Rattle – (Like shaking a baby rattle)
Rattle characteristics include fast repeated contact / vibration or similar movement / loose parts/missing clip or fastener / incorrect clearance.
- Knock – (Like a knock on a door)
Knock characteristics include hollow sounds / sometimes repeating / often brought on by driver action.
- Tick – (Like a clock second hand)
Tick characteristics include gentle contacting of light materials / loose components / can be caused by driver action or road conditions.
- Thump – (Heavy, muffled knock noise)
Thump characteristics include softer knock / dull sounds often brought on by activity.
- Buzz – (Like a bumblebee)
Buzz characteristics include high frequency rattle / firm contact.
- Often the degree of acceptable noise level varies depending upon the person. A noise that a technician may judge as acceptable may be very irritating to a customer.
- Weather conditions, especially humidity and temperature, may have a great effect on noise level.

DUPLICATE THE NOISE AND TEST DRIVE

SQUEAK AND RATTLE TROUBLE DIAGNOSES

< SYMPTOM DIAGNOSIS >

If possible, drive the vehicle with the customer until the noise is duplicated. Note any additional information on the Diagnostic Worksheet regarding the conditions or location of the noise. This information can be used to duplicate the same conditions when the repair is reconfirmed.

If the noise can be duplicated easily during the test drive, to help identify the source of the noise, try to duplicate the noise with the vehicle stopped by doing one or all of the following items:

- 1) Close a door.
 - 2) Tap or push/pull around the area where the noise appears to be coming from.
 - 3) Rev the engine.
 - 4) Use a floor jack to recreate vehicle "twist".
 - 5) At idle, apply engine load (electrical load, half-clutch on M/T models, drive position on A/T models).
 - 6) Raise the vehicle on a hoist and hit a tire with a rubber hammer.
- Drive the vehicle and attempt to duplicate the conditions the customer states exist when the noise occurs.
 - If it is difficult to duplicate the noise, drive the vehicle slowly on an undulating or rough road to stress the vehicle body.

CHECK RELATED SERVICE BULLETINS

After verifying the customer concern or symptom, check ASIST for Technical Service Bulletins (TSBs) related to the concern or symptom.

If a TSB relates to the symptom, follow the procedure to repair the noise.

LOCATE THE NOISE AND IDENTIFY THE ROOT CAUSE

1. Narrow down the noise to a general area. To help pinpoint the source of the noise, use a listening tool (Chassis ear: J-39570, engine ear, and mechanics stethoscope).
2. Narrow down the noise to a more specific area and identify the cause of the noise by:
 - Removing the component(s) in the area that is / are suspected to be the cause of the noise. Do not use too much force when removing clips and fasteners, otherwise clips and fasteners can be broken or lost during the repair, resulting in the creation of new noise.
 - Tapping or pushing/pulling the component(s) that is / are suspected to be the cause of the noise. Do not tap or push/pull the component(s) with excessive force, otherwise the noise is eliminated only temporarily.
 - Feeling for a vibration by hand by touching the component(s) that is / are suspected to be the cause of the noise.
 - Placing a piece of paper between components that are suspected to be the cause of the noise.
 - Looking for loose components and contact marks.
Refer to [IP-8, "Inspection Procedure"](#).

REPAIR THE CAUSE

- If the cause is a loose component, tighten the component securely.
- If the cause is insufficient clearance between components:
 - Separate components by repositioning or loosening and retightening the components, if possible.
 - Insulate components with a suitable insulator such as urethane pads, foam blocks, felt cloth tape, or urethane tape. A NISSAN Squeak and Rattle Kit (J-43980) is available through the authorized NISSAN Parts Department.

CAUTION:

Never use excessive force as many components are constructed of plastic and may be damaged.

NOTE:

Always check with the Parts Department for the latest parts information.

The following materials are contained in the NISSAN Squeak and Rattle Kit (J-43980). Each item can be ordered separately as needed.

URETHANE PADS [1.5 mm (0.059 in) thick]

Insulates connectors, harness, etc.

- 76268-9E005: 100 × 135 mm (3.937 × 5.315 in)
- 76884-71L01: 60 × 85 mm (2.362 × 3.346 in)
- 76884-71L02: 15 × 25 mm (0.591 × 0.984 in)

INSULATOR (Foam blocks)

Insulates components from contact. Can be used to fill space behind a panel.

- 73982-9E000: 45 mm (1.772 in) thick, 50 × 50 mm (1.969 × 1.969 in)
- 73982-50Y00: 10 mm (0.394 in) thick, 50 × 50 mm (1.969 × 1.969 in)

INSULATOR (Light foam block)

80845-71L00: 30 mm (1.18 in) thick, 30 × 50 mm (1.181 × 1.969 in)

FELT CLOTHTAPE

SQUEAK AND RATTLE TROUBLE DIAGNOSES

< SYMPTOM DIAGNOSIS >

Used to insulate where movement does not occur. Ideal for instrument panel applications.

- 68370-4B000: 15 × 25 mm (0.591 × 0.984 in) pad
- 68239-13E00: 5 mm (0.197 in) wide tape roll

The following materials, not found in the kit, can also be used to repair squeaks and rattles.

UHMW (TEFLON) TAPE

Insulates where slight movement is present. Ideal for instrument panel applications.

SILICONE GREASE

Used in place of UHMW tape that is visible or does not fit. Only lasts a few months.

SILICONE SPRAY

Used when grease cannot be applied.

DUCT TAPE

Used to eliminate movement.

CONFIRM THE REPAIR

After repair is complete, test drive the vehicle to confirm that the cause of noise is repaired by test driving the vehicle. Operate the vehicle under the same conditions as when the noise originally occurred. Refer to the notes on the Diagnostic Worksheet.

Inspection Procedure

INFOID:000000007772068

Refer to Table of Contents for specific component removal and installation information.

INSTRUMENT PANEL

Most incidents are caused by contact and movement between:

1. The cluster lid A and instrument panel
2. Acrylic lens and combination meter housing
3. Instrument panel to front pillar garnish
4. Instrument panel to windshield
5. Instrument panel mounting pins
6. Wiring harnesses behind the combination meter
7. A/C defroster duct and duct joint

These incidents can usually be located by tapping or moving the components to duplicate the noise or by pressing on the components while driving to stop the noise. Most of these incidents can be repaired by applying felt cloth tape or silicon spray (in hard to reach areas). Urethane pads can be used to insulate wiring harness.

CAUTION:

Never use silicone spray to isolate a squeak or rattle. If the area is saturated with silicone, the recheck of repair becomes impossible.

CENTER CONSOLE

Components to check include:

1. Shifter assembly cover to finisher
2. A/C control unit and cluster lid C
3. Wiring harnesses behind audio and A/C control unit

The instrument panel repair and isolation procedures also apply to the center console.

DOORS

Check the following items:

1. Finisher and inner panel making a slapping noise
2. Inside handle escutcheon connection to door finisher
3. Wiring harnesses tapping
4. Door striker out of alignment causing a popping noise on starts and stops

Tapping, moving the components, or pressing on them while driving to duplicate the conditions can isolate many of these incidents. The areas can usually be insulated with felt cloth tape or insulator foam blocks from the NISSAN Squeak and Rattle Kit (J-43980) to repair the noise.

TRUNK

Trunk noises are often caused by a loose jack or loose items put into the trunk by the customer.

In addition check for the following items:

SQUEAK AND RATTLE TROUBLE DIAGNOSES

< SYMPTOM DIAGNOSIS >

1. Trunk lid dumpers out of adjustment
2. Trunk lid striker out of adjustment
3. Trunk lid torsion bars knocking together
4. A loose license plate or bracket

Most of these incidents can be repaired by adjusting, securing, or insulating the item(s) or component(s) causing the noise.

SUNROOF/HEADLINING

Noises in the sunroof / headlining area can often be traced to one of the following items:

1. Sunroof lid, rail, linkage, or seals making a rattle or light knocking noise
2. Sunvisor shaft shaking in the holder
3. Front or rear windshield touching headlining and squeaking

Again, pressing on the components to stop the noise while duplicating the conditions can isolate most of these incidents. Repairs usually consist of insulating with felt cloth tape.

SEATS

When isolating seat noise it is important to note the position the seat is in and the load placed on the seat when the noise occurs. These conditions should be duplicated when verifying and isolating the cause of the noise.

Causes of seat noise include:

1. Headrest rods and holder
2. A squeak between the seat pad cushion and frame
3. The rear seatback lock and bracket

These noises can be isolated by moving or pressing on the suspected components while duplicating the conditions under which the noise occurs. Most of these incidents can be repaired by repositioning the component or applying urethane tape to the contact area.

UNDERHOOD

Some interior noise may be caused by components under the hood or on the engine wall. The noise is then transmitted into the passenger compartment.

Causes of transmitted underhood noise include:

1. Any component mounted to the engine wall
2. Components that pass through the engine wall
3. Engine wall mounts and connectors
4. Loose radiator mounting pins
5. Hood bumpers out of adjustment
6. Hood striker out of adjustment

These noises can be difficult to isolate since they cannot be reached from the interior of the vehicle. The best method is to secure, move, or insulate one component at a time and test drive the vehicle. Also, engine RPM or load can be changed to isolate the noise. Repairs can usually be made by moving, adjusting, securing, or insulating the component causing the noise.

A
B
C
D
E
F
G
H
I
IP
K
L
M
N
O
P

SQUEAK AND RATTLE TROUBLE DIAGNOSES

< SYMPTOM DIAGNOSIS >

Diagnostic Worksheet

INFOID:000000007772069



SQUEAK & RATTLE DIAGNOSTIC WORKSHEET

Dear Nissan Customer:

We are concerned about your satisfaction with your Nissan vehicle. Repairing a squeak or rattle sometimes can be very difficult. To help us fix your Nissan right the first time, please take a moment to note the area of the vehicle where the squeak or rattle occurs and under what conditions. You may be asked to take a test drive with a service advisor or technician to ensure we confirm the noise you are hearing.

I. WHERE DOES THE NOISE COME FROM? (circle the area of the vehicle)

The illustrations are for reference only, and may not reflect the actual configuration of your vehicle.

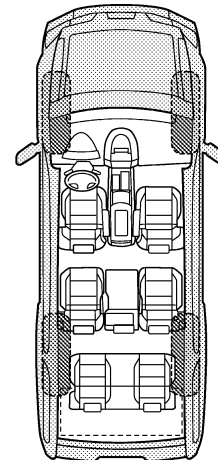
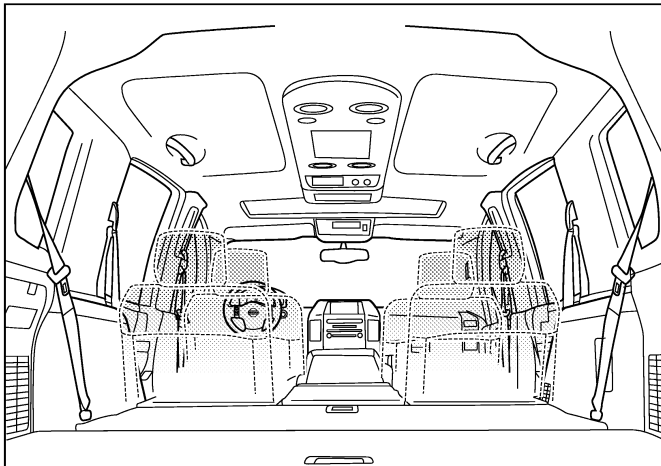
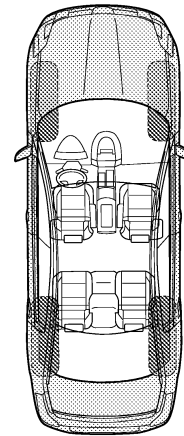
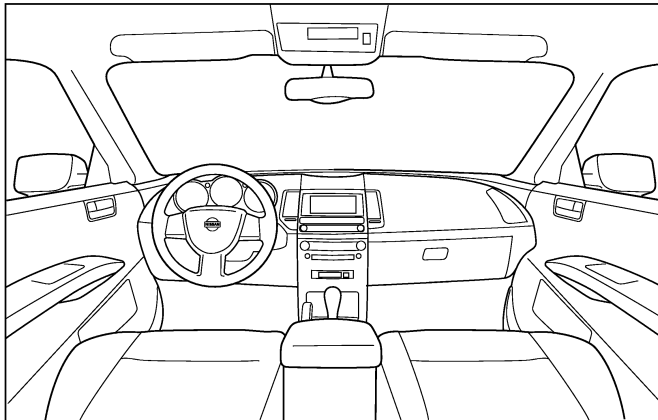

Continue to page 2 of the worksheet and briefly describe the location of the noise or rattle. In addition, please indicate the conditions which are present when the noise occurs.

PIIB8740E

SQUEAK AND RATTLE TROUBLE DIAGNOSES

< SYMPTOM DIAGNOSIS >

SQUEAK & RATTLE DIAGNOSTIC WORKSHEET - page 2

Briefly describe the location where the noise occurs:

II. WHEN DOES IT OCCUR? (please check the boxes that apply)

- | | |
|---|--|
| <input type="checkbox"/> anytime | <input type="checkbox"/> after sitting out in the rain |
| <input type="checkbox"/> 1st time in the morning | <input type="checkbox"/> when it is raining or wet |
| <input type="checkbox"/> only when it is cold outside | <input type="checkbox"/> dry or dusty conditions |
| <input type="checkbox"/> only when it is hot outside | <input type="checkbox"/> other: |

III. WHEN DRIVING:

- through driveways
- over rough roads
- over speed bumps
- only about ____ mph
- on acceleration
- coming to a stop
- on turns: left, right or either (circle)
- with passengers or cargo
- other: _____
- after driving ____ miles or ____ minutes

IV. WHAT TYPE OF NOISE

- squeak (like tennis shoes on a clean floor)
- creak (like walking on an old wooden floor)
- rattle (like shaking a baby rattle)
- knock (like a knock at the door)
- tick (like a clock second hand)
- thump (heavy, muffled knock noise)
- buzz (like a bumble bee)

TO BE COMPLETED BY DEALERSHIP PERSONNEL

Test Drive Notes:

	YES	NO	Initials of person performing
Vehicle test driven with customer	<input type="checkbox"/>	<input type="checkbox"/>	_____
- Noise verified on test drive	<input type="checkbox"/>	<input type="checkbox"/>	_____
- Noise source located and repaired	<input type="checkbox"/>	<input type="checkbox"/>	_____
- Follow up test drive performed to confirm repair	<input type="checkbox"/>	<input type="checkbox"/>	_____

VIN: _____ Customer Name: _____
W.O.# _____ Date: _____

This form must be attached to Work Order

PIIB8742E

A
B
C
D
E
F
G
H
I
IP
K
L
M
N
O
P

INSTRUMENT PANEL ASSEMBLY

< REMOVAL AND INSTALLATION >

REMOVAL AND INSTALLATION

INSTRUMENT PANEL ASSEMBLY

Exploded View

INFOID:000000007772070

SEC. 680

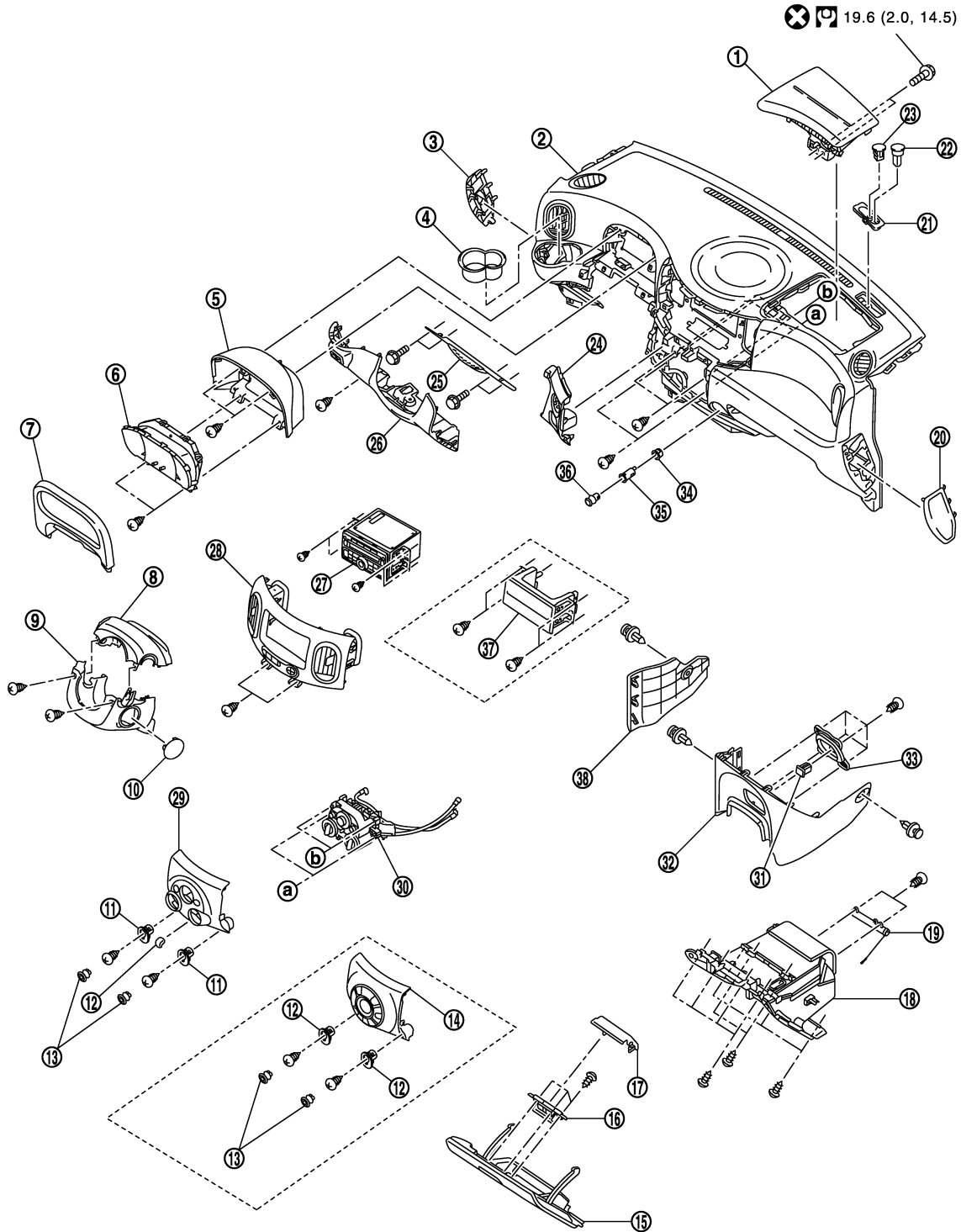



JMJIA3045GB

INSTRUMENT PANEL ASSEMBLY

< REMOVAL AND INSTALLATION >

- | | | |
|-----------------------------------|---------------------------------|------------------------------------|
| 1. Front passenger air bag module | 2. Instrument panel assembly | 3. Instrument side finisher LH |
| 4. Cup holder | 5. Cluster lid A (front) | 6. Combination meter |
| 7. Cluster lid A (rear) | 8. Steering column upper cover | 9. Steering column lower cover |
| 10. Steering lock escutcheon | 11. Hook cover | 12. Knob |
| 13. Hook | 14. A/C finisher (auto A/C) | 15. Glove box assembly |
| 16. Glove box lock | 17. Glove box lock cover | 18. Glove box cover |
| 19. Glove box damper | 20. Instrument side finisher RH | 21. Instrument mask |
| 22. Optical sensor | 23. Sunload sensor | 24. Switch panel finisher |
| 25. Knee protector | 26. Instrument lower panel LH | 27. Audio unit |
| 28. Cluster lid C | 29. A/C finisher (manual A/C) | 30. A/C controller (manual A/C) |
| 31. USB connector | 32. Instrument lower cover | 33. Instrument lower cover bracket |
| 34. Ring | 35. Inner socket | 36. Power socket finisher |
| 37. Audio mask | 38. Instrument lower cover LH | |

 : Always replace after every disassembly.

 : N·m (kg-m, ft-lb)

Removal and Installation

INFOID:000000007772071

WORK STEP

When removing instrument panel assembly, combination meter, audio unit (audio mask), cup holder, or center console assembly take steps in the order shown by the numbers below.

PARTS	INSTRUMENT PANEL ASSEMBLY	COMBINATION METER	AUDIO UNIT, NAVI CONTROL UNIT, AUDIO MASK	CUP HOLDER	CENTER CONSOLE
Shift knob (MT models)	[1]				[1]
Front console cover	[2]				[2]
Rear console cover	[3]				[3]
Console mask	[4]				[4]
Center console assembly	[5]				[5]
Instrument side finisher LH	[6]			[1]	
Instrument lower panel LH	[7]			[2]	
Knee protector	[8]				
Cup holder				[3]	
Driver air bag module	[9]				
Steering wheel	[10]				
Steering lock escutcheon	[11]				
Steering column upper cover	[12]	[1]			
Steering column lower cover	[13]				
Lighting & turn signal switch	[14]				
Wiper and washer switch	[15]				
Cluster lid A (rear)	[16]	[2]			
Combination meter	[17]	[3]			
Cluster lid A (front)	[18]				
Front body side welt LH	[19]				
Front pillar garnish LH	[20]				
A/C finisher	[21]		[1]		

INSTRUMENT PANEL ASSEMBLY

< REMOVAL AND INSTALLATION >

A/C control fixing screws (manual A/C)	[22]				
Cluster lid C	[23]		[2]		
Audio unit, NAVI control unit, audio mask	[24]		[3]		
Switch panel finisher	[25]				
Instrument lower cover LH	[26]				
Instrument lower cover	[27]				
Instrument mask	[28]				
Glove box cover assembly	[29]				
Instrument side finisher RH	[30]				
Passenger air bag module	[31]				
Front body side welt RH	[32]				
Front pillar garnish RH	[33]				
Instrument panel assembly	[34]				

[]: Number indicates step in removal procedure.

WARNING:

Before servicing, turn ignition switch OFF, disconnect battery negative terminal and wait 3 minutes or more.

CAUTION:

When removing, always use a remover tool that is made of plastic.

REMOVAL

- Put selector lever in [N] position (CVT models).
- Remove shift knob (MT models). Refer to [TM-18. "Removal and Installation"](#).
- Remove front console cover.
 - Remove front console cover with a flat-bladed screwdriver (A) wrapped in a tape.
 - Pull up front console cover.

 : Pawl

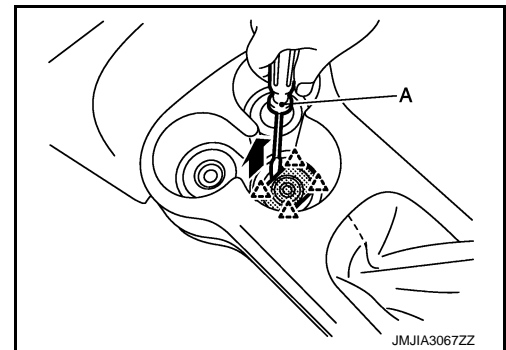

- Remove mounting nut of center console front side.
- Remove rear console cover.
 - Remove rear console cover with hook and pick tool (A) as shown in the figure.
 - Pull up rear console cover.

 : Pawl

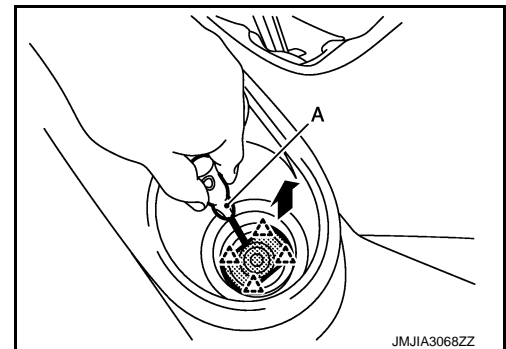

- Remove mounting nuts of center console rear side.

INSTRUMENT PANEL ASSEMBLY

< REMOVAL AND INSTALLATION >

7. Insert a deep-well socket wrench (A) to rotate adjusting nut to loosen cable sufficiently. Refer to [PB-3, "Inspection and Adjustment"](#).

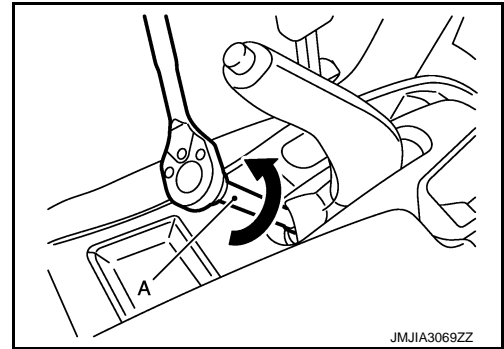

8. Remove console mask.
1. Pull upward to release console mask fixing clips from center console with remover tool (A).
 2. Disconnect seat heated switch harness connectors. (with seat heater)

 : Clip

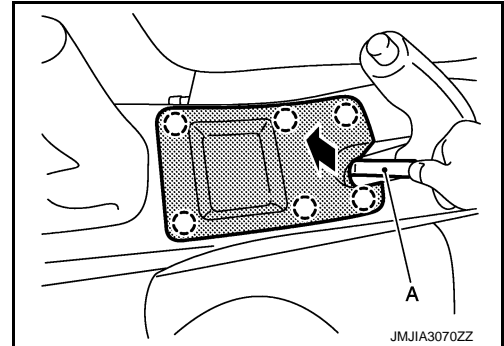

9. Lift up center console assembly back side, and then remove center console assembly.

10. Remove instrument side finisher LH.
Insert finger into instrument side finisher LH hole. Disengage the pawls while pulling in lateral direction, and pull back.

CAUTION:

Disengage slowly so that pawls of instrument side finisher LH are not damaged.

 : Pawl

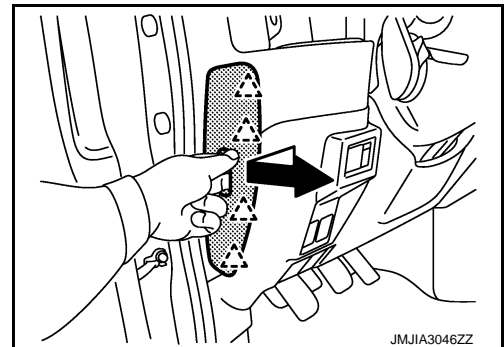

11. Remove instrument lower panel LH.

1. Remove hood opener and fuel lid opener lever. Refer to [DLK-185, "Removal and Installation"](#).
2. Remove fixing screw (A).
3. Pull back instrument lower panel LH.
4. Disconnect harness connectors, harness clip.
5. Release data link connector (pawls) then remove it from instrument lower panel LH.

 : Pawl

 : Metal clip

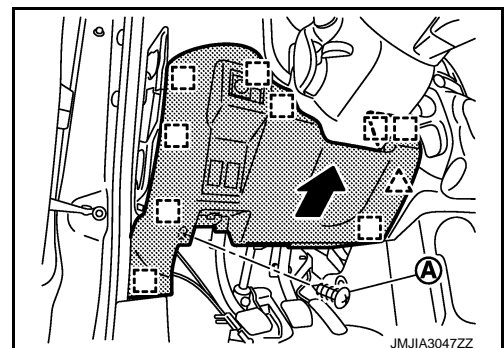

A
B
C
D
E
F
G
H
I
IP
K
L
M
N
O
P

INSTRUMENT PANEL ASSEMBLY

< REMOVAL AND INSTALLATION >

12. Remove knee protector.
 1. Remove fixing bolts (A).
 2. Pull back knee protector.

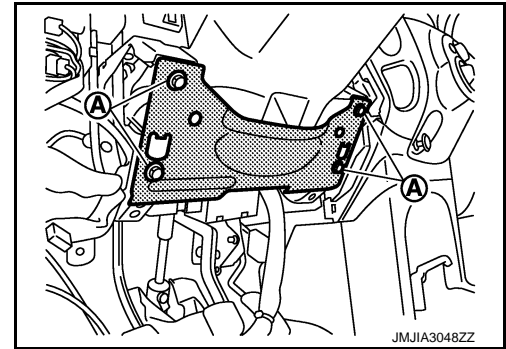

13. Remove driver air bag module. Refer to [SR-10. "Removal and Installation"](#).
14. Remove steering wheel. Refer to [ST-8. "Removal and Installation"](#).
15. Remove the steering column cover.
 1. Remove the steering lock escutcheon.



1. Steering lock escutcheon
(without Intelligent key system)

 : Pawl

2. Steering lock escutcheon
(with Intelligent key system)

- Without intelligent key system: Remove steering lock escutcheon (1) using remover tool (A).
- With intelligent key system: Insert remover tool between steering lock escutcheon and steering column cover to disengage the pawls.

2. Remove the steering column fixing screws (A).
3. Pull up the steering column upper cover (3), and then disengage the pawls.
4. Pull down the steering column lower cover (4), and then remove the steering column lower cover.

 : Pawl

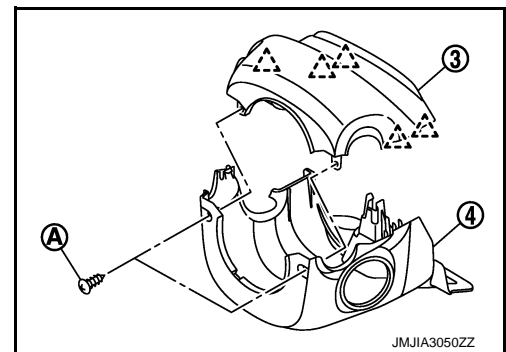

16. Remove lighting & turn signal switch. Refer to [EXL-174. "Exploded View"](#).
17. Remove wiper and washer switch. Refer to [WW-129. "Exploded View"](#).

INSTRUMENT PANEL ASSEMBLY

< REMOVAL AND INSTALLATION >

18. Remove cluster lid A (rear).

1. Pull back cluster lid A (rear) while holding the lower side and disengage the pawls and the metal clips under side.
2. Remove the metal clips of cluster lid A (rear) upper side.

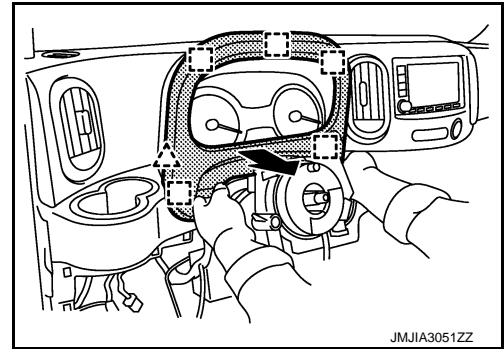
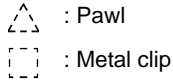

19. Remove combination meter. Refer to [MWI-90, "Removal and Installation"](#).

20. Remove cluster lid A (front).

1. Remove fixing screws (A).
2. Pull back the cluster lid A (front), and then disengage the pawls and metal clips.

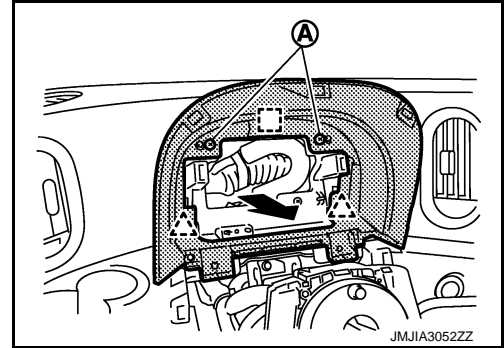
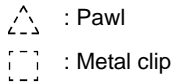

21. Remove the body side welt LH. Refer to [INT-16, "Removal and Installation"](#).

22. Remove the front pillar garnish LH. Refer to [INT-16, "Removal and Installation"](#).

23. Remove A/C finisher.

1. Intake door lever knob (with manual A/C). Refer to [HAC-218, "Removal and Installation"](#).
2. Pull up and back, and then remove hooks (2) from A/C finisher (1).

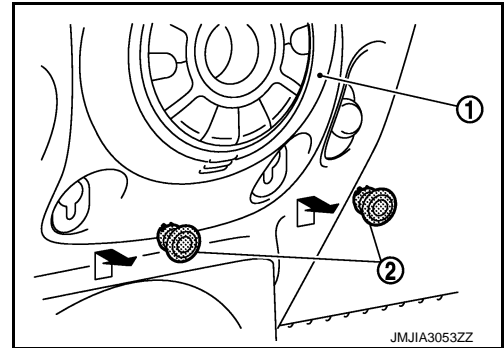

3. Remove fixing screws (A), and then remove hook cover (3) from A/C finisher (1).

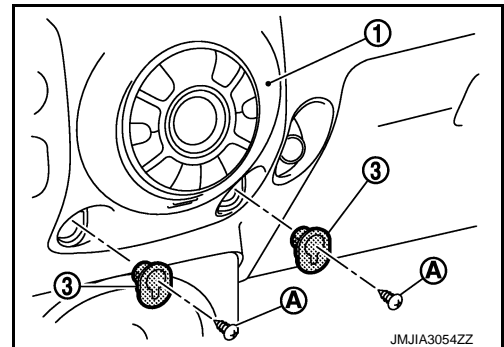

A
B
C
D
E
F
G
H
I
IP
K
L
M
N
O
P

INSTRUMENT PANEL ASSEMBLY

< REMOVAL AND INSTALLATION >

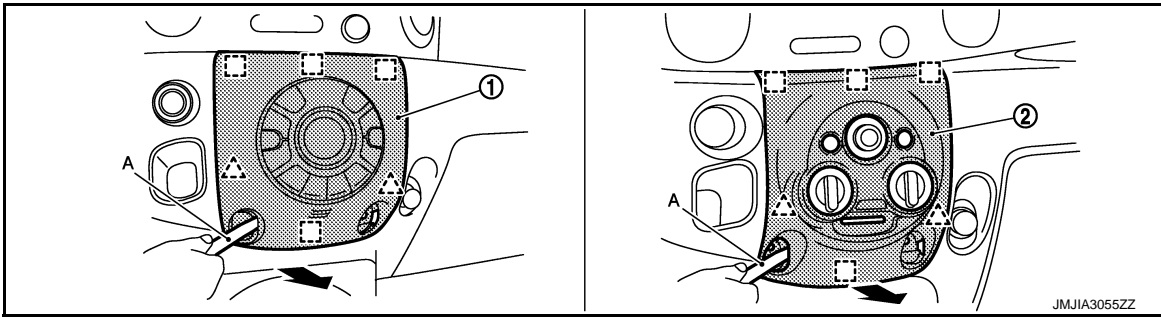

1. A/C finisher (Auto A/C)

2. A/C finisher (Manual A/C)

 : Pawl

 : Metal clip

4. Insert remover tool (A) through the hook cover mounting and disengage the pawls of the lower metal clips of the A/C finisher (1 or 2) lower side.
5. Pull back the A/C finisher and disengage the metal clips upper side.
6. Disconnect harness connectors. (with Auto A/C)

24. Remove A/C control fixing screws (with Manual A/C). Refer to [HAC-218. "Exploded View"](#).

25. Remove cluster lid C.

1. Remove fixing screws (A).
2. Pull back the cluster lid C while holding the lower side and disengage the pawls and metal clips.
3. Disconnect harness connectors.

 : Pawl

 : Metal clip

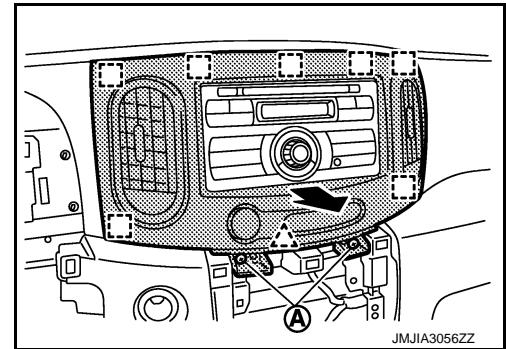

26. Remove audio unit, NAVI control unit, or audio mask.

- Audio unit: Refer to [AV-55. "Removal and Installation"](#).
- NAVI control unit: Refer to [AV-116. "Removal and Installation"](#).
- Audio mask: Remove fixing screws, and then remove audio mask.

27. Remove switch panel finisher.

1. Pull back the switch panel finisher while holding the lower side and disengage the pawls and metal clips.
2. Disconnect harness connectors.

 : Pawl

 : Metal clip

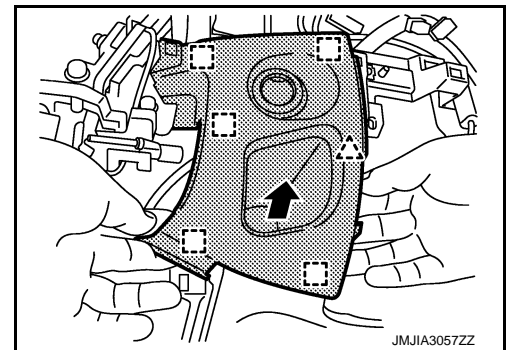

INSTRUMENT PANEL ASSEMBLY

< REMOVAL AND INSTALLATION >

28. Remove instrument lower cover LH.

1. Remove fixing clip (A).
2. Disengage fixing pawls, and then remove instrument lower cover LH as shown in the figure.

 : Pawl

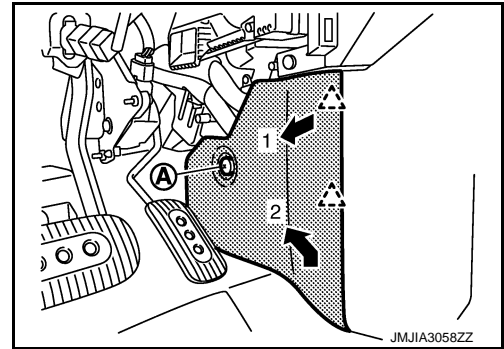

29. Remove instrument lower cover.

1. Remove fixing clip (A).
2. Pull back instrument lower cover, and disengage the pawls and metal clips.
3. Disconnect harness connectors.

 : Pawl

 : Metal clip

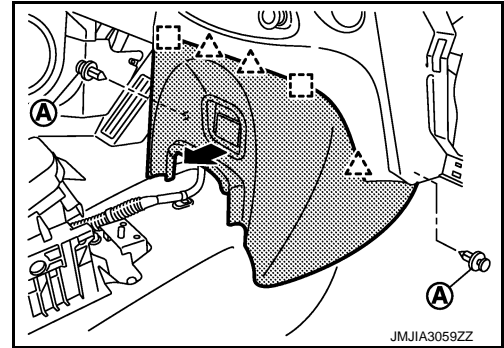

30. Remove instrument mask.

1. Insert remover tool (A) between instrument mask and instrument panel assembly to disengage the pawls as shown in the figure.
2. Disconnect harness connectors.

 : Pawl

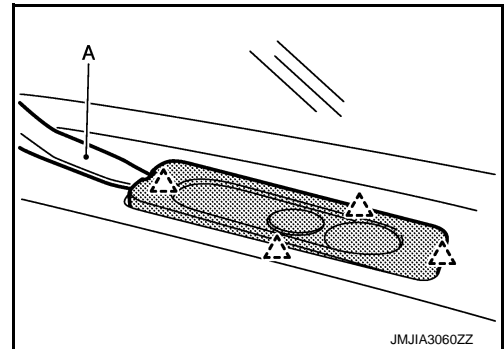

31. Remove glove box cover assembly.

1. Remove glove box cover assembly (lower side) fixing screws (A).

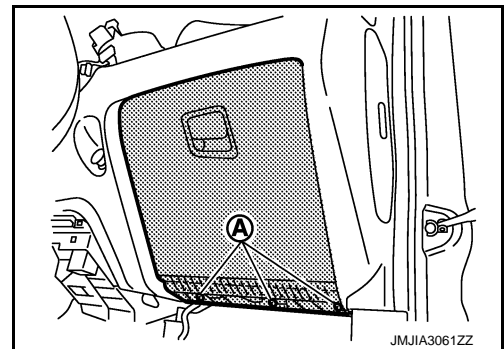

2. Open the glove box lid.

A
B
C
D
E
F
G
H
I
IP
K
L
M
N
O
P

INSTRUMENT PANEL ASSEMBLY

< REMOVAL AND INSTALLATION >

3. Remove glove box cover assembly (upper side) fixing screws (A).
4. Pull back the glove box cover assembly while holding the lower side and disengage the pawls.

CAUTION:

Never pull the glove box lid.

 : Pawl

5. Disconnect harness connectors.

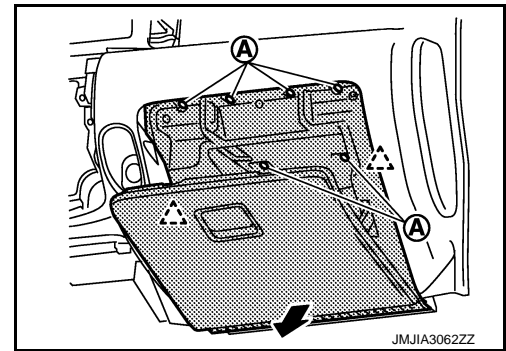

32. Remove instrument side finisher RH.

1. Insert remover tool (A) between instrument side finisher RH and instrument panel assembly to disengage the pawls as shown in the figure.
2. Pull back instrument side finisher RH.

CAUTION:

Disengage slowly so that pawls of instrument side finisher RH are not damaged.

 : Pawl

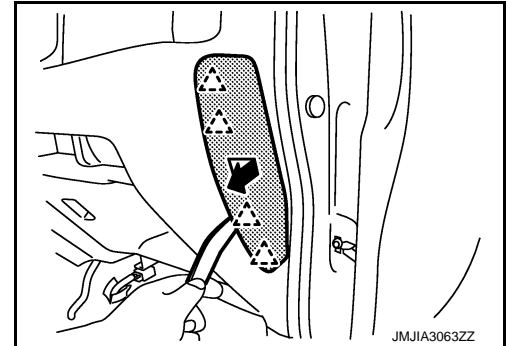

33. Remove front passenger air bag module. Refer to [SR-16, "Removal and Installation"](#).

34. Remove front body side welt RH. Refer to [INT-16, "Removal and Installation"](#).

35. Remove front pillar garnish RH. Refer to [INT-16, "Removal and Installation"](#).

36. Remove instrument panel assembly.

1. Disconnect power socket harness connector. Refer to [PWO-4, "Removal and Installation"](#).
2. Remove instrument panel assembly fixing screws (A) and bolts (B).

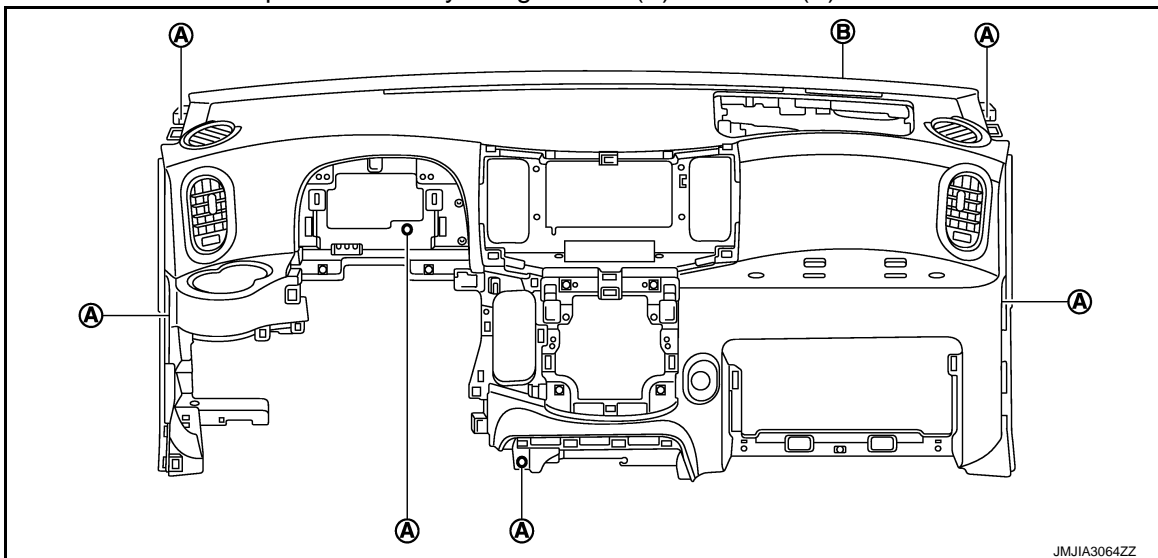

CAUTION:

Cover tool with a shop cloth to prevent windshield glass from being damaged.

3. Remove instrument panel assembly from passenger door opening portion.

CAUTION:

- **Cover select lever knob upper surface with a shop cloth to prevent it from being damaged.**
- **When removing instrument panel assembly, 2 workers are required to prevent it from dropping.**

37. Remove the following parts after removing the instrument panel assembly.

- Side ventilator grille: Refer to [VTL-8, "SIDE VENTILATOR GRILLE : Removal and Installation"](#).
- Center ventilator duct: Refer to [VTL-9, "CENTER VENTILATOR DUCT : Removal and Installation"](#).
- Side ventilator duct: Refer to [VTL-9, "SIDE VENTILATOR DUCT : Removal and Installation"](#).

INSTRUMENT PANEL ASSEMBLY

< REMOVAL AND INSTALLATION >

- Front defroster nozzle: Refer to [VTL-9. "FRONT DEFROSTER NOZZLE : Removal and Installation"](#).
- Side defroster nozzle: Refer to [VTL-10. "SIDE DEFROSTER NOZZLE : Removal and Installation"](#).
- Antenna feeder
- Audio system: Refer to [AV-65. "Harness Layout"](#).
- Base audio with navigation: Refer to [AV-128. "Feeder Layout"](#).
- Power socket: Refer to [PWO-4. "Exploded View"](#).

NOTE:

Removal of Cup Holder.

1. Remove instrument lower panel LH.
2. Disengage the cup holder front pawls from the back of the instrument panel assembly, in order from 1-2 as shown in the figure, and lift.
3. Disengage the remaining clips, in order from 3-4 as shown in the figure, using the remover tool (A).

 : Pawl

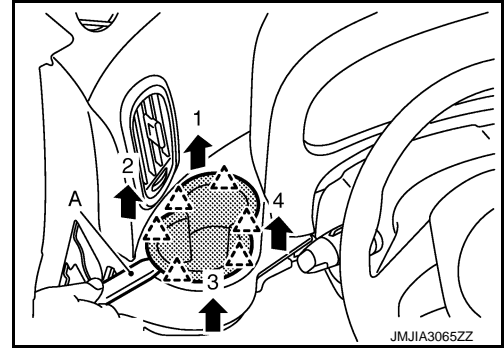

INSTALLATION

Note the following item, and then install in the reverse order of removal.

CAUTION:

- **Never use the steering wheel mounting nut after removal, replace with the new nut.**
- **Never use the passenger air bag module mounting bolts after removal, replace with the new bolts.**

A
B
C
D
E
F
G
H
I
IP
K
L
M
N
O
P

CENTER CONSOLE ASSEMBLY

< REMOVAL AND INSTALLATION >



CENTER CONSOLE ASSEMBLY

Exploded View

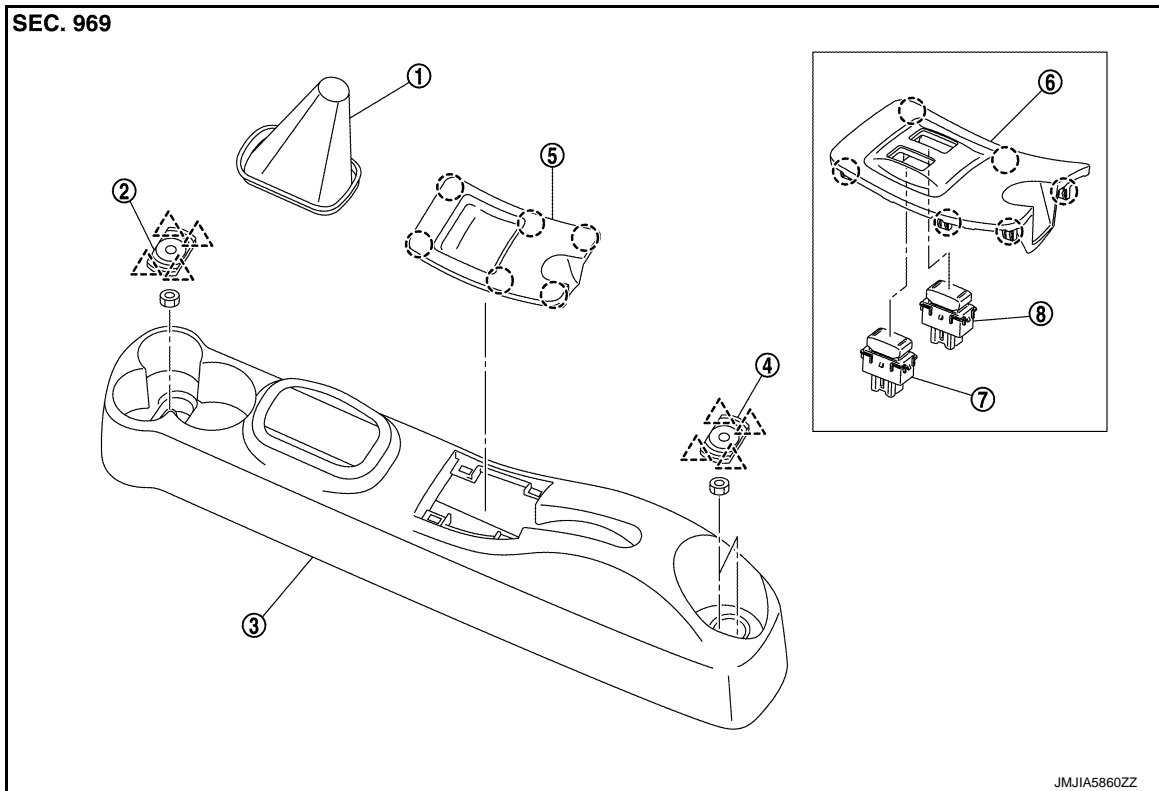
INFOID:000000007772072



- | | | |
|-----------------------------|---------------------------------------|------------------------------------|
| 1. Console boot (MT models) | 2. Front console cover | 3. Center console assembly |
| 4. Rear console cover | 5. Console mask (without heated seat) | 6. Console mask (with heated seat) |
| 7. Heated seat switch LH | 8. Heated seat switch RH | |

-  : Clip
-  : Pawl

Removal and Installation

INFOID:000000007772073

REMOVAL

1. Put selector lever in "N" position (CVT models).
2. Remove shift knob (MT models). Refer to [TM-18, "Removal and Installation"](#).
3. Remove front console cover.
 1. Remove front console cover with a flat-bladed screwdriver (A) wrapped in a tape.
 2. Pull up front console cover.

-  : Pawl

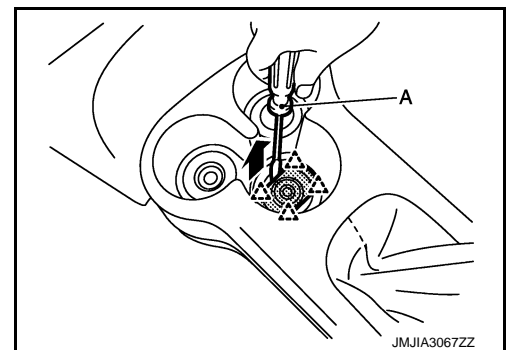

4. Remove mounting nut of center console front side.

CENTER CONSOLE ASSEMBLY

< REMOVAL AND INSTALLATION >

5. Remove rear console cover.
 1. Remove rear console cover with hook and pick tool (A) as shown in the figure.
 2. Pull up rear console cover.

 : Pawl

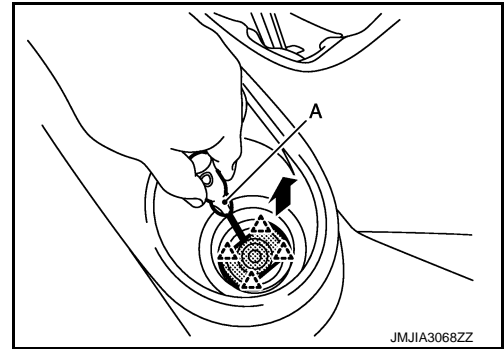

6. Remove mounting nuts of center console rear side.
7. Insert a deep-well socket wrench (A) to rotate adjusting nut to loosen cable sufficiently. Refer to [PB-3, "Inspection and Adjustment"](#).

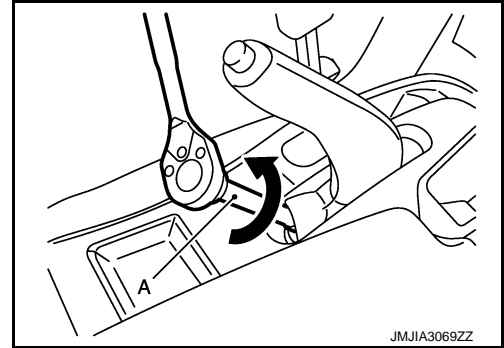

8. Remove console mask.
 1. Pull upward to console mask fixing clips from center console with remover tool (A).
 2. Disconnect seat heated switch harness connectors (models with heated seat system).

 : Clip

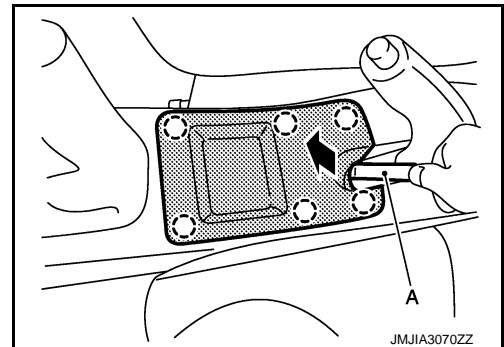

9. Lift up center console assembly back side, and then remove center console assembly.

INSTALLATION

Note the following item, and then install in the reverse order of removal.

CAUTION:

After installation, adjust the parking brake lever stroke. Refer to [PB-3, "Inspection and Adjustment"](#).

A
B
C
D
E
F
G
H
I
IP
K
L
M
N
O
P