

SECTION **BCS**

BODY CONTROL SYSTEM

A
B
C
D
E
F
G
H
I
J
K
L
N
O
P

CONTENTS

BASIC INSPECTION	3	DOOR LOCK	17
INSPECTION AND ADJUSTMENT	3	DOOR LOCK : CONSULT-III Function (BCM - DOOR LOCK)	17
ADDITIONAL SERVICE WHEN REPLACING CONTROL UNIT (BCM)	3	REAR WINDOW DEFOGGER	18
ADDITIONAL SERVICE WHEN REPLACING CONTROL UNIT (BCM) : Description	3	REAR WINDOW DEFOGGER : CONSULT-III Function (BCM - REAR DEFOGGER)	18
ADDITIONAL SERVICE WHEN REPLACING CONTROL UNIT (BCM) : Work Procedure	3	BUZZER	19
CONFIGURATION (BCM)	3	BUZZER : CONSULT-III Function (BCM - BUZZER)	19
CONFIGURATION (BCM) : Description	3	INT LAMP	19
CONFIGURATION (BCM) : Work Procedure	4	INT LAMP : CONSULT-III Function (BCM - INT LAMP)	20
CONFIGURATION (BCM) : Configuration list	5	HEADLAMP	21
SYSTEM DESCRIPTION	6	HEADLAMP : CONSULT-III Function (BCM - HEAD LAMP)	21
BODY CONTROL SYSTEM	6	WIPER	23
System Description	6	WIPER : CONSULT-III Function (BCM - WIPER).....	23
Component Parts Location	7	FLASHER	24
COMBINATION SWITCH READING SYSTEM	8	FLASHER : CONSULT-III Function (BCM - FLASHER)	24
System Diagram	8	INTELLIGENT KEY	25
System Description	8	INTELLIGENT KEY : CONSULT-III Function (BCM - INTELLIGENT KEY)	25
Component Parts Location	11	COMB SW	28
SIGNAL BUFFER SYSTEM	12	COMB SW : CONSULT-III Function (BCM - COMB SW)	28
System Diagram	12	BCM	29
System Description	12	BCM : CONSULT-III Function (BCM - BCM)	29
POWER CONSUMPTION CONTROL SYSTEM	13	IMMU	29
System Diagram	13	IMMU : CONSULT-III Function (BCM - IMMU)	30
System Description	13	BATTERY SAVER	30
Component Parts Location	15	BATTERY SAVER : CONSULT-III Function (BCM - BATTERY SAVER)	30
DIAGNOSIS SYSTEM (BCM)	16		
COMMON ITEM	16		
COMMON ITEM : CONSULT-III Function (BCM - COMMON ITEM)	16		

BCS

TRUNK	31	POWER SUPPLY AND GROUND CIRCUIT	41
TRUNK : CONSULT-III Function (BCM - TRUNK)..	31	Diagnosis Procedure	41
THEFT ALM	32	COMBINATION SWITCH INPUT CIRCUIT	42
THEFT ALM : CONSULT-III Function (BCM -		Diagnosis Procedure	42
THEFT)	32	COMBINATION SWITCH OUTPUT CIRCUIT ...	44
RETAIND PWR	33	Diagnosis Procedure	44
RETAIND PWR : CONSULT-III Function (BCM -		ECU DIAGNOSIS INFORMATION	46
RETAINED PWR)	33	BCM (BODY CONTROL MODULE)	46
SIGNAL BUFFER	33	Reference Value	46
SIGNAL BUFFER : CONSULT-III Function (BCM		Wiring Diagram - BCM -	70
- SIGNAL BUFFER)	33	Fail-safe	76
AIR PRESSURE MONITOR	33	DTC Inspection Priority Chart	78
AIR PRESSURE MONITOR : Diagnosis Descrip-		DTC Index	80
tion	34	SYMPTOM DIAGNOSIS	83
AIR PRESSURE MONITOR : CONSULT-III Func-		COMBINATION SWITCH SYSTEM SYMP-	
tion (BCM - AIR PRESSURE MONITOR)	35	TOMS	83
DTC/CIRCUIT DIAGNOSIS	37	Symptom Table	83
U1000 CAN COMM CIRCUIT	37	PRECAUTION	84
Description	37	PRECAUTIONS	84
DTC Logic	37	Precaution for Supplemental Restraint System	
Diagnosis Procedure	37	(SRS) "AIR BAG" and "SEAT BELT PRE-TEN-	
U1010 CONTROL UNIT (CAN)	38	SIONER"	84
DTC Logic	38	REMOVAL AND INSTALLATION	85
Diagnosis Procedure	38	BCM (BODY CONTROL MODULE)	85
U0415 VEHICLE SPEED SIG	39	Exploded View	85
Description	39	Removal and Installation	85
DTC Logic	39	COMBINATION SWITCH	86
Diagnosis Procedure	39	Exploded View	86
B2562 LOW VOLTAGE	40	Removal and Installation	86
DTC Logic	40		
Diagnosis Procedure	40		

INSPECTION AND ADJUSTMENT

< BASIC INSPECTION >

BASIC INSPECTION

INSPECTION AND ADJUSTMENT

ADDITIONAL SERVICE WHEN REPLACING CONTROL UNIT (BCM)

ADDITIONAL SERVICE WHEN REPLACING CONTROL UNIT (BCM) : Description

INFOID:000000004922440

BEFORE REPLACEMENT

When replacing BCM, save or print current vehicle specification with CONSULT-III configuration before replacement.

NOTE:

If "READ CONFIGURATION" can not be used, use the "WRITE CONFIGURATION - Manual selection" after replacing BCM.

AFTER REPLACEMENT

CAUTION:

- When replacing BCM, you must perform "WRITE CONFIGURATION" with CONSULT-III.
- Complete the procedure of "WRITE CONFIGURATION" in order.
- If you set incorrect "WRITE CONFIGURATION", incidents might occur.
- Configuration is different for each vehicle model. Confirm configuration of each vehicle model.
- When replacing BCM, perform the system initialization (NATS).

ADDITIONAL SERVICE WHEN REPLACING CONTROL UNIT (BCM) : Work Procedure

INFOID:000000004922441

1. SAVING VEHICLE SPECIFICATION

CONSULT-III Configuration

Perform "READ CONFIGURATION" to save or print current vehicle specification. Refer to [BCS-3, "CONFIGURATION \(BCM\) : Description"](#).

NOTE:

If "READ CONFIGURATION" can not be used, use the "WRITE CONFIGURATION - Manual selection" after replacing BCM.

>> GO TO 2.

2. REPLACE BCM

Replace BCM. Refer to [BCS-85, "Exploded View"](#).

>> GO TO 3.

3. WRITING VEHICLE SPECIFICATION

CONSULT-III Configuration

Perform "WRITE CONFIGURATION - Config file" or "WRITE CONFIGURATION - Manual selection" to write vehicle specification. Refer to [BCS-4, "CONFIGURATION \(BCM\) : Work Procedure"](#).

>> GO TO 4.

4. INITIALIZE BCM (NATS)

Perform BCM initialization. (NATS)

>> WORK END

CONFIGURATION (BCM)

CONFIGURATION (BCM) : Description

INFOID:000000004922442

Vehicle specification needs to be written with CONSULT-III because it is not written after replacing BCM.

A
B
C
D
E
F
G
H
I
J
K
L

BCS

N
O
P

INSPECTION AND ADJUSTMENT

< BASIC INSPECTION >

Configuration has three functions as follows.

Function	Description
READ CONFIGURATION	<ul style="list-style-type: none">• Reads the vehicle configuration of current BCM.• Saves the read vehicle configuration.
WRITE CONFIGURATION - Manual selection	Writes the vehicle configuration with manual selection.
WRITE CONFIGURATION - Config file	Writes the vehicle configuration with saved data.

NOTE:

Manual setting item: Items which need selection by vehicle specifications

Automatic setting item: Items which are written in automatically (Setting can not be changed)

CAUTION:

- When replacing BCM, you must perform “WRITE CONFIGURATION” with CONSULT-III.
- Complete the procedure of “WRITE CONFIGURATION” in order.
- If you set incorrect “WRITE CONFIGURATION”, incidents might occur.
- Configuration is different for each vehicle model. Confirm configuration of each vehicle model.
- Never perform “WRITE CONFIGURATION” except for new BCM.

CONFIGURATION (BCM) : Work Procedure

INFOID:000000004922443

1. WRITING MODE SELECTION

ⓅCONSULT-III Configuration

Select “CONFIGURATION” of BCM.

When writing saved data>>GO TO 2.

When writing manually>>GO TO 3.

2. PERFORM “WRITE CONFIGURATION - CONFIG FILE”

ⓅCONSULT-III Configuration

Perform “WRITE CONFIGURATION - Config file”.

>> WORK END

3. PERFORM “WRITE CONFIGURATION - MANUAL SELECTION”

ⓅCONSULT-III Configuration

1. Select “WRITE CONFIGURATION - Manual selection”.
2. Identify the correct model and configuration list. Refer to [BCS-5. “CONFIGURATION \(BCM\) : Configuration list”](#).
3. Confirm and/or change setting value for each item.
CAUTION:
Thoroughly read and understand the vehicle specification. Incorrect settings may result in abnormal control of ECU.
4. Select “SETTING”.
CAUTION:
Make sure to select “SETTING” even if the indicated configuration of brand new BCM is same as the desirable configuration. If not, configuration which is set automatically by selecting vehicle model can not be memorized.
5. When “COMMAND FINISHED”, select “END”.

>> GO TO 4.

4. OPERATION CHECK

Confirm that each function controlled by BCM operates normally.

>> WORK END

INSPECTION AND ADJUSTMENT

< BASIC INSPECTION >

CONFIGURATION (BCM) : Configuration list

INFOID:000000004345173

CAUTION:

Thoroughly read and understand the vehicle specification. Incorrect settings may result in abnormal control of ECU.

MANUAL SETTING ITEM		NOTE
Items	Setting value	
AUTO LIGHT	WITH ⇔ WITHOUT	—
DTRL	WITH ⇔ WITHOUT	<ul style="list-style-type: none"> • WITH: With daytime running light system • WITHOUT: Without daytime running light system

⇔: Items which confirm vehicle specifications

AUTO SETTING ITEM		NOTE
Items	Setting value	
UNLOCK WITH SHOCK	WITHOUT	—
AUTO DOOR LOCK SPEED	MODE2	—
P-POS WARN	MODE1	—
Trunk/Glass Hatch select	Glass Hatch	“Glass Hatch” is indicated also for vehicles without a glass hatch.
PANIC ALM TYPE	MODE1	—
TR OPEN SW (INT)	MODE1	—
WELCOME LIGHT TIMER	MODE2	—
H/L BULB	DEFAULT	—
FR FOG LAMP	WITH	—
RR FOG LAMP	WITH	“WITH” is indicated also for vehicles without a rear fog lamp.
DI LMP VARIAT	MODE2	—
LIGHT RECOG	MODE4	—
TRANSMISSION	AT with ABS	—
RAIN SENSOR CONFIG	WITHOUT	—
REAR WIPER	WITH	—
THEFT ALM AREA	MODE2	—
H/L WASHER	MODE1	—
BCM AC CONTROL	MODE1	—
WELCOME LIGHT TIMER2	MODE4	—
TPMS	WITH	—
TIRE PRESSURE	230kPa	—
FR FOG LOGIC	MODE1	—
AUTO LOCK&UNLOCK FUNC	WITH	—
AUTO DOOR LOCK SELECT	WITH	—
AUTO DOOR UNLOCK SELECT	WITH	—
FOG ON WITH AUTO LIGHT	WITHOUT	—
Key Fob Type	MODE9	—
DROP WIP FUNCTION	WITH	—
WELCOME LIGHT OP SET	WITH	—

BODY CONTROL SYSTEM

< SYSTEM DESCRIPTION >

SYSTEM DESCRIPTION

BODY CONTROL SYSTEM

System Description

INFOID:000000004345174

OUTLINE

- BCM (Body Control Module) controls the various electrical components. It inputs the information required to the control from CAN communication and the signal received from each switch and sensor.
- BCM has combination switch reading function for reading the operation status of combination switches (light, turn signal, wiper and washer) in addition to a function for controlling the operation of various electrical components. It also has the signal transmission function as the passed point of signal and the power saving control function that reduces the power consumption with the ignition switch OFF.
- BCM is equipped with the diagnosis function that performs the diagnosis with CONSULT-III and various settings.

BCM CONTROL FUNCTION LIST

System	Reference
Combination switch reading system	BCS-8, "System Diagram"
Signal buffer system	BCS-12, "System Diagram"
Power consumption control system	BCS-13, "System Diagram"
Auto light system	<ul style="list-style-type: none"> • EXL-14, "System Diagram" (Xenon type headlamp) • EXL-214, "System Diagram" (Halogen type headlamp)
Turn signal and hazard warning lamp system	<ul style="list-style-type: none"> • EXL-26, "System Diagram" (Xenon type headlamp) • EXL-222, "System Diagram" (Halogen type headlamp)
Headlamp system	<ul style="list-style-type: none"> • EXL-11, "System Diagram" (Xenon type headlamp) • EXL-211, "System Diagram" (Halogen type headlamp)
Parking, license plate and tail lamps system	<ul style="list-style-type: none"> • EXL-28, "System Diagram" (Xenon type headlamp) • EXL-224, "System Diagram" (Halogen type headlamp)
Front fog lamp system	<ul style="list-style-type: none"> • EXL-24, "System Diagram" (Xenon type headlamp) • EXL-220, "System Diagram" (Halogen type headlamp)
Exterior lamp battery saver system	<ul style="list-style-type: none"> • EXL-30, "System Diagram" (Xenon type headlamp) • EXL-226, "System Diagram" (Halogen type headlamp)
Daytime running light system	<ul style="list-style-type: none"> • EXL-17, "System Diagram" (Xenon type headlamp) • EXL-217, "System Diagram" (Halogen type headlamp)
Interior room lamp control system	INL-5, "System Diagram"
Step lamp system	
Interior room lamp battery saver system	INL-9, "System Diagram"
Front wiper and washer system	WW-5, "System Diagram"
Rear wiper and washer system	WW-10, "System Diagram"
Warning chime system	WCS-5, "WARNING CHIME SYSTEM : System Diagram"
Door lock system	DLK-11, "System Diagram"
Infiniti Vehicle Immobilizer System (IVIS) - NATS	SEC-15, "System Diagram"
Vehicle security system	SEC-19, "System Diagram"
Panic alarm	
Automatic drive positioner system	ADP-12, "AUTOMATIC DRIVE POSITIONER SYSTEM : System Diagram"
Rear window defogger system	DEF-4, "System Diagram"

BODY CONTROL SYSTEM

< SYSTEM DESCRIPTION >

System	Reference	
Intelligent Key system/engine start system	Door lock unlock function	
	Remote keyless function	
	Back door open function	DLK-15, "INTELLIGENT KEY SYSTEM : System Diagram"
	Warning function	
	Key reminder function	
	Engine start function	
Power window system	PWC-7, "System Diagram"	
Retained accessory power (RAP) system	PWC-7, "System Description"	
Tire pressure monitor system (TPMS) - AIR PRESSURE MONITOR	WT-9, "System Diagram"	

Component Parts Location

INFOID:000000004345175

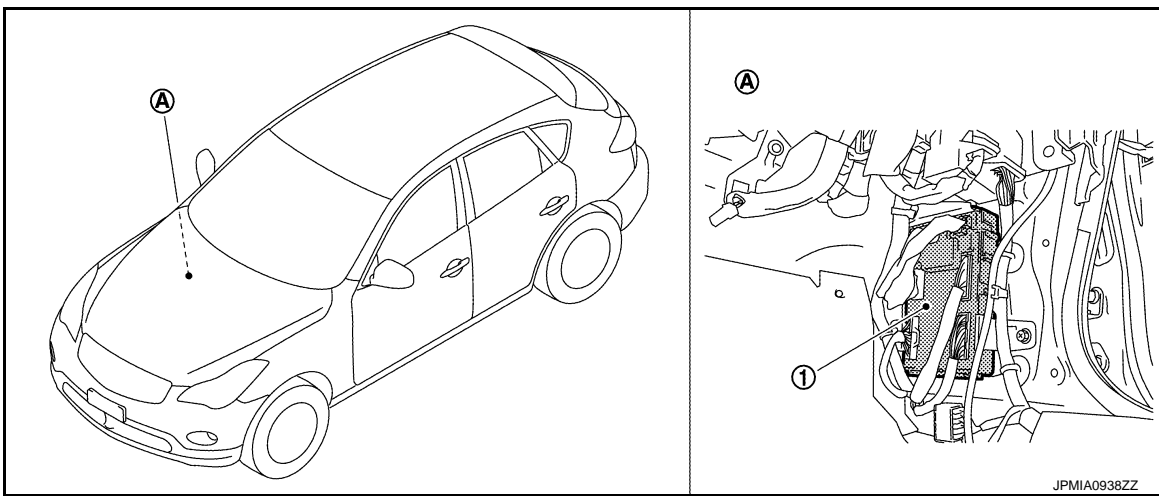

- 1. BCM
- A. Dash side lower (passenger side)

BCS

COMBINATION SWITCH READING SYSTEM

< SYSTEM DESCRIPTION >

COMBINATION SWITCH READING SYSTEM

System Diagram

INFOID:000000004345176

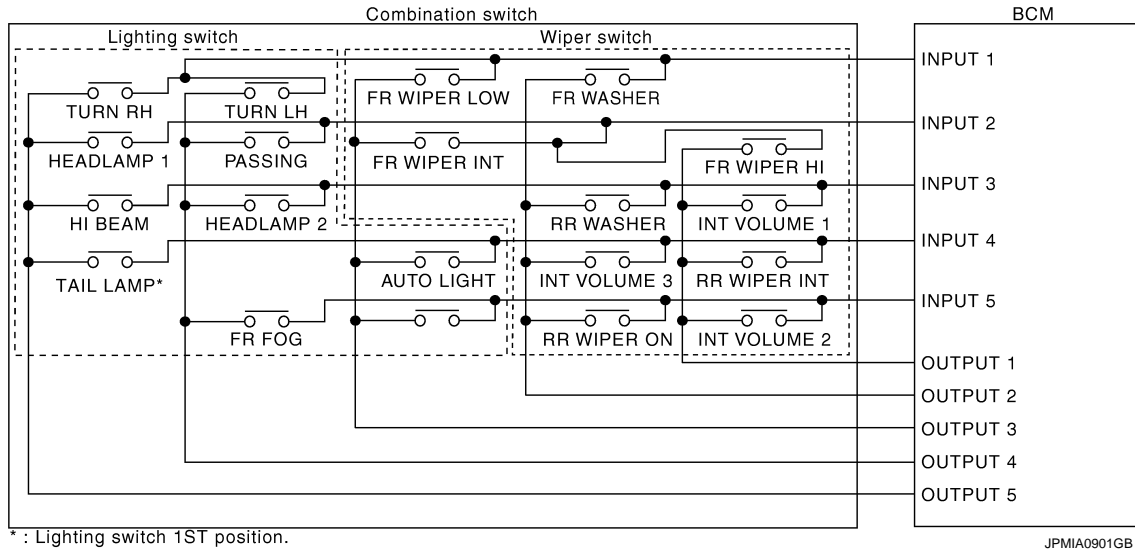

System Description

INFOID:000000004345177

OUTLINE

- BCM reads the status of the combination switch (light, turn signal, wiper and washer) and recognizes the status of each switch.
- BCM is a combination of 5 output terminals (OUTPUT 1 - 5) and 5 input terminals (INPUT 1 - 5). It reads a maximum of 20 switch status.

COMBINATION SWITCH MATRIX

Combination switch circuit

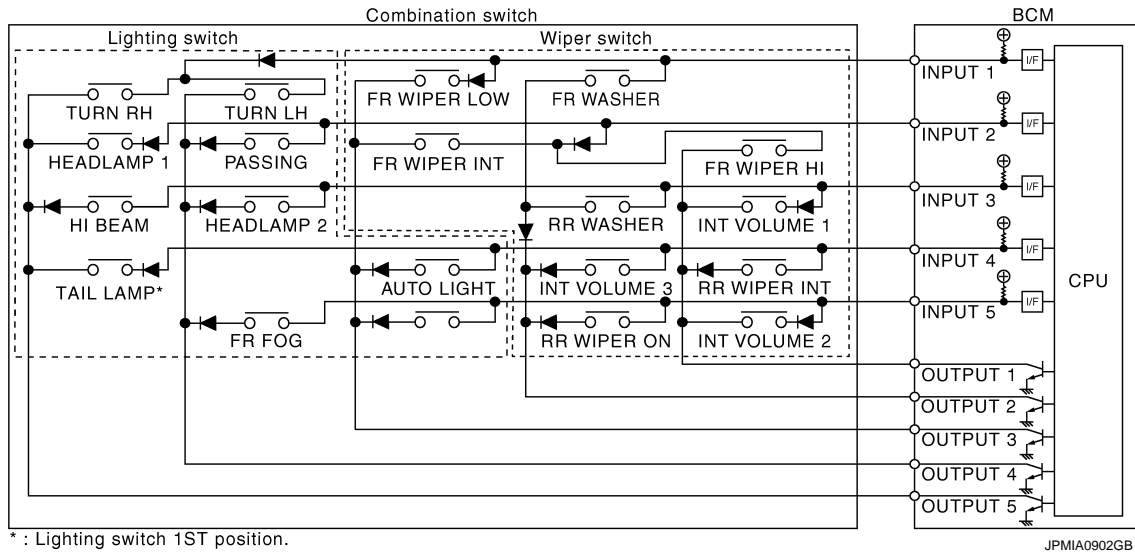

Combination switch INPUT-OUTPUT system list

System	OUTPUT 1	OUTPUT 2	OUTPUT 3	OUTPUT 4	OUTPUT 5
INPUT 1	—	FR WASHER	FR WIPER LOW	TURN LH	TURN RH
INPUT 2	FR WIPER HI	—	FR WIPER INT	PASSING	HEADLAMP 1
INPUT 3	INT VOLUME 1	RR WASHER	—	HEADLAMP 2	HI BEAM

COMBINATION SWITCH READING SYSTEM

< SYSTEM DESCRIPTION >

System	OUTPUT 1	OUTPUT 2	OUTPUT 3	OUTPUT 4	OUTPUT 5
INPUT 4	RR WIPER INT	INT VOLUME 3	AUTO LIGHT	—	TAIL LAMP
INPUT 5	INT VOLUME 2	RR WIPER ON	—	FR FOG	—

NOTE:

Headlamp has a dual system switch.

COMBINATION SWITCH READING FUNCTION

Description

- BCM reads the status of the combination switch at 10 ms interval normally.

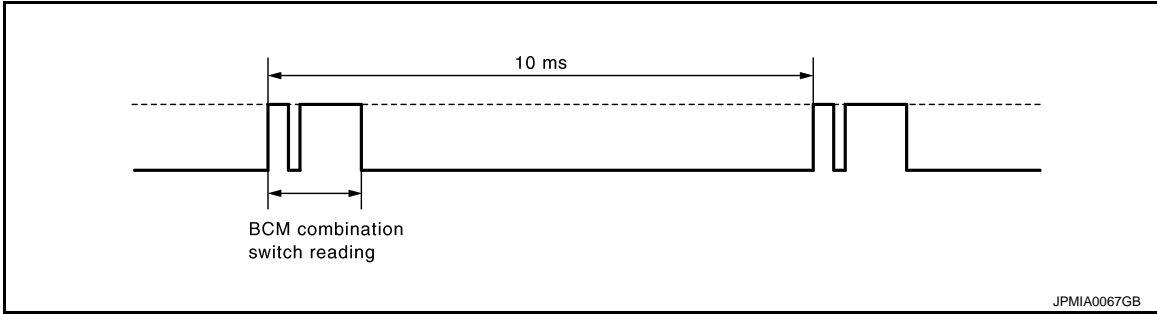

NOTE:

BCM reads the status of the combination switch at 60 ms interval when BCM is controlled at low power consumption mode.

- BCM operates as follows and judges the status of the combination switch.
 - INPUT 1 - 5 outputs the voltage waveforms of 5 systems simultaneously.
 - It operates the transistor on OUTPUT side in the following order: OUTPUT 5 → 4 → 3 → 2 → 1.
 - The voltage waveform of INPUT corresponding to the formed circuit changes according to the operation of the transistor on OUTPUT side if any (1 or more) switches are ON.
 - It reads this change of the voltage as the status signal of the combination switch.

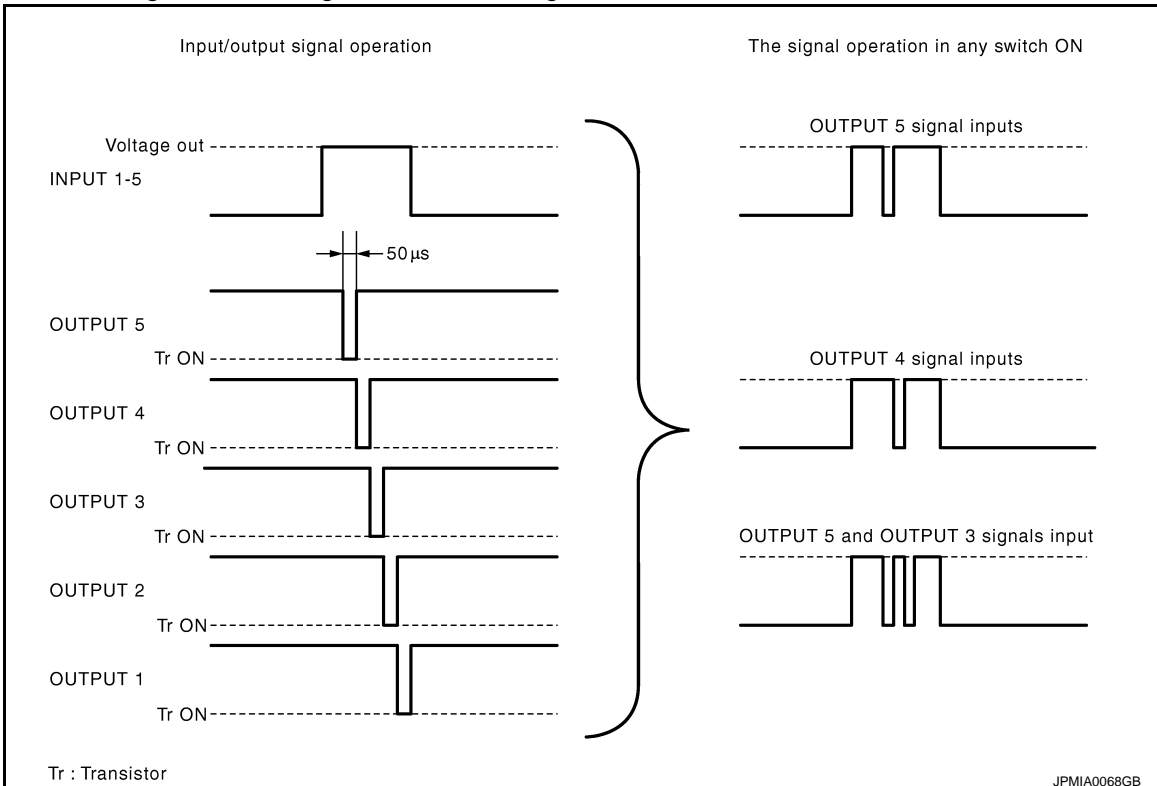

Operation Example

In the following operation example, the combination of the status signals of the combination switch is replaced as follows: INPUT 1 - 5 to "1 - 5" and OUTPUT 1 - 5 to "A - E".

Example 1: When a switch (TURN RH switch) is turned ON

COMBINATION SWITCH READING SYSTEM

< SYSTEM DESCRIPTION >

- The circuit between INPUT 1 and OUTPUT 5 is formed when the TURN RH switch is turned ON.

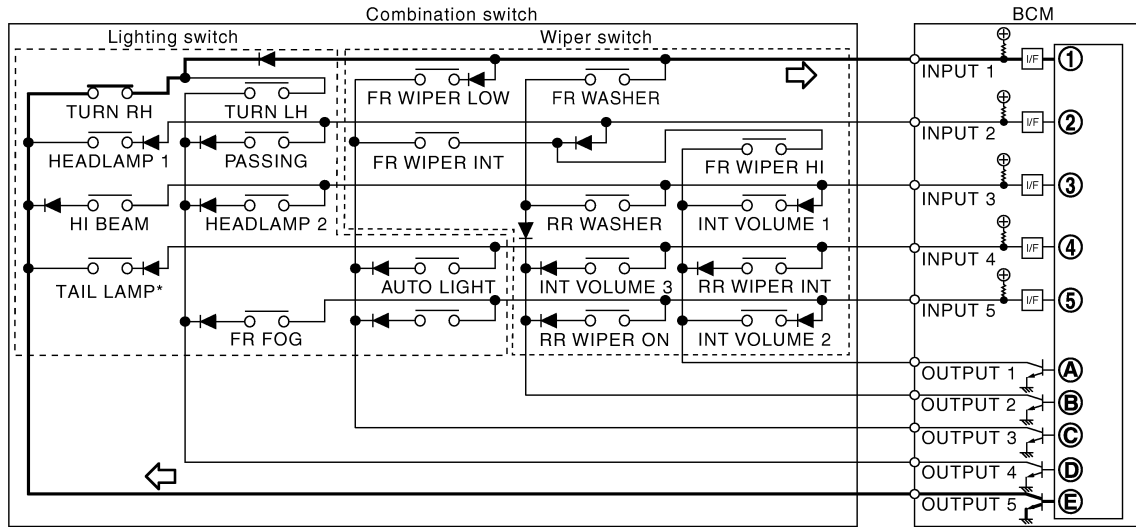

* : Lighting switch 1ST position.

JPMIA0903GB

- BCM detects the combination switch status signal "1E" when the signal of OUTPUT 5 is input to INPUT 1.
- BCM judges that the TURN RH switch is ON when the signal "1E" is detected.

Example 2: When some switches (turn RH switch, front wiper LO switch) are turned ON

- The circuits between INPUT 1 and OUTPUT 5 and between INPUT 1 and OUTPUT 3 are formed when the TURN RH switch and FR WIPER LOW switch are turned ON.

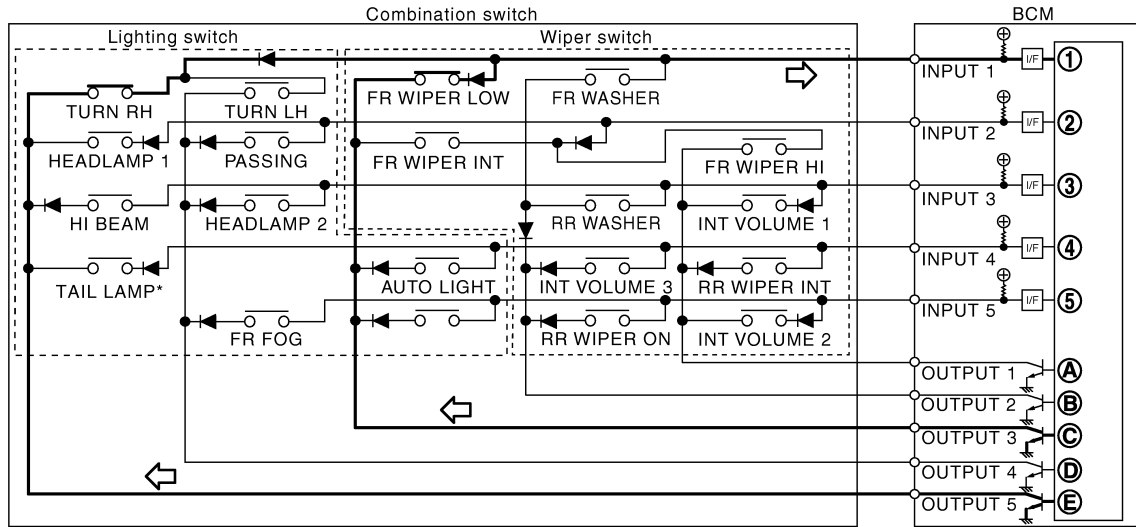

* : Lighting switch 1ST position.

JPMIA0904GB

- BCM detects the combination switch status signal "1CE" when the signals of OUTPUT 3 and OUTPUT 5 are input to INPUT 1.
- BCM judges that the TURN RH switch and FR WIPER LOW switch are ON when the signal "1CE" is detected.

WIPER INTERMITTENT DIAL POSITION

BCM judges the wiper intermittent dial 1 - 7 by the status of INT VOLUME 1, 2 and 3 switches.

Wiper intermittent dial position	Switch status		
	INT VOLUME 1	INT VOLUME 2	INT VOLUME 3
1	ON	ON	ON
2	ON	ON	OFF
3	ON	OFF	OFF
4	OFF	OFF	OFF
5	OFF	OFF	ON

COMBINATION SWITCH READING SYSTEM

< SYSTEM DESCRIPTION >

Wiper intermittent dial position	Switch status		
	INT VOLUME 1	INT VOLUME 2	INT VOLUME 3
6	OFF	ON	ON
7	OFF	ON	OFF

NOTE:

For details of wiper intermittent dial position, refer to [WW-5. "System Description"](#).

Component Parts Location

INFOID:000000004345178

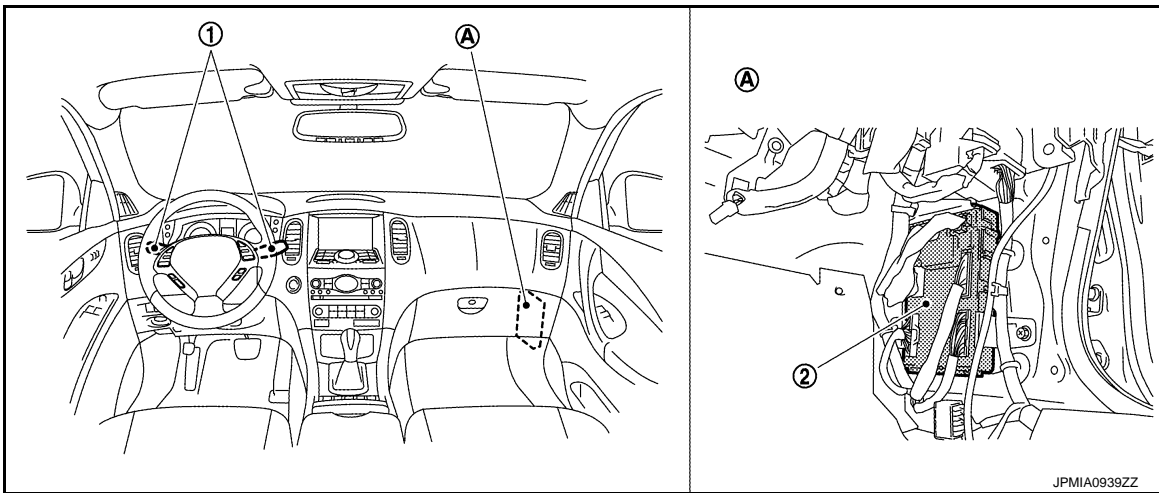

- 1. Combination switch
- 2. BCM
- A. Dash side lower (Passenger side)

A
B
C
D
E
F
G
H
I
J
K
L

BCS

N
O
P

SIGNAL BUFFER SYSTEM

< SYSTEM DESCRIPTION >

SIGNAL BUFFER SYSTEM

System Diagram

INFOID:000000004345179

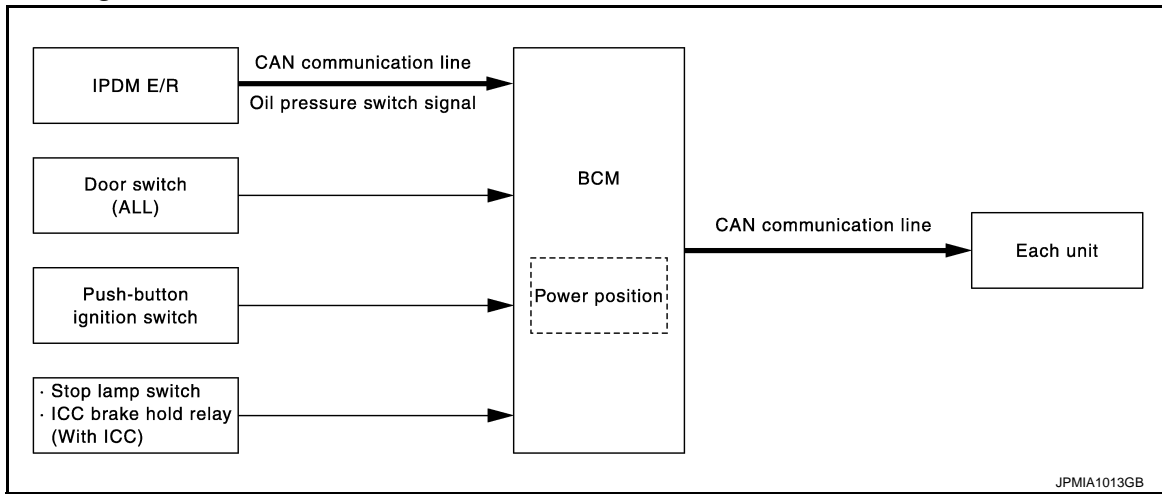

System Description

INFOID:000000004345180

OUTLINE

BCM has the signal transmission function that outputs/transmits each input/received signal to each unit.

Signal transmission function list

Signal name	Input	Output	Description
<ul style="list-style-type: none"> Ignition switch ON signal Ignition switch signal 	Push-button ignition switch (push switch)	<ul style="list-style-type: none"> IPDM E/R (CAN) Driver seat control unit (CAN) 	Inputs the push-button ignition switch (push switch) signal and transmits the ignition switch status judged with BCM via CAN communication.
Door switch signal	Any door switch	<ul style="list-style-type: none"> Combination meter (via unified meter and A/C amp.) (CAN) IPDM E/R (CAN) Driver seat control unit (CAN) 	Inputs the door switch signal and transmits it via CAN communication.
Oil pressure switch signal	IPDM E/R (CAN)	Combination meter (via unified meter and A/C amp.) (CAN)	Transmits the received oil pressure switch signal via CAN communication.
Stop lamp switch signal	<ul style="list-style-type: none"> Stop lamp switch ICC brake hold relay (With ICC) 	TCM (CAN)	Inputs the stop lamp switch 1 signal and stop lamp switch 2 signal, and transmits it via CAN communication.

POWER CONSUMPTION CONTROL SYSTEM

< SYSTEM DESCRIPTION >

POWER CONSUMPTION CONTROL SYSTEM

System Diagram

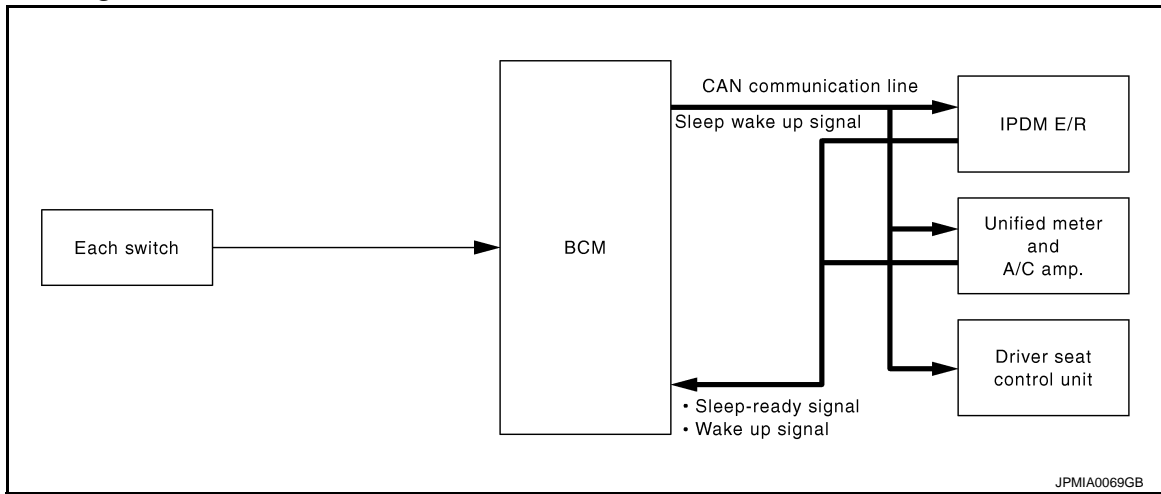

System Description

INFOID:000000004345182

OUTLINE

- BCM incorporates a power saving control function that reduces the power consumption according to the vehicle status.
- BCM switches the status (control mode) by itself with the power saving control function. It performs the sleep request to each unit [IPDM E/R, combination meter (unified meter and A/C amp.) and driver seat control unit] that operates with the ignition switch OFF.

Normal mode (wake-up)

- CAN communication is normally performed with other units
- Each control with BCM is operating properly

CAN communication sleep mode (CAN sleep)

- CAN transmission is stopped
- Control with BCM only is operating

Low power consumption mode (BCM sleep)

- Low power consumption control is active
- CAN transmission is stopped

LOW POWER CONSUMPTION CONTROL WITH BCM

BCM reduces the power consumption with the following operation in the low power consumption mode.

- The reading interval of the each switches changes from 10 ms interval to 60 ms interval.

Sleep mode activation

- BCM receives the sleep-ready signal (ready) from IPDM E/R and unified meter and A/C amp. via CAN communication.
- BCM transmits the sleep wake up signal (sleep) to each unit when all of the CAN sleep conditions are fulfilled.
- Each unit stops the transmission of CAN communication with the sleep wake up signal. BCM is in CAN communication sleep mode.
- BCM is in the low power consumption mode and perform the low power consumption control when all of the BCM sleep conditions are fulfilled with CAN sleep condition.

A
B
C
D
E
F
G
H
I
J
K
L
N
O
P

BCS

POWER CONSUMPTION CONTROL SYSTEM

< SYSTEM DESCRIPTION >

Sleep condition

CAN sleep condition	BCM sleep condition
<ul style="list-style-type: none"> • Receiving the sleep-ready signal (ready) from all units • Ignition switch: OFF • Vehicle security system and panic alarm: Not operation • Warning chime: Not operation • Intelligent Key system buzzer: Not operation • Stop lamp switch: OFF • ICC brake hold relay (with ICC): ON • Key slot (card switch) status: No change • Turn signal indicator lamp: Not operation • Exterior lamp: OFF • Door lock status: No change • CONSULT-III communication status: Not communication • Meter display signal: Non-transmission • Door switch status: No change • Rear window defogger: OFF 	<ul style="list-style-type: none"> • Interior room lamp battery saver: Time out • RAP system: OFF • Power window switch communication: No transmission • Push-button ignition switch illumination: OFF • Infiniti Vehicle Immobilizer System (IVIS) - NATS: Not operation • Remote keyless entry receiver communication status: No communication • Tire pressure monitor system (TPMS) - AIR PRESSURE MONITOR: Stop • LOCK indicator lamp: OFF • ACC indicator lamp: OFF • ON indicator lamp: OFF

Wake-up operation

- BCM changes from the low power consumption mode to the CAN communication sleep mode when the any of the BCM wake-up conditions is fulfilled. Only the control with BCM is activated.
- BCM transmits the sleep wake up signal (wake up) to each unit when any of the CAN wake-up conditions is fulfilled. It changes from the low power consumption mode or the CAN communication sleep mode to the normal mode.
- Each unit starts the transmission of CAN communication with the sleep wake up signal. In addition, the unified meter and A/C amp. transmits the wake up signal to BCM via CAN communication to report the CAN communication start.

Wake-up condition

BCM wake-up condition	CAN wake-up condition
<ul style="list-style-type: none"> • Power window switch communication: Receiving • Remote keyless entry receiver communication: Receiving 	<ul style="list-style-type: none"> • Receiving the sleep-ready signal (Not-ready) from any units • Key slot (key switch): OFF → ON, ON → OFF • Push-button ignition switch (push switch): OFF → ON • Hazard switch: OFF → ON • PASSING switch: OFF → ON, ON → OFF • TAIL LAMP switch: OFF → ON • Driver door switch: OFF → ON, ON → OFF • Passenger door switch: OFF → ON, ON → OFF • Rear RH door switch: OFF → ON, ON → OFF • Rear LH door switch: OFF → ON, ON → OFF • Back door switch: OFF → ON, ON → OFF • Driver door request switch: OFF → ON • Passenger door request switch: OFF → ON • Back door opener request switch: OFF → ON • Stop lamp switch: ON • ICC brake hold relay (with ICC): ON

POWER CONSUMPTION CONTROL SYSTEM

< SYSTEM DESCRIPTION >

Component Parts Location

INFOID:000000004345183

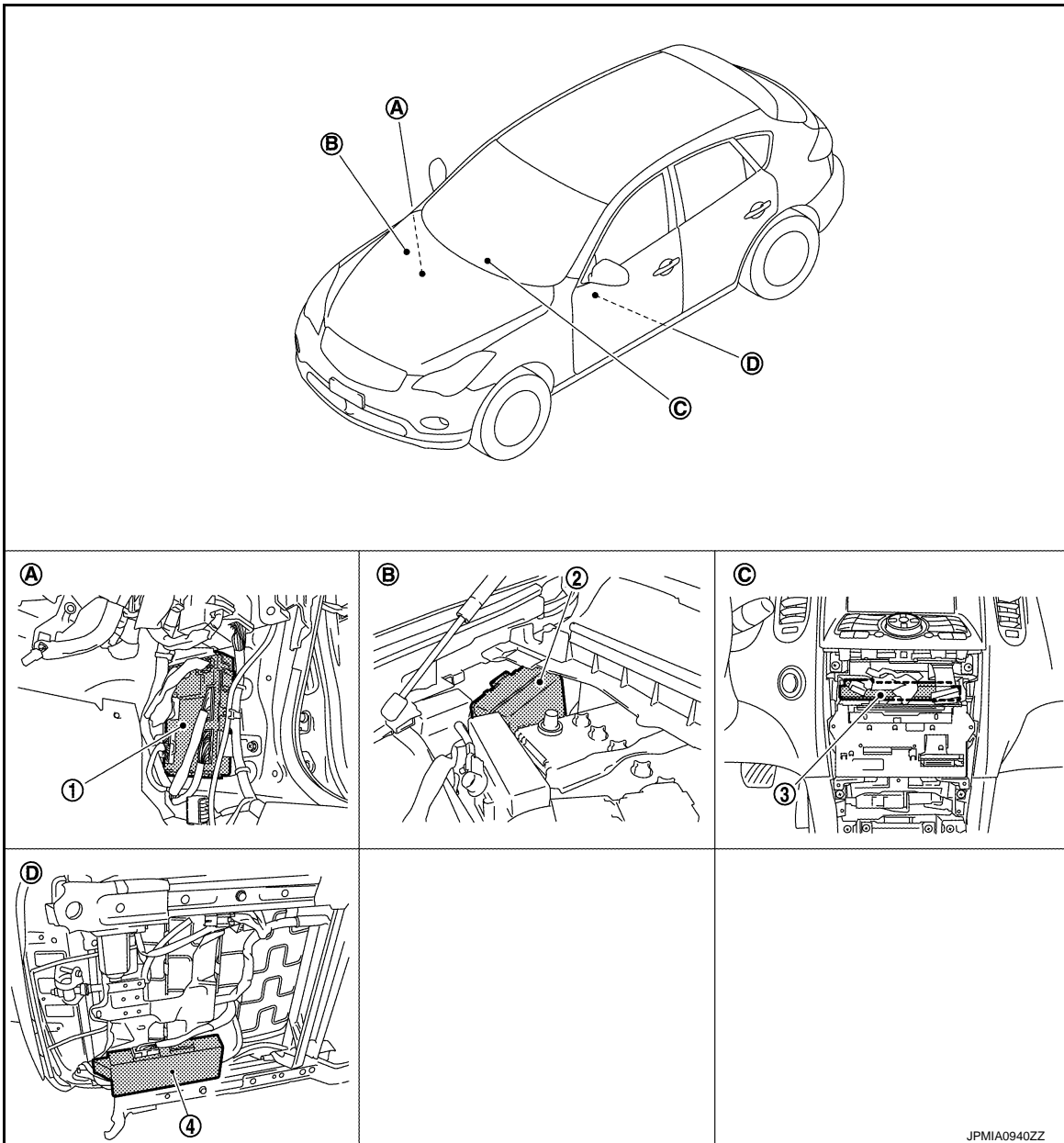

- | | | |
|---|--------------------------------|-------------------------------|
| 1. BCM | 2. IPDM E/R | 3. Unified meter and A/C amp. |
| 4. Driver seat control unit | | |
| A. Dash side lower (passenger side) | B. Engine room dash panel (RH) | C. Behind cluster lid C |
| D. Backside of the seat cushion (driver seat) | | |

JPMIA0940ZZ

BCS

DIAGNOSIS SYSTEM (BCM)

< SYSTEM DESCRIPTION >

DIAGNOSIS SYSTEM (BCM)

COMMON ITEM

COMMON ITEM : CONSULT-III Function (BCM - COMMON ITEM)

INFOID:000000004345184

APPLICATION ITEM

CONSULT-III performs the following functions via CAN communication with BCM.

Diagnosis mode	Function Description
Work Support	Changes the setting for each system function.
Self Diagnostic Result	Displays the diagnosis results judged by BCM.
CAN Diag Support Monitor	Monitors the reception status of CAN communication viewed from BCM. Refer to CONSULT-III operation manual.
Data Monitor	The BCM input/output signals are displayed.
Active Test	The signals used to activate each device are forcibly supplied from BCM.
Ecu Identification	The BCM part number is displayed.
Configuration	<ul style="list-style-type: none"> Read and save the vehicle specification. Write the vehicle specification when replacing BCM.

SYSTEM APPLICATION

BCM can perform the following functions for each system.

NOTE:

It can perform the diagnosis modes except the following for all sub system selection items.

×: Applicable item

System	Sub system selection item	Diagnosis mode		
		Work Support	Data Monitor	Active Test
Door lock	DOOR LOCK	×	×	×
Rear window defogger	REAR DEFOGGER		×	×
Warning chime	BUZZER		×	×
Interior room lamp timer	INT LAMP	×	×	×
Exterior lamp	HEAD LAMP	×	×	×
Wiper and washer	WIPER	×	×	×
Turn signal and hazard warning lamps	FLASHER	×	×	×
—	AIR CONDITONER*			
<ul style="list-style-type: none"> Intelligent Key system Engine start system 	INTELLIGENT KEY	×	×	×
Combination switch	COMB SW		×	
Body control system	BCM	×		
IVIS - NATS	IMMU		×	×
Interior room lamp battery saver	BATTERY SAVER	×	×	×
Back door open system	TRUNK		×	×
Vehicle security system	THEFT ALM	×	×	×
RAP system	RETAINED PWR		×	
Signal buffer system	SIGNAL BUFFER		×	×
TPMS	TPMS (AIR PRESSURE MONITOR)	×	×	×

NOTE:

*: This item is displayed, but is not used.

FREEZE FRAME DATA (FFD)

The BCM records the following vehicle condition at the time a particular DTC is detected, and displays on CONSULT-III.

DIAGNOSIS SYSTEM (BCM)

< SYSTEM DESCRIPTION >

CONSULT screen item	Indication/Unit	Description		
Vehicle Speed	km/h	Vehicle speed of the moment a particular DTC is detected		A
Odo/Trip Meter	km	Total mileage (Odometer value) of the moment a particular DTC is detected		B
Vehicle Condition	SLEEP>LOCK	Power position status of the moment a particular DTC is detected	While turning BCM status from low power consumption mode to normal mode (Power supply position is "LOCK")	C
	SLEEP>OFF		While turning BCM status from low power consumption mode to normal mode (Power supply position is "OFF".)	D
	LOCK>ACC		While turning power supply position from "LOCK" to "ACC"	E
	ACC>ON		While turning power supply position from "ACC" to "IGN"	F
	RUN>ACC		While turning power supply position from "RUN" to "ACC" (Vehicle is stopping and selector lever is except P position.)	G
	CRANK>RUN		While turning power supply position from "CRANKING" to "RUN" (From cranking up the engine to run it)	H
	RUN>URGENT		While turning power supply position from "RUN" to "ACC" (Emergency stop operation)	I
	ACC>OFF		While turning power supply position from "ACC" to "OFF"	J
	OFF>LOCK		While turning power supply position from "OFF" to "LOCK"	K
	OFF>ACC		While turning power supply position from "OFF" to "ACC"	L
	ON>CRANK		While turning power supply position from "IGN" to "CRANKING"	
	OFF>SLEEP		While turning BCM status from normal mode (Power supply position is "OFF".) to low power consumption mode	
	LOCK>SLEEP		While turning BCM status from normal mode (Power supply position is "LOCK".) to low power consumption mode	
	LOCK		Power supply position is "LOCK" (Ignition switch OFF with steering is locked.)	
	OFF		Power supply position is "OFF" (Ignition switch OFF with steering is unlocked.)	
	ACC		Power supply position is "ACC" (Ignition switch ACC)	
ON	Power supply position is "IGN" (Ignition switch ON with engine stopped)			
ENGINE RUN	Power supply position is "RUN" (Ignition switch ON with engine running)			
CRANKING	Power supply position is "CRANKING" (At engine cranking)			
IGN Counter	0 - 39	The number of times that ignition switch is turned ON after DTC is detected <ul style="list-style-type: none"> • The number is 0 when a malfunction is detected now. • The number increases like 1 → 2 → 3...38 → 39 after returning to the normal condition whenever ignition switch OFF → ON. • The number is fixed to 39 until the self-diagnosis results are erased if it is over 39. 		BCS

DOOR LOCK

DOOR LOCK : CONSULT-III Function (BCM - DOOR LOCK)

INFOID:000000004923597

BCM CONSULT-III FUNCTION

CONSULT-III performs the following functions via CAN communication with BCM.

Diagnosis mode	Function Description
WORK SUPPORT	Changes the setting for each system function.
DATA MONITOR	The BCM input/output signals are displayed.
ACTIVE TEST	The signals used to activate each device are forcibly supplied from BCM.

WORK SUPPORT

DIAGNOSIS SYSTEM (BCM)

< SYSTEM DESCRIPTION >

Monitor item	Description
DOOR LOCK-UNLOCK SET	Selective unlock function mode can be changed to operate (WITH) or not operate (WITHOUT) with this mode.
AUTOMATIC DOOR LOCK SELECT	Automatic door lock function mode can be selected from the following in this mode. <ul style="list-style-type: none"> • VH SPD: All doors are locked when vehicle speed more than 24km/h (15MPH) • P RANGE: All doors are locked when shifting the selector lever from P position to other than the P position
AUTOMATIC DOOR UNLOCK SELECT	Automatic door unlock function mode can be selected from the following in the mode. <ul style="list-style-type: none"> • MODE 1: All doors are unlocked when the power supply position is changed from ON to OFF • MODE 2: All doors are unlocked when shifting the selector lever from any position other than the P to P position • MODE 3: Driver side door is unlocked when the power supply position is changed from ON to OFF • MODE 4: Driver side door is unlocked when shifting the selector lever from any position other than the P to P position
AUTOMATIC LOCK/UNLOCK SET	Automatic door lock/unlock function mode can be selected from the following in this mode. <ul style="list-style-type: none"> • Off: non-operational • Unlock Only: door unlock operation only • Lock Only: door lock operation only • Lock/Unlock: lock/unlock operation

DATA MONITOR

Monitor Item	Contents
REQ SW-DR	Indicated [ON/OFF] condition of door request switch (driver side).
REQ SW-AS	Indicated [ON/OFF] condition of door request switch (passenger side).
REQ SW-BD/TR	Indicated [ON/OFF] condition of back door request switch.
DOOR SW-DR	Indicated [ON/OFF] condition of front door switch (driver side).
DOOR SW-AS	Indicated [ON/OFF] condition of front door switch (passenger side).
DOOR SW-RR	Indicated [ON/OFF] condition of rear door switch RH.
DOOR SW-RL	Indicated [ON/OFF] condition of rear door switch LH.
DOOR SW-BK	Indicated [ON/OFF] condition of back door switch.
CDL LOCK SW	Indicated [ON/OFF] condition of lock signal from door lock unlock switch.
CDL UNLOCK SW	Indicated [ON/OFF] condition of unlock signal from door lock unlock switch.
KEY CYL LK-SW	Indicated [ON/OFF] condition of lock signal from door key cylinder.
KEY CYL UN-SW	Indicated [ON/OFF] condition of unlock signal from door key cylinder.

ACTIVE TEST

Test item	Description
DOOR LOCK	This test is able to check door lock/unlock operation. <ul style="list-style-type: none"> • The all door lock actuators are locked when "ALL LCK" on CONSULT-III screen is touched. • The all door lock actuators are unlocked when "ALL UNLK" on CONSULT-III screen is touched. • The door lock actuator (driver side) is unlocked when "DR UNLK" on CONSULT-III screen is touched. • The door lock actuator (passenger side) is unlocked when "AS UNLK" on CONSULT- III screen is touched. • The door lock actuator (rear LH and RH) is unlocked when "OTR ULK" on CONSULT-III screen is touched.

REAR WINDOW DEFOGGER

REAR WINDOW DEFOGGER : CONSULT-III Function (BCM - REAR DEFOGGER)

INFOID:000000004923605

Data monitor

DIAGNOSIS SYSTEM (BCM)

< SYSTEM DESCRIPTION >

Monitor Item	Description
REAR DEF SW	This is displayed even when it is not equipped.
PUSH SW	Indicates [ON/OFF] condition of push switch.

ACTIVE TEST

Test Item	Description
REAR DEFOGGER	This test is able to check rear window defogger operation. Rear window defogger operates when "ON" on CONSULT-III screen is touched.

BUZZER

BUZZER : CONSULT-III Function (BCM - BUZZER)

INFOID:000000004923613

CONSULT-III APPLICATION ITEMS

Test item	Diagnosis mode	Description
BUZZER	Data Monitor	Displays BCM input data in real time.
	Active Test	Operation of electrical loads can be checked by sending driving signal to them.

DATA MONITOR

Display item [Unit]	Description
VEH SPEED 1 [Km/h]	Value of vehicle speed signal received from ABS actuator and electric unit (control unit) with CAN communication line.
PUSH SW [On/Off]	Status of push button ignition switch judged by BCM.
UNLK SEN-DR [On/Off]	Status of unlock sensor judged by BCM.
KEY SW-SLOT [On/Off]	Status of key slot judged by BCM.
TAIL LAMP SW [On/Off]	Status of each switch judged by BCM using the combination switch readout function.
FR FOG SW [On/Off]	Status of front fog lamp switch judged by BCM.
DOOR SW-DR [On/Off]	Status of driver side door switch judged by BCM.

ACTIVE TEST

Display item [Unit]	Description
IGN KEY WARN ALM	The key warning chime operation can be checked by operating the relevant function (On/Off).
SEAT BELT WARN TEST	The seat belt warning chime operation can be checked by operating the relevant function (On/Off).
ID REGIST WARNING	The ID regist warning chime operation can be checked by operating the relevant function (On/Off).
LIGHT WARN ALM	The light warning chime operation can be checked by operating the relevant function (On/Off).

INT LAMP

DIAGNOSIS SYSTEM (BCM)

< SYSTEM DESCRIPTION >

INT LAMP : CONSULT-III Function (BCM - INT LAMP)

INFOID:000000004923609

WORK SUPPORT

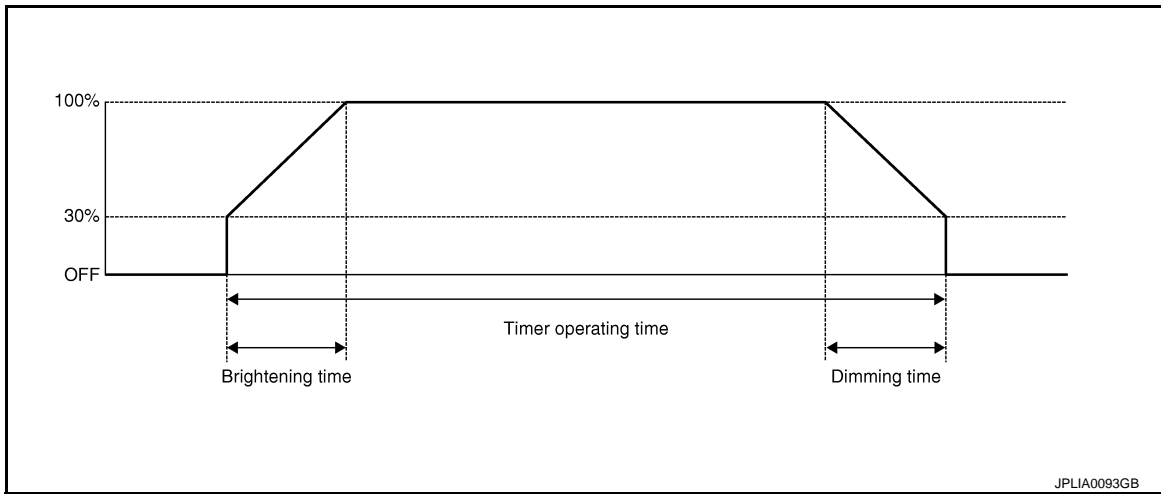

Service item	Setting item	Setting	
SET I/L D-UNLCK INTCON	ON*	With the interior room lamp timer function	
	OFF	Without the interior room lamp timer function	
ROOM LAMP TIMER SET	MODE 2	7.5 sec.	Sets the interior room lamp ON time. (Timer operating time)
	MODE 3*	15 sec.	
	MODE 4	30 sec.	
ROOM LAMP ON TIME SET	MODE 1	0.5 sec.	Sets the interior room lamp gradual brightening time.
	MODE 2*	1 sec.	
	MODE 3	2 sec.	
	MODE 4	3 sec.	
ROOM LAMP OFF TIME SET	MODE 5	0 sec.	Sets the interior room lamp gradual dimming time.
	MODE 1	0.5 sec.	
	MODE 2	1 sec.	
	MODE 3	2 sec.	
	MODE 4*	3 sec.	
R LAMP TIMER LOGIC SET	MODE 5	0 sec.	Sets the interior room lamp gradual dimming time.
	MODE 1*	Interior room lamp timer activates with synchronizing all doors.	
	MODE 2	Interior room lamp timer activates with synchronizing the driver door only.	

*: Initial setting

DATA MONITOR

Monitor item [Unit]	Description
REQ SW-DR [On/Off]	The switch status input from request switch (driver side)
REQ SW-AS [On/Off]	The switch status input from request switch (passenger side)
PUSH SW [On/Off]	The switch status input from push-button ignition switch
KEY SW-SLOT [On/Off]	Key switch status input from key slot

DIAGNOSIS SYSTEM (BCM)

< SYSTEM DESCRIPTION >

Monitor item [Unit]	Description
DOOR SW-DR [On/Off]	The switch status input from front door switch (driver side)
DOOR SW-AS [On/Off]	The switch status input from front door switch (passenger side)
DOOR SW-RR [On/Off]	The switch status input from rear door switch RH
DOOR SW- RL [On/Off]	The switch status input from rear door switch LH
DOOR SW-BK [On/Off]	NOTE: The item is indicated, but not monitored.
CDL LOCK SW [On/Off]	Lock switch status received from central door lock switch by power window switch serial link
CDL UNLOCK SW [On/Off]	Unlock switch status received from central door lock switch by power window switch serial link
KEY CYL LK-SW [On/Off]	Lock switch status received from key cylinder switch by power window switch serial link
KEY CYL UN-SW [On/Off]	Unlock switch status received from key cylinder switch by power window switch serial link
TRNK/HAT MNTR [On/Off]	The switch status input from trunk room lamp switch
RKE-LOCK [On/Off]	Lock signal status received from remote keyless entry receiver
RKE-UNLOCK [On/Off]	Unlock signal status received from remote keyless entry receiver

ACTIVE TEST

Test item	Operation	Description
INT LAMP	On	Outputs the interior room lamp control signal to turn map lamp and personal lamp ON (Map lamp switch is in DOOR position).
	Off	Stops the interior room lamp control signal to turn map lamp and personal lamp OFF.
STEP LAMP TEST	On	Outputs the step lamp control signal to turn step lamp ON.
	Off	Stops the step lamp control signal to turn step lamp OFF.
LUGGAGE LAMP TEST	On	Outputs the trunk room lamp control signal to turn step lamp ON.
	Off	Stops the trunk room lamp control signal to turn step lamp ON.

HEADLAMP

HEADLAMP : CONSULT-III Function (BCM - HEAD LAMP)

INFOID:000000004923607

WORK SUPPORT

Service item	Setting item	Setting
BATTERY SAVER SET	On*	With the exterior lamp battery saver function
	Off	Without the exterior lamp battery saver function

DIAGNOSIS SYSTEM (BCM)

< SYSTEM DESCRIPTION >

Service item	Setting item	Setting
ILL DELAY SET	MODE 1*	45 sec.
	MODE 2	Without the function
	MODE 3	30 sec.
	MODE 4	60 sec.
	MODE 5	90 sec.
	MODE 6	120 sec.
	MODE 7	150 sec.
	MODE 8	180 sec.
CUSTOM A/LIGHT SETTING	MODE 1*	Normal
	MODE 2	More sensitive setting than normal setting (Turns ON earlier than normal operation.)
	MODE 3	More sensitive setting than MODE 2 (Turns ON earlier than MODE 2.)
	MODE 4	Less sensitive setting than normal setting (Turns ON later than normal operation.)

*: Initial setting

DATA MONITOR

Monitor item [Unit]	Description	
PUSH SW [On/Off]	The switch status input from push-button ignition switch	
ENGINE STATE [Stop/Stall/Crank/Run]	The engine status received from ECM with CAN communication	
VEH SPEED 1 [km/h]	The value of the vehicle speed received from unified meter and A/C amp. with CAN communication	
KEY SW-SLOT [On/Off]	Key switch status input from key slot	
TURN SIGNAL R [On/Off]	Each switch status that BCM judges from the combination switch reading function	
TURN SIGNAL L [On/Off]		
TAIL LAMP SW [On/Off]		
HI BEAM SW [On/Off]		
HEAD LAMP SW1 [On/Off]		
HEAD LAMP SW2 [On/Off]		
PASSING SW [On/Off]		
AUTO LIGHT SW [On/Off]		
FR FOG SW [On/Off]		
RR FOG SW [On/Off]		
DOOR SW-DR [On/Off]		The switch status input from front door switch (driver side)
DOOR SW-AS [On/Off]		The switch status input from front door switch (passenger side)

NOTE:
The item is indicated, but not monitored.

DIAGNOSIS SYSTEM (BCM)

< SYSTEM DESCRIPTION >

Monitor item [Unit]	Description
DOOR SW-RR [On/Off]	The switch status input from rear door switch RH
DOOR SW- RL [On/Off]	The switch status input from rear door switch LH
DOOR SW-BK [On/Off]	NOTE: The item is indicated, but not monitored.
OPTICAL SENSOR [V]	The value of exterior brightness voltage input from the optical sensor

ACTIVE TEST

Test item	Operation	Description
TAIL LAMP	On	Transmits the position light request signal to IPDM E/R with CAN communication to turn the tail lamp ON.
	Off	Stops the position light request signal transmission.
HEAD LAMP	Hi	Transmits the high beam request signal with CAN communication to turn the headlamp (HI).
	Low	Transmits the low beam request signal with CAN communication to turn the headlamp (LO).
	Off	Stops the high & low beam request signal transmission.
FR FOG LAMP	On	Transmits the front fog light request signal to IPDM E/R with CAN communication to turn the front fog lamp ON.
	Off	Stops the front fog light request signal transmission.
RR FOG LAMP	On	NOTE:
	Off	The item is indicated, but cannot be tested.
DAYTIME RUNNING LIGHT	On	NOTE:
	Off	The item is indicated, but cannot be tested.
CORNERING LAMP	RH	NOTE:
	LH	The item is indicated, but cannot be tested.
	Off	
ILL DIM SIGNAL	On	NOTE:
	Off	The item is indicated, but cannot be tested.

WIPER

WIPER : CONSULT-III Function (BCM - WIPER)

INFOID:000000004923612

BCS

WORK SUPPORT

Service item	Setting item	Description
WIPER SPEED SETTING	On	With vehicle speed (Front wiper intermittent time linked with the vehicle speed and wiper intermittent dial position)
	Off*	Without vehicle speed (Front wiper intermittent time linked with the wiper intermittent dial position)

*:Factory setting

DATA MONITOR

DIAGNOSIS SYSTEM (BCM)

< SYSTEM DESCRIPTION >

Monitor Item [Unit]	Description
PUSH SW [Off/On]	The switch status input from push-button ignition switch.
VEHICLE SPEED 1 [km/h]	The value of the vehicle speed signal received from unified meter and A/C amp. with CAN communication.
FR WIPER HI [Off/On]	Each switch status that BCM judges from the combination switch reading function.
FR WIPER LOW [Off/On]	
FR WASHER SW [Off/On]	
FR WIPER INT [Off/On]	
FR WIPER STOP [Off/On]	Front wiper motor (stop position) status received from IPDM E/R with CAN communication.
INT VOLUME [1 - 7]	Each switch status that BCM judges from the combination switch reading function.
RR WIPER ON [Off/On]	Each switch status that BCM judges from the combination switch reading function.
RR WIPER INT [Off/On]	
RR WASHER SW [Off/On]	
RR WIPER STOP [Off/On]	Rear wiper motor (stop position) status input from the rear wiper motor.

ACTIVE TEST

Test item	Operation	Description
FR WIPER	Hi	Transmits the front wiper request signal (HI) to IPDM E/R with CAN communication to operate the front wiper HI operation.
	Lo	Transmits the front wiper request signal (LO) to IPDM E/R with CAN communication to operate the front wiper LO operation.
	INT	Transmits the front wiper request signal (INT) to IPDM E/R with CAN communication to operate the front wiper INT operation.
	Off	Stops transmitting the front wiper request signal to stop the front wiper operation.
RR WIPER	On	Outputs the voltage to operate the rear wiper motor.
	Off	Stops the voltage to stop.

FLASHER

FLASHER : CONSULT-III Function (BCM - FLASHER)

INFOID:000000004923608

WORK SUPPORT

Service item	Setting item	Setting
HAZARD ANSWER BACK	Lock Only*	With locking only
	Unlk Only	With unlocking only
	Lock/Unlk	With locking/unlocking
	Off	Without the function
		Sets the hazard warning lamp answer back function when the door is lock/unlock with the request switch or the key fob.

*: Initial setting

DATA MONITOR

DIAGNOSIS SYSTEM (BCM)

< SYSTEM DESCRIPTION >

Monitor item [Unit]	Description
REQ SW-DR [On/Off]	The switch status input from the request switch (driver side)
REQ SW-AS [On/Off]	The switch status input from the request switch (passenger side)
PUSH SW [On/Off]	The switch status input from the push-button ignition switch
TURN SIGNAL R [On/Off]	Each switch condition that BCM judges from the combination switch reading function
TURN SIGNAL L [On/Off]	
HAZARD SW [On/Off]	The switch status input from the hazard switch
RKE-LOCK [On/Off]	Lock signal status received from the remote keyless entry receiver
RKE-UNLOCK [On/Off]	Unlock signal status received from the remote keyless entry receiver
RKE-PANIC [On/Off]	Panic alarm signal status received from the remote keyless entry receiver

ACTIVE TEST

Test item	Operation	Description
FLASHER	RH	Outputs the voltage to blink the right side turn signal lamps.
	LH	Outputs the voltage to blink the left side turn signal lamps.
	Off	Stops the voltage to turn the turn signal lamps OFF.

INTELLIGENT KEY

INTELLIGENT KEY : CONSULT-III Function (BCM - INTELLIGENT KEY)

INFOID:000000004923598

WORK SUPPORT

Monitor item	Description
CONFIRM KEY FOB ID	It can be checked whether Intelligent Key ID code is registered or not in this mode.
AUTO LOCK SET	Auto door lock time can be changed in this mode. <ul style="list-style-type: none"> • MODE 1: 1 minute • MODE 2: 5 minutes • MODE 3: 30 seconds • MODE 4: 2 minutes
LOCK/UNLOCK BY I-KEY	Door lock/unlock function by door request switch (driver side, passenger side and back door) mode can be changed to operate (ON) or not operate (OFF) in this mode.
ENGINE START BY I-KEY	Engine start function mode can be changed to operate (ON) or not operate (OFF) with this mode.
TRUNK/GLASS HATCH OPEN	Buzzer reminder function mode by back door request switch can be changed to operate (ON) or not operate (OFF) with this mode.
PANIC ALARM SET	Panic alarm button pressing time on Intelligent Key remote control button can be selected from the following with this mode. <ul style="list-style-type: none"> • MODE 1: 0.5 sec. • MODE 2: Non-operation • MODE 3: 1.5 sec.

A
B
C
D
E
F
G
H
I
J
K
L
N
O
P

BCS

DIAGNOSIS SYSTEM (BCM)

< SYSTEM DESCRIPTION >

Monitor item	Description
PW DOWN SET	Unlock button pressing time on Intelligent Key button can be selected from the following with this mode. <ul style="list-style-type: none"> • MODE 1: 3 sec. • MODE 2: Non-operation • MODE 3: 5 sec.
TAKE OUT FROM WIN WARN	NOTE: This item is displayed, but cannot be supported.
TRUNK OPEN DELAY	NOTE: This item is displayed, but cannot be supported.
LO- BATT OF KEY FOB WARN	Intelligent Key low battery warning mode can be changed to operate (ON) or not operate (OFF) with this mode.
ANTI KEY LOCK IN FUNCTI	Key reminder function mode can be changed to operate (ON) or not operate (OFF) with this mode.
HAZARD ANSWER BACK	Hazard reminder function mode can be selected from the following with this mode. <ul style="list-style-type: none"> • LOCK ONLY: Door lock operation only • UNLOCK ONLY: Door unlock operation only • LOCK/UNLOCK: Lock/unlock operation • OFF: Non-operation
ANS BACK I-KEY LOCK	Buzzer reminder function (lock operation) mode by door request switch (driver side and passenger side) can be selected from the following with this mode. <ul style="list-style-type: none"> • Horn chirp: Sound horn • Buzzer: Sound Intelligent Key warning buzzer • OFF: Non-operation
ANS BACK I-KEY UNLOCK	Buzzer reminder function (unlock operation) mode by door request switch can be changed to operate (ON) or not operate (OFF) with this mode.
SHORT CRANKING OUTPUT	Starter motor can operate during the times below. <ul style="list-style-type: none"> • 70 msec. • 100 msec. • 200 msec.
INSIDE ANT DIAGNOSIS	This function allows inside key antenna self-diagnosis.
HORN WITH KEYLESS LOCK	Horn reminder function mode by Intelligent Key button can be changed to operate (ON) or not operate (OFF) with this mode.
WELCOME LIGHT OP SET	Welcome light function mode can be changed to operate (WITH) or not operate (WITHOUT) with this mode.
WELCOME LIGHT SELECT	Welcome light function mode can be selected from the following with this mode. <ul style="list-style-type: none"> • Without room lamp • With room lamp • Without paddle lamp • With paddle lamp

SELF-DIAG RESULT

Refer to [DLK-167. "DTC Index"](#).

DATA MONITOR

Monitor Item	Condition
REQ SW -DR	Indicates [ON/OFF] condition of door request switch (driver side).
REQ SW -AS	Indicates [ON/OFF] condition of door request switch (passenger side).
REQ SW -RR	NOTE: This item is displayed, but cannot be monitored.
REQ SW -RL	NOTE: This item is displayed, but cannot be monitored.
REQ SW -BD/TR	Indicates [ON/OFF] condition of back door request switch.
PUSH SW	Indicates [ON/OFF] condition of push-button ignition switch.
IGN RLY2 -F/B	Indicates [ON/OFF] condition of ignition relay 2.

DIAGNOSIS SYSTEM (BCM)

< SYSTEM DESCRIPTION >

Monitor Item	Condition	A
CLUCH SW	NOTE: This item is displayed, but cannot be monitored.	A
BRAKE SW 1	Indicates [ON/OFF] condition of brake switch power supply.	B
BRAKE SW 2	Indicates [ON/OFF] condition of brake switch.	B
DETE/CANCL SW	Indicates [ON/OFF] condition of P position.	C
SFT PN/N SW	Indicates [ON/OFF] condition of P or N position.	C
S/L -LOCK	Indicates [ON/OFF] condition of steering lock unit (LOCK).	D
S/L -UNLOCK	Indicates [ON/OFF] condition of steering lock unit (UNLOCK).	D
S/L RELAY -F/B	Indicates [ON/OFF] condition of ignition switch.	D
UNLK SEN -DR	Indicates [ON/OFF] condition of driver door UNLOCK status.	E
PUSH SW -IPDM	Indicates [ON/OFF] condition of push-button ignition switch.	E
IGN RLY1 -F/B	Indicates [ON/OFF] condition of ignition relay 1.	F
DETE SW -IPDM	Indicates [ON/OFF] condition of P position.	F
SFT PN -IPDM	Indicates [ON/OFF] condition of P or N position.	F
SFT P -MET	Indicates [ON/OFF] condition of P position.	G
SFT N -MET	Indicates [ON/OFF] condition of N position.	G
ENGINE STATE	Indicates [STOP/START/CRANK/RUN] condition of engine states.	H
S/L LOCK-IPDM	Indicates [ON/OFF] condition of steering lock unit (LOCK).	H
S/L UNLK-IPDM	Indicates [ON/OFF] condition of steering lock unit (UNLOCK).	H
S/L RELAY-REQ	Indicates [ON/OFF] condition of steering lock relay.	I
VEH SPEED 1	Display the vehicle speed signal received from unified meter and A/C amp. by numerical value [Km/h].	I
VEH SPEED 2	Display the vehicle speed signal received from ABS or VDC or CVT by numerical value [Km/h].	J
DOOR STAT-DR	Indicates [LOCK/READY/UNLOCK] condition of driver side door status.	J
DOOR STAT-AS	Indicates [LOCK/READY/UNLOCK] condition of passenger side door status.	K
ID OK FLAG	Indicates [SET/RESET] condition of key ID.	K
PRMT ENG STRT	Indicates [SET/RESET] condition of engine start possibility.	L
PRMT RKE STRT	NOTE: This item is displayed, but cannot be monitored.	L
KEY SW -SLOT	Indicates [ON/OFF] condition of key slot.	L
TRNK/HAT MNTR	NOTE: This item is displayed, but cannot be monitored.	N
RKE-LOCK	Indicates [ON/OFF] condition of LOCK signal from Intelligent Key.	O
RKE-UNLOCK	Indicates [ON/OFF] condition of UNLOCK signal from Intelligent Key.	O
RKE-TR/BD	NOTE: This item is displayed, but cannot be monitored.	P
RKE-PANIC	Indicates [ON/OFF] condition of PANIC button of Intelligent Key.	P
RKE-P/W OPEN	Indicates [ON/OFF] condition of P/W DOWN signal from Intelligent Key.	P
RKE-MODE CHG	Indicates [ON/OFF] condition of MODE CHANGE signal from Intelligent Key.	P
RKE OPE COUN1	When remote keyless entry receiver receives the signal transmitted while operating on Intelligent Key, the numerical value start changing.	P
RKE OPE COUN2	NOTE: This item is displayed, but cannot be monitored.	P

BCS

ACTIVE TEST

DIAGNOSIS SYSTEM (BCM)

< SYSTEM DESCRIPTION >

Test item	Description
BATTERY SAVER	This test is able to check interior room lamp operation. The interior room lamp will be activated after "ON" on CONSULT-III screen is touched.
PW REMOTO DOWN SET	This test is able to check power window down operation. The power window down will be activated after "ON" on CONSULT-III screen is touched.
INSIDE BUZZER	This test is able to check warning chime in combination meter operation. <ul style="list-style-type: none"> • Take away warning chime sounds when "TAKE OUT" on CONSULT-III screen is touched. • Key warning chime sounds when "KEY WARN" on CONSULT-III screen is touched. • P position warning chime sounds when "P RNG WARN" on CONSULT-III screen is touched. • ACC warning chime sounds when "ACC WARN" on CONSULT-III screen is touched.
OUTSIDE BUZZER	This test is able to check Intelligent Key warning buzzer operation. The Intelligent Key warning buzzer will be activated after "ON" on CONSULT-III screen is touched.
INDICATOR	This test is able to check warning lamp operation. <ul style="list-style-type: none"> • "KEY" Warning lamp illuminates when "KEY ON" on CONSULT-III screen is touched. • "KEY" Warning lamp flashes when "KEY IND" on CONSULT-III screen is touched.
INT LAMP	This test is able to check interior room lamp operation. The interior room lamp will be activated after "ON" on CONSULT-III screen is touched.
LCD	This test is able to check meter display information <ul style="list-style-type: none"> • Engine start information displays when "BP N" on CONSULT-III screen is touched. • Engine start information displays when "BP I" on CONSULT-III screen is touched. • Key ID warning displays when "ID NG" on CONSULT-III screen is touched. • Steering lock information displays when "ROTAT" on CONSULT-III screen is touched. • P position warning displays when "SFT P" on CONSULT-III screen is touched. • Intelligent Key insert information displays when "INSRT" on CONSULT-III screen is touched. • Intelligent Key low battery warning displays when "BATT" on CONSULT-III screen is touched. • Take away through window warning displays when "NO KY" on CONSULT-III screen is touched. • Take away warning display when "OUTKY" on CONSULT-III screen is touched. • OFF position warning display when "LK WN" on CONSULT-III screen is touched.
TRUNK/GLASS HATCH	This test is able to check back door opener actuator open operation. This actuator opens when "ON" on CONSULT-III screen is touched.
FLASHER	This test is able to check hazard warning lamp operation. The hazard warning lamps will be activated after "ON" on CONSULT-III screen is touched.
HORN	This test is able to check horn operation. The horn will be activated after "ON" on CONSULT-III screen is touched.
P RANGE	This test is able to check A/T shift selector power supply A/T shift selector power is supplied when "ON" on CONSULT-III screen is touched.
ENGINE SW ILLUMI	This test is able to check push-ignition switch illumination operation. Push-ignition switch illumination illuminates when "ON" on CONSULT-III screen is touched.
LOCK INDICATOR	This test is able to check LOCK indicator in push-ignition switch operation. LOCK indicator in push-ignition switch illuminates when "ON" on CONSULT-III screen is touched;
ACC INDICATOR	This test is able to check ACC indicator in push-ignition switch operation. Indicator in push-ignition switch illuminates when "ON" on CONSULT-III screen is touched.
IGNITION ON IND	This test is able to check ON indicator in push-ignition switch operation. Indicator in push-ignition switch illuminates when "ON" on CONSULT-III screen is touched.
KEY SLOT ILLUMI	This test is able to check key slot illumination operation. Key slot illumination flash when "ON" on CONSULT-III screen is touched.
TRUNK/BACK DOOR	NOTE: This item is displayed, but cannot be tested.

COMB SW

COMB SW : CONSULT-III Function (BCM - COMB SW)

INFOID:000000004345193

DATA MONITOR

DIAGNOSIS SYSTEM (BCM)

< SYSTEM DESCRIPTION >

Monitor item [UNIT]	Description
FR WIPER HI [Off/On]	Displays the status of the FR WIPER HI switch in combination switch judged by BCM with the combination switch reading function.
FR WIPER LOW [Off/On]	Displays the status of the FR WIPER LOW switch in combination switch judged by BCM with the combination switch reading function.
FR WASHER SW [Off/On]	Displays the status of the FR WASHER switch in combination switch judged by BCM with the combination switch reading function.
FR WIPER INT [Off/On]	Displays the status of the FR WIPER INT switch in combination switch judged by BCM with the combination switch reading function.
FR WIPER STOP [Off/On]	Displays the status of the front wiper stop position signal received from IPDM E/R via CAN communication.
INT VOLUME [1 - 7]	Displays the status of wiper intermittent dial position judged by BCM with the combination switch reading function.
RR WIPER ON [Off/On]	Displays the status of the RR WIPER ON switch in combination switch judged by BCM with the combination switch reading function.
RR WIPER INT [Off/On]	Displays the status of the RR WIPER INT switch in combination switch judged by BCM with the combination switch reading function.
RR WASHER SW [Off/On]	Displays the status of the RR WASHER switch in combination switch judged by BCM with the combination switch reading function.
RR WIPER STOP [Off/On]	Displays the status of the rear wiper stop position signal received from rear wiper motor.
TURN SIGNAL R [Off/On]	Displays the status of the TURN RH switch in combination switch judged by BCM with the combination switch reading function.
TURN SIGNAL L [Off/On]	Displays the status of the TURN LH switch in combination switch judged by BCM with the combination switch reading function.
TAIL LAMP SW [Off/On]	Displays the status of the TAIL LAMP switch in combination switch judged by BCM with the combination switch reading function.
HI BEAM SW [Off/On]	Displays the status of the HI BEAM switch in combination switch judged by BCM with the combination switch reading function.
HEAD LAMP SW 1 [Off/On]	Displays the status of the HEADLAMP 1 switch in combination switch judged by BCM with the combination switch reading function.
HEAD LAMP SW 2 [Off/On]	Displays the status of the HEADLAMP 2 switch in combination switch judged by BCM with the combination switch reading function.
PASSING SW [Off/On]	Displays the status of the PASSING switch in combination switch judged by BCM with the combination switch reading function.
AUTO LIGHT SW [Off/On]	Displays the status of the AUTO LIGHT switch in combination switch judged by BCM with the combination switch reading function.
FR FOG SW [Off/On]	Displays the status of the FR FOG switch in combination switch judged by BCM with the combination switch reading function.
RR FOG SW [Off/On]	NOTE: The item is indicated, but not monitored.

BCM

BCM : CONSULT-III Function (BCM - BCM)

INFOID:000000004345194

WORK SUPPORT

Item	Description
RESET SETTING VALUE	Return a value set with Work Support of each system to a default value in factory shipment.

IMMU

DIAGNOSIS SYSTEM (BCM)

< SYSTEM DESCRIPTION >

IMMU : CONSULT-III Function (BCM - IMMU)

INFOID:000000004923601

DATA MONITOR

Monitor item	Content
CONFRM ID ALL	Indicates [YET] at all time. Switch to [DONE] when a registered Intelligent Key is inserted into the key slot.
CONFIRM ID4	
CONFIRM ID3	
CONFIRM ID2	
CONFIRM ID1	
TP 4	Indicates the number of ID which has been registered.
TP 3	
TP 2	
TP 1	
PUSH SW	Indicates [ON/OFF] condition of push-button ignition switch.
KEY SW -SLOT	Indicates [ON/OFF] condition of key slot.

ACTIVE TEST

Test item	Description
THEFT IND	This test is able to check security indicator lamp operation. The lamp will be turned on when "ON" on CONSULT-III screen touched.

BATTERY SAVER

BATTERY SAVER : CONSULT-III Function (BCM - BATTERY SAVER)

INFOID:000000004923611

WORK SUPPORT

Service item	Setting item	Setting
BATTERY SAVER SET	On*	With the exterior lamp battery saver function
	Off	Without the exterior lamp battery saver function
ROOM LAMP BAT SAV SET	On*	With the interior room lamp battery saver function
	Off	Without the interior room lamp battery saver function
ROOM LAMP TIMER SET	MODE 1*	30 min.
	MODE 2	60 min.
		Sets the interior room lamp battery saver timer operating time.

*: Initial setting

DATA MONITOR

Monitor item [Unit]	Description
REQ SW-DR [On/Off]	The switch status input from request switch (driver side)
REQ SW-AS [On/Off]	The switch status input from request switch (passenger side)
REQ SW-RR [On/Off]	NOTE: The item is indicated, but not monitored.
REQ SW-RL [On/Off]	
PUSH SW [On/Off]	The switch status input from push-button ignition switch

DIAGNOSIS SYSTEM (BCM)

< SYSTEM DESCRIPTION >

Monitor item [Unit]	Description
KEY SW-SLOT [On/Off]	Key switch status input from key slot
UNLK SEN-DR [On/Off]	Driver door unlock status input from unlock sensor
DOOR SW-DR [On/Off]	The switch status input from front door switch (driver side)
DOOR SW-AS [On/Off]	The switch status input from front door switch (passenger side)
DOOR SW-RR [On/Off]	The switch status input from rear door switch RH
DOOR SW- RL [On/Off]	The switch status input from rear door switch LH
DOOR SW-BK [On/Off]	NOTE: The item is indicated, but not monitored.
CDL LOCK SW [On/Off]	Lock switch status received from central door lock switch by power window switch serial link
CDL UNLOCK SW [On/Off]	Unlock switch status received from central door lock switch by power window switch serial link
KEY CYL LK-SW [On/Off]	Lock switch status received from key cylinder switch by power window switch serial link
KEY CYL UN-SW [On/Off]	Unlock switch status received from key cylinder switch by power window switch serial link
TRNK/HAT MNTR [On/Off]	The switch status input from trunk room lamp switch
RKE-LOCK [On/Off]	Lock signal status received from remote keyless entry receiver
RKE-UNLOCK [On/Off]	Unlock signal status received from remote keyless entry receiver

ACTIVE TEST

Test item	Operation	Description
BATTERY SAVER	Off	Cuts the interior room lamp power supply to turn interior room lamp OFF.
	On	Outputs the interior room lamp power supply to turn interior room lamp ON.*

*: Each lamp switch is in ON position.

TRUNK

TRUNK : CONSULT-III Function (BCM - TRUNK)

INFOID:000000004923599

BCM CONSULT-III FUNCTION

CONSULT-III performs the following functions via CAN communication with BCM.

Diagnosis mode	Function Description
DATA MONITOR	The BCM input/output signals are displayed.
ACTIVE TEST	The signals used to activate each device are forcibly supplied from BCM.

DATA MONITOR

Monitor Item	Contents
PUSH SW	Indicates [ON/OFF] condition of push-button ignition switch.
UNLK SEN -DR	Indicates [ON/OFF] condition of driver door UNLOCK status.
VEH SPEED 1	Indicates [Km/h] condition of vehicle speed signal from combination meter.

A
B
C
D
E
F
G
H
I
J
K
L
N
O
P



DIAGNOSIS SYSTEM (BCM)

< SYSTEM DESCRIPTION >

Monitor Item	Contents
KEY CYL SW-TR	NOTE: This item is displayed, but cannot be monitored.
TR CANCEL SW	NOTE: This item is displayed, but cannot be monitored.
TR/BD OPEN SW	Indicates [ON/OFF] condition of back door opener switch.
TRNK/HAT MNTR	NOTE: This item is displayed, but cannot be monitored.
RKE-TR/BD*	NOTE: This item is displayed, but cannot be monitored.

ACTIVE TEST

Test item	Description
TRUNK/GLASS HATCH	This test is able to check back door opener actuator open operation. This actuator opens when ^{***}

THEFT ALM

THEFT ALM : CONSULT-III Function (BCM - THEFT)

INFOID:000000004923600

DATA MONITOR

Monitored Item	Description
REQ SW -DR	Indicates [ON/OFF] condition of door request switch (driver side).
REQ SW -AS	Indicates [ON/OFF] condition of door request switch (passenger side).
REQ SW -RR	NOTE: This is displayed even when it is not equipped.
REQ SW -RL	NOTE: This is displayed even when it is not equipped.
REQ SW -BD/TR	Indicates [ON/OFF] condition of back door request switch.
PUSH SW	Indicates [ON/OFF] condition of push-button ignition switch
UNLK SEN -DR	Indicates [ON/OFF] condition of driver door UNLOCK status.
KEY SW -SLOT	Indicates [ON/OFF] condition of key slot.
DOOR SW-DR	Indicates [ON/OFF] condition of front door switch LH.
DOOR SW-AS	Indicates [ON/OFF] condition of front door switch RH.
DOOR SW-RR	Indicates [ON/OFF] condition of rear door switch RH.
DOOR SW-RL	Indicates [ON/OFF] condition of rear door switch LH.
DOOR SW-BK	Indicates [ON/OFF] condition of back door switch.
CDL LOCK SW	Indicates [ON/OFF] condition of lock signal from door lock/unlock switch LH and RH.
CDL UNLOCK SW	Indicates [ON/OFF] condition of unlock signal from door lock/unlock switch LH and RH.
KEY CYL LK-SW	Indicates [ON/OFF] condition of lock signal from front door key cylinder switch.
KEY CYL UN-SW	Indicates [ON/OFF] condition of unlock signal from front door key cylinder switch.
KEY CYL SW-TR	NOTE: This is displayed even when it is not equipped.
TR/BD OPEN SW	Indicates [ON/OFF] condition of back door opener switch.
TRNK/HAT MNTR	NOTE: This is displayed even when it is not equipped.
RKE-LOCK	Indicates [ON/OFF] condition of LOCK signal from Intelligent Key.

DIAGNOSIS SYSTEM (BCM)

< SYSTEM DESCRIPTION >

Monitored Item	Description
RKE-UNLOCK	Indicates [ON/OFF] condition of UNLOCK signal from Intelligent Key.
RKE-TR/BD	NOTE: This is displayed even when it is not equipped.

WORK SUPPORT

Test Item	Description
SECURITY ALARM SET	This mode is able to confirm and change security alarm ON-OFF setting.
THEFT ALM TRG	The switch which triggered vehicle security alarm is recorded. This mode is able to confirm and erase the record of vehicle security alarm. The trigger data can be erased by touching "CLEAR" on CONSULT-III screen.

ACTIVE TEST

Test Item	Description
THEFT IND	This test is able to check security indicator lamp operation. The lamp will be turned on when "ON" on CONSULT-III screen is touched.
VEHICLE SECURITY HORN	This test is able to check vehicle security horn operation. The horns will be activated for 0.5 seconds after "ON" on CONSULT-III screen is touched.
HEADLAMP(HI)	This test is able to check vehicle security lamp operation. The headlamps will be activated for 0.5 seconds after "ON" on CONSULT-III screen is touched.
FLASHER	This test is able to check vehicle security hazard lamp operation. The hazard lamps will be activated after "ON" on CONSULT-III screen is touched.

RETAINED PWR

RETAINED PWR : CONSULT-III Function (BCM - RETAINED PWR)

INFOID:000000004923602

Data monitor

Monitor Item	Description
DOOR SW-DR	Indicates [ON/OFF] condition of driver side door switch.
DOOR SW-AS	Indicates [ON/OFF] condition of passenger side door switch.

SIGNAL BUFFER

SIGNAL BUFFER : CONSULT-III Function (BCM - SIGNAL BUFFER)

INFOID:000000004345200

DATA MONITOR

Monitor item [UNIT]	Description
PUSH SW [Off/On]	Displays the status of the push-button ignition switch (push switch) judged by BCM.

ACTIVE TEST

Test item	Operation	Description
OIL PRESSURE SW	Off	OFF
	On	BCM transmits the oil pressure switch signal to the unified meter and A/C amp. via CAN communication, which illuminates the oil pressure warning lamp in the combination meter.

AIR PRESSURE MONITOR

A
B
C
D
E
F
G
H
I
J
K
L

BCS

N
O
P

DIAGNOSIS SYSTEM (BCM)

< SYSTEM DESCRIPTION >

AIR PRESSURE MONITOR : Diagnosis Description

INFOID:00000004923603

DESCRIPTION

During driving, the TPMS receives the signal transmitted from the transmitter installed in each wheel, when the tire pressure becomes low. The control unit (BCM) of this system has pressure judgment and trouble diagnosis functions.

When the TPMS detects low inflation pressure or another unusual symptom, the low tire pressure warning lamps in the combination meter comes on.

SELF DIAGNOSTIC PROCEDURE (WITH CONSULT-III)

④ With CONSULT-III

Touch "SELF-DIAG RESULT" display shows malfunction experienced since the last erasing operation. Refer to [WT-83, "DTC Index"](#).

SELF DIAGNOSTIC PROCEDURE (WITHOUT CONSULT-III)

⊗ Without CONSULT-III

To start the self-diagnostic results mode, ground terminal of the tire pressure warning check connector. The malfunction location is indicated by the low tire pressure warning lamp blinking.

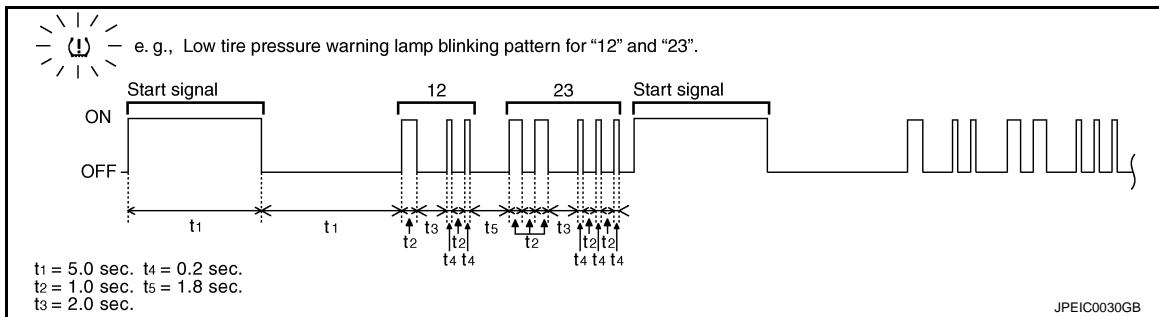

NOTE:

When the low tire pressure warning lamp blinks 5 Hz and continues repeating it, the system is normal.

Blinking pattern	Items	Diagnostic items detected when...	Check item
15	Tire pressure value (Front LH)	Front LH tire pressure drops to * kPa (* kg/cm ² , * psi) or less. [NOTE]	WT-17
16	Tire pressure value (Front RH)	Front RH tire pressure drops to * kPa (* kg/cm ² , * psi) or less. [NOTE]	
17	Tire pressure value (Rear RH)	Rear RH tire pressure drops to * kPa (* kg/cm ² , * psi) or less. [NOTE]	
18	Tire pressure value (Rear LH)	Rear LH tire pressure drops to * kPa (* kg/cm ² , * psi) or less. [NOTE]	
21	Transmitter no data (Front LH)	Data from front LH transmitter can not be receive.	WT-19
22	Transmitter no data (Front RH)	Data from front RH transmitter can not be receive.	
23	Transmitter no data (Rear RH)	Data from rear RH transmitter can not be receive.	
24	Transmitter no data (Rear LH)	Data from rear LH transmitter can not be receive.	WT-22
31	Transmitter checksum error (Front LH)	Checksum data from front LH transmitter is malfunctioning.	
32	Transmitter checksum error (Front RH)	Checksum data from front RH transmitter is malfunctioning.	
33	Transmitter checksum error (Rear RH)	Checksum data from rear RH transmitter is malfunctioning.	
34	Transmitter checksum error (Rear LH)	Checksum data from rear LH transmitter is malfunctioning.	

DIAGNOSIS SYSTEM (BCM)

< SYSTEM DESCRIPTION >

Blinking pattern	Items	Diagnostic items detected when...	Check item	
35	Transmitter pressure data error (Front LH)	Air pressure data from front LH transmitter is malfunction.	WT-25	A
36	Transmitter pressure data error (Front RH)	Air pressure data from front RH transmitter is malfunction.		B
37	Transmitter pressure data error (Rear RH)	Air pressure data from rear RH transmitter is malfunction.		C
38	Transmitter pressure data error (Rear LH)	Air pressure data from rear LH transmitter is malfunction.		
41	Transmitter function code error (Front LH)	Function code data from front LH transmitter is malfunction.	WT-27	D
42	Transmitter function code error (Front RH)	Function code data from front RH transmitter is malfunction.		E
43	Transmitter function code error (Rear RH)	Function code data from rear RH transmitter is malfunction.		F
44	Transmitter function code error (Rear LH)	Function code data from rear LH transmitter is malfunction.		
45	Transmitter battery voltage low (Front LH)	Battery voltage of front LH transmitter drops.	WT-30	G
46	Transmitter battery voltage low (Front RH)	Battery voltage of front RH transmitter drops.		H
47	Transmitter battery voltage low (Rear RH)	Battery voltage of rear RH transmitter drops.		I
48	Transmitter battery voltage low (Rear LH)	Battery voltage of rear LH transmitter drops.		
52	Vehicle speed signal error	Vehicle speed signal error.	WT-33	
53	Control unit	Tire pressure monitoring system malfunction in BCM.	WT-34	
No blinking	Tire pressure warning check switch	Tire pressure warning switch circuit is open.	-	J

NOTE:

NOTE: 182.7 kPa (1.9 kg/cm², 26 psi): Standard air pressure is for 230 kPa (2.3 kg/cm², 33 psi) vehicles.

ERASE SELF-DIAGNOSIS

Ⓟ With CONSULT-III

1. Perform applicable inspection of malfunctioning item and then repair or replace.
2. Turn ignition switch ON and select "SELF-DIAG RESULTS" mode for "AIR PRESSURE MONITOR" with CONSULT-III.
3. Touch "ERASE" on CONSULT-III screen to erase memory.

ⓧ Without CONSULT-III

- In order to make it easier to find the cause of hard-to-duplicate malfunctions, malfunction information is stored into the control unit as necessary during use by the user. This memory is not erased no matter how many times the ignition switch is turned ON and OFF.
- However, this information is erased by turning ignition switch OFF after performing self-diagnostic or by erasing the memory using the CONSULT-III.

AIR PRESSURE MONITOR : CONSULT-III Function (BCM - AIR PRESSURE MONITOR)

INFOID:000000004923604

WORK SUPPORT MODE

ID Read

The registered ID number is displayed.

ID Regist

DIAGNOSIS SYSTEM (BCM)

< SYSTEM DESCRIPTION >

Refer to [WT-6. "ID REGISTRATION PROCEDURE : Special Repair Requirement"](#).

SELF-DIAG RESULTS MODE

Operation Procedure

Refer to [WT-83. "DTC Index"](#).

DATA MONITOR MODE

Screen of data monitor mode is displayed.

NOTE:

When malfunction is detected, CONSULT-III perform REAL-TIME DIAGNOSIS. Also, any malfunction detected while in this mode will be displayed at real time.

Display item list

Monitor	Condition	Specification
AIR PRESS FL AIR PRESS FR AIR PRESS RR AIR PRESS RL	<ul style="list-style-type: none"> Drive vehicle for a few minutes. or Ignition switch ON and transmitter activation tool is transmitting activation signals. 	Tire pressure (kPa, kg/cm ² or Psi)
ID REGST FL1 ID REGST FR1 ID REGST RR1 ID REGST RL1	Ignition switch ON	Registration ID: Green No registration: Red
WARNING LAMP		Low tire pressure warning lamp ON: on Low tire pressure warning lamp OFF: off
BUZZER		Buzzer in combination meter ON: on Buzzer in combination meter OFF: off

NOTE:

Before performing the self-diagnosis, be sure to register the ID, or erase the actual malfunction location may be different from that displayed on CONSULT-III.

ACTIVE TEST MODE

NOTE:

Before performing the self-diagnosis, be sure to register the ID, or erase the actual malfunction may be different from that displayed on CONSULT-III.

TEST ITEM LIST

Test item	Content
WARNING LAMP	This test is able to check to check that the low tire pressure warning lamp turns on.
ID REGIST WARNING	This test is able to check to check that the buzzer sounds or the low tire pressure warning lamp turns on.
FLASHER	This test is able to check to check that each turn signal lamp turns on.
HORN	This test is able to check to check that the horn sounds.

U1000 CAN COMM CIRCUIT

< DTC/CIRCUIT DIAGNOSIS >

DTC/CIRCUIT DIAGNOSIS

U1000 CAN COMM CIRCUIT

Description

INFOID:0000000004345203

CAN (Controller Area Network) is a serial communication line for real time applications. It is an on-vehicle multiplex communication line with high data communication speed and excellent error detection ability. Modern vehicle is equipped with many electronic control unit, and each control unit shares information and links with other control units during operation (not independent). In CAN communication, control units are connected with 2 communication lines (CAN H-line, CAN L-line) allowing a high rate of information transmission with less wiring. Each control unit transmits/receives data but selectively reads required data only.

CAN Communication Signal Chart. Refer to [LAN-26, "CAN Communication Signal Chart"](#).

DTC Logic

INFOID:0000000004345204

DTC DETECTION LOGIC

DTC	CONSULT-III display description	DTC Detection Condition	Possible cause
U1000	CAN COMM	When BCM cannot communicate CAN communication signal continuously for 2 seconds or more.	CAN communication system

Diagnosis Procedure

INFOID:0000000004345205

1.PERFORM SELF DIAGNOSTIC

1. Turn ignition switch ON and wait for 2 seconds or more.
2. Check "Self Diagnostic Result".

Is DTC "U1000" displayed?

- YES >> Refer to [LAN-17, "Trouble Diagnosis Flow Chart"](#).
NO >> Refer to [GI-40, "Intermittent Incident"](#).

A
B
C
D
E
F
G
H
I
J
K
L

BCS

N
O
P

U1010 CONTROL UNIT (CAN)

< DTC/CIRCUIT DIAGNOSIS >

U1010 CONTROL UNIT (CAN)

DTC Logic

INFOID:000000004345206

DTC DETECTION LOGIC

DTC	CONSULT-III display description	DTC Detection Condition	Possible cause
U1010	CONTROL UNIT(CAN)	BCM detected internal CAN communication circuit malfunction.	BCM

Diagnosis Procedure

INFOID:000000004345207

1.REPLACE BCM

When DTC "U1010" is detected, replace BCM.

>> Replace BCM. Refer to [BCS-85. "Exploded View"](#).

U0415 VEHICLE SPEED SIG

< DTC/CIRCUIT DIAGNOSIS >

U0415 VEHICLE SPEED SIG

Description

INFOID:000000004345208

U0415 is displayed if any unusual condition is present in the reception status of the vehicle speed signal from the ABS actuator and electric unit (control unit).

DTC Logic

INFOID:000000004345209

DTC DETECTION LOGIC

DTC	CONSULT-III display description	DTC Detection Condition	Probable cause
U0415	VEHICLE SPEED	When the vehicle speed signal received from the ABS actuator and electric unit (control unit) remains abnormal for 2 seconds or more.	<ul style="list-style-type: none">• ABS actuator and electric unit (control unit)• BCM

DTC CONFIRMATION PROCEDURE

1. DTC CONFIRMATION

1. Erase the DTC.
2. Turn ignition switch OFF.
3. Perform the "Self Diagnostic Result" of CONSULT-III, when passed 2 seconds or more after the ignition switch is turned ON.

Is any DTC detected?

- YES >> Refer to [BCS-39, "Diagnosis Procedure"](#).
NO >> INSPECTION END

Diagnosis Procedure

INFOID:000000004345210

1. ABS ACTUATOR AND ELECTRIC UNIT (CONTROL UNIT) SELF-DIAG RESULTS

Perform "Self-Diagnostic Result" of ABS actuator and electric unit (control unit) with CONSULT-III. Refer to [BRC-31, "CONSULT-III Function"](#).

Is any DTC detected?

- YES >> Repair or replace the malfunctioning part.
NO >> Replace BCM. Refer to [BCS-85, "Exploded View"](#).

A
B
C
D
E
F
G
H
I
J
K
L

BCS

N
O
P

B2562 LOW VOLTAGE

< DTC/CIRCUIT DIAGNOSIS >

B2562 LOW VOLTAGE

DTC Logic

INFOID:000000004345211

DTC DETECTION LOGIC

DTC	CONSULT-III display description	DTC Detection Condition	Possible cause
B2562	LOW VOLTAGE	When the power supply voltage to BCM remains less than 8.8 V for 120 seconds or more	Harness or connector (power supply circuit)

DTC CONFIRMATION PROCEDURE

1. DTC CONFIRMATION

1. Erase DTC.
2. Turn ignition switch OFF.
3. Perform the "Self Diagnostic Result" of CONSULT-III, when passed 120 seconds or more after the ignition switch is turned ON.

Is any DTC detected?

- YES >> Refer to [BCS-40, "Diagnosis Procedure"](#).
NO >> INSPECTION END

Diagnosis Procedure

INFOID:000000004345212

1. CHECK POWER SUPPLY CIRCUIT

Check BCM power supply circuit. Refer to [BCS-41, "Diagnosis Procedure"](#).

Is the circuit normal?

- YES >> Replace BCM. Refer to [BCS-85, "Exploded View"](#).
NO >> Repair the malfunctioning part.

POWER SUPPLY AND GROUND CIRCUIT

< DTC/CIRCUIT DIAGNOSIS >

POWER SUPPLY AND GROUND CIRCUIT

Diagnosis Procedure

INFOID:000000004345213

1. CHECK FUSE AND FUSIBLE LINK

Check that the following fuse and fusible link are not blown.

Signal name	Fuse and fusible link No.
Battery power supply	K
	10

Is the fuse fusing?

YES >> Replace the blown fuse or fusible link after repairing the affected circuit if a fuse or fusible link is blown.

NO >> GO TO 2.

2. CHECK POWER SUPPLY CIRCUIT

1. Turn ignition switch OFF.
2. Disconnect BCM connectors.
3. Check voltage between BCM harness connector and ground.

Terminals		Voltage (Approx.)
(+)	(-)	
BCM		Ground Battery voltage
Connector	Terminal	
M118	1	
M119	11	

Is the measurement value normal?

YES >> GO TO 3.

NO >> Repair harness or connector.

3. CHECK GROUND CIRCUIT

Check continuity between BCM harness connector and ground.

BCM		Ground	Continuity
Connector	Terminal		
M119	13		Existed

Does continuity exist?

YES >> INSPECTION END

NO >> Repair harness or connector.

A
B
C
D
E
F
G
H
I
J
K
L
N
O
P

BCS

COMBINATION SWITCH INPUT CIRCUIT

< DTC/CIRCUIT DIAGNOSIS >

COMBINATION SWITCH INPUT CIRCUIT

Diagnosis Procedure

INFOID:000000004345214

1. CHECK INPUT 1 - 5 SYSTEM CIRCUIT FOR OPEN

1. Turn the ignition switch OFF.
2. Disconnect the BCM and combination switch connectors.
3. Check continuity between BCM harness connector and combination switch harness connector.

System	BCM		Combination switch		Continuity
	Connector	Terminal	Connector	Terminal	
INPUT 1	M122	107	M33	11	Existed
INPUT 2		109		9	
INPUT 3		88		7	
INPUT 4		108		10	
INPUT 5		87		13	

Does continuity exist?

YES >> GO TO 2.

NO >> Repair the harnesses or connectors.

2. CHECK INPUT 1 - 5 SYSTEM CIRCUIT FOR SHORT

Check for continuity between BCM harness connector and ground.

System	BCM		Ground	Continuity
	Connector	Terminal		
INPUT 1	M122	107	Ground	Not existed
INPUT 2		109		
INPUT 3		88		
INPUT 4		108		
INPUT 5		87		

Does continuity exist?

YES >> Repair the harnesses or connectors.

NO >> GO TO 3.

3. CHECK BCM OUTPUT VOLTAGE

1. Connect the BCM connector.
2. Check voltage between BCM harness connector and ground.

System	Terminals		Ground	Voltage (Approx.)	
	(+)				(-)
	BCM				
	Connector	Terminal			
INPUT 1	M122	107	Ground	Refer to BCS-46. "Reference Value" .	
INPUT 2		109			
INPUT 3		88			
INPUT 4		108			
INPUT 5		87			

Is the measurement value normal?

YES >> GO TO 4.

NO >> Replace BCM. Refer to [BCS-85. "Exploded View"](#).

COMBINATION SWITCH INPUT CIRCUIT

< DTC/CIRCUIT DIAGNOSIS >

4. CHECK BCM INPUT SIGNAL

1. Connect the combination switch connector.
2. Turn ON any switch in the system that is malfunctioning.
3. Check voltage between BCM harness connector and ground.

System	Terminals		Voltage (Approx.)
	(+)	(-)	
	BCM		
Connector	Terminal	Ground	Refer to BCS-46 . "Reference Value".
INPUT 1	107		
INPUT 2	109		
INPUT 3	88		
INPUT 4	108		
INPUT 5	87		

Is the measurement value normal when any of the switches is turned ON?

- YES >> Replace BCM. Refer to [BCS-85](#). "Exploded View".
NO >> Replace the combination switch.

A
B
C
D
E
F
G
H
I
J
K
L

BCS

N
O
P

COMBINATION SWITCH OUTPUT CIRCUIT

< DTC/CIRCUIT DIAGNOSIS >

COMBINATION SWITCH OUTPUT CIRCUIT

Diagnosis Procedure

INFOID:000000004345215

1. CHECK OUTPUT 1 - 5 SYSTEM CIRCUIT FOR OPEN

1. Turn the ignition switch OFF.
2. Disconnect the BCM and combination switch connectors.

NOTE:

BCM connector disconnects M123 only.

3. Check continuity between BCM harness connector and combination switch harness connector.

System	BCM		Combination switch		Continuity
	Connector	Terminal	Connector	Terminal	
OUTPUT 1	M123	143	M33	12	Existed
OUTPUT 2		144		14	
OUTPUT 3		145		5	
OUTPUT 4		146		2	
OUTPUT 5		142		8	

Does continuity exist?

YES >> GO TO 2.

NO >> Repair the harnesses or connectors.

2. CHECK OUTPUT 1 - 5 SYSTEM CIRCUIT FOR SHORT

Check for continuity between BCM harness connector and ground.

System	BCM		Ground	Continuity
	Connector	Terminal		
OUTPUT 1	M123	143	Ground	Not existed
OUTPUT 2		144		
OUTPUT 3		145		
OUTPUT 4		146		
OUTPUT 5		142		

Does continuity exist?

YES >> Repair the harnesses or connectors.

NO >> GO TO 3.

3. CHECK COMBINATION SWITCH INTERNAL CIRCUIT

1. Connect the combination switch connector.
2. Turn ON any switch in the system that is malfunctioning.
3. Check voltage between combination switch harness connector and ground.

NOTE:

Check that the combination switch outputs a signal from combination switch input system.

COMBINATION SWITCH OUTPUT CIRCUIT

< DTC/CIRCUIT DIAGNOSIS >

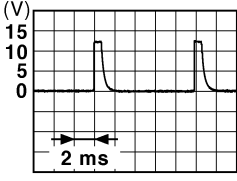
System	Terminals		Value (Approx.)
	(+)	(-)	
	Combination switch		
	Connector	Terminal	
OUTPUT 1	M33	12	 1.4 V
OUTPUT 2		14	
OUTPUT 3		5	
OUTPUT 4		2	
OUTPUT 5		8	
		Ground	

Is the measurement value normal when any of the switches is turned ON?

- YES >> Replace BCM. Refer to [BCS-85, "Exploded View"](#).
- NO >> Replace the combination switch.

A
B
C
D
E
F
G
H
I
J
K
L
N
O
P

BCS

BCM (BODY CONTROL MODULE)

< ECU DIAGNOSIS INFORMATION >

ECU DIAGNOSIS INFORMATION

BCM (BODY CONTROL MODULE)

Reference Value

INFOID:000000004345216

VALUES ON THE DIAGNOSIS TOOL

CONSULT-III MONITOR ITEM

Monitor Item	Condition	Value/Status
FR WIPER HI	Other than front wiper switch HI	Off
	Front wiper switch HI	On
FR WIPER LOW	Other than front wiper switch LO	Off
	Front wiper switch LO	On
FR WASHER SW	Front washer switch OFF	Off
	Front washer switch ON	On
FR WIPER INT	Other than front wiper switch INT	Off
	Front wiper switch INT	On
FR WIPER STOP	Front wiper is not in STOP position	Off
	Front wiper is in STOP position	On
INT VOLUME	Wiper intermittent dial is in a dial position 1 - 7	Wiper intermittent dial position
RR WIPER ON	Other than rear wiper switch ON	Off
	Rear wiper switch ON	On
RR WIPER INT	Other than rear wiper switch INT	Off
	Rear wiper switch INT	On
RR WASHER SW	Rear washer switch OFF	Off
	Rear washer switch ON	On
RR WIPER STOP	Rear wiper is in STOP position	Off
	Rear wiper is not in STOP position	On
TURN SIGNAL R	Other than turn signal switch RH	Off
	Turn signal switch RH	On
TURN SIGNAL L	Other than turn signal switch LH	Off
	Turn signal switch LH	On
TAIL LAMP SW	Other than lighting switch 1ST and 2ND	Off
	Lighting switch 1ST or 2ND	On
HI BEAM SW	Other than lighting switch HI	Off
	Lighting switch HI	On
HEAD LAMP SW 1	Other than lighting switch 2ND	Off
	Lighting switch 2ND	On
HEAD LAMP SW 2	Other than lighting switch 2ND	Off
	Lighting switch 2ND	On
PASSING SW	Other than lighting switch PASS	Off
	Lighting switch PASS	On
AUTO LIGHT SW	Other than lighting switch AUTO	Off
	Lighting switch AUTO	On
FR FOG SW	Front fog lamp switch OFF	Off
	Front fog lamp switch ON	On

BCM (BODY CONTROL MODULE)

< ECU DIAGNOSIS INFORMATION >

Monitor Item	Condition	Value/Status	
RR FOG SW	NOTE: The item is indicated, but not monitored.	Off	A
DOOR SW-DR	Driver door closed	Off	B
	Driver door opened	On	
DOOR SW-AS	Passenger door closed	Off	C
	Passenger door opened	On	
DOOR SW-RR	Rear RH door closed	Off	D
	Rear RH door opened	On	
DOOR SW-RL	Rear LH door closed	Off	E
	Rear LH door opened	On	
DOOR SW-BK	Back door closed	Off	F
	Back door opened	On	
CDL LOCK SW	Other than power door lock switch LOCK	Off	G
	Power door lock switch LOCK	On	
CDL UNLOCK SW	Other than power door lock switch UNLOCK	Off	H
	Power door lock switch UNLOCK	On	
KEY CYL LK-SW	Other than driver door key cylinder LOCK position	Off	I
	Driver door key cylinder LOCK position	On	
KEY CYL UN-SW	Other than driver door key cylinder UNLOCK position	Off	J
	Driver door key cylinder UNLOCK position	On	
KEY CYL SW-TR	NOTE: The item is indicated, but not monitored.	Off	K
HAZARD SW	Hazard switch is OFF	Off	L
	Hazard switch is ON	On	
REAR DEF SW	NOTE: The item is indicated, but not monitored.	Off	
TR CANCEL SW	NOTE: The item is indicated, but not monitored.	Off	
TR/BD OPEN SW	Back door opener switch OFF	Off	BCS
	While the back door opener switch is turned ON	On	
TRNK/HAT MNTR	NOTE: The item is indicated, but not monitored.	Off	
RKE-LOCK	LOCK button of the key is not pressed	Off	N
	LOCK button of the key is pressed	On	
RKE-UNLOCK	UNLOCK button of the key is not pressed	Off	O
	UNLOCK button of the key is pressed	On	
RKE-TR/BD	NOTE: The item is indicated, but not monitored.	Off	
RKE-PANIC	PANIC button of the key is not pressed	Off	P
	PANIC button of the key is pressed	On	
RKE-P/W OPEN	UNLOCK button of the key is not pressed	Off	
	UNLOCK button of the key is pressed and held	On	
RKE-MODE CHG	LOCK/UNLOCK button of the key is not pressed and held simultaneously	Off	
	LOCK/UNLOCK button of the key is pressed and held simultaneously	On	

BCM (BODY CONTROL MODULE)

< ECU DIAGNOSIS INFORMATION >

Monitor Item	Condition	Value/Status
OPTICAL SENSOR	Bright outside of the vehicle	Close to 5 V
	Dark outside of the vehicle	Close to 0 V
REQ SW -DR	Driver door request switch is not pressed	Off
	Driver door request switch is pressed	On
REQ SW -AS	Passenger door request switch is not pressed	Off
	Passenger door request switch is pressed	On
REQ SW -RR	NOTE: The item is indicated, but not monitored.	Off
REQ SW -RL	NOTE: The item is indicated, but not monitored.	Off
REQ SW -BD/TR	Back door request switch is not pressed	Off
	Back door request switch is pressed	On
PUSH SW	Push-button ignition switch (push switch) is not pressed	Off
	Push-button ignition switch (push switch) is pressed	On
IGN RLY2 -F/B	Ignition switch in OFF or ACC position	Off
	Ignition switch in ON position	On
ACC RLY -F/B	NOTE: The item is indicated, but not monitored.	Off
CLUCH SW	NOTE: The item is indicated, but not monitored.	Off
BRAKE SW 1	The brake pedal is depressed when No. 7 fuse is blown	Off
	The brake pedal is not depressed when No. 7 fuse is blown, or No. 7 fuse is normal	On
BRAKE SW 2	The brake pedal is not depressed	Off
	The brake pedal is depressed	On
DETE/CANCL SW	Selector lever in P position	Off
	Selector lever in any position other than P	On
SFT PN/N SW	Selector lever in any position other than P and N	Off
	Selector lever in P or N position	On
S/L -LOCK	Steering is unlocked	Off
	Steering is locked	On
S/L -UNLOCK	Steering is locked	Off
	Steering is unlocked	On
S/L RELAY-F/B	Ignition switch in OFF or ACC position	Off
	Ignition switch in ON position	On
UNLK SEN -DR	Driver door is unlocked	Off
	Driver door is locked	On
PUSH SW -IPDM	Push-button ignition switch (push-switch) is not pressed	Off
	Push-button ignition switch (push-switch) is pressed	On
IGN RLY1 -F/B	Ignition switch in OFF or ACC position	Off
	Ignition switch in ON position	On
DETE SW -IPDM	Selector lever in any position other than P	Off
	Selector lever in P position	On
SFT PN -IPDM	Selector lever in any position other than P and N	Off
	Selector lever in P or N position	On

BCM (BODY CONTROL MODULE)

< ECU DIAGNOSIS INFORMATION >

Monitor Item	Condition	Value/Status	
SFT P -MET	Selector lever in any position other than P	Off	A
	Selector lever in P position	On	
SFT N -MET	Selector lever in any position other than N	Off	B
	Selector lever in N position	On	
ENGINE STATE	Engine stopped	Stop	
	While the engine stalls	Stall	C
	At engine cranking	Crank	
	Engine running	Run	D
S/L LOCK-IPDM	Steering is unlocked	Off	
	Steering is locked	On	
S/L UNLK-IPDM	Steering is locked	Off	E
	Steering is unlocked	On	
S/L RELAY-REQ	Steering lock system is not the LOCK condition and the changing condition from LOCK to UNLOCK.	Off	F
	Steering lock system is the LOCK condition or the changing condition from LOCK to UNLOCK.	On	
VEH SPEED 1	While driving	Equivalent to speedometer reading	G
VEH SPEED 2	While driving	Equivalent to speedometer reading	
DOOR STAT-DR	Driver door is locked	LOCK	H
	Wait with selective UNLOCK operation (5 seconds)	READY	
	Driver door is unlocked	UNLOCK	
DOOR STAT-AS	Passenger door is locked	LOCK	I
	Wait with selective UNLOCK operation (5 seconds)	READY	
	Passenger door is unlocked	UNLOCK	J
ID OK FLAG	Steering is locked	Reset	
	Steering is unlocked	Set	
PRMT ENG STRT	The engine start is prohibited	Reset	K
	The engine start is permitted	Set	
PRMT RKE STRT	NOTE: The item is indicated, but not monitored.	Reset	L
KEY SW -SLOT	The key is not inserted into key slot	Off	
	The key is inserted into key slot	On	
RKE OPE COUN1	During the operation of the key	Operation frequency of the key	BCS
RKE OPE COUN2	NOTE: The item is indicated, but not monitored.	—	
CONFIRM ID ALL	The key ID that the key slot receives does not accord with any key ID registered to BCM.	Yet	N
	The key ID that the key slot receives accords with any key ID registered to BCM.	Done	O
CONFIRM ID4	The key ID that the key slot receives does not accord with the fourth key ID registered to BCM.	Yet	
	The key ID that the key slot receives accords with the fourth key ID registered to BCM.	Done	P
CONFIRM ID3	The key ID that the key slot receives does not accord with the third key ID registered to BCM.	Yet	
	The key ID that the key slot receives accords with the third key ID registered to BCM.	Done	

BCM (BODY CONTROL MODULE)

< ECU DIAGNOSIS INFORMATION >

Monitor Item	Condition	Value/Status
CONFIRM ID2	The key ID that the key slot receives does not accord with the second key ID registered to BCM.	Yet
	The key ID that the key slot receives accords with the second key ID registered to BCM.	Done
CONFIRM ID1	The key ID that the key slot receives does not accord with the first key ID registered to BCM.	Yet
	The key ID that the key slot receives accords with the first key ID registered to BCM.	Done
TP 4	The ID of fourth key is not registered to BCM	Yet
	The ID of fourth key is registered to BCM	Done
TP 3	The ID of third key is not registered to BCM	Yet
	The ID of third key is registered to BCM	Done
TP 2	The ID of second key is not registered to BCM	Yet
	The ID of second key is registered to BCM	Done
TP 1	The ID of first key is not registered to BCM	Yet
	The ID of first key is registered to BCM	Done
AIR PRESS FL	Ignition switch ON (Only when the signal from the transmitter is received)	Air pressure of front LH tire
AIR PRESS FR	Ignition switch ON (Only when the signal from the transmitter is received)	Air pressure of front RH tire
AIR PRESS RR	Ignition switch ON (Only when the signal from the transmitter is received)	Air pressure of rear RH tire
AIR PRESS RL	Ignition switch ON (Only when the signal from the transmitter is received)	Air pressure of rear LH tire
ID REGST FL1	ID of front LH tire transmitter is registered	Done
	ID of front LH tire transmitter is not registered	Yet
ID REGST FR1	ID of front RH tire transmitter is registered	Done
	ID of front RH tire transmitter is not registered	Yet
ID REGST RR1	ID of rear RH tire transmitter is registered	Done
	ID of rear RH tire transmitter is not registered	Yet
ID REGST RL1	ID of rear LH tire transmitter is registered	Done
	ID of rear LH tire transmitter is not registered	Yet
WARNING LAMP	Tire pressure indicator OFF	Off
	Tire pressure indicator ON	On
BUZZER	Tire pressure warning alarm is not sounding	Off
	Tire pressure warning alarm is sounding	On

BCM (BODY CONTROL MODULE)

< ECU DIAGNOSIS INFORMATION >

TERMINAL LAYOUT

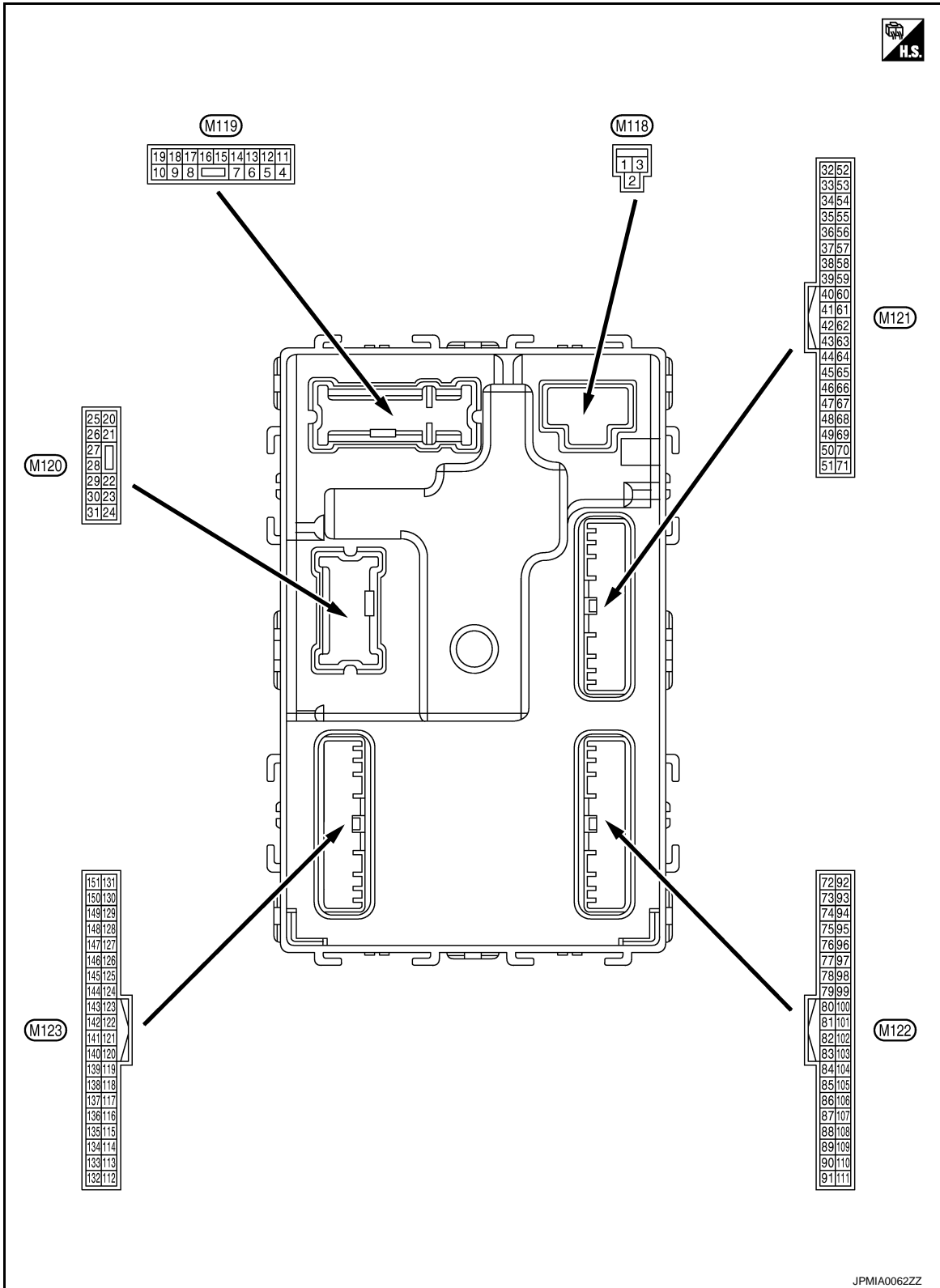

PHYSICAL VALUES

A
B
C
D
E
F
G
H
I
J
K
L
M
N
O
P

BCS

JPMIA0062ZZ

BCM (BODY CONTROL MODULE)

< ECU DIAGNOSIS INFORMATION >

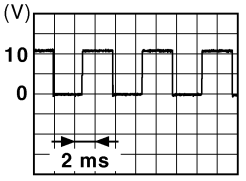
Terminal No. (Wire color)		Description		Condition		Value (Approx.)
+	-					
1 (W)	Ground	Battery power supply	Input	Ignition switch OFF		Battery voltage
2 (Y)	Ground	P/W power supply (BAT)	Output	Ignition switch OFF		Battery voltage
3 (O)	Ground	P/W power supply (RAP)	Output	Ignition switch ON		Battery voltage
4 (LG)	Ground	Interior room lamp power supply	Output	Interior room lamp battery saver is activated. (Cuts the interior room lamp power supply)		0 V
				Interior room lamp battery saver is not activated. (Outputs the interior room lamp power supply)		Battery voltage
5 (L)	Ground	Passenger door UN- LOCK	Output	Passenger door	UNLOCK (Actuator is activated)	Battery voltage
					Other than UNLOCK (Actuator is not activated)	0 V
7 (Y)	Ground	Step lamp	Output	Step lamp	ON	0 V
					OFF	Battery voltage
8 (V)	Ground	All doors, fuel lid LOCK	Output	All doors	LOCK (Actuator is activated)	Battery voltage
					Other than LOCK (Actuator is not activated)	0 V
9 (G)	Ground	Driver door, fuel lid UNLOCK	Output	Driver door	UNLOCK (Actuator is activated)	Battery voltage
					Other than UNLOCK (Actuator is not activated)	0 V
10 (BR)	Ground	Rear RH door and rear LH door UN- LOCK	Output	Rear RH door and rear LH door	UNLOCK (Actuator is activated)	Battery voltage
					Other than UNLOCK (Actuator is not activated)	0 V
11 (R)	Ground	Battery power supply	Input	Ignition switch OFF		Battery voltage
13 (B)	Ground	Ground	—	Ignition switch ON		0 V
14 (W)	Ground	Push-button ignition switch illumination ground	Output	Tail lamp	OFF	0 V
					ON	<p>NOTE: When the illumination brightening/dimming level is in the neutral position</p>  <p style="text-align: right; font-size: small;">JSNIA0010GB</p>
15 (Y)	Ground	ACC indicator lamp	Output	Ignition switch	OFF or ON	Battery voltage
					ACC	0 V

BCM (BODY CONTROL MODULE)

< ECU DIAGNOSIS INFORMATION >

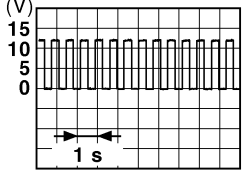
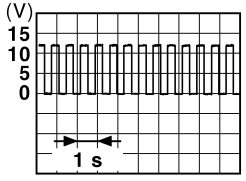
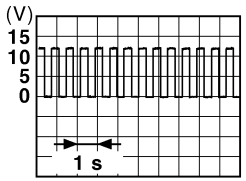
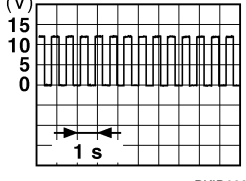
Terminal No. (Wire color)		Description		Condition	Value (Approx.)
+	-	Signal name	Input/ Output		
17 (W)	Ground	Turn signal RH (Front)	Output	Ignition switch ON	Turn signal switch OFF
				Turn signal switch RH	0 V
					 <p style="text-align: center;">6.5 V</p>
18 (O)	Ground	Turn signal LH (Front)	Output	Ignition switch ON	Turn signal switch OFF
				Turn signal switch LH	0 V
					 <p style="text-align: center;">6.5 V</p>
19 (V)	Ground	Room lamp timer control	Output	Interior room lamp	OFF
					ON
20 (V)	Ground	Turn signal RH (Rear)	Output	Ignition switch ON	Turn signal switch OFF
				Turn signal switch RH	0 V
					 <p style="text-align: center;">6.5 V</p>
23 (G)	Ground	Back door open	Output	Back door	OPEN (Back door opener actuator is activated)
					Other than OPEN (Back door opener actuator is not activated)
					0 V
25 (G)	Ground	Turn signal LH (Rear)	Output	Ignition switch ON	Turn signal switch OFF
				Turn signal switch LH	0 V
					 <p style="text-align: center;">6.5 V</p>
26 (G)	Ground	Rear wiper	Output	Rear wiper	OFF (Stopped)
					ON (Operated)

A
B
C
D
E
F
G
H
I
J
K
L
N
O
P

BCS

BCM (BODY CONTROL MODULE)

< ECU DIAGNOSIS INFORMATION >

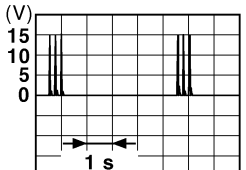
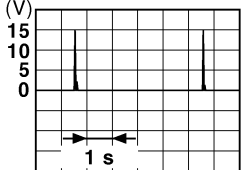
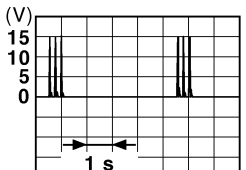
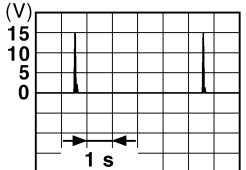
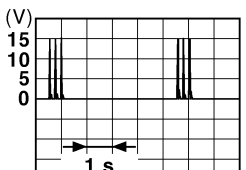
Terminal No. (Wire color)		Description		Condition	Value (Approx.)
+	-	Signal name	Input/ Output		
34 (SB)	Ground	Luggage room antenna (-)	Output		
				When Intelligent Key is not in the passenger compartment	 <p style="text-align: right; font-size: small;">JMKIA0063GB</p>
35 (V)	Ground	Luggage room antenna (+)	Output	Ignition switch OFF	 <p style="text-align: right; font-size: small;">JMKIA0062GB</p>
				When Intelligent Key is not in the passenger compartment	 <p style="text-align: right; font-size: small;">JMKIA0063GB</p>
38 (B)	Ground	Back door antenna (-)	Output	When the back door opener request switch is operated with ignition switch OFF	 <p style="text-align: right; font-size: small;">JMKIA0062GB</p>
				When Intelligent Key is not in the antenna detection area	 <p style="text-align: right; font-size: small;">JMKIA0063GB</p>

BCM (BODY CONTROL MODULE)

< ECU DIAGNOSIS INFORMATION >

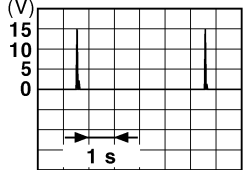
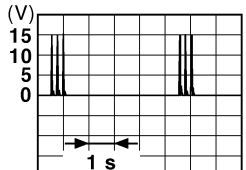
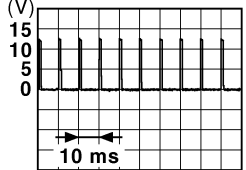
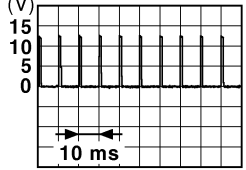
Terminal No. (Wire color)		Description		Condition	Value (Approx.)	
		Signal name	Input/ Output			
+	-					
39 (W)	Ground	Back door antenna (+)	Output	When the back door opener request switch is operated with ignition switch OFF	When Intelligent Key is in the antenna detection area	 <small>JMKIA0062GB</small>
				When Intelligent Key is not in the antenna detection area	 <small>JMKIA0063GB</small>	
47 (Y)	Ground	Ignition relay (IPDM E/R) control	Output	Ignition switch	OFF or ACC	Battery voltage
					ON	0 V
52 (SB)	Ground	Starter relay control	Output	Ignition switch ON	When selector lever is in P or N position	Battery voltage
					When selector lever is not in P or N position	0 V
61 (W)	Ground	Back door opener request switch	Input	Back door opener request switch	ON (Pressed)	0 V
					OFF (Not pressed)	 <small>JPMIA0016GB</small> 1.0 V
64 (V)	Ground	Intelligent Key warning buzzer (Engine room)	Output	Intelligent Key warning buzzer (Engine room)	Sounding	0 V
					Not sounding	Battery voltage
65 (O)	Ground	Rear wiper stop position	Input	Rear wiper	In stop position	 <small>JPMIA0016GB</small> 1.0 V
					Not in stop position	0 V

A
B
C
D
E
F
G
H
I
J
K
L
N
O
P

BCS

BCM (BODY CONTROL MODULE)

< ECU DIAGNOSIS INFORMATION >

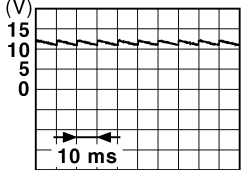
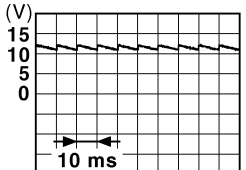
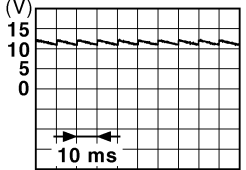
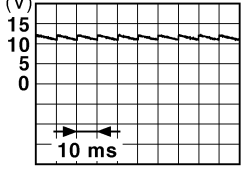
Terminal No. (Wire color)		Description		Condition	Value (Approx.)	
+	-	Signal name	Input/ Output			
66 (R)	Ground	Back door switch	Input	Back door switch	OFF (Door close)	 <small>JPMIA0011GB</small> 11.8 V
					ON (Door open)	0 V
67 (G)	Ground	Back door opener switch	Input	Back door opener switch	Pressed	0 V
					Not pressed	 <small>JPMIA0011GB</small> 11.8 V
68 (BR)	Ground	Rear RH door switch	Input	Rear RH door switch	OFF (Door close)	 <small>JPMIA0011GB</small> 11.8 V
					ON (Door open)	0 V
69 (R)	Ground	Rear LH door switch	Input	Rear LH door switch	OFF (Door close)	 <small>JPMIA0011GB</small> 11.8 V
					ON (Door open)	0 V

BCM (BODY CONTROL MODULE)

< ECU DIAGNOSIS INFORMATION >

Terminal No. (Wire color)		Description		Condition	Value (Approx.)
+	-	Signal name	Input/ Output		
72 (R)	Ground	Room antenna 2 (-) (Center console)	Output	Ignition switch OFF	<p style="text-align: right; font-size: small;">JMKIA0062GB</p>
				When Intelligent Key is not in the passenger compart- ment	<p style="text-align: right; font-size: small;">JMKIA0063GB</p>
73 (G)	Ground	Room antenna 2 (+) (Center console)	Output	Ignition switch OFF	<p style="text-align: right; font-size: small;">JMKIA0062GB</p>
				When Intelligent Key is not in the passenger compart- ment	<p style="text-align: right; font-size: small;">JMKIA0063GB</p>
74 (SB)	Ground	Passenger door an- tenna (-)	Output	When the pas- senger door re- quest switch is operated with ig- nition switch OFF	<p style="text-align: right; font-size: small;">JMKIA0062GB</p>
				When Intelligent Key is not in the antenna detec- tion area	<p style="text-align: right; font-size: small;">JMKIA0063GB</p>

A
B
C
D
E
F
G
H
I
J
K
L
N
O
P

BCS

BCM (BODY CONTROL MODULE)

< ECU DIAGNOSIS INFORMATION >

Terminal No. (Wire color)		Description		Condition	Value (Approx.)
+	-	Signal name	Input/ Output		
75 (GR)	Ground	Passenger door antenna (+)	Output	When Intelligent Key is in the antenna detection area	<p style="text-align: right; font-size: small;">JMKIA0062GB</p>
				When Intelligent Key is not in the antenna detection area	<p style="text-align: right; font-size: small;">JMKIA0063GB</p>
76 (V)	Ground	Driver door antenna (-)	Output	When Intelligent Key is in the antenna detection area	<p style="text-align: right; font-size: small;">JMKIA0062GB</p>
				When Intelligent Key is not in the antenna detection area	<p style="text-align: right; font-size: small;">JMKIA0063GB</p>
77 (LG)	Ground	Driver door antenna (+)	Output	When Intelligent Key is in the antenna detection area	<p style="text-align: right; font-size: small;">JMKIA0062GB</p>
				When Intelligent Key is not in the antenna detection area	<p style="text-align: right; font-size: small;">JMKIA0063GB</p>

BCM (BODY CONTROL MODULE)

< ECU DIAGNOSIS INFORMATION >





Terminal No. (Wire color)		Description		Condition	Value (Approx.)	
+	-	Signal name	Input/ Output			
78 (Y)	Ground	Room antenna 1 (-) (Instrument panel)	Output	Ignition switch OFF	<p style="text-align: right; font-size: small;">JMKIA0062GB</p>	
				Ignition switch OFF	<p style="text-align: right; font-size: small;">JMKIA0063GB</p>	
79 (BR)	Ground	Room antenna 1 (+) (Instrument panel)	Output	Ignition switch OFF	<p style="text-align: right; font-size: small;">JMKIA0062GB</p>	
				Ignition switch OFF	<p style="text-align: right; font-size: small;">JMKIA0063GB</p>	
80 (GR)	Ground	NATS antenna amp (Built in key slot)	Input/ Output	During waiting	Ignition switch is pressed while inserting the key into the key slot.	Just after pressing ignition switch. Pointer of tester should move.
81 (W)	Ground	NATS antenna amp (Built in key slot)	Input/ Output	During waiting	Ignition switch is pressed while inserting the key into the key slot.	Just after pressing ignition switch. Pointer of tester should move.
82 (R)	Ground	Ignition relay [Fuse block (J/B)] control	Output	Ignition switch	OFF or ACC	0 V
				Ignition switch	ON	Battery voltage

A
B
C
D
E
F
G
H
I
J
K
L
N
O
P

BCS

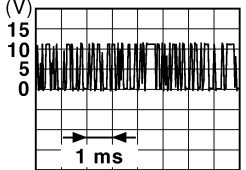
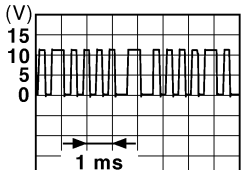
BCM (BODY CONTROL MODULE)

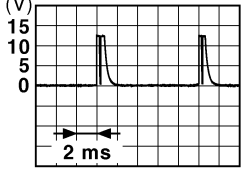
< ECU DIAGNOSIS INFORMATION >

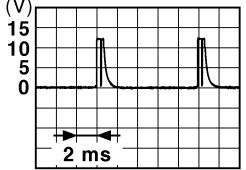
Terminal No. (Wire color)		Description		Condition	Value (Approx.)	
+	-	Signal name	Input/ Output			
83 (Y)	Ground	Remote keyless entry receiver communication	Input/ Output	During waiting	 <small>JMKIA0064GB</small>	
				When operating either button on the key	 <small>JMKIA0065GB</small>	
87 (BR)	Ground	Combination switch INPUT 5	Input	Combination switch	All switches OFF (Wiper intermittent dial 4)	 <small>JPMIA0041GB</small> 1.4 V
					Front fog lamp switch ON (Wiper intermittent dial 4)	 <small>JPMIA0037GB</small> 1.3 V
					Rear wiper switch ON (Wiper intermittent dial 4)	 <small>JPMIA0039GB</small> 1.3 V
					Any of the conditions below with all switches OFF <ul style="list-style-type: none"> • Wiper intermittent dial 1 • Wiper intermittent dial 2 • Wiper intermittent dial 6 • Wiper intermittent dial 7 	 <small>JPMIA0040GB</small> 1.3 V

BCM (BODY CONTROL MODULE)

< ECU DIAGNOSIS INFORMATION >

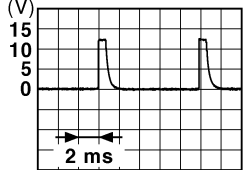
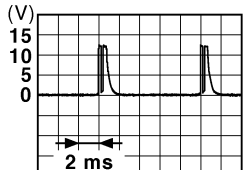
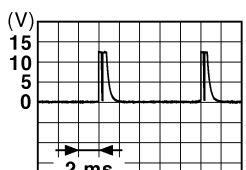
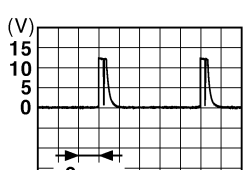
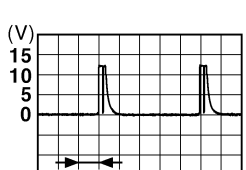
Terminal No. (Wire color)		Description		Condition	Value (Approx.)	
+	-	Signal name	Input/ Output			
88 (V)	Ground	Combination switch INPUT 3	Input	Combination switch	All switches OFF (Wiper intermittent dial 4)	 <p style="text-align: right;">1.4 V</p>
					Lighting switch HI (Wiper intermittent dial 4)	 <p style="text-align: right;">1.3 V</p>
					Lighting switch 2ND (Wiper intermittent dial 4)	 <p style="text-align: right;">1.3 V</p>
					Rear washer switch ON (Wiper intermittent dial 4)	 <p style="text-align: right;">1.3 V</p>
					Any of the conditions below with all switches OFF	 <p style="text-align: right;">1.3 V</p>
					<ul style="list-style-type: none"> • Wiper intermittent dial 1 • Wiper intermittent dial 2 • Wiper intermittent dial 3 	
89 (BR)	Ground	Push-button ignition switch (Push switch)	Input	Push-button igni- tion switch (push switch)	Pressed	0 V
					Not pressed	Battery voltage
90 (P)	Ground	CAN-L	Input/ Output	—	—	
91 (L)	Ground	CAN-H	Input/ Output	—	—	

A
B
C
D
E
F
G
H
I
J
K
L
N
O
P

BCS

BCM (BODY CONTROL MODULE)

< ECU DIAGNOSIS INFORMATION >

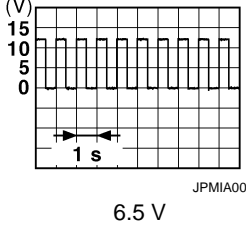
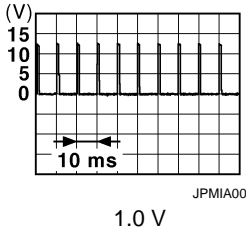
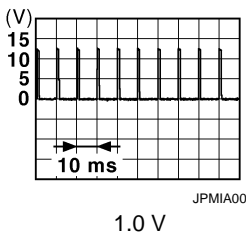
Terminal No. (Wire color)		Description		Condition		Value (Approx.)
+	-	Signal name	Input/ Output			
92 (LG)	Ground	Key slot illumination	Output	Key slot illumination	OFF	0 V
					Blinking	
93 (V)	Ground	ON indicator lamp	Output	Ignition switch	OFF or ACC	Battery voltage
					ON	0 V
94 (Y)	Ground	Puddle lamp control	Output	Puddle lamp	OFF	Battery voltage
					ON	0 V
95 (O)	Ground	ACC relay control	Output	Ignition switch	OFF	0 V
					ACC or ON	Battery voltage
96 (GR)	Ground	A/T shift selector (Detention switch) power supply	Output	—	—	Battery voltage
97 (L)	Ground	Steering lock condition No. 1	Input	Steering lock	LOCK status	0 V
					UNLOCK status	Battery voltage
98 (P)	Ground	Steering lock condition No. 2	Input	Steering lock	LOCK status	Battery voltage
					UNLOCK status	0 V
99 (R)	Ground	Selector lever P position switch	Input	Selector lever	P position	0 V
					Any position other than P	Battery voltage
100 (G)	Ground	Passenger door request switch	Input	Passenger door request switch	ON (Pressed)	0 V
					OFF (Not pressed)	
101 (SB)	Ground	Driver door request switch	Input	Driver door request switch	ON (Pressed)	0 V
					OFF (Not pressed)	
102 (O)	Ground	Blower fan motor relay control	Output	Ignition switch	OFF or ACC	0 V
					ON	Battery voltage

BCM (BODY CONTROL MODULE)

< ECU DIAGNOSIS INFORMATION >

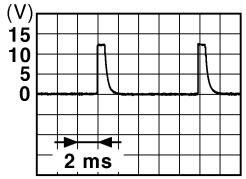
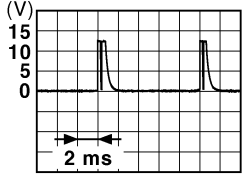
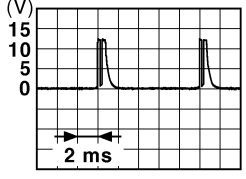
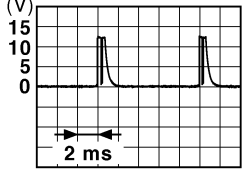
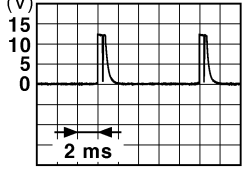
Terminal No. (Wire color)		Description		Condition	Value (Approx.)	
		Signal name	Input/ Output			
+	-					
103 (LG)	Ground	Remote keyless entry receiver power supply	Output	Ignition switch OFF	Battery voltage	
106 (W)	Ground	Steering lock unit power supply	Output	Ignition switch	OFF or ACC	
					ON	0 V
107 (LG)	Ground	Combination switch INPUT 1	Input	Combination switch (Wiper intermittent dial 4)	All switches OFF	 <p style="text-align: center;">1.4 V</p>
					Turn signal switch LH	 <p style="text-align: center;">1.3 V</p>
					Turn signal switch RH	 <p style="text-align: center;">1.3 V</p>
					Front wiper switch LO	 <p style="text-align: center;">1.3 V</p>
					Front washer switch ON	 <p style="text-align: center;">1.3 V</p>

A
B
C
D
E
F
G
H
I
J
K
L
N
O
P

BCS



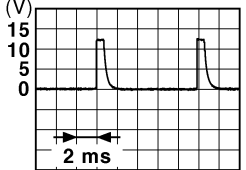
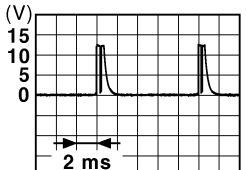
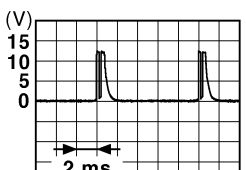
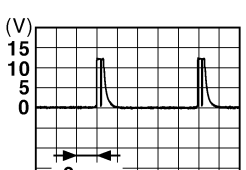
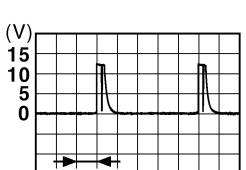

BCM (BODY CONTROL MODULE)

< ECU DIAGNOSIS INFORMATION >

Terminal No. (Wire color)		Description		Condition	Value (Approx.)	
		Signal name	Input/ Output			
+	-					
108 (R)	Ground	Combination switch INPUT 4	Input	Combination switch	All switches OFF (Wiper intermittent dial 4)	 <p style="text-align: right; font-size: small;">JPMIA0041GB</p> <p style="text-align: center;">1.4 V</p>
					Lighting switch AUTO (Wiper intermittent dial 4)	 <p style="text-align: right; font-size: small;">JPMIA0038GB</p> <p style="text-align: center;">1.3 V</p>
					Lighting switch 1ST (Wiper intermittent dial 4)	 <p style="text-align: right; font-size: small;">JPMIA0036GB</p> <p style="text-align: center;">1.3 V</p>
					Rear wiper switch INT (Wiper intermittent dial 4)	 <p style="text-align: right; font-size: small;">JPMIA0040GB</p> <p style="text-align: center;">1.3 V</p>
					Any of the conditions below with all switches OFF	 <p style="text-align: right; font-size: small;">JPMIA0039GB</p> <p style="text-align: center;">1.3 V</p>

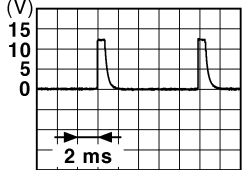
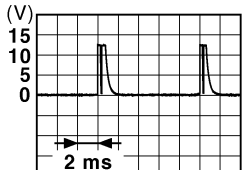
BCM (BODY CONTROL MODULE)

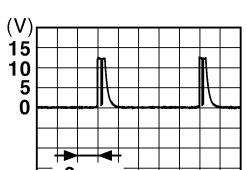
< ECU DIAGNOSIS INFORMATION >

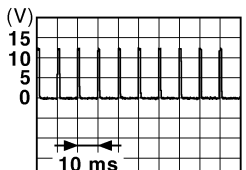
Terminal No. (Wire color)		Description		Condition	Value (Approx.)	
+	-	Signal name	Input/ Output			
109 (Y)	Ground	Combination switch INPUT 2	Input	Combination switch (Wiper intermit- tent dial 4)	All switches OFF	 <p style="text-align: right;">1.4 V</p>
					Lighting switch PASS	 <p style="text-align: right;">1.3 V</p>
					Lighting switch 2ND	 <p style="text-align: right;">1.3 V</p>
					Front wiper switch INT	 <p style="text-align: right;">1.3 V</p>
					Front wiper switch HI	 <p style="text-align: right;">1.3 V</p>
					ON	0 V
110 (G)	Ground	Hazard switch	Input	Hazard switch	 <p style="text-align: right;">1.1 V</p>	
				OFF		

A
B
C
D
E
F
G
H
I
J
K
L
N
O
P

BCS

BCM (BODY CONTROL MODULE)

< ECU DIAGNOSIS INFORMATION >

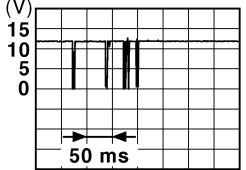
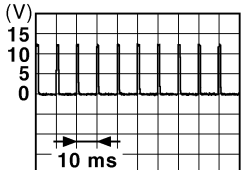
Terminal No. (Wire color)		Description		Condition	Value (Approx.)	
+	-	Signal name	Input/ Output			
111 (Y)	Ground	Steering lock unit communication	Input/ Output	Steering lock	LOCK status	Battery voltage
				LOCK or UNLOCK		JMKIA0066GB
				For 15 seconds after UN- LOCK	Battery voltage	
				15 seconds or later after UNLOCK	0 V	
113 (P)	Ground	Optical sensor	Input	Ignition switch ON	When bright outside of the vehicle	Close to 5 V
				When dark outside of the vehicle	Close to 0 V	
116 (SB)	Ground	Stop lamp switch 1	Input	—	Battery voltage	
118 (P)	Ground	Stop lamp switch 2 (Without ICC)	Input	Stop lamp switch	OFF (Brake pedal is not depressed)	0 V
					ON (Brake pedal is de- pressed)	Battery voltage
		Stop lamp switch 2 (With ICC)		Stop lamp switch OFF (Brake pedal is not de- pressed) and ICC brake hold relay OFF	0 V	
				Stop lamp switch ON (Brake pedal is de- pressed) or ICC brake hold relay ON	Battery voltage	
119 (SB)	Ground	Front door lock as- sembly driver side (Unlock sensor)	Input	Driver door	LOCK status (Unlock sensor switch OFF)	
				UNLOCK status (Unlock switch sensor ON)	0 V	
121 (BR)	Ground	Key slot switch	Input	When the key is inserted into key slot	Battery voltage	
				When the key is not inserted into key slot	0 V	
123 (W)	Ground	IGN feedback	Input	Ignition switch	OFF or ACC	0 V
				ON	Battery voltage	

BCM (BODY CONTROL MODULE)

< ECU DIAGNOSIS INFORMATION >

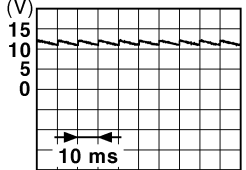
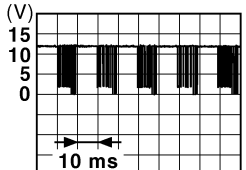
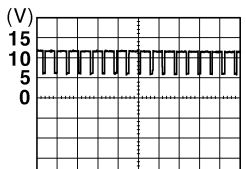

Terminal No. (Wire color)		Description		Condition		Value (Approx.)
+	-	Signal name	Input/ Output			
124 (LG)	Ground	Passenger door switch	Input	Passenger door switch	OFF (Door close)	 <p style="text-align: right;">11.8 V</p>
					ON (Door open)	0 V
132 (V)	Ground	Power window switch communication	Input/ Output	Ignition switch ON	 <p style="text-align: right;">10.2 V</p>	
					Ignition switch OFF or ACC	Battery voltage
133 (W)	Ground	Push-button ignition switch illumination	Output	Push-button igni- tion switch illumina- tion	ON (Tail lamps OFF)	9.5 V
					ON (Tail lamps ON)	<p>NOTE: The pulse width of this wave is varied by the illumination bright- ening/dimming level.</p> 
					OFF	0 V
134 (GR)	Ground	LOCK indicator lamp	Output	LOCK indicator lamp	OFF	Battery voltage
					ON	0 V
137 (O)	Ground	Receiver and sensor ground	Input	Ignition switch ON	0 V	
138 (Y)	Ground	Receiver and sensor power supply	Output	Ignition switch	OFF	0 V
					ACC or ON	5.0 V

A
B
C
D
E
F
G
H
I
J
K
L
N
O
P

BCS

BCM (BODY CONTROL MODULE)

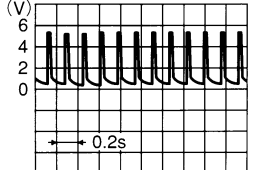
< ECU DIAGNOSIS INFORMATION >

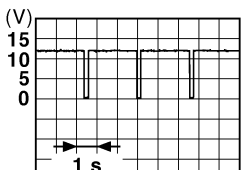
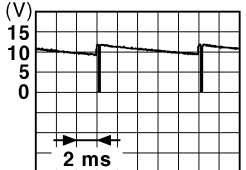
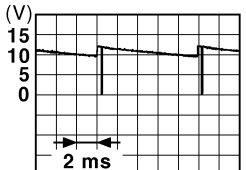
Terminal No. (Wire color)		Description		Condition	Value (Approx.)
+	-	Signal name	Input/ Output		
139 (L)	Ground	Tire pressure receiver communication	Input/ Output	Ignition switch ON	Standby state  OCC3881D
				When receiving the signal from the transmitter  OCC3880D	
140 (GR)	Ground	Selector lever P/N position	Input	Selector lever	P or N position Battery voltage
				Except P and N positions	0 V
141 (G)	Ground	Security indicator	Output	Security indicator	ON 0 V
				Blinking  JPMA0014GB 11.3 V	
142 (O)	Ground	Combination switch OUTPUT 5	Output	Combination switch (Wiper intermittent dial 4)	All switches OFF 0 V
				Lighting switch 1ST Lighting switch HI Lighting switch 2ND Turn signal switch RH  JPMA0031GB 10.7 V	
143 (P)	Ground	Combination switch OUTPUT 1	Output	Combination switch	All switches OFF (Wiper intermittent dial 4) 0 V
				Front wiper switch HI (Wiper intermittent dial 4) Rear wiper switch INT (Wiper intermittent dial 4) Any of the conditions below with all switches OFF • Wiper intermittent dial 1 • Wiper intermittent dial 2 • Wiper intermittent dial 3 • Wiper intermittent dial 6 • Wiper intermittent dial 7  JPMA0032GB 10.7 V	

BCM (BODY CONTROL MODULE)

< ECU DIAGNOSIS INFORMATION >

Terminal No. (Wire color)		Description		Condition	Value (Approx.)		
+	-	Signal name	Input/ Output				
144 (G)	Ground	Combination switch OUTPUT 2	Output	Combination switch	All switches OFF (Wiper intermittent dial 4)	0 V	
					Front washer switch ON (Wiper intermittent dial 4)		
					Rear wiper switch ON (Wiper intermittent dial 4)		
					Rear washer switch ON (Wiper intermittent dial 4)		
					Any of the conditions below with all switches OFF <ul style="list-style-type: none"> • Wiper intermittent dial 1 • Wiper intermittent dial 5 • Wiper intermittent dial 6 		
145 (L)	Ground	Combination switch OUTPUT 3	Output	Combination switch (Wiper intermit- tent dial 4)	All switches OFF	0 V	
					Front wiper switch INT		
					Front wiper switch LO		
					Lighting switch AUTO		
146 (SB)	Ground	Combination switch OUTPUT 4	Output	Combination switch (Wiper intermit- tent dial 4)	All switches OFF	0 V	
					Front fog lamp switch ON		
					Lighting switch 2ND		
					Lighting switch PASS		
					Turn signal switch LH	10.7 V	
149 (W)	Ground	Tire pressure warn- ing check switch	Input	Ignition switch ON		11.8 V	
150 (LG)	Ground	Driver door switch	Input	Driver door switch	OFF (Door close)		11.8 V
					ON (Door open)	0 V	
151 (G)	Ground	Rear window defog- ger relay control	Output	Rear window de- fogger	Active	0 V	
					Not activated	Battery voltage	

A
B
C
D
E
F
G
H
I
J
K
L
N
O
P

BCS

BCM (BODY CONTROL MODULE)

< ECU DIAGNOSIS INFORMATION >

Wiring Diagram - BCM -

INFOID:000000004345217

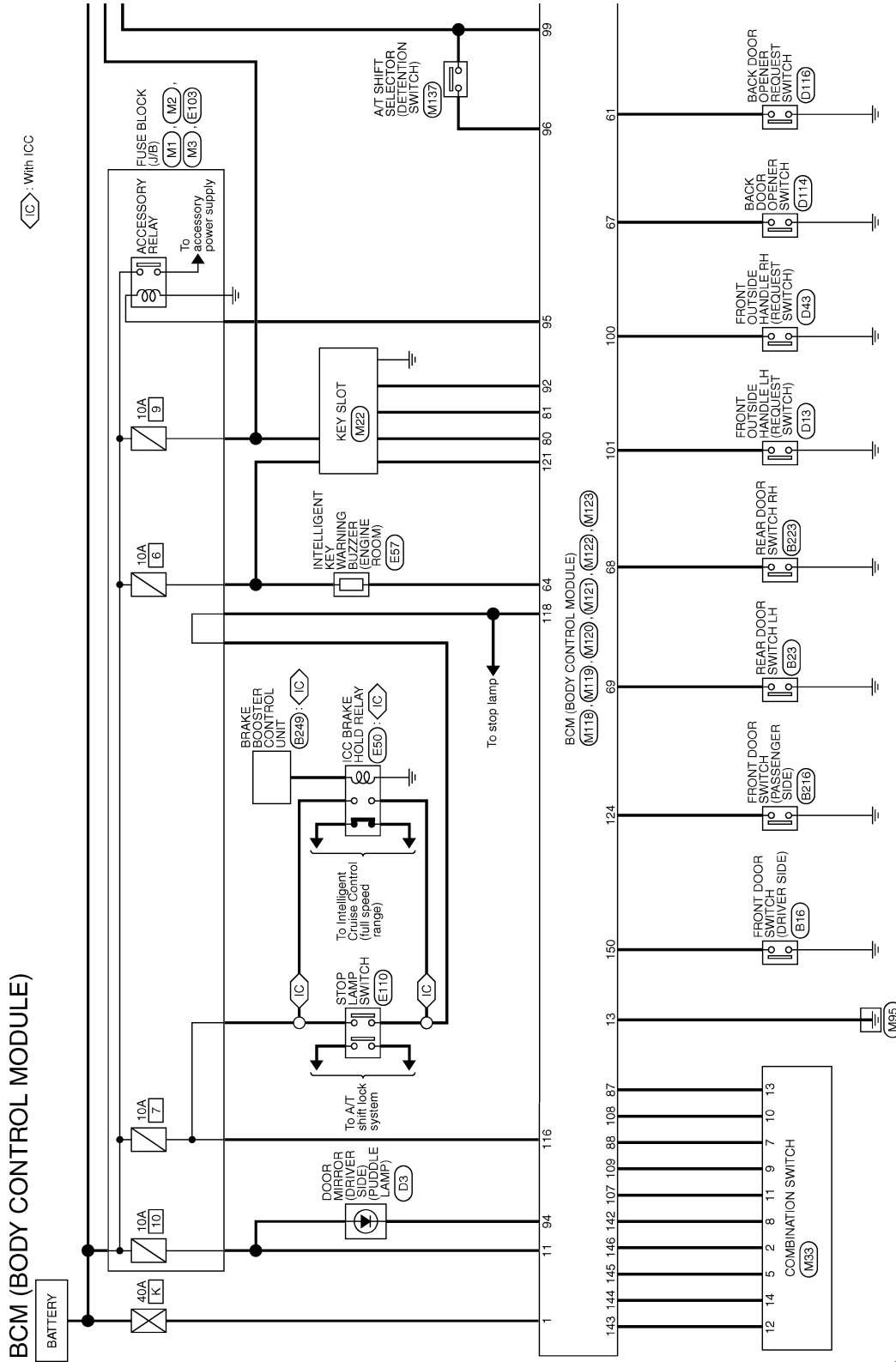

JCMWA3119GB

2008/08/28

BCM (BODY CONTROL MODULE)

< ECU DIAGNOSIS INFORMATION >

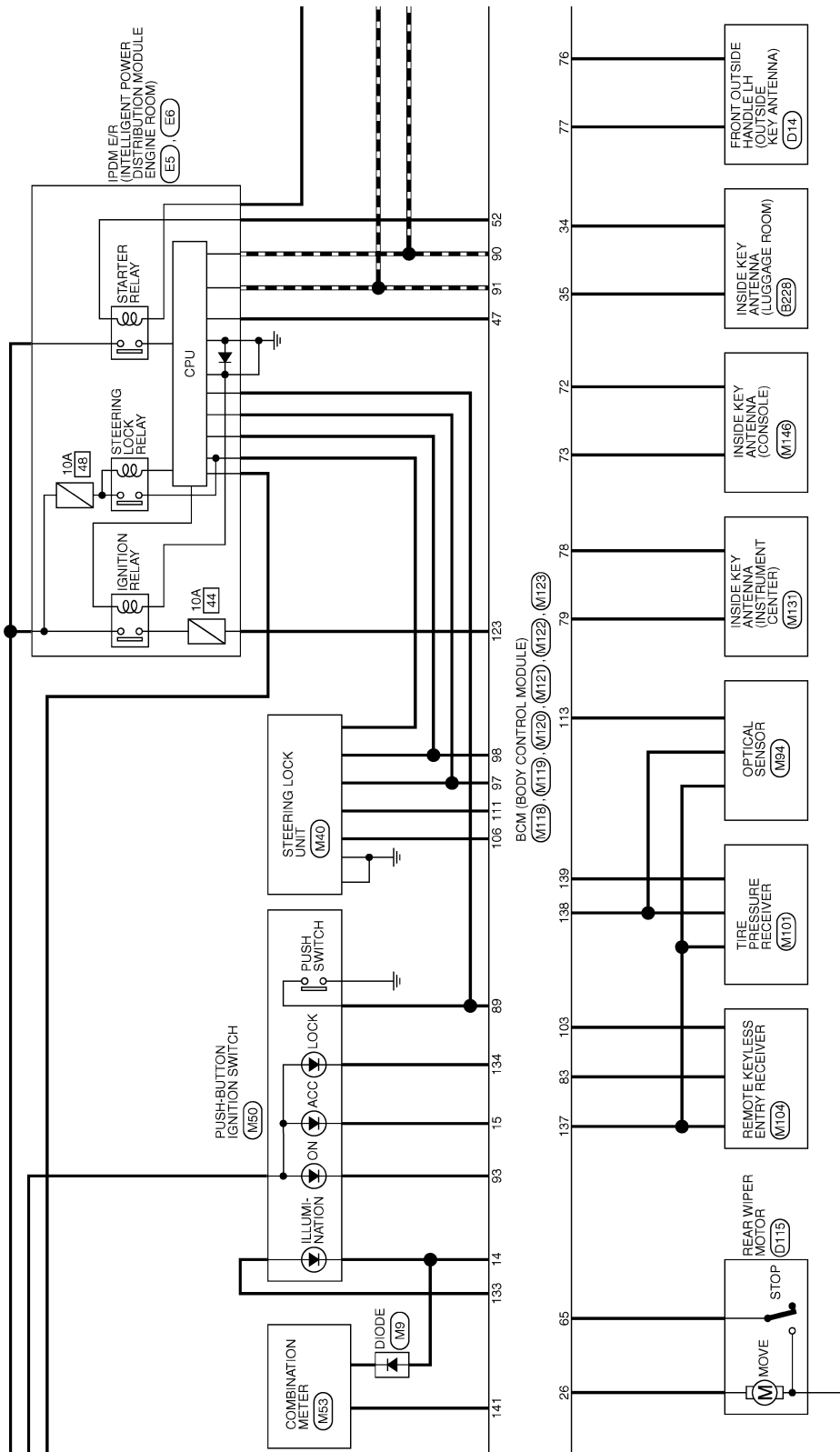

*: This connector is not shown in "Harness Layout".

JCMWA3120GB

A
B
C
D
E
F
G
H
I
J
K
L
N
O
P

BCS

BCM (BODY CONTROL MODULE)

< ECU DIAGNOSIS INFORMATION >

- ◊RF◊ : With sunroof
- ◊PM◊ : With automatic drive positioner
- ◊OP◊ : Without automatic drive positioner

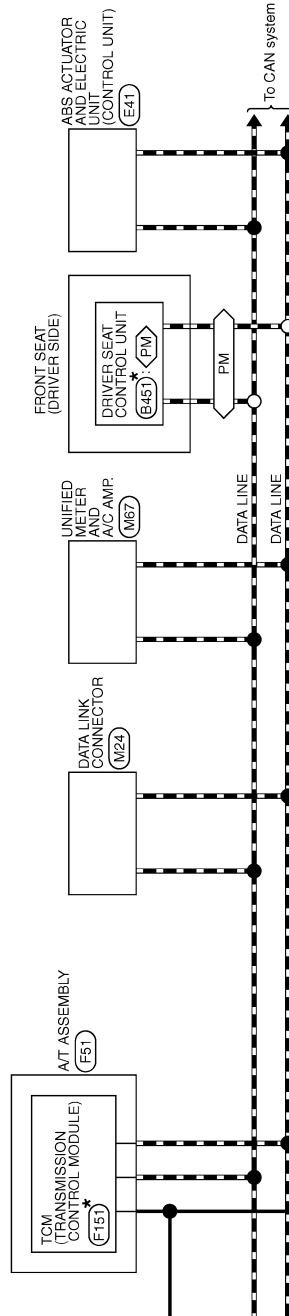

BCM (BODY CONTROL MODULE)
 (M11B) (M119) (M120) (M121) (M122) (M123)

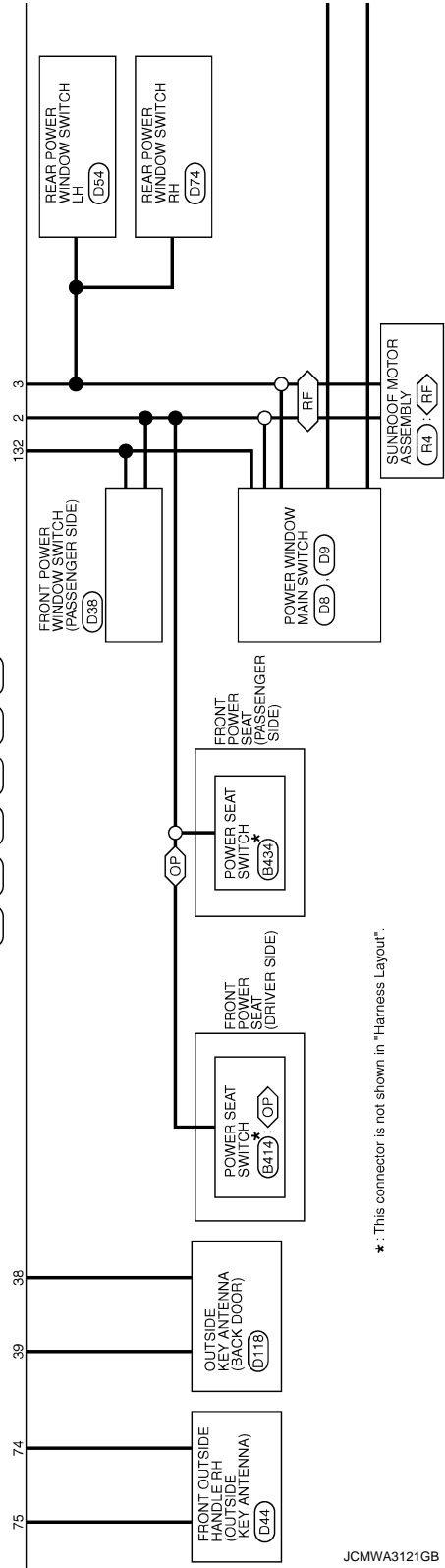

* : This connector is not shown in "Harness Layout".

JCMWA3121GB

BCM (BODY CONTROL MODULE)

< ECU DIAGNOSIS INFORMATION >

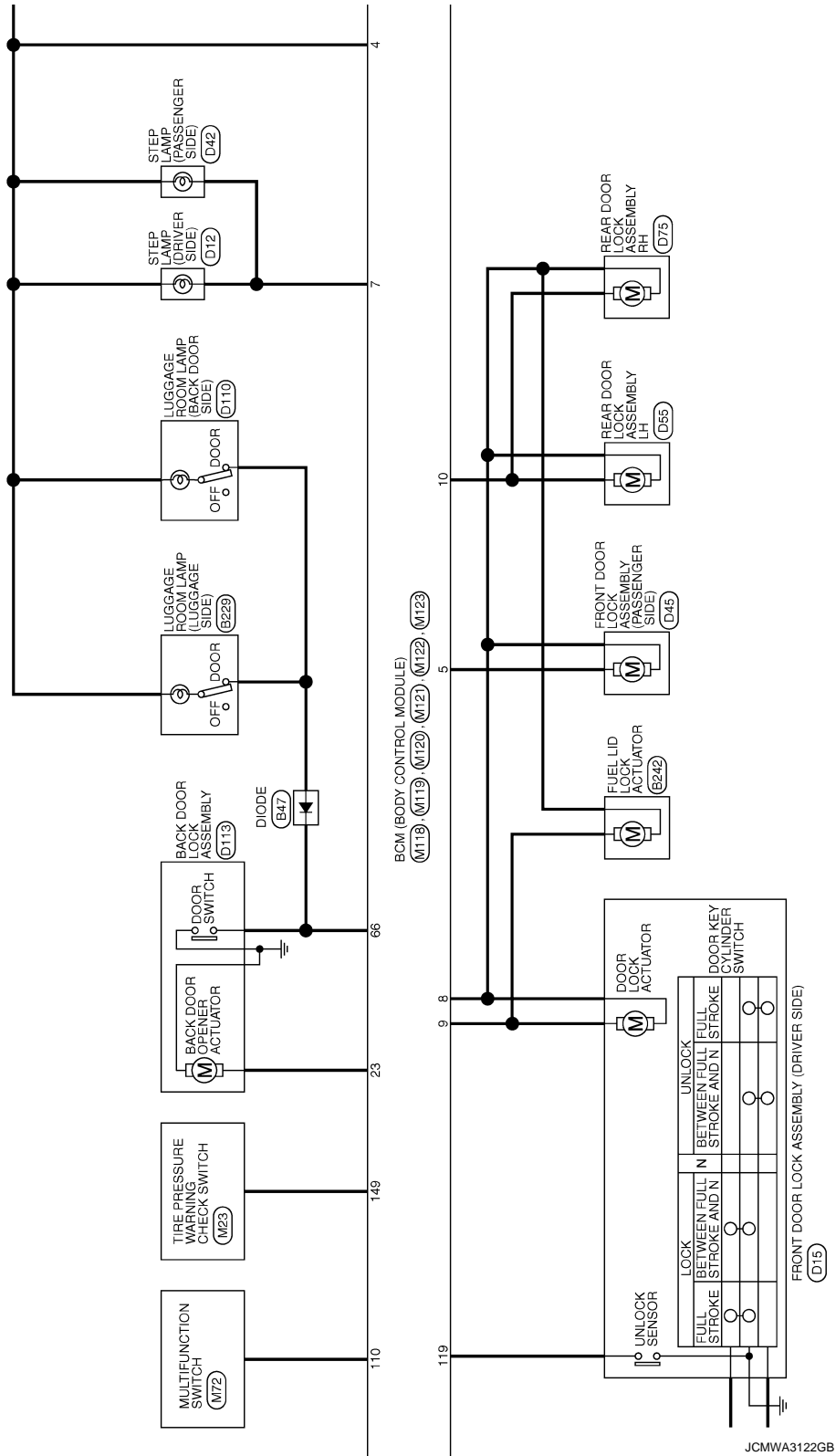

JCMWA3122GB

A
B
C
D
E
F
G
H
I
J
K
L
M
N
O
P

BCS

BCM (BODY CONTROL MODULE)

< ECU DIAGNOSIS INFORMATION >

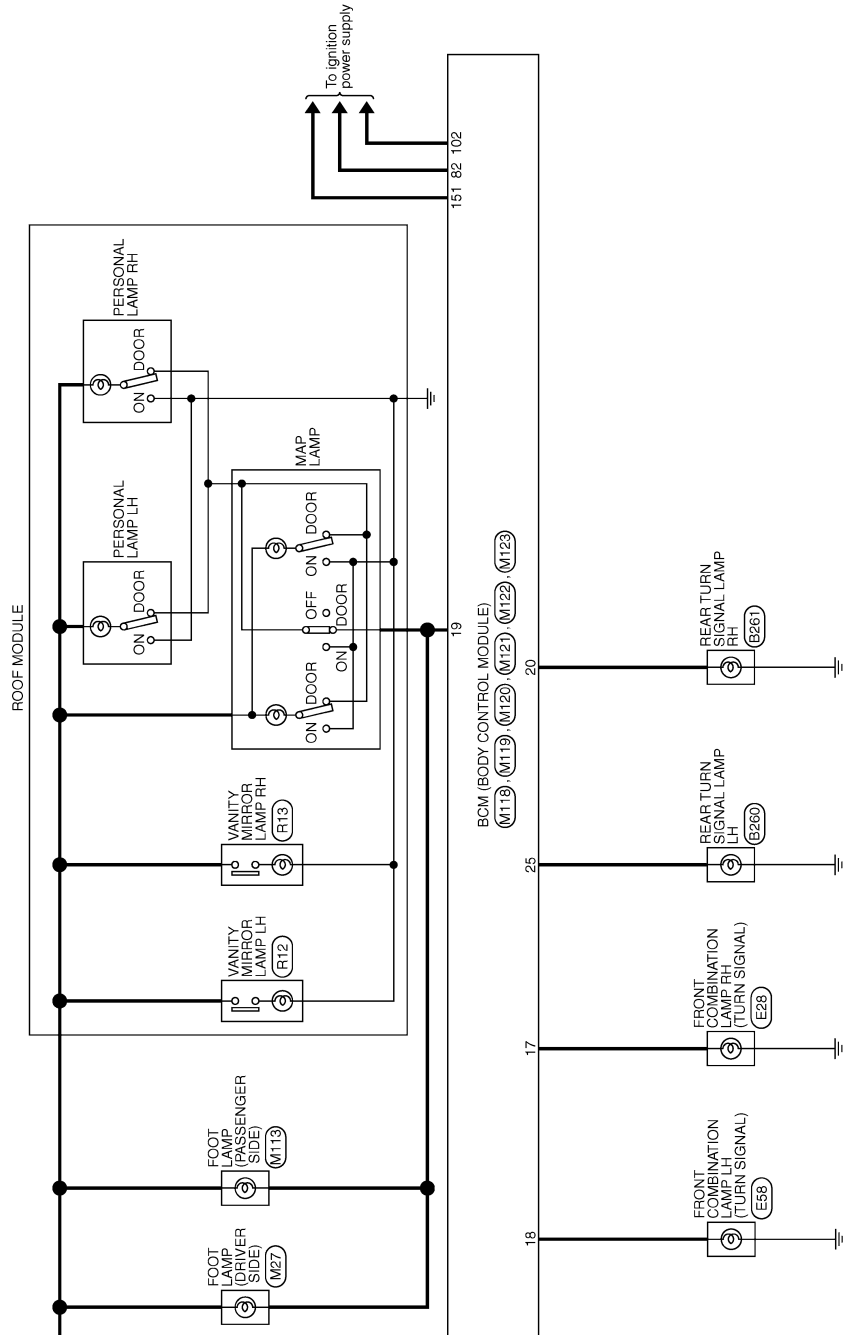

JCMWA3123GB

BCM (BODY CONTROL MODULE)

< ECU DIAGNOSIS INFORMATION >

BCM (BODY CONTROL MODULE)

Connector No.	M33
Connector Name	COMBINATION SWITCH
Connector Type	TH16FW-NH

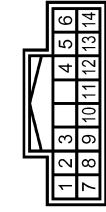

Terminal No.	Color of Wire	Signal Name [Specification]
2	SB	OUTPUT 4
5	L	OUTPUT 3
7	V	INPUT 3
8	O	OUTPUT 5
9	Y	INPUT 2
10	R	INPUT 4
11	LG	INPUT 1
12	P	OUTPUT 1
13	BR	INPUT 5
14	G	OUTPUT 2

Connector No.	M120
Connector Name	BCM (BODY CONTROL MODULE)
Connector Type	MS12FW-CS



Terminal No.	Color of Wire	Signal Name [Specification]
20	V	TURN SIGNAL RH (REAR)
23	G	BACK DOOR OPEN OUTPUT
25	G	TURN SIGNAL LH (REAR)
26	G	REAR WIPER OUTPUT

Connector No.	M118
Connector Name	BCM (BODY CONTROL MODULE)
Connector Type	MS3FB-LC



Terminal No.	Color of Wire	Signal Name [Specification]
1	W	BAT (+/L)
2	Y	POWER WINDOW POWER SUPPLY(BAT)
3	O	POWER WINDOW POWER SUPPLY(RAP)

Connector No.	M121
Connector Name	BCM (BODY CONTROL MODULE)
Connector Type	TH40FGY-NH



Terminal No.	Color of Wire	Signal Name [Specification]
34	SB	LUGGAGE ROOM ANT-
35	V	LUGGAGE ROOM ANT+
38	B	BACK DOOR ANT-
39	W	BACK DOOR ANT+
47	Y	IGN RELAY (IPDM/EL) CONT
52	SR	STARTER RELAY CONT
61	W	BACK DOOR OPENER REQUEST SW
64	V	KEY WARN BUZZER (ENG ROOM)
66	O	REAR WIPER STOP POSITION
68	R	BACK DOOR SW
67	GR	BACK DOOR OPENER SW

Connector No.	M119
Connector Name	BCM (BODY CONTROL MODULE)
Connector Type	MS16FW-CS

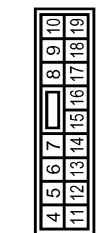

Terminal No.	Color of Wire	Signal Name [Specification]
4	LG	INTERIOR ROOM LAMP POWER SUPPLY
5	L	PASSENGER DOOR UNLOCK OUTPUT
7	Y	STEP LAMP OUTPUT
8	V	ALL DOOR FUEL LID LOCK OUTPUT
9	G	DRIVER DOOR FUEL LID UNLOCK OUTPUT
10	BR	REAR DOOR UNLOCK OUTPUT
11	R	BAT (FUSE)
13	B	GND
14	W	PUSH-BUTTON IGNITION SW ILL GND
15	Y	ACC. IND
17	W	TURN SIGNAL RH (FRONT)

Terminal No.	68	BR	REAR RH DOOR SW
69	R		REAR LH DOOR SW

Terminal No.	18	O	TURN SIGNAL LH (FRONT)
19	V		ROOM LAMP TIMER CONTROL

A
B
C
D
E
F
G
H
I
J
K
L
N
O
P

BCS

BCM (BODY CONTROL MODULE)

< ECU DIAGNOSIS INFORMATION >

138	Y	RECEIVER/SENSOR POWER SUPPLY
139	L	TIRE PRESSURE RECEIVER COMM
140	GR	SHIFT N/P
141	G	SECURITY INDICATOR OUTPUT
142	O	COMBI SW OUTPUT 5
143	P	COMBI SW OUTPUT 1
144	G	COMBI SW OUTPUT 2
145	L	COMBI SW OUTPUT 3
146	SB	COMBI SW OUTPUT 4
149	W	TIRE PRESS WARNING CHECK SW
150	LG	DRIVER DOOR SW
151	G	REAR WINDOW DEFROGGER RELAY CONT

Connector No.	M123
Connector Name	BCM (BODY CONTROL MODULE)
Connector Type	TH40FG-NH



Terminal No.	Color of Wire	Signal Name [Specification]
113	P	OPTICAL SENSOR
116	SB	STOP LAMP SW 1
118	P	STOP LAMP SW 2
119	SB	DR DOOR UNLOCK SENSOR
121	BR	KEY SLOT SW
123	W	IGN F/B
124	LG	PASSENGER DOOR SW
132	V	POWER WINDOW SW COMM
133	W	PUSH-BUTTON IGNITION SW ILL POWER
134	GR	LOCK IND
137	O	RECEIVER/SENSOR GND

83	Y	KEYLESS ENTRY RECEIVER COMM
87	BR	COMBI SW INPUT 5
88	V	COMBI SW INPUT 3
89	BR	PUSH SW
90	P	CAN-L
91	L	CAN-H
92	LG	KEY SLOT ILL
93	V	GN IND
94	Y	PUDDLE LAMP CONT
95	O	ACC RELAY CONT
96	GR	A/T SHIFT SELECTOR POWER SUPPLY
97	L	S/L CONDITION 1
98	P	S/L CONDITION 2
99	R	SHIFT P
100	G	PASSENGER DOOR REQUEST SW
101	SB	DRIVER DOOR REQUEST SW
102	O	BLOWER FAN MOTOR RELAY CONT
103	LG	KEYLESS ENTRY RECEIVER POWER SUPPLY
106	W	S/L UNIT POWER SUPPLY
107	LG	COMBI SW INPUT 1
108	R	COMBI SW INPUT 4
109	Y	COMBI SW INPUT 2
110	G	HAZARD SW
111	Y	S/L UNIT COMM

BCM (BODY CONTROL MODULE)

Connector No.	M122
Connector Name	BCM (BODY CONTROL MODULE)
Connector Type	TH40FB-NH



Terminal No.	Color of Wire	Signal Name [Specification]
72	R	ROOM ANT2-
73	G	ROOM ANT2+
74	SB	PASSENGER DOOR ANT-
75	GR	PASSENGER DOOR ANT+
76	V	DRIVER DOOR ANT-
77	LG	DRIVER DOOR ANT+
78	Y	ROOM ANT1-
79	BR	ROOM ANT1+
80	GR	IMMOBI ANTENNA CONTROL
81	W	IMMOBI ANTENNA SIGNAL
82	R	IGN RELAY (F/B) CONT

JCMWA3125GB

Fail-safe

INFOID:000000004345218

FAIL-SAFE CONTROL BY DTC

BCM performs fail-safe control when any DTC are detected.

BCM (BODY CONTROL MODULE)

< ECU DIAGNOSIS INFORMATION >

Display contents of CONSULT	Fail-safe	Cancellation	
B2013: ID DISCORD BCM-S/L	Inhibit engine cranking	Erase DTC	A
B2014: CHAIN OF S/L-BCM	Inhibit engine cranking	Erase DTC	
B2190: NATS ANTENNA AMP	Inhibit engine cranking	Erase DTC	B
B2191: DIFFERENCE OF KEY	Inhibit engine cranking	Erase DTC	
B2192: ID DISCORD BCM-ECM	Inhibit engine cranking	Erase DTC	C
B2193: CHAIN OF BCM-ECM	Inhibit engine cranking	Erase DTC	
B2195: ANTI SCANNING	Inhibit engine cranking	Ignition switch ON → OFF	
B2557: VEHICLE SPEED	Inhibit steering lock	When normal vehicle speed signals are received from ABS actuator and electric unit (control unit) for 500 ms	D
B2560: STARTER CONT RELAY	Inhibit engine cranking	500 ms after the following CAN signal communication status becomes consistent <ul style="list-style-type: none"> • Starter control relay signal • Starter relay status signal 	E
B2601: SHIFT POSITION	Inhibit steering lock	500 ms after the following signal reception status becomes consistent <ul style="list-style-type: none"> • Selector lever P position switch signal • P range signal (CAN) 	F
B2602: SHIFT POSITION	Inhibit steering lock	5 seconds after the following BCM recognition conditions are fulfilled <ul style="list-style-type: none"> • Ignition switch is in the ON position • Selector lever P position switch signal: Except P position (battery voltage) • Vehicle speed: 4 km/h (2.5 MPH) or more 	G H
B2603: SHIFT POSI STATUS	Inhibit steering lock	500 ms after the following BCM recognition conditions are fulfilled <ul style="list-style-type: none"> • Ignition switch is in the ON position • Selector lever P position switch signal: Except P position (battery voltage) • Selector lever P/N position signal: Except P and N positions (0 V) 	I J
B2604: PNP SW	Inhibit steering lock	500 ms after any of the following BCM recognition conditions are fulfilled <ul style="list-style-type: none"> • Status 1 <ul style="list-style-type: none"> - Ignition switch is in the ON position - Selector lever P/N position signal: P and N position (battery voltage) - P range signal or N range signal (CAN): ON • Status 2 <ul style="list-style-type: none"> - Ignition switch is in the ON position - Selector lever P/N position signal: Except P and N positions (0 V) - P range signal and N range signal (CAN): OFF 	K L
B2605: PNP SW	Inhibit steering lock	500 ms after any of the following BCM recognition conditions are fulfilled <ul style="list-style-type: none"> • Ignition switch is in the ON position <ul style="list-style-type: none"> - Power position: IGN - Selector lever P/N position signal: Except P and N positions (0 V) - Interlock/PNP switch signal (CAN): OFF • Status 2 <ul style="list-style-type: none"> - Ignition switch is in the ON position - Selector lever P/N position signal: P or N position (battery voltage) - PNP switch signal (CAN): ON 	N O
B2606: S/L RELAY	Inhibit engine cranking	500 ms after the following CAN signal communication status becomes consistent <ul style="list-style-type: none"> • Steering lock relay signal (Request signal) • Steering lock relay signal (Condition signal) 	P

BCS

BCM (BODY CONTROL MODULE)

< ECU DIAGNOSIS INFORMATION >

Display contents of CONSULT	Fail-safe	Cancellation
B2607: S/L RELAY	Inhibit engine cranking	500 ms after the following CAN signal communication status becomes consistent <ul style="list-style-type: none"> Steering lock relay signal (Request signal) Steering lock relay signal (Condition signal)
B2608: STARTER RELAY	Inhibit engine cranking	500 ms after the following signal communication status becomes consistent <ul style="list-style-type: none"> Starter motor relay control signal Starter relay status signal (CAN)
B2609: S/L STATUS	<ul style="list-style-type: none"> Inhibit engine cranking Inhibit steering lock 	When the following steering lock conditions agree <ul style="list-style-type: none"> BCM steering lock control status Steering lock condition No. 1 signal status Steering lock condition No. 2 signal status
B260A: IGNITION RELAY	Inhibit engine cranking	500 ms after the following conditions are fulfilled <ul style="list-style-type: none"> IGN relay (IPDM E/R) control signal: OFF (Battery voltage) Ignition ON signal (CAN to IPDM E/R): OFF (Request signal) Ignition ON signal (CAN from IPDM E/R): OFF (Condition signal)
B260F: ENG STATE SIG LOST	Maintains the power supply position attained at the time of DTC detection	When any of the following conditions are fulfilled <ul style="list-style-type: none"> Power position changes to ACC Receives engine status signal (CAN)
B2612: S/L STATUS	<ul style="list-style-type: none"> Inhibit engine cranking Inhibit steering lock 	When any of the following conditions are fulfilled <ul style="list-style-type: none"> Steering lock unit status signal (CAN) is received normally The BCM steering lock control status matches the steering lock status recognized by the steering lock unit status signal (CAN from IPDM E/R)
B2617: STARTER RELAY CIRC	Inhibit engine cranking	1 second after the starter motor relay control inside BCM becomes normal
B2618: BCM	Inhibit engine cranking	1 second after the ignition relay (IPDM E/R) control inside BCM becomes normal
B2619: BCM	Inhibit engine cranking	1 second after the steering lock unit power supply output control inside BCM becomes normal
B261E: VEHICLE TYPE	Inhibit engine cranking	BCM initialization
B26E9: S/L STATUS	<ul style="list-style-type: none"> Inhibit engine cranking Inhibit steering lock 	When BCM transmits the LOCK request signal to steering lock unit, and receives LOCK response signal from steering lock unit, the following conditions are fulfilled <ul style="list-style-type: none"> Steering condition No. 1 signal: LOCK (0 V) Steering condition No. 2 signal: LOCK (Battery voltage)

HIGH FLASHER OPERATION

BCM detects the turn signal lamp circuit status by the current value.

BCM increases the turn signal lamp blinking speed if the bulb or harness open is detected with the turn signal lamp operating.

NOTE:

The blinking speed is normal while activating the hazard warning lamp.

REAR WIPER MOTOR PROTECTION

BCM detects the rear wiper stopping position according to the rear wiper stop position signal.

When the rear wiper stop position signal does not change for more than 5 seconds while driving the rear wiper, BCM stops power supply to protect the rear wiper motor.

Condition of cancellation

- More than 1 minute is passed after the rear wiper stops.
- Turn rear wiper switch OFF.
- Operate the rear wiper switch or rear washer switch.

DTC Inspection Priority Chart

INFOID:000000004345219

If some DTCs are displayed at the same time, perform inspections one by one based on the following priority chart.

BCM (BODY CONTROL MODULE)

< ECU DIAGNOSIS INFORMATION >

Priority	DTC	A
1	B2562: LOW VOLTAGE	A
2	<ul style="list-style-type: none"> • U1000: CAN COMM CIRCUIT • U1010: CONTROL UNIT (CAN) 	B
3	<ul style="list-style-type: none"> • B2190: NATS ANTENNA AMP • B2191: DIFFERENCE OF KEY • B2192: ID DISCORD BCM-ECM • B2193: CHAIN OF BCM-ECM • B2195: ANTI SCANNING 	C
4	<ul style="list-style-type: none"> • B2013: ID DISCORD BCM-S/L • B2014: CHAIN OF S/L-BCM • B2553: IGNITION RELAY • B2555: STOP LAMP • B2556: PUSH-BTN IGN SW • B2557: VEHICLE SPEED • B2560: STARTER CONT RELAY • B2601: SHIFT POSITION • B2602: SHIFT POSITION • B2603: SHIFT POSI STATUS • B2604: PNP SW • B2605: PNP SW • B2606: S/L RELAY • B2607: S/L RELAY • B2608: STARTER RELAY • B2609: S/L STATUS • B260A: IGNITION RELAY • B260B: STEERING LOCK UNIT • B260C: STEERING LOCK UNIT • B260D: STEERING LOCK UNIT • B260F: ENG STATE SIG LOST • B2612: S/L STATUS • B2614: ACC RELAY CIRC • B2615: BLOWER RELAY CIRC • B2616: IGN RELAY CIRC • B2617: STARTER RELAY CIRC • B2618: BCM • B2619: BCM • B261A: PUSH-BTN IGN SW • B261E: VEHICLE TYPE • B26E9: S/L STATUS • B26EA: KEY REGISTRATION • C1729: VHCL SPEED SIG ERR • U0415: VEHICLE SPEED SIG 	D E F G H I J K L

BCS

N

O

P

BCM (BODY CONTROL MODULE)

< ECU DIAGNOSIS INFORMATION >

Priority	DTC
5	<ul style="list-style-type: none"> • C1704: LOW PRESSURE FL • C1705: LOW PRESSURE FR • C1706: LOW PRESSURE RR • C1707: LOW PRESSURE RL • C1708: [NO DATA] FL • C1709: [NO DATA] FR • C1710: [NO DATA] RR • C1711: [NO DATA] RL • C1712: [CHECKSUM ERR] FL • C1713: [CHECKSUM ERR] FR • C1714: [CHECKSUM ERR] RR • C1715: [CHECKSUM ERR] RL • C1716: [PRESSDATA ERR] FL • C1717: [PRESSDATA ERR] FR • C1718: [PRESSDATA ERR] RR • C1719: [PRESSDATA ERR] RL • C1720: [CODE ERR] FL • C1721: [CODE ERR] FR • C1722: [CODE ERR] RR • C1723: [CODE ERR] RL • C1724: [BATT VOLT LOW] FL • C1725: [BATT VOLT LOW] FR • C1726: [BATT VOLT LOW] RR • C1727: [BATT VOLT LOW] RL • C1734: CONTROL UNIT
6	<ul style="list-style-type: none"> • B2621: INSIDE ANTENNA • B2622: INSIDE ANTENNA • B2623: INSIDE ANTENNA

DTC Index

INFOID:000000004345220

NOTE:

The details of time display are as follows.

- CRNT: A malfunction is detected now.
- PAST: A malfunction was detected in the past.

IGN counter is displayed on Freeze Frame Data. For details of Freeze Frame Data, refer to [BCS-16. "COMMON ITEM : CONSULT-III Function \(BCM - COMMON ITEM\)".](#)

CONSULT display	Fail-safe	Freeze Frame Data •Vehicle Speed •Odo/Trip Meter •Vehicle Condition	Intelligent Key warning lamp ON	Tire pressure monitor warning lamp ON	Reference page
No DTC is detected. further testing may be required.	—	—	—	—	—
U1000: CAN COMM CIRCUIT	—	—	—	—	BCS-37
U1010: CONTROL UNIT (CAN)	—	—	—	—	BCS-38
U0415: VEHICLE SPEED SIG	—	—	—	—	BCS-39
B2013: ID DISCORD BCM-S/L	×	×	—	—	SEC-48
B2014: CHAIN OF S/L-BCM	×	×	—	—	SEC-49
B2190: NATS ANTENNA AMP	×	—	—	—	SEC-41
B2191: DIFFERENCE OF KEY	×	—	—	—	SEC-44
B2192: ID DISCORD BCM-ECM	×	—	—	—	SEC-45
B2193: CHAIN OF BCM-ECM	×	—	—	—	SEC-46
B2195: ANTI SCANNING	×	—	—	—	SEC-47
B2553: IGNITION RELAY	—	×	—	—	PCS-49

BCM (BODY CONTROL MODULE)

< ECU DIAGNOSIS INFORMATION >

CONSULT display	Fail-safe	Freeze Frame Data •Vehicle Speed •Odo/Trip Meter •Vehicle Condition	Intelligent Key warning lamp ON	Tire pressure monitor warning lamp ON	Reference page
B2555: STOP LAMP	—	×	—	—	SEC-52
B2556: PUSH-BTN IGN SW	—	×	×	—	SEC-54
B2557: VEHICLE SPEED	×	×	×	—	SEC-56
B2560: STARTER CONT RELAY	×	×	×	—	SEC-57
B2562: LOW VOLTAGE	—	×	—	—	BCS-40
B2601: SHIFT POSITION	×	×	×	—	SEC-58
B2602: SHIFT POSITION	×	×	×	—	SEC-61
B2603: SHIFT POSI STATUS	×	×	×	—	SEC-63
B2604: PNP SW	×	×	×	—	SEC-66
B2605: PNP SW	×	×	×	—	SEC-68
B2606: S/L RELAY	×	×	×	—	SEC-70
B2607: S/L RELAY	×	×	×	—	SEC-71
B2608: STARTER RELAY	×	×	×	—	SEC-73
B2609: S/L STATUS	×	×	×	—	SEC-75
B260A: IGNITION RELAY	×	×	×	—	PCS-51
B260B: STEERING LOCK UNIT	—	×	×	—	SEC-79
B260C: STEERING LOCK UNIT	—	×	×	—	SEC-80
B260D: STEERING LOCK UNIT	—	×	×	—	SEC-81
B260F: ENG STATE SIG LOST	×	×	×	—	SEC-82
B2612: S/L STATUS	×	×	×	—	SEC-86
B2614: ACC RELAY CIRC	—	×	×	—	PCS-53
B2615: BLOWER RELAY CIRC	—	×	×	—	PCS-56
B2616: IGN RELAY CIRC	—	×	×	—	PCS-59
B2617: STARTER RELAY CIRC	×	×	×	—	SEC-90
B2618: BCM	×	×	×	—	PCS-62
B2619: BCM	×	×	×	—	SEC-92
B261A: PUSH-BTN IGN SW	—	×	×	—	SEC-93
B261E: VEHICLE TYPE	×	×	× (Turn ON for 15 seconds)	—	SEC-96
B2621: INSIDE ANTENNA	—	×	—	—	DLK-59
B2622: INSIDE ANTENNA	—	×	—	—	DLK-61
B2623: INSIDE ANTENNA	—	×	—	—	DLK-63
B26E1: ENG STATE NO RES	×	×	×	—	SEC-83
B26E9: S/L STATUS	×	×	× (Turn ON for 15 seconds)	—	SEC-84
B26EA: KEY REGISTRATION	—	×	× (Turn ON for 15 seconds)	—	SEC-85
C1704: LOW PRESSURE FL	—	—	—	×	WT-17
C1705: LOW PRESSURE FR	—	—	—	×	
C1706: LOW PRESSURE RR	—	—	—	×	
C1707: LOW PRESSURE RL	—	—	—	×	

A
B
C
D
E
F
G
H
I
J
K
L
BCS
N
O
P

BCM (BODY CONTROL MODULE)

< ECU DIAGNOSIS INFORMATION >

CONSULT display	Fail-safe	Freeze Frame Data •Vehicle Speed •Odo/Trip Meter •Vehicle Condition	Intelligent Key warning lamp ON	Tire pressure monitor warning lamp ON	Reference page
C1708: [NO DATA] FL	—	—	—	×	WT-19
C1709: [NO DATA] FR	—	—	—	×	
C1710: [NO DATA] RR	—	—	—	×	
C1711: [NO DATA] RL	—	—	—	×	
C1712: [CHECKSUM ERR] FL	—	—	—	×	WT-22
C1713: [CHECKSUM ERR] FR	—	—	—	×	
C1714: [CHECKSUM ERR] RR	—	—	—	×	
C1715: [CHECKSUM ERR] RL	—	—	—	×	
C1716: [PRESSDATA ERR] FL	—	—	—	×	WT-25
C1717: [PRESSDATA ERR] FR	—	—	—	×	
C1718: [PRESSDATA ERR] RR	—	—	—	×	
C1719: [PRESSDATA ERR] RL	—	—	—	×	
C1720: [CODE ERR] FL	—	—	—	×	WT-27
C1721: [CODE ERR] FR	—	—	—	×	
C1722: [CODE ERR] RR	—	—	—	×	
C1723: [CODE ERR] RL	—	—	—	×	
C1724: [BATT VOLT LOW] FL	—	—	—	×	WT-30
C1725: [BATT VOLT LOW] FR	—	—	—	×	
C1726: [BATT VOLT LOW] RR	—	—	—	×	
C1727: [BATT VOLT LOW] RL	—	—	—	×	
C1729: VHCL SPEED SIG ERR	—	—	—	×	WT-33
C1734: CONTROL UNIT	—	—	—	×	WT-34

COMBINATION SWITCH SYSTEM SYMPTOMS

< SYMPTOM DIAGNOSIS >

SYMPTOM DIAGNOSIS

COMBINATION SWITCH SYSTEM SYMPTOMS

Symptom Table

INFOID:000000004345221

1. Perform "Data Monitor" of CONSULT-III to check for any malfunctioning item.
2. Check the malfunction combinations.

Malfunction item: x

Malfunction combination	Data monitor item																
	FR WIPER HI	FR WIPER LOW	FR WASHER SW	FR WIPER INT	RR WIPER ON	RR WIPER INT	RR WASHER SW	INT VOLUME	TURN SIGNAL R	TURN SIGNAL L	TAIL LAMP SW	HI BEAM SW	HEAD LAMP SW 1	HEAD LAMP SW 2	PASSING SW	AUTO LIGHT SW	FR FOG SW
A		x	x						x	x							
B	x			x									x		x		
C							x	x				x		x			
D						x		x			x					x	
E					x			x									x
F	x					x		x									
G			x		x		x	x									
H		x		x												x	
I										x				x	x		x
J									x		x	x	x				
K	All Items																
L	If only one item is detected or the item is not applicable to the combinations A to K																

3. Identify the malfunctioning part from the agreed combination and repair or replace the part.

Malfunction combination	Malfunctioning part	Repair or replace
A	Combination switch INPUT 1 circuit	Inspect the combination switch input circuit applicable to the malfunctioning part. Refer to BCS-42, "Diagnosis Procedure" .
B	Combination switch INPUT 2 circuit	
C	Combination switch INPUT 3 circuit	
D	Combination switch INPUT 4 circuit	
E	Combination switch INPUT 5 circuit	
F	Combination switch OUTPUT 1 circuit	Inspect the combination switch output circuit applicable to the malfunctioning part. Refer to BCS-44, "Diagnosis Procedure" .
G	Combination switch OUTPUT 2 circuit	
H	Combination switch OUTPUT 3 circuit	
I	Combination switch OUTPUT 4 circuit	
J	Combination switch OUTPUT 5 circuit	
K	BCM	Replace BCM. Refer to BCS-85, "Exploded View" .
L	Combination switch	Replace the combination switch.

PRECAUTIONS

< PRECAUTION >

PRECAUTION

PRECAUTIONS

Precaution for Supplemental Restraint System (SRS) "AIR BAG" and "SEAT BELT PRE-TENSIONER"

INFOID:000000004345222

The Supplemental Restraint System such as "AIR BAG" and "SEAT BELT PRE-TENSIONER", used along with a front seat belt, helps to reduce the risk or severity of injury to the driver and front passenger for certain types of collision. This system includes seat belt switch inputs and dual stage front air bag modules. The SRS system uses the seat belt switches to determine the front air bag deployment, and may only deploy one front air bag, depending on the severity of a collision and whether the front occupants are belted or unbelted. Information necessary to service the system safely is included in the "SRS AIR BAG" and "SEAT BELT" of this Service Manual.

WARNING:

- To avoid rendering the SRS inoperative, which could increase the risk of personal injury or death in the event of a collision that would result in air bag inflation, all maintenance must be performed by an authorized NISSAN/INFINITI dealer.
- Improper maintenance, including incorrect removal and installation of the SRS, can lead to personal injury caused by unintentional activation of the system. For removal of Spiral Cable and Air Bag Module, see the "SRS AIR BAG".
- Do not use electrical test equipment on any circuit related to the SRS unless instructed to in this Service Manual. SRS wiring harnesses can be identified by yellow and/or orange harnesses or harness connectors.

PRECAUTIONS WHEN USING POWER TOOLS (AIR OR ELECTRIC) AND HAMMERS

WARNING:

- When working near the Air Bag Diagnosis Sensor Unit or other Air Bag System sensors with the ignition ON or engine running, DO NOT use air or electric power tools or strike near the sensor(s) with a hammer. Heavy vibration could activate the sensor(s) and deploy the air bag(s), possibly causing serious injury.
- When using air or electric power tools or hammers, always switch the ignition OFF, disconnect the battery, and wait at least 3 minutes before performing any service.

BCM (BODY CONTROL MODULE)

< REMOVAL AND INSTALLATION >

REMOVAL AND INSTALLATION

BCM (BODY CONTROL MODULE)

Exploded View

INFOID:000000004345223

CAUTION:

Before replacing BCM, perform "READ CONFIGURATION" to save or print current vehicle specification. Refer to [BCS-3, "CONFIGURATION \(BCM\) : Description"](#).

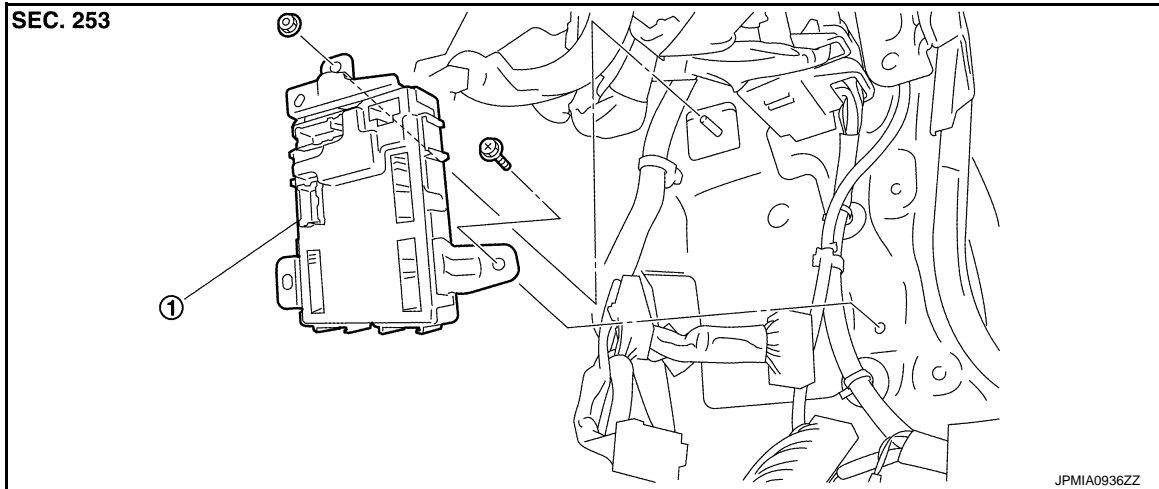

1. BCM

Removal and Installation

INFOID:000000004345224

CAUTION:

Before replacing BCM, perform "READ CONFIGURATION" to save or print current vehicle specification. Refer to [BCS-3, "CONFIGURATION \(BCM\) : Description"](#).

REMOVAL

1. Remove dash side finisher (passenger side). Refer to [INT-20, "Exploded View"](#).
2. Remove bolt and nut.
3. Remove BCM and disconnect the connector.

INSTALLATION

Install in the reverse order of removal.

CAUTION:

- Be sure to perform "WRITE CONFIGURATION" when replacing BCM.
- Be sure to perform the system initialization (NATS) when replacing BCM. Refer to [BCS-4, "CONFIGURATION \(BCM\) : Work Procedure"](#).

A
B
C
D
E
F
G
H
I
J
K
L
N
O
P

BCS

COMBINATION SWITCH

< REMOVAL AND INSTALLATION >

COMBINATION SWITCH

Exploded View

INFOID:000000004345225

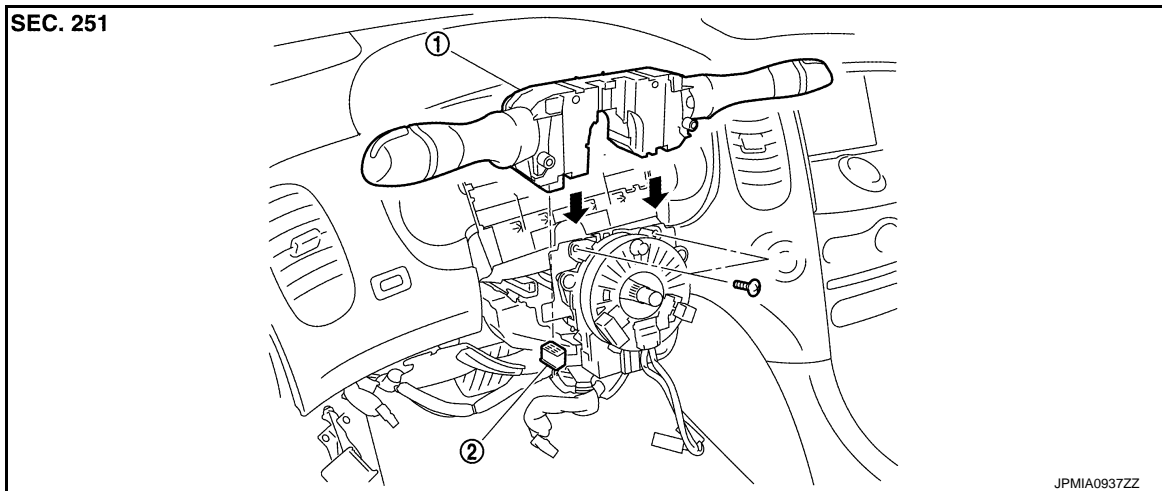

1. Combination switch

2. Combination switch connector

Removal and Installation

INFOID:000000004345226

REMOVAL

1. Remove steering column cover. Refer to [IP-12. "Exploded View"](#).
2. Remove screws.
3. Disconnect the connector.
4. Pull up the combination switch to remove it.

INSTALLATION

Install in the reverse order of removal.