

RF
SECTION
ROOF

A
B
C

CONTENTS

<p>BASIC INSPECTION 3</p> <p>DIAGNOSIS AND REPAIR WORKFLOW 3</p> <p style="padding-left: 20px;">Work Flow3</p> <p>INSPECTION AND ADJUSTMENT 4</p> <p>ADDITIONAL SERVICE WHEN REPLACING CONTROL UNIT4</p> <p style="padding-left: 20px;">ADDITIONAL SERVICE WHEN REPLACING CONTROL UNIT : Description4</p> <p style="padding-left: 20px;">ADDITIONAL SERVICE WHEN REPLACING CONTROL UNIT : Special Repair Requirement4</p> <p>SYSTEM DESCRIPTION 5</p> <p>SUNROOF SYSTEM 5</p> <p style="padding-left: 20px;">System Diagram5</p> <p style="padding-left: 20px;">System Description5</p> <p style="padding-left: 20px;">Component Parts Location6</p> <p style="padding-left: 20px;">Component Description6</p> <p>DIAGNOSIS SYSTEM (BCM) 7</p> <p>COMMON ITEM7</p> <p style="padding-left: 20px;">COMMON ITEM : CONSULT-III Function (BCM - COMMON ITEM)7</p> <p>RETAINED PWR8</p> <p style="padding-left: 20px;">RETAINED PWR : CONSULT-III Function (BCM - RETAINED PWR)8</p> <p>DTC/CIRCUIT DIAGNOSIS 9</p> <p>POWER SUPPLY AND GROUND CIRCUIT 9</p> <p>BCM (BODY CONTROL MODULE)9</p> <p style="padding-left: 20px;">BCM (BODY CONTROL MODULE) : Diagnosis Procedure9</p> <p>SUNROOF MOTOR ASSEMBLY9</p> <p style="padding-left: 20px;">SUNROOF MOTOR ASSEMBLY : Diagnosis Procedure9</p>	<p>SUNROOF SWITCH11</p> <p style="padding-left: 20px;">Description11</p> <p style="padding-left: 20px;">Component Function Check11</p> <p style="padding-left: 20px;">Diagnosis Procedure11</p> <p style="padding-left: 20px;">Component Inspection12</p> <p>DOOR SWITCH13</p> <p style="padding-left: 20px;">Description13</p> <p style="padding-left: 20px;">Component Function Check13</p> <p style="padding-left: 20px;">Diagnosis Procedure13</p> <p style="padding-left: 20px;">Component Inspection14</p> <p>ECU DIAGNOSIS INFORMATION15</p> <p>BCM (BODY CONTROL MODULE)15</p> <p style="padding-left: 20px;">Reference Value15</p> <p style="padding-left: 20px;">Wiring Diagram - BCM -39</p> <p style="padding-left: 20px;">Fail-safe45</p> <p style="padding-left: 20px;">DTC Inspection Priority Chart48</p> <p style="padding-left: 20px;">DTC Index48</p> <p>SUNROOF MOTOR ASSEMBLY51</p> <p style="padding-left: 20px;">Reference Value51</p> <p style="padding-left: 20px;">Wiring Diagram - SUNROOF -52</p> <p>SYMPTOM DIAGNOSIS56</p> <p>SUNROOF DOES NOT OPERATE PROPERLY56</p> <p style="padding-left: 20px;">Diagnosis Procedure56</p> <p>AUTO OPERATION DOES NOT OPERATE57</p> <p style="padding-left: 20px;">Diagnosis Procedure57</p> <p>RETAINED POWER OPERATION DOES NOT OPERATE PROPERLY58</p> <p style="padding-left: 20px;">Diagnosis Procedure58</p> <p>ANTI-PINCH FUNCTION DOES NOT OPERATE59</p> <p style="padding-left: 20px;">Diagnosis Procedure59</p>	<p>D E F G H I J RF L M N O P</p>
--	---	---

SQUEAK AND RATTLE TROUBLE DIAG- NOSES	60	Exploded View	69
Work Flow	60	Removal and Installation	69
Inspection Procedure	62	Adjustment	70
Diagnostic Worksheet	64	SUNROOF MOTOR ASSEMBLY	72
PRECAUTION	66	Exploded View	72
PRECAUTIONS	66	Removal and Installation	72
Precaution for Supplemental Restraint System (SRS) "AIR BAG" and "SEAT BELT PRE-TEN- SIONER"	66	SUNROOF UNIT ASSEMBLY	74
Precaution Necessary for Steering Wheel Rota- tion after Battery Disconnect	66	Exploded View	74
PREPARATION	68	Removal and Installation	75
PREPARATION	68	Disassembly and Assembly	76
Special Service Tool	68	SUNSHADE	77
Commercial Service Tool	68	Exploded View	77
REMOVAL AND INSTALLATION	69	Removal and Installation	77
GLASS LID	69	WIND DEFLECTOR	79
		Exploded View	79
		Removal and Installation	79
		SUNROOF SWITCH	80
		Exploded View	80
		Removal and Installation	80

DIAGNOSIS AND REPAIR WORKFLOW

< BASIC INSPECTION >

BASIC INSPECTION

DIAGNOSIS AND REPAIR WORKFLOW

Work Flow

INFOID:000000003829240

DETAILED FLOW

1.OBTAIN INFORMATION ABOUT SYMPTOM

Interview the customer to obtain as much malfunction information (conditions and environment when the malfunction occurred) as possible when the customer brings the vehicle in.

>> GO TO 2.

2.REPRODUCE THE MALFUNCTION INFORMATION

Check the malfunction on the vehicle that the customer describes.
Inspect the relation of the symptoms and the condition when the symptoms occur.

>> GO TO 3.

3.IDENTIFY THE MALFUNCTIONING SYSTEM WITH "SYMPTOM DIAGNOSIS"

Use "Symptom diagnosis" from the symptom inspection result in step 2 and then identify where to start performing the diagnosis based on possible causes and symptoms.

>> GO TO 4.

4.IDENTIFY THE MALFUNCTIONING PARTS WITH "COMPONENT DIAGNOSIS"

Perform the diagnosis with "Component diagnosis" of the applicable system.

>> GO TO 5.

5.REPAIR OR REPLACE THE MALFUNCTIONING PARTS

Repair or replace the specified malfunctioning parts.

>> GO TO 6.

6.FINAL CHECK

Check that malfunctions are not reproduced when obtaining the malfunction information from the customer, referring to the symptom inspection result in step 2.

Are the malfunctions corrected?

YES >> INSPECTION END

NO >> GO TO 3.

A
B
C
D
E
F
G
H
I
J
RF
L
M
N
O
P

INSPECTION AND ADJUSTMENT

< BASIC INSPECTION >

INSPECTION AND ADJUSTMENT

ADDITIONAL SERVICE WHEN REPLACING CONTROL UNIT

ADDITIONAL SERVICE WHEN REPLACING CONTROL UNIT : Description

INFOID:000000003829241

If any of the following operations are performed, the initialization is necessary.

- Power supply to the sunroof motor assembly is cut off while the sunroof is operating.
- Disassembly and assembly of sunroof unit assembly.

ADDITIONAL SERVICE WHEN REPLACING CONTROL UNIT : Special Repair Requirement

INFOID:000000003829242

INITIALIZATION PROCEDURE

If the sunroof does not close or open automatically, use the following procedure to return sunroof operation to normal.

1. Close the sunroof if it is not in the closed position. It may be necessary to repeatedly press the switch to close the sunroof.
2. Press the tilt up switch and start the tilt up operation.
3. Release the tilt up switch once, press and hold the tilt up switch again.
4. The glass lid moves slight toward tilt up direction then stops. (Press and hold the switch during this operation)
5. Release the switch again, and press and hold the tilt up switch within the first 6 seconds.
6. After 4 seconds, the glass lid will be automatically operated in sequence of tilt down, slide open and slide close.
7. After the glass lid stops, release the switch 0.5 seconds later.
8. Check anti-pinch function. If the sunroof operation is normal, the initialization is done.

CHECK ANTI-PINCH FUNCTION

1. Fully open the sunroof.
 2. Place a wooden object (wooden hammer handle, etc.) near the fully closed position.
 3. Close the sunroof completely with auto-slide close.
- Check that sunroof opens for approximately 150 mm (5.91 in) or 2 seconds without pinching a wooden object and stops.

CAUTION:

- **Never check with hands or other part of body because they may be pinched. Never get pinched.**
- **Depending on environment and driving conditions, if a similar impact or load is applied to the sunroof it may tilt up or open.**
- **Check that auto-slide operates before inspection when system initialization is performed.**
- **Perform initial setting when auto-slide operation or anti-pinch function does not operate normally.**

SUNROOF SYSTEM

< SYSTEM DESCRIPTION >

SYSTEM DESCRIPTION

SUNROOF SYSTEM

System Diagram

INFOID:000000003829243

SUNROOF

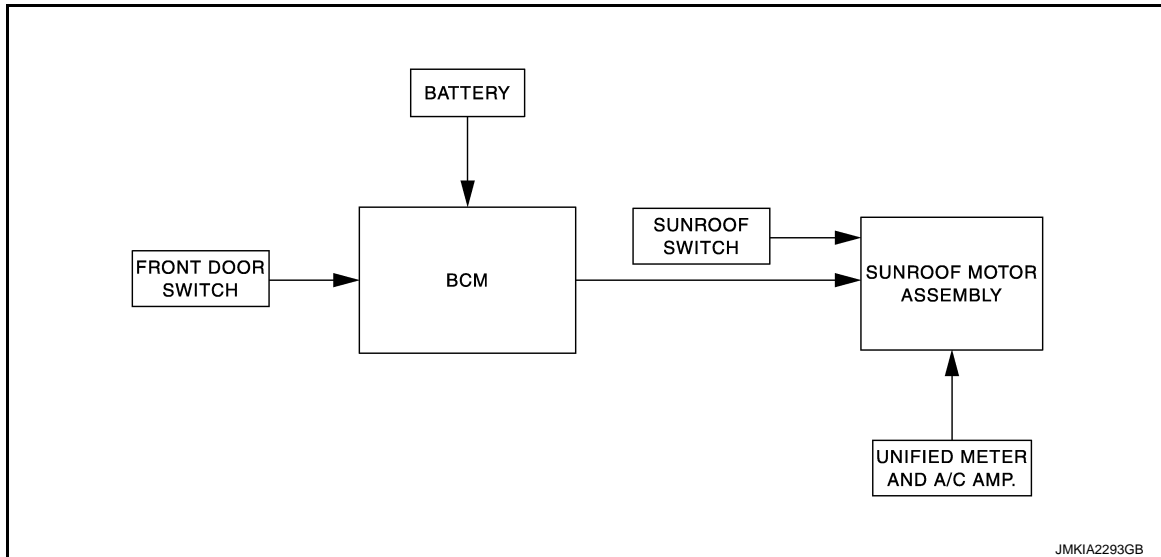

System Description

INFOID:000000003829244

SUNROOF OPERATION

- Sunroof motor assembly operates with the power supply that is output from BCM while ignition switch is ON or retained power is operating.
- Tilt up/down and slide open/close signals from sunroof switch activates the sunroof motor to move arbitrarily.
- Sunroof motor assembly receives a vehicle speed signal from unified meter and A/C amp. and controls the sunroof motor torque at the time of high speed operation.

AUTO OPERATION

Sunroof AUTO feature makes it possible to slide open and slide close or tilt up and tilt down the sunroof without holding the sunroof switch in the slide open/tilt down or slide close/tilt up position.

RETAINED POWER OPERATION

Retained power operation is an additional power supply function that enables sunroof system to operate 45 seconds even after the ignition switch is turned OFF.

RETAINED POWER FUNCTION CANCEL CONDITIONS

- Front door CLOSE (door switch OFF)→OPEN (door switch ON).
- When ignition switch is ON again.
- When timer time passes. (45 seconds)

ANTI-PINCH FUNCTION

CAUTION:

There are some small distances immediately before the closed position that cannot be detected.

The CPU of sunroof motor assembly monitors the sunroof condition by the signals from sunroof motor. When sunroof motor assembly detects an interruption during close or tilt down operation, sunroof motor tilts up or open [150 mm (5.91 in) or more] sunroof.

SUNROOF SYSTEM

< SYSTEM DESCRIPTION >

Component Parts Location

INFOID:000000003829245

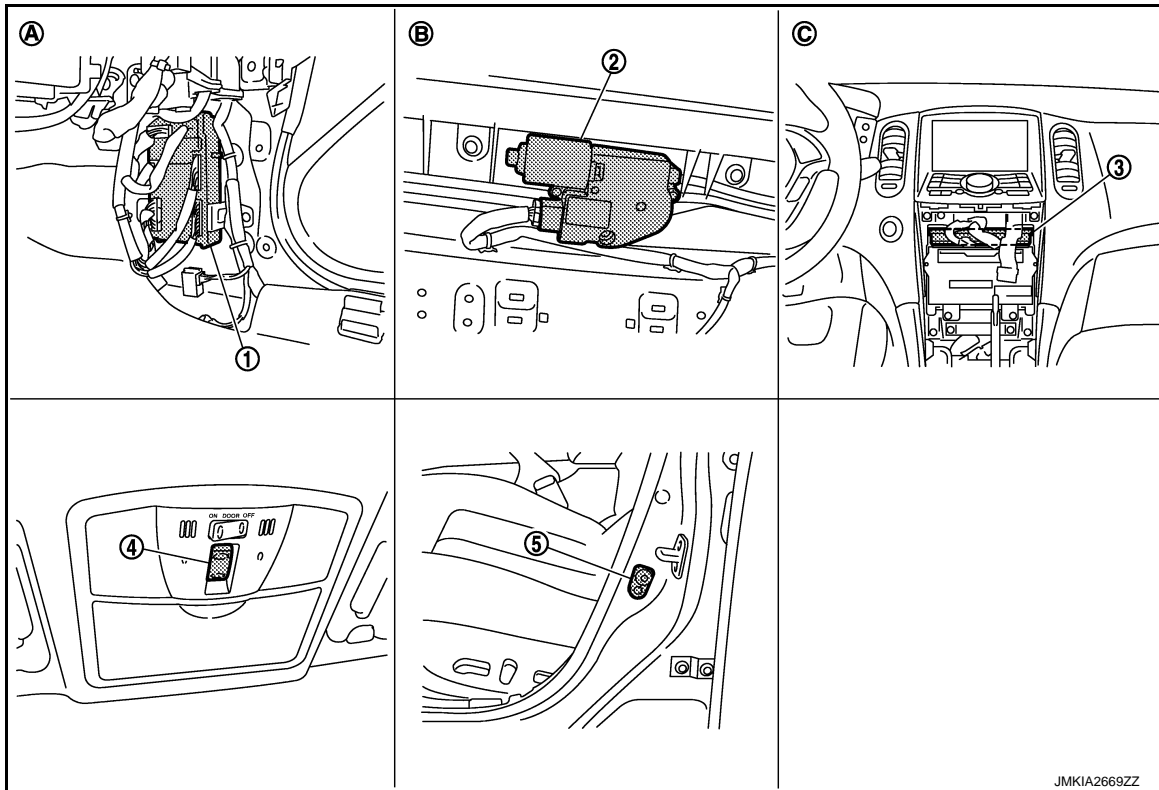

- | | | |
|-------------------------------------|--|-----------------------------------|
| 1. BCM M118, M119, M123 | 2. Sunroof motor assembly R4 | 3. Unified meter and A/C amp. M66 |
| 4. Sunroof switch R16 | 5. Front door switch (driver side) B16 | |
| A. Dash side lower (passenger side) | B. View with headlining removed | C. Behind cluster lid C |

Component Description

INFOID:000000003829246

Component	Function
BCM	<ul style="list-style-type: none"> Supplies the power to sunroof motor assembly. Controls retained power.
Sunroof switch	Transmits tilt up/down and slides open/close operation signal to sunroof motor assembly.
Sunroof motor assembly	It is sunroof motor and CPU integrated type that enables tilt up/down and slide open/close by sunroof switch operation
Front door switch	Detects door open/close condition and transmits to BCM.
Unified meter and A/C amp.	Transmits vehicle speed signal to sunroof motor assembly.

DIAGNOSIS SYSTEM (BCM)

< SYSTEM DESCRIPTION >

DIAGNOSIS SYSTEM (BCM) COMMON ITEM

COMMON ITEM : CONSULT-III Function (BCM - COMMON ITEM)

INFOID:000000003894437

APPLICATION ITEM

CONSULT-III performs the following functions via CAN communication with BCM.

Diagnosis mode	Function Description
Work Support	Changes the setting for each system function.
Self Diagnostic Result	Displays the diagnosis results judged by BCM.
CAN Diag Support Monitor	Monitors the reception status of CAN communication viewed from BCM. Refer to CONSULT-III operation manual.
Data Monitor	The BCM input/output signals are displayed.
Active Test	The signals used to activate each device are forcibly supplied from BCM.
Ecu Identification	The BCM part number is displayed.
Configuration	<ul style="list-style-type: none"> Read and save the vehicle specification. Write the vehicle specification when replacing BCM.

SYSTEM APPLICATION

BCM can perform the following functions for each system.

NOTE:

It can perform the diagnosis modes except the following for all sub system selection items.

x: Applicable item

System	Sub system selection item	Diagnosis mode		
		Work Support	Data Monitor	Active Test
Door lock	DOOR LOCK	×	×	×
Rear window defogger	REAR DEFOGGER		×	×
Warning chime	BUZZER		×	×
Interior room lamp timer	INT LAMP	×	×	×
Exterior lamp	HEAD LAMP	×	×	×
Wiper and washer	WIPER	×	×	×
Turn signal and hazard warning lamps	FLASHER	×	×	×
—	AIR CONDITONER*			
<ul style="list-style-type: none"> Intelligent Key system Engine start system 	INTELLIGENT KEY	×	×	×
Combination switch	COMB SW		×	
Body control system	BCM	×		
IVIS - NATS	IMMU		×	×
Interior room lamp battery saver	BATTERY SAVER	×	×	×
Back door open	TRUNK		×	×
Vehicle security system	THEFT ALM	×	×	×
RAP system	RETAINED PWR		×	
Signal buffer system	SIGNAL BUFFER		×	×

NOTE:

*: This item is displayed, but is not used.

FREEZE FRAME DATA (FFD)

The BCM records the following vehicle condition at the time a particular DTC is detected, and displays on CONSULT-III.

DIAGNOSIS SYSTEM (BCM)

< SYSTEM DESCRIPTION >

CONSULT screen item	Indication/Unit	Description	
Vehicle Speed	km/h	Vehicle speed of the moment a particular DTC is detected	
Odo/Trip Meter	km	Total mileage (Odometer value) of the moment a particular DTC is detected	
Vehicle Condition	SLEEP>LOCK	Power position status of the moment a particular DTC is detected	While turning BCM status from low power consumption mode to normal mode (Power supply position is "LOCK")
	SLEEP>OFF		While turning BCM status from low power consumption mode to normal mode (Power supply position is "OFF".)
	LOCK>ACC		While turning power supply position from "LOCK" to "ACC"
	ACC>ON		While turning power supply position from "ACC" to "IGN"
	RUN>ACC		While turning power supply position from "RUN" to "ACC" (Vehicle is stopping and selector lever is except P position.)
	CRANK>RUN		While turning power supply position from "CRANKING" to "RUN" (From cranking up the engine to run it)
	RUN>URGENT		While turning power supply position from "RUN" to "ACC" (Emergency stop operation)
	ACC>OFF		While turning power supply position from "ACC" to "OFF"
	OFF>LOCK		While turning power supply position from "OFF" to "LOCK"
	OFF>ACC		While turning power supply position from "OFF" to "ACC"
	ON>CRANK		While turning power supply position from "IGN" to "CRANKING"
	OFF>SLEEP		While turning BCM status from normal mode (Power supply position is "OFF".) to low power consumption mode
	LOCK>SLEEP		While turning BCM status from normal mode (Power supply position is "LOCK".) to low power consumption mode
	LOCK		Power supply position is "LOCK" (Ignition switch OFF with steering is locked.)
	OFF		Power supply position is "OFF" (Ignition switch OFF with steering is unlocked.)
	ACC		Power supply position is "ACC" (Ignition switch ACC)
	ON		Power supply position is "IGN" (Ignition switch ON with engine stopped)
	ENGINE RUN		Power supply position is "RUN" (Ignition switch ON with engine running)
CRANKING	Power supply position is "CRANKING" (At engine cranking)		
IGN Counter	0 - 39	<p>The number of times that ignition switch is turned ON after DTC is detected</p> <ul style="list-style-type: none"> • The number is 0 when a malfunction is detected now. • The number increases like 1 → 2 → 3...38 → 39 after returning to the normal condition whenever ignition switch OFF → ON. • The number is fixed to 39 until the self-diagnosis results are erased if it is over 39. 	

RETAINED PWR

RETAINED PWR : CONSULT-III Function (BCM - RETAINED PWR)

INFOID:000000003894436

Data monitor

Monitor Item	Description
DOOR SW-DR	Indicates [ON/OFF] condition of driver side door switch.
DOOR SW-AS	Indicates [ON/OFF] condition of passenger side door switch.

POWER SUPPLY AND GROUND CIRCUIT

< DTC/CIRCUIT DIAGNOSIS >

DTC/CIRCUIT DIAGNOSIS

POWER SUPPLY AND GROUND CIRCUIT

BCM (BODY CONTROL MODULE)

BCM (BODY CONTROL MODULE) : Diagnosis Procedure

INFOID:000000003970991

1. CHECK FUSE AND FUSIBLE LINK

Check that the following fuse and fusible link are not blown.

Signal name	Fuse and fusible link No.
Battery power supply	L
	10

Is the fuse fusing?

YES >> Replace the blown fuse or fusible link after repairing the affected circuit if a fuse or fusible link is blown.

NO >> GO TO 2.

2. CHECK POWER SUPPLY CIRCUIT

1. Turn ignition switch OFF.
2. Disconnect BCM connectors.
3. Check voltage between BCM harness connector and ground.

Terminals		Voltage (Approx.)
(+)	(-)	
BCM		Ground Battery voltage
Connector	Terminal	
M118	1	
M119	11	

Is the measurement value normal?

YES >> GO TO 3.

NO >> Repair harness or connector.

3. CHECK GROUND CIRCUIT

Check continuity between BCM harness connector and ground.

BCM		Ground	Continuity
Connector	Terminal		
M119	13		Existed

Does continuity exist?

YES >> INSPECTION END

NO >> Repair harness or connector.

SUNROOF MOTOR ASSEMBLY

SUNROOF MOTOR ASSEMBLY : Diagnosis Procedure

INFOID:000000003829251

1. CHECK POWER SUPPLY CIRCUIT

1. Turn ignition switch OFF.
2. Disconnect sunroof motor assembly connector.
3. Turn ignition switch ON.
4. Check voltage between sunroof motor assembly harness connector and ground.

POWER SUPPLY AND GROUND CIRCUIT

< DTC/CIRCUIT DIAGNOSIS >

(+)		(-)	Voltage (V) (Approx.)
Sunroof motor assembly			
Connector	Terminal	Ground	Battery voltage
R4	9		
	7		

Is the inspection result normal?

YES >> GO TO 2.

NO >> GO TO 3.

2. CHECK GROUND CIRCUIT

1. Turn ignition switch OFF.
2. Check continuity between sunroof motor assembly harness connector and ground.

Sunroof motor assembly		Ground	Continuity
Connector	Terminal		
R4	10		Existed

Is the inspection result normal?

YES >> INSPECTION END

NO >> Repair or replace harness.

3. CHECK SUNROOF MOTOR CIRCUIT

1. Turn ignition switch OFF.
2. Disconnect BCM connector.
3. Check continuity between BCM harness connector and sunroof motor assembly harness connector.

BCM		Sunroof motor assembly		Continuity
Connector	Terminal	Connector	Terminal	
M118	2	R4	7	Existed
	3		9	

4. Check continuity between BCM harness connector and ground.

BCM		Ground	Continuity
Connector	Terminal		
M118	2		Not existed
	3		

Is the inspection result normal?

YES >> Replace BCM. Refer to [BCS-82. "Removal and Installation"](#).

NO >> Repair or replace harness.

SUNROOF SWITCH

< DTC/CIRCUIT DIAGNOSIS >

SUNROOF SWITCH

Description

INFOID:000000003829252

Tilt up/down and slide open/close by sunroof switch operation.

Component Function Check

INFOID:000000003829253

1.CHECK SUNROOF MOTOR OPERATION

Check tilt up/down and slide open/close operations using sunroof switch.

Is the inspection result normal?

- YES >> Sunroof switch is OK.
NO >> Refer to [RF-11, "Diagnosis Procedure"](#).

Diagnosis Procedure

INFOID:000000003829254

SUNROOF SWITCH

1.CHECK SUNROOF SWITCH POWER SUPPLY CIRCUIT

1. Turn ignition switch OFF.
2. Disconnect sunroof switch connector.
3. Turn ignition switch ON.
4. Check voltage between sunroof switch harness connector and ground.

(+)		(-)	Voltage (V) (Approx.)
Sunroof switch			
Connector	Terminal	Ground	Battery voltage
R16	1		
	3		

Is the inspection result normal?

- YES >> GO TO 2.
NO >> GO TO 4.

2.CHECK GROUND CIRCUIT

1. Turn ignition switch OFF.
2. Check continuity between sunroof switch harness connector and ground.

Sunroof switch		Ground	Continuity
Connector	Terminal		
R16	2		Existed

Is the inspection result normal?

- YES >> GO TO 3.
NO >> Repair or replace harness.

3.CHECK SUNROOF SWITCH

Check sunroof switch.

Refer to [RF-12, "Component Inspection"](#).

Is the inspection result normal?

- YES >> GO TO 5.
NO >> Replace sunroof switch (built in map lamp assembly). Refer to [RF-80, "Removal and Installation"](#).

4.CHECK SUNROOF SWITCH CIRCUIT

1. Turn ignition switch OFF.
2. Disconnect sunroof motor assembly connector.
3. Check continuity between sunroof switch assembly harness connector and sunroof switch harness connector.

SUNROOF SWITCH

< DTC/CIRCUIT DIAGNOSIS >

Sunroof switch		Sunroof motor assembly		Continuity
Connector	Terminal	Connector	Terminal	
R16	1	R4	5	Existed
	3		1	

4. Check continuity between sunroof switch assembly harness connector and ground.

Sunroof motor assembly		Ground	Continuity
Connector	Terminal		
R4	5		Not existed
	1		

Is the inspection result normal?

YES >> Replace sunroof motor assembly. [RF-72. "Removal and Installation"](#)

NO >> Repair or replace harness.

5. CHECK INTERMITTENT INCIDENT

Refer to [GI-35. "Intermittent Incident"](#).

>> INSPECTION END

Component Inspection

INFOID:000000003829255

SUNROOF SWITCH

1. CHECK SUNROOF SWITCH

- Turn ignition switch OFF.
- Disconnect sunroof switch connector.
- Check continuity between sunroof switch terminals.

Terminals		Sunroof switch	Condition	Continuity
1	2			TILT the DOWN/SLIDE OPEN
		Other than the above		Not existed
3		TILT UP/SLIDE the CLOSE		Existed
		Other than the above		Not existed

Is the inspection result normal?

YES >> INSPECTION END

NO >> Replace sunroof switch (built in map lamp assembly). Refer to [RF-80. "Removal and Installation"](#).

DOOR SWITCH

< DTC/CIRCUIT DIAGNOSIS >

DOOR SWITCH

Description

INFOID:000000003829256

Detects door open/closed condition.

Component Function Check

INFOID:000000003829257

1.CHECK FUNCTION

Check door switches ("DOOR SW-DR", "DOOR SW-AS") in the "Data Monitor" mode using CONSULT-III.

Monitor item	Door condition	Display
DOOR SW-DR	CLOSE → OPEN	OFF → ON
DOOR SW-AS		

Is the inspection result normal?

- YES >> Door switch is OK.
 NO >> Refer to [RF-13, "Diagnosis Procedure"](#).

Diagnosis Procedure

INFOID:000000003829258

1.CHECK FRONT DOOR SWITCH INPUT SIGNAL

- Turn ignition switch OFF.
- Disconnect malfunctioning front door switch connector.
- Check voltage signal between malfunctioning front door switch harness connector and ground.

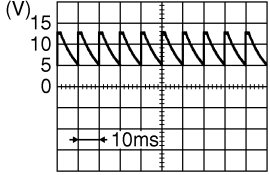
(+)		Terminal	(-)	Voltage (V) (Approx.)
Front door switch				
Connector				
Driver side	B16	2	Ground	 <p>JPMIA0594GB</p>
Passenger side	B216			

Is the inspection result normal?

- YES >> GO TO 3.
 NO >> GO TO 2.

2.CHECK DOOR SWITCH CIRCUIT

- Disconnect BCM connector.
- Check continuity between BCM harness connector and malfunctioning door switch harness connector.

BCM		Front door switch		Continuity
Connector	Terminal	Connector	Terminal	
M123	124	B216	2	Existed
	150	B16		

- Check continuity between BCM harness connector and ground.

BCM		Ground	Continuity
Connector	Terminal		
M123	124		Not existed
	150		

DOOR SWITCH

< DTC/CIRCUIT DIAGNOSIS >

Is the inspection result normal?

YES >> Replace BCM. Refer to [BCS-82, "Removal and Installation"](#).

NO >> Repair or replace harness.

3.CHECK FRONT DOOR SWITCH

Check front door switch.

Refer to [RF-14, "Component Inspection"](#).

Is the inspection result normal?

YES >> GO TO 4.

NO >> Replace malfunctioning front door switch. Refer to [DLK-269, "Removal and Installation"](#).

4.CHECK INTERMITTENT INCIDENT

Refer to [GI-35, "Intermittent Incident"](#).

>> INSPECTION END

Component Inspection

INFOID:000000003829259

1.CHECK FRONT DOOR SWITCH

1. Turn ignition switch OFF.
2. Disconnect malfunctioning front door switch connector.
3. Check malfunctioning front door switch.

(+)			(-)	Condition	Continuity		
Front door switch							
Connector		Terminal	Ground part of door switch	Door switch			
Driver side	B16	2				Pressed	Not existed
						Released	Existed
Passenger side	B216	2				Pressed	Not existed
			Released	Existed			

Is the inspection result normal?

YES >> Front door switch is OK.

NO >> Replace malfunctioning front door switch. Refer to [DLK-269, "Removal and Installation"](#).

BCM (BODY CONTROL MODULE)

< ECU DIAGNOSIS INFORMATION >

ECU DIAGNOSIS INFORMATION

BCM (BODY CONTROL MODULE)

Reference Value

INFOID:000000003894428

VALUES ON THE DIAGNOSIS TOOL

CONSULT-III MONITOR ITEM

Monitor Item	Condition	Value/Status
FR WIPER HI	Other than front wiper switch HI	Off
	Front wiper switch HI	On
FR WIPER LOW	Other than front wiper switch LO	Off
	Front wiper switch LO	On
FR WASHER SW	Front washer switch OFF	Off
	Front washer switch ON	On
FR WIPER INT	Other than front wiper switch INT	Off
	Front wiper switch INT	On
FR WIPER STOP	Front wiper is not in STOP position	Off
	Front wiper is in STOP position	On
INT VOLUME	Wiper intermittent dial is in a dial position 1 - 7	Wiper intermittent dial position
RR WIPER ON	Other than rear wiper switch ON	Off
	Rear wiper switch ON	On
RR WIPER INT	Other than rear wiper switch INT	Off
	Rear wiper switch INT	On
RR WASHER SW	Rear washer switch OFF	Off
	Rear washer switch ON	On
RR WIPER STOP	Rear wiper is in STOP position	Off
	Rear wiper is not in STOP position	On
TURN SIGNAL R	Other than turn signal switch RH	Off
	Turn signal switch RH	On
TURN SIGNAL L	Other than turn signal switch LH	Off
	Turn signal switch LH	On
TAIL LAMP SW	Other than lighting switch 1ST and 2ND	Off
	Lighting switch 1ST or 2ND	On
HI BEAM SW	Other than lighting switch HI	Off
	Lighting switch HI	On
HEAD LAMP SW 1	Other than lighting switch 2ND	Off
	Lighting switch 2ND	On
HEAD LAMP SW 2	Other than lighting switch 2ND	Off
	Lighting switch 2ND	On
PASSING SW	Other than lighting switch PASS	Off
	Lighting switch PASS	On
AUTO LIGHT SW	Other than lighting switch AUTO	Off
	Lighting switch AUTO	On
FR FOG SW	Front fog lamp switch OFF	Off
	Front fog lamp switch ON	On

BCM (BODY CONTROL MODULE)

< ECU DIAGNOSIS INFORMATION >

Monitor Item	Condition	Value/Status
RR FOG SW	NOTE: The item is indicated, but not monitored.	Off
DOOR SW-DR	Driver door closed	Off
	Driver door opened	On
DOOR SW-AS	Passenger door closed	Off
	Passenger door opened	On
DOOR SW-RR	Rear RH door closed	Off
	Rear RH door opened	On
DOOR SW-RL	Rear LH door closed	Off
	Rear LH door opened	On
DOOR SW-BK	Back door closed	Off
	Back door opened	On
CDL LOCK SW	Other than power door lock switch LOCK	Off
	Power door lock switch LOCK	On
CDL UNLOCK SW	Other than power door lock switch UNLOCK	Off
	Power door lock switch UNLOCK	On
KEY CYL LK-SW	Other than driver door key cylinder LOCK position	Off
	Driver door key cylinder LOCK position	On
KEY CYL UN-SW	Other than driver door key cylinder UNLOCK position	Off
	Driver door key cylinder UNLOCK position	On
KEY CYL SW-TR	NOTE: The item is indicated, but not monitored.	Off
HAZARD SW	Hazard switch is OFF	Off
	Hazard switch is ON	On
REAR DEF SW	NOTE: The item is indicated, but not monitored.	Off
TR CANCEL SW	NOTE: The item is indicated, but not monitored.	Off
TR/BD OPEN SW	Back door opener switch OFF	Off
	While the back door opener switch is turned ON	On
TRNK/HAT MNTR	NOTE: The item is indicated, but not monitored.	Off
RKE-LOCK	LOCK button of the Intelligent Key is not pressed	Off
	LOCK button of the Intelligent Key is pressed	On
RKE-UNLOCK	UNLOCK button of the Intelligent Key is not pressed	Off
	UNLOCK button of the Intelligent Key is pressed	On
RKE-TR/BD	NOTE: The item is indicated, but not monitored.	Off
RKE-PANIC	PANIC button of the Intelligent Key is not pressed	Off
	PANIC button of the Intelligent Key is pressed	On
RKE-P/W OPEN	UNLOCK button of the Intelligent Key is not pressed	Off
	UNLOCK button of the Intelligent Key is pressed and held	On
RKE-MODE CHG	LOCK/UNLOCK button of the Intelligent Key is not pressed and held simultaneously	Off
	LOCK/UNLOCK button of the Intelligent Key is pressed and held simultaneously	On
OPTICAL SENSOR	Bright outside of the vehicle	Close to 5 V
	Dark outside of the vehicle	Close to 0 V

BCM (BODY CONTROL MODULE)

< ECU DIAGNOSIS INFORMATION >

Monitor Item	Condition	Value/Status	
REQ SW -DR	Driver door request switch is not pressed	Off	A
	Driver door request switch is pressed	On	
REQ SW -AS	Passenger door request switch is not pressed	Off	B
	Passenger door request switch is pressed	On	
REQ SW -RR	NOTE: The item is indicated, but not monitored.	Off	C
REQ SW -RL	NOTE: The item is indicated, but not monitored.	Off	
REQ SW -BD/TR	Back door request switch is not pressed	Off	D
	Back door request switch is pressed	On	
PUSH SW	Push-button ignition switch (push switch) is not pressed	Off	E
	Push-button ignition switch (push switch) is pressed	On	
IGN RLY2 -F/B	Ignition switch in OFF or ACC position	Off	F
	Ignition switch in ON position	On	
CLUCH SW	NOTE: The item is indicated, but not monitored.	Off	
BRAKE SW 1	The brake pedal is depressed when No. 7 fuse is blown	Off	G
	The brake pedal is not depressed when No. 7 fuse is blown, or No. 7 fuse is normal	On	
BRAKE SW 2	The brake pedal is not depressed	Off	H
	The brake pedal is depressed	On	
DETE/CANCL SW	Selector lever in P position	Off	I
	Selector lever in any position other than P	On	
SFT PN/N SW	Selector lever in any position other than P and N	Off	J
	Selector lever in P or N position	On	
S/L -LOCK	Steering is unlocked	Off	
	Steering is locked	On	
S/L -UNLOCK	Steering is locked	Off	RF
	Steering is unlocked	On	
S/L RELAY-F/B	Ignition switch in OFF or ACC position	Off	L
	Ignition switch in ON position	On	
UNLK SEN -DR	Driver door is unlocked	Off	M
	Driver door is locked	On	
PUSH SW -IPDM	Push-button ignition switch (push-switch) is not pressed	Off	N
	Push-button ignition switch (push-switch) is pressed	On	
IGN RLY1 -F/B	Ignition switch in OFF or ACC position	Off	O
	Ignition switch in ON position	On	
DETE SW -IPDM	Selector lever in any position other than P	Off	P
	Selector lever in P position	On	
SFT PN -IPDM	Selector lever in any position other than P and N	Off	
	Selector lever in P or N position	On	
SFT P -MET	Selector lever in any position other than P	Off	
	Selector lever in P position	On	
SFT N -MET	Selector lever in any position other than N	Off	
	Selector lever in N position	On	

BCM (BODY CONTROL MODULE)

< ECU DIAGNOSIS INFORMATION >

Monitor Item	Condition	Value/Status
ENGINE STATE	Engine stopped	Stop
	While the engine stalls	Stall
	At engine cranking	Crank
	Engine running	Run
S/L LOCK-IPDM	Steering is unlocked	Off
	Steering is locked	On
S/L UNLK-IPDM	Steering is locked	Off
	Steering is unlocked	On
S/L RELAY-REQ	Steering lock system is not the LOCK condition and the changing condition from LOCK to UNLOCK	Off
	Steering lock system is the LOCK condition or the changing condition from LOCK to UNLOCK	On
VEH SPEED 1	While driving	Equivalent to speedometer reading
VEH SPEED 2	While driving	Equivalent to speedometer reading
DOOR STAT-DR	Driver door is locked	LOCK
	Wait with selective UNLOCK operation (5 seconds)	READY
	Driver door is unlocked	UNLOCK
DOOR STAT-AS	Passenger door is locked	LOCK
	Wait with selective UNLOCK operation (5 seconds)	READY
	Passenger door is unlocked	UNLOCK
ID OK FLAG	Steering is locked	Reset
	Steering is unlocked	Set
PRMT ENG STRT	The engine start is prohibited	Reset
	The engine start is permitted	Set
PRMT RKE STRT	NOTE: The item is indicated, but not monitored.	Reset
KEY SW -SLOT	The Intelligent Key is not inserted into key slot	Off
	The Intelligent Key is inserted into key slot	On
RKE OPE COUN1	During the operation of the Intelligent Key	Operation frequency of the Intelligent Key
RKE OPE COUN2	NOTE: The item is indicated, but not monitored.	—
CONFIRM ID ALL	The key ID that the key slot receives is not recognized by any key ID registered to BCM.	Yet
	The key ID that the key slot receives accords with any key ID registered to BCM.	Done
CONFIRM ID4	The key ID that the key slot receives is not recognized by the fourth key ID registered to BCM.	Yet
	The key ID that the key slot receives is recognized by the fourth key ID registered to BCM.	Done
CONFIRM ID3	The key ID that the key slot receives is not recognized by the third key ID registered to BCM.	Yet
	The key ID that the key slot receives is recognized by the third key ID registered to BCM.	Done
CONFIRM ID2	The key ID that the key slot receives is not recognized by the second key ID registered to BCM.	Yet
	The key ID that the key slot receives is recognized by the second key ID registered to BCM.	Done

BCM (BODY CONTROL MODULE)

< ECU DIAGNOSIS INFORMATION >

Monitor Item	Condition	Value/Status	
CONFIRM ID1	The key ID that the key slot receives is not recognized by the first key ID registered to BCM.	Yet	A
	The key ID that the key slot receives is recognized by the first key ID registered to BCM.	Done	B
TP 4	The ID of fourth Intelligent Key is not registered to BCM	Yet	C
	The ID of fourth Intelligent Key is registered to BCM	Done	
TP 3	The ID of third Intelligent Key is not registered to BCM	Yet	D
	The ID of third Intelligent Key is registered to BCM	Done	
TP 2	The ID of second Intelligent Key is not registered to BCM	Yet	E
	The ID of second Intelligent Key is registered to BCM	Done	
TP 1	The ID of first Intelligent Key is not registered to BCM	Yet	F
	The ID of first Intelligent Key is registered to BCM	Done	

F

G

H

I

J

RF

L

M

N

O

P

BCM (BODY CONTROL MODULE)

< ECU DIAGNOSIS INFORMATION >

TERMINAL LAYOUT

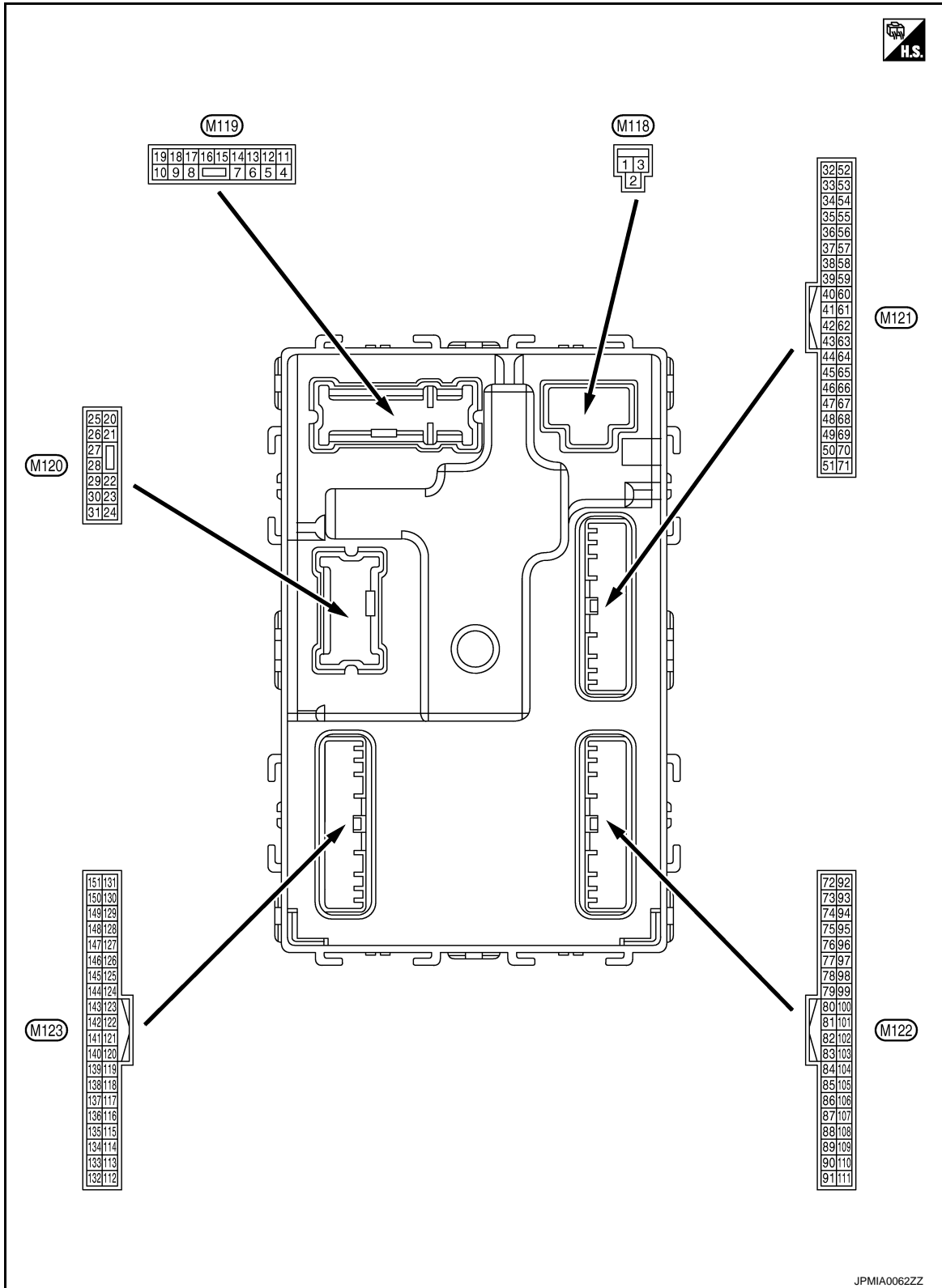

PHYSICAL VALUES

BCM (BODY CONTROL MODULE)

< ECU DIAGNOSIS INFORMATION >

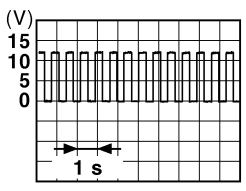
Terminal No. (Wire color)		Description		Condition		Value (Approx.)
		Signal name	Input/ Output			
+	-					
1 (W)	Ground	Battery power supply	Input	Ignition switch OFF		Battery voltage
2 (Y)	Ground	P/W power supply (BAT)	Output	Ignition switch OFF		12 V
3 (O)	Ground	P/W power supply (RAP)	Output	Ignition switch ON		12 V
4 (P)	Ground	Interior room lamp power supply (Battery saver signal)	Output	Interior room lamp battery saver is activated. (Cuts the interior room lamp power supply)		0 V
				Interior room lamp battery saver is not activated. (Outputs the interior room lamp power supply)		12 V
5 (V)	Ground	Passenger door UN- LOCK	Output	Passenger door	UNLOCK (Actuator is activated)	12 V
					Other than UNLOCK (Actuator is not activated)	0 V
7 (Y)	Ground	Step lamp	Output	Step lamp	ON	0 V
					OFF	12 V
8 (V)	Ground	All doors, fuel lid LOCK	Output	All doors, fuel lid	LOCK (Actuator is activated)	12 V
					Other than LOCK (Actuator is not activated)	0 V
9 (G)	Ground	Driver door, fuel lid UNLOCK	Output	Driver door, fuel lid	UNLOCK (Actuator is activated)	12 V
					Other than UNLOCK (Actuator is not activated)	0 V
10 (BR)	Ground	Rear RH door and rear LH door UN- LOCK	Output	Rear RH door and rear LH door	UNLOCK (Actuator is activated)	12 V
					Other than UNLOCK (Actuator is not activated)	0 V
11 (R)	Ground	Battery power supply	Input	Ignition switch OFF		Battery voltage
13 (B)	Ground	Ground	—	Ignition switch ON		0 V
15 (Y)	Ground	ACC indicator lamp	Output	Ignition switch	OFF (LOCK indicator is not illuminated)	Battery voltage
					ACC or ON	0 V
17 (W)	Ground	Turn signal RH (Front)	Output	Ignition switch ON	Turn signal switch OFF	0 V
					Turn signal switch RH	 <p style="text-align: center;">6.5 V</p>

A
B
C
D
E
F
G
H
I
J
RF
L
M
N
O
P

BCM (BODY CONTROL MODULE)

< ECU DIAGNOSIS INFORMATION >

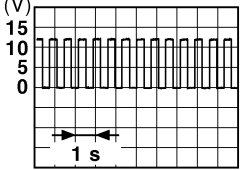
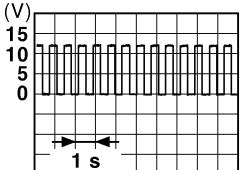
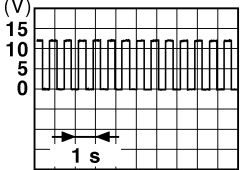
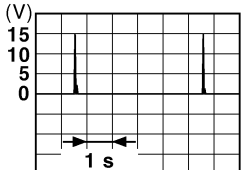
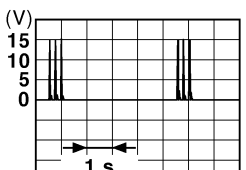
Terminal No. (Wire color)		Description		Condition	Value (Approx.)
+	-	Signal name	Input/ Output		
18 (O)	Ground	Turn signal LH (Front)	Output	Ignition switch ON	0 V
				Turn signal switch OFF	6.5 V
Turn signal switch LH 					PKID0926E
19 (SB)	Ground	Room lamp timer	Output	Other than under condition	5.0 V
				<ul style="list-style-type: none"> Interior room lamp timer is activated. (Door is unlocked. etc...) Welcome light function is activated. 	0 V
20 (V)	Ground	Turn signal RH (Rear)	Output	Ignition switch ON	0 V
				Turn signal switch OFF	6.5 V
Turn signal switch RH 					PKID0926E
25 (G)	Ground	Turn signal LH (Rear)	Output	Ignition switch ON	0 V
				Turn signal switch OFF	6.5 V
Turn signal switch LH 					PKID0926E
26 (G)	Ground	Rear wiper	Output	Rear wiper	0 V
				OFF (Stopped)	12 V
34 (SB)	Ground	Luggage room anten- na (-)	Output	Ignition switch OFF	0 V
				When Intelligent Key is in the passenger compart- ment 	JMKIA0062GB
When Intelligent Key is not in the passenger compart- ment 					JMKIA0063GB

BCM (BODY CONTROL MODULE)

< ECU DIAGNOSIS INFORMATION >

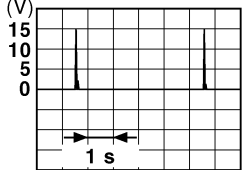
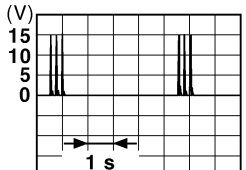
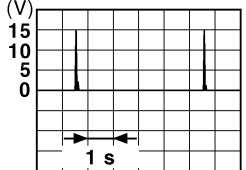
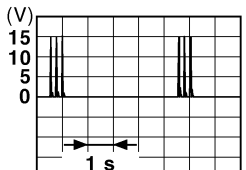
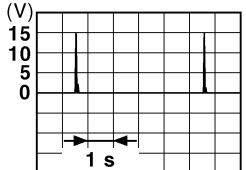
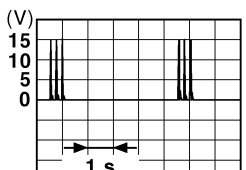
Terminal No. (Wire color)		Description		Condition	Value (Approx.)	
		Signal name	Input/ Output			
+	-					
35 (V)	Ground	Luggage room antenna (+)	Output	Ignition switch OFF	 <p style="text-align: right; font-size: small;">JMKIA0062GB</p>	
				When Intelligent Key is not in the passenger compartment	 <p style="text-align: right; font-size: small;">JMKIA0063GB</p>	
38 (B)	Ground	Back door antenna (-)	Output	When the back door opener request switch is operated with ignition switch OFF	 <p style="text-align: right; font-size: small;">JMKIA0062GB</p>	
				When Intelligent Key is not in the antenna detection area	 <p style="text-align: right; font-size: small;">JMKIA0063GB</p>	
39 (W)	Ground	Back door antenna (+)	Output	When the back door opener request switch is operated with ignition switch OFF	 <p style="text-align: right; font-size: small;">JMKIA0062GB</p>	
				When Intelligent Key is not in the antenna detection area	 <p style="text-align: right; font-size: small;">JMKIA0063GB</p>	
47 (Y)	Ground	Ignition relay (IPDM E/R) control	Output	Ignition switch	OFF or ACC	12 V
				ON	0 V	

A
B
C
D
E
F
G
H
I
J
L
M
N
O
P

RF

BCM (BODY CONTROL MODULE)

< ECU DIAGNOSIS INFORMATION >

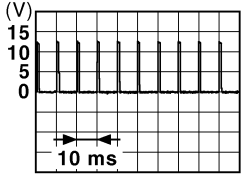
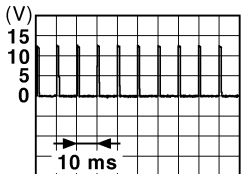
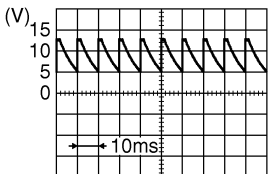
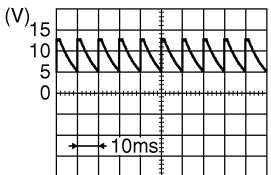
Terminal No. (Wire color)		Description		Condition	Value (Approx.)	
+	-	Signal name	Input/ Output			
48 (W)	Ground	Back door opener switch operation	Output	Back door opener switch	Not pressed	12 V
					Pressed	0 V
52 (LG)	Ground	Starter relay control	Output	Ignition switch ON	When selector lever is in P or N position	12 V
					When selector lever is not in P or N position	0 V
61 (W)	Ground	Back door opener re- quest switch	Input	Back door re- quest switch	ON (Pressed)	0 V
					OFF (Not pressed)	 1.0 V
64 (L)	Ground	Intelligent Key warn- ing buzzer (Engine room)	Output	Intelligent Key warning buzzer (Engine room)	Sounding	0 V
					Not sounding	12 V
65 (O)	Ground	Rear wiper stop posi- tion	Input	Rear wiper	In stop position	 1.0 V
					Not in stop position	0 V
66 (LG)	Ground	Back door switch	Input	Back door switch	OFF (Door close)	12 V
					ON (Door open)	0 V
67 (P)	Ground	Back door opener switch	Input	Back door opener switch	Pressed	0 V
					Not pressed	 8.5 - 9.0 V
68 (BR)	Ground	Rear RH door switch	Input	Rear RH door switch	OFF (Door close)	 8.5 - 9.0 V
					ON (Door open)	0 V

BCM (BODY CONTROL MODULE)

< ECU DIAGNOSIS INFORMATION >

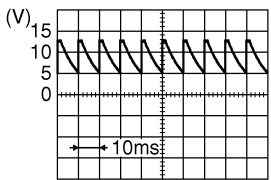
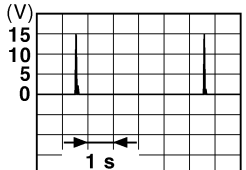
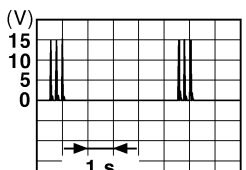
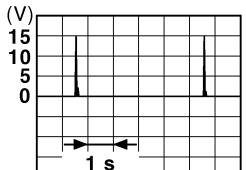
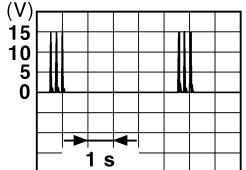
Terminal No. (Wire color)		Description		Condition	Value (Approx.)
		Signal name	Input/ Output		
+	-				
69 (R)	Ground	Rear LH door switch	Input	Rear LH door switch	 <p style="text-align: center;">8.5 - 9.0 V</p>
				ON (Door open)	0 V
72 (R)	Ground	Room antenna 2 (-) (Center console)	Output	Ignition switch OFF	
				When Intelligent Key is not in the passenger compartment	
73 (G)	Ground	Room antenna 2 (+) (Center console)	Output	Ignition switch OFF	
				When Intelligent Key is not in the passenger compartment	

A
B
C
D
E
F
G
H
I
J
L
M
N
O
P

RF

BCM (BODY CONTROL MODULE)

< ECU DIAGNOSIS INFORMATION >

Terminal No. (Wire color)		Description		Condition	Value (Approx.)
+	-	Signal name	Input/ Output		
74 (SB)	Ground	Passenger door antenna (-)	Output	When Intelligent Key is in the antenna detection area	<p style="text-align: right; font-size: small;">JMKIA0062GB</p>
				When Intelligent Key is not in the antenna detection area	<p style="text-align: right; font-size: small;">JMKIA0063GB</p>
75 (BR)	Ground	Passenger door antenna (+)	Output	When Intelligent Key is in the antenna detection area	<p style="text-align: right; font-size: small;">JMKIA0062GB</p>
				When Intelligent Key is not in the antenna detection area	<p style="text-align: right; font-size: small;">JMKIA0063GB</p>
76 (V)	Ground	Driver door antenna (-)	Output	When Intelligent Key is in the antenna detection area	<p style="text-align: right; font-size: small;">JMKIA0062GB</p>
				When Intelligent Key is not in the antenna detection area	<p style="text-align: right; font-size: small;">JMKIA0063GB</p>

BCM (BODY CONTROL MODULE)

< ECU DIAGNOSIS INFORMATION >

Terminal No. (Wire color)		Description		Condition	Value (Approx.)
+	-	Signal name	Input/ Output		
77 (LG)	Ground	Driver door antenna (+)	Output	When Intelligent Key is in the antenna detection area	
				When the driver door request switch is operat- ed with ignition switch OFF	
78 (Y)	Ground	Room antenna 1 (-) (Instrument panel)	Output	When Intelligent Key is in the passenger compart- ment	
				When Intelligent Key is not in the passenger compart- ment	
79 (BR)	Ground	Room antenna 1 (+) (Instrument panel)	Output	When Intelligent Key is in the passenger compart- ment	
				When Intelligent Key is not in the passenger compart- ment	

A
B
C
D
E
F
G
H
I
J
L
M
N
O
P

RF

BCM (BODY CONTROL MODULE)

< ECU DIAGNOSIS INFORMATION >

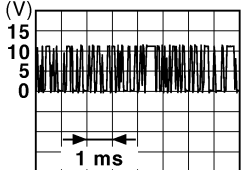
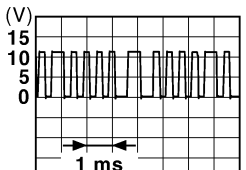
Terminal No. (Wire color)		Description		Condition		Value (Approx.)
		Signal name	Input/ Output			
+	-					
80 (GR)	Ground	NATS antenna amp.	Input/ Output	During waiting	Ignition switch is pressed while inserting the Intelligent Key into the key slot.	Just after pressing ignition switch. Pointer of tester should move.
81 (W)	Ground	NATS antenna amp.	Input/ Output	During waiting	Ignition switch is pressed while inserting the Intelligent Key into the key slot.	Just after pressing ignition switch. Pointer of tester should move.
82 (P)	Ground	Ignition relay [Fuse block (J/B)] control	Output	Ignition switch	OFF or ACC	0 V
					ON	12 V
83 (GR)	Ground	Remote keyless entry receiver communication	Input/ Output	During waiting		 <p style="text-align: right; font-size: small;">JMKIA0064GB</p>
				When operating either button on the Intelligent Key		 <p style="text-align: right; font-size: small;">JMKIA0065GB</p>

BCM (BODY CONTROL MODULE)

< ECU DIAGNOSIS INFORMATION >

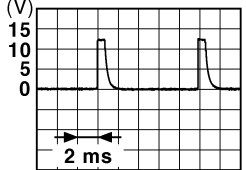
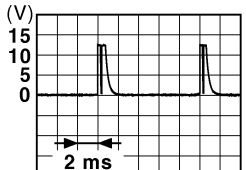
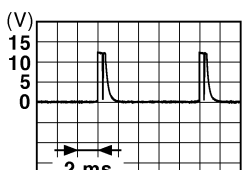
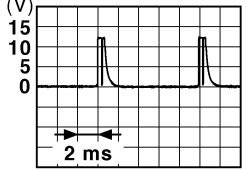

Terminal No. (Wire color)		Description		Condition	Value (Approx.)	
		Signal name	Input/ Output			
+	-					
87 (BR)	Ground	Combination switch INPUT 5	Input	Combination switch	All switches OFF (Wiper intermittent dial 4)	 <p style="text-align: right;">1.4 V</p>
					Front fog lamp switch ON (Wiper intermittent dial 4)	 <p style="text-align: right;">1.3 V</p>
					Rear wiper switch ON (Wiper intermittent dial 4)	 <p style="text-align: right;">1.3 V</p>
					Any of the conditions below with all switches OFF <ul style="list-style-type: none"> • Wiper intermittent dial 1 • Wiper intermittent dial 2 • Wiper intermittent dial 6 • Wiper intermittent dial 7 	 <p style="text-align: right;">1.3 V</p>

A
B
C
D
E
F
G
H
I
J
L
M
N
O
P

RF

BCM (BODY CONTROL MODULE)

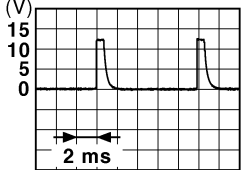
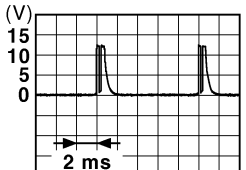
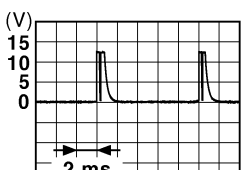
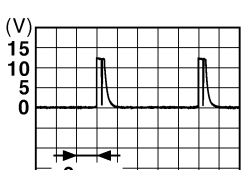
< ECU DIAGNOSIS INFORMATION >

Terminal No. (Wire color)		Description		Condition	Value (Approx.)	
+	-	Signal name	Input/ Output			
88 (V)	Ground	Combination switch INPUT 3	Input	Combination switch	All switches OFF (Wiper intermittent dial 4)	 <p style="text-align: right; font-size: small;">JPMA0041GB</p> <p style="text-align: center;">1.4 V</p>
					Lighting switch HI (Wiper intermittent dial 4)	 <p style="text-align: right; font-size: small;">JPMA0036GB</p> <p style="text-align: center;">1.3 V</p>
					Lighting switch 2ND (Wiper intermittent dial 4)	 <p style="text-align: right; font-size: small;">JPMA0037GB</p> <p style="text-align: center;">1.3 V</p>
					Rear washer switch ON (Wiper intermittent dial 4)	 <p style="text-align: right; font-size: small;">JPMA0039GB</p> <p style="text-align: center;">1.3 V</p>
					Any of the conditions below with all switches OFF	<ul style="list-style-type: none"> • Wiper intermittent dial 1 • Wiper intermittent dial 2 • Wiper intermittent dial 3  <p style="text-align: right; font-size: small;">JPMA0040GB</p> <p style="text-align: center;">1.3 V</p>
89 (SB)	Ground	Push-button ignition switch (Push switch)	Input	Push-button igni- tion switch (Push switch)	Pressed	0 V
					Not pressed	12 V
90 (P)	Ground	CAN-L	Input/ Output	—	—	
91 (L)	Ground	CAN-H	Input/ Output	—	—	

BCM (BODY CONTROL MODULE)

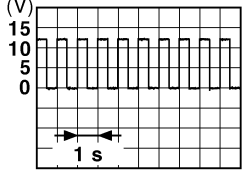
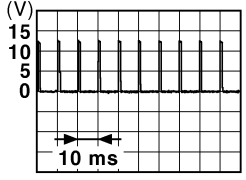
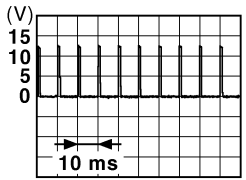

< ECU DIAGNOSIS INFORMATION >

Terminal No. (Wire color)		Description		Condition	Value (Approx.)	
+	-	Signal name	Input/ Output			
92 (LG)	Ground	Key slot illumination	Output	Key slot illumination	OFF	12 V
					Blinking	
					ON	0 V
93 (V)	Ground	ON indicator lamp	Output	Ignition switch	OFF (LOCK indicator is not illuminated)	Battery voltage
					ON or ACC	0 V
95 (O)	Ground	ACC relay control	Output	Ignition switch	OFF	0 V
					ACC or ON	12 V
96 (GR)	Ground	A/T shift selector (Detention switch) power supply	Output	—	12 V	
97 (L)	Ground	Steering lock condition No. 1	Input	Steering lock	LOCK status	0 V
					UNLOCK status	12 V
98 (P)	Ground	Steering lock condition No. 2	Input	Steering lock	LOCK status	12 V
					UNLOCK status	0 V
99 (R)	Ground	Selector lever P position switch	Input	Selector lever	P position	0 V
					Any position other than P	12 V
100 (G)	Ground	Passenger door request switch	Input	Passenger door request switch	ON (Pressed)	0 V
					OFF (Not pressed)	
101 (SB)	Ground	Driver door request switch	Input	Driver door request switch	ON (Pressed)	0 V
					OFF (Not pressed)	
102 (O)	Ground	Blower fan motor relay control	Output	Ignition switch	OFF or ACC	0 V
					ON	12 V
103 (BR)	Ground	Remote keyless entry receiver power supply	Output	Ignition switch OFF	12 V	

A
B
C
D
E
F
G
H
I
J
RF
L
M
N
O
P



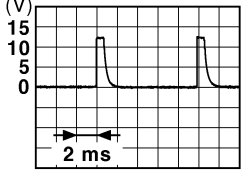

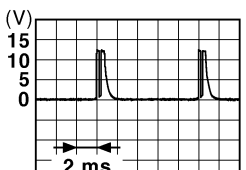
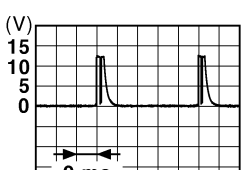
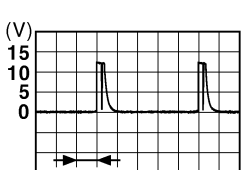
BCM (BODY CONTROL MODULE)

< ECU DIAGNOSIS INFORMATION >

Terminal No. (Wire color)		Description		Condition	Value (Approx.)
+	-	Signal name	Input/ Output		
106 (W)	Ground	Steering lock unit power supply	Output	Ignition switch	OFF or ACC 12 V
				ON 0 V	
107 (LG)	Ground	Combination switch INPUT 1	Input	Combination switch (Wiper intermit- tent dial 4)	All switches OFF  JPMA0041GB 1.4 V
					Turn signal switch LH  JPMA0037GB 1.3 V
					Turn signal switch RH  JPMA0036GB 1.3 V
					Front wiper switch LO  JPMA0038GB 1.3 V
					Front washer switch ON  JPMA0039GB 1.3 V

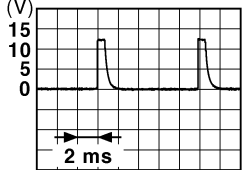
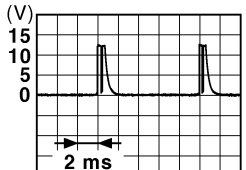
BCM (BODY CONTROL MODULE)

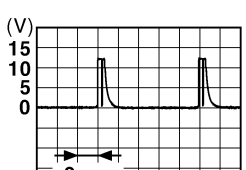

< ECU DIAGNOSIS INFORMATION >

Terminal No. (Wire color)		Description		Condition	Value (Approx.)	
		Signal name	Input/ Output			
+	-					
108 (R)	Ground	Combination switch INPUT 4	Input	Combination switch	All switches OFF (Wiper intermittent dial 4)	 1.4 V
					Lighting switch AUTO (Wiper intermittent dial 4)	 1.3 V
					Lighting switch 1ST (Wiper intermittent dial 4)	 1.3 V
					Rear wiper switch INT (Wiper intermittent dial 4)	 1.3 V
					Any of the conditions below with all switches OFF	 1.3 V
					<ul style="list-style-type: none"> • Wiper intermittent dial 1 • Wiper intermittent dial 5 • Wiper intermittent dial 6 	

A
B
C
D
E
F
G
H
I
J
RF
L
M
N
O
P

BCM (BODY CONTROL MODULE)

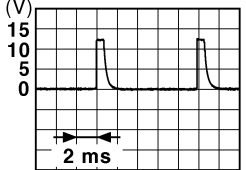
< ECU DIAGNOSIS INFORMATION >

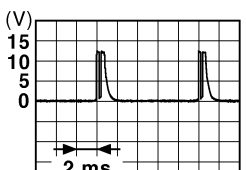
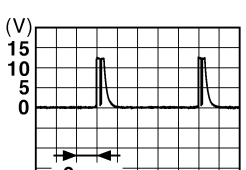
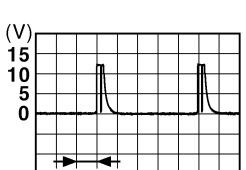
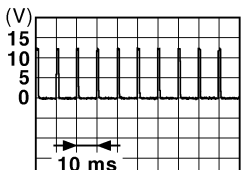
Terminal No. (Wire color)		Description		Condition	Value (Approx.)	
+	-	Signal name	Input/ Output			
109 (Y)	Ground	Combination switch INPUT 2	Input	Combination switch (Wiper intermittent dial 4)	All switches OFF	 <p style="text-align: right;">JPMIA0041GB</p> <p style="text-align: center;">1.4 V</p>
					Lighting switch PASS	 <p style="text-align: right;">JPMIA0037GB</p> <p style="text-align: center;">1.3 V</p>
					Lighting switch 2ND	 <p style="text-align: right;">JPMIA0036GB</p> <p style="text-align: center;">1.3 V</p>
					Front wiper switch INT	 <p style="text-align: right;">JPMIA0038GB</p> <p style="text-align: center;">1.3 V</p>
					Front wiper switch HI	 <p style="text-align: right;">JPMIA0040GB</p> <p style="text-align: center;">1.3 V</p>
110 (G)	Ground	Hazard switch	Input	Hazard switch	ON	0 V
					OFF	 <p style="text-align: right;">JPMIA0012GB</p> <p style="text-align: center;">1.1 V</p>

BCM (BODY CONTROL MODULE)



< ECU DIAGNOSIS INFORMATION >

Terminal No. (Wire color)		Description		Condition	Value (Approx.)	
		Signal name	Input/ Output			
+	-					
111 (GR)	Ground	Steering lock unit communication	Input/ Output	Steering lock	LOCK status	12 V
					LOCK or UNLOCK	<p style="text-align: right; font-size: small;">JMKIA0066GB</p>
					For 15 seconds after UN- LOCK	12 V
				15 seconds or later after UNLOCK	0 V	
112 (GR)	Ground	Rain sensor serial link	Input/ Output	Ignition switch ON	<p style="text-align: right; font-size: small;">JPMIA0156GB</p>	
					8.7 V	
113 (P)	Ground	Optical sensor	Input	Ignition switch ON	When bright outside of the vehicle	Close to 5 V
				When dark outside of the vehicle	Close to 0 V	
116 (BR)	Ground	Stop lamp switch 1	Input	—	Battery voltage	
118 (P)	Ground	Stop lamp switch 2 (Without ICC)	Input	Stop lamp switch	OFF (Brake pedal is not depressed)	0 V
					ON (Brake pedal is de- pressed)	Battery voltage
		Stop lamp switch 2 (With ICC)		Stop lamp switch OFF (Brake pedal is not de- pressed) and ICC brake hold relay OFF	0 V	
				Stop lamp switch ON (Brake pedal is de- pressed) or ICC brake hold relay ON	Battery voltage	
119 (SB)	Ground	Front door lock as- sembly driver side (Unlock sensor)	Input	Driver door	LOCK status (Unlock sensor switch OFF)	<p style="text-align: right; font-size: small;">JPMIA0594GB</p>
					UNLOCK status (Unlock switch sensor ON)	0 V
121 (BR)	Ground	Key slot switch	Input	When the Intelligent Key is inserted into key slot	12 V	
				When the Intelligent Key is not inserted into key slot	0 V	
122 (V)	Ground	ACC feedback	Input	Ignition switch	OFF	0 V
				ACC or ON	Battery voltage	

A
B
C
D
E
F
G
H
I
J
RF
L
M
N
O
P

BCM (BODY CONTROL MODULE)

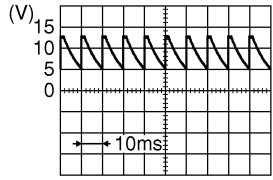
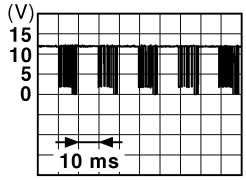
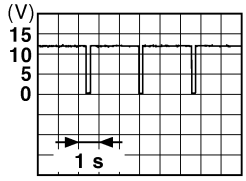
< ECU DIAGNOSIS INFORMATION >

Terminal No. (Wire color)		Description		Condition		Value (Approx.)
		Signal name	Input/ Output			
+	-					
123 (W)	Ground	IGN feedback	Input	Ignition switch	OFF or ACC	0 V
					ON	Battery voltage
124 (LG)	Ground	Passenger door switch	Input	Passenger door switch	OFF (Door close)	 <p style="text-align: right; font-size: small;">JPMA0594GB</p>
					ON (Door opene)	0 V
132 (O)	Ground	Power window switch communication	Input/ Output	Ignition switch ON	 <p style="text-align: right; font-size: small;">JPMA0013GB</p>	
				Ignition switch OFF or ACC	12 V	
134 (GR)	Ground	LOCK indicator lamp	Output	LOCK indicator lamp	OFF	Battery voltage
					ON	0 V
137 (B)	Ground	Receiver and sensor ground	Input	Ignition switch ON		0 V
138 (Y)	Ground	Sensor power supply	Output	Ignition switch	OFF	0 V
					ACC or ON	5.0 V
140 (R)	Ground	Selector lever P/N position	Input	Selector lever	P or N position	12 V
					Except P and N positions	0 V
141 (G)	Ground	Security indicator	Output	Security indicator	Blinking	 <p style="text-align: right; font-size: small;">JPMA0014GB</p>
					OFF	12 V
142 (O)	Ground	Combination switch OUTPUT 5	Output	Combination switch (Wiper intermittent dial 4)	All switches OFF	0 V
					Lighting switch 1ST	 <p style="text-align: right; font-size: small;">JPMA0031GB</p>
					Lighting switch HI	
					Lighting switch 2ND	
Turn signal switch RH	10.7 V					

BCM (BODY CONTROL MODULE)

< ECU DIAGNOSIS INFORMATION >

Terminal No. (Wire color)		Description		Condition	Value (Approx.)	
		Signal name	Input/ Output			
+	-					
143 (P)	Ground	Combination switch OUTPUT 1	Output	Combination switch	All switches OFF (Wiper intermittent dial 4)	0 V
					Front wiper switch HI (Wiper intermittent dial 4)	
					Rear wiper switch INT (Wiper intermittent dial 4)	
					Any of the conditions below with all switches OFF	
					<ul style="list-style-type: none"> • Wiper intermittent dial 1 • Wiper intermittent dial 2 • Wiper intermittent dial 3 • Wiper intermittent dial 6 • Wiper intermittent dial 7 	
					10.7 V	
144 (G)	Ground	Combination switch OUTPUT 2	Output	Combination switch	All switches OFF (Wiper intermittent dial 4)	0 V
					Front washer switch ON (Wiper intermittent dial 4)	
					Rear wiper switch ON (Wiper intermittent dial 4)	
					Rear washer switch ON (Wiper intermittent dial 4)	
					Any of the conditions below with all switches OFF	
<ul style="list-style-type: none"> • Wiper intermittent dial 1 • Wiper intermittent dial 5 • Wiper intermittent dial 6 						
					10.7 V	
145 (L)	Ground	Combination switch OUTPUT 3	Output	Combination switch (Wiper intermit- tent dial 4)	All switches OFF	0 V
					Front wiper switch INT	
					Front wiper switch LO	
					Lighting switch AUTO	
					Any of the conditions below with all switches OFF	
					10.7 V	
146 (SB)	Ground	Combination switch OUTPUT 4	Output	Combination switch (Wiper intermit- tent dial 4)	All switches OFF	0 V
					Front fog lamp switch ON	
					Lighting switch 2ND	
					Lighting switch PASS	
					Any of the conditions below with all switches OFF	
<ul style="list-style-type: none"> • Turn signal switch LH 						
					10.7 V	

A
B
C
D
E
F
G
H
I
J
L
M
N
O
P

RF

BCM (BODY CONTROL MODULE)

< ECU DIAGNOSIS INFORMATION >

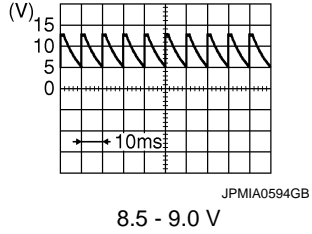
Terminal No. (Wire color)		Description		Condition	Value (Approx.)	
+	-	Signal name	Input/ Output			
150 (GR)	Ground	Driver door switch	Input	Driver door switch	OFF (Door close)	
				ON (Door open)	0 V	
151 (G)	Ground	Rear window defogger relay control	Output	Rear window defogger	Active	0 V
				Not activated	Battery voltage	

BCM (BODY CONTROL MODULE)

< ECU DIAGNOSIS INFORMATION >

Wiring Diagram - BCM -

INFOID:000000003894429

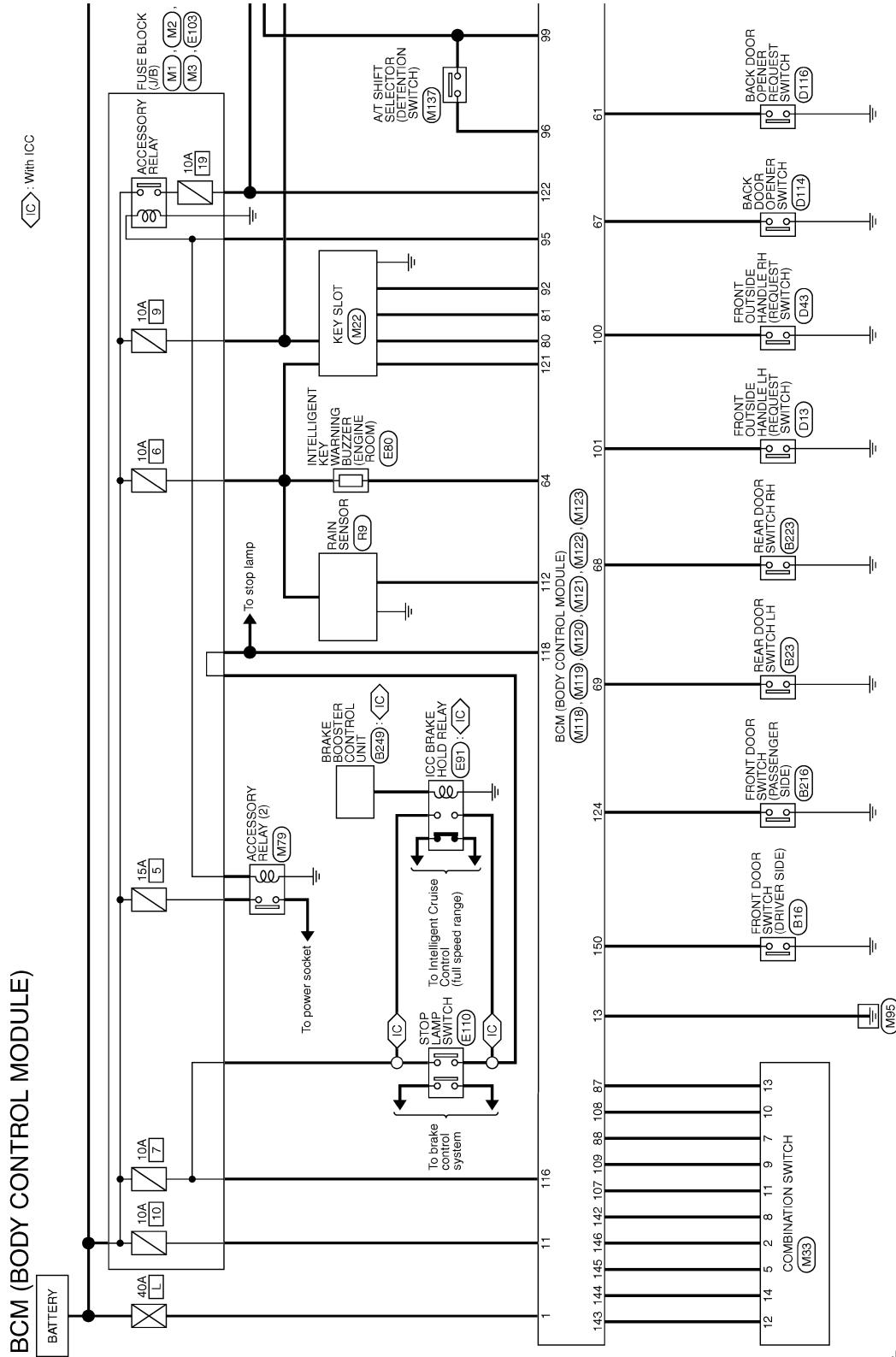

2008/03/04

JCMWM1990GB

A
B
C
D
E
F
G
H
I
J
L
M
N
O
P

RF

BCM (BODY CONTROL MODULE)

< ECU DIAGNOSIS INFORMATION >

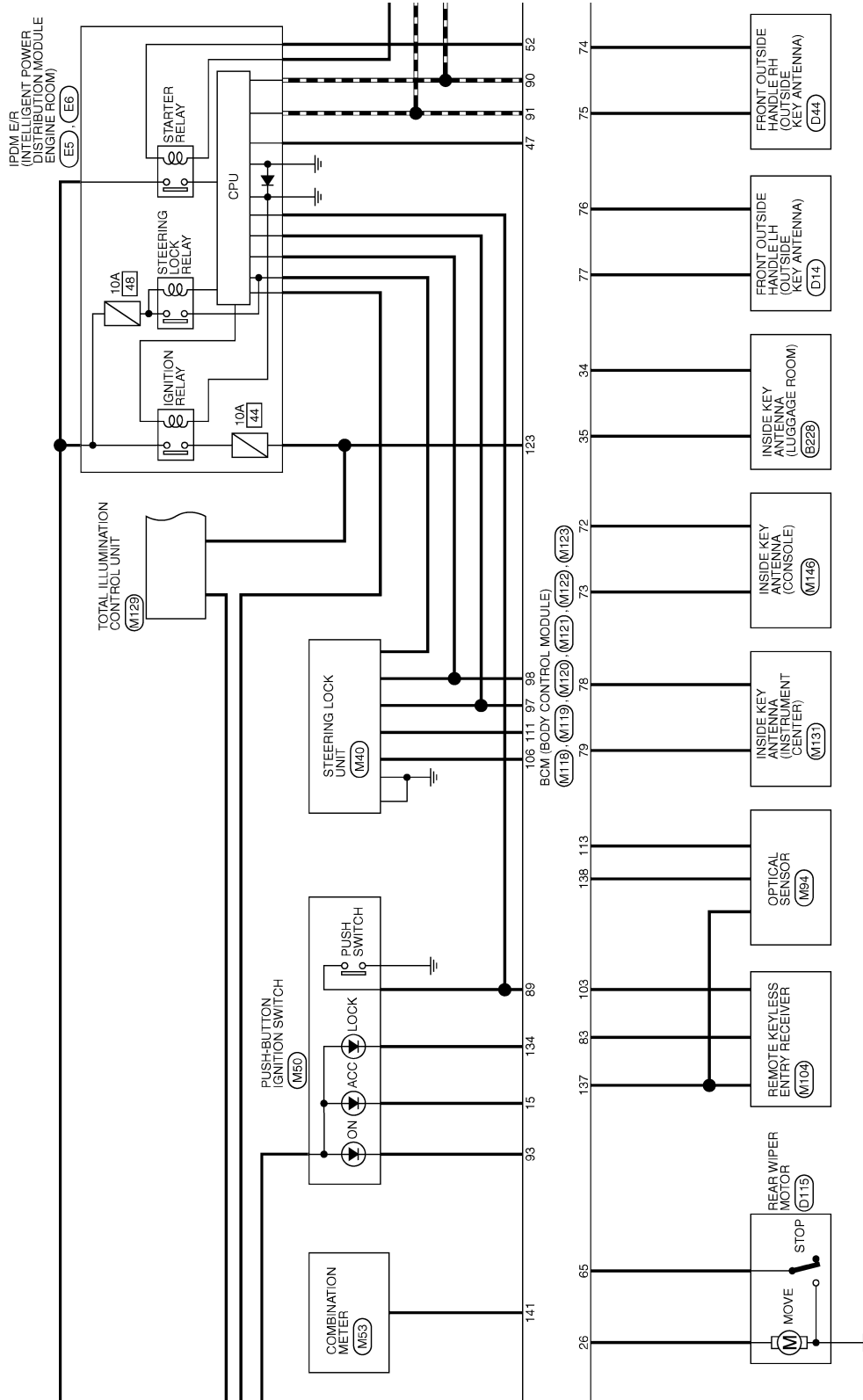

JCMWM1991GB

BCM (BODY CONTROL MODULE)

< ECU DIAGNOSIS INFORMATION >

- <VC> : With VC engine
- <VK> : With VK engine
- <NV> : With NAVI
- <ON> : Without NAVI
- <OP> : Without automatic drive positioner
- <AN> : With rear anti-pinch system
- <NA> : Without rear anti-pinch system

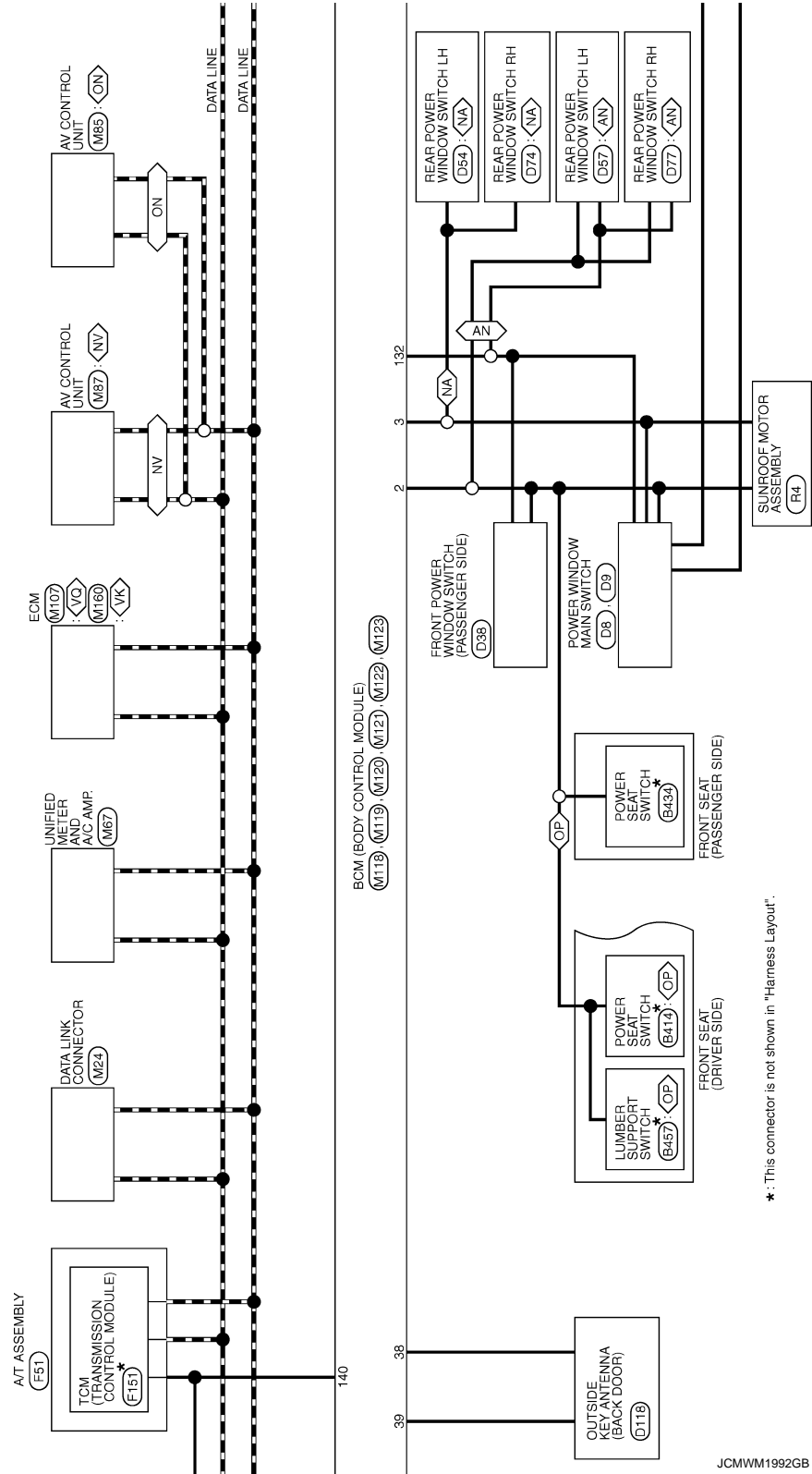

JCMWM1992GB

A
B
C
D
E
F
G
H
I
J
RF
L
M
N
O
P

BCM (BODY CONTROL MODULE)

< ECU DIAGNOSIS INFORMATION >

◊(PM)◊: With automatic drive positioner

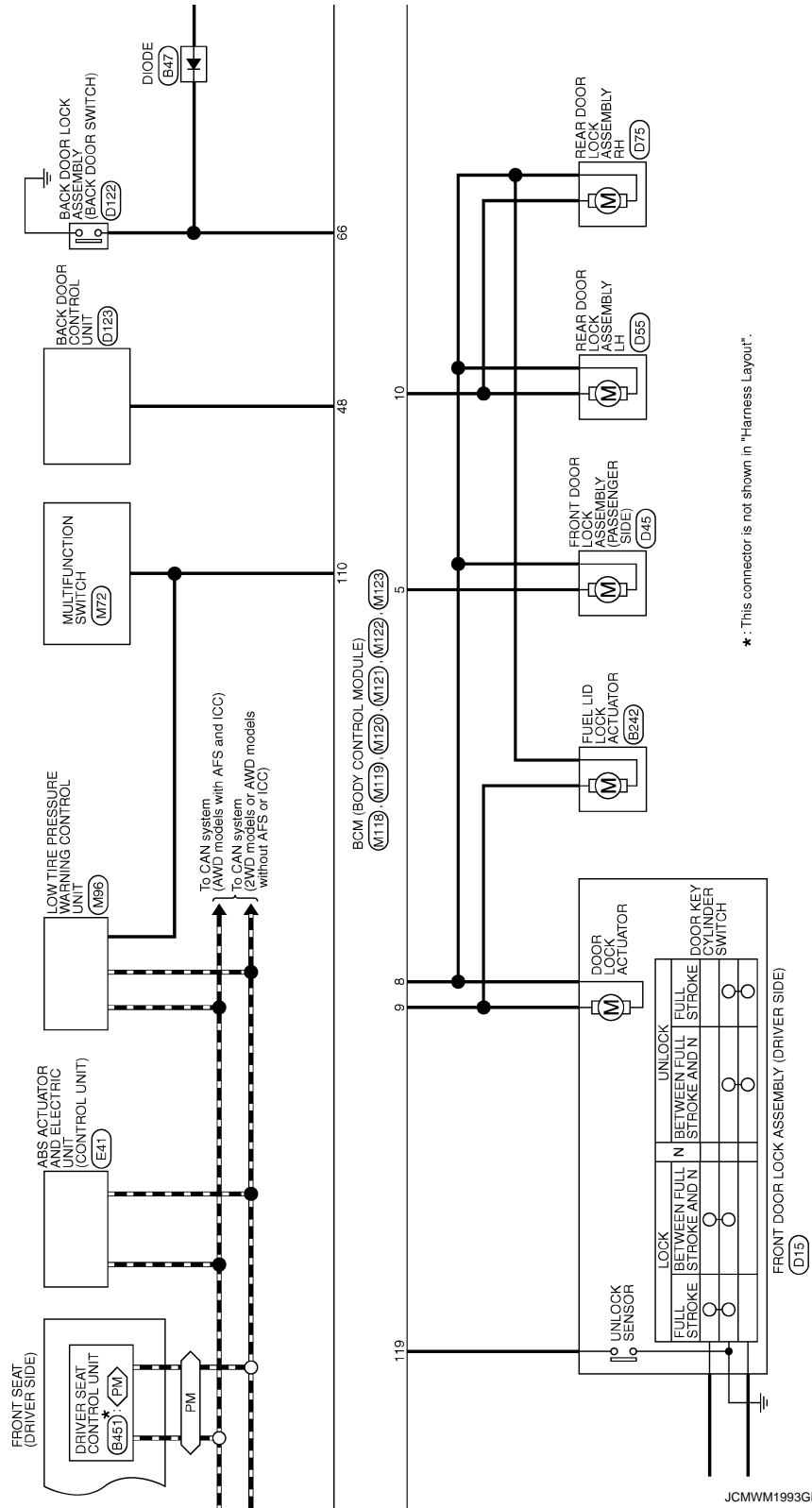

BCM (BODY CONTROL MODULE)

< ECU DIAGNOSIS INFORMATION >

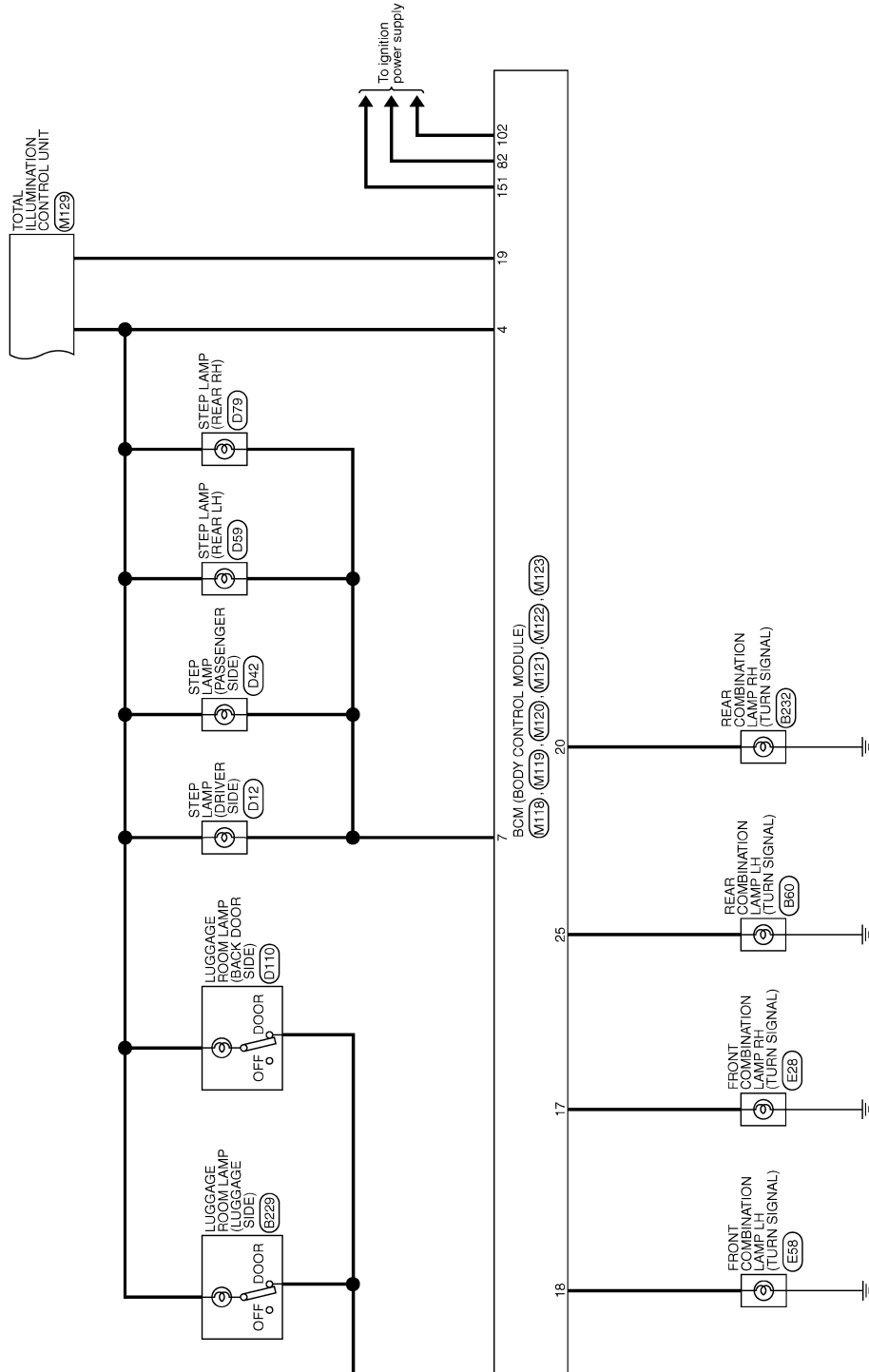

JCMWM1994GB

A
B
C
D
E
F
G
H
I
J
RF
L
M
N
O
P

BCM (BODY CONTROL MODULE)

< ECU DIAGNOSIS INFORMATION >

19	SB	ROOM LAMP TIMER
----	----	-----------------

Connector No.	M119
Connector Name	BCM (BODY CONTROL MODULE)
Connector Type	NS16FW-CS

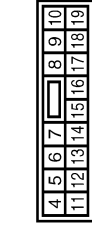

Terminal No.	Color of Wire	Signal Name [Specification]
4	P	INT ROOM LAMP PWR SUPPLY(BAT SAVE)
5	V	PASSENGER DOOR UNLOCK OUTPUT
7	Y	STEP LAMP OUTPUT
8	V	ALL DOOR FUEL LID LOCK OUTPUT
9	G	DRIVER DOOR FUEL LID UNLOCK OUTPUT
10	BR	REAR DOOR UNLOCK OUTPUT
11	R	BAT (USE)
13	B	GNL
15	Y	ACC IND
17	W	TURN SIGNAL RH (FRONT)
18	O	TURN SIGNAL LH (FRONT)

67	P	BACK DOOR OPENER SW
68	BR	REAR RH DOOR SW
69	R	REAR LH DOOR SW

Connector No.	M118
Connector Name	BCM (BODY CONTROL MODULE)
Connector Type	M03FB-LC



Terminal No.	Color of Wire	Signal Name [Specification]
1	W	BAT (F/L)
2	Y	POWER WINDOW POWER SUPPLY(BAT)
3	O	POWER WINDOW POWER SUPPLY(TRAP)

Connector No.	M121
Connector Name	BCM (BODY CONTROL MODULE)
Connector Type	TH40FGY-NH

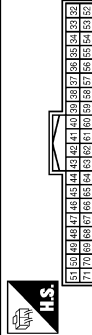

Terminal No.	Color of Wire	Signal Name [Specification]
34	SB	LUGGAGE ROOM ANT-
35	V	LUGGAGE ROOM ANT+
38	B	BACK DOOR ANT-
39	W	BACK DOOR ANT+
47	Y	IGN RELAY (PDM E/R) CONT
48	W	BK DOOR OPENER SW OPERATION
52	LG	STARTER RELAY CONT
61	W	BACK DOOR OPENER REQUEST SW
64	L	L-KEY WARN BUZZER (ENG ROOM)
65	O	REAR WIPER STOP POSITION
66	LG	BACK DOOR SW

BCM (BODY CONTROL MODULE)

Connector No.	M33
Connector Name	COMBINATION SWITCH
Connector Type	TH16FW-NH

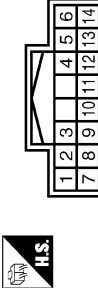

Terminal No.	Color of Wire	Signal Name [Specification]
2	SB	OUTPUT 4
5	L	OUTPUT 3
7	V	INPUT 3
8	O	OUTPUT 5
9	Y	INPUT 2
10	R	INPUT 4
11	LG	INPUT 1
12	P	OUTPUT 1
13	BR	INPUT 5
14	G	OUTPUT 2

Connector No.	M120
Connector Name	BCM (BODY CONTROL MODULE)
Connector Type	NS12FW-CS



Terminal No.	Color of Wire	Signal Name [Specification]
20	V	TURN SIGNAL RH (REAR)
25	G	TURN SIGNAL LH (REAR)
26	G	REAR WIPER OUTPUT

JCMWM1995GB

BCM (BODY CONTROL MODULE)

< ECU DIAGNOSIS INFORMATION >

137	B	RECEIVER SENSOR GND
138	Y	SENSOR POWER SUPPLY
140	R	SHIFT UP
141	G	SECURITY INDICATOR OUTPUT
142	O	COMBI SW OUTPUT 3
143	P	COMBI SW OUTPUT 1
144	G	COMBI SW OUTPUT 2
145	L	COMBI SW OUTPUT 3
146	SB	COMBI SW OUTPUT 4
150	GR	DRIVER DOOR SW
151	G	REAR WINDOW DEFOGGER RELAY CONT

Connector No.	M123
Connector Name	BCM (BODY CONTROL MODULE)
Connector Type	TH40FB-NH

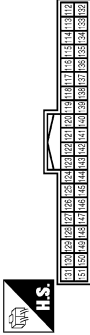

Terminal No.	Color of Wire	Signal Name [Specification]
112	GR	RAIN SENSOR SERIAL LINK
113	P	OPTICAL SENSOR
116	BR	STOP LAMP SW 1
118	P	STOP LAMP SW 2
119	SB	DR DOOR UNLOCK SENSOR
121	BR	KEY SLOT SW
122	V	ACC P/B
123	W	IGN P/B
124	LG	PASSENGER DOOR SW
132	O	POWER WINDOW SW COMM
134	GR	LOCK IND

83	GR	KEYLESS ENTRY RECEIVER SIGNAL
87	BR	COMBI SW INPUT 5
88	V	COMBI SW INPUT 3
89	SB	PUSH SW
90	P	CAN-L
91	L	CAN-H
92	LG	KEY SLOT ILL
93	V	ON IND
95	O	ACC RELAY CONT
96	GR	A/T SHIFT SELECTOR POWER SUPPLY
97	L	S/L CONDITION 1
98	P	S/L CONDITION 2
99	R	SHIFT P
100	G	PASSENGER DOOR REQUEST SW
101	R	DRIVER DOOR REQUEST SW
102	O	BLOWER FAN MOTOR RELAY CONT
103	BR	KEYLESS ENTRY RECEIVER POWER SUPPLY
106	W	S/L UNIT POWER SUPPLY
107	LG	COMBI SW INPUT 1
108	R	COMBI SW INPUT 4
109	Y	COMBI SW INPUT 2
110	G	HAZARD SW
111	GR	S/L UNIT COMM

BCM (BODY CONTROL MODULE)

Connector No.	M122
Connector Name	BCM (BODY CONTROL MODULE)
Connector Type	TH40FB-NH

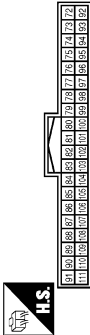

Terminal No.	Color of Wire	Signal Name [Specification]
72	R	ROOM ANT2-
73	G	ROOM ANT2+
74	SB	PASSENGER DOOR ANT-
75	BR	PASSENGER DOOR ANT+
76	V	DRIVER DOOR ANT-
77	LG	DRIVER DOOR ANT+
78	Y	ROOM ANTI-
79	BR	ROOM ANTI+
80	GR	IMMOBI ANTENNA CONTROL
81	W	IMMOBI ANTENNA SIGNAL
82	P	IGN RELAY (F/B) CONT

Fail-safe

FAIL-SAFE CONTROL BY DTC

BCM performs fail-safe control when any DTC are detected.

JCMWM1996GB

INFOID:000000005176730

A
B
C
D
E
F
G
H
I
J
L
M
N
O
P

RF

BCM (BODY CONTROL MODULE)

< ECU DIAGNOSIS INFORMATION >

Display contents of CONSULT	Fail-safe	Cancellation
B2013: ID DISCORD BCM-S/L	Inhibit engine cranking	Erase DTC
B2014: CHAIN OF S/L-BCM	Inhibit engine cranking	Erase DTC
B2190: NATS ANTENNA AMP	Inhibit engine cranking	Erase DTC
B2191: DIFFERENCE OF KEY	Inhibit engine cranking	Erase DTC
B2192: ID DISCORD BCM-ECM	Inhibit engine cranking	Erase DTC
B2193: CHAIN OF BCM-ECM	Inhibit engine cranking	Erase DTC
B2195: ANTI SCANNING	Inhibit engine cranking	Ignition switch ON → OFF
B2557: VEHICLE SPEED	Inhibit steering lock	When normal vehicle speed signals are received from ABS actuator and electric unit (control unit) for 500 ms
B2560: STARTER CONT RELAY	Inhibit engine cranking	500 ms after the following CAN signal communication status becomes consistent <ul style="list-style-type: none"> • Starter control relay signal • Starter relay status signal
B2601: SHIFT POSITION	Inhibit steering lock	500 ms after the following signal reception status becomes consistent <ul style="list-style-type: none"> • Selector lever P position switch signal • P range signal (CAN)
B2602: SHIFT POSITION	Inhibit steering lock	5 seconds after the following BCM recognition conditions are fulfilled <ul style="list-style-type: none"> • Ignition switch is in the ON position • Selector lever P position switch signal: Except P position (battery voltage) • Vehicle speed: 4 km/h (2.5 MPH) or more
B2603: SHIFT POSI STATUS	Inhibit steering lock	500 ms after the following BCM recognition conditions are fulfilled <ul style="list-style-type: none"> • Ignition switch is in the ON position • Selector lever P position switch signal: Except P position (battery voltage) • Selector lever P/N position signal: Except P and N positions (0 V)
B2604: PNP SW	Inhibit steering lock	500 ms after any of the following BCM recognition conditions are fulfilled <ul style="list-style-type: none"> • Status 1 <ul style="list-style-type: none"> - Ignition switch is in the ON position - Selector lever P/N position signal: P and N position (battery voltage) - P range signal or N range signal (CAN): ON • Status 2 <ul style="list-style-type: none"> - Ignition switch is in the ON position - Selector lever P/N position signal: Except P and N positions (0 V) - P range signal and N range signal (CAN): OFF
B2605: PNP SW	Inhibit steering lock	500 ms after any of the following BCM recognition conditions are fulfilled <ul style="list-style-type: none"> • Ignition switch is in the ON position <ul style="list-style-type: none"> - Power position: IGN - Selector lever P/N position signal: Except P and N positions (0 V) - Interlock/PNP switch signal (CAN): OFF • Status 2 <ul style="list-style-type: none"> - Ignition switch is in the ON position - Selector lever P/N position signal: P or N position (battery voltage) - PNP switch signal (CAN): ON
B2606: S/L RELAY	Inhibit engine cranking	500 ms after the following CAN signal communication status becomes consistent <ul style="list-style-type: none"> • Steering lock relay signal (Request signal) • Steering lock relay signal (Condition signal)

BCM (BODY CONTROL MODULE)

< ECU DIAGNOSIS INFORMATION >

Display contents of CONSULT	Fail-safe	Cancellation
B2607: S/L RELAY	Inhibit engine cranking	500 ms after the following CAN signal communication status becomes consistent <ul style="list-style-type: none"> Steering lock relay signal (Request signal) Steering lock relay signal (Condition signal)
B2608: STARTER RELAY	Inhibit engine cranking	500 ms after the following signal communication status becomes consistent <ul style="list-style-type: none"> Starter motor relay control signal Starter relay status signal (CAN)
B2609: S/L STATUS	<ul style="list-style-type: none"> Inhibit engine cranking Inhibit steering lock 	When the following steering lock conditions agree <ul style="list-style-type: none"> BCM steering lock control status Steering lock condition No. 1 signal status Steering lock condition No. 2 signal status
B260A: IGNITION RELAY	Inhibit engine cranking	500 ms after the following conditions are fulfilled <ul style="list-style-type: none"> IGN relay (IPDM E/R) control signal: OFF (Battery voltage) Ignition ON signal (CAN to IPDM E/R): OFF (Request signal) Ignition ON signal (CAN from IPDM E/R): OFF (Condition signal)
B260F: ENG STATE SIG LOST	Maintains the power supply position attained at the time of DTC detection	When any of the following conditions are fulfilled <ul style="list-style-type: none"> Power position changes to ACC Receives engine status signal (CAN)
B2612: S/L STATUS	<ul style="list-style-type: none"> Inhibit engine cranking Inhibit steering lock 	When any of the following conditions are fulfilled <ul style="list-style-type: none"> Steering lock unit status signal (CAN) is received normally The BCM steering lock control status matches the steering lock status recognized by the steering lock unit status signal (CAN from IPDM E/R)
B2617: STARTER RELAY CIRC	Inhibit engine cranking	1 second after the starter motor relay control inside BCM becomes normal
B2618: BCM	Inhibit engine cranking	1 second after the ignition relay (IPDM E/R) control inside BCM becomes normal
B2619: BCM	Inhibit engine cranking	1 second after the steering lock unit power supply output control inside BCM becomes normal
B261E: VEHICLE TYPE	Inhibit engine cranking	BCM initialization
B26E9: S/L STATUS	<ul style="list-style-type: none"> Inhibit engine cranking Inhibit steering lock 	When BCM transmits the LOCK request signal to steering lock unit, and receives LOCK response signal from steering lock unit, the following conditions are fulfilled <ul style="list-style-type: none"> Steering condition No. 1 signal: LOCK (0 V) Steering condition No. 2 signal: LOCK (Battery voltage)

HIGH FLASHER OPERATION

BCM detects the turn signal lamp circuit status by the current value.
 BCM increases the turn signal lamp blinking speed if the bulb or harness open is detected with the turn signal lamp operating.

NOTE:

The blinking speed is normal while activating the hazard warning lamp.

FAIL-SAFE CONTROL BY RAIN SENSOR MALFUNCTION

- BCM judges the rain sensor serial link error by the rain sensor serial link condition and detects the rain sensor malfunction by rain sensor malfunction signal.
- When BCM detects the rain sensor serial link error or the rain sensor malfunction while front wiper AUTO operation, BCM operates a fail-safe control.

NOTE:

If rain sensor malfunction is detected when ignition switch is turned OFF ⇒ ON and front wiper switch is INT position, BCM operates a fail-safe control.

REAR WIPER MOTOR PROTECTION

BCM detects the rear wiper stopping position according to the rear wiper stop position signal.
 When the rear wiper stop position signal does not change for more than 5 seconds while driving the rear wiper, BCM stops power supply to protect the rear wiper motor.

Condition of cancellation

- More than 1 minute is passed after the rear wiper stops.

BCM (BODY CONTROL MODULE)

< ECU DIAGNOSIS INFORMATION >

2. Turn rear wiper switch OFF.
3. Operate the rear wiper switch or rear washer switch.

DTC Inspection Priority Chart

INFOID:000000003894431

If some DTCs are displayed at the same time, perform inspections one by one based on the following priority chart.

Priority	DTC
1	B2562: LOW VOLTAGE
2	<ul style="list-style-type: none"> • U1000: CAN COMM • U1010: CONTROL UNIT (CAN)
3	<ul style="list-style-type: none"> • B2190: NATS ANTENNA AMP • B2191: DIFFERENCE OF KEY • B2192: ID DISCORD BCM-ECM • B2193: CHAIN OF BCM-ECM • B2195: ANTI SCANNING
4	<ul style="list-style-type: none"> • B2013: ID DISCORD BCM-S/L • B2014: CHAIN OF S/L-BCM • B2553: IGNITION RELAY • B2555: STOP LAMP • B2556: PUSH-BTN IGN SW • B2557: VEHICLE SPEED • B2560: STARTER CONT RELAY • B2601: SHIFT POSITION • B2602: SHIFT POSITION • B2603: SHIFT POSI STATUS • B2604: PNP SW • B2605: PNP SW • B2606: S/L RELAY • B2607: S/L RELAY • B2608: STARTER RELAY • B2609: S/L STATUS • B260A: IGNITION RELAY • B260B: STEERING LOCK UNIT • B260C: STEERING LOCK UNIT • B260D: STEERING LOCK UNIT • B260F: ENG STATE SIG LOST • B2612: S/L STATUS • B2614: ACC RELAY CIRC • B2615: BLOWER RELAY CIRC • B2616: IGN RELAY CIRC • B2617: STARTER RELAY CIRC • B2618: BCM • B2619: BCM • B261A: PUSH-BTN IGN SW • B261E: VEHICLE TYPE • B26E9: S/L STATUS • B26EA: KEY REGISTRATION • U0415: VEHICLE SPEED SIG
5	<ul style="list-style-type: none"> • B2621: INSIDE ANTENNA • B2622: INSIDE ANTENNA • B2623: INSIDE ANTENNA
6	B26E7: TPMS CAN COMM

DTC Index

INFOID:000000003894432

NOTE:

The details of time display are as follows.

- CRNT: A malfunction is detected now.
- PAST: A malfunction was detected in the past.

IGN counter is displayed on Freeze Frame Data. For details of Freeze Frame Data, refer to [RF-7. "COMMON ITEM : CONSULT-III Function \(BCM - COMMON ITEM\)".](#)

BCM (BODY CONTROL MODULE)

< ECU DIAGNOSIS INFORMATION >

CONSULT display	Fail-safe	Freeze Frame Data •Vehicle Speed •Odo/Trip Meter •Vehicle Condition	Intelligent Key warn- ing lamp ON	Reference page
No DTC is detected. Further testing may be required.	—	—	—	—
U1000: CAN COMM	—	—	—	BCS-34
U1010: CONTROL UNIT (CAN)	—	—	—	BCS-35
U0415: VEHICLE SPEED SIG	—	—	—	BCS-36
B2013: ID DISCORD BCM-S/L	×	×	—	SEC-50
B2014: CHAIN OF S/L-BCM	×	×	—	SEC-51
B2190: NATS ANTENNA AMP	×	—	—	SEC-42
B2191: DIFFERENCE OF KEY	×	—	—	SEC-45
B2192: ID DISCORD BCM-ECM	×	—	—	SEC-46
B2193: CHAIN OF BCM-ECM	×	—	—	SEC-48
B2195: ANTI SCANNING	×	—	—	SEC-49
B2553: IGNITION RELAY	—	×	—	PCS-50
B2555: STOP LAMP	—	×	—	SEC-54
B2556: PUSH-BTN IGN SW	—	×	×	SEC-56
B2557: VEHICLE SPEED	×	×	×	SEC-58
B2560: STARTER CONT RELAY	×	×	×	SEC-59
B2562: LOW VOLTAGE	—	×	—	BCS-37
B2601: SHIFT POSITION	×	×	×	SEC-60
B2602: SHIFT POSITION	×	×	×	SEC-63
B2603: SHIFT POSI STATUS	×	×	×	SEC-65
B2604: PNP SW	×	×	×	SEC-68
B2605: PNP SW	×	×	×	SEC-70
B2606: S/L RELAY	×	×	×	SEC-72
B2607: S/L RELAY	×	×	×	SEC-73
B2608: STARTER RELAY	×	×	×	SEC-75
B2609: S/L STATUS	×	×	×	SEC-77
B260A: IGNITION RELAY	×	×	×	PCS-52
B260B: STEERING LOCK UNIT	—	×	×	SEC-81
B260C: STEERING LOCK UNIT	—	×	×	SEC-82
B260D: STEERING LOCK UNIT	—	×	×	SEC-83
B260F: ENG STATE SIG LOST	×	×	×	SEC-84
B2612: S/L STATUS	×	×	×	SEC-88
B2614: ACC RELAY CIRC	—	×	×	PCS-54
B2615: BLOWER RELAY CIRC	—	×	×	PCS-56
B2616: IGN RELAY CIRC	—	×	×	PCS-58
B2617: STARTER RELAY CIRC	×	×	×	SEC-92
B2618: BCM	×	×	×	PCS-60
B2619: BCM	×	×	×	SEC-94
B261A: PUSH-BTN IGN SW	—	×	×	SEC-95
B261E: VEHICLE TYPE	×	×	× (Turn ON for 15 seconds)	SEC-98

A
B
C
D
E
F
G
H
I
J
RF
L
M
N
O
P

BCM (BODY CONTROL MODULE)

< ECU DIAGNOSIS INFORMATION >

CONSULT display	Fail-safe	Freeze Frame Data •Vehicle Speed •Odo/Trip Meter •Vehicle Condition	Intelligent Key warn- ing lamp ON	Reference page
B2621: INSIDE ANTENNA	—	×	—	DLK-61
B2622: INSIDE ANTENNA	—	×	—	DLK-63
B2623: INSIDE ANTENNA	—	×	—	DLK-65
B26E7: TPMS CAN COMM	—	—	—	BCS-38
B26E9: S/L STATUS	×	×	× (Turn ON for 15 seconds)	SEC-86
B26EA: KEY REGISTRATION	—	×	× (Turn ON for 15 seconds)	SEC-87

SUNROOF MOTOR ASSEMBLY

< ECU DIAGNOSIS INFORMATION >

SUNROOF MOTOR ASSEMBLY

Reference Value

INFOID:000000003829266

TERMINAL LAYOUT

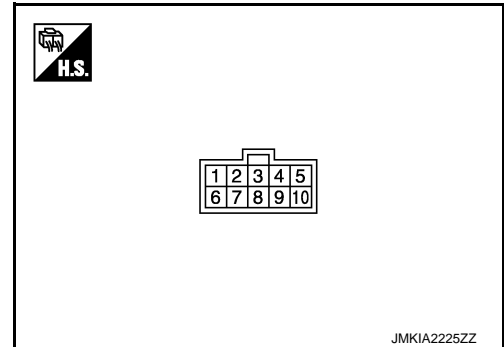

PHYSICAL VALUES

Terminal No. (Wire color)		Description		Condition	Voltage (V) (Approx.)
+	-	Signal name	Input/ Output		
1 (GR)	Ground	Sunroof switch (tilt up/ slide close) signal	Input	Sunroof switch in the following position • TILT UP • SLIDE CLOSE	0
				Other than above	Battery voltage
5 (P)	Ground	Sunroof switch (tilt down/ slide open) signal	Input	Sunroof switch in the following position • TILT DOWN • SLIDE OPEN	0
				Other than the above	Battery voltage
7 (BR)	Ground	Sunroof power supply	Input	—	Battery voltage
8 (L)	Ground	Vehicle speed signal (2- pulse)	Input	Speedometer operated [When vehicle speed is approx.40 km/h (25 MPH)]	
9 (Y)	Ground	RAP signal	Input	Ignition switch ON	Battery voltage
				Within 45 seconds after ignition switch is turned to OFF.	Battery voltage
				When driver side or passenger side door is opened during re- tained power operation.	0
10 (G)	Ground	Ground	—	—	0

SUNROOF MOTOR ASSEMBLY

< ECU DIAGNOSIS INFORMATION >

SUNROOF

Connector No. B1	WIRE TO WIRE TH80FW-CS16-TM4		Terminal No. 78	Color of Wire GR	Signal Name [Specification]	—
Connector No. B201	WIRE TO WIRE TH80FW-CS16-TM4		Terminal No. 60	Color of Wire GR	Signal Name [Specification]	—
Connector No. B16	FRONT DOOR SWITCH (DRIVER SIDE) A03FW		Terminal No. 2	Color of Wire GR	Signal Name [Specification]	—
Connector No. E108	WIRE TO WIRE TH80FW-CS16-TM4		Terminal No. 96	Color of Wire W	Signal Name [Specification]	—
Connector No. B216	FRONT DOOR SWITCH (PASSENGER SIDE) A03FW		Terminal No. 2	Color of Wire GR	Signal Name [Specification]	—
Connector No. M1	FUSE BLOCK (J/B) NS00FW-M2		Terminal No. 7A	Color of Wire R	Signal Name [Specification]	—
Connector No. M7	WIRE TO WIRE TH80MW-CS16-TM4		Terminal No. 78	Color of Wire GR	Signal Name [Specification]	—
Connector No. M6	WIRE TO WIRE TH80MW-CS16-TM4		Terminal No. 96	Color of Wire W	Signal Name [Specification]	—
Connector No. M1	FUSE BLOCK (J/B) NS00FW-M2		Terminal No. 7A	Color of Wire R	Signal Name [Specification]	—
Connector No. M7	WIRE TO WIRE TH80MW-CS16-TM4		Terminal No. 78	Color of Wire GR	Signal Name [Specification]	—

A
B
C
D
E
F
G
H
I
J
RF
L
M
N
O
P

SUNROOF MOTOR ASSEMBLY

< ECU DIAGNOSIS INFORMATION >

SUNROOF

Connector No.	M118
Connector Name	BCM (BODY CONTROL MODULE)
Connector Type	MS3FB-LC



Terminal No.	Color of Wire	Signal Name [Specification]
1	W	BAT (F/L)
2	Y	POWER WINDOW POWER SUPPLY(BAT)

Connector No.	M117
Connector Name	WIRE TO WIRE
Connector Type	TH20MF-CS18-TM4



Terminal No.	Color of Wire	Signal Name [Specification]
60	LG	-

Connector No.	M106
Connector Name	WIRE TO WIRE
Connector Type	TK10MF-NS8



Terminal No.	Color of Wire	Signal Name [Specification]
10	B	-
15	SHIELD	-
16	G	-
17	BR	-
18	Y	-

Connector No.	M66
Connector Name	UNIFIED METER AND A/C AMP.
Connector Type	TH40FV-NH

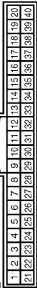

Terminal No.	Color of Wire	Signal Name [Specification]
8	L	VEHICLE SPEED (2-PULSE)

Connector No.	FZ2
Connector Name	WIRE TO WIRE
Connector Type	TH24FV-NH



Terminal No.	Color of Wire	Signal Name [Specification]
1	P	-
2	GR	-
24	B	-

Connector No.	R1
Connector Name	WIRE TO WIRE
Connector Type	TK10FV-NS8



Terminal No.	Color of Wire	Signal Name [Specification]
10	B	-
15	SHIELD	-
16	G	-
17	BR	-
18	Y	-

Connector No.	M123
Connector Name	BCM (BODY CONTROL MODULE)
Connector Type	TH40FG-NH



Terminal No.	Color of Wire	Signal Name [Specification]
124	LG	PASSENGER DOOR SW
150	GR	DRIVER DOOR SW

Connector No.	M119
Connector Name	BCM (BODY CONTROL MODULE)
Connector Type	NS16FV-CS





Terminal No.	Color of Wire	Signal Name [Specification]
11	R	BAT (FUSE)
13	B	GND

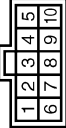

JCKWM1498GB

SUNROOF MOTOR ASSEMBLY

< ECU DIAGNOSIS INFORMATION >

SUNROOF		
Connector No.	R4	R18
Connector Name	SUNROOF MOTOR ASSEMBLY	SUNROOF SWITCH
Connector Type	TEA10PQY	TKG3FW
 		
Terminal No.	Color of Wire	Signal Name [Specification]
1	GR	SW-BIT1
5	P	SW-BIT0
7	BR	-R
8	I	SPEED SENSOR(2P)
9	Y	TIMER(LGN)
10	G	GND

Connector No.	R11	R18
Connector Name	WIRE TO WIRE	SUNROOF SWITCH
Connector Type	THZAMP-NH	TKG3FW
 		
Terminal No.	Color of Wire	Signal Name [Specification]
1	LG	-
2	GR	-
24	O	-

Connector No.	R18	R18
Connector Name	SUNROOF SWITCH	SUNROOF SWITCH
Connector Type	TKG3FW	TKG3FW
 		
Terminal No.	Color of Wire	Signal Name [Specification]
1	LG	-
2	O	-
3	GR	-

A
B
C
D
E
F
G
H
I
J
RF
L
M
N
O
P

JCKWM1499GB

SUNROOF DOES NOT OPERATE PROPERLY

< SYMPTOM DIAGNOSIS >

SYMPTOM DIAGNOSIS

SUNROOF DOES NOT OPERATE PROPERLY

Diagnosis Procedure

INFOID:000000003829268

1. CHECK SUNROOF MECHANISM

Check the following items.

- Operation malfunction caused by sunroof mechanism deformation, pinched harness or other foreign matter.
- Operation malfunction and interference with other parts by poor installation.

Is the inspection result normal?

YES >> GO TO 2.

NO >> Repair or replace the malfunctioning parts.

2. CHECK BCM POWER SUPPLY AND GROUND CIRCUIT

Check BCM power supply and ground circuit.

Refer to [RF-9, "BCM \(BODY CONTROL MODULE\) : Diagnosis Procedure"](#).

Is the inspection result normal?

YES >> GO TO 3.

NO >> Repair or replace the malfunctioning parts.

3. CHECK SUNROOF MOTOR ASSEMBLY POWER SUPPLY AND GROUND CIRCUIT

Check sunroof motor assembly power supply and ground circuit.

Refer to [RF-9, "SUNROOF MOTOR ASSEMBLY : Diagnosis Procedure"](#).

Is the inspection result normal?

YES >> GO TO 4.

NO >> Repair or replace the malfunctioning parts.

4. CHECK SUNROOF SWITCH

Check sunroof switch.

Refer to [RF-11, "Component Function Check"](#).

Is the inspection result normal?

YES >> GO TO 5.

NO >> Replace sunroof switch. Refer to [RF-80, "Removal and Installation"](#).

5. CONFIRM THE OPERATION

Confirm the operation again.

Is the result normal?

YES >> Check intermittent incident. Refer to [GI-35, "Intermittent Incident"](#).

NO >> GO TO 1.

AUTO OPERATION DOES NOT OPERATE

< SYMPTOM DIAGNOSIS >

AUTO OPERATION DOES NOT OPERATE

Diagnosis Procedure

INFOID:000000003829269

1. PERFORM INITIALIZATION PROCEDURE

Perform initialization procedure.

Refer to [RF-4, "ADDITIONAL SERVICE WHEN REPLACING CONTROL UNIT : Special Repair Requirement"](#).

Is the inspection result normal?

- YES >> Sunroof system is normal.
- NO >> Replace sunroof motor assembly.

A
B
C
D
E
F
G
H
I
J
RF
L
M
N
O
P

RETAINED POWER OPERATION DOES NOT OPERATE PROPERLY

< SYMPTOM DIAGNOSIS >

RETAINED POWER OPERATION DOES NOT OPERATE PROPERLY

Diagnosis Procedure

INFOID:000000003829271

1. CHECK DOOR SWITCH

Check door switch.

Refer to [RF-13, "Component Function Check"](#).

Is the inspection result normal?

YES >> GO TO 2.

NO >> Replace the malfunctioning door switch.

2. CONFIRM THE OPERATION

Confirm the operation again.

Is the result normal?

YES >> Check intermittent incident. Refer to [GI-35, "Intermittent Incident"](#).

NO >> GO TO 1.

ANTI-PINCH FUNCTION DOES NOT OPERATE

< SYMPTOM DIAGNOSIS >

ANTI-PINCH FUNCTION DOES NOT OPERATE

Diagnosis Procedure

INFOID:000000003829272

1.CHECK SUNROOF MECHANISM

Check the following items.

- Operation malfunction caused by sunroof mechanism deformation, pinched harness or other foreign materials.
- Operation malfunction and interference with other parts by poor installation.

Is the inspection result normal?

YES >> GO TO 2.

NO >> Repair or replace the malfunctioning parts.

2.PERFORM INITIALIZATION PROCEDURE

Perform initialization procedure.

Refer to [RF-4, "ADDITIONAL SERVICE WHEN REPLACING CONTROL UNIT : Special Repair Requirement"](#).

Is the inspection result normal?

YES >> Sunroof system is normal.

NO >> Replace sunroof motor assembly.

A
B
C
D
E
F
G
H
I
J
RF
L
M
N
O
P

SQUEAK AND RATTLE TROUBLE DIAGNOSES

< SYMPTOM DIAGNOSIS >

SQUEAK AND RATTLE TROUBLE DIAGNOSES

Work Flow

INFOID:000000004063229

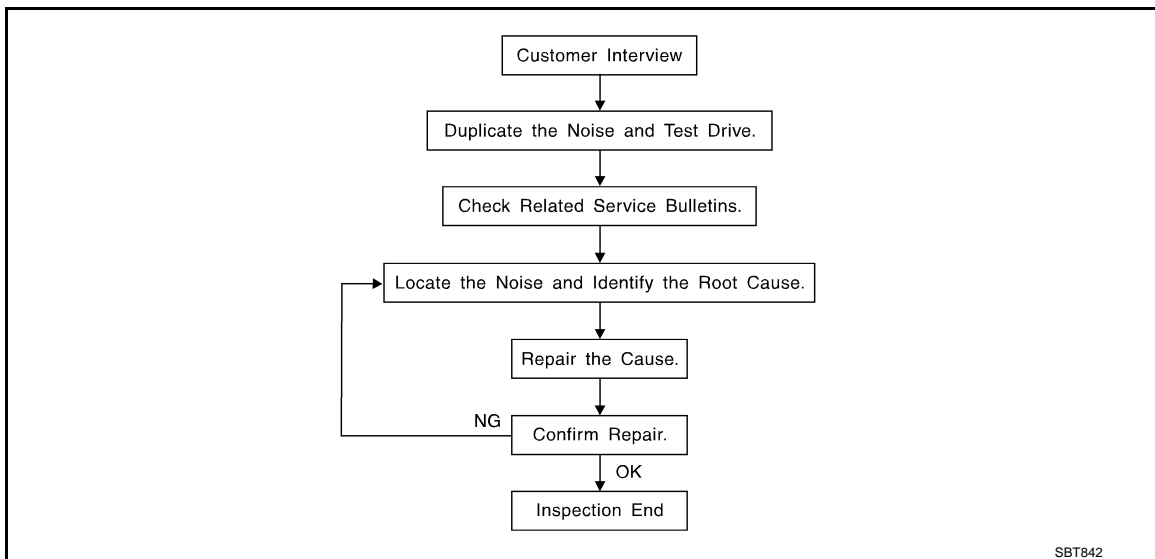

CUSTOMER INTERVIEW

Interview the customer if possible, to determine the conditions that exist when the noise occurs. Use the Diagnostic Worksheet during the interview to document the facts and conditions when the noise occurs and any of customer's comments; refer to [RF-64, "Diagnostic Worksheet"](#). This information is necessary to duplicate the conditions that exist when the noise occurs.

- The customer may not be able to provide a detailed description or the location of the noise. Attempt to obtain all the facts and conditions that exist when the noise occurs (or does not occur).
- If there is more than one noise in the vehicle, perform a diagnosis and repair the noise that the customer is concerned about. This can be accomplished by performing a cruise test on the vehicle with the customer.
- After identifying the type of noise, isolate the noise in terms of its characteristics. The noise characteristics are provided so the customer, service adviser and technician are all speaking the same language when defining the noise.
- Squeak – (Like tennis shoes on a clean floor)
Squeak characteristics include the light contact/fast movement/brought on by road conditions/hard surfaces = higher pitch noise/softer surfaces = lower pitch noises/edge to surface = chirping
- Creak – (Like walking on an old wooden floor)
Creak characteristics include firm contact/slow movement/twisting with a rotational movement/pitch dependent on materials/often brought on by activity.
- Rattle – (Like shaking a baby rattle)
Rattle characteristics include the fast repeated contact/vibration or similar movement/loose parts/missing clip or fastener/incorrect clearance.
- Knock – (Like a knock on a door)
Knock characteristics include hollow sounding/sometimes repeating/often brought on by driver action.
- Tick – (Like a clock second hand)
Tick characteristics include gentle contacting of light materials/loose components/can be caused by driver action or road conditions.
- Thump – (Heavy, muffled knock noise)
Thump characteristics include softer knock/dead sound often brought on by activity.
- Buzz – (Like a bumblebee)
Buzz characteristics include high frequency rattle/firm contact.
- Often the degree of acceptable noise level will vary depending up on the person. A noise that a technician may judge as acceptable may be very irritating to the customer.
- Weather conditions, especially humidity and temperature, may have a great effect on noise level.

DUPLICATE THE NOISE AND TEST DRIVE

If possible, drive the vehicle with the customer until the noise is duplicated. Note any additional information on the Diagnostic Worksheet regarding the conditions or location of the noise. This information can be used to duplicate the same conditions when the repair is reconfirmed.

SQUEAK AND RATTLE TROUBLE DIAGNOSES

< SYMPTOM DIAGNOSIS >

If the noise can be duplicated easily during the test drive, to help identify the source of the noise, try to duplicate the noise with the vehicle stopped by doing one or all of the following:

- 1) Close a door.
 - 2) Tap or push/pull around the area where the noise appears to be coming from.
 - 3) Rev the engine.
 - 4) Use a floor jack to recreate vehicle "twist".
 - 5) At idle, apply engine load (electrical load, half-clutch on M/T models, drive position on A/T models).
 - 6) Raise the vehicle on a hoist and hit a tire with a rubber hammer.
- Drive the vehicle and attempt to duplicate the conditions the customer states exist when the noise occurs.
 - If it is difficult to duplicate the noise, drive the vehicle slowly on an undulating or rough road to stress the vehicle body.

CHECK RELATED SERVICE BULLETINS

After verifying the customer concern or symptom, check ASIST for Technical Service Bulletins (TSBs) related to that concern or symptom.

If a TSB relates to the symptom, follow the procedure to repair the noise.

LOCATE THE NOISE AND IDENTIFY THE ROOT CAUSE

1. Narrow down the noise to a general area. To help pinpoint the source of the noise, use a listening tool (Chassis ear: J-39570, Engine ear and mechanics stethoscope).
2. Narrow down the noise to a more specific area and identify the cause of the noise by:
 - Removing the components in the area that is are suspected to be the cause of the noise.
Do not use too much force when removing clips and fasteners, otherwise clips and fastener can be broken or lost during the repair, resulting in the creation of new noise.
 - Tapping or pushing/pulling the component that is are suspected to be the cause of the noise.
Do not tap or push/pull the component with excessive force, otherwise the noise will be eliminated only temporarily.
 - Feeling for a vibration by hand by touching the component(s) that is are suspected to be the cause of the noise.
 - Placing a piece of paper between components that are suspected to be the cause of the noise.
 - Looking for loose components and contact marks.
Refer to [RF-62, "Inspection Procedure"](#).

REPAIR THE CAUSE

- If the cause is a loose component, tighten the component securely.
- If the cause is insufficient clearance between components:
 - Separate components by repositioning or loosening and retightening the component, if possible.
 - Insulate components with a suitable insulator such as urethane pads, foam blocks, felt cloth tape or urethane tape. A Nissan Squeak and Rattle Kit (J-43980) is available through the authorized Nissan Parts Department.

CAUTION:

Never use excessive force as many components are constructed of plastic and may be damaged.

NOTE:

Always check with the Parts Department for the latest parts information.

The following materials are contained in the Nissan Squeak and Rattle Kit (J-43980). Each item can be ordered separately as needed.

URETHANE PADS [1.5 mm (0.059 in) thick]

Insulates connectors, harness, etc.

76268-9E005: 100 × 135 mm (3.94 × 5.31 in)/76884-71L01: 60 × 85 mm (2.36 × 3.35 in)/76884-71L02: 15 × 25 mm (0.59 × 0.98 in)

INSULATOR (Foam blocks)

Insulates components from contact. Can be used to fill space behind a panel.

73982-9E000: 45 mm (1.77 in) thick, 50 × 50 mm (1.97 × 1.97 in)/73982-

50Y00: 10 mm (0.39 in) thick, 50 × 50 mm (1.97 × 1.97 in)

INSULATOR (Light foam block)

80845-71L00: 30 mm (1.18 in) thick, 30 × 50 mm (1.18 × 1.97in)

FELT CLOTHTAPE

Used to insulate where movement does not occur. Ideal for instrument panel applications.

68370-4B000: 15 × 25 mm (0.59 × 0.98 in) pad/68239-13E00: 5 mm (0.20 in) wide tape roll

The following materials, not found in the kit, can also be used to repair squeaks and rattles.

UHMW (TEFLON) TAPE

SQUEAK AND RATTLE TROUBLE DIAGNOSES

< SYMPTOM DIAGNOSIS >

Insulates where slight movement is present. Ideal for instrument panel applications.

SILICONE GREASE

Used in place of UHMW tape that is be visible or does not fit. Will only last a few months.

SILICONE SPRAY

Used when grease cannot be applied.

DUCT TAPE

Used to eliminate movement.

CONFIRM THE REPAIR

Confirm that the cause of a noise is repaired by test driving the vehicle. Operate the vehicle under the same conditions as when the noise originally occurred. Refer to the notes on the Diagnostic Worksheet.

Inspection Procedure

INFOID:000000004063230

Refer to Table of Contents for specific component removal and installation information.

INSTRUMENT PANEL

Most incidents are caused by contact and movement between:

1. The cluster lid A and instrument panel
2. Acrylic lens and combination meter housing
3. Instrument panel to front pillar garnish
4. Instrument panel to windshield
5. Instrument panel mounting pins
6. Wiring harnesses behind the combination meter
7. A/C defroster duct and duct joint

These incidents can usually be located by tapping or moving the components to duplicate the noise or by pressing on the components while driving to stop the noise. Most of these incidents can be repaired by applying felt cloth tape or silicon spray (in hard to reach areas). Urethane pads can be used to insulate wiring harness.

CAUTION:

Never use silicone spray to isolate a squeak or rattle. If the area is saturated with silicone, the recheck of repair becomes impossible.

CENTER CONSOLE

Components to pay attention to include:

1. Shifter assembly cover to finisher
2. A/C control unit and cluster lid C
3. Wiring harnesses behind audio and A/C control unit

The instrument panel repair and isolation procedures also apply to the center console.

DOORS

Pay attention to the following:

1. Finisher and inner panel making a slapping noise
2. Inside handle escutcheon to door finisher
3. Wiring harnesses tapping
4. Door striker out of alignment causing a popping noise on starts and stops

Tapping or moving the components or pressing on them while driving to duplicate the conditions can isolate many of these incidents. The areas can usually be insulated with felt cloth tape or insulator foam blocks from the Nissan Squeak and Rattle Kit (J-43980) to repair the noise.

TRUNK

Trunk noises are often caused by a loose jack or loose items put into the trunk by the customer.

In addition look for the following:

1. Trunk lid dumpers out of adjustment
2. Trunk lid striker out of adjustment
3. The trunk lid torsion bars knocking together
4. A loose license plate or bracket

SQUEAK AND RATTLE TROUBLE DIAGNOSES

< SYMPTOM DIAGNOSIS >

Most of these incidents can be repaired by adjusting, securing or insulating the item(s) or component(s) causing the noise.

SUNROOF/HEADLINING

Noises in the sunroof/headlining area can often be traced to one of the following:

1. Sunroof lid, rail, linkage or seals making a rattle or light knocking noise
2. Sunvisor shaft shaking in the holder
3. Front or rear windshield touching headlining and squeaking

Again, pressing on the components to stop the noise while duplicating the conditions can isolate most of these incidents. Repairs usually consist of insulating with felt cloth tape.

SEATS

When isolating seat noise it's important to note the position the seats in and the load placed on the seat when the noise occurs. These conditions should be duplicated when verifying and isolating the cause of the noise.

Cause of seat noise include:

1. Headrest rods and holder
2. A squeak between the seat pad cushion and frame
3. The rear seatback lock and bracket

These noises can be isolated by moving or pressing on the suspected components while duplicating the conditions under which the noise occurs. Most of these incidents can be repaired by repositioning the component or applying urethane tape to the contact area.

UNDERHOOD

Some interior noise may be caused by components under the hood or on the engine wall. The noise is then transmitted into the passenger compartment.

Causes of transmitted underhood noise include:

1. Any component mounted to the engine wall
2. Components that pass through the engine wall
3. Engine wall mounts and connectors
4. Loose radiator mounting pins
5. Hood bumpers out of adjustment
6. Hood striker out of adjustment

These noises can be difficult to isolate since they cannot be reached from the interior of the vehicle. The best method is to secure, move or insulate one component at a time and test drive the vehicle. Also, engine RPM or load can be changed to isolate the noise. Repairs can usually be made by moving, adjusting, securing, or insulating the component causing the noise.

A
B
C
D
E
F
G
H
I
J
RF
L
M
N
O
P

SQUEAK AND RATTLE TROUBLE DIAGNOSES

< SYMPTOM DIAGNOSIS >

Diagnostic Worksheet

INFOID:000000003829275



SQUEAK & RATTLE DIAGNOSTIC WORKSHEET

Dear Infiniti Customer:

We are concerned about your satisfaction with your Infiniti vehicle. Repairing a squeak or rattle sometimes can be very difficult. To help us fix your Infiniti right the first time, please take a moment to note the area of the vehicle where the squeak or rattle occurs and under what conditions. You may be asked to take a test drive with a service consultant or technician to ensure we confirm the noise you are hearing.

I. WHERE DOES THE NOISE COME FROM? (circle the area of the vehicle)

The illustrations are for reference only, and may not reflect the actual configuration of your vehicle.

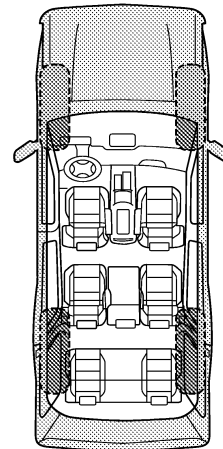
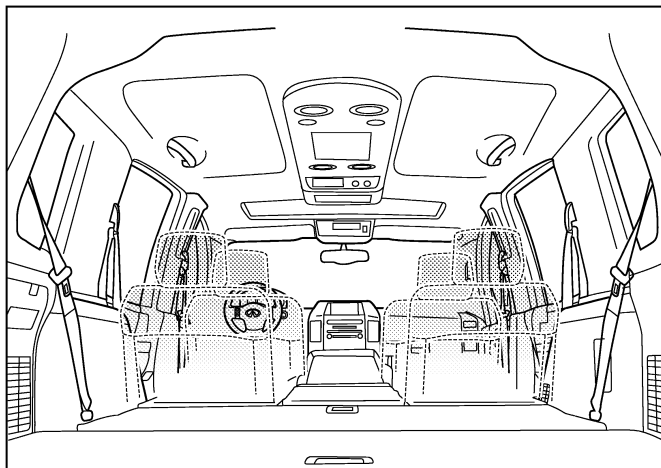
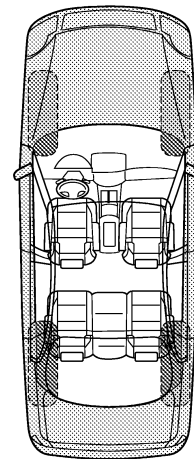
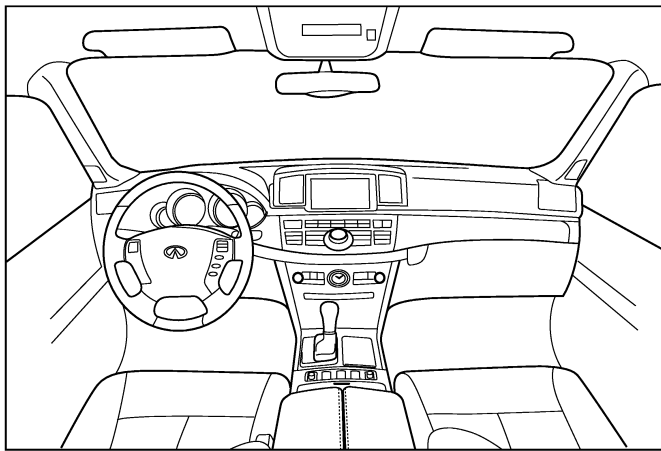

Continue to page 2 of the worksheet and briefly describe the location of the noise or rattle. In addition, please indicate the conditions which are present when the noise occurs.

PIIB8741E

SQUEAK AND RATTLE TROUBLE DIAGNOSES

< SYMPTOM DIAGNOSIS >

SQUEAK & RATTLE DIAGNOSTIC WORKSHEET - page 2

Briefly describe the location where the noise occurs:

II. WHEN DOES IT OCCUR? (please check the boxes that apply)

- | | |
|---|--|
| <input type="checkbox"/> anytime | <input type="checkbox"/> after sitting out in the rain |
| <input type="checkbox"/> 1st time in the morning | <input type="checkbox"/> when it is raining or wet |
| <input type="checkbox"/> only when it is cold outside | <input type="checkbox"/> dry or dusty conditions |
| <input type="checkbox"/> only when it is hot outside | <input type="checkbox"/> other: |

III. WHEN DRIVING:

- through driveways
- over rough roads
- over speed bumps
- only about ____ mph
- on acceleration
- coming to a stop
- on turns: left, right or either (circle)
- with passengers or cargo
- other: _____
- after driving ____ miles or ____ minutes

IV. WHAT TYPE OF NOISE

- squeak (like tennis shoes on a clean floor)
- creak (like walking on an old wooden floor)
- rattle (like shaking a baby rattle)
- knock (like a knock at the door)
- tick (like a clock second hand)
- thump (heavy, muffled knock noise)
- buzz (like a bumble bee)

TO BE COMPLETED BY DEALERSHIP PERSONNEL

Test Drive Notes:

	YES	NO	Initials of person performing
Vehicle test driven with customer	<input type="checkbox"/>	<input type="checkbox"/>	_____
- Noise verified on test drive	<input type="checkbox"/>	<input type="checkbox"/>	_____
- Noise source located and repaired	<input type="checkbox"/>	<input type="checkbox"/>	_____
- Follow up test drive performed to confirm repair	<input type="checkbox"/>	<input type="checkbox"/>	_____

VIN: _____ Customer Name: _____
W.O.# _____ Date: _____

This form must be attached to Work Order

PIIB8742E

A
B
C
D
E
F
G
H
I
J
RF
L
M
N
O
P

PRECAUTIONS

< PRECAUTION >

PRECAUTION

PRECAUTIONS

Precaution for Supplemental Restraint System (SRS) "AIR BAG" and "SEAT BELT PRE-TENSIONER"

INFOID:000000004167325

The Supplemental Restraint System such as "AIR BAG" and "SEAT BELT PRE-TENSIONER", used along with a front seat belt, helps to reduce the risk or severity of injury to the driver and front passenger for certain types of collision. This system includes seat belt switch inputs and dual stage front air bag modules. The SRS system uses the seat belt switches to determine the front air bag deployment, and may only deploy one front air bag, depending on the severity of a collision and whether the front occupants are belted or unbelted. Information necessary to service the system safely is included in the "SRS AIR BAG" and "SEAT BELT" of this Service Manual.

WARNING:

- To avoid rendering the SRS inoperative, which could increase the risk of personal injury or death in the event of a collision which would result in air bag inflation, all maintenance must be performed by an authorized NISSAN/INFINITI dealer.
- Improper maintenance, including incorrect removal and installation of the SRS, can lead to personal injury caused by unintentional activation of the system. For removal of Spiral Cable and Air Bag Module, see the "SRS AIR BAG".
- Do not use electrical test equipment on any circuit related to the SRS unless instructed to in this Service Manual. SRS wiring harnesses can be identified by yellow and/or orange harnesses or harness connectors.

PRECAUTIONS WHEN USING POWER TOOLS (AIR OR ELECTRIC) AND HAMMERS

WARNING:

- When working near the Air Bag Diagnosis Sensor Unit or other Air Bag System sensors with the ignition ON or engine running, DO NOT use air or electric power tools or strike near the sensor(s) with a hammer. Heavy vibration could activate the sensor(s) and deploy the air bag(s), possibly causing serious injury.
- When using air or electric power tools or hammers, always switch the ignition OFF, disconnect the battery, and wait at least 3 minutes before performing any service.

Precaution Necessary for Steering Wheel Rotation after Battery Disconnect

INFOID:000000003829277

NOTE:

- Before removing and installing any control units, first turn the push-button ignition switch to the LOCK position, then disconnect both battery cables.
- After finishing work, confirm that all control unit connectors are connected properly, then re-connect both battery cables.
- Always use CONSULT-III to perform self-diagnosis as a part of each function inspection after finishing work. If a DTC is detected, perform trouble diagnosis according to self-diagnosis results.

This vehicle is equipped with a push-button ignition switch and a steering lock unit.

If the battery is disconnected or discharged, the steering wheel will lock and cannot be turned.

If turning the steering wheel is required with the battery disconnected or discharged, follow the procedure below before starting the repair operation.

OPERATION PROCEDURE

1. Connect both battery cables.

NOTE:

Supply power using jumper cables if battery is discharged.

2. Turn the push-button ignition switch to ACC position.
(At this time, the steering lock will be released.)
3. Disconnect both battery cables. The steering lock will remain released with both battery cables disconnected and the steering wheel can be turned.
4. Perform the necessary repair operation.

PRECAUTIONS

< PRECAUTION >

5. When the repair work is completed, re-connect both battery cables. With the brake pedal released, turn the push-button ignition switch from ACC position to ON position, then to LOCK position. (The steering wheel will lock when the push-button ignition switch is turned to LOCK position.)
6. Perform self-diagnosis check of all control units using CONSULT-III.

A

B

C

D

E

F

G

H

I

J

RF

L

M

N

O

P

PREPARATION

< PREPARATION >

PREPARATION

PREPARATION

Special Service Tool

INFOID:000000003829278

The actual shapes of Kent-Moore tools may differ from those of special service tools illustrated here.

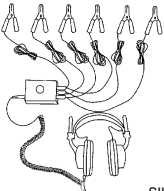
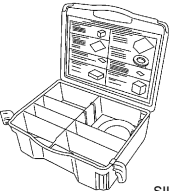
Tool number (Kent-Moore No.) Tool name	Description
<p>(J39570) Chassis ear</p>  <p style="text-align: right;">SIIA0993E</p>	<p>Locates the noise</p>
<p>(J43980) NISSAN Squeak and Rattle Kit</p>  <p style="text-align: right;">SIIA0994E</p>	<p>Repairs the cause of noise</p>

Commercial Service Tool

INFOID:000000003829279

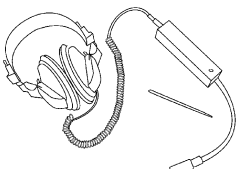
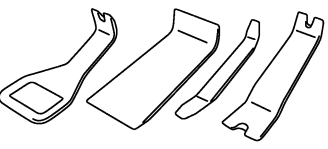
Tool name	Description
<p>Engine ear</p>  <p style="text-align: right;">SIIA0995E</p>	<p>Locates the noise</p>
<p>Remover tool</p>  <p style="text-align: right;">PIIB7923J</p>	<p>Removes clips, pawls and metal clips</p>

GLASS LID

< REMOVAL AND INSTALLATION >

REMOVAL AND INSTALLATION

GLASS LID

Exploded View

INFOID:000000003829280

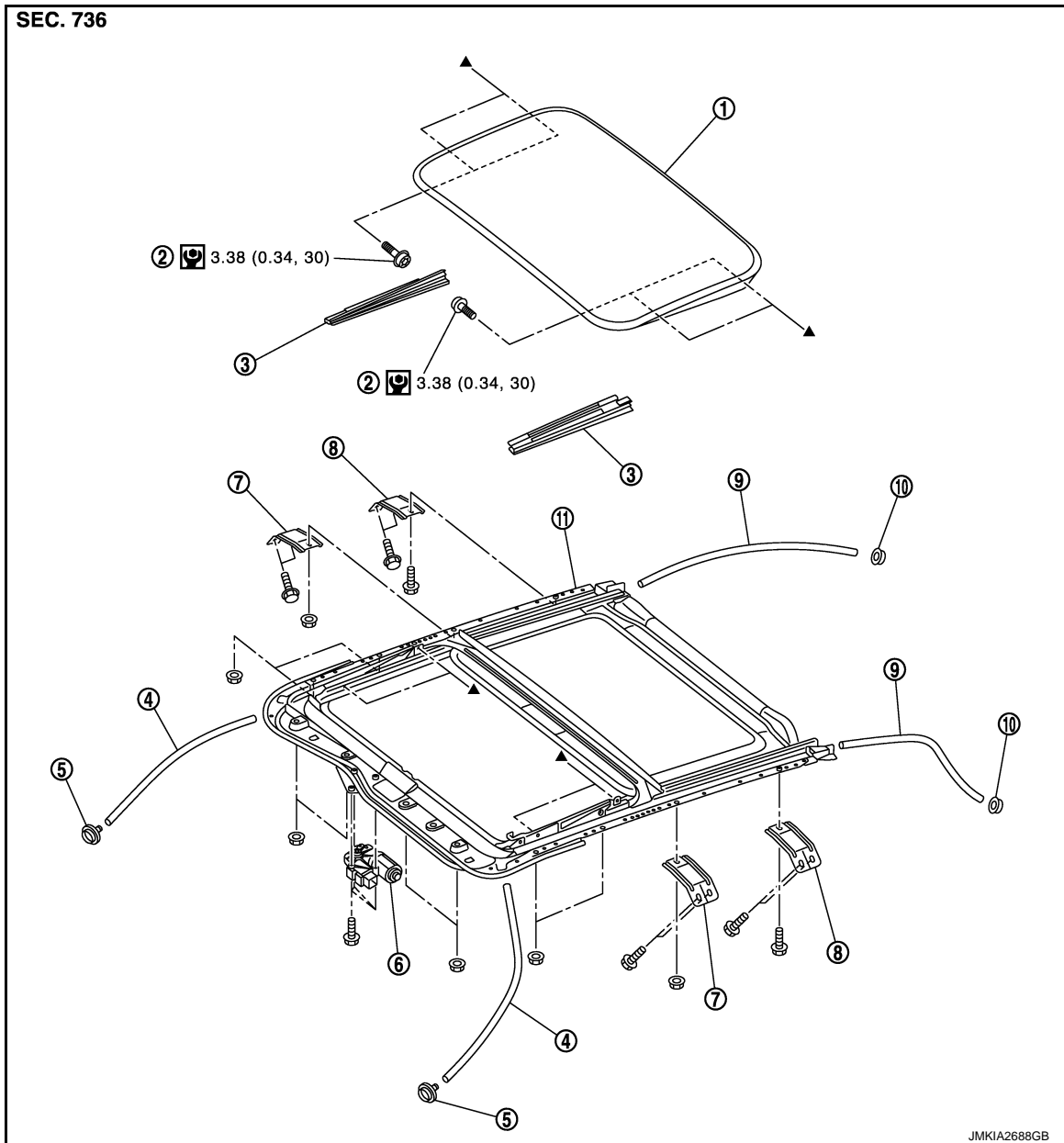

- | | | |
|----------------------------------|---------------------------------|---------------------------|
| 1. Glass lid | 2. TORX bolt | 3. Inner blind (LH/RH) |
| 4. Drain hose (front) | 5. Drain connector (front) | 6. Sunroof motor assembly |
| 7. Sunroof front bracket (LH/RH) | 8. Sunroof rear bracket (LH/RH) | 9. Drain hose (rear) |
| 10. Drain connector (rear) | 11. Sunroof unit assembly | |

Refer to [GI-4, "Components"](#) for symbols in the figure.

Removal and Installation

INFOID:000000003829281

REMOVAL

CAUTION:

Always work with 2 workers.

A
B
C
D
E
F
G
H
I
J
RF
L
M
N
O
P

GLASS LID

< REMOVAL AND INSTALLATION >

1. Remove the inner blind.
2. Remove the TORX bolts (A).

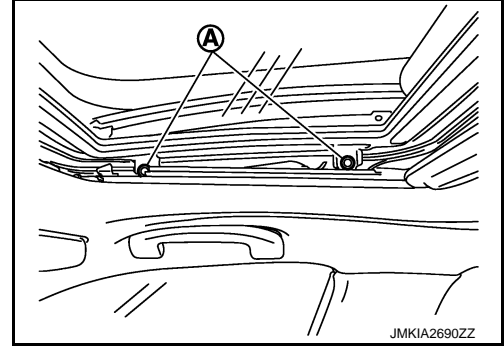

3. Remove the glass lid from the vehicle.

INSTALLATION

CAUTION:

After installing the glass lid, perform the leak test and check that there is no malfunction.

NOTE:

After installation perform fitting adjustment. Refer to [RF-70, "Adjustment"](#).
Install in the reverse order of removal.

Adjustment

INFOID:000000003829282

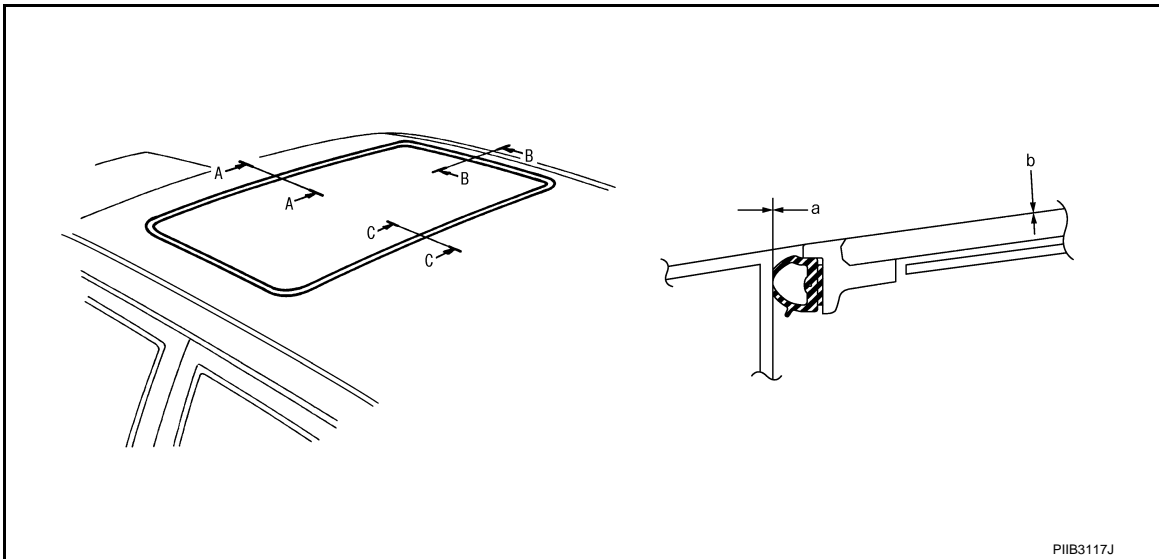

PIIB3117J

LID WEATHER-STRIP OVERLAP ADJUSTMENT AND SURFACE MISMATCH ADJUSTMENT

1. Tilt up glass lid, and then remove Inner blind (left and right).
2. After loosening glass lid from TORX bolts (left and right), tilt down glass lid.
3. Adjust glass lid from outside of vehicle so it resembles "A – A" "B – B" "C – C" as shown in the figure.

Portion		a (Wether-strip overlap)	b (Surface height)
Glass lid front end	A – A	0.6 – 2.2 mm (0.024 – 0.087 in)	–0.7 – 2.3 mm (–0.028 – 0.091 in)
Glass lid side end	B – B	0.6 – 2.2 mm (0.024 – 0.087 in)	–0.7 – 2.3 mm (–0.028 – 0.091 in)
Glass lid rear end	C – C	0.6 – 2.2 mm (0.024 – 0.087 in)	–0.7 – 2.3 mm (–0.028 – 0.091 in)

4. To prevent glass lid from moving after adjustment, first tighten the TORX bolts of front left, and then tighten the TORX bolts of rear right.
5. Tighten remaining TORX bolts, being careful to prevent glass lid from moving.
6. Tilt glass lid up and down several times to check that it moves smoothly.

NOTE:

GLASS LID

< REMOVAL AND INSTALLATION >

After adjusting the sunroof unit assembly, perform additional service. Refer to [RF-4. "ADDITIONAL SERVICE WHEN REPLACING CONTROL UNIT : Special Repair Requirement"](#).

- A
- B
- C
- D
- E
- F
- G
- H
- I
- J
- RF**
- L
- M
- N
- O
- P

SUNROOF MOTOR ASSEMBLY

< REMOVAL AND INSTALLATION >

SUNROOF MOTOR ASSEMBLY

Exploded View

INFOID:000000003952787

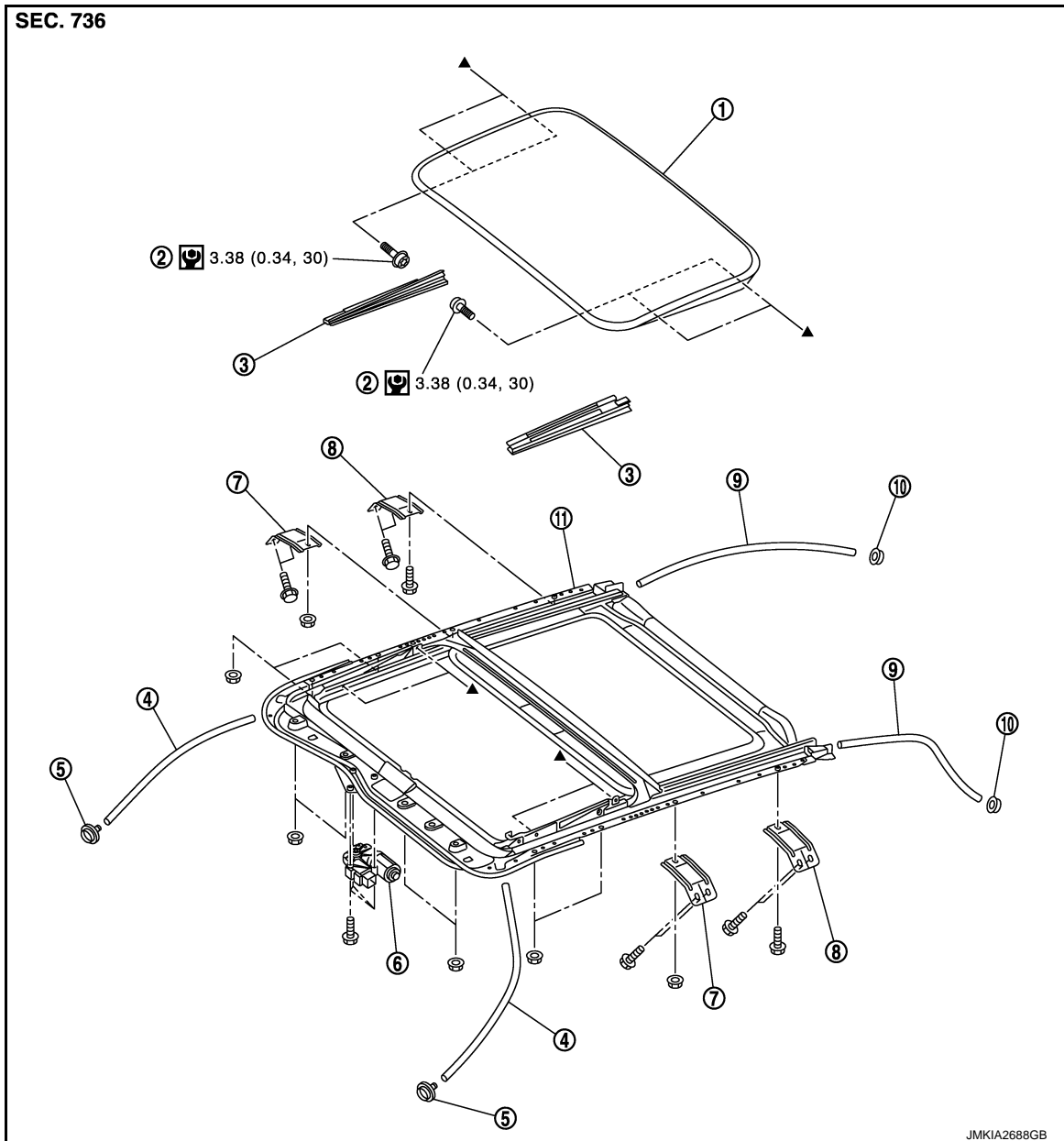

- | | | |
|----------------------------------|---------------------------------|---------------------------|
| 1. Glass lid | 2. TORX bolt | 3. Inner blind (LH/RH) |
| 4. Drain hose (front) | 5. Drain connector (front) | 6. Sunroof motor assembly |
| 7. Sunroof front bracket (LH/RH) | 8. Sunroof rear bracket (LH/RH) | 9. Drain hose (rear) |
| 10. Drain connector (rear) | 11. Sunroof unit assembly | |

Refer to [GI-4, "Components"](#) for symbols in the figure.

Removal and Installation

INFOID:000000003829284

REMOVAL

CAUTION:

- Before removing sunroof motor, check that glass lid is fully closed.
- After removing sunroof motor, never attempt to rotate sunroof motor assembly as a single unit.

1. Remove the map lamp assembly. Refer to [INL-169, "Removal and Installation"](#).

SUNROOF MOTOR ASSEMBLY

< REMOVAL AND INSTALLATION >

2. Remove the sunroof motor assembly.
 - Disconnect connector (A) from sunroof motor assembly (1).
 - Remove sunroof motor assembly mounting screws (B), and then remove sunroof motor assembly.

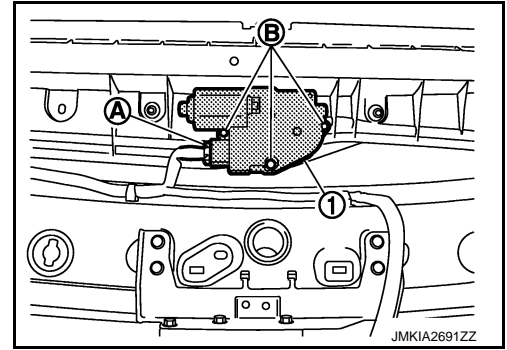

INSTALLATION

CAUTION:

Before installing the sunroof motor assembly, always place the link and wire assembly in the symmetrical and fully closed position.

1. Move the sunroof motor assembly laterally a little so that the gear is completely engaged into the wire on the sunroof unit assembly and mounting surface becomes parallel. Then tighten the sunroof motor assembly with screws.
2. Install the map lamp assembly. Refer to [INL-169. "Removal and Installation"](#).

A
B
C
D
E
F
G
H
I
J
RF
L
M
N
O
P

SUNROOF UNIT ASSEMBLY

< REMOVAL AND INSTALLATION >

SUNROOF UNIT ASSEMBLY

Exploded View

INFOID:000000003829285

REMOVAL

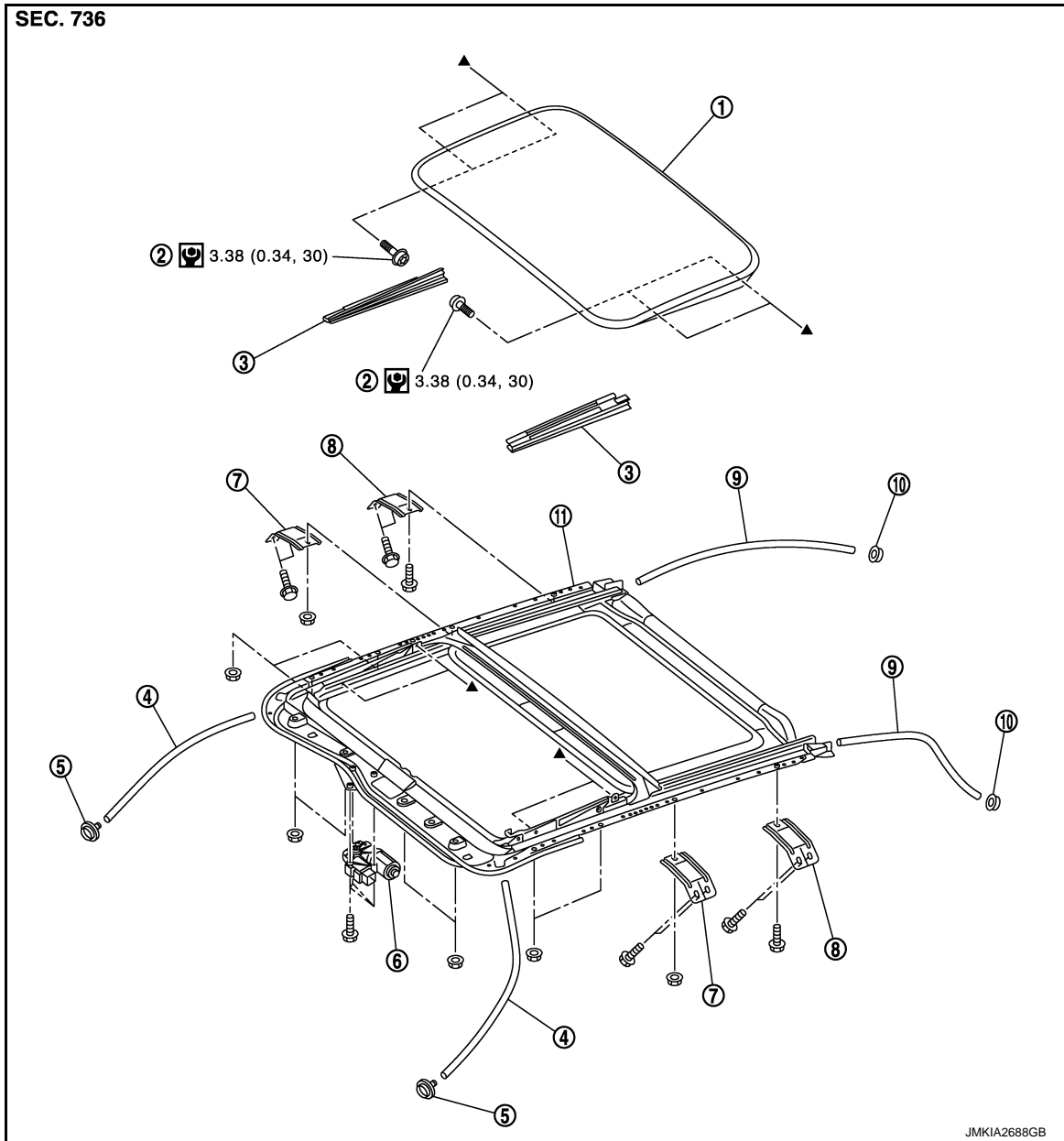

- | | | |
|----------------------------------|---------------------------------|---------------------------|
| 1. Glass lid | 2. TORX bolt | 3. Inner blind (LH/RH) |
| 4. Drain hose (front) | 5. Drain connector (front) | 6. Sunroof motor assembly |
| 7. Sunroof front bracket (LH/RH) | 8. Sunroof rear bracket (LH/RH) | 9. Drain hose (rear) |
| 10. Drain connector (rear) | 11. Sunroof unit assembly | |

Refer to [GI-4, "Components"](#) for symbols in the figure.

DISASSEMBLY

SUNROOF UNIT ASSEMBLY

< REMOVAL AND INSTALLATION >

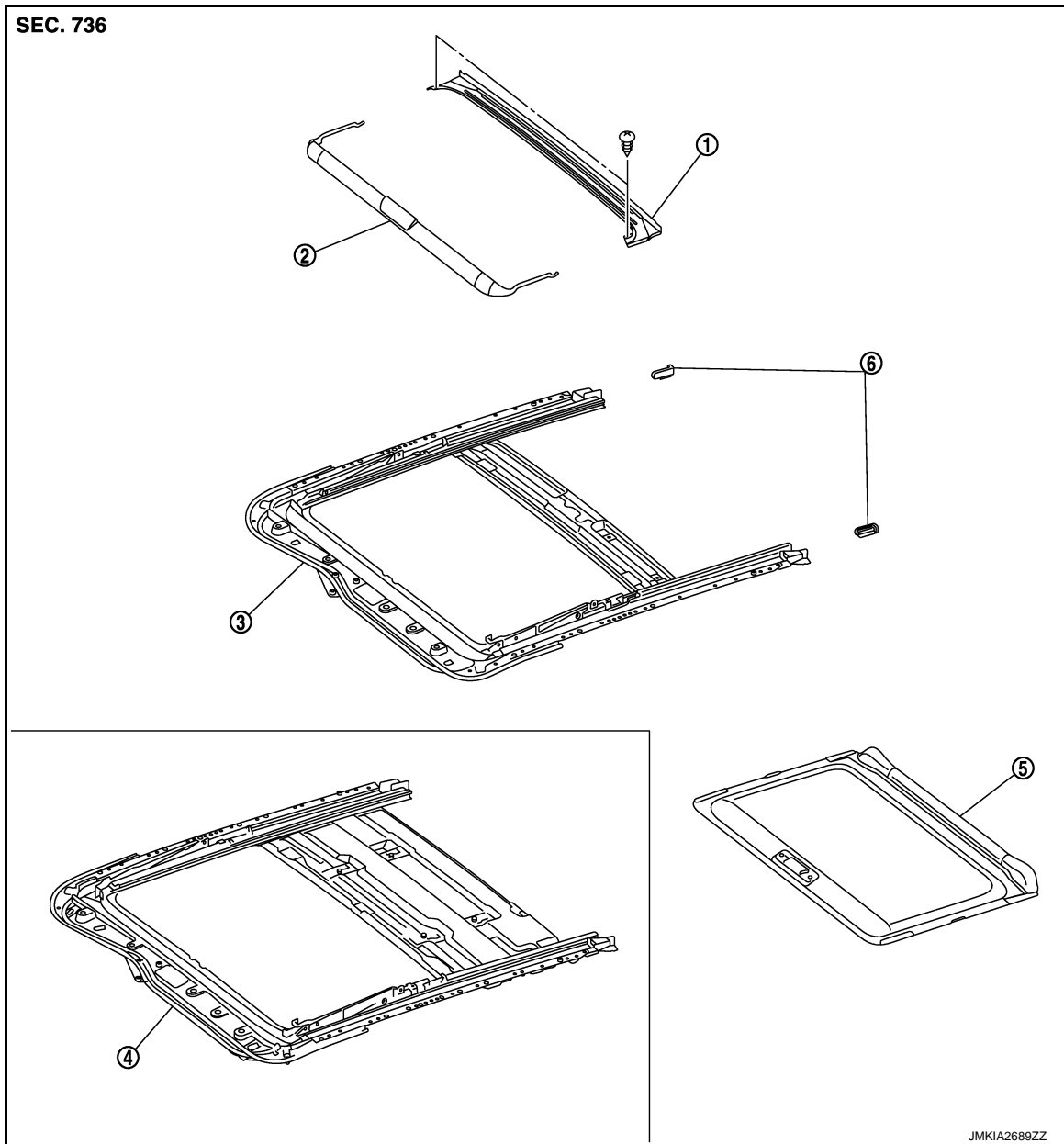

- | | | |
|--|-------------------|-----------------------------|
| 1. Rear drain | 2. Wind deflector | 3. Sunroof frame |
| 4. Sunroof frame (with rear display model) | 5. Sunshade | 6. Sunshade stopper (LH/RH) |

Removal and Installation

INFOID:000000003829286

REMOVAL

CAUTION:

- Always work with 2 workers.
- Fully close the glass lid, before removal, then never operate sunroof motor assembly after removal.
- When taking sunroof unit assembly out, use shop cloths to protect the seats and trim from damage.

1. Remove the headlining. Refer to [INT-24, "Removal and Installation"](#).
2. Remove the glass lid. Refer to [RF-69, "Removal and Installation"](#).
3. Remove the sunroof motor assembly. Refer to [RF-72, "Removal and Installation"](#).
4. Disconnect drain hoses.
5. Remove the rear display. Refer to [AV-1047, "Removal and Installation"](#). (With rear display model only)
6. Remove the side curtain air bag mounting bolt. Refer to [SR-13, "Removal and Installation"](#).

SUNROOF UNIT ASSEMBLY

< REMOVAL AND INSTALLATION >

7. Remove the sunroof front brackets (LH/RH).
8. Remove the sunroof rear brackets (LH/RH).
9. Remove nuts from the front end and side rail, and then remove sunroof unit assembly from roof panel.
10. Remove sunroof unit assembly through the back door while being careful not to damage the seats and trim.

INSTALLATION

CAUTION:

After installing the sunroof unit assembly and glass lid, perform the leak test and check that there is no malfunction.

1. Temporarily tighten the mounting bolts to the sunroof rear brackets (LH/RH).
2. Temporarily tighten the mounting bolts to the sunroof front brackets (LH/RH).
3. Bring sunroof unit into back door.
4. Temporarily tighten the mounting nuts to the side rail of sunroof unit assembly.
5. Temporarily tighten the mounting nuts to the front end of sunroof unit assembly.
6. Tighten the installation points diagonally excluding the installation points of the sunroof brackets around the roof opening.
7. Tighten the sunroof bracket bolts of the vehicle side, and then tighten the bolt of the rail side.
8. Install the side curtain air bag mounting bolt. Refer to [SR-13, "Removal and Installation"](#).
9. Install the rear display. Refer to [AV-1047, "Removal and Installation"](#). (With rear display model only)
10. Install the sunroof motor assembly. Refer to [RF-72, "Removal and Installation"](#).
11. Install the glass lid. Refer to [RF-69, "Removal and Installation"](#).

NOTE:

After installation, perform fitting adjustment. Refer to [RF-70, "Adjustment"](#).

12. Connect drain hoses.
13. Install the headlining. Refer to [INT-24, "Removal and Installation"](#).

Disassembly and Assembly

INFOID:000000003829287

DISASSEMBLY

1. Remove the screw, and then rear drain.
2. Remove the sunshade. Refer to [RF-77, "Removal and Installation"](#).
3. Remove the wind deflector. Refer to [RF-79, "Removal and Installation"](#).

ASSEMBLY

Assemble in the reverse order of disassembly.

SUNSHADE

< REMOVAL AND INSTALLATION >

SUNSHADE

Exploded View

INFOID:000000003939945

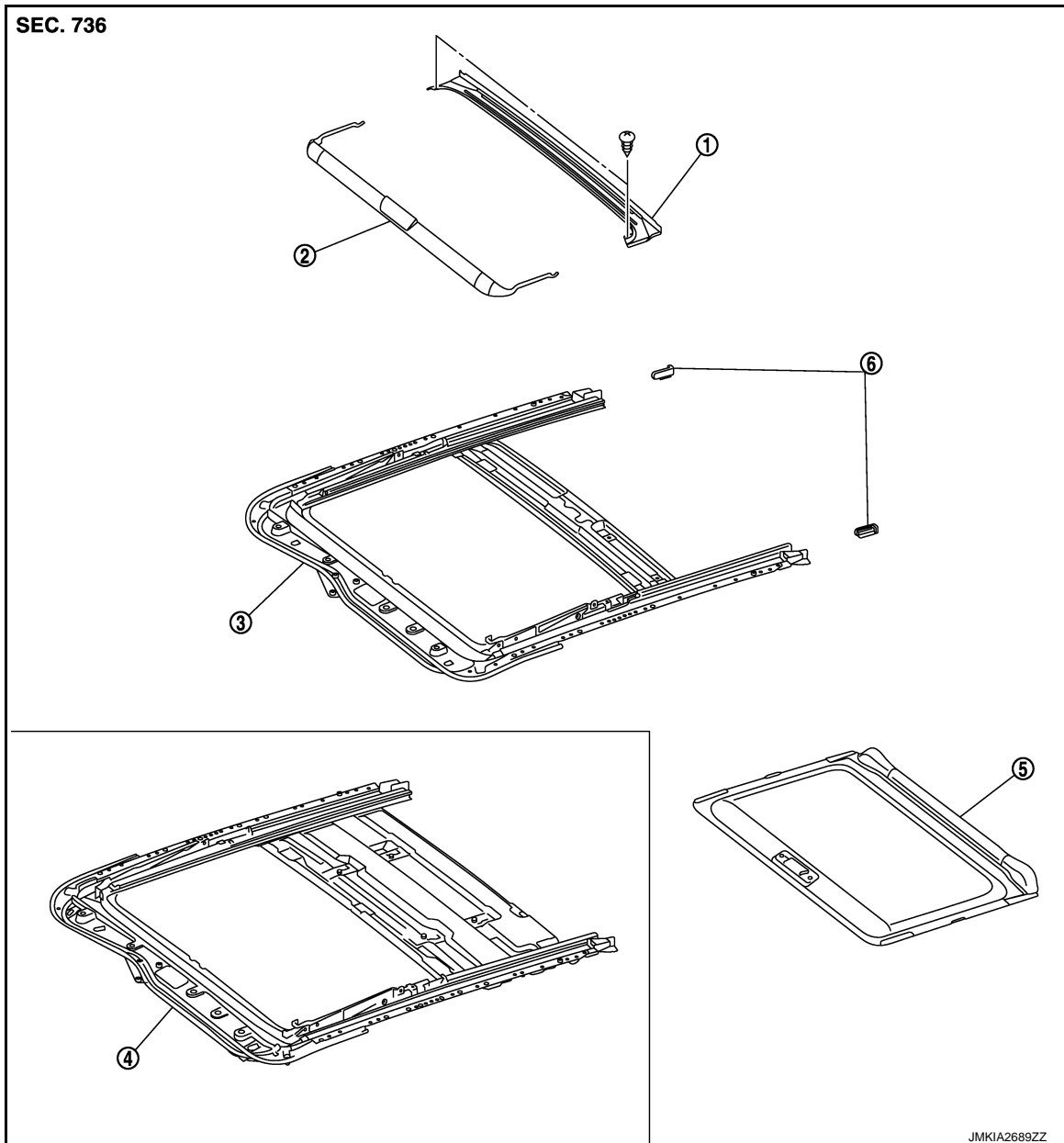

1. Rear drain
2. Wind deflector
3. Sunroof frame
4. Sunroof frame (with rear display model)
5. Sunshade
6. Sunshade stopper (LH/RH)

Removal and Installation

INFOID:000000003829289

REMOVAL

1. Remove the headlining. Refer to [INT-24, "Removal and Installation"](#).

A
B
C
D
E
F
G
H
I
J
RF
L
M
N
O
P

SUNSHADE

< REMOVAL AND INSTALLATION >

2. Remove the sunshade stopper (LH/RH) from the sunroof frame end.

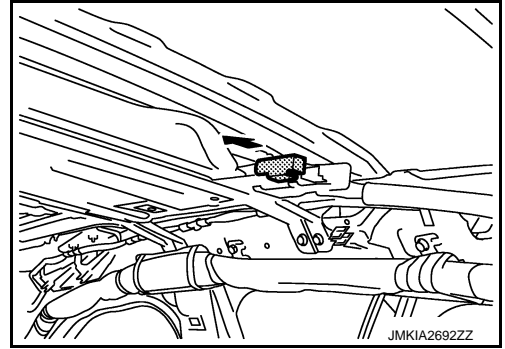

3. Remove the sunshade from the rear end of sunroof frame.

INSTALLATION

Install in the reverse order of removal.

WIND DEFLECTOR

< REMOVAL AND INSTALLATION >

WIND DEFLECTOR

Exploded View

INFOID:000000003953008

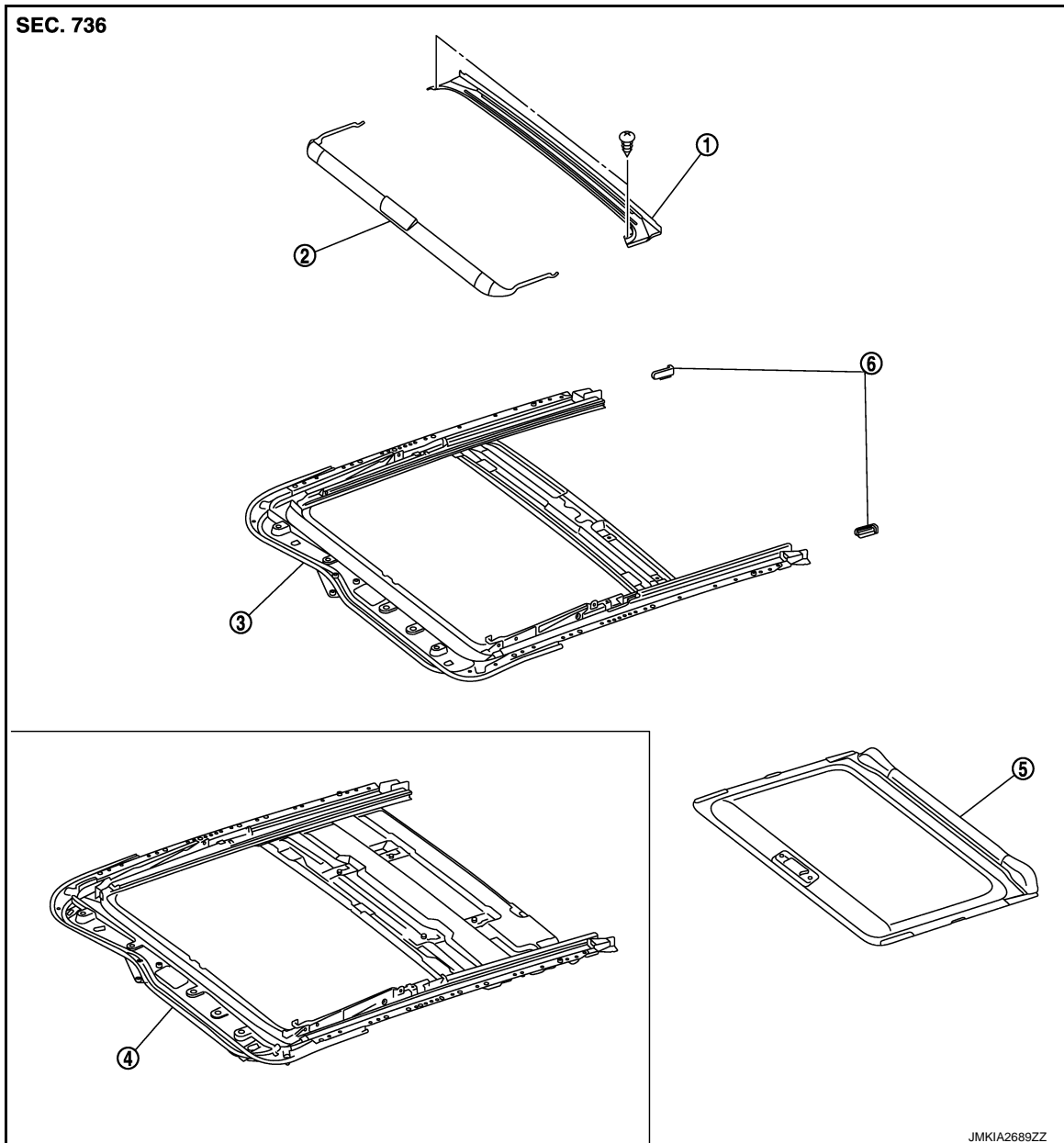

- | | | |
|--|-------------------|-----------------------------|
| 1. Rear drain | 2. Wind deflector | 3. Sunroof frame |
| 4. Sunroof frame (with rear display model) | 5. Sunshade | 6. Sunshade stopper (LH/RH) |

Removal and Installation

INFOID:000000003829291

Removal

1. Open the glass lid to see the wind deflector installation point on the sun roof slide rail.
2. Remove the wind deflector.
 - Remove the spring from sunroof frame groove.
 - Turn the wind deflector and remove it from sunroof frame.

Installation

Install in the reverse order of removal.

A
B
C
D
E
F
G
H
I
J
RF
L
M
N
O
P

SUNROOF SWITCH

< REMOVAL AND INSTALLATION >

SUNROOF SWITCH

Exploded View

INFOID:000000003829292

Refer to [INT-23, "Exploded View"](#).

Removal and Installation

INFOID:000000003829293

Removal

Remove the sunroof switch. Refer to [INT-24, "Removal and Installation"](#).

Installation

Install in the reverse order of removal.