

SECTION **EX**
EXHAUST SYSTEM

A
EX
C
D
E
F
G
H
I
J
K
L
M

CONTENTS

PREPARATION	2	Checking Exhaust System	3
Special Service Tool	2	Removal and Installation	4
Commercial Service Tools	2	REMOVAL	5
EXHAUST SYSTEM	3	INSTALLATION	5
		INSPECTION AFTER INSTALLATION	6

PREPARATION

PREPARATION

PFP:00002

Special Service Tool

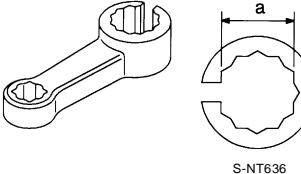

EBS00M60

The actual shapes of Kent-Moore tools may differ from those of special service tools illustrated here.

Tool number (Kent-Moore No.) Tool name	Description
KV10114400 (J-38365) Heated oxygen sensor wrench <div style="text-align: center;">  <p>S-NT636</p> </div>	Loosening or tightening heated oxygen sensors: a: 22 mm (0.87 in)

Commercial Service Tools

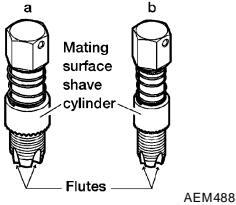
EBS00M6P

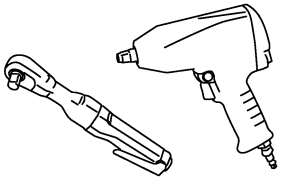
(Kent-Moore No.) Tool name	Description
(J-43897-18) (J-43897-12) Oxygen sensor thread cleaner <div style="text-align: center;">  <p>AEM488</p> </div>	Reconditioning the exhaust system threads before installing a new heated oxygen sensor (Use with anti-seize lubricant shown below): a: J-43897-18 (18 mm, 0.71 in) dia. for zirconia oxygen sensor b: J-43897-12 (12 mm, 0.47 in) dia. for titania oxygen sensor
Anti-seize lubricant (Permatex 133AR or equivalent meeting MIL specification MIL-A-907) <div style="text-align: center;">  <p>AEM489</p> </div>	Lubricating oxygen sensor thread cleaning tool when reconditioning exhaust system threads
Power tool <div style="text-align: center;">  <p>PBIC0190E</p> </div>	Loosening nuts and bolts

EXHAUST SYSTEM

EXHAUST SYSTEM

PFP:20100

Checking Exhaust System

EBS00M6Q

Check exhaust pipes, muffler and mounting for improper attachment, leaks, cracks, damage or deterioration.

- If anything is found, repair or replace damaged parts.

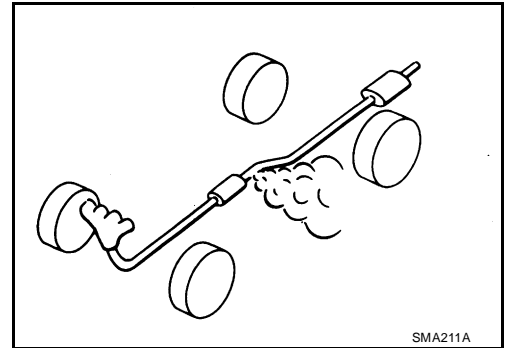

A

EX

C

D

E

F

G

H

I

J

K

L

M

EXHAUST SYSTEM

Removal and Installation

EBS00M6R

Exhaust System QR25DE

SEC. 200

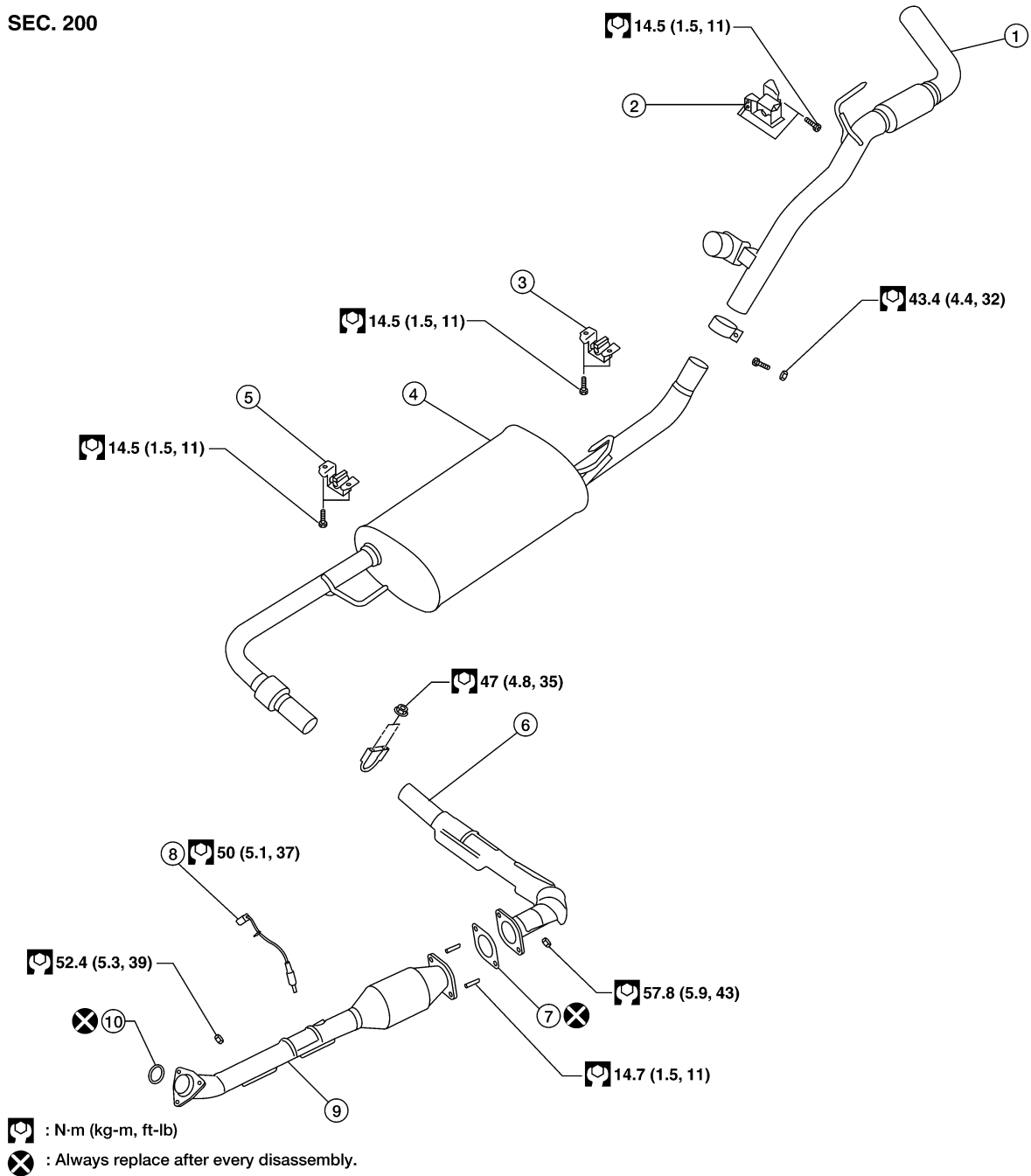

- | | | |
|-----------------|---------------------------------|--------------------------------|
| 1. Tailpipe | 2. Tailpipe hanger bracket | 3. Muffler hanger bracket rear |
| 4. Main muffler | 5. Muffler hanger bracket front | 6. Center exhaust tube |
| 7. Gasket | 8. Heated oxygen sensor 2 | 9. Front exhaust tube |
| 10. Ring gasket | | |

WBIA0616E

EXHAUST SYSTEM

Exhaust System VQ40DE

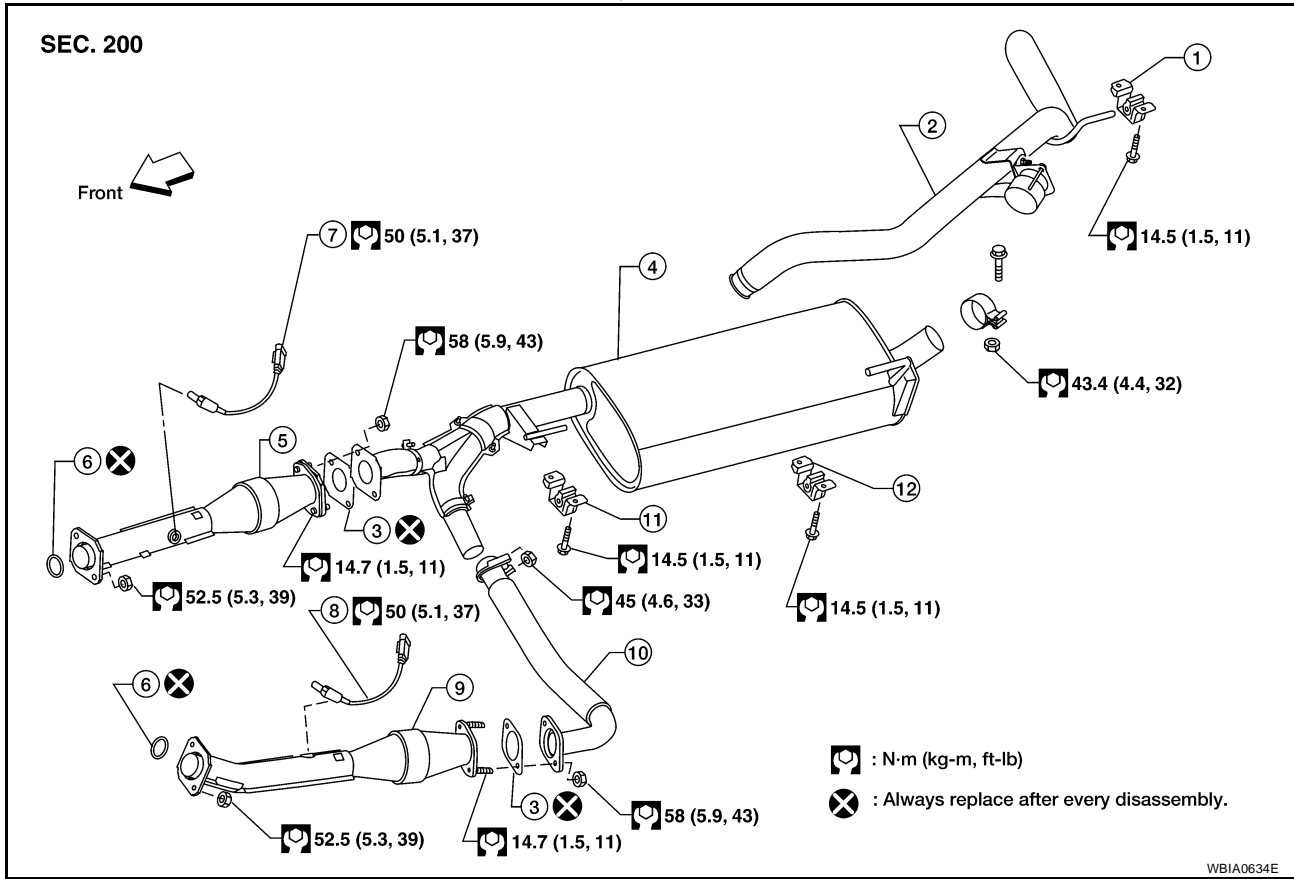

- | | | |
|------------------------------------|------------------------------------|--------------------------------|
| 1. Tailpipe hanger bracket | 2. Tailpipe | 3. Gasket |
| 4. Main muffler | 5. Right front exhaust tube | 6. Ring gasket |
| 7. Heated oxygen sensor 2 (bank 1) | 8. Heated oxygen sensor 2 (bank 2) | 9. Left front exhaust tube |
| 10. Center exhaust tube | 11. Muffer hanger bracket front | 12. Muffer hanger bracket rear |

CAUTION:

- Be sure to use genuine exhaust system parts or equivalents which are specially designed for heat resistance, corrosion resistance, and shape.
- Perform the operation with the exhaust system fully cooled. The system will be hot just after the engine stops.
- Be careful not to cut your hand on the heat insulator edge.

REMOVAL

Remove exhaust system components using power tool.

INSTALLATION

Installation is in the reverse order of removal.

CAUTION:

- Always replace exhaust gaskets with new ones when reassembling.
- Before installing a new heated oxygen sensor, clean and lube the exhaust tube threads using tool.

Tool number

A : — (J-43897-18)

B : — (J-43897-12)

- Discard any heated oxygen sensor which has been dropped from a height of more than 0.5 m (19.7 in) onto a hard surface such as a concrete floor; install a new one.
- Do not over-torque the heated oxygen sensor. Doing so may damage the heated oxygen sensor, resulting in the MIL coming on.

EXHAUST SYSTEM

- If any mounting insulator is badly deformed, repair or replace it. If deposits such as mud pile up on the mounting insulators, clean and inspect them.
- Temporarily tighten the mounting nuts on the exhaust manifold side and the mounting bolts on the vehicle side. Check each part for interference with other components, and then tighten the nuts and bolts to specification.

INSPECTION AFTER INSTALLATION

- With the engine running, check exhaust tube joints for gas leakage and unusual noises.
- Check to ensure that mounting brackets and mounting rubbers are installed properly and free from undue stress. Improper installation could result in excessive noise and vibration.