

SECTION **DEF**
DEFOGGER

A
B
C
D
E
F
G
H
I
J
K
DEF
M
N
O
P

CONTENTS

BASIC INSPECTION	3	Description	13
DIAGNOSIS AND REPAIR WORKFLOW	3	Component Function Check	13
Repair Work Flow	3	Diagnosis Procedure	13
SYSTEM DESCRIPTION	4	Component Inspection	14
REAR WINDOW DEFOGGER SYSTEM	4	DOOR MIRROR DEFOGGER RH	15
System Diagram	4	Description	15
System Description	4	Component Function Check	15
Component Parts Location	5	Diagnosis Procedure	15
Component Description	5	Component Inspection	16
DIAGNOSIS SYSTEM (BCM)	6	ECU DIAGNOSIS INFORMATION	17
COMMON ITEM	6	BCM (BODY CONTROL MODULE)	17
COMMON ITEM : CONSULT-III Function (BCM -		Reference Value	17
COMMON ITEM)	6	Terminal Layout	20
REAR WINDOW DEFOGGER	6	Physical Values	20
REAR WINDOW DEFOGGER : CONSULT-III		WIRING DIAGRAM	26
Function (BCM - REAR DEFOGGER)	7	REAR WINDOW DEFOGGER	26
DTC/CIRCUIT DIAGNOSIS	8	Wiring Diagram	26
REAR WINDOW DEFOGGER SWITCH	8	SYMPTOM DIAGNOSIS	32
Description	8	REAR WINDOW DEFOGGER AND DOOR	
Component Function Check	8	MIRROR DEFOGGER DO NOT OPERATE.	32
Diagnosis Procedure Front Air Control	8	Diagnosis Procedure	32
REAR WINDOW DEFOGGER RELAY	10	REAR WINDOW DEFOGGER DOES NOT	
Description	10	OPERATE BUT BOTH OF DOOR MIRROR	
Component Function Check	10	DEFOGGER OPERATE.	33
Diagnosis Procedure	10	Diagnosis Procedure	33
REAR WINDOW DEFOGGER POWER SUP-		BOTH DOORS MIRROR DEFOGGER DON'T	
PLY AND GROUND CIRCUIT	11	OPERATE BUT REAR WINDOW DEFOG-	
Description	11	GER OPERATES	34
Component Function Check	11	Diagnosis Procedure	34
Diagnosis Procedure	11	DRIVER SIDE DOOR MIRROR DEFOGGER	
Component Inspection	12	DOES NOT OPERATE.	35
DOOR MIRROR DEFOGGER LH	13	Diagnosis Procedure	35

PASSENGER SIDE DOOR MIRROR DEFOGGER DOES NOT OPERATE.	36	PRECAUTIONS	38
Diagnosis Procedure	36	Precaution for Supplemental Restraint System (SRS) "AIR BAG" and "SEAT BELT PRE-TENSIONER"	38
REAR WINDOW DEFOGGER SWITCH DOES NOT LIGHT, BUT REAR WINDOW DEFOGGER OPERATES	37	Handling for Adhesive and Primer	38
Diagnosis Procedure	37	REMOVAL AND INSTALLATION	39
PRECAUTION	38	FILAMENT	39
		Filament Check	39
		Filament Repair	39

DIAGNOSIS AND REPAIR WORKFLOW

< BASIC INSPECTION >

BASIC INSPECTION

DIAGNOSIS AND REPAIR WORKFLOW

Repair Work Flow

INFOID:000000006250227

DETAILED FLOW

1. LISTEN TO CUSTOMER COMPLAINT

Listen to customer complaint. Get detailed information about the conditions and environment when the symptom occurs.

>> GO TO 2

2. VERIFY THE SYMPTOM WITH OPERATIONAL CHECK

Verify the symptom with operational check.

>> GO TO 3

3. GO TO APPROPRIATE TROUBLE DIAGNOSIS

Go to appropriate trouble diagnosis.

>> GO TO 4

4. REPAIR OR REPLACE

Repair or replace the specific parts.

>> GO TO 5

5. FINAL CHECK

Final check.

Is inspection result normal?

YES >> Inspection End

NO >> Refer to [GI-46, "Intermittent Incident"](#).

A

B

C

D

E

F

G

H

I

J

K

DEF

M

N

O

P

REAR WINDOW DEFOGGER SYSTEM

< SYSTEM DESCRIPTION >

SYSTEM DESCRIPTION

REAR WINDOW DEFOGGER SYSTEM

System Diagram

INFOID:000000006250228

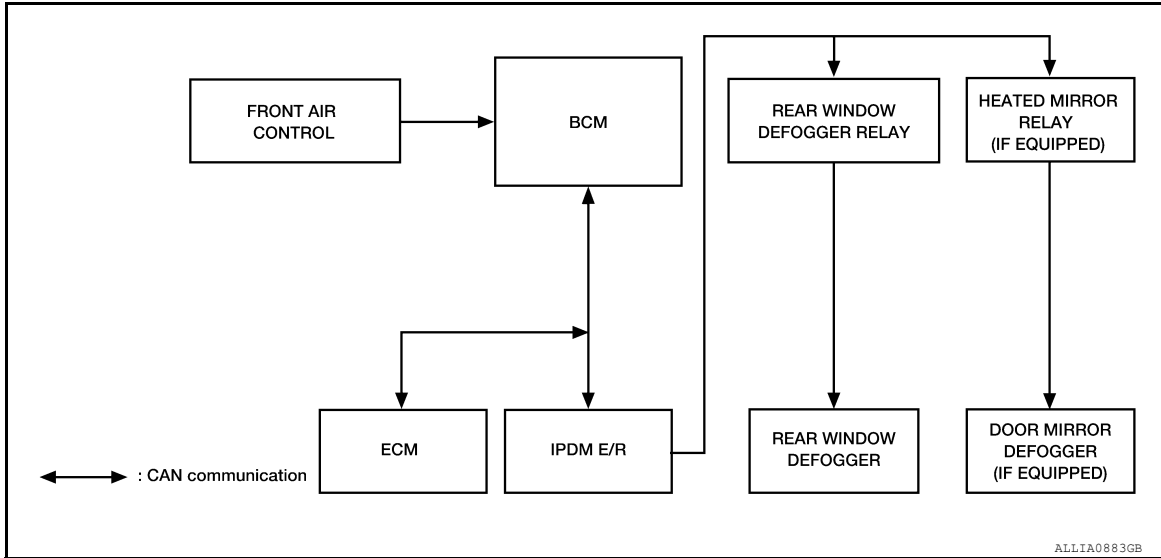

ALLIA0883GB

System Description

INFOID:000000006250229

Operation Description

- When rear window defogger switch is turned ON while ignition switch is ON, the front air control transmits rear window defogger switch signal to BCM.
- BCM transmits rear window defogger control signal to IPDM E/R via CAN communication when rear window defogger operates.
- IPDM E/R turns rear window defogger relay and heated mirror relay (if equipped) ON when rear window defogger switch signal is received.
- Rear window defogger and door mirror defogger (if equipped) are supplied with power and operate when rear window defogger relay and heated mirror relay (if equipped) turn ON.
- Rear window defogger ON is displayed when signal is received.

Timer function

- BCM turns rear window defogger relay and heated mirror relay (if equipped) ON for approximately 15 minutes when rear window defogger switch is turned ON while ignition switch is ON. It makes rear window defogger and door mirror defogger (if equipped) operate.
- Timer is canceled after pressing rear window defogger switch again during timer operation. Then BCM turns rear window defogger relay and heated mirror relay (if equipped) OFF. The same reaction also occurs during timer operation, if the ignition switch is turned OFF.

INPUT/OUTPUT SIGNAL CHART

Switch	Input signal to BCM	BCM function	Actuator
Rear window defogger switch	Defogger switch signal	Rear window defogger & door mirror defogger (if equipped) control	Rear window defogger Door mirror defogger (if equipped)
Ignition switch	Ignition signal		

REAR WINDOW DEFOGGER SYSTEM

< SYSTEM DESCRIPTION >

Component Parts Location

INFOID:000000006250230

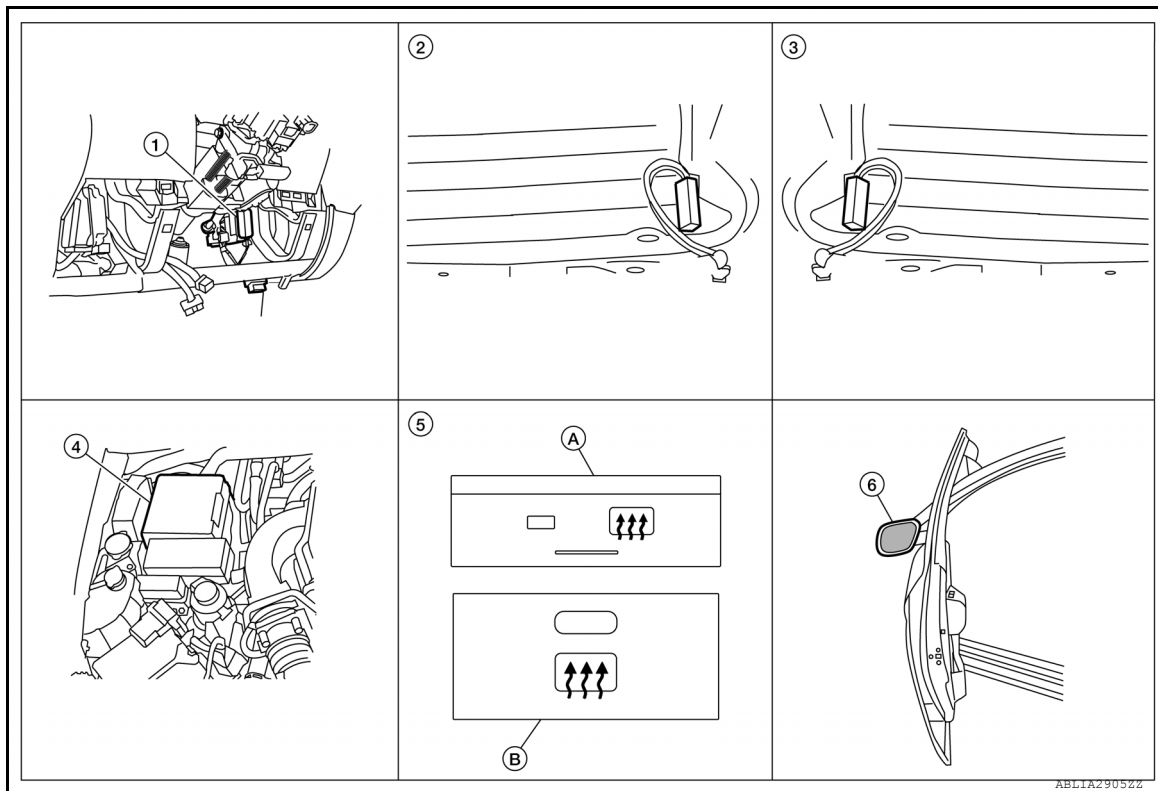

1. BCM M18, M20 (view with lower instrument panel LH removed)
2. Rear window defogger connector B165
3. Rear window defogger ground connector B210
4. IPDM E/R E120, E122, E124
5. A. Rear window defogger switch (with VBC)
B. Rear window defogger switch (without VBC)
6. Door mirror (door mirror defogger) LH D4, RH D107

Component Description

INFOID:000000006250231

BCM	<ul style="list-style-type: none"> Operates the rear window defogger with the operation of rear window defogger switch. Performs the timer control of rear window defogger.
Rear window defogger relay	<ul style="list-style-type: none"> Operates the rear window defogger and the door mirror defogger (if equipped) with the control signal from BCM.
Rear window defogger switch	<ul style="list-style-type: none"> The rear window defogger switch is turned ON. Turns the indicator lamp ON when detecting the operation of rear window defogger.
Rear window defogger	<ul style="list-style-type: none"> Heats the heating wire with the power supply from the rear window defogger relay to prevent the rear window from fogging up.
Door mirror defogger (if equipped)	<ul style="list-style-type: none"> Heats the heating wire with the power supply from the heated mirror relay to prevent the door mirror from fogging up.

DEF

M

N

O

P

DIAGNOSIS SYSTEM (BCM)

< SYSTEM DESCRIPTION >

DIAGNOSIS SYSTEM (BCM)

COMMON ITEM

COMMON ITEM : CONSULT-III Function (BCM - COMMON ITEM)

INFOID:000000006709016

APPLICATION ITEM

CONSULT-III performs the following functions via CAN communication with BCM.

Direct Diagnostic Mode	Description
Ecu Identification	The BCM part number is displayed.
Self Diagnostic Result	The BCM self diagnostic results are displayed.
Data Monitor	The BCM input/output data is displayed in real time.
Active Test	The BCM activates outputs to test components.
Work support	The settings for BCM functions can be changed.
Configuration	<ul style="list-style-type: none"> • The vehicle specification can be read and saved. • The vehicle specification can be written when replacing BCM.
CAN Diag Support Mntr	The result of transmit/receive diagnosis of CAN communication is displayed.

SYSTEM APPLICATION

BCM can perform the following functions.

System	Sub System	Direct Diagnostic Mode						
		Ecu Identification	Self Diagnostic Result	Data Monitor	Active Test	Work support	Configuration	CAN Diag Support Mntr
Door lock	DOOR LOCK		×	×	×	×		
Rear window defogger	REAR DEFOGGER			×	×			
Warning chime	BUZZER			×	×			
Interior room lamp timer	INT LAMP			×	×	×		
Remote keyless entry system	MULTI REMOTE ENT			×	×	×		
Exterior lamp	HEAD LAMP			×	×	×		
Wiper and washer	WIPER			×	×	×		
Turn signal and hazard warning lamps	FLASHER			×	×			
Air conditioner	AIR CONDITIONER			×				
Combination switch	COMB SW			×				
BCM	BCM	×	×			×	×	×
Immobilizer	IMMU		×	×	×			
Interior room lamp battery saver	BATTERY SAVER			×	×	×		
Vehicle security system	THEFT ALM			×	×	×		
RAP system	RETAINED PWR			×	×	×		
Signal buffer system	SIGNAL BUFFER			×	×			
TPMS	AIR PRESSURE MONITOR		×	×	×	×		
Panic alarm system	PANIC ALARM				×			

REAR WINDOW DEFOGGER

DIAGNOSIS SYSTEM (BCM)

< SYSTEM DESCRIPTION >

REAR WINDOW DEFOGGER : CONSULT-III Function (BCM - REAR DEFOGGER)

INFOID:000000006709017

DATA MONITOR

Monitor Item [Unit]	Description
IGN ON SW [On/Off]	Indicates condition of ignition switch ON position.
ACC ON SW [On/Off]	Indicates condition of ignition switch ACC position.
REAR DEF SW [On/Off]	Indicates condition of rear window defogger switch.

ACTIVE TEST

Test Item	Description
REAR DEFOGGER	This test is able to check rear window defogger operation [Off/On].

A
B
C
D
E
F
G
H
I
J
K
DEF
M
N
O
P

DEF

REAR WINDOW DEFOGGER SWITCH

< DTC/CIRCUIT DIAGNOSIS >

DTC/CIRCUIT DIAGNOSIS

REAR WINDOW DEFOGGER SWITCH

Description

INFOID:000000006250234

- The rear window defogger is operated by turning the rear window defogger switch ON.
- Turns the indicator lamp in the rear window defogger switch ON when operating the rear window defogger.

Component Function Check

INFOID:000000006250235

1. CHECK REAR WINDOW DEFOGGER SWITCH FUNCTION

Check that the indicator lamp of rear window defogger illuminates with rear window defogger switch ON.

Is the inspection result normal?

- YES >> Rear window defogger switch function is OK.
NO >> Refer to [DEF-8, "Diagnosis Procedure Front Air Control"](#).

Diagnosis Procedure Front Air Control

INFOID:000000006250236

Regarding Wiring Diagram information, refer to [DEF-26, "Wiring Diagram"](#).

1. CHECK REAR WINDOW DEFOGGER SWITCH REQUEST SIGNAL

1. Turn ignition switch ON.
2. Check voltage between front air control harness connector and ground.

Terminals		(-)	Condition of rear window defogger switch	Voltage (V) (Approx.)
(+)	Terminal			
Front air control connector		Ground	ON	0
M49 (without VBC)	11			
M50 (with VBC)	16	OFF	5	

Is the inspection result normal?

- YES >> GO TO 4
NO >> GO TO 2

2. CHECK REAR WINDOW DEFOGGER SWITCH VOLTAGE SIGNAL

1. Turn ignition switch OFF.
2. Disconnect front air control.
3. Turn ignition switch ON.
4. Check voltage between front air control harness connector and ground.

Terminals		(-)	Voltage (V) (Approx.)
(+)	Terminal		
Front air control connector		Ground	5
M49 (without VBC)	11		
M50 (with VBC)	16		

Is the inspection result normal?

- YES >> Replace front air control. Refer to [VTL-7, "Removal and Installation"](#).

REAR WINDOW DEFOGGER SWITCH

< DTC/CIRCUIT DIAGNOSIS >

NO >> GO TO 3

3. CHECK HARNESS CONTINUITY

1. Turn ignition switch OFF.
2. Disconnect BCM harness connector M18.
3. Check continuity between BCM harness connector M18 terminal 9 and front air control harness connector.

BCM connector	Terminal	Front air control connector	Terminal	Continuity
M18	9	M49 (without VBC)	11	Yes
		M50 (with VBC)	16	

4. Check continuity between BCM harness connector M18 terminal 9 and ground.

BCM connector	Terminal	Ground	Continuity
M18	9		No

Is the inspection result normal?

YES >> Replace BCM. Refer to [BCS-51, "Removal and Installation"](#).

NO >> Repair or replace harness as necessary.

4. CHECK REAR WINDOW DEFOGGER SWITCH INDICATOR CIRCUIT

Check voltage between front air control harness connector and ground.

Terminals		(-)	Condition of rear window defogger switch	Voltage (V) (Approx.)
(+)	Terminal			
Front air control connector		Ground	ON	Battery voltage
M49 (without VBC)	25		OFF	0
M50 (with VBC)	10			

Is the inspection result normal?

YES >> Replace front air control. Refer to [VTL-7, "Removal and Installation"](#).

NO >> Repair or replace harness as necessary.

A
B
C
D
E
F
G
H
I
J
K

DEF

M
N
O
P

REAR WINDOW DEFOGGER RELAY

< DTC/CIRCUIT DIAGNOSIS >

REAR WINDOW DEFOGGER RELAY

Description

INFOID:000000006250237

Power is supplied to the rear window defogger with BCM control.

Component Function Check

INFOID:000000006250238

1. CHECK REAR WINDOW DEFOGGER RELAY POWER SUPPLY CIRCUIT

Check that an operation noise of rear window defogger relay (located in IPDM E/R) can be heard when turning the rear window defogger switch ON.

Is the inspection result normal?

- YES >> Rear window defogger relay power supply circuit is OK.
 NO >> Refer to [DEF-10, "Diagnosis Procedure"](#).

Diagnosis Procedure

INFOID:000000006250239

Regarding Wiring Diagram information, refer to [DEF-26, "Wiring Diagram"](#).

1. CHECK FUSES

Check if any of the following fuses in the IPDM E/R are blown.

COMPONENT PARTS	AMPERE	FUSE NO.
IPDM E/R	15A	46
IPDM E/R	15A	47

Is the inspection result normal?

- YES >> GO TO 2
 NO >> If fuse is blown, be sure to eliminate cause of malfunction before installing new fuse.

2. CHECK REAR WINDOW DEFOGGER RELAY POWER SUPPLY CIRCUIT

- Turn ignition switch ON.
- Check voltage between IPDM E/R harness connector E124 terminal 60 and ground.

Terminals		Condition of rear window defogger switch	Voltage (V) (Approx.)
(+)	(-)		
IPDM E/R connector	Terminal		
E124	60	ON	Battery voltage
		OFF	0

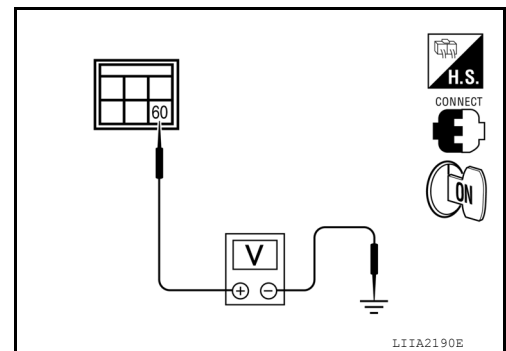

Is the inspection result normal?

- YES >> GO TO 3
 NO >> Replace IPDM E/R. Refer to [PCS-29, "Removal and Installation of IPDM E/R"](#).

3. CHECK INTERMITTENT INCIDENT

Check intermittent incident.
 Refer to [GI-46, "Intermittent Incident"](#).

Is the inspection result normal?

- YES >> Check the following.
- Battery power supply circuit
 - IPDM E/R
- NO >> Repair or replace the malfunctioning parts.

REAR WINDOW DEFOGGER POWER SUPPLY AND GROUND CIRCUIT

< DTC/CIRCUIT DIAGNOSIS >

REAR WINDOW DEFOGGER POWER SUPPLY AND GROUND CIRCUIT

Description

INFOID:000000006250240

Heats the heating wire with the power supply from the rear window defogger relay to prevent the rear window from fogging up.

Component Function Check

INFOID:000000006250241

1. CHECK REAR WINDOW DEFOGGER

Check that the heating wire of rear window defogger is heated when turning the rear window defogger switch ON.

Is the inspection result normal?

- YES >> Rear window defogger is OK.
- NO >> Refer to [DEF-11. "Diagnosis Procedure"](#).

Diagnosis Procedure

INFOID:000000006250242

Regarding Wiring Diagram information, refer to [DEF-26. "Wiring Diagram"](#).

1. CHECK POWER SUPPLY CIRCUIT

1. Turn ignition switch ON.
2. Check voltage between rear window defogger harness connector B165 terminal 1 and ground.

Terminals		(-)	Condition of rear window defogger switch	Voltage (V) (Approx.)
(+) Terminal				
Rear window defogger connector	Terminal			
B165	1	Ground	ON	Battery voltage
			OFF	0

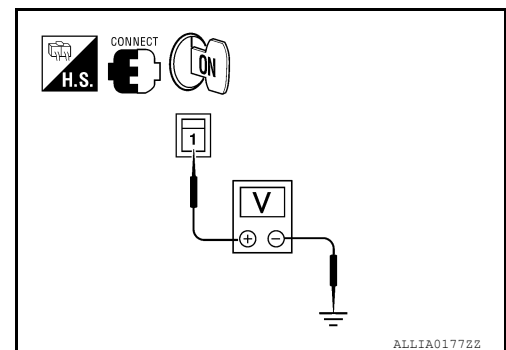

Is the inspection result normal?

- YES >> GO TO 2
- NO >> GO TO 3

2. CHECK GROUND CIRCUIT

1. Turn ignition switch OFF.
2. Disconnect rear window defogger.
3. Check continuity between rear window defogger harness connector B210 terminal 2 and ground.

Rear window defogger connector	Terminal	Ground	Continuity
B210	2		Yes

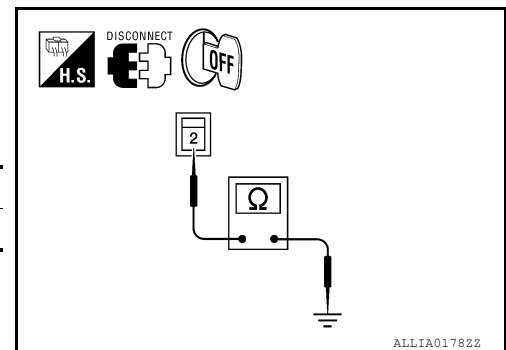

Is the inspection result normal?

- YES >> GO TO 4
- NO >> Repair or replace harness as necessary.

3. CHECK HARNESS CONTINUITY

A
B
C
D
E
F
G
H
I
J
K
DEF
M
N
O
P

REAR WINDOW DEFOGGER POWER SUPPLY AND GROUND CIRCUIT

< DTC/CIRCUIT DIAGNOSIS >

1. Disconnect IPDM E/R.
2. Check continuity between rear window defogger harness connector B165 (A) terminal 1 and IPDM E/R harness connector E124 (B) terminal 60.

Rear window defogger connector	Terminal	IPDM E/R connector	Terminal	Continuity
B165 (A)	1	E124 (B)	60	Yes

3. Check continuity between rear window defogger harness connector B165 (A) terminal 1 and ground.

Rear window defogger connector	Terminal	Ground	Continuity
B165 (A)	1		No

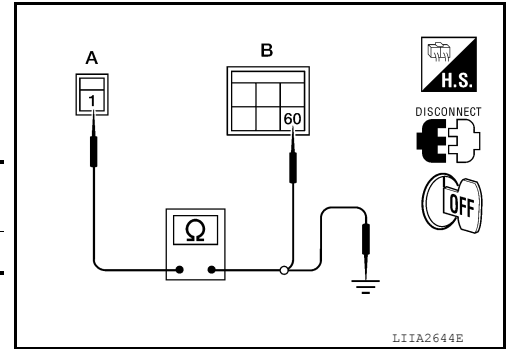

Is the inspection result normal?

- YES >> GO TO 5
 NO >> Replace or repair harness.

4. CHECK FILAMENT

Check filament.

Refer to [DEF-12, "Component Inspection"](#).

Is the inspection result normal?

- YES >> Refer to [GI-46, "Intermittent Incident"](#).
 NO >> Repair filament. Refer to [DEF-39, "Filament Repair"](#).

5. CHECK INTERMITTENT INCIDENT

Check intermittent incident.

Refer to [GI-46, "Intermittent Incident"](#).

Is the inspection result normal?

- YES >> Check the following.
- Battery power supply circuit
 - IPDM E/R
- NO >> Repair or replace the malfunctioning parts.

Component Inspection

INFOID:000000006250243

1. CHECK FILAMENT

Check the filament for damage or open circuits.

Refer to [DEF-39, "Filament Check"](#).

Is the inspection result normal?

- YES >> Inspection End.
 NO >> Repair filament. Refer to [DEF-39, "Filament Repair"](#).

DOOR MIRROR DEFOGGER LH

< DTC/CIRCUIT DIAGNOSIS >

DOOR MIRROR DEFOGGER LH

Description

INFOID:000000006250244

Heats the heating wire with the power supply from the heated mirror relay to prevent the door mirror from fogging up.

Component Function Check

INFOID:000000006250245

1. CHECK DOOR MIRROR DEFOGGER LH

Check that heating wire of door mirror defogger LH is heated when turning the rear window defogger switch ON.

Is the inspection result normal?

- YES >> Door mirror defogger is OK.
- NO >> Refer to [DEF-13. "Diagnosis Procedure"](#).

Diagnosis Procedure

INFOID:000000006250246

Regarding Wiring Diagram information, refer to [DEF-26. "Wiring Diagram"](#).

1. CHECK POWER SUPPLY

Check if the following fuse in the IPDM E/R is blown.

COMPONENT PARTS	AMPERE	FUSE NO.
IPDM E/R	15A	43

Is the inspection result normal?

- YES >> GO TO 2
- NO >> If fuse is blown, be sure to eliminate cause of malfunction before installing new fuse.

2. CHECK DOOR MIRROR DEFOGGER POWER SUPPLY CIRCUIT

Check voltage between IPDM E/R harness connector E120 terminal 23 and ground.

Connector	Terminal		Condition	Voltage (V) (Approx.)
	(+)	(-)		
E120	23	Ground	Rear window defogger switch ON	Battery voltage
			Rear window defogger switch OFF	0

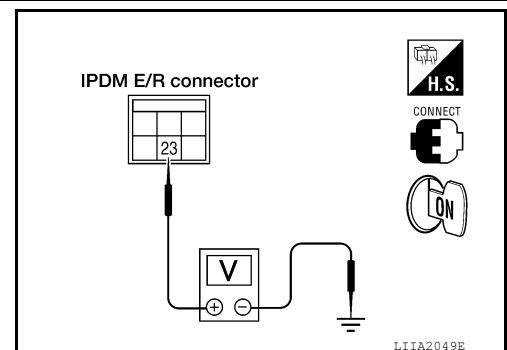

Is the inspection result normal?

- YES >> GO TO 3
- NO >> Replace IPDM E/R. Refer to [PCS-29. "Removal and Installation of IPDM E/R"](#).

3. CHECK DOOR MIRROR DEFOGGER POWER SUPPLY CIRCUIT

A
B
C
D
E
F
G
H
I
J
K
DEF
M
N
O
P

DOOR MIRROR DEFOGGER LH

< DTC/CIRCUIT DIAGNOSIS >

1. Turn ignition switch OFF.
2. Disconnect door mirror LH.
3. Turn ignition switch ON.
4. Check voltage between door mirror LH harness connector D4 terminal 1 and ground.

Connector	Terminal		Condition	Voltage (V) (Approx.)
	(+)	(-)		
D4	1	Ground	Rear window defogger switch ON	Battery voltage
			Rear window defogger switch OFF	0

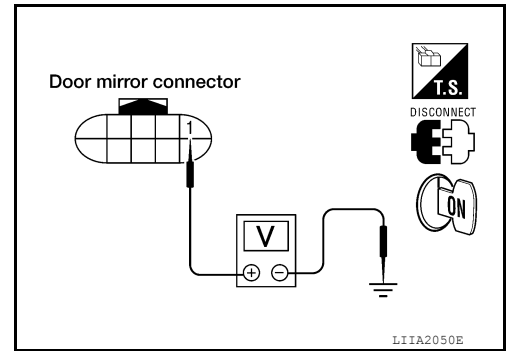

Is the inspection result normal?

- YES >> GO TO 4
 NO >> Repair or replace harness.

4. CHECK DOOR MIRROR DEFOGGER GROUND CIRCUIT

Check continuity between door mirror LH harness connector D4 terminal 6 and ground.

6 - Ground : Continuity should exist.

Is the inspection result normal?

- YES >> GO TO 5
 NO >> Repair or replace harness.

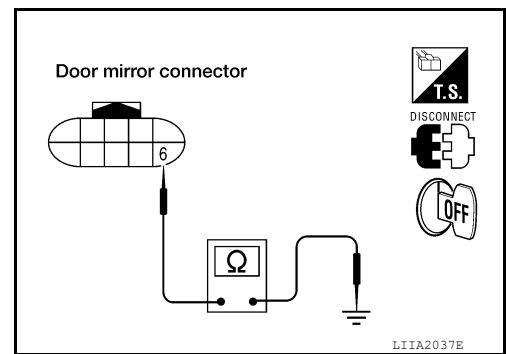

5. CHECK DOOR MIRROR DEFOGGER LH

Check door mirror defogger LH.
 Refer to [DEF-14, "Component Inspection"](#).

Is the inspection result normal?

- YES >> Check intermittent incident. Refer to [GI-46, "Intermittent Incident"](#).
 NO >> Replace door mirror. Refer to [MIR-17, "Door Mirror Assembly"](#).

Component Inspection

INFOID:000000006250247

1. CHECK DOOR MIRROR DEFOGGER

Check continuity between door mirror LH terminals 1 and 6.

1 - 6 : Continuity should exist.

Is the inspection result normal?

- YES >> Check the condition of the harness and the connector.
 NO >> Replace malfunctioning door mirror LH. Refer to [MIR-17, "Door Mirror Assembly"](#).

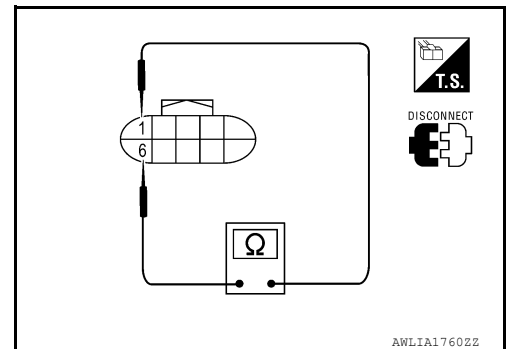

DOOR MIRROR DEFOGGER RH

< DTC/CIRCUIT DIAGNOSIS >

DOOR MIRROR DEFOGGER RH

Description

INFOID:000000006250248

Heats the heating wire with the power supply from the heated mirror relay to prevent the door mirror from fogging up.

Component Function Check

INFOID:000000006250249

1. CHECK DOOR MIRROR DEFOGGER RH

Check that the heating wire of door mirror defogger RH is heated when turning the rear window defogger switch ON.

Is the inspection result normal?

- YES >> Door mirror defogger RH is OK.
- NO >> Refer to [DEF-15. "Diagnosis Procedure"](#).

Diagnosis Procedure

INFOID:000000006250250

Regarding Wiring Diagram information, refer to [DEF-26. "Wiring Diagram"](#).

1. CHECK POWER SUPPLY

Check if the following fuse in the IPDM E/R is blown.

COMPONENT PARTS	AMPERE	FUSE NO.
IPDM E/R	15A	43

Is the inspection result normal?

- YES >> GO TO 2
- NO >> If fuse is blown, be sure to eliminate cause of malfunction before installing new fuse.

2. CHECK DOOR MIRROR DEFOGGER POWER SUPPLY CIRCUIT

Check voltage between IPDM E/R harness connector E120 terminal 23 and ground.

Connector	Terminal		Condition	Voltage (V) (Approx.)
	(+)	(-)		
E120	23	Ground	Rear window defogger switch ON	Battery voltage
			Rear window defogger switch OFF	0

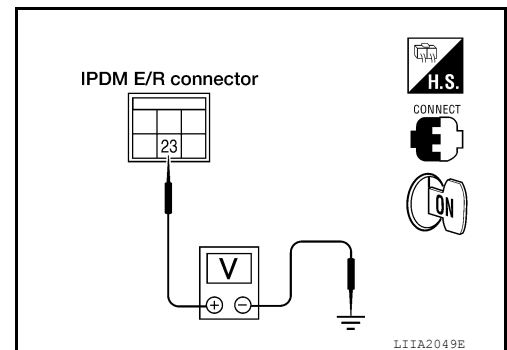

Is the inspection result normal?

- YES >> GO TO 3
- NO >> Replace IPDM E/R. Refer to [PCS-29. "Removal and Installation of IPDM E/R"](#).

3. CHECK DOOR MIRROR DEFOGGER POWER SUPPLY CIRCUIT

A
B
C
D
E
F
G
H
I
J
K
DEF
M
N
O
P

DOOR MIRROR DEFOGGER RH

< DTC/CIRCUIT DIAGNOSIS >

1. Turn ignition switch OFF.
2. Disconnect door mirror RH.
3. Turn ignition switch ON.
4. Check voltage between door mirror RH harness connector D107 terminal 1 and ground.

Connector	Terminal		Condition	Voltage (V) (Approx.)
	(+)	(-)		
D107	1	Ground	Rear window defogger switch ON	Battery voltage
			Rear window defogger switch OFF	0

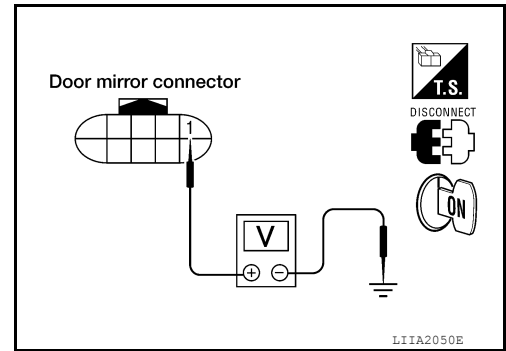

Is the inspection result normal?

- YES >> GO TO 4
 NO >> Repair or replace harness as necessary.

4. CHECK DOOR MIRROR DEFOGGER GROUND CIRCUIT

Check continuity between door mirror RH harness connector D107 terminal 6 and ground.

6 - Ground : Continuity should exist.

Is the inspection result normal?

- YES >> GO TO 5
 NO >> Repair or replace harness.

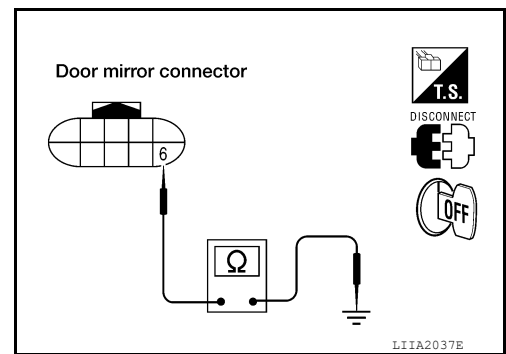

5. CHECK DOOR MIRROR DEFOGGER RH

Check door mirror defogger RH.
 Refer to [DEF-16, "Component Inspection"](#).

Is the inspection result normal?

- YES >> Check intermittent incident. Refer to [GI-46, "Intermittent Incident"](#).
 NO >> Replace door mirror. Refer to [MIR-17, "Door Mirror Assembly"](#).

Component Inspection

INFOID:000000006250251

1. CHECK DOOR MIRROR DEFOGGER

Check continuity between door mirror RH terminals 1 and 6.

1 - 6 : Continuity should exist.

Is the inspection result normal?

- YES >> Check the condition of the harness and the connector.
 NO >> Replace malfunctioning door mirror RH. Refer to [MIR-17, "Door Mirror Assembly"](#).

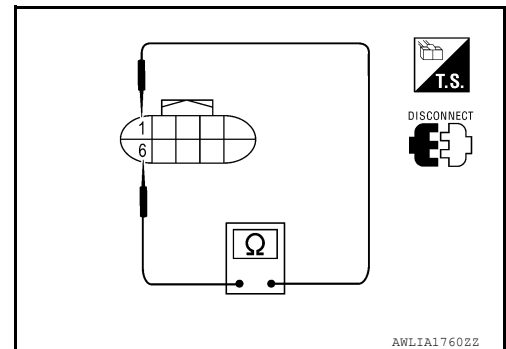

BCM (BODY CONTROL MODULE)

< ECU DIAGNOSIS INFORMATION >

ECU DIAGNOSIS INFORMATION

BCM (BODY CONTROL MODULE)

Reference Value

INFOID:000000006709018

NOTE:

The Signal Tech II Tool (J-50190) can be used to perform the following functions. Refer to the Signal Tech II User Guide for additional information.

- Activate and display TPMS transmitter IDs
- Display tire pressure reported by the TPMS transmitter
- Read TPMS DTCs
- Register TPMS transmitter IDs
- Test remote keyless entry keyfob relative signal strength

VALUES ON THE DIAGNOSIS TOOL

Monitor Item	Condition	Value/Status
ACC ON SW	Ignition switch OFF or ON	Off
	Ignition switch ACC	On
AIR COND SW	A/C switch OFF	Off
	A/C switch ON	On
AIR PRESS FL	Front left tire air pressure value	kPa, kg/cm ² , psi
AIR PRESS FR	Front right tire air pressure value	kPa, kg/cm ² , psi
AIR PRESS RL	Rear left tire air pressure value	kPa, kg/cm ² , psi
AIR PRESS RR	Rear right tire air pressure value	kPa, kg/cm ² , psi
BRAKE SW	Brake pedal released	Off
	Brake pedal applied	On
BUCKLE SW	Seat belt buckle unfastened	Off
	Seat belt buckle fastened	On
BUZZER	Buzzer in combination meter OFF	Off
	Buzzer in combination meter ON	On
CARGO LAMP SW	Cargo lamp switch OFF	Off
	Cargo lamp switch ON	On
CDL LOCK SW	Door lock/unlock switch does not operate	Off
	Press door lock/unlock switch to the LOCK side	On
CDL UNLOCK SW	Door lock/unlock switch does not operate	Off
	Press door lock/unlock switch to the UNLOCK side	On
DOOR SW-AS	Front door RH closed	Off
	Front door RH opened	On
DOOR SW-DR	Front door LH closed	Off
	Front door LH opened	On
DOOR SW-RL	Rear door LH closed	Off
	Rear door LH opened	On
DOOR SW-RR	Rear door RH closed	Off
	Rear door RH opened	On
FAN ON SIG	Blower motor fan switch OFF	Off
	Blower motor fan switch ON	On

BCM (BODY CONTROL MODULE)

< ECU DIAGNOSIS INFORMATION >

Monitor Item	Condition	Value/Status
FR FOG SW	Front fog lamp switch OFF	Off
	Front fog lamp switch ON	On
FR WASHER SW	Front washer switch OFF	Off
	Front washer switch ON	On
FR WIPER LOW	Front wiper switch OFF	Off
	Front wiper switch LO	On
FR WIPER HI	Front wiper switch OFF	Off
	Front wiper switch HI	On
FR WIPER INT	Front wiper switch OFF	Off
	Front wiper switch INT	On
FR WIPER STOP	Any position other than front wiper stop position	Off
	Front wiper stop position	On
HAZARD SW	When hazard switch is not pressed	Off
	When hazard switch is pressed	On
HEAD LAMP SW 1	Headlamp switch OFF	Off
	Headlamp switch 1st	On
HEAD LAMP SW 2	Headlamp switch OFF	Off
	Headlamp switch 1st	On
HI BEAM SW	High beam switch OFF	Off
	High beam switch HI	On
ID REGST FL1	ID registration of front left tire incomplete	YET
	ID registration of front left tire complete	DONE
ID REGST FR1	ID registration of front right tire incomplete	YET
	ID registration of front right tire complete	DONE
ID REGST RL1	ID registration of rear left tire incomplete	YET
	ID registration of rear left tire complete	DONE
ID REGST RR1	ID registration of rear right tire incomplete	YET
	ID registration of rear right tire complete	DONE
IGN ON SW	Ignition switch OFF or ACC	Off
	Ignition switch ON	On
IGN SW CAN	Ignition switch OFF or ACC	Off
	Ignition switch ON	On
INT VOLUME	Wiper intermittent dial is in a dial position 1 - 7	1 - 7
KEY CYL LK-SW	Door key cylinder LOCK position	Off
	Door key cylinder other than LOCK position	On
KEY CYL UN-SW	Door key cylinder UNLOCK position	Off
	Door key cylinder other than UNLOCK position	On
KEY ON SW	Mechanical key is removed from key cylinder	Off
	Mechanical key is inserted to key cylinder	On
KEYLESS LOCK	LOCK button of key fob is not pressed	Off
	LOCK button of key fob is pressed	On
KEYLESS PANIC	PANIC button of key fob is not pressed	Off
	PANIC button of key fob is pressed	On

BCM (BODY CONTROL MODULE)

< ECU DIAGNOSIS INFORMATION >

Monitor Item	Condition	Value/Status	
KEYLESS UNLOCK	UNLOCK button of key fob is not pressed	Off	A
	UNLOCK button of key fob is pressed	On	
LIGHT SW 1ST	Lighting switch OFF	Off	B
	Lighting switch 1st	On	
OIL PRESS SW	<ul style="list-style-type: none"> • Ignition switch OFF or ACC • Engine running 	Off	C
	Ignition switch ON	On	
PASSING SW	Other than lighting switch PASS	Off	D
	Lighting switch PASS	On	
REAR DEF SW	Rear window defogger switch OFF	Off	E
	Rear window defogger switch ON	On	
TURN SIGNAL L	Turn signal switch OFF	Off	F
	Turn signal switch LH	On	
TURN SIGNAL R	Turn signal switch OFF	Off	F
	Turn signal switch RH	On	
VEHICLE SPEED	While driving	Equivalent to speedometer reading	G
WARNING LAMP	Low tire pressure warning lamp in combination meter OFF	Off	H
	Low tire pressure warning lamp in combination meter ON	On	

A
B
C
D
E
F
G
H
I
J
K
DEF
M
N
O
P

DEF

BCM (BODY CONTROL MODULE)

< ECU DIAGNOSIS INFORMATION >

Terminal Layout

INFOID:000000006709019

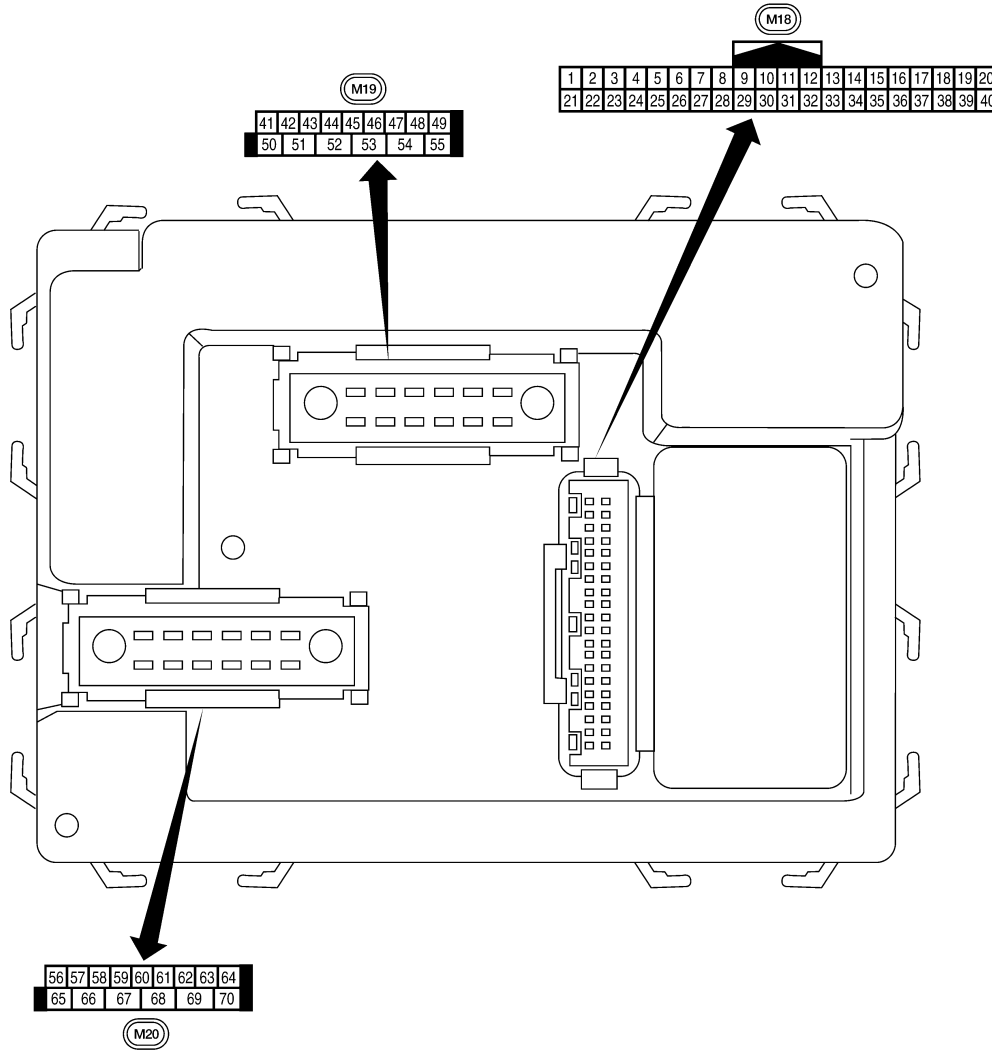



LIIA2443E

Physical Values

INFOID:000000006709020

BCM (BODY CONTROL MODULE)

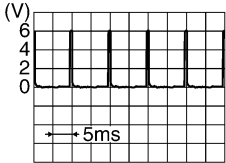
< ECU DIAGNOSIS INFORMATION >

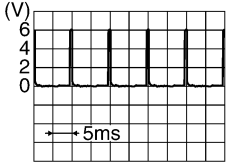
Terminal	Wire color	Item	Signal input/output	Measuring condition		Reference value or waveform (Approx.)
				Ignition switch	Operation or condition	
1	BR	Ignition keyhole illumination	Output	OFF	Door is locked (SW OFF)	Battery voltage
					Door is unlocked (SW ON)	0V
2	P	Combination switch input 5	Input	ON	Lighting, turn, wiper OFF Wiper dial position 4	 <p style="text-align: right; font-size: small;">SKIA5291E</p>
3	SB	Combination switch input 4	Input	ON	Lighting, turn, wiper OFF Wiper dial position 4	 <p style="text-align: right; font-size: small;">SKIA5292E</p>
4	V	Combination switch input 3	Input	ON	Lighting, turn, wiper OFF Wiper dial position 4	 <p style="text-align: right; font-size: small;">SKIA5291E</p>
5	L	Combination switch input 2	Input	ON	Lighting, turn, wiper OFF Wiper dial position 4	 <p style="text-align: right; font-size: small;">SKIA5292E</p>
6	R	Combination switch input 1				
7	GR	Front door lock assembly LH (key cylinder switch) unlock	Input	OFF	ON (open, 2nd turn)	Momentary 1.5V
8	SB	Front door lock assembly LH (key cylinder switch) lock			OFF (closed)	0V
			On (open)	Momentary 1.5V		
9	Y	Rear window defogger switch	Input	ON	Rear window defogger switch ON	0V
					Rear window defogger switch OFF	5V
11	G/B	Ignition switch (ACC or ON)	Input	ACC or ON	Ignition switch ACC or ON	Battery voltage
12	LG	Front door switch RH (All)	Input	OFF	ON (open)	0V
		Rear door switch upper RH (King Cab)			OFF (closed)	Battery voltage
		Rear door switch lower RH (King Cab)				

A
B
C
D
E
F
G
H
I
J
K
DEF
M
N
O
P

DEF

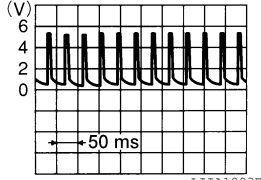
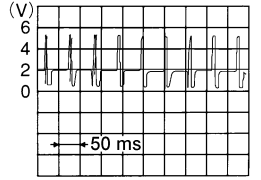
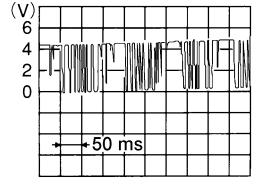

BCM (BODY CONTROL MODULE)

< ECU DIAGNOSIS INFORMATION >

Terminal	Wire color	Item	Signal input/output	Measuring condition		Reference value or waveform (Approx.)
				Ignition switch	Operation or condition	
13	L	Rear door switch RH (Crew Cab)	Input	OFF	ON (open)	0V
					OFF (closed)	Battery voltage
15	W	Tire pressure warning check connector	Input	OFF	—	5V
18	BR	Remote keyless entry receiver (Ground)	Output	OFF	—	0V
19	V	Remote keyless entry receiver (power supply)	Output	OFF	Ignition switch OFF	 <small>LI1A1893E</small>
20	G	Remote keyless entry receiver signal (Signal)	Input	OFF	Stand-by (keyfob buttons released)	 <small>LI1A1894E</small>
					When remote keyless entry receiver receives signal from keyfob (keyfob buttons pressed)	 <small>LI1A1895E</small>
21	GR	NATS antenna amp.	Input	OFF → ON	Ignition switch (OFF → ON)	Just after turning ignition switch ON: Pointer of tester should move.
23	G	Security indicator lamp	Output	OFF	Goes OFF → illuminates (Every 2.4 seconds)	Battery voltage → 0V
25	BR	NATS antenna amp.	Input	OFF → ON	Ignition switch (OFF → ON)	Just after turning ignition switch ON: Pointer of tester should move.
27	W	Compressor ON signal	Input	ON	A/C switch OFF	5V
					A/C switch ON	0V
28	R	Front blower monitor	Input	ON	Front blower motor OFF	Battery voltage
					Front blower motor ON	0V
29	G	Hazard switch	Input	OFF	ON	0V
					OFF	5V
31	GR	Cargo lamp switch	Input	OFF	ON	0V
					OFF	Battery voltage

BCM (BODY CONTROL MODULE)

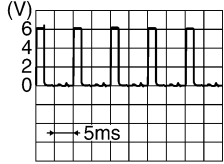
< ECU DIAGNOSIS INFORMATION >

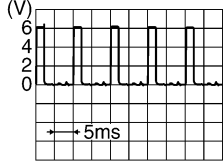
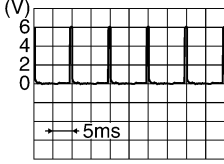
Terminal	Wire color	Item	Signal input/output	Measuring condition		Reference value or waveform (Approx.)
				Ignition switch	Operation or condition	
32	O	Combination switch output 5	Output	ON	Lighting, turn, wiper OFF Wiper dial position 4	 <p style="text-align: right; font-size: small;">SKIA5291E</p>
33	GR	Combination switch output 4	Output	ON	Lighting, turn, wiper OFF Wiper dial position 4	 <p style="text-align: right; font-size: small;">SKIA5292E</p>
34	G	Combination switch output 3	Output	ON	Lighting, turn, wiper OFF Wiper dial position 4	 <p style="text-align: right; font-size: small;">SKIA5291E</p>
35	BR	Combination switch output 2	Output	ON	Lighting, turn, wiper OFF Wiper dial position 4	 <p style="text-align: right; font-size: small;">SKIA5292E</p>
36	LG	Combination switch output 1				
37	B	Key switch	Input	OFF	Key inserted Key removed	Battery voltage 0V
38	W/R	Ignition switch (ON)	Input	ON	—	Battery voltage
39	L	CAN-H	—	—	—	—
40	P	CAN-L	—	—	—	—
45	V	Lock switch	Input	OFF	ON (lock) OFF	0V Battery voltage
46	LG	Unlock switch	Input	OFF	ON (unlock) OFF	0V Battery voltage
47	GR	Front door switch LH (All)	Input	OFF	ON (open)	0V
		Rear door switch upper LH (King Cab)			OFF (closed)	Battery voltage
		Rear door switch lower LH (King Cab)				
48	P	Rear door switch LH (Crew Cab)	Input	OFF	ON (open) OFF (closed)	0V Battery voltage
					50	P

A
B
C
D
E
F
G
H
I
J
K
DEF
M
N
O
P

BCM (BODY CONTROL MODULE)

< ECU DIAGNOSIS INFORMATION >

Terminal	Wire color	Item	Signal input/output	Measuring condition		Reference value or waveform (Approx.)
				Ignition switch	Operation or condition	
51	O	Trailer turn signal (right)	Output	ON	Turn right ON	<p style="text-align: right; font-size: small;">SKIA3009J</p>
52	LG	Trailer turn signal (left)	Output	ON	Turn left ON	<p style="text-align: right; font-size: small;">SKIA3009J</p>
56	R/Y	Battery saver output	Output	OFF	15 minutes after ignition switch is turned OFF	0V
				ON	—	Battery voltage
57	R/Y	Battery power supply	Input	—	—	Battery voltage
58	W	Optical sensor	Input	ON	When optical sensor is illuminated	3.1V or more
					When optical sensor is not illuminated	0.6V or less
59	GR	Front door lock assembly LH (unlock)	Output	OFF	OFF (neutral)	0V
					ON (unlock)	Battery voltage
60	LG	Turn signal (left)	Output	ON	Turn left ON	<p style="text-align: right; font-size: small;">SKIA3009J</p>
61	G	Turn signal (right)	Output	ON	Turn right ON	<p style="text-align: right; font-size: small;">SKIA3009J</p>
63	BR	Interior room/map lamp	Output	OFF	Any door switch ON (open)	0V
					OFF (closed)	Battery voltage
65	V	All door lock actuators (lock)	Output	OFF	OFF (neutral)	0V
					ON (lock)	Battery voltage
66	L	Front door lock actuator RH, rear door lock actuators LH/RH (unlock)	Output	OFF	OFF (neutral)	0V
					ON (unlock)	Battery voltage
67	B	Ground	Input	ON	—	0V

BCM (BODY CONTROL MODULE)

< ECU DIAGNOSIS INFORMATION >

Terminal	Wire color	Item	Signal input/output	Measuring condition		Reference value or waveform (Approx.)
				Ignition switch	Operation or condition	
68 ¹	O	Power window power supply (RAP)	Output	—	Ignition switch ON	Battery voltage
					Within 45 seconds after ignition switch OFF	Battery voltage
					More than 45 seconds after ignition switch OFF	0V
					When front door LH or RH is open or power window timer operates	0V
68 ²	SB	Power window power supply (RAP)	Output	—	Ignition switch ON	Battery voltage
					Within 45 seconds after ignition switch OFF	Battery voltage
					More than 45 seconds after ignition switch OFF	0V
					When front door LH or RH is open or power window timer operates	0V
69	P	Power window power supply (BAT)	Output	OFF	—	Battery voltage
70	W	Battery power supply	Input	OFF	—	Battery voltage

1: King cab (with power door lock system)

2: Crew cab (with power door lock system)

A
B
C
D
E
F
G
H
I
J
K
DEF
M
N
O
P

DEF

REAR WINDOW DEFOGGER

< WIRING DIAGRAM >

WIRING DIAGRAM

REAR WINDOW DEFOGGER

Wiring Diagram

INFOID:000000006647328

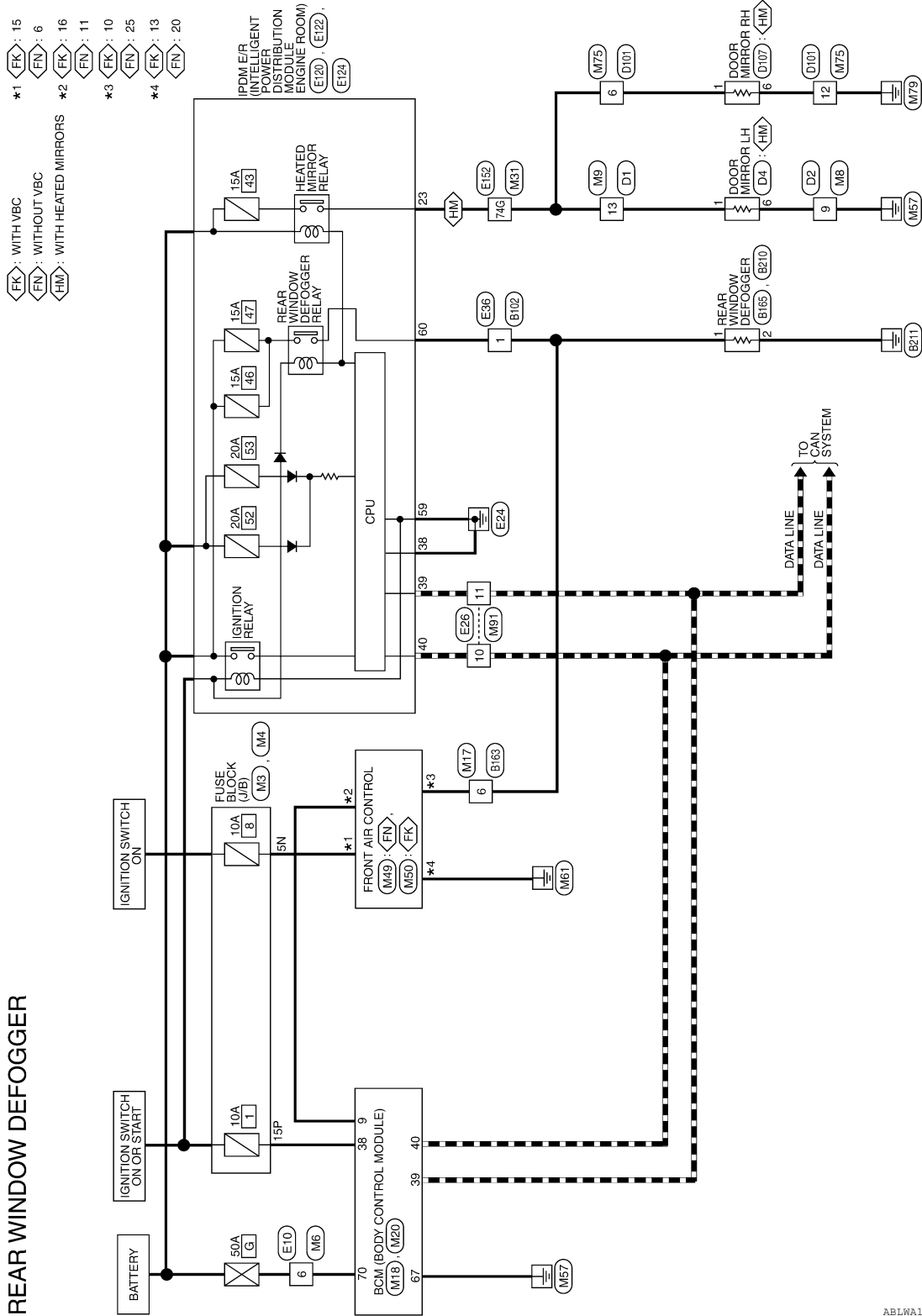

ABLWA1221GB

REAR WINDOW DEFOGGER

< WIRING DIAGRAM >

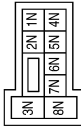

REAR WINDOW DEFOGGER CONNECTORS

Connector No.	M3
Connector Name	FUSE BLOCK (J/B)
Connector Color	WHITE



Terminal No.	5N	Color of Wire	W/G	Signal Name	-
--------------	----	---------------	-----	-------------	---

Connector No.	M4
Connector Name	FUSE BLOCK (J/B)
Connector Color	WHITE

Terminal No.	15P	Color of Wire	W/R	Signal Name	-
--------------	-----	---------------	-----	-------------	---

Connector No.	M6
Connector Name	WIRE TO WIRE
Connector Color	WHITE

Terminal No.	6	Color of Wire	W	Signal Name	-
--------------	---	---------------	---	-------------	---

Connector No.	M8
Connector Name	WIRE TO WIRE
Connector Color	BROWN

Terminal No.	9	Color of Wire	B	Signal Name	-
--------------	---	---------------	---	-------------	---

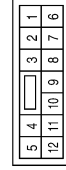
Connector No.	M9
Connector Name	WIRE TO WIRE
Connector Color	WHITE

Terminal No.	13	Color of Wire	LG	Signal Name	-
--------------	----	---------------	----	-------------	---

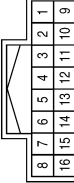
Connector No.	M17
Connector Name	WIRE TO WIRE
Connector Color	WHITE



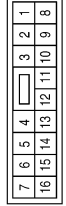

Terminal No.	6	Color of Wire	R	Signal Name	-
--------------	---	---------------	---	-------------	---

A
B
C
D
E
F
G
H
I
J
K
DEF
M
N
O
P

REAR WINDOW DEFOGGER

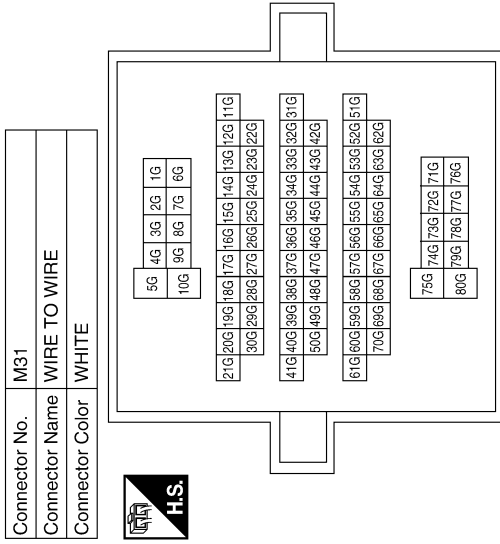
< WIRING DIAGRAM >



Connector No.	M20
Connector Name	BCM (BODY CONTROL MODULE)
Connector Color	BLACK



Terminal No.	Color of Wire	Signal Name
67	B	GND (POWER)
70	W	BAT (F/L)

Connector No.	M18
Connector Name	BCM (BODY CONTROL MODULE)
Connector Color	WHITE

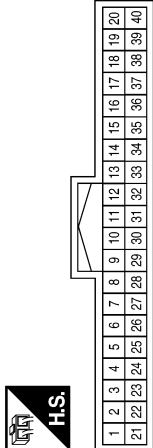

Terminal No.	Color of Wire	Signal Name
9	Y	RR DEFOGGER SW
38	W/R	IGN SW
39	L	CAN-H
40	P	CAN-L

Terminal No.	Color of Wire	Signal Name
74G	LG	-

Connector No.	M75
Connector Name	WIRE TO WIRE
Connector Color	WHITE

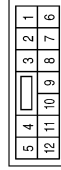

Terminal No.	Color of Wire	Signal Name
6	L	-
12	B	-

Connector No.	M50
Connector Name	FRONT AIR CONTROL (WITH VBC)
Connector Color	BLACK

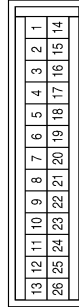

Terminal No.	Color of Wire	Signal Name
10	R	RR DEF STATUS
13	B	GND
15	W/G	IGN
16	Y	REAR DEFFROST REQUEST

Connector No.	M49
Connector Name	FRONT AIR CONTROL (WITHOUT VBC)
Connector Color	BLACK

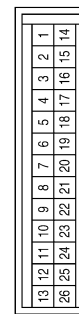

Terminal No.	Color of Wire	Signal Name
6	W/G	IGN
11	Y	REAR DEFFROST REQUEST
20	B	GND
25	R	RR DEF STATUS

ABLIA2821GB

REAR WINDOW DEFOGGER

< WIRING DIAGRAM >

Connector No.	E26
Connector Name	WIRE TO WIRE
Connector Color	WHITE

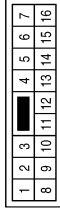

Terminal No.	Color of Wire	Signal Name
10	P	-
11	L	-

Connector No.	E10
Connector Name	WIRE TO WIRE
Connector Color	WHITE



Terminal No.	Color of Wire	Signal Name
6	W	-

Connector No.	M81
Connector Name	WIRE TO WIRE
Connector Color	WHITE

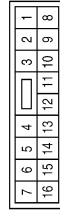

Terminal No.	Color of Wire	Signal Name
10	P	-
11	L	-

Connector No.	E122
Connector Name	IPDM E/R (INTELLIGENT POWER DISTRIBUTION MODULE ENGINE ROOM)
Connector Color	WHITE

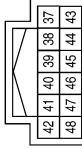

Terminal No.	Color of Wire	Signal Name
38	B	GND (SIGNAL)
39	L	CAN-H
40	P	CAN-L

Connector No.	E120
Connector Name	IPDM E/R (INTELLIGENT POWER DISTRIBUTION MODULE ENGINE ROOM)
Connector Color	WHITE

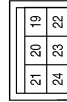

Terminal No.	Color of Wire	Signal Name
23	LG	HEATED MIRROR

Connector No.	E36
Connector Name	WIRE TO WIRE
Connector Color	WHITE



Terminal No.	Color of Wire	Signal Name
1	GR	-

ABLIA2822GB

A
B
C
D
E
F
G
H
I
J
K
DEF
M
N
O
P

REAR WINDOW DEFOGGER

< WIRING DIAGRAM >

Connector No.	B102
Connector Name	WIRE TO WIRE
Connector Color	WHITE



Terminal No.	Color of Wire	Signal Name
1	B	-

Connector No.	E152
Connector Name	WIRE TO WIRE
Connector Color	WHITE

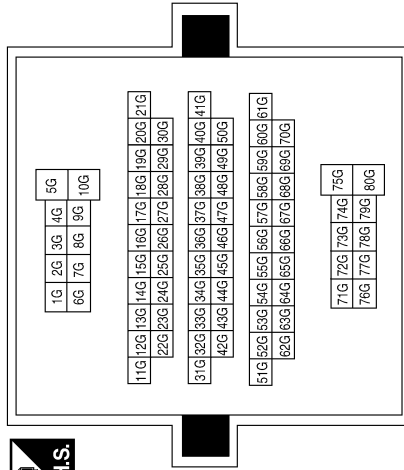

Terminal No.	Color of Wire	Signal Name
74G	LG	-

Connector No.	E124
Connector Name	IPDM E/R (INTELLIGENT POWER DISTRIBUTION MODULE ENGINE ROOM)
Connector Color	BLACK



Terminal No.	Color of Wire	Signal Name
59	B	GND (POWER)
60	GR	RR DEF

Connector No.	B210
Connector Name	REAR WINDOW DEFOGGER
Connector Color	BLACK



Terminal No.	Color of Wire	Signal Name
2	B	-

Connector No.	B165
Connector Name	REAR WINDOW DEFOGGER
Connector Color	BLACK



Terminal No.	Color of Wire	Signal Name
1	B	-

Connector No.	B163
Connector Name	WIRE TO WIRE
Connector Color	WHITE

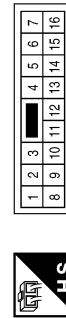

Terminal No.	Color of Wire	Signal Name
6	R	-

ABLIA2823GB

REAR WINDOW DEFOGGER

< WIRING DIAGRAM >

Connector No.	D4
Connector Name	DOOR MIRROR LH (WITH HEATED MIRROR)
Connector Color	BLACK

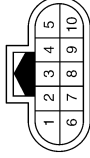

Terminal No.	Color of Wire	Signal Name
1	L/B	-
6	B	-

Connector No.	D2
Connector Name	WIRE TO WIRE
Connector Color	BROWN

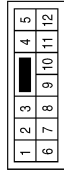

Terminal No.	Color of Wire	Signal Name
9	B	-

Connector No.	D1
Connector Name	WIRE TO WIRE
Connector Color	WHITE

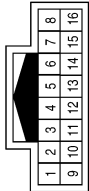

Terminal No.	Color of Wire	Signal Name
13	L/B	-

Connector No.	D107
Connector Name	DOOR MIRROR RH (WITH HEATED MIRROR)
Connector Color	BLACK

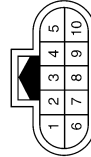

Terminal No.	Color of Wire	Signal Name
1	L/B	-
6	B	-

Connector No.	D101
Connector Name	WIRE TO WIRE
Connector Color	WHITE

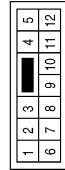

Terminal No.	Color of Wire	Signal Name
6	L/B	-
12	B	-

ABLIA2824GB

A
B
C
D
E
F
G
H
I
J
K
DEF
M
N
O
P

REAR WINDOW DEFOGGER AND DOOR MIRROR DEFOGGER DO NOT OPERATE.

< SYMPTOM DIAGNOSIS >

SYMPTOM DIAGNOSIS

REAR WINDOW DEFOGGER AND DOOR MIRROR DEFOGGER DO NOT OPERATE.

Diagnosis Procedure

INFOID:000000006250256

1. CHECK REAR WINDOW DEFOGGER SWITCH

Check rear window defogger switch.

Refer to [DEF-8, "Component Function Check"](#).

Is the inspection result normal?

YES >> GO TO 2

NO >> Repair or replace the malfunctioning parts.

2. CHECK REAR WINDOW DEFOGGER RELAY

Check rear window defogger relay.

Refer to [DEF-10, "Component Function Check"](#).

Is the inspection result normal?

YES >> GO TO 3

NO >> Repair or replace the malfunctioning parts.

3. CHECK REAR WINDOW DEFOGGER POWER SUPPLY AND GROUND CIRCUIT

Check rear window defogger power supply and ground circuit.

Refer to [DEF-11, "Component Function Check"](#).

Is the inspection result normal?

YES >> Check intermittent incident. Refer to [GI-46, "Intermittent Incident"](#).

NO >> Repair or replace the malfunctioning parts.

REAR WINDOW DEFOGGER DOES NOT OPERATE BUT BOTH OF DOOR MIRROR DEFOGGER OPERATE.

< SYMPTOM DIAGNOSIS >

REAR WINDOW DEFOGGER DOES NOT OPERATE BUT BOTH OF DOOR MIRROR DEFOGGER OPERATE.

Diagnosis Procedure

INFOID:000000006250257

1. CHECK REAR WINDOW DEFOGGER POWER SUPPLY AND GROUND CIRCUIT

Check rear window defogger power supply and ground circuit.

Refer to [DEF-11, "Component Function Check"](#).

Is the inspection result normal?

YES >> Refer to [GI-46, "Intermittent Incident"](#).

NO >> Repair or replace the malfunctioning parts.

A
B
C
D
E
F
G
H
I
J
K
DEF
M
N
O
P

BOTH DOORS MIRROR DEFOGGER DON'T OPERATE BUT REAR WINDOW DEFOGGER OPERATES

< SYMPTOM DIAGNOSIS >

BOTH DOORS MIRROR DEFOGGER DON'T OPERATE BUT REAR WINDOW DEFOGGER OPERATES

Diagnosis Procedure

INFOID:000000006250258

1. CHECK BOTH DOOR MIRROR DEFOGGER

-
1. Check door mirror LH. Refer to [DEF-13, "Component Function Check"](#).
 2. Check door mirror RH. Refer to [DEF-15, "Component Function Check"](#).

Is the inspection result normal?

- YES >> Check intermittent incident. Refer to [GI-46, "Intermittent Incident"](#).
NO >> Repair or replace the malfunctioning parts.

DRIVER SIDE DOOR MIRROR DEFOGGER DOES NOT OPERATE.

< SYMPTOM DIAGNOSIS >

DRIVER SIDE DOOR MIRROR DEFOGGER DOES NOT OPERATE.

Diagnosis Procedure

INFOID:000000006250259

1. CHECK DOOR MIRROR DEFOGGER LH

Check door mirror defogger LH.

Refer to [DEF-13, "Component Function Check"](#).

Is the inspection result normal?

YES >> Refer to [GI-46, "Intermittent Incident"](#).

NO >> Repair or replace the malfunctioning parts.

A
B
C
D
E
F
G
H
I
J
K
DEF
M
N
O
P

PASSENGER SIDE DOOR MIRROR DEFOGGER DOES NOT OPERATE.

< SYMPTOM DIAGNOSIS >

PASSENGER SIDE DOOR MIRROR DEFOGGER DOES NOT OPERATE.

Diagnosis Procedure

INFOID:000000006250260

1. CHECK DOOR MIRROR DEFOGGER RH

Check door mirror defogger RH.

Refer to [DEF-15, "Component Function Check"](#).

Is the inspection result normal?

YES >> Refer to [GI-46, "Intermittent Incident"](#).

NO >> Repair or replace the malfunctioning parts.

REAR WINDOW DEFOGGER SWITCH DOES NOT LIGHT, BUT REAR WINDOW DEFOGGER OPERATES

< SYMPTOM DIAGNOSIS >

REAR WINDOW DEFOGGER SWITCH DOES NOT LIGHT, BUT REAR WINDOW DEFOGGER OPERATES

Diagnosis Procedure

INFOID:000000006250261

1. CHECK REAR WINDOW DEFOGGER SWITCH

Check that the rear window defogger switch is operating normally.

Is the inspection result normal?

YES >> Refer to [GI-46. "Intermittent Incident"](#).

NO >> Refer to [DEF-8. "Diagnosis Procedure Front Air Control"](#).

A
B
C
D
E
F
G
H
I
J
K
DEF
M
N
O
P

PRECAUTIONS

< PRECAUTION >

PRECAUTION

PRECAUTIONS

Precaution for Supplemental Restraint System (SRS) "AIR BAG" and "SEAT BELT PRE-TENSIONER"

INFOID:000000006250262

The Supplemental Restraint System such as "AIR BAG" and "SEAT BELT PRE-TENSIONER", used along with a front seat belt, helps to reduce the risk or severity of injury to the driver and front passenger for certain types of collision. This system includes seat belt switch inputs and dual stage front air bag modules. The SRS system uses the seat belt switches to determine the front air bag deployment, and may only deploy one front air bag, depending on the severity of a collision and whether the front occupants are belted or unbelted. Information necessary to service the system safely is included in the SR and SB section of this Service Manual.

WARNING:

- To avoid rendering the SRS inoperative, which could increase the risk of personal injury or death in the event of a collision which would result in air bag inflation, all maintenance must be performed by an authorized NISSAN/INFINITI dealer.
- Improper maintenance, including incorrect removal and installation of the SRS, can lead to personal injury caused by unintentional activation of the system. For removal of Spiral Cable and Air Bag Module, see the SR section.
- Do not use electrical test equipment on any circuit related to the SRS unless instructed to in this Service Manual. SRS wiring harnesses can be identified by yellow and/or orange harnesses or harness connectors.

PRECAUTIONS WHEN USING POWER TOOLS (AIR OR ELECTRIC) AND HAMMERS

WARNING:

- When working near the Airbag Diagnosis Sensor Unit or other Airbag System sensors with the Ignition ON or engine running, DO NOT use air or electric power tools or strike near the sensor(s) with a hammer. Heavy vibration could activate the sensor(s) and deploy the air bag(s), possibly causing serious injury.
- When using air or electric power tools or hammers, always switch the Ignition OFF, disconnect the battery, and wait at least 3 minutes before performing any service.

Handling for Adhesive and Primer

INFOID:000000006250263

- Do not use an adhesive which is past its usable date. Shelf life of this product is limited to six months after the date of manufacture. Carefully adhere to the expiration or manufacture date printed on the box.
- Keep primers and adhesive in a cool, dry place. Ideally, they should be stored in a refrigerator.
- Open the seal of the primer and adhesive just before application. Discard the remainder.
- Before application, be sure to shake the primer container to stir the contents. If any floating material is found, do not use it.
- If any primer or adhesive contacts the skin, wipe it off with gasoline or equivalent and wash the skin with soap.
- When using primer and adhesive, always observe the precautions in the instruction manual.

FILAMENT

< REMOVAL AND INSTALLATION >

REMOVAL AND INSTALLATION

FILAMENT

Filament Check

INFOID:000000006250264

1. When measuring voltage, wrap tin foil around the top of the negative probe. Then press the foil against the wire with your finger.

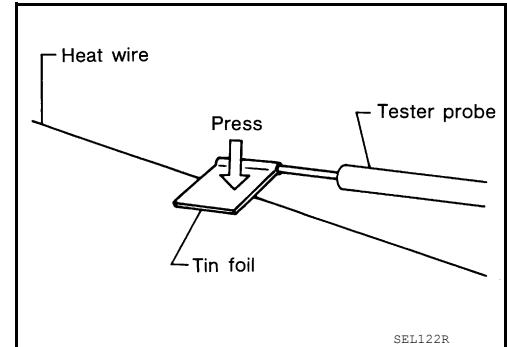

2. Attach probe circuit tester (in Volt range) to middle portion of each filament.

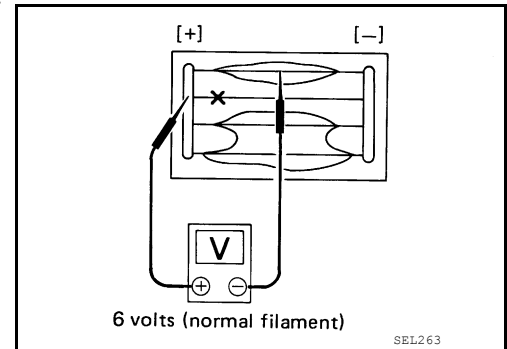

3. If a filament is burned out, circuit tester registers 0 or battery voltage.
4. To locate burned out point, move probe to left and right along filament. Test needle will swing abruptly when probe passes the point.

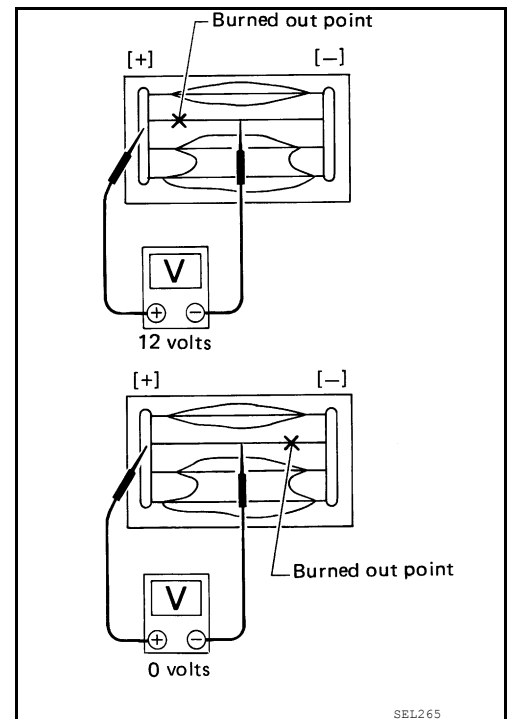

Filament Repair

INFOID:000000006250265

REPAIR EQUIPMENT

- Conductive silver composition (DuPont No. 4817 or equivalent)
- Ruler 30 cm (11.8 in) long

A
B
C
D
E
F
G
H
I
J
K
DEF
M
N
O
P

FILAMENT

< REMOVAL AND INSTALLATION >

- Drawing pen
- Heat gun
- Alcohol
- Cloth

REPAIRING PROCEDURE

1. Wipe broken heat wire and its surrounding area clean with a cloth dampened in alcohol.
2. Apply a small amount of conductive silver composition to tip of drawing pen. Shake silver composition container before use.
3. Place ruler on glass along broken line. Deposit conductive silver composition on break with drawing pen. Slightly overlap existing heat wire on both sides [preferably 5 mm (0.20 in)] of the break.

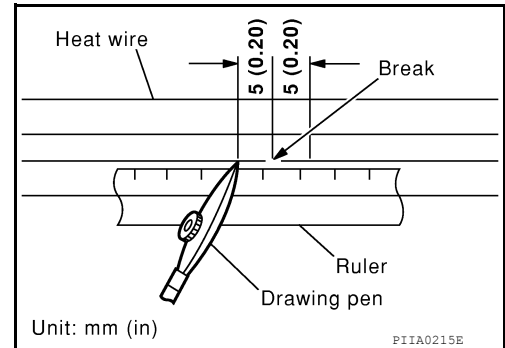

4. After repair has been completed, check repaired wire for continuity. This check should be conducted 10 minutes after silver composition is deposited. Do not touch repaired area while test is being conducted.

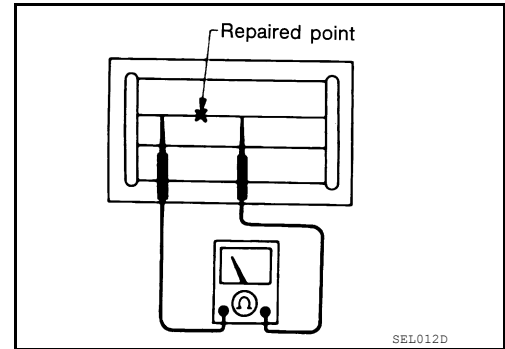

5. Apply a constant stream of hot air directly to the repaired area for approximately 20 minutes with a heat gun. A minimum distance of 3 cm (1.2 in) should be kept between repaired area and hot air outlet. If a heat gun is not available, let the repaired area dry for 24 hours.

