

SECTION **GW**
GLASS & WINDOW SYSTEM

A
B
C
D
E
F
G
H
I
J
GW
L
M
N
O
P

CONTENTS

SYMPTOM DIAGNOSIS	2	Commercial Service Tool	9
SQUEAK AND RATTLE TROUBLE DIAG- NOSES	2	REMOVAL AND INSTALLATION	10
Work Flow	2	WINDSHIELD GLASS	10
Generic Squeak and Rattle Troubleshooting	4	Removal and Installation	10
Diagnostic Worksheet	6	REAR WINDOW GLASS AND MOLDING	14
PRECAUTION	8	Removal and Installation	14
PRECAUTIONS	8	FRONT DOOR GLASS AND REGULATOR	16
Precaution for Supplemental Restraint System (SRS) "AIR BAG" and "SEAT BELT PRE-TEN- SIONER"	8	Front Door Glass	16
Procedure without Cowl Top Cover	8	Front Door Glass Regulator	16
Handling for Adhesive and Primer	8	REAR DOOR GLASS AND REGULATOR	20
PREPARATION	9	Rear Door Glass	20
PREPARATION	9	Rear Door Glass Regulator	20
Special Service Tool	9	SIDE WINDOW GLASS	24
		Removal and Installation	24

SQUEAK AND RATTLE TROUBLE DIAGNOSES

< SYMPTOM DIAGNOSIS >

SYMPTOM DIAGNOSIS

SQUEAK AND RATTLE TROUBLE DIAGNOSES

Work Flow

INFOID:000000006822374

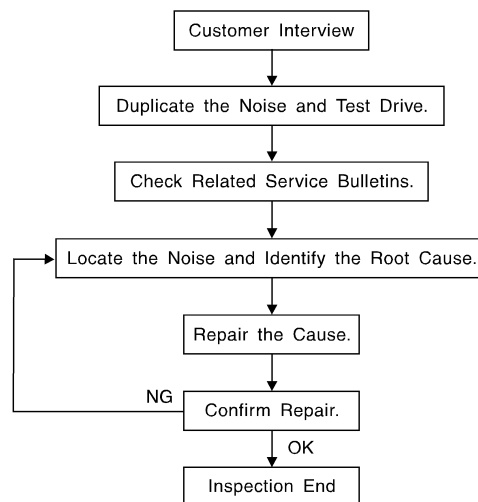

SBT842

CUSTOMER INTERVIEW

Interview the customer if possible, to determine the conditions that exist when the noise occurs. Use the Diagnostic Worksheet during the interview to document the facts and conditions when the noise occurs and any customer's comments; refer to [GW-6, "Diagnostic Worksheet"](#). This information is necessary to duplicate the conditions that exist when the noise occurs.

- The customer may not be able to provide a detailed description or the location of the noise. Attempt to obtain all the facts and conditions that exist when the noise occurs (or does not occur).
- If there is more than one noise in the vehicle, be sure to diagnose and repair the noise that the customer is concerned about. This can be accomplished by test driving the vehicle with the customer.
- After identifying the type of noise, isolate the noise in terms of its characteristics. The noise characteristics are provided so the customer, service adviser and technician are all speaking the same language when defining the noise.
- Squeak —(Like tennis shoes on a clean floor)
Squeak characteristics include the light contact/fast movement/brought on by road conditions/hard surfaces = higher pitch noise/softer surfaces = lower pitch noises/edge to surface = chirping.
- Creak—(Like walking on an old wooden floor)
Creak characteristics include firm contact/slow movement/twisting with a rotational movement/pitch dependent on materials/often brought on by activity.
- Rattle—(Like shaking a baby rattle)
Rattle characteristics include the fast repeated contact/vibration or similar movement/loose parts/missing clip or fastener/incorrect clearance.
- Knock —(Like a knock on a door)
Knock characteristics include hollow sounding/sometimes repeating/often brought on by driver action.
- Tick—(Like a clock second hand)
Tick characteristics include gentle contacting of light materials/loose components/can be caused by driver action or road conditions.
- Thump—(Heavy, muffled knock noise)
Thump characteristics include softer knock/dead sound often brought on by activity.
- Buzz—(Like a bumble bee)
Buzz characteristics include high frequency rattle/firm contact.
- Often the degree of acceptable noise level will vary depending upon the person. A noise that you may judge as acceptable may be very irritating to the customer.
- Weather conditions, especially humidity and temperature, may have a great effect on noise level.

DUPLICATE THE NOISE AND TEST DRIVE

SQUEAK AND RATTLE TROUBLE DIAGNOSES

< SYMPTOM DIAGNOSIS >

If possible, drive the vehicle with the customer until the noise is duplicated. Note any additional information on the Diagnostic Worksheet regarding the conditions or location of the noise. This information can be used to duplicate the same conditions when you confirm the repair.

If the noise can be duplicated easily during the test drive, to help identify the source of the noise, try to duplicate the noise with the vehicle stopped by doing one or all of the following:

- 1) Close a door.
 - 2) Tap or push/pull around the area where the noise appears to be coming from.
 - 3) Rev the engine.
 - 4) Use a floor jack to recreate vehicle "twist".
 - 5) At idle, apply engine load (electrical load, half-clutch on M/T model, drive position on CVT and A/T models).
 - 6) Raise the vehicle on a hoist and hit a tire with a rubber hammer.
- Drive the vehicle and attempt to duplicate the conditions the customer states exist when the noise occurs.
 - If it is difficult to duplicate the noise, drive the vehicle slowly on an undulating or rough road to stress the vehicle body.

CHECK RELATED SERVICE BULLETINS

After verifying the customer concern or symptom, check ASIST for Technical Service Bulletins (TSBs) related to that concern or symptom.

If a TSB relates to the symptom, follow the procedure to repair the noise.

LOCATE THE NOISE AND IDENTIFY THE ROOT CAUSE

1. Narrow down the noise to a general area. To help pinpoint the source of the noise, use a listening tool (Chassis Ear: J-39570, Engine Ear: J-39565 and mechanic's stethoscope).
2. Narrow down the noise to a more specific area and identify the cause of the noise by:
 - removing the components in the area that you suspect the noise is coming from.
Do not use too much force when removing clips and fasteners, otherwise clips and fasteners can be broken or lost during the repair, resulting in the creation of new noise.
 - tapping or pushing/pulling the component that you suspect is causing the noise.
Do not tap or push/pull the component with excessive force, otherwise the noise will be eliminated only temporarily.
 - feeling for a vibration with your hand by touching the component(s) that you suspect is (are) causing the noise.
 - placing a piece of paper between components that you suspect are causing the noise.
 - looking for loose components and contact marks.Refer to [GW-4, "Generic Squeak and Rattle Troubleshooting"](#).

REPAIR THE CAUSE

- If the cause is a loose component, tighten the component securely.
- If the cause is insufficient clearance between components:
 - separate components by repositioning or loosening and retightening the component, if possible.
 - insulate components with a suitable insulator such as urethane pads, foam blocks, felt cloth tape or urethane tape. A NISSAN Squeak and Rattle Kit (J-43980) is available through your authorized NISSAN Parts Department.

CAUTION:

Do not use excessive force as many components are constructed of plastic and may be damaged.

Always check with the Parts Department for the latest parts information.

The following materials are contained in the NISSAN Squeak and Rattle Kit (J-43980). Each item can be ordered separately as needed.

URETHANE PADS [1.5 mm (0.059 in) thick]

Insulates connectors, harness, etc.

76268-9E005: 100×135 mm (3.94×5.31 in)/76884-71L01: 60×85 mm (2.36×3.35 in)/76884-71L02: 15×25 mm (0.59×0.98 in)

INSULATOR (Foam blocks)

Insulates components from contact. Can be used to fill space behind a panel.

73982-9E000: 45 mm (1.77 in) thick, 50×50 mm (1.97×1.97 in)/73982-50Y00: 10 mm (0.39 in) thick, 50×50 mm (1.97×1.97 in)

INSULATOR (Light foam block)

80845-71L00: 30 mm (1.18 in) thick, 30×50 mm (1.18×1.97 in)

FELT CLOTH TAPE

Used to insulate where movement does not occur. Ideal for instrument panel applications.

68370-4B000: 15×25 mm (0.59×0.98 in) pad/68239-13E00: 5 mm (0.20 in) wide tape roll. The following materials not found in the kit can also be used to repair squeaks and rattles.

SQUEAK AND RATTLE TROUBLE DIAGNOSES

< SYMPTOM DIAGNOSIS >

UHMW (TEFLON) TAPE

Insulates where slight movement is present. Ideal for instrument panel applications.

SILICONE GREASE

Used instead of UHMW tape that will be visible or not fit.

Note: Will only last a few months.

SILICONE SPRAY

Use when grease cannot be applied.

DUCT TAPE

Use to eliminate movement.

CONFIRM THE REPAIR

Confirm that the cause of a noise is repaired by test driving the vehicle. Operate the vehicle under the same conditions as when the noise originally occurred. Refer to the notes on the Diagnostic Worksheet.

Generic Squeak and Rattle Troubleshooting

INFOID:000000006822375

Refer to Table of Contents for specific component removal and installation information.

INSTRUMENT PANEL

Most incidents are caused by contact and movement between:

1. The cluster lid A and instrument panel
2. Acrylic lens and combination meter housing
3. Instrument panel to front pillar garnish
4. Instrument panel to windshield
5. Instrument panel pins
6. Wiring harnesses behind the combination meter
7. A/C defroster duct and duct joint

These incidents can usually be located by tapping or moving the components to duplicate the noise or by pressing on the components while driving to stop the noise. Most of these incidents can be repaired by applying felt cloth tape or silicone spray (in hard to reach areas). Urethane pads can be used to insulate wiring harness.

CAUTION:

Do not use silicone spray to isolate a squeak or rattle. If you saturate the area with silicone, you will not be able to recheck the repair.

CENTER CONSOLE

Components to pay attention to include:

1. Shift selector assembly cover to finisher
2. A/C control unit and cluster lid C
3. Wiring harnesses behind audio and A/C control unit

The instrument panel repair and isolation procedures also apply to the center console.

DOORS

Pay attention to the:

1. Finisher and inner panel making a slapping noise
2. Inside handle escutcheon to door finisher
3. Wiring harnesses tapping
4. Door striker out of alignment causing a popping noise on starts and stops

Tapping or moving the components or pressing on them while driving to duplicate the conditions can isolate many of these incidents. You can usually insulate the areas with felt cloth tape or insulator foam blocks from the NISSAN Squeak and Rattle Kit (J-43980) to repair the noise.

TRUNK

Trunk noises are often caused by a loose jack or loose items put into the trunk by the owner.

In addition look for:

1. Trunk lid bumpers out of adjustment
2. Trunk lid striker out of adjustment
3. The trunk lid torsion bars knocking together

SQUEAK AND RATTLE TROUBLE DIAGNOSES

< SYMPTOM DIAGNOSIS >

4. A loose license plate or bracket

Most of these incidents can be repaired by adjusting, securing or insulating the item(s) or component(s) causing the noise.

A

SUNROOF/HEADLINING

Noises in the sunroof/headlining area can often be traced to one of the following:

B

1. Sunroof lid, rail, linkage or seals making a rattle or light knocking noise
2. Sun visor shaft shaking in the holder
3. Front or rear windshield touching headliner and squeaking

C

Again, pressing on the components to stop the noise while duplicating the conditions can isolate most of these incidents. Repairs usually consist of insulating with felt cloth tape.

D

OVERHEAD CONSOLE (FRONT AND REAR)

Overhead console noises are often caused by the console panel clips not being engaged correctly. Most of these incidents are repaired by pushing up on the console at the clip locations until the clips engage.

E

In addition look for:

1. Loose harness or harness connectors.
2. Front console map/reading lamp lens loose.
3. Loose screws at console attachment points.

F

SEATS

When isolating seat noise it's important to note the position the seat is in and the load placed on the seat when the noise is present. These conditions should be duplicated when verifying and isolating the cause of the noise.

G

Cause of seat noise include:

H

1. Headrest rods and holder
2. A squeak between the seat pad cushion and frame
3. The rear seatback lock and bracket

I

These noises can be isolated by moving or pressing on the suspected components while duplicating the conditions under which the noise occurs. Most of these incidents can be repaired by repositioning the component or applying urethane tape to the contact area.

J

UNDERHOOD

Some interior noise may be caused by components under the hood or on the engine wall. The noise is then transmitted into the passenger compartment.

GW

Causes of transmitted underhood noise include:

1. Any component installed to the engine wall
2. Components that pass through the engine wall
3. Engine wall mounts and connectors
4. Loose radiator installation pins
5. Hood bumpers out of adjustment
6. Hood striker out of adjustment

L

M

These noises can be difficult to isolate since they cannot be reached from the interior of the vehicle. The best method is to secure, move or insulate one component at a time and test drive the vehicle. Also, engine RPM or load can be changed to isolate the noise. Repairs can usually be made by moving, adjusting, securing, or insulating the component causing the noise.

N

O

P

SQUEAK AND RATTLE TROUBLE DIAGNOSES

< SYMPTOM DIAGNOSIS >

Diagnostic Worksheet

INFOID:00000006822376

Dear Customer:

We are concerned about your satisfaction with your vehicle. Repairing a squeak or rattle sometimes can be very difficult. To help us fix your vehicle right the first time, please take a moment to note the area of the vehicle where the squeak or rattle occurs and under what conditions. You may be asked to take a test drive with a service advisor or technician to ensure we confirm the noise you are hearing.

SQUEAK & RATTLE DIAGNOSTIC WORKSHEET

I. WHERE DOES THE NOISE COME FROM? (circle the area of the vehicle)

The illustrations are for reference only, and may not reflect the actual configuration of your vehicle.



Continue to page 2 of the worksheet and briefly describe the location of the noise or rattle. In addition, please indicate the conditions which are present when the noise occurs.

SQUEAK AND RATTLE TROUBLE DIAGNOSES

< SYMPTOM DIAGNOSIS >

SQUEAK & RATTLE DIAGNOSTIC WORKSHEET - page 2

Briefly describe the location where the noise occurs:

II. WHEN DOES IT OCCUR? (please check the boxes that apply)

- | | |
|---|--|
| <input type="checkbox"/> Anytime | <input type="checkbox"/> After sitting out in the rain |
| <input type="checkbox"/> 1st time in the morning | <input type="checkbox"/> When it is raining or wet |
| <input type="checkbox"/> Only when it is cold outside | <input type="checkbox"/> Dry or dusty conditions |
| <input type="checkbox"/> Only when it is hot outside | <input type="checkbox"/> Other: |

III. WHEN DRIVING:

- Through driveways
- Over rough roads
- Over speed bumps
- Only about ____ mph
- On acceleration
- Coming to a stop
- On turns: left, right or either (circle)
- With passengers or cargo
- Other: _____
- After driving ____ miles or ____ minutes

IV. WHAT TYPE OF NOISE

- Squeak (like tennis shoes on a clean floor)
- Creak (like walking on an old wooden floor)
- Rattle (like shaking a baby rattle)
- Knock (like a knock at the door)
- Tick (like a clock second hand)
- Thump (heavy muffled knock noise)
- Buzz (like a bumble bee)

TO BE COMPLETED BY DEALERSHIP PERSONNEL

Test Drive Notes:

	YES	NO	Initials of person performing
Vehicle test driven with customer	<input type="checkbox"/>	<input type="checkbox"/>	_____
- Noise verified on test drive	<input type="checkbox"/>	<input type="checkbox"/>	_____
- Noise source located and repaired	<input type="checkbox"/>	<input type="checkbox"/>	_____
- Follow up test drive performed to confirm repair	<input type="checkbox"/>	<input type="checkbox"/>	_____

VIN: _____ Customer Name _____

W.O.# _____ Date: _____

This form must be attached to Work Order

LATA0071E

A
B
C
D
E
F
G
H
I
J
L
M
N
O
P

GW

PRECAUTIONS

< PRECAUTION >

PRECAUTION

PRECAUTIONS

Precaution for Supplemental Restraint System (SRS) "AIR BAG" and "SEAT BELT PRE-TENSIONER"

INFOID:000000006250136

The Supplemental Restraint System such as "AIR BAG" and "SEAT BELT PRE-TENSIONER", used along with a front seat belt, helps to reduce the risk or severity of injury to the driver and front passenger for certain types of collision. This system includes seat belt switch inputs and dual stage front air bag modules. The SRS system uses the seat belt switches to determine the front air bag deployment, and may only deploy one front air bag, depending on the severity of a collision and whether the front occupants are belted or unbelted. Information necessary to service the system safely is included in the SR and SB section of this Service Manual.

WARNING:

- To avoid rendering the SRS inoperative, which could increase the risk of personal injury or death in the event of a collision which would result in air bag inflation, all maintenance must be performed by an authorized NISSAN/INFINITI dealer.
- Improper maintenance, including incorrect removal and installation of the SRS, can lead to personal injury caused by unintentional activation of the system. For removal of Spiral Cable and Air Bag Module, see the SR section.
- Do not use electrical test equipment on any circuit related to the SRS unless instructed to in this Service Manual. SRS wiring harnesses can be identified by yellow and/or orange harnesses or harness connectors.

PRECAUTIONS WHEN USING POWER TOOLS (AIR OR ELECTRIC) AND HAMMERS

WARNING:

- When working near the Airbag Diagnosis Sensor Unit or other Airbag System sensors with the Ignition ON or engine running, DO NOT use air or electric power tools or strike near the sensor(s) with a hammer. Heavy vibration could activate the sensor(s) and deploy the air bag(s), possibly causing serious injury.
- When using air or electric power tools or hammers, always switch the Ignition OFF, disconnect the battery, and wait at least 3 minutes before performing any service.

Procedure without Cowl Top Cover

INFOID:000000008178822

When performing the procedure after removing cowl top cover, cover the lower end of windshield with urethane, etc.

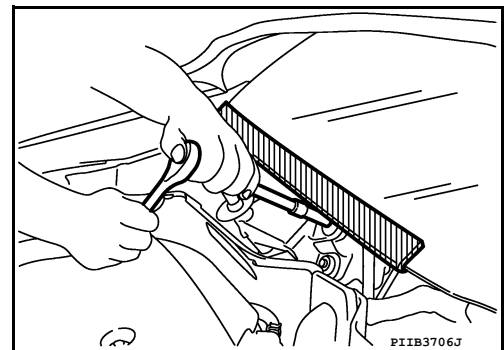

Handling for Adhesive and Primer

INFOID:000000006250137

- Do not use an adhesive which is past its usable date. Shelf life of this product is limited to six months after the date of manufacture. Carefully adhere to the expiration or manufacture date printed on the box.
- Keep primers and adhesive in a cool, dry place. Ideally, they should be stored in a refrigerator.
- Open the seal of the primer and adhesive just before application. Discard the remainder.
- Before application, be sure to shake the primer container to stir the contents. If any floating material is found, do not use it.
- If any primer or adhesive contacts the skin, wipe it off with gasoline or equivalent and wash the skin with soap.
- When using primer and adhesive, always observe the precautions in the instruction manual.

PREPARATION

< PREPARATION >

PREPARATION

PREPARATION

Special Service Tool

INFOID:000000006250138

The actual shapes of Kent-Moore tools may differ from those of special service tools illustrated here.

Tool number (Kent-Moore No.) Tool name	Description
— (J-39570) Chassis ear	Locating the noise
— (J-43980) NISSAN Squeak and Rattle Kit	Repairing the cause of noise

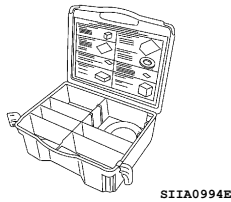
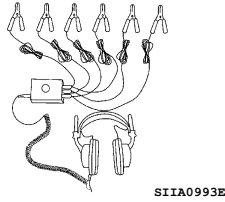

Commercial Service Tool

INFOID:000000008178893

GW

(Kent-Moore No.) Tool name	Description
(J-39565) Engine ear	Locating the noise
Suction Lifter	Holding door glass

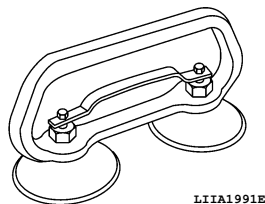
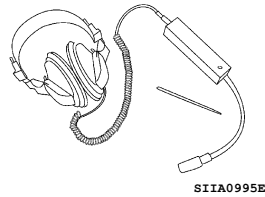

WINDSHIELD GLASS

< REMOVAL AND INSTALLATION >

REMOVAL AND INSTALLATION

WINDSHIELD GLASS

Removal and Installation

INFOID:000000006250140

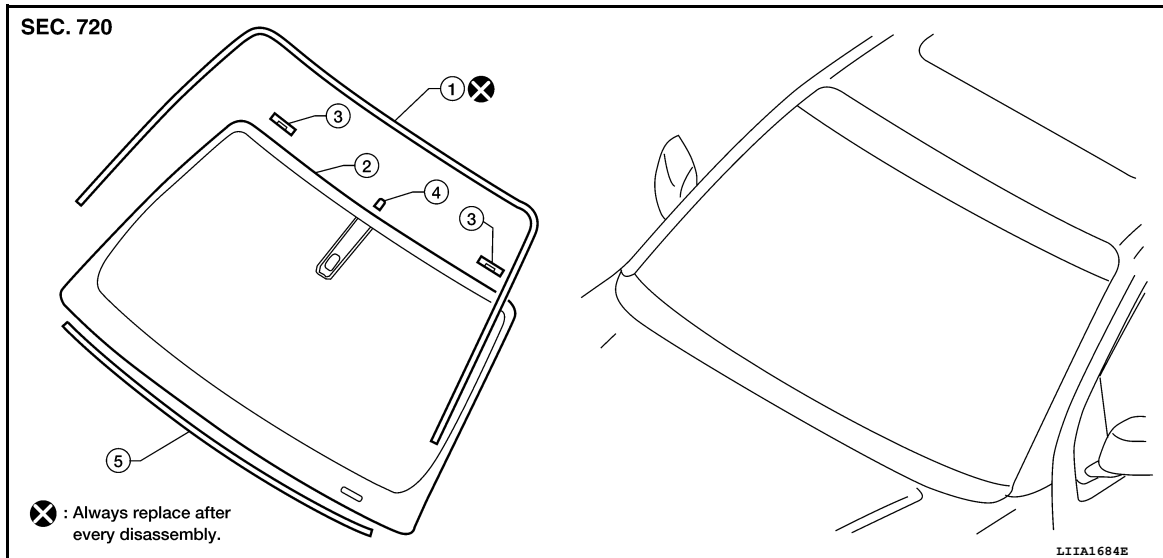

- | | | |
|----------------|---------------|-----------------------------|
| 1. Molding | 2. Windshield | 3. Windshield position pins |
| 4. Mirror base | 5. Insulator | |

REMOVAL

1. Remove inside mirror. Refer to [MIR-16, "Inside Mirror Assembly"](#).
2. Remove the front pillar upper finisher. Refer to [INT-19, "Removal and Installation"](#).
3. Remove cowl top cover. Refer to [EXT-24, "Removal and Installation"](#).
4. Remove windshield glass using piano wire or power cutting tool (A) and an inflatable pump bag (B).

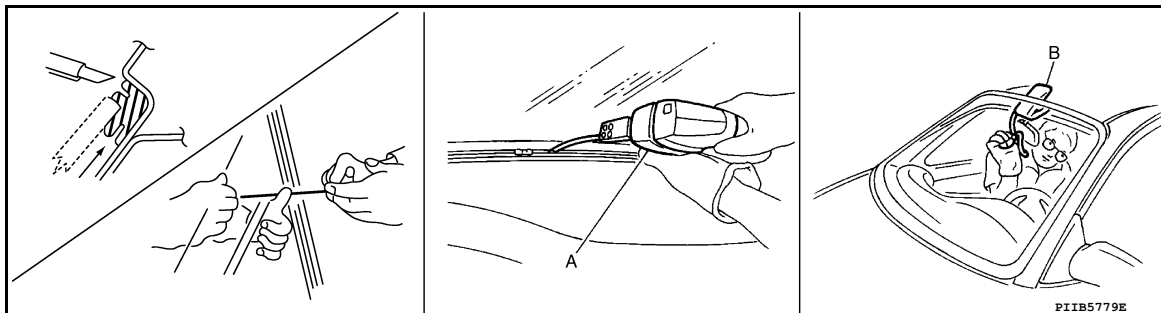

- Apply protective tape around the windshield glass to protect the painted surface from damage.
- If the windshield glass is to be reused, mark the body and the glass with mating marks.

WARNING:

When cutting the glass from the vehicle, always wear safety glasses and heavy gloves to help prevent glass splinters from entering your eyes or cutting your hands.

CAUTION:

- Be careful not to scratch the glass when removing.
- Do not set or stand glass on its edge. Small chips may develop into cracks.
- Protect the painted surface around the windshield glass from damage.

INSTALLATION

Installation is in the reverse order of removal.

WINDSHIELD GLASS

< REMOVAL AND INSTALLATION >

- Use a genuine NISSAN Urethane Adhesive Kit (if available) or equivalent and follow the instructions furnished with it.
- While the urethane adhesive is curing, open a door window. This will prevent the glass from being forced out by passenger compartment air pressure when a door is closed.
- The molding must be installed securely so that it is in position and leaves no gap.
- Inform the customer that the vehicle should remain stationary until the urethane adhesive has completely cured (preferably 24 hours). Curing time varies with temperature and humidity.

WARNING:

- **Keep heat and open flames away as primers and adhesive are flammable.**
- **The materials contained in the kit are harmful if swallowed, and may irritate skin and eyes. Avoid contact with the skin and eyes.**
- **Use in an open, well ventilated location. Avoid breathing the vapors. They can be harmful if inhaled. If affected by vapor inhalation, immediately move to an area with fresh air.**
- **Driving the vehicle before the urethane adhesive has completely cured may affect the performance of the windshield in case of an accident.**

CAUTION:

- **Do not use an adhesive which is past its usable term. Shelf life of this product is limited to six months after the date of manufacture. Carefully adhere to the expiration or manufacture date printed on the box.**
- **Keep primers and adhesive in a cool, dry place. Ideally, they should be stored in a refrigerator.**
- **Do not leave primers or adhesive cartridge unattended with their caps open or off.**
- **The vehicle should not be driven for at least 24 hours or until the urethane adhesive has completely cured. Curing time varies depending on temperature and humidities. The curing time will increase under lower temperatures and lower humidities.**

A
B
C
D
E
F
G
H
I
J
L
M
N
O
P

GW

WINDSHIELD GLASS

< REMOVAL AND INSTALLATION >

SEC. 720

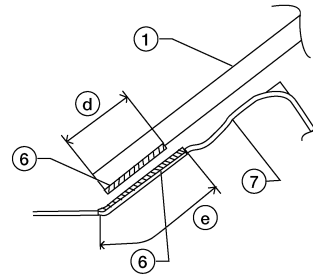
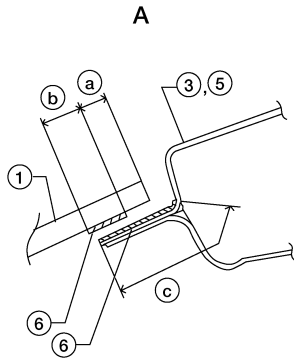
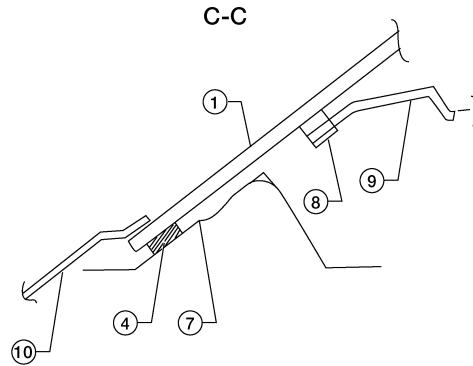
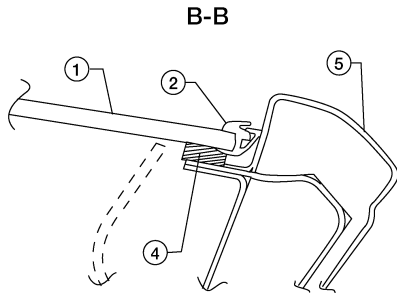
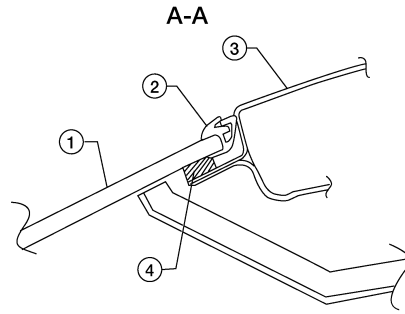
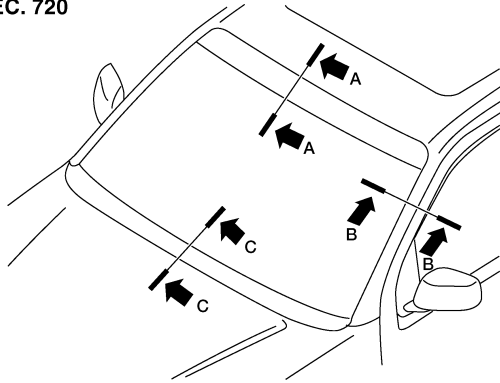

C

D

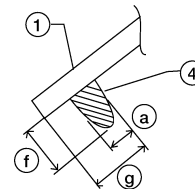
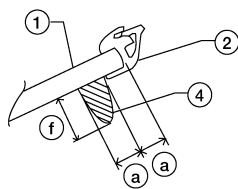

WIA1032E

- | | | |
|------------------------------|--------------------------------|-------------------------|
| 1. Windshield glass | 2. Molding | 3. Roof |
| 4. Urethane | 5. A-pillar | 6. Primer |
| 7. Cowl top panel | 8. Insulator | 9. Instrument panel |
| 10. Cowl top cover | A. Primer area (top and sides) | B. Primer area (bottom) |
| C. Bond area (top and sides) | D. Bond area (bottom) | a. 7.0 mm (0.27 in) |

WINDSHIELD GLASS

< REMOVAL AND INSTALLATION >

- | | | |
|----------------------|----------------------|----------------------|
| b. 10.0 mm (0.39 in) | c. 22.0 mm (0.86 in) | d. 20.0 mm (0.78 in) |
| e. 28.0 mm (1.10 in) | f. 12.0 mm (0.47 in) | g. 15.0 mm (0.59 in) |

A

Repairing Water Leaks for Windshield

Leaks can be repaired without removing and reinstalling glass.

If water is leaking between the urethane adhesive material and body or glass, determine the extent of leakage. This can be done by applying water to the windshield area while pushing glass outward.

To stop the leak, apply primer (if necessary) and then urethane adhesive to the leak point.

B

C

D

E

F

G

H

I

J

GW

L

M

N

O

P

REAR WINDOW GLASS AND MOLDING

< REMOVAL AND INSTALLATION >

REAR WINDOW GLASS AND MOLDING

Removal and Installation

INFOID:000000006250141

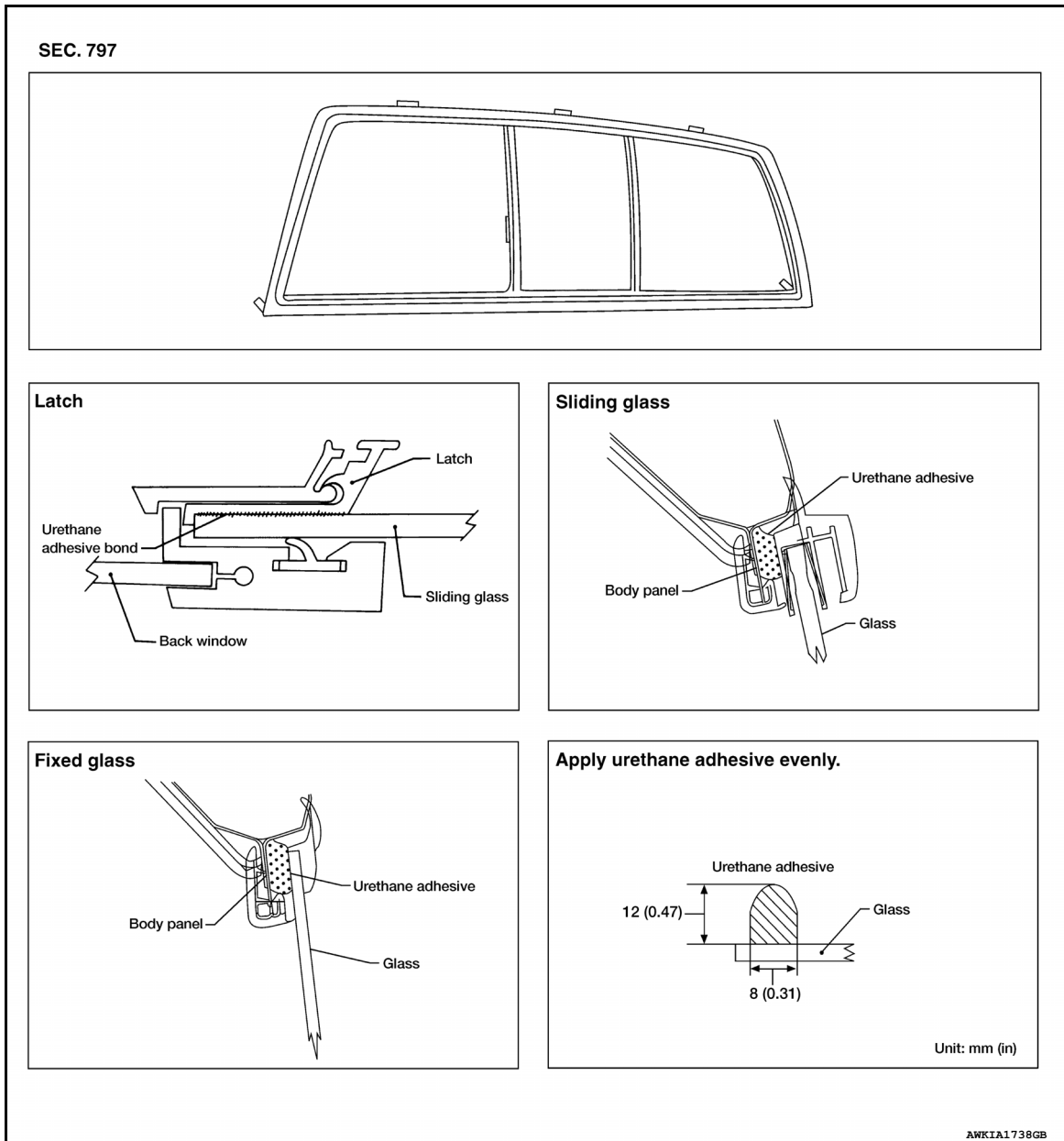

REMOVAL

1. Remove or lower the headliner. Refer to [INT-25. "Removal and Installation"](#).
2. Remove glass using piano wire or power cutting tool and an inflatable pump bag.
3. If the rear window glass is to be reused, mark the body and the glass with mating marks.

WARNING:

When cutting the glass from the vehicle, always wear safety glasses and heavy gloves to help prevent glass splinters from entering your eyes or cutting your hands.

CAUTION:

- When the rear window glass is to be reused, do not use a cutting knife or power cutting tool.
- Be careful not to scratch the glass when removing.
- Do not set or stand the glass on its edge. Small chips may develop into cracks.

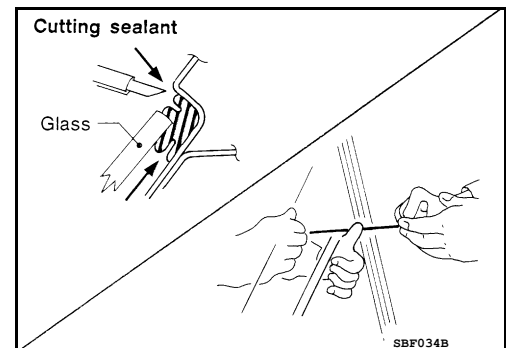

REAR WINDOW GLASS AND MOLDING

< REMOVAL AND INSTALLATION >

INSTALLATION

Installation is in the reverse order of removal.

- Use a genuine NISSAN Urethane Adhesive Kit (if available) or equivalent and follow the instructions furnished with it.
- While the urethane adhesive is curing, open a door window. This will prevent the glass from being forced out by passenger compartment air pressure when a door is closed.
- The molding must be installed securely so that it is in position and leaves no gap.
- Check gap along bottom to confirm that glass does not contact sheet metal.
- Inform the customer that the vehicle should remain stationary until the urethane adhesive has completely cured (preferably 24 hours). Curing time varies with temperature and humidity.

WARNING:

- **Keep heat and open flames away as primers and adhesive are flammable.**
- **The materials contained in the kit are harmful if swallowed, and may irritate skin and eyes. Avoid contact with the skin and eyes.**
- **Use in an open, well ventilated location. Avoid breathing the vapors. They can be harmful if inhaled. If affected by vapor inhalation, immediately move to an area with fresh air.**
- **Driving the vehicle before the urethane adhesive has completely cured may affect the performance of the rear window in case of an accident.**

CAUTION:

- **Do not use an adhesive which is past its usable term. Shelf life of this product is limited to six months after the date of manufacture. Carefully adhere to the expiration or manufacture date printed on the box.**
- **Keep primers and adhesive in a cool, dry place. Ideally, they should be stored in a refrigerator.**
- **Do not leave primers or adhesive cartridge unattended with their caps open or off.**
- **The vehicle should not be driven for at least 24 hours or until the urethane adhesive has completely cured. Curing time varies depending on temperature and humidity. The curing time will increase under lower temperatures and lower humidities.**

Repairing Water Leaks for Rear Window Glass

Leaks can be repaired without removing or reinstalling glass.

If water is leaking between urethane adhesive material and body or glass, determine the extent of leakage.

This can be done by applying water to the rear window area while pushing glass outward.

To stop leak, apply primer (if necessary) and then urethane adhesive to the leak point.

A
B
C
D
E
F
G
H
I
J
L
M
N
O
P

GW

FRONT DOOR GLASS AND REGULATOR

< REMOVAL AND INSTALLATION >

FRONT DOOR GLASS AND REGULATOR

Front Door Glass

INFOID:000000006250142

REMOVAL

1. Remove the front door finisher. Refer to [INT-15, "Removal and Installation"](#).
2. Remove the front door handle bracket.
3. Remove the vapor barrier.
4. Temporarily reconnect the power window switch (if equipped).
5. For power windows, operate the power window switch to raise/lower the door window until the glass bolts can be seen.
6. For manual windows, temporarily reinstall the window crank handle and lower the window until the glass bolts can be seen.
7. Remove the glass bolts.

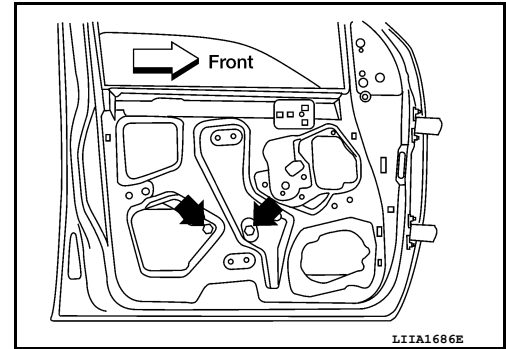

8. While holding the door window, raise it at the rear and pull the glass out of the sash toward the outside of the door.

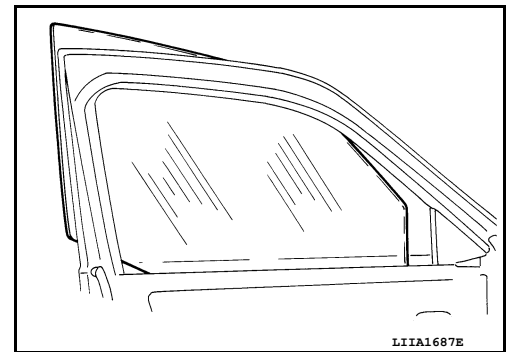

INSTALLATION

Installation is in the reverse order of removal.

Glass bolts : 6.1 N·m (0.62 kg-m, 54 in-lb)

- Check the glass for proper fit. Follow the FITTING INSPECTION procedure.
- On the drivers door, reset the motor if equipped. Follow the SETTING AFTER INSTALLATION procedure.

FITTING INSPECTION

- Check that the glass fits securely into the glass run groove.
- Lower the glass slightly [approximately 10 to 20 mm (0.39 to 0.79 in)] and check that the clearance to the sash is parallel. If the clearance between the glass and sash is not parallel, loosen the regulator bolts, guide rail bolts, and glass and guide rail bolts to adjust the glass position.

Regulator and motor or manual crank assembly bolts : 5.1 N·m (0.52 kg-m, 45 in-lb)

Glass bolts : 6.1 N·m (0.62 kg-m, 54 in-lb)

Front Door Glass Regulator

INFOID:000000006250143

REMOVAL

1. Remove the front door finisher. Refer to [INT-15, "Removal and Installation"](#).
2. Remove the front door handle bracket.
3. Remove the vapor barrier.

FRONT DOOR GLASS AND REGULATOR

< REMOVAL AND INSTALLATION >

4. Temporarily reconnect the power window switch (if equipped).
5. For power windows, operate the power window switch to raise/lower the door window until the glass bolts can be seen.
6. For manual windows, temporarily reinstall the window crank handle and lower the window until the glass bolts can be seen.
7. Remove the glass bolts.

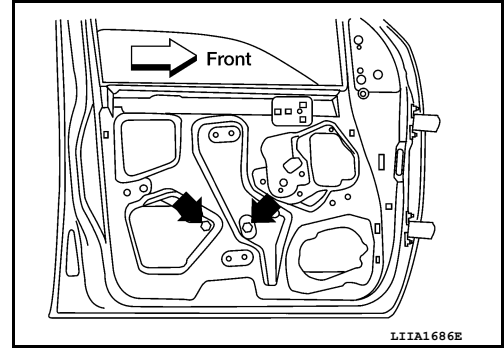

8. Raise the front door glass and hold it in place with suitable tool (A).
9. Disconnect the harness connector from the regulator assembly (if equipped).

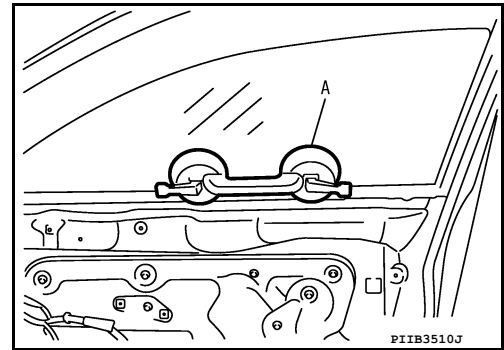

10. Remove the bolts and the regulator assembly.

NOTE:

Power window shown, manual window similar.

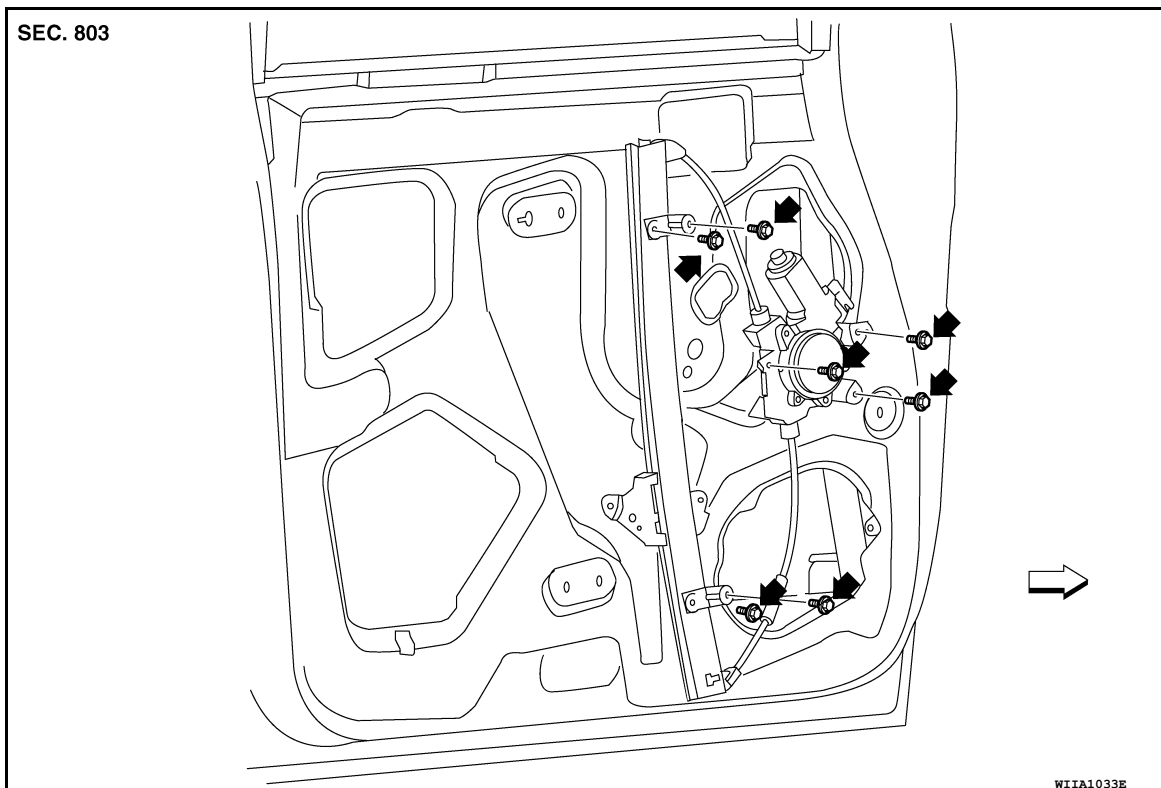

← Front

A
B
C
D
E
F
G
H
I
J
L
M
N
O
P

GW

FRONT DOOR GLASS AND REGULATOR

< REMOVAL AND INSTALLATION >

DISASSEMBLY AND ASSEMBLY

Remove the regulator motor or manual crank assembly from the regulator assembly.

INSPECTION AFTER REMOVAL

Check the regulator assembly for the following items. If a malfunction is detected, replace or grease it.

- Wire wear
- Regulator deformation
- Grease condition for each sliding part

INSTALLATION

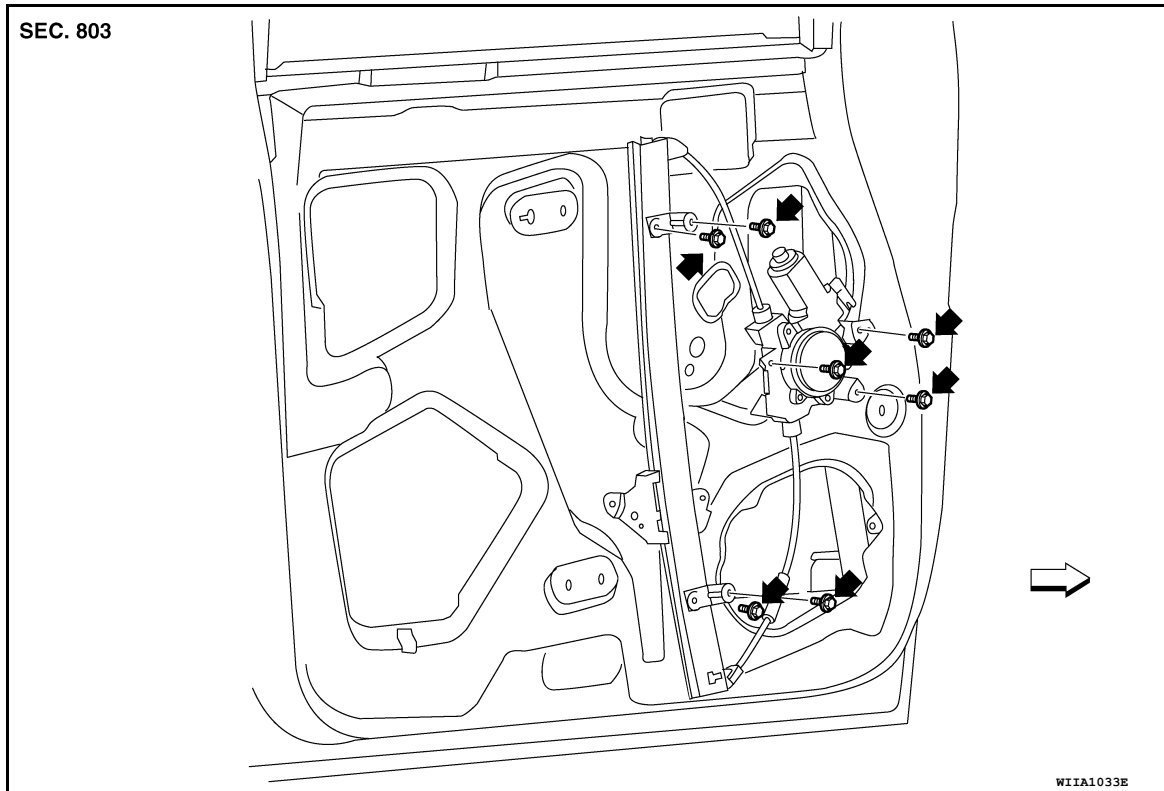

← Front

1. Install the regulator assembly.
 - a. Loosely install the top rear regulator bolt to use along with the temporary holds on the window motor or crank assembly to install the assembly in the door.
 - b. Install the top front regulator bolt.
 - c. Install the bottom front regulator bolt.
 - d. Install the bottom rear regulator bolt.
 - e. Tighten the top rear regulator bolt.
 - f. Install the top window motor or manual crank assembly bolt.
 - g. Install the lower window motor or manual crank assembly bolt
 - h. Install the rear window motor or manual crank assembly bolt.

Regulator and motor or manual crank assembly bolts : 5.1 N·m (0.52 kg-m, 45 in-lb)

2. Connect the harness connector to the regulator assembly (if equipped).

FRONT DOOR GLASS AND REGULATOR

< REMOVAL AND INSTALLATION >

3. Lower the glass and ensure that it is in both the front and rear glass channels. Tighten glass bolts.

Glass bolts : 6.1 N·m (0.62 kg-m, 54 in-lb)

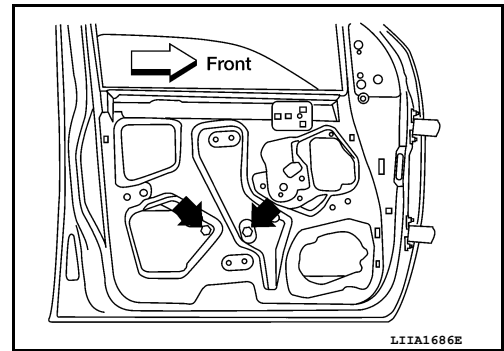

4. Check the glass for proper fit. Follow the FITTING INSPECTION procedure.
5. Install the vapor barrier.
6. Install the front door handle bracket.
7. Install front door finisher. Refer to [INT-15, "Removal and Installation"](#).

A
B
C
D
E
F
G
H
I
J
L
M
N
O
P

GW

REAR DOOR GLASS AND REGULATOR

< REMOVAL AND INSTALLATION >

REAR DOOR GLASS AND REGULATOR

Rear Door Glass

INFOID:000000006250144

REMOVAL

1. Remove the rear door finisher. Refer to [INT-15. "Removal and Installation"](#).
2. Remove the rear door handle bracket.
3. Remove the vapor barrier.
4. Remove the inside seal.
5. Temporarily reconnect the power window switch (if equipped).
6. Remove the glass run from the partition glass.
7. For power windows, operate the power window switch to raise/lower the door window until the glass bolts can be seen.
8. For manual windows, temporarily reinstall the window crank handle and lower the window until the glass bolts can be seen.
9. Remove the partition sash bolt (lower) and screw (upper) to remove the sash.
10. Remove the bolts and the glass.

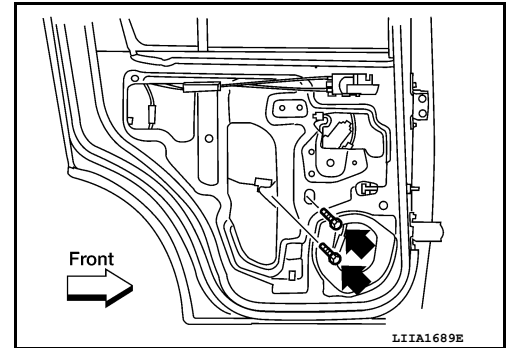

INSTALLATION

Installation is in the reverse order of removal.

Glass bolts : 6.1 N·m (0.62 kg-m, 54 in-lb)

- Check the glass alignment. Follow the FITTING INSPECTION procedure.

FITTING INSPECTION

- Check that the glass fits securely into the glass run groove.
- Lower the glass slightly [approximately 10 to 20 mm (0.39 to 0.79 in)], and check that the clearance to the sash is parallel. If the clearance between the glass and sash is not parallel, loosen the regulator bolts, guide rail bolts, and glass carrier plate bolts to adjust the glass position.

Regulator and motor or manual crank assembly bolts : 6.1 N·m (0.62 kg-m, 54 in-lb)

Glass bolts : 6.1 N·m (0.62 kg-m, 54 in-lb)

Rear Door Glass Regulator

INFOID:000000006250145

REMOVAL

1. Remove the rear door finisher. Refer to [INT-15. "Removal and Installation"](#).
2. Remove the rear door handle bracket.
3. Remove the vapor barrier.
4. Temporarily reconnect the power window switch (if equipped).

REAR DOOR GLASS AND REGULATOR

< REMOVAL AND INSTALLATION >

5. For power windows, operate the power window switch to raise/lower the door window until the glass bolts can be seen.

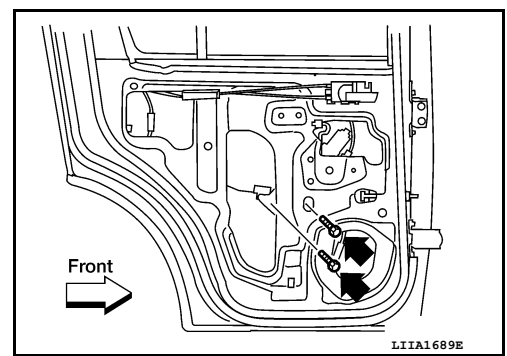

6. For manual windows, temporarily reinstall the window crank handle and lower the window until the glass bolts can be seen.
7. Raise the rear door glass and hold it in place with suitable tool (A).

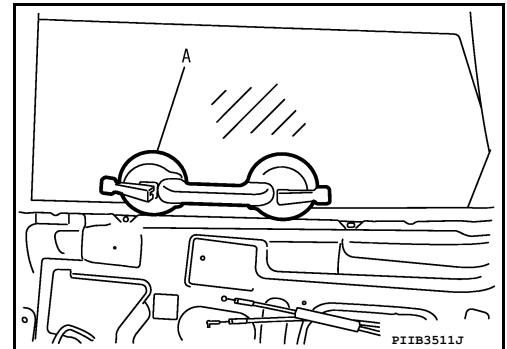

8. Remove the bolts and the regulator assembly.
- Disconnect the connector from the regulator assembly (if equipped).

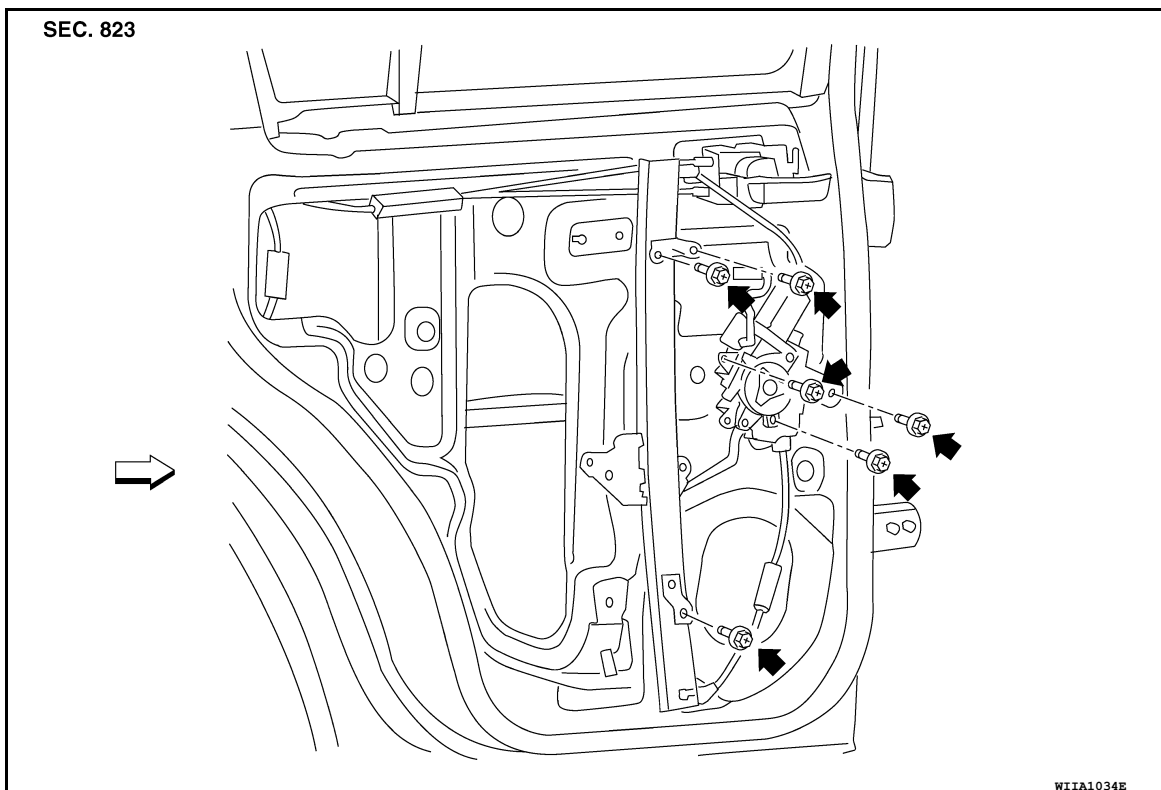

↩ Front

A
B
C
D
E
F
G
H
I
J
L
M
N
O
P

GW

REAR DOOR GLASS AND REGULATOR

< REMOVAL AND INSTALLATION >

INSPECTION AFTER REMOVAL

Check the regulator assembly for the following items. If a malfunction is detected, replace or grease it.

- Gear wear
- Regulator deformation
- Spring damage
- Grease condition for each sliding part

INSTALLATION

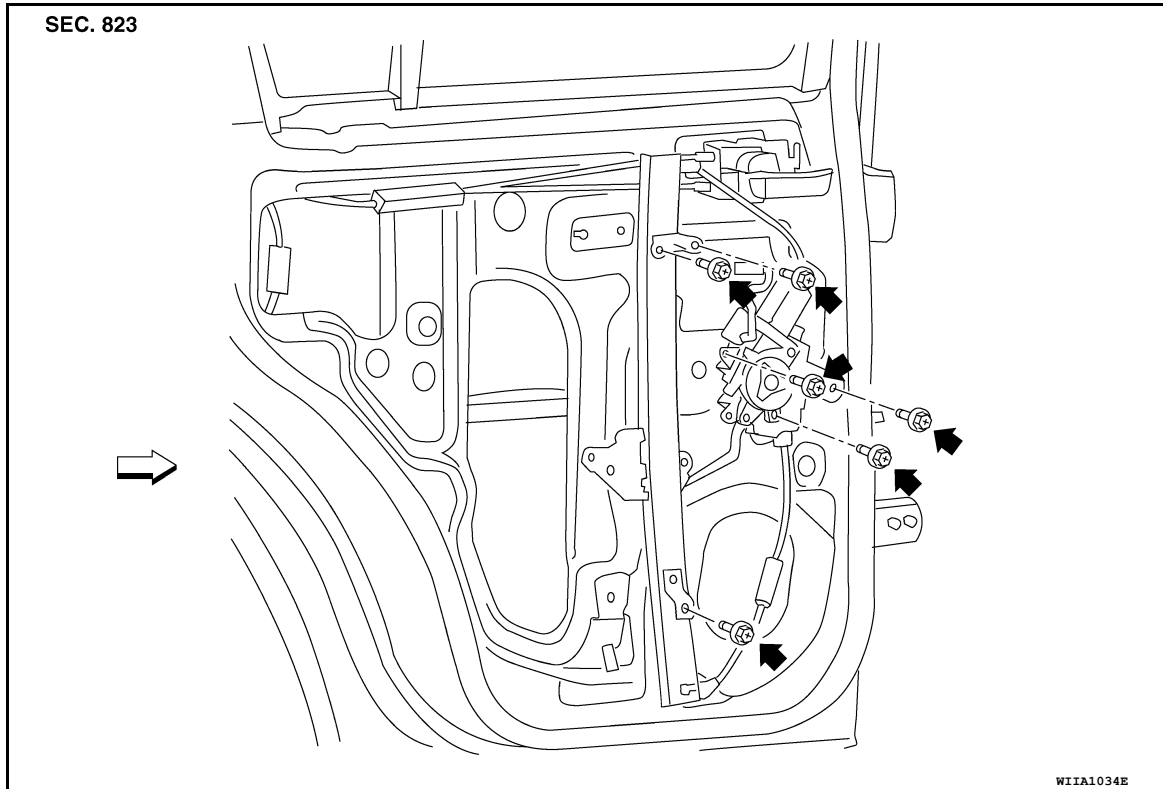

⇐ Front

1. Connect the harness connector and install the regulator assembly.
 - a. Loosely install the top rear regulator bolt to use along with the temporary holds on the window motor or manual crank assembly to install the assembly in the door.
 - b. Install the top front regulator bolt.
 - c. Install the bottom regulator bolt.
 - d. Tighten the top rear regulator bolt.
 - e. Install the top window motor or manual crank assembly bolt.
 - f. Install the lower window motor or manual crank assembly bolt.
 - g. Install the front window motor or manual crank assembly bolt.

Regulator and motor or manual crank assembly bolts : 6.1 N·m (0.62 kg-m, 54 in-lb)

REAR DOOR GLASS AND REGULATOR

< REMOVAL AND INSTALLATION >

2. Lower the glass and ensure that it is in both the front and rear glass channels. Tighten glass bolts.

Glass bolts : 6.1 N·m (0.62 kg-m, 54 in-lb)

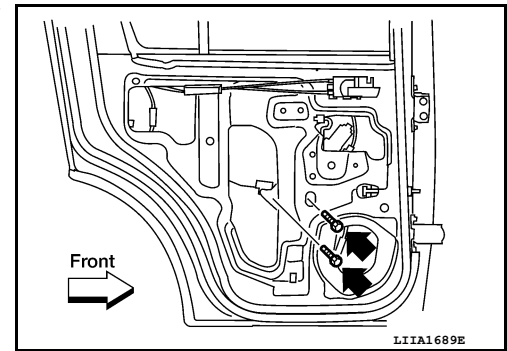

3. Install the partition sash
4. Check the glass alignment. Follow the Fitting Inspection procedure.
5. Install the inside seal.
6. Reposition the vapor barrier.
7. Install the rear door handle bracket.
8. Install the rear door finisher. Refer to [INT-15. "Removal and Installation"](#).

A
B
C
D
E
F
G
H
I
J
L
M
N
O
P

GW

SIDE WINDOW GLASS

< REMOVAL AND INSTALLATION >

SIDE WINDOW GLASS

Removal and Installation

INFOID:00000006250146

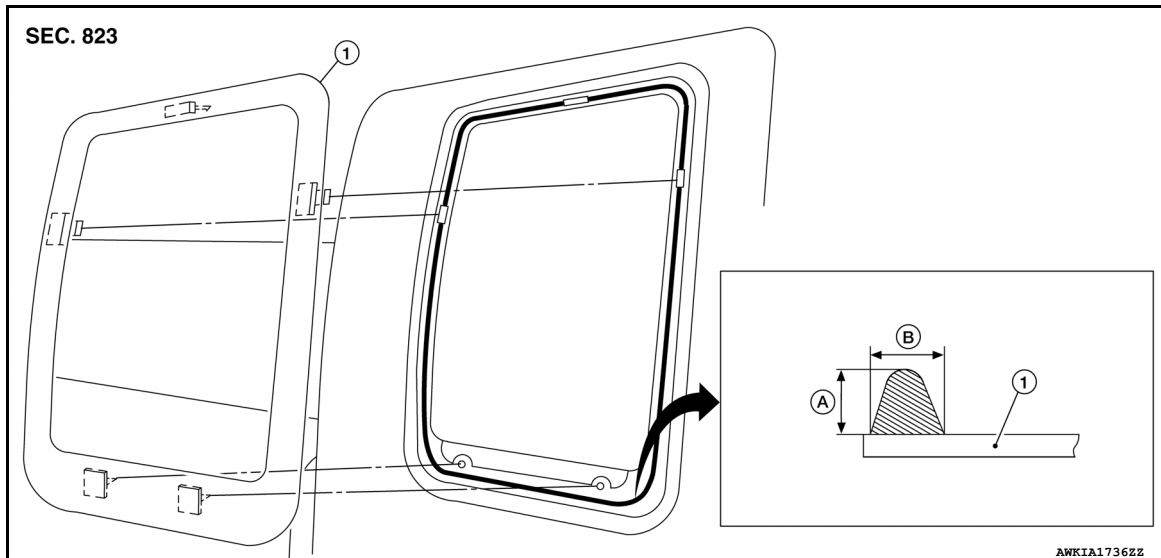

1. Side window glass

A. Urethane height: 12.0 mm (0.47 in)

B. Urethane width: 8.0 mm (0.31 in)

REMOVAL

1. Remove the rear door finisher. Refer to [INT-15, "Removal and Installation"](#).
2. Remove the side window glass using piano wire or power cutting tool as shown.
 - Apply protective tape around the side window opening to protect the painted surface from damage.
 - If the side window glass is to be reused, mark the body and the glass with mating marks.

WARNING:

When cutting the side window glass from the vehicle, always wear safety glasses and heavy gloves to help prevent glass splinters from entering your eyes or cutting your hands.

CAUTION:

- **When the side window glass is to be reused, do not use a cutting knife or power cutting tool.**
- **Be careful not to scratch the glass when removing.**
- **Do not set or stand the glass on its edge. Small chips may develop into cracks.**

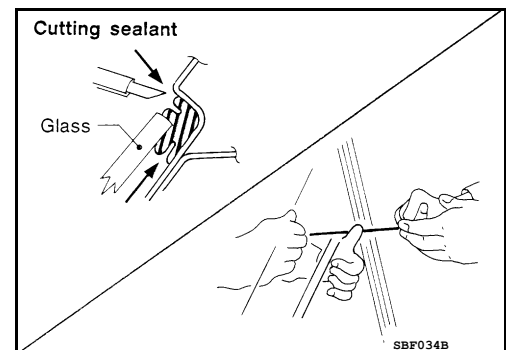

INSTALLATION

Installation is in the reverse order of removal.

- Use a genuine NISSAN Urethane Adhesive Kit (if available) or equivalent and follow the instructions furnished with it.
- While the urethane adhesive is curing, open a door window. This will prevent the glass from being forced out by passenger compartment air pressure when a door is closed.
- Check gap along bottom to confirm that glass does not contact sheet metal.
- Inform the customer that the vehicle should remain stationary until the urethane adhesive has completely cured (preferably 24 hours). Curing time varies with temperature and humidity.

WARNING:

- **Keep heat and open flames away as primers and adhesive are flammable.**
- **The materials contained in the kit are harmful if swallowed, and may irritate skin and eyes. Avoid contact with the skin and eyes.**
- **Use in an open, well ventilated location. Avoid breathing the vapors. They can be harmful if inhaled. If affected by vapor inhalation, immediately move to an area with fresh air.**

SIDE WINDOW GLASS

< REMOVAL AND INSTALLATION >

- Driving the vehicle before the urethane adhesive has completely cured may affect the performance of the glass in case of an accident.

CAUTION:

- Do not use an adhesive which is past its usable term. Shelf life of this product is limited to six months after the date of manufacture. Carefully adhere to the expiration or manufacture date printed on the box.
- Keep primers and adhesive in a cool, dry place. Ideally, they should be stored in a refrigerator.
- Do not leave primers or adhesive cartridge unattended with their caps open or off.
- The vehicle should not be driven for at least 24 hours or until the urethane adhesive has completely cured. Curing time varies depending on temperature and humidity. The curing time will increase under lower temperatures and lower humidities.

Repairing Water Leaks for Side Window Glass

Leaks can be repaired without removing or reinstalling glass.

If water is leaking between urethane adhesive material and body or glass, determine the extent of leakage.

This can be done by applying water to the side window area while pushing glass outward.

To stop leak, apply primer (if necessary) and then urethane adhesive to the leak point.

A

B

C

D

E

F

G

H

I

J

GW

L

M

N

O

P