

SECTION **MIR**
MIRRORS

A
B
C
D
E
F
G
H
I
J
K
M
N
O
P

CONTENTS

WIRING DIAGRAM	2	PREPARATION	17
DOOR MIRROR	2	PREPARATION	17
Wiring Diagram - With Heated Mirrors	2	Special Service Tool	17
Wiring Diagram - Without Heated Mirrors	6	Commercial Service Tool	17
INSIDE MIRROR	10	UNIT REMOVAL AND INSTALLATION	18
Wiring Diagram - With Homelink Universal Transceiver	10	INSIDE MIRROR	18
Wiring Diagram - Without Homelink Universal Transceiver	13	Inside Mirror Assembly	18
PRECAUTION	16	DOOR MIRROR	19
PRECAUTIONS	16	Door Mirror Assembly	19
Precaution for Supplemental Restraint System (SRS) "AIR BAG" and "SEAT BELT PRE-TENSIONER"	16	Door Mirror Glass	20
		UNIT DISASSEMBLY AND ASSEMBLY ...	21
		DOOR MIRROR	21
		Mirror Actuator	21

MIR

DOOR MIRROR

< WIRING DIAGRAM >

WIRING DIAGRAM

DOOR MIRROR

Wiring Diagram - With Heated Mirrors

INFOID:000000007327330

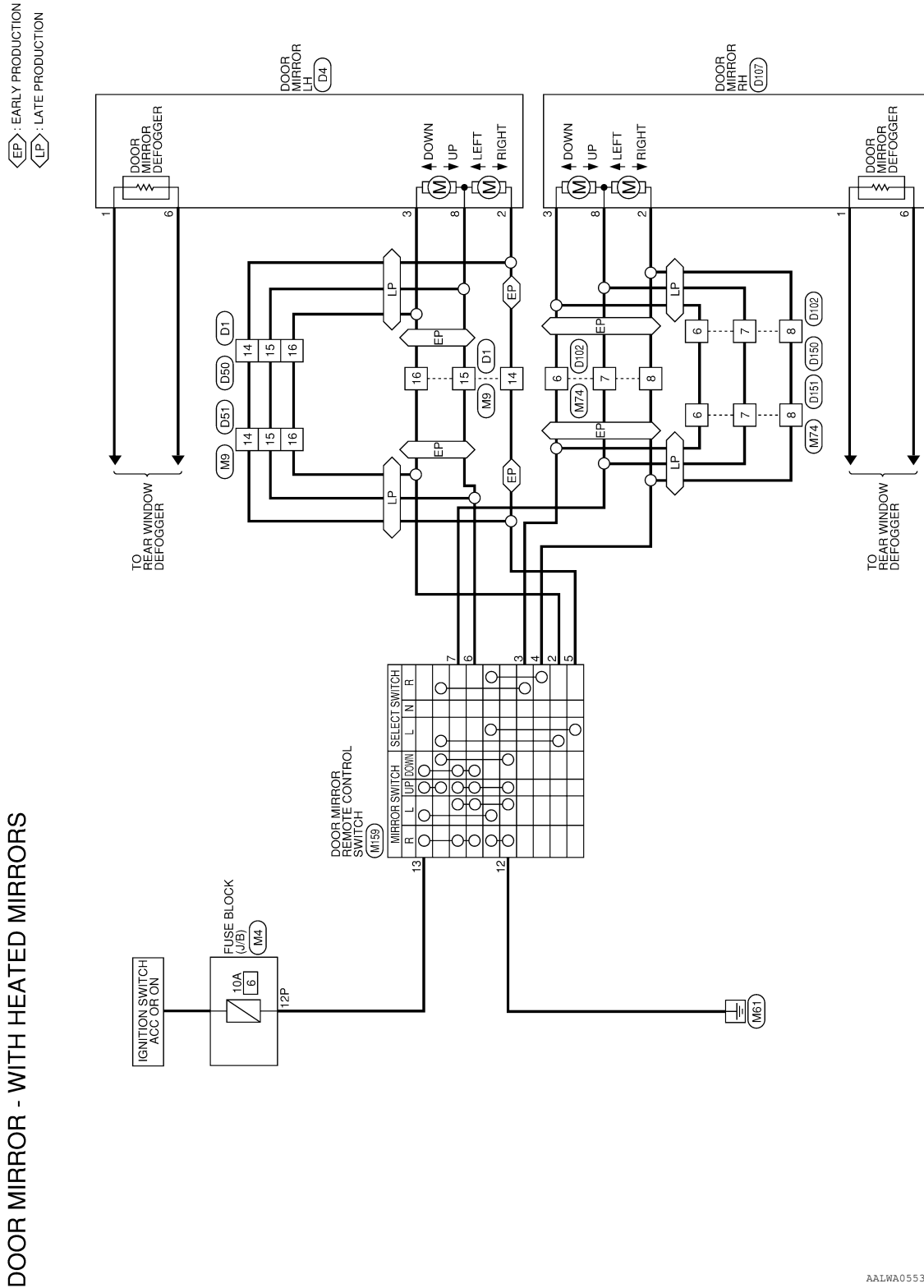

AALWA0553GB

DOOR MIRROR

< WIRING DIAGRAM >

DOOR MIRROR CONNECTORS - WITH HEATED MIRRORS

Connector No.	M4
Connector Name	FUSE BLOCK (J/B)
Connector Color	WHITE

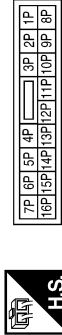

Terminal No.	Color of Wire	Signal Name
12P	G/Y	-

Connector No.	M9
Connector Name	WIRE TO WIRE
Connector Color	WHITE

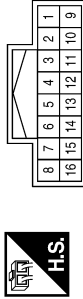

Terminal No.	Color of Wire	Signal Name
14	Y	-
15	V	-
16	L	-

Connector No.	M74
Connector Name	WIRE TO WIRE
Connector Color	WHITE

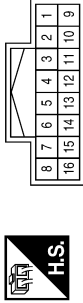

Terminal No.	Color of Wire	Signal Name
6	R	-
7	P	-
8	LG	-

Connector No.	M159
Connector Name	DOOR MIRROR REMOTE CONTROL SWITCH
Connector Color	WHITE

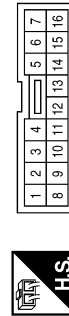

Terminal No.	Color of Wire	Signal Name
2	L	-
3	R	-

Terminal No.	Color of Wire	Signal Name
4	LG	-
5	Y	-
6	V	-
7	P	-
12	B	-
13	G/Y	-

Connector No.	D1
Connector Name	WIRE TO WIRE
Connector Color	WHITE

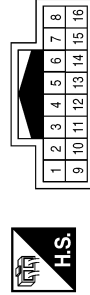

Terminal No.	Color of Wire	Signal Name
14	Y/R	-
15	V/W	-
16	L/R	-

A
B
C
D
E
F
G
H
I
J
K
M
N
O
P

MIR

AWLIA0426GB

DOOR MIRROR

< WIRING DIAGRAM >

Connector No.	D51
Connector Name	WIRE TO WIRE
Connector Color	WHITE

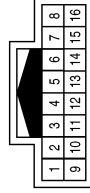

Terminal No.	Color of Wire	Signal Name
14	Y	-
15	V	-
16	L	-

Connector No.	D50
Connector Name	WIRE TO WIRE
Connector Color	WHITE

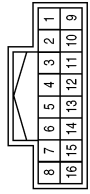

Terminal No.	Color of Wire	Signal Name
14	Y	-
15	V	-
16	L	-

Connector No.	D4
Connector Name	DOOR MIRROR LH (WITH HEATED MIRROR)
Connector Color	BLACK

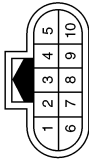

Terminal No.	Color of Wire	Signal Name
1	L/B	-
2	Y/R	-
3	L/R	-
6	B	-
8	V/W	-

Connector No.	D150
Connector Name	WIRE TO WIRE
Connector Color	WHITE

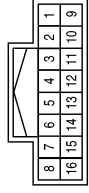

Terminal No.	Color of Wire	Signal Name
6	R	-
7	P	-
8	LG	-

Connector No.	D107
Connector Name	DOOR MIRROR RH (WITH HEATED MIRROR)
Connector Color	BLACK

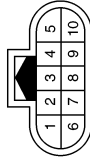

Terminal No.	Color of Wire	Signal Name
1	L/B	-
2	Y/B	-
3	L/B	-
6	B	-
8	V/W	-

Connector No.	D102
Connector Name	WIRE TO WIRE
Connector Color	WHITE

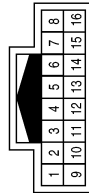

Terminal No.	Color of Wire	Signal Name
6	L/B	-
7	V/W	-
8	Y/B	-

AALIA1116GB

DOOR MIRROR

< WIRING DIAGRAM >

Connector No.	D151
Connector Name	WIRE TO WIRE
Connector Color	WHITE

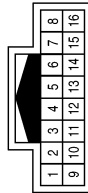

Terminal No.	Color of Wire	Signal Name
6	R	-
7	P	-
8	LG	-

AALIA1117GB

A
B
C
D
E
F
G
H
I
J
K
MIR
N
O
P

DOOR MIRROR

< WIRING DIAGRAM >

Wiring Diagram - Without Heated Mirrors

INFOID:000000007327331

◁EP> : EARLY PRODUCTION
 ▷LP> : LATE PRODUCTION

DOOR MIRROR - WITHOUT HEATED MIRRORS

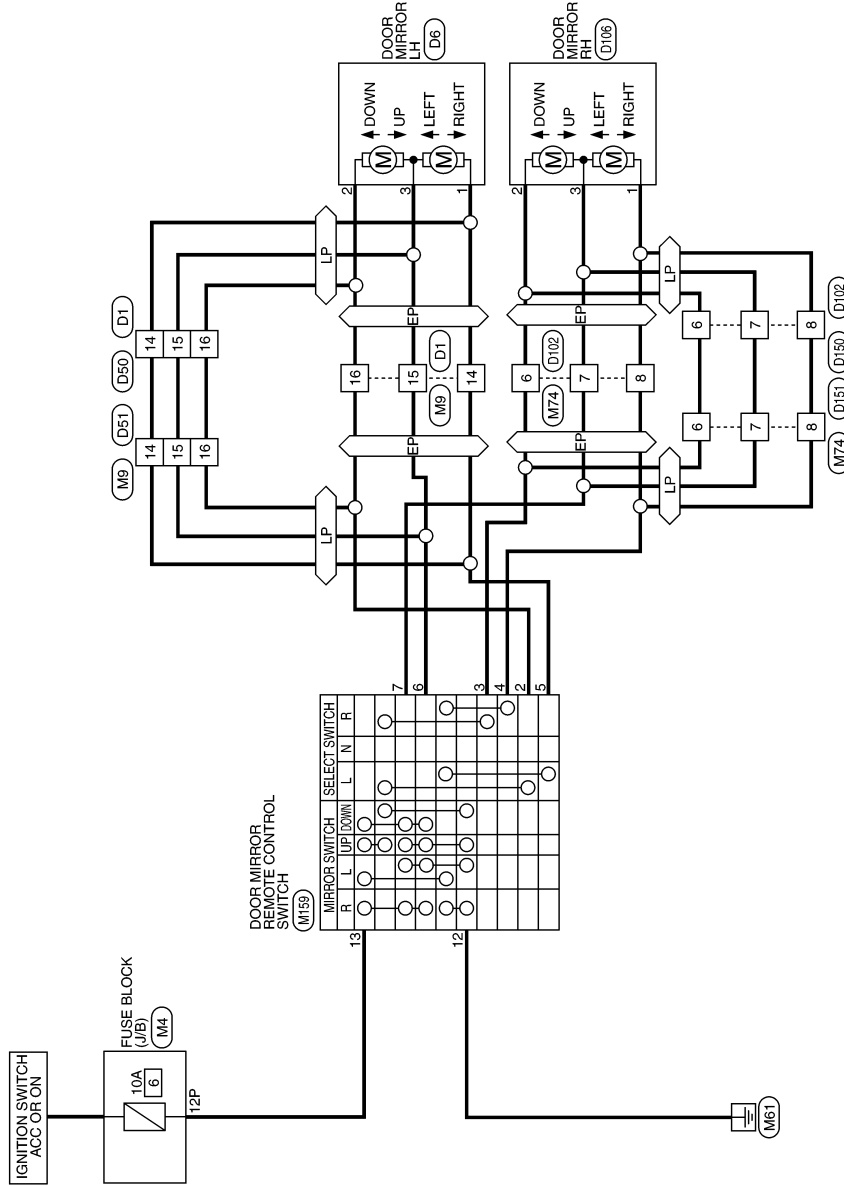

ABLWA2005GB

DOOR MIRROR

< WIRING DIAGRAM >

DOOR MIRROR CONNECTORS - WITHOUT HEATED MIRRORS

Connector No.	M4
Connector Name	FUSE BLOCK (J/B)
Connector Color	WHITE

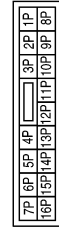

Terminal No.	Color of Wire	Signal Name
12P	G/Y	-

Connector No.	M9
Connector Name	WIRE TO WIRE
Connector Color	WHITE



Terminal No.	Color of Wire	Signal Name
14	Y	-
15	V	-
16	L	-

Connector No.	M74
Connector Name	WIRE TO WIRE
Connector Color	WHITE

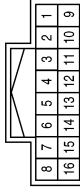

Terminal No.	Color of Wire	Signal Name
6	R	-
7	P	-
8	LG	-

Connector No.	M159
Connector Name	DOOR MIRROR REMOTE CONTROL SWITCH
Connector Color	WHITE

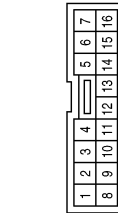

Terminal No.	Color of Wire	Signal Name
2	L	-
3	R	-

Terminal No.	Color of Wire	Signal Name
4	LG	-
5	Y	-
6	V	-
7	P	-
12	B	-
13	G/Y	-

Connector No.	D1
Connector Name	WIRE TO WIRE
Connector Color	WHITE



Terminal No.	Color of Wire	Signal Name
14	Y/R	-
15	V/W	-
16	L/R	-

ABLIA4447GB

A
B
C
D
E
F
G
H
I
J
K
L
M
N
O
P

MIR

DOOR MIRROR

< WIRING DIAGRAM >

Connector No.	D6
Connector Name	DOOR MIRROR LH (WITHOUT HEATED MIRROR)
Connector Color	BLACK



Terminal No.	Color of Wire	Signal Name
1	Y/R	-
2	L/R	-
3	V/W	-

Connector No.	D50
Connector Name	WIRE TO WIRE
Connector Color	WHITE

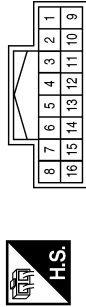

Terminal No.	Color of Wire	Signal Name
14	Y	-
15	V	-
16	L	-

Connector No.	D51
Connector Name	WIRE TO WIRE
Connector Color	WHITE

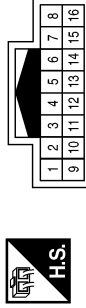

Terminal No.	Color of Wire	Signal Name
14	Y	-
15	V	-
16	L	-

Connector No.	D102
Connector Name	WIRE TO WIRE
Connector Color	WHITE

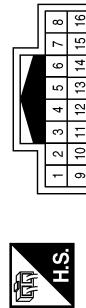

Terminal No.	Color of Wire	Signal Name
6	L/B	-
7	V/W	-
8	Y/B	-

Connector No.	D106
Connector Name	DOOR MIRROR RH (WITHOUT HEATED MIRROR)
Connector Color	BLACK



Terminal No.	Color of Wire	Signal Name
1	Y/B	-
2	L/B	-
3	V/W	-

Connector No.	D150
Connector Name	WIRE TO WIRE
Connector Color	WHITE

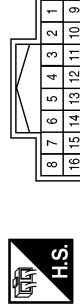

Terminal No.	Color of Wire	Signal Name
6	R	-
7	P	-
8	LG	-

DOOR MIRROR

< WIRING DIAGRAM >

Connector No.	D151
Connector Name	WIRE TO WIRE
Connector Color	WHITE

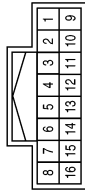

Terminal No.	Color of Wire	Signal Name
6	R	-
7	P	-
8	LG	-

A
B
C
D
E
F
G
H
I
J
K
MIR
N
O
P

ABLIA4449GB

INSIDE MIRROR

< WIRING DIAGRAM >

INSIDE MIRROR

Wiring Diagram - With Homelink Universal Transceiver

INFOID:000000007327332

INSIDE MIRROR - WITH HOMELINK UNIVERSAL TRANSCEIVER

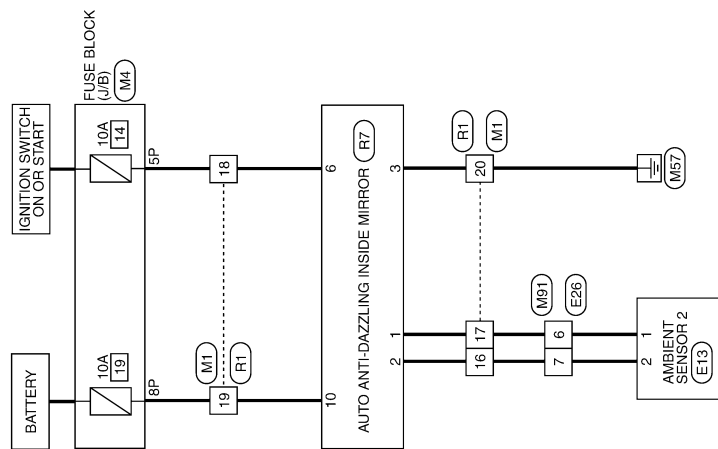

ABLWA1220GB

INSIDE MIRROR

< WIRING DIAGRAM >

INSIDE MIRROR CONNECTORS - WITH HOMELINK UNIVERSAL TRANSCIEVER

Connector No.	M1
Connector Name	WIRE TO WIRE
Connector Color	WHITE

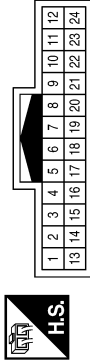

Terminal No.	Color of Wire	Signal Name
16	V	-
17	LG	-
18	W/G	-
19	R/Y	-
20	B	-

Connector No.	M4
Connector Name	FUSE BLOCK (J/B)
Connector Color	WHITE



Terminal No.	Color of Wire	Signal Name
5P	W/G	-
8P	R/Y	-

Connector No.	M91
Connector Name	WIRE TO WIRE
Connector Color	WHITE

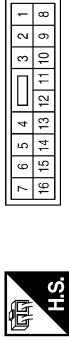

Terminal No.	Color of Wire	Signal Name
6	LG	-
7	V	-

Connector No.	E13
Connector Name	AMBIENT SENSOR 2
Connector Color	BLACK



Terminal No.	Color of Wire	Signal Name
1	LG	TEMP +
2	V	TEMP -

Connector No.	E26
Connector Name	WIRE TO WIRE
Connector Color	WHITE

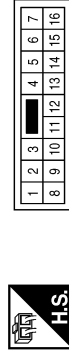

Terminal No.	Color of Wire	Signal Name
6	LG	-
7	V	-

Connector No.	R1
Connector Name	WIRE TO WIRE
Connector Color	WHITE

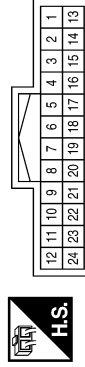

Terminal No.	Color of Wire	Signal Name
16	V	-
17	LG	-
18	W/G	-
19	R/Y	-
20	B	-

A
B
C
D
E
F
G
H
I
J
K
L
M
N
O
P

MIR

INSIDE MIRROR

< WIRING DIAGRAM >

Connector No.	R7
Connector Name	AUTO ANTI-DAZZLING INSIDE MIRROR (WITH HOMELINK UNIVERSAL TRANSCIEVER)
Connector Color	BLACK

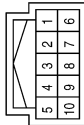

Terminal No.	Color of Wire	Signal Name
1	LG	TEMP +
2	V	TEMP -
3	B	GND
6	W/G	IGN
10	R/Y	B

ABLIA2820GB

INSIDE MIRROR

< WIRING DIAGRAM >

Wiring Diagram - Without Homelink Universal Transceiver

INFOID:000000007327333

INSIDE MIRROR - WITHOUT HOMELINK UNIVERSAL TRANSCEIVER

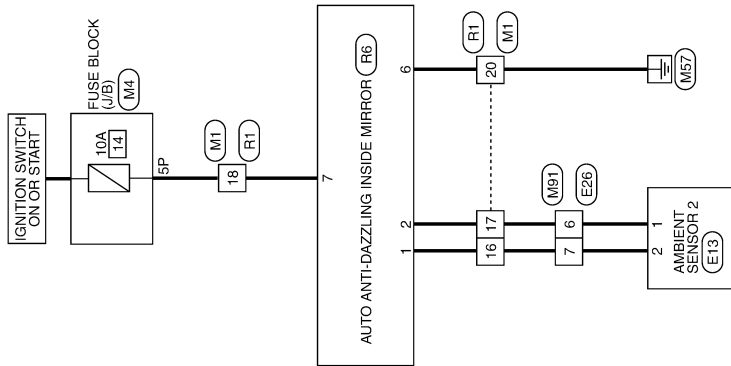

A
B
C
D
E
F
G
H
I
J
K
M
N
O
P

MIR

ABLWA1219GB

INSIDE MIRROR

< WIRING DIAGRAM >

INSIDE MIRROR CONNECTORS - WITHOUT HOMELINK UNIVERSAL TRANSCIEVER

Connector No.	M1
Connector Name	WIRE TO WIRE
Connector Color	WHITE

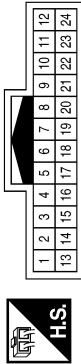

Terminal No.	Color of Wire	Signal Name
16	V	-
17	LG	-
18	W/G	-
20	B	-

Connector No.	M4
Connector Name	FUSE BLOCK (J/B)
Connector Color	WHITE

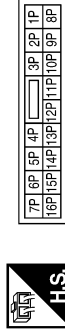

Terminal No.	Color of Wire	Signal Name
5P	W/G	-

Connector No.	M91
Connector Name	WIRE TO WIRE
Connector Color	WHITE

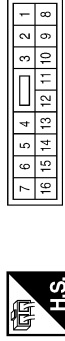

Terminal No.	Color of Wire	Signal Name
6	LG	-
7	V	-

Connector No.	E13
Connector Name	AMBIENT SENSOR 2
Connector Color	BLACK



Terminal No.	Color of Wire	Signal Name
1	LG	TEMP +
2	V	TEMP -

Connector No.	E26
Connector Name	WIRE TO WIRE
Connector Color	WHITE

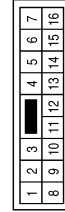

Terminal No.	Color of Wire	Signal Name
6	LG	-
7	V	-

Connector No.	R1
Connector Name	WIRE TO WIRE
Connector Color	WHITE

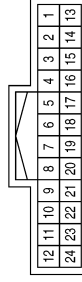

Terminal No.	Color of Wire	Signal Name
16	V	-
17	LG	-
18	W/G	-
20	B	-

INSIDE MIRROR

< WIRING DIAGRAM >

A
B
C
D
E
F
G
H
I
J
K
M
N
O
P

Connector No.	R6
Connector Name	AUTO ANTI-DAZZLING INSIDE MIRROR (WITHOUT HOMELINK UNIVERSAL TRANSCIEVER)
Connector Color	WHITE

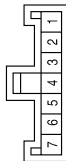

Terminal No.	Color of Wire	Signal Name
1	V	TEMP -
2	LG	TEMP +
6	B	GND
7	W/G	IGN

MIR

ABLIA2818GB

PRECAUTIONS

< PRECAUTION >

PRECAUTION

PRECAUTIONS

Precaution for Supplemental Restraint System (SRS) "AIR BAG" and "SEAT BELT PRE-TENSIONER"

INFOID:000000007327334

The Supplemental Restraint System such as "AIR BAG" and "SEAT BELT PRE-TENSIONER", used along with a front seat belt, helps to reduce the risk or severity of injury to the driver and front passenger for certain types of collision. This system includes seat belt switch inputs and dual stage front air bag modules. The SRS system uses the seat belt switches to determine the front air bag deployment, and may only deploy one front air bag, depending on the severity of a collision and whether the front occupants are belted or unbelted. Information necessary to service the system safely is included in the SR and SB section of this Service Manual.

WARNING:

- To avoid rendering the SRS inoperative, which could increase the risk of personal injury or death in the event of a collision which would result in air bag inflation, all maintenance must be performed by an authorized NISSAN/INFINITI dealer.
- Improper maintenance, including incorrect removal and installation of the SRS, can lead to personal injury caused by unintentional activation of the system. For removal of Spiral Cable and Air Bag Module, see the SR section.
- Do not use electrical test equipment on any circuit related to the SRS unless instructed to in this Service Manual. SRS wiring harnesses can be identified by yellow and/or orange harnesses or harness connectors.

PRECAUTIONS WHEN USING POWER TOOLS (AIR OR ELECTRIC) AND HAMMERS

WARNING:

- When working near the Airbag Diagnosis Sensor Unit or other Airbag System sensors with the Ignition ON or engine running, DO NOT use air or electric power tools or strike near the sensor(s) with a hammer. Heavy vibration could activate the sensor(s) and deploy the air bag(s), possibly causing serious injury.
- When using air or electric power tools or hammers, always switch the Ignition OFF, disconnect the battery, and wait at least 3 minutes before performing any service.

PREPARATION

< PREPARATION >

PREPARATION

PREPARATION

Special Service Tool

INFOID:000000007327335

The actual shapes of Kent-Moore tools may differ from those of special service tools illustrated here.

Tool number (Kent-Moore No.) Tool name	Description
— (J-39570) Chassis ear	Locating the noise
— (J-43980) NISSAN Squeak and Rattle Kit	Repairing the cause of noise

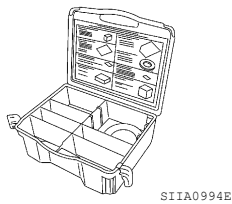
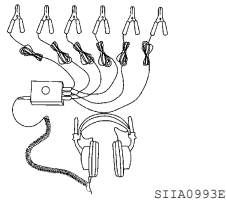

Commercial Service Tool

INFOID:000000007327336

(Kent-Moore No.) Tool name	Description
(J-39565) Engine ear	Locating the noise

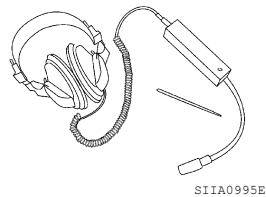

A
B
C
D
E
F
G
H
I
J
K
M
N
O
P

MIR

INSIDE MIRROR

< UNIT REMOVAL AND INSTALLATION >

UNIT REMOVAL AND INSTALLATION

INSIDE MIRROR

Inside Mirror Assembly

INFOID:000000007815413

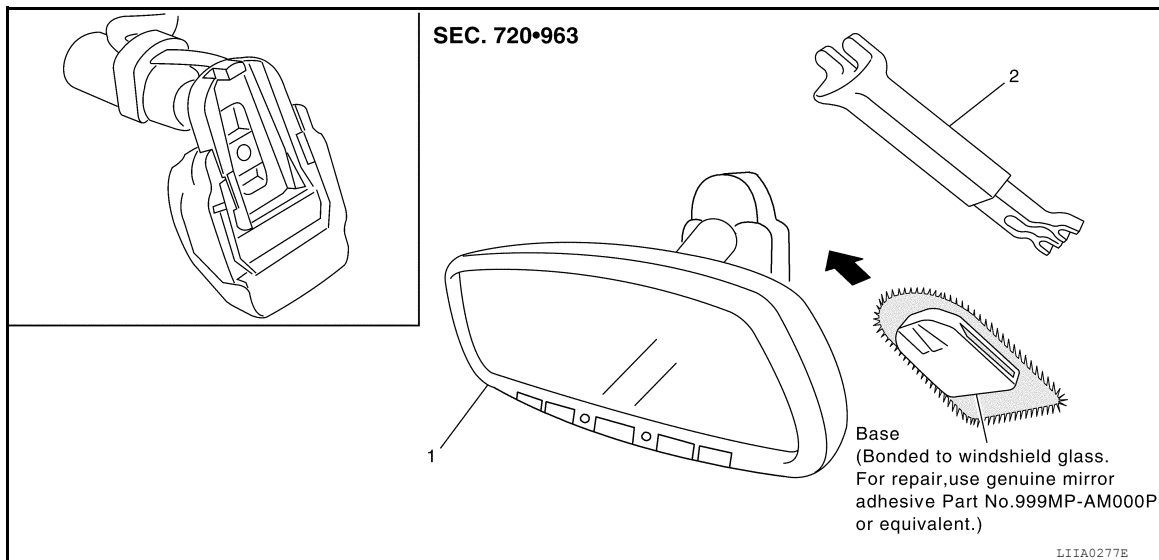

1. Inside mirror

2. Inside mirror finisher (If equipped)

REMOVAL

1. Remove the mirror finisher (if equipped).
2. Remove the screw and slide the mirror upward to remove.
3. Disconnect the connector (if equipped).
4. Remove the mirror.

INSTALLATION

Installation is in the reverse order of removal.

DOOR MIRROR

< UNIT REMOVAL AND INSTALLATION >

DOOR MIRROR

Door Mirror Assembly

INFOID:000000007327339

EXPLODED VIEW

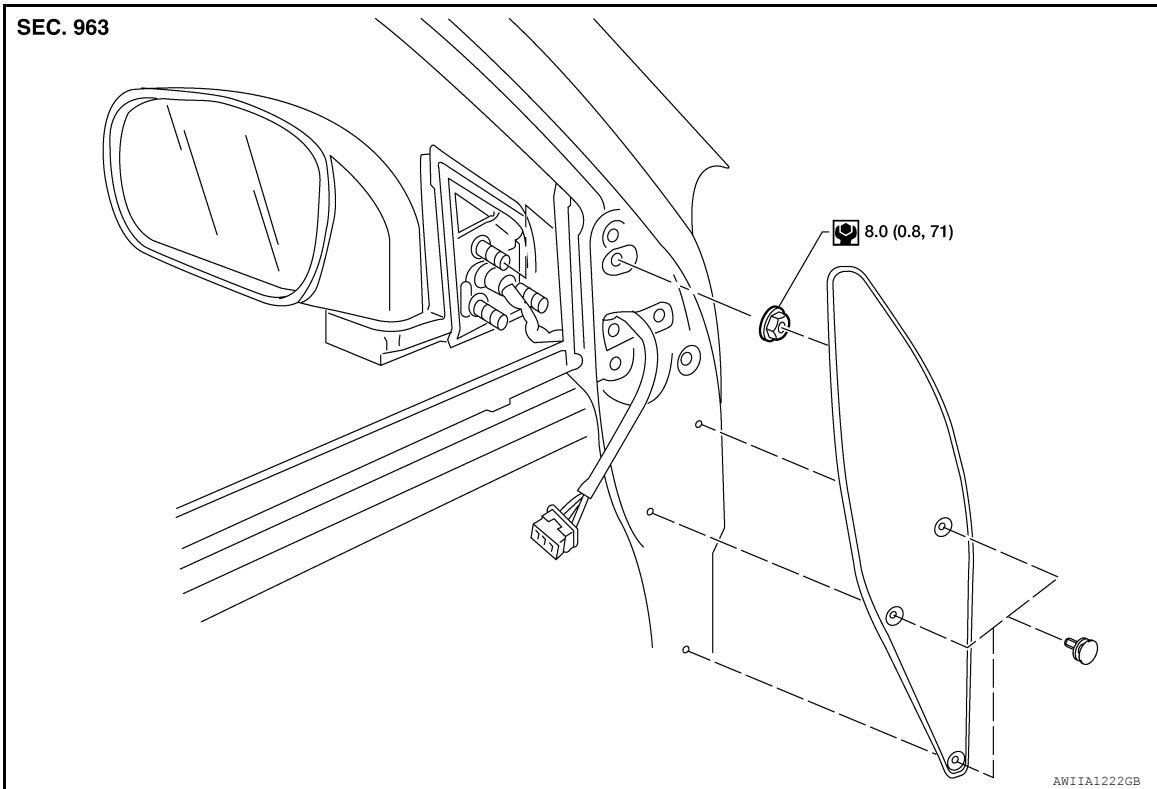

NOTE:

Power mirror shown, manual mirror similar.

MANUAL MIRROR

CAUTION:

Be careful not to damage the mirror body.

Removal

1. Remove the front door sash cover.
2. Remove the front door finisher. Refer to [INT-15, "Removal and Installation"](#).
3. Remove the nuts and the door mirror assembly.

Installation

Installation is in the reverse order of removal

POWER MIRROR

CAUTION:

Be careful not to damage the mirror body.

Removal

1. Remove the front door sash cover.
2. Remove the front door finisher. Refer to [INT-15, "Removal and Installation"](#).
3. Disconnect the door mirror harness connector.
4. Remove the nuts and the door mirror assembly.

Installation

Installation is in the reverse order of removal.

A
B
C
D
E
F
G
H
I
J
K
M
N
O
P

MIR

DOOR MIRROR

< UNIT REMOVAL AND INSTALLATION >

Door Mirror Glass

INFOID:000000007327340

REMOVAL

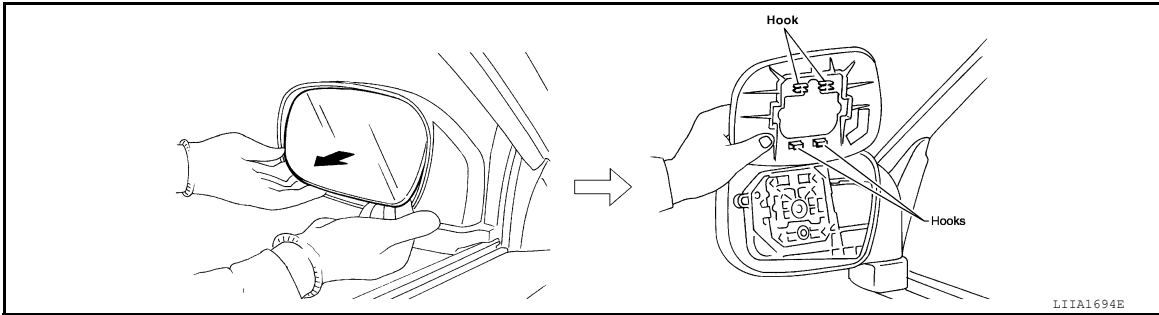

1. Angle the mirror fully up.
2. Remove the door mirror.
 - Pull from the bottom to disengage the clips.
 - Continue to pivot the mirror upward from the bottom to separate the hooks.
 - Disconnect the harness connectors (if equipped).

INSTALLATION

Installation is in the reverse order of removal.

DOOR MIRROR

< UNIT DISASSEMBLY AND ASSEMBLY >

UNIT DISASSEMBLY AND ASSEMBLY

DOOR MIRROR

Mirror Actuator

INFOID:000000007327341

DISASSEMBLY AND ASSEMBLY

Disassembly

1. Remove the door mirror glass. Refer to [MIR-20. "Door Mirror Glass"](#)
2. Remove the screws (A) and release the actuator from housing (B).

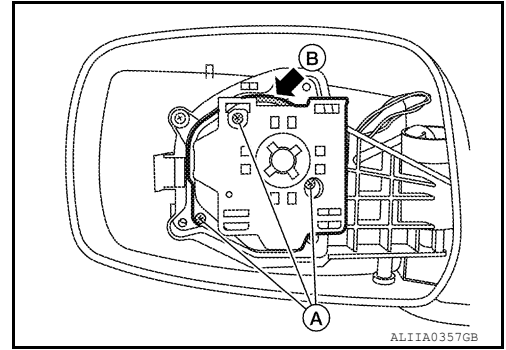

3. Disconnect the connectors (A) and remove the actuator (1).

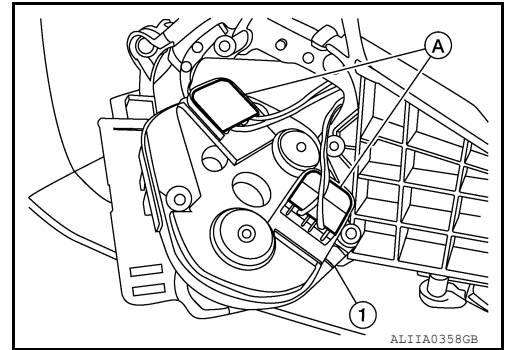

Assembly

Assembly is the reverse order of disassembly.

A
B
C
D
E
F
G
H
I
J
K
M
N
O
P

MIR