

SECTION **AV**

AUDIO, VISUAL & NAVIGATION SYSTEM

CONTENTS

BASE AUDIO (EXCEPT MEXICO)	
BASIC INSPECTION	7
DIAGNOSIS AND REPAIR WORKFLOW	7
Work Flow	7
SYSTEM DESCRIPTION	9
AUDIO SYSTEM	9
System Diagram	9
System Description	9
Component Parts Location	10
Component Description	11
DTC/CIRCUIT DIAGNOSIS	12
POWER SUPPLY AND GROUND CIRCUIT	12
AUDIO UNIT	12
AUDIO UNIT : Diagnosis Procedure	12
BLUETOOTH® CONTROL UNIT	12
BLUETOOTH® CONTROL UNIT : Diagnosis Procedure	12
MICROPHONE	13
MICROPHONE : Diagnosis Procedure	13
FRONT DOOR SPEAKER	15
Description	15
Diagnosis Procedure	15
FRONT TWEETER	17
Description	17
Diagnosis Procedure	17
REAR DOOR SPEAKER	19
Description	19
Diagnosis Procedure	19
STEERING SWITCH	21
Diagnosis Procedure	21
MICROPHONE SIGNAL CIRCUIT	23
Diagnosis Procedure	23
ECU DIAGNOSIS INFORMATION	25
AUDIO UNIT	25
Reference Value	25
BLUETOOTH® CONTROL UNIT	28
Reference Value	28
WIRING DIAGRAM	30
BASE AUDIO SYSTEM	30
Wiring Diagram	30
SYMPTOM DIAGNOSIS	41
AUDIO SYSTEM	41
Symptom Table	41
NORMAL OPERATING CONDITION	44
Description	44
PRECAUTION	46
PRECAUTIONS	46
Precaution for Supplemental Restraint System (SRS) "AIR BAG" and "SEAT BELT PRE-TENSIONER"	46
Precaution for Trouble Diagnosis	46
Precaution for Harness Repair	46
Precaution for Work	47
PREPARATION	48
PREPARATION	48
Special Service Tool	48
Commercial Service Tools	48
REMOVAL AND INSTALLATION	49
AUDIO UNIT	49

A
B
C
D
E
F
G
H
I
J
K
L
M
AV
O
P

Removal and Installation	49	BASE AUDIO SYSTEM	72
FRONT TWEETER	50	Wiring Diagram	72
Removal and Installation	50	SYMPTOM DIAGNOSIS	78
FRONT DOOR SPEAKER	51	AUDIO SYSTEM	78
Removal and Installation	51	Symptom Table	78
REAR DOOR SPEAKER	52	NORMAL OPERATING CONDITION	80
Removal and Installation	52	Description	80
STEERING SWITCH	53	PRECAUTION	81
Removal and Installation	53	PRECAUTIONS	81
BLUETOOTH CONTROL UNIT	54	Precaution for Supplemental Restraint System (SRS) "AIR BAG" and "SEAT BELT PRE-TEN- SIONER"	81
Removal and Installation	54	Precaution for Trouble Diagnosis	81
MICROPHONE	56	Precaution for Harness Repair	81
Removal and Installation	56	Precaution for Work	82
AUDIO ANTENNA	57	PREPARATION	83
Location of Antenna	57	PREPARATION	83
Removal and Installation	57	Special Service Tool	83
BASE AUDIO (FOR MEXICO)		Commercial Service Tools	83
BASIC INSPECTION	59	REMOVAL AND INSTALLATION	84
DIAGNOSIS AND REPAIR WORKFLOW	59	AUDIO UNIT	84
Work Flow	59	Removal and Installation	84
SYSTEM DESCRIPTION	61	FRONT TWEETER	85
AUDIO SYSTEM	61	Removal and Installation	85
System Diagram	61	FRONT DOOR SPEAKER	86
System Description	61	Removal and Installation	86
Component Parts Location	62	REAR DOOR SPEAKER	87
Component Description	62	Removal and Installation	87
DTC/CIRCUIT DIAGNOSIS	63	AUDIO ANTENNA	88
POWER SUPPLY AND GROUND CIRCUIT	63	Location of Antenna	88
AUDIO UNIT	63	Removal and Installation	88
AUDIO UNIT : Diagnosis Procedure	63	DISPLAY AUDIO WITHOUT AMPLIFIER	
FRONT DOOR SPEAKER	64	SYSTEM DESCRIPTION	90
Description	64	COMPONENT PARTS	90
Diagnosis Procedure	64	Component Parts Location	90
FRONT TWEETER	66	Component Description	91
Description	66	SYSTEM	92
Diagnosis Procedure	66	System Diagram	92
REAR DOOR SPEAKER	68	System Description	92
Description	68	DIAGNOSIS SYSTEM (AUDIO UNIT)	94
Diagnosis Procedure	68	Description	94
ECU DIAGNOSIS INFORMATION	70	On Board Diagnosis Function	94
AUDIO UNIT	70	ECU DIAGNOSIS INFORMATION	99
Reference Value	70	AUDIO UNIT	99
WIRING DIAGRAM	72		

Reference Value	99	Precaution for Supplemental Restraint System (SRS) "AIR BAG" and "SEAT BELT PRE-TENSIONER"	143	A
BLUETOOTH® CONTROL UNIT	102	Precaution for Trouble Diagnosis	143	B
Reference Value	102	Precaution for Harness Repair	143	
WIRING DIAGRAM	104	Precaution for Work	144	
DISPLAY AUDIO WITHOUT AMPLIFIER	104	PREPARATION	145	C
Wiring Diagram	104	PREPARATION	145	
BASIC INSPECTION	120	Special Service Tools	145	D
DIAGNOSIS AND REPAIR WORKFLOW	120	Commercial Service Tools	145	
Work Flow	120	REMOVAL AND INSTALLATION	146	E
DTC/CIRCUIT DIAGNOSIS	122	AUDIO UNIT	146	
POWER SUPPLY AND GROUND CIRCUIT	122	Removal and Installation	146	F
AUDIO UNIT	122	FRONT TWEETER	147	
AUDIO UNIT : Diagnosis Procedure	122	Removal and Installation	147	G
BLUETOOTH® CONTROL UNIT	122	FRONT DOOR SPEAKER	148	
BLUETOOTH® CONTROL UNIT : Diagnosis Procedure	122	Removal and Installation	148	H
MICROPHONE	123	REAR DOOR SPEAKER	149	
MICROPHONE : Diagnosis Procedure	123	Removal and Installation	149	I
FRONT DOOR SPEAKER	125	STEERING SWITCH	150	
Diagnosis Procedure	125	Removal and Installation	150	J
FRONT TWEETER	127	BLUETOOTH CONTROL UNIT	151	
Diagnosis Procedure	127	Removal and Installation	151	K
REAR DOOR SPEAKER	129	MICROPHONE	153	
Diagnosis Procedure	129	Removal and Installation	153	L
REAR VIEW CAMERA IMAGE SIGNAL CIRCUIT	131	AUDIO ANTENNA	154	
Diagnosis Procedure	131	Location of Antenna	154	M
STEERING SWITCH	133	Removal and Installation	154	
Diagnosis Procedure	133	SATELLITE RADIO ANTENNA	156	
MICROPHONE SIGNAL CIRCUIT	135	Removal and Installation	156	
Diagnosis Procedure	135	USB CONNECTOR	157	
USB CONNECTOR	137	Removal and Installation	157	
Diagnosis Procedure	137	REAR VIEW CAMERA	158	
SYMPTOM DIAGNOSIS	138	Removal and Installation	158	AV
AUDIO SYSTEM	138	DISPLAY AUDIO WITH AMPLIFIER		
Symptom Table	138	SYSTEM DESCRIPTION	159	O
NORMAL OPERATING CONDITION	141	COMPONENT PARTS	159	
Description	141	Component Parts Location	159	P
PRECAUTION	143	Component Description	160	
PRECAUTIONS	143	SYSTEM	161	
		System Diagram	161	
		System Description	161	
		DIAGNOSIS SYSTEM (AUDIO UNIT)	163	
		Description	163	
		On Board Diagnosis Function	163	

ECU DIAGNOSIS INFORMATION	169	Diagnosis Procedure	221
AUDIO UNIT	169	USB CONNECTOR	223
Reference Value	169	Diagnosis Procedure	223
AUDIO AMP	172	SYMPTOM DIAGNOSIS	224
Reference Value	172	AUDIO SYSTEM	224
BLUETOOTH® CONTROL UNIT	175	Symptom Table	224
Reference Value	175	NORMAL OPERATING CONDITION	228
WIRING DIAGRAM	177	Description	228
DISPLAY AUDIO WITH AMPLIFIER	177	PRECAUTION	230
Wiring Diagram	177	PRECAUTIONS	230
BASIC INSPECTION	195	Precaution for Supplemental Restraint System (SRS) "AIR BAG" and "SEAT BELT PRE-TENSIONER"	230
DIAGNOSIS AND REPAIR WORKFLOW	195	Precaution for Trouble Diagnosis	230
Work Flow	195	Precaution for Harness Repair	230
DTC/CIRCUIT DIAGNOSIS	197	Precaution for Work	231
POWER SUPPLY AND GROUND CIRCUIT ..	197	PREPARATION	232
AUDIO UNIT	197	PREPARATION	232
AUDIO UNIT : Diagnosis Procedure	197	Special Service Tools	232
AUDIO AMP	197	Commercial Service Tools	232
AUDIO AMP : Diagnosis Procedure	197	REMOVAL AND INSTALLATION	233
BLUETOOTH® CONTROL UNIT	198	AUDIO UNIT	233
BLUETOOTH® CONTROL UNIT : Diagnosis Procedure	198	Removal and Installation	233
MICROPHONE	199	AUDIO AMP	234
MICROPHONE : Diagnosis Procedure	199	Removal and Installation	234
FRONT DOOR SPEAKER	201	FRONT TWEETER	235
Diagnosis Procedure	201	Removal and Installation	235
FRONT TWEETER	204	FRONT DOOR SPEAKER	236
Diagnosis Procedure	204	Removal and Installation	236
REAR DOOR SPEAKER	207	REAR DOOR SPEAKER	237
Diagnosis Procedure	207	Removal and Installation	237
REAR TWEETER	210	REAR TWEETER	238
Diagnosis Procedure	210	Removal and Installation	238
SUBWOOFER	213	SUBWOOFER	239
Diagnosis Procedure	213	Removal and Installation	239
AMP ON SIGNAL CIRCUIT	216	STEERING SWITCH	240
Diagnosis Procedure	216	Removal and Installation	240
REAR VIEW CAMERA IMAGE SIGNAL CIRCUIT	217	BLUETOOTH CONTROL UNIT	241
Diagnosis Procedure	217	Removal and Installation	241
STEERING SWITCH	219	MICROPHONE	243
Diagnosis Procedure	219	Removal and Installation	243
MICROPHONE SIGNAL CIRCUIT	221	AUDIO ANTENNA	244
		Location of Antenna	244

Removal and Installation	244	REGISTRATION (AV CONTROL UNIT)	285	
SATELLITE RADIO ANTENNA	246	REGISTRATION (AV CONTROL UNIT) : Descrip-	285	A
Removal and Installation	246	tion	285	
USB CONNECTOR	247	REGISTRATION (AV CONTROL UNIT) : Work	285	B
Removal and Installation	247	Procedure	285	
REAR VIEW CAMERA	248	DTC/CIRCUIT DIAGNOSIS	287	
Removal and Installation	248	U1000 CAN COMM CIRCUIT	287	C
NAVIGATION		DTC Logic	287	
SYSTEM DESCRIPTION	249	Diagnosis Procedure	287	
COMPONENT PARTS	249	U1010 CONTROL UNIT (CAN)	288	D
Component Parts Location	249	DTC Logic	288	
Component Description	250	U1217 AV CONTROL UNIT	289	E
SYSTEM	251	DTC Logic	289	
System Diagram	251	U1229 AV CONTROL UNIT	290	F
System Description	251	DTC Logic	290	
DIAGNOSIS SYSTEM (AV CONTROL UNIT)..	255	U122F AV CONTROL UNIT	291	G
Description	255	DTC Logic	291	
On Board Diagnosis Function	255	U1244 GPS ANTENNA	292	H
CONSULT Function	256	DTC Logic	292	
ECU DIAGNOSIS INFORMATION	257	Diagnosis Procedure	292	
AV CONTROL UNIT	257	U1258 SATELLITE RADIO ANTENNA	293	I
Reference Value	257	DTC Logic	293	
DTC Index	259	Diagnosis Procedure	293	
AUDIO AMP	261	U1263 USB	294	J
Reference Value	261	DTC Logic	294	
WIRING DIAGRAM	264	Diagnosis Procedure	294	
NAVIGATION SYSTEM	264	U1265 AUDIO AMP.	295	K
Wiring Diagram	264	DTC Logic	295	
BASIC INSPECTION	281	Diagnosis Procedure	295	
DIAGNOSIS AND REPAIR WORKFLOW	281	U12AA CONFIGURATION ERROR	296	L
Work Flow	281	DTC Logic	296	
INSPECTION AND ADJUSTMENT	283	Diagnosis Procedure	296	
ADDITIONAL SERVICE WHEN REPLACING AV		U12AB ANTENNA	297	M
CONTROL UNIT	283	DTC Logic	297	
ADDITIONAL SERVICE WHEN REPLACING AV		Diagnosis Procedure	297	
CONTROL UNIT : Description	283	U12AC AV CONTROL UNIT	298	AV
ADDITIONAL SERVICE WHEN REPLACING AV		DTC Logic	298	
CONTROL UNIT : Work Procedure	283	U12AD AV CONTROL UNIT	299	O
CONFIGURATION (AV CONTROL UNIT)	284	DTC Logic	299	
CONFIGURATION (AV CONTROL UNIT) : De-		U12AE AV CONTROL UNIT	300	P
scription	284	DTC Logic	300	
CONFIGURATION (AV CONTROL UNIT) : Work		U12AF AV CONTROL UNIT	301	
Procedure	284	DTC Logic	301	
CONFIGURATION (AV CONTROL UNIT) : Con-		U12B0 POWER SUPPLY VOLTAGE	302	
figuration List	285	DTC Logic	302	
		Diagnosis Procedure	302	

U12B1 POWER SUPPLY VOLTAGE	303	Precaution for Supplemental Restraint System (SRS) "AIR BAG" and "SEAT BELT PRE-TENSIONER"	345
DTC Logic	303	Precaution for Trouble Diagnosis	345
Diagnosis Procedure	303	Precaution for Harness Repair	345
U1310 AV CONTROL UNIT	304	Precaution for Work	346
DTC Logic	304		
POWER SUPPLY AND GROUND CIRCUIT ..	305	PREPARATION	347
AV CONTROL UNIT	305	PREPARATION	347
AV CONTROL UNIT : Diagnosis Procedure	305	Special Service Tools	347
AUDIO AMP.	305	Commercial Service Tools	347
AUDIO AMP. : Diagnosis Procedure	305	REMOVAL AND INSTALLATION	348
FRONT DOOR SPEAKER	307	AV CONTROL UNIT	348
Diagnosis Procedure	307	Removal and Installation	348
FRONT TWEETER	310	AUDIO AMP.	349
Diagnosis Procedure	310	Removal and Installation	349
REAR DOOR SPEAKER	313	FRONT TWEETER	350
Diagnosis Procedure	313	Removal and Installation	350
REAR TWEETER	316	FRONT DOOR SPEAKER	351
Diagnosis Procedure	316	Removal and Installation	351
SUBWOOFER	319	REAR DOOR SPEAKER	352
Diagnosis Procedure	319	Removal and Installation	352
AMP ON SIGNAL CIRCUIT	322	REAR TWEETER	353
Diagnosis Procedure	322	Removal and Installation	353
REAR VIEW CAMERA IMAGE SIGNAL CIRCUIT	323	SUBWOOFER	354
Diagnosis Procedure	323	Removal and Installation	354
STEERING SWITCH	325	STEERING SWITCH	355
Diagnosis Procedure	325	Removal and Installation	355
MICROPHONE SIGNAL CIRCUIT	327	MICROPHONE	356
Diagnosis Procedure	327	Removal and Installation	356
USB CONNECTOR	329	AUDIO ANTENNA	357
Diagnosis Procedure	329	Location of Antenna	357
AUXILIARY INPUT JACK	330	Removal and Installation	357
Diagnosis Procedure	330	AUXILIARY INPUT JACK	359
SYMPTOM DIAGNOSIS	331	Removal and Installation	359
MULTI AV SYSTEM	331	SATELLITE RADIO ANTENNA	360
Symptom Table	331	Removal and Installation	360
NORMAL OPERATING CONDITION	336	GPS ANTENNA	361
Description	336	Removal and Installation	361
PRECAUTION	345	USB CONNECTOR	362
PRECAUTIONS	345	Removal and Installation	362
		REAR VIEW CAMERA	363
		Removal and Installation	363

BASIC INSPECTION

DIAGNOSIS AND REPAIR WORKFLOW

Work Flow

INFOID:000000009482071

OVERALL SEQUENCE

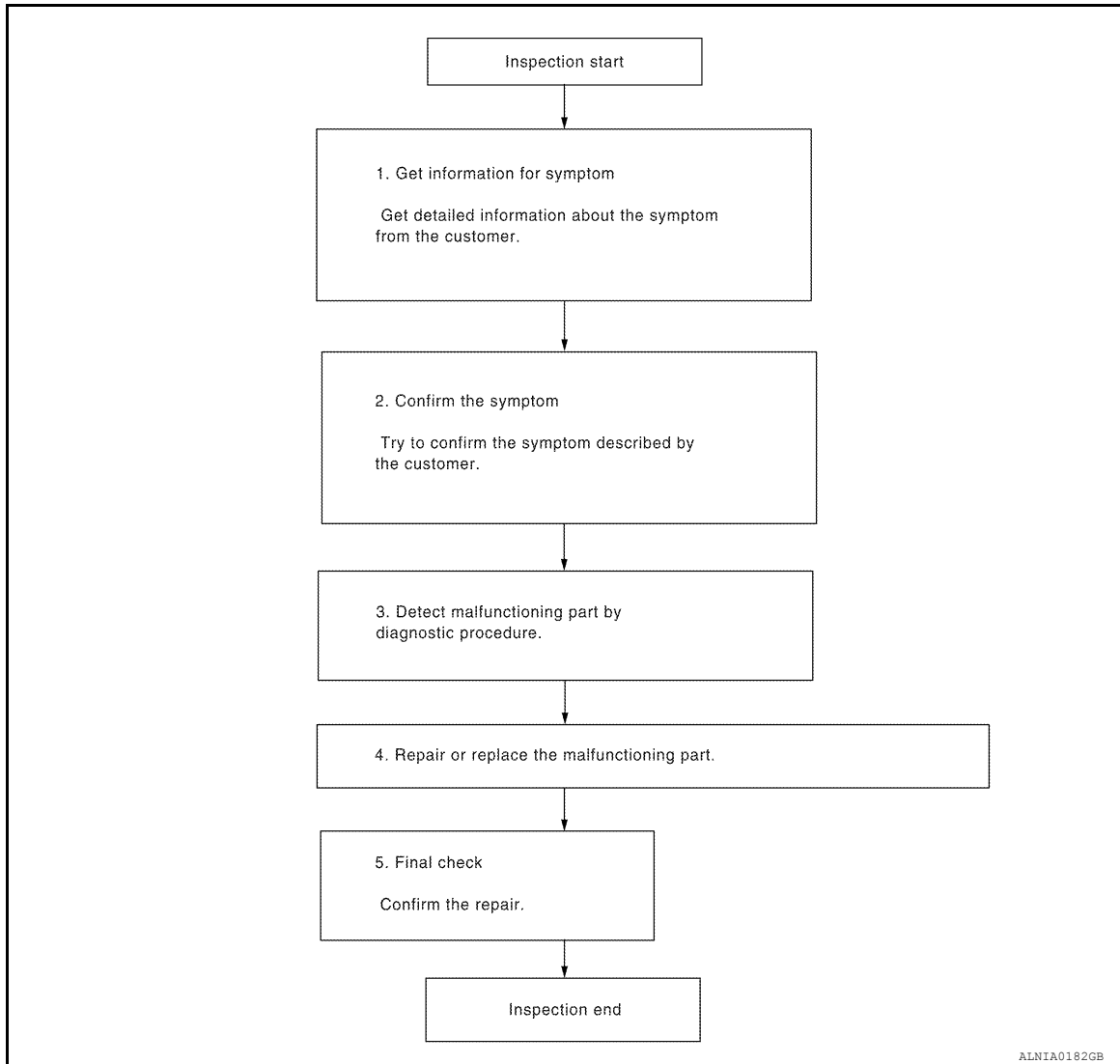

DETAILED FLOW

1.GET INFORMATION FOR SYMPTOM

Get detailed information from the customer about the symptom (the condition and the environment when the incident/malfunction occurred).

>> GO TO 2

2.CONFIRM THE SYMPTOM

Try to confirm the symptom described by the customer. Verify relation between the symptom and the condition when the symptom is detected.

>> GO TO 3

3.DETECT MALFUNCTIONING PART BY DIAGNOSTIC PROCEDURE

Inspect according to Diagnostic Procedure of the system.

A
B
C
D
E
F
G
H
I
J
K
L
M

AV

O

P

DIAGNOSIS AND REPAIR WORKFLOW

< BASIC INSPECTION >

[BASE AUDIO (EXCEPT MEXICO)]

Is malfunctioning part detected?

YES >> GO TO 4

NO >> GO TO 2

4. REPAIR OR REPLACE THE MALFUNCTIONING PART

1. Repair or replace the malfunctioning part.
2. Reconnect parts or connectors disconnected during Diagnostic Procedure.

>> GO TO 5

5. FINAL CHECK

Refer to confirmed symptom in step 2, and make sure that the symptom is not detected.

Has the symptom been repaired?

YES >> Inspection End.

NO >> GO TO 2

SYSTEM DESCRIPTION

AUDIO SYSTEM

System Diagram

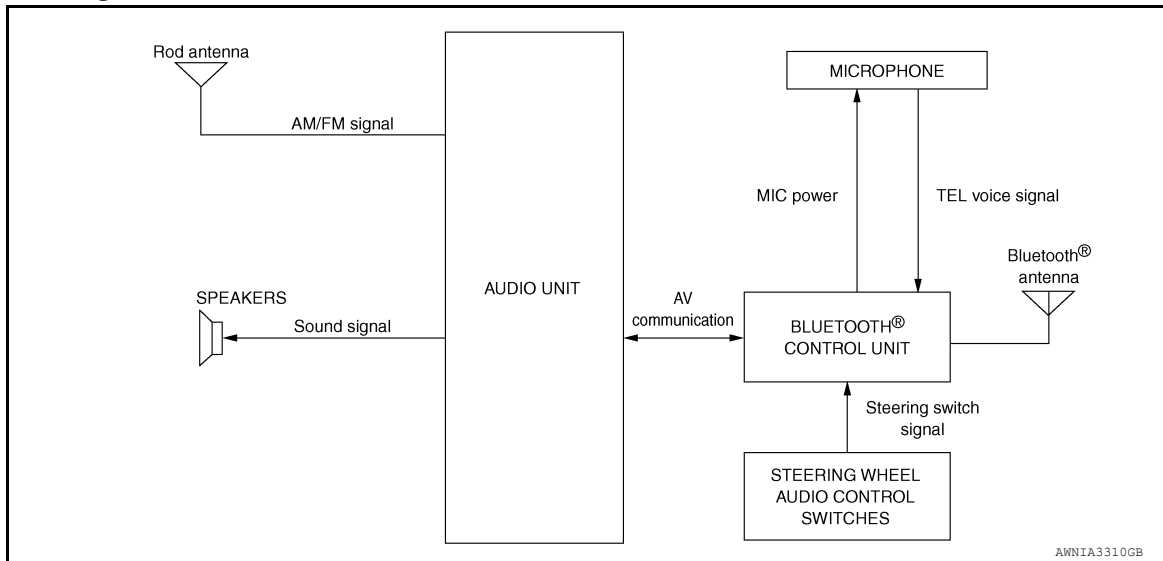

System Description

INFOID:000000009482073

AUDIO SYSTEM

The audio system consists of the following components

- Audio unit
- Rod antenna
- Front door speakers
- Front tweeters
- Rear door speakers
- Steering wheel audio control switches

When the audio system is on, radio signals are received by the rod antenna. The audio unit then sends audio signals to the front door speakers, front tweeters and rear door speakers.

Refer to Owner's Manual for audio system operating instructions.

HANDS-FREE PHONE SYSTEM

System Operation

NOTE:

Cellular telephones must have their wireless connection set up (paired) before using the Bluetooth® telephone system.

The Bluetooth® telephone system allows users who have a Bluetooth® cellular telephone to make a wireless connection between their cellular telephone and the Bluetooth® control unit. Hands-free cellular telephone calls can be sent and received. Some Bluetooth® cellular telephones may not be recognized by the Bluetooth® control unit. When a cellular telephone or the Bluetooth® control unit is replaced, the telephone must be paired with the Bluetooth® control unit. Different cellular telephones may have different pairing procedures, refer to the cellular telephone operating manual.

Refer to the Owner's Manual for Bluetooth® telephone system operating instructions.

Bluetooth® Control Unit

When the ignition switch is turned to ACC or ON, the Bluetooth® control unit will power up. During power up, the Bluetooth® control unit is initialized and performs various self-checks. Initialization may take up to 20 seconds. If a phone is present in the vehicle and paired with the Bluetooth® control unit, Nissan Voice Recognition will then become active. Bluetooth® telephone functions can be turned off using the Nissan Voice Recognition system.

A
B
C
D
E
F
G
H
I
J
K
L
M
O
P

AV

AUDIO SYSTEM

[BASE AUDIO (EXCEPT MEXICO)]

< SYSTEM DESCRIPTION >

Steering Wheel Audio Control Switches

When buttons on the steering wheel audio control switch are pushed, the resistance in steering wheel audio control switch circuit changes, depending on which button is pushed. The Bluetooth® control unit uses this signal to perform various functions while navigating through the voice recognition system.

The following functions can be performed using the steering wheel audio control switch:

- Initiate self-diagnosis of the Bluetooth® telephone system
- Start a voice recognition session
- Answer and end telephone calls
- Adjust the volume of calls

Microphone

The microphone is located in the roof console assembly. The microphone sends a signal to the Bluetooth® control unit. The microphone can be actively tested during self-diagnosis.

Audio Unit

The audio unit receives signals from the Bluetooth® control unit and sends audio signals to the speakers.

Component Parts Location

INFOID:000000009482074

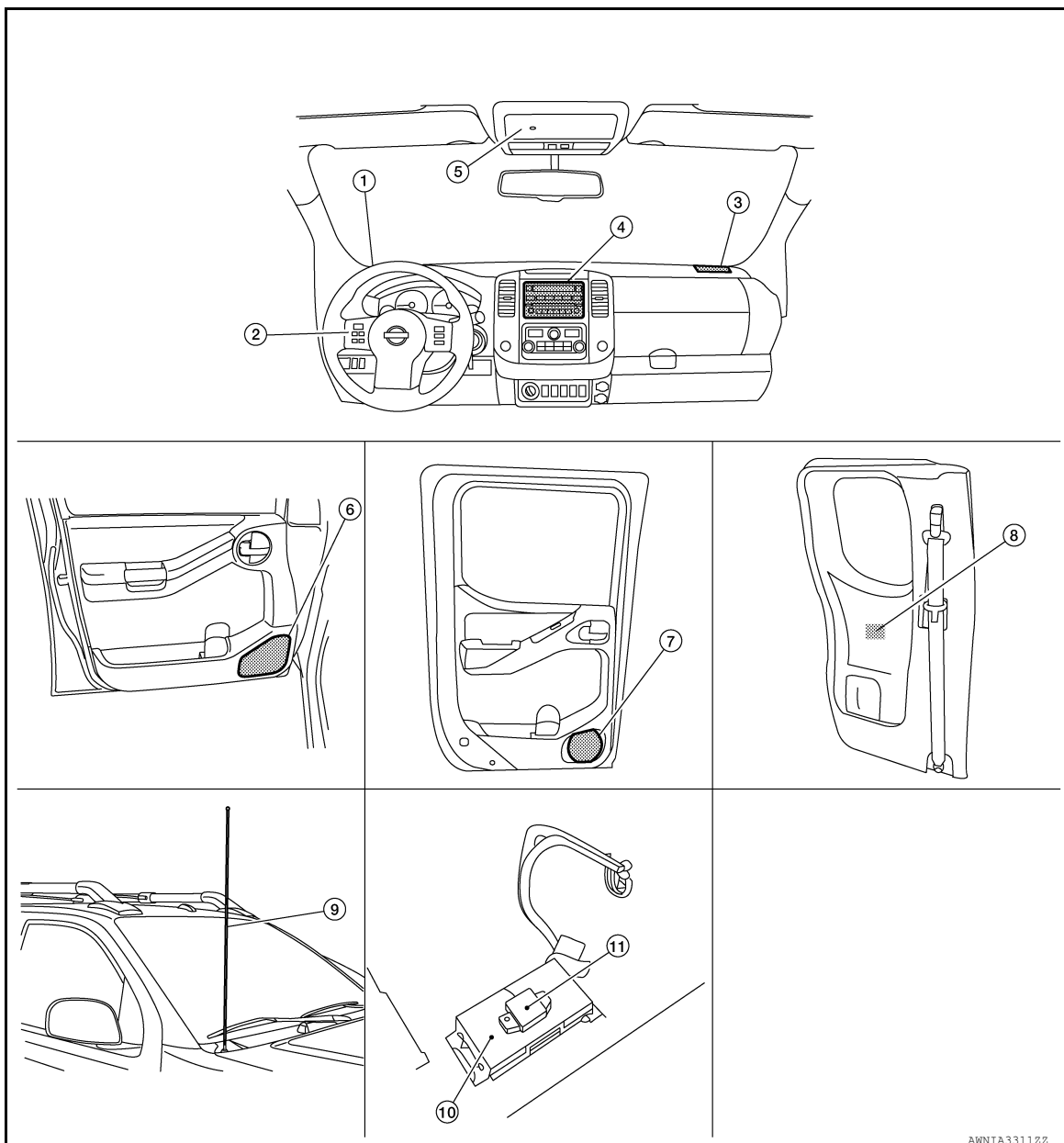

AWNIA3311ZZ

AUDIO SYSTEM

< SYSTEM DESCRIPTION >

[BASE AUDIO (EXCEPT MEXICO)]

- | | | | |
|---|--|--|---|
| 1. Front tweeter LH M109 (crew cab) | 2. Steering wheel audio control switches | 3. Front tweeter RH M111 (crew cab) | A |
| 4. Audio unit M32, M43, M60 | 5. Microphone R8 | 6. Front door speaker LH D12
Front door speaker RH D112 | |
| 7. Rear door speaker LH D207 (crew cab)
Rear door speaker RH D307 (crew cab) | 8. Rear door speaker LH B76 (king cab)
Rear door speaker RH B160 (king cab) | 9. Rod antenna | B |
| 10. Bluetooth® control unit B141, B142, B143 (Underneath passenger seat) | 11. Bluetooth® antenna | | C |

Component Description

INFOID:000000009482075

Part name	Description
Audio unit	Controls audio system functions
Front door speakers	<ul style="list-style-type: none"> Outputs audio signal from audio unit Outputs high, mid and low range sounds
Front tweeters	<ul style="list-style-type: none"> Outputs audio signal from audio unit Outputs high range sounds
Rear door speakers	<ul style="list-style-type: none"> Outputs audio signal from audio unit Outputs high, mid and low range sounds
Steering wheel audio control switches	<ul style="list-style-type: none"> Operations for audio, hands-free phone and voice recognition are possible. Steering switch signal is output to Bluetooth® control unit. Bluetooth® control unit outputs steering switch signal to audio unit.
Microphone	<ul style="list-style-type: none"> Used for hands-free phone operations. Microphone signal is transmitted to Bluetooth® control unit. Power is supplied from Bluetooth® control unit.
Bluetooth® control unit	<ul style="list-style-type: none"> Inputs TEL voice signal from Bluetooth® antenna and outputs it to audio unit. Controlled via AV communication by audio unit.
Bluetooth® antenna	Receives TEL voice signal and outputs it to Bluetooth® control unit.
Rod antenna	AM/FM signal is received and transmitted to the audio unit.

AV

POWER SUPPLY AND GROUND CIRCUIT

< DTC/CIRCUIT DIAGNOSIS >

[BASE AUDIO (EXCEPT MEXICO)]

DTC/CIRCUIT DIAGNOSIS

POWER SUPPLY AND GROUND CIRCUIT AUDIO UNIT

AUDIO UNIT : Diagnosis Procedure

INFOID:000000009482076

Regarding Wiring Diagram information, refer to [AV-30, "Wiring Diagram"](#).

1.CHECK FUSE

Check that the following fuses are not blown.

Terminal No.	Signal name	Fuse No.
7	ACC power supply	4 (10A)
19	Battery power supply	29 (20A)

Are the fuses blown?

- YES >> Replace the blown fuse after repairing the affected circuit.
NO >> GO TO 2.

2.CHECK POWER SUPPLY CIRCUIT

1. Turn ignition switch OFF.
2. Disconnect audio unit connector M43.
3. Check voltage between audio unit connector M43 and ground.

Audio unit		Ground	Condition	Voltage (Approx.)
Connector	Terminal			
M43	7	—	Ignition switch: ON	Battery voltage
	19		Ignition switch: OFF	

Is the inspection result normal?

- YES >> Inspection End.
NO >> Repair or replace harness or connectors.

BLUETOOTH® CONTROL UNIT

BLUETOOTH® CONTROL UNIT : Diagnosis Procedure

INFOID:000000010228043

Regarding Wiring Diagram information, refer to [AV-30, "Wiring Diagram"](#).

1.CHECK FUSE

Check that the following fuses are not blown.

Terminal No.	Signal name	Fuse No.
1	Battery power supply	29 (20A)
2	ACC power supply	4 (10A)
3	Ignition power supply	12 (10A)

Are the fuses blown?

- YES >> Replace the blown fuse after repairing the affected circuit.
NO >> GO TO 2.

2.CHECK POWER SUPPLY CIRCUIT

POWER SUPPLY AND GROUND CIRCUIT

[BASE AUDIO (EXCEPT MEXICO)]

< DTC/CIRCUIT DIAGNOSIS >

1. Turn ignition switch OFF.
2. Disconnect Bluetooth® control unit connector B141.
3. Check voltage between Bluetooth® control unit connector B141 and ground.

Bluetooth® control unit		Ground	Condition	Voltage (Approx.)
Connector	Terminal			
B141	1	—	Ignition switch: OFF	Battery voltage
	2		Ignition switch: ON	
	3			

Is the inspection result normal?

YES >> GO TO 3.

NO >> Repair or replace harness or connectors.

3.CHECK GROUND CIRCUIT

1. Turn ignition switch OFF.
2. Check continuity between Bluetooth® control unit connector B141 and ground.

Bluetooth® control unit		Ground	Continuity
Connector	Terminal		
B141	4	—	Yes
	22		
	23		

Is the inspection result normal?

YES >> Inspection End.

NO >> Repair or replace harness or connectors.

MICROPHONE

MICROPHONE : Diagnosis Procedure

INFOID:000000010228044

Regarding Wiring Diagram information, refer to [AV-30. "Wiring Diagram"](#).

1.CHECK POWER SUPPLY CIRCUIT

1. Turn ignition switch ON.
2. Check voltage between microphone connector R8 and ground.

Microphone		Ground	Value (Approx.)
Connector	Terminal		
R8	4	—	5V

Is the inspection result normal?

YES >> GO TO 3.

NO >> GO TO 2.

2.CHECK POWER SUPPLY CIRCUIT CONTINUITY

1. Turn ignition switch OFF.
2. Disconnect microphone connector and Bluetooth® control unit connector B141.
3. Check continuity between microphone connector R8 and Bluetooth® control unit connector B141.

POWER SUPPLY AND GROUND CIRCUIT

< DTC/CIRCUIT DIAGNOSIS >

[BASE AUDIO (EXCEPT MEXICO)]

Microphone		Bluetooth® control unit		Continuity
Connector	Terminal	Connector	Terminal	
R8	4	B141	29	Yes

4. Check continuity between microphone connector R8 and ground.

Microphone		—	Continuity
Connector	Terminal		
R8	4	Ground	No

Is the inspection result normal?

YES >> Replace the Bluetooth® control unit. Refer to [AV-54, "Removal and Installation"](#).

NO >> Repair or replace harness or connectors.

3. CHECK GROUND CIRCUIT

1. Turn ignition switch OFF.
2. Disconnect microphone connector and Bluetooth® control unit connector B141.
3. Check continuity between microphone connector R8 and Bluetooth® control unit connector B141.

Microphone		Bluetooth® control unit		Continuity
Connector	Terminal	Connector	Terminal	
R8	2	B141	8	Yes

Is the inspection result normal?

YES >> Inspection End.

NO >> Repair or replace harness or connectors.

FRONT DOOR SPEAKER

< DTC/CIRCUIT DIAGNOSIS >

[BASE AUDIO (EXCEPT MEXICO)]

FRONT DOOR SPEAKER

Description

INFOID:000000009482077

The audio unit sends audio signals to the front door speakers using the front door speaker circuits.

Diagnosis Procedure

INFOID:000000009482078

Regarding Wiring Diagram information, refer to [AV-30, "Wiring Diagram"](#).

1. CONNECTOR CHECK

Check the audio unit and speaker connectors for the following:

- Proper connection
- Damage
- Disconnected or loose terminals

Is the inspection result normal?

YES >> GO TO 2

NO >> Repair the terminals or connectors.

2. CHECK FRONT DOOR SPEAKER SIGNAL CIRCUIT CONTINUITY

1. Disconnect audio unit connector M43 and suspect front door speaker connector.
2. Check continuity between audio unit connector M43 and suspect front door speaker connector.

Audio unit		Front door speaker		Continuity
Connector	Terminal	Connector	Terminal	
M43	2	D12 (LH)	1	Yes
	3		2	
	11	D112 (RH)	1	
	12		2	

3. Check continuity between audio unit connector M43 and ground.

Audio unit		Ground	Continuity
Connector	Terminal		
M43	2	—	No
	3		
	11		
	12		

Is the inspection result normal?

YES >> GO TO 3

NO >> Repair or replace harness or connectors.

3. CHECK FRONT DOOR SPEAKER SIGNAL

1. Connect audio unit connector M43 and suspect front door speaker connector.
2. Turn ignition switch to ACC.
3. Push audio unit POWER switch.
4. Check signal between the terminals of audio unit connector M43.

Audio unit connector M43		Condition	Reference value
(+)	(-)		
Terminal	Terminal		

A
B
C
D
E
F
G
H
I
J
K
L
M
AV
O
P

FRONT DOOR SPEAKER

< DTC/CIRCUIT DIAGNOSIS >

[BASE AUDIO (EXCEPT MEXICO)]

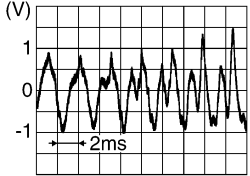
2	3	Audio signal output	
11	12		

SKIB3609E

Is the inspection result normal?

- YES >> Replace front door speaker. Refer to [AV-51. "Removal and Installation"](#).
- NO >> Replace audio unit. Refer to [AV-49. "Removal and Installation"](#).

FRONT TWEETER

< DTC/CIRCUIT DIAGNOSIS >

[BASE AUDIO (EXCEPT MEXICO)]

FRONT TWEETER

Description

INFOID:000000009482079

The audio unit sends audio signals to the front tweeters using the front tweeter circuits.

Diagnosis Procedure

INFOID:000000009482080

Regarding Wiring Diagram information, refer to [AV-30, "Wiring Diagram"](#).

1. CONNECTOR CHECK

Check the audio unit and speaker connectors for the following:

- Proper connection
- Damage
- Disconnected or loose terminals

Is the inspection result normal?

YES >> GO TO 2

NO >> Repair the terminals or connectors.

2. CHECK FRONT DOOR SPEAKER SIGNAL CIRCUIT CONTINUITY

1. Disconnect audio unit connector M43 and suspect front tweeter connector.
2. Check continuity between audio unit connector M43 and suspect front tweeter connector.

Audio unit		Front tweeter		Continuity
Connector	Terminal	Connector	Terminal	
M43	2	M109 (LH)	1	Yes
	3		2	
	11	M111 (RH)	1	
	12		2	

3. Check continuity between audio unit connector M43 and ground.

Audio unit		Ground	Continuity
Connector	Terminal		
M43	2	—	No
	3		
	11		
	12		

Is the inspection result normal?

YES >> GO TO 3

NO >> Repair or replace harness or connectors.

3. CHECK FRONT DOOR SPEAKER SIGNAL

1. Connect audio unit connector M43 and suspect front tweeter connector.
2. Turn ignition switch to ACC.
3. Push audio unit POWER switch.
4. Check signal between the terminals of audio unit connector M43.

Audio unit connector M43		Condition	Reference value
(+)	(-)		
Terminal	Terminal		

A
B
C
D
E
F
G
H
I
J
K
L
M
AV
O
P

FRONT TWEETER

< DTC/CIRCUIT DIAGNOSIS >

[BASE AUDIO (EXCEPT MEXICO)]

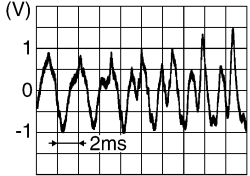
2	3	Audio signal output	
11	12		

SKIB3609E

Is the inspection result normal?

- YES >> Replace front tweeter. Refer to [AV-50. "Removal and Installation"](#).
- NO >> Replace audio unit. Refer to [AV-49. "Removal and Installation"](#).

REAR DOOR SPEAKER

< DTC/CIRCUIT DIAGNOSIS >

[BASE AUDIO (EXCEPT MEXICO)]

REAR DOOR SPEAKER

Description

INFOID:000000009482081

The audio unit sends audio signals to the rear door speakers using the rear door speaker circuits.

Diagnosis Procedure

INFOID:000000009482082

Regarding Wiring Diagram information, refer to [AV-30, "Wiring Diagram"](#).

1. CONNECTOR CHECK

Check the audio unit and speaker connectors for the following:

- Proper connection
- Damage
- Disconnected or loose terminals

Is the inspection result normal?

YES >> GO TO 2

NO >> Repair the terminals or connectors.

2. CHECK FRONT DOOR SPEAKER SIGNAL CIRCUIT CONTINUITY

1. Disconnect audio unit connector M43 and suspect rear door speaker connector.
2. Check continuity between audio unit connector M43 and suspect rear door speaker connector.

Audio unit		Rear door speaker		Continuity
Connector	Terminal	Connector	Terminal	
M43	4	D207 (LH) (crew cab)	1	Yes
	5		2	
	13	D307 (RH) (crew cab)	1	
	14		2	
	4	B76 (LH) (king cab)	1	
	5		2	
	13	B160 (RH) (king cab)	1	
	14		2	

3. Check continuity between audio unit connector M43 and ground.

Audio unit		Ground	Continuity
Connector	Terminal		
M43	4	—	No
	5		
	13		
	14		

Is the inspection result normal?

YES >> GO TO 3

NO >> Repair or replace harness or connectors.

3. CHECK FRONT DOOR SPEAKER SIGNAL

1. Connect audio unit connector M43 and suspect rear door speaker connector.
2. Turn ignition switch to ACC.
3. Push audio unit POWER switch.
4. Check signal between the terminals of audio unit connector M43.

REAR DOOR SPEAKER

< DTC/CIRCUIT DIAGNOSIS >

[BASE AUDIO (EXCEPT MEXICO)]

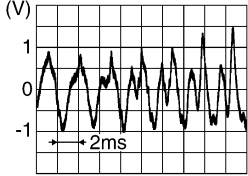
Audio unit connector M43		Condition	Reference value
(+)	(-)		
Terminal	Terminal		
4	5	Audio signal output	
13	14		

SKIB3609E

Is the inspection result normal?

- YES >> Replace rear door speaker. Refer to [AV-52, "Removal and Installation"](#).
- NO >> Replace audio unit. Refer to [AV-49, "Removal and Installation"](#).

STEERING SWITCH

< DTC/CIRCUIT DIAGNOSIS >

[BASE AUDIO (EXCEPT MEXICO)]

STEERING SWITCH





Diagnosis Procedure

INFOID:000000010228063

Regarding Wiring Diagram information, refer to [AV-30. "Wiring Diagram"](#).

1. CHECK STEERING WHEEL AUDIO CONTROL SWITCH RESISTANCE

1. Disconnect combination switch connector M102.
2. Check resistance between combination switch connector terminals.

Combination switch connector M102		Condition	Resistance (Ω) (Approx.)
Terminal	Terminal		
16	18	Depress VOL DOWN switch.	1
		Depress VOL UP switch.	121
		Depress  switch.	321
Depress MODE switch.		1	
15		Depress  switch.	121
		Depress  switch.	321
		Depress  switch.	723

Is the inspection result normal?

YES >> GO TO 2.

NO >> Replace steering wheel audio control switches. Refer to [AV-53. "Removal and Installation"](#).

2. CHECK HARNESS BETWEEN BLUETOOTH® CONTROL UNIT AND COMBINATION SWITCH

1. Turn ignition switch OFF.
2. Disconnect Bluetooth® control unit connector B141 and combination switch connector M30.
3. Check continuity between Bluetooth® control unit connector B141 and combination switch connector M30.

Bluetooth® control unit		Combination switch		Continuity
Connector	Terminal	Connector	Terminal	
B141	12	M30	24	Yes
	13		25	
	14		31	

4. Check continuity between Bluetooth® control unit connector B141 and ground.

Bluetooth® control unit		—	Continuity
Connector	Terminal		
B141	12	Ground	No
	13		
	14		

Is the inspection result normal?

YES >> GO TO 3.

NO >> Repair or replace harness or connectors.

3. SPIRAL CABLE CHECK

Check continuity between combination switch connectors M30 and M102.

STEERING SWITCH

< DTC/CIRCUIT DIAGNOSIS >

[BASE AUDIO (EXCEPT MEXICO)]

Combination switch				Continuity
Connector	Terminal	Connector	Terminal	
M30	24	M102	15	Yes
	25		16	
	31		18	

Is the inspection result normal?

YES >> GO TO 4.

NO >> Replace spiral cable. Refer to [SR-13, "Removal and Installation"](#).

4. CHECK HARNESS BETWEEN BLUETOOTH® CONTROL UNIT AND AUDIO UNIT

1. Disconnect audio unit connector M44.
2. Check continuity between Bluetooth® control unit connector B141 and audio unit connector M43.

Bluetooth® control unit		Audio unit		Continuity
Connector	Terminal	Connector	Terminal	
B141	17	M43	6	Yes
	18		16	
	19		15	

3. Check continuity between Bluetooth® control unit connector B141 and ground.

Bluetooth® control unit		—	Continuity
Connector	Terminal		
B141	17	Ground	No
	18		
	19		

Is the inspection result normal?

YES >> Replace audio unit. Refer to [AV-49, "Removal and Installation"](#).

NO >> Repair or replace harness or connectors.

MICROPHONE SIGNAL CIRCUIT

< DTC/CIRCUIT DIAGNOSIS >

[BASE AUDIO (EXCEPT MEXICO)]

MICROPHONE SIGNAL CIRCUIT

Diagnosis Procedure

INFOID:000000010228064

Regarding Wiring Diagram information, refer to [AV-30. "Wiring Diagram"](#).

1. CHECK HARNESS BETWEEN BLUETOOTH® CONTROL UNIT AND MICROPHONE

1. Turn ignition switch OFF.
2. Disconnect Bluetooth® control unit connector B141 and microphone connector.
3. Check continuity between Bluetooth® control unit connector B141 and microphone connector R8.

Bluetooth® control unit		Microphone		Continuity
Connector	Terminal	Connector	Terminal	
B141	7	R8	1	Yes
	8		2	
	29		4	

4. Check continuity between Bluetooth® control unit connector B141 and ground.

Bluetooth® control unit		—	Continuity
Connector	Terminal		
B141	7	Ground	No
	8		
	29		

Is the inspection result normal?

YES >> GO TO 2.

NO >> Repair harness or connector.

2. CHECK MICROPHONE POWER SUPPLY

1. Connect Bluetooth® control unit connector B141 and microphone connector.
2. Turn ignition switch ON.
3. Check voltage between microphone connector R8 terminal 4 and ground.

Microphone		Ground	Value (Approx.)
Connector	Terminal		
R8	4	—	5V

Is the inspection result normal?

YES >> GO TO 3.

NO >> Replace Bluetooth® control unit. Refer to [AV-54. "Removal and Installation"](#).

3. CHECK MICROPHONE SIGNAL

Check signal between Bluetooth® control unit connector B141 with CONSULT or and oscilloscope.

MICROPHONE SIGNAL CIRCUIT

< DTC/CIRCUIT DIAGNOSIS >

[BASE AUDIO (EXCEPT MEXICO)]

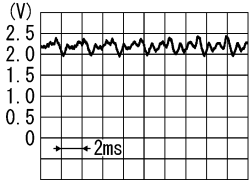
Bluetooth® control unit connector B141		Condition	Reference signal
(+)	(-)		
Terminal	Terminal		
7	8	Speak into microphone.	 <p style="text-align: right; font-size: small;">PKIB5037J</p>

Is the inspection result normal?

- YES >> Replace Bluetooth® control unit. Refer to [AV-54. "Removal and Installation"](#).
- NO >> Replace microphone. Refer to [AV-56. "Removal and Installation"](#).

AUDIO UNIT

< ECU DIAGNOSIS INFORMATION >

[BASE AUDIO (EXCEPT MEXICO)]

ECU DIAGNOSIS INFORMATION

AUDIO UNIT

Reference Value

INFOID:000000009482083

TERMINAL LAYOUT

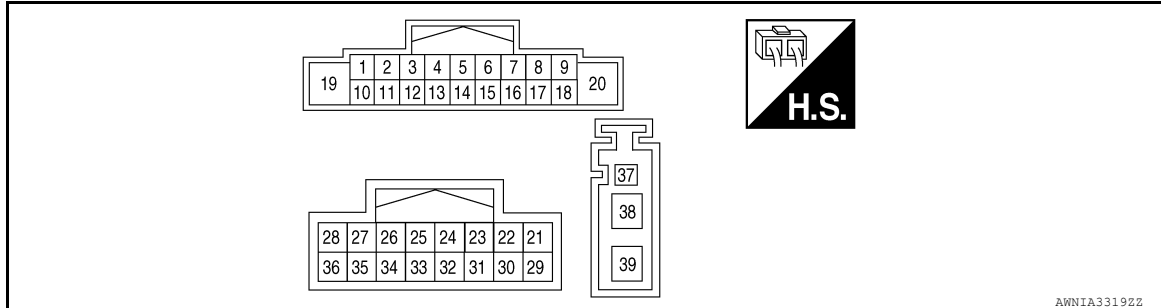



PHYSICAL VALUES

Terminal (Wire color)		Description		Condition		Reference value (Approx.)
+	-	Signal name	Input/Output			
2 (BR)	3 (L)	Sound signal front door speaker and front tweeter LH	Output	Ignition switch ON	Audio output	 <small>SKIB3609E</small>
4 (G)	5 (B)	Sound signal rear door speaker LH	Output	Ignition switch ON	Audio output	 <small>SKIB3609E</small>
6 (V)	Ground	STRG SW A	Input	ON	Press and hold MODE switch.	0 V
					Press and hold Δ switch.	1.34 V
					Press and hold ∇ switch.	2.45 V
					Press and hold switch.	3.43 V
					Except for above.	5.0 V
7 (G/B)	Ground	ACC power supply	Input	Ignition switch ACC or ON	—	Battery voltage
8 (GR)	Ground	ILL control	Input	Ignition switch ACC or ON	—	0V

AUDIO UNIT

< ECU DIAGNOSIS INFORMATION >

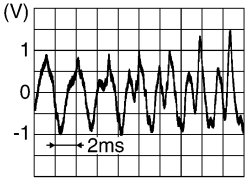
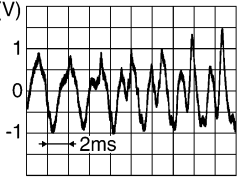
[BASE AUDIO (EXCEPT MEXICO)]

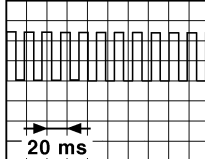
Terminal (Wire color)		Description		Condition		Reference value (Approx.)
+	-	Signal name	Input/ Output			
9 (R)	Ground	Light switch	Input	Ignition switch ACC or ON	—	Battery voltage
11 (LG)	12 (R)	Sound signal front door speaker and front tweeter RH	Output	Ignition switch ON	Voice output	
13 (GR)	14 (BG)	Sound signal rear door speaker RH	Output	Ignition switch ON	Voice output	
15 (BG)	-	STRG SW ground	Output	-	-	-
16 (LG)	Ground	STRG SW B	Input	ON	Press VOL DOWN switch	0 V
					Press VOL UP switch.	1.34 V
					Press  switch.	2.45 V
					Except for above.	5.0 V
18 (SB)	Ground	Vehicle speed signal	Input	ON	When vehicle speed is ap- prox. 40 km/h (25 MPH)	
19 (Y)	Ground	Battery power supply	Input	Ignition switch OFF	—	Battery voltage
20 (B)	—	GND	—	—	—	—
21 (G)	—	MCAN1 L	—	—	—	—
22 (R)	—	MCAN1 H	—	—	—	—
23	—	MCAN shield	—	—	—	—
25 (BR)	—	EQ4 Ground	—	—	—	—
26 (L)	—	EQ3 Ground	—	—	—	—
27 (G)	—	EQ2 Ground	—	—	—	—
29 (W)	—	MCAN2 L	—	—	—	—

AUDIO UNIT

< ECU DIAGNOSIS INFORMATION >

[BASE AUDIO (EXCEPT MEXICO)]

Terminal (Wire color)		Description		Condition		Reference value (Approx.)
+	-	Signal name	Input/ Output			
30 (L)	—	MCAN2 H	—	—	—	—
33 (W)	34 (GR)	Telephone audio in	—	—	—	—
36 (R)	Ground	Telephone ON	Output	ON	—	—
38 (B)	Ground	AM-FM main antenna	Input	ON	—	5.0 V

A
B
C
D
E
F
G
H
I
J
K
L
M

AV

O
P

BLUETOOTH® CONTROL UNIT

< ECU DIAGNOSIS INFORMATION >

[BASE AUDIO (EXCEPT MEXICO)]

BLUETOOTH® CONTROL UNIT

Reference Value

INFOID:000000010228242

TERMINAL LAYOUT

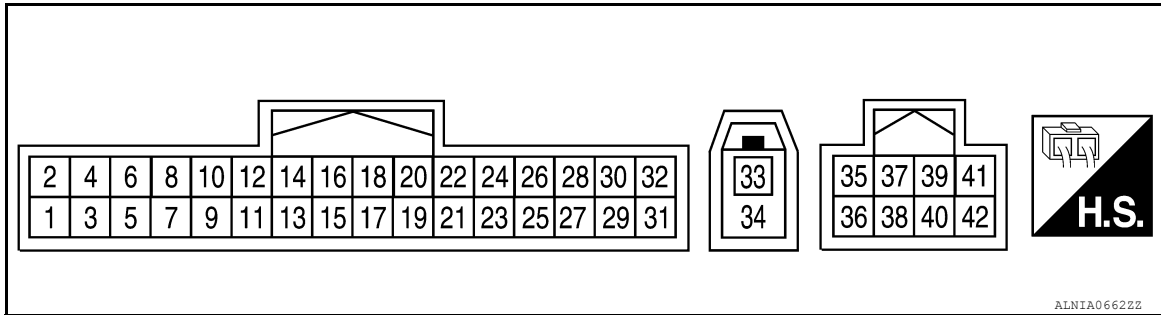







PHYSICAL VALUES

Terminal (wire color)		Description		Condition		Reference value (Approx.)
+	-	Signal name	Input/output	Ignition switch	Condition	
1 (R/B)	Ground	Battery power	Input	-	-	Battery voltage
2 (G/Y)	Ground	ACC power	Input	ACC or ON	-	Battery voltage
3 (W/G)	Ground	IGN power	Input	ON or START	-	Battery voltage
4 (B)	Ground	Ground	-	ON	-	0V
6	-	MIC Shield	-	-	-	-
7 (G)	8 (L)	MIC in signal	Input	-	-	-
9 (W)	10 (B)	Audio out	Output	ACC or ON	Bluetooth® control unit sends audio signal	
11 (R)	Ground	Telephone ON	-	-	-	-
12 (BR)	Ground	Ladder in 1	Input	ACC or ON	Press and hold MODE switch.	0 V
					Press and hold △ switch.	1.34 V
					Press and hold ▽ switch.	2.45 V
					Press and hold switch.	3.43 V
					Except for above.	5.0 V

BLUETOOTH® CONTROL UNIT

< ECU DIAGNOSIS INFORMATION >

[BASE AUDIO (EXCEPT MEXICO)]

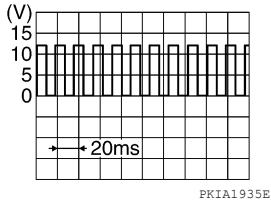
Terminal (wire color)		Description		Condition		Reference value (Approx.)
+	-	Signal name	Input/ output	Ignition switch	Condition	
13 (L)	Ground	Ladder in 2	Input	ACC or ON	Press VOL DOWN switch	0 V
					Press VOL UP switch.	1.34 V
					Press  switch.	2.45 V
					Except for above.	5.0 V
14 (G)	-	Ladder in ground	Input	-	-	-
17 (V)	Ground	Ladder out 1	Input	ACC or ON	Press and hold MODE switch.	0 V
					Press and hold  switch.	1.34 V
					Press and hold  switch.	2.45 V
					Press and hold   switch.	3.43 V
					Except for above.	5.0 V
18 (LG)	Ground	Ladder out 2	Input	ACC or ON	Press VOL DOWN switch	0 V
					Press VOL UP switch.	1.34 V
					Press  switch.	2.45 V
					Except for above.	5.0 V
19 (BG)	Ground	Ladder out ground	Output	-	--	-
22 (B)	Ground	Cont 3	-	-	-	0V
23 (B)	Ground	Cont 4	-	-	-	0V
28 (SB)	Ground	Vehicle speed signal (8-pulse)	Input	ON	When vehicle speed is approx. 40 km/h (25 MPH)	
29 (Y)	Ground	Microphone power	Output	ON	-	5V
33 (B)	-	Bluetooth® antenna	-	-	-	-
34	-	Bluetooth® antenna shield	-	-	-	-
35 (R)	-	MCAN H	-	-	-	-
36 (G)	-	MCAN L	-	-	-	-
37	-	MCAN shield	-	-	-	-

A
B
C
D
E
F
G
H
I
J
K
L
M
AV
O
P

BASE AUDIO SYSTEM

[BASE AUDIO (EXCEPT MEXICO)]

< WIRING DIAGRAM >

WIRING DIAGRAM

BASE AUDIO SYSTEM

Wiring Diagram

INFOID:000000009482084

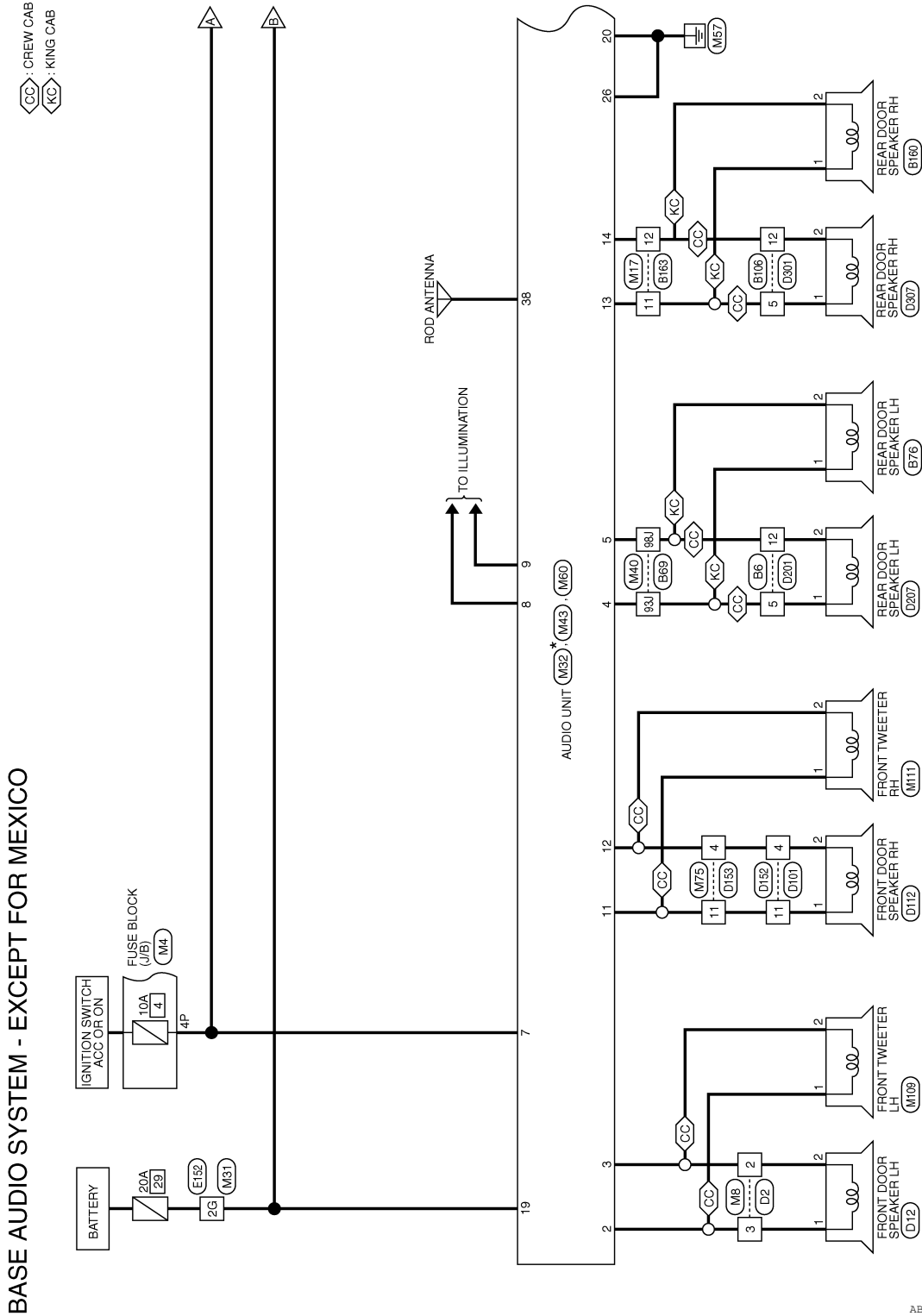

ABNWA2064GB

BASE AUDIO SYSTEM

[BASE AUDIO (EXCEPT MEXICO)]

< WIRING DIAGRAM >

CC: CREW CAB
KC: KING CAB

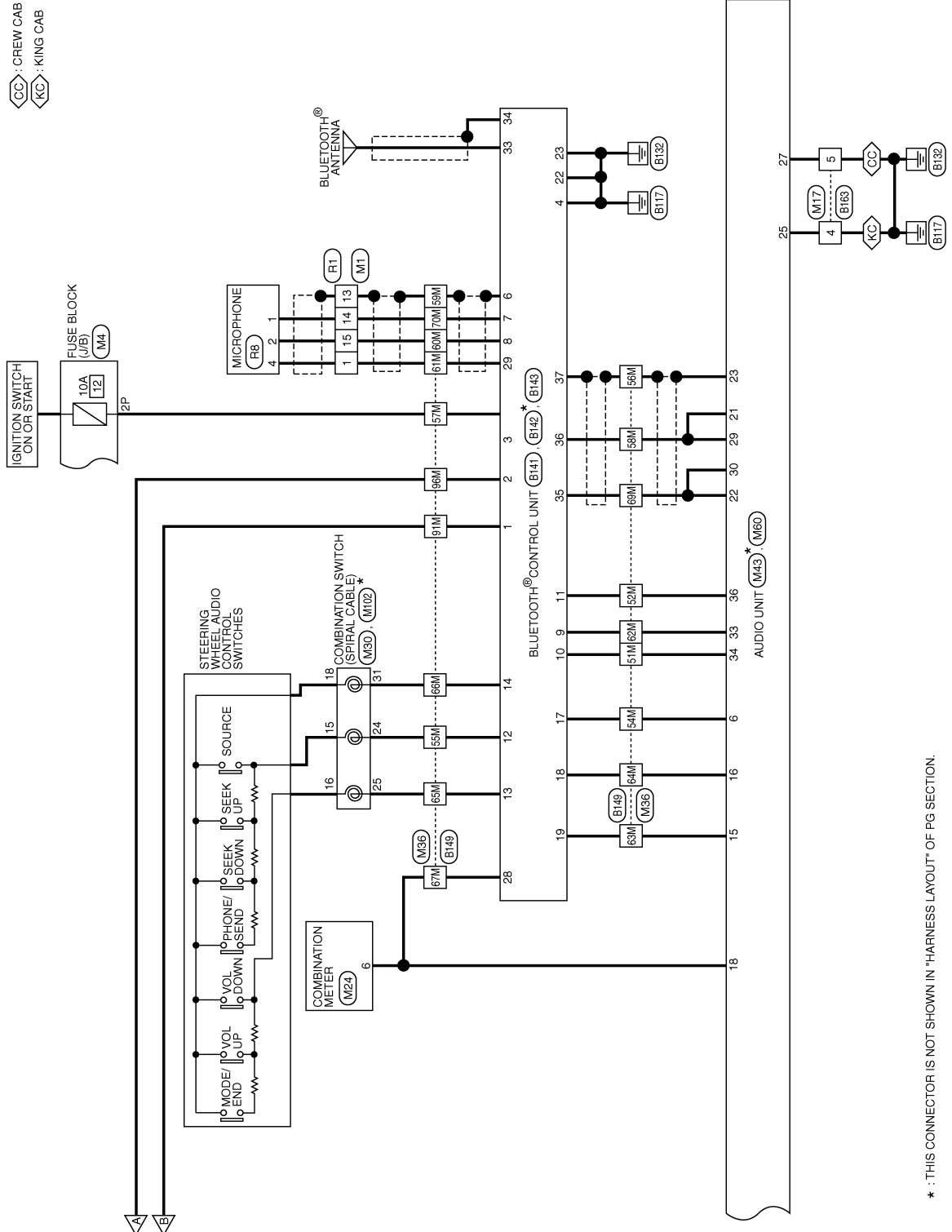

* : THIS CONNECTOR IS NOT SHOWN IN "HARNES LAYOUT" OF PG SECTION.

ABNWA2065GB

A
B
C
D
E
F
G
H
I
J
K
L
M
N
O
P

AV

BASE AUDIO SYSTEM

[BASE AUDIO (EXCEPT MEXICO)]

< WIRING DIAGRAM >

BASE AUDIO SYSTEM CONNECTORS - EXCEPT FOR MEXICO

Connector No.	M1
Connector Name	WIRE TO WIRE
Connector Color	WHITE

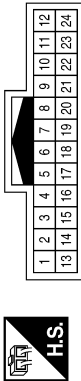

Terminal No.	Color of Wire	Signal Name
1	Y	– (WITHOUT NAVI)
13	SHIELD	–
14	G	– (WITHOUT NAVI)
15	L	– (WITHOUT NAVI)

Connector No.	M4
Connector Name	FUSE BLOCK (J/B)
Connector Color	WHITE

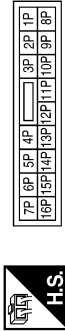

Terminal No.	Color of Wire	Signal Name
2P	W/G	–
4P	G/B	–

Connector No.	M8
Connector Name	WIRE TO WIRE
Connector Color	BROWN



Terminal No.	Color of Wire	Signal Name
2	L	–
3	BR	–

Connector No.	M17
Connector Name	WIRE TO WIRE
Connector Color	WHITE

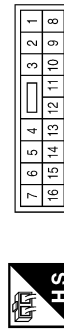

Terminal No.	Color of Wire	Signal Name
4	BR	–
5	G	–
11	GR	– (WITH BASE AUDIO SYSTEM)
12	BG	– (WITH BASE AUDIO SYSTEM)

Connector No.	M24
Connector Name	COMBINATION METER
Connector Color	WHITE

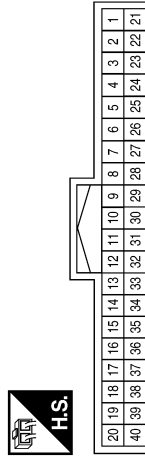

Terminal No.	Color of Wire	Signal Name
6	SB	SPEED OUT 8

Connector No.	M30
Connector Name	COMBINATION SWITCH (SPIRAL CABLE)
Connector Color	GRAY



Terminal No.	Color of Wire	Signal Name
24	BR	–
25	L	– (WITHOUT NAVI)
31	G	–

BASE AUDIO SYSTEM

< WIRING DIAGRAM >

[BASE AUDIO (EXCEPT MEXICO)]

A
B
C
D
E
F
G
H
I
J
K
L
M
N
O
P

Connector No.	M32
Connector Name	AUDIO UNIT (BASE AUDIO SYSTEM - EXCEPT FOR MEXICO)
Connector Color	GRAY

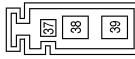

Terminal No.	Color of Wire	Signal Name
37	-	-
38	B	ANT MAIN
39	-	-

Connector No.	M31
Connector Name	WIRE TO WIRE
Connector Color	WHITE

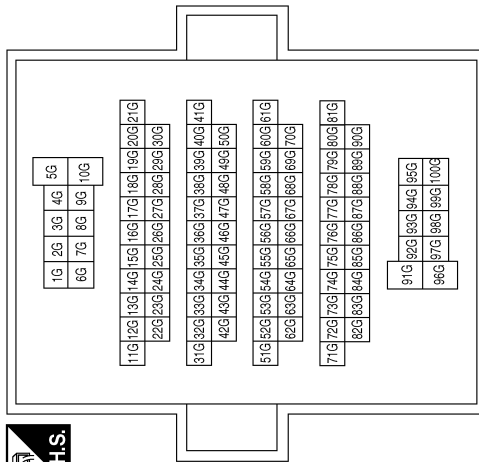

Terminal No.	Color of Wire	Signal Name
2G	Y	-

ABNIA5567GB

AV

BASE AUDIO SYSTEM

< WIRING DIAGRAM >

[BASE AUDIO (EXCEPT MEXICO)]

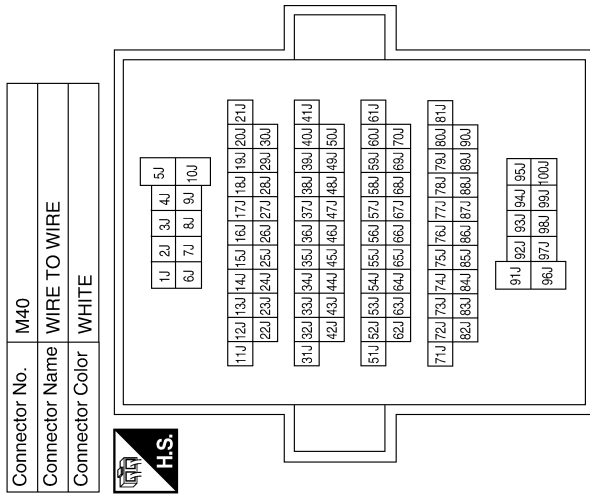

Terminal No.	Color of Wire	Signal Name
93J	G	-
98J	B	-

Terminal No.	Color of Wire	Signal Name
12	R	FR SP RH (-)
13	GR	RR SP RH (+)
14	BG	RR SP RH (-)
15	BG	REMOTE GND SWC
16	LG	REMOTE B SWC
17	-	-
18	SB	SPEED SIGNAL
19	Y	BAT
20	B	GND

Terminal No.	Color of Wire	Signal Name
51M	GR	-(FOR BASE AUDIO SYSTEM)
52M	R	-
54M	V	-
55M	BR	-
56M	SHIELD	-
57M	W/G	-
58M	G	-
59M	SHIELD	-
60M	L	-
61M	Y	-
62M	W	-
63M	BG	-
64M	LG	-
65M	L	-
66M	G	-
67M	SB	-
69M	R	-
70M	G	-
91M	R/B	-
96M	G/Y	-

Terminal No.	Color of Wire	Signal Name
2	BR	FR SP LH (+)
3	L	FR SP LH (-)
4	G	RR SP LH (+)
5	B	RR SP LH (-)
6	V	REMOTE A SWC
7	G/B	ACC
8	GR	ILL CONT
9	R	LIGHT SW
10	-	-
11	LG	FR SP RH (+)

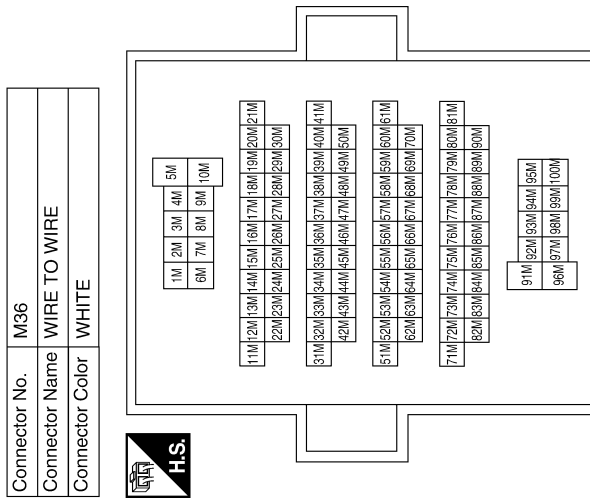

Connector No.	M43
Connector Name	AUDIO UNIT (BASE AUDIO SYSTEM - EXCEPT FOR MEXICO)
Connector Color	WHITE

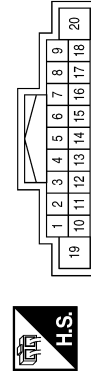

Terminal No.	Color of Wire	Signal Name
1	-	-

ABNIA5568GB

BASE AUDIO SYSTEM

< WIRING DIAGRAM >

[BASE AUDIO (EXCEPT MEXICO)]

Connector No.	M75
Connector Name	WIRE TO WIRE
Connector Color	WHITE

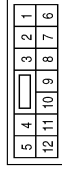

Terminal No.	Color of Wire	Signal Name
4	R	-
11	LG	-

Terminal No.	Color of Wire	Signal Name
26	L	EQ3
27	G	EQ2
28	-	-
29	W	M CAN 2 L
30	L	M CAN 2 H
31	-	-
32	-	-
33	W	TEL I/F (+)
34	GR	TEL I/F (-)
35	-	-
36	R	TEL ON

Connector No.	M60
Connector Name	AUDIO UNIT (BASE AUDIO SYSTEM - EXCEPT FOR MEXICO)
Connector Color	WHITE

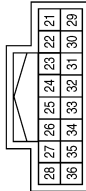

Terminal No.	Color of Wire	Signal Name
21	G	M CAN 1 L
22	R	M CAN 1 H
23	SHIELD	M CAN 1 SHIELD
24	-	-
25	BR	EQ4

Connector No.	M111
Connector Name	FRONT TWEETER RH
Connector Color	BROWN



Terminal No.	Color of Wire	Signal Name
1	W	-
2	L	-(WITHOUT AMPLIFIER)

Connector No.	M109
Connector Name	FRONT TWEETER LH
Connector Color	BROWN



Terminal No.	Color of Wire	Signal Name
1	G	-(WITHOUT AMPLIFIER)
2	L	-(WITHOUT AMPLIFIER)

Connector No.	M102
Connector Name	COMBINATION SWITCH (SPIRAL CABLE)
Connector Color	GRAY



Terminal No.	Color of Wire	Signal Name
15	GR	-
16	G	-
18	B	-

ABNIA5569GB

A
B
C
D
E
F
G
H
I
J
K
L
M
N
O
P

AV

BASE AUDIO SYSTEM

< WIRING DIAGRAM >

[BASE AUDIO (EXCEPT MEXICO)]

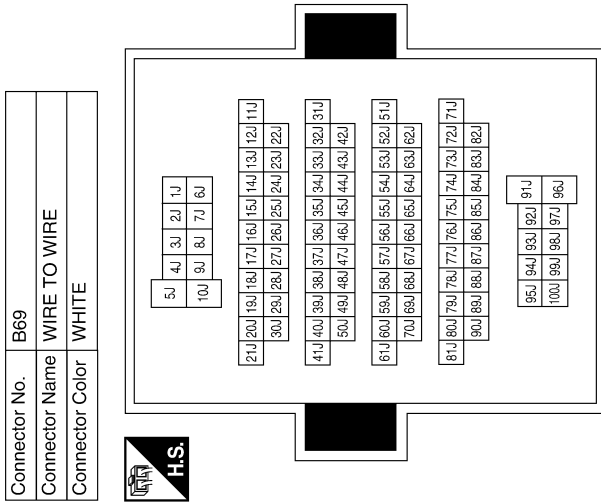

Terminal No.	Color of Wire	Signal Name
93J	G	-
98J	B	-



Terminal No.	Color of Wire	Signal Name
5	G	-
12	B	-



Terminal No.	Color of Wire	Signal Name
2G	Y	-



Terminal No.	Color of Wire	Signal Name
5	GR	- (EXCEPT DISPLAY AUDIO WITHOUT AMPLIFIER)

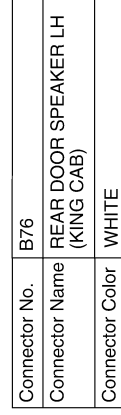

Terminal No.	Color of Wire	Signal Name
1	G	-
2	B	-

ABNIA5570GB

BASE AUDIO SYSTEM

< WIRING DIAGRAM >

[BASE AUDIO (EXCEPT MEXICO)]

Connector No.	B142
Connector Name	BLUETOOTH® CONTROL UNIT
Connector Color	BLACK



Terminal No.	Color of Wire	Signal Name
33	B	BT ANTENNA
34	SHIELD	BT ANTENNA SHIELD

Terminal No.	Color of Wire	Signal Name
13	L	LADDER IN 2
14	G	LADDER IN GND
15	-	-
16	-	-
17	V	LADDER OUT 1
18	LG	LADDER OUT 2
19	BG	LADDER OUT GND
20	-	-
21	-	-
22	B	CONT 3
23	B	CONT 4
24	-	-
25	-	-
26	-	-
27	-	-
28	SB	SPEED SIGNAL
28	Y	MIC POWER
30	-	-
31	-	-
32	-	-

Connector No.	B141
Connector Name	BLUETOOTH® CONTROL UNIT
Connector Color	WHITE

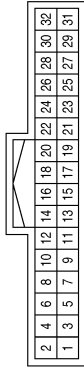

Terminal No.	Color of Wire	Signal Name
1	R/B	BATT
2	G/Y	ACC
3	W/G	IGN
4	B	GND
5	-	-
6	SHIELD	MIC SHIELD
7	G	MIC IN +
8	L	MIC IN -
9	W	AUDIO OUT +
10	B	AUDIO OUT -
11	R	TEL ON
12	BR	LADDER IN 1

Terminal No.	Color of Wire	Signal Name
37	SHIELD	CAN SHIELD 1
38	-	-
39	-	-
40	-	-
41	-	-
42	-	-

Connector No.	B143
Connector Name	BLUETOOTH® CONTROL UNIT
Connector Color	WHITE



Terminal No.	Color of Wire	Signal Name
35	R	CAN-H1
36	G	CAN-L1

ABNIA5571GB

A
B
C
D
E
F
G
H
I
J
K
L
M
N
O
P

AV

BASE AUDIO SYSTEM

< WIRING DIAGRAM >

[BASE AUDIO (EXCEPT MEXICO)]

Connector No.	B160
Connector Name	REAR DOOR SPEAKER RH (KING CAB)
Connector Color	WHITE



Terminal No.	Color of Wire	Signal Name
1	GR	– (WITH BASE AUDIO SYSTEM)
2	BG	– (WITH BASE AUDIO SYSTEM)

Terminal No.	Color of Wire	Signal Name
51M	GR	– (FOR BASE AUDIO SYSTEM)
52M	R	–
54M	V	–
55M	BR	–
56M	SHIELD	–
57M	W/G	–
58M	G	–
59M	SHIELD	–
60M	L	–
61M	Y	–
62M	W	–
63M	BG	–
64M	LG	–
65M	L	–
66M	G	–
67M	SB	–
69M	R	–
70M	G	–
91M	R/B	–
96M	G/Y	–

Connector No.	B149
Connector Name	WIRE TO WIRE
Connector Color	WHITE

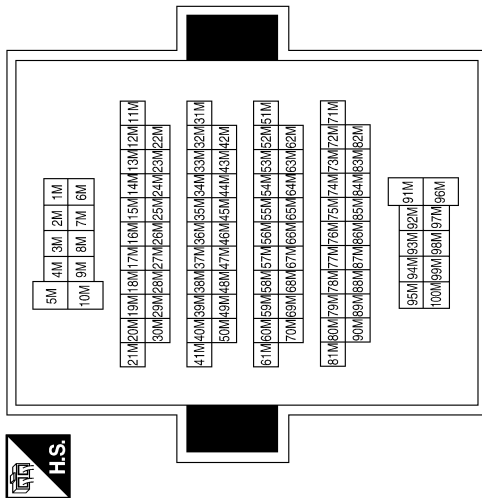

Connector No.	R8
Connector Name	MICROPHONE
Connector Color	WHITE



Terminal No.	Color of Wire	Signal Name
1	G	– (WITHOUT NAVI)
2	L	– (WITHOUT NAVI)
4	Y	– (WITHOUT NAVI)

Connector No.	R1
Connector Name	WIRE TO WIRE
Connector Color	WHITE

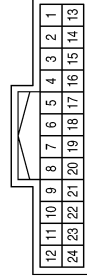

Terminal No.	Color of Wire	Signal Name
1	Y	– (WITHOUT NAVI)
13	SHIELD	–
14	G	– (WITHOUT NAVI)
15	L	– (WITHOUT NAVI)

Connector No.	B163
Connector Name	WIRE TO WIRE
Connector Color	WHITE

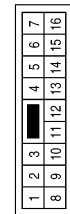

Terminal No.	Color of Wire	Signal Name
4	BR	–
5	G	–
11	GR	– (WITH BASE AUDIO SYSTEM)
12	BG	– (WITH BASE AUDIO SYSTEM)

ABNIA5573GB

BASE AUDIO SYSTEM

< WIRING DIAGRAM >

[BASE AUDIO (EXCEPT MEXICO)]

Connector No.	D101
Connector Name	WIRE TO WIRE
Connector Color	WHITE



1	2	3	4	5
6	7	8	9	10
11	12			

Terminal No.	Color of Wire	Signal Name
4	L/B	-
11	W/B	-

Connector No.	D12
Connector Name	FRONT DOOR SPEAKER LH
Connector Color	WHITE



2	1
---	---

Terminal No.	Color of Wire	Signal Name
1	L/W	-
2	L/R	-

Connector No.	D2
Connector Name	WIRE TO WIRE
Connector Color	BROWN



1	2	3	4	5
6	7	8	9	10
11	12			

Terminal No.	Color of Wire	Signal Name
2	L/R	-
3	L/W	-

Connector No.	D153
Connector Name	WIRE TO WIRE
Connector Color	WHITE



1	2	3	4	5
6	7	8	9	10
11	12			

Terminal No.	Color of Wire	Signal Name
4	R	-
11	LG	-

Connector No.	D152
Connector Name	WIRE TO WIRE
Connector Color	WHITE



5	4	3	2	1
12	11	10	9	8
7	6			

Terminal No.	Color of Wire	Signal Name
4	R	-
11	LG	-

Connector No.	D112
Connector Name	FRONT DOOR SPEAKER RH
Connector Color	WHITE



2	1
---	---

Terminal No.	Color of Wire	Signal Name
1	W/B	-
2	L/B	-

ABNIA5657GB

A
B
C
D
E
F
G
H
I
J
K
L
M
N
O
P

AV

BASE AUDIO SYSTEM

< WIRING DIAGRAM >

[BASE AUDIO (EXCEPT MEXICO)]

Connector No.	D301
Connector Name	WIRE TO WIRE
Connector Color	WHITE

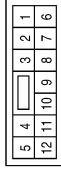

Terminal No.	Color of Wire	Signal Name
5	L	-
12	O	-

Connector No.	D207
Connector Name	REAR DOOR SPEAKER LH (CREW CAB)
Connector Color	WHITE



Terminal No.	Color of Wire	Signal Name
1	L	-
2	O	-

Connector No.	D201
Connector Name	WIRE TO WIRE
Connector Color	WHITE

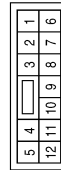

Terminal No.	Color of Wire	Signal Name
5	L	-
12	O	-

Connector No.	D307
Connector Name	REAR DOOR SPEAKER RH (CREW CAB)
Connector Color	WHITE



Terminal No.	Color of Wire	Signal Name
1	L	-
2	O	-

ABNIA5658GB

AUDIO SYSTEM

< SYMPTOM DIAGNOSIS >

[BASE AUDIO (EXCEPT MEXICO)]

SYMPTOM DIAGNOSIS

AUDIO SYSTEM

Symptom Table

INFOID:000000009482085

AUDIO SYSTEM

Symptoms	Check items	Probable malfunction location
The disk cannot be removed.	Audio unit	Malfunction in audio unit. Refer to AV-49, "Removal and Installation" .
No sound comes out or the level of the sound is low.	No sound from all speakers.	<ul style="list-style-type: none"> • Speaker circuit shorted to ground. Refer to AV-30, "Wiring Diagram". • Audio unit power supply and ground circuits malfunction. Refer to AV-12, "AUDIO UNIT : Diagnosis Procedure".
	Only a certain speaker (front tweeter LH, front tweeter RH, front door speaker LH, front door speaker RH, rear door speaker LH, rear door speaker RH) does not output sound.	<ul style="list-style-type: none"> • Poor connector connection of speaker. • Sound signal circuit malfunction between audio unit and speaker. Refer to: <ul style="list-style-type: none"> - AV-17, "Diagnosis Procedure" (front tweeter). - AV-15, "Diagnosis Procedure" (front door speaker). - AV-19, "Diagnosis Procedure" (rear door speaker). • Malfunction in speaker. Refer to: <ul style="list-style-type: none"> - AV-50, "Removal and Installation" (front tweeter). - AV-51, "Removal and Installation" (front door speaker). - AV-52, "Removal and Installation" (rear door speaker). • Malfunction in audio unit. Refer to AV-49, "Removal and Installation".

A
B
C
D
E
F
G
H
I
J
K
L
M
O
P

AV

AUDIO SYSTEM

< SYMPTOM DIAGNOSIS >

[BASE AUDIO (EXCEPT MEXICO)]

Symptoms	Check items	Probable malfunction location
Noise is mixed with audio.	Noise comes out from all speakers.	Malfunction in audio unit. Refer to AV-49, "Removal and Installation" .
	Noise comes out only from a certain speaker (front tweeter LH, front tweeter RH, front door speaker LH, front door speaker RH, rear door speaker LH, rear door speaker RH).	<ul style="list-style-type: none"> • Poor connector connection of speaker. • Sound signal circuit malfunction between audio unit and speaker. Refer to: <ul style="list-style-type: none"> - AV-17, "Diagnosis Procedure" (front tweeter). - AV-15, "Diagnosis Procedure" (front door speaker). - AV-19, "Diagnosis Procedure" (rear door speaker). <ul style="list-style-type: none"> • Malfunction in speaker. • Poor Installation of speaker (e.g. backlash and looseness). Refer to: <ul style="list-style-type: none"> - AV-50, "Removal and Installation" (front tweeter). - AV-51, "Removal and Installation" (front door speaker). - AV-52, "Removal and Installation" (rear door speaker). <ul style="list-style-type: none"> • Malfunction in audio unit. Refer to AV-49, "Removal and Installation" .
	Noise is mixed with radio only (when the vehicle hits a bump or while driving over bad roads)	Poor connector connection of antenna or antenna feeder. Refer to AV-57, "Location of Antenna" .
No radio reception or poor reception.	<ul style="list-style-type: none"> • Other audio sounds are normal. • Any radio station cannot be received or poor reception is caused even after moving to a service area with good reception (e.g. a place with clear view and no obstacles generating external noises). 	<ul style="list-style-type: none"> • Rod antenna is not fully connected to antenna base. • Antenna base/rod connection (thread zone) has foreign material or corrosion inside. • Poor connector connection of antenna or antenna feeder. Refer to AV-57, "Location of Antenna" .
Buzz/rattle sound from speaker	The majority of buzz/rattle sounds are not indicative of an issue with the speaker, usually something nearby the speaker is causing the buzz/rattle.	Refer to "SQUEAK AND RATTLE TROUBLE DIAGNOSIS" in the appropriate interior trim section.

RELATED TO HANDS-FREE PHONE

- Before performing diagnosis, confirm that the cellular phone being used by the customer is compatible with the vehicle.
- It is possible that a malfunction is occurring due to a version change of the phone even though the phone is a compatible type. This can be confirmed by changing the cellular phone to another compatible type, and check that it operates normally. It is important to determine whether the cause of the malfunction is the vehicle or the cellular phone.

Check Compatibility

1. Make sure the customer's Bluetooth® related concern is understood.
2. Verify the customer's concern.

NOTE:
The customer's phone may be required, depending upon their concern.
3. Write down the customer's phone brand, model and service provider.



NOTE:
It is necessary to know the service provider. On occasion, a given phone may be on the approved list with one provider, but may not be on the approved list with other providers.
4. Go to "www.nissanusa.com/bluetooth/".
 - a. Using the website's search engine, find out if the customer's phone is on the approved list.

AUDIO SYSTEM

[BASE AUDIO (EXCEPT MEXICO)]

< SYMPTOM DIAGNOSIS >

- b. If the customer's phone is NOT on the approved list:
Stop diagnosis here. The customer needs to obtain a Bluetooth® phone that is on the approved list before any further action.
- c. If the feature related to the customer's concern shows as "N" (not compatible):
Stop diagnosis here. If the customer still wants the feature to function, they will need to get an approved phone showing the feature as "Y" (compatible) in the "Basic Features".
- d. If the feature related to the customer's concern shows as "Y" (compatible):
Perform diagnosis as per the following table.

Symptoms	Check items	Probable malfunction location
Does not recognize cellular phone connection (no connection is displayed on the display at the guide).	Repeat the registration of cellular phone.	
Hands-free phone cannot be established.	<ul style="list-style-type: none"> • Hands-free phone operation can be made, but the communication cannot be established. • Hands-free phone operation can be performed, however, voice between each other cannot be heard during the conversation. 	Malfunction in audio unit. Replace audio unit. Refer to AV-49. "Removal and Installation" .
The other party's voice cannot be heard by hands-free phone.	Check the "microphone speaker" in Inspection & Adjustment Mode if sound is heard.	
Originating sound is not heard by the other party with hands-free phone communication.	Sound operation function is normal.	
	Sound operation function does not work.	Microphone signal circuit malfunction. Refer to AV-23. "Diagnosis Procedure" .
The system cannot be operated.	<ul style="list-style-type: none"> • The voice recognition can be controlled. • Steering switch's VOL UP and VOL DOWN switch works, but  does not work. 	Steering switch malfunction. Replace steering switch. Refer to AV-53. "Removal and Installation" .
	Steering switch's  , VOL UP and VOL DOWN switches do not work.	Steering switch signal circuit malfunction. Refer to AV-21. "Diagnosis Procedure" .
	All steering switches do not work.	Steering switch ground circuit malfunction. Refer to AV-21. "Diagnosis Procedure" .

A
B
C
D
E
F
G
H
I
J
K
L
M
O
P

AV

NORMAL OPERATING CONDITION

< SYMPTOM DIAGNOSIS >

[BASE AUDIO (EXCEPT MEXICO)]

NORMAL OPERATING CONDITION

Description

INFOID:000000009482086

The majority of the audio concerns are the result of outside causes (bad CD, electromagnetic interference, etc.).

NOISE

The following noise results from variations in field strength, such as fading noise and multi-path noise, or external noise from trains and other sources. It is not a malfunction.

- Fading noise: This noise occurs because of variations in the field strength in a narrow range due to mountains or buildings blocking the signal.
- Multi-path noise: This noise results from the waves sent directly from the broadcast station arriving at the antenna at a different time from the waves which reflect off mountains or buildings.

The vehicle itself can be a source of noise if noise prevention parts or electrical equipment is malfunctioning. Check if noise is caused and/or changed by engine speed, ignition switch turned to each position, and operation of each piece of electrical equipment to determine the cause.

NOTE:

The source of the noise can be found easily by listening to the noise while removing the fuses of electrical components, one by one.

Type of Noise and Possible Cause

Occurrence condition		Possible cause
Occurs only when engine is ON.	A continuous growling noise occurs. The speed of the noise varies with changes in the engine speed.	<ul style="list-style-type: none"> • Ignition components
The occurrence of the noise is linked with the operation of the fuel pump.		<ul style="list-style-type: none"> • Fuel pump condenser
Noise only occurs when various electrical components are operating.	A cracking or snapping sound occurs with the operation of various switches.	<ul style="list-style-type: none"> • Relay malfunction, audio unit malfunction
	The noise occurs when various motors are operating.	<ul style="list-style-type: none"> • Motor case ground • Motor
The noise occurs constantly, not just under certain conditions.		Poor ground of antenna feeder line
A cracking or snapping sound occurs while the vehicle is being driven, especially when it is vibrating excessively.		<ul style="list-style-type: none"> • Ground wire of body parts • Ground due to improper part installation • Wiring connections or a short circuit

RELATED TO HANDS-FREE PHONE

Symptom	Cause and Counter measure
Does not recognize cellular phone connection (No connection is displayed on the display at the guide).	<p>Some Bluetooth® enabled cellular phones may not be recognized by the in-vehicle phone module.</p> <p>Refer to "RELATED TO HANDS-FREE PHONE (Check Compatibility)" in AV-138, "Symptom Table".</p>
Cannot use hands-free phone.	<p>Customer will not be able to use a hands-free phone under the following conditions:</p> <ul style="list-style-type: none"> • The vehicle is outside of the telephone service area. • The vehicle is in an area where it is difficult to receive radio waves; such as in a tunnel, in an underground parking garage, near a tall building or in a mountainous area. • The cellular phone is locked to prevent it from being dialed. <p>NOTE:</p> <p>While a cellular phone is connected through the Bluetooth® wireless connection, the battery power of the cellular phone may discharge quicker than usual. The Bluetooth® Hands-Free Phone System cannot charge cellular phones.</p>

NORMAL OPERATING CONDITION

< SYMPTOM DIAGNOSIS >

[BASE AUDIO (EXCEPT MEXICO)]

Symptom	Cause and Counter measure
The other party's voice cannot be heard by hands-free phone.	When the radio wave condition is not ideal or ambient sound is too loud, it may be difficult to hear the other person's voice during a call.
Poor sound quality.	Do not place the cellular phone in an area surrounded by metal or far away from the in-vehicle phone module to prevent tone quality degradation and wireless connection disruption.

A

B

C

D

E

F

G

H

I

J

K

L

M

AV

O

P

PRECAUTION

PRECAUTIONS

Precaution for Supplemental Restraint System (SRS) "AIR BAG" and "SEAT BELT PRE-TENSIONER"

INFOID:000000010138324

The Supplemental Restraint System such as "AIR BAG" and "SEAT BELT PRE-TENSIONER", used along with a front seat belt, helps to reduce the risk or severity of injury to the driver and front passenger for certain types of collision. This system includes seat belt switch inputs and dual stage front air bag modules. The SRS system uses the seat belt switches to determine the front air bag deployment, and may only deploy one front air bag, depending on the severity of a collision and whether the front occupants are belted or unbelted. Information necessary to service the system safely is included in the SR and SB section of this Service Manual.

WARNING:

- To avoid rendering the SRS inoperative, which could increase the risk of personal injury or death in the event of a collision which would result in air bag inflation, all maintenance must be performed by an authorized NISSAN/INFINITI dealer.
- Improper maintenance, including incorrect removal and installation of the SRS, can lead to personal injury caused by unintentional activation of the system. For removal of Spiral Cable and Air Bag Module, see the SR section.
- Do not use electrical test equipment on any circuit related to the SRS unless instructed to in this Service Manual. SRS wiring harnesses can be identified by yellow and/or orange harnesses or harness connectors.

PRECAUTIONS WHEN USING POWER TOOLS (AIR OR ELECTRIC) AND HAMMERS

WARNING:

- When working near the Airbag Diagnosis Sensor Unit or other Airbag System sensors with the Ignition ON or engine running, DO NOT use air or electric power tools or strike near the sensor(s) with a hammer. Heavy vibration could activate the sensor(s) and deploy the air bag(s), possibly causing serious injury.
- When using air or electric power tools or hammers, always switch the Ignition OFF, disconnect the battery and wait at least three minutes before performing any service.

Precaution for Trouble Diagnosis

INFOID:000000009482088

AV COMMUNICATION SYSTEM

- Do not apply voltage of 7.0 V or higher to the measurement terminals.
- Use the tester with its open terminal voltage being 7.0 V or less.
- Be sure to turn ignition switch OFF and disconnect the battery cable from the negative terminal before checking the circuit.

Precaution for Harness Repair

INFOID:000000009482089

AV COMMUNICATION SYSTEM

- Solder the repaired parts, and wrap with tape. [Frays of twisted line must be within 110 mm (4.33 in).]

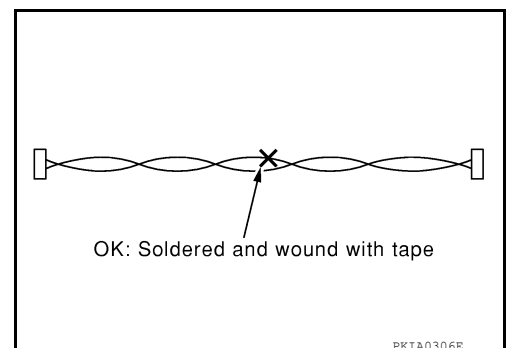

PRECAUTIONS

< PRECAUTION >

[BASE AUDIO (EXCEPT MEXICO)]

- Do not perform bypass wire connections for the repair parts. (The spliced wire will become separated and the characteristics of twisted line will be lost.)

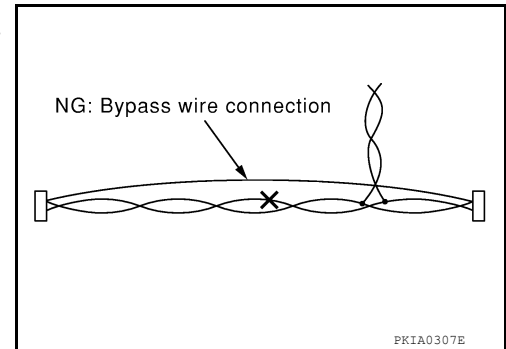

Precaution for Work

INFOID:000000009482090

- When removing or disassembling each component, be careful not to damage or deform it. If a component may be subject to interference, be sure to protect it with a shop cloth.
- When removing (disengaging) components with a screwdriver or similar tool, be sure to wrap the component with a shop cloth or vinyl tape to protect it.
- Protect the removed parts with a shop cloth and prevent them from being dropped.
- Replace a deformed or damaged clip.
- If a part is specified as a non-reusable part, always replace it with a new one.
- Be sure to tighten bolts and nuts securely to the specified torque.
- After installation is complete, be sure to check that each part works properly.
- Follow the steps below to clean components:
 - Water soluble dirt:
 - Dip a soft cloth into lukewarm water, wring the water out of the cloth and wipe the dirty area.
 - Then rub with a soft, dry cloth.
 - Oily dirt:
 - Dip a soft cloth into lukewarm water with mild detergent (concentration: within 2 to 3%) and wipe the dirty area.
 - Then dip a cloth into fresh water, wring the water out of the cloth and wipe the detergent off.
 - Then rub with a soft, dry cloth.
 - Do not use organic solvent such as thinner, benzene, alcohol or gasoline.
 - For genuine leather seats, use a genuine leather seat cleaner.

A
B
C
D
E
F
G
H
I
J
K
L
M

AV

O
P

PREPARATION

< PREPARATION >

[BASE AUDIO (EXCEPT MEXICO)]

PREPARATION

PREPARATION

Special Service Tool

INFOID:000000009482091

The actual shape of the tools may differ from those of illustrated here.

Tool number (TechMate No.) Tool name	Description
— (J-46534) Trim Tool Set	Removing trim components

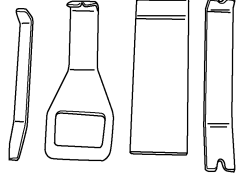

AWJIA04832Z

Commercial Service Tools

INFOID:000000009482092

Tool name	Description
Power tool	Loosening nuts, screws and bolts



PIIB1407E

REMOVAL AND INSTALLATION

AUDIO UNIT

Removal and Installation

INFOID:000000009482093

REMOVAL

1. Remove cluster lid C. Refer to [IP-19. "Removal and Installation"](#).
2. Remove the audio control unit screws using power tools.
3. Pull out the audio unit from the instrument panel and disconnect the harness connector from the audio unit.

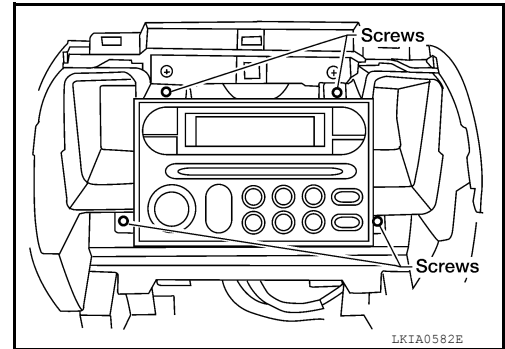

INSTALLATION

Installation is in the reverse order of removal.

A
B
C
D
E
F
G
H
I
J
K
L
M
N
O
P

AV

FRONT TWEETER

< REMOVAL AND INSTALLATION >

[BASE AUDIO (EXCEPT MEXICO)]

FRONT TWEETER

Removal and Installation

INFOID:000000009482094

REMOVAL

1. Remove the front tweeter grille.
2. Remove the front tweeter screws (A).
3. Pull out the front tweeter (1), then disconnect the harness connector from the front tweeter and remove.

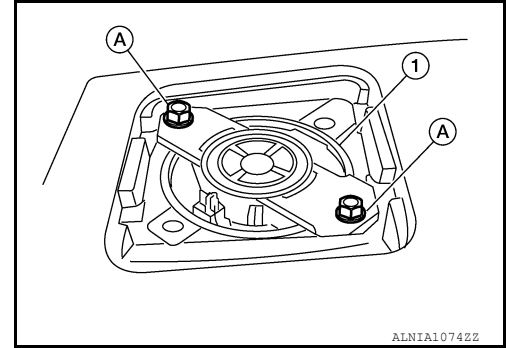

INSTALLATION

Installation is in the reverse order of removal.

FRONT DOOR SPEAKER

< REMOVAL AND INSTALLATION >

[BASE AUDIO (EXCEPT MEXICO)]

FRONT DOOR SPEAKER

Removal and Installation

INFOID:000000009482095

REMOVAL

1. Remove the front door finisher. Refer to [INT-15, "Removal and Installation"](#).
2. Remove the front door speaker screws (A).
3. Pull out the front door speaker (1).
4. Disconnect the harness connector from the front door speaker (1) and remove.

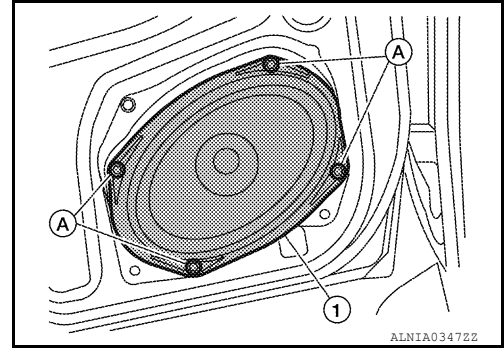

INSTALLATION

Installation is in the reverse order of removal.

A
B
C
D
E
F
G
H
I
J
K
L
M
N
O
P

AV

REAR DOOR SPEAKER

< REMOVAL AND INSTALLATION >

[BASE AUDIO (EXCEPT MEXICO)]

REAR DOOR SPEAKER

Removal and Installation

INFOID:000000009482096

REMOVAL

1. Remove the rear door finisher. Refer to [INT-15. "Removal and Installation"](#).
2. Remove the rear door speaker screws (A).
3. Disconnect the harness connector (B) from the rear door speaker (1) and remove.

NOTE:

King cab shown, crew cab similar.

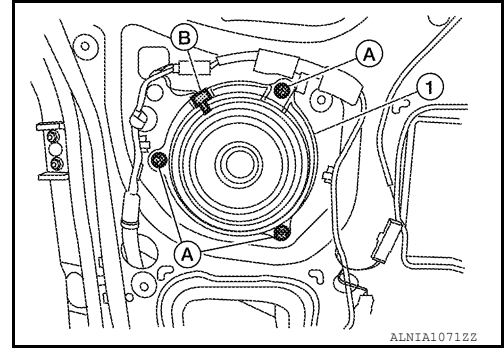

INSTALLATION

Installation is in the reverse order of removal.

STEERING SWITCH

< REMOVAL AND INSTALLATION >

[BASE AUDIO (EXCEPT MEXICO)]

STEERING SWITCH

Removal and Installation

INFOID:000000010239655

Removal and Installation

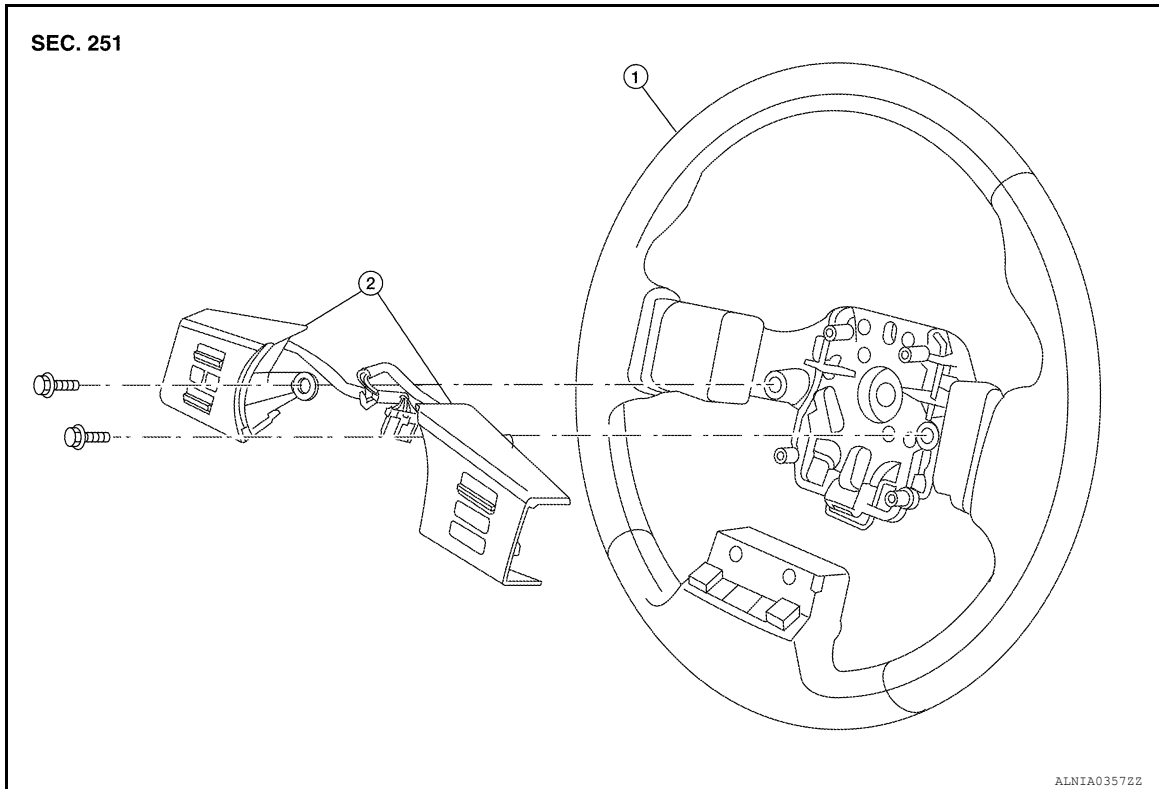

1. Steering wheel

2. Steering wheel audio control switches

REMOVAL

1. Remove the driver air bag module. Refer to [SR-11, "Removal and Installation"](#).
2. Remove the steering wheel audio control switch assembly screws.
3. Disconnect the harness connectors from the steering wheel audio control switches.
4. Remove the steering wheel audio control switches by pulling on steering wheel audio control switches to release the pawls.

○: Pawl

CAUTION:

Do not tilt steering wheel audio control switches during removal or damage may occur to the pawls.

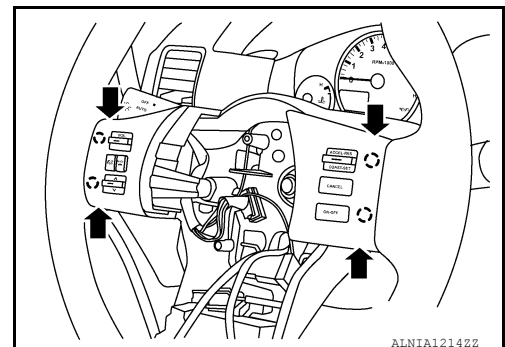

INSTALLATION

Installation is in the reverse order of removal.

A
B
C
D
E
F
G
H
I
J
K
L
M
AV
O
P

BLUETOOTH CONTROL UNIT

< REMOVAL AND INSTALLATION >

[BASE AUDIO (EXCEPT MEXICO)]

BLUETOOTH CONTROL UNIT

Removal and Installation

INFOID:000000010239656

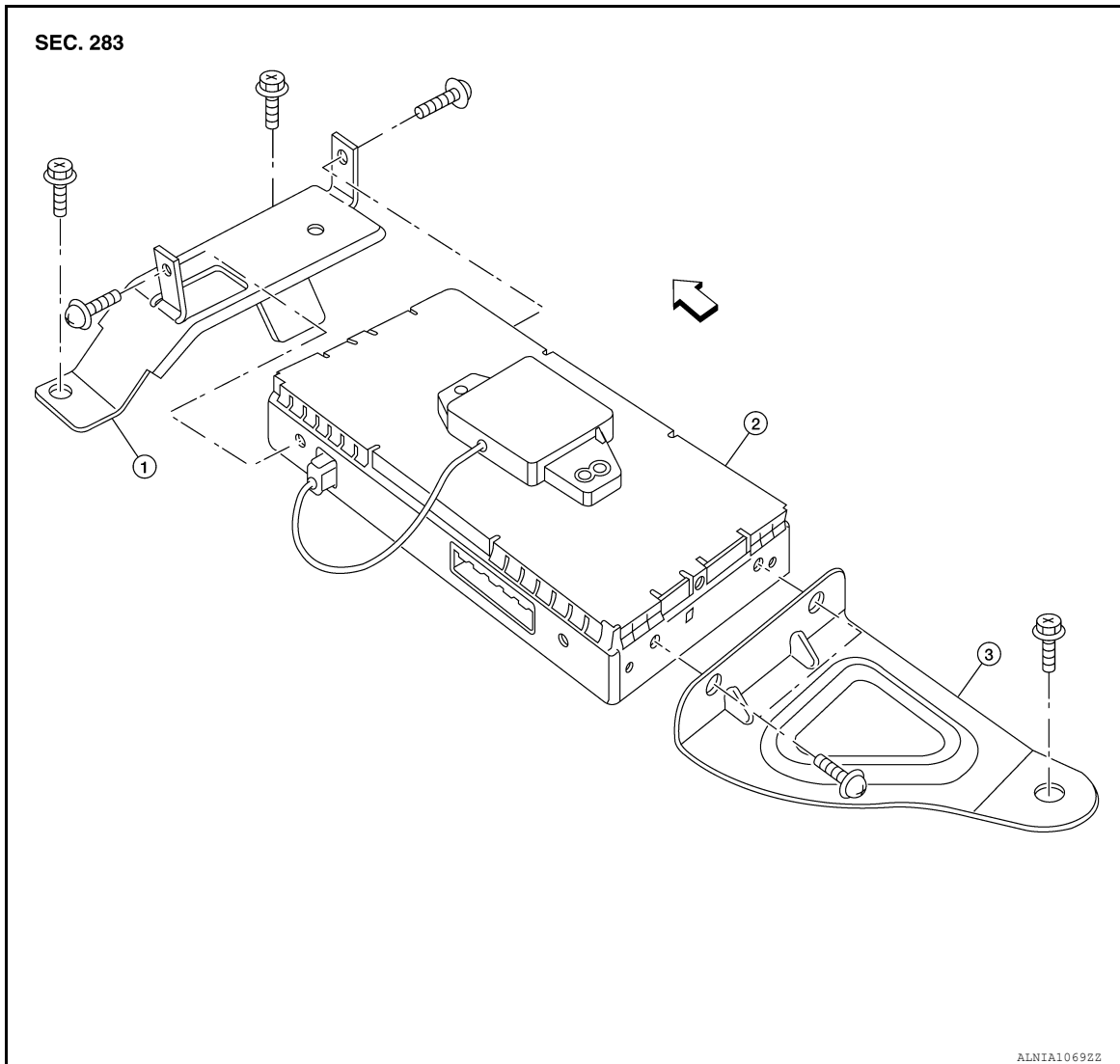

1. Bluetooth control unit front bracket 2. Bluetooth control unit/antenna 3. Bluetooth control unit rear bracket

⇐ Front

REMOVAL

NOTE:

Do not remove the RH front seat from the vehicle.

1. Remove the RH front seat bolts, disconnect the harness connectors from the RH front seat. Refer to [SE-32. "Removal and Installation"](#).
2. Tilt the RH front seat back to access the bluetooth control unit.

BLUETOOTH CONTROL UNIT

< REMOVAL AND INSTALLATION >

[BASE AUDIO (EXCEPT MEXICO)]

3. Disconnect the harness connector (B) from the Bluetooth control unit.
4. Remove the Bluetooth control unit screws (A), then remove the Bluetooth control unit assembly (1).
5. Remove the Bluetooth control unit bracket screws and Bluetooth control unit front and rear brackets.

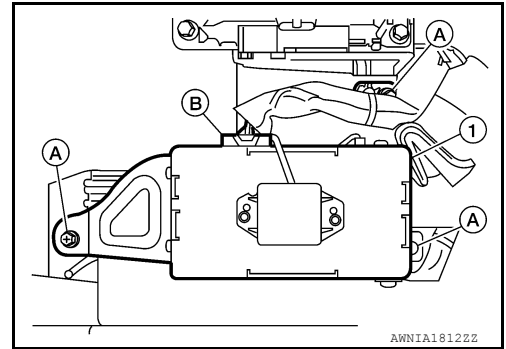

INSTALLATION

Installation is in the reverse order of removal.

A
B
C
D
E
F
G
H
I
J
K
L
M

AV

O
P

MICROPHONE

< REMOVAL AND INSTALLATION >

[BASE AUDIO (EXCEPT MEXICO)]

MICROPHONE

Removal and Installation

INFOID:000000010239660

REMOVAL

1. Remove the roof console. Refer to [INT-25, "Removal and Installation"](#).
2. Release the pawls that retain the Bluetooth microphone (1) to the roof console.
3. Disconnect the harness connector (A) from the Bluetooth microphone (1) and remove.

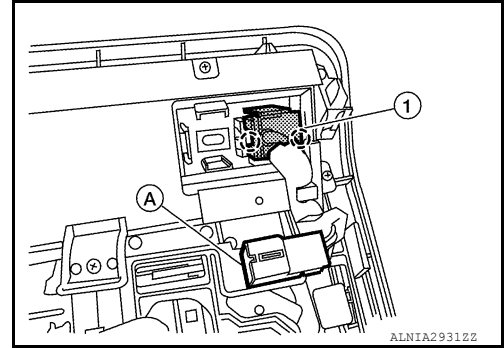

INSTALLATION

Installation is in the reverse order of removal.

AUDIO ANTENNA

< REMOVAL AND INSTALLATION >

[BASE AUDIO (EXCEPT MEXICO)]

AUDIO ANTENNA

Location of Antenna

INFOID:000000009482097

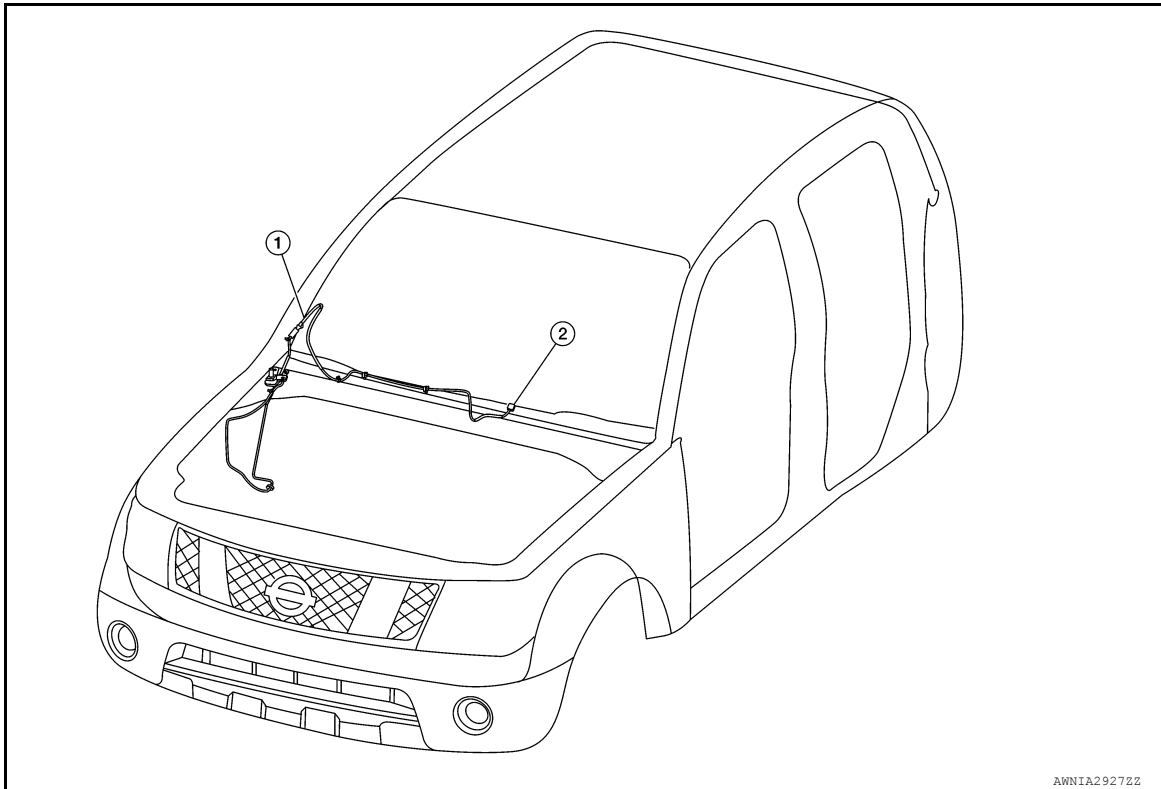

1. Coaxial antenna feeder 2. Coaxial connector

Removal and Installation

INFOID:000000009482098

REMOVAL

1. Remove instrument lower panel RH and glove box. Refer to [JP-24. "Removal and Installation"](#).
2. Disconnect audio antenna cable from antenna feeder.
3. Remove antenna rod.
4. Remove rubber seal.
5. Remove cowl top. Refer to [EXT-24. "Removal and Installation"](#).
6. Remove fender protector. Refer to [EXT-27. "Removal and Installation of Front Fender Protector"](#).
7. Remove antenna base bolts.
8. Remove antenna base and cable.

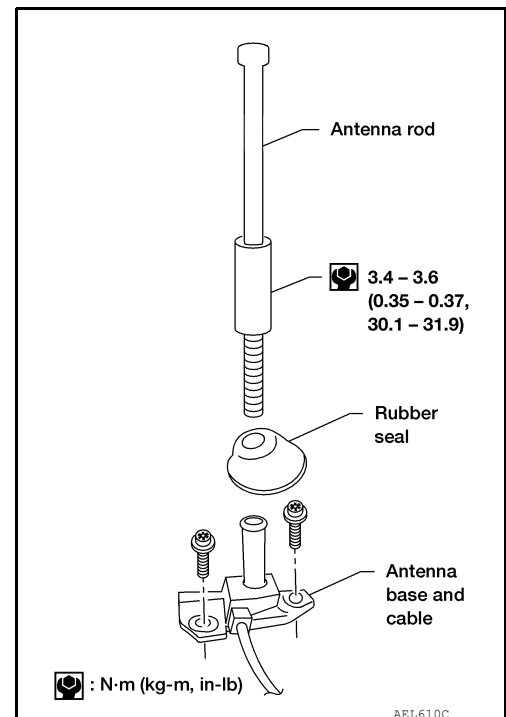

A
B
C
D
E
F
G
H
I
J
K
L
M
AV
O
P

AUDIO ANTENNA

< REMOVAL AND INSTALLATION >

[BASE AUDIO (EXCEPT MEXICO)]

INSTALLATION

Installation is in the reverse order of removal.

CAUTION:

Always properly tighten the antenna rod during installation or the antenna rod may bend or break during vehicle operation.

BASIC INSPECTION

DIAGNOSIS AND REPAIR WORKFLOW

Work Flow

INFOID:000000010227910

OVERALL SEQUENCE

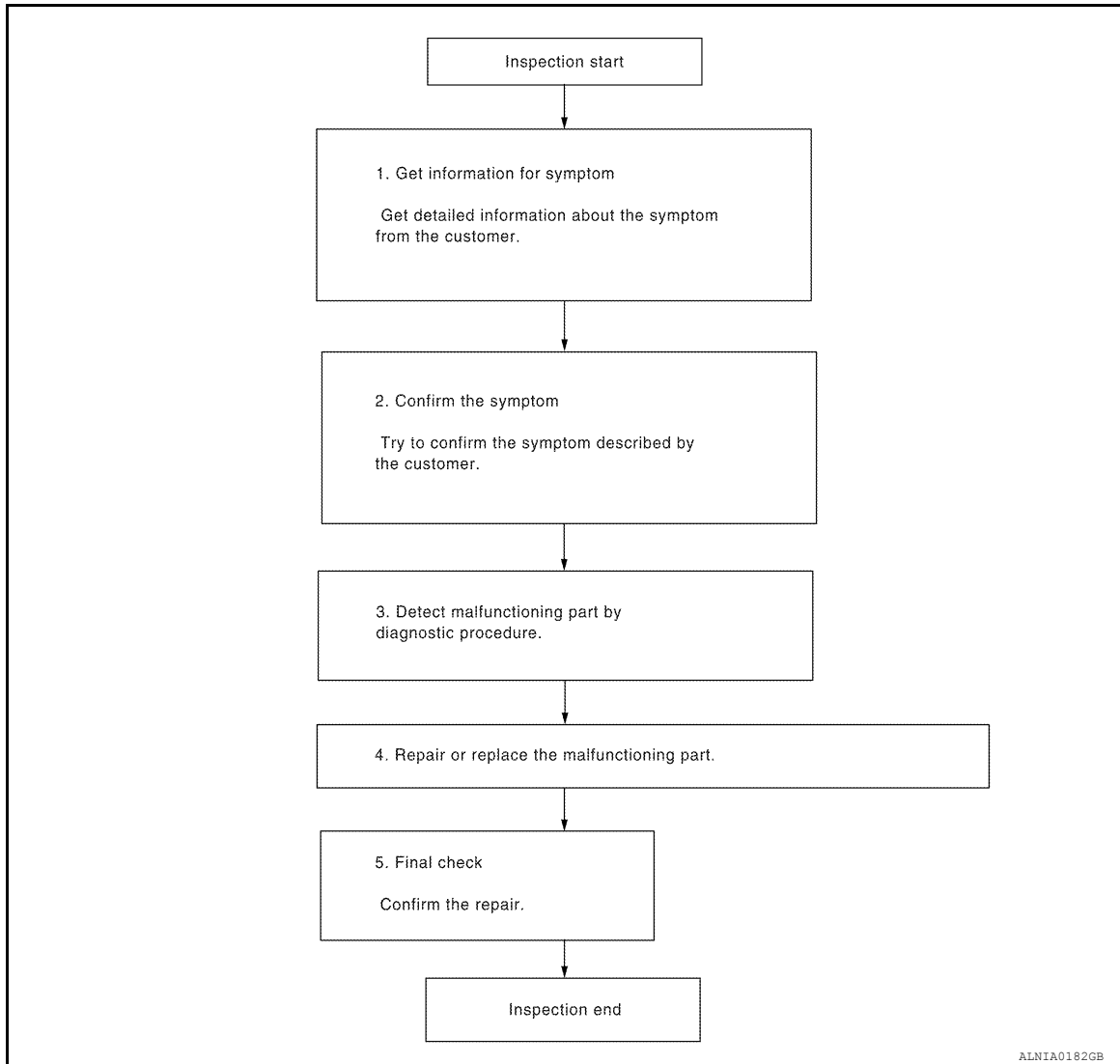

DETAILED FLOW

1.GET INFORMATION FOR SYMPTOM

Get detailed information from the customer about the symptom (the condition and the environment when the incident/malfunction occurred).

>> GO TO 2

2.CONFIRM THE SYMPTOM

Try to confirm the symptom described by the customer. Verify relation between the symptom and the condition when the symptom is detected.

>> GO TO 3

3.DETECT MALFUNCTIONING PART BY DIAGNOSTIC PROCEDURE

Inspect according to Diagnostic Procedure of the system.

A
B
C
D
E
F
G
H
I
J
K
L
M

AV

O

P

DIAGNOSIS AND REPAIR WORKFLOW

< BASIC INSPECTION >

[BASE AUDIO (FOR MEXICO)]

Is malfunctioning part detected?

YES >> GO TO 4
NO >> GO TO 2

4. REPAIR OR REPLACE THE MALFUNCTIONING PART

1. Repair or replace the malfunctioning part.
2. Reconnect parts or connectors disconnected during Diagnostic Procedure.

>> GO TO 5

5. FINAL CHECK

Refer to confirmed symptom in step 2, and make sure that the symptom is not detected.

Has the symptom been repaired?

YES >> Inspection End.
NO >> GO TO 2

SYSTEM DESCRIPTION

AUDIO SYSTEM

System Diagram

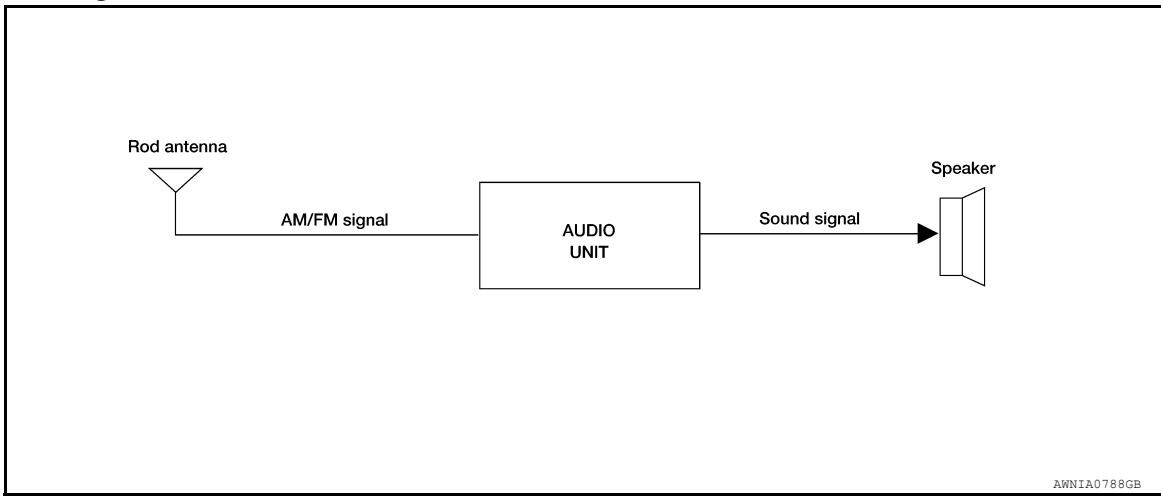

System Description

INFOID:0000000010227912

AUDIO SYSTEM

The audio system consists of the following components

- Audio unit
- Rod antenna
- Front door speakers
- Front tweeters
- Rear door speakers

When the audio system is on, radio signals are received by the rod antenna. The audio unit then sends audio signals to the front door speakers, front tweeters and rear door speakers.

Refer to Owner's Manual for audio system operating instructions.

A
B
C
D
E
F
G
H
I
J
K
L
M
O
P

AV

AUDIO SYSTEM

< SYSTEM DESCRIPTION >

[BASE AUDIO (FOR MEXICO)]

Component Parts Location

INFOID:000000010227913

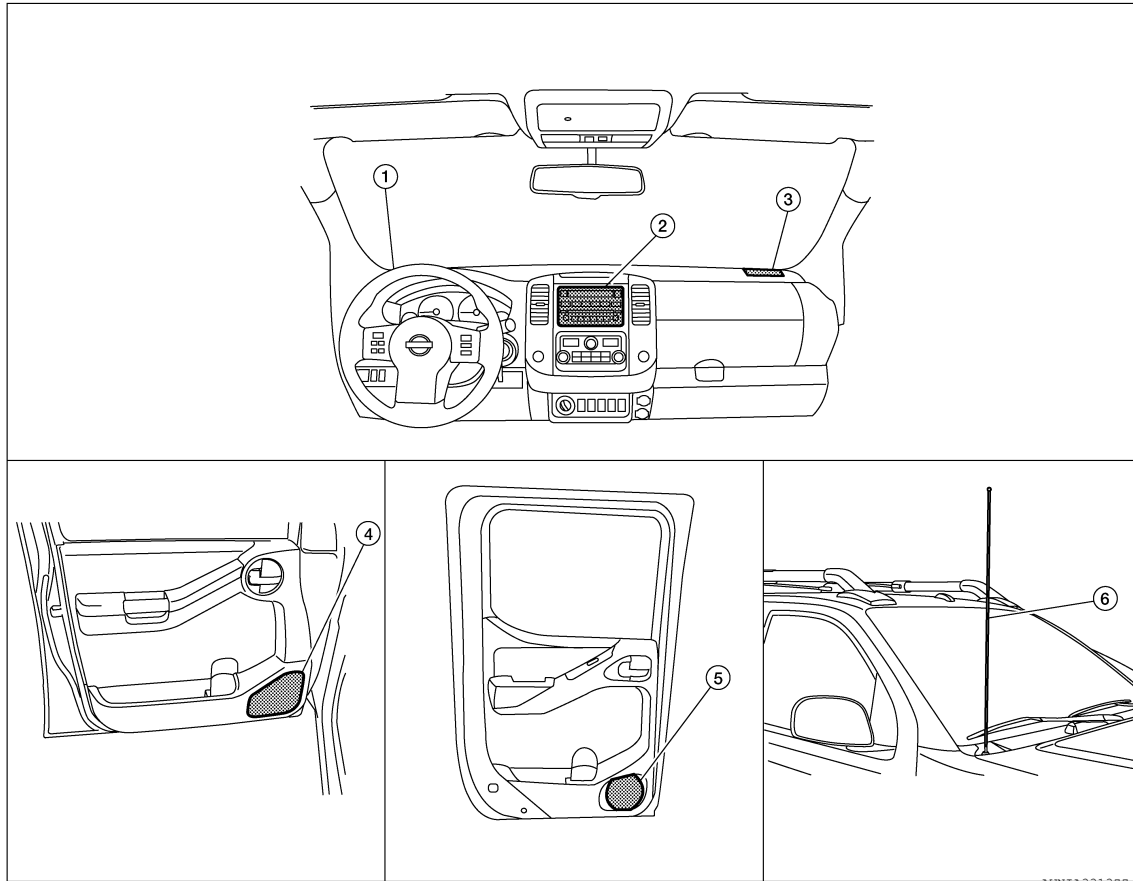

- | | | |
|--|---|--------------------------|
| 1. Front tweeter LH M109 | 2. Audio unit M11, M12 | 3. Front tweeter RH M111 |
| 4. Front door speaker LH D12
Front door speaker RH D112 | 5. Rear door speaker LH D207
Rear door speaker RH D307 | 6. Rod antenna |

Component Description

INFOID:000000010227914

Part name	Description
Audio unit	Controls audio system functions
Front door speakers	<ul style="list-style-type: none"> Outputs audio signal from audio unit Outputs high, mid and low range sounds
Front tweeters	<ul style="list-style-type: none"> Outputs audio signal from audio unit Outputs high range sounds
Rear door speakers	<ul style="list-style-type: none"> Outputs audio signal from audio unit Outputs high, mid and low range sounds

POWER SUPPLY AND GROUND CIRCUIT

< DTC/CIRCUIT DIAGNOSIS >

[BASE AUDIO (FOR MEXICO)]

DTC/CIRCUIT DIAGNOSIS

POWER SUPPLY AND GROUND CIRCUIT AUDIO UNIT

AUDIO UNIT : Diagnosis Procedure

INFOID:000000010227915

Regarding Wiring Diagram information, refer to [AV-72, "Wiring Diagram"](#).

1. CHECK FUSE

Check that the following fuses are not blown.

Terminal No.	Signal name	Fuse No.
7	ACC power supply	4 (10A)
19	Battery power supply	29 (20A)

Are the fuses blown?

- YES >> Replace the blown fuse after repairing the affected circuit.
NO >> GO TO 2.

2. CHECK POWER SUPPLY CIRCUIT

1. Turn ignition switch OFF.
2. Disconnect audio unit connector M12.
3. Check voltage between audio unit connector M12 and ground.

Audio unit		Ground	Condition	Voltage (Approx.)
Connector	Terminal			
M12	7	—	Ignition switch: ON	Battery voltage
	19		Ignition switch: OFF	

Is the inspection result normal?

- YES >> Inspection End.
NO >> Repair or replace harness or connectors.

A
B
C
D
E
F
G
H
I
J
K
L
M
O
P



FRONT DOOR SPEAKER

< DTC/CIRCUIT DIAGNOSIS >

[BASE AUDIO (FOR MEXICO)]

FRONT DOOR SPEAKER

Description

INFOID:000000010227916

The audio unit sends audio signals to the front door speakers using the front door speaker circuits.

Diagnosis Procedure

INFOID:000000010227917

Regarding Wiring Diagram information, refer to [AV-72, "Wiring Diagram"](#).

1. CONNECTOR CHECK

Check the audio unit and speaker connectors for the following:

- Proper connection
- Damage
- Disconnected or loose terminals

Is the inspection result normal?

YES >> GO TO 2

NO >> Repair the terminals or connectors.

2. CHECK FRONT DOOR SPEAKER SIGNAL CIRCUIT CONTINUITY

1. Disconnect audio unit connector M12 and suspect front door speaker connector.
2. Check continuity between audio unit connector M12 and suspect front door speaker connector.

Audio unit		Front door speaker		Continuity
Connector	Terminal	Connector	Terminal	
M12	2	D12 (LH)	1	Yes
	3		2	
	11	D112 (RH)	1	
	12		2	

3. Check continuity between audio unit connector M12 and ground.

Audio unit		Ground	Continuity
Connector	Terminal		
M12	2	—	No
	3		
	11		
	12		

Is the inspection result normal?

YES >> GO TO 3

NO >> Repair or replace harness or connectors.

3. CHECK FRONT DOOR SPEAKER SIGNAL

1. Connect audio unit connector M12 and suspect front door speaker connector.
2. Turn ignition switch to ACC.
3. Push audio unit POWER switch.
4. Check signal between the terminals of audio unit connector M12.

Audio unit connector M12		Condition	Reference value
(+)	(-)		
Terminal	Terminal		

FRONT DOOR SPEAKER

< DTC/CIRCUIT DIAGNOSIS >

[BASE AUDIO (FOR MEXICO)]

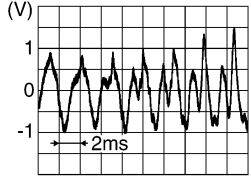
2	3	Audio signal output	
11	12		

Is the inspection result normal?

- YES >> Replace front door speaker. Refer to [AV-86. "Removal and Installation"](#).
- NO >> Replace audio unit. Refer to [AV-84. "Removal and Installation"](#).

A
B
C
D
E
F
G
H
I
J
K
L
M
O
P

AV

FRONT TWEETER

< DTC/CIRCUIT DIAGNOSIS >

[BASE AUDIO (FOR MEXICO)]

FRONT TWEETER

Description

INFOID:000000010227918

The audio unit sends audio signals to the front tweeters using the front tweeter circuits.

Diagnosis Procedure

INFOID:000000010227919

Regarding Wiring Diagram information, refer to [AV-72, "Wiring Diagram"](#).

1.CONNECTOR CHECK

Check the audio unit and speaker connectors for the following:

- Proper connection
- Damage
- Disconnected or loose terminals

Is the inspection result normal?

YES >> GO TO 2

NO >> Repair the terminals or connectors.

2.CHECK FRONT DOOR SPEAKER SIGNAL CIRCUIT CONTINUITY

1. Disconnect audio unit connector M12 and suspect front tweeter connector.
2. Check continuity between audio unit connector M12 and suspect front tweeter connector.

Audio unit		Front tweeter		Continuity
Connector	Terminal	Connector	Terminal	
M12	2	M109 (LH)	1	Yes
	3		2	
	11	M111 (RH)	1	
	12		2	

3. Check continuity between audio unit connector M12 and ground.

Audio unit		Ground	Continuity
Connector	Terminal		
M12	2	—	No
	3		
	11		
	12		

Is the inspection result normal?

YES >> GO TO 3

NO >> Repair or replace harness or connectors.

3.CHECK FRONT DOOR SPEAKER SIGNAL

1. Connect audio unit connector M12 and suspect front tweeter connector.
2. Turn ignition switch to ACC.
3. Push audio unit POWER switch.
4. Check signal between the terminals of audio unit connector M12.

Audio unit connector M12		Condition	Reference value
(+)	(-)		
Terminal	Terminal		

FRONT TWEETER

< DTC/CIRCUIT DIAGNOSIS >

[BASE AUDIO (FOR MEXICO)]

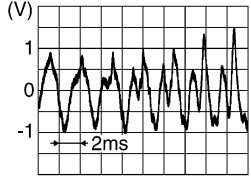
2	3	Audio signal output	
11	12		

Is the inspection result normal?

- YES >> Replace front tweeter. Refer to [AV-85. "Removal and Installation"](#).
- NO >> Replace audio unit. Refer to [AV-84. "Removal and Installation"](#).

A
B
C
D
E
F
G
H
I
J
K
L
M
O
P

AV

REAR DOOR SPEAKER

< DTC/CIRCUIT DIAGNOSIS >

[BASE AUDIO (FOR MEXICO)]

REAR DOOR SPEAKER

Description

INFOID:000000010227920

The audio unit sends audio signals to the rear door speakers using the rear door speaker circuits.

Diagnosis Procedure

INFOID:000000010227921

Regarding Wiring Diagram information, refer to [AV-72, "Wiring Diagram"](#).

1. CONNECTOR CHECK

Check the audio unit and speaker connectors for the following:

- Proper connection
- Damage
- Disconnected or loose terminals

Is the inspection result normal?

YES >> GO TO 2

NO >> Repair the terminals or connectors.

2. CHECK FRONT DOOR SPEAKER SIGNAL CIRCUIT CONTINUITY

1. Disconnect audio unit connector M12 and suspect rear door speaker connector.
2. Check continuity between audio unit connector M12 and suspect rear door speaker connector.

Audio unit		Rear door speaker		Continuity
Connector	Terminal	Connector	Terminal	
M12	4	D207 (LH)	1	Yes
	5		2	
	13	D307 (RH)	1	
	14		2	

3. Check continuity between audio unit connector M12 and ground.

Audio unit		Ground	Continuity
Connector	Terminal		
M12	4	—	No
	5		
	13		
	14		

Is the inspection result normal?

YES >> GO TO 3

NO >> Repair or replace harness or connectors.

3. CHECK FRONT DOOR SPEAKER SIGNAL

1. Connect audio unit connector M12 and suspect rear door speaker connector.
2. Turn ignition switch to ACC.
3. Push audio unit POWER switch.
4. Check signal between the terminals of audio unit connector M12.

Audio unit connector M12		Condition	Reference value
(+)	(-)		
Terminal	Terminal		

REAR DOOR SPEAKER

< DTC/CIRCUIT DIAGNOSIS >

[BASE AUDIO (FOR MEXICO)]

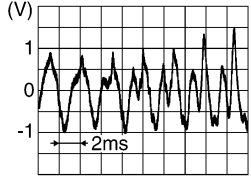
4	5	Audio signal output	
13	14		

Is the inspection result normal?

- YES >> Replace rear door speaker. Refer to [AV-87. "Removal and Installation"](#).
- NO >> Replace audio unit. Refer to [AV-84. "Removal and Installation"](#).

A
B
C
D
E
F
G
H
I
J
K
L
M
O
P

AV

AUDIO UNIT

< ECU DIAGNOSIS INFORMATION >

[BASE AUDIO (FOR MEXICO)]

ECU DIAGNOSIS INFORMATION

AUDIO UNIT

Reference Value

INFOID:000000010227922

TERMINAL LAYOUT

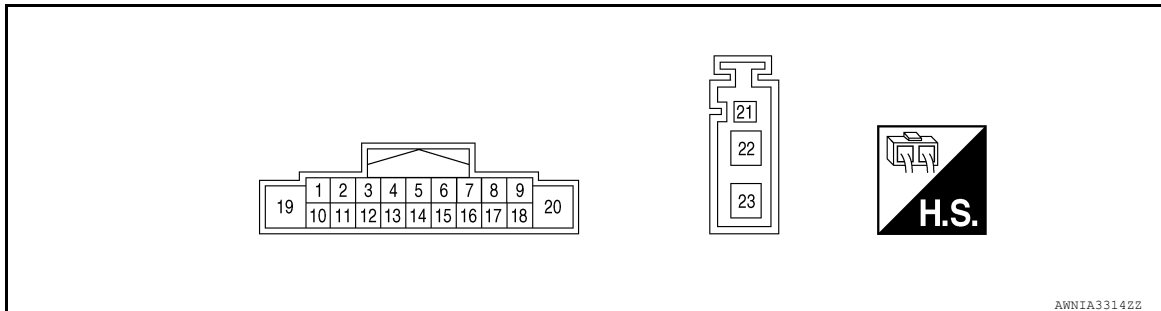

AWNIA33142Z

PHYSICAL VALUES

Terminal (Wire color)		Description		Condition		Reference value (Approx.)
+	-	Signal name	Input/ Output			
2 (BR)	3 (L)	Sound signal front door speaker and front tweeter LH	Output	Ignition switch ON	Audio output	<p>SKIB3609E</p>
4 (G)	5 (B)	Sound signal rear door speaker LH	Output	Ignition switch ON	Audio output	<p>SKIB3609E</p>
7 (G/B)	Ground	ACC power supply	Input	Ignition switch ACC or ON	—	Battery voltage
8 (GR)	Ground	ILL control	Input	Ignition switch ACC or ON	—	0V
9 (R)	Ground	Light switch	Input	Ignition switch ACC or ON	—	Battery voltage

AUDIO UNIT

< ECU DIAGNOSIS INFORMATION >

[BASE AUDIO (FOR MEXICO)]

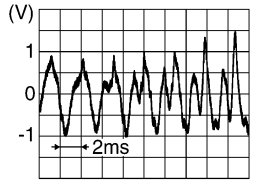
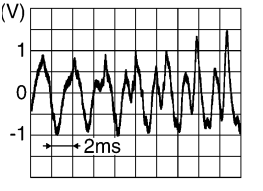
Terminal (Wire color)		Description		Condition		Reference value (Approx.)
+	-	Signal name	Input/ Output			
11 (LG)	12 (R)	Sound signal front door speaker and front tweeter RH	Output	Ignition switch ON	Voice output	
13 (GR)	14 (BG)	Sound signal rear door speaker RH	Output	Ignition switch ON	Voice output	
19 (Y)	Ground	Battery power supply	Input	Ignition switch OFF	—	Battery voltage
22 (B)	Ground	AM-FM main antenna	Input	ON	—	5.0 V

A
B
C
D
E
F
G
H
I
J
K
L
M

AV

O
P

BASE AUDIO SYSTEM

[BASE AUDIO (FOR MEXICO)]

< WIRING DIAGRAM >

WIRING DIAGRAM

BASE AUDIO SYSTEM

Wiring Diagram

INFOID:000000010227923

BASE AUDIO SYSTEM - FOR MEXICO

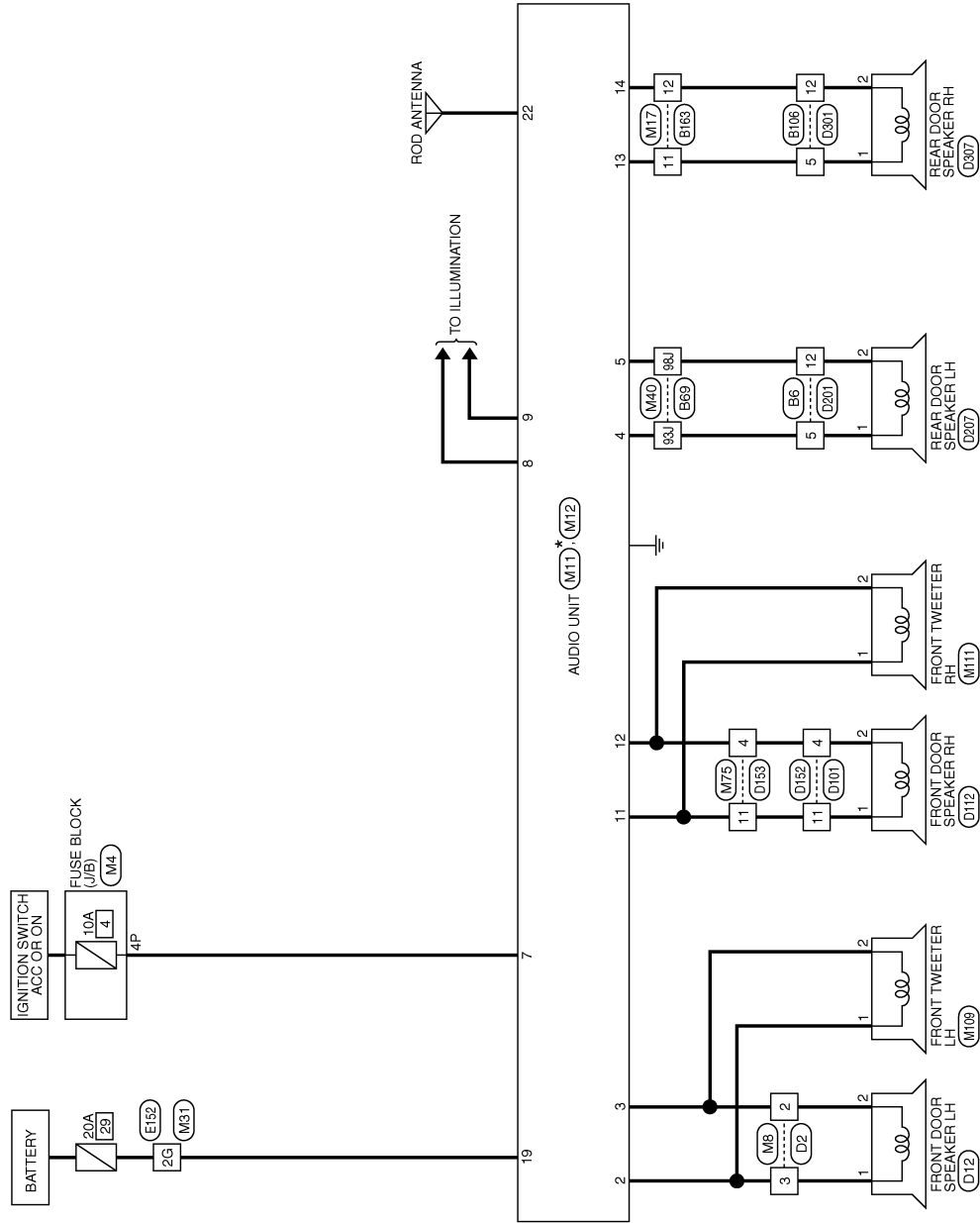

ABNWA2082GB

BASE AUDIO SYSTEM

< WIRING DIAGRAM >

[BASE AUDIO (FOR MEXICO)]

BASE AUDIO SYSTEM CONNECTORS - FOR MEXICO

Connector No.	M4
Connector Name	FUSE BLOCK (J/B)
Connector Color	WHITE



Terminal No.	Color of Wire	Signal Name
4P	G/B	-

Connector No.	M8
Connector Name	WIRE TO WIRE
Connector Color	BROWN

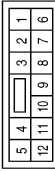

Terminal No.	Color of Wire	Signal Name
2	L	-
3	BR	-

Connector No.	M11
Connector Name	AUDIO UNIT (BASE AUDIO SYSTEM - FOR MEXICO)
Connector Color	GRAY

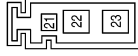

Terminal No.	Color of Wire	Signal Name
21	-	-
22	B	ANT MAIN
23	-	-

Connector No.	M12
Connector Name	AUDIO UNIT (BASE AUDIO SYSTEM - FOR MEXICO)
Connector Color	WHITE

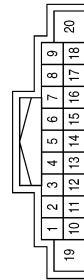

Terminal No.	Color of Wire	Signal Name
1	-	-
2	BR	FR SP LH (+)
3	L	FR SP LH (-)
4	G	RR SP LH (+)
5	B	RR SP LH (-)
6	-	-
7	G/B	ACC
8	GR	ILL CONT

Terminal No.	Color of Wire	Signal Name
9	R	LIGHT SW
10	-	-
11	LG	FR SP RH (+)
12	R	FR SP RH (-)
13	GR	RR SP RH (+)
14	BG	RR SP RH (-)
15	-	-
16	-	-
17	-	-
18	-	-
19	Y	BAT
20	-	-

Connector No.	M17
Connector Name	WIRE TO WIRE
Connector Color	WHITE

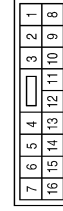

Terminal No.	Color of Wire	Signal Name
11	GR	- (WITH BASE AUDIO SYSTEM)
12	BG	- (WITH BASE AUDIO SYSTEM)

ABNIA5649GB

A
B
C
D
E
F
G
H
I
J
K
L
M
N
O
P



BASE AUDIO SYSTEM

< WIRING DIAGRAM >

[BASE AUDIO (FOR MEXICO)]

Connector No.	M75
Connector Name	WIRE TO WIRE
Connector Color	WHITE

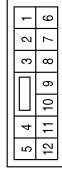

Terminal No.	Color of Wire	Signal Name
4	R	-
11	LG	-

Connector No.	M40
Connector Name	WIRE TO WIRE
Connector Color	WHITE

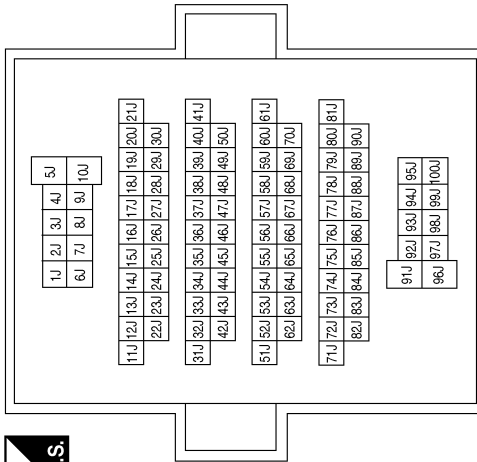

Terminal No.	Color of Wire	Signal Name
93J	G	-
98J	B	-

Connector No.	M31
Connector Name	WIRE TO WIRE
Connector Color	WHITE

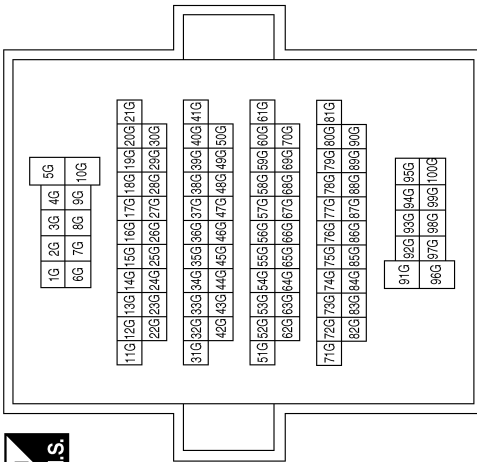

Terminal No.	Color of Wire	Signal Name
2G	Y	-

Connector No.	M111
Connector Name	FRONT TWEETER RH
Connector Color	BROWN



Terminal No.	Color of Wire	Signal Name
1	W	-
2	L	-(WITHOUT AMPLIFIER)

Connector No.	M109
Connector Name	FRONT TWEETER LH
Connector Color	BROWN

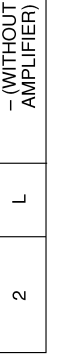

Terminal No.	Color of Wire	Signal Name
1	G	-(WITHOUT AMPLIFIER)
2	L	-(WITHOUT AMPLIFIER)

ABNIA5650GB

BASE AUDIO SYSTEM

< WIRING DIAGRAM >

[BASE AUDIO (FOR MEXICO)]

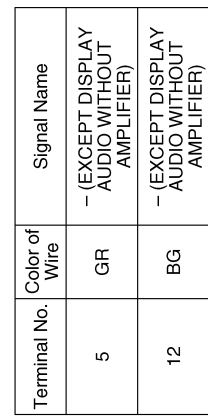
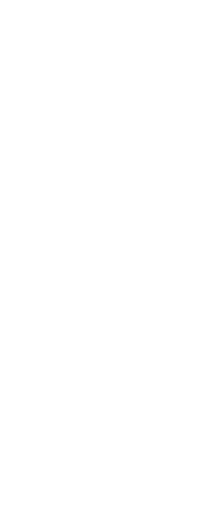
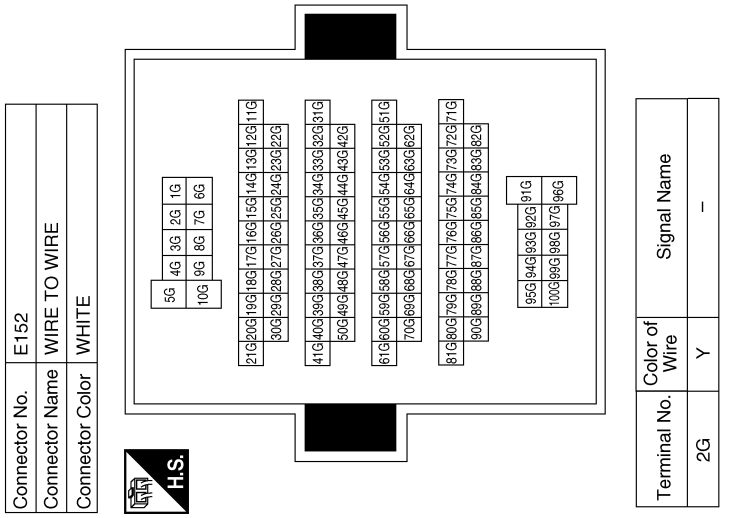
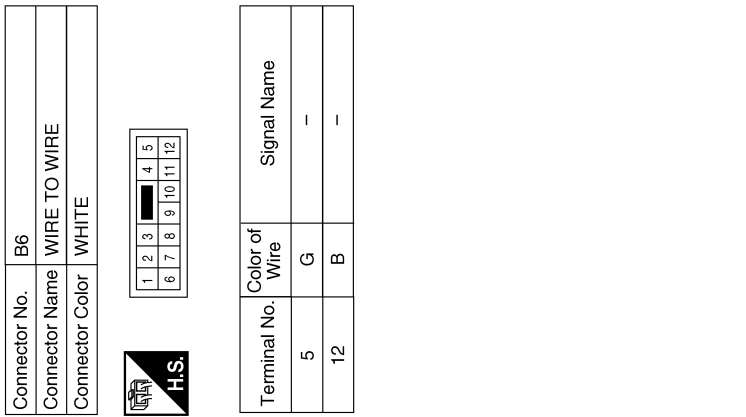
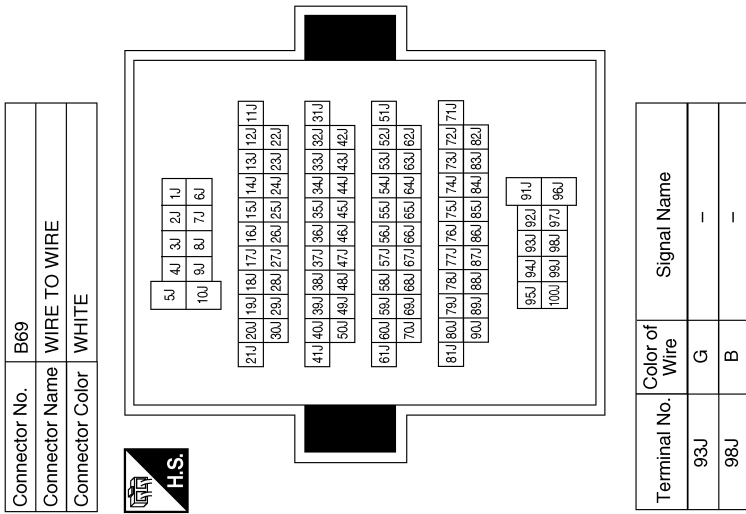

ABNIA5651GB

A
B
C
D
E
F
G
H
I
J
K
L
M
N
O
P

AV

BASE AUDIO SYSTEM

< WIRING DIAGRAM >

[BASE AUDIO (FOR MEXICO)]

Connector No.	D12
Connector Name	FRONT DOOR SPEAKER LH
Connector Color	WHITE



Terminal No.	Color of Wire	Signal Name
1	L/W	-
2	L/R	-

Connector No.	D2
Connector Name	WIRE TO WIRE
Connector Color	BROWN

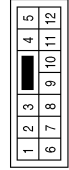

Terminal No.	Color of Wire	Signal Name
2	L/R	-
3	L/W	-

Connector No.	B163
Connector Name	WIRE TO WIRE
Connector Color	WHITE

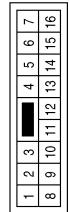

Terminal No.	Color of Wire	Signal Name
11	GR	- (WITH BASE AUDIO SYSTEM)
12	BG	- (WITH BASE AUDIO SYSTEM)

Connector No.	D152
Connector Name	WIRE TO WIRE
Connector Color	WHITE

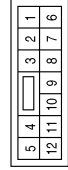

Terminal No.	Color of Wire	Signal Name
4	R	-
11	LG	-

Connector No.	D112
Connector Name	FRONT DOOR SPEAKER RH
Connector Color	WHITE



Terminal No.	Color of Wire	Signal Name
1	W/B	-
2	L/B	-

Connector No.	D101
Connector Name	WIRE TO WIRE
Connector Color	WHITE



Terminal No.	Color of Wire	Signal Name
4	L/B	-
11	W/B	-

ABNIA5652GB

BASE AUDIO SYSTEM

< WIRING DIAGRAM >

[BASE AUDIO (FOR MEXICO)]

Connector No.	D207
Connector Name	REAR DOOR SPEAKER LH (CREW CAB)
Connector Color	WHITE



Terminal No.	Color of Wire	Signal Name
1	L	-
2	O	-

Connector No.	D201
Connector Name	WIRE TO WIRE
Connector Color	WHITE

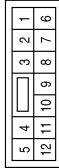

Terminal No.	Color of Wire	Signal Name
5	L	-
12	O	-

Connector No.	D153
Connector Name	WIRE TO WIRE
Connector Color	WHITE

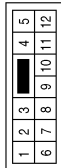

Terminal No.	Color of Wire	Signal Name
4	R	-
11	LG	-

Connector No.	D307
Connector Name	REAR DOOR SPEAKER RH (CREW CAB)
Connector Color	WHITE



Terminal No.	Color of Wire	Signal Name
1	L	-
2	O	-

Connector No.	D301
Connector Name	WIRE TO WIRE
Connector Color	WHITE

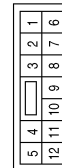

Terminal No.	Color of Wire	Signal Name
5	L	-
12	O	-

ABNIA5653GB

A
B
C
D
E
F
G
H
I
J
K
L
M
N
O
P

AV

SYMPTOM DIAGNOSIS

AUDIO SYSTEM

Symptom Table

INFOID:0000000010227924

AUDIO SYSTEM

Symptoms	Check items	Probable malfunction location
The disk cannot be removed.	Audio unit	Malfunction in audio unit. Refer to AV-84, "Removal and Installation" .
No sound comes out or the level of the sound is low.	No sound from all speakers.	<ul style="list-style-type: none"> • Speaker circuit shorted to ground. Refer to AV-72, "Wiring Diagram". • Audio unit power supply and ground circuits malfunction. Refer to AV-63, "AUDIO UNIT : Diagnosis Procedure".
	Only a certain speaker (front tweeter LH, front tweeter RH, front door speaker LH, front door speaker RH, rear door speaker LH, rear door speaker RH) does not output sound.	<ul style="list-style-type: none"> • Poor connector connection of speaker. • Sound signal circuit malfunction between audio unit and speaker. Refer to: <ul style="list-style-type: none"> - AV-66, "Diagnosis Procedure" (front tweeter). - AV-64, "Diagnosis Procedure" (front door speaker). - AV-68, "Diagnosis Procedure" (rear door speaker). • Malfunction in speaker. Refer to: <ul style="list-style-type: none"> - AV-85, "Removal and Installation" (front tweeter). - AV-86, "Removal and Installation" (front door speaker). - AV-87, "Removal and Installation" (rear door speaker). • Malfunction in audio unit. Refer to AV-84, "Removal and Installation".

AUDIO SYSTEM

< SYMPTOM DIAGNOSIS >

[BASE AUDIO (FOR MEXICO)]

Symptoms	Check items	Probable malfunction location
Noise is mixed with audio.	Noise comes out from all speakers.	Malfunction in audio unit. Refer to AV-84, "Removal and Installation" .
	Noise comes out only from a certain speaker (front tweeter LH, front tweeter RH, front door speaker LH, front door speaker RH, rear door speaker LH, rear door speaker RH).	<ul style="list-style-type: none"> • Poor connector connection of speaker. • Sound signal circuit malfunction between audio unit and speaker. Refer to: <ul style="list-style-type: none"> - AV-66, "Diagnosis Procedure" (front tweeter). - AV-64, "Diagnosis Procedure" (front door speaker). - AV-68, "Diagnosis Procedure" (rear door speaker). <ul style="list-style-type: none"> • Malfunction in speaker. • Poor Installation of speaker (e.g. backlash and looseness). Refer to: <ul style="list-style-type: none"> - AV-85, "Removal and Installation" (front tweeter). - AV-86, "Removal and Installation" (front door speaker). - AV-87, "Removal and Installation" (rear door speaker). <ul style="list-style-type: none"> • Malfunction in audio unit. Refer to AV-84, "Removal and Installation" .
	Noise is mixed with radio only (when the vehicle hits a bump or while driving over bad roads)	Poor connector connection of antenna or antenna feeder. Refer to AV-88, "Location of Antenna" .
No radio reception or poor reception.	<ul style="list-style-type: none"> • Other audio sounds are normal. • Any radio station cannot be received or poor reception is caused even after moving to a service area with good reception (e.g. a place with clear view and no obstacles generating external noises). 	<ul style="list-style-type: none"> • Rod antenna is not fully connected to antenna base. • Antenna base/rod connection (thread zone) has foreign material or corrosion inside. • Poor connector connection of antenna or antenna feeder. Refer to AV-88, "Location of Antenna" .
Buzz/rattle sound from speaker	The majority of buzz/rattle sounds are not indicative of an issue with the speaker, usually something nearby the speaker is causing the buzz/rattle.	Refer to "SQUEAK AND RATTLE TROUBLE DIAGNOSIS" in the appropriate interior trim section.

A
B
C
D
E
F
G
H
I
J
K
L
M

AV

O
P

NORMAL OPERATING CONDITION

< SYMPTOM DIAGNOSIS >

[BASE AUDIO (FOR MEXICO)]

NORMAL OPERATING CONDITION

Description

INFOID:000000010227925

The majority of the audio concerns are the result of outside causes (bad CD, electromagnetic interference, etc.).

NOISE

The following noise results from variations in field strength, such as fading noise and multi-path noise, or external noise from trains and other sources. It is not a malfunction.

- Fading noise: This noise occurs because of variations in the field strength in a narrow range due to mountains or buildings blocking the signal.
- Multi-path noise: This noise results from the waves sent directly from the broadcast station arriving at the antenna at a different time from the waves which reflect off mountains or buildings.

The vehicle itself can be a source of noise if noise prevention parts or electrical equipment is malfunctioning. Check if noise is caused and/or changed by engine speed, ignition switch turned to each position, and operation of each piece of electrical equipment to determine the cause.

NOTE:

The source of the noise can be found easily by listening to the noise while removing the fuses of electrical components, one by one.

Type of Noise and Possible Cause

Occurrence condition		Possible cause
Occurs only when engine is ON.	A continuous growling noise occurs. The speed of the noise varies with changes in the engine speed.	• Ignition components
The occurrence of the noise is linked with the operation of the fuel pump.		• Fuel pump condenser
Noise only occurs when various electrical components are operating.	A cracking or snapping sound occurs with the operation of various switches.	• Relay malfunction, audio unit malfunction
	The noise occurs when various motors are operating.	• Motor case ground • Motor
The noise occurs constantly, not just under certain conditions.		Poor ground of antenna feeder line
A cracking or snapping sound occurs while the vehicle is being driven, especially when it is vibrating excessively.		• Ground wire of body parts • Ground due to improper part installation • Wiring connections or a short circuit

PRECAUTION

PRECAUTIONS

Precaution for Supplemental Restraint System (SRS) "AIR BAG" and "SEAT BELT PRE-TENSIONER"

INFOID:000000010227926

The Supplemental Restraint System such as "AIR BAG" and "SEAT BELT PRE-TENSIONER", used along with a front seat belt, helps to reduce the risk or severity of injury to the driver and front passenger for certain types of collision. This system includes seat belt switch inputs and dual stage front air bag modules. The SRS system uses the seat belt switches to determine the front air bag deployment, and may only deploy one front air bag, depending on the severity of a collision and whether the front occupants are belted or unbelted. Information necessary to service the system safely is included in the SR and SB section of this Service Manual.

WARNING:

- To avoid rendering the SRS inoperative, which could increase the risk of personal injury or death in the event of a collision which would result in air bag inflation, all maintenance must be performed by an authorized NISSAN/INFINITI dealer.
- Improper maintenance, including incorrect removal and installation of the SRS, can lead to personal injury caused by unintentional activation of the system. For removal of Spiral Cable and Air Bag Module, see the SR section.
- Do not use electrical test equipment on any circuit related to the SRS unless instructed to in this Service Manual. SRS wiring harnesses can be identified by yellow and/or orange harnesses or harness connectors.

PRECAUTIONS WHEN USING POWER TOOLS (AIR OR ELECTRIC) AND HAMMERS

WARNING:

- When working near the Airbag Diagnosis Sensor Unit or other Airbag System sensors with the Ignition ON or engine running, DO NOT use air or electric power tools or strike near the sensor(s) with a hammer. Heavy vibration could activate the sensor(s) and deploy the air bag(s), possibly causing serious injury.
- When using air or electric power tools or hammers, always switch the Ignition OFF, disconnect the battery, and wait at least 3 minutes before performing any service.

Precaution for Trouble Diagnosis

INFOID:000000010227927

AV COMMUNICATION SYSTEM

- Do not apply voltage of 7.0 V or higher to the measurement terminals.
- Use the tester with its open terminal voltage being 7.0 V or less.
- Be sure to turn ignition switch OFF and disconnect the battery cable from the negative terminal before checking the circuit.

Precaution for Harness Repair

INFOID:000000010227928

AV COMMUNICATION SYSTEM

- Solder the repaired parts, and wrap with tape. [Frays of twisted line must be within 110 mm (4.33 in).]

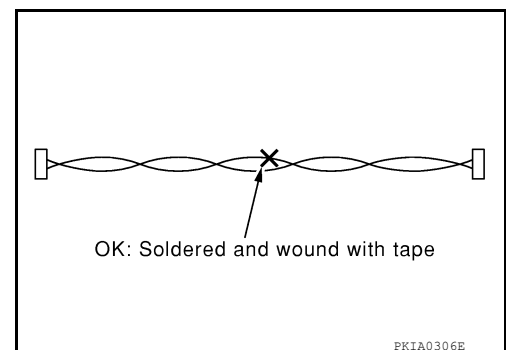

A
B
C
D
E
F
G
H
I
J
K
L
M
O
P

AV

PRECAUTIONS

[BASE AUDIO (FOR MEXICO)]

< PRECAUTION >

- Do not perform bypass wire connections for the repair parts. (The spliced wire will become separated and the characteristics of twisted line will be lost.)

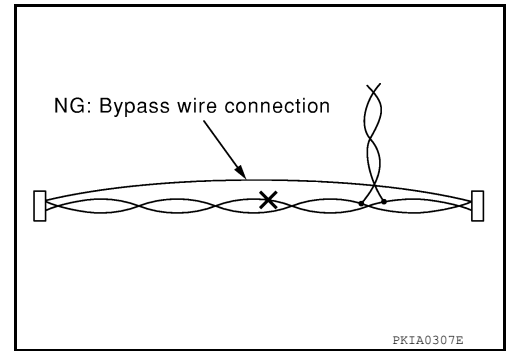

Precaution for Work

INFOID:000000010227929

- When removing or disassembling each component, be careful not to damage or deform it. If a component may be subject to interference, be sure to protect it with a shop cloth.
- When removing (disengaging) components with a screwdriver or similar tool, be sure to wrap the component with a shop cloth or vinyl tape to protect it.
- Protect the removed parts with a shop cloth and prevent them from being dropped.
- Replace a deformed or damaged clip.
- If a part is specified as a non-reusable part, always replace it with a new one.
- Be sure to tighten bolts and nuts securely to the specified torque.
- After installation is complete, be sure to check that each part works properly.
- Follow the steps below to clean components:
 - Water soluble dirt:
 - Dip a soft cloth into lukewarm water, wring the water out of the cloth and wipe the dirty area.
 - Then rub with a soft, dry cloth.
 - Oily dirt:
 - Dip a soft cloth into lukewarm water with mild detergent (concentration: within 2 to 3%) and wipe the dirty area.
 - Then dip a cloth into fresh water, wring the water out of the cloth and wipe the detergent off.
 - Then rub with a soft, dry cloth.
 - Do not use organic solvent such as thinner, benzene, alcohol or gasoline.
 - For genuine leather seats, use a genuine leather seat cleaner.

PREPARATION

< PREPARATION >

[BASE AUDIO (FOR MEXICO)]

PREPARATION

PREPARATION

Special Service Tool

INFOID:0000000010227930

The actual shape of the tools may differ from those illustrated here.

Tool number (TechMate No.) Tool name	Description
— (J-46534) Trim Tool Set	Removing trim components

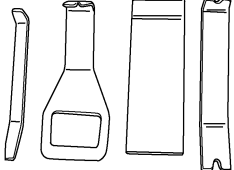

AWJIA04832Z

Commercial Service Tools

INFOID:0000000010227931

Tool name	Description
Power tool	Loosening nuts, screws and bolts

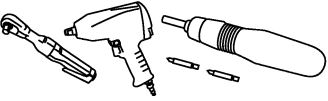

PIIB1407E

A
B
C
D
E
F
G
H
I
J
K
L
M
AV
O
P

REMOVAL AND INSTALLATION

AUDIO UNIT

Removal and Installation

INFOID:000000010227932

REMOVAL

1. Remove cluster lid C. Refer to [JP-19. "Removal and Installation"](#).
2. Remove the audio control unit screws using power tools.
3. Pull out the audio unit from the instrument panel and disconnect the harness connector from the audio unit.

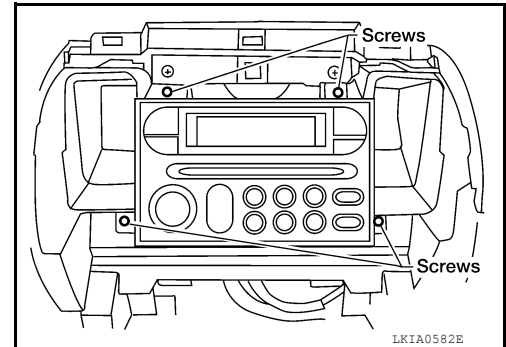

INSTALLATION

Installation is in the reverse order of removal.

FRONT TWEETER

< REMOVAL AND INSTALLATION >

[BASE AUDIO (FOR MEXICO)]

FRONT TWEETER

Removal and Installation

INFOID:000000010227933

REMOVAL

CAUTION:

Use a suitable tool to prevent damage to the front tweeter speaker grille trim and the instrument panel.

1. Remove the front tweeter grille.
2. Remove the front tweeter screws (A).
3. Pull out the front tweeter (1), then disconnect the harness connector from the front tweeter and remove.

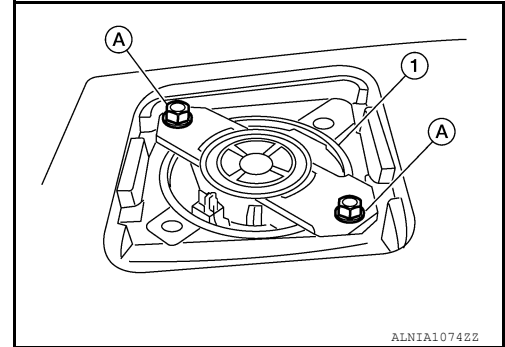

INSTALLATION

Installation is in the reverse order of removal.

A
B
C
D
E
F
G
H
I
J
K
L
M
AV
O
P

FRONT DOOR SPEAKER

< REMOVAL AND INSTALLATION >

[BASE AUDIO (FOR MEXICO)]

FRONT DOOR SPEAKER

Removal and Installation

INFOID:000000010227934

REMOVAL

1. Remove the front door finisher. Refer to [INT-15, "Removal and Installation"](#).
2. Remove the front door speaker screws (A).
3. Pull out the front door speaker (1).
4. Disconnect the harness connector from the front door speaker (1) and remove.

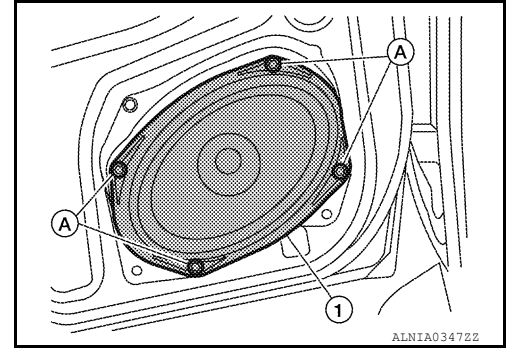

INSTALLATION

Installation is in the reverse order of removal.

REAR DOOR SPEAKER

< REMOVAL AND INSTALLATION >

[BASE AUDIO (FOR MEXICO)]

REAR DOOR SPEAKER

Removal and Installation

INFOID:000000010227935

REMOVAL

1. Remove the rear door finisher. Refer to [INT-15. "Removal and Installation"](#).
2. Remove the rear door speaker screws (A).
3. Disconnect the harness connector (B) from the rear door speaker (1) and remove.

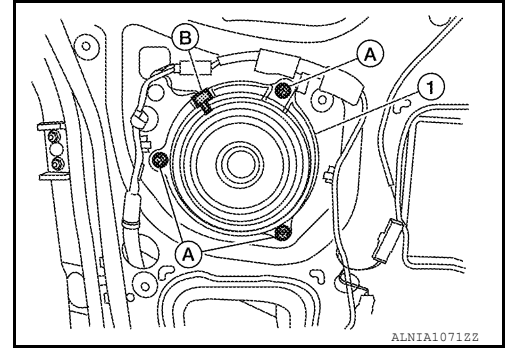

INSTALLATION

Installation is in the reverse order of removal.

A
B
C
D
E
F
G
H
I
J
K
L
M
AV
O
P

AUDIO ANTENNA

< REMOVAL AND INSTALLATION >

[BASE AUDIO (FOR MEXICO)]

AUDIO ANTENNA

Location of Antenna

INFOID:000000010227936

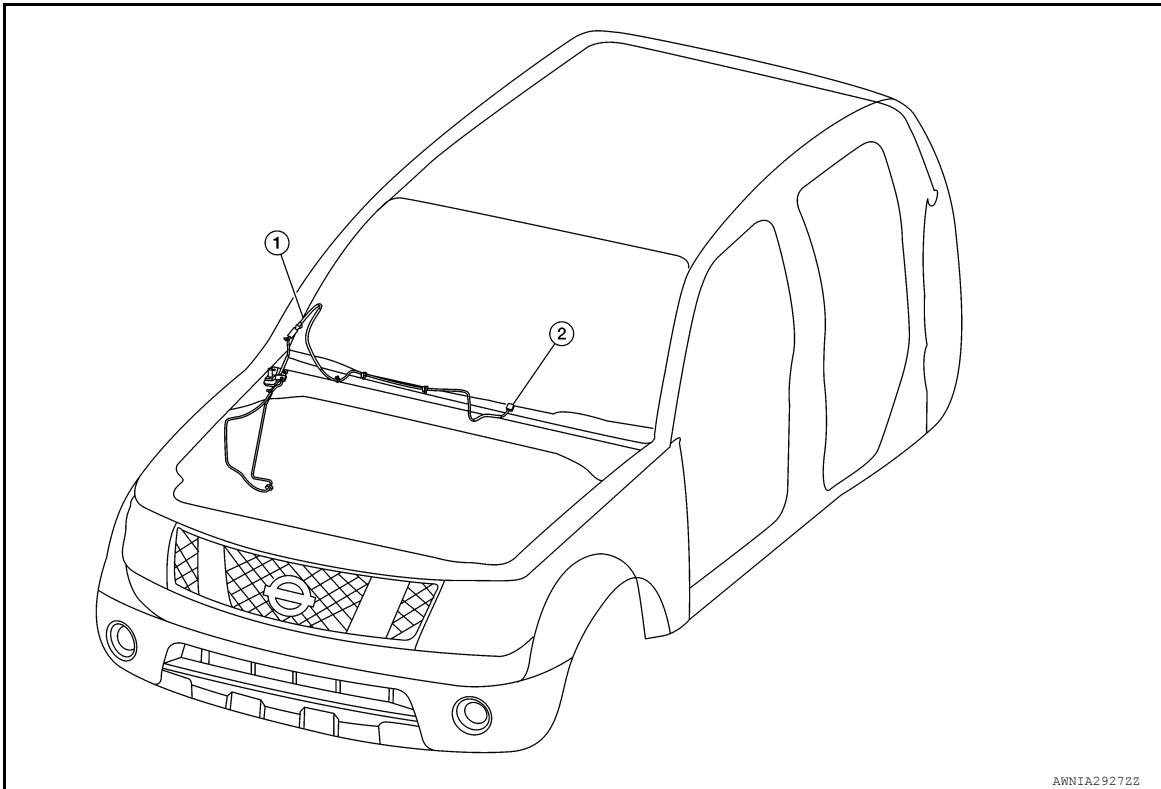

AWNIA29272Z

1. Coaxial antenna feeder
2. Coaxial connector

Removal and Installation

INFOID:000000010227937

REMOVAL

1. Remove instrument lower panel RH and glove box. Refer to [IP-24, "Removal and Installation"](#).
2. Disconnect audio antenna cable from antenna feeder.
3. Remove antenna rod.
4. Remove rubber seal.
5. Remove cowl top. Refer to [EXT-24, "Removal and Installation"](#).
6. Remove fender protector. Refer to [EXT-27, "Removal and Installation of Front Fender Protector"](#).
7. Remove antenna base bolts.
8. Remove antenna base and cable.

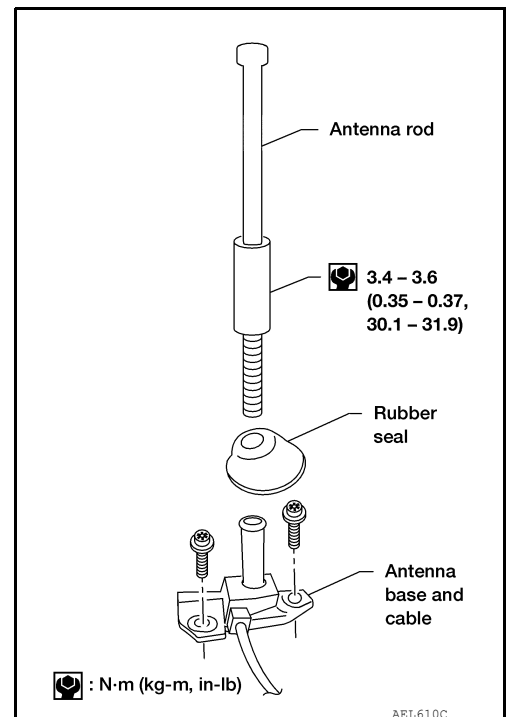

AEL610C

AUDIO ANTENNA

< REMOVAL AND INSTALLATION >

[BASE AUDIO (FOR MEXICO)]

INSTALLATION

Installation is in the reverse order of removal.

CAUTION:

Always properly tighten the antenna rod during installation or the antenna rod may bend or break during vehicle operation.

A

B

C

D

E

F

G

H

I

J

K

L

M

AV

O

P

COMPONENT PARTS

< SYSTEM DESCRIPTION >

[DISPLAY AUDIO WITHOUT AMPLIFIER]

SYSTEM DESCRIPTION

COMPONENT PARTS

Component Parts Location

INFOID:000000009482099

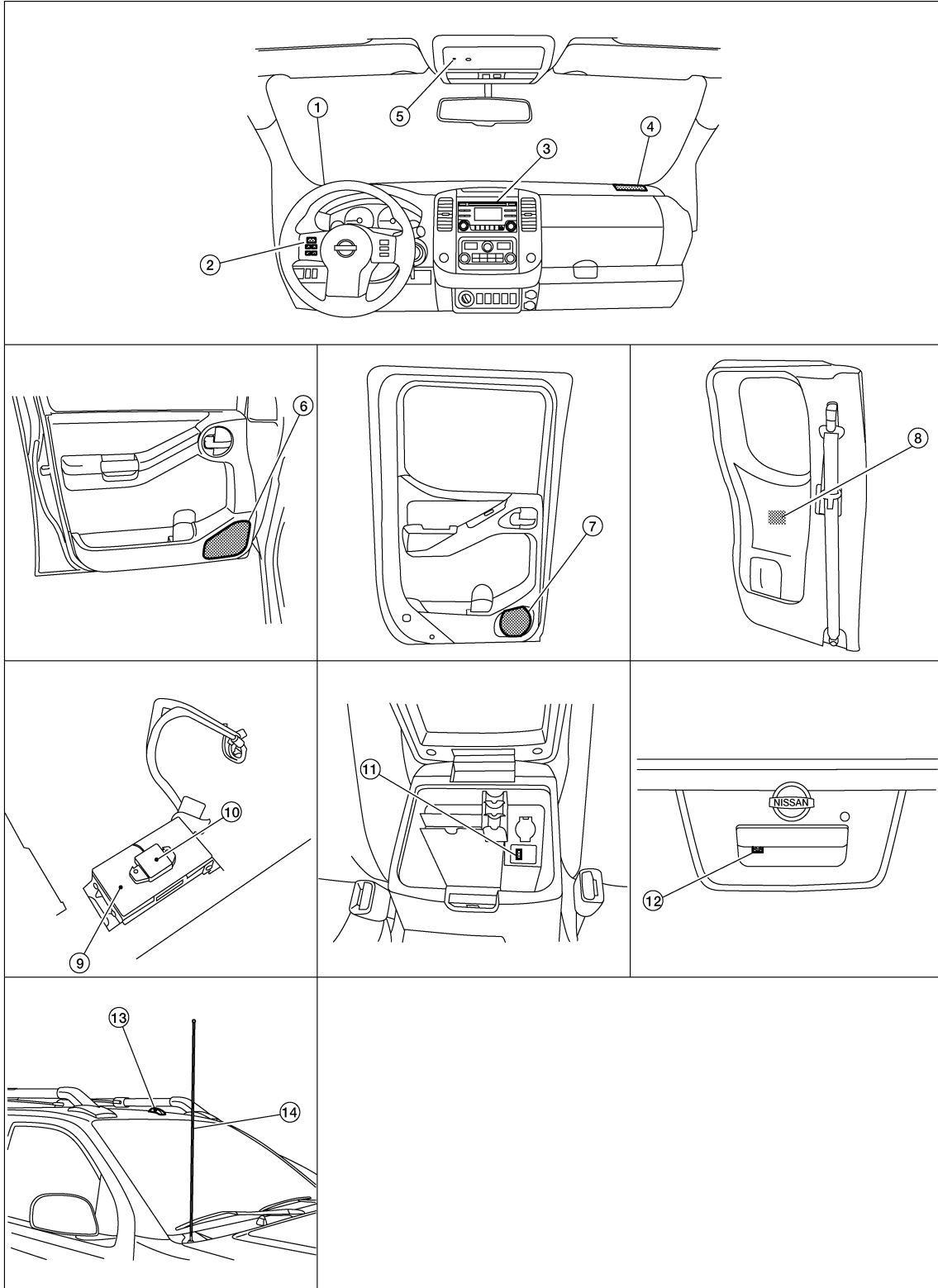

AWNIA2917ZZ

COMPONENT PARTS

[DISPLAY AUDIO WITHOUT AMPLIFIER]

< SYSTEM DESCRIPTION >

- | | | | |
|---|--|---|---|
| 1. Front tweeter LH M109 | 2. Steering wheel audio control switches | 3. Audio unit M41, M44, M45, M64 | A |
| 4. Front tweeter RH M111 | 5. Microphone R8 | 6. Front door speaker LH D12
Front door speaker RH D112 | |
| 7. Rear door speaker LH D207 (crew cab)
Rear door speaker RH D307 (crew cab) | 8. Rear door speaker LH B76 (king cab)
Rear door speaker RH B160 (king cab) | 9. Bluetooth® control unit B141, B142, B143 (Underneath passenger seat) | B |
| 10. Bluetooth® antenna | 11. USB interface M214 | 12. Rear view camera C251 | C |
| 13. Satellite antenna | 14. Rod antenna | | |

Component Description

INFOID:000000009482100

Part name	Description
Audio unit	<ul style="list-style-type: none"> Controls audio, USB connection, AUX IN connection, satellite radio and rear view camera functions. Display unit is built in to audio unit.
Front door speakers	Outputs high, mid and low range audio signals from audio unit.
Rear door speakers	
Front tweeters	
Steering wheel audio control switches	<ul style="list-style-type: none"> Operations for audio, hands-free phone and voice recognition are possible. Steering switch signal is output to Bluetooth® control unit. Bluetooth® control unit outputs steering switch signal to audio unit.
Microphone	<ul style="list-style-type: none"> Used for hands-free phone operations. Microphone signal is transmitted to Bluetooth® control unit. Power is supplied from Bluetooth® control unit.
Bluetooth® control unit	<ul style="list-style-type: none"> Inputs TEL voice signal from Bluetooth® antenna and outputs it to audio unit. Controlled via AV communication by audio unit.
Bluetooth® antenna	Receives TEL voice signal and outputs it to Bluetooth® control unit.
USB interface	USB sound and data input signals are transmitted to audio unit.
Rear view camera	<ul style="list-style-type: none"> Outputs image of vehicle rear to audio unit. Power is supplied from audio unit.
Satellite antenna	Satellite radio signal is received and transmitted to audio unit.
Rod antenna	AM/FM signal is received and transmitted to the audio unit.

AV

SYSTEM

< SYSTEM DESCRIPTION >

[DISPLAY AUDIO WITHOUT AMPLIFIER]

SYSTEM

System Diagram

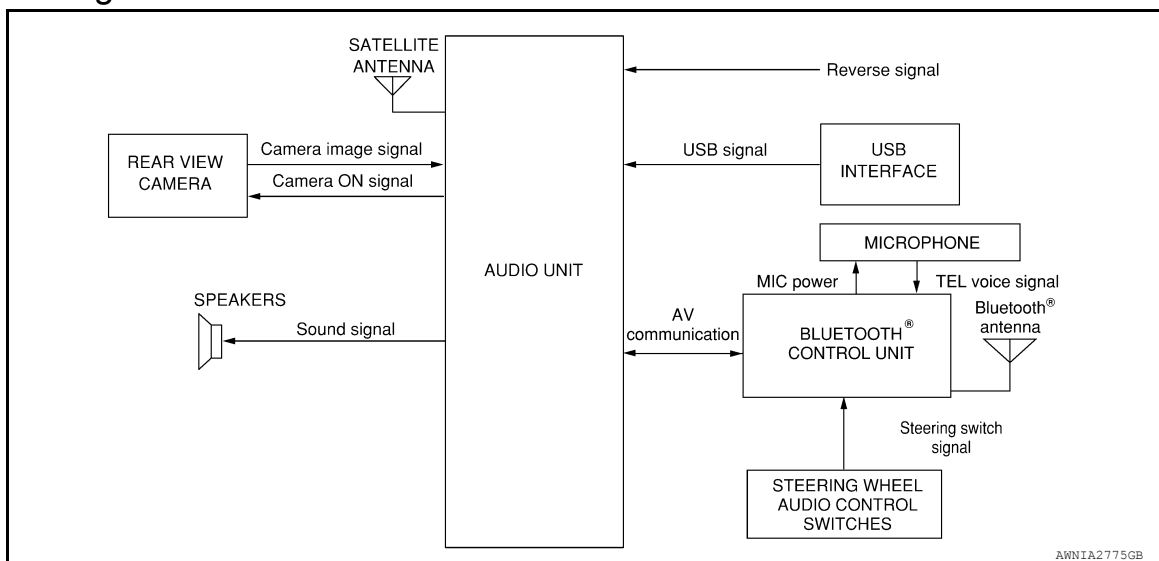

System Description

INFOID:000000009482102

AUDIO SYSTEM

The audio system consists of the following components

- Audio unit
- Front door speakers
- Front tweeters
- Rear door speakers
- Steering wheel audio control switches
- USB interface
- Rod antenna

When the audio system is on, AM/FM signals received by the rod antenna are sent to the audio unit. The audio unit then sends audio signals to the front door speakers, front tweeters and rear door speakers. Refer to Owner's Manual for audio system operating instructions.

SATELLITE RADIO SYSTEM

The satellite radio system consists of the following components

- Satellite antenna
- Satellite radio tuner integral to the audio unit

When the satellite radio system is on, satellite radio signals are supplied to the audio unit from the satellite antenna. The audio unit then sends audio signals to the speakers. Refer to Owner's Manual for satellite radio system operating instructions.

HANDS-FREE PHONE SYSTEM

System Operation

NOTE:

Cellular telephones must have their wireless connection set up (paired) before using the Bluetooth® telephone system.

The Bluetooth® telephone system allows users who have a Bluetooth® cellular telephone to make a wireless connection between their cellular telephone and the Bluetooth® control unit. Hands-free cellular telephone calls can be sent and received. Some Bluetooth® cellular telephones may not be recognized by the Bluetooth® control unit. When a cellular telephone or the Bluetooth® control unit is replaced, the telephone must be paired with the Bluetooth® control unit. Different cellular telephones may have different pairing procedures, refer to the cellular telephone operating manual.

Refer to the Owner's Manual for Bluetooth® telephone system operating instructions.

Bluetooth® Control Unit

When the ignition switch is turned to ACC or ON, the Bluetooth® control unit will power up. During power up, the Bluetooth® control unit is initialized and performs various self-checks. Initialization may take up to 20 seconds. If a phone is present in the vehicle and paired with the Bluetooth® control unit, Nissan Voice Recognition will then become active. Bluetooth® telephone functions can be turned off using the Nissan Voice Recognition system.

Steering Wheel Audio Control Switches

When buttons on the steering wheel audio control switch are pushed, the resistance in steering wheel audio control switch circuit changes, depending on which button is pushed. The Bluetooth® control unit uses this signal to perform various functions while navigating through the voice recognition system.

The following functions can be performed using the steering wheel audio control switch:

- Initiate self-diagnosis of the Bluetooth® telephone system
- Start a voice recognition session
- Answer and end telephone calls
- Adjust the volume of calls

Microphone

The microphone is located in the roof console assembly. The microphone sends a signal to the Bluetooth® control unit. The microphone can be actively tested during self-diagnosis.

Audio Unit

The audio unit receives signals from the Bluetooth® control unit and sends audio signals to the speakers.

REAR VIEW CAMERA SYSTEM

- The audio unit supplies power to the rear view camera when the reverse signal is received from the TCM.
- The rear view camera transmits rear view camera images to the audio unit when power is supplied from the audio unit.
- The audio unit combines a warning message and fixed guide lines with an image received from the rear view camera to display a rear view camera image on the screen.

A
B
C
D
E
F
G
H
I
J
K
L
M
O
P

AV

DIAGNOSIS SYSTEM (AUDIO UNIT)

< SYSTEM DESCRIPTION >

[DISPLAY AUDIO WITHOUT AMPLIFIER]

DIAGNOSIS SYSTEM (AUDIO UNIT)

Description

INFOID:000000009482103

The audio unit on board diagnosis performs the functions listed in the table below:

Mode		Description
Self Diagnosis		<ul style="list-style-type: none"> • Audio unit diagnosis. • Diagnoses the connections across system components.
Confirmation/ Adjustment	Display Diagnosis	The following check functions are available: color tone check by color bar display and white display, light and shade check by gray scale display.
	Vehicle Signals	Diagnosis of signals can be performed for vehicle speed, lights, reverse, EQ pin, destination and camera type.
	Speaker Test	The connection of a speaker can be confirmed by test tone.
	Error History	The system malfunction and the frequency when occurring in the past are displayed. When the malfunctioning item is selected, the time and place that the selected malfunction last occurred are displayed.
	Camera System	Guiding line position that overlaps rear view camera image can be adjusted.
	AV COMM Diagnosis	The communication condition of each unit of display audio system can be monitored.
	Delete Unit Connection Log	Erase the connection history of unit and error history.
	Initialize Setting	Initializes the audio unit memory.

On Board Diagnosis Function

INFOID:000000009482104

SELF DIAGNOSIS MODE

Audio Unit Self Diagnosis

1. Select Self Diagnosis.
2. Self diagnosis screen is displayed. The bar graph visible in center of screen indicates progress of self diagnosis.
3. Diagnosis results are displayed after the self diagnosis is completed. The unit names and the connection lines are color coded according to the diagnostic results.

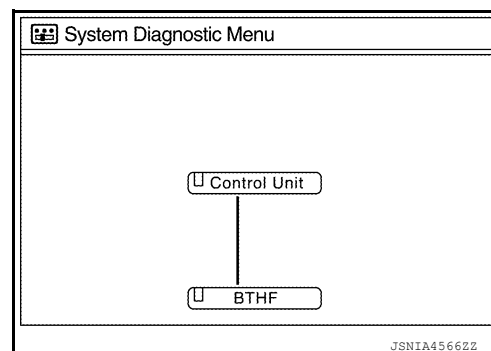

Diagnosis results	Unit	Connection line
Normal	Green	Green
Connection malfunction	Gray	Yellow
Unit malfunction ¹	Red	Green

1: Control unit (audio unit) is displayed in red.

- Replace audio unit if Self Diagnosis did not run because control unit malfunction is indicated. The symptom is audio unit internal error. Refer to [AV-146, "Removal and Installation"](#).
- If multiple errors occur at the same time for a single unit, the screen switch colors are determined according to the following order of priority: red > gray.

DIAGNOSIS SYSTEM (AUDIO UNIT)

[DISPLAY AUDIO WITHOUT AMPLIFIER]

< SYSTEM DESCRIPTION >

- Comments of self diagnosis results can be viewed in the diagnosis result screen.

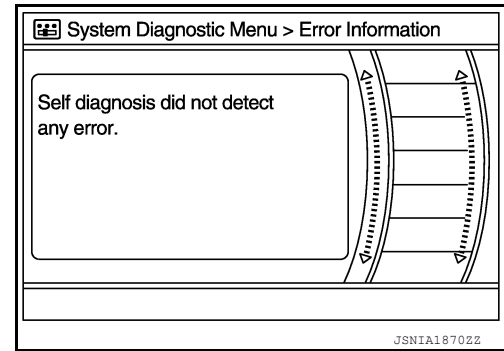

Audio Unit Self Diagnosis Results

Only Unit Part Is Displayed In Red		
Screen switch	Description	Possible cause
Control unit	Malfunction is detected in audio unit power supply and ground circuits.	<ul style="list-style-type: none"> Audio unit power supply or ground circuits. Refer to AV-122, "AUDIO UNIT : Diagnosis Procedure". If no malfunction is detected in audio unit power supply and ground circuits, replace audio unit. Refer to AV-146, "Removal and Installation".

A Connecting Cable Between Units Is Displayed In Yellow		
Area with yellow connection lines	Description	Possible cause
Control unit ↔ BTHF	When one of the following is detected: <ul style="list-style-type: none"> malfunction is detected in Bluetooth® control unit power supply and ground circuits. malfunction is detected in AV communication circuits between audio unit and Bluetooth® control unit. 	<ul style="list-style-type: none"> Bluetooth® control unit power supply or ground circuits. Refer to AV-122, "BLUETOOTH® CONTROL UNIT : Diagnosis Procedure". AV communication circuits between audio unit and Bluetooth® control unit.

Audio Unit Confirmation/Adjustment

- Select Confirmation/Adjustment.
- Select each switch on the Confirmation/Adjustment screen to display the relevant trouble diagnosis screen. Press the BACK switch to return to the initial Confirmation/Adjustment screen.

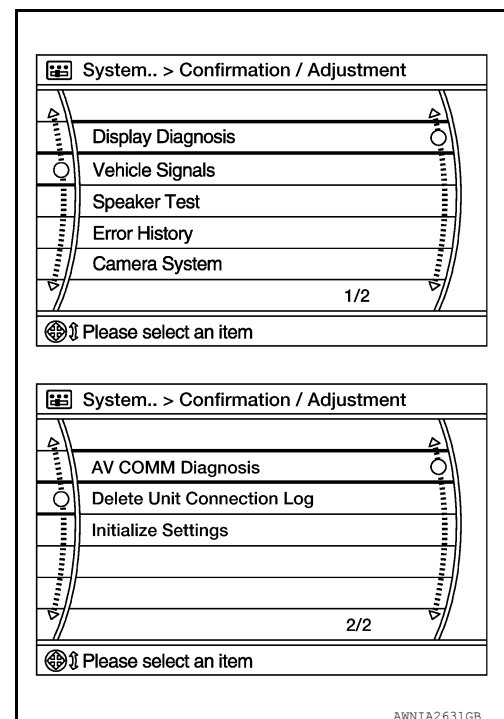

DIAGNOSIS SYSTEM (AUDIO UNIT)

[DISPLAY AUDIO WITHOUT AMPLIFIER]

< SYSTEM DESCRIPTION >

Display Diagnosis

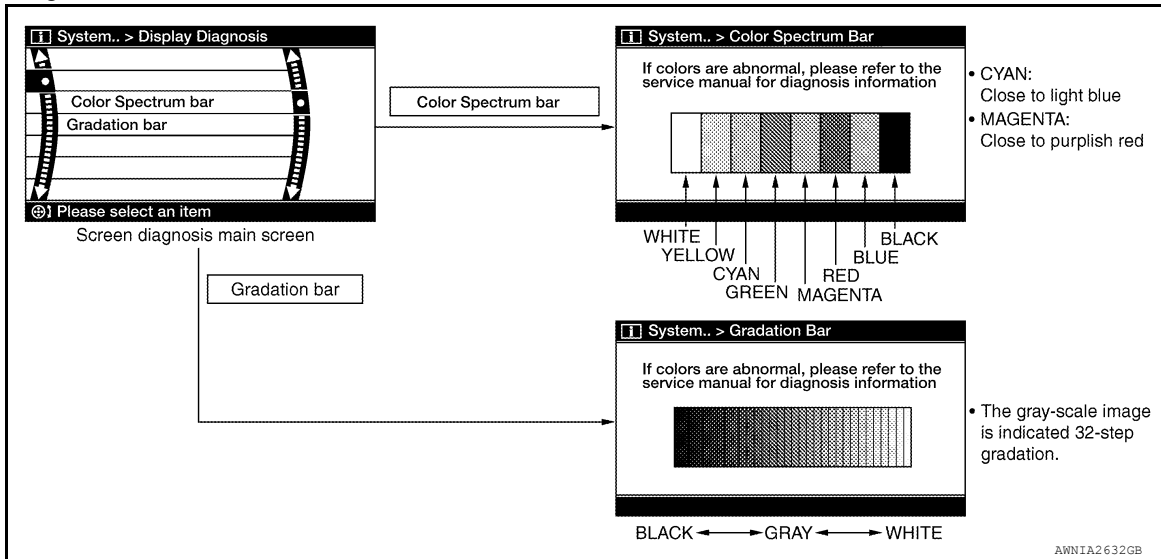

Vehicle Signals

A comparison check can be made of each actual vehicle signal and the signals recognized by the system.

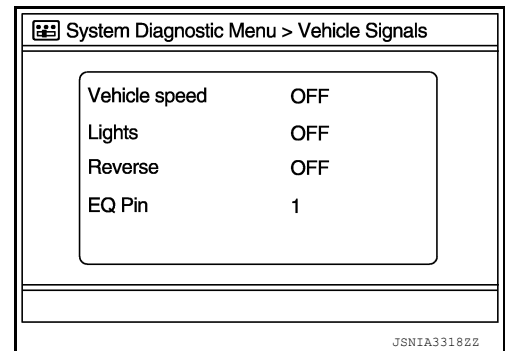

Speaker Test

Select Speaker Test to display the Speaker Diagnosis screen. Press Start to generate a test tone in a speaker. Press Start again to generate a test tone in the next speaker. Press End to stop the test tones.

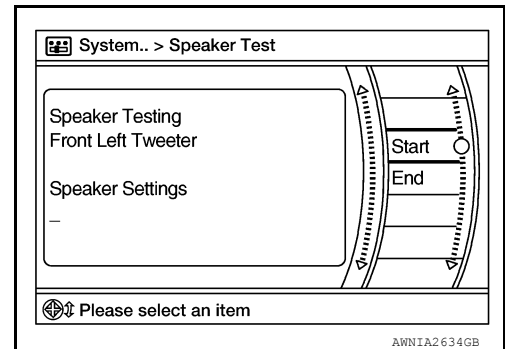

Error History

The self diagnosis results are judged depending on whether any error occurs from when Self Diagnosis is selected until the self diagnosis results are displayed.

However, the diagnosis results are judged normal if an error has occurred before the ignition switch is turned ON and then no error has occurred until the self diagnosis start. Check the Error Record to detect any error that may have occurred before the self diagnosis start because of this situation.

The frequency of occurrence is displayed in a count up manner. The actual count up method differs depending on the error item.

Count up method A

- The counter is set to 40 if an error occurs. 1 is subtracted from the counter if the condition is normal at a next ignition ON cycle.
- The counter lower limit is 1. The counter can be reset (no error record display) with the Delete log switch.

Count up method B

DIAGNOSIS SYSTEM (AUDIO UNIT)

[DISPLAY AUDIO WITHOUT AMPLIFIER]

< SYSTEM DESCRIPTION >

- The counter increases by 1 if an error occurs when ignition switch is ON. The counter will not decrease even if the condition is normal at the next ignition ON cycle.
- The counter upper limit is 50. Any counts exceeding 50 are ignored. The counter can be reset (no error record display) with the Delete log switch.

Display type of occurrence frequency	Error history display item
Count up method A	AV communication line, control unit (AV)
Count up method B	Other than the above

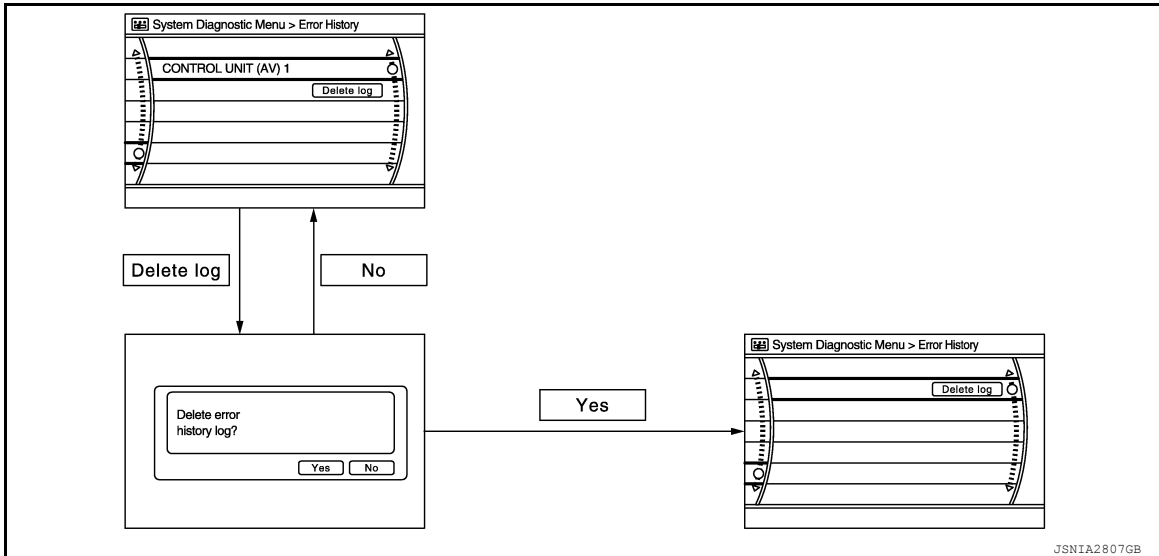

Error item

Some error items may be displayed simultaneously according to the cause. If some error items are displayed simultaneously, the detection of the cause can be performed by the combination of display items

Error item	Description	Possible cause
CONTROL UNIT (AV)	AV communication circuit initial diagnosis malfunction is detected.	Replace the audio unit if the malfunction occurs constantly. Refer to AV-146. "Removal and Installation" .
<ul style="list-style-type: none"> • AV COMM CIRCUIT • H/F Unit Connection Error 	When one of the following is detected: <ul style="list-style-type: none"> • malfunction is detected in Bluetooth® control unit power supply and ground circuits. • malfunction is detected in AV communication circuits between audio unit and Bluetooth® control unit. 	<ul style="list-style-type: none"> • Bluetooth® control unit power supply or ground circuits. Refer to AV-122. "BLUETOOTH® CONTROL UNIT : Diagnosis Procedure". • AV communication circuits between audio unit and Bluetooth® control unit.

Camera System

This mode is used to adjust the guide line display position of the rear view camera.

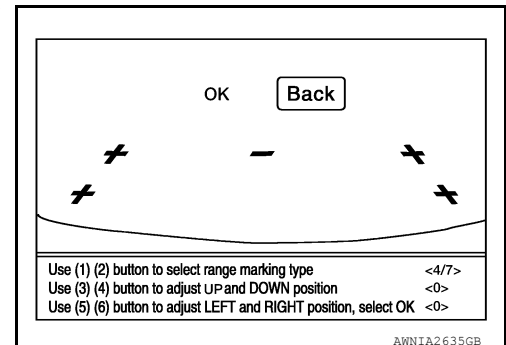

AV COMM Diagnosis

DIAGNOSIS SYSTEM (AUDIO UNIT)

[DISPLAY AUDIO WITHOUT AMPLIFIER]

< SYSTEM DESCRIPTION >

- Displays the communication status between audio unit (master unit) and each unit.
- The error counter displays OK if any malfunction was not detected in the past and displays 0 if a malfunction is detected. It increases by 1 if the condition is normal at the next ignition switch ON cycle. The upper limit of the counter is 39.
- The error counter is erased if Reset is pressed.

Items	Status (Current)	Counter (Past)
C Rx(BTHF-ITM)	OK / ???	OK / 0 – 39

NOTE:

“???” indicates UNKWN.

Delete Unit Connection Log

Deletes any unit connection records and error records from the audio unit memory (clears the records of the unit that has been removed).

Initialize Settings

Deletes data stored from the audio unit.

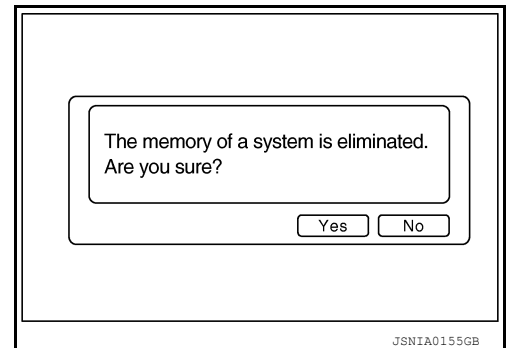
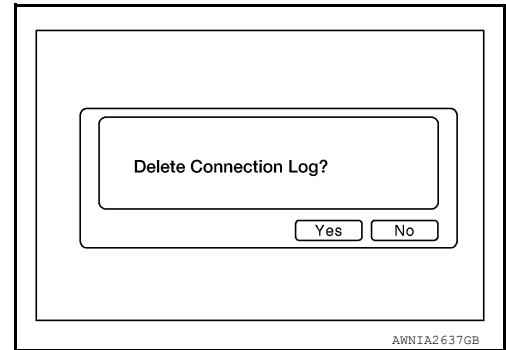
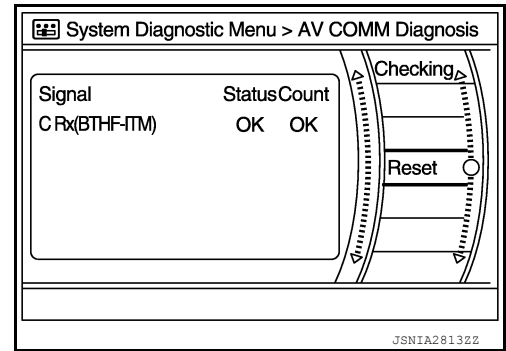

AUDIO UNIT

< ECU DIAGNOSIS INFORMATION >

[DISPLAY AUDIO WITHOUT AMPLIFIER]

ECU DIAGNOSIS INFORMATION

AUDIO UNIT

Reference Value

INFOID:000000009482105

TERMINAL LAYOUT

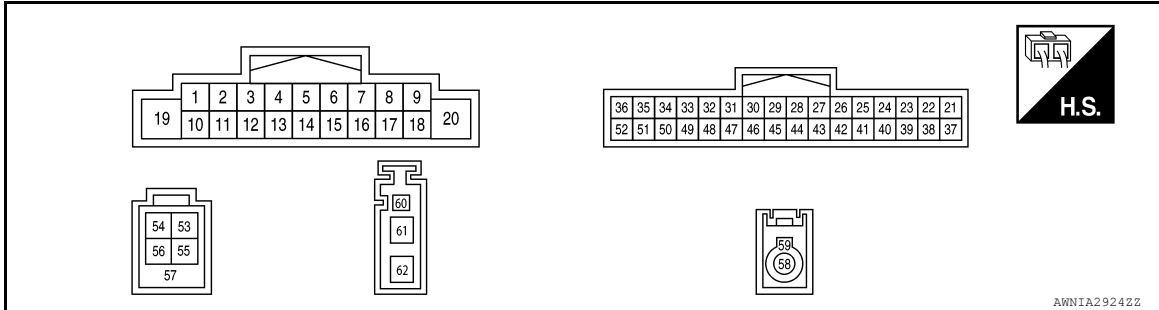



PHYSICAL VALUES

Terminal (Wire color)		Description		Condition		Reference value (Approx.)
+	-	Signal name	Input/ Output	Ignition switch	Operation	
2 (BR)	3 (L)	Sound signal front speaker LH	Output	ON	Sound output	 SKIB3609E
4 (G)	5 (B)	Sound signal rear speaker LH	Output	ON	Sound output	 SKIB3609E
6 (V)	Ground	STRG SW A	Input	ON	Press and hold MODE switch.	0 V
					Press and hold Δ switch.	1.34 V
					Press and hold ∇ switch.	2.45 V
					Press and hold switch.	3.43 V
					Except for above.	5.0 V
7 (G/B)	Ground	ACC power supply	Input	ACC	—	Battery voltage
9 (R)	8 (GR)	Illumination control signal	Input	ON	Headlamps ON	Battery voltage

AUDIO UNIT

< ECU DIAGNOSIS INFORMATION >

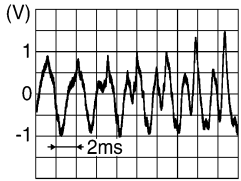
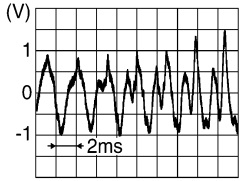
[DISPLAY AUDIO WITHOUT AMPLIFIER]

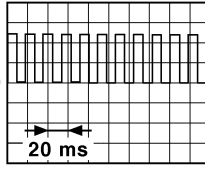
Terminal (Wire color)		Description		Condition		Reference value (Approx.)
+	-	Signal name	Input/ Output	Ignition switch	Operation	
11 (LG)	12 (R)	Sound signal front speaker RH	Output	ON	Sound output	 <small>SKIB3609E</small>
13 (P)	14 (W)	Sound signal rear speaker RH	Output	ON	Sound output	 <small>SKIB3609E</small>
15 (O)	-	STRG SW ground	Output	-	-	-
16 (LG)	Ground	STRG SW B	Input	ON	Press VOL DOWN switch	0 V
					Press VOL UP switch.	1.34 V
					Press  switch.	2.45 V
					Except for above.	5.0 V
18 (SB)	Ground	Vehicle speed signal	Input	ON	When vehicle speed is approx. 40 km/h (25 MPH)	 <small>JSNIA0012GB</small>
19 (Y)	Ground	Battery power supply	Input	OFF	-	Battery voltage
20 (B)	-	GND	-	-	-	-
25 (W)	24 (B)	Telephone audio in	-	-	-	0 V
28 (R)	-	MCAN2 H	-	-	-	-
29 (G)	-	MCAN2 L	-	-	-	-
30	-	MCAN shield	-	-	-	-
31 (L)	-	MCAN1 H	-	-	-	-
32 (W)	-	MCAN1 L	-	-	-	-
33	-	CAM shield	-	-	-	-
34 (G/Y)	Ground	Camera ON signal	Output	ACC	Shift selector is in R position	6.0V

AUDIO UNIT

< ECU DIAGNOSIS INFORMATION >

[DISPLAY AUDIO WITHOUT AMPLIFIER]

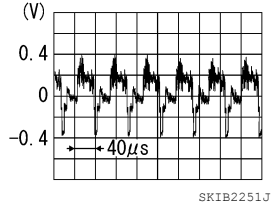
Terminal (Wire color)		Description		Condition		Reference value (Approx.)
+	-	Signal name	Input/ Output	Ignition switch	Operation	
35 (B)	Ground	Camera video signal	Input	ON	With rear view camera ON	
36 (W)	—	Video ground	—	—	—	—
44 (BR)	—	Camera DET	—	—	—	—
48 (B)	—	EQ4	—	—	—	—
50 (SB)	Ground	Reverse signal	Input	ON	R position	Battery voltage
					Other than R position	0 V
53 (R)	—	V BUS signal	—	—	—	—
54 (B)	—	USB ground	—	—	—	—
55 (G)	—	USB D+	—	—	—	—
56 (W)	—	USB D-	—	—	—	—
57	—	Shield	—	—	—	—
58 (B)	Ground	Satellite antenna signal	Input	ON	—	5.0 V
59 (B)	—	SAT Shield	—	—	—	—
61 (B)	Ground	AM-FM main antenna	Input	ON	—	5.0 V

A
B
C
D
E
F
G
H
I
J
K
L
M

AV

BLUETOOTH® CONTROL UNIT

< ECU DIAGNOSIS INFORMATION >

[DISPLAY AUDIO WITHOUT AMPLIFIER]

BLUETOOTH® CONTROL UNIT

Reference Value

INFOID:000000009482106

TERMINAL LAYOUT

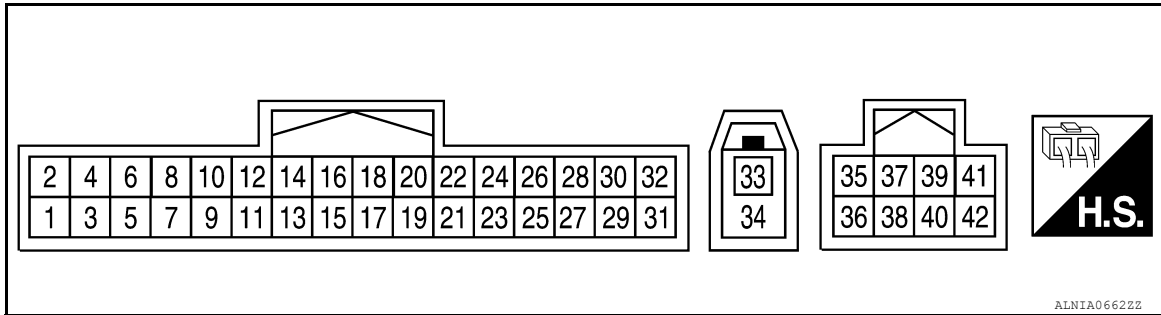



PHYSICAL VALUES

Terminal (wire color)		Description	Condition			Reference value (Approx.)
+	-		Signal name	Input/output	Ignition switch	
1 (R/B)	Ground	Battery power	Input	-	-	Battery voltage
2 (G/Y)	Ground	ACC power	Input	ACC or ON	-	Battery voltage
3 (W/G)	Ground	IGN power	Input	ON or START	-	Battery voltage
4 (B)	Ground	Ground	-	ON	-	0V
6	-	MIC Shield	-	-	-	-
7 (G)	8 (L)	MIC in signal	Input	-	-	-
9 (W)	10 (B)	Audio out	Output	ACC or ON	Bluetooth® control unit sends audio signal	<p>SKIB3609E</p>
12 (BR)	Ground	Ladder in 1	Input	ACC or ON	Press and hold MODE switch.	0 V
					Press and hold △ switch.	1.34 V
					Press and hold ▽ switch.	2.45 V
					Press and hold ⚡ switch.	3.43 V
					Except for above.	5.0 V
13 (L)	Ground	Ladder in 2	Input	ACC or ON	Press VOL DOWN switch	0 V
					Press VOL UP switch.	1.34 V
					Press ⚡ switch.	2.45 V
					Except for above.	5.0 V

BLUETOOTH® CONTROL UNIT

< ECU DIAGNOSIS INFORMATION >

[DISPLAY AUDIO WITHOUT AMPLIFIER]

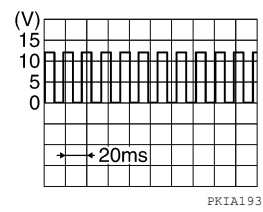
Terminal (wire color)		Description		Condition		Reference value (Approx.)
+	-	Signal name	Input/ output	Ignition switch	Condition	
14 (G)	-	Ladder in ground	Input	-	-	-
17 (V)	Ground	Ladder out 1	Input	ACC or ON	Press and hold MODE switch.	0 V
					Press and hold Δ switch.	1.34 V
					Press and hold ∇ switch.	2.45 V
					Press and hold  switch.	3.43 V
					Except for above.	5.0 V
18 (LG)	Ground	Ladder out 2	Input	ACC or ON	Press VOL DOWN switch	0 V
					Press VOL UP switch.	1.34 V
					Press  switch.	2.45 V
					Except for above.	5.0 V
19 (BG)	Ground	Ladder out ground	Output	-	-	-
21 (B)	Ground	Cont 2	-	-	-	0V
23 (B)	Ground	Cont 4	-	-	-	0V
28 (SB)	Ground	Vehicle speed signal (8-pulse)	Input	ON	When vehicle speed is approx. 40 km/h (25 MPH)	 <p style="text-align: right; font-size: small;">FKIA1935E</p>
29 (Y)	Ground	Microphone power	Output	ON	-	5V
33 (B)	-	Bluetooth® antenna	-	-	-	-
34	-	Bluetooth® antenna shield	-	-	-	-
35 (R)	-	MCAN H	-	-	-	-
36 (G)	-	MCAN L	-	-	-	-
37	-	MCAN shield	-	-	-	-

A
B
C
D
E
F
G
H
I
J
K
L
M
AV
O
P

DISPLAY AUDIO WITHOUT AMPLIFIER

[DISPLAY AUDIO WITHOUT AMPLIFIER]

< WIRING DIAGRAM >

WIRING DIAGRAM

DISPLAY AUDIO WITHOUT AMPLIFIER

Wiring Diagram

INFOID:000000009482107

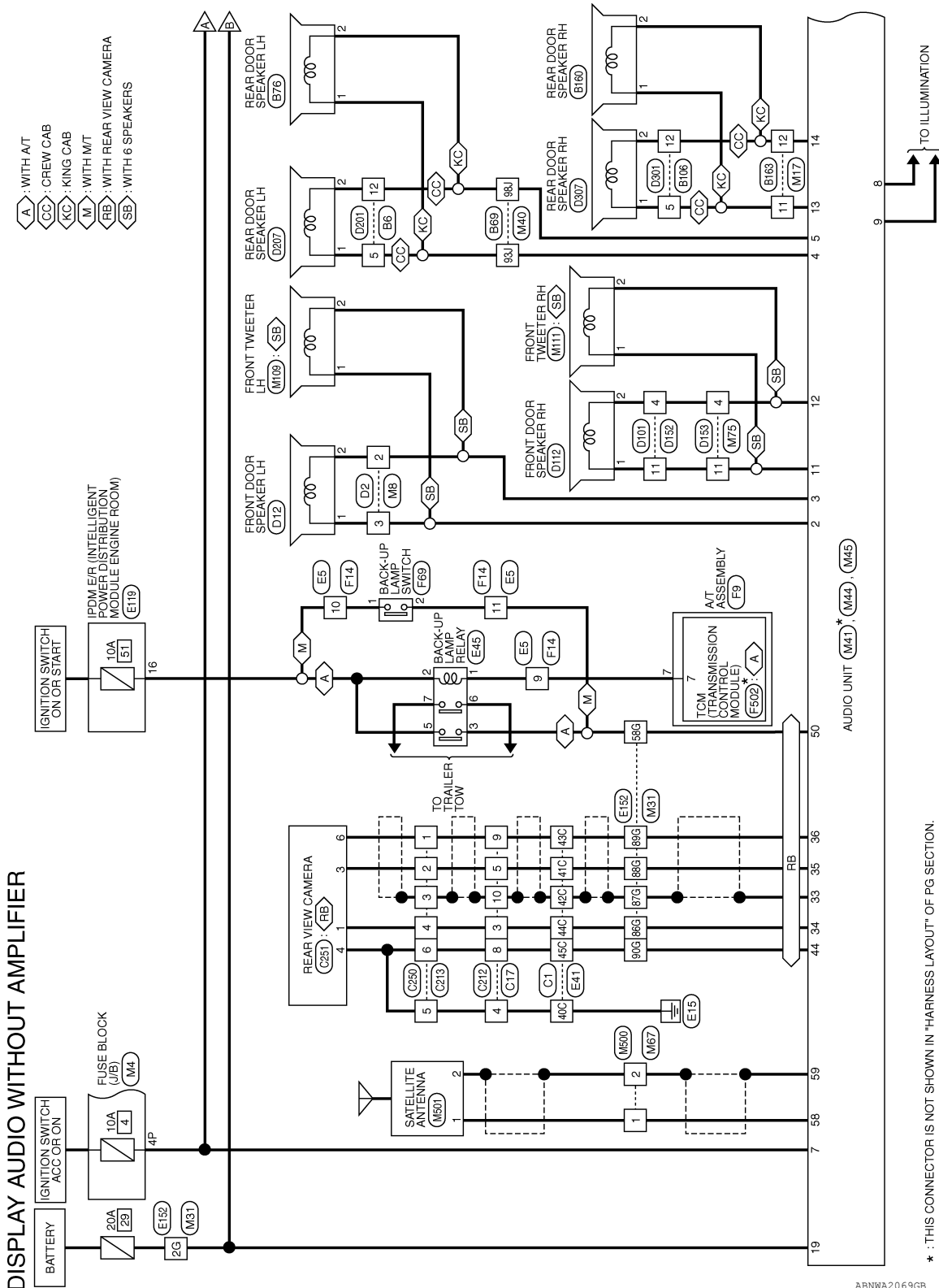

ABNWA2069GB

DISPLAY AUDIO WITHOUT AMPLIFIER

[DISPLAY AUDIO WITHOUT AMPLIFIER]

< WIRING DIAGRAM >

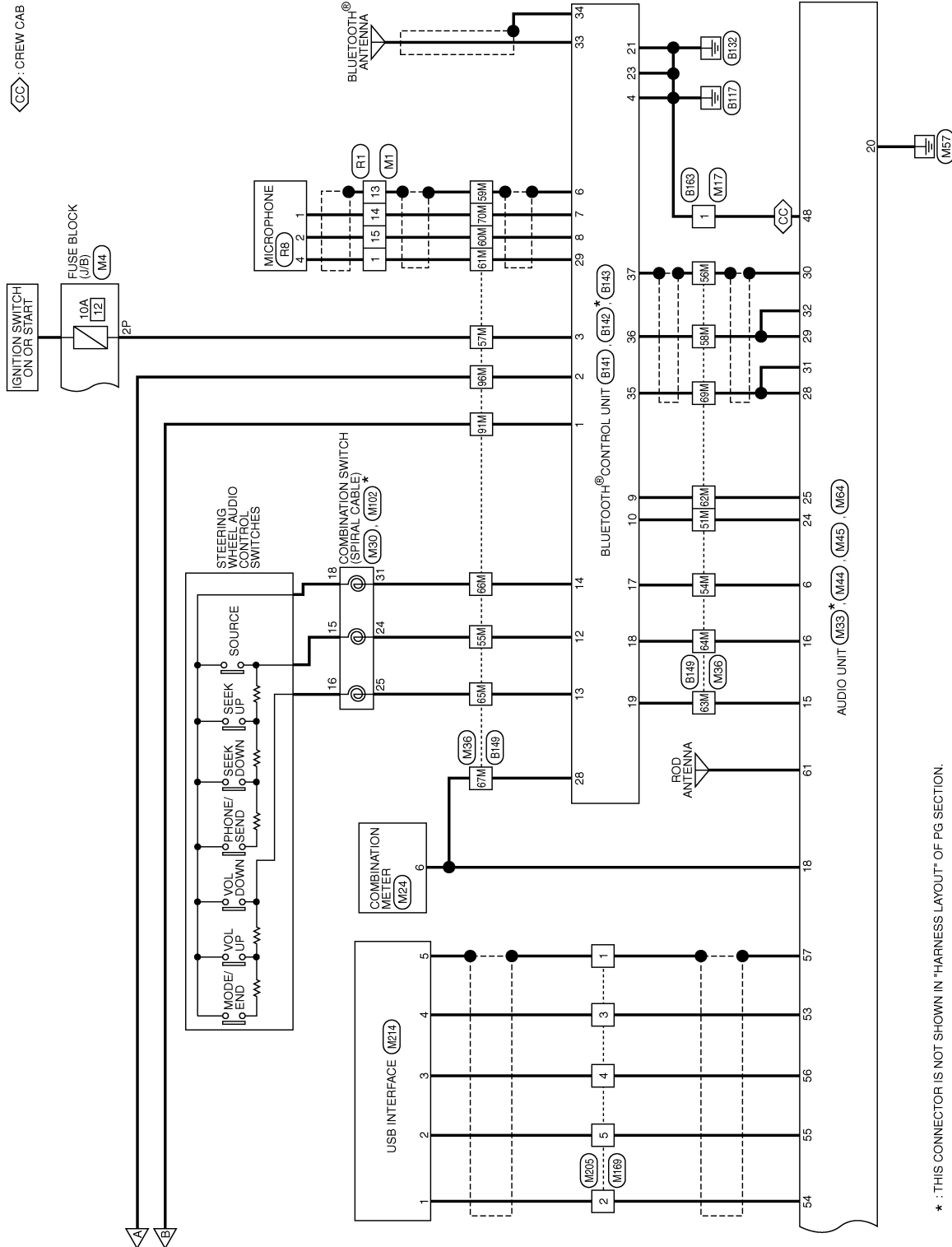

* : THIS CONNECTOR IS NOT SHOWN IN "HARNES LAYOUT" OF PG SECTION.

ABNWA2070GB

A
B
C
D
E
F
G
H
I
J
K
L
M
N
O
P

AV

DISPLAY AUDIO WITHOUT AMPLIFIER

[DISPLAY AUDIO WITHOUT AMPLIFIER]

< WIRING DIAGRAM >

DISPLAY AUDIO WITHOUT AMPLIFIER CONNECTORS

Connector No.	M8
Connector Name	WIRE TO WIRE
Connector Color	BROWN

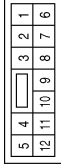

Terminal No.	Color of Wire	Signal Name
2	L	-
3	BR	-

Connector No.	M4
Connector Name	FUSE BLOCK (J/B)
Connector Color	WHITE

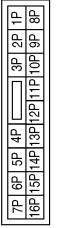

Terminal No.	Color of Wire	Signal Name
2P	W/G	-
4P	G/B	-

Connector No.	M1
Connector Name	WIRE TO WIRE
Connector Color	WHITE



Terminal No.	Color of Wire	Signal Name
1	Y	-(WITHOUT NAVI)
13	SHIELD	-
14	G	-(WITHOUT NAVI)
15	L	-(WITHOUT NAVI)

Connector No.	M30
Connector Name	COMBINATION SWITCH (SPIRAL CABLE)
Connector Color	GRAY

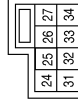

Terminal No.	Color of Wire	Signal Name
24	BR	-
25	L	-(WITHOUT NAVI)
31	G	-

Connector No.	M24
Connector Name	COMBINATION METER
Connector Color	WHITE

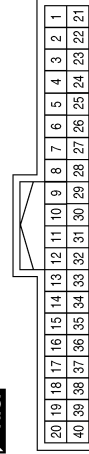

Terminal No.	Color of Wire	Signal Name
6	SB	SPEED OUT 8

Connector No.	M17
Connector Name	WIRE TO WIRE
Connector Color	WHITE



Terminal No.	Color of Wire	Signal Name
1	B	-
11	P	-(EXCEPT BASE AUDIO SYSTEM)
12	W	-(EXCEPT BASE AUDIO SYSTEM)

ABNIA5622GB

DISPLAY AUDIO WITHOUT AMPLIFIER

< WIRING DIAGRAM >

[DISPLAY AUDIO WITHOUT AMPLIFIER]

Connector No.	M33
Connector Name	AUDIO UNIT (WITH DISPLAY AUDIO WITHOUT AMPLIFIER)
Connector Color	GRAY

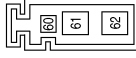

Terminal No.	Color of Wire	Signal Name
60	-	-
61	B	ANT MAIN
62	-	-

Terminal No.	Color of Wire	Signal Name
2G	Y	-
58G	SB	-
86G	G/Y	-
87G	SHIELD	-
88G	B	-
89G	W	-
90G	BR	-

Connector No.	M31
Connector Name	WIRE TO WIRE
Connector Color	WHITE

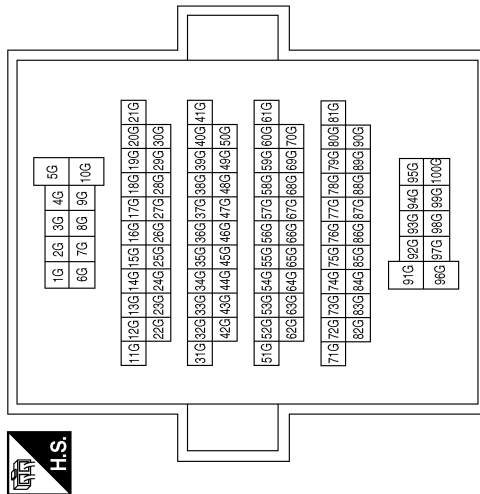

A
B
C
D
E
F
G
H
I
J
K
L
M
N
O
P

AV

ABNIA5623GB

DISPLAY AUDIO WITHOUT AMPLIFIER

[DISPLAY AUDIO WITHOUT AMPLIFIER]

< WIRING DIAGRAM >

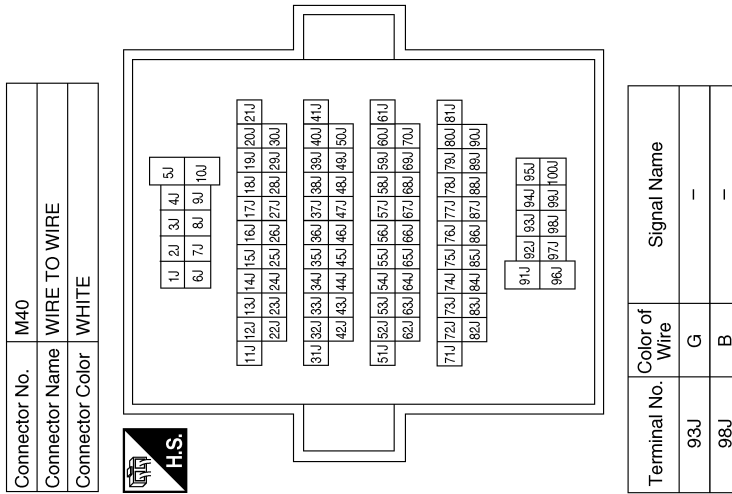

Terminal No.	Color of Wire	Signal Name
51M	B	-(EXCEPT BASE AUDIO SYSTEM)
54M	V	-
55M	BR	-
56M	SHIELD	-
57M	W/G	-
58M	G	-
59M	SHIELD	-
60M	L	-
61M	Y	-
62M	W	-
63M	BG	-
64M	LG	-
65M	L	-
66M	G	-
67M	SB	-
69M	R	-
70M	G	-
91M	R/B	-
96M	G/Y	-

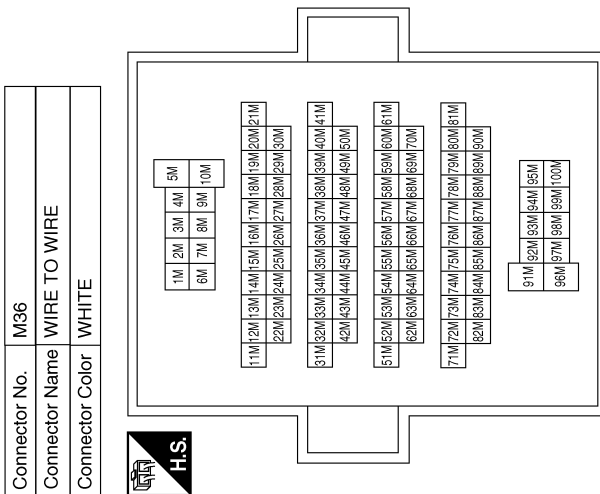

ABNIA5624GB

DISPLAY AUDIO WITHOUT AMPLIFIER

[DISPLAY AUDIO WITHOUT AMPLIFIER]

< WIRING DIAGRAM >

Terminal No.	Color of Wire	Signal Name
7	G/B	ACC
8	GR	ILL (-)
9	R	ILL (+)
10	-	-
11	LG	FR SP RH (+)
12	R	FR SP RH (-)
13	P	RR SP RH (+)
14	W	RR SP RH (-)
15	O	STRG SW GND
16	LG	STRG SW B
17	-	-
18	SB	SPD
19	Y	+B
20	B	GND

Connector No.	M44
Connector Name	AUDIO UNIT (WITH DISPLAY AUDIO WITHOUT AMPLIFIER)
Connector Color	WHITE

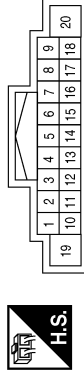

Terminal No.	Color of Wire	Signal Name
1	-	-
2	BR	FR SP LH (+)
3	L	FR SP LH (-)
4	G	RR SP LH (+)
5	B	RR SP LH (-)
6	V	STRG SW A

Connector No.	M41
Connector Name	AUDIO UNIT (WITH DISPLAY AUDIO WITHOUT AMPLIFIER)
Connector Color	PINK

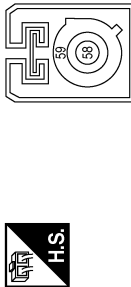

Terminal No.	Color of Wire	Signal Name
58	B	SAT ANT
59	SHIELD	SAT SHIELD

Terminal No.	Color of Wire	Signal Name
40	-	-
41	-	-
42	-	-
43	-	-
44	BR	CAM DET
45	-	-
46	-	-
47	-	-
48	B	EQ4
49	-	-
50	SB	REVERSE
51	-	-
52	-	-

Terminal No.	Color of Wire	Signal Name
26	-	-
27	-	-
28	R	MCAN2 H
29	G	MCAN2 L
30	SHIELD	MCAN GND
31	L	MCAN1 H
32	W	MCAN1 L
33	SHIELD	CAM GND
34	G/Y	CAMERA ON
35	B	CAM VIDEO
36	W	VIDEO GND
37	-	-
38	-	-
39	-	-

Connector No.	M45
Connector Name	AUDIO UNIT (WITH DISPLAY AUDIO WITHOUT AMPLIFIER)
Connector Color	WHITE

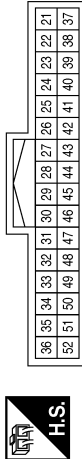

Terminal No.	Color of Wire	Signal Name
21	-	-
22	-	-
23	-	-
24	B	TEL VOICE (-)
25	W	TEL VOICE (+)

ABNIA5625GB

A
B
C
D
E
F
G
H
I
J
K
L
M
N
O
P

AV

DISPLAY AUDIO WITHOUT AMPLIFIER

[DISPLAY AUDIO WITHOUT AMPLIFIER]

< WIRING DIAGRAM >

Connector No.	M75
Connector Name	WIRE TO WIRE
Connector Color	WHITE

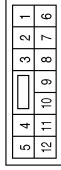

Terminal No.	Color of Wire	Signal Name
4	R	-
11	LG	-

Connector No.	M67
Connector Name	WIRE TO WIRE
Connector Color	PINK

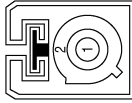

Terminal No.	Color of Wire	Signal Name
1	B	-
2	SHIELD	-

Connector No.	M64
Connector Name	AUDIO UNIT (WITH DISPLAY AUDIO WITHOUT AMPLIFIER)
Connector Color	GREEN

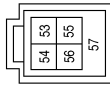

Terminal No.	Color of Wire	Signal Name
53	R	VBUS
54	B	USB GND
55	G	USB D+
56	W	USB D-
57	SHIELD	SHIELD

Connector No.	M111
Connector Name	FRONT TWEETER RH
Connector Color	BROWN



Terminal No.	Color of Wire	Signal Name
1	W	-
2	L	-(WITHOUT AMPLIFIER)

Connector No.	M109
Connector Name	FRONT TWEETER LH
Connector Color	BROWN



Terminal No.	Color of Wire	Signal Name
1	G	-(WITHOUT AMPLIFIER)
2	L	-(WITHOUT AMPLIFIER)

Connector No.	M102
Connector Name	COMBINATION SWITCH (SPIRAL CABLE)
Connector Color	GRAY



Terminal No.	Color of Wire	Signal Name
15	GR	-
16	G	-
18	B	-

ABNIA5626GB

DISPLAY AUDIO WITHOUT AMPLIFIER

[DISPLAY AUDIO WITHOUT AMPLIFIER]

< WIRING DIAGRAM >

Connector No.	M214
Connector Name	USB INTERFACE
Connector Color	BLUE

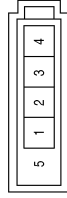

Terminal No.	Color of Wire	Signal Name
1	B	-
2	G	-
3	W	-
4	R	-
5	SHIELD	-

Connector No.	M205
Connector Name	WIRE TO WIRE
Connector Color	BLUE

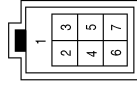

Terminal No.	Color of Wire	Signal Name
1	SHIELD	-
2	B	-
3	R	-
4	W	-
5	G	-

Connector No.	M169
Connector Name	WIRE TO WIRE
Connector Color	BLUE

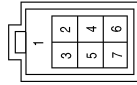

Terminal No.	Color of Wire	Signal Name
1	SHIELD	-
2	B	-
3	R	-
4	W	-
5	G	-

Connector No.	E5
Connector Name	WIRE TO WIRE
Connector Color	WHITE



Terminal No.	Color of Wire	Signal Name
9	LG	-
10	W/G	-
11	SB	-

Connector No.	M501
Connector Name	SATELLITE ANTENNA
Connector Color	BROWN

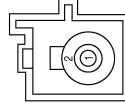

Terminal No.	Color of Wire	Signal Name
1	B	-
2	SHIELD	-

Connector No.	M500
Connector Name	WIRE TO WIRE
Connector Color	PINK

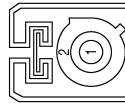

Terminal No.	Color of Wire	Signal Name
1	B	-
2	SHIELD	-

ABNIA5627GB

A
B
C
D
E
F
G
H
I
J
K
L
M
N
O
P

AV

DISPLAY AUDIO WITHOUT AMPLIFIER

[DISPLAY AUDIO WITHOUT AMPLIFIER]

< WIRING DIAGRAM >

Connector No.	E45
Connector Name	BACK-UP LAMP RELAY (WITH A/T)
Connector Color	BROWN



Terminal No.	Color of Wire	Signal Name
1	LG	-
2	W/G	-
3	SB	-
5	W/G	-
6	Y	-
7	W/G	-

Terminal No.	Color of Wire	Signal Name
40C	GR	-
41C	B	-
42C	SHIELD	-
43C	W	-
44C	G/Y	-
45C	BR	-

Connector No.	E41
Connector Name	WIRE TO WIRE
Connector Color	BLACK

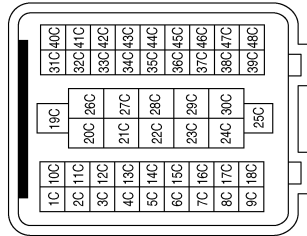

Terminal No.	Color of Wire	Signal Name
2G	Y	-
58G	SB	-
86G	G/Y	-
87G	SHIELD	-
88G	B	-
89G	W	-
90G	BR	-

Connector No.	E152
Connector Name	WIRE TO WIRE
Connector Color	WHITE

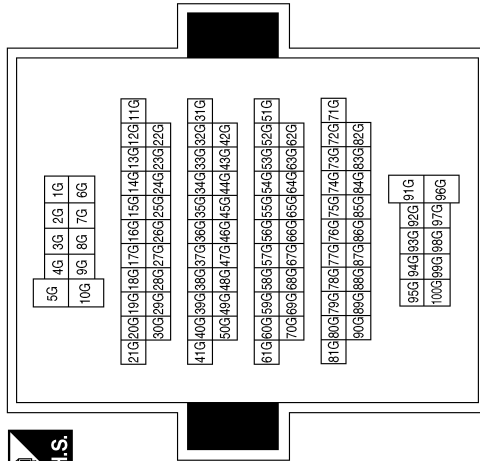

Connector No.	E119
Connector Name	IPDM E/R (INTELLIGENT POWER DISTRIBUTION MODULE ENGINE ROOM)
Connector Color	WHITE

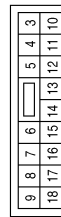

Terminal No.	Color of Wire	Signal Name
16	W/G	REVERSE LAMP

ABNIA5628GB

DISPLAY AUDIO WITHOUT AMPLIFIER

[DISPLAY AUDIO WITHOUT AMPLIFIER]

< WIRING DIAGRAM >

Connector No.	F69
Connector Name	BACK-UP LAMP SWITCH
Connector Color	WHITE



Terminal No.	Color of Wire	Signal Name
1	W/G	-
2	SB	-

Connector No.	F14
Connector Name	WIRE TO WIRE
Connector Color	WHITE

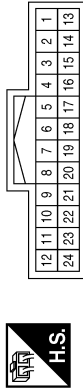

Terminal No.	Color of Wire	Signal Name
9	LG	-
10	W/G	-
11	SB	-

Connector No.	F9
Connector Name	A/T ASSEMBLY
Connector Color	GREEN



Terminal No.	Color of Wire	Signal Name
7	LG	-

Terminal No.	Color of Wire	Signal Name
40C	GR	-
41C	B	-
42C	SHIELD	-
43C	W	-
44C	G/Y	-
45C	BR	-

Connector No.	C1
Connector Name	WIRE TO WIRE
Connector Color	BLACK

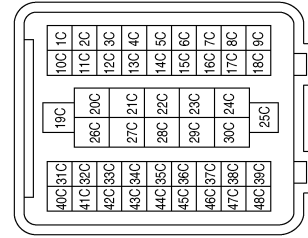

Connector No.	F502
Connector Name	TCM (TRANSMISSION CONTROL MODULE)
Connector Color	GRAY

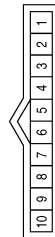

Terminal No.	Color of Wire	Signal Name
7	O	REV LAMP RLY

ABNIA5629GB

A
B
C
D
E
F
G
H
I
J
K
L
M
O
P

AV

DISPLAY AUDIO WITHOUT AMPLIFIER

[DISPLAY AUDIO WITHOUT AMPLIFIER]

< WIRING DIAGRAM >

Connector No.	C213
Connector Name	WIRE TO WIRE
Connector Color	BLACK



Terminal No.	Color of Wire	Signal Name
1	W	-
2	B	-
3	SHIELD	-
4	G/Y	-
5	GR	-
6	BR	-

Connector No.	C212
Connector Name	WIRE TO WIRE
Connector Color	GRAY

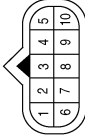

Terminal No.	Color of Wire	Signal Name
3	G/Y	-
4	GR	-
5	B	-
8	BR	-
9	W	-
10	SHIELD	-

Connector No.	C17
Connector Name	WIRE TO WIRE
Connector Color	GRAY

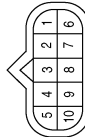

Terminal No.	Color of Wire	Signal Name
3	G/Y	-
4	GR	-
5	B	-
8	BR	-
9	W	-
10	SHIELD	-

Connector No.	B6
Connector Name	WIRE TO WIRE
Connector Color	WHITE

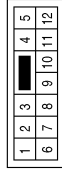

Terminal No.	Color of Wire	Signal Name
5	G	-
12	B	-

Connector No.	C251
Connector Name	REAR VIEW CAMERA
Connector Color	GRAY



Terminal No.	Color of Wire	Signal Name
1	G/Y	-
3	B	-
4	GR	-
6	W	-

Connector No.	C250
Connector Name	WIRE TO WIRE
Connector Color	BLACK



Terminal No.	Color of Wire	Signal Name
1	W	-
2	B	-
3	SHIELD	-
4	G/Y	-
5	GR	-
6	BR	-

ABNIA5630GB

DISPLAY AUDIO WITHOUT AMPLIFIER

[DISPLAY AUDIO WITHOUT AMPLIFIER]

< WIRING DIAGRAM >

Connector No.	B106
Connector Name	WIRE TO WIRE
Connector Color	WHITE

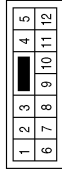

Terminal No.	Color of Wire	Signal Name
5	P	-(WITH DISPLAY AUDIO WITHOUT AMPLIFIER)
12	W	-(WITH DISPLAY AUDIO WITHOUT AMPLIFIER)

Connector No.	B76
Connector Name	REAR DOOR SPEAKER LH (KING CAB)
Connector Color	WHITE



Terminal No.	Color of Wire	Signal Name
1	G	-
2	B	-

Connector No.	B69
Connector Name	WIRE TO WIRE
Connector Color	WHITE

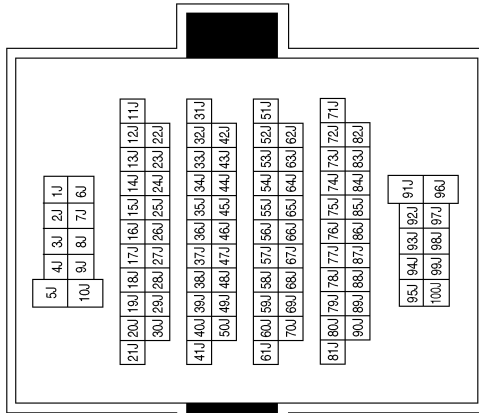
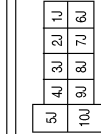

Terminal No.	Color of Wire	Signal Name
93J	G	-
98J	B	-

A
B
C
D
E
F
G
H
I
J
K
L
M
N
O
P

AV

DISPLAY AUDIO WITHOUT AMPLIFIER

[DISPLAY AUDIO WITHOUT AMPLIFIER]

< WIRING DIAGRAM >

Terminal No.	Color of Wire	Signal Name
21	B	CONT 2
22	-	-
23	B	CONT 4
24	-	-
25	-	-
26	-	-
27	-	-
28	SB	SPEED SIGNAL
29	Y	MIC POWER
30	-	-
31	-	-
32	-	-

Terminal No.	Color of Wire	Signal Name
6	SHIELD	MIC SHIELD
7	G	MIC IN+
8	L	MIC IN-
9	W	AUDIO OUT+
10	B	AUDIO OUT-
11	-	-
12	BR	LADDER IN 1
13	L	LADDER IN 2
14	G	LADDER IN GND
15	-	-
16	-	-
17	V	LADDER OUT 1
18	LG	LADDER OUT 2
19	BG	LADDER OUT GND
20	-	-

Connector No.	B141
Connector Name	BLUETOOTH® CONTROL UNIT
Connector Color	WHITE

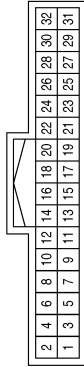

Terminal No.	Color of Wire	Signal Name
1	R/B	BATT
2	G/Y	ACC
3	W/G	IGN
4	B	GND
5	-	-

Terminal No.	Color of Wire	Signal Name
35	R	CAN-H1
36	G	CAN-L1
37	SHIELD	CAN SHIELD 1
38	-	-
39	-	-
40	-	-
41	-	-
42	-	-

Connector No.	B143
Connector Name	BLUETOOTH® CONTROL UNIT
Connector Color	WHITE

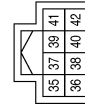

Connector No.	B142
Connector Name	BLUETOOTH® CONTROL UNIT
Connector Color	BLACK



Terminal No.	Color of Wire	Signal Name
33	B	BT ANTENNA
34	SHIELD	BT ANTENNA SHIELD

ABNIA5632GB

DISPLAY AUDIO WITHOUT AMPLIFIER

[DISPLAY AUDIO WITHOUT AMPLIFIER]

< WIRING DIAGRAM >

Terminal No.	Color of Wire	Signal Name
66M	G	-
67M	SB	-
69M	R	-
70M	G	-
91M	R/B	-
96M	G/Y	-

Terminal No.	Color of Wire	Signal Name
51M	B	-(EXCEPT BASE AUDIO SYSTEM)
54M	V	-
55M	BR	-
56M	SHIELD	-
57M	W/G	-
58M	G	-
59M	SHIELD	-
60M	L	-
61M	Y	-
62M	W	-
63M	BG	-
64M	LG	-
65M	L	-

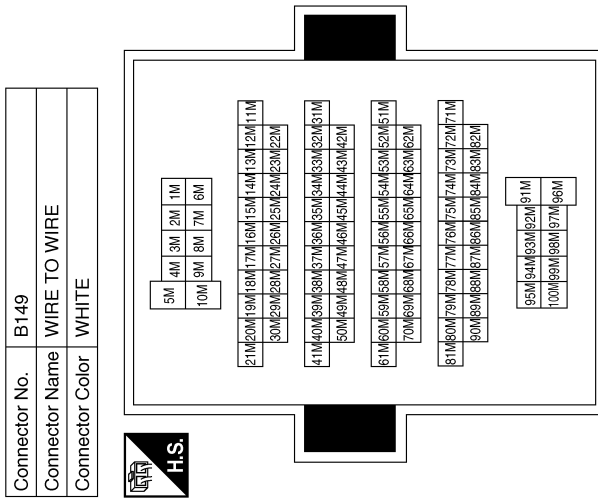

Connector No.	B149
Connector Name	WIRE TO WIRE
Connector Color	WHITE

Connector No.	R1
Connector Name	WIRE TO WIRE
Connector Color	WHITE

Connector No.	B163
Connector Name	WIRE TO WIRE
Connector Color	WHITE

Connector No.	B160
Connector Name	REAR DOOR SPEAKER RH (KING CAB)
Connector Color	WHITE

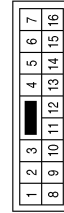
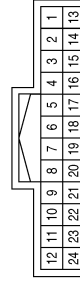

Terminal No.	Color of Wire	Signal Name
1	Y	-(WITHOUT NAVI)
13	SHIELD	-
14	G	-(WITHOUT NAVI)
15	L	-(WITHOUT NAVI)

Terminal No.	Color of Wire	Signal Name
1	B	-
11	P	-(EXCEPT BASE AUDIO SYSTEM)
12	W	-(EXCEPT BASE AUDIO SYSTEM)

Terminal No.	Color of Wire	Signal Name
1	P	-(WITH DISPLAY AUDIO WITHOUT AMPLIFIER)
2	W	-(WITH DISPLAY AUDIO WITHOUT AMPLIFIER)

ABNIA5633GB

A B C D E F G H I J K L M N O P

AV

DISPLAY AUDIO WITHOUT AMPLIFIER

[DISPLAY AUDIO WITHOUT AMPLIFIER]

< WIRING DIAGRAM >

Connector No.	D12
Connector Name	FRONT DOOR SPEAKER LH
Connector Color	WHITE



Terminal No.	Color of Wire	Signal Name
1	L/W	-
2	L/R	-

Connector No.	D2
Connector Name	WIRE TO WIRE
Connector Color	BROWN



Terminal No.	Color of Wire	Signal Name
2	L/R	-
3	L/W	-

Connector No.	R8
Connector Name	MICROPHONE
Connector Color	WHITE

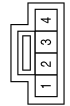

Terminal No.	Color of Wire	Signal Name
1	G	-(WITHOUT NAVI)
2	L	-(WITHOUT NAVI)
4	Y	-(WITHOUT NAVI)

Connector No.	D152
Connector Name	WIRE TO WIRE
Connector Color	WHITE

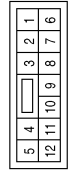

Terminal No.	Color of Wire	Signal Name
4	R	-
11	LG	-

Connector No.	D112
Connector Name	FRONT DOOR SPEAKER RH
Connector Color	WHITE



Terminal No.	Color of Wire	Signal Name
1	W/B	-
2	L/B	-

Connector No.	D101
Connector Name	WIRE TO WIRE
Connector Color	WHITE

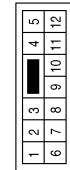

Terminal No.	Color of Wire	Signal Name
4	L/B	-
11	W/B	-

ABNIA5634GB

DISPLAY AUDIO WITHOUT AMPLIFIER

[DISPLAY AUDIO WITHOUT AMPLIFIER]

< WIRING DIAGRAM >

Connector No.	D207
Connector Name	REAR DOOR SPEAKER LH (CREW CAB)
Connector Color	WHITE



Terminal No.	Color of Wire	Signal Name
1	L	-
2	O	-

Connector No.	D201
Connector Name	WIRE TO WIRE
Connector Color	WHITE

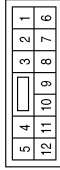

Terminal No.	Color of Wire	Signal Name
5	L	-
12	O	-

Connector No.	D153
Connector Name	WIRE TO WIRE
Connector Color	WHITE

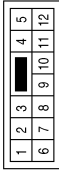

Terminal No.	Color of Wire	Signal Name
4	R	-
11	LG	-

Connector No.	D307
Connector Name	REAR DOOR SPEAKER RH (CREW CAB)
Connector Color	WHITE



Terminal No.	Color of Wire	Signal Name
1	L	-
2	O	-

Connector No.	D301
Connector Name	WIRE TO WIRE
Connector Color	WHITE



Terminal No.	Color of Wire	Signal Name
5	L	-
12	O	-

ABNIA5635GB

A
B
C
D
E
F
G
H
I
J
K
L
M
N
O
P

AV

BASIC INSPECTION

DIAGNOSIS AND REPAIR WORKFLOW

Work Flow

INFOID:000000009482108

OVERALL SEQUENCE

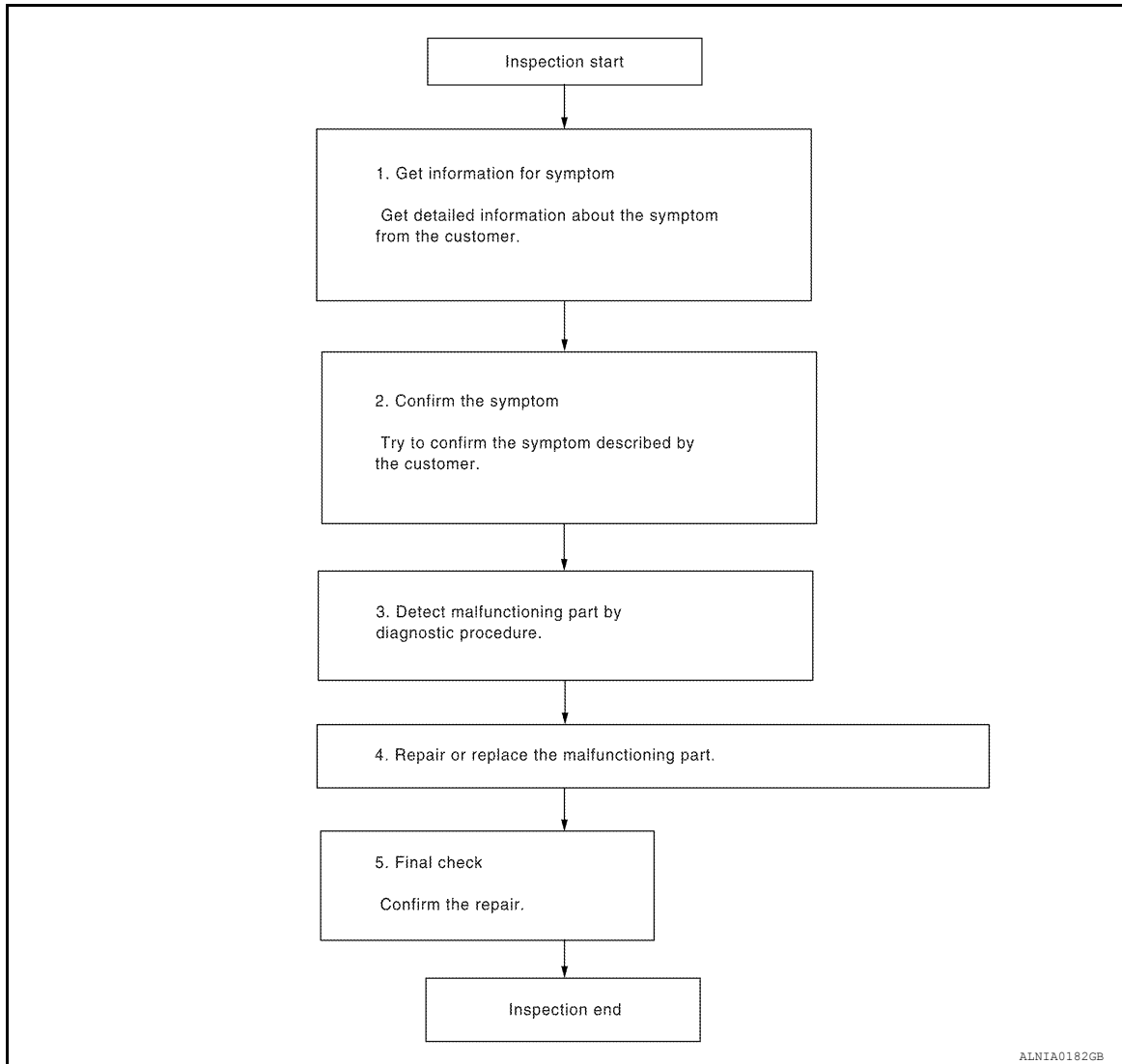

DETAILED FLOW

1.GET INFORMATION FOR SYMPTOM

Get detailed information from the customer about the symptom (the condition and the environment when the incident/malfunction occurred).

>> GO TO 2.

2.CONFIRM THE SYMPTOM

Try to confirm the symptom described by the customer. Verify relation between the symptom and the condition when the symptom is detected.

>> GO TO 3.

3.DETECT MALFUNCTIONING PART BY DIAGNOSTIC PROCEDURE

Inspect according to Diagnostic Procedure of the system.

DIAGNOSIS AND REPAIR WORKFLOW

< BASIC INSPECTION >

[DISPLAY AUDIO WITHOUT AMPLIFIER]

Is malfunctioning part detected?

YES >> GO TO 4.

NO >> GO TO 2.

4.REPAIR OR REPLACE THE MALFUNCTIONING PART

1. Repair or replace the malfunctioning part.
2. Reconnect parts or connectors disconnected during Diagnostic Procedure.

>> GO TO 5.

5.FINAL CHECK

Refer to confirmed symptom in step 2, and make sure that the symptom is not detected.

Was the repair confirmed?

YES >> Inspection End.

NO >> GO TO 2.

A

B

C

D

E

F

G

H

I

J

K

L

M

AV

O

P

POWER SUPPLY AND GROUND CIRCUIT

< DTC/CIRCUIT DIAGNOSIS >

[DISPLAY AUDIO WITHOUT AMPLIFIER]

DTC/CIRCUIT DIAGNOSIS

POWER SUPPLY AND GROUND CIRCUIT AUDIO UNIT

AUDIO UNIT : Diagnosis Procedure

INFOID:000000009482109

1.CHECK FUSE

Check that the following fuses are not blown.

Terminal No.	Signal name	Fuse No.
7	ACC power supply	4 (10A)
19	Battery power supply	29 (20A)

Are the fuses blown?

- YES >> Replace the blown fuse after repairing the affected circuit.
NO >> GO TO 2.

2.CHECK POWER SUPPLY CIRCUIT

1. Turn ignition switch OFF.
2. Disconnect audio unit connector M44.
3. Check voltage between audio unit connector M44 and ground.

Audio unit		Ground	Condition	Voltage (Approx.)
Connector	Terminal			
M44	7	—	Ignition switch: ON	Battery voltage
	19		Ignition switch: OFF	

Is the inspection result normal?

- YES >> GO TO 3.
NO >> Repair or replace harness or connectors.

3.CHECK GROUND CIRCUIT

Check continuity between audio unit connector M44 and ground.

Audio unit		Ground	Continuity
Connector	Terminal		
M44	20	—	Yes

Is the inspection result normal?

- YES >> Inspection End.
NO >> Repair or replace harness or connectors.

BLUETOOTH® CONTROL UNIT

BLUETOOTH® CONTROL UNIT : Diagnosis Procedure

INFOID:000000009482110

Regarding Wiring Diagram information, refer to [AV-104, "Wiring Diagram"](#).

1.CHECK FUSE

Check that the following fuses are not blown.

POWER SUPPLY AND GROUND CIRCUIT

< DTC/CIRCUIT DIAGNOSIS >

[DISPLAY AUDIO WITHOUT AMPLIFIER]

Terminal No.	Signal name	Fuse No.
1	Battery power supply	29 (20A)
2	ACC power supply	4 (10A)
3	Ignition power supply	12 (10A)

Are the fuses blown?

YES >> Replace the blown fuse after repairing the affected circuit.

NO >> GO TO 2.

2.CHECK POWER SUPPLY CIRCUIT

1. Turn ignition switch OFF.
2. Disconnect Bluetooth® control unit connector B141.
3. Check voltage between Bluetooth® control unit connector B141 and ground.

Bluetooth® control unit		Ground	Condition	Voltage (Approx.)
Connector	Terminal			
B141	1	—	Ignition switch: OFF	Battery voltage
	2		Ignition switch: ON	
	3			

Is the inspection result normal?

YES >> GO TO 3.

NO >> Repair or replace harness or connectors.

3.CHECK GROUND CIRCUIT

1. Turn ignition switch OFF.
2. Check continuity between Bluetooth® control unit connector B141 and ground.

Bluetooth® control unit		Ground	Continuity
Connector	Terminal		
B141	4	—	Yes
	21		
	23		

Is the inspection result normal?

YES >> Inspection End.

NO >> Repair or replace harness or connectors.

MICROPHONE

MICROPHONE : Diagnosis Procedure

INFOID:000000009482111

AV

Regarding Wiring Diagram information, refer to [AV-104, "Wiring Diagram"](#).

1.CHECK POWER SUPPLY CIRCUIT

1. Turn ignition switch ON.
2. Check voltage between microphone connector R8 and ground.

Microphone		Ground	Value (Approx.)
Connector	Terminal		
R8	4	—	5V

Is the inspection result normal?

POWER SUPPLY AND GROUND CIRCUIT

[DISPLAY AUDIO WITHOUT AMPLIFIER]

< DTC/CIRCUIT DIAGNOSIS >

- YES >> GO TO 3.
NO >> GO TO 2.

2. CHECK POWER SUPPLY CIRCUIT CONTINUITY

1. Turn ignition switch OFF.
2. Disconnect microphone connector and Bluetooth® control unit connector B141.
3. Check continuity between microphone connector R8 and Bluetooth® control unit connector B141.

Microphone		Bluetooth® control unit		Continuity
Connector	Terminal	Connector	Terminal	
R8	4	B141	29	Yes

4. Check continuity between microphone connector R8 and ground.

Microphone		—	Continuity
Connector	Terminal		
R8	4	Ground	No

Is the inspection result normal?

- YES >> Replace the Bluetooth® control unit. Refer to [AV-151, "Removal and Installation"](#).
NO >> Repair or replace harness or connectors.

3. CHECK GROUND CIRCUIT

1. Turn ignition switch OFF.
2. Disconnect microphone connector and Bluetooth® control unit connector B141.
3. Check continuity between microphone connector R8 and Bluetooth® control unit connector B141.

Microphone		Bluetooth® control unit		Continuity
Connector	Terminal	Connector	Terminal	
R8	2	B141	8	Yes

Is the inspection result normal?

- YES >> Inspection End.
NO >> Repair or replace harness or connectors.

FRONT DOOR SPEAKER

[DISPLAY AUDIO WITHOUT AMPLIFIER]

< DTC/CIRCUIT DIAGNOSIS >

FRONT DOOR SPEAKER

Diagnosis Procedure

INFOID:000000009482112

Regarding Wiring Diagram information, refer to [AV-104. "Wiring Diagram"](#).

1. CONNECTOR CHECK

Check the audio unit and speaker connectors for the following:

- Proper connection
- Damage
- Disconnected or loose terminals

Is the inspection result normal?

YES >> GO TO 2

NO >> Repair the terminals or connectors.

2. CHECK FRONT DOOR SPEAKER SIGNAL CIRCUIT CONTINUITY

1. Disconnect audio unit connector M44 and suspect front door speaker connector.
2. Check continuity between audio unit connector M44 and suspect front door speaker connector.

Audio unit		Front door speaker		Continuity
Connector	Terminal	Connector	Terminal	
M44	2	D12 (LH)	1	Yes
	3		2	
	11	D112 (RH)	1	
	12		2	

3. Check continuity between audio unit connector M44 and ground.

Audio unit		Ground	Continuity
Connector	Terminal		
M44	2	—	No
	3		
	11		
	12		

Is the inspection result normal?

YES >> GO TO 3

NO >> Repair or replace harness or connectors.

3. CHECK FRONT DOOR SPEAKER SIGNAL

1. Connect audio unit connector M44 and suspect front door speaker connector.
2. Turn ignition switch to ACC.
3. Push audio unit POWER switch.
4. Check signal between the terminals of audio unit connector M44.

Audio unit connector M44		Condition	Reference value
(+)	(-)		
Terminal	Terminal		

FRONT DOOR SPEAKER

< DTC/CIRCUIT DIAGNOSIS >

[DISPLAY AUDIO WITHOUT AMPLIFIER]

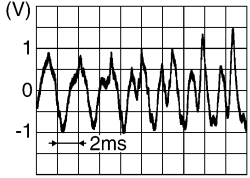
2	3		
11	12	Audio signal output	

Is the inspection result normal?

- YES >> Replace front door speaker. Refer to [AV-148. "Removal and Installation"](#).
- NO >> Replace audio unit. Refer to [AV-146. "Removal and Installation"](#).

FRONT TWEETER

< DTC/CIRCUIT DIAGNOSIS >

[DISPLAY AUDIO WITHOUT AMPLIFIER]

FRONT TWEETER

Diagnosis Procedure

INFOID:000000009482113

Regarding Wiring Diagram information, refer to [AV-104. "Wiring Diagram"](#).

1. CONNECTOR CHECK

Check the audio unit and speaker connectors for the following:

- Proper connection
- Damage
- Disconnected or loose terminals

Is the inspection result normal?

YES >> GO TO 2

NO >> Repair the terminals or connectors.

2. CHECK FRONT DOOR SPEAKER SIGNAL CIRCUIT CONTINUITY

1. Disconnect audio unit connector M44 and suspect front tweeter connector.
2. Check continuity between audio unit connector M44 and suspect front tweeter connector.

Audio unit		Front tweeter		Continuity
Connector	Terminal	Connector	Terminal	
M44	2	M109 (LH)	1	Yes
	3		2	
	11	M111 (RH)	1	
	12		2	

3. Check continuity between audio unit connector M44 and ground.

Audio unit		Ground	Continuity
Connector	Terminal		
M44	2	—	No
	3		
	11		
	12		

Is the inspection result normal?

YES >> GO TO 3

NO >> Repair or replace harness or connectors.

3. CHECK FRONT DOOR SPEAKER SIGNAL

1. Connect audio unit connector M44 and suspect front tweeter connector.
2. Turn ignition switch to ACC.
3. Push audio unit POWER switch.
4. Check signal between the terminals of audio unit connector M44.

Audio unit connector M44		Condition	Reference value
(+)	(-)		
Terminal	Terminal		

FRONT TWEETER

< DTC/CIRCUIT DIAGNOSIS >

[DISPLAY AUDIO WITHOUT AMPLIFIER]

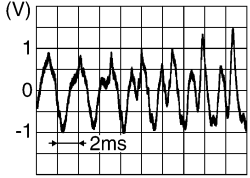
2	3		
11	12	Audio signal output	

Is the inspection result normal?

- YES >> Replace front tweeter. Refer to [AV-147. "Removal and Installation"](#).
- NO >> Replace audio unit. Refer to [AV-146. "Removal and Installation"](#).

REAR DOOR SPEAKER

[DISPLAY AUDIO WITHOUT AMPLIFIER]

< DTC/CIRCUIT DIAGNOSIS >

REAR DOOR SPEAKER

Diagnosis Procedure

INFOID:000000009482114

Regarding Wiring Diagram information, refer to [AV-104. "Wiring Diagram"](#).

1. CONNECTOR CHECK

Check the audio unit and speaker connectors for the following:

- Proper connection
- Damage
- Disconnected or loose terminals

Is the inspection result normal?

YES >> GO TO 2

NO >> Repair the terminals or connectors.

2. CHECK FRONT DOOR SPEAKER SIGNAL CIRCUIT CONTINUITY

1. Disconnect audio unit connector M44 and suspect rear door speaker connector.
2. Check continuity between audio unit connector M44 and suspect rear door speaker connector.

Audio unit		Rear door speaker		Continuity
Connector	Terminal	Connector	Terminal	
M44	4	D207 (LH) (crew cab)	1	Yes
	5		2	
	13	D307 (RH) (crew cab)	1	
	14		2	
	4	B76 (LH) (king cab)	1	
	5		2	
	13	B160 (RH) (king cab)	1	
	14		2	

3. Check continuity between audio unit connector M44 and ground.

Audio unit		Ground	Continuity
Connector	Terminal		
M44	4	—	No
	5		
	13		
	14		

Is the inspection result normal?

YES >> GO TO 3

NO >> Repair or replace harness or connectors.

3. CHECK FRONT DOOR SPEAKER SIGNAL

1. Connect audio unit connector M44 and suspect rear door speaker connector.
2. Turn ignition switch to ACC.
3. Push audio unit POWER switch.
4. Check signal between the terminals of audio unit connector M44.

REAR DOOR SPEAKER

< DTC/CIRCUIT DIAGNOSIS >

[DISPLAY AUDIO WITHOUT AMPLIFIER]

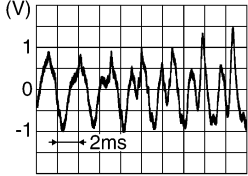
Audio unit connector M44		Condition	Reference value
(+)	(-)		
Terminal	Terminal		
4	5	Audio signal output	
13	14		

SKIB3609E

Is the inspection result normal?

- YES >> Replace rear door speaker. Refer to [AV-149. "Removal and Installation"](#).
- NO >> Replace audio unit. Refer to [AV-146. "Removal and Installation"](#).

REAR VIEW CAMERA IMAGE SIGNAL CIRCUIT

< DTC/CIRCUIT DIAGNOSIS >

[DISPLAY AUDIO WITHOUT AMPLIFIER]

REAR VIEW CAMERA IMAGE SIGNAL CIRCUIT

Diagnosis Procedure

INFOID:000000009482115

Regarding Wiring Diagram information, refer to [AV-104. "Wiring Diagram"](#).

1. CHECK REVERSE INPUT SIGNAL

1. Turn ignition switch ON.
2. Shift the selector lever to R (reverse).
3. Check voltage between audio unit connector M45 and ground.

Audio unit		Ground	Condition	Voltage (Approx.)
Connector	Terminal			
M45	50	—	Selector lever in R (reverse)	Battery Voltage

Is the inspection result normal?

YES >> GO TO 2.

NO >> Repair or replace harness or connectors.

2. CHECK CAMERA POWER SUPPLY CIRCUIT CONTINUITY

1. Turn ignition switch OFF.
2. Disconnect audio unit connector M45 and rear view camera connector.
3. Check continuity between audio unit connector M45 and rear view camera connector C251.

Audio unit		Rear view camera		Continuity
Connector	Terminal	Connector	Terminal	
M45	34	C251	1	Yes

4. Check continuity between audio unit connector M45 and ground.

Audio unit		Ground	Continuity
Connector	Terminal		
M45	34		No

Is the inspection result normal?

YES >> GO TO 3.

NO >> Repair or replace harness or connectors.

3. CHECK CAMERA POWER SUPPLY VOLTAGE

1. Connect audio unit connector M45 and rear view camera connector.
2. Turn ignition switch ON.
3. Shift the selector lever to R (reverse).
4. Check voltage between audio unit connector M45 and ground.

Audio unit		Ground	Condition	Voltage (Approx.)
Connector	Terminal			
M45	34	—	Selector lever is in "R".	6.0 V

Is the inspection result normal?

YES >> GO TO 4.

NO >> Replace audio unit. Refer to [AV-146. "Removal and Installation"](#).

4. CHECK CAMERA IMAGE SIGNAL CIRCUIT CONTINUITY

1. Turn ignition switch OFF.

A

B

C

D

E

F

G

H

I

J

K

L

M

AV

O

P

REAR VIEW CAMERA IMAGE SIGNAL CIRCUIT

[DISPLAY AUDIO WITHOUT AMPLIFIER]

< DTC/CIRCUIT DIAGNOSIS >

2. Disconnect audio unit connector M45 and rear view camera connector.
3. Check continuity between audio unit connector M45 and rear view camera connector C251.

Audio unit		Rear view camera		Continuity
Connector	Terminal	Connector	Terminal	
M45	35	C251	3	Yes

4. Check continuity between audio unit connector M45 and ground.

Audio unit		Ground	Continuity
Connector	Terminal		
M45	35		No

Is the inspection result normal?

- YES >> GO TO 5.
 NO >> Repair or replace harness or connectors.

5. CHECK CAMERA GROUND CIRCUIT CONTINUITY

Check continuity between audio unit connector M45 and rear view camera connector C251.

Audio unit		Rear view camera		Continuity
Connector	Terminal	Connector	Terminal	
M45	36	C251	6	Yes

Is the inspection result normal?

- YES >> GO TO 6.
 NO >> Repair or replace harness or connectors.

6. CHECK CAMERA IMAGE SIGNAL

1. Connect audio unit connector M45 and rear view camera connector.
2. Turn ignition switch ON.
3. Shift the selector lever to R (reverse).
4. Check signal between audio unit connector M45 and ground.

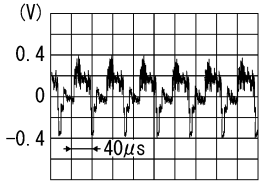
Audio unit		Ground	Condition	Reference value
(+)		(-)		
Connector	Terminal			
M45	35	—	Camera image displayed.	 <p style="text-align: right; font-size: small;">SKIB2251J</p>

Is the inspection result normal?

- YES >> Replace audio unit. Refer to [AV-146. "Removal and Installation"](#).
 NO >> Replace rear view camera.

STEERING SWITCH

< DTC/CIRCUIT DIAGNOSIS >

[DISPLAY AUDIO WITHOUT AMPLIFIER]

STEERING SWITCH





Diagnosis Procedure

INFOID:000000009482116

Regarding Wiring Diagram information, refer to [AV-104. "Wiring Diagram"](#).

1. CHECK STEERING WHEEL AUDIO CONTROL SWITCH RESISTANCE

1. Disconnect combination switch connector M102.
2. Check resistance between combination switch connector terminals.

Combination switch connector M102		Condition	Resistance (Ω) (Approx.)
Terminal	Terminal		
16	18	Depress VOL DOWN switch.	1
		Depress VOL UP switch.	121
		Depress  switch.	321
15		Depress MODE switch.	1
		Depress  switch.	121
		Depress  switch.	321
		Depress  switch.	723

Is the inspection result normal?

YES >> GO TO 2.

NO >> Replace steering wheel audio control switches. Refer to [AV-150. "Removal and Installation"](#).

2. CHECK HARNESS BETWEEN BLUETOOTH® CONTROL UNIT AND COMBINATION SWITCH

1. Turn ignition switch OFF.
2. Disconnect Bluetooth® control unit connector B141 and combination switch connector M30.
3. Check continuity between Bluetooth® control unit connector B141 and combination switch connector M30.

Bluetooth® control unit		Combination switch		Continuity
Connector	Terminal	Connector	Terminal	
B141	12	M30	24	Yes
	13		25	
	14		31	

4. Check continuity between Bluetooth® control unit connector B141 and ground.

Bluetooth® control unit		—	Continuity
Connector	Terminal		
B141	12	Ground	No
	13		
	14		

Is the inspection result normal?

YES >> GO TO 3.

NO >> Repair or replace harness or connectors.

3. SPIRAL CABLE CHECK

Check continuity between combination switch connectors M30 and M102.

STEERING SWITCH

< DTC/CIRCUIT DIAGNOSIS >

[DISPLAY AUDIO WITHOUT AMPLIFIER]

Combination switch				Continuity
Connector	Terminal	Connector	Terminal	
M30	24	M102	15	Yes
	25		16	
	31		18	

Is the inspection result normal?

YES >> GO TO 4.

NO >> Replace spiral cable. Refer to [SR-13. "Removal and Installation"](#).

4. CHECK HARNESS BETWEEN BLUETOOTH® CONTROL UNIT AND AUDIO UNIT

1. Disconnect audio unit connector M44.
2. Check continuity between Bluetooth® control unit connector B141 and audio unit connector M44.

Bluetooth® control unit		Audio unit		Continuity
Connector	Terminal	Connector	Terminal	
B141	17	M44	6	Yes
	18		16	
	19		15	

3. Check continuity between Bluetooth® control unit connector B141 and ground.

Bluetooth® control unit		—	Continuity
Connector	Terminal		
B141	17	Ground	No
	18		
	19		

Is the inspection result normal?

YES >> Replace audio unit. Refer to [AV-146. "Removal and Installation"](#).

NO >> Repair or replace harness or connectors.

MICROPHONE SIGNAL CIRCUIT

< DTC/CIRCUIT DIAGNOSIS >

[DISPLAY AUDIO WITHOUT AMPLIFIER]

MICROPHONE SIGNAL CIRCUIT

Diagnosis Procedure

INFOID:000000009482117

Regarding Wiring Diagram information, refer to [AV-104. "Wiring Diagram"](#).

1. CHECK HARNESS BETWEEN BLUETOOTH® CONTROL UNIT AND MICROPHONE

1. Turn ignition switch OFF.
2. Disconnect Bluetooth® control unit connector B141 and microphone connector.
3. Check continuity between Bluetooth® control unit connector B141 and microphone connector R8.

Bluetooth® control unit		Microphone		Continuity
Connector	Terminal	Connector	Terminal	
B141	7	R8	1	Yes
	8		2	
	29		4	

4. Check continuity between Bluetooth® control unit connector B141 and ground.

Bluetooth® control unit		—	Continuity
Connector	Terminal		
B141	7	Ground	No
	8		
	29		

Is the inspection result normal?

YES >> GO TO 2.

NO >> Repair harness or connector.

2. CHECK MICROPHONE POWER SUPPLY

1. Connect Bluetooth® control unit connector B141 and microphone connector.
2. Turn ignition switch ON.
3. Check voltage between microphone connector R8 terminal 4 and ground.

Microphone		Ground	Value (Approx.)
Connector	Terminal		
R8	4	—	5V

Is the inspection result normal?

YES >> GO TO 3.

NO >> Replace Bluetooth® control unit. Refer to [AV-151. "Removal and Installation"](#).

3. CHECK MICROPHONE SIGNAL

Check signal between Bluetooth® control unit connector B141 with CONSULT or and oscilloscope.

A
B
C
D
E
F
G
H
I
J
K
L
M
AV
O
P

MICROPHONE SIGNAL CIRCUIT

< DTC/CIRCUIT DIAGNOSIS >

[DISPLAY AUDIO WITHOUT AMPLIFIER]

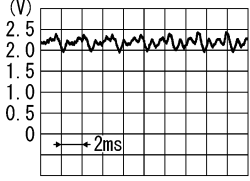
Bluetooth® control unit connector B141		Condition	Reference signal
(+)	(-)		
Terminal	Terminal		
7	8	Speak into microphone.	 <p style="text-align: right; font-size: small;">PKIB5037J</p>

Is the inspection result normal?

- YES >> Replace Bluetooth® control unit. Refer to [AV-151. "Removal and Installation"](#).
- NO >> Replace microphone. Refer to [AV-153. "Removal and Installation"](#).

USB CONNECTOR

< DTC/CIRCUIT DIAGNOSIS >

[DISPLAY AUDIO WITHOUT AMPLIFIER]

USB CONNECTOR

Diagnosis Procedure

INFOID:000000009482118

Regarding Wiring Diagram information, refer to [AV-104. "Wiring Diagram"](#).

1. CHECK USB INTERFACE HARNESS CONTINUITY

1. Turn ignition switch OFF.
2. Disconnect audio unit connector M64 and USB interface connector M214.
3. Check continuity between audio unit connector M64 and USB interface connector M214.

Audio unit		USB interface		Continuity
Connector	Terminal	Connector	Terminal	
M64	53	M214	4	Yes
	54		1	
	55		2	
	56		3	
	57		5	

4. Check continuity between audio unit connector M64 and ground.

Audio unit		—	Continuity
Connector	Terminal		
M64	54	Ground	No
	57		

Is the inspection result normal?

- YES >> Replace the USB interface. Refer to [AV-157. "Removal and Installation"](#).
 NO >> Repair or replace harness or connectors.

A
B
C
D
E
F
G
H
I
J
K
L
M
O
P

AV

AUDIO SYSTEM

< SYMPTOM DIAGNOSIS >

[DISPLAY AUDIO WITHOUT AMPLIFIER]

SYMPTOM DIAGNOSIS

AUDIO SYSTEM

Symptom Table

INFOID:000000009482119

RELATED TO AUDIO

Symptoms	Check items	Probable malfunction location
The disk cannot be removed.	Audio unit	Malfunction in audio unit. Refer to AV-94, "On Board Diagnosis Function" .
No sound comes out or the level of the sound is low.	No sound from all speakers.	<ul style="list-style-type: none"> • Speaker circuit shorted to ground. Refer to AV-104, "Wiring Diagram". • Audio unit power supply and ground circuits malfunction. Refer to AV-122, "AUDIO UNIT : Diagnosis Procedure".
	Only a certain speaker (front door speaker LH, front door speaker RH, front tweeter LH, front tweeter RH, rear door speaker LH, rear door speaker RH) does not output sound.	<ul style="list-style-type: none"> • Poor connector connection of speaker. • Sound signal circuit malfunction between audio unit and speaker. Refer to: <ul style="list-style-type: none"> - AV-125, "Diagnosis Procedure" (front door speaker). - AV-127, "Diagnosis Procedure" (front tweeter). - AV-129, "Diagnosis Procedure" (rear door speaker). • Malfunction in speaker. Refer to: <ul style="list-style-type: none"> - AV-148, "Removal and Installation" (front door speaker). - AV-147, "Removal and Installation" (front tweeter). - AV-149, "Removal and Installation" (rear door speaker). • Malfunction in audio unit. Refer to AV-94, "On Board Diagnosis Function".

AUDIO SYSTEM

[DISPLAY AUDIO WITHOUT AMPLIFIER]

< SYMPTOM DIAGNOSIS >

Symptoms	Check items	Probable malfunction location
Noise is mixed with audio.	Noise comes out from all speakers.	Malfunction in audio unit. Refer to AV-94, "On Board Diagnosis Function" .
	Noise comes out only from a certain speaker (front door speaker LH, front door speaker RH, front tweeter LH, front tweeter RH, rear door speaker LH, rear door speaker RH).	<ul style="list-style-type: none"> • Poor connector connection of speaker. • Sound signal circuit malfunction between audio unit and speaker. Refer to: <ul style="list-style-type: none"> - AV-125, "Diagnosis Procedure" (front door speaker). - AV-127, "Diagnosis Procedure" (front tweeter). - AV-129, "Diagnosis Procedure" (rear door speaker). • Malfunction in speaker. • Poor Installation of speaker (e.g. backlash and looseness). Refer to: <ul style="list-style-type: none"> - AV-148, "Removal and Installation" (front door speaker). - AV-147, "Removal and Installation" (front tweeter). - AV-149, "Removal and Installation" (rear door speaker). • Malfunction in audio unit. Refer to AV-94, "On Board Diagnosis Function".
	Noise is mixed with radio only (when the vehicle hits a bump or while driving over bad roads)	Poor connector connection of antenna or antenna feeder. Refer to AV-154, "Location of Antenna" .
No radio reception or poor reception.	<ul style="list-style-type: none"> • Other audio sounds are normal. • Any radio station cannot be received or poor reception is caused even after moving to a service area with good reception (e.g. a place with clear view and no obstacles generating external noises). 	<ul style="list-style-type: none"> • Rod antenna is not fully connected to antenna base. • Antenna base/rod connection (thread zone) has foreign material or corrosion inside. • Poor connector connection of antenna or antenna feeder. Refer to AV-154, "Location of Antenna".
No satellite radio reception.	Satellite radio antenna malfunction.	<ul style="list-style-type: none"> • Poor continuity in antenna feeder. • Poor connector connection of antenna or antenna feeder. • Loose satellite radio antenna mounting nut. Refer to AV-154, "Location of Antenna".
Buzz/rattle sound from speaker	The majority of buzz/rattle sounds are not indicative of an issue with the speaker, usually something nearby the speaker is causing the buzz/rattle.	Refer to "SQUEAK AND RATTLE TROUBLE DIAGNOSIS" in the appropriate interior trim section.

RELATED TO HANDS-FREE PHONE

- Before performing diagnosis, confirm that the cellular phone being used by the customer is compatible with the vehicle.
- It is possible that a malfunction is occurring due to a version change of the phone even though the phone is a compatible type. This can be confirmed by changing the cellular phone to another compatible type, and check that it operates normally. It is important to determine whether the cause of the malfunction is the vehicle or the cellular phone.

Check Compatibility

1. Make sure the customer's Bluetooth[®] related concern is understood.
2. Verify the customer's concern.

NOTE:

The customer's phone may be required, depending upon their concern.

A
B
C
D
E
F
G
H
I
J
K
L
M
AV

AUDIO SYSTEM

[DISPLAY AUDIO WITHOUT AMPLIFIER]

< SYMPTOM DIAGNOSIS >

3. Write down the customer's phone brand, model and service provider.

NOTE:

It is necessary to know the service provider. On occasion, a given phone may be on the approved list with one provider, but may not be on the approved list with other providers.

4. Go to "www.nissanusa.com/bluetooth/".

a. Using the website's search engine, find out if the customer's phone is on the approved list.

b. If the customer's phone is NOT on the approved list:



Stop diagnosis here. The customer needs to obtain a Bluetooth® phone that is on the approved list before any further action.

c. If the feature related to the customer's concern shows as "N" (not compatible):

Stop diagnosis here. If the customer still wants the feature to function, they will need to get an approved phone showing the feature as "Y" (compatible) in the "Basic Features".

d. If the feature related to the customer's concern shows as "Y" (compatible):

Perform diagnosis as per the following table.

Symptoms	Check items	Probable malfunction location
Does not recognize cellular phone connection (no connection is displayed on the display at the guide).	Repeat the registration of cellular phone.	
Hands-free phone cannot be established.	<ul style="list-style-type: none"> Hands-free phone operation can be made, but the communication cannot be established. Hands-free phone operation can be performed, however, voice between each other cannot be heard during the conversation. 	Malfunction in audio unit. Replace audio unit. Refer to AV-146, "Removal and Installation" .
The other party's voice cannot be heard by hands-free phone.	Check the "microphone speaker" in Inspection & Adjustment Mode if sound is heard.	
Originating sound is not heard by the other party with hands-free phone communication.	Sound operation function is normal.	
	Sound operation function does not work.	Microphone signal circuit malfunction. Refer to AV-135, "Diagnosis Procedure" .
The system cannot be operated.	<ul style="list-style-type: none"> The voice recognition can be controlled. Steering switch's VOL UP and VOL DOWN switch works, but   does not work. 	Steering switch malfunction. Replace steering switch. Refer to AV-150, "Removal and Installation" .
	Steering switch's  , VOL UP and VOL DOWN switches do not work.	Steering switch signal circuit malfunction. Refer to AV-133, "Diagnosis Procedure" .
	All steering switches do not work.	Steering switch ground circuit malfunction. Refer to AV-133, "Diagnosis Procedure" .

RELATED TO REAR VIEW CAMERA

Symptoms	Check items	Probable malfunction location
Rear view camera is inoperative.	Reverse signal circuit malfunction.	Reverse signal circuit malfunction between BCM and audio unit. Refer to AV-131, "Diagnosis Procedure" .
	Camera image signal circuit malfunction.	Camera image signal circuit malfunction between rear view camera and audio unit. Refer to AV-131, "Diagnosis Procedure" .
	Rear view camera malfunction.	Replace rear view camera.

NORMAL OPERATING CONDITION

< SYMPTOM DIAGNOSIS >

[DISPLAY AUDIO WITHOUT AMPLIFIER]

NORMAL OPERATING CONDITION

Description

INFOID:000000009482120

RELATED TO NOISE

The majority of the audio concerns are the result of outside causes (bad CD, electromagnetic interference, etc.).

The following noise results from variations in field strength, such as fading noise and multi-path noise, or external noise from trains and other sources. It is not a malfunction.

- Fading noise: This noise occurs because of variations in the field strength in a narrow range due to mountains or buildings blocking the signal.
- Multi-path noise: This noise results from the waves sent directly from the broadcast station arriving at the antenna at a different time from the waves which reflect off mountains or buildings.

The vehicle itself can be a source of noise if noise prevention parts or electrical equipment is malfunctioning. Check if noise is caused and/or changed by engine speed, ignition switch turned to each position, and operation of each piece of electrical equipment, and determine the cause.

NOTE:

The source of the noise can be found easily by listening to the noise while removing the fuses of electrical components, one by one.

Type of Noise and Possible Cause

Occurrence condition		Possible cause
Occurs only when engine is ON.	A continuous growling noise occurs. The speed of the noise varies with changes in the engine speed.	<ul style="list-style-type: none"> • Ignition components
The occurrence of the noise is linked with the operation of the fuel pump.		<ul style="list-style-type: none"> • Fuel pump condenser
Noise only occurs when various electrical components are operating.	A cracking or snapping sound occurs with the operation of various switches.	<ul style="list-style-type: none"> • Relay malfunction, audio unit malfunction
	The noise occurs when various motors are operating.	<ul style="list-style-type: none"> • Motor case ground • Motor
The noise occurs constantly, not just under certain conditions.		<ul style="list-style-type: none"> • Rear defogger coil malfunction • Open circuit in printed heater • Poor ground of antenna feeder line
A cracking or snapping sound occurs while the vehicle is being driven, especially when it is vibrating excessively.		<ul style="list-style-type: none"> • Ground wire of body parts • Ground due to improper part installation • Wiring connections or a short circuit

RELATED TO HANDS-FREE PHONE

Symptom	Cause and Counter measure
Does not recognize cellular phone connection (No connection is displayed on the display at the guide).	<p>Some Bluetooth[®] enabled cellular phones may not be recognized by the in-vehicle phone module.</p> <p>Refer to "RELATED TO HANDS-FREE PHONE (Check Compatibility)" in AV-138, "Symptom Table".</p>
Cannot use hands-free phone.	<p>Customer will not be able to use a hands-free phone under the following conditions:</p> <ul style="list-style-type: none"> • The vehicle is outside of the telephone service area. • The vehicle is in an area where it is difficult to receive radio waves; such as in a tunnel, in an underground parking garage, near a tall building or in a mountainous area. • The cellular phone is locked to prevent it from being dialed. <p>NOTE:</p> <p>While a cellular phone is connected through the Bluetooth[®] wireless connection, the battery power of the cellular phone may discharge quicker than usual. The Bluetooth[®] Hands-Free Phone System cannot charge cellular phones.</p>

NORMAL OPERATING CONDITION

< SYMPTOM DIAGNOSIS >

[DISPLAY AUDIO WITHOUT AMPLIFIER]

Symptom	Cause and Counter measure
The other party's voice cannot be heard by hands-free phone.	When the radio wave condition is not ideal or ambient sound is too loud, it may be difficult to hear the other person's voice during a call.
Poor sound quality.	Do not place the cellular phone in an area surrounded by metal or far away from the in-vehicle phone module to prevent tone quality degradation and wireless connection disruption.

PRECAUTIONS

[DISPLAY AUDIO WITHOUT AMPLIFIER]

< PRECAUTION >

PRECAUTION

PRECAUTIONS

Precaution for Supplemental Restraint System (SRS) "AIR BAG" and "SEAT BELT PRE-TENSIONER"

INFOID:000000010138327

The Supplemental Restraint System such as "AIR BAG" and "SEAT BELT PRE-TENSIONER", used along with a front seat belt, helps to reduce the risk or severity of injury to the driver and front passenger for certain types of collision. This system includes seat belt switch inputs and dual stage front air bag modules. The SRS system uses the seat belt switches to determine the front air bag deployment, and may only deploy one front air bag, depending on the severity of a collision and whether the front occupants are belted or unbelted. Information necessary to service the system safely is included in the SR and SB section of this Service Manual.

WARNING:

- To avoid rendering the SRS inoperative, which could increase the risk of personal injury or death in the event of a collision which would result in air bag inflation, all maintenance must be performed by an authorized NISSAN/INFINITI dealer.
- Improper maintenance, including incorrect removal and installation of the SRS, can lead to personal injury caused by unintentional activation of the system. For removal of Spiral Cable and Air Bag Module, see the SR section.
- Do not use electrical test equipment on any circuit related to the SRS unless instructed to in this Service Manual. SRS wiring harnesses can be identified by yellow and/or orange harnesses or harness connectors.

PRECAUTIONS WHEN USING POWER TOOLS (AIR OR ELECTRIC) AND HAMMERS

WARNING:

- When working near the Airbag Diagnosis Sensor Unit or other Airbag System sensors with the Ignition ON or engine running, DO NOT use air or electric power tools or strike near the sensor(s) with a hammer. Heavy vibration could activate the sensor(s) and deploy the air bag(s), possibly causing serious injury.
- When using air or electric power tools or hammers, always switch the Ignition OFF, disconnect the battery and wait at least three minutes before performing any service.

Precaution for Trouble Diagnosis

INFOID:000000009482122

AV COMMUNICATION SYSTEM

- Do not apply voltage of 7.0 V or higher to the measurement terminals.
- Use the tester with its open terminal voltage being 7.0 V or less.
- Be sure to turn ignition switch OFF and disconnect the battery cable from the negative terminal before checking the circuit.

Precaution for Harness Repair

INFOID:000000009482123

AV COMMUNICATION SYSTEM

- Solder the repaired parts, and wrap with tape. [Frays of twisted line must be within 110 mm (4.33 in).]

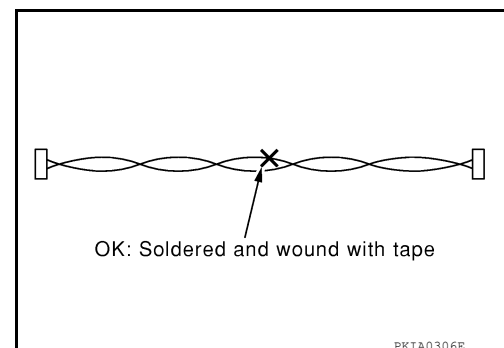

PRECAUTIONS

[DISPLAY AUDIO WITHOUT AMPLIFIER]

< PRECAUTION >

- Do not perform bypass wire connections for the repair parts. (The spliced wire will become separated and the characteristics of twisted line will be lost.)

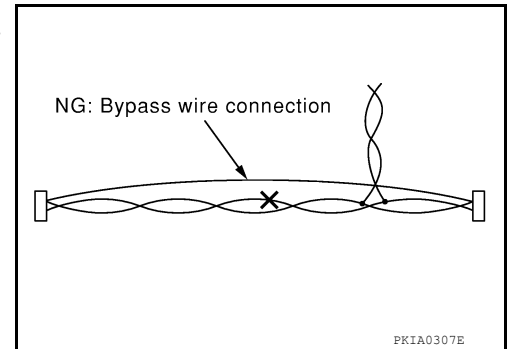

Precaution for Work

INFOID:000000009482124

- When removing or disassembling each component, be careful not to damage or deform it. If a component may be subject to interference, be sure to protect it with a shop cloth.
- When removing (disengaging) components with a screwdriver or similar tool, be sure to wrap the component with a shop cloth or vinyl tape to protect it.
- Protect the removed parts with a shop cloth and prevent them from being dropped.
- Replace a deformed or damaged clip.
- If a part is specified as a non-reusable part, always replace it with a new one.
- Be sure to tighten bolts and nuts securely to the specified torque.
- After installation is complete, be sure to check that each part works properly.
- Follow the steps below to clean components:
 - Water soluble dirt:
 - Dip a soft cloth into lukewarm water, wring the water out of the cloth and wipe the dirty area.
 - Then rub with a soft, dry cloth.
 - Oily dirt:
 - Dip a soft cloth into lukewarm water with mild detergent (concentration: within 2 to 3%) and wipe the dirty area.
 - Then dip a cloth into fresh water, wring the water out of the cloth and wipe the detergent off.
 - Then rub with a soft, dry cloth.
 - Do not use organic solvent such as thinner, benzene, alcohol or gasoline.
 - For genuine leather seats, use a genuine leather seat cleaner.

PREPARATION

[DISPLAY AUDIO WITHOUT AMPLIFIER]

< PREPARATION >

PREPARATION

PREPARATION

Special Service Tools

INFOID:000000009482125

The actual shape of the tools may differ from those illustrated here.

Tool number (TechMate No.) Tool name	Description
— (J-46534) Trim Tool Set	Removing trim components

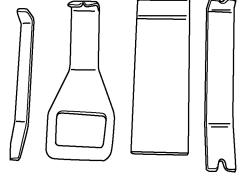

AWJIA04832Z

Commercial Service Tools

INFOID:000000009482126

Tool name	Description
Power tool	Loosening nuts, screws and bolts



PIIB1407E

A
B
C
D
E
F
G
H
I
J
K
L
M
AV
O
P

REMOVAL AND INSTALLATION

AUDIO UNIT

Removal and Installation

INFOID:000000009482127

REMOVAL

1. Disconnect the negative battery terminal. Refer to [PG-83. "Removal and Installation"](#).
2. Remove cluster lid C. Refer to [IP-19. "Removal and Installation"](#).
3. Remove the screws (A) from the bracket.
4. Remove the audio unit (1) from cluster lid C.

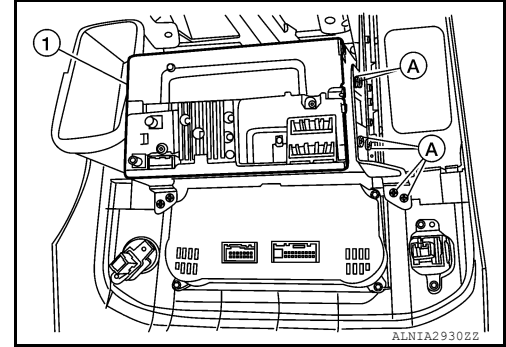

INSTALLATION

Installation is in the reverse order of removal.

FRONT TWEETER

< REMOVAL AND INSTALLATION >

[DISPLAY AUDIO WITHOUT AMPLIFIER]

FRONT TWEETER

Removal and Installation

INFOID:000000009482128

REMOVAL

1. Remove the front tweeter grille.
2. Remove the front tweeter screws (A).
3. Pull out the front tweeter (1), then disconnect the harness connector from the front tweeter and remove.

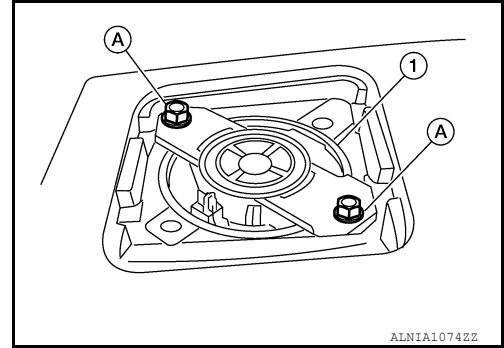

INSTALLATION

Installation is in the reverse order of removal.

A
B
C
D
E
F
G
H
I
J
K
L
M
AV
O
P

FRONT DOOR SPEAKER

< REMOVAL AND INSTALLATION >

[DISPLAY AUDIO WITHOUT AMPLIFIER]

FRONT DOOR SPEAKER

Removal and Installation

INFOID:000000009482129

REMOVAL

1. Remove the front door finisher. Refer to [INT-15, "Removal and Installation"](#).
2. Remove the front door speaker screws (A).
3. Pull out the front door speaker (1).
4. Disconnect the harness connector from the front door speaker (1) and remove.

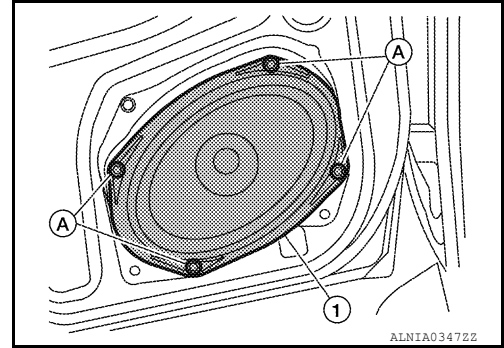

INSTALLATION

Installation is in the reverse order of removal.

REAR DOOR SPEAKER

< REMOVAL AND INSTALLATION >

[DISPLAY AUDIO WITHOUT AMPLIFIER]

REAR DOOR SPEAKER

Removal and Installation

INFOID:000000009482130

REMOVAL

1. Remove the rear door finisher. Refer to [INT-15. "Removal and Installation"](#).
2. Remove the rear door speaker screws (A).
3. Disconnect the harness connector (B) from the rear door speaker (1) and remove.

NOTE:

King cab shown, crew cab similar.

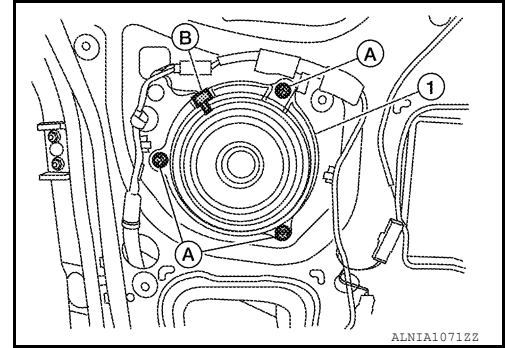

INSTALLATION

Installation is in the reverse order of removal.

A
B
C
D
E
F
G
H
I
J
K
L
M
N
O
P

AV

STEERING SWITCH

< REMOVAL AND INSTALLATION >

[DISPLAY AUDIO WITHOUT AMPLIFIER]

STEERING SWITCH

Removal and Installation

INFOID:000000009482131

Removal and Installation

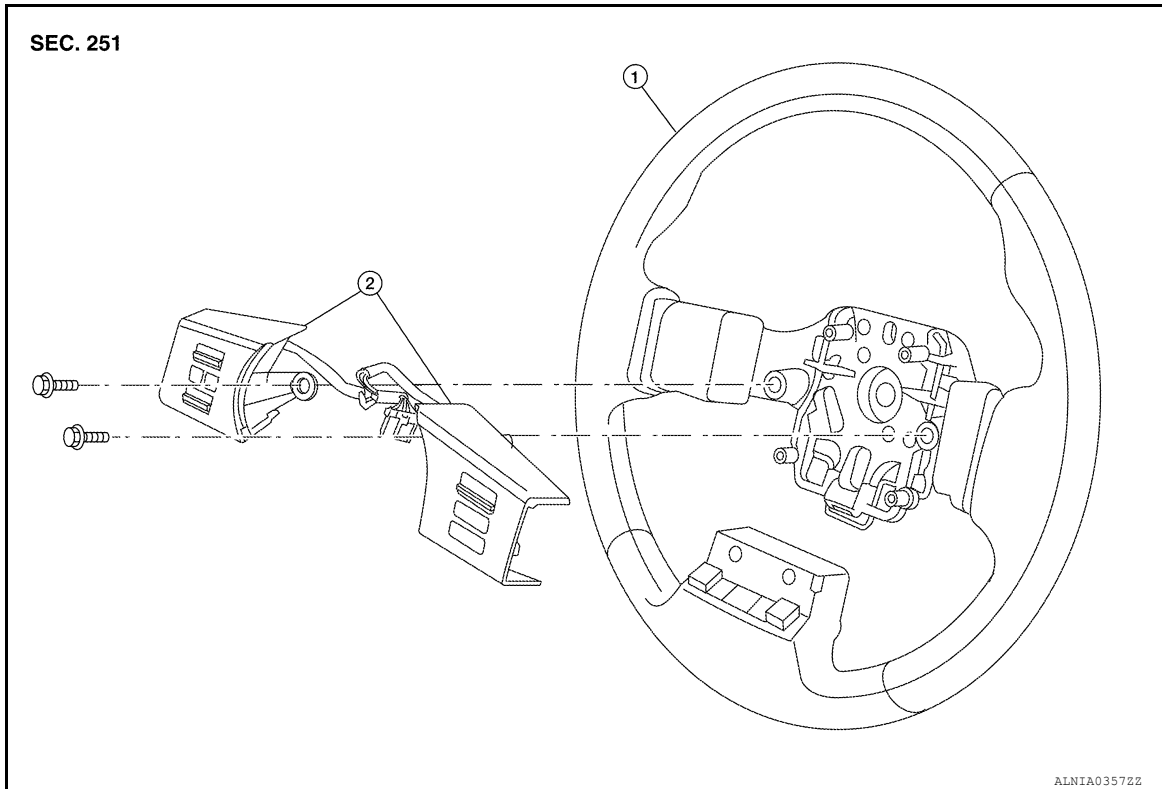

1. Steering wheel

2. Steering wheel audio control switches

REMOVAL

1. Remove the driver air bag module. Refer to [SR-11, "Removal and Installation"](#).
2. Remove the steering wheel audio control switch assembly screws.
3. Disconnect the harness connectors from the steering wheel audio control switches.
4. Remove the steering wheel audio control switches by pulling on steering wheel audio control switches to release the pawls.

○: Pawl

CAUTION:

Do not tilt steering wheel audio control switches during removal or damage may occur to the pawls.

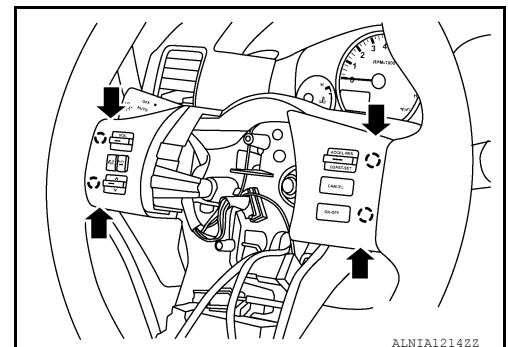

INSTALLATION

Installation is in the reverse order of removal.

BLUETOOTH CONTROL UNIT

< REMOVAL AND INSTALLATION >

[DISPLAY AUDIO WITHOUT AMPLIFIER]

BLUETOOTH CONTROL UNIT

Removal and Installation

INFOID:00000009482132

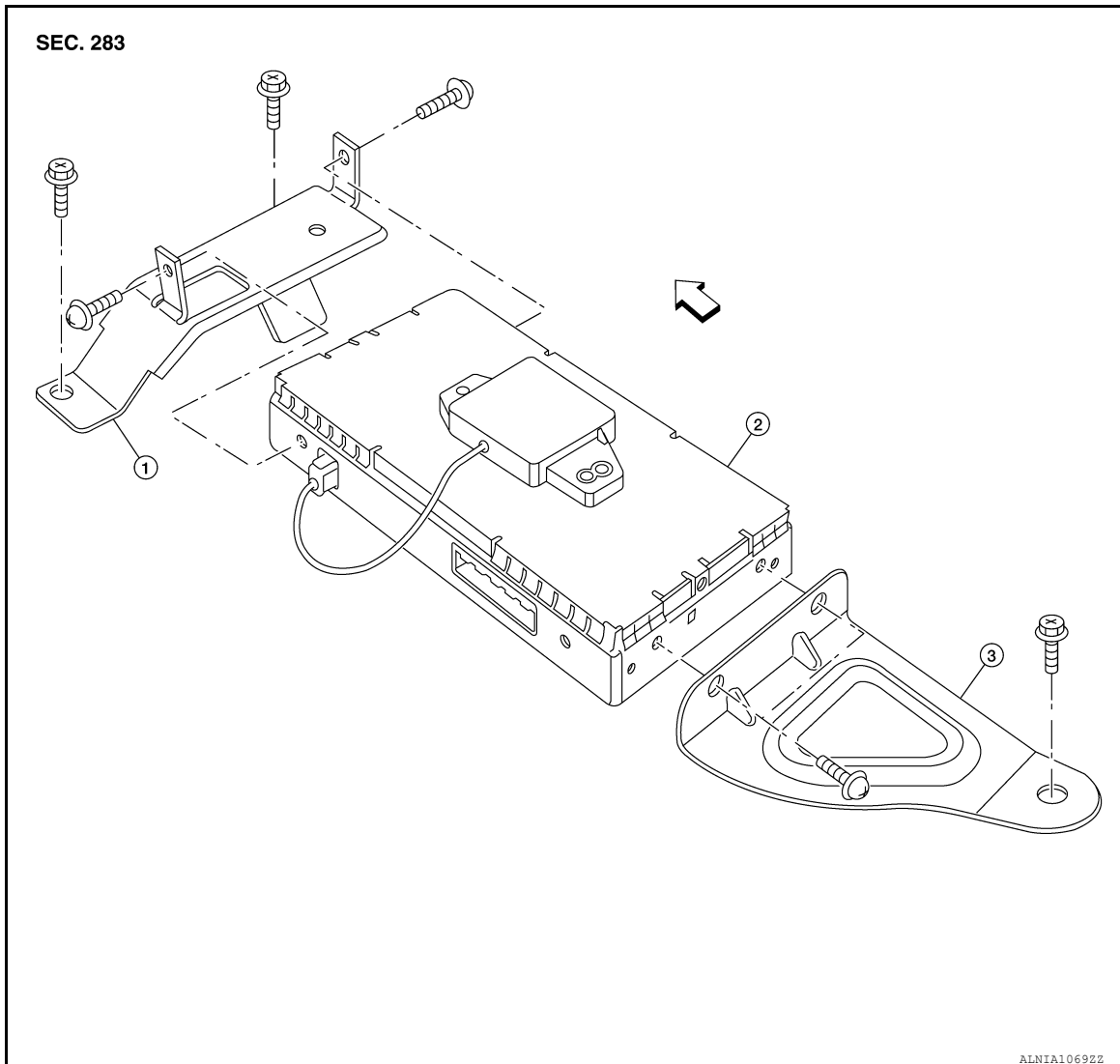

1. Bluetooth control unit front bracket 2. Bluetooth control unit/antenna 3. Bluetooth control unit rear bracket
↔ Front

REMOVAL

NOTE:

Do not remove the RH front seat from the vehicle.

1. Remove the RH front seat bolts, disconnect the harness connectors from the RH front seat. Refer to [SE-32. "Removal and Installation"](#).
2. Tilt the RH front seat back to access the bluetooth control unit.

A
B
C
D
E
F
G
H
I
J
K
L
M
N
O
P

AV

BLUETOOTH CONTROL UNIT

< REMOVAL AND INSTALLATION >

[DISPLAY AUDIO WITHOUT AMPLIFIER]

3. Disconnect the harness connector (B) from the Bluetooth control unit.
4. Remove the Bluetooth control unit screws (A), then remove the Bluetooth control unit assembly (1).
5. Remove the Bluetooth control unit bracket screws and the Bluetooth control unit front and rear brackets.

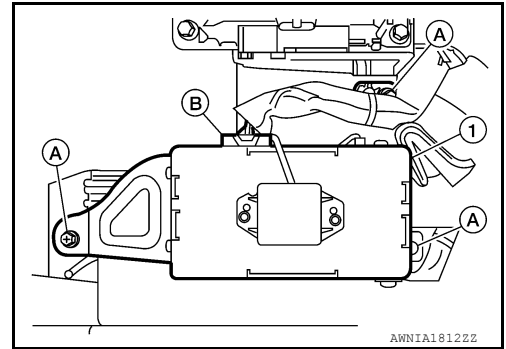

INSTALLATION

Installation is in the reverse order of removal.

MICROPHONE

< REMOVAL AND INSTALLATION >

[DISPLAY AUDIO WITHOUT AMPLIFIER]

MICROPHONE

Removal and Installation

INFOID:000000009482133

REMOVAL

1. Remove the roof console. Refer to [INT-25, "Removal and Installation"](#).
2. Release the pawls that retain the Bluetooth microphone (1) to the roof console.
3. Disconnect the harness connector (A) from the Bluetooth microphone (1) and remove.

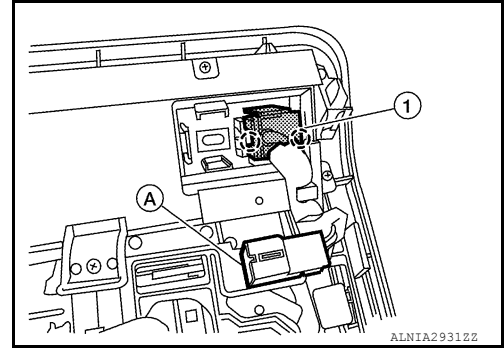

INSTALLATION

Installation is in the reverse order of removal.

A
B
C
D
E
F
G
H
I
J
K
L
M
O
P

AV

AUDIO ANTENNA

< REMOVAL AND INSTALLATION >

[DISPLAY AUDIO WITHOUT AMPLIFIER]

AUDIO ANTENNA

Location of Antenna

INFOID:000000009482134

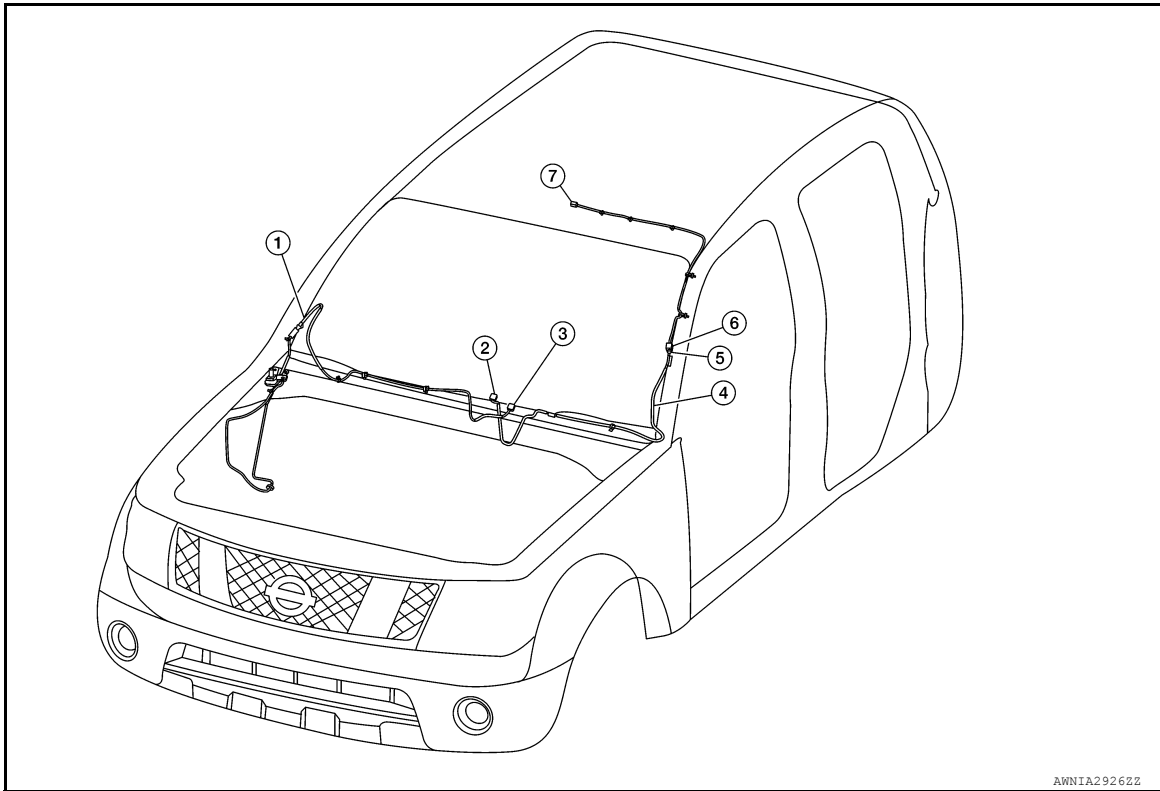

AWNIA2926ZZ

- | | | |
|-----------------------------|--------|---------|
| 1. Coaxial antenna feeder | 2. M41 | 3. M33 |
| 4. Satellite antenna feeder | 5. M67 | 6. M500 |
| 7. M501 | | |

Removal and Installation

INFOID:000000009482135

REMOVAL

1. Remove instrument lower panel RH and glove box. Refer to [IP-24. "Removal and Installation"](#).
2. Disconnect audio antenna cable from antenna feeder.

AUDIO ANTENNA

< REMOVAL AND INSTALLATION >

[DISPLAY AUDIO WITHOUT AMPLIFIER]

3. Remove antenna rod.
4. Remove rubber seal.
5. Remove cowl top. Refer to [EXT-24. "Removal and Installation"](#).
6. Remove fender protector. Refer to [EXT-27. "Removal and Installation of Front Fender Protector"](#).
7. Remove antenna base bolts.
8. Remove antenna base and cable.

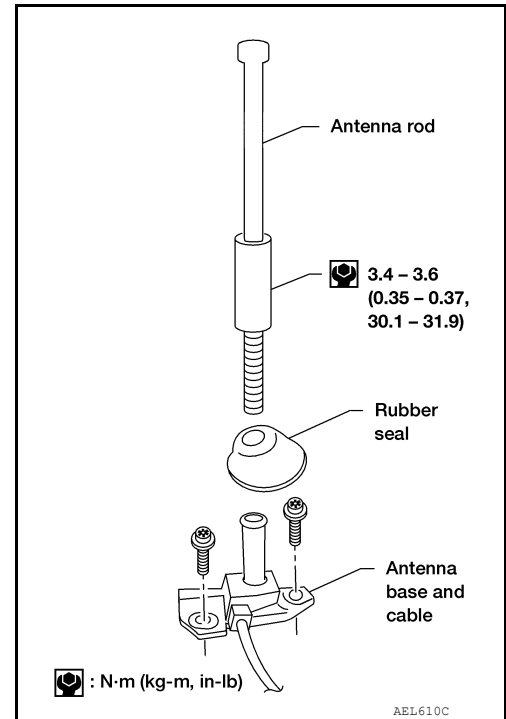

INSTALLATION

Installation is in the reverse order of removal.

CAUTION:

Always properly tighten the antenna rod during installation or the antenna rod may bend or break during vehicle operation.

A
B
C
D
E
F
G
H
I
J
K
L
M
AV
O
P

SATELLITE RADIO ANTENNA

< REMOVAL AND INSTALLATION >

[DISPLAY AUDIO WITHOUT AMPLIFIER]

SATELLITE RADIO ANTENNA

Removal and Installation

INFOID:000000009482136

REMOVAL

1. Remove the roof console. Refer to [INT-25, "Removal and Installation"](#).
2. Disconnect the harness connector from the satellite radio antenna.
3. Remove the satellite radio antenna nut.
4. Remove the satellite radio antenna.

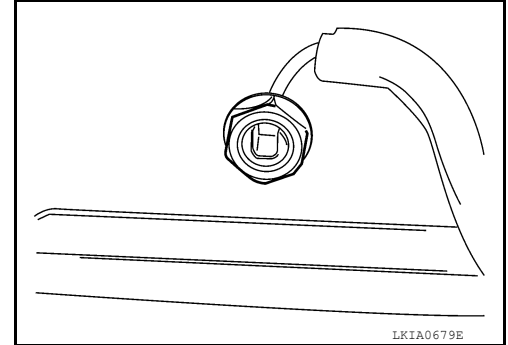

LKIA0679E

INSTALLATION

Installation is in the reverse order of removal.

USB CONNECTOR

< REMOVAL AND INSTALLATION >

[DISPLAY AUDIO WITHOUT AMPLIFIER]

USB CONNECTOR

Removal and Installation

INFOID:000000009482137

REMOVAL

1. Remove the center console assembly. Refer to [IP-26. "Removal and Installation"](#).
2. Push the pawl from the back of the center console to remove the USB interface.

INSTALLATION

Installation is in the reverse order of removal.

A

B

C

D

E

F

G

H

I

J

K

L

M

AV

O

P

REAR VIEW CAMERA

< REMOVAL AND INSTALLATION >

[DISPLAY AUDIO WITHOUT AMPLIFIER]

REAR VIEW CAMERA

Removal and Installation

INFOID:000000009482138

REMOVAL

1. Remove the tail gate protector. Refer to [EXT-38. "Removal and Installation"](#).
2. Remove the rear view camera screws and the rear view camera.

INSTALLATION

Installation is in the reverse order of removal.

COMPONENT PARTS

< SYSTEM DESCRIPTION >

[DISPLAY AUDIO WITH AMPLIFIER]

SYSTEM DESCRIPTION

COMPONENT PARTS

Component Parts Location

INFOID:000000009482139

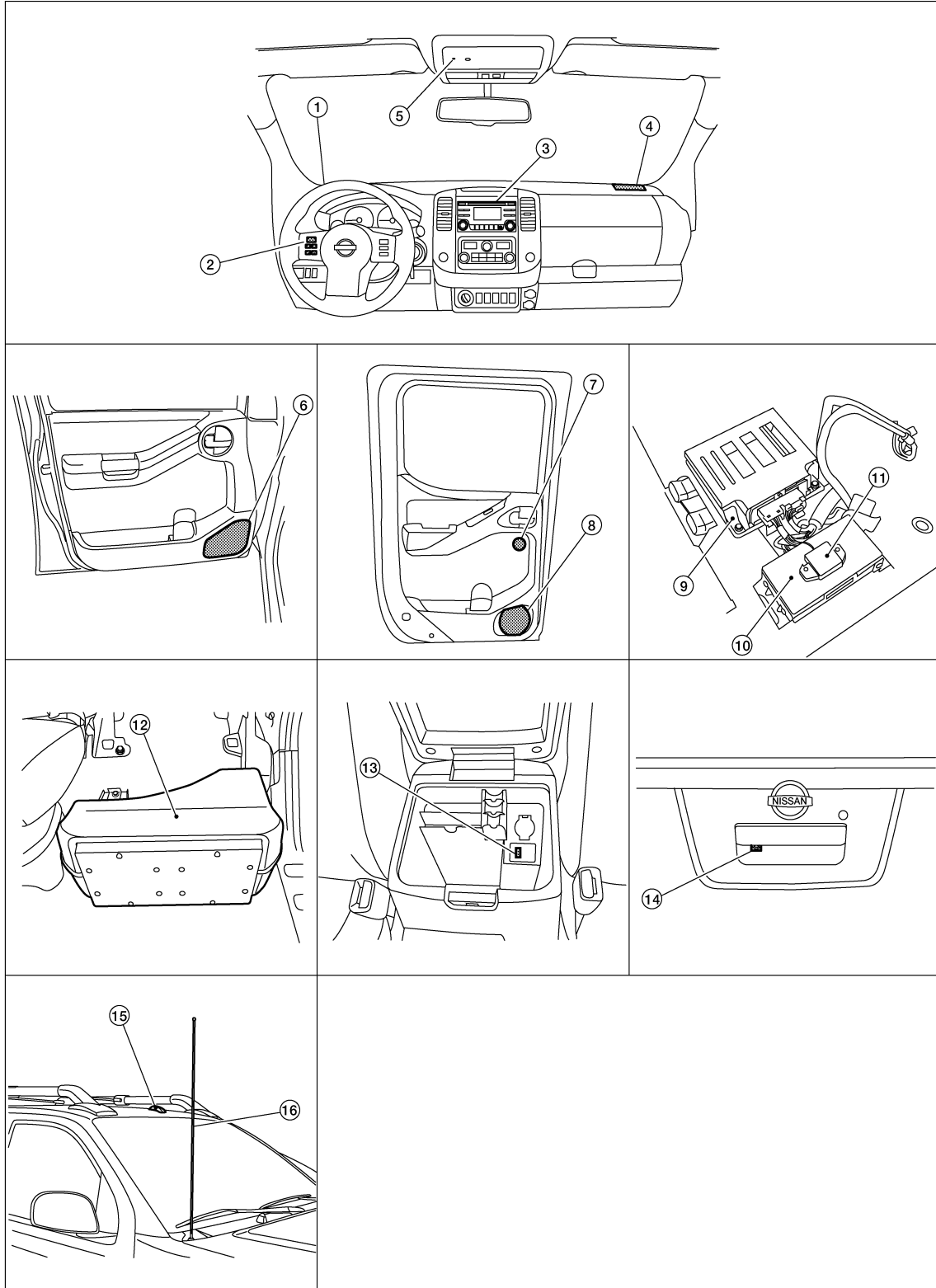

A
B
C
D
E
F
G
H
I
J
K
L
M
AV
O
P

COMPONENT PARTS

< SYSTEM DESCRIPTION >

[DISPLAY AUDIO WITH AMPLIFIER]

- | | | |
|--|---|--|
| 1. Front tweeter LH M109 | 2. Steering wheel audio control switches | 3. Audio unit M46, M48, M65, M66 |
| 4. Front tweeter RH M111 | 5. Microphone R8 | 6. Front door speaker LH D12
Front door speaker RH D112 |
| 7. Rear tweeter LH D208
Rear tweeter RH D308 | 8. Rear door speaker LH D207
Rear door speaker RH D307 | 9. Audio amp B158, B159 (Underneath passenger seat) |
| 10. Bluetooth® control unit B141, B142, B143 (Underneath passenger seat) | 11. Bluetooth® antenna | 12. Subwoofer B72 (Underneath rear LH seat) |
| 13. USB interface M214 | 14. Rear view camera C251 | 15. Satellite antenna |
| 16. Rod antenna | | |

Component Description

INFOID:000000009482140

Part name	Description
Audio unit	<ul style="list-style-type: none"> Controls audio, USB connection, AUX IN connection, satellite radio and rear view camera functions. Display unit is built in to audio unit.
Audio amplifier	Receives audio signals from audio unit and outputs audio signals to each speaker.
Front tweeters	Outputs high, mid and low range audio signals from audio amp.
Front door speakers	
Rear tweeters	
Rear door speakers	
Subwoofer	
Steering wheel audio control switches	<ul style="list-style-type: none"> Operations for audio, hands-free phone and voice recognition are possible. Steering switch signal is output to Bluetooth® control unit. Bluetooth® control unit outputs steering switch signal to audio unit.
Microphone	<ul style="list-style-type: none"> Used for hands-free phone operations. Microphone signal is transmitted to Bluetooth® control unit. Power is supplied from Bluetooth® control unit.
Bluetooth® control unit	<ul style="list-style-type: none"> Inputs TEL voice signal from Bluetooth® antenna and outputs it to audio unit. Controlled via AV communication by audio unit.
Bluetooth® antenna	Receives TEL voice signal and outputs it to Bluetooth® control unit.
USB interface	USB sound and data input signals are transmitted to audio unit.
Rear view camera	<ul style="list-style-type: none"> Outputs image of vehicle rear to audio unit. Power is supplied from audio unit.
Satellite antenna	Satellite radio signal is received and transmitted to audio unit.
Rod antenna	AM/FM signal is received and transmitted to audio unit.

SYSTEM

< SYSTEM DESCRIPTION >

[DISPLAY AUDIO WITH AMPLIFIER]

SYSTEM

System Diagram

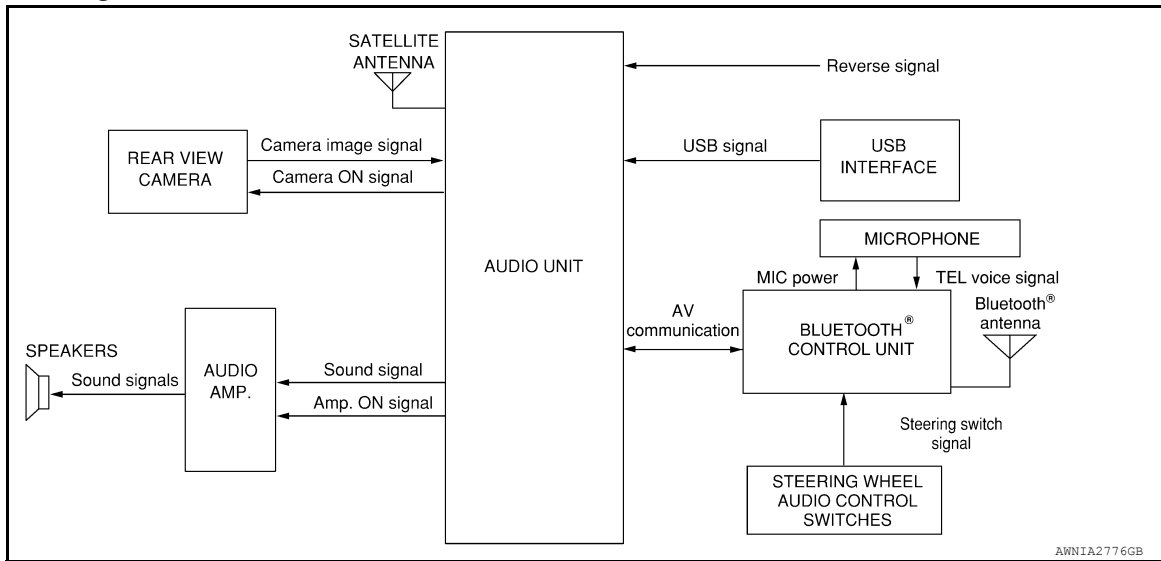

System Description

INFOID:000000009482142

AUDIO SYSTEM

The audio system consists of the following components

- Audio unit
- Audio amplifier
- Front tweeters
- Front door speakers
- Rear tweeters
- Rear door speakers
- Subwoofer
- Steering wheel audio control switches
- USB interface
- Rod antenna

When the audio system is on, AM/FM signals received by the rod antenna are sent to the audio unit. The audio unit then sends audio signals to the audio amplifier. The audio amplifier then sends audio signals to the front tweeters, front door speakers, rear tweeters, rear door speakers and subwoofer.

Refer to Owner's Manual for audio system operating instructions.

SATELLITE RADIO SYSTEM

The satellite radio system consists of the following components

- Satellite antenna
- Satellite radio tuner integral to audio unit

When the satellite radio system is on, satellite radio signals are supplied to the audio unit from the satellite antenna. The audio unit then sends audio signals to the audio amplifier. The audio amplifier amplifies the audio signals before sending them to the speakers, tweeters and subwoofer.

Refer to Owner's Manual for satellite radio system operating instructions.

HANDS-FREE PHONE SYSTEM

System Operation

NOTE:

Cellular telephones must have their wireless connection set up (paired) before using the Bluetooth® telephone system.

The Bluetooth® telephone system allows users who have a Bluetooth® cellular telephone to make a wireless connection between their cellular telephone and the Bluetooth® control unit. Hands-free cellular telephone calls can be sent and received. Some Bluetooth® cellular telephones may not be recognized by the Bluetooth® control unit. When a cellular telephone or the Bluetooth® control unit is replaced, the telephone must be paired

A
B
C
D
E
F
G
H
I
J
K
L
M
O
P

AV

with the Bluetooth® control unit. Different cellular telephones may have different pairing procedures, refer to the cellular telephone operating manual.

Refer to the Owner's Manual for Bluetooth® telephone system operating instructions.

Bluetooth® Control Unit

When the ignition switch is turned to ACC or ON, the Bluetooth® control unit will power up. During power up, the Bluetooth® control unit is initialized and performs various self-checks. Initialization may take up to 20 seconds. If a phone is present in the vehicle and paired with the Bluetooth® control unit, Nissan Voice Recognition will then become active. Bluetooth® telephone functions can be turned off using the Nissan Voice Recognition system.

Steering Wheel Audio Control Switches

When buttons on the steering wheel audio control switch are pushed, the resistance in steering wheel audio control switch circuit changes, depending on which button is pushed. The Bluetooth® control unit uses this signal to perform various functions while navigating through the voice recognition system.

The following functions can be performed using the steering wheel audio control switch:

- Initiate self-diagnosis of the Bluetooth® telephone system
- Start a voice recognition session
- Answer and end telephone calls
- Adjust the volume of calls

Microphone

The microphone is located in the roof console assembly. The microphone sends a signal to the Bluetooth® control unit. The microphone can be actively tested during self-diagnosis.

Audio Unit

The audio unit receives signals from the Bluetooth® control unit and sends audio signals to the audio amplifier. The audio amplifier amplifies the audio signals before sending them to the speakers.

REAR VIEW CAMERA SYSTEM

- The audio unit supplies power to the rear view camera when the reverse signal is received.
- The rear view camera transmits rear view camera images to the audio unit when power is supplied from the audio unit.
- The audio unit combines a warning message and fixed guide lines with an image received from the rear view camera to display a rear view camera image on the screen.

DIAGNOSIS SYSTEM (AUDIO UNIT)

< SYSTEM DESCRIPTION >

[DISPLAY AUDIO WITH AMPLIFIER]

DIAGNOSIS SYSTEM (AUDIO UNIT)

Description

INFOID:000000009482143

The audio unit on board diagnosis performs the functions listed in the table below:

Mode		Description
Self Diagnosis		<ul style="list-style-type: none"> • Audio unit diagnosis. • Diagnoses the connections across system components.
Confirmation/ Adjustment	Display Diagnosis	The following check functions are available: color tone check by color bar display and white display, light and shade check by gray scale display.
	Vehicle Signals	Diagnosis of signals can be performed for vehicle speed, lights, reverse, EQ pin, destination and camera type.
	Speaker Test	The connection of a speaker can be confirmed by test tone.
	Error History	The system malfunction and the frequency when occurring in the past are displayed. When the malfunctioning item is selected, the time and place that the selected malfunction last occurred are displayed.
	Camera System	Guiding line position that overlaps rear view camera image can be adjusted.
	AV COMM Diagnosis	The communication condition of each unit of display audio system can be monitored.
	Delete Unit Connection Log	Erase the connection history of unit and error history.
	Initialize Setting	Initializes the audio unit memory.

On Board Diagnosis Function

INFOID:000000009482144

METHOD OF STARTING

1. Turn the ignition ON.
2. Turn the audio system OFF.
3. While pressing the preset 1 button, turn the volume control dial clockwise or counterclockwise for 40 clicks or more. When self-diagnosis mode begins, a short beep will be heard. Shifting from current screen to previous screen is performed by pressing BACK button.

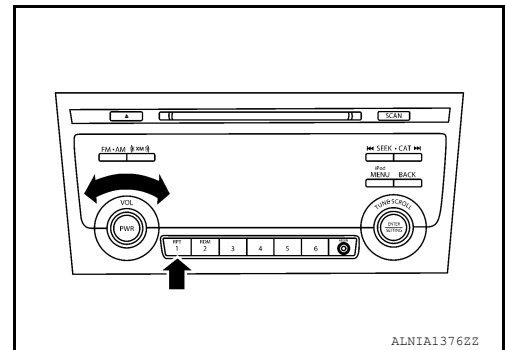

4. The trouble diagnosis initial screen is displayed, and Self Diagnosis or Confirmation/Adjustment can be selected.

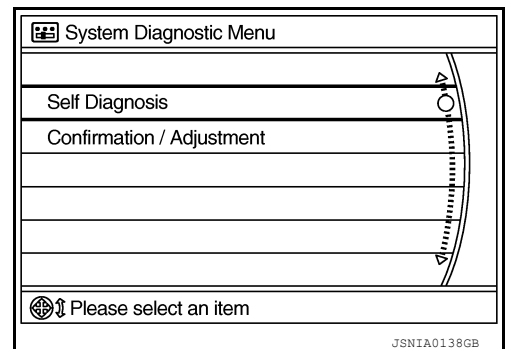

SELF DIAGNOSIS MODE

Audio Unit Self Diagnosis

1. Select Self Diagnosis.

A
B
C
D
E
F
G
H
I
J
K
L
M
AV
O
P

DIAGNOSIS SYSTEM (AUDIO UNIT)

[DISPLAY AUDIO WITH AMPLIFIER]

< SYSTEM DESCRIPTION >

2. Self diagnosis screen is displayed. The bar graph visible in center of screen indicates progress of self diagnosis.
3. Diagnosis results are displayed after the self diagnosis is completed. The unit names and the connection lines are color coded according to the diagnostic results.

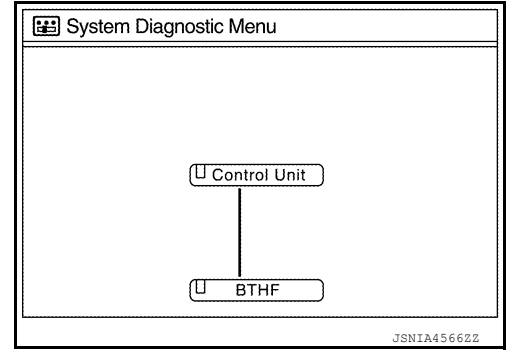

Diagnosis results	Unit	Connection line
Normal	Green	Green
Connection malfunction	Gray	Yellow
Unit malfunction ¹	Red	Green

1: Control unit (audio unit) is displayed in red.

- Replace audio unit if Self Diagnosis did not run because control unit malfunction is indicated. The symptom is audio unit internal error. Refer to [AV-233. "Removal and Installation"](#).
 - If multiple errors occur at the same time for a single unit, the screen switch colors are determined according to the following order of priority: red > gray.
4. Comments of self diagnosis results can be viewed in the diagnosis result screen.

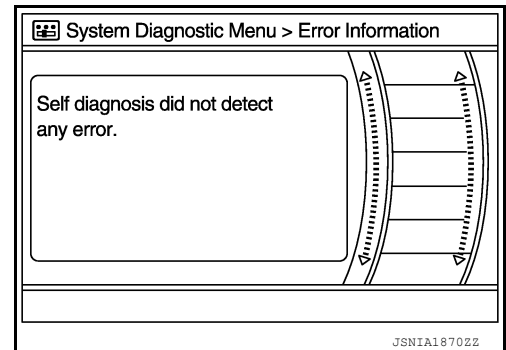

Audio Unit Self Diagnosis Results

Only Unit Part Is Displayed In Red		
Screen switch	Description	Possible cause
Control unit	Malfunction is detected in audio unit power supply and ground circuits.	<ul style="list-style-type: none"> • Audio unit power supply or ground circuits. Refer to AV-197. "AUDIO UNIT : Diagnosis Procedure". • If no malfunction is detected in audio unit power supply and ground circuits, replace audio unit. Refer to AV-233. "Removal and Installation".

DIAGNOSIS SYSTEM (AUDIO UNIT)

< SYSTEM DESCRIPTION >

[DISPLAY AUDIO WITH AMPLIFIER]

A Connecting Cable Between Units Is Displayed In Yellow

Area with yellow connection lines	Description	Possible cause
Control unit ↔ BTHF	When one of the following is detected: <ul style="list-style-type: none"> malfunction is detected in Bluetooth® control unit power supply and ground circuits. malfunction is detected in AV communication circuits between audio unit and Bluetooth® control unit. 	<ul style="list-style-type: none"> Bluetooth® control unit power supply or ground circuits. Refer to AV-198, "BLUETOOTH® CONTROL UNIT : Diagnosis Procedure". AV communication circuits between audio unit and Bluetooth® control unit.

Audio Unit Confirmation/Adjustment

- Select Confirmation/Adjustment.
- Select each switch on the Confirmation/Adjustment screen to display the relevant trouble diagnosis screen. Press the BACK switch to return to the initial Confirmation/Adjustment screen.

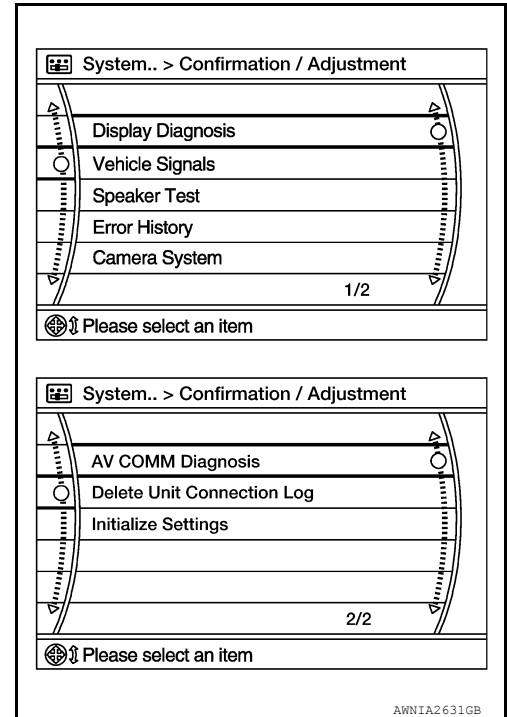

Display Diagnosis

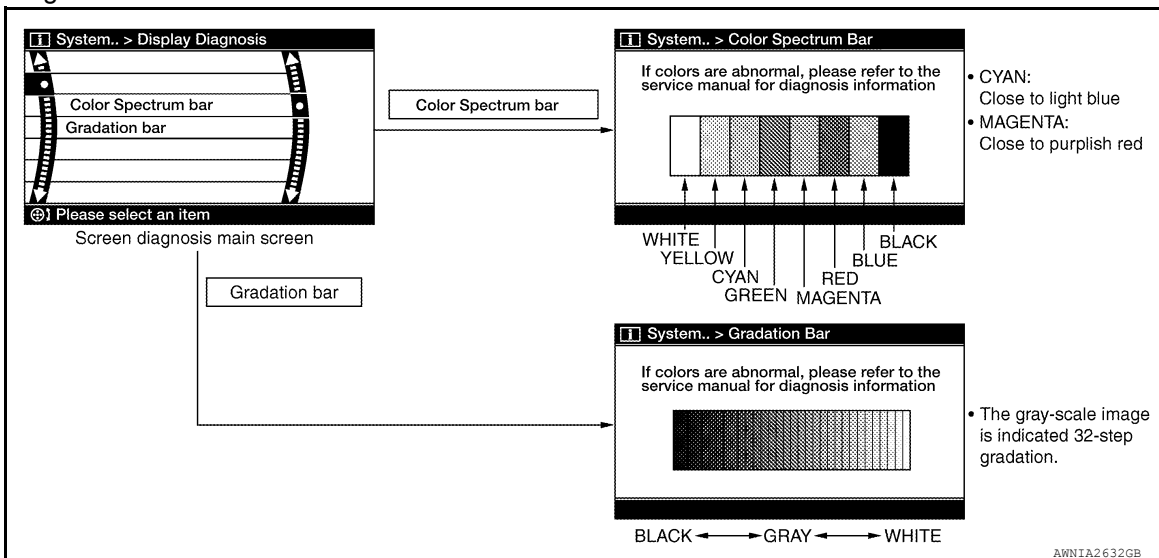

Vehicle Signals

DIAGNOSIS SYSTEM (AUDIO UNIT)

< SYSTEM DESCRIPTION >

[DISPLAY AUDIO WITH AMPLIFIER]

A comparison check can be made of each actual vehicle signal and the signals recognized by the system.

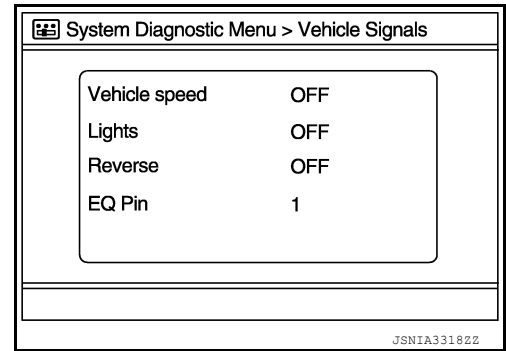

Speaker Test

Select Speaker Test to display the Speaker Diagnosis screen. Press Start to generate a test tone in a speaker. Press Start again to generate a test tone in the next speaker. Press End to stop the test tones.

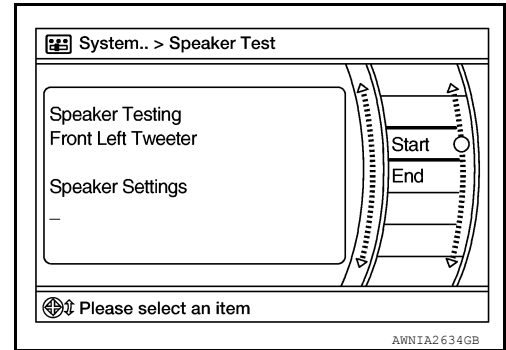

Error History

The self diagnosis results are judged depending on whether any error occurs from when Self Diagnosis is selected until the self diagnosis results are displayed.

However, the diagnosis results are judged normal if an error has occurred before the ignition switch is turned ON and then no error has occurred until the self diagnosis start. Check the Error Record to detect any error that may have occurred before the self diagnosis start because of this situation.

The frequency of occurrence is displayed in a count up manner. The actual count up method differs depending on the error item.

Count up method A

- The counter is set to 40 if an error occurs. 1 is subtracted from the counter if the condition is normal at a next ignition ON cycle.
- The counter lower limit is 1. The counter can be reset (no error record display) with the Delete log switch.

Count up method B

- The counter increases by 1 if an error occurs when ignition switch is ON. The counter will not decrease even if the condition is normal at the next ignition ON cycle.
- The counter upper limit is 50. Any counts exceeding 50 are ignored. The counter can be reset (no error record display) with the Delete log switch.

Display type of occurrence frequency	Error history display item
Count up method A	AV communication line, control unit (AV)
Count up method B	Other than the above

DIAGNOSIS SYSTEM (AUDIO UNIT)

< SYSTEM DESCRIPTION >

[DISPLAY AUDIO WITH AMPLIFIER]

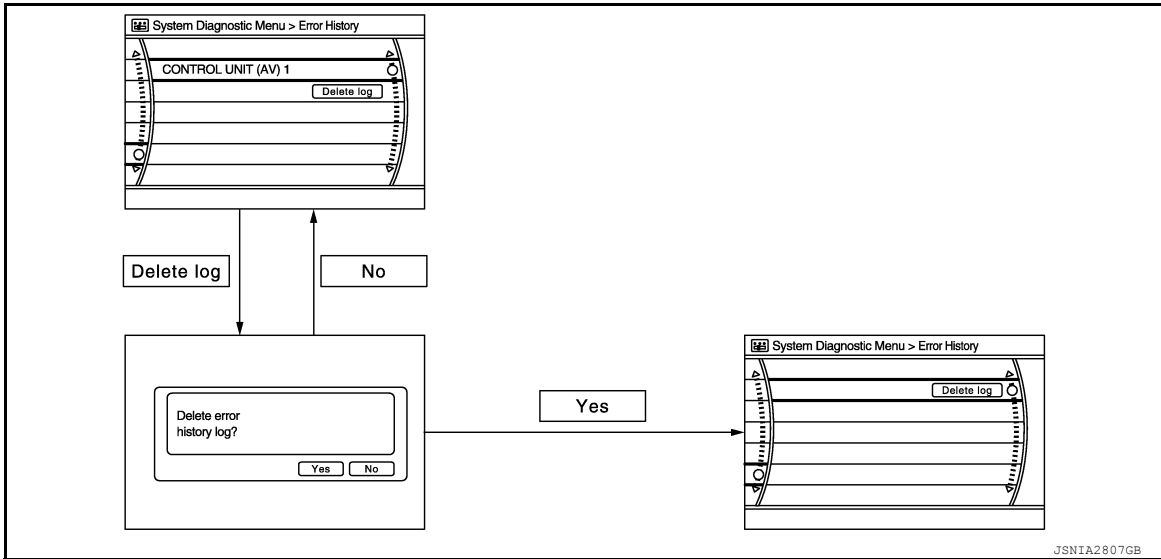

Error item

Some error items may be displayed simultaneously according to the cause. If some error items are displayed simultaneously, the detection of the cause can be performed by the combination of display items

Error item	Description	Possible cause
CONTROL UNIT (AV)	AV communication circuit initial diagnosis malfunction is detected.	Replace the audio unit if the malfunction occurs constantly. Refer to AV-233. "Removal and Installation" .
<ul style="list-style-type: none"> • AV COMM CIRCUIT • H/F Unit Connection Error 	When one of the following is detected: <ul style="list-style-type: none"> • malfunction is detected in Bluetooth® control unit power supply and ground circuits. • malfunction is detected in AV communication circuits between audio unit and Bluetooth® control unit. 	<ul style="list-style-type: none"> • Bluetooth® control unit power supply or ground circuits. Refer to AV-198. "BLUETOOTH® CONTROL UNIT : Diagnosis Procedure". • AV communication circuits between audio unit and Bluetooth® control unit.

Camera System

This mode is used to adjust the guide line display position of the rear view camera.

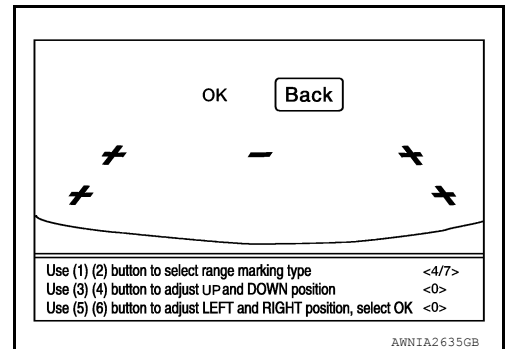

AV COMM Diagnosis

- Displays the communication status between audio unit (master unit) and each unit.
- The error counter displays OK if any malfunction was not detected in the past and displays 0 if a malfunction is detected. It increases by 1 if the condition is normal at the next ignition switch ON cycle. The upper limit of the counter is 39.
- The error counter is erased if Reset is pressed.

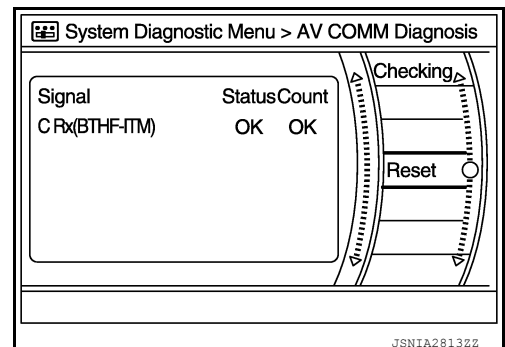

Items	Status (Current)	Counter (Past)
C Rx(BTHF-ITM)	OK / ???	OK / 0 – 39

DIAGNOSIS SYSTEM (AUDIO UNIT)

< SYSTEM DESCRIPTION >

[DISPLAY AUDIO WITH AMPLIFIER]

NOTE:

“???” indicates UNKWN.

Delete Unit Connection Log

Deletes any unit connection records and error records from the audio unit memory (clears the records of the unit that has been removed).

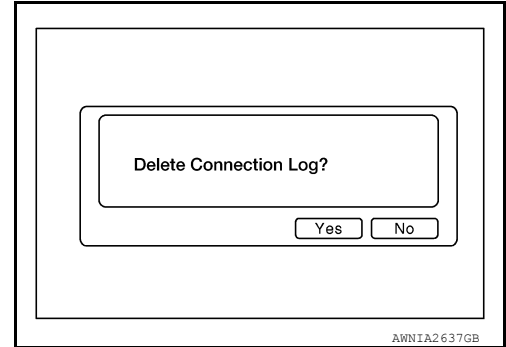

Initialize Settings

Deletes data stored from the audio unit.

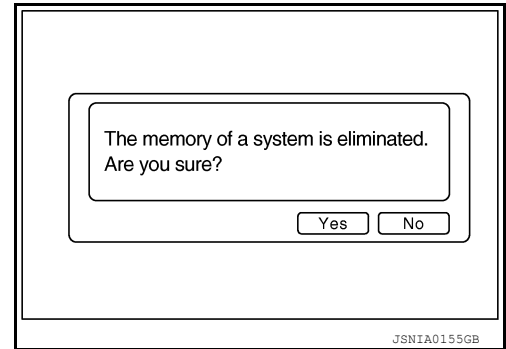

AUDIO UNIT

< ECU DIAGNOSIS INFORMATION >

[DISPLAY AUDIO WITH AMPLIFIER]

ECU DIAGNOSIS INFORMATION

AUDIO UNIT

Reference Value

INFOID:000000009482145

TERMINAL LAYOUT

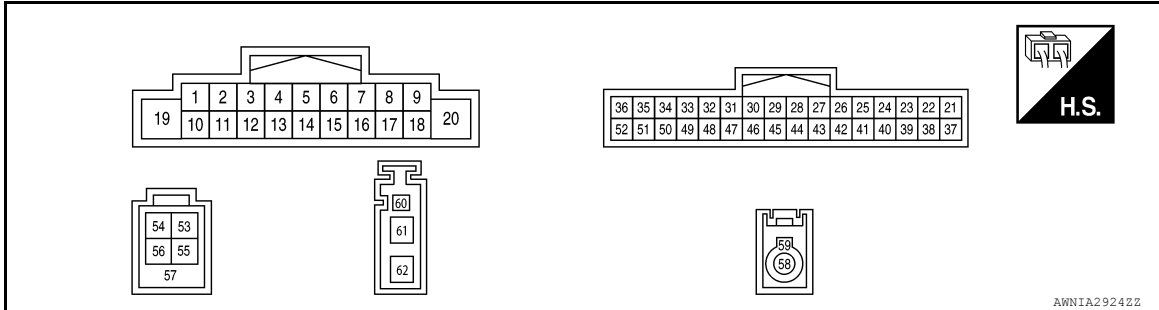



PHYSICAL VALUES

Terminal (Wire color)		Description		Condition		Reference value (Approx.)
+	-	Signal name	Input/ Output	Ignition switch	Operation	
1 (G/W)	Ground	Amp. ON signal	Output	ACC	—	Battery voltage
2 (W)	3 (B)	Sound signal front speaker LH	Output	ON	Sound output	 SKIB3609E
4 (P)	5 (B/R)	Sound signal rear speaker LH	Output	ON	Sound output	 SKIB3609E
6 (V)	15 (BG)	Steering switch signal A	Input	ON	Press and hold MODE switch.	0 V
					Press and hold Δ switch.	1.34 V
					Press and hold ∇ switch.	2.45 V
					Press and hold switch.	3.43 V
					Except for above.	5.0 V
7 (G/B)	Ground	ACC power supply	Input	ACC	—	Battery voltage
9 (R)	8 (GR)	Illumination control signal	Input	ON	Headlamps ON	Battery voltage

AUDIO UNIT

< ECU DIAGNOSIS INFORMATION >

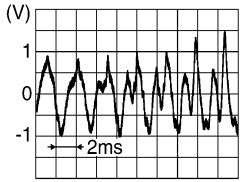
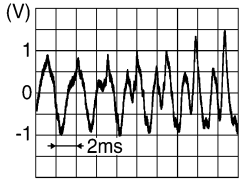
[DISPLAY AUDIO WITH AMPLIFIER]

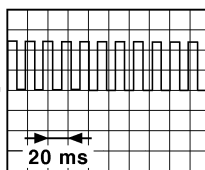
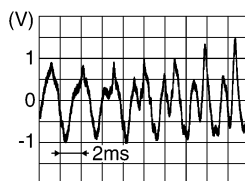
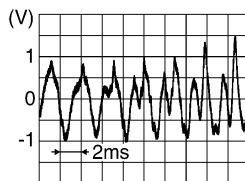
Terminal (Wire color)		Description	Input/ Output	Condition		Reference value (Approx.)
+	-			Signal name	Ignition switch	
11 (Y)	12 (R)	Sound signal front speaker RH	Output	ON	Sound output	 <small>SKIB3609E</small>
13 (L)	14 (B/W)	Sound signal rear speaker RH	Output	ON	Sound output	 <small>SKIB3609E</small>
16 (LG)	15 (BG)	Steering switch signal B	Input	ON	Press and hold VOL DOWN switch	0 V
					Press and hold VOL UP switch	1.34 V
					Press and hold  switch	2.45 V
					Except for above.	5.0 V
18 (SB)	Ground	Vehicle speed signal	Input	ON	When vehicle speed is ap- prox. 40 km/h (25 MPH)	 <small>JSNIA0012GB</small>
19 (Y)	Ground	Battery power supply	Input	OFF	—	Battery voltage
20 (B)	Ground	Ground	—	ON	—	0 V
24 (B)	—	TEL I/F -	Input	ON	—	 <small>SKIB3609E</small>
25 (W)	—	TEL I/F +	Input	ON	—	 <small>SKIB3609E</small>
28 (R)	—	MCAN2 H	Input/ Output	—	—	—

AUDIO UNIT

< ECU DIAGNOSIS INFORMATION >

[DISPLAY AUDIO WITH AMPLIFIER]

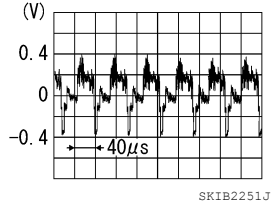
Terminal (Wire color)		Description		Condition		Reference value (Approx.)	
+	-	Signal name	Input/ Output	Ignition switch	Operation		
29 (G)	—	MCAN2 L	Input/ Output	—	—	—	A
30	Shield	MCAN shield	—	—	—	—	B
31 (L)	—	MCAN1 H	Input/ Output	—	—	—	C
32 (W)	—	MCAN1 L	Input/ Output	—	—	—	D
33	Shield	Camera ground	—	ON	—	0 V	E
34 (G/Y)	—	Camera ON	Input/ Output	—	—	—	E
35 (B)	Ground	Camera video	Input	ON	With rear view camera ON		F
36 (W)	Ground	Video ground	—	—	—	—	G
44 (BR)	Ground	Camera det	—	ON	—	0 V	H
46 (B)	Ground	EQ2	—	ON	—	0 V	I
47 (B)	Ground	EQ3	—	ON	—	0 V	J
50 (SB)	Ground	Reverse signal	Input	ON	Selector lever in R (re- verse)	Battery voltage	K
					Selector lever in any posi- tion other than R (reverse)	0 V	
53 (R)	—	V BUS signal	—	—	—	—	L
54 (B)	—	USB ground	—	—	—	—	M
55 (G)	—	USB D+ signal	—	—	—	—	M
56 (W)	—	USB D- signal	—	—	—	—	AV
57	—	Shield	—	—	—	—	
58 (B)	Ground	Satellite antenna signal	Input	ON	—	5.0 V	O
59 (B)	—	SAT Shield	—	—	—	—	
61 (B)	Ground	AM-FM main antenna	Input	ON	—	5.0 V	P

AUDIO AMP

< ECU DIAGNOSIS INFORMATION >

[DISPLAY AUDIO WITH AMPLIFIER]

AUDIO AMP

Reference Value

INFOID:000000009482146

TERMINAL LAYOUT

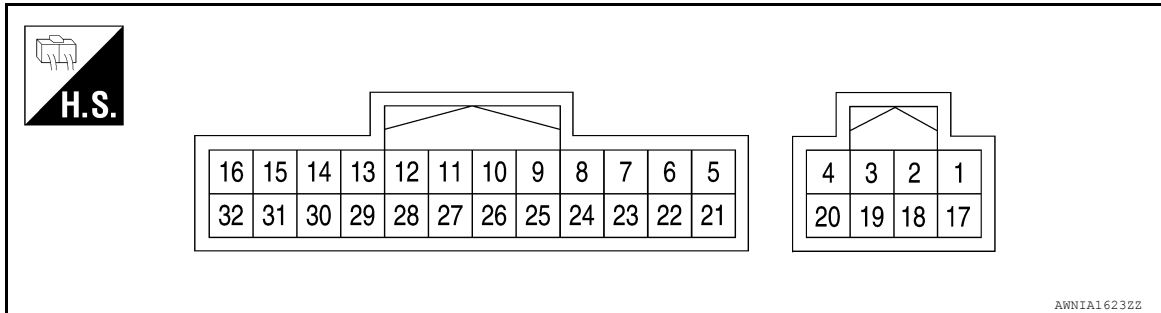

PHYSICAL VALUES

Terminal (wire color)		Description		Condition		Reference value (Approx.)
+	-	Signal name	Input/Output	Ignition switch	Operation	
1 (Y)	Ground	Battery	Input	-	-	Battery voltage
2 (W)	18 (G)	Subwoofer	Output	ON	Receive audio signal	 SKIA0177E
3 (BR/W)	19 (BR)	Subwoofer	Output	ON	Receive audio signal	 SKIA0177E
4 (B)	Ground	Ground	-	ON	-	-
9 (G/W)	Ground	Amp. ON signal	Input	ON	-	Greater than 6.5 V
11 (G)	27 (B)	Rear door speaker LH	Output	ON	Receive audio signal	 SKIA0177E

AUDIO AMP

< ECU DIAGNOSIS INFORMATION >

[DISPLAY AUDIO WITH AMPLIFIER]

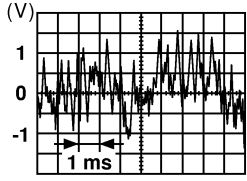
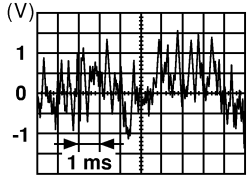
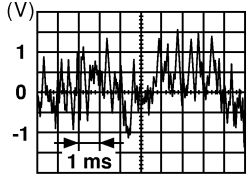
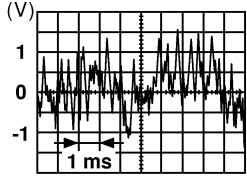
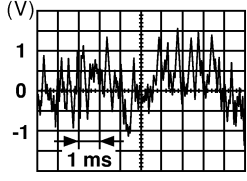
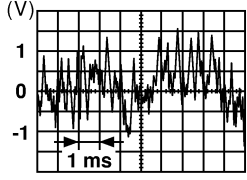
Terminal (wire color)		Description		Condition		Reference value (Approx.)
+	-	Signal name	Input/Output	Ignition switch	Operation	
12 (GR)	28 (BG)	Rear door speaker RH	Output	ON	Receive audio signal	 <p style="text-align: right; font-size: small;">SKIA0177E</p>
13 (W)	29 (P)	Front tweeter RH	Output	ON	Receive audio signal	 <p style="text-align: right; font-size: small;">SKIA0177E</p>
14 (Y)	30 (GR)	Front tweeter LH	Output	ON	Receive audio signal	 <p style="text-align: right; font-size: small;">SKIA0177E</p>
15 (BR)	31 (L)	Front door speaker LH	Output	ON	Receive audio signal	 <p style="text-align: right; font-size: small;">SKIA0177E</p>
16 (LG)	32 (R)	Front door speaker RH	Output	ON	Receive audio signal	 <p style="text-align: right; font-size: small;">SKIA0177E</p>
17 (R/B)	Ground	Battery	Input	-	-	Battery voltage
20 (B)	Ground	Ground	-	ON	-	-
21 (Y)	5 (R)	Audio sound signal front RH	Input	ON	Receive audio signal	 <p style="text-align: right; font-size: small;">SKIA0177E</p>

A
B
C
D
E
F
G
H
I
J
K
L
M
AV
O
P

AUDIO AMP

< ECU DIAGNOSIS INFORMATION >

[DISPLAY AUDIO WITH AMPLIFIER]

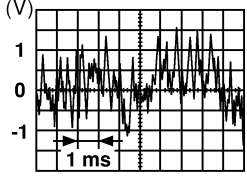
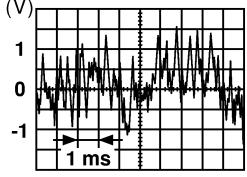
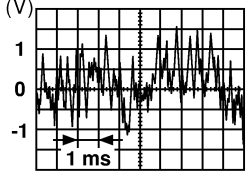
Terminal (wire color)		Description		Condition		Reference value (Approx.)
+	-	Signal name	Input/ Output	Ignition switch	Operation	
22 (W)	6 (B)	Audio sound signal front LH	Input	ON	Receive audio signal	
23 (L)	7 (B/W)	Audio sound signal rear RH	Input	ON	Receive audio signal	
24 (P)	8 (B/R)	Audio sound signal rear LH	Input	ON	Receive audio signal	

BLUETOOTH® CONTROL UNIT

< ECU DIAGNOSIS INFORMATION >

[DISPLAY AUDIO WITH AMPLIFIER]

BLUETOOTH® CONTROL UNIT

Reference Value

INFOID:000000009482147

TERMINAL LAYOUT

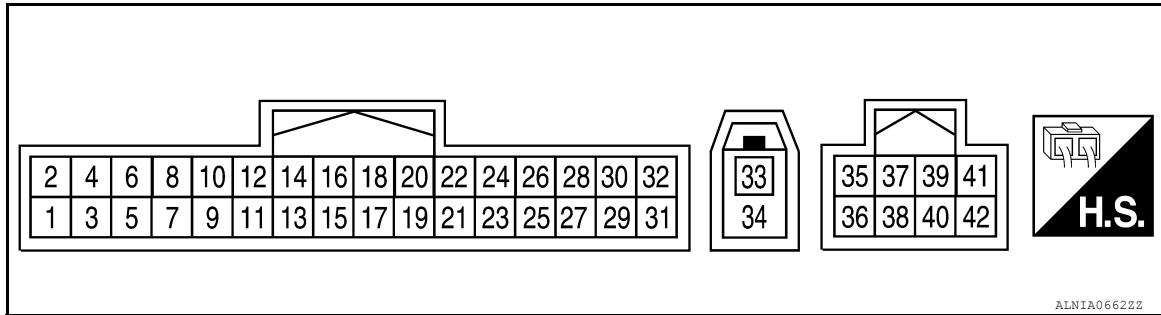



PHYSICAL VALUES

Terminal (wire color)		Description	Condition			Reference value (Approx.)
+	-	Signal name	Input/output	Ignition switch	Condition	
1 (R/B)	Ground	Battery power	Input	-	-	Battery voltage
2 (G/Y)	Ground	ACC power	Input	ACC or ON	-	Battery voltage
3 (W/G)	Ground	IGN power	Input	ON or START	-	Battery voltage
4 (B)	Ground	Ground	-	ON	-	0V
6	-	MIC Shield	-	-	-	-
7 (G)	8 (L)	MIC in signal	Input	-	-	-
9 (W)	10 (B)	Audio out	Output	ACC or ON	Bluetooth® control unit sends audio signal	
12 (BR)	Ground	Ladder in 1	Input	ACC or ON	Press and hold MODE switch.	0 V
					Press and hold Δ switch.	1.34 V
					Press and hold ∇ switch.	2.45 V
					Press and hold ⚡ switch.	3.43 V
					Except for above.	5.0 V
13 (L)	Ground	Ladder in 2	Input	ACC or ON	Press VOL DOWN switch	0 V
					Press VOL UP switch.	1.34 V
					Press ⚡ switch.	2.45 V
					Except for above.	5.0 V

BLUETOOTH® CONTROL UNIT

< ECU DIAGNOSIS INFORMATION >

[DISPLAY AUDIO WITH AMPLIFIER]

Terminal (wire color)		Description		Condition		Reference value (Approx.)
+	-	Signal name	Input/ output	Ignition switch	Condition	
14 (G)	-	Ladder in ground	Input	-	-	-
17 (V)	Ground	Ladder out 1	Input	ACC or ON	Press and hold MODE switch.	0 V
					Press and hold Δ switch.	1.34 V
					Press and hold ∇ switch.	2.45 V
					Press and hold  switch.	3.43 V
					Except for above.	5.0 V
18 (LG)	Ground	Ladder out 2	Input	ACC or ON	Press VOL DOWN switch	0 V
					Press VOL UP switch.	1.34 V
					Press  switch.	2.45 V
					Except for above.	5.0 V
19 (BG)	Ground	Ladder out ground	Output	-	-	-
21 (B)	Ground	Cont 2	-	-	-	0V
28 (SB)	Ground	Vehicle speed signal (8-pulse)	Input	ON	When vehicle speed is approx. 40 km/h (25 MPH)	 <p style="text-align: right; font-size: small;">PKIA1935E</p>
29 (Y)	Ground	Microphone power	Output	ON	-	5V
33 (B)	-	Bluetooth® antenna	-	-	-	-
34	-	Bluetooth® antenna shield	-	-	-	-
35 (R)	-	MCAN H	-	-	-	-
36 (G)	-	MCAN L	-	-	-	-
37	-	MCAN shield	-	-	-	-

DISPLAY AUDIO WITH AMPLIFIER

[DISPLAY AUDIO WITH AMPLIFIER]

< WIRING DIAGRAM >

WIRING DIAGRAM

DISPLAY AUDIO WITH AMPLIFIER

Wiring Diagram

INFOID:000000009482148

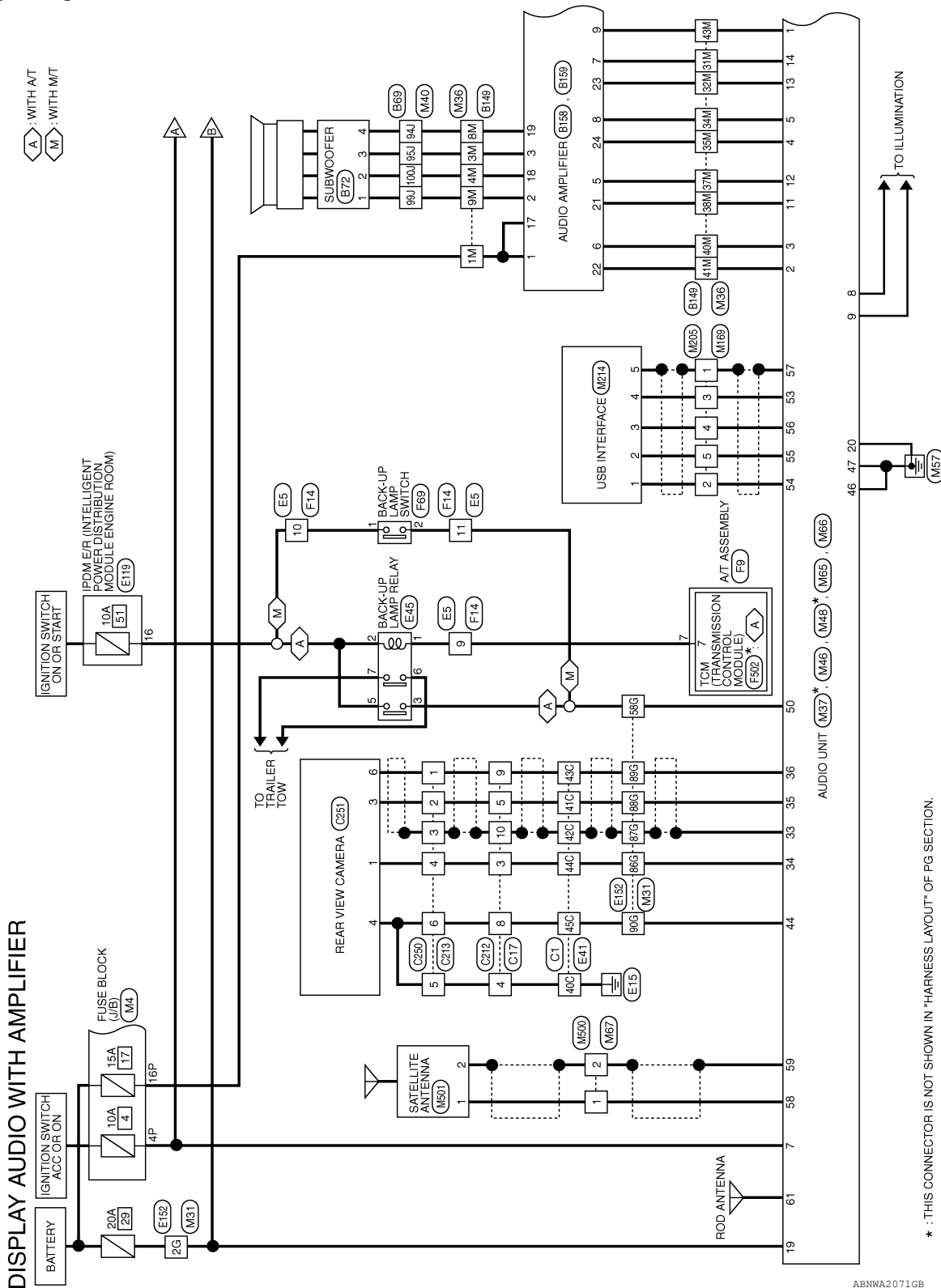

* : THIS CONNECTOR IS NOT SHOWN IN "HARNESS LAYOUT" OF PG SECTION.

ABNWA2071GB

A
B
C
D
E
F
G
H
I
J
K
L
M
N
O
P

AV

DISPLAY AUDIO WITH AMPLIFIER

[DISPLAY AUDIO WITH AMPLIFIER]

< WIRING DIAGRAM >

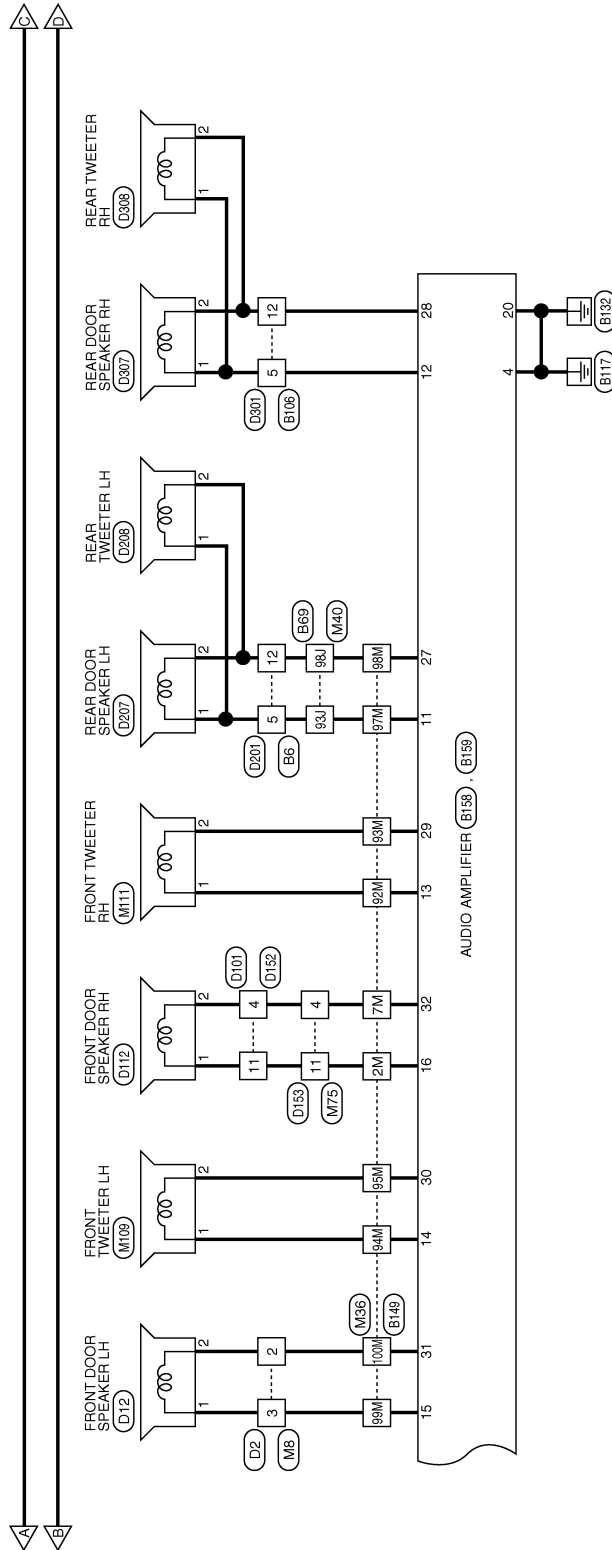

ABNWA2072GB

DISPLAY AUDIO WITH AMPLIFIER

< WIRING DIAGRAM >

[DISPLAY AUDIO WITH AMPLIFIER]

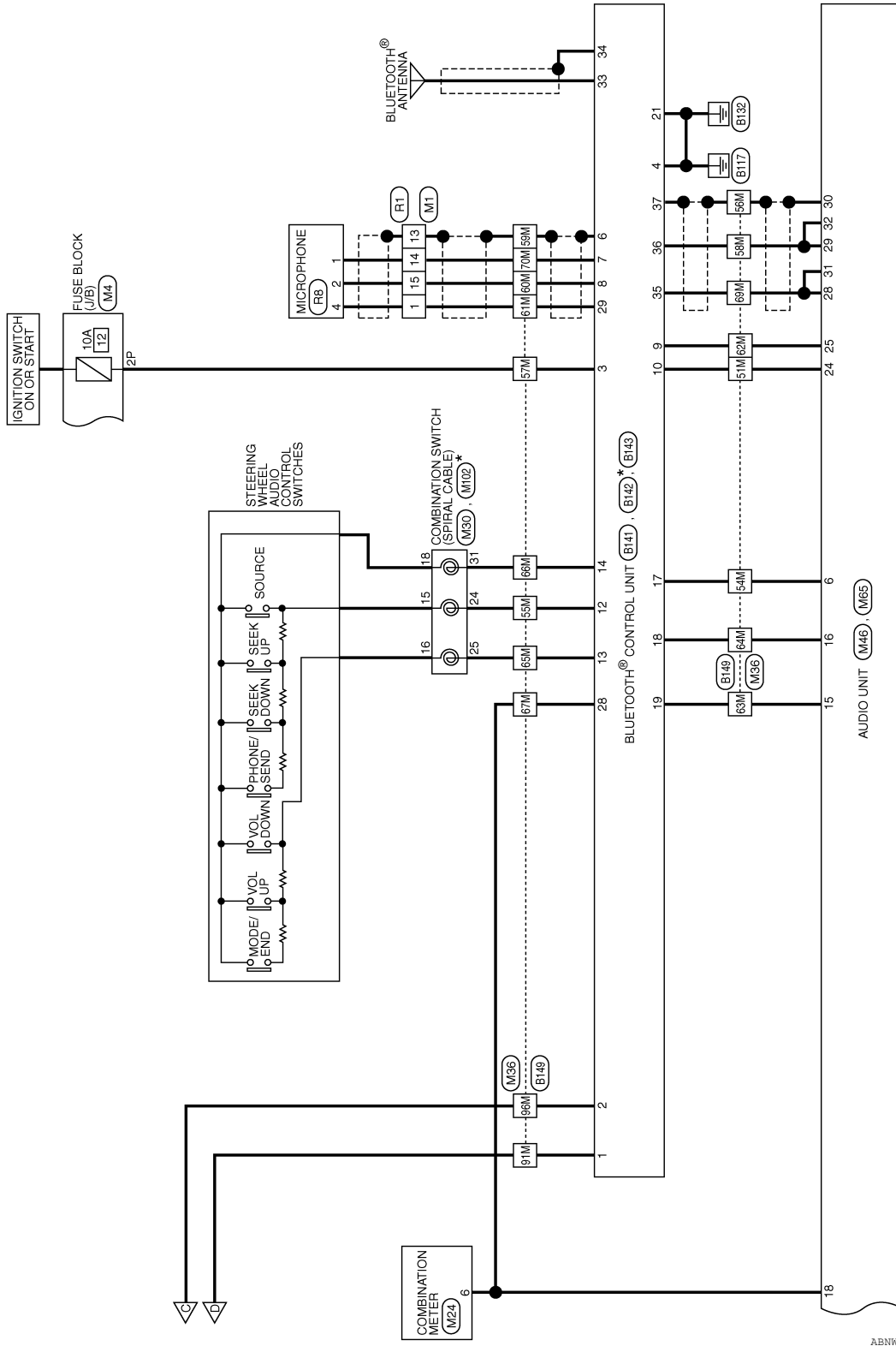

* : THIS CONNECTOR IS NOT SHOWN IN "HARNESS LAYOUT" OF PG SECTION.

ABNWA2073GB

A
B
C
D
E
F
G
H
I
J
K
L
M
N
O
P

AV

DISPLAY AUDIO WITH AMPLIFIER

[DISPLAY AUDIO WITH AMPLIFIER]

< WIRING DIAGRAM >

DISPLAY AUDIO WITH AMPLIFIER CONNECTORS

Connector No.	M8
Connector Name	WIRE TO WIRE
Connector Color	BROWN

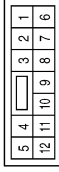

Terminal No.	Color of Wire	Signal Name
2	L	-
3	BR	-

Connector No.	M4
Connector Name	FUSE BLOCK (J/B)
Connector Color	WHITE

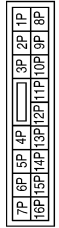

Terminal No.	Color of Wire	Signal Name
2P	W/G	-
4P	G/B	-
16P	R/B	-

Connector No.	M1
Connector Name	WIRE TO WIRE
Connector Color	WHITE

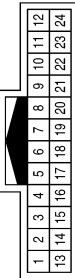

Terminal No.	Color of Wire	Signal Name
1	Y	- (WITHOUT NAVI)
13	SHIELD	-
14	G	- (WITHOUT NAVI)
15	L	- (WITHOUT NAVI)

Connector No.	M30
Connector Name	COMBINATION SWITCH (SPIRAL CABLE)
Connector Color	GRAY

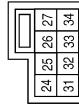

Terminal No.	Color of Wire	Signal Name
24	BR	-
25	L	- (WITHOUT NAVI)
31	G	-

Connector No.	M24
Connector Name	COMBINATION METER
Connector Color	WHITE

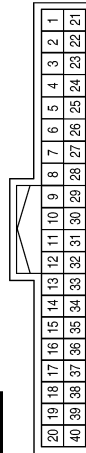

Terminal No.	Color of Wire	Signal Name
6	SB	SPEED OUT 8

ABNIA4223GB

DISPLAY AUDIO WITH AMPLIFIER

< WIRING DIAGRAM >

[DISPLAY AUDIO WITH AMPLIFIER]

Terminal No.	Color of Wire	Signal Name
38M	Y	-
40M	B	-
41M	W	-
43M	G/W	-
51M	B	-(EXCEPT BASE AUDIO SYSTEM)
54M	V	-
55M	BR	-
56M	SHIELD	-
57M	W/G	-
58M	G	-
59M	SHIELD	-
60M	L	-
61M	Y	-
62M	W	-
63M	BG	-
64M	LG	-
65M	L	-
66M	G	-
67M	SB	-
69M	R	-
70M	G	-
91M	R/B	-
92M	W	-
93M	P	-
94M	Y	-
95M	GR	-
96M	G/Y	-
97M	G	-
98M	B	-
99M	BR	-
100M	L	-

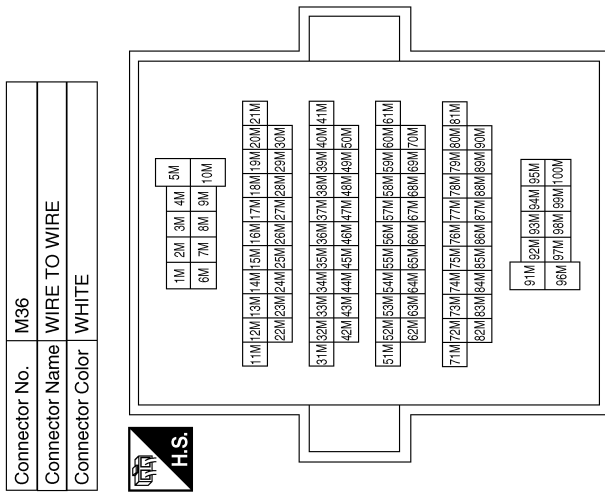

Terminal No.	Color of Wire	Signal Name
1M	R/B	-
2M	LG	-
3M	BR/W	-
4M	G	-
7M	R	-
8M	BR	-
9M	W	-
31M	B/W	-
32M	L	-
34M	B/R	-
35M	P	-
37M	R	-

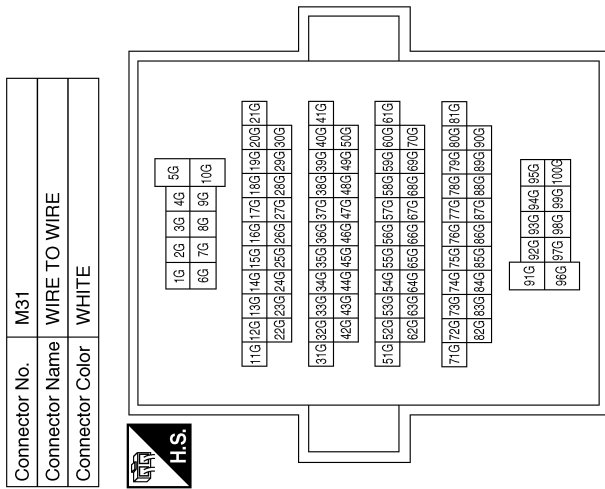

Terminal No.	Color of Wire	Signal Name
2G	Y	-
58G	SB	-
86G	G/Y	-
87G	SHIELD	-
88G	B	-
89G	W	-
90G	BR	-

ABNIA5591GB

A
B
C
D
E
F
G
H
I
J
K
L
M
N
O
P

AV

DISPLAY AUDIO WITH AMPLIFIER

< WIRING DIAGRAM >

[DISPLAY AUDIO WITH AMPLIFIER]

Connector No.	M46
Connector Name	AUDIO UNIT (WITH DISPLAY AUDIO WITH AMPLIFIER)
Connector Color	WHITE

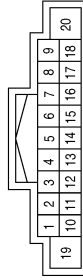

Terminal No.	Color of Wire	Signal Name
1	G/W	AMP ON
2	W	FR SP LH (+)
3	B	FR SP LH (-)
4	P	RR SP LH (+)
5	B/R	RR SP LH (-)
6	V	STRG SW A
7	G/B	ACC
8	GR	ILL (-)
9	R	ILL (+)
10	-	-
11	Y	FR SP RH (+)
12	R	FR SP RH (-)
13	L	RR SP RH (+)
14	B/W	RR SP RH (-)
15	BG	STRG SW GND
16	LG	STRG SW B
17	-	-
18	SB	SPD
19	Y	+B
20	B	GND

Connector No.	M40
Connector Name	WIRE TO WIRE
Connector Color	WHITE

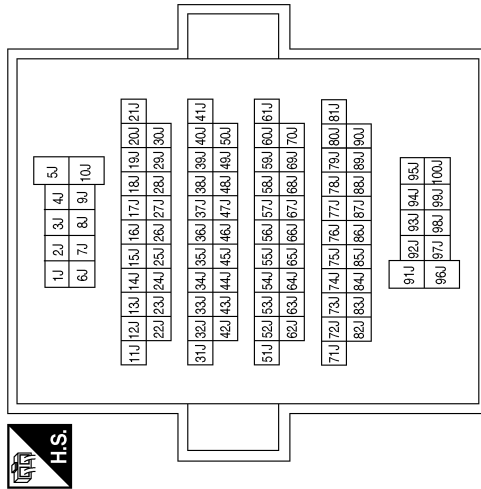

Terminal No.	Color of Wire	Signal Name
93J	G	-
94J	BR	-
95J	BR/W	-
98J	B	-
99J	W	-
100J	G	-

Connector No.	M37
Connector Name	AUDIO UNIT (WITH DISPLAY AUDIO WITH AMPLIFIER)
Connector Color	GRAY

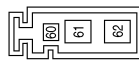

Terminal No.	Color of Wire	Signal Name
60	-	-
61	B	ANT MAIN
62	-	-

ABNIA5592GB

DISPLAY AUDIO WITH AMPLIFIER

< WIRING DIAGRAM >

[DISPLAY AUDIO WITH AMPLIFIER]

Connector No.	M48
Connector Name	AUDIO UNIT (WITH DISPLAY AUDIO WITH AMPLIFIER)
Connector Color	PINK

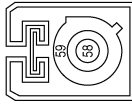

Terminal No.	Color of Wire	Signal Name
58	B	SAT ANT
59	SHIELD	SAT SHIELD

Connector No.	M65
Connector Name	AUDIO UNIT (WITH DISPLAY AUDIO WITH AMPLIFIER)
Connector Color	WHITE

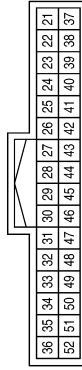

Terminal No.	Color of Wire	Signal Name
21	-	-
22	-	-
23	-	-
24	B	TEL VIOCE (-)
25	W	TEL VIOCE (+)
26	-	-
27	-	-
28	R	MCAN2 H

Terminal No.	Color of Wire	Signal Name
29	G	MCAN2 L
30	SHIELD	MCAN GND
31	L	MCAN1 H
32	W	MCAN1 L
33	SHIELD	CAM GND
34	GY	CAMERA ON
35	B	CAM VIDEO
36	W	VIDEO GND
37	-	-
38	-	-
39	-	-
40	-	-

Terminal No.	Color of Wire	Signal Name
41	-	-
42	-	-
43	-	-
44	BR	CAM DET
45	-	-
46	B	EQ2
47	B	EQ3
48	-	-
49	-	-
50	SB	REVERSE
51	-	-
52	-	-

ABNIA4226GB

A
B
C
D
E
F
G
H
I
J
K
L
M
N
O
P

AV

DISPLAY AUDIO WITH AMPLIFIER

< WIRING DIAGRAM >

[DISPLAY AUDIO WITH AMPLIFIER]

Connector No.	M75
Connector Name	WIRE TO WIRE
Connector Color	WHITE

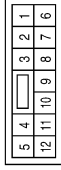

Terminal No.	Color of Wire	Signal Name
4	R	-
11	LG	-

Connector No.	M67
Connector Name	WIRE TO WIRE
Connector Color	PINK

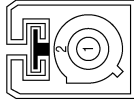

Terminal No.	Color of Wire	Signal Name
1	B	-
2	SHIELD	-

Connector No.	M66
Connector Name	AUDIO UNIT (WITH DISPLAY AUDIO WITH AMPLIFIER)
Connector Color	GREEN

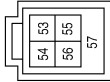

Terminal No.	Color of Wire	Signal Name
53	R	VBUS
54	B	USB GND
55	G	USB D +
56	W	USB D -
57	SHIELD	SHIELD

Connector No.	M111
Connector Name	FRONT TWEETER RH
Connector Color	BROWN



Terminal No.	Color of Wire	Signal Name
1	W	-
2	P	-(WITH AMPLIFIER)

Connector No.	M109
Connector Name	FRONT TWEETER LH
Connector Color	BROWN



Terminal No.	Color of Wire	Signal Name
1	Y	-(WITH AMPLIFIER)
2	GR	-(WITH AMPLIFIER)

Connector No.	M102
Connector Name	COMBINATION SWITCH (SPIRAL CABLE)
Connector Color	GRAY



Terminal No.	Color of Wire	Signal Name
15	GR	-
16	G	-
18	B	-

ABNIA4227GB

DISPLAY AUDIO WITH AMPLIFIER

[DISPLAY AUDIO WITH AMPLIFIER]

< WIRING DIAGRAM >

Connector No.	M214
Connector Name	USB INTERFACE
Connector Color	BLUE

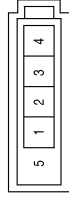

Terminal No.	Color of Wire	Signal Name
1	B	-
2	G	-
3	W	-
4	R	-
5	SHIELD	-

Connector No.	M205
Connector Name	WIRE TO WIRE
Connector Color	BLUE

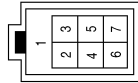

Terminal No.	Color of Wire	Signal Name
1	SHIELD	-
2	B	-
3	R	-
4	W	-
5	G	-

Connector No.	M169
Connector Name	WIRE TO WIRE
Connector Color	BLUE

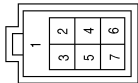

Terminal No.	Color of Wire	Signal Name
1	SHIELD	-
2	B	-
3	R	-
4	W	-
5	G	-

Connector No.	E5
Connector Name	WIRE TO WIRE
Connector Color	WHITE

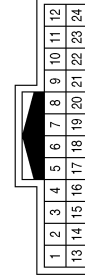

Terminal No.	Color of Wire	Signal Name
9	LG	-
10	W/G	-
11	SB	-

Connector No.	M501
Connector Name	SATELLITE ANTENNA
Connector Color	BROWN

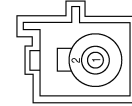

Terminal No.	Color of Wire	Signal Name
1	B	-
2	SHIELD	-

Connector No.	M500
Connector Name	WIRE TO WIRE
Connector Color	PINK

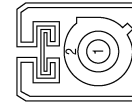

Terminal No.	Color of Wire	Signal Name
1	B	-
2	SHIELD	-

ABNIA5593GB

A
B
C
D
E
F
G
H
I
J
K
L
M
N
O
P

AV

DISPLAY AUDIO WITH AMPLIFIER

< WIRING DIAGRAM >

[DISPLAY AUDIO WITH AMPLIFIER]

Connector No.	E45
Connector Name	BACK-UP LAMP RELAY (WITH AV7)
Connector Color	BROWN



Terminal No.	Color of Wire	Signal Name
1	LG	-
2	W/G	-
3	SB	-
5	W/G	-
6	Y	-
7	W/G	-

Terminal No.	Color of Wire	Signal Name
40C	GR	-
41C	B	-
42C	SHIELD	-
43C	W	-
44C	G/Y	-
45C	BR	-

Connector No.	E41
Connector Name	WIRE TO WIRE
Connector Color	BLACK

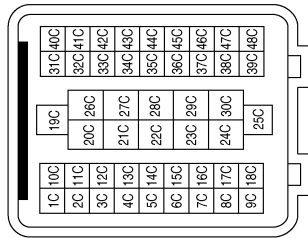

Connector No.	E119
Connector Name	IPDM E/R (INTELLIGENT POWER DISTRIBUTION MODULE ENGINE ROOM)
Connector Color	WHITE

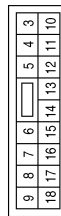

Terminal No.	Color of Wire	Signal Name
16	W/G	REVERSE LAMP

Connector No.	E152
Connector Name	WIRE TO WIRE
Connector Color	WHITE

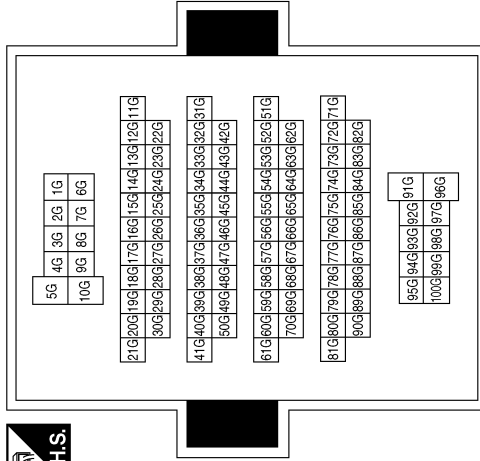

Terminal No.	Color of Wire	Signal Name
2G	Y	-
58G	SB	-
86G	G/Y	-
87G	SHIELD	-
88G	B	-
89G	W	-
90G	BR	-

ABNIA5594GB

DISPLAY AUDIO WITH AMPLIFIER

[DISPLAY AUDIO WITH AMPLIFIER]

< WIRING DIAGRAM >

Connector No.	F69
Connector Name	BACK-UP LAMP SWITCH
Connector Color	WHITE



Terminal No.	Color of Wire	Signal Name
1	W/G	-
2	SB	-

Connector No.	F14
Connector Name	WIRE TO WIRE
Connector Color	WHITE

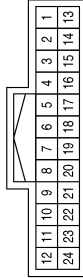

Terminal No.	Color of Wire	Signal Name
9	LG	-
10	W/G	-
11	SB	-

Connector No.	F9
Connector Name	A/T ASSEMBLY
Connector Color	GREEN

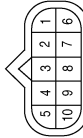

Terminal No.	Color of Wire	Signal Name
7	LG	-

Terminal No.	Color of Wire	Signal Name
40C	GR	-
41C	B	-
42C	SHIELD	-
43C	W	-
44C	G/Y	-
45C	BR	-

Connector No.	C1
Connector Name	WIRE TO WIRE
Connector Color	BLACK

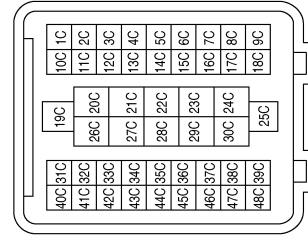

Connector No.	F502
Connector Name	TCM (TRANSMISSION CONTROL MODULE)
Connector Color	GRAY



Terminal No.	Color of Wire	Signal Name
7	O	REV LAMP RLY

ABNIA5621GB

A
B
C
D
E
F
G
H
I
J
K
L
M
N
O
P

AV

DISPLAY AUDIO WITH AMPLIFIER

[DISPLAY AUDIO WITH AMPLIFIER]

< WIRING DIAGRAM >

Connector No.	C213
Connector Name	WIRE TO WIRE
Connector Color	BLACK



Terminal No.	Color of Wire	Signal Name
1	W	-
2	B	-
3	SHIELD	-
4	G/Y	-
5	GR	-
6	BR	-

Connector No.	C212
Connector Name	WIRE TO WIRE
Connector Color	GRAY

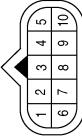

Terminal No.	Color of Wire	Signal Name
3	G/Y	-
4	GR	-
5	B	-
8	BR	-
9	W	-
10	SHIELD	-

Connector No.	C17
Connector Name	WIRE TO WIRE
Connector Color	GRAY

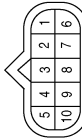

Terminal No.	Color of Wire	Signal Name
3	G/Y	-
4	GR	-
5	B	-
8	BR	-
9	W	-
10	SHIELD	-

Connector No.	B6
Connector Name	WIRE TO WIRE
Connector Color	WHITE

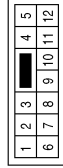

Terminal No.	Color of Wire	Signal Name
5	G	-
12	B	-

Connector No.	C251
Connector Name	REAR VIEW CAMERA
Connector Color	GRAY



Terminal No.	Color of Wire	Signal Name
1	G/Y	-
3	B	-
4	GR	-
6	W	-

Connector No.	C250
Connector Name	WIRE TO WIRE
Connector Color	BLACK



Terminal No.	Color of Wire	Signal Name
1	W	-
2	B	-
3	SHIELD	-
4	G/Y	-
5	GR	-
6	BR	-

ABNIA5595GB

DISPLAY AUDIO WITH AMPLIFIER

< WIRING DIAGRAM >

[DISPLAY AUDIO WITH AMPLIFIER]

Connector No.	B72
Connector Name	SUBWOOFER
Connector Color	GRAY



Terminal No.	Color of Wire	Signal Name
1	W	-
2	G	-
3	BR/W	-
4	BR	-

Terminal No.	Color of Wire	Signal Name
93J	G	-
94J	BR	-
95J	BR/W	-
96J	B	-
99J	W	-
100J	G	-

Connector No.	B69
Connector Name	WIRE TO WIRE
Connector Color	WHITE

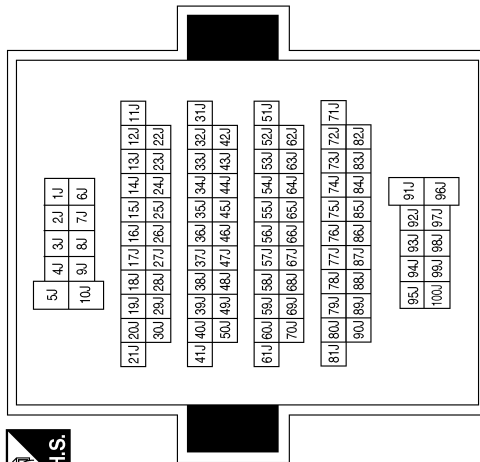

Connector No.	B106
Connector Name	WIRE TO WIRE
Connector Color	WHITE



Terminal No.	Color of Wire	Signal Name
5	GR	-(EXCEPT DISPLAY AUDIO WITHOUT AMPLIFIER)
12	BG	-(EXCEPT DISPLAY AUDIO WITHOUT AMPLIFIER)

ABNIA5596GB

A
B
C
D
E
F
G
H
I
J
K
L
M
N
O
P



DISPLAY AUDIO WITH AMPLIFIER

< WIRING DIAGRAM >

[DISPLAY AUDIO WITH AMPLIFIER]

Terminal No.	Color of Wire	Signal Name
21	B	CONT 2
22	-	-
23	-	-
24	-	-
25	-	-
26	-	-
27	-	-
28	SB	SPEED SIGNAL
29	Y	MIC POWER
30	-	-
31	-	-
32	-	-

Terminal No.	Color of Wire	Signal Name
6	SHIELD	MIC SHIELD
7	G	MIC IN+
8	L	MIC IN-
9	W	AUDIO OUT+
10	B	AUDIO OUT-
11	-	-
12	BR	LADDER IN 1
13	L	LADDER IN 2
14	G	LADDER IN GND
15	-	-
16	-	-
17	V	LADDER OUT 1
18	LG	LADDER OUT 2
19	BG	LADDER OUT GND
20	-	-

Connector No.	B141
Connector Name	BLUETOOTH® CONTROL UNIT
Connector Color	WHITE

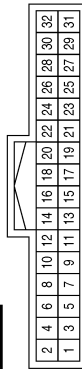

Terminal No.	Color of Wire	Signal Name
1	R/B	BATT
2	G/Y	ACC
3	W/G	IGN
4	B	GND
5	-	-

Terminal No.	Color of Wire	Signal Name
35	R	CAN-H1
36	G	CAN-L1
37	SHIELD	CAN SHIELD 1
38	-	-
39	-	-
40	-	-
41	-	-
42	-	-

Connector No.	B143
Connector Name	BLUETOOTH® CONTROL UNIT
Connector Color	WHITE

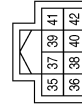

Connector No.	B142
Connector Name	BLUETOOTH® CONTROL UNIT
Connector Color	BLACK



Terminal No.	Color of Wire	Signal Name
33	B	BT ANTENNA
34	SHIELD	BT ANTENNA SHIELD

ABNIA5597GB

DISPLAY AUDIO WITH AMPLIFIER

< WIRING DIAGRAM >

[DISPLAY AUDIO WITH AMPLIFIER]

Terminal No.	Color of Wire	Signal Name
65M	L	-
66M	G	-
67M	SB	-
69M	R	-
70M	G	-
91M	R/B	-
92M	W	-
93M	P	-
94M	Y	-
95M	GR	-
96M	G/Y	-
97M	G	-
98M	B	-
99M	BR	-
100M	L	-

Terminal No.	Color of Wire	Signal Name
8M	BR	-
9M	W	-
31M	B/W	-
32M	L	-
34M	B/R	-
35M	P	-
37M	R	-
38M	Y	-
40M	B	-
41M	W	-
43M	G/W	-
51M	B	- (EXCEPT BASE AUDIO SYSTEM)
54M	V	-
55M	BR	-
56M	SHIELD	-
57M	W/G	-
58M	G	-
59M	SHIELD	-
60M	L	-
61M	Y	-
62M	W	-
63M	BG	-
64M	LG	-

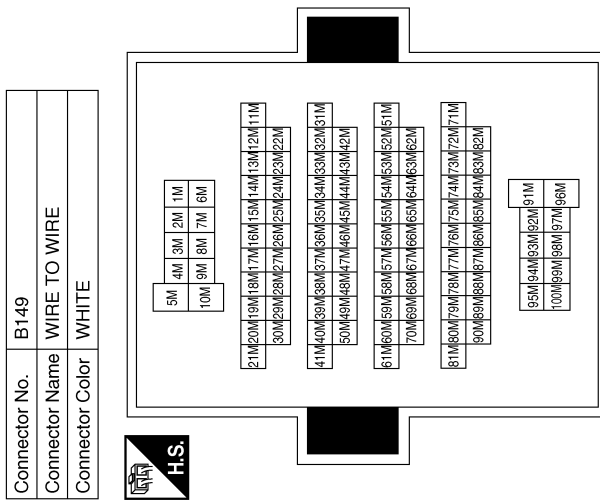

Terminal No.	Color of Wire	Signal Name
1M	R/B	-
2M	LG	-
3M	BR/W	-
4M	G	-
7M	R	-

A
B
C
D
E
F
G
H
I
J
K
L
M
N
O
P

AV

ABNIA5598GB

DISPLAY AUDIO WITH AMPLIFIER

< WIRING DIAGRAM >

[DISPLAY AUDIO WITH AMPLIFIER]

Terminal No.	Color of Wire	Signal Name
13	W	-
14	Y	-
15	BR	-
16	LG	-
21	Y	-
22	W	-
23	L	-
24	P	-
27	B	-
28	BG	-
29	P	-
30	GR	-
31	L	-
32	R	-

Connector No.	B159
Connector Name	AUDIO AMPLIFIER
Connector Color	WHITE

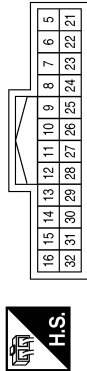

Terminal No.	Color of Wire	Signal Name
5	R	-
6	B	-
7	BR/W	-
8	B/R	-
9	G/W	-
11	G	-
12	GR	-

Connector No.	B158
Connector Name	AUDIO AMPLIFIER
Connector Color	WHITE

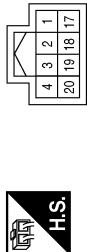

Terminal No.	Color of Wire	Signal Name
1	Y	-
2	W	-
3	BR/W	-
4	B	-
17	R/B	-
18	G	-
19	BR	-
20	B	-

Connector No.	D2
Connector Name	WIRE TO WIRE
Connector Color	BROWN

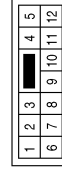

Terminal No.	Color of Wire	Signal Name
2	L/R	-
3	L/W	-

Connector No.	R8
Connector Name	MICROPHONE
Connector Color	WHITE

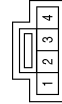

Terminal No.	Color of Wire	Signal Name
1	G	-(WITHOUT NAVI)
2	L	-(WITHOUT NAVI)
4	Y	-(WITHOUT NAVI)

Connector No.	R1
Connector Name	WIRE TO WIRE
Connector Color	WHITE

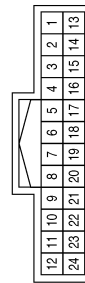

Terminal No.	Color of Wire	Signal Name
1	Y	-(WITHOUT NAVI)
13	SHIELD	-
14	G	-(WITHOUT NAVI)
15	L	-(WITHOUT NAVI)

ABNIA5599GB

DISPLAY AUDIO WITH AMPLIFIER

[DISPLAY AUDIO WITH AMPLIFIER]

< WIRING DIAGRAM >

Connector No.	D112
Connector Name	FRONT DOOR SPEAKER RH
Connector Color	WHITE



Terminal No.	Color of Wire	Signal Name
1	W/B	-
2	L/B	-

Connector No.	D101
Connector Name	WIRE TO WIRE
Connector Color	WHITE

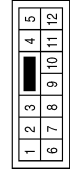

Terminal No.	Color of Wire	Signal Name
4	L/B	-
11	W/B	-

Connector No.	D12
Connector Name	FRONT DOOR SPEAKER LH
Connector Color	WHITE



Terminal No.	Color of Wire	Signal Name
1	L/W	-
2	L/R	-

Connector No.	D201
Connector Name	WIRE TO WIRE
Connector Color	WHITE

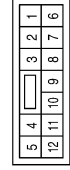

Terminal No.	Color of Wire	Signal Name
5	L	-
12	O	-

Connector No.	D153
Connector Name	WIRE TO WIRE
Connector Color	WHITE

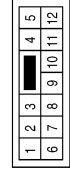

Terminal No.	Color of Wire	Signal Name
4	R	-
11	LG	-

Connector No.	D152
Connector Name	WIRE TO WIRE
Connector Color	WHITE

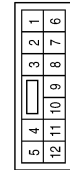

Terminal No.	Color of Wire	Signal Name
4	R	-
11	LG	-

ABNIA4236GB

A
B
C
D
E
F
G
H
I
J
K
L
M
N
O
P

AV

DISPLAY AUDIO WITH AMPLIFIER

< WIRING DIAGRAM >

[DISPLAY AUDIO WITH AMPLIFIER]

Connector No.	D301
Connector Name	WIRE TO WIRE
Connector Color	WHITE

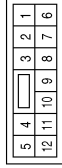

Terminal No.	Color of Wire	Signal Name
5	L	-
12	O	-

Connector No.	D208
Connector Name	REAR TWEETER LH
Connector Color	BROWN



Terminal No.	Color of Wire	Signal Name
1	L	-
2	O	-

Connector No.	D207
Connector Name	REAR DOOR SPEAKER LH (CREW CAB)
Connector Color	WHITE



Terminal No.	Color of Wire	Signal Name
1	L	-
2	O	-

Connector No.	D308
Connector Name	REAR TWEETER RH
Connector Color	BROWN



Terminal No.	Color of Wire	Signal Name
1	L	-
2	O	-

Connector No.	D307
Connector Name	REAR DOOR SPEAKER RH (CREW CAB)
Connector Color	WHITE



Terminal No.	Color of Wire	Signal Name
1	L	-
2	O	-

ABNIA5600GB

BASIC INSPECTION

DIAGNOSIS AND REPAIR WORKFLOW

Work Flow

INFOID:000000009482149

OVERALL SEQUENCE

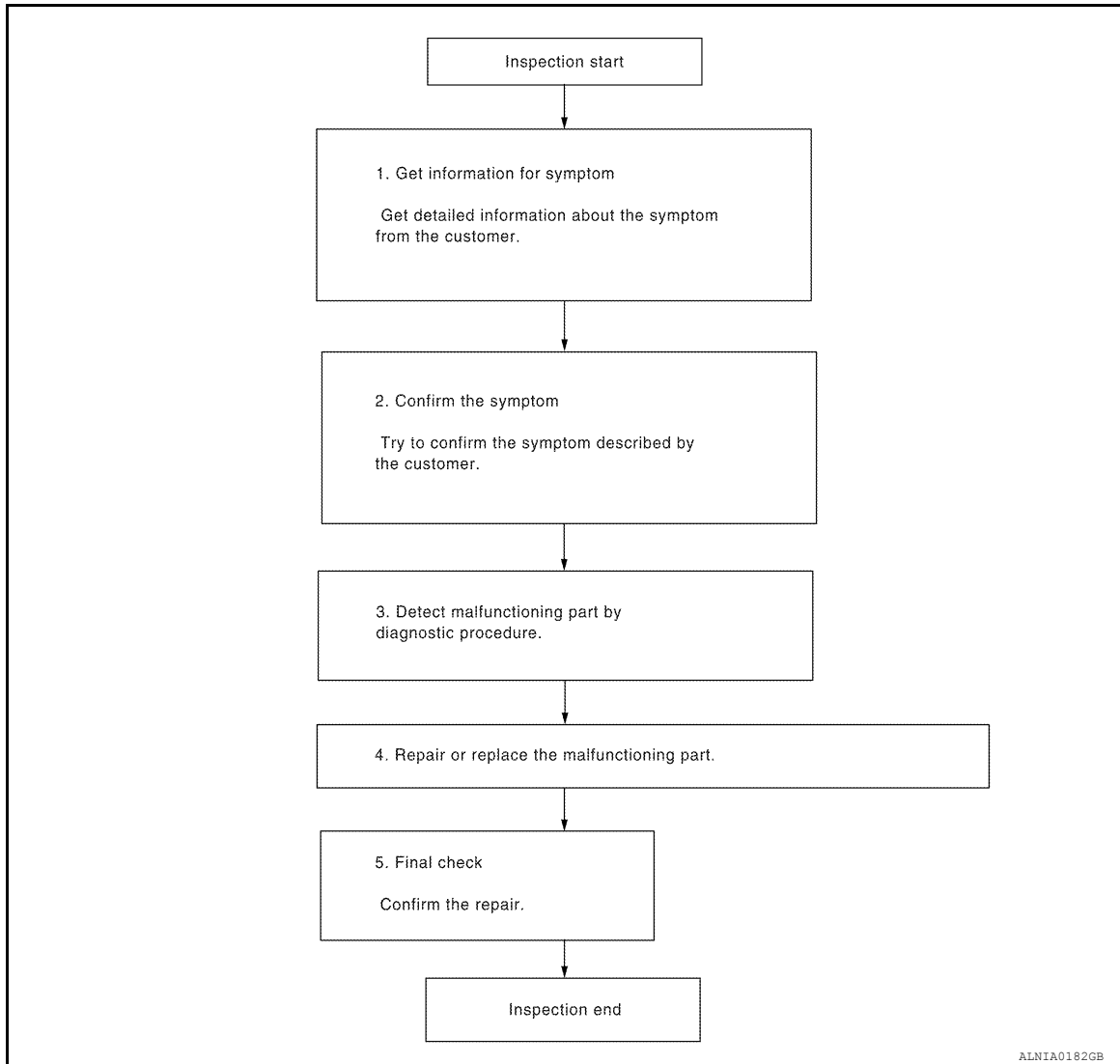

DETAILED FLOW

1.GET INFORMATION FOR SYMPTOM

Get detailed information from the customer about the symptom (the condition and the environment when the incident/malfunction occurred).

>> GO TO 2

2.CONFIRM THE SYMPTOM

Try to confirm the symptom described by the customer. Verify relation between the symptom and the condition when the symptom is detected.

>> GO TO 3

3.DETECT MALFUNCTIONING PART BY DIAGNOSTIC PROCEDURE

Inspect according to Diagnostic Procedure of the system.

A
B
C
D
E
F
G
H
I
J
K
L
M

AV

O

P

DIAGNOSIS AND REPAIR WORKFLOW

< BASIC INSPECTION >

[DISPLAY AUDIO WITH AMPLIFIER]

Is malfunctioning part detected?

YES >> GO TO 4

NO >> GO TO 2

4. REPAIR OR REPLACE THE MALFUNCTIONING PART

1. Repair or replace the malfunctioning part.
2. Reconnect parts or connectors disconnected during Diagnostic Procedure.

>> GO TO 5

5. FINAL CHECK

Refer to confirmed symptom in step 2, and make sure that the symptom is not detected.

Was the repair confirmed?

YES >> Inspection End.

NO >> GO TO 2

POWER SUPPLY AND GROUND CIRCUIT

< DTC/CIRCUIT DIAGNOSIS >

[DISPLAY AUDIO WITH AMPLIFIER]

DTC/CIRCUIT DIAGNOSIS

POWER SUPPLY AND GROUND CIRCUIT AUDIO UNIT

AUDIO UNIT : Diagnosis Procedure

INFOID:000000009482150

Regarding Wiring Diagram information, refer to [AV-177, "Wiring Diagram"](#).

1. CHECK FUSE

Check that the following fuses are not blown.

Terminal No.	Signal name	Fuse No.
7	ACC power supply	4 (10A)
19	Battery power supply	29 (20A)

Are the fuses blown?

- YES >> Replace the blown fuse after repairing the affected circuit.
NO >> GO TO 2.

2. CHECK POWER SUPPLY CIRCUIT

1. Turn ignition switch OFF.
2. Disconnect audio unit connector M46.
3. Check voltage between audio unit connector M46 and ground.

Audio unit		Ground	Condition	Voltage (Approx.)
Connector	Terminal			
M46	7	—	Ignition switch: ON	Battery voltage
	19		Ignition switch: OFF	

Is the inspection result normal?

- YES >> GO TO 3.
NO >> Repair or replace harness or connectors.

3. CHECK GROUND CIRCUIT

1. Disconnect audio unit connector M65.
2. Check continuity between audio unit connectors and ground.

Audio unit		Ground	Continuity
Connector	Terminal		
M46	20	—	Yes
M65	46		
	47		

Is the inspection result normal?

- YES >> Inspection End.
NO >> Repair or replace harness or connectors.

AUDIO AMP

AUDIO AMP : Diagnosis Procedure

INFOID:000000009482151

Regarding Wiring Diagram information, refer to [AV-177, "Wiring Diagram"](#).

POWER SUPPLY AND GROUND CIRCUIT

< DTC/CIRCUIT DIAGNOSIS >

[DISPLAY AUDIO WITH AMPLIFIER]

1.CHECK FUSE

Check that the following fuse is not blown.

Terminal No.	Signal name	Fuse No.
1	Battery power supply	17 (15A)
17		

Is the fuse blown?

- YES >> Replace the blown fuse after repairing the affected circuit.
NO >> GO TO 2.

2.CHECK POWER SUPPLY CIRCUIT

1. Turn ignition switch OFF.
2. Disconnect audio amplifier connector B158.
3. Check voltage between audio amplifier connector B158 and ground.

Audio amplifier		Ground	Condition	Voltage (Approx.)
Connector	Terminal			
B158	1	—	Ignition switch: OFF	Battery voltage
	17			

Is the inspection result normal?

- YES >> GO TO 3.
NO >> Repair or replace harness or connectors.

3.CHECK GROUND CIRCUIT

Check continuity between audio amplifier connector B158 and ground.

Audio amplifier		Ground	Continuity
Connector	Terminal		
B158	4	—	Yes
	20		

Is the inspection result normal?

- YES >> Inspection End.
NO >> Repair or replace harness or connectors.

BLUETOOTH® CONTROL UNIT

BLUETOOTH® CONTROL UNIT : Diagnosis Procedure

INFOID:000000009482152

Regarding Wiring Diagram information, refer to [AV-177. "Wiring Diagram"](#).

1.CHECK FUSE

Check that the following fuses are not blown.

Terminal No.	Signal name	Fuse No.
1	Battery power supply	29 (20A)
2	ACC power supply	4 (10A)
3	Ignition power supply	12 (10A)

Are the fuses blown?

- YES >> Replace the blown fuse after repairing the affected circuit.
NO >> GO TO 2.

POWER SUPPLY AND GROUND CIRCUIT

< DTC/CIRCUIT DIAGNOSIS >

[DISPLAY AUDIO WITH AMPLIFIER]

2.CHECK POWER SUPPLY CIRCUIT

1. Turn ignition switch OFF.
2. Disconnect Bluetooth® control unit connector B141.
3. Check voltage between Bluetooth® control unit connector B141 and ground.

Bluetooth® control unit		Ground	Condition	Voltage (Approx.)
Connector	Terminal			
B141	1	—	Ignition switch: OFF	Battery voltage
	2		Ignition switch: ON	
	3			

Is the inspection result normal?

YES >> GO TO 3.

NO >> Repair or replace harness or connectors.

3.CHECK GROUND CIRCUIT

1. Turn ignition switch OFF.
2. Check continuity between Bluetooth® control unit connector B141 and ground.

Bluetooth® control unit		Ground	Continuity
Connector	Terminal		
B141	4	—	Yes
	21		

Is the inspection result normal?

YES >> Inspection End.

NO >> Repair or replace harness or connectors.

MICROPHONE

MICROPHONE : Diagnosis Procedure

INFOID:000000009482153

Regarding Wiring Diagram information, refer to [AV-104, "Wiring Diagram"](#).

1.CHECK POWER SUPPLY CIRCUIT

1. Turn ignition switch ON.
2. Check voltage between microphone connector R8 and ground.

Microphone		Ground	Value (Approx.)
Connector	Terminal		
R8	4	—	5V

Is the inspection result normal?

YES >> GO TO 3.

NO >> GO TO 2.

2.CHECK POWER SUPPLY CIRCUIT CONTINUITY

1. Turn ignition switch OFF.
2. Disconnect microphone connector and Bluetooth® control unit connector B141.
3. Check continuity between microphone connector R8 and Bluetooth® control unit connector B141.

POWER SUPPLY AND GROUND CIRCUIT

< DTC/CIRCUIT DIAGNOSIS >

[DISPLAY AUDIO WITH AMPLIFIER]

Microphone		Bluetooth® control unit		Continuity
Connector	Terminal	Connector	Terminal	
R8	4	B141	29	Yes

4. Check continuity between microphone connector R8 and ground.

Microphone		—	Continuity
Connector	Terminal		
R8	4	Ground	No

Is the inspection result normal?

YES >> Replace the Bluetooth® control unit. Refer to [AV-151, "Removal and Installation"](#).

NO >> Repair or replace harness or connectors.

3. CHECK GROUND CIRCUIT

1. Turn ignition switch OFF.
2. Disconnect microphone connector and Bluetooth® control unit connector B141.
3. Check continuity between microphone connector R8 and Bluetooth® control unit connector B141.

Microphone		Bluetooth® control unit		Continuity
Connector	Terminal	Connector	Terminal	
R8	2	B141	8	Yes

Is the inspection result normal?

YES >> Inspection End.

NO >> Repair or replace harness or connectors.

FRONT DOOR SPEAKER

< DTC/CIRCUIT DIAGNOSIS >

[DISPLAY AUDIO WITH AMPLIFIER]

FRONT DOOR SPEAKER

Diagnosis Procedure

INFOID:000000009482154

Regarding Wiring Diagram information, refer to [AV-177. "Wiring Diagram"](#).

1. CONNECTOR CHECK

Check the audio unit, audio amplifier and speaker connectors for the following:

- Proper connection
- Damage
- Disconnected or loose terminals

Is the inspection result normal?

YES >> GO TO 2

NO >> Repair the terminals or connectors.

2. CHECK FRONT DOOR SPEAKER SIGNAL CIRCUIT CONTINUITY

1. Disconnect audio amplifier connector B159 and suspect front door speaker connector.
2. Check continuity between audio amplifier connector B159 and suspect front door speaker connector.

Audio amplifier		Front door speaker		Continuity
Connector	Terminal	Connector	Terminal	
B159	15	D12 (LH)	1	Yes
	31		2	
	16	D112 (RH)	1	
	32		2	

3. Check continuity between audio amplifier connector B159 and ground.

Audio amplifier		Ground	Continuity
Connector	Terminal		
B159	15	—	No
	31		
	16		
	32		

Is the inspection result normal?

YES >> GO TO 3

NO >> Repair or replace harness or connectors.

3. CHECK FRONT DOOR SPEAKER SIGNAL

1. Connect audio amplifier connector B159 and suspect front door speaker connector.
2. Turn ignition switch to ACC.
3. Push audio unit POWER switch.
4. Check signal between the terminals of audio amplifier connector B159.

Audio amplifier connector B159		Condition	Reference value
(+)	(-)		
Terminal	Terminal		

FRONT DOOR SPEAKER

< DTC/CIRCUIT DIAGNOSIS >

[DISPLAY AUDIO WITH AMPLIFIER]

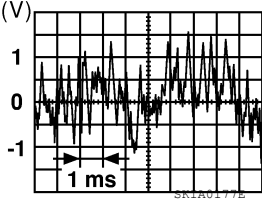
15	31	Audio signal output	
16	32		

Is the inspection result normal?

- YES >> Replace front door speaker. Refer to [AV-236, "Removal and Installation"](#).
- NO >> GO TO 4.

4. CHECK PRE-AMP SIGNAL CIRCUIT CONTINUITY

1. Disconnect audio unit connector M46 and audio amplifier connector B159.
2. Check continuity between audio unit connector M46 and audio amplifier connector B159.

Audio unit		Audio amplifier		Continuity
Connector	Terminal	Connector	Terminal	
M46	2	B159	22	Yes
	3		6	
	11		21	
	12		5	

3. Check continuity between audio unit connector M46 and ground.

Audio unit		Ground	Continuity
Connector	Terminal		
M46	2	—	No
	3		
	11		
	12		

Is the inspection result normal?

- YES >> GO TO 5.
- NO >> Repair or replace harness or connectors.

5. CHECK PRE-AMP SIGNAL

1. Connect audio unit connector M46 and audio amplifier connector B159.
2. Turn ignition switch to ACC.
3. Push audio unit POWER switch.
4. Check signal between the terminals of audio unit connector M46.

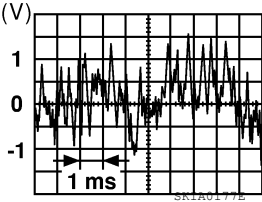
Audio unit connector M46		Condition	Reference value
(+)	(-)		
Terminal	Terminal	Audio signal output	
2	3		
11	12		

Is the inspection result normal?

FRONT DOOR SPEAKER

< DTC/CIRCUIT DIAGNOSIS >

[DISPLAY AUDIO WITH AMPLIFIER]

-
- YES >> Replace audio amplifier. Refer to [AV-234, "Removal and Installation"](#).
NO >> Replace audio unit. Refer to [AV-233, "Removal and Installation"](#).

A

B

C

D

E

F

G

H

I

J

K

L

M

AV

O

P

FRONT TWEETER

< DTC/CIRCUIT DIAGNOSIS >

[DISPLAY AUDIO WITH AMPLIFIER]

FRONT TWEETER

Diagnosis Procedure

INFOID:000000009482155

Regarding Wiring Diagram information, refer to [AV-177. "Wiring Diagram"](#).

1. CONNECTOR CHECK

Check the audio unit, audio amplifier and speaker connectors for the following:

- Proper connection
- Damage
- Disconnected or loose terminals

Is the inspection result normal?

YES >> GO TO 2

NO >> Repair the terminals or connectors.

2. CHECK FRONT TWEETER SIGNAL CIRCUIT CONTINUITY

1. Disconnect audio amplifier connector B159 and suspect front tweeter connector.
2. Check continuity between audio amplifier connector B159 and suspect front tweeter connector.

Audio amplifier		Front tweeter		Continuity
Connector	Terminal	Connector	Terminal	
B159	14	M109 (LH)	1	Yes
	30		2	
	13	M111 (RH)	1	
	29		2	

3. Check continuity between audio amplifier connector B159 and ground.

Audio amplifier		Ground	Continuity
Connector	Terminal		
B159	14	—	No
	30		
	13		
	29		

Is the inspection result normal?

YES >> GO TO 3

NO >> Repair or replace harness or connectors.

3. CHECK FRONT TWEETER SIGNAL

1. Connect audio amplifier connector B159 and suspect front tweeter connector.
2. Turn ignition switch to ACC.
3. Push audio unit POWER switch.
4. Check signal between the terminals of audio amplifier connector B159.

Audio amplifier connector B159		Condition	Reference value
(+)	(-)		
Terminal	Terminal		

FRONT TWEETER

< DTC/CIRCUIT DIAGNOSIS >

[DISPLAY AUDIO WITH AMPLIFIER]

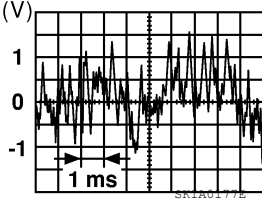
14	30	Audio signal output	
13	29		

Is the inspection result normal?

- YES >> Replace front tweeter. Refer to [AV-235, "Removal and Installation"](#).
- NO >> GO TO 4.

4. CHECK PRE-AMP SIGNAL CIRCUIT CONTINUITY

1. Disconnect audio unit connector M46 and audio amplifier connector B159.
2. Check continuity between audio unit connector M46 and audio amplifier connector B159.

Audio unit		Audio amplifier		Continuity
Connector	Terminal	Connector	Terminal	
M46	2	B159	22	Yes
	3		6	
	11		21	
	12		5	

3. Check continuity between audio unit connector M46 and ground.

Audio unit		Ground	Continuity
Connector	Terminal		
M46	2	—	No
	3		
	11		
	12		

Is the inspection result normal?

- YES >> GO TO 5.
- NO >> Repair or replace harness or connectors.

5. CHECK PRE-AMP SIGNAL

1. Connect audio unit connector M46 and audio amplifier connector B159.
2. Turn ignition switch to ACC.
3. Push audio unit POWER switch.
4. Check signal between the terminals of audio unit connector M46.

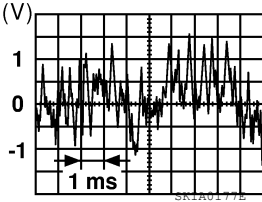
Audio unit connector M46		Condition	Reference value
(+) Terminal	(-) Terminal		
2	3	Audio signal output	
11	12		

Is the inspection result normal?

A
B
C
D
E
F
G
H
I
J
K
L
M
AV
O
P

FRONT TWEETER

< DTC/CIRCUIT DIAGNOSIS >

[DISPLAY AUDIO WITH AMPLIFIER]

- YES >> Replace audio amplifier. Refer to [AV-234, "Removal and Installation"](#).
- NO >> Replace audio unit. Refer to [AV-233, "Removal and Installation"](#).

REAR DOOR SPEAKER

< DTC/CIRCUIT DIAGNOSIS >

[DISPLAY AUDIO WITH AMPLIFIER]

REAR DOOR SPEAKER

Diagnosis Procedure

INFOID:000000009482156

Regarding Wiring Diagram information, refer to [AV-177. "Wiring Diagram"](#).

1. CONNECTOR CHECK

Check the audio unit, audio amplifier and speaker connectors for the following:

- Proper connection
- Damage
- Disconnected or loose terminals

Is the inspection result normal?

YES >> GO TO 2

NO >> Repair the terminals or connectors.

2. CHECK REAR DOOR SPEAKER SIGNAL CIRCUIT CONTINUITY

1. Disconnect audio amplifier connector B159 and suspect rear door speaker connector.
2. Check continuity between audio amplifier connector B159 and suspect rear door speaker connector.

Audio amplifier		Rear door speaker		Continuity
Connector	Terminal	Connector	Terminal	
B159	11	D207 (LH)	1	Yes
	27		2	
	12	D307 (RH)	1	
	28		2	

3. Check continuity between audio amplifier connector B159 and ground.

Audio amplifier		Ground	Continuity
Connector	Terminal		
B159	11	—	No
	27		
	12		
	28		

Is the inspection result normal?

YES >> GO TO 3

NO >> Repair or replace harness or connectors.

3. CHECK REAR DOOR SPEAKER SIGNAL

1. Connect audio amplifier connector B159 and suspect rear door speaker connector.
2. Turn ignition switch to ACC.
3. Push audio unit POWER switch.
4. Check signal between the terminals of audio amplifier connector B159.

Audio amplifier connector B159		Condition	Reference value
(+)	(-)		
Terminal	Terminal		

REAR DOOR SPEAKER

< DTC/CIRCUIT DIAGNOSIS >

[DISPLAY AUDIO WITH AMPLIFIER]

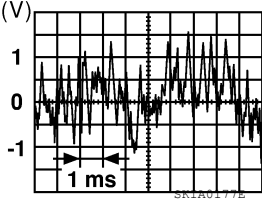
11	27	Audio signal output	
12	28		

Is the inspection result normal?

- YES >> Replace rear door speaker. Refer to [AV-237, "Removal and Installation"](#).
- NO >> GO TO 4.

4. CHECK PRE-AMP SIGNAL CIRCUIT CONTINUITY

1. Disconnect audio unit connector M46 and audio amplifier connector B159.
2. Check continuity between audio unit connector M46 and audio amplifier connector B159.

Audio unit		Audio amplifier		Continuity
Connector	Terminal	Connector	Terminal	
M46	4	B159	24	Yes
	5		8	
	13		23	
	14		7	

3. Check continuity between audio unit connector M46 and ground.

Audio unit		Ground	Continuity
Connector	Terminal		
M46	4	—	No
	5		
	13		
	14		

Is the inspection result normal?

- YES >> GO TO 5.
- NO >> Repair or replace harness or connectors.

5. CHECK PRE-AMP SIGNAL

1. Connect audio unit connector M46 and audio amplifier connector B159.
2. Turn ignition switch to ACC.
3. Push audio unit POWER switch.
4. Check signal between the terminals of audio unit connector M46.

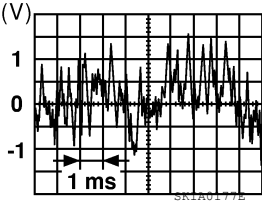
Audio unit connector M46		Condition	Reference value
(+)	(-)		
Terminal	Terminal	Audio signal output	
4	5		
13	14		

Is the inspection result normal?

REAR DOOR SPEAKER

< DTC/CIRCUIT DIAGNOSIS >

[DISPLAY AUDIO WITH AMPLIFIER]

-
- YES >> Replace audio amplifier. Refer to [AV-234, "Removal and Installation"](#).
NO >> Replace audio unit. Refer to [AV-233, "Removal and Installation"](#).

A

B

C

D

E

F

G

H

I

J

K

L

M

AV

O

P

REAR TWEETER

< DTC/CIRCUIT DIAGNOSIS >

[DISPLAY AUDIO WITH AMPLIFIER]

REAR TWEETER

Diagnosis Procedure

INFOID:000000009482157

Regarding Wiring Diagram information, refer to [AV-177. "Wiring Diagram"](#).

1. CONNECTOR CHECK

Check the audio unit, audio amplifier and speaker connectors for the following:

- Proper connection
- Damage
- Disconnected or loose terminals

Is the inspection result normal?

YES >> GO TO 2

NO >> Repair the terminals or connectors.

2. CHECK REAR TWEETER SIGNAL CIRCUIT CONTINUITY

1. Disconnect audio amplifier connector B159 and suspect rear tweeter connector.
2. Check continuity between audio amplifier connector B159 and suspect rear tweeter connector.

Audio amplifier		Rear tweeter		Continuity
Connector	Terminal	Connector	Terminal	
B159	11	D208 (LH)	1	Yes
	27		2	
	12	D308 (RH)	1	
	28		2	

3. Check continuity between audio amplifier connector B159 and ground.

Audio amplifier		Ground	Continuity
Connector	Terminal		
B159	11	—	No
	27		
	12		
	28		

Is the inspection result normal?

YES >> GO TO 3

NO >> Repair or replace harness or connectors.

3. CHECK REAR TWEETER SIGNAL

1. Connect audio amplifier connector B159 and suspect rear tweeter connector.
2. Turn ignition switch to ACC.
3. Push audio unit POWER switch.
4. Check signal between the terminals of audio amplifier connector B159.

Audio amplifier connector B159		Condition	Reference value
(+)	(-)		
Terminal	Terminal		

REAR TWEETER

< DTC/CIRCUIT DIAGNOSIS >

[DISPLAY AUDIO WITH AMPLIFIER]

11	27	Audio signal output	
12	28		

Is the inspection result normal?

- YES >> Replace rear tweeter. Refer to [AV-238, "Removal and Installation"](#).
- NO >> GO TO 4.

4. CHECK PRE-AMP SIGNAL CIRCUIT CONTINUITY

1. Disconnect audio unit connector M46 and audio amplifier connector B159.
2. Check continuity between audio unit connector M46 and audio amplifier connector B159.

Audio unit		Audio amplifier		Continuity
Connector	Terminal	Connector	Terminal	
M46	4	B159	24	Yes
	5		8	
	13		23	
	14		7	

3. Check continuity between audio unit connector M46 and ground.

Audio unit		Ground	Continuity
Connector	Terminal		
M46	4	—	No
	5		
	13		
	14		

Is the inspection result normal?

- YES >> GO TO 5.
- NO >> Repair or replace harness or connectors.

5. CHECK PRE-AMP SIGNAL

1. Connect audio unit connector M46 and audio amplifier connector B159.
2. Turn ignition switch to ACC.
3. Push audio unit POWER switch.
4. Check signal between the terminals of audio unit connector M46.

Audio unit connector M46		Condition	Reference value
(+) Terminal	(-) Terminal		
4	5	Audio signal output	
13	14		

Is the inspection result normal?

A
B
C
D
E
F
G
H
I
J
K
L
M

AV

O
P

REAR TWEETER

< DTC/CIRCUIT DIAGNOSIS >

[DISPLAY AUDIO WITH AMPLIFIER]

- YES >> Replace audio amplifier. Refer to [AV-234, "Removal and Installation"](#).
- NO >> Replace audio unit. Refer to [AV-233, "Removal and Installation"](#).

SUBWOOFER

< DTC/CIRCUIT DIAGNOSIS >

[DISPLAY AUDIO WITH AMPLIFIER]

SUBWOOFER

Diagnosis Procedure

INFOID:000000009482158

Regarding Wiring Diagram information, refer to [AV-177. "Wiring Diagram"](#).

1.CONNECTOR CHECK

Check the audio unit, audio amplifier and subwoofer connectors for the following:

- Proper connection
- Damage
- Disconnected or loose terminals

Is the inspection result normal?

YES >> GO TO 2

NO >> Repair the terminals or connectors.

2.CHECK SUBWOOFER SIGNAL CIRCUIT CONTINUITY

1. Disconnect audio amplifier connector B158 and subwoofer connector.
2. Check continuity between audio amplifier connector B158 and subwoofer connector.

Audio amplifier		Subwoofer		Continuity
Connector	Terminal	Connector	Terminal	
B158	2	B72	1	Yes
	18		2	
	3		3	
	19		4	

3. Check continuity between audio amplifier connector B158 and ground.

Audio amplifier		Ground	Continuity
Connector	Terminal		
B158	2	—	No
	18		
	3		
	19		

Is the inspection result normal?

YES >> GO TO 3

NO >> Repair or replace harness or connectors.

3.CHECK SUBWOOFER SIGNAL

1. Connect audio amplifier connector B158 and subwoofer connector.
2. Turn ignition switch to ACC.
3. Push audio unit POWER switch.
4. Check signal between the terminals of audio amplifier connector B158.

Audio amplifier connector B158		Condition	Reference value
(+)	(-)		
Terminal	Terminal		

SUBWOOFER

< DTC/CIRCUIT DIAGNOSIS >

[DISPLAY AUDIO WITH AMPLIFIER]

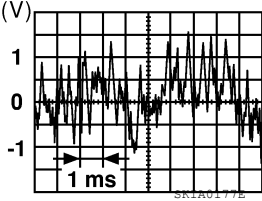
2	18	Audio signal output	
3	19		

Is the inspection result normal?

- YES >> Replace subwoofer. Refer to [AV-239, "Removal and Installation"](#).
 NO >> GO TO 4.

4. CHECK PRE-AMP SIGNAL CIRCUIT CONTINUITY

1. Disconnect audio unit connector M46 and audio amplifier connector B159.
2. Check continuity between audio unit connector M46 and audio amplifier connector B159.

Audio unit		Audio amplifier		Continuity
Connector	Terminal	Connector	Terminal	
M46	4	B159	24	Yes
	5		8	
	13		23	
	14		7	

3. Check continuity between audio unit connector M46 and ground.

Audio unit		Ground	Continuity
Connector	Terminal		
M46	4	—	No
	5		
	13		
	14		

Is the inspection result normal?

- YES >> GO TO 5.
 NO >> Repair or replace harness or connectors.

5. CHECK PRE-AMP SIGNAL

1. Connect audio unit connector M46 and audio amplifier connector B159.
2. Turn ignition switch to ACC.
3. Push audio unit POWER switch.
4. Check signal between the terminals of audio unit connector M46.

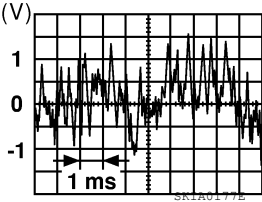
Audio unit connector M46		Condition	Reference value
(+) Terminal	(-) Terminal		
4	5	Audio signal output	
13	14		

Is the inspection result normal?

SUBWOOFER

< DTC/CIRCUIT DIAGNOSIS >

[DISPLAY AUDIO WITH AMPLIFIER]

-
- YES >> Replace audio amplifier. Refer to [AV-234, "Removal and Installation"](#).
 - NO >> Replace audio unit. Refer to [AV-233, "Removal and Installation"](#).

A
B
C
D
E
F
G
H
I
J
K
L
M
AV
O
P

AMP ON SIGNAL CIRCUIT

< DTC/CIRCUIT DIAGNOSIS >

[DISPLAY AUDIO WITH AMPLIFIER]

AMP ON SIGNAL CIRCUIT

Diagnosis Procedure

INFOID:000000009482159

Regarding Wiring Diagram information, refer to [AV-177. "Wiring Diagram"](#).

1. CHECK AUDIO AMPLIFIER AMP ON SIGNAL

1. Turn audio system ON.
2. Check voltage between audio amplifier connector B159 and ground.

Audio amplifier		Ground	Voltage (Approx.)
Connector	Terminal		
B159	9	—	Greater than 6.5 V

Is inspection result normal?

- YES >> Inspection End.
NO >> GO TO 2.

2. CHECK AUDIO UNIT AMP ON SIGNAL

Check voltage between audio unit connector M46 and ground.

Audio unit		Ground	Voltage (Approx.)
Connector	Terminal		
M46	1	—	Greater than 6.5 V

Is inspection result normal?

- YES >> Repair or replace harness or connectors.
NO >> Replace audio unit. Refer to [AV-233. "Removal and Installation"](#).

REAR VIEW CAMERA IMAGE SIGNAL CIRCUIT

< DTC/CIRCUIT DIAGNOSIS >

[DISPLAY AUDIO WITH AMPLIFIER]

REAR VIEW CAMERA IMAGE SIGNAL CIRCUIT

Diagnosis Procedure

INFOID:000000009482160

Regarding Wiring Diagram information, refer to [AV-177. "Wiring Diagram"](#).

1. CHECK REVERSE INPUT SIGNAL

1. Turn ignition switch ON.
2. Shift the selector lever to R (reverse).
3. Check voltage between audio unit connector M65 and ground.

Audio unit		Ground	Condition	Voltage (Approx.)
Connector	Terminal			
M65	50	—	Selector lever in R (reverse)	Battery Voltage

Is the inspection result normal?

YES >> GO TO 2.

NO >> Repair or replace harness or connectors.

2. CHECK CAMERA POWER SUPPLY CIRCUIT CONTINUITY

1. Turn ignition switch OFF.
2. Disconnect audio unit connector M65 and rear view camera connector.
3. Check continuity between audio unit connector M65 and rear view camera connector C251.

Audio unit		Rear view camera		Continuity
Connector	Terminal	Connector	Terminal	
M65	34	C251	1	Yes

4. Check continuity between audio unit connector M45 and ground.

Audio unit		Ground	Continuity
Connector	Terminal		
M65	34		No

Is the inspection result normal?

YES >> GO TO 3.

NO >> Repair or replace harness or connectors.

3. CHECK CAMERA POWER SUPPLY VOLTAGE

1. Connect audio unit connector M65 and rear view camera connector.
2. Turn ignition switch ON.
3. Shift the selector lever to R (reverse).
4. Check voltage between audio unit connector M65 and ground.

Audio unit		Ground	Condition	Voltage (Approx.)
Connector	Terminal			
M65	34	—	Selector lever is in "R".	6.0 V

Is the inspection result normal?

YES >> GO TO 4.

NO >> Replace audio unit. Refer to [AV-233. "Removal and Installation"](#).

4. CHECK CAMERA IMAGE SIGNAL CIRCUIT CONTINUITY

1. Turn ignition switch OFF.

A

B

C

D

E

F

G

H

I

J

K

L

M

AV

O

P

REAR VIEW CAMERA IMAGE SIGNAL CIRCUIT

[DISPLAY AUDIO WITH AMPLIFIER]

< DTC/CIRCUIT DIAGNOSIS >

2. Disconnect audio unit connector M65 and rear view camera connector.
3. Check continuity between audio unit connector M65 and rear view camera connector C251.

Audio unit		Rear view camera		Continuity
Connector	Terminal	Connector	Terminal	
M65	35	C251	3	Yes

4. Check continuity between audio unit connector M65 and ground.

Audio unit		Ground	Continuity
Connector	Terminal		
M65	35		No

Is the inspection result normal?

- YES >> GO TO 5.
 NO >> Repair or replace harness or connectors.

5. CHECK CAMERA GROUND CIRCUIT CONTINUITY

Check continuity between audio unit connector M65 and rear view camera connector C251.

Audio unit		Rear view camera		Continuity
Connector	Terminal	Connector	Terminal	
M65	36	C251	6	Yes

Is the inspection result normal?

- YES >> GO TO 6.
 NO >> Repair or replace harness or connectors.

6. CHECK CAMERA IMAGE SIGNAL

1. Connect audio unit connector M65 and rear view camera connector.
2. Turn ignition switch ON.
3. Shift the selector lever to R (reverse).
4. Check signal between audio unit connector M65 and ground.

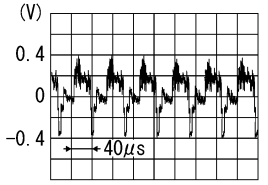
Audio unit		Ground	Condition	Reference value
(+)		(-)		
Connector	Terminal			
M65	35	—	Camera image displayed.	 <p style="text-align: right; font-size: small;">SKIB2251J</p>

Is the inspection result normal?

- YES >> Replace audio unit. Refer to [AV-233. "Removal and Installation"](#).
 NO >> Replace rear view camera. Refer to [AV-248. "Removal and Installation"](#).

STEERING SWITCH

< DTC/CIRCUIT DIAGNOSIS >

[DISPLAY AUDIO WITH AMPLIFIER]

STEERING SWITCH





Diagnosis Procedure

INFOID:000000009482161

Regarding Wiring Diagram information, refer to [AV-177. "Wiring Diagram"](#).

1. CHECK STEERING WHEEL AUDIO CONTROL SWITCH RESISTANCE

1. Disconnect combination switch connector M102.
2. Check resistance between combination switch connector terminals.

Combination switch connector M102		Condition	Resistance (Ω) (Approx.)
Terminal	Terminal		
16	18	Depress VOL DOWN switch.	1
		Depress VOL UP switch.	121
		Depress  switch.	321
15		Depress MODE switch.	1
		Depress  switch.	121
		Depress  switch.	321
		Depress  switch.	723

Is the inspection result normal?

YES >> GO TO 2.

NO >> Replace steering wheel audio control switches. Refer to [AV-240. "Removal and Installation"](#).

2. CHECK HARNESS BETWEEN BLUETOOTH® CONTROL UNIT AND COMBINATION SWITCH

1. Turn ignition switch OFF.
2. Disconnect Bluetooth® control unit connector B141 and combination switch connector M30.
3. Check continuity between Bluetooth® control unit connector B141 and combination switch connector M30.

Bluetooth® control unit		Combination switch		Continuity
Connector	Terminal	Connector	Terminal	
B141	12	M30	24	Yes
	13		25	
	14		31	

4. Check continuity between Bluetooth® control unit connector B141 and ground.

Bluetooth® control unit		—	Continuity
Connector	Terminal		
B141	12	Ground	No
	13		
	14		

Is the inspection result normal?

YES >> GO TO 3.

NO >> Repair or replace harness or connectors.

3. SPIRAL CABLE CHECK

Check continuity between combination switch connectors M30 and M102.

STEERING SWITCH

< DTC/CIRCUIT DIAGNOSIS >

[DISPLAY AUDIO WITH AMPLIFIER]

Combination switch				Continuity
Connector	Terminal	Connector	Terminal	
M30	24	M102	15	Yes
	25		16	
	31		18	

Is the inspection result normal?

YES >> GO TO 4.

NO >> Replace spiral cable. Refer to [SR-13. "Removal and Installation"](#).

4. CHECK HARNESS BETWEEN BLUETOOTH® CONTROL UNIT AND AUDIO UNIT

1. Disconnect audio unit connector M46.
2. Check continuity between Bluetooth® control unit connector B141 and audio unit connector M46.

Bluetooth® control unit		Audio unit		Continuity
Connector	Terminal	Connector	Terminal	
B141	17	M46	6	Yes
	18		16	
	19		15	

3. Check continuity between Bluetooth® control unit connector B141 and ground.

Bluetooth® control unit		—	Continuity
Connector	Terminal		
B141	17	Ground	No
	18		
	19		

Is the inspection result normal?

YES >> Replace audio unit. Refer to [AV-233. "Removal and Installation"](#).

NO >> Repair or replace harness or connectors.

MICROPHONE SIGNAL CIRCUIT

< DTC/CIRCUIT DIAGNOSIS >

[DISPLAY AUDIO WITH AMPLIFIER]

MICROPHONE SIGNAL CIRCUIT

Diagnosis Procedure

INFOID:000000009482162

Regarding Wiring Diagram information, refer to [AV-177. "Wiring Diagram"](#).

1. CHECK HARNESS BETWEEN BLUETOOTH® CONTROL UNIT AND MICROPHONE

1. Turn ignition switch OFF.
2. Disconnect Bluetooth® control unit connector B141 and microphone connector.
3. Check continuity between Bluetooth® control unit connector B141 and microphone connector R8.

Bluetooth® control unit		Microphone		Continuity
Connector	Terminal	Connector	Terminal	
B141	7	R8	1	Yes
	8		2	
	29		4	

4. Check continuity between Bluetooth® control unit connector B141 and ground.

Bluetooth® control unit		—	Continuity
Connector	Terminal		
B141	7	Ground	No
	8		
	29		

Is the inspection result normal?

YES >> GO TO 2.

NO >> Repair harness or connector.

2. CHECK MICROPHONE POWER SUPPLY

1. Connect Bluetooth® control unit connector B141 and microphone connector.
2. Turn ignition switch ON.
3. Check voltage between microphone connector R8 terminal 4 and ground.

Microphone		Ground	Value (Approx.)
Connector	Terminal		
R8	4	—	5V

Is the inspection result normal?

YES >> GO TO 3.

NO >> Replace Bluetooth® control unit. Refer to [AV-241. "Removal and Installation"](#).

3. CHECK MICROPHONE SIGNAL

Check signal between Bluetooth® control unit connector B141 with CONSULT or and oscilloscope.

MICROPHONE SIGNAL CIRCUIT

< DTC/CIRCUIT DIAGNOSIS >

[DISPLAY AUDIO WITH AMPLIFIER]

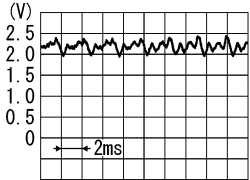
Bluetooth® control unit connector B141		Condition	Reference signal
(+)	(-)		
Terminal	Terminal		
7	8	Speak into microphone.	 <p>(V) 2.5 2.0 1.5 1.0 0.5 0</p> <p>← 2ms</p> <p>PKIB5037J</p>

Is the inspection result normal?

- YES >> Replace Bluetooth® control unit. Refer to [AV-241. "Removal and Installation"](#).
 NO >> Replace microphone. Refer to [AV-243. "Removal and Installation"](#).

USB CONNECTOR

< DTC/CIRCUIT DIAGNOSIS >

[DISPLAY AUDIO WITH AMPLIFIER]

USB CONNECTOR

Diagnosis Procedure

INFOID:000000009482163

Regarding Wiring Diagram information, refer to [AV-177. "Wiring Diagram"](#).

1. CHECK USB INTERFACE HARNESS CONTINUITY

1. Turn ignition switch OFF.
2. Disconnect audio unit connector M65 and USB interface connector M214.
3. Check continuity between audio unit connector M65 and USB interface connector M214.

Audio unit		USB interface		Continuity
Connector	Terminal	Connector	Terminal	
M65	53	M214	4	Yes
	54		1	
	55		2	
	56		3	
	57		5	

4. Check continuity between audio unit connector M65 and ground.

Audio unit		—	Continuity
Connector	Terminal		
M65	54	Ground	No
	57		

Is the inspection result normal?

- YES >> Replace the USB interface. Refer to [AV-247. "Removal and Installation"](#).
NO >> Repair or replace harness or connectors.

SYMPTOM DIAGNOSIS

AUDIO SYSTEM

Symptom Table

INFOID:000000009482164

RELATED TO AUDIO

Symptoms	Check items	Probable malfunction location
The disk cannot be removed.	Audio unit	Malfunction in audio unit. Refer to AV-163. "On Board Diagnosis Function" .
No sound comes out or the level of the sound is low.	No sound from all speakers.	<ul style="list-style-type: none"> • Speaker circuit shorted to ground. Refer to AV-177. "Wiring Diagram". • Audio amp. ON signal circuit malfunction. Refer to AV-216. "Diagnosis Procedure". • Audio amplifier power supply and ground circuits malfunction. Refer to AV-197. "AUDIO AMP : Diagnosis Procedure".
	Only a certain speaker (front door speaker LH, front door speaker RH, front tweeter LH, front tweeter RH, rear door speaker LH, rear door speaker RH, rear tweeter LH, rear tweeter RH, subwoofer) does not output sound.	<ul style="list-style-type: none"> • Poor connector connection of speaker. • Sound signal circuit malfunction between audio unit and audio amplifier. Refer to: <ul style="list-style-type: none"> - AV-201. "Diagnosis Procedure" (front door speaker). - AV-207. "Diagnosis Procedure" (rear door speaker). • Sound signal circuit malfunction between audio amplifier and speaker. Refer to: <ul style="list-style-type: none"> - AV-201. "Diagnosis Procedure" (front door speaker). - AV-204. "Diagnosis Procedure" (front tweeter). - AV-207. "Diagnosis Procedure" (rear door speaker). - AV-210. "Diagnosis Procedure" (rear tweeter). - AV-213. "Diagnosis Procedure" (subwoofer). • Malfunction in speaker. Refer to: <ul style="list-style-type: none"> - AV-236. "Removal and Installation" (front door speaker). - AV-235. "Removal and Installation" (front tweeter). - AV-237. "Removal and Installation" (rear door speaker). - AV-238. "Removal and Installation" (rear tweeter). - AV-239. "Removal and Installation" (subwoofer). • Malfunction in audio unit. Refer to AV-163. "On Board Diagnosis Function". • Malfunction in audio amplifier. Replace audio amplifier. Refer to AV-234. "Removal and Installation".

AUDIO SYSTEM

< SYMPTOM DIAGNOSIS >

[DISPLAY AUDIO WITH AMPLIFIER]

Symptoms	Check items	Probable malfunction location
Noise is mixed with audio.	Noise comes out from all speakers.	<ul style="list-style-type: none"> • Malfunction in audio unit. Refer to AV-163. "On Board Diagnosis Function". • Malfunction in audio amplifier. Replace audio amplifier. Refer to AV-234. "Removal and Installation".
	Noise comes out only from a certain speaker (front door speaker LH, front door speaker RH, front tweeter LH, front tweeter RH, rear door speaker LH, rear door speaker RH, rear tweeter LH, rear tweeter RH, sub-woofer).	<ul style="list-style-type: none"> • Poor connector connection of speaker. • Sound signal circuit malfunction between audio unit and audio amplifier. Refer to: <ul style="list-style-type: none"> - AV-201. "Diagnosis Procedure" (front door speaker). - AV-207. "Diagnosis Procedure" (rear door speaker). • Sound signal circuit malfunction between audio amplifier and speaker. Refer to: <ul style="list-style-type: none"> - AV-201. "Diagnosis Procedure" (front door speaker). - AV-204. "Diagnosis Procedure" (front tweeter). - AV-207. "Diagnosis Procedure" (rear door speaker). - AV-210. "Diagnosis Procedure" (rear tweeter). - AV-213. "Diagnosis Procedure" (sub-woofer). • Malfunction in speaker. • Poor Installation of speaker (e.g. backlash and looseness). Refer to: <ul style="list-style-type: none"> - AV-236. "Removal and Installation" (front door speaker). - AV-235. "Removal and Installation" (front tweeter). - AV-237. "Removal and Installation" (rear door speaker). - AV-238. "Removal and Installation" (rear tweeter). - AV-239. "Removal and Installation" (sub-woofer). • Malfunction in audio unit. Refer to AV-163. "On Board Diagnosis Function". • Malfunction in audio amplifier. Replace audio amplifier. Refer to AV-234. "Removal and Installation".
	Noise is mixed with radio only (when the vehicle hits a bump or while driving over bad roads)	<ul style="list-style-type: none"> • Malfunction in audio unit. Refer to AV-163. "On Board Diagnosis Function". • Malfunction in audio amplifier. Replace audio amplifier. Refer to AV-234. "Removal and Installation".
No radio reception or poor reception.	<ul style="list-style-type: none"> • Other audio sounds are normal. • Any radio station cannot be received or poor reception is caused even after moving to a service area with good reception (e.g. a place with clear view and no obstacles generating external noises). 	<ul style="list-style-type: none"> • Antenna amp. ON signal circuit malfunction. Refer to AV-216. "Diagnosis Procedure". • Rod antenna is not fully connected to antenna base. • Antenna base/rod connection (thread zone) has foreign material or corrosion inside. • Poor connector connection of antenna or antenna feeder. Refer to AV-244. "Location of Antenna".

A
B
C
D
E
F
G
H
I
J
K
L
M
AV

AUDIO SYSTEM

< SYMPTOM DIAGNOSIS >

[DISPLAY AUDIO WITH AMPLIFIER]

Symptoms	Check items	Probable malfunction location
No satellite radio reception.	Satellite radio antenna malfunction.	<ul style="list-style-type: none"> • Poor continuity in antenna feeder. • Poor connector connection of antenna or antenna feeder. • Loose satellite radio antenna mounting nut. Refer to AV-244, "Location of Antenna".
Buzz/rattle sound from speaker	The majority of buzz/rattle sounds are not indicative of an issue with the speaker, usually something nearby the speaker is causing the buzz/rattle.	Refer to "SQUEAK AND RATTLE TROUBLE DIAGNOSIS" in the appropriate interior trim section.

RELATED TO HANDS-FREE PHONE

- Before performing diagnosis, confirm that the cellular phone being used by the customer is compatible with the vehicle.
- It is possible that a malfunction is occurring due to a version change of the phone even though the phone is a compatible type. This can be confirmed by changing the cellular phone to another compatible type, and check that it operates normally. It is important to determine whether the cause of the malfunction is the vehicle or the cellular phone.

Check Compatibility



1. Make sure the customer's Bluetooth® related concern is understood.
2. Verify the customer's concern.
NOTE:
The customer's phone may be required, depending upon their concern.
3. Write down the customer's phone brand, model and service provider.
NOTE:
It is necessary to know the service provider. On occasion, a given phone may be on the approved list with one provider, but may not be on the approved list with other providers.
4. Go to "www.nissanusa.com/bluetooth/".
 - a. Using the website's search engine, find out if the customer's phone is on the approved list.
 - b. If the customer's phone is NOT on the approved list:
Stop diagnosis here. The customer needs to obtain a Bluetooth® phone that is on the approved list before any further action.
 - c. If the feature related to the customer's concern shows as "N" (not compatible):
Stop diagnosis here. If the customer still wants the feature to function, they will need to get an approved phone showing the feature as "Y" (compatible) in the "Basic Features".
 - d. If the feature related to the customer's concern shows as "Y" (compatible):
Perform diagnosis as per the following table.

Symptoms	Check items	Probable malfunction location
Does not recognize cellular phone connection (no connection is displayed on the display at the guide).	Repeat the registration of cellular phone.	
Hands-free phone cannot be established.	<ul style="list-style-type: none"> • Hands-free phone operation can be made, but the communication cannot be established. • Hands-free phone operation can be performed, however, voice between each other cannot be heard during the conversation. 	Malfunction in audio unit. Replace audio unit. Refer to AV-233, "Removal and Installation" .
The other party's voice cannot be heard by hands-free phone.	Check the "microphone speaker" in Inspection & Adjustment Mode if sound is heard.	
Originating sound is not heard by the other party with hands-free phone communication.	Sound operation function is normal.	
	Sound operation function does not work.	Microphone signal circuit malfunction. Refer to AV-221, "Diagnosis Procedure" .

AUDIO SYSTEM

< SYMPTOM DIAGNOSIS >

[DISPLAY AUDIO WITH AMPLIFIER]

Symptoms	Check items	Probable malfunction location
The system cannot be operated.	<ul style="list-style-type: none"> • The voice recognition can be controlled. • Steering switch's VOL UP and VOL DOWN switch works, but  does not work. 	Steering switch malfunction. Replace steering switch. Refer to AV-240, "Removal and Installation" .
	Steering switch's  , VOL UP and VOL DOWN switches do not work.	Steering switch signal circuit malfunction. Refer to AV-219, "Diagnosis Procedure" .
	All steering switches do not work.	Steering switch ground circuit malfunction. Refer to AV-219, "Diagnosis Procedure" .

RELATED TO REAR VIEW CAMERA

Symptoms	Check items	Probable malfunction location
Rear view camera is inoperative.	Reverse signal circuit malfunction.	Reverse signal circuit malfunction between BCM and audio unit. Refer to AV-217, "Diagnosis Procedure" .
	Camera image signal circuit malfunction.	Camera image signal circuit malfunction between rear view camera and audio unit. Refer to AV-217, "Diagnosis Procedure" .
	Rear view camera malfunction.	Replace rear view camera. Refer to AV-248, "Removal and Installation" .

A
B
C
D
E
F
G
H
I
J
K
L
M

AV

O
P

NORMAL OPERATING CONDITION

< SYMPTOM DIAGNOSIS >

[DISPLAY AUDIO WITH AMPLIFIER]

NORMAL OPERATING CONDITION

Description

INFOID:000000009482165

RELATED TO NOISE

The majority of the audio concerns are the result of outside causes (bad CD, electromagnetic interference, etc.).

The following noise results from variations in field strength, such as fading noise and multi-path noise, or external noise from trains and other sources. It is not a malfunction.

- Fading noise: This noise occurs because of variations in the field strength in a narrow range due to mountains or buildings blocking the signal.
- Multi-path noise: This noise results from the waves sent directly from the broadcast station arriving at the antenna at a different time from the waves which reflect off mountains or buildings.

The vehicle itself can be a source of noise if noise prevention parts or electrical equipment is malfunctioning. Check if noise is caused and/or changed by engine speed, ignition switch turned to each position, and operation of each piece of electrical equipment, and determine the cause.

NOTE:

The source of the noise can be found easily by listening to the noise while removing the fuses of electrical components, one by one.

Type of Noise and Possible Cause

Occurrence condition		Possible cause
Occurs only when engine is ON.	A continuous growling noise occurs. The speed of the noise varies with changes in the engine speed.	• Ignition components
The occurrence of the noise is linked with the operation of the fuel pump.		• Fuel pump condenser
Noise only occurs when various electrical components are operating.	A cracking or snapping sound occurs with the operation of various switches.	• Relay malfunction, audio unit malfunction
	The noise occurs when various motors are operating.	• Motor case ground • Motor
The noise occurs constantly, not just under certain conditions.		• Rear defogger coil malfunction • Open circuit in printed heater • Poor ground of antenna feeder line
A cracking or snapping sound occurs while the vehicle is being driven, especially when it is vibrating excessively.		• Ground wire of body parts • Ground due to improper part installation • Wiring connections or a short circuit

RELATED TO HANDS-FREE PHONE

Symptom	Cause and Counter measure
Does not recognize cellular phone connection (No connection is displayed on the display at the guide).	Some Bluetooth® enabled cellular phones may not be recognized by the in-vehicle phone module. Refer to "RELATED TO HANDS-FREE PHONE (Check Compatibility)" in AV-224. "Symptom Table" .
Cannot use hands-free phone.	Customer will not be able to use a hands-free phone under the following conditions: <ul style="list-style-type: none">• The vehicle is outside of the telephone service area.• The vehicle is in an area where it is difficult to receive radio waves; such as in a tunnel, in an underground parking garage, near a tall building or in a mountainous area.• The cellular phone is locked to prevent it from being dialed. NOTE: While a cellular phone is connected through the Bluetooth® wireless connection, the battery power of the cellular phone may discharge quicker than usual. The Bluetooth® Hands-Free Phone System cannot charge cellular phones.

NORMAL OPERATING CONDITION

< SYMPTOM DIAGNOSIS >

[DISPLAY AUDIO WITH AMPLIFIER]

Symptom	Cause and Counter measure
The other party's voice cannot be heard by hands-free phone.	When the radio wave condition is not ideal or ambient sound is too loud, it may be difficult to hear the other person's voice during a call.
Poor sound quality.	Do not place the cellular phone in an area surrounded by metal or far away from the in-vehicle phone module to prevent tone quality degradation and wireless connection disruption.

A
B
C
D
E
F
G
H
I
J
K
L
M
O
P

AV

PRECAUTIONS

< PRECAUTION >

[DISPLAY AUDIO WITH AMPLIFIER]

PRECAUTION

PRECAUTIONS

Precaution for Supplemental Restraint System (SRS) "AIR BAG" and "SEAT BELT PRE-TENSIONER"

INFOID:000000010138333

The Supplemental Restraint System such as "AIR BAG" and "SEAT BELT PRE-TENSIONER", used along with a front seat belt, helps to reduce the risk or severity of injury to the driver and front passenger for certain types of collision. This system includes seat belt switch inputs and dual stage front air bag modules. The SRS system uses the seat belt switches to determine the front air bag deployment, and may only deploy one front air bag, depending on the severity of a collision and whether the front occupants are belted or unbelted. Information necessary to service the system safely is included in the SR and SB section of this Service Manual.

WARNING:

- To avoid rendering the SRS inoperative, which could increase the risk of personal injury or death in the event of a collision which would result in air bag inflation, all maintenance must be performed by an authorized NISSAN/INFINITI dealer.
- Improper maintenance, including incorrect removal and installation of the SRS, can lead to personal injury caused by unintentional activation of the system. For removal of Spiral Cable and Air Bag Module, see the SR section.
- Do not use electrical test equipment on any circuit related to the SRS unless instructed to in this Service Manual. SRS wiring harnesses can be identified by yellow and/or orange harnesses or harness connectors.

PRECAUTIONS WHEN USING POWER TOOLS (AIR OR ELECTRIC) AND HAMMERS

WARNING:

- When working near the Airbag Diagnosis Sensor Unit or other Airbag System sensors with the Ignition ON or engine running, DO NOT use air or electric power tools or strike near the sensor(s) with a hammer. Heavy vibration could activate the sensor(s) and deploy the air bag(s), possibly causing serious injury.
- When using air or electric power tools or hammers, always switch the Ignition OFF, disconnect the battery and wait at least three minutes before performing any service.

Precaution for Trouble Diagnosis

INFOID:000000009482167

AV COMMUNICATION SYSTEM

- Do not apply voltage of 7.0 V or higher to the measurement terminals.
- Use the tester with its open terminal voltage being 7.0 V or less.
- Be sure to turn ignition switch OFF and disconnect the battery cable from the negative terminal before checking the circuit.

Precaution for Harness Repair

INFOID:000000009482168

AV COMMUNICATION SYSTEM

- Solder the repaired parts, and wrap with tape. [Frays of twisted line must be within 110 mm (4.33 in).]

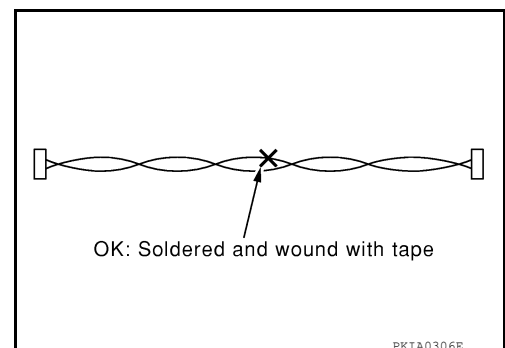

PRECAUTIONS

< PRECAUTION >

[DISPLAY AUDIO WITH AMPLIFIER]

- Do not perform bypass wire connections for the repair parts. (The spliced wire will become separated and the characteristics of twisted line will be lost.)

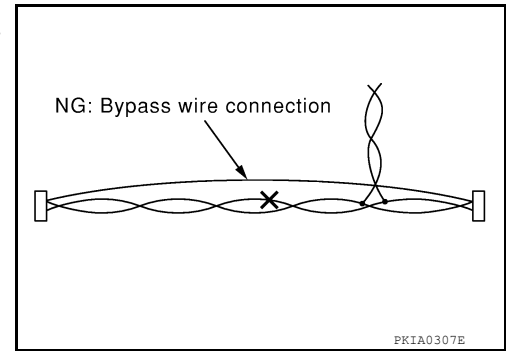

Precaution for Work

INFOID:000000009482169

- When removing or disassembling each component, be careful not to damage or deform it. If a component may be subject to interference, be sure to protect it with a shop cloth.
- When removing (disengaging) components with a screwdriver or similar tool, be sure to wrap the component with a shop cloth or vinyl tape to protect it.
- Protect the removed parts with a shop cloth and prevent them from being dropped.
- Replace a deformed or damaged clip.
- If a part is specified as a non-reusable part, always replace it with a new one.
- Be sure to tighten bolts and nuts securely to the specified torque.
- After installation is complete, be sure to check that each part works properly.
- Follow the steps below to clean components:
 - Water soluble dirt:
 - Dip a soft cloth into lukewarm water, wring the water out of the cloth and wipe the dirty area.
 - Then rub with a soft, dry cloth.
 - Oily dirt:
 - Dip a soft cloth into lukewarm water with mild detergent (concentration: within 2 to 3%) and wipe the dirty area.
 - Then dip a cloth into fresh water, wring the water out of the cloth and wipe the detergent off.
 - Then rub with a soft, dry cloth.
 - Do not use organic solvent such as thinner, benzene, alcohol or gasoline.
 - For genuine leather seats, use a genuine leather seat cleaner.

A
B
C
D
E
F
G
H
I
J
K
L
M

AV

O
P

PREPARATION

< PREPARATION >

[DISPLAY AUDIO WITH AMPLIFIER]

PREPARATION

PREPARATION

Special Service Tools

INFOID:000000009482170

The actual shape of the tools may differ from those illustrated here.

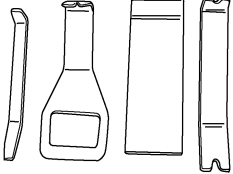
Tool number (TechMate No.) Tool name	Description
<p>— (J-46534) Trim Tool Set</p>  <p style="text-align: center;">AWJIA04832Z</p>	<p>Removing trim components</p>

Commercial Service Tools

INFOID:000000009482171

Tool name	Description
<p>Power tool</p>  <p style="text-align: center;">PIIB1407E</p>	<p>Loosening nuts, screws and bolts</p>

REMOVAL AND INSTALLATION

AUDIO UNIT

Removal and Installation

INFOID:000000009482172

REMOVAL

1. Disconnect the negative battery terminal. Refer to [PG-83. "Removal and Installation"](#).
2. Remove cluster lid C. Refer to [IP-19. "Removal and Installation"](#).
3. Remove the screws (A) from the bracket.
4. Remove the audio unit (1) from cluster lid C.

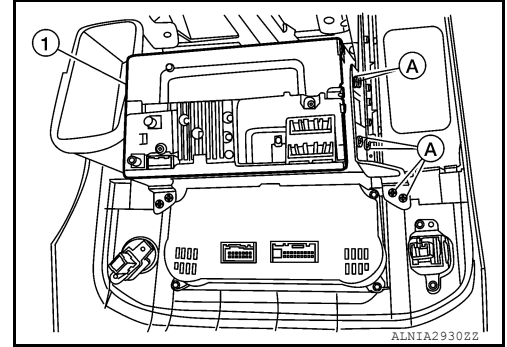

INSTALLATION

Installation is in the reverse order of removal.

A
B
C
D
E
F
G
H
I
J
K
L
M

AV

O
P

AUDIO AMP.

< REMOVAL AND INSTALLATION >

[DISPLAY AUDIO WITH AMPLIFIER]

AUDIO AMP.

Removal and Installation

INFOID:000000009482173

REMOVAL

NOTE:

Do not remove the RH front seat from the vehicle.

1. Remove the RH front seat bolts, disconnect the harness connectors from the RH front seat. Refer to [SE-32. "Removal and Installation"](#).
2. Tilt the RH front seat back to access the audio amp. (1) and remove the audio amp. kick shield screws (C).
⇐: Front
3. Disconnect the harness connectors (A) from the audio amp. and remove the audio amp. (1) from the bracket (2).
4. Remove the audio amp. bracket screws (B) and bracket (2).

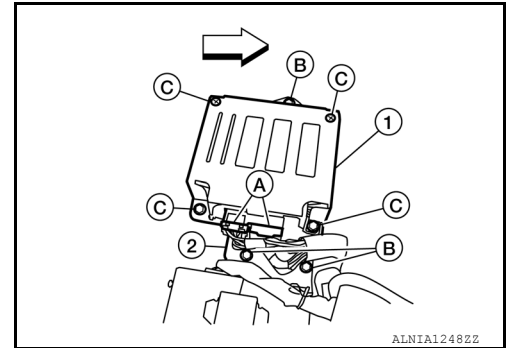

INSTALLATION

Installation is in the reverse order of removal.

FRONT TWEETER

< REMOVAL AND INSTALLATION >

[DISPLAY AUDIO WITH AMPLIFIER]

FRONT TWEETER

Removal and Installation

INFOID:000000009482174

REMOVAL

1. Remove the front tweeter grille.
2. Remove the front tweeter screws (A).
3. Pull out the front tweeter (1), then disconnect the harness connector from the front tweeter and remove.

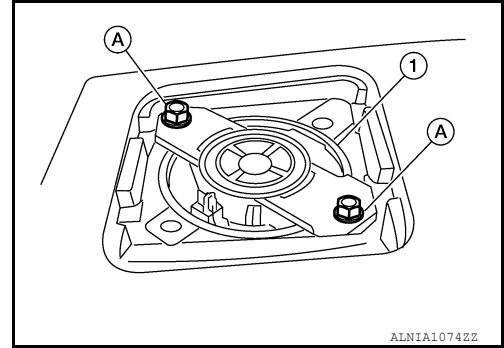

INSTALLATION

Installation is in the reverse order of removal.

A
B
C
D
E
F
G
H
I
J
K
L
M
O
P

AV

FRONT DOOR SPEAKER

< REMOVAL AND INSTALLATION >

[DISPLAY AUDIO WITH AMPLIFIER]

FRONT DOOR SPEAKER

Removal and Installation

INFOID:000000009482175

REMOVAL

1. Remove the front door finisher. Refer to [INT-15, "Removal and Installation"](#).
2. Remove the front door speaker screws (A).
3. Pull out the front door speaker (1).
4. Disconnect the harness connector from the front door speaker (1) and remove.

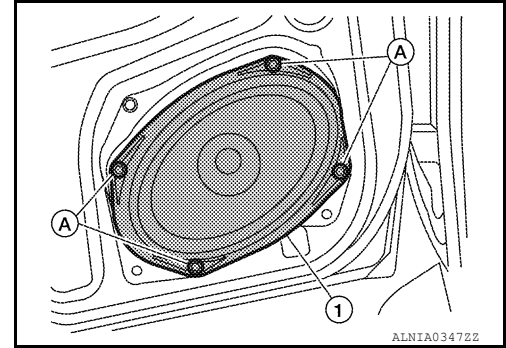

INSTALLATION

Installation is in the reverse order of removal.

REAR DOOR SPEAKER

< REMOVAL AND INSTALLATION >

[DISPLAY AUDIO WITH AMPLIFIER]

REAR DOOR SPEAKER

Removal and Installation

INFOID:000000009482176

REMOVAL

1. Remove the rear door finisher. Refer to [INT-15. "Removal and Installation"](#).
2. Remove the rear door speaker screws (A).
3. Disconnect the harness connector (B) from the rear door speaker (1) and remove.

NOTE:

King cab shown, crew cab similar.

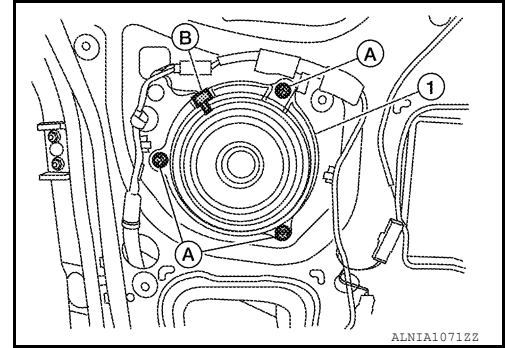

INSTALLATION

Installation is in the reverse order of removal.

A
B
C
D
E
F
G
H
I
J
K
L
M
O
P

AV

REAR TWEETER

< REMOVAL AND INSTALLATION >

[DISPLAY AUDIO WITH AMPLIFIER]

REAR TWEETER

Removal and Installation

INFOID:000000009482177

REMOVAL

1. Remove the rear door finisher. Refer to [INT-15. "Removal and Installation"](#).
2. Remove the rear door tweeter screws (A) and the rear door tweeter (1).

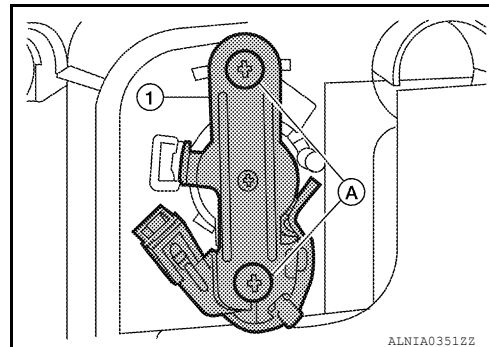

INSTALLATION

Installation is in the reverse order of removal.

SUBWOOFER

< REMOVAL AND INSTALLATION >

[DISPLAY AUDIO WITH AMPLIFIER]

SUBWOOFER

Removal and Installation

INFOID:000000009482178

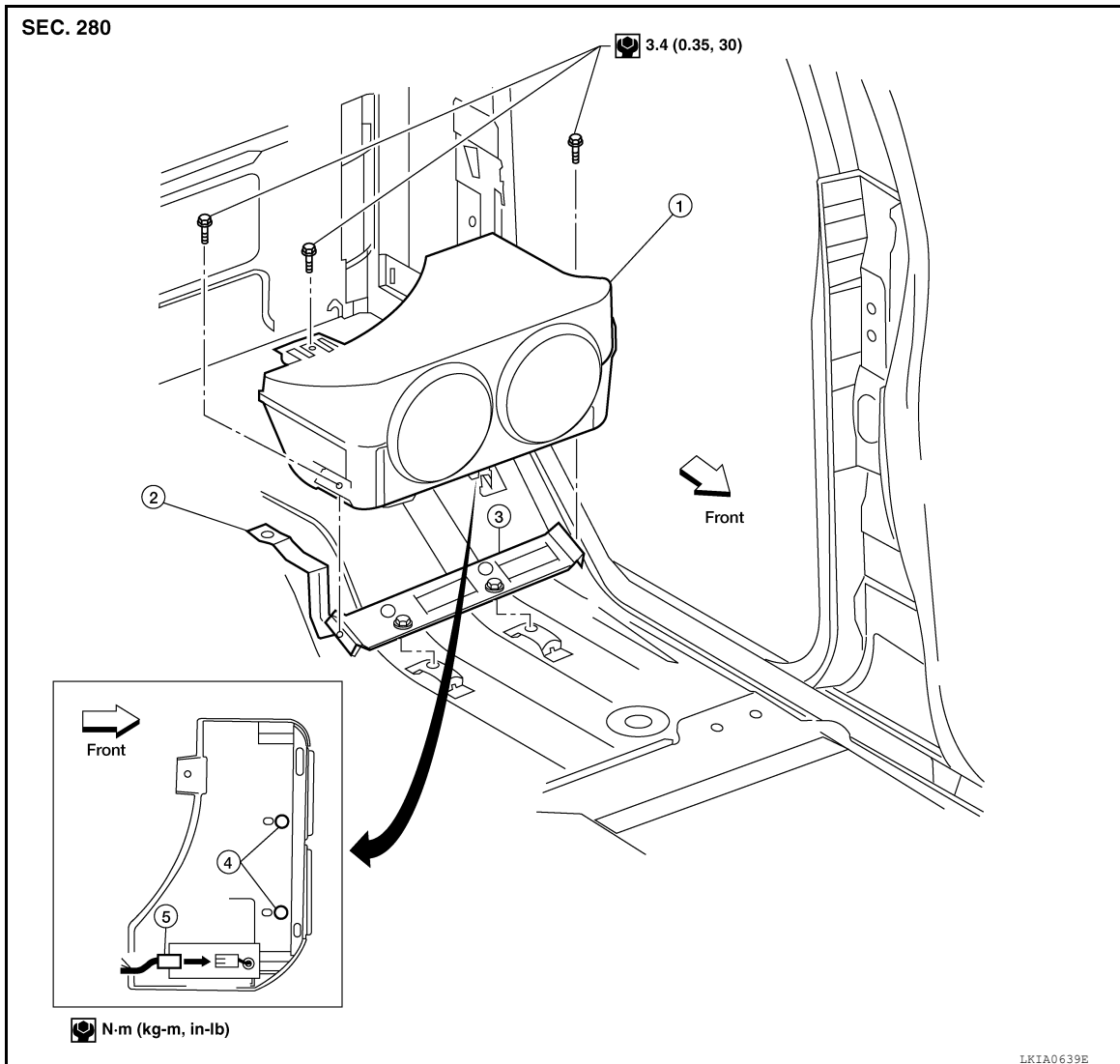

- | | | |
|-----------------|--------------|-----------------------|
| 1. Subwoofer | 2. Bracket | 3. Locating pin plate |
| 4. Locating pin | 5. Connector | |

REMOVAL

1. Position the LH rear seat cushion in the folded up position.
2. Remove storage box (RH) (crew cab). Refer to [INT-23, "Removal and Installation"](#).
3. Remove the subwoofer screws.
4. Disconnect the harness connector from the subwoofer and remove.

INSTALLATION

Installation is in the reverse order of removal.

A
B
C
D
E
F
G
H
I
J
K
L
M
N
O
P

AV

STEERING SWITCH

< REMOVAL AND INSTALLATION >

[DISPLAY AUDIO WITH AMPLIFIER]

STEERING SWITCH

Removal and Installation

INFOID:000000009482179

Removal and Installation

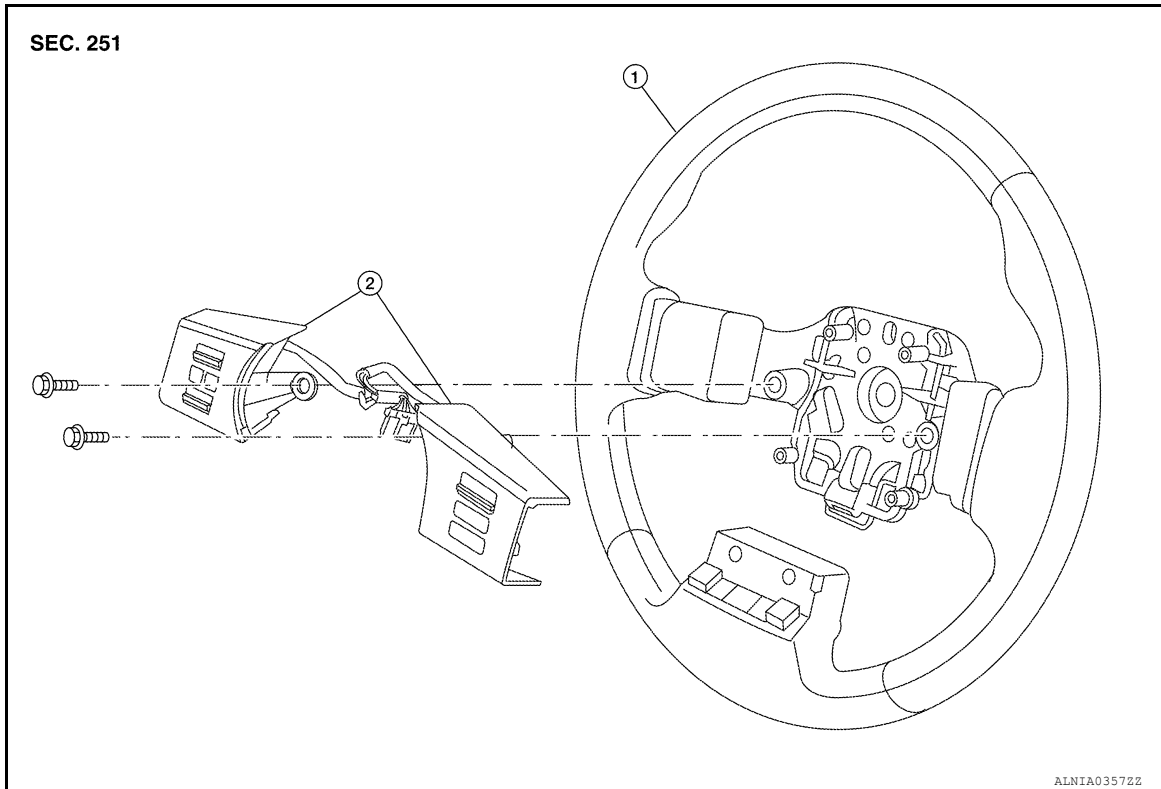

1. Steering wheel

2. Steering wheel audio control switches

REMOVAL

1. Remove the driver air bag module. Refer to [SR-11, "Removal and Installation"](#).
2. Remove the steering wheel audio control switch assembly screws.
3. Disconnect the harness connectors from the steering wheel audio control switches.
4. Remove the steering wheel audio control switches by pulling on steering wheel audio control switches to release the pawls.

○: Pawl

CAUTION:

Do not tilt steering wheel audio control switches during removal or damage may occur to the pawls.

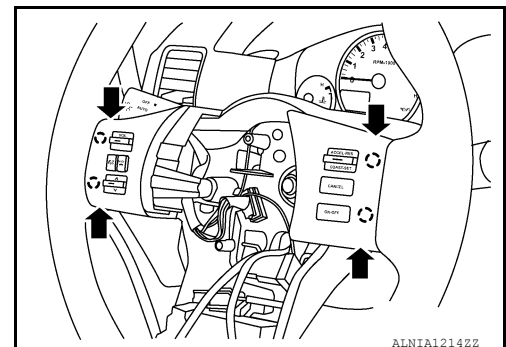

INSTALLATION

Installation is in the reverse order of removal.

BLUETOOTH CONTROL UNIT

< REMOVAL AND INSTALLATION >

[DISPLAY AUDIO WITH AMPLIFIER]

BLUETOOTH CONTROL UNIT

Removal and Installation

INFOID:00000009482180

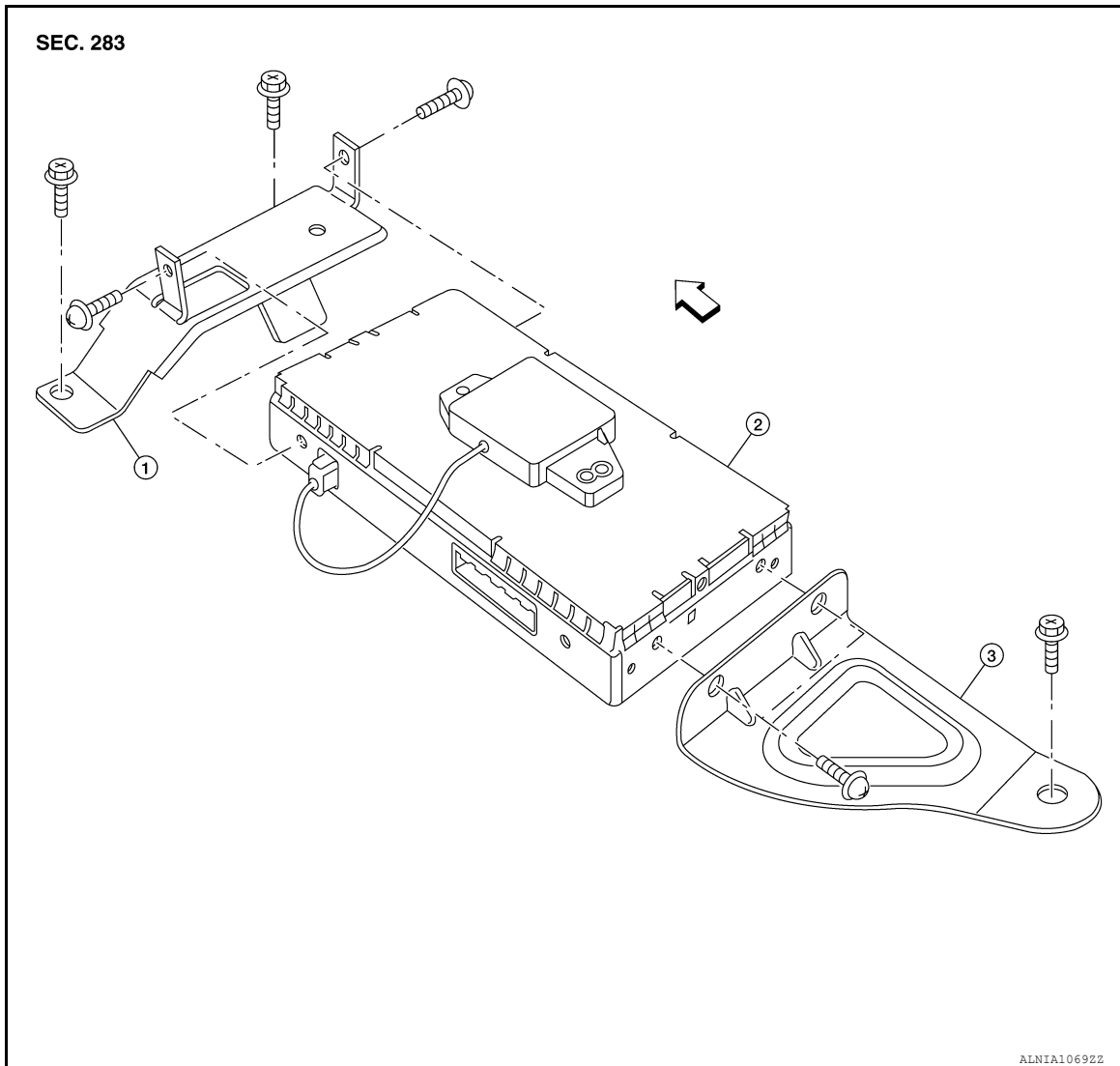

1. Bluetooth control unit front bracket 2. Bluetooth control unit/antenna 3. Bluetooth control unit rear bracket
↔ Front

REMOVAL

NOTE:

Do not remove the RH front seat from the vehicle.

1. Remove the RH front seat bolts, disconnect the harness connectors from the RH front seat. Refer to [SE-32. "Removal and Installation"](#).
2. Tilt the RH front seat back to access the bluetooth control unit.

A
B
C
D
E
F
G
H
I
J
K
L
M
N
O
P

AV

BLUETOOTH CONTROL UNIT

< REMOVAL AND INSTALLATION >

[DISPLAY AUDIO WITH AMPLIFIER]

3. Disconnect the harness connector (B) from the Bluetooth control unit.
4. Remove the Bluetooth control unit screws (A), then remove the Bluetooth control unit assembly (1).
5. Remove the Bluetooth control unit bracket screws and Bluetooth control unit front and rear brackets.

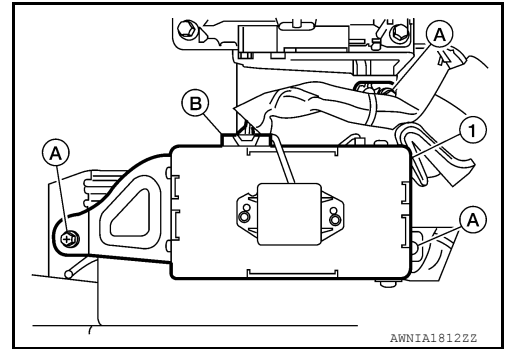

INSTALLATION

Installation is in the reverse order of removal.

MICROPHONE

< REMOVAL AND INSTALLATION >

[DISPLAY AUDIO WITH AMPLIFIER]

MICROPHONE

Removal and Installation

INFOID:000000009482181

REMOVAL

1. Remove the roof console. Refer to [INT-25, "Removal and Installation"](#).
2. Release the pawls that retain the Bluetooth microphone (1) to the roof console.
3. Disconnect the harness connector (A) from the Bluetooth microphone (1) and remove.

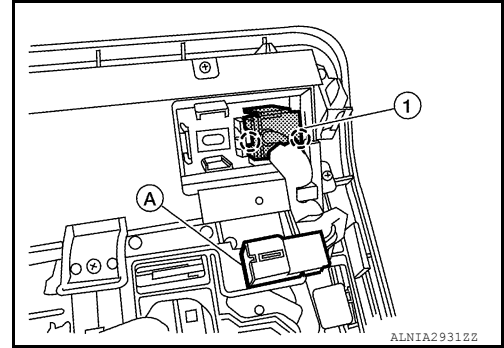

INSTALLATION

Installation is in the reverse order of removal.

A
B
C
D
E
F
G
H
I
J
K
L
M

AV

O
P

AUDIO ANTENNA

< REMOVAL AND INSTALLATION >

[DISPLAY AUDIO WITH AMPLIFIER]

AUDIO ANTENNA

Location of Antenna

INFOID:000000009482182

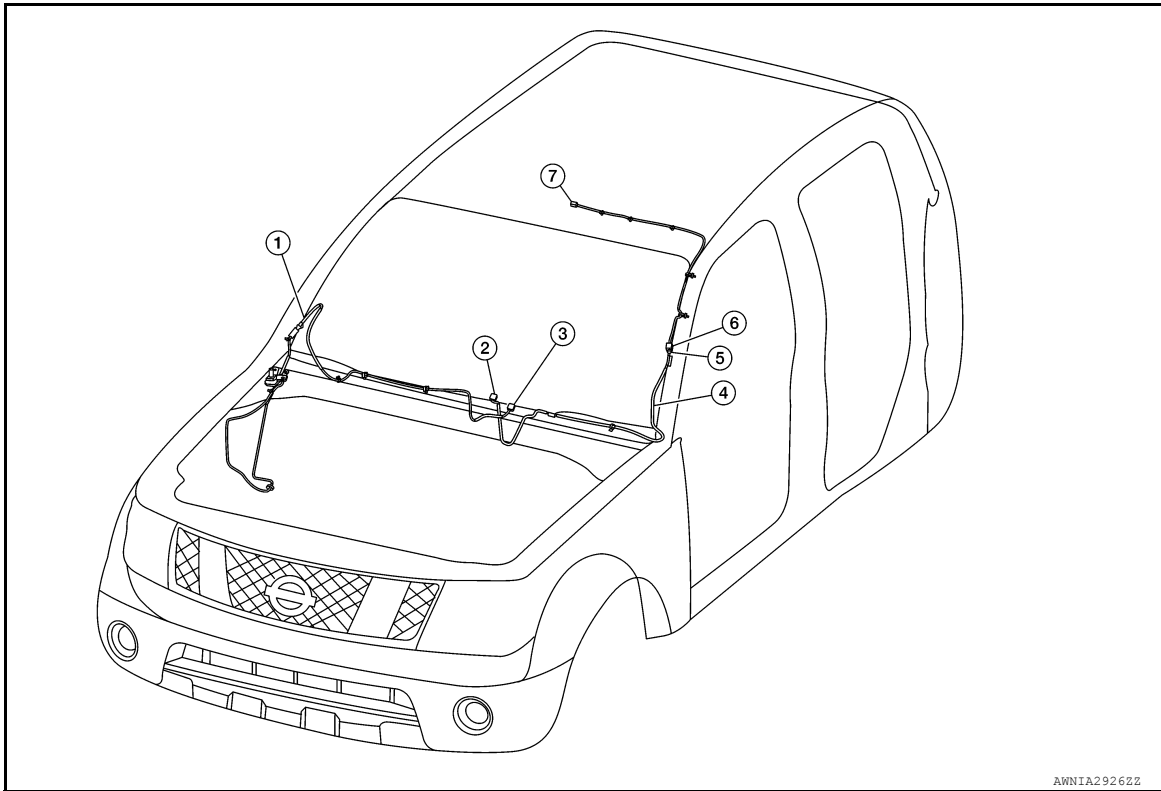

AWNIA2926ZZ

- | | | |
|-----------------------------|--------|---------|
| 1. Coaxial antenna feeder | 2. M48 | 3. M37 |
| 4. Satellite antenna feeder | 5. M67 | 6. M500 |
| 7. M501 | | |

Removal and Installation

INFOID:000000009482183

REMOVAL

1. Remove instrument lower panel RH and glove box. Refer to [IP-24. "Removal and Installation"](#).
2. Disconnect audio antenna cable from antenna feeder.

AUDIO ANTENNA

< REMOVAL AND INSTALLATION >

[DISPLAY AUDIO WITH AMPLIFIER]

3. Remove antenna rod.
4. Remove rubber seal.
5. Remove cowl top. Refer to [EXT-24. "Removal and Installation"](#).
6. Remove fender protector. Refer to [EXT-27. "Removal and Installation of Front Fender Protector"](#).
7. Remove antenna base bolts.
8. Remove antenna base and cable.

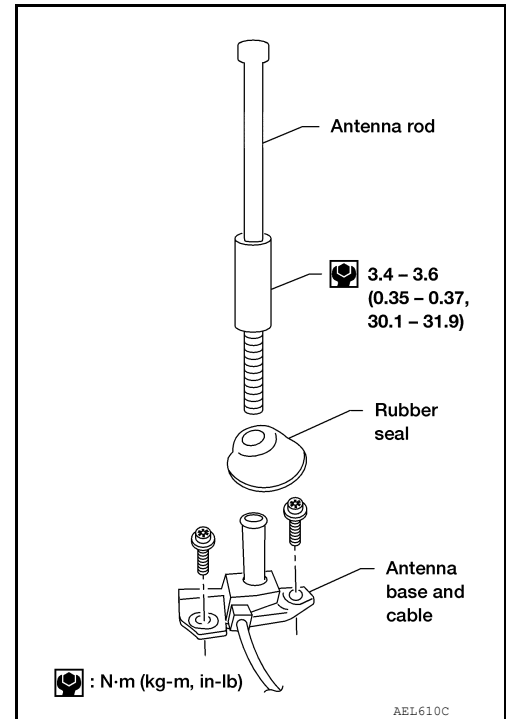

INSTALLATION

Installation is in the reverse order of removal.

CAUTION:

Always properly tighten the antenna rod during installation or the antenna rod may bend or break during vehicle operation.

A
B
C
D
E
F
G
H
I
J
K
L
M
AV
O
P

SATELLITE RADIO ANTENNA

< REMOVAL AND INSTALLATION >

[DISPLAY AUDIO WITH AMPLIFIER]

SATELLITE RADIO ANTENNA

Removal and Installation

INFOID:000000009482184

REMOVAL

1. Remove the roof console. Refer to [INT-25, "Removal and Installation"](#).
2. Disconnect the harness connector from the satellite radio antenna.
3. Remove the satellite radio antenna nut.
4. Remove the satellite radio antenna.

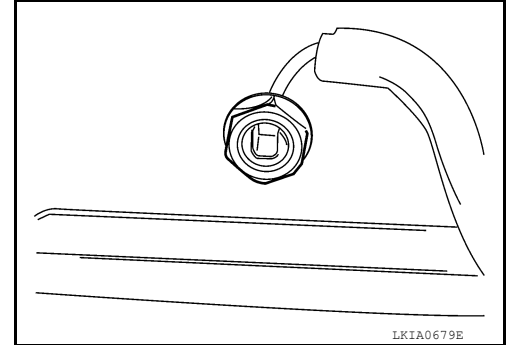

LKIA0679E

INSTALLATION

Installation is in the reverse order of removal.

USB CONNECTOR

< REMOVAL AND INSTALLATION >

[DISPLAY AUDIO WITH AMPLIFIER]

USB CONNECTOR

Removal and Installation

INFOID:000000009482185

REMOVAL

1. Remove the center console assembly. Refer to [IP-26. "Removal and Installation"](#).
2. Push the pawl from the back of the center console to remove the USB interface.

INSTALLATION

Installation is in the reverse order of removal.

A

B

C

D

E

F

G

H

I

J

K

L

M

AV

O

P

REAR VIEW CAMERA

< REMOVAL AND INSTALLATION >

[DISPLAY AUDIO WITH AMPLIFIER]

REAR VIEW CAMERA

Removal and Installation

INFOID:000000009482186

REMOVAL

1. Remove the tail gate protector. Refer to [EXT-38. "Removal and Installation"](#).
2. Remove the rear view camera screws and the rear view camera.

INSTALLATION

Installation is in the reverse order of removal.

SYSTEM DESCRIPTION

COMPONENT PARTS

Component Parts Location

INFOID:000000009482187

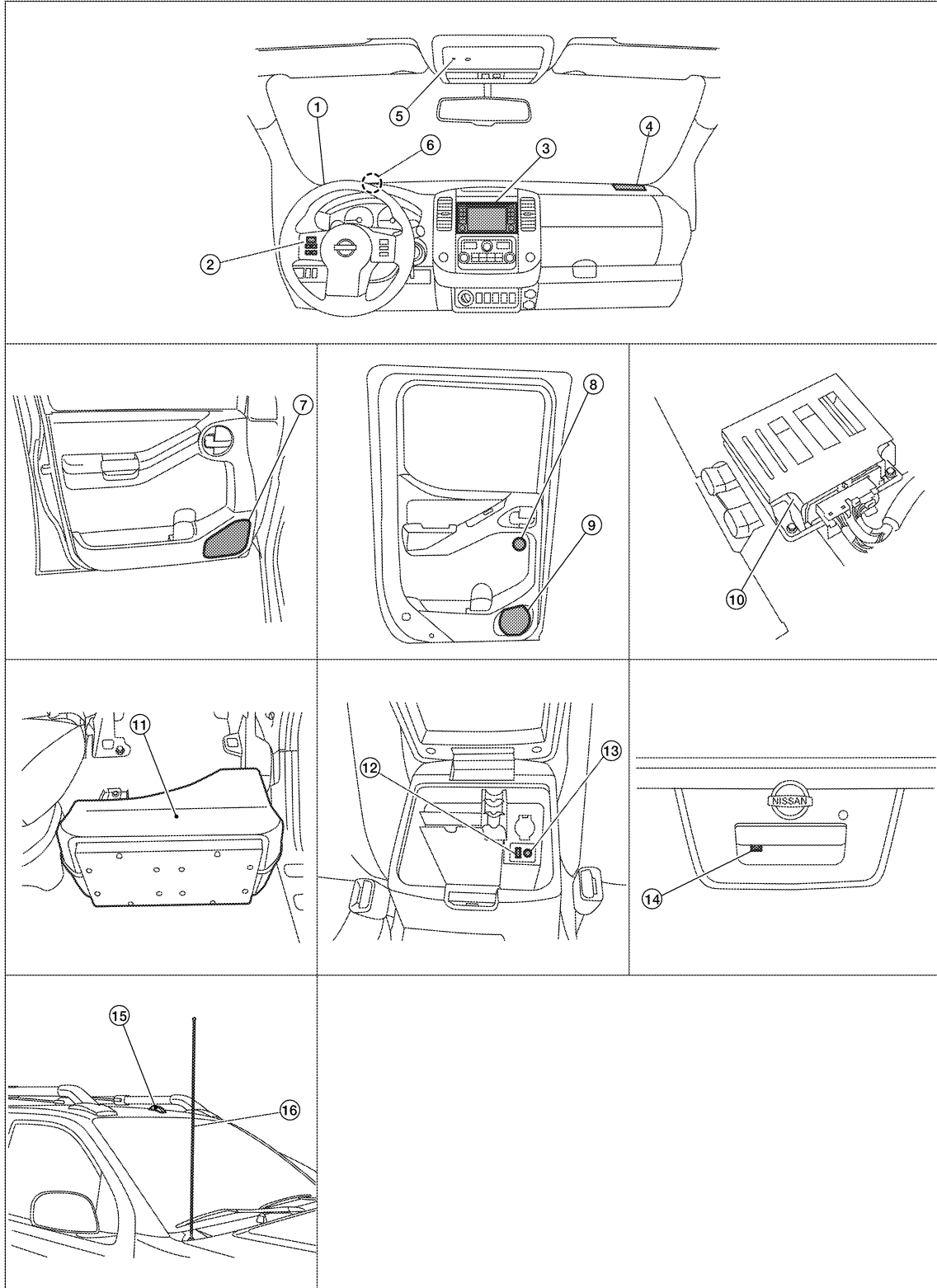

A
B
C
D
E
F
G
H
I
J
K
L
M
AV
O
P

COMPONENT PARTS

< SYSTEM DESCRIPTION >

[NAVIGATION]

- | | | |
|--|---|--|
| 1. Front tweeter LH M109 | 2. Steering wheel audio control switches | 3. AV control unit M96, M97, M98, M99, M100 |
| 4. Front tweeter RH M111 | 5. Microphone R8 | 6. GPS antenna (Underneath instrument panel, forward of combination meter) |
| 7. Front door speaker LH D12
Front door speaker RH D112 | 8. Rear door tweeter LH D208
Rear door tweeter RH D308 | 9. Rear door speaker LH D207
Rear door speaker RH D307 |
| 10. Audio amp B158, B159 (Underneath passenger seat) | 11. Subwoofer B72 (Underneath rear LH seat) | 12. USB interface M214 |
| 13. AUX in jack M215 | 14. Rear view camera C251 | 15. Satellite antenna |
| 16. Rod antenna | | |

Component Description

INFOID:000000009482188

Part name	Description
AV control unit	<ul style="list-style-type: none"> • Operation of navigation and audio systems are integrated. • Includes the audio, hands-free phone, navigation, satellite radio, rear view monitor, USB connection and AUX IN connection functions. • Map data can be loaded from SD-card inserted in SD-card slot. • Audio signals are output to audio amplifier. • Inputs illumination signals required for display dimming control. • Inputs signals for driving status recognition (vehicle speed and reverse). • Touch panel functions can be operated by touching display directly.
Map SD-card	A collection of Map data.
Audio amplifier	Receives audio signals from AV control unit and outputs audio signals to each speaker.
Front tweeters	Outputs high, mid and low range audio signals from audio amp.
Front door speakers	
Rear tweeters	
Rear door speakers	
Subwoofer	
Steering wheel audio control switches	<ul style="list-style-type: none"> • Operations for audio, hands-free phone and voice recognition are possible. • Steering switch signal is output to combination meter. • Combination meter outputs steering switch signal to AV control unit.
Microphone	<ul style="list-style-type: none"> • Used for hands-free phone operations. • Microphone signal is transmitted to AV control unit. • Power is supplied from AV control unit.
USB interface	USB sound and data signals are transmitted to AV control unit.
AUX input	Auxillary sound signals are transmitted to AV control unit.
Rear view camera	<ul style="list-style-type: none"> • Outputs image of vehicle rear to AV control unit. • Power is supplied from AV control unit.
Satellite antenna	Satellite radio signal is received and transmitted to AV control unit.
GPS antenna	GPS signal is received and transmitted to AV control unit.
Rod antenna	AM/FM signal is received and transmitted to AV control unit.

SYSTEM

System Diagram

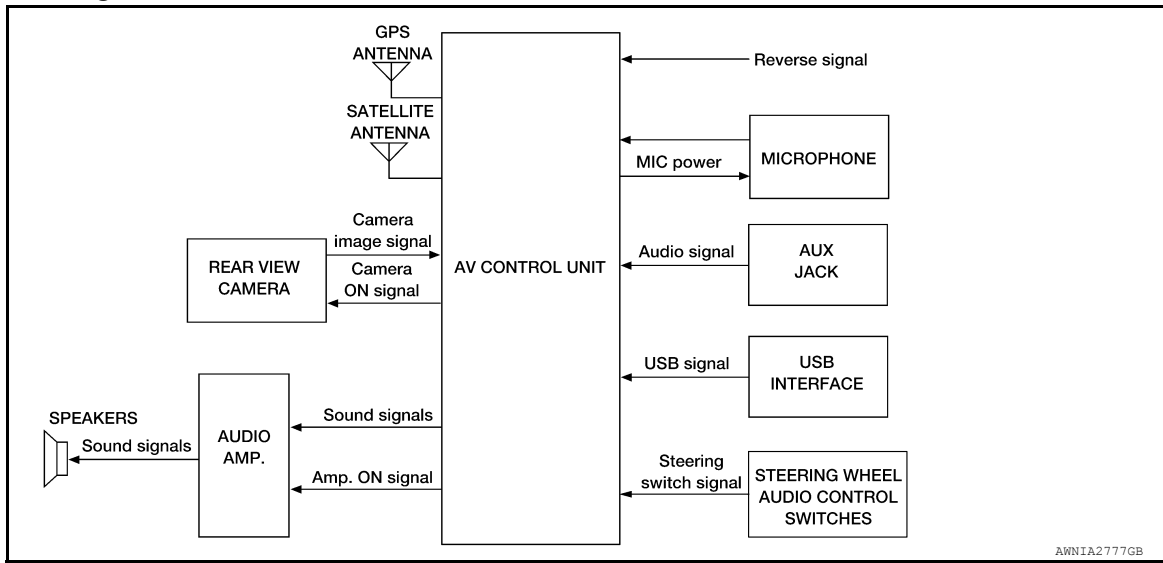

System Description

INFOID:000000009482190

Refer to Owner's Manual for navigation and audio system operating instructions. Audio function and display are built into AV control unit. This navigation has the following functions.

- Map data on SD-card
- Full support for playback of music from iPod® and USB device
- High resolution color 5 inch display with touch panel function
- FM/AM twin digital tuner
- USB mass storage connection
- Satellite radio
- Hands-free phone system

iPod® is a trademark of Apple inc., registered in the U.S. and other countries.

NAVIGATION SYSTEM FUNCTION

Description

- The navigation system can be operated by control panel of the AV control unit and display (touch panel) of the AV control unit.
- Guide sound during the operation of the navigation system is output from AV control unit to front speakers.
- AV control unit calculates the vehicle location based on the signals from GYRO (angle speed sensor), vehicle sensor, and GPS satellite, as well as the map data from map SD-card. The vehicle location is displayed on the AV control unit.

POSITION DETECTION PRINCIPLE

The navigation system periodically calculates the vehicle's current position according to the following three signals:

- Travel distance of the vehicle as determined by the vehicle speed sensor
- Turning angle of the vehicle as determined by the gyroscope (angular velocity sensor)
- Direction of vehicle travel as determined by the GPS antenna (GPS information)

The current position of the vehicle is then identified by comparing the calculated vehicle position with map data read from the map SD-card (map-matching), and indicated on the screen as a vehicle mark. More accurate data is judged and used by comparing vehicle position detection results found by the GPS with the result by map-matching.

A
B
C
D
E
F
G
H
I
J
K
L
M
AV
O
P

SYSTEM

< SYSTEM DESCRIPTION >

[NAVIGATION]

The current vehicle position will be calculated by detecting the distance the vehicle moved from the previous calculation point and its direction.

- Travel distance
Travel distance calculations are based on the vehicle speed sensor input signal. Therefore, the calculation may become incorrect as the tires wear down. To prevent this, an automatic distance correction function has been adopted.
- Travel direction
Change in the travel direction of the vehicle is calculated by a gyroscope (angular velocity sensor) and a GPS antenna (GPS information). They have both advantages and disadvantages.

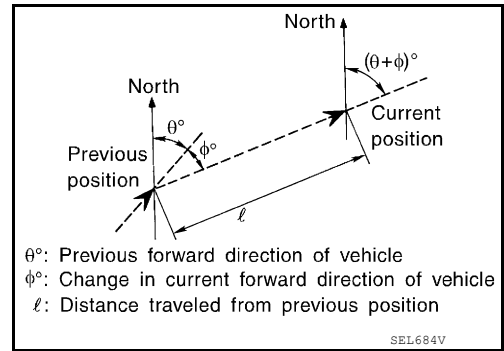

Type	Advantage	Disadvantage
Gyroscope (angular velocity sensor)	Can detect the vehicle's turning angle quite accurately.	Direction errors may accumulate when vehicle is driven for long distances without stopping.
GPS antenna (GPS information)	Can detect the vehicle's travel direction (North/South/East/West).	Correct direction cannot be detected when vehicle speed is low.

More accurate traveling direction is detected because priorities are set for the signals from these two devices according to the situation.

MAP-MATCHING

Map-matching compares a current location detected by the method in the "Location Detection Principle" with a road map data from map SD-card.

NOTE:

The road map data is based on data stored in the map SD-card.

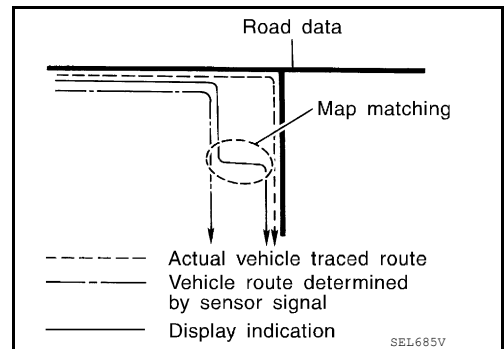

The vehicle position may not be corrected under the following circumstances and after driving for a certain time when GPS information is difficult to receive. In this case, the vehicle mark on the display must be corrected manually.

- In map-matching, alternative routes to reach the destination will be shown and prioritized, after the road on which the vehicle is currently driven has been judged and the vehicle mark has been repositioned.
Alternative routes will be shown in different order of priority, and the incorrect road can be avoided if there is an error in distance and/or direction.
Routes are of the same priority if two roads are running in parallel. Therefore, the vehicle mark may appear on either of them alternately, depending on maneuvering of the steering wheel and configuration of the road.

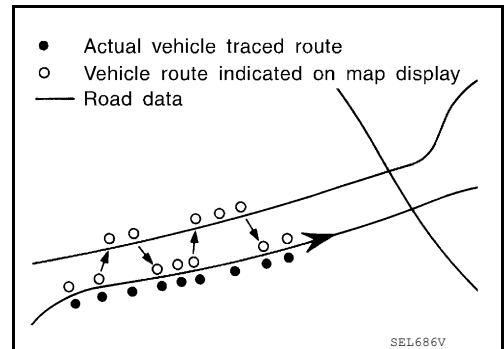

SYSTEM

< SYSTEM DESCRIPTION >

[NAVIGATION]

- Map-matching does not function correctly when a road on which the vehicle is driving is new and not recorded in the map SD-card, or when road pattern stored in the map data and the actual road pattern are different due to repair. The map-matching function may find another road and position the vehicle mark on it when driving on a road not present in the map. Then, the vehicle mark may change to it when the correct road is detected.
- Effective range for comparing the vehicle position and travel direction calculated by the distance and direction with the road data read from the map SD-card is limited. Therefore, correction by map-matching is not possible when there is an excessive gap between current vehicle position and the position on the map.

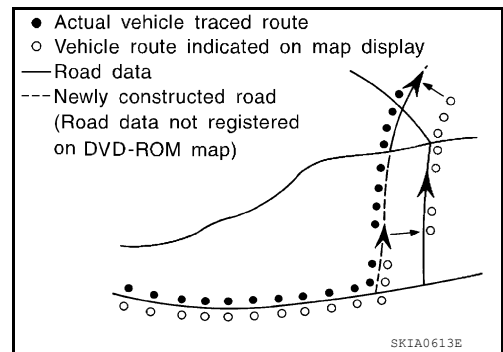

GPS (Global Positioning System)

GPS (Global Positioning System) is developed for and is controlled by the US Department of Defense. The system utilizes GPS satellites (NAVSTAR), transmitting out radio waves while flying on an orbit around the earth at an altitude of approximately 21,000 km (13,049 mile).

The receiver calculates the travel position in three dimensions (latitude/longitude/altitude) according to the time lag of the radio waves that four or more GPS satellites transmit (three-dimensional positioning). The GPS receiver calculates the travel position in two dimensions (latitude/longitude) with the previous altitude data if the GPS receiver receives only three radio waves (two-dimensional positioning). GPS position correction is not performed while stopping the vehicle.

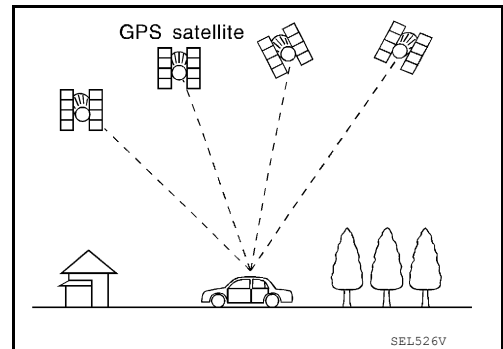

Accuracy of the GPS will deteriorate under the following conditions:

- In two-dimensional positioning, GPS accuracy will deteriorate when altitude of the vehicle position changes.
- The position of GPS satellite affects GPS detection precision. The position detection may not be precisely performed.
- The position detection is not performed if GPS receiver does not receive radio waves from GPS satellites. (Inside a tunnel, parking in a building, under an elevated highway etc.) GPS receiver may not receive radio waves from GPS satellites if any object is placed on the GPS antenna.

NOTE:

- The detection result has an error of approximately 10 m (32.81 ft) even with a high-precision three dimensional positioning.
- There may be cases when the accuracy is lowered and radio waves are stopped intentionally because the GPS satellite signal is controlled by the US trace control center.

SATELLITE RADIO FUNCTION

- Satellite radio function is built into AV control unit.
- Sound signal (satellite radio) is received by satellite antenna and transmitted to AV control unit. AV control unit then sends audio signals to the audio amplifier. The audio amplifier amplifies the audio signals before sending them to the speakers, tweeters and subwoofer.

AUXILIARY INPUT FUNCTION

- Sound can be output from an external device by connecting a device to the AUX jack.
- AUX sound signals are transmitted to each speaker via AV control unit.

REAR VIEW MONITOR FUNCTION

Camera Image Operation Principle

- The ITS control unit supplies power to the rear view camera when receiving a reverse signal.
- The rear view camera transmits camera images to the ITS control unit when power is supplied from the ITS control unit.
- The ITS control unit transmits camera images to the AV control unit.
- The AV control unit combines a warning message and fixed guide lines with an image received from the ITS control unit to display a rear view camera image on the screen.

USB CONNECTION FUNCTION

A

B

C

D

E

F

G

H

I

J

K

L

M

AV

O

P

- iPod® or music files in USB memory can be played.
- Sound signals are transmitted from USB connector and AUX jack to the AV control unit and output to each speaker and tweeter.
- iPod® is recharged when connected to USB connector and AUX jack.

NOTE:

Use the enclosed USB harness when connecting iPod® to USB connector and AUX jack.

iPod® is a trademark of Apple inc., registered in the U.S. and other countries.

SPEED SENSITIVE VOLUME SYSTEM

- Volume level of this system goes up and down automatically in proportion to the vehicle speed.
- The control level can be selected by the customer.

HANDS-FREE PHONE SYSTEM

- Bluetooth® control is built into AV control unit.
- The connection between cellular phone and AV control unit is performed with Bluetooth® communication.
- The voice guidance signal is input from the AV control unit and output to the front speakers when operating the cellular phone.

When A Call Is Originated

- Spoken voice sound output from the microphone (microphone signal) is input to AV control unit.
- AV control unit outputs to cellular phone with Bluetooth® communication as a TEL voice signal.
- Voice sound is then heard at the other party.

When Receiving A Call

- Voice sound is input to own cellular phone from the other party.
- TEL voice signal is input to AV control unit by establishing Bluetooth® communication from cellular phone, and the signal is output to the audio amplifier. The audio amplifier amplifies the audio signals before sending them to the speakers.

DIAGNOSIS SYSTEM (AV CONTROL UNIT)

< SYSTEM DESCRIPTION >

[NAVIGATION]

DIAGNOSIS SYSTEM (AV CONTROL UNIT)

Description

INFOID:000000009482191

The AV control unit on board diagnosis performs the functions listed in the table below:

Mode	Item	Content	
Version	—	Version data of the AV control unit is displayed.	
User Configuration	Touch Display Calibration	Allows correction of the position detection accuracy of the touch panel.	
Radio	FM monitor	Monitors the dynamic values of the current tuner	
	AM monitor		
	XM monitor	Version data is displayed.	
	XM functions	<ul style="list-style-type: none"> • Clear XM Chipset NVM • Reset All XM Settings • Clear IGS • XM CBM Debug Mode • External Diag Mode Current status is displayed.	
System State	Running System Status	<ul style="list-style-type: none"> • SD card slot Access • Power Supply • Speed Signal • Direction Signal • Illumination Signal • GPS Antenna • GPS Tracking • Satellites Visible • Satellites Tracked • Microphone Current • Steering wheel key • Radio Antenna • USB Device • iPod® firmware version • BT Status The current system status is displayed.	
	Speaker Test 4kHz	—	This activates a sequence of test tone outputs to the audio circuits one after the other for 1 second.
	Speaker Test 100Hz		
		Display-Test	—
	Self Test	<ul style="list-style-type: none"> • SD Card Access • BT Module Access • Radio Antenna • GPS Antenna • XM Antenna A system self test is executed and the results are stored into the error memory.	

Perform CONSULT diagnosis if the AV control unit on board diagnosis does not start or the screen does not display anything.

On Board Diagnosis Function

INFOID:000000009482192

METHOD OF STARTING

1. Turn the ignition ON.
2. Turn the audio system OFF.

DIAGNOSIS SYSTEM (AV CONTROL UNIT)

< SYSTEM DESCRIPTION >

[NAVIGATION]

- While pressing the seek forward button, turn the TUNE dial counterclockwise 3 or more clicks, then clockwise 3 or more clicks, then counterclockwise 3 or more clicks. When self diagnosis mode begins, a short beep will be heard. Shifting from current screen to previous screen is performed by pressing BACK button.

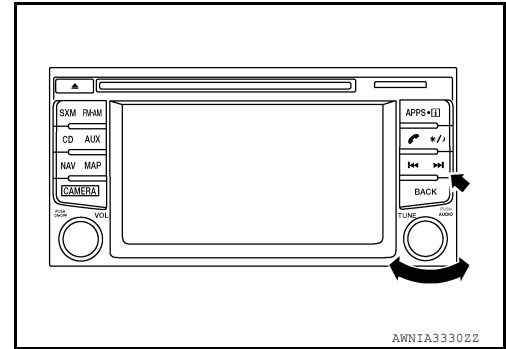

- The trouble diagnosis initial screen is displayed, and Version, User Config, Radio, System State or Self Test can be selected.

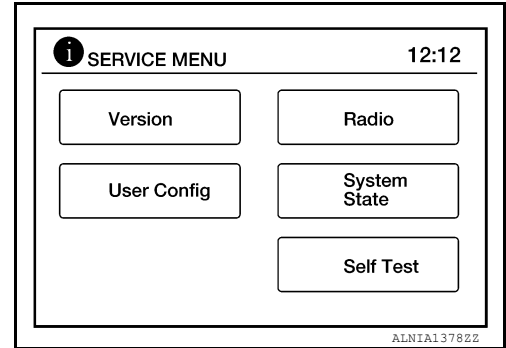

CONSULT Function

INFOID:000000009482193

CONSULT FUNCTIONS

CONSULT performs the following functions via communication with the AV control unit.

Direct Diagnostic Mode	Description
Ecu Identification	The AV control unit part number is displayed.
Self Diagnostic Result	The AV control unit self diagnostic results are displayed.
Data Monitor	The AV control unit input/output data is displayed in real time.
Configuration	<ul style="list-style-type: none"> The vehicle specification can be read and saved. The vehicle specification can be written when replacing AV control unit.
CAN Diag Support Mntr	<ul style="list-style-type: none"> The result of transmit/receive diagnosis of AV communication is displayed. The result of transmit/receive diagnosis of CAN communication is displayed.

ECU IDENTIFICATION

The part number of AV control unit is displayed.

SELF DIAGNOSTIC RESULT

Refer to [AV-259. "DTC Index"](#).

DATA MONITOR

Monitor Item [Unit]	Description
VHCL SPD SIG [On/Off]	Indicates vehicle speed signal received from combination meter on CAN communication line.
ILLUM SIG [On/Off]	Indicates condition of illumination signal for the AV control unit.
IGN SIG [On/Off]	Indicates condition of ignition signal.
REV SIG [On/Off]	Indicates condition of reverse signal received from BCM.

CONFIGURATION

Refer to [AV-284. "CONFIGURATION \(AV CONTROL UNIT\) : Description"](#).

CAN DIAG SUPPORT MNTR

Refer to [LAN-10. "CAN Diagnostic Support Monitor"](#).

AV CONTROL UNIT

< ECU DIAGNOSIS INFORMATION >

[NAVIGATION]

ECU DIAGNOSIS INFORMATION

AV CONTROL UNIT

Reference Value

INFOID:000000009482194

TERMINAL LAYOUT

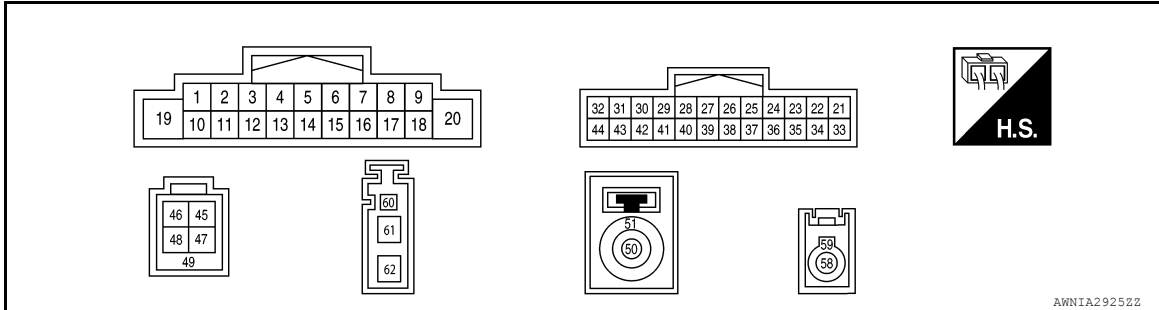



PHYSICAL VALUES

Terminal (Wire color)		Description		Condition		Reference value (Approx.)
+	-	Signal name	Input/ Output	Ignition switch	Operation	
1 (G/W)	Ground	Amp. ON signal	Output	ACC	—	Battery voltage
2 (W)	3 (B)	Sound signal front speaker LH	Output	ON	Sound output	 SKIB3609E
4 (P)	5 (B/R)	Sound signal rear speaker LH	Output	ON	Sound output	 SKIB3609E
6 (BR)	15 (G)	Steering switch signal A	Input	ON	Press and hold MODE switch.	0 V
					Press and hold Δ switch.	1.34 V
					Press and hold ∇ switch.	2.45 V
					Press and hold switch.	3.43 V
					Except for above.	5.0 V
7 (G/B)	Ground	ACC power supply	Input	ACC	—	Battery voltage
8 (L)	—	CAN (H)	Input/ Output	—	—	—
9 (R)	44 (GR)	Illumination control signal	Input	ON	Headlamps ON	Battery voltage

AV CONTROL UNIT

< ECU DIAGNOSIS INFORMATION >

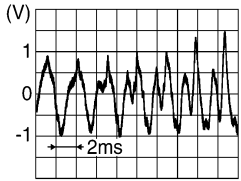
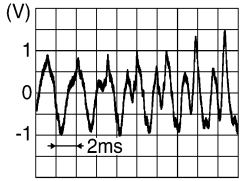
[NAVIGATION]

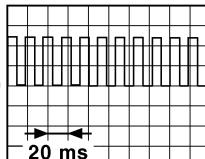
Terminal (Wire color)		Description		Condition		Reference value (Approx.)
+	-	Signal name	Input/ Output	Ignition switch	Operation	
11 (Y)	12 (R)	Sound signal front speaker RH	Output	ON	Sound output	 <small>SKIB3609E</small>
13 (L)	14 (B/W)	Sound signal rear speaker RH	Output	ON	Sound output	 <small>SKIB3609E</small>
16 (W)	15 (G)	Steering switch signal B	Input	ON	Press and hold VOL DOWN switch	0 V
					Press and hold VOL UP switch	1.34 V
					Press and hold  switch	2.45 V
					Except for above	5.0 V
17 (P)	—	CAN (L)	Input/ Output	—	—	—
18 (SB)	Ground	Vehicle speed signal	Input	ON	When vehicle speed is ap- prox. 40 km/h (25 MPH)	 <small>JSNIA0012GB</small>
19 (Y)	Ground	Battery power supply	Input	OFF	—	Battery voltage
20 (B)	Ground	Ground	—	ON	—	0 V
23 (P)	—	MR output	—	—	—	—
28 (SB)	Ground	Reverse signal	Input	ON	Selector lever in R (re- verse)	Battery voltage
					Selector lever in any posi- tion other than R (reverse)	0 V
30 (B)	—	Audio L	Input	—	—	—
31 (R)	—	Audio ground	—	—	—	—
32 (W)	—	Audio R	Input	—	—	—
33	Shield	Camera ground	—	—	—	—
34 (G/Y)	—	Camera ON	—	—	—	—

AV CONTROL UNIT

< ECU DIAGNOSIS INFORMATION >

[NAVIGATION]

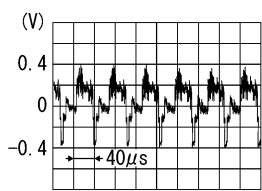
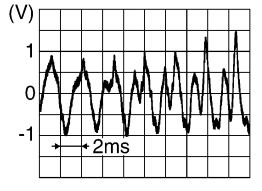
Terminal (Wire color)		Description		Condition		Reference value (Approx.)
+	-	Signal name	Input/ Output	Ignition switch	Operation	
36 (B)	35 (W)	Camera image signal	Input	ON	When camera image is displayed	 <p style="text-align: right; font-size: small;">SKIB2251J</p>
37 (W/B)	Ground	Ignition power supply	Input	ON or START	—	Battery voltage
42 (L)	Ground	Microphone power supply	Output	ON	—	5.0 V
43 (P)	41 (Shield)	Microphone signal	Input	ON	While speaking into microphone.	 <p style="text-align: right; font-size: small;">SKIB3609E</p>
45 (R)	—	USB ground	—	—	—	—
46 (B)	—	USB D- signal	—	—	—	—
47 (G)	—	USB D+ signal	—	—	—	—
48 (W)	—	V BUS signal	—	—	—	—
49	—	Shield	—	—	—	—
50 (B)	Ground	GPS antenna signal	Input	ON	—	5.0 V
51	—	GPS Shield	—	—	—	—
58 (B)	Ground	Satellite antenna signal	Input	ON	—	5.0 V
59	—	SAT Shield	—	—	—	—
61 (B)	Ground	AM-FM main antenna	Input	ON	—	5.0 V

DTC Index

INFOID:000000009482195

CONSULT Display	Reference Page
U1000: CAN COMM CIRCUIT	AV-287, "DTC Logic"
U1010: CONTROL UNIT (CAN)	AV-288, "DTC Logic"
U1217: BLUETOOTH MODULE	AV-289, "DTC Logic"
U1229: iPod CERTIFICATION	AV-290, "DTC Logic"
U122F: Digital broadcasting connection error	AV-291, "DTC Logic"
U1244: GPS ANTENNA CONN	AV-292, "DTC Logic"
U1258: XM ANTENNA CONN	AV-293, "DTC Logic"
U1263: USB OVERCURRENT	AV-294, "DTC Logic"

AV CONTROL UNIT

< ECU DIAGNOSIS INFORMATION >

[NAVIGATION]

CONSULT Display	Reference Page
U1265: AMP ON TERMINAL	AV-295, "DTC Logic"
U12AA: Configuration Error	AV-296, "DTC Logic"
U12AB: FM Antenna error	AV-297, "DTC Logic"
U12AC: Display Temperature too High	AV-298, "DTC Logic"
U12AD: ECU Temperature too High	AV-299, "DTC Logic"
U12AE: Internal Amplifier temperature Warning	AV-300, "DTC Logic"
U12AF: CD Mechanism Temperature Warning	AV-301, "DTC Logic"
U12B0: Supply Voltage Goes below 9V > 20s	AV-302, "DTC Logic"
U12B1: Supply Voltage Goes High > 16V for 20s	AV-303, "DTC Logic"
U1310: CONTROL UNIT (AV)	AV-304, "DTC Logic"

AUDIO AMP

< ECU DIAGNOSIS INFORMATION >

[NAVIGATION]

AUDIO AMP

Reference Value

INFOID:000000009482196

TERMINAL LAYOUT

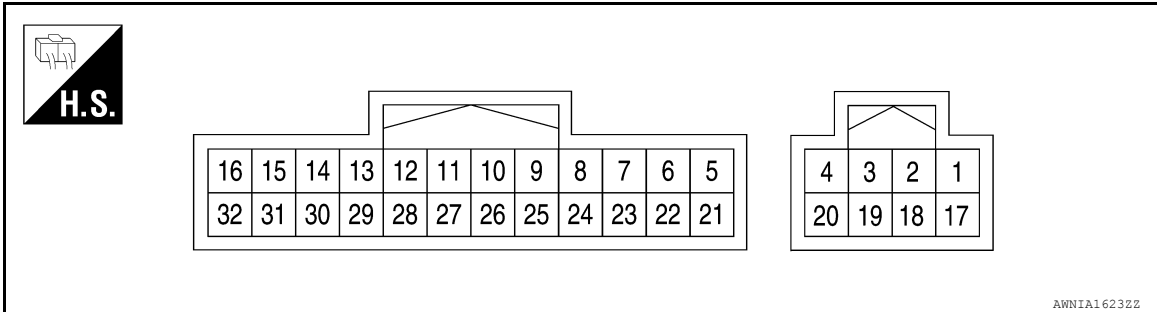

PHYSICAL VALUES

Terminal (wire color)		Description	Condition			Reference value (Approx.)
+	-	Signal name	Input/Output	Ignition switch	Operation	
1 (Y)	Ground	Battery	Input	-	-	Battery voltage
2 (W)	18 (G)	Subwoofer	Output	ON	Receive audio signal	 SKIA0177E
3 (BR/W)	19 (BR)	Subwoofer	Output	ON	Receive audio signal	 SKIA0177E
4 (B)	Ground	Ground	-	ON	-	-
9 (G/W)	Ground	Amp. ON signal	Input	ON	-	Greater than 6.5 V
11 (G)	27 (B)	Rear door speaker LH	Output	ON	Receive audio signal	 SKIA0177E

AUDIO AMP

< ECU DIAGNOSIS INFORMATION >

[NAVIGATION]

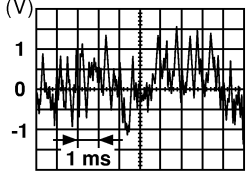
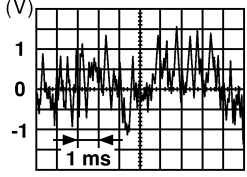
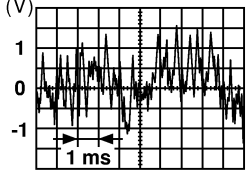
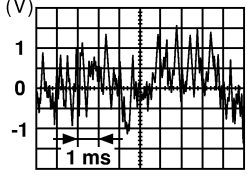
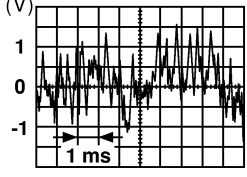
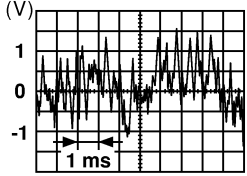
Terminal (wire color)		Description	Condition			Reference value (Approx.)
+	-		Signal name	Input/ Output	Ignition switch	
12 (GR)	28 (BG)	Rear door speaker RH	Output	ON	Receive audio signal	 <p style="text-align: right; font-size: small;">SKIA0177E</p>
13 (W)	29 (P)	Front tweeter RH	Output	ON	Receive audio signal	 <p style="text-align: right; font-size: small;">SKIA0177E</p>
14 (Y)	30 (GR)	Front tweeter LH	Output	ON	Receive audio signal	 <p style="text-align: right; font-size: small;">SKIA0177E</p>
15 (BR)	31 (L)	Front door speaker LH	Output	ON	Receive audio signal	 <p style="text-align: right; font-size: small;">SKIA0177E</p>
16 (LG)	32 (R)	Front door speaker RH	Output	ON	Receive audio signal	 <p style="text-align: right; font-size: small;">SKIA0177E</p>
17 (R/B)	Ground	Battery	Input	-	-	Battery voltage
20 (B)	Ground	Ground	-	ON	-	-
21 (Y)	5 (R)	Audio sound signal front RH	Input	ON	Receive audio signal	 <p style="text-align: right; font-size: small;">SKIA0177E</p>

AUDIO AMP

< ECU DIAGNOSIS INFORMATION >

[NAVIGATION]

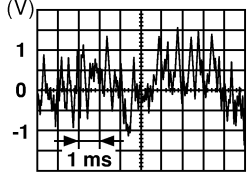
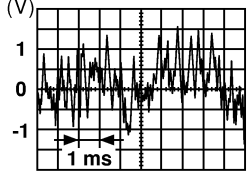
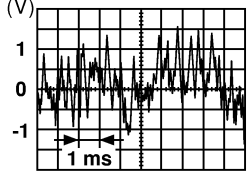
Terminal (wire color)		Description		Condition		Reference value (Approx.)
+	-	Signal name	Input/ Output	Ignition switch	Operation	
22 (W)	6 (B)	Audio sound signal front LH	Input	ON	Receive audio signal	
23 (L)	7 (B/W)	Audio sound signal rear RH	Input	ON	Receive audio signal	
24 (P)	8 (B/R)	Audio sound signal rear LH	Input	ON	Receive audio signal	

A
B
C
D
E
F
G
H
I
J
K
L
M

AV

O
P

WIRING DIAGRAM

NAVIGATION SYSTEM

Wiring Diagram

INFOID:000000009482197

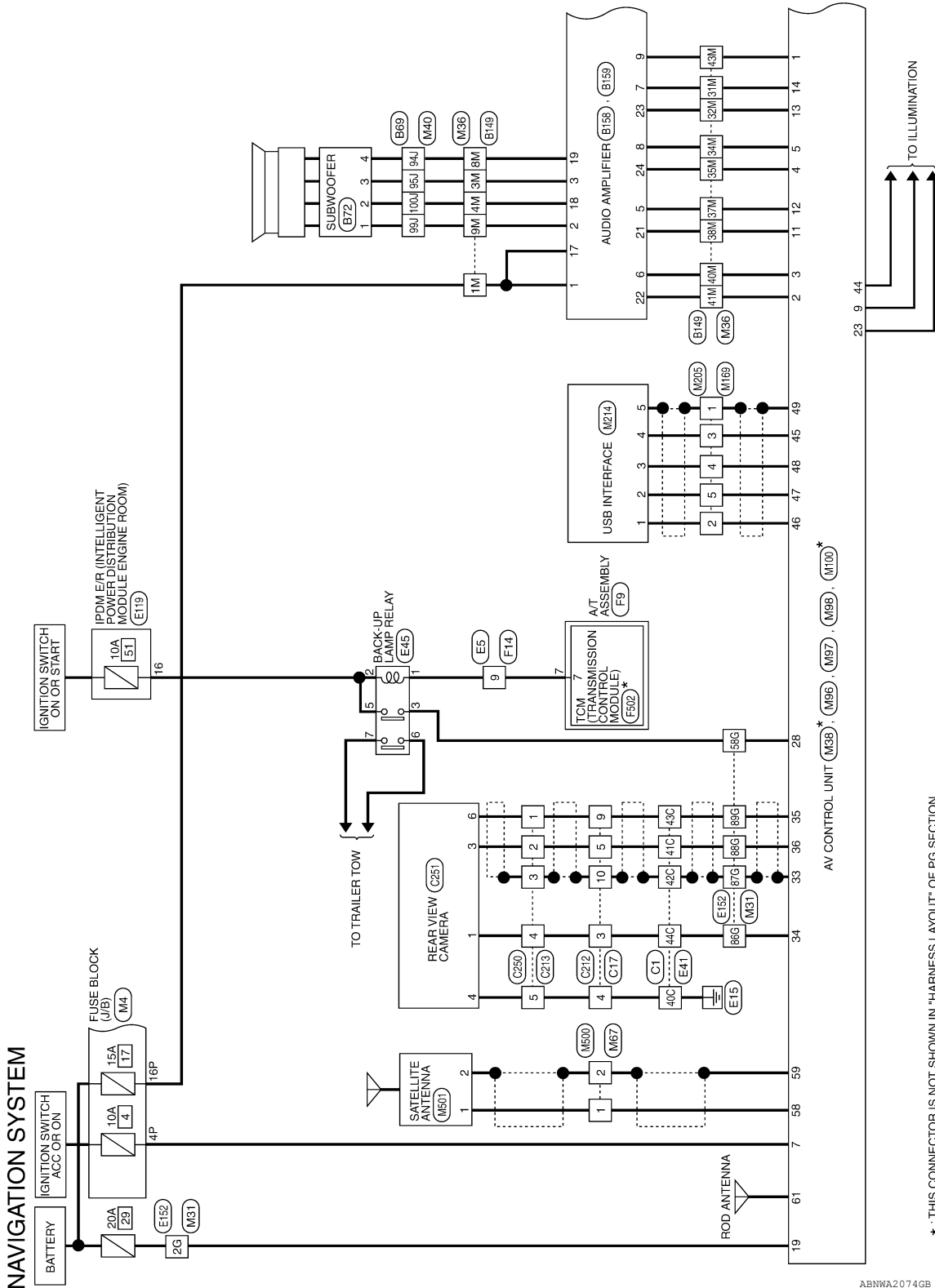

* : THIS CONNECTOR IS NOT SHOWN IN "HARNES LAYOUT" OF PG SECTION.

ABNWA2074GB

NAVIGATION SYSTEM

< WIRING DIAGRAM >

[NAVIGATION]

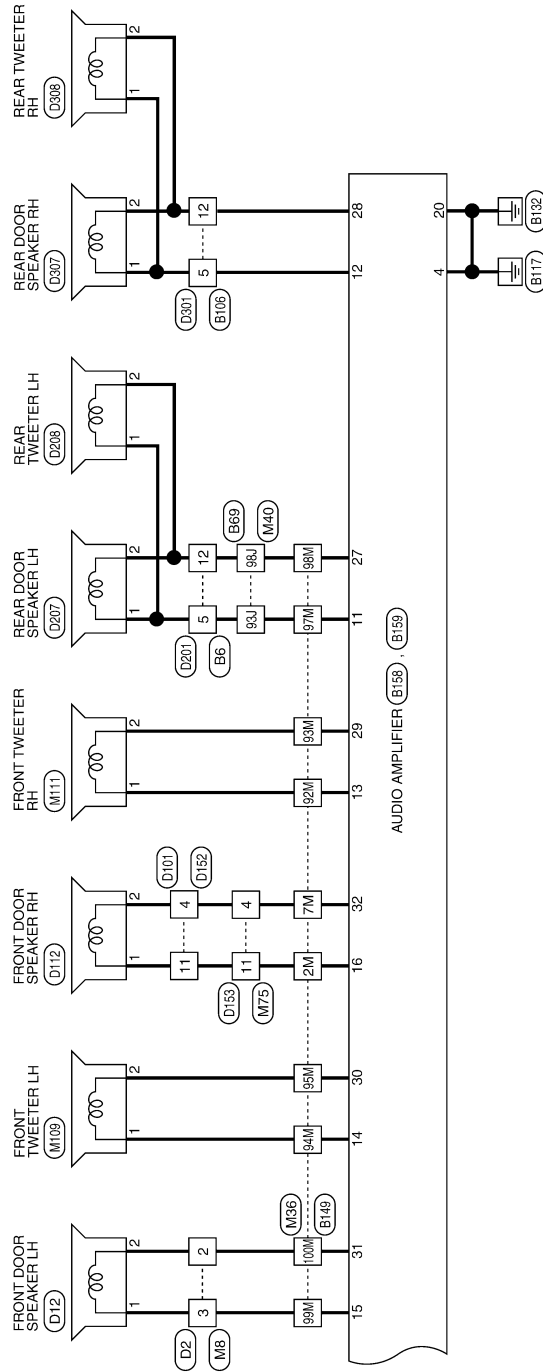

A
B
C
D
E
F
G
H
I
J
K
L
M
AV
O
P

ABNWA2075GB

NAVIGATION SYSTEM

< WIRING DIAGRAM >

[NAVIGATION]

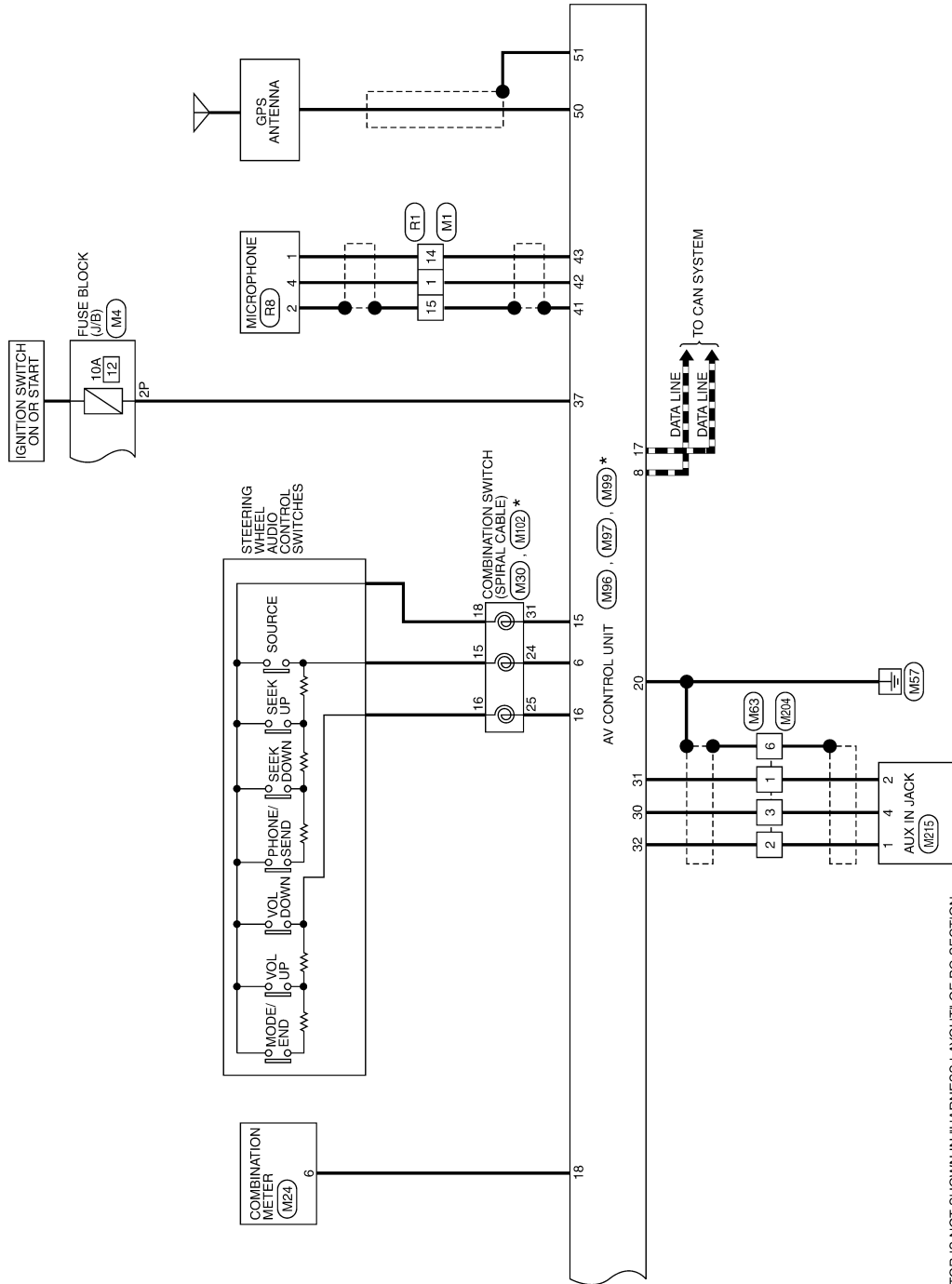

* : THIS CONNECTOR IS NOT SHOWN IN "HARNESS LAYOUT" OF PG SECTION.

ABNWA2077GB

NAVIGATION SYSTEM CONNECTORS

Connector No.	M8
Connector Name	WIRE TO WIRE
Connector Color	BROWN

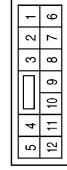

Terminal No.	Color of Wire	Signal Name
2	L	-
3	BR	-

Connector No.	M4
Connector Name	FUSE BLOCK (J/B)
Connector Color	WHITE

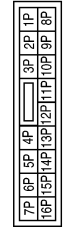

Terminal No.	Color of Wire	Signal Name
2P	W/G	-
4P	G/B	-
16P	R/B	-

Connector No.	M1
Connector Name	WIRE TO WIRE
Connector Color	WHITE

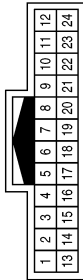

Terminal No.	Color of Wire	Signal Name
1	L	- (WITH NAVI)
14	P	- (WITH NAVI)
15	SHIELD	- (WITH NAVI)

Connector No.	M30
Connector Name	COMBINATION SWITCH (SPIRAL CABLE)
Connector Color	GRAY

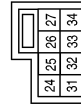

Terminal No.	Color of Wire	Signal Name
24	BR	-
25	W	- (WITH NAVI)
31	G	-

Connector No.	M24
Connector Name	COMBINATION METER
Connector Color	WHITE

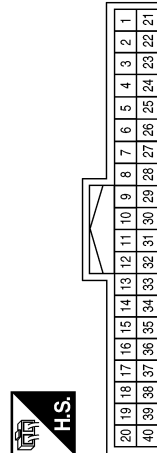

Terminal No.	Color of Wire	Signal Name
6	SB	SPEED OUT 8

ABNIA4208GB

A
B
C
D
E
F
G
H
I
J
K
L
M
N
O
P



NAVIGATION SYSTEM

< WIRING DIAGRAM >

[NAVIGATION]

Terminal No.	Color of Wire	Signal Name
32M	L	-
34M	B/R	-
35M	P	-
37M	R	-
38M	Y	-
40M	B	-
41M	W	-
43M	G/W	-
92M	W	-
93M	P	-
94M	Y	-
95M	GR	-
97M	G	-
98M	B	-
99M	BR	-
100M	L	-

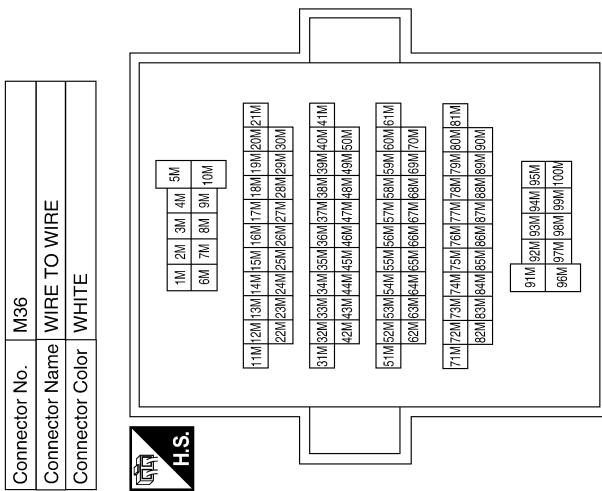

Terminal No.	Color of Wire	Signal Name
1M	R/B	-
2M	LG	-
3M	BR/W	-
4M	G	-
7M	R	-
8M	BR	-
9M	W	-
31M	B/W	-

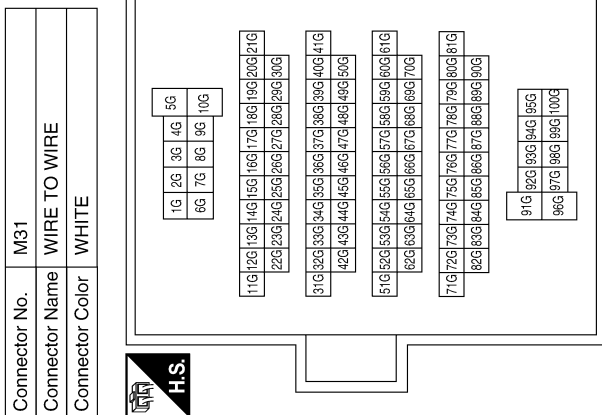

Terminal No.	Color of Wire	Signal Name
2G	Y	-
58G	SB	-
86G	G/Y	-
87G	SHIELD	-
88G	B	-
89G	W	-

ABNIA5601GB

NAVIGATION SYSTEM

< WIRING DIAGRAM >

[NAVIGATION]

Connector No.	M63
Connector Name	WIRE TO WIRE
Connector Color	WHITE



Terminal No.	Color of Wire	Signal Name
1	R	-
2	W	-
3	B	-
6	SHIELD	-

Connector No.	M40
Connector Name	WIRE TO WIRE
Connector Color	WHITE

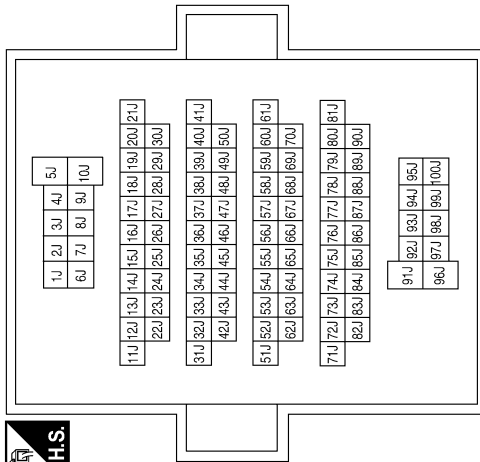
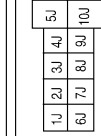

Terminal No.	Color of Wire	Signal Name
93J	G	-
94J	BR	-
95J	BR/W	-
98J	B	-
99J	W	-
100J	G	-

Connector No.	M38
Connector Name	AV CONTROL UNIT
Connector Color	GRAY

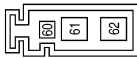

Terminal No.	Color of Wire	Signal Name
60	-	-
61	B	ANT MAIN
62	-	-

A
B
C
D
E
F
G
H
I
J
K
L
M
AV
O
P

NAVIGATION SYSTEM

< WIRING DIAGRAM >

[NAVIGATION]

Connector No.	M96
Connector Name	AV CONTROL UNIT (WITH NAVI)
Connector Color	WHITE

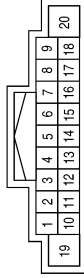

Terminal No.	Color of Wire	Signal Name
1	G/W	AMP ON
2	W	FR SP LH (+)
3	B	FR SP LH (-)
4	P	RR SP LH (+)
5	B/R	RR SP LH (-)
6	BR	STRG SW A
7	G/B	ACC
8	L	CAN-H
9	R	LIGHT SW
10	-	-
11	Y	FR SP RH (+)
12	R	FR SP RH (-)
13	L	RR SP RH (+)
14	B/W	RR SP RH (-)
15	G	STRG SW GND
16	W	STRG SW B
17	P	CAN-L
18	SB	SPD
19	Y	+B
20	B	GND

Connector No.	M75
Connector Name	WIRE TO WIRE
Connector Color	WHITE

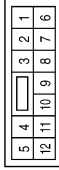

Terminal No.	Color of Wire	Signal Name
4	R	-
11	LG	-

Connector No.	M67
Connector Name	WIRE TO WIRE
Connector Color	PINK

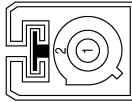

Terminal No.	Color of Wire	Signal Name
1	B	-
2	SHIELD	-

ABNIA4211GB

NAVIGATION SYSTEM

< WIRING DIAGRAM >

[NAVIGATION]

Connector No.	M98
Connector Name	AV CONTROL UNIT (WITH NAVI)
Connector Color	GREEN

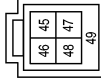

Terminal No.	Color of Wire	Signal Name
45	R	VBUS
46	B	USB GND
47	G	USB D+
48	W	USB D-
49	SHIELD	SHIELD

Terminal No.	Color of Wire	Signal Name
29	-	-
30	B	AUX L (+)
31	R	AUX GND
32	W	AUX R (+)
33	SHIELD	CAM GND
34	G/Y	CAMERA ON
35	W	VIDEO GND
36	B	CAM VIDEO
37	W/G	IGN
38	-	-
39	-	-
40	-	-
41	SHIELD	MIC GND
42	L	MIC VCC
43	P	MIC SIG
44	GR	ILL CONT

Connector No.	M97
Connector Name	AV CONTROL UNIT (WITH NAVI)
Connector Color	WHITE

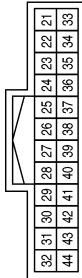

Terminal No.	Color of Wire	Signal Name
21	-	-
22	-	-
23	P	MR OUTPUT
24	-	-
25	-	-
26	-	-
27	-	-
28	SB	REVERSE

Connector No.	M102
Connector Name	COMBINATION SWITCH (SPIRAL CABLE)
Connector Color	GRAY



Terminal No.	Color of Wire	Signal Name
15	GR	-
16	G	-
18	B	-

Connector No.	M100
Connector Name	AV CONTROL UNIT (WITH NAVI)
Connector Color	PINK

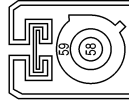

Terminal No.	Color of Wire	Signal Name
58	B	SAT ANT
59	SHIELD	SAT SHIELD

Connector No.	M99
Connector Name	AV CONTROL UNIT (WITH NAVI)
Connector Color	BLUE

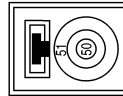

Terminal No.	Color of Wire	Signal Name
50	B	GPS ANT
51	SHIELD	GPS SHIELD

ABNIA4212GB

A
B
C
D
E
F
G
H
I
J
K
L
M
N
O
P

AV

NAVIGATION SYSTEM

< WIRING DIAGRAM >

[NAVIGATION]

Connector No.	M169
Connector Name	WIRE TO WIRE
Connector Color	BLUE

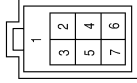

Terminal No.	Color of Wire	Signal Name
1	SHIELD	-
2	B	-
3	R	-
4	W	-
5	G	-

Connector No.	M111
Connector Name	FRONT TWEETER RH
Connector Color	BROWN



Terminal No.	Color of Wire	Signal Name
1	W	-
2	P	-(WITH AMPLIFIER)

Connector No.	M109
Connector Name	FRONT TWEETER LH
Connector Color	BROWN



Terminal No.	Color of Wire	Signal Name
1	Y	-(WITH AMPLIFIER)
2	GR	-(WITH AMPLIFIER)

Connector No.	M214
Connector Name	USB INTERFACE
Connector Color	BLUE

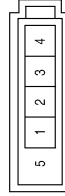

Terminal No.	Color of Wire	Signal Name
1	B	-
2	G	-
3	W	-
4	R	-
5	SHIELD	-

Connector No.	M205
Connector Name	WIRE TO WIRE
Connector Color	BLUE

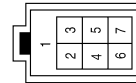

Terminal No.	Color of Wire	Signal Name
1	SHIELD	-
2	B	-
3	R	-
4	W	-
5	G	-

Connector No.	M204
Connector Name	WIRE TO WIRE
Connector Color	WHITE



Terminal No.	Color of Wire	Signal Name
1	R	-
2	W	-
3	B	-
6	SHIELD	-

ABNIA4213GB

NAVIGATION SYSTEM

< WIRING DIAGRAM >

[NAVIGATION]

Connector No.	M501
Connector Name	SATELLITE ANTENNA
Connector Color	BROWN

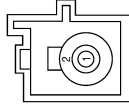

Terminal No.	Color of Wire	Signal Name
1	B	-
2	SHIELD	-

Connector No.	M500
Connector Name	WIRE TO WIRE
Connector Color	PINK

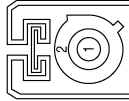

Terminal No.	Color of Wire	Signal Name
1	B	-
2	SHIELD	-

Connector No.	M215
Connector Name	AUX IN JACK
Connector Color	WHITE

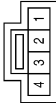

Terminal No.	Color of Wire	Signal Name
1	W	-
2	R	-
4	B	-

Terminal No.	Color of Wire	Signal Name
40C	GR	-
41C	B	-
42C	SHIELD	-
43C	W	-
44C	G/Y	-

Connector No.	E41
Connector Name	WIRE TO WIRE
Connector Color	BLACK

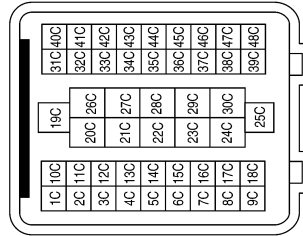

Connector No.	E5
Connector Name	WIRE TO WIRE
Connector Color	WHITE

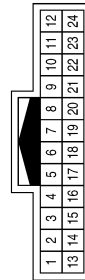

Terminal No.	Color of Wire	Signal Name
9	LG	-

ABNIA5605GB

A
B
C
D
E
F
G
H
I
J
K
L
M
N
O
P

AV

Connector No.	E119
Connector Name	IPDM E/R (INTELLIGENT POWER DISTRIBUTION MODULE ENGINE ROOM)
Connector Color	WHITE

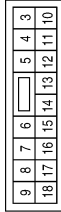

Terminal No.	Color of Wire	Signal Name
16	W/G	REVERSE LAMP

Connector No.	E45
Connector Name	BACK-UP LAMP RELAY (WITH A/T)
Connector Color	BROWN



Terminal No.	Color of Wire	Signal Name
1	LG	-
2	W/G	-
3	SB	-
5	W/G	-
6	Y	-
7	W/G	-

Connector No.	F9
Connector Name	A/T ASSEMBLY
Connector Color	GREEN

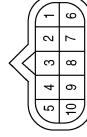

Terminal No.	Color of Wire	Signal Name
7	LG	-

Terminal No.	Color of Wire	Signal Name
2G	Y	-
58G	SB	-
86G	G/Y	-
87G	SHIELD	-
88G	B	-
89G	W	-

Connector No.	E152
Connector Name	WIRE TO WIRE
Connector Color	WHITE

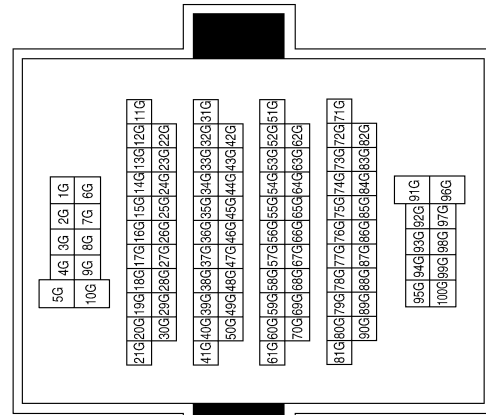

ABNIA5606GB

NAVIGATION SYSTEM

< WIRING DIAGRAM >

[NAVIGATION]

Connector No.	C1
Connector Name	WIRE TO WIRE
Connector Color	BLACK

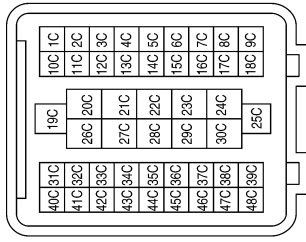

Terminal No.	Color of Wire	Signal Name
40C	GR	-
41C	B	-
42C	SHIELD	-
43C	W	-
44C	G/Y	-

Connector No.	F502
Connector Name	TCM (TRANSMISSION CONTROL MODULE)
Connector Color	GRAY



Terminal No.	Color of Wire	Signal Name
7	O	REV LAMP RLY

Connector No.	F14
Connector Name	WIRE TO WIRE
Connector Color	WHITE

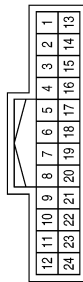

Terminal No.	Color of Wire	Signal Name
9	LG	-

Connector No.	C213
Connector Name	WIRE TO WIRE
Connector Color	BLACK



Terminal No.	Color of Wire	Signal Name
1	W	-
2	B	-
3	SHIELD	-
4	G/Y	-
5	GR	-

Connector No.	C212
Connector Name	WIRE TO WIRE
Connector Color	GRAY

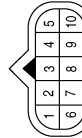

Terminal No.	Color of Wire	Signal Name
3	G/Y	-
4	GR	-
5	B	-
9	W	-
10	SHIELD	-

Connector No.	C17
Connector Name	WIRE TO WIRE
Connector Color	GRAY

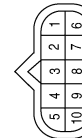

Terminal No.	Color of Wire	Signal Name
3	G/Y	-
4	GR	-
5	B	-
9	W	-
10	SHIELD	-

ABNIA5620GB

A
B
C
D
E
F
G
H
I
J
K
L
M
N
O
P

AV

NAVIGATION SYSTEM

< WIRING DIAGRAM >

[NAVIGATION]

Connector No.	B6
Connector Name	WIRE TO WIRE
Connector Color	WHITE

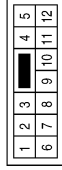

Terminal No.	Color of Wire	Signal Name
5	G	-
12	B	-

Connector No.	C251
Connector Name	REAR VIEW CAMERA
Connector Color	GRAY



Terminal No.	Color of Wire	Signal Name
1	G/Y	-
3	B	-
4	GR	-
6	W	-

Connector No.	C250
Connector Name	WIRE TO WIRE
Connector Color	BLACK



Terminal No.	Color of Wire	Signal Name
1	W	-
2	B	-
3	SHIELD	-
4	G/Y	-
5	GR	-

Connector No.	B72
Connector Name	SUBWOOFER
Connector Color	GRAY



Terminal No.	Color of Wire	Signal Name
1	W	-
2	G	-
3	BR/W	-
4	BR	-

Terminal No.	Color of Wire	Signal Name
93J	G	-
94J	BR	-
95J	BR/W	-
98J	B	-
99J	W	-
100J	G	-

Connector No.	B69
Connector Name	WIRE TO WIRE
Connector Color	WHITE

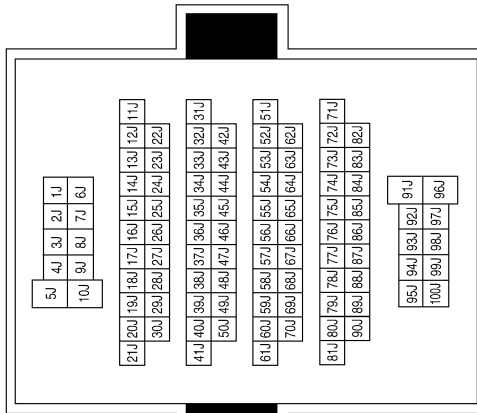

ABNIA5607GB

NAVIGATION SYSTEM

< WIRING DIAGRAM >

[NAVIGATION]

Terminal No.	Color of Wire	Signal Name
34M	B/R	-
35M	P	-
37M	R	-
38M	Y	-
40M	B	-
41M	W	-
43M	G/W	-
92M	W	-
93M	P	-
94M	Y	-
95M	GR	-
97M	G	-
98M	B	-
99M	BR	-
100M	L	-

Connector No.	B149
Connector Name	WIRE TO WIRE
Connector Color	WHITE

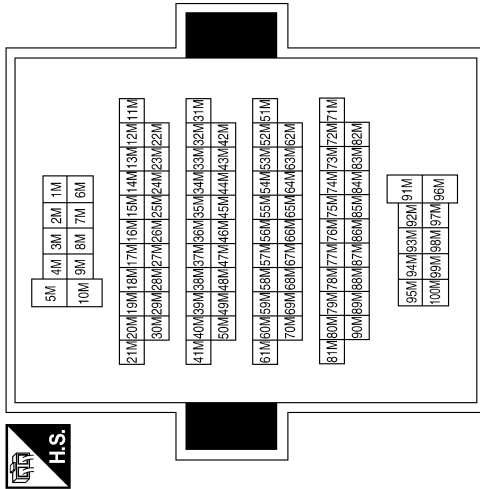

Terminal No.	Color of Wire	Signal Name
1M	R/B	-
2M	LG	-
3M	BR/W	-
4M	G	-
7M	R	-
8M	BR	-
9M	W	-
31M	B/W	-
32M	L	-

Connector No.	B106
Connector Name	WIRE TO WIRE
Connector Color	WHITE

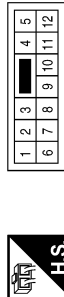

Terminal No.	Color of Wire	Signal Name
5	GR	-(EXCEPT DISPLAY AUDIO WITHOUT AMPLIFIER)
12	BG	-(EXCEPT DISPLAY AUDIO WITHOUT AMPLIFIER)

A
B
C
D
E
F
G
H
I
J
K
L
M
N
O
P

AV

ABNIA5608GB

NAVIGATION SYSTEM

< WIRING DIAGRAM >

[NAVIGATION]

Terminal No.	Color of Wire	Signal Name
13	W	-
14	Y	-
15	BR	-
16	LG	-
21	Y	-
22	W	-
23	L	-
24	P	-
27	B	-
28	BG	-
29	P	-
30	GR	-
31	L	-
32	R	-

Connector No.	B159
Connector Name	AUDIO AMPLIFIER
Connector Color	WHITE



Terminal No.	Color of Wire	Signal Name
5	R	-
6	B	-
7	B/W	-
8	B/R	-
9	G/W	-
11	G	-
12	GR	-

Connector No.	B158
Connector Name	AUDIO AMPLIFIER
Connector Color	WHITE

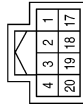

Terminal No.	Color of Wire	Signal Name
1	Y	-
2	W	-
3	BR/W	-
4	B	-
17	R/B	-
18	G	-
19	BR	-
20	B	-

Connector No.	D2
Connector Name	WIRE TO WIRE
Connector Color	BROWN



Connector No.	R8
Connector Name	MICROPHONE
Connector Color	WHITE

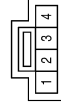

Terminal No.	Color of Wire	Signal Name
2	L/R	-
3	L/W	-

Connector No.	R1
Connector Name	WIRE TO WIRE
Connector Color	WHITE

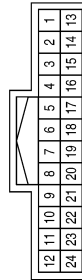

Terminal No.	Color of Wire	Signal Name
1	L	- (WITH NAVI)
14	P	- (WITH NAVI)
15	SHIELD	- (WITH NAVI)

ABNIA5609GB

NAVIGATION SYSTEM

< WIRING DIAGRAM >

[NAVIGATION]

Connector No.	D112
Connector Name	FRONT DOOR SPEAKER RH
Connector Color	WHITE



Terminal No.	Color of Wire	Signal Name
1	W/B	-
2	L/B	-

Connector No.	D101
Connector Name	WIRE TO WIRE
Connector Color	WHITE

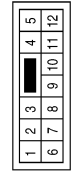

Terminal No.	Color of Wire	Signal Name
4	L/B	-
11	W/B	-

Connector No.	D12
Connector Name	FRONT DOOR SPEAKER LH
Connector Color	WHITE



Terminal No.	Color of Wire	Signal Name
1	L/W	-
2	L/R	-

Connector No.	D201
Connector Name	WIRE TO WIRE
Connector Color	WHITE



Terminal No.	Color of Wire	Signal Name
5	L	-
12	O	-

Connector No.	D153
Connector Name	WIRE TO WIRE
Connector Color	WHITE

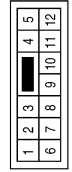

Terminal No.	Color of Wire	Signal Name
4	R	-
11	LG	-

Connector No.	D152
Connector Name	WIRE TO WIRE
Connector Color	WHITE

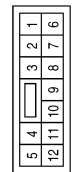

Terminal No.	Color of Wire	Signal Name
4	R	-
11	LG	-

ABNIA4220GB

A
B
C
D
E
F
G
H
I
J
K
L
M
N
O
P

AV

NAVIGATION SYSTEM

< WIRING DIAGRAM >

[NAVIGATION]

Connector No.	D301
Connector Name	WIRE TO WIRE
Connector Color	WHITE

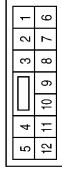

Terminal No.	Color of Wire	Signal Name
5	L	-
12	O	-

Connector No.	D208
Connector Name	REAR TWEETER LH
Connector Color	BROWN



Terminal No.	Color of Wire	Signal Name
1	L	-
2	O	-

Connector No.	D207
Connector Name	REAR DOOR SPEAKER LH (CREW CAB)
Connector Color	WHITE



Terminal No.	Color of Wire	Signal Name
1	L	-
2	O	-

Connector No.	D308
Connector Name	REAR TWEETER RH
Connector Color	BROWN



Terminal No.	Color of Wire	Signal Name
1	L	-
2	O	-

Connector No.	D307
Connector Name	REAR DOOR SPEAKER RH (CREW CAB)
Connector Color	WHITE



Terminal No.	Color of Wire	Signal Name
1	L	-
2	O	-

ABNIA5610GB

BASIC INSPECTION

DIAGNOSIS AND REPAIR WORKFLOW

Work Flow

INFOID:000000009482198

OVERALL SEQUENCE

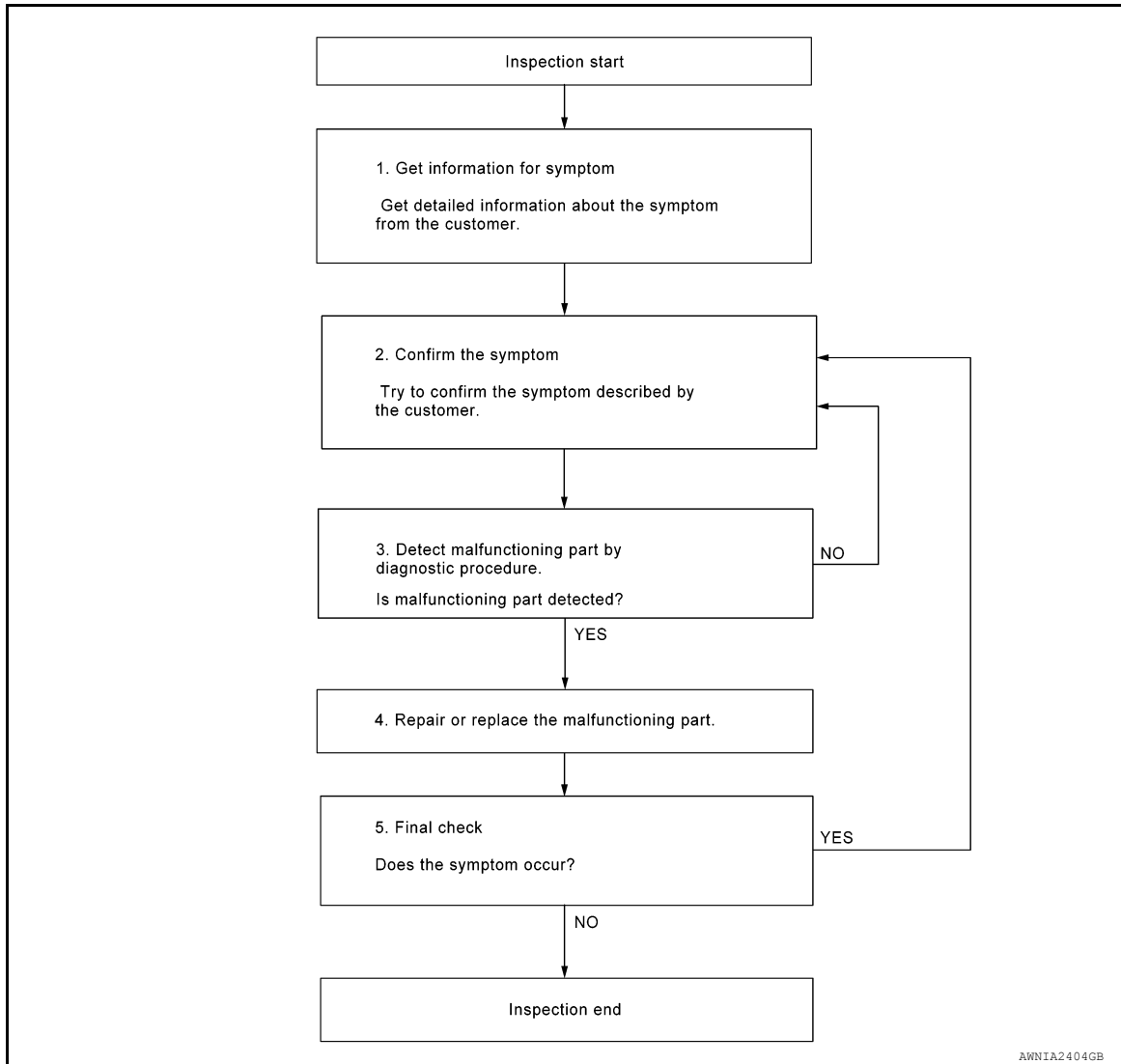

DETAILED FLOW

1.GET INFORMATION FOR SYMPTOM

Get detailed information from the customer about the symptom (the condition and the environment when the incident/malfunction occurred).

>> GO TO 2

2.CONFIRM THE SYMPTOM

Try to confirm the symptom described by the customer. Verify relation between the symptom and the condition when the symptom is detected. Refer to [AV-331, "Symptom Table"](#).

>> GO TO 3

3.DETECT MALFUNCTIONING PART BY DIAGNOSTIC PROCEDURE

Inspect according to Diagnostic Procedure of the system.

A
B
C
D
E
F
G
H
I
J
K
L
M

AV

O

P

DIAGNOSIS AND REPAIR WORKFLOW

< BASIC INSPECTION >

[NAVIGATION]

Is malfunctioning part detected?

- YES >> GO TO 4
- NO >> GO TO 2

4. REPAIR OR REPLACE THE MALFUNCTIONING PART

1. Repair or replace the malfunctioning part.
2. Reconnect parts or connectors disconnected during Diagnostic Procedure.

>> GO TO 5

5. FINAL CHECK

Refer to confirmed symptom in step 2, and make sure that the symptom is not detected.

Was the repair confirmed?

- YES >> Inspection End.
- NO >> GO TO 2

INSPECTION AND ADJUSTMENT

ADDITIONAL SERVICE WHEN REPLACING AV CONTROL UNIT

ADDITIONAL SERVICE WHEN REPLACING AV CONTROL UNIT : Description

INFOID:000000009482199

BEFORE REPLACEMENT

When replacing AV control unit, save or print current vehicle specification with CONSULT configuration before replacement.

NOTE:

If "Before Replace ECU" cannot be used, use the "After Replace ECU" or "Manual Configuration" after replacing AV control unit.

AFTER REPLACEMENT

CAUTION:

When replacing AV control unit, you must perform "After Replace ECU" with CONSULT.

- Complete the procedure of "After Replace ECU" in order.
- If you set incorrect "After Replace ECU", incidents might occur.
- Configuration is different for each vehicle model. Confirm configuration of each vehicle model.

ADDITIONAL SERVICE WHEN REPLACING AV CONTROL UNIT : Work Procedure

INFOID:000000009482200

1. SAVING VEHICLE SPECIFICATION

④-CONSULT

Enter "Re/Programming, Configuration" and perform "Before Replace ECU" to save or print current vehicle specification.

NOTE:

If "Before Replace ECU" cannot be used, use the "After Replace ECU" or "Manual Configuration" after replacing AV control unit.

>> GO TO 2.

2. REPLACE AV CONTROL UNIT

Replace AV control unit. Refer to [AV-348, "Removal and Installation"](#).

>> GO TO 3.

3. WRITING VEHICLE SPECIFICATION

④CONSULT

1. Enter "Re/Programming, Configuration".
2. If "Before Replace ECU" operation was performed, automatically an "Operation Log Selection" screen will be displayed. Select the applicable file from the "Saved Data List" and press "Confirm" to write vehicle specification. Refer to [AV-284, "CONFIGURATION \(AV CONTROL UNIT\) : Work Procedure"](#).
3. If "Before Replace ECU" operation was not performed, select "After Replace ECU" or "Manual Configuration" to write vehicle specification. Refer to [AV-284, "CONFIGURATION \(AV CONTROL UNIT\) : Work Procedure"](#).

>> GO TO 4.

4. REGISTER AV CONTROL UNIT

Perform AV control unit registration. Refer to [AV-285, "REGISTRATION \(AV CONTROL UNIT\) : Work Procedure"](#).

>> GO TO 5.

5. OPERATION CHECK

Check that the operation of the AV control unit and camera images (fixed guide lines) are normal.

>> Work End.

CONFIGURATION (AV CONTROL UNIT)

CONFIGURATION (AV CONTROL UNIT) : Description

INFOID:000000009482201

Vehicle specification needs to be written with CONSULT because it is not written after replacing AV control unit.

Configuration has three functions as follows:

Function	Description
"Before Replace ECU"	<ul style="list-style-type: none"> • Reads the vehicle configuration of current AV control unit. • Saves the read vehicle configuration.
"After Replace ECU"	Writes the vehicle configuration with manual selection.
"Select Saved Data List"	Writes the vehicle configuration with saved data.

CAUTION:

- When replacing AV control unit, you must perform "Select Saved Data List" or "After Replace ECU" with CONSULT.
- Complete the procedure of "Select Saved Data List" or "After Replace ECU" in order.
- If you set incorrect "Select Saved Data List" or "After Replace ECU", incidents might occur.
- Configuration is different for each vehicle model. Confirm configuration of each vehicle model.
- Never perform "Select Saved Data List" or "After Replace ECU" except for new AV control unit.

CONFIGURATION (AV CONTROL UNIT) : Work Procedure

INFOID:000000009482202

1. WRITING MODE SELECTION

ⓅCONSULT

Select "Reprogramming, Configuration" of AV control unit.

When writing saved data>>GO TO 2.

When writing manually>>GO TO 3.

2. PERFORM "SAVED DATA LIST"

ⓅCONSULT

Automatically "Operation Log Selection" window will display if "Before Replace ECU" was performed. Select applicable file from the "Save Data List" and press "Confirm".

>> Work End.

3. PERFORM "AFTER REPLACE ECU" OR "MANUAL CONFIGURATION"

ⓅCONSULT

1. Select "After Replace ECU" or "Manual Configuration".
2. Identify the correct model and configuration list. Refer to [AV-285, "CONFIGURATION \(AV CONTROL UNIT\) : Configuration List"](#).
3. Confirm and/or change setting value for each item.

CAUTION:
Thoroughly read and understand the vehicle specification. ECU control may not operate normally if the setting is not correct.
4. Select "Next".

CAUTION:
Make sure to select "Next", confirm each setting value and press "OK" even if the indicated configuration of brand new AV control unit is same as the desirable configuration. If not, configuration which is set automatically by selecting vehicle model can not be memorized.
5. When "Completed", select "End".

>> GO TO 4.

4. OPERATION CHECK

Confirm that each function controlled by AV control unit operates normally.

>> Work End.

CONFIGURATION (AV CONTROL UNIT) : Configuration List

INFOID:000000009482203

CAUTION:

Thoroughly read and understand the vehicle specification. Incorrect settings may result in abnormal control of ECU.

MANUAL SETTING ITEM	
Items	Setting value
SOUND SYSTEM	BASE ⇔ BOSE
CAMERA SYSTEM	NONE/AVM ⇔ REAR CAMERA

⇔: Items which confirm vehicle specifications

REGISTRATION (AV CONTROL UNIT)

REGISTRATION (AV CONTROL UNIT) : Description

INFOID:0000000011217827

AFTER REPLACEMENT

If the AV control unit is replaced with a new AV control unit, the new AV control unit must be registered using the registration code.

CAUTION:

If the new AV control unit registration code is not registered, the “APPS” mode will not function.

REGISTRATION (AV CONTROL UNIT) : Work Procedure

INFOID:0000000011217828

1. RECORD REGISTRATION CODE FOR REPLACEMENT AV CONTROL UNIT

1. Refer to the replacement AV control unit's label located on the top of the AV control unit.

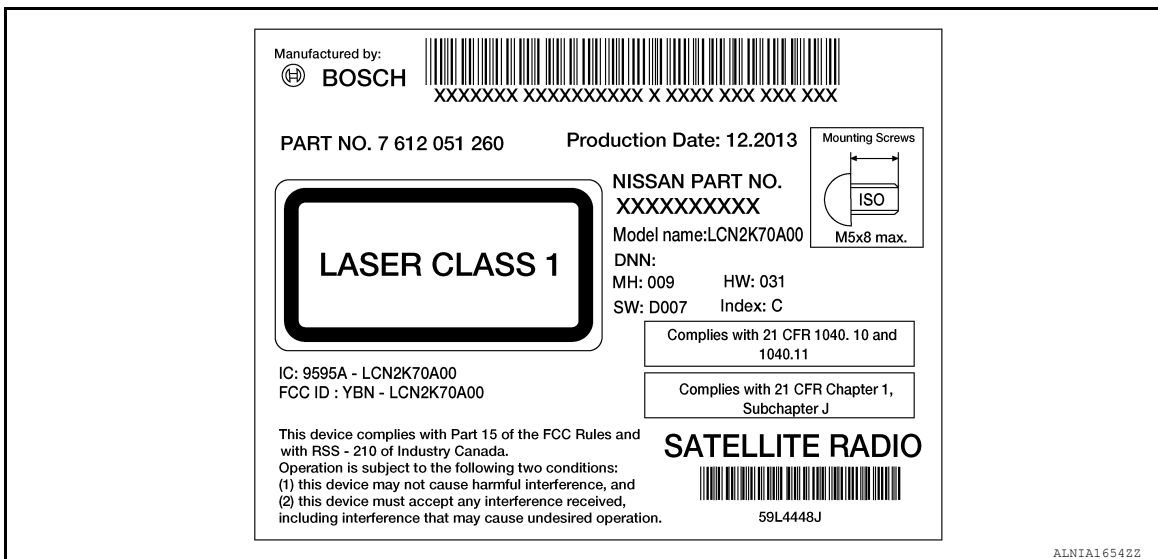

2. Create a registration code to supply to NISSAN Owner Services by combining the last 9 digits of the NISSAN PART NO. (1) and the first 7 digits of the bar code number (2).

INSPECTION AND ADJUSTMENT

< BASIC INSPECTION >

[NAVIGATION]

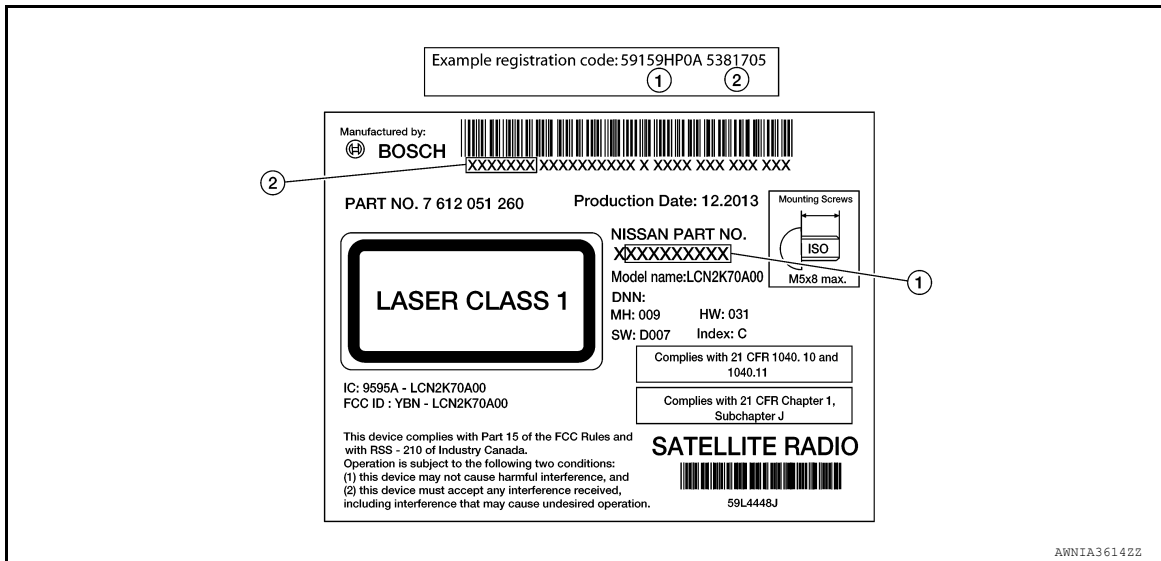

3. Record the registration code.

>> GO TO 2.

2. REGISTER REPLACEMENT AV CONTROL UNIT

Register the replacement AV control unit by contacting NISSAN Owner Services. Refer to TSB.

>> GO TO 3.

3. OPERATION CHECK

Verify that the AV control unit "APPS" function operates normally.

>> Work End.

U1000 CAN COMM CIRCUIT

< DTC/CIRCUIT DIAGNOSIS >

[NAVIGATION]

DTC/CIRCUIT DIAGNOSIS

U1000 CAN COMM CIRCUIT

DTC Logic

INFOID:000000009482204

DTC DETECTION LOGIC

CONSULT Display	DTC Detection Condition	Possible Cause
CAN COMM CIRCUIT [U1000]	AV control unit is not transmitting or receiving CAN communication signal for 2 seconds or more.	CAN communication system.

Diagnosis Procedure

INFOID:000000009482205

1. PERFORM SELF DIAGNOSTIC RESULT

1. Turn ignition switch ON and wait for 2 seconds or more.
2. Perform Self Diagnostic Result for MULTI AV.

Is CAN COMM CIRCUIT displayed?

- YES >> Refer to [LAN-14, "Trouble Diagnosis Flow Chart"](#).
NO >> Refer to [GI-42, "Intermittent Incident"](#).

A
B
C
D
E
F
G
H
I
J
K
L
M
O
P

AV

U1010 CONTROL UNIT (CAN)

< DTC/CIRCUIT DIAGNOSIS >

[NAVIGATION]

U1010 CONTROL UNIT (CAN)

DTC Logic

INFOID:000000009482206

DTC DETECTION LOGIC

CONSULT Display	DTC Detection Condition	Possible Cause
CONTROL UNIT (CAN) [U1010]	Error during CAN controller hardware initialization (VCAN).	Replace the AV control unit if the malfunction occurs constantly. Refer to AV-348, "Removal and Installation" .

U1217 AV CONTROL UNIT

< DTC/CIRCUIT DIAGNOSIS >

[NAVIGATION]

U1217 AV CONTROL UNIT

DTC Logic

INFOID:000000009482207

DTC DETECTION LOGIC

CONSULT Display	DTC Detection Condition	Possible Cause
BLUETOOTH MODULE [U1217]	Connection failure to the internal Bluetooth® sub unit is detected.	Replace AV control unit if malfunction occurs constantly. Refer to AV-348, "Removal and Installation" .

A
B
C
D
E
F
G
H
I
J
K
L
M

AV

O
P

U1229 AV CONTROL UNIT

< DTC/CIRCUIT DIAGNOSIS >

[NAVIGATION]

U1229 AV CONTROL UNIT

DTC Logic

INFOID:000000009482208

DTC DETECTION LOGIC

CONSULT Display	DTC Detection Condition	Possible Cause
iPod CERTIFICATION [U1229]	iPod authentication chip error.	Replace AV control unit if malfunction occurs constantly. Refer to AV-348, "Removal and Installation" .

U122F AV CONTROL UNIT

< DTC/CIRCUIT DIAGNOSIS >

[NAVIGATION]

U122F AV CONTROL UNIT

DTC Logic

INFOID:000000009482209

DTC DETECTION LOGIC

CONSULT Display	DTC Detection Condition	Possible Cause
Digital broadcasting connection error [U122F]	Communication error with digital audio broadcast module internal to AV control unit.	Replace AV control unit if malfunction occurs constantly. Refer to AV-348, "Removal and Installation" .

A
B
C
D
E
F
G
H
I
J
K
L
M

AV

O
P

U1244 GPS ANTENNA

< DTC/CIRCUIT DIAGNOSIS >

[NAVIGATION]

U1244 GPS ANTENNA

DTC Logic

INFOID:000000009482210

DTC DETECTION LOGIC

CONSULT Display	DTC Detection Condition	Possible Cause
GPS ANTENNA CONN [U1244]	Open or short to ground is detected in GPS antenna connection.	<ul style="list-style-type: none">GPS antenna disconnection.Open or short to ground in GPS antenna signal circuit.

Diagnosis Procedure

INFOID:000000009482211

Regarding Wiring Diagram information, refer to [AV-264, "Wiring Diagram"](#).

1. GPS ANTENNA INSPECTION

Visually inspect the GPS antenna and antenna feeder. Refer to [AV-357, "Location of Antenna"](#).

Is inspection result normal?

YES >> GO TO 2.

NO >> Repair or replace malfunctioning components.

2. CHECK AV CONTROL UNIT VOLTAGE

1. Disconnect AV control unit connector M99.
2. Turn ignition switch ON.
3. Check voltage between AV control unit connector M99 and ground.

AV control unit		Ground	Voltage
Connector	Terminal		
M99	50	—	5.0 V

Is inspection result normal?

YES >> Replace GPS antenna.

NO >> Replace AV control unit. Refer to [AV-348, "Removal and Installation"](#).

U1258 SATELLITE RADIO ANTENNA

< DTC/CIRCUIT DIAGNOSIS >

[NAVIGATION]

U1258 SATELLITE RADIO ANTENNA

DTC Logic

INFOID:000000009482212

DTC DETECTION LOGIC

CONSULT Display	DTC Detection Condition	Possible Cause
XM ANTENNA CONN [U1258]	Open or short to ground is detected in satellite antenna connection.	<ul style="list-style-type: none">Satellite antenna disconnection.Open or short to ground in satellite antenna signal circuit.

Diagnosis Procedure

INFOID:000000009482213

Regarding Wiring Diagram information, refer to [AV-264, "Wiring Diagram"](#).

1. SATELLITE ANTENNA INSPECTION

Visually inspect the satellite antenna and antenna feeder. Refer to [AV-357, "Location of Antenna"](#).

Is inspection result normal?

YES >> GO TO 2.

NO >> Repair or replace malfunctioning components.

2. CHECK AV CONTROL UNIT VOLTAGE

1. Disconnect AV control unit connector M100.
2. Turn ignition switch ON.
3. Check voltage between AV control unit connector M100 and ground.

AV control unit		Ground	Voltage
Connector	Terminal		
M100	58	—	5.0 V

Is inspection result normal?

YES >> Replace satellite radio antenna. Refer to [AV-360, "Removal and Installation"](#).

NO >> Replace AV control unit. Refer to [AV-348, "Removal and Installation"](#).

A
B
C
D
E
F
G
H
I
J
K
L
M
O
P



U1263 USB

DTC Logic

INFOID:000000009482214

DTC DETECTION LOGIC

CONSULT Display	DTC Detection Condition	Possible Cause
USB OVERCURRENT [U1263]	Overcurrent in USB harness is detected.	<ul style="list-style-type: none"> Device connected to USB interface. Harness between the AV control unit and USB interface.

DTC CONFIRMATION PROCEDURE

1. PERFORM SELF DIAGNOSTIC RESULT

1. If there is a device connected to the USB interface, disconnect it.
2. Turn ignition switch ON and wait for 2 seconds or more.
3. Perform Self Diagnostic Result for MULTI AV.

Is DTC U1263 displayed?

- YES >> Refer to [AV-294, "Diagnosis Procedure"](#).
- NO >> Inspection End.

Diagnosis Procedure

INFOID:000000009482215

1. CHECK USB INTERFACE HARNESS

Visually inspect USB interface harness. Refer to [AV-362, "Removal and Installation"](#).

Is the inspection result normal?

- YES >> GO TO 2.
- NO >> Replace USB interface harness. Refer to [AV-362, "Removal and Installation"](#).

2. CHECK USB INTERFACE HARNESS

Check USB interface harness. Refer to [AV-329, "Diagnosis Procedure"](#).

Is the inspection result normal?

- YES >> Replace AV control unit. Refer to [AV-348, "Removal and Installation"](#).
- NO >> Replace USB interface harness. Refer to [AV-362, "Removal and Installation"](#).

U1265 AUDIO AMP.

< DTC/CIRCUIT DIAGNOSIS >

[NAVIGATION]

U1265 AUDIO AMP.

DTC Logic

INFOID:000000009482216

CONSULT Display	DTC Detection Condition	Possible Cause
AMP ON TERMINAL [U1265]	Open or short to ground is detected in audio amp. ON signal circuit.	Open or short to ground in audio amp. ON signal circuit.

Diagnosis Procedure

INFOID:000000009482217

Regarding Wiring Diagram information, refer to [AV-264, "Wiring Diagram"](#).

1. CHECK CONTINUITY BETWEEN AV CONTROL UNIT AND AUDIO AMP.

1. Turn ignition switch OFF.
2. Disconnect AV control unit connector M96 and audio amplifier connector B158.
3. Check continuity between AV control unit connector M96 and audio amp. connector B158.

AV control unit		Audio amplifier		Continuity
Connector	Terminal	Connector	Terminal	
M96	1	B158	9	Yes

4. Check continuity between AV control unit connector M96 and ground.

AV control unit		Ground	Continuity
Connector	Terminal		
M96	1	—	No

Is the inspection result normal?

- YES >> GO TO 2.
NO >> Repair or replace harness or connectors.

2. CHECK AV CONTROL UNIT VOLTAGE

1. Connect AV control unit connector M96.
2. Turn ignition switch ON.
3. Check voltage between AV control unit connector M96 and ground.

AV control unit		Ground	Voltage (Approx.)
Connector	Terminal		
M96	1	—	Battery voltage

Is the inspection result normal?

- YES >> Replace audio amplifier. Refer to [AV-349, "Removal and Installation"](#).
NO >> Replace AV control unit. Refer to [AV-348, "Removal and Installation"](#).

A
B
C
D
E
F
G
H
I
J
K
L
M
AV
O
P

U12AA CONFIGURATION ERROR

< DTC/CIRCUIT DIAGNOSIS >

[NAVIGATION]

U12AA CONFIGURATION ERROR

DTC Logic

INFOID:000000009482218

DTC DETECTION LOGIC

CONSULT Display	DTC Detection Condition	Possible Cause
Configuration Error [U12AA]	AV control unit is not properly configured or configuration is corrupt.	Configuration data needs to be written. Refer to AV-284, "CONFIGURATION (AV CONTROL UNIT) : Work Procedure" .

Diagnosis Procedure

INFOID:000000009482219

1.PERFORM CONFIGURATION

When U12AA is detected, configuration data must be written.

>> Write configuration data with CONSULT. Refer to [AV-284, "CONFIGURATION \(AV CONTROL UNIT\) : Work Procedure"](#).

U12AB ANTENNA

< DTC/CIRCUIT DIAGNOSIS >

[NAVIGATION]

U12AB ANTENNA

DTC Logic

INFOID:000000009482220

DTC DETECTION LOGIC

CONSULT Display	DTC Detection Condition	Possible Cause
FM Antenna error [U12AB]	Open or short to ground is detected in rod antenna connection.	<ul style="list-style-type: none">• Rod antenna disconnection.• Open or short to ground in antenna feeder.

Diagnosis Procedure

INFOID:000000009482221

Regarding Wiring Diagram information, refer to [AV-264, "Wiring Diagram"](#).

1. ROD ANTENNA INSPECTION

Visually inspect the rod antenna and antenna feeder. Refer to [AV-357, "Location of Antenna"](#).

Is inspection result normal?

- YES >> Replace AV control unit. Refer to [AV-348, "Removal and Installation"](#).
- NO >> Repair or replace malfunctioning components.

A
B
C
D
E
F
G
H
I
J
K
L
M

AV

O
P

U12AC AV CONTROL UNIT

< DTC/CIRCUIT DIAGNOSIS >

[NAVIGATION]

U12AC AV CONTROL UNIT

DTC Logic

INFOID:000000009482222

DTC DETECTION LOGIC

CONSULT Display	DTC Detection Condition	Possible Cause
Display Temperature too High [U12AC]	Display temperature has exceeded maximum temperature. Display is switched OFF to avoid irreversible damage.	Replace AV control unit if malfunction occurs constantly. Refer to AV-348, "Removal and Installation" .

U12AD AV CONTROL UNIT

< DTC/CIRCUIT DIAGNOSIS >

[NAVIGATION]

U12AD AV CONTROL UNIT

DTC Logic

INFOID:000000009482223

DTC DETECTION LOGIC

CONSULT Display	DTC Detection Condition	Possible Cause
ECU Temperature too High [U12AD]	AV control unit temperature has exceeded maximum temperature.	Replace AV control unit if malfunction occurs constantly. Refer to AV-348, "Removal and Installation" .

A

B

C

D

E

F

G

H

I

J

K

L

M

AV

O

P

U12AE AV CONTROL UNIT

< DTC/CIRCUIT DIAGNOSIS >

[NAVIGATION]

U12AE AV CONTROL UNIT

DTC Logic

INFOID:000000009482224

DTC DETECTION LOGIC

CONSULT Display	DTC Detection Condition	Possible Cause
Internal Amplifier temperature Warning [U12AE]	Internal amplifier temperature has exceeded maximum temperature.	Replace AV control unit if malfunction occurs constantly. Refer to AV-348, "Removal and Installation" .

U12AF AV CONTROL UNIT

< DTC/CIRCUIT DIAGNOSIS >

[NAVIGATION]

U12AF AV CONTROL UNIT

DTC Logic

INFOID:000000009482225

DTC DETECTION LOGIC

CONSULT Display	DTC Detection Condition	Possible Cause
CD Mechanism Temperature Warning [U12AF]	CD drive temperature has exceeded maximum temperature. CD drive is switched OFF to avoid irreversible damage.	Replace AV control unit if malfunction occurs constantly. Refer to AV-348, "Removal and Installation" .

A
B
C
D
E
F
G
H
I
J
K
L
M
O
P

AV

U12B0 POWER SUPPLY VOLTAGE

< DTC/CIRCUIT DIAGNOSIS >

[NAVIGATION]

U12B0 POWER SUPPLY VOLTAGE

DTC Logic

INFOID:000000009482226

DTC DETECTION LOGIC

CONSULT Display	DTC Detection Condition	Possible Cause
Supply Voltage Goes below 9V > 20s [U12B0]	AV control unit supply voltage exceeds lower limits.	<ul style="list-style-type: none">• Charging system malfunction.• AV control unit power supply or ground circuits.

Diagnosis Procedure

INFOID:000000009482227

1. CHECK CHARGING SYSTEM

Check the vehicle charging system. Refer to [CHG-2, "Work Flow \(With EXP-800 NI or GR8-1200 NI\)"](#) or [CHG-5, "Work Flow \(Without EXP-800 NI or GR8-1200 NI\)"](#).

Is the inspection result normal?

YES >> GO TO 2.

NO >> Repair or replace the malfunctioning components.

2. CHECK AV CONTROL UNIT POWER SUPPLY AND GROUND CIRCUITS

Perform the AV control unit power supply and ground circuit diagnosis procedure. Refer to [AV-305, "AV CONTROL UNIT : Diagnosis Procedure"](#).

Is the inspection result normal?

YES >> Replace the AV control unit. Refer to [AV-348, "Removal and Installation"](#).

NO >> Repair or replace harness or connectors.

U12B1 POWER SUPPLY VOLTAGE

< DTC/CIRCUIT DIAGNOSIS >

[NAVIGATION]

U12B1 POWER SUPPLY VOLTAGE

DTC Logic

INFOID:000000009482228

DTC DETECTION LOGIC

CONSULT Display	DTC Detection Condition	Possible Cause
Supply Voltage Goes High > 16V for 20s [U12B1]	AV control unit supply voltage exceeds upper limits.	Charging system malfunction.

Diagnosis Procedure

INFOID:000000009482229

1. CHECK CHARGING SYSTEM

Check the vehicle charging system. Refer to [CHG-2, "Work Flow \(With EXP-800 NI or GR8-1200 NI\)"](#) or [CHG-5, "Work Flow \(Without EXP-800 NI or GR8-1200 NI\)"](#).

Is the inspection result normal?

- YES >> Replace the AV control unit. Refer to [AV-348, "Removal and Installation"](#).
- NO >> Repair or replace the malfunctioning components.

A
B
C
D
E
F
G
H
I
J
K
L
M
O
P

AV

U1310 AV CONTROL UNIT

< DTC/CIRCUIT DIAGNOSIS >

[NAVIGATION]

U1310 AV CONTROL UNIT

DTC Logic

INFOID:000000009482230

DTC DETECTION LOGIC

CONSULT Display	DTC Detection Condition	Possible Cause
CONTROL UNIT (AV) [U1310]	Error during CAN controller hardware initialization (MCAN).	Replace AV control unit if malfunction occurs constantly. Refer to AV-348, "Removal and Installation" .

POWER SUPPLY AND GROUND CIRCUIT

< DTC/CIRCUIT DIAGNOSIS >

[NAVIGATION]

POWER SUPPLY AND GROUND CIRCUIT

AV CONTROL UNIT

AV CONTROL UNIT : Diagnosis Procedure

INFOID:000000009482231

Regarding Wiring Diagram information, refer to [AV-264. "Wiring Diagram"](#).

1.CHECK FUSE

Check that the following fuses are not blown.

Terminal No.	Signal name	Fuse No.
7	ACC power supply	4 (10A)
19	Battery power supply	29 (20A)
37	IGN power supply	12 (10A)

Are the fuses blown?

YES >> Replace the blown fuse after repairing the affected circuit.

NO >> GO TO 2.

2.CHECK POWER SUPPLY CIRCUIT

1. Turn ignition switch OFF.
2. Disconnect audio unit connector M96 and M97.
3. Check voltage between audio unit connectors and ground.

Audio unit		Ground	Condition	Voltage (Approx.)
Connector	Terminal			
M96	19	—	Ignition switch: OFF	Battery voltage
	7		Ignition switch: ON	
M97	37			

Is the inspection result normal?

YES >> GO TO 3.

NO >> Repair or replace harness or connectors.

3.CHECK GROUND CIRCUIT

Check continuity between audio unit connector M96 and ground.

Audio unit		Ground	Continuity
Connector	Terminal		
M96	20	—	Yes

Is the inspection result normal?

YES >> Inspection End.

NO >> Repair or replace harness or connectors.

AUDIO AMP.

AUDIO AMP. : Diagnosis Procedure

INFOID:000000009482232

Regarding Wiring Diagram information, refer to [AV-264. "Wiring Diagram"](#).

1.CHECK FUSE

Check that the following fuse is not blown.

POWER SUPPLY AND GROUND CIRCUIT

< DTC/CIRCUIT DIAGNOSIS >

[NAVIGATION]

Terminal No.	Signal name	Fuse No.
1	Battery power supply	17 (15A)
17		

Is the fuse blown?

YES >> Replace the blown fuse after repairing the affected circuit.

NO >> GO TO 2.

2. CHECK POWER SUPPLY CIRCUIT

1. Turn ignition switch OFF.
2. Disconnect audio amplifier connector B158.
3. Check voltage between audio amplifier connector B158 and ground.

Audio amplifier		Ground	Condition	Voltage (Approx.)
Connector	Terminal			
B158	1	—	Ignition switch: OFF	Battery voltage
	17			

Is the inspection result normal?

YES >> GO TO 3.

NO >> Repair or replace harness or connectors.

3. CHECK GROUND CIRCUIT

Check continuity between audio amplifier connector B158 and ground.

Audio amplifier		Ground	Continuity
Connector	Terminal		
B158	4	—	Yes
	20		

Is the inspection result normal?

YES >> Inspection End.

NO >> Repair or replace harness or connectors.

FRONT DOOR SPEAKER

< DTC/CIRCUIT DIAGNOSIS >

[NAVIGATION]

FRONT DOOR SPEAKER

Diagnosis Procedure

INFOID:000000009482233

Regarding Wiring Diagram information, refer to [AV-264. "Wiring Diagram"](#).

1. CONNECTOR CHECK

Check the AV control unit, audio amplifier and speaker connectors for the following:

- Proper connection
- Damage
- Disconnected or loose terminals

Is the inspection result normal?

YES >> GO TO 2

NO >> Repair the terminals or connectors.

2. CHECK FRONT DOOR SPEAKER SIGNAL CIRCUIT CONTINUITY

1. Disconnect audio amplifier connector B159 and suspect front door speaker connector.
2. Check continuity between audio amplifier connector B159 and suspect front door speaker connector.

Audio amplifier		Front door speaker		Continuity
Connector	Terminal	Connector	Terminal	
B159	15	D12 (LH)	1	Yes
	31		2	
	16	D112 (RH)	1	
	32		2	

3. Check continuity between audio amplifier connector B159 and ground.

Audio amplifier		Ground	Continuity
Connector	Terminal		
B159	15	—	No
	31		
	16		
	32		

Is the inspection result normal?

YES >> GO TO 3

NO >> Repair or replace harness or connectors.

3. CHECK FRONT DOOR SPEAKER SIGNAL

1. Connect audio amplifier connector B159 and suspect front door speaker connector.
2. Turn ignition switch to ACC.
3. Push AV control unit POWER switch.
4. Check signal between the terminals of audio amplifier connector B159.

Audio amplifier connector B159		Condition	Reference value
(+)	(-)		
Terminal	Terminal		

FRONT DOOR SPEAKER

< DTC/CIRCUIT DIAGNOSIS >

[NAVIGATION]

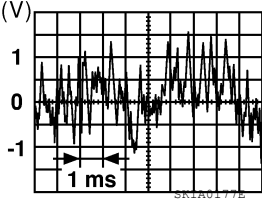
15	31	Audio signal output	
16	32		

Is the inspection result normal?

YES >> Replace front door speaker. Refer to [AV-351, "Removal and Installation"](#).

NO >> GO TO 4.

4. CHECK PRE-AMP SIGNAL CIRCUIT CONTINUITY

1. Disconnect AV control unit connector M96 and audio amplifier connector B159.
2. Check continuity between AV control unit connector M96 and audio amplifier connector B159.

AV control unit		Audio amplifier		Continuity
Connector	Terminal	Connector	Terminal	
M96	2	B159	22	Yes
	3		6	
	11		21	
	12		5	

3. Check continuity between AV control unit connector M96 and ground.

AV control unit		Ground	Continuity
Connector	Terminal		
M96	2	—	No
	3		
	11		
	12		

Is the inspection result normal?

YES >> GO TO 5.

NO >> Repair or replace harness or connectors.

5. CHECK PRE-AMP SIGNAL

1. Connect AV control unit connector M96 and audio amplifier connector B159.
2. Turn ignition switch to ACC.
3. Push AV control unit POWER switch.
4. Check signal between the terminals of AV control unit connector M96.

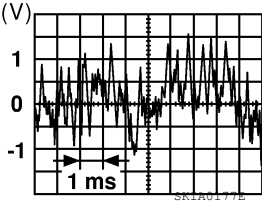
AV control unit connector M96		Condition	Reference value
(+) Terminal	(-) Terminal		
2	3	Audio signal output	
11	12		

Is the inspection result normal?

FRONT DOOR SPEAKER

< DTC/CIRCUIT DIAGNOSIS >

[NAVIGATION]

YES >> Replace audio amplifier. Refer to [AV-349, "Removal and Installation"](#).
NO >> Replace AV control unit. Refer to [AV-348, "Removal and Installation"](#).

- A
- B
- C
- D
- E
- F
- G
- H
- I
- J
- K
- L
- M
- AV
- O
- P

FRONT TWEETER

Diagnosis Procedure

INFOID:000000009482234

Regarding Wiring Diagram information, refer to [AV-264. "Wiring Diagram"](#).

1. CONNECTOR CHECK

Check the AV control unit, audio amplifier and speaker connectors for the following:

- Proper connection
- Damage
- Disconnected or loose terminals

Is the inspection result normal?

- YES >> GO TO 2
 NO >> Repair the terminals or connectors.

2. CHECK FRONT TWEETER SIGNAL CIRCUIT CONTINUITY

1. Disconnect audio amplifier connector B159 and suspect front tweeter connector.
2. Check continuity between audio amplifier connector B159 and suspect front tweeter connector.

Audio amplifier		Front tweeter		Continuity
Connector	Terminal	Connector	Terminal	
B159	14	M109 (LH)	1	Yes
	30		2	
	13	M111 (RH)	1	
	29		2	

3. Check continuity between audio amplifier connector B159 and ground.

Audio amplifier		Ground	Continuity
Connector	Terminal		
B159	14	—	No
	30		
	13		
	29		

Is the inspection result normal?

- YES >> GO TO 3
 NO >> Repair or replace harness or connectors.

3. CHECK FRONT TWEETER SIGNAL

1. Connect audio amplifier connector B159 and suspect front tweeter connector.
2. Turn ignition switch to ACC.
3. Push AV control unit POWER switch.
4. Check signal between the terminals of audio amplifier connector B159.

Audio amplifier connector B159		Condition	Reference value
(+)	(-)		
Terminal	Terminal		

FRONT TWEETER

< DTC/CIRCUIT DIAGNOSIS >

[NAVIGATION]

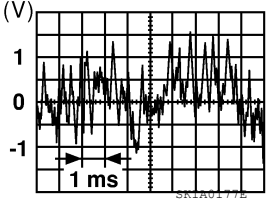
14	30	Audio signal output	
13	29		

Is the inspection result normal?

- YES >> Replace front tweeter. Refer to [AV-350, "Removal and Installation"](#).
- NO >> GO TO 4.

4. CHECK PRE-AMP SIGNAL CIRCUIT CONTINUITY

1. Disconnect AV control unit connector M96 and audio amplifier connector B159.
2. Check continuity between AV control unit connector M96 and audio amplifier connector B159.

AV control unit		Audio amplifier		Continuity
Connector	Terminal	Connector	Terminal	
M96	2	B159	22	Yes
	3		6	
	11		21	
	12		5	

3. Check continuity between AV control unit connector M96 and ground.

AV control unit		Ground	Continuity
Connector	Terminal		
M96	2	—	No
	3		
	11		
	12		

Is the inspection result normal?

- YES >> GO TO 5.
- NO >> Repair or replace harness or connectors.

5. CHECK PRE-AMP SIGNAL

1. Connect AV control unit connector M96 and audio amplifier connector B159.
2. Turn ignition switch to ACC.
3. Push AV control unit POWER switch.
4. Check signal between the terminals of AV control unit connector M96.

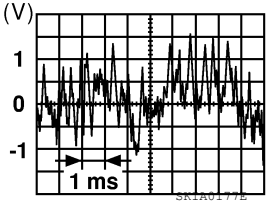
AV control unit connector M96		Condition	Reference value
(+)	(-)		
Terminal	Terminal	Audio signal output	
2	3		
11	12		

Is the inspection result normal?

A
B
C
D
E
F
G
H
I
J
K
L
M
O
P

AV

FRONT TWEETER

< DTC/CIRCUIT DIAGNOSIS >

[NAVIGATION]

- YES >> Replace audio amplifier. Refer to [AV-349, "Removal and Installation"](#).
- NO >> Replace AV control unit. Refer to [AV-348, "Removal and Installation"](#).

REAR DOOR SPEAKER

< DTC/CIRCUIT DIAGNOSIS >

[NAVIGATION]

REAR DOOR SPEAKER

Diagnosis Procedure

INFOID:000000009482235

Regarding Wiring Diagram information, refer to [AV-264. "Wiring Diagram"](#).

1. CONNECTOR CHECK

Check the AV control unit, audio amplifier and speaker connectors for the following:

- Proper connection
- Damage
- Disconnected or loose terminals

Is the inspection result normal?

YES >> GO TO 2

NO >> Repair the terminals or connectors.

2. CHECK REAR DOOR SPEAKER SIGNAL CIRCUIT CONTINUITY

1. Disconnect audio amplifier connector B159 and suspect rear door speaker connector.
2. Check continuity between audio amplifier connector B159 and suspect rear door speaker connector.

Audio amplifier		Rear door speaker		Continuity
Connector	Terminal	Connector	Terminal	
B159	11	D207 (LH)	1	Yes
	27		2	
	12	D307 (RH)	1	
	28		2	

3. Check continuity between audio amplifier connector B159 and ground.

Audio amplifier		Ground	Continuity
Connector	Terminal		
B159	11	—	No
	27		
	12		
	28		

Is the inspection result normal?

YES >> GO TO 3

NO >> Repair or replace harness or connectors.

3. CHECK REAR DOOR SPEAKER SIGNAL

1. Connect audio amplifier connector B159 and suspect rear door speaker connector.
2. Turn ignition switch to ACC.
3. Push AV control unit POWER switch.
4. Check signal between the terminals of audio amplifier connector B159.

Audio amplifier connector B159		Condition	Reference value
(+)	(-)		
Terminal	Terminal		

REAR DOOR SPEAKER

< DTC/CIRCUIT DIAGNOSIS >

[NAVIGATION]

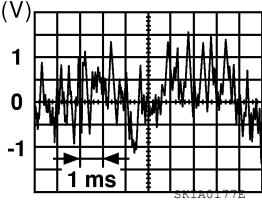
11	27	Audio signal output	
12	28		

Is the inspection result normal?

- YES >> Replace rear door speaker. Refer to [AV-352, "Removal and Installation"](#).
- NO >> GO TO 4.

4. CHECK PRE-AMP SIGNAL CIRCUIT CONTINUITY

1. Disconnect AV control unit connector M96 and audio amplifier connector B159.
2. Check continuity between AV control unit connector M96 and audio amplifier connector B159.

AV control unit		Audio amplifier		Continuity
Connector	Terminal	Connector	Terminal	
M96	4	B159	24	Yes
	5		8	
	13		23	
	14		7	

3. Check continuity between AV control unit connector M96 and ground.

AV control unit		Ground	Continuity
Connector	Terminal		
M96	4	—	No
	5		
	13		
	14		

Is the inspection result normal?

- YES >> GO TO 5.
- NO >> Repair or replace harness or connectors.

5. CHECK PRE-AMP SIGNAL

1. Connect AV control unit connector M96 and audio amplifier connector B159.
2. Turn ignition switch to ACC.
3. Push AV control unit POWER switch.
4. Check signal between the terminals of AV control unit connector M96.

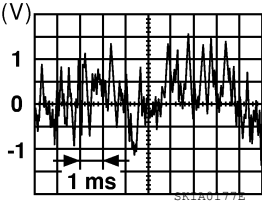
AV control unit connector M96		Condition	Reference value
(+) Terminal	(-) Terminal		
4	5	Audio signal output	
13	14		

Is the inspection result normal?

REAR DOOR SPEAKER

< DTC/CIRCUIT DIAGNOSIS >

[NAVIGATION]

YES >> Replace audio amplifier. Refer to [AV-349, "Removal and Installation"](#).
NO >> Replace AV control unit. Refer to [AV-348, "Removal and Installation"](#).

- A
- B
- C
- D
- E
- F
- G
- H
- I
- J
- K
- L
- M
- AV
- O
- P

REAR TWEETER

< DTC/CIRCUIT DIAGNOSIS >

[NAVIGATION]

REAR TWEETER

Diagnosis Procedure

INFOID:000000009482236

Regarding Wiring Diagram information, refer to [AV-264. "Wiring Diagram"](#).

1. CONNECTOR CHECK

Check the AV control unit, audio amplifier and speaker connectors for the following:

- Proper connection
- Damage
- Disconnected or loose terminals

Is the inspection result normal?

YES >> GO TO 2

NO >> Repair the terminals or connectors.

2. CHECK REAR TWEETER SIGNAL CIRCUIT CONTINUITY

1. Disconnect audio amplifier connector B159 and suspect rear tweeter connector.
2. Check continuity between audio amplifier connector B159 and suspect rear tweeter connector.

Audio amplifier		Rear tweeter		Continuity
Connector	Terminal	Connector	Terminal	
B159	11	D208 (LH)	1	Yes
	27		2	
	12	D308 (RH)	1	
	28		2	

3. Check continuity between audio amplifier connector B159 and ground.

Audio amplifier		Ground	Continuity
Connector	Terminal		
B159	11	—	No
	27		
	12		
	28		

Is the inspection result normal?

YES >> GO TO 3

NO >> Repair or replace harness or connectors.

3. CHECK REAR TWEETER SIGNAL

1. Connect audio amplifier connector B159 and suspect rear tweeter connector.
2. Turn ignition switch to ACC.
3. Push AV control unit POWER switch.
4. Check signal between the terminals of audio amplifier connector B159.

Audio amplifier connector B159		Condition	Reference value
(+)	(-)		
Terminal	Terminal		

REAR TWEETER

< DTC/CIRCUIT DIAGNOSIS >

[NAVIGATION]

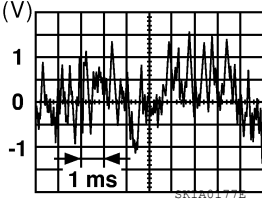
11	27	Audio signal output	
12	28		

Is the inspection result normal?

- YES >> Replace rear tweeter. Refer to [AV-353, "Removal and Installation"](#).
- NO >> GO TO 4.

4. CHECK PRE-AMP SIGNAL CIRCUIT CONTINUITY

1. Disconnect AV control unit connector M96 and audio amplifier connector B159.
2. Check continuity between AV control unit connector M96 and audio amplifier connector B159.

AV control unit		Audio amplifier		Continuity
Connector	Terminal	Connector	Terminal	
M96	4	B159	24	Yes
	5		8	
	13		23	
	14		7	

3. Check continuity between AV control unit connector M96 and ground.

AV control unit		Ground	Continuity
Connector	Terminal		
M96	4	—	No
	5		
	13		
	14		

Is the inspection result normal?

- YES >> GO TO 5.
- NO >> Repair or replace harness or connectors.

5. CHECK PRE-AMP SIGNAL

1. Connect AV control unit connector M96 and audio amplifier connector B159.
2. Turn ignition switch to ACC.
3. Push AV control unit POWER switch.
4. Check signal between the terminals of AV control unit connector M96.

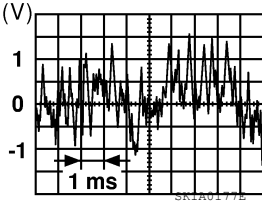
AV control unit connector M96		Condition	Reference value
(+)	(-)		
Terminal	Terminal	Audio signal output	
4	5		
13	14		

Is the inspection result normal?

A
B
C
D
E
F
G
H
I
J
K
L
M
O
P

AV

REAR TWEETER

< DTC/CIRCUIT DIAGNOSIS >

[NAVIGATION]

- YES >> Replace audio amplifier. Refer to [AV-349, "Removal and Installation"](#).
- NO >> Replace AV control unit. Refer to [AV-348, "Removal and Installation"](#).

SUBWOOFER

< DTC/CIRCUIT DIAGNOSIS >

[NAVIGATION]

SUBWOOFER

Diagnosis Procedure

INFOID:000000009482237

Regarding Wiring Diagram information, refer to [AV-264. "Wiring Diagram"](#).

1.CONNECTOR CHECK

Check the AV control unit, audio amplifier and subwoofer connectors for the following:

- Proper connection
- Damage
- Disconnected or loose terminals

Is the inspection result normal?

YES >> GO TO 2

NO >> Repair the terminals or connectors.

2.CHECK SUBWOOFER SIGNAL CIRCUIT CONTINUITY

1. Disconnect audio amplifier connector B158 and subwoofer connector.
2. Check continuity between audio amplifier connector B158 and subwoofer connector.

Audio amplifier		Subwoofer		Continuity
Connector	Terminal	Connector	Terminal	
B158	2	B72	1	Yes
	18		2	
	3		3	
	19		4	

3. Check continuity between audio amplifier connector B158 and ground.

Audio amplifier		Ground	Continuity
Connector	Terminal		
B158	2	—	No
	18		
	3		
	19		

Is the inspection result normal?

YES >> GO TO 3

NO >> Repair or replace harness or connectors.

3.CHECK SUBWOOFER SIGNAL

1. Connect audio amplifier connector B158 and subwoofer connector.
2. Turn ignition switch to ACC.
3. Push AV control unit POWER switch.
4. Check signal between the terminals of audio amplifier connector B158.

Audio amplifier connector B158		Condition	Reference value
(+)	(-)		
Terminal	Terminal		

A
B
C
D
E
F
G
H
I
J
K
L
M
AV
O
P

SUBWOOFER

< DTC/CIRCUIT DIAGNOSIS >

[NAVIGATION]

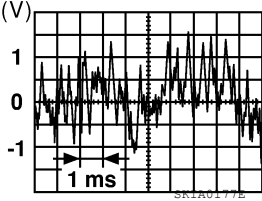
2	18	Audio signal output	
3	19		

Is the inspection result normal?

- YES >> Replace subwoofer. Refer to [AV-354, "Removal and Installation"](#).
 NO >> GO TO 4.

4. CHECK PRE-AMP SIGNAL CIRCUIT CONTINUITY

1. Disconnect AV control unit connector M96 and audio amplifier connector B159.
2. Check continuity between AV control unit connector M96 and audio amplifier connector B159.

AV control unit		Audio amplifier		Continuity
Connector	Terminal	Connector	Terminal	
M96	4	B159	24	Yes
	5		8	
	13		23	
	14		7	

3. Check continuity between AV control unit connector M96 and ground.

AV control unit		Ground	Continuity
Connector	Terminal		
M96	4	—	No
	5		
	13		
	14		

Is the inspection result normal?

- YES >> GO TO 5.
 NO >> Repair or replace harness or connectors.

5. CHECK PRE-AMP SIGNAL

1. Connect AV control unit connector M96 and audio amplifier connector B159.
2. Turn ignition switch to ACC.
3. Push AV control unit POWER switch.
4. Check signal between the terminals of AV control unit connector M96.

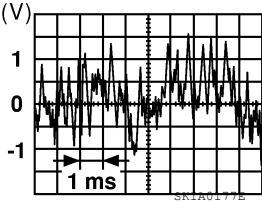
AV control unit connector M96		Condition	Reference value
(+) Terminal	(-) Terminal		
4	5	Audio signal output	
13	14		

Is the inspection result normal?

SUBWOOFER

< DTC/CIRCUIT DIAGNOSIS >

[NAVIGATION]

YES >> Replace audio amplifier. Refer to [AV-349, "Removal and Installation"](#).
NO >> Replace AV control unit. Refer to [AV-348, "Removal and Installation"](#).

- A
- B
- C
- D
- E
- F
- G
- H
- I
- J
- K
- L
- M
- AV
- O
- P

AMP ON SIGNAL CIRCUIT

< DTC/CIRCUIT DIAGNOSIS >

[NAVIGATION]

AMP ON SIGNAL CIRCUIT

Diagnosis Procedure

INFOID:000000009482238

Regarding Wiring Diagram information, refer to [AV-264. "Wiring Diagram"](#).

1. CHECK AUDIO AMPLIFIER AMP ON SIGNAL

1. Turn audio system ON.
2. Check voltage between audio amplifier connector B159 and ground.

Audio amplifier		Ground	Voltage (Approx.)
Connector	Terminal		
B159	9	—	Greater than 6.5 V

Is inspection result normal?

- YES >> Inspection End.
NO >> GO TO 2.

2. CHECK AV CONTROL UNIT AMP ON SIGNAL

Check voltage between AV control unit connector M96 and ground.

AV control unit		Ground	Voltage (Approx.)
Connector	Terminal		
M96	1	—	Greater than 6.5 V

Is inspection result normal?

- YES >> Repair or replace harness or connectors.
NO >> Replace AV control unit. Refer to [AV-348. "Removal and Installation"](#).

REAR VIEW CAMERA IMAGE SIGNAL CIRCUIT

< DTC/CIRCUIT DIAGNOSIS >

[NAVIGATION]

REAR VIEW CAMERA IMAGE SIGNAL CIRCUIT

Diagnosis Procedure

INFOID:000000009482239

Regarding Wiring Diagram information, refer to [AV-264. "Wiring Diagram"](#).

1. CHECK REVERSE INPUT SIGNAL

1. Turn ignition switch ON.
2. Shift the selector lever to R (reverse).
3. Check voltage between AV control unit connector M97 and ground.

AV control unit		Ground	Condition	Voltage (Approx.)
Connector	Terminal			
M97	28	—	Selector lever in R (reverse)	Battery Voltage

Is the inspection result normal?

YES >> GO TO 2.

NO >> Repair or replace harness or connectors.

2. CHECK CAMERA POWER SUPPLY CIRCUIT CONTINUITY

1. Turn ignition switch OFF.
2. Disconnect AV control unit connector M97 and rear view camera connector.
3. Check continuity between AV control unit connector M97 and rear view camera connector C251.

AV control unit		Rear view camera		Continuity
Connector	Terminal	Connector	Terminal	
M97	34	C251	1	Yes

4. Check continuity between AV control unit connector M97 and ground.

AV control unit		Ground	Continuity
Connector	Terminal		
M97	34		No

Is the inspection result normal?

YES >> GO TO 3.

NO >> Repair or replace harness or connectors.

3. CHECK CAMERA POWER SUPPLY VOLTAGE

1. Connect AV control unit connector M97 and rear view camera connector.
2. Turn ignition switch ON.
3. Shift the selector lever to R (reverse).
4. Check voltage between AV control unit connector M97 and ground.

AV control unit		Ground	Condition	Voltage (Approx.)
Connector	Terminal			
M97	34	—	Selector lever is in "R".	6.0 V

Is the inspection result normal?

YES >> GO TO 4.

NO >> Replace AV control unit. Refer to [AV-348. "Removal and Installation"](#).

4. CHECK CAMERA IMAGE SIGNAL CIRCUIT CONTINUITY

1. Turn ignition switch OFF.

A

B

C

D

E

F

G

H

I

J

K

L

M

AV

O

P

REAR VIEW CAMERA IMAGE SIGNAL CIRCUIT

< DTC/CIRCUIT DIAGNOSIS >

[NAVIGATION]

2. Disconnect AV control unit connector M97 and rear view camera connector.
3. Check continuity between AV control unit connector M97 and rear view camera connector C251.

AV control unit		Rear view camera		Continuity
Connector	Terminal	Connector	Terminal	
M97	36	C251	3	Yes

4. Check continuity between AV control unit connector M97 and ground.

AV control unit		Ground	Continuity
Connector	Terminal		
M97	36		No

Is the inspection result normal?

- YES >> GO TO 5.
 NO >> Repair or replace harness or connectors.

5. CHECK CAMERA GROUND CIRCUIT CONTINUITY

Check continuity between AV control unit connector M97 and rear view camera connector C251.

AV control unit		Rear view camera		Continuity
Connector	Terminal	Connector	Terminal	
M97	35	C251	6	Yes

Is the inspection result normal?

- YES >> GO TO 6.
 NO >> Repair or replace harness or connectors.

6. CHECK CAMERA IMAGE SIGNAL

1. Connect AV control unit connector M97 and rear view camera connector.
2. Turn ignition switch ON.
3. Shift the selector lever to R (reverse).
4. Check signal between AV control unit connector M97 and ground.

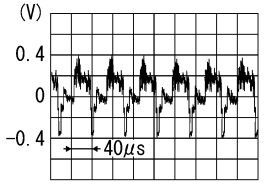
AV control unit		Ground	Condition	Reference value
(+)		(-)		
Connector	Terminal			
M97	36	—	Camera image displayed.	 <small>SKIB2251J</small>

Is the inspection result normal?

- YES >> Replace AV control unit. Refer to [AV-348. "Removal and Installation"](#).
 NO >> Replace rear view camera. Refer to [AV-363. "Removal and Installation"](#).

STEERING SWITCH

< DTC/CIRCUIT DIAGNOSIS >

[NAVIGATION]

STEERING SWITCH





Diagnosis Procedure

INFOID:000000009482240

Regarding Wiring Diagram information, refer to [AV-264, "Wiring Diagram"](#).

1. CHECK STEERING WHEEL AUDIO CONTROL SWITCH RESISTANCE

1. Disconnect combination switch connector M102.
2. Check resistance between combination switch connector terminals.

Combination switch connector M102		Condition	Resistance (Ω) (Approx.)
Terminal	Terminal		
16	18	Depress VOL DOWN switch.	1
		Depress VOL UP switch.	121
		Depress  switch.	321
15		Depress MODE switch.	1
		Depress  switch.	121
		Depress  switch.	321
		Depress  switch.	723

Is the inspection result normal?

YES >> GO TO 2.

NO >> Replace steering wheel audio control switches. Refer to [AV-240, "Removal and Installation"](#).

2. CHECK HARNESS BETWEEN AV CONTROL UNIT AND COMBINATION SWITCH

1. Turn ignition switch OFF.
2. Disconnect AV control unit connector M96 and combination switch connector M30.
3. Check continuity between AV control unit connector M96 and combination switch connector M30.

AV control unit		Combination switch		Continuity
Connector	Terminal	Connector	Terminal	
M96	6	M30	24	Yes
	16		25	
	15		31	

4. Check continuity between AV control unit connector M96 and ground.

AV control unit		—	Continuity
Connector	Terminal		
M96	6	Ground	No
	16		
	15		

Is the inspection result normal?

YES >> GO TO 3.

NO >> Repair or replace harness or connectors.

3. SPIRAL CABLE CHECK

Check continuity between combination switch connectors M30 and M102.

STEERING SWITCH

< DTC/CIRCUIT DIAGNOSIS >

[NAVIGATION]

Combination switch				Continuity
Connector	Terminal	Connector	Terminal	
M30	24	M102	15	Yes
	25		16	
	31		18	

Is the inspection result normal?

YES >> Replace AV control unit. Refer to [AV-348, "Removal and Installation"](#).

NO >> Replace spiral cable. Refer to [SR-13, "Removal and Installation"](#).

MICROPHONE SIGNAL CIRCUIT

< DTC/CIRCUIT DIAGNOSIS >

[NAVIGATION]

MICROPHONE SIGNAL CIRCUIT

Diagnosis Procedure

INFOID:000000009482241

Regarding Wiring Diagram information, refer to [AV-264. "Wiring Diagram"](#).

1. CHECK MICROPHONE SIGNAL CIRCUIT CONTINUITY

1. Turn ignition switch OFF.
2. Disconnect AV control unit connector M97 and microphone connector R8.
3. Check continuity between AV control unit connector M97 and microphone connector R8.

AV control unit		Microphone		Continuity
Connector	Terminal	Connector	Terminal	
M97	41	R8	2	Yes
	42		4	
	43		1	

4. Check continuity between AV control unit connector M97 and ground.

AV control unit		Ground	Continuity
Connector	Terminal		
M97	41	—	No
	42		
	43		

Is inspection result normal?

- YES >> GO TO 2.
NO >> Repair or replace harness or connectors.

2. CHECK MICROPHONE VCC VOLTAGE

1. Connect AV control unit connector M97.
2. Turn ignition switch ON.
3. Check voltage between terminals of AV control unit connector M97.

AV control unit connector M97		Voltage (Approx.)
(+)	(-)	
Terminal	Terminal	
42	41	5.0 V

Is the inspection result normal?

- YES >> GO TO 3.
NO >> Replace AV control unit. Refer to [AV-348. "Removal and Installation"](#).

3. CHECK MICROPHONE SIGNAL

1. Connect microphone connector.
2. Check signal between terminals of AV control unit connector M97.

A
B
C
D
E
F
G
H
I
J
K
L
M
AV
O
P

MICROPHONE SIGNAL CIRCUIT

< DTC/CIRCUIT DIAGNOSIS >

[NAVIGATION]

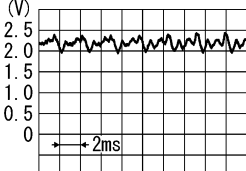
AV control unit connector M97		Condition	Reference value
(+)	(-)		
Terminal	Terminal		
42	43	Speak into microphone.	 <p style="text-align: right; font-size: small;">PRIB5037J</p>

Is the inspection result normal?

- YES >> Replace AV control unit. Refer to [AV-348. "Removal and Installation"](#).
- NO >> Replace microphone. Refer to [AV-356. "Removal and Installation"](#).

USB CONNECTOR

Diagnosis Procedure

INFOID:000000009482242

Regarding Wiring Diagram information, refer to [AV-264. "Wiring Diagram"](#).

1. CHECK USB INTERFACE HARNESS CONTINUITY

1. Turn ignition switch OFF.
2. Disconnect AV control unit connector M98 and USB interface connector M214.
3. Check continuity between AV control unit connector M98 and USB interface connector M214.

AV control unit		USB interface		Continuity
Connector	Terminal	Connector	Terminal	
M98	45	M214	4	Yes
	46		1	
	47		2	
	48		3	
	49		5	

4. Check continuity between AV control unit connector M98 and ground.

AV control unit		—	Continuity
Connector	Terminal		
M98	45	Ground	No
	47		

Is the inspection result normal?

- YES >> Replace the USB interface. Refer to [AV-362. "Removal and Installation"](#).
 NO >> Repair or replace harness or connectors.

A
B
C
D
E
F
G
H
I
J
K
L
M
O
P



AUXILIARY INPUT JACK

< DTC/CIRCUIT DIAGNOSIS >

[NAVIGATION]

AUXILIARY INPUT JACK

Diagnosis Procedure

INFOID:000000009482243

Regarding Wiring Diagram information, refer to [AV-264. "Wiring Diagram"](#).

1. CHECK AUX JACK HARNESS CONTINUITY

1. Turn ignition switch OFF.
2. Disconnect AV control unit connector M97 and AUX jack connector M215.
3. Check continuity between AV control unit connector M97 and AUX jack connector M215.

AV control unit		AUX jack		Continuity
Connector	Terminal	Connector	Terminal	
M97	30	M215	4	Yes
	31		2	
	32		1	

4. Check continuity between AV control unit connector M97 and ground.

AV control unit		—	Continuity
Connector	Terminal		
M97	30	Ground	No
	32		

Is the inspection result normal?

- YES >> Replace the AUX jack. Refer to [AV-359. "Removal and Installation"](#).
NO >> Repair or replace harness or connectors.

SYMPTOM DIAGNOSIS

MULTI AV SYSTEM

Symptom Table

INFOID:000000009482244

RELATED TO AUDIO

Symptoms	Check items	Probable malfunction location
The disk cannot be removed.	AV control unit	Malfunction in AV control unit. Refer to AV-255. "On Board Diagnosis Function" .

- A
- B
- C
- D
- E
- F
- G
- H
- I
- J
- K
- L
- M
- O
- P

AV

MULTI AV SYSTEM

< SYMPTOM DIAGNOSIS >

[NAVIGATION]

Symptoms	Check items	Probable malfunction location
	No sound from all speakers.	<ul style="list-style-type: none"> • Speaker circuit shorted to ground. Refer to AV-264. "Wiring Diagram". • Amp ON signal circuit malfunction. Refer to AV-322. "Diagnosis Procedure". • Audio amplifier power supply and ground circuits malfunction. Refer to AV-305. "AUDIO AMP. : Diagnosis Procedure".
No sound comes out or the level of the sound is low.	Only a certain speaker (front door speaker LH, front door speaker RH, front tweeter LH, front tweeter RH, rear door speaker LH, rear door speaker RH, rear tweeter LH, rear tweeter RH, subwoofer) does not output sound.	<ul style="list-style-type: none"> • Poor connector connection of speaker. • Sound signal circuit malfunction between AV control unit and audio amplifier. Refer to: <ul style="list-style-type: none"> - AV-307. "Diagnosis Procedure" (front door speaker). - AV-310. "Diagnosis Procedure" (front tweeter). - AV-313. "Diagnosis Procedure" (rear door speaker). - AV-316. "Diagnosis Procedure" (rear tweeter). - AV-319. "Diagnosis Procedure" (subwoofer). • Sound signal circuit malfunction between audio amplifier and speaker. Refer to: <ul style="list-style-type: none"> - AV-307. "Diagnosis Procedure" (front door speaker). - AV-310. "Diagnosis Procedure" (front tweeter). - AV-313. "Diagnosis Procedure" (rear door speaker). - AV-316. "Diagnosis Procedure" (rear tweeter). - AV-319. "Diagnosis Procedure" (subwoofer). • Malfunction in speaker. Refer to: <ul style="list-style-type: none"> - AV-351. "Removal and Installation" (front door speaker). - AV-350. "Removal and Installation" (front tweeter). - AV-352. "Removal and Installation" (rear door speaker). - AV-353. "Removal and Installation" (rear tweeter). - AV-354. "Removal and Installation" (subwoofer). • Malfunction in AV control unit. Refer to AV-255. "On Board Diagnosis Function". • Malfunction in audio amplifier. Replace Audio amplifier. Refer to AV-349. "Removal and Installation".

MULTI AV SYSTEM

< SYMPTOM DIAGNOSIS >

[NAVIGATION]

Symptoms	Check items	Probable malfunction location
	Noise comes out from all speakers.	<ul style="list-style-type: none"> • Malfunction in AV control unit. Refer to AV-255. "On Board Diagnosis Function". • Malfunction in audio amplifier. Replace audio amp. Refer to AV-349. "Removal and Installation".
Noise is mixed with audio.	Noise comes out only from a certain speaker (front door speaker LH, front door speaker RH, front tweeter LH, front tweeter RH, rear door speaker LH, rear door speaker RH, rear tweeter LH, rear tweeter RH, sub-woofer).	<ul style="list-style-type: none"> • Poor connector connection of speaker. • Sound signal circuit malfunction between AV control unit and audio amplifier. Refer to: <ul style="list-style-type: none"> - AV-307. "Diagnosis Procedure" (front door speaker). - AV-310. "Diagnosis Procedure" (front tweeter). - AV-313. "Diagnosis Procedure" (rear door speaker). - AV-316. "Diagnosis Procedure" (rear tweeter). - AV-319. "Diagnosis Procedure" (sub-woofer). • Sound signal circuit malfunction between audio amplifier and speaker. Refer to: <ul style="list-style-type: none"> - AV-307. "Diagnosis Procedure" (front door speaker). - AV-310. "Diagnosis Procedure" (front tweeter). - AV-313. "Diagnosis Procedure" (rear door speaker). - AV-316. "Diagnosis Procedure" (rear tweeter). - AV-319. "Diagnosis Procedure" (sub-woofer). • Malfunction in speaker. • Poor Installation of speaker (e.g. backlash and looseness). Refer to: <ul style="list-style-type: none"> - AV-351. "Removal and Installation" (front door speaker). - AV-350. "Removal and Installation" (front tweeter). - AV-352. "Removal and Installation" (rear door speaker). - AV-353. "Removal and Installation" (rear tweeter). - AV-354. "Removal and Installation" (sub-woofer). • Malfunction in AV control unit. Refer to AV-255. "On Board Diagnosis Function". • Malfunction in audio amplifier. Replace audio amplifier. Refer to AV-349. "Removal and Installation".
	Noise is mixed with radio only (when the vehicle hits a bump or while driving over bad roads)	<ul style="list-style-type: none"> • Poor connector connection of antenna or antenna feeder. Refer to AV-357. "Location of Antenna".

A
B
C
D
E
F
G
H
I
J
K
L
M
AV
O
P

MULTI AV SYSTEM

< SYMPTOM DIAGNOSIS >

[NAVIGATION]

Symptoms	Check items	Probable malfunction location
No radio reception or poor reception.	<ul style="list-style-type: none"> Other audio sounds are normal. Any radio station cannot be received or poor reception is caused even after moving to a service area with good reception (e.g. a place with clear view and no obstacles generating external noises). 	<ul style="list-style-type: none"> Antenna amp. ON signal circuit malfunction. <p>Refer to AV-322. "Diagnosis Procedure".</p> <ul style="list-style-type: none"> Rod antenna is not fully connected to antenna base. Antenna base/rod connection (thread zone) has foreign material or corrosion inside. Poor connector connection of antenna or antenna feeder. <p>Refer to AV-357. "Location of Antenna".</p>
No satellite radio reception.	<p>There is malfunction in the CONSULT self diagnosis result.</p> <p>Refer to AV-256. "CONSULT Function".</p>	<ul style="list-style-type: none"> Malfunction in antenna, antenna feeder or AV control unit. Perform DTC diagnosis. <p>Refer to AV-256. "CONSULT Function".</p> <ul style="list-style-type: none"> Poor continuity in antenna feeder. Poor connector connection of antenna or antenna feeder. <p>Refer to AV-357. "Location of Antenna".</p>
	<p>There is no malfunction in the CONSULT self diagnosis result.</p> <p>Refer to AV-256. "CONSULT Function".</p>	<ul style="list-style-type: none"> Poor continuity in antenna feeder. Poor connector connection of antenna or antenna feeder. Loose satellite radio antenna mounting nut. <p>Refer to AV-357. "Location of Antenna".</p>
Buzz/rattle sound from speaker	<p>The majority of buzz/rattle sounds are not indicative of an issue with the speaker, usually something nearby the speaker is causing the buzz/rattle.</p>	<p>Refer to "SQUEAK AND RATTLE TROUBLE DIAGNOSIS" in the appropriate interior trim section.</p>

RELATED TO HANDS-FREE PHONE

- Before performing diagnosis, confirm that the cellular phone being used by the customer is compatible with the vehicle.
- It is possible that a malfunction is occurring due to a version change of the phone even though the phone is a compatible type. This can be confirmed by changing the cellular phone to another compatible type, and check that it operates normally. It is important to determine whether the cause of the malfunction is the vehicle or the cellular phone.

Check Compatibility

- Make sure the customer's Bluetooth® related concern is understood.
- Verify the customer's concern.

NOTE:
The customer's phone may be required, depending upon their concern.
- Write down the customer's phone brand, model and service provider.

NOTE:
It is necessary to know the service provider. On occasion, a given phone may be on the approved list with one provider, but may not be on the approved list with other providers.
- Go to "www.nissanusa.com/bluetooth/".
 - Using the website's search engine, find out if the customer's phone is on the approved list.
 - If the customer's phone is NOT on the approved list:

Stop diagnosis here. The customer needs to obtain a Bluetooth® phone that is on the approved list before any further action.
 - If the feature related to the customer's concern shows as "N" (not compatible):



Stop diagnosis here. If the customer still wants the feature to function, they will need to get an approved phone showing the feature as "Y" (compatible) in the "Basic Features".
 - If the feature related to the customer's concern shows as "Y" (compatible):

Perform diagnosis as per the following table.

MULTI AV SYSTEM

< SYMPTOM DIAGNOSIS >

[NAVIGATION]

Symptoms	Check items	Probable malfunction location
Does not recognize cellular phone connection (no connection is displayed on the display at the guide).	Repeat the registration of cellular phone.	
Hands-free phone cannot be established.	<ul style="list-style-type: none"> Hands-free phone operation can be made, but the communication cannot be established. Hands-free phone operation can be performed, however, voice between each other cannot be heard during the conversation. 	Malfunction in AV control unit. Replace AV control unit. Refer to AV-348, "Removal and Installation" .
The other party's voice cannot be heard by hands-free phone.	Check the "microphone speaker" in Inspection & Adjustment Mode if sound is heard.	
Originating sound is not heard by the other party with hands-free phone communication.	Sound operation function is normal.	
	Sound operation function does not work.	Microphone signal circuit malfunction. Refer to AV-327, "Diagnosis Procedure" .
The system cannot be operated.	<ul style="list-style-type: none"> The voice recognition can be controlled. Steering switch's VOL UP and VOL DOWN switch works, but   does not work. 	Steering switch malfunction. Replace steering switch. Refer to AV-355, "Removal and Installation" .
	Steering switch's  , VOL UP and VOL DOWN switches do not work.	Steering switch signal circuit malfunction. Refer to AV-325, "Diagnosis Procedure" .
	All steering switches do not work.	Steering switch ground circuit malfunction. Refer to AV-325, "Diagnosis Procedure" .

RELATED TO NAVIGATION

Symptoms	Check items	Probable malfunction location
Navigation system is inoperative.	Navigation malfunction.	<ul style="list-style-type: none"> Malfunction in SD card. Malfunction in AV control unit. Refer to AV-255, "On Board Diagnosis Function".
	Steering switches malfunction.	Steering switch signal circuit malfunction. Refer to AV-325, "Diagnosis Procedure" .
	Voice activated control malfunction.	Microphone signal circuit malfunction. Refer to AV-327, "Diagnosis Procedure" . Steering switch signal circuit malfunction. Refer to AV-325, "Diagnosis Procedure" .

RELATED TO REAR VIEW CAMERA

Symptoms	Check items	Probable malfunction location
Rear view camera is inoperative.	Reverse signal circuit malfunction.	Reverse signal circuit malfunction between BCM and AV control unit. Refer to AV-323, "Diagnosis Procedure" .
	Camera image signal circuit malfunction.	Camera image signal circuit malfunction between rear view camera and AV control unit. Refer to AV-323, "Diagnosis Procedure" .
	Rear view camera malfunction.	Replace rear view camera. Refer to AV-363, "Removal and Installation" .

NORMAL OPERATING CONDITION

< SYMPTOM DIAGNOSIS >

[NAVIGATION]

NORMAL OPERATING CONDITION

Description

INFOID:000000009482245

RELATED TO NOISE

The majority of the audio concerns are the result of outside causes (bad CD, electromagnetic interference, etc.).

The following noise results from variations in field strength, such as fading noise and multi-path noise, or external noise from trains and other sources. It is not a malfunction.

- Fading noise: This noise occurs because of variations in the field strength in a narrow range due to mountains or buildings blocking the signal.
- Multi-path noise: This noise results from the waves sent directly from the broadcast station arriving at the antenna at a different time from the waves which reflect off mountains or buildings.

The vehicle itself can be a source of noise if noise prevention parts or electrical equipment is malfunctioning. Check if noise is caused and/or changed by engine speed, ignition switch turned to each position, and operation of each piece of electrical equipment, and determine the cause.

NOTE:

The source of the noise can be found easily by listening to the noise while removing the fuses of electrical components, one by one.

Type of Noise and Possible Cause

Occurrence condition		Possible cause
Occurs only when engine is ON.	A continuous growling noise occurs. The speed of the noise varies with changes in the engine speed.	<ul style="list-style-type: none"> • Ignition components
The occurrence of the noise is linked with the operation of the fuel pump.		<ul style="list-style-type: none"> • Fuel pump condenser
Noise only occurs when various electrical components are operating.	A cracking or snapping sound occurs with the operation of various switches.	<ul style="list-style-type: none"> • Relay malfunction, AV control unit malfunction
	The noise occurs when various motors are operating.	<ul style="list-style-type: none"> • Motor case ground • Motor
The noise occurs constantly, not just under certain conditions.		<ul style="list-style-type: none"> • Rear defogger coil malfunction • Open circuit in printed heater • Poor ground of antenna feeder line
A cracking or snapping sound occurs while the vehicle is being driven, especially when it is vibrating excessively.		<ul style="list-style-type: none"> • Ground wire of body parts • Ground due to improper part installation • Wiring connections or a short circuit

RELATED TO HANDS-FREE PHONE

Symptom	Cause and Counter measure
Does not recognize cellular phone connection (No connection is displayed on the display at the guide).	<p>Some Bluetooth[®] enabled cellular phones may not be recognized by the in-vehicle phone module.</p> <p>Refer to "RELATED TO HANDS-FREE PHONE (Check Compatibility)" in AV-331, "Symptom Table".</p>
Cannot use hands-free phone.	<p>Customer will not be able to use a hands-free phone under the following conditions:</p> <ul style="list-style-type: none"> • The vehicle is outside of the telephone service area. • The vehicle is in an area where it is difficult to receive radio waves; such as in a tunnel, in an underground parking garage, near a tall building or in a mountainous area. • The cellular phone is locked to prevent it from being dialed. <p>NOTE:</p> <p>While a cellular phone is connected through the Bluetooth[®] wireless connection, the battery power of the cellular phone may discharge quicker than usual. The Bluetooth[®] Hands-Free Phone System cannot charge cellular phones.</p>

NORMAL OPERATING CONDITION

< SYMPTOM DIAGNOSIS >

[NAVIGATION]

Symptom	Cause and Counter measure
The other party's voice cannot be heard by hands-free phone.	When the radio wave condition is not ideal or ambient sound is too loud, it may be difficult to hear the other person's voice during a call.
Poor sound quality.	Do not place the cellular phone in an area surrounded by metal or far away from the in-vehicle phone module to prevent tone quality degradation and wireless connection disruption.

RELATED TO NAVIGATION

Basic Operation

Symptom	Cause	Remedy
No image is shown.	Display brightness adjustment is set fully to DARK side.	Adjust the display brightness.
No guide sound is heard. Audio guide volume is too low or too high.	Volume control is set to OFF, MIN or MAX.	Adjust the audio guide volume.
	Audio guidance is not available while the vehicle is driving on a dark pink route.	System is not malfunctioning.
Screen is too dark. Motion of the image is too slow.	Temperature inside the vehicle is low.	Wait until the temperature inside the vehicle reaches the proper temperature.
Small black or bright spots appear on the screen.	Symptom peculiar to a liquid crystal display (display unit).	System is not malfunctioning.

Vehicle Mark

Symptom	Cause	Remedy
Map screen and BIRDVIEW™ Name of the place vary with the screen.	Some thinning of the character data is done to prevent the display becoming to complex. In some cases and in some locations, the display contents may differ. The same place name, street name, etc. may not be displayed every time on account of the data processing.	System is not malfunctioning.
Vehicle mark is not positioned correctly.	Vehicle is transferred by ferry or by towing after its ignition switch is turned to OFF.	Drive the vehicle for a while in the GPS satellite signal receiving condition.
Screen will not switch to nighttime mode after the lighting switch is turned ON.	The daytime screen is selected by the "SWITCH SCREENS" when the last time the screen dimming setting is done. Switching between daytime/nighttime screen may be inhibited by the automatic illumination adjustment function.	Perform screen dimming and select the nighttime screen by "SWITCH SCREENS".
Map screen will not scroll in accordance with the vehicle travel.	Current location is not displayed.	Press "MAP" button to display the current location.
Vehicle mark will not be shown.	Current location is not displayed.	Press "MAP" button to display the current location.
Accuracy indicator (GPS satellite mark) on the map screen stays gray.	GPS satellite signal is intercepted because the vehicle is in or behind a building.	Move the vehicle out to an open space.
	GPS satellite signal cannot be received because an obstacle is placed on top of the instrument panel.	Do not place anything on top of the meter display (instrument panel).
	GPS satellites are not visible from current location.	Wait until GPS satellites are visible by moving the vehicle.

NORMAL OPERATING CONDITION

< SYMPTOM DIAGNOSIS >

[NAVIGATION]

Symptom	Cause	Remedy
Vehicle location accuracy is low.	Accuracy indicator (GPS satellite mark) on the map screen stays gray.	Current location is not determined.
	Vehicle speed setting by the vehicle speed pulse has been deviated (advanced or retarded) from the actual vehicle speed because tire chain is fitted or the system has been used on another vehicle.	Drive the vehicle for a while [for approx. 30 minutes at approx. 30 km/h (19 MPH)] and the deviation will be automatically adjusted. If advancement or retard still occur, perform the distance adjustment by CONFIRMATION/ADJUSTMENT mode of diagnosis function.
	Map data has error or omission. (Vehicle mark is always deviated to the same position.)	As a rule, an updated map DVD-ROM will be released once a year.

Destination, Passing Points and Menu Items Cannot be Selected/Set

Symptom	Cause	Remedy
Destination cannot be set.	Destination to be set is on an expressway.	Set the destination on an ordinary road.
Passing point is not searched when re-searching the route.	The vehicle has already passed the passing point, or the system judged so.	To include the passing points that have been passed into the route again, set the route again.
Route information will not be displayed.	Route searching has not been done.	Set the destination and perform route searching.
	Vehicle mark is not on the recommended route.	Drive on the recommended route.
	Route guide is turned OFF.	Turn route guide ON.
	Route information is not available on the dark pink route.	System is not malfunctioning.
After the route searching, no guide sign will appear as the vehicle goes near the entrance/exit to the toll road.	Vehicle mark is not on the recommended route. (On the display, only guide signs related to the recommended route will be shown.)	Drive on the recommended route.
Automatic route searching is not possible.	Vehicle is driving on a highway (gray route), or no recommended route is available.	Drive on a road to be searched. Or re-search the route manually. In this case, however, the whole route will be searched.
Performed automatic detour search (or detour search). However, the result is the same as that of the previous search.	Performed search with every conditions considered. However, the result is the same as that of the previous search.	System is not malfunctioning.
Passing points cannot be set.	More than five passing points were set.	Passing points can be set up to five. To stop at more than five points, perform sharing in several steps.
When setting the route, the starting point cannot be selected.	The current vehicle location is always set as the starting point of a route.	System is not malfunctioning.
Some menu items cannot be selected.	The vehicle is being driven.	Stop the vehicle at a safe place and then operate the system.

Voice Guide

NORMAL OPERATING CONDITION

< SYMPTOM DIAGNOSIS >

[NAVIGATION]

Symptom	Cause	Remedy
Voice guide will not operate.	Note: Voice guide is only available at intersections that satisfy certain conditions (indicated by ● on the map). Therefore, guidance may not be given even when the route on the map changes direction.	System is not malfunctioning.
	The vehicle is not on the recommended route.	Return to the recommended route or re-search the route.
	Voice guide is turned OFF.	Turn voice guide ON.
	Route guide is turned OFF.	Turn route guide ON.
Voice guide does not match the actual road pattern.	Voice guide may vary with the direction to which the vehicle is turn and the connection of the road to other roads.	Drive in conformity to the actual traffic rules.

Route Search

Symptom	Cause	Remedy
No route is shown.	No road to be searched is found around the destination.	Find wider road (orange road or wider) nearby and reset the destination and passing points onto it. Take care of the traveling direction when there are separate up and down roads.
	Starting point and the destination are too close.	Set the destination at more distant point.
	Conditional traffic regulation (day of the week/ time of the day) is set at the area around the current location or the destination.	Turn the time-regulating search conditions OFF. Turn "Avoid regulation time" in the search conditions OFF.
Indicated route is intermittent.	In some areas, highways (gray routes) are not used for the search ^(Note) Therefore, the route to the current location or the passing points may be intermittent.	System is not malfunctioning.
When the vehicle has passed the recommended route, it is deleted from the screen.	A recommended route is controlled by each section. When the vehicle has passed the passing point 1, then the map data from the starting point up to the passing point 1 will be deleted. (The data may remain undeleted in some area.)	System is not malfunctioning.
Detouring route is recommended.	In some areas, highways (gray routes) are not used for the search. (Note). Therefore, detour route may be recommended.	Set the route closer to the basic route (gray route).
	A detour route may be shown when some traffic regulation (one-way traffic, etc.) is set at the area around the starting point or the destination.	Slightly move the starting point or the destination, or set the passing point on the route of your choice.
	In the area where highways (gray routes) are used for the search, left turn has priority around the current location and the destination (passing points). For this reason, the recommended route may be detouring.	System is not malfunctioning.
Landmarks on the map do not match the actual ones.	This can be happen due to omission or error in the map data.	As a rule, an updated map DVD-ROM will be released once a year. Wait until the latest map has become available.
Recommended route is far from the starting point, passing points, and destination.	Starting point, passing points, and destination of the route guide were set far from the desired points because route searching data around these area were not stored.	Reset the destination onto the road nearby. If this road is one of the highways (gray routes), an ordinary road nearby may be displayed as the recommended route.

NOTE:

Except for the ordinance-designated cities. (Malfunctioning areas may be changed in the updated map disc.)

Examples of Current-Location Mark Displacement

NORMAL OPERATING CONDITION

< SYMPTOM DIAGNOSIS >

[NAVIGATION]

Vehicle's travel amount is calculated by reading its travel distance and turning angle. Therefore, if the vehicle is driven in the following manner, an error will occur in the vehicle's current location display. If correct location has not been restored after driving the vehicle for a while, perform location correction.

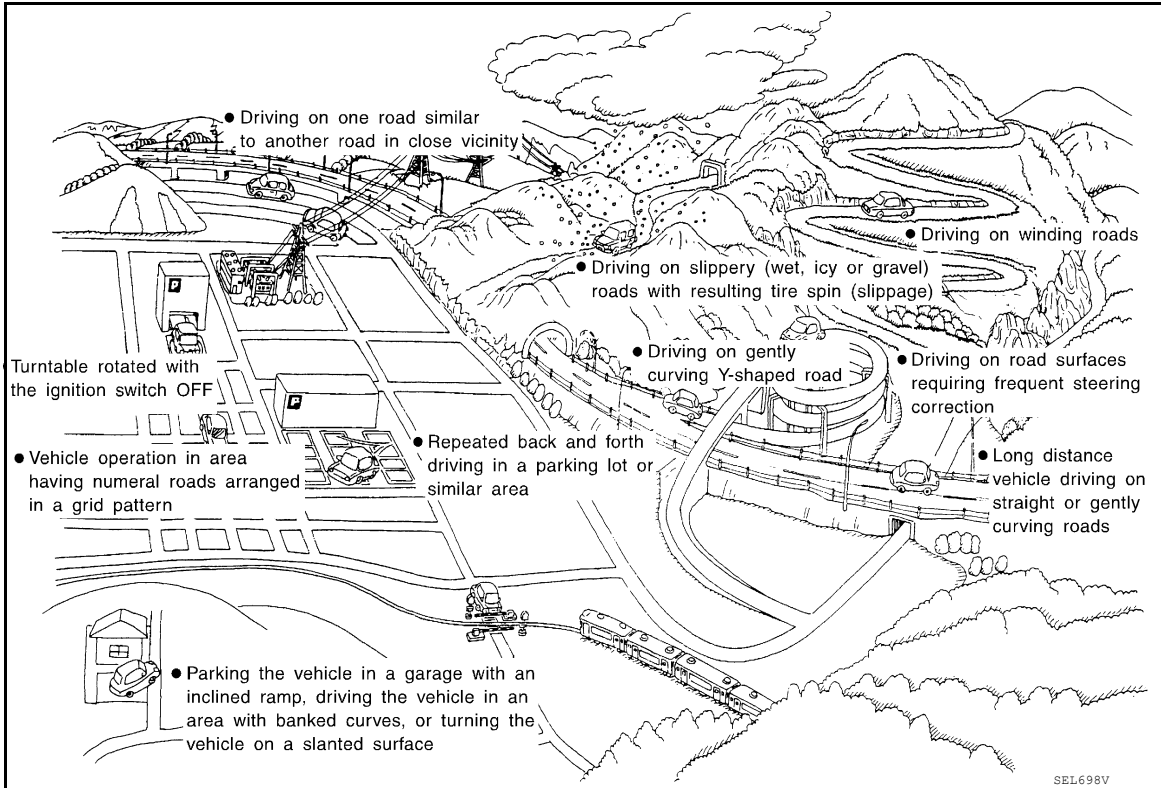

NORMAL OPERATING CONDITION

< SYMPTOM DIAGNOSIS >

[NAVIGATION]

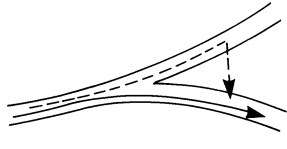
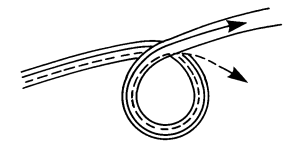
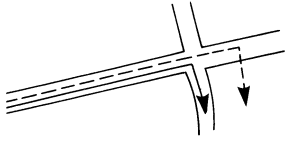
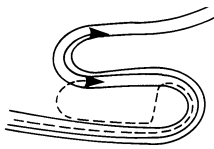
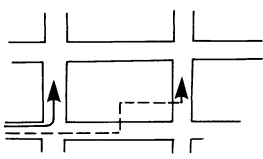
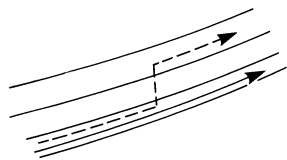
Cause (condition) –: While driving ooo: Display	Driving condition	Remarks (correction, etc.)
Y-intersections  <small>ELK0192D</small>	At a Y intersection or similar gradual division of roads, an error in the direction of travel deduced by the sensor may result in the current-location mark appearing on the wrong road.	If after travelling about 10 km (6 miles) the correct location has not been restored, perform location correction and, if necessary, direction correction.
Spiral roads  <small>ELK0193D</small>	When driving on a large, continuous spiral road (such as loop bridge), turning angle error is accumulated and the vehicle mark may deviate from the correct location.	
Straight roads  <small>ELK0194D</small>	When driving on a long, straight road and slow curve without stopping, map-matching does not work effectively enough and distance errors may accumulate. As a result, the vehicle mark may deviate from the correct location when the vehicle is turned at a corner.	
Zigzag roads  <small>ELK0195D</small>	When driving on a zigzag road, the map may be matched to other roads in the similar direction nearby at every turn, and the vehicle mark may deviate from the correct location.	
Roads laid out in a grid pattern  <small>ELK0196D</small>	When driving where roads are laid out in a grid pattern, or where many roads are running in the similar direction nearby, the map may be matched to them by mistake and the vehicle mark may deviate from the correct location.	
Parallel roads  <small>ELK0197D</small>	When two roads are running in parallel (such as highway and sideway), the map may be matched to the other road by mistake and the vehicle mark may deviate from the correct location.	

A
B
C
D
E
F
G
H
I
J
K
L
M
AV
O
P

NORMAL OPERATING CONDITION

< SYMPTOM DIAGNOSIS >

[NAVIGATION]

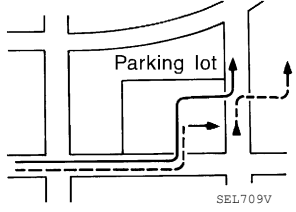
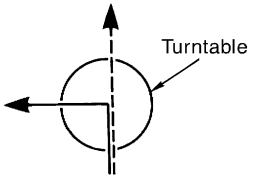
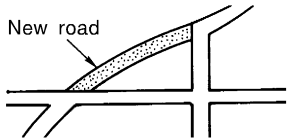
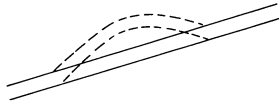
	Cause (condition) -: While driving ooo: Display	Driving condition	Remarks (correction, etc.)
Place	In a parking lot  SEL709V	When driving in a parking lot, or other location where there are no roads on the map, matching may place the vehicle mark on a nearby road. When the vehicle returns to the road, the vehicle mark may have deviated from the correct location. When driving in circle or turning the steering wheel repeatedly, direction errors accumulate, and the vehicle mark may deviate from the correct location.	If after travelling about 10 km (6 miles) the correct location has not been restored, perform location correction and, if necessary, direction correction.
	Turntable  SEL710V	When the ignition switch is OFF, the navigation system cannot get the signal from the gyroscope (angular speed sensor). Therefore, the displayed direction may be wrong and the correct road may not be easily returned to after rotating the vehicle on a turntable with the ignition OFF.	
	Slippery roads	On snow, wet roads, gravel, or other roads where tires may slip easily, accumulated mileage errors may cause the vehicle mark to deviate from the correct road.	
	Slopes	When parking in sloped garages, when travelling on banked roads, or in other cases where the vehicle turns when tilted, an error in the turning angle will occur, and the vehicle mark may deviate from the road.	
Map data	Road not displayed on the map screen  SEL699V	When driving on new roads or other roads not displayed on the map screen, map matching does not function correctly and matches the location to a nearby road. When the vehicle returns to a road which is on the map, the vehicle mark may deviate from the correct road.	
	Different road pattern (Changed due to repair)  ELK0201D	If the road pattern stored in the map data and the actual road pattern are different, map matching does not function correctly and matches the location to a nearby road. The vehicle mark may deviate from the correct road.	
Vehicle	Use of tire chains	When tire chains are used, the mileage is not correctly detected, and the vehicle mark may deviate from the correct road.	Drive the vehicle for a while. If the distance still deviates, adjust it by using the distance adjustment function. (If the tire chain is removed, recover the original value.)

NORMAL OPERATING CONDITION

< SYMPTOM DIAGNOSIS >

[NAVIGATION]

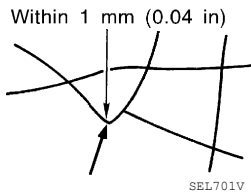
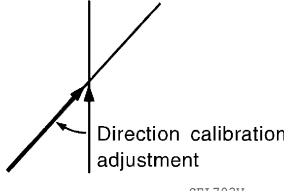
Cause (condition) –: While driving ooo: Display	Driving condition	Remarks (correction, etc.)
Precautions for driving	Just after the engine is started	If the vehicle is driven just after the engine is started when the gyroscope (angular speed sensor) correction is not completed, the vehicle can lose its direction and may have deviated from the correct location. Wait for a short while before driving after starting the engine.
	Continuous driving without stopping	When driving long distances without stopping, direction errors may accumulate, and the current-location mark may deviate from the correct road. Stop and adjust the orientation.
	Abusive driving	Spinning the wheels or engaging in other kinds of abusive driving may result in the system being unable perform correct detection, and may cause the vehicle mark to deviate from the correct road. If after travelling about 10 km (6 miles) the correct location has not been restored, perform location correction and, if necessary, direction correction.
How to correct location	Position correction accuracy 	If the accuracy of location settings is poor, accuracy may be reduced when the correct road cannot be found, particularly in places where there are many roads. Enter in the road displayed on the screen with an accuracy of approx. 1mm. Caution: Whenever possible, use detailed map for the correction.
	Direction when location is corrected 	If the accuracy of location settings during correction is poor, accuracy may be reduced afterwards. Perform direction correction.

Location Correction by Map-Matching is Slow

- The map-matching function needs to refer to the data of the surrounding area. It is necessary to drive some distance for the function to work.
- Because map-matching operates on this principle, when there are many roads running in similar directions in the surrounding area, no matching determination may be made. The location may not be corrected until some special feature is found.

Name of Road is Not Displayed

The current road name may not be displayed if there are no road names displayed on the map screen.

Contents of Display Differ for Birdview™ and the (Flat) Map Screen

Difference of the BIRDVIEW™ screen from the flat map screen are as follows.

- The current place name displays names which are primarily in the direction of vehicle travel.
- The amount of time before the vehicle travel or turn angle is updated on the screen is longer than for the (flat) map display.
- The conditions for display of place names, roads, and other data are different for nearby areas and for more distant areas.
- Some thinning of the character data is done to prevent the display becoming too complex. In some cases and in some locations, the display contents may differ.
- The same place name, street name, etc. may be displayed multiple times.

Vehicle Mark Shows a Position Which is Completely Wrong

In the following cases, the vehicle mark may appear on completely different position in the map depending on the GPS satellite signal receiving conditions. In this case, perform location correction and direction correction.

- When location correction has not been done
- If the receiving conditions of the GPS satellite signal is poor, if the vehicle mark becomes out of place, it may move to a completely different location and not come back if location correction is not done. The position will be corrected if the GPS signal can be received.
- When the vehicle has traveled by ferry, or when the vehicle has been being towed

NORMAL OPERATING CONDITION

< SYMPTOM DIAGNOSIS >

[NAVIGATION]

- Because calculation of the current location cannot be done when traveling with the ignition off, for example when traveling by ferry or when being towed, the location before travel is displayed. If the precise location can be detected with GPS, the location will be corrected.

Vehicle Mark Jumps

In the following cases, the vehicle mark may appear to jump as a result of automatic correction of the current location.

- When map matching has been done
 - If the current location and the vehicle mark are different when map matching is done, the vehicle mark may seem to jump. At this time, the location may be “corrected” to the wrong road or to a location which is not on a road.
- When GPS location correction has been done
 - If the current location and the vehicle mark are different when the location is corrected using GPS measurements, the vehicle mark may seem to jump. At this time, the location may be “corrected” to a location which is not on a road.

Vehicle Mark is in a River or Sea

The navigation system moves the vehicle mark with no distinction between land and rivers or sea. If the vehicle mark is somehow out of place, it may appear that the vehicle is driving in a river or the sea.

Vehicle Mark Automatically Rotates

The system wrongly memorizes the rotating status as stopping when the ignition switch is turned ON with the turntable rotating. That causes the vehicle mark to rotate when the vehicle is stopped.

When Driving on Same Road, Sometimes Vehicle Mark is in Right Place and Sometimes it is in Wrong Place

The conditions of the GPS antenna (GPS data) and gyroscope (angular speed sensor) change gradually. Depending on the road traveled and the operation of the steering wheel, the location detection results will be different. Therefore, even on a road on which the location has never been wrong, conditions may cause the vehicle mark to deviate.

PRECAUTION

PRECAUTIONS

Precaution for Supplemental Restraint System (SRS) "AIR BAG" and "SEAT BELT PRE-TENSIONER"

INFOID:000000010138390

The Supplemental Restraint System such as "AIR BAG" and "SEAT BELT PRE-TENSIONER", used along with a front seat belt, helps to reduce the risk or severity of injury to the driver and front passenger for certain types of collision. This system includes seat belt switch inputs and dual stage front air bag modules. The SRS system uses the seat belt switches to determine the front air bag deployment, and may only deploy one front air bag, depending on the severity of a collision and whether the front occupants are belted or unbelted. Information necessary to service the system safely is included in the SR and SB section of this Service Manual.

WARNING:

- To avoid rendering the SRS inoperative, which could increase the risk of personal injury or death in the event of a collision which would result in air bag inflation, all maintenance must be performed by an authorized NISSAN/INFINITI dealer.
- Improper maintenance, including incorrect removal and installation of the SRS, can lead to personal injury caused by unintentional activation of the system. For removal of Spiral Cable and Air Bag Module, see the SR section.
- Do not use electrical test equipment on any circuit related to the SRS unless instructed to in this Service Manual. SRS wiring harnesses can be identified by yellow and/or orange harnesses or harness connectors.

PRECAUTIONS WHEN USING POWER TOOLS (AIR OR ELECTRIC) AND HAMMERS

WARNING:

- When working near the Airbag Diagnosis Sensor Unit or other Airbag System sensors with the Ignition ON or engine running, DO NOT use air or electric power tools or strike near the sensor(s) with a hammer. Heavy vibration could activate the sensor(s) and deploy the air bag(s), possibly causing serious injury.
- When using air or electric power tools or hammers, always switch the Ignition OFF, disconnect the battery and wait at least three minutes before performing any service.

Precaution for Trouble Diagnosis

INFOID:000000009482247

AV COMMUNICATION SYSTEM

- Do not apply voltage of 7.0 V or higher to the measurement terminals.
- Use the tester with its open terminal voltage being 7.0 V or less.
- Be sure to turn ignition switch OFF and disconnect the battery cable from the negative terminal before checking the circuit.

Precaution for Harness Repair

INFOID:000000009482248

AV COMMUNICATION SYSTEM

- Solder the repaired parts, and wrap with tape. [Frays of twisted line must be within 110 mm (4.33 in).]

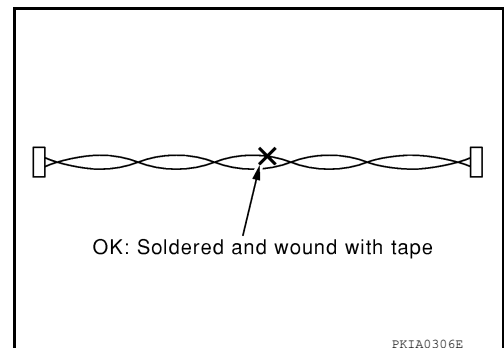

A
B
C
D
E
F
G
H
I
J
K
L
M
O
P

AV

PRECAUTIONS

< PRECAUTION >

[NAVIGATION]

- Do not perform bypass wire connections for the repair parts. (The spliced wire will become separated and the characteristics of twisted line will be lost.)

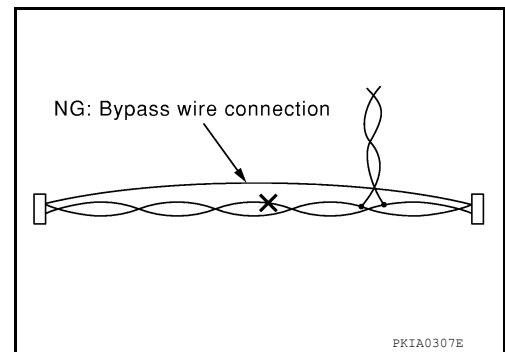

Precaution for Work

INFOID:000000009482249

- When removing or disassembling each component, be careful not to damage or deform it. If a component may be subject to interference, be sure to protect it with a shop cloth.
- When removing (disengaging) components with a screwdriver or similar tool, be sure to wrap the component with a shop cloth or vinyl tape to protect it.
- Protect the removed parts with a shop cloth and prevent them from being dropped.
- Replace a deformed or damaged clip.
- If a part is specified as a non-reusable part, always replace it with a new one.
- Be sure to tighten bolts and nuts securely to the specified torque.
- After installation is complete, be sure to check that each part works properly.
- Follow the steps below to clean components:
 - Water soluble dirt:
 - Dip a soft cloth into lukewarm water, wring the water out of the cloth and wipe the dirty area.
 - Then rub with a soft, dry cloth.
 - Oily dirt:
 - Dip a soft cloth into lukewarm water with mild detergent (concentration: within 2 to 3%) and wipe the dirty area.
 - Then dip a cloth into fresh water, wring the water out of the cloth and wipe the detergent off.
 - Then rub with a soft, dry cloth.
 - Do not use organic solvent such as thinner, benzene, alcohol or gasoline.
 - For genuine leather seats, use a genuine leather seat cleaner.

PREPARATION

< PREPARATION >

[NAVIGATION]

PREPARATION

PREPARATION

Special Service Tools

INFOID:000000009482250

The actual shape of the tools may differ from those illustrated here.

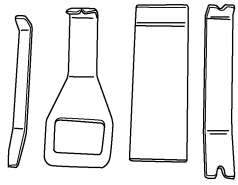
Tool number (TechMate No.) Tool name	Description
— (J-46534) Trim Tool Set  AWJIA04832Z	Removing trim components

Commercial Service Tools

INFOID:000000009482251

Tool name	Description
Power tool  PIIB1407E	Loosening nuts, screws and bolts

A
B
C
D
E
F
G
H
I
J
K
L
M
AV
O
P

REMOVAL AND INSTALLATION

AV CONTROL UNIT

Removal and Installation

INFOID:000000009482252

REMOVAL

CAUTION:

Before replacing AV control unit, perform "READ CONFIGURATION" to save current vehicle specification. Refer to [AV-283, "ADDITIONAL SERVICE WHEN REPLACING AV CONTROL UNIT : Work Procedure"](#).

1. Disconnect the negative battery terminal. Refer to [PG-83, "Removal and Installation"](#).
2. Remove cluster lid C. Refer to [IP-19, "Removal and Installation"](#).
3. Remove the screws (A) from the bracket.
4. Remove the audio unit (1) from cluster lid C.

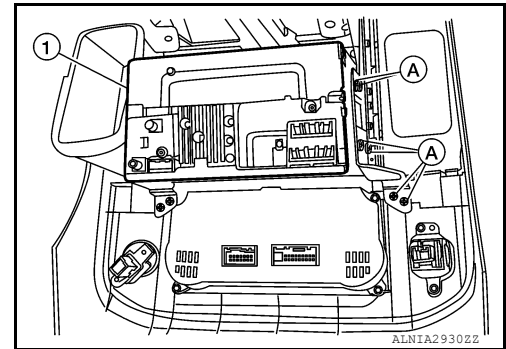

INSTALLATION

Installation is in the reverse order of removal.

CAUTION:

- When replacing AV control unit, perform "WRITE CONFIGURATION". Refer to [AV-285, "CONFIGURATION \(AV CONTROL UNIT\) : Configuration List"](#).
- When replacing AV control unit, the AV control unit must be registered. Refer to [AV-285, "REGISTRATION \(AV CONTROL UNIT\) : Description"](#).

AUDIO AMP.

< REMOVAL AND INSTALLATION >

[NAVIGATION]

AUDIO AMP.

Removal and Installation

INFOID:00000009482253

REMOVAL

NOTE:

Do not remove the RH front seat from the vehicle.

1. Remove the RH front seat bolts, disconnect the harness connectors from the RH front seat. Refer to [SE-32. "Removal and Installation"](#).
2. Tilt the RH front seat back to access the audio amp. (1) and remove the audio amp. kick shield screws (C).
↶: Front
3. Disconnect the harness connectors (A) from the audio amp. and remove the audio amp. (1) from the bracket (2).
4. Remove the audio amp. bracket screws (B) and bracket (2).

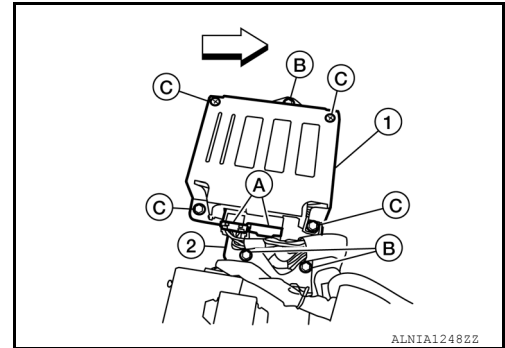

INSTALLATION

Installation is in the reverse order of removal.

A
B
C
D
E
F
G
H
I
J
K
L
M

AV

O
P

FRONT TWEETER

< REMOVAL AND INSTALLATION >

[NAVIGATION]

FRONT TWEETER

Removal and Installation

INFOID:000000009482254

REMOVAL

1. Remove the front tweeter grille.
2. Remove the front tweeter screws (A).
3. Pull out the front tweeter (1), then disconnect the harness connector from the front tweeter and remove.

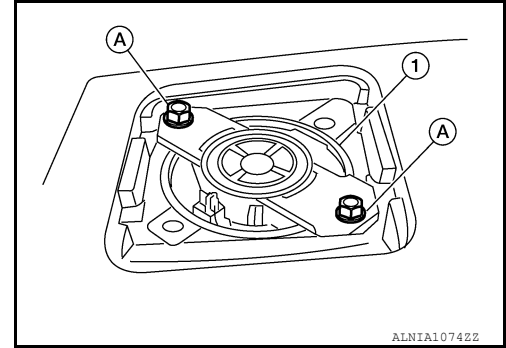

INSTALLATION

Installation is in the reverse order of removal.

FRONT DOOR SPEAKER

< REMOVAL AND INSTALLATION >

[NAVIGATION]

FRONT DOOR SPEAKER

Removal and Installation

INFOID:000000009482255

REMOVAL

1. Remove the front door finisher. Refer to [INT-15, "Removal and Installation"](#).
2. Remove the front door speaker screws (A).
3. Pull out the front door speaker (1) and disconnect the harness connector from the front door speaker.
4. Remove the front door speaker (1).

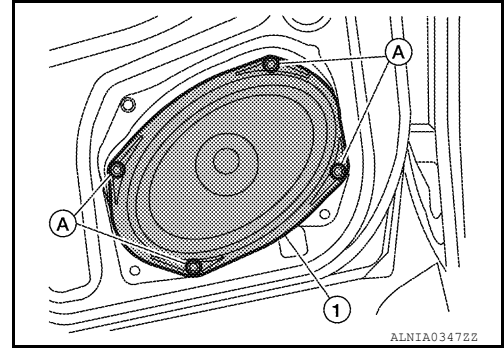

INSTALLATION

Installation is in the reverse order of removal.

A
B
C
D
E
F
G
H
I
J
K
L
M
N
O
P

AV

REAR DOOR SPEAKER

< REMOVAL AND INSTALLATION >

[NAVIGATION]

REAR DOOR SPEAKER

Removal and Installation

INFOID:000000009482256

REMOVAL

1. Remove the rear door finisher. Refer to [INT-15. "Removal and Installation"](#).
2. Remove the rear door speaker screws (A).
3. Disconnect the harness connector (B) from the rear door speaker (1) and remove.

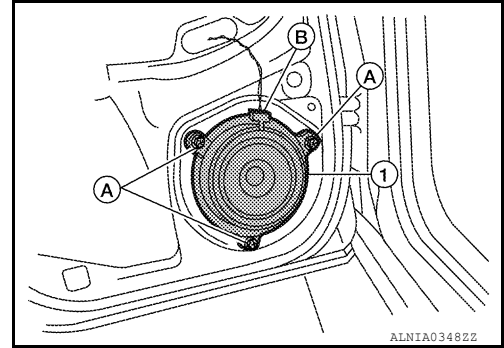

INSTALLATION

Installation is in the reverse order of removal.

REAR TWEETER

< REMOVAL AND INSTALLATION >

[NAVIGATION]

REAR TWEETER

Removal and Installation

INFOID:000000009482257

REMOVAL

1. Remove the rear door finisher. Refer to [INT-15. "Removal and Installation"](#).
2. Remove the rear door tweeter screws (A) and rear door tweeter (1).

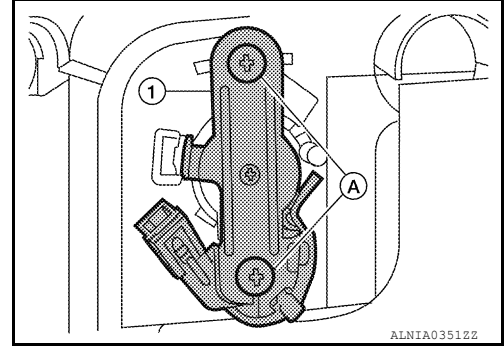

INSTALLATION

Installation is in the reverse order of removal.

A
B
C
D
E
F
G
H
I
J
K
L
M
O
P

AV

SUBWOOFER

< REMOVAL AND INSTALLATION >

[NAVIGATION]

SUBWOOFER

Removal and Installation

INFOID:000000009482258

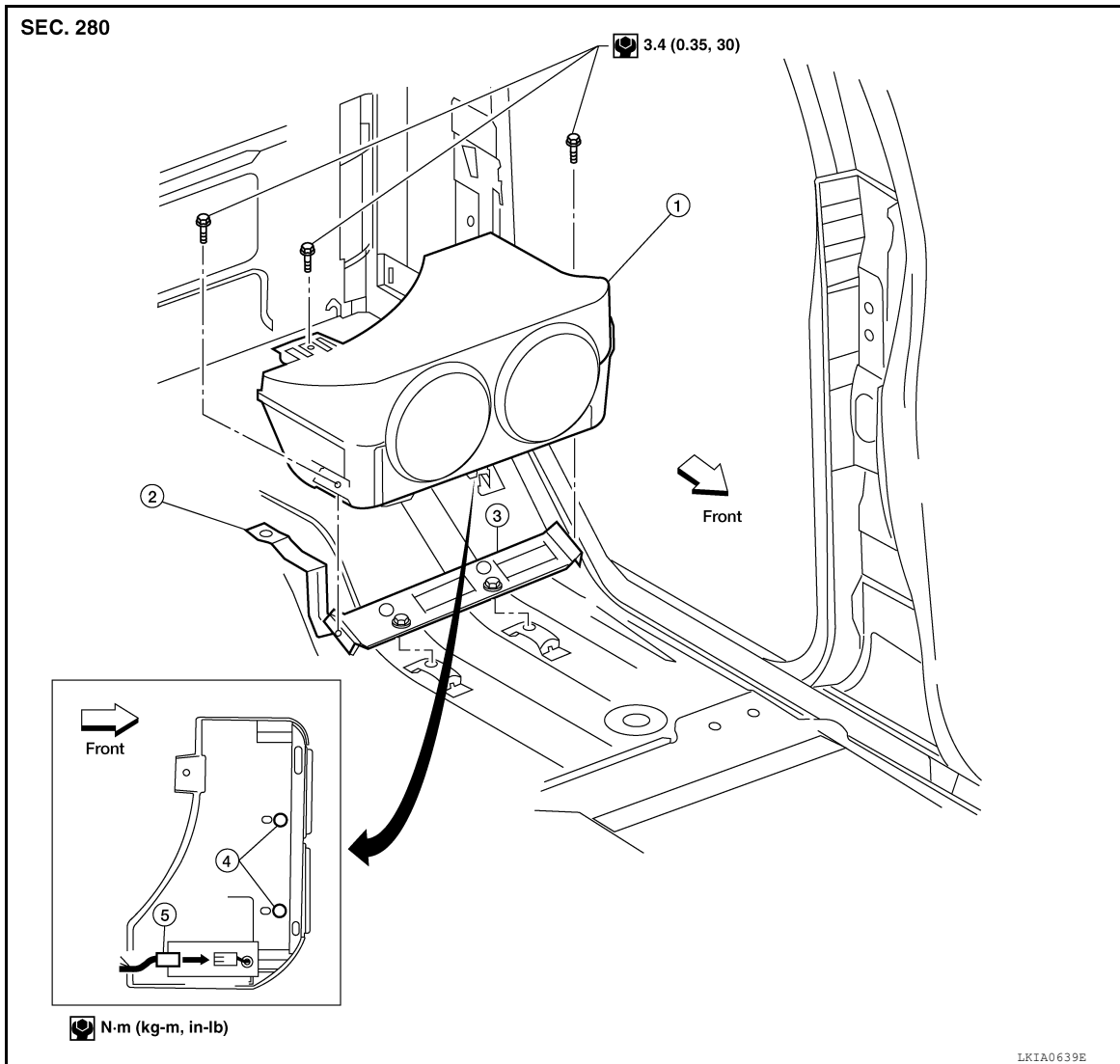

- | | | |
|-----------------|--------------|-----------------------|
| 1. Subwoofer | 2. Bracket | 3. Locating pin plate |
| 4. Locating pin | 5. Connector | |

REMOVAL

1. Position the LH rear seat cushion in the folded up position.
2. Remove storage box (RH) (crew cab). Refer to [INT-23, "Removal and Installation"](#).
3. Remove the subwoofer screws.
4. Disconnect the harness connector from the subwoofer and remove.

INSTALLATION

Installation is in the reverse order of removal.

STEERING SWITCH

< REMOVAL AND INSTALLATION >

[NAVIGATION]

STEERING SWITCH

Removal and Installation

INFOID:00000009482259

Removal and Installation

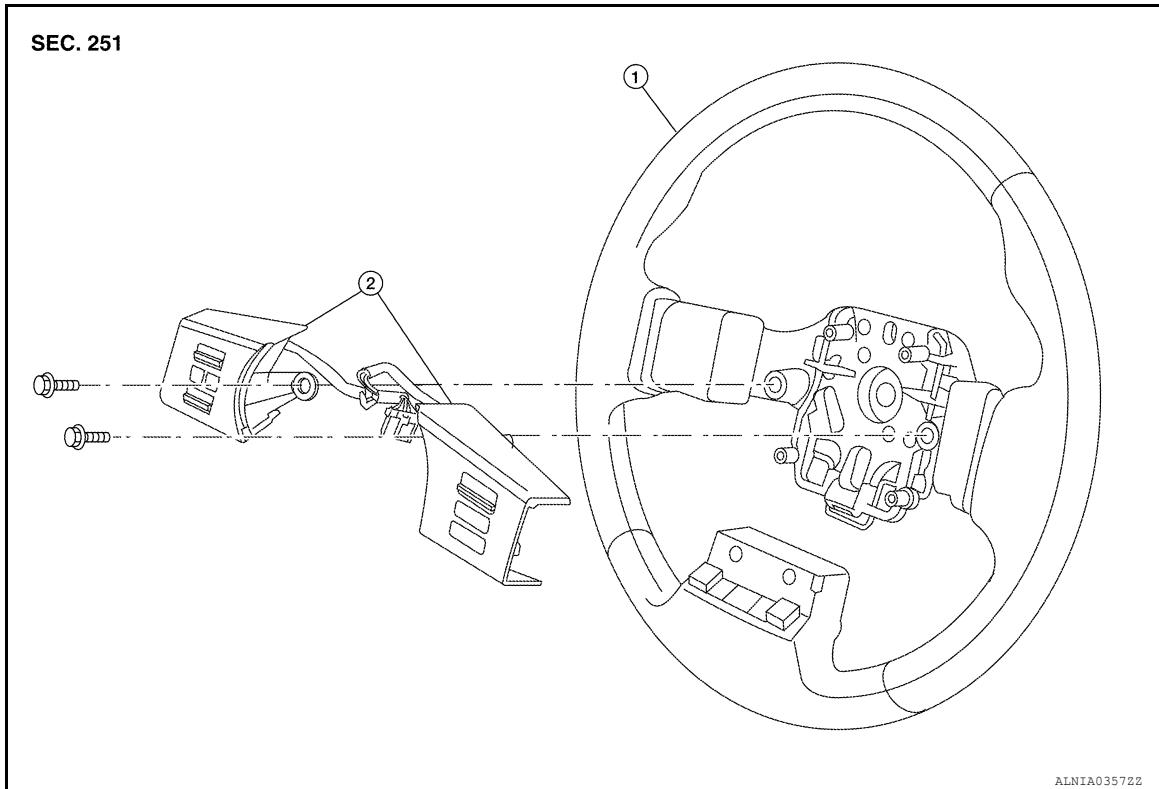

1. Steering wheel

2. Steering wheel audio control switches

REMOVAL

1. Remove the driver air bag module. Refer to [SR-11, "Removal and Installation"](#).
2. Remove the steering wheel audio control switch assembly screws.
3. Disconnect the harness connectors from the steering wheel audio control switches.
4. Remove the steering wheel audio control switches by pulling on steering wheel audio control switches to release the pawls.

○: Pawl

CAUTION:

Do not tilt steering wheel audio control switches during removal or damage may occur to the pawls.

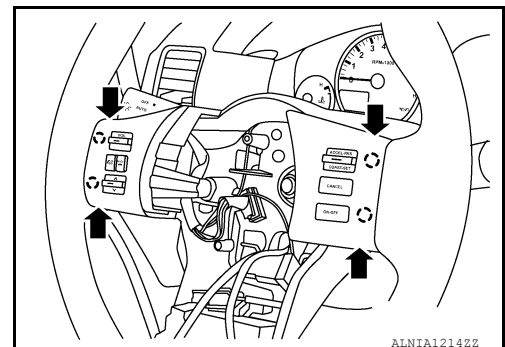

INSTALLATION

Installation is in the reverse order of removal.

A
B
C
D
E
F
G
H
I
J
K
L
M
AV
O
P

MICROPHONE

Removal and Installation

INFOID:000000009482260

REMOVAL

1. Remove the roof console. Refer to [INT-25, "Removal and Installation"](#).
2. Release the pawls that retain the Bluetooth microphone (1) to the roof console.
3. Disconnect the harness connector (A) from the Bluetooth microphone (1) and remove.

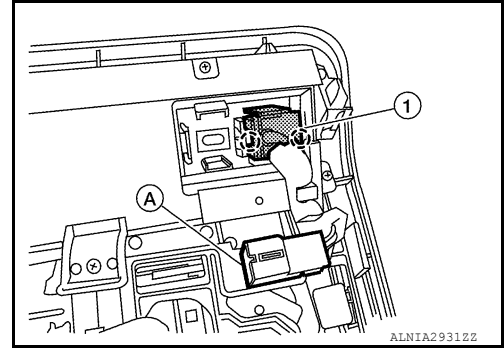

INSTALLATION

Installation is in the reverse order of removal.

AUDIO ANTENNA

< REMOVAL AND INSTALLATION >

[NAVIGATION]

AUDIO ANTENNA

Location of Antenna

INFOID:000000009482261

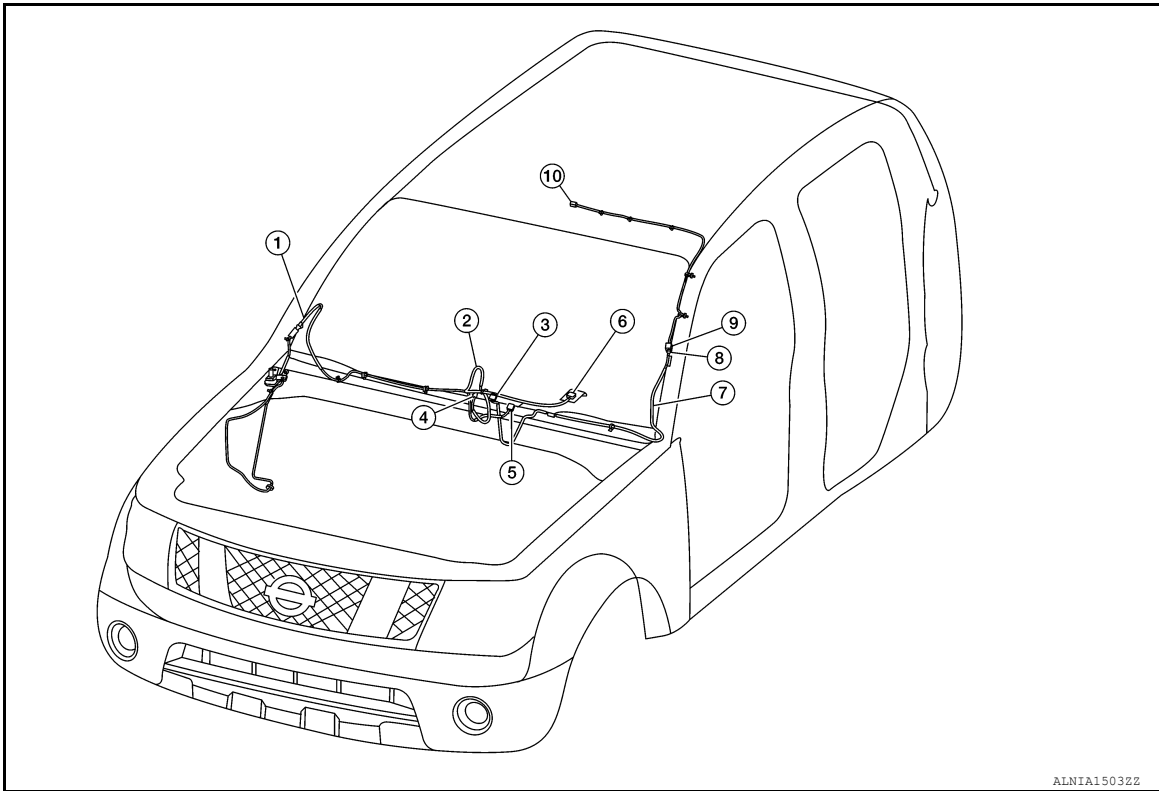

- | | | |
|-----------------------------|-----------------------|----------------|
| 1. Coaxial antenna feeder | 2. GPS antenna feeder | 3. M100 |
| 4. M99 | 5. M38 | 6. GPS antenna |
| 7. Satellite antenna feeder | 8. M67 | 9. M500 |
| 10. M501 | | |

Removal and Installation

INFOID:000000009482262

REMOVAL

1. Remove instrument lower panel RH and glove box. Refer to [IP-24, "Removal and Installation"](#).
2. Disconnect audio antenna cable from antenna feeder.

A
B
C
D
E
F
G
H
I
J
K
L
M
O
P

AV

AUDIO ANTENNA

< REMOVAL AND INSTALLATION >

[NAVIGATION]

3. Remove antenna rod.
4. Remove rubber seal.
5. Remove cowl top. Refer to [EXT-24. "Removal and Installation"](#).
6. Remove fender protector. Refer to [EXT-27. "Removal and Installation of Front Fender Protector"](#).
7. Remove antenna base bolts.
8. Remove antenna base and cable.

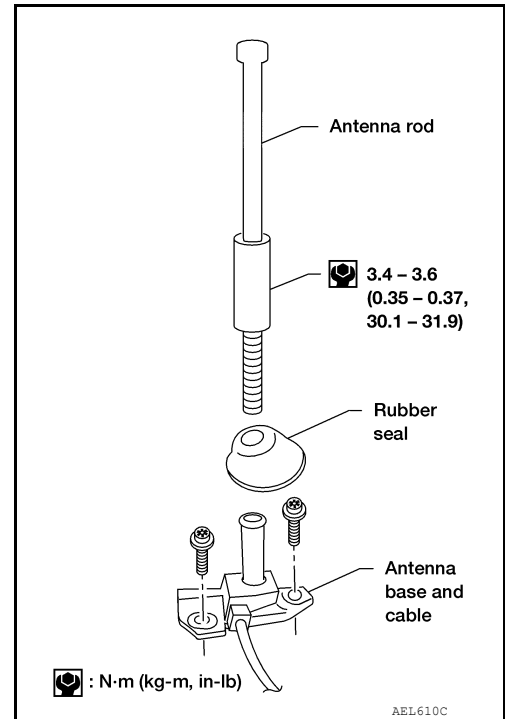

INSTALLATION

Installation is in the reverse order of removal.

CAUTION:

Always properly tighten the antenna rod during installation or the antenna rod may bend or break during vehicle operation.

AUXILIARY INPUT JACK

< REMOVAL AND INSTALLATION >

[NAVIGATION]

AUXILIARY INPUT JACK

Removal and Installation

INFOID:000000009482263

Removal

1. Remove the front center console bin. Refer to [IP-29. "Exploded View"](#).
2. Remove the auxiliary input jack.

Installation

Installation is in the reverse order of removal.

A

B

C

D

E

F

G

H

I

J

K

L

M

AV

O

P

SATELLITE RADIO ANTENNA

< REMOVAL AND INSTALLATION >

[NAVIGATION]

SATELLITE RADIO ANTENNA

Removal and Installation

INFOID:000000009482264

REMOVAL

1. Remove the roof console. Refer to [INT-25, "Removal and Installation"](#).
2. Disconnect the harness connector from the satellite radio antenna.
3. Remove the satellite radio antenna nut.
4. Remove the satellite radio antenna.

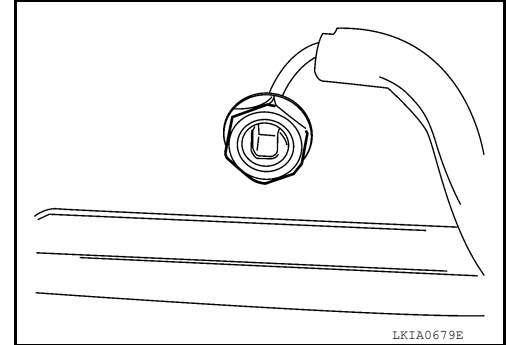

INSTALLATION

Installation is in the reverse order of removal.

GPS ANTENNA

Removal and Installation

INFOID:000000009482265

REMOVAL

1. Remove the combination meter. Refer to [MWI-90. "Removal and Installation"](#).
2. Remove the GPS antenna screw and the GPS antenna.

INSTALLATION

Installation is in the reverse order of removal.

A

B

C

D

E

F

G

H

I

J

K

L

M

AV

O

P

USB CONNECTOR

Removal and Installation

INFOID:000000009482266

REMOVAL

1. Remove the center console assembly. Refer to [IP-26. "Removal and Installation"](#).
2. Push the pawl from the back of the center console to remove the USB interface.

INSTALLATION

Installation is in the reverse order of removal.

REAR VIEW CAMERA

Removal and Installation

INFOID:000000009482267

REMOVAL

1. Remove the tail gate protector. Refer to [EXT-38. "Removal and Installation"](#).
2. Remove the rear view camera screws and the rear view camera.

INSTALLATION

Installation is in the reverse order of removal.

A
B
C
D
E
F
G
H
I
J
K
L
M
N
O
P

AV