

SECTION **EX**  
EXHAUST SYSTEM

A  
EX  
C  
D  
E  
F  
G  
H  
I  
J  
K  
L  
M  
N  
O  
P

CONTENTS

<b>PRECAUTION</b> .....	2	<b>PERIODIC MAINTENANCE</b> .....	4
<b>PRECAUTIONS</b> .....	2	<b>EXHAUST SYSTEM</b> .....	4
Precaution for Supplemental Restraint System (SRS) "AIR BAG" and "SEAT BELT PRE-TENSIONER" .....	2	Checking Exhaust System .....	4
<b>PREPARATION</b> .....	3	<b>REMOVAL AND INSTALLATION</b> .....	5
<b>PREPARATION</b> .....	3	<b>EXHAUST SYSTEM</b> .....	5
Special Service Tool .....	3	Exploded View .....	5
Commercial Service Tool .....	3	Removal and Installation .....	6

# PRECAUTIONS

< PRECAUTION >

## PRECAUTION

### PRECAUTIONS

#### Precaution for Supplemental Restraint System (SRS) "AIR BAG" and "SEAT BELT PRE-TENSIONER"

INFOID:000000010138344

The Supplemental Restraint System such as "AIR BAG" and "SEAT BELT PRE-TENSIONER", used along with a front seat belt, helps to reduce the risk or severity of injury to the driver and front passenger for certain types of collision. This system includes seat belt switch inputs and dual stage front air bag modules. The SRS system uses the seat belt switches to determine the front air bag deployment, and may only deploy one front air bag, depending on the severity of a collision and whether the front occupants are belted or unbelted. Information necessary to service the system safely is included in the SR and SB section of this Service Manual.

**WARNING:**

- To avoid rendering the SRS inoperative, which could increase the risk of personal injury or death in the event of a collision which would result in air bag inflation, all maintenance must be performed by an authorized NISSAN/INFINITI dealer.
- Improper maintenance, including incorrect removal and installation of the SRS, can lead to personal injury caused by unintentional activation of the system. For removal of Spiral Cable and Air Bag Module, see the SR section.
- Do not use electrical test equipment on any circuit related to the SRS unless instructed to in this Service Manual. SRS wiring harnesses can be identified by yellow and/or orange harnesses or harness connectors.

#### PRECAUTIONS WHEN USING POWER TOOLS (AIR OR ELECTRIC) AND HAMMERS

**WARNING:**

- When working near the Airbag Diagnosis Sensor Unit or other Airbag System sensors with the Ignition ON or engine running, DO NOT use air or electric power tools or strike near the sensor(s) with a hammer. Heavy vibration could activate the sensor(s) and deploy the air bag(s), possibly causing serious injury.
- When using air or electric power tools or hammers, always switch the Ignition OFF, disconnect the battery and wait at least three minutes before performing any service.

# PREPARATION

< PREPARATION >

## PREPARATION

### PREPARATION

#### Special Service Tool

INFOID:000000009478605

A

EX

The actual shape of the tools may differ from those illustrated here.

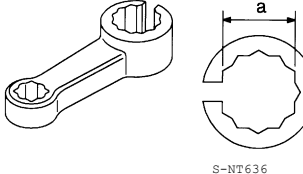
Tool number (TechMate No.) Tool name	Description
KV10114400 (J-38365) Heated oxygen sensor wrench  	Loosening or tightening heated oxygen sensors: <b>a: 22 mm (0.87 in)</b>



C

D

E

#### Commercial Service Tool

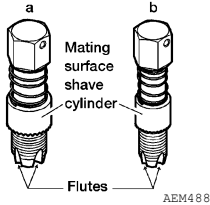
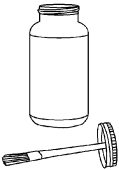
INFOID:000000009478606

(TechMate No.) Tool name	Description
(J-43897-18) (J-43897-12) Oxygen sensor thread cleaner  	Reconditioning the exhaust system threads before installing a new heated oxygen sensor (Use with anti-seize lubricant shown below): <b>a: J-43897-18 (18 mm, 0.71 in) dia. for zirconia oxygen sensor</b> <b>b: J-43897-12 (12 mm, 0.47 in) dia. for titania oxygen sensor</b>
Anti-seize lubricant (Permatex 133AR or equivalent meeting MIL specification MIL-A-907)  	Lubricating oxygen sensor thread cleaning tool when reconditioning exhaust system threads
Power tool  	Loosening nuts, screws and bolts

F

G

H

I

J

K

L

M

N

O

P

# EXHAUST SYSTEM

< PERIODIC MAINTENANCE >

## PERIODIC MAINTENANCE

### EXHAUST SYSTEM

#### Checking Exhaust System

INFOID:000000009478607

Check exhaust pipes, muffler and mounting for improper attachment, leaks, cracks, damage or deterioration.

- If anything is found, repair or replace damaged parts.

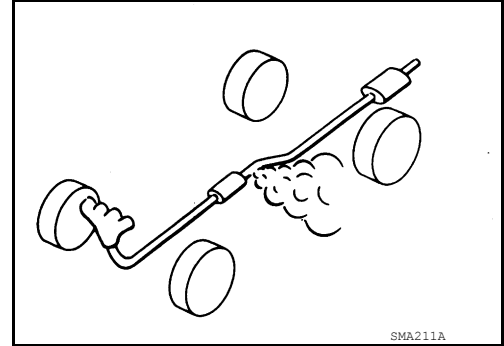

# EXHAUST SYSTEM

< REMOVAL AND INSTALLATION >

## REMOVAL AND INSTALLATION

### EXHAUST SYSTEM

Exploded View

INFOID:000000009478608

A

EX

Exhaust System QR25DE

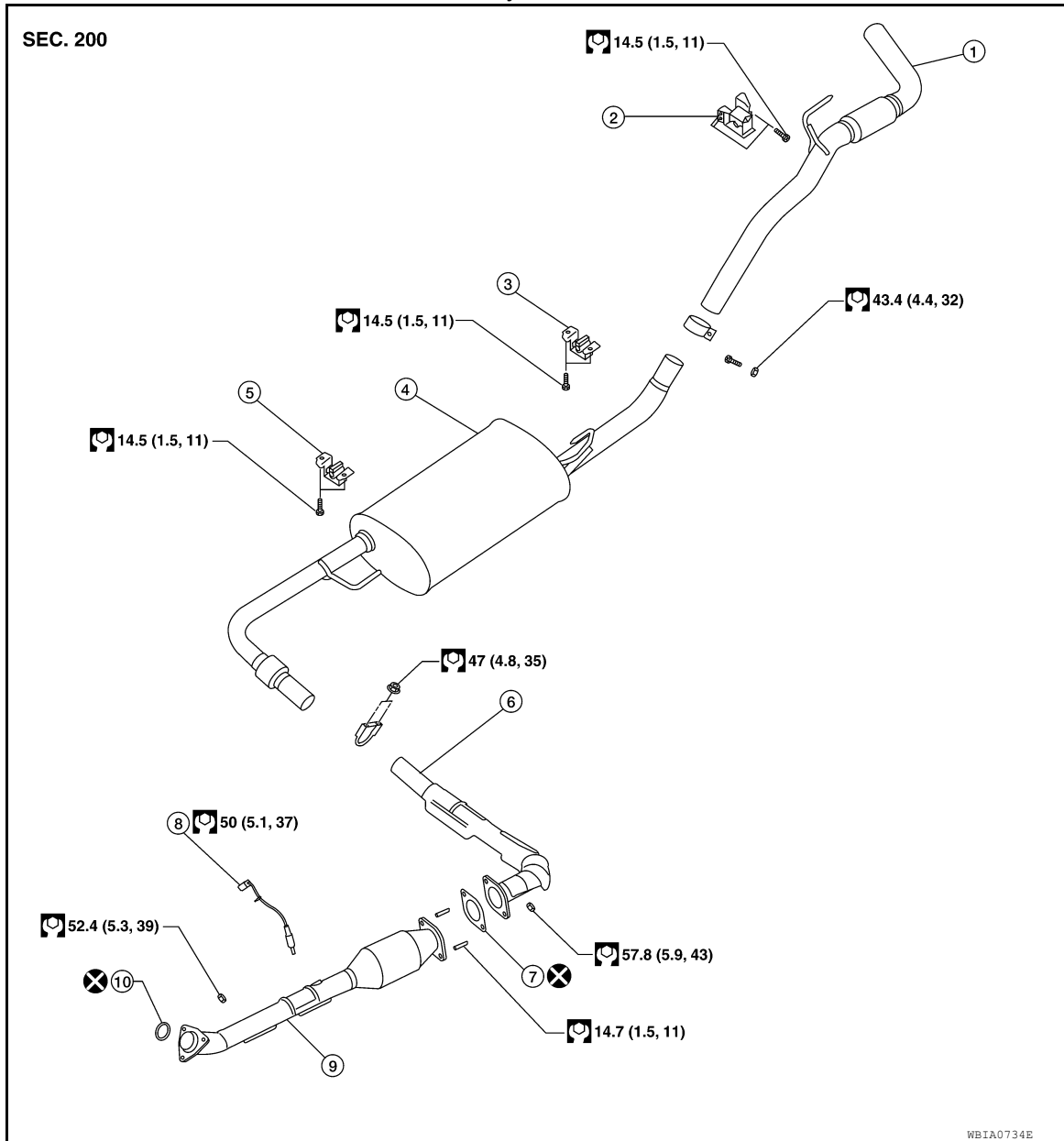

C

D

E

F

G

H

I

J

K

L

M

N

- |                 |                                 |                                |
|-----------------|---------------------------------|--------------------------------|
| 1. Tailpipe     | 2. Tailpipe hanger bracket      | 3. Muffler hanger bracket rear |
| 4. Main muffler | 5. Muffler hanger bracket front | 6. Center exhaust tube         |
| 7. Gasket       | 8. Heated oxygen sensor 2       | 9. Front exhaust tube          |
| 10. Ring gasket |                                 |                                |

O

P

# EXHAUST SYSTEM

< REMOVAL AND INSTALLATION >

## Exhaust System VQ40DE

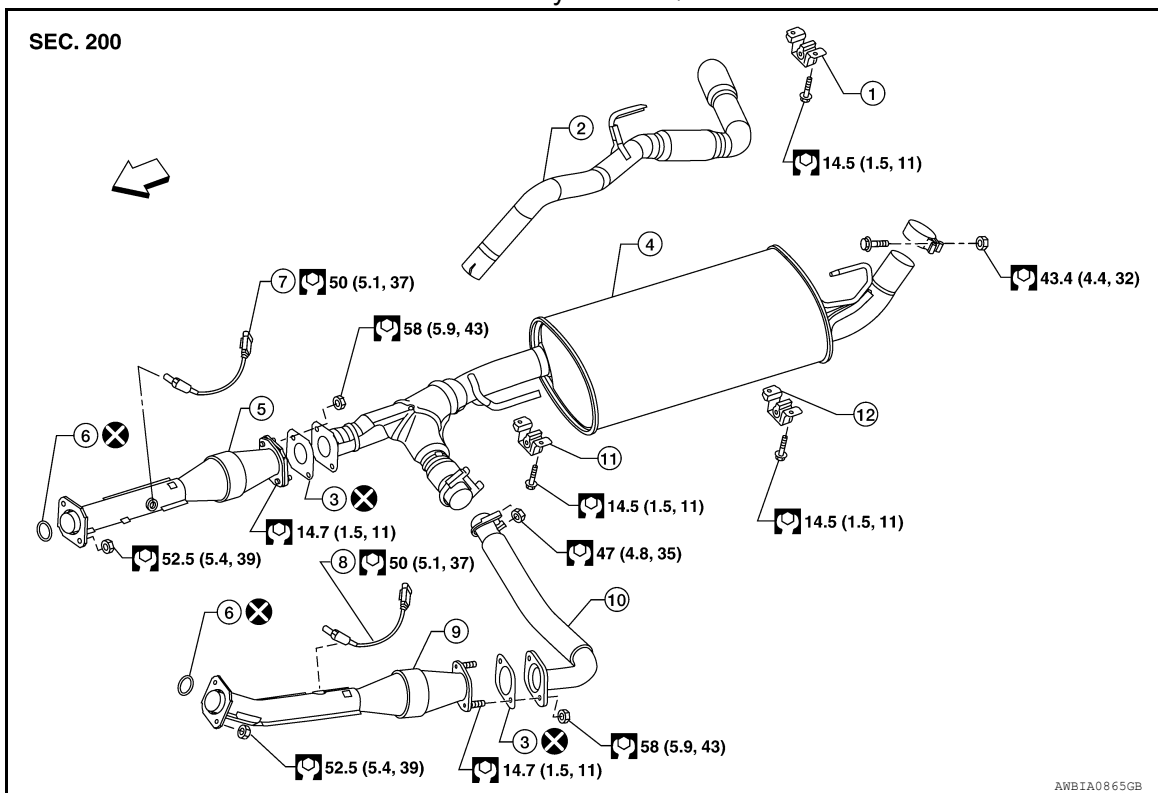

- |                                    |                                    |                                 |
|------------------------------------|------------------------------------|---------------------------------|
| 1. Tailpipe hanger bracket         | 2. Tailpipe                        | 3. Gasket                       |
| 4. Main muffler                    | 5. Right front exhaust tube        | 6. Ring gasket                  |
| 7. Heated oxygen sensor 2 (bank 1) | 8. Heated oxygen sensor 2 (bank 2) | 9. Left front exhaust tube      |
| 10. Center exhaust tube            | 11. Muffler hanger bracket front   | 12. Muffler hanger bracket rear |

← Front

## Removal and Installation

INFOID:000000009478609

### WARNING:

- Perform the operation with the exhaust system fully cooled. The system will be hot just after the engine stops.
- Be careful not to cut your hand on the heat insulator edge.

### CAUTION:

- Be sure to use genuine exhaust system parts or equivalents which are specially designed for heat resistance, corrosion resistance, and shape.

### REMOVAL

- Remove exhaust system components using power tool.
- Remove heated oxygen sensor using Tool as needed.

**Tool number** : KV10114400 (J-38365)

### INSTALLATION

Installation is in the reverse order of removal.

### CAUTION:

- Always replace exhaust gaskets with new ones when reassembling.
- Before installing a new heated oxygen sensor, clean and lube the exhaust tube threads using suitable tool.

**Oxygen sensor thread cleaner** : — (J-43897-18)

**Oxygen sensor thread cleaner** : — (J-43897-12)

# EXHAUST SYSTEM

## < REMOVAL AND INSTALLATION >

- Discard any heated oxygen sensor which has been dropped from a height of more than 0.5 m (19.7 in) onto a hard surface such as a concrete floor; install a new one.
- Do not over-tighten the heated oxygen sensor. Doing so may damage the heated oxygen sensor, resulting in the MIL coming on.
- If any mounting insulator is badly deformed, repair or replace it. If deposits such as mud pile up on the mounting insulators, clean and inspect them.
- Temporarily tighten the nuts on the exhaust manifold side and the bolts on the vehicle side. Check each part for interference with other components, and then tighten the nuts and bolts to specification.

## INSPECTION AFTER INSTALLATION

- With the engine running, check exhaust tube joints for gas leaks and unusual noises.
- Ensure mounting brackets and mounting rubbers are installed properly and free from undue stress. Improper installation could result in excessive noise and vibration.

A

EX

C

D

E

F

G

H

I

J

K

L

M

N

O

P