

SECTION **DLK**
DOOR & LOCK

A
B
C

CONTENTS

INTELLIGENT KEY SYSTEM		
BASIC INSPECTION	6	
DIAGNOSIS AND REPAIR WORKFLOW	6	
Work Flow	6	
INSPECTION AND ADJUSTMENT	9	
ADDITIONAL SERVICE WHEN REPLACING CONTROL UNIT	9	
ADDITIONAL SERVICE WHEN REPLACING CONTROL UNIT : Description	9	
ADDITIONAL SERVICE WHEN REPLACING CONTROL UNIT : Special Repair Requirement	9	
FUNCTION DIAGNOSIS	10	
DOOR LOCK FUNCTION	10	
DOOR LOCK AND UNLOCK SWITCH	10	
DOOR LOCK AND UNLOCK SWITCH : System Diagram	10	
DOOR LOCK AND UNLOCK SWITCH : System Description	10	
DOOR LOCK AND UNLOCK SWITCH : Component Parts Location	10	
DOOR LOCK AND UNLOCK SWITCH : Component Description	13	
DOOR REQUEST SWITCH	13	
DOOR REQUEST SWITCH : System Diagram	13	
DOOR REQUEST SWITCH : System Description	13	
DOOR REQUEST SWITCH : Component Parts Location	15	
DOOR REQUEST SWITCH : Component Description	18	
INTELLIGENT KEY	18	
INTELLIGENT KEY : System Diagram	18	
INTELLIGENT KEY : System Description	18	
INTELLIGENT KEY : Component Parts Location	20	
INTELLIGENT KEY : Component Description	23	
TRUNK OPEN FUNCTION	24	
TRUNK LID OPENER SWITCH	24	
TRUNK LID OPENER SWITCH : System Diagram	24	
TRUNK LID OPENER SWITCH : System Description	24	
TRUNK LID OPENER SWITCH : Component Parts Location	24	
TRUNK LID OPENER SWITCH : Component Description	27	
TRUNK REQUEST SWITCH	27	
TRUNK REQUEST SWITCH : System Diagram	27	
TRUNK REQUEST SWITCH : System Description	27	
TRUNK REQUEST SWITCH : Component Parts Location	29	
TRUNK REQUEST SWITCH : Component Description	32	
INTELLIGENT KEY	32	
INTELLIGENT KEY : System Diagram	32	
INTELLIGENT KEY : System Description	32	
INTELLIGENT KEY : Component Parts Location	33	
INTELLIGENT KEY : Component Description	36	
WARNING FUNCTION	37	
System Description	37	
Component Parts Location	41	
KEY REMINDER FUNCTION	45	
System Description	45	
Component Parts Location	45	
INTEGRATED HOMELINK TRANSMITTER	49	
Component Description	49	
DIAGNOSIS SYSTEM (BCM)	50	
COMMON ITEM	50	
COMMON ITEM : CONSULT-III Function (BCM - COMMON ITEM)	50	

D
E
F
G
H
I
J
DLK

L
M
N
O
P

DOOR LOCK	50	KEY SLOT	72
DOOR LOCK : CONSULT-III Function (BCM - DOOR LOCK)	50	Description	72
INTELLIGENT KEY	51	Component Function Check	72
INTELLIGENT KEY : CONSULT-III Function (BCM - INTELLIGENT KEY)	51	Diagnosis Procedure	72
TRUNK	54	Component Inspection	73
TRUNK : CONSULT-III Function (BCM - TRUNK)	54	KEY CYLINDER SWITCH	74
COMPONENT DIAGNOSIS	56	Description	74
U1000 CAN COMM CIRCUIT	56	Component Function Check	74
Description	56	Diagnosis Procedure	74
DTC Logic	56	Component Inspection	75
Diagnosis Procedure	56	Special Repair Requirement	75
U1010 CONTROL UNIT (CAN)	57	UNLOCK SENSOR	77
DTC Logic	57	Description	77
Diagnosis Procedure	57	Component Function Check	77
Special Repair Requirement	57	Diagnosis Procedure	77
B2621 INSIDE KEY ANTENNA 1	58	Component Inspection	78
Description	58	TRUNK LID OPENER SWITCH	80
DTC Logic	58	Description	80
Diagnosis Procedure	58	Component Function Check	80
B2622 INSIDE KEY ANTENNA 2	60	Diagnosis Procedure	80
Description	60	Component Inspection	81
DTC Logic	60	TRUNK LID OPENER CANCEL SWITCH	82
Diagnosis Procedure	60	Description	82
B2623 INSIDE KEY ANTENNA 3	62	Component Function Check	82
Description	62	Diagnosis Procedure	82
DTC Logic	62	Component Inspection	83
Diagnosis Procedure	62	TRUNK ROOM LAMP SWITCH	84
POWER SUPPLY AND GROUND CIRCUIT	64	Description	84
Diagnosis Procedure	64	Component Function Check	84
DOOR SWITCH	65	Diagnosis Procedure	84
Description	65	Component Inspection	85
Component Function Check	65	DOOR REQUEST SWITCH	87
Diagnosis Procedure	65	Description	87
Component Inspection	67	Component Function Check	87
DOOR LOCK AND UNLOCK SWITCH	68	Diagnosis Procedure	87
DRIVER SIDE	68	Component Inspection	89
DRIVER SIDE : Description	68	TRUNK OPENER REQUEST SWITCH	90
DRIVER SIDE : Component Function Check	68	Description	90
DRIVER SIDE : Diagnosis Procedure	68	Component Function Check	90
DRIVER SIDE : Special Repair Requirement	69	Diagnosis Procedure	90
PASSENGER SIDE	69	Component Inspection	91
PASSENGER SIDE : Description	69	DOOR LOCK ACTUATOR	92
PASSENGER SIDE :		DRIVER SIDE	92
Component Function Check	69	DRIVER SIDE : Description	92
PASSENGER SIDE : Diagnosis Procedure	70	DRIVER SIDE : Component Function Check	92
PASSENGER SIDE : Special Repair Requirement	71	DRIVER SIDE : Diagnosis Procedure	92
		PASSENGER SIDE	92
		PASSENGER SIDE : Description	93
		PASSENGER SIDE :	
		Component Function Check	93
		PASSENGER SIDE : Diagnosis Procedure	93

REAR LH	93	Component Function Check	114	
REAR LH : Description	93	Diagnosis Procedure	114	A
REAR LH : Component Function Check	94			
REAR LH : Diagnosis Procedure	94			
REAR RH	94	HAZARD FUNCTION	115	
REAR RH : Description	94	Description	115	B
REAR RH : Component Function Check	94	Component Function Check	115	
REAR RH : Diagnosis Procedure	95	Diagnosis Procedure	115	
TRUNK LID OPENER ACTUATOR	96	INTEGRATED HOMELINK TRANSMITTER ..	116	C
Description	96	Description	116	
Component Function Check	96	Component Function Check	116	
Diagnosis Procedure	96	Diagnosis Procedure	116	D
FUEL LID OPENER ACTUATOR	98	INTEGRATED HOMELINK TRANSMITTER		
Description	98	SYSTEM	118	E
Component Function Check	98	Wiring Diagram (BCM - INTEGRATED		
Diagnosis Procedure	98	HOMELINK TRANSMITTER SYSTEM)	118	
INTELLIGENT KEY WARNING BUZZER	99	ECU DIAGNOSIS	120	F
Description	99	BCM (BODY CONTROL MODULE)	120	
Component Function Check	99	Reference Value	120	
Diagnosis Procedure	99	Wiring Diagram — POWER DOOR LOCK SYS-		G
Component Inspection	100	TEM —	143	
OUTSIDE KEY ANTENNA	101	Wiring Diagram — INTELLIGENT KEY SYSTEM		
Description	101	—	148	H
Component Function Check	101	Wiring Diagram — TRUNK LID OPENER SYS-		
Diagnosis Procedure	101	TEM —	158	
REMOTE KEYLESS ENTRY RECEIVER	104	Fail Safe	161	I
Description	104	DTC Inspection Priority Chart	163	
Component Function Check	104	DTC Index	164	
Diagnosis Procedure	104	SYMPTOM DIAGNOSIS	167	J
INTELLIGENT KEY	107	INTELLIGENT KEY SYSTEM SYMPTOMS ...	167	
Description	107	Symptom Table	167	DLK
Component Function Check	107	DOOR LOCK FUNCTION SYMPTOMS	168	
Diagnosis Procedure	107	DOOR LOCK AND UNLOCK SWITCH	168	L
Component Inspection	107	DOOR LOCK AND UNLOCK SWITCH : Symptom		
Special Repair Requirement	108	Table	168	
KEY SLOT ILLUMINATION	109	DOOR REQUEST SWITCH	168	M
Description	109	DOOR REQUEST SWITCH : Symptom Table	168	
Component Function Check	109	INTELLIGENT KEY	169	N
Diagnosis Procedure	109	INTELLIGENT KEY : Symptom Table	169	
HORN FUNCTION	111	TRUNK OPEN FUNCTION SYMPTOMS	171	O
Description	111	TRUNK LID OPENER SWITCH	171	
Component Function Check	111	TRUNK LID OPENER SWITCH : Symptom Table.	171	
Diagnosis Procedure	111	TRUNK REQUEST SWITCH	171	P
COMBINATION METER DISPLAY FUNC-		TRUNK REQUEST SWITCH : Symptom Table ...	171	
TION	113	INTELLIGENT KEY	171	
Description	113	INTELLIGENT KEY : Symptom Table	171	
Component Function Check	113	WARNING FUNCTION SYMPTOMS	173	
Diagnosis Procedure	113	Symptom Table	173	
WARNING CHIME FUNCTION	114			
Description	114			

KEY REMINDER FUNCTION SYMPTOMS	176	DOOR	200
Symptom Table	176	FRONT DOOR	200
HAZARD AND BUZZER REMINDER FUNCTION SYMPTOMS	177	FRONT DOOR : Exploded View	200
Symptom Table	177	FRONT DOOR : Removal and Installation	201
HAZARD AND HORN REMINDER FUNCTION SYMPTOMS	178	FRONT DOOR : Adjustment	202
Symptom Table	178	REAR DOOR	203
SQUEAK AND RATTLE TROUBLE DIAGNOSES	179	REAR DOOR : Exploded View	203
Work Flow	179	REAR DOOR : Removal and Installation	204
Inspection Procedure	181	REAR DOOR : Adjustment	205
Diagnostic Worksheet	183	DOOR LOCK	207
PRECAUTION	185	FRONT DOOR LOCK	207
PRECAUTIONS	185	FRONT DOOR LOCK : Exploded View	207
Precaution for Supplemental Restraint System (SRS) "AIR BAG" and "SEAT BELT PRE-TENSIONER"	185	FRONT DOOR LOCK : Removal and Installation	207
Precaution for Procedure without Cowl Top Cover	185	REAR DOOR LOCK	209
Precaution Necessary for Steering Wheel Rotation after Battery Disconnect	185	REAR DOOR LOCK : Exploded View	209
Work	186	REAR DOOR LOCK : Removal and Installation	210
PREPARATION	187	TRUNK LID	213
PREPARATION	187	TRUNK LID ASSEMBLY	213
Special Service Tools	187	TRUNK LID ASSEMBLY : Exploded View	213
Commercial Service Tools	187	TRUNK LID ASSEMBLY : Removal and Installation	214
ON-VEHICLE MAINTENANCE	188	TRUNK LID ASSEMBLY : Adjustment	215
PRE-INSPECTION FOR DIAGNOSTIC	188	TRUNK LID LOCK	215
Basic Inspection	188	TRUNK LID LOCK : Exploded View	215
ON-VEHICLE REPAIR	190	TRUNK LID LOCK : Removal and Installation	216
HOOD	190	TRUNK LID WEATHERSTRIP	216
HOOD ASSEMBLY	190	TRUNK LID WEATHERSTRIP : Exploded View	216
HOOD ASSEMBLY : Exploded View	190	TRUNK LID WEATHERSTRIP : Removal and Installation	217
HOOD ASSEMBLY : Removal and Installation	191	DOOR SWITCH	218
HOOD ASSEMBLY : Adjustment	192	Removal and Installation	218
HOOD LOCK CONTROL	192	INSIDE KEY ANTENNA	219
HOOD LOCK CONTROL : Exploded View	192	INSTRUMENT CENTER	219
HOOD LOCK CONTROL : Removal and Installation	193	INSTRUMENT CENTER : Exploded View	219
HOOD LOCK CONTROL : Inspection	195	INSTRUMENT CENTER : Removal and Installation	219
RADIATOR CORE SUPPORT	196	CONSOLE	219
Exploded View	196	CONSOLE : Exploded View	219
Removal and Installation	196	CONSOLE : Removal and Installation	219
FRONT FENDER	199	TRUNK ROOM	219
Exploded View	199	TRUNK ROOM : Exploded View	219
Removal and Installation	199	TRUNK ROOM : Removal and Installation	219
		OUTSIDE KEY ANTENNA	221
		DRIVER SIDE	221
		DRIVER SIDE : Exploded View	221
		DRIVER SIDE : Removal and Installation	221
		PASSENGER SIDE	221

PASSENGER SIDE : Exploded View	221	TRUNK OPENER REQUEST SWITCH	224	
PASSENGER SIDE : Removal and Installation ...	221	Exploded View	224	A
REAR BUMPER	221	Removal and Installation	224	
REAR BUMPER : Exploded View	221	TRUNK LID OPENER SWITCH	225	B
REAR BUMPER : Removal and Installation	221	Exploded View	225	
INTELLIGENT KEY WARNING BUZZER	222	Removal and Installation	225	
Exploded View	222	TRUNK LID OPENER CANCEL SWITCH	226	C
Removal and Installation	222	Exploded View	226	
KEY SLOT	223	Removal and Installation	226	
Exploded View	223	REMOTE KEYLESS ENTRY RECEIVER	227	D
Removal and Installation	223	Exploded View	227	
		Removal and Installation	227	E
				F
				G
				H
				I
				J
				DLK
				L
				M
				N
				O
				P

DIAGNOSIS AND REPAIR WORKFLOW

< BASIC INSPECTION >

[INTELLIGENT KEY SYSTEM]

BASIC INSPECTION

DIAGNOSIS AND REPAIR WORKFLOW

Work Flow

INFOID:000000000961084

OVERALL SEQUENCE

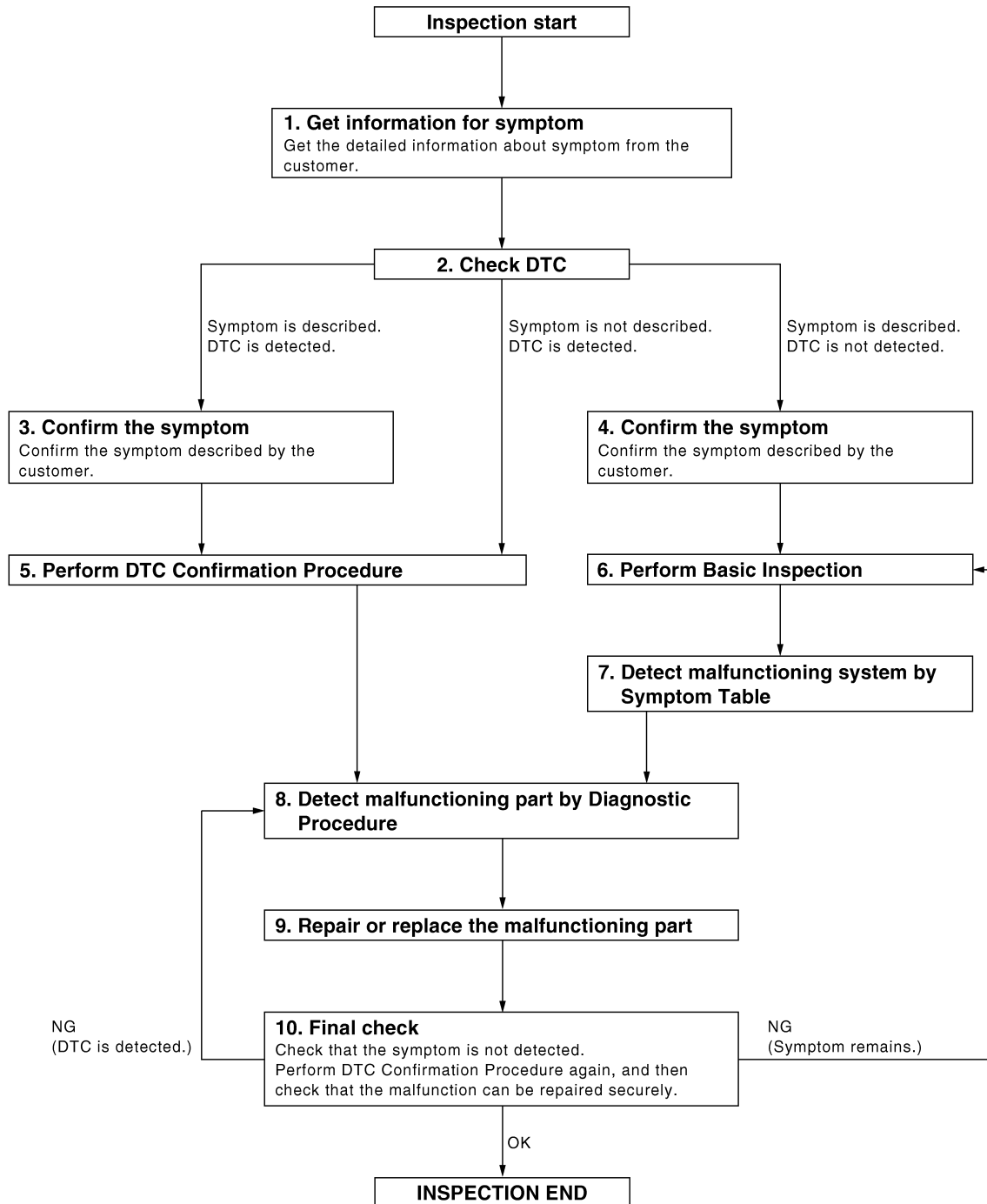

DETAILED FLOW

JMKIA0101GB

DIAGNOSIS AND REPAIR WORKFLOW

< BASIC INSPECTION >

[INTELLIGENT KEY SYSTEM]

1.GET INFORMATION FOR SYMPTOM

Get the detailed information from the customer about the symptom (the condition and the environment when the incident/malfunction occurred).

>> GO TO 2.

2.CHECK DTC

1. Check DTC.
2. Perform the following procedure if DTC is displayed.
 - Record DTC and freeze frame data (Print them out with CONSULT-III.)
 - Erase DTC.
 - Study the relationship between the cause detected by DTC and the symptom described by the customer.
3. Check related service bulletins for information.

Is any symptom described and any DTC detected?

Symptom is described, DTC is displayed>>GO TO 3.

Symptom is described, DTC is not displayed>>GO TO 4.

Symptom is not described, DTC is displayed>>GO TO 5.

3.CONFIRM THE SYMPTOM

Confirm the symptom described by the customer.

Connect CONSULT-III to the vehicle in "DATA MONITOR" mode and check real time diagnosis results.

Verify relation between the symptom and the condition when the symptom is detected.

>> GO TO 5.

4.CONFIRM THE SYMPTOM

Confirm the symptom described by the customer.

Connect CONSULT-III to the vehicle in "DATA MONITOR " mode and check real time diagnosis results.

Verify relation between the symptom and the condition when the symptom is detected.

>> GO TO 6.

5.PERFORM DTC CONFIRMATION PROCEDURE

Perform DTC Confirmation Procedure for the displayed DTC, and then check that DTC is detected again.

At this time, always connect CONSULT-III to the vehicle, and check diagnostic results in real time.

If two or more DTCs are detected, refer to [DLK-163. "DTC Inspection Priority Chart"](#) and determine trouble diagnosis order.

NOTE:

- Freeze frame data is useful if the DTC is not detected.
- Perform Component Function Check if DTC Confirmation Procedure is not included in Service Manual. This simplified check procedure is an effective alternative though DTC cannot be detected during this check. If the result of Component Function Check is NG, it is the same as the detection of DTC by DTC Confirmation Procedure.

Is DTC detected?

YES >> GO TO 8.

NO >> Refer to [GI-39. "Intermittent Incident"](#).

6.PERFORM BASIC INSPECTION

Perform [DLK-188. "Basic Inspection"](#).

Inspection End>>GO TO 7.

7.DETECT MALFUNCTIONING SYSTEM BY SYMPTOM TABLE

Detect malfunctioning system according to [DLK-167. "Symptom Table"](#) based on the confirmed symptom in step 4, and determine the trouble diagnosis order based on possible causes and symptom.

>> GO TO 8.

A
B
C
D
E
F
G
H
I
J

DLK

L
M
N
O
P

DIAGNOSIS AND REPAIR WORKFLOW

< BASIC INSPECTION >

[INTELLIGENT KEY SYSTEM]

8. DETECT MALFUNCTIONING PART BY DIAGNOSTIC PROCEDURE

Inspect according to Diagnostic Procedure of the system.

NOTE:

The Diagnostic Procedure described based on open circuit inspection. A short circuit inspection is also required for the circuit check in the Diagnostic Procedure.

Is malfunctioning part detected?

YES >> GO TO 9.

NO >> Check voltage of related BCM terminals using CONSULT-III.

9. REPAIR OR REPLACE THE MALFUNCTIONING PART

1. Repair or replace the malfunctioning part.
2. Reconnect parts or connectors disconnected during Diagnostic Procedure again after repair and replacement.
3. Check DTC. If DTC is displayed, erase it.

>> GO TO 10.

10. FINAL CHECK

When DTC was detected in step 2, perform DTC Confirmation Procedure or Component Function Check again, and then check that the malfunction have been repaired securely.

When symptom was described from the customer, refer to confirmed symptom in step 3 or 4, and check that the symptom is not detected.

Does the symptom reappear?

YES (DTC is detected)>>GO TO 8.

YES (Symptom remains)>>GO TO 6.

NO >> **INSPECTION END**

INSPECTION AND ADJUSTMENT

< BASIC INSPECTION >

[INTELLIGENT KEY SYSTEM]

INSPECTION AND ADJUSTMENT

ADDITIONAL SERVICE WHEN REPLACING CONTROL UNIT

A

ADDITIONAL SERVICE WHEN REPLACING CONTROL UNIT : Description

INFOID:000000000961085

B

Perform the system initialization when replacing BCM, replacing Intelligent Key or registering an additional Intelligent Key.

C

ADDITIONAL SERVICE WHEN REPLACING CONTROL UNIT : Special Repair Requirement

INFOID:000000000961086

D

Refer to the CONSULT-III operation manual for the initialization procedure.

E

F

G

H

I

J

DLK

L

M

N

O

P

FUNCTION DIAGNOSIS

DOOR LOCK FUNCTION

DOOR LOCK AND UNLOCK SWITCH

DOOR LOCK AND UNLOCK SWITCH : System Diagram

INFOID:000000000961087

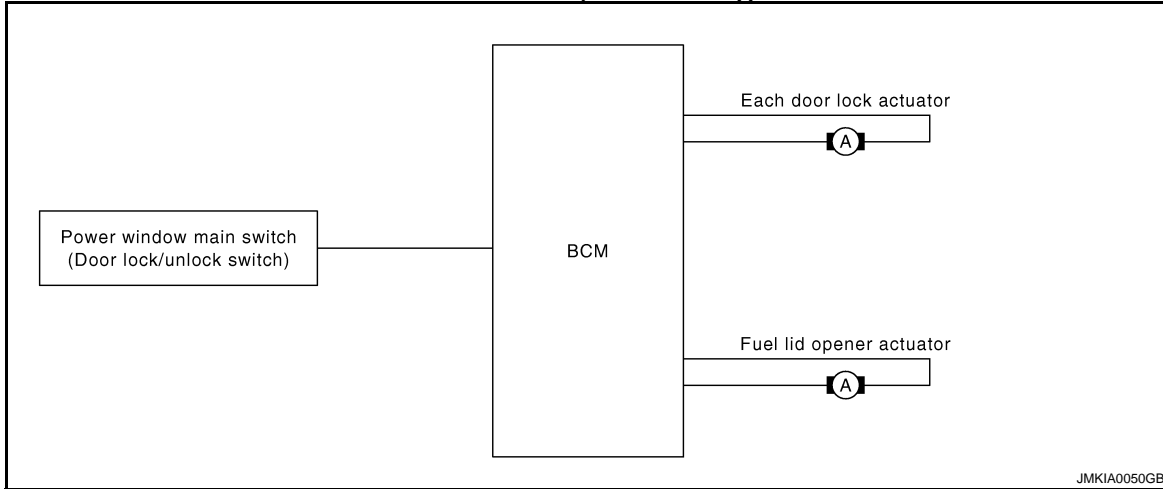

JMKIA0050GB

DOOR LOCK AND UNLOCK SWITCH : System Description

INFOID:000000000961088

Switch	Input/output signal to BCM	BCM function	Actuator
Door lock and unlock switch (Driver side)	Door lock/unlock signal	Door lock /unlock control	Door lock actuator
Door lock and unlock switch (Passenger side)			
Door key cylinder switch			

DOOR LOCK FUNCTION

Functions Available by Operating the Door Lock and Unlock Switches on Driver Door and Passenger Door

- Interlocked with the locking operation of door lock and unlock switch, door lock actuators of all doors and fuel lid lock actuator are locked.
- Interlocked with the unlocking operation of door lock and unlock switch, door lock actuators of all doors and fuel lid lock actuator are unlocked.

Functions Available by Operating the Key Cylinder Switch on Driver Door

- Interlocked with the locking operation of door key cylinder, door lock actuators of all doors and fuel lid lock actuator are locked.

Selective Unlock Operation

- When door key cylinder is unlocked, door lock actuator driver side and fuel lid lock actuator are unlocked.
- When door key cylinder is unlocked for the second time within 5 seconds after the first operation, door lock actuators on all doors are unlocked.

Select unlock operation mode can be changed using "DOOR LOCK-UNLOCK SET" mode in "WORK SUPPORT". Refer to [DLK-50, "DOOR LOCK : CONSULT-III Function \(BCM - DOOR LOCK\)"](#).

Key Reminder System

Refer to [DLK-45, "System Description"](#).

DOOR LOCK AND UNLOCK SWITCH : Component Parts Location

INFOID:000000000961089

DOOR LOCK FUNCTION

< FUNCTION DIAGNOSIS >

[INTELLIGENT KEY SYSTEM]

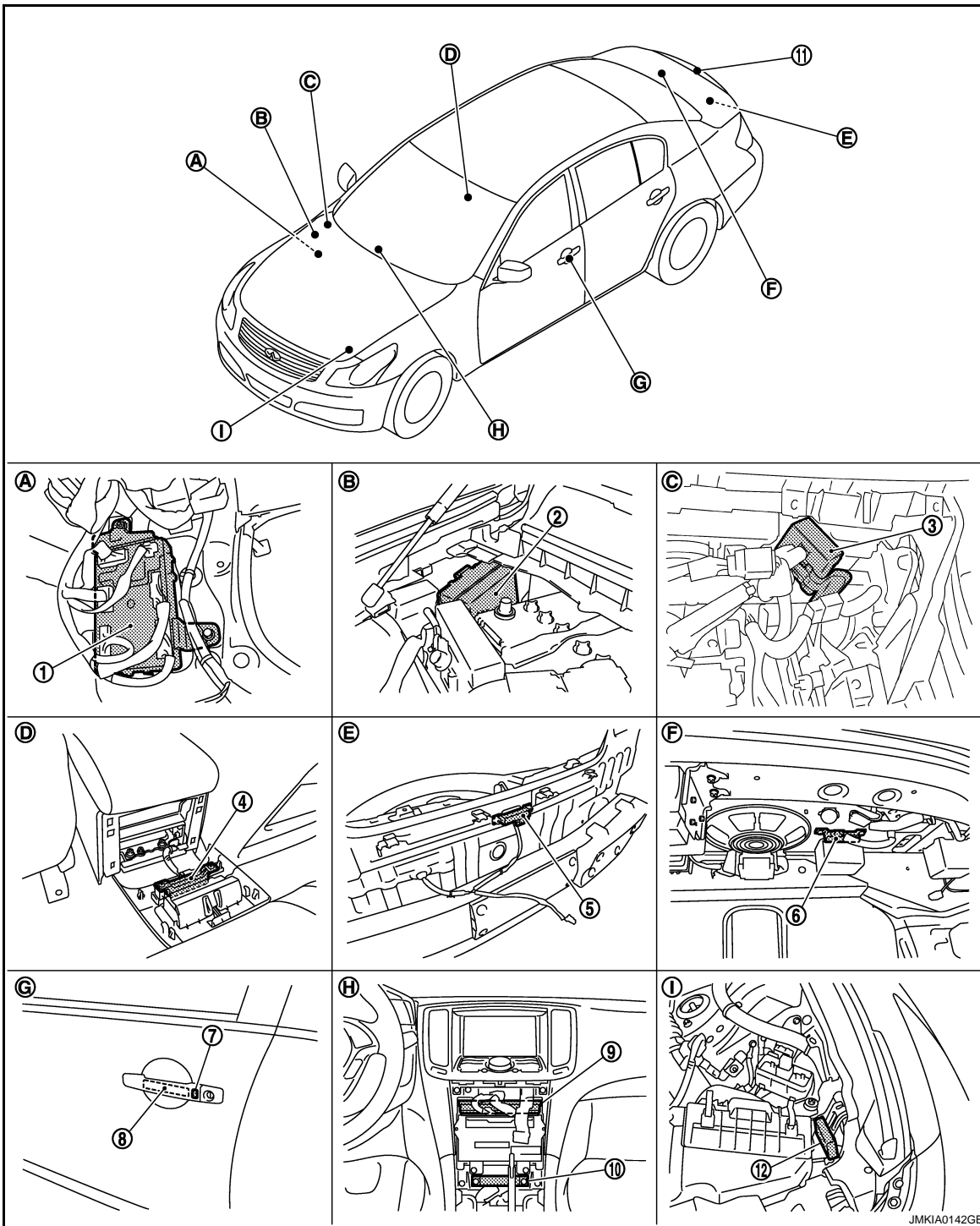

A
B
C
D
E
F
G
H
I
J
K
L
M
N
O
P

DLK

- | | | |
|--|---|---|
| 1. BCM
M118,M119,M120,M121,M122,M123 | 2. IPDM E/R E5,E6 | 3. Remote keyless entry receiver
M104 |
| 4. Inside key antenna (console) M146 | 5. Outside key antenna (rear bumper)
B63 | 6. Inside key antenna (trunk room)
B49 |
| 7. Front outside handle LH (request switch)
D13 | 8. Front outside handle LH (outside key
antenna) D14 | 9. Unified meter and A/C AMP
M66,M67 |
| 10. Inside key antenna (instrument center)
M131 | 11. Trunk lid request switch B304 | 12. Intelligent Key warning buzzer (en-
gine room) E57 |
| A. Dash side lower (Passenger side). | B. Engine room dash panel (RH). | C. View with instrument assist lower
panel removed. |

DOOR LOCK FUNCTION

< FUNCTION DIAGNOSIS >

[INTELLIGENT KEY SYSTEM]

- D. View with console rear finisher removed. E. View with rear bumper removed. F. View with trunk rear finisher (upper) removed.
- G. View of front door LH. H. Behind cluster lid C. I. View with hood seal assembly removed.

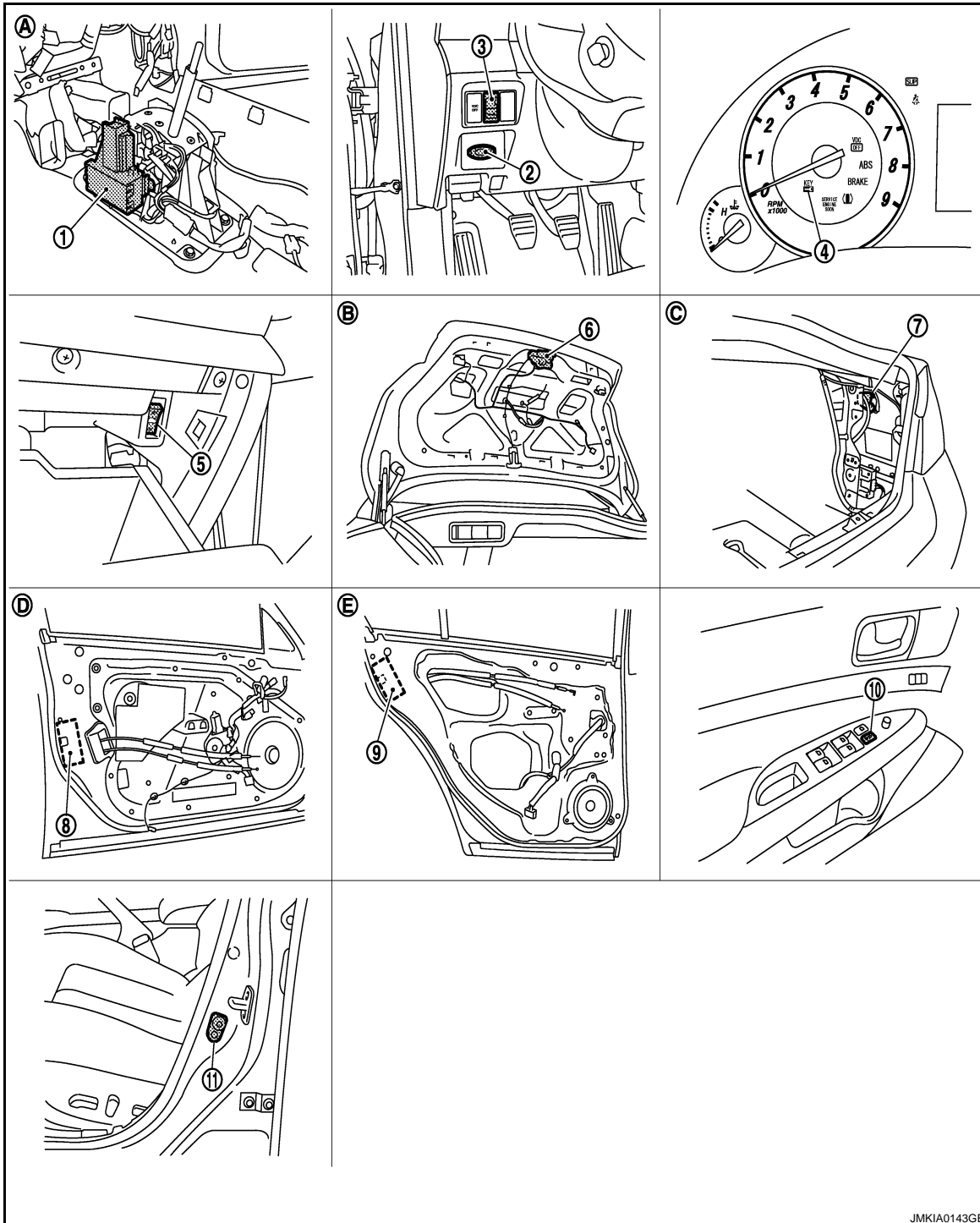

JMKIA0143GB

- | | | |
|--|---|---|
| 1. A/T device (detention switch) | 2. Key slot M22 | 3. Trunk lid opener switch M20 |
| 4. Combination meter (Key warning lamp) M53 | 5. Trunk opener cancel switch M105 | 6. Trunk lid lock assembly (trunk lid opener actuator) B303 |
| 7. Fuel lid opener actuator B242 | 8. Front door lock assembly (driver side) D15 | 9. Rear door lock assembly D55 |
| 10. Power window main switch (door lock unlock switch) D8,D9 | 11. Front door switch B16 | |

DOOR LOCK FUNCTION

[INTELLIGENT KEY SYSTEM]

< FUNCTION DIAGNOSIS >

- A. View with center console assembly removed.
- B. View with trunk lid finisher removed.
- C. View with trunk side finisher removed.
- D. View with front door finisher removed.
- E. View with rear door finisher removed.

DOOR LOCK AND UNLOCK SWITCH : Component Description

INFOID:000000000961090

Item	Function
BCM	Controls the door lock function and room lamp function.
Door lock and unlock switch	Transmits lock or unlock signal to BCM.
Door lock actuator	Receives lock/unlock signal from BCM and locks/unlocks each door.
Door switch	Transmits door open/close condition to BCM.

DOOR REQUEST SWITCH

DOOR REQUEST SWITCH : System Diagram

INFOID:000000000961091

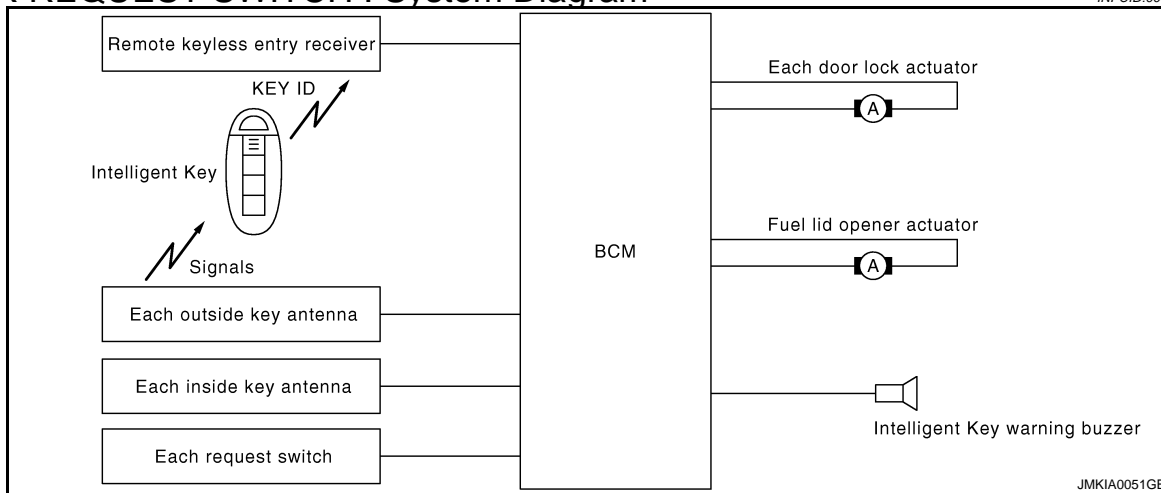

DOOR REQUEST SWITCH : System Description

INFOID:000000000961092

Only when pressing the request switch, it is possible to lock and unlock the door by carrying the Intelligent Key.

- The Intelligent Key system is a system that makes it possible to lock and unlock the door locks (door lock/unlock function) by carrying the Intelligent Key, which operates based on the results of electronic ID verification using two-way communications between the Intelligent Key and the vehicle (BCM).

CAUTION:

The driver should always carry the Intelligent Key

- If an action that does not meet the operating conditions of the Intelligent Key system is taken, the buzzer goes off to inform the driver (Warning chime function).
- When a door lock is locked, unlocked or trunk open with request switch or remote controller button operation, the hazard lamps flash and the Intelligent Key warning buzzer or horn sounds (Hazard and buzzer/horn reminder function).
- The settings for each function can be changed with the CONSULT-III.
- If an Intelligent Key is lost, a new Intelligent Key can be registered. A maximum of 4 Intelligent Keys can be registered.
- It is possible to perform a diagnosis on the system and register an Intelligent Key with the CONSULT-III.

OPERATION DESCRIPTION/DOOR LOCK/UNLOCK

- When the BCM detects that each door request switch is pressed, it starts the outside key antenna and inside key antenna corresponding to the pressed door request switch and transmits the request signal to the Intelligent Key. And then, check that the Intelligent Key is near the door.
- If the Intelligent Key is within the outside key antenna detection area, it receives the request signal and transmits the key ID signal to the BCM via remote keyless entry receiver.
- BCM receives the key ID signal and compares it with the registered key ID.

A
B
C
D
E
F
G
H
I
J

DLK

L
M
N
O
P

DOOR LOCK FUNCTION

[INTELLIGENT KEY SYSTEM]

< FUNCTION DIAGNOSIS >

- BCM sends the door lock/unlock signal and sounds Intelligent Key buzzer warning (lock: 2 time, unlock: 1 times) at the same time as a reminder.

OPERATION CONDITION

If the following conditions are not satisfied, door lock/unlock operation is not performed even if the request switch is operated.

Each request switch operation	Operation condition
Lock operation	<ul style="list-style-type: none"> • All doors are closed • Ignition switch is in OFF position • Intelligent Key is out of key slot • Intelligent Key is outside the vehicle • Intelligent Key is within outside key antenna detection area
Unlock Operation	<ul style="list-style-type: none"> • Intelligent Key is outside the vehicle • Intelligent Key is within outside key antenna detection area *

*: Even with a registered Intelligent Key remaining inside the vehicle, door locks can be unlocked from outside of the vehicle with a spare Intelligent Key as long as key IDs are different.

OUTSIDE KEY ANTENNA DETECTION AREA

The outside key antenna detection area of door lock/unlock function is in the range of approximately 80 cm (31.50 in) surrounding the driver and passenger door handles (1).

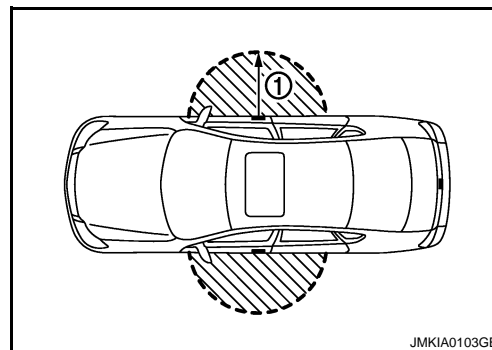

SELECTIVE UNLOCK FUNCTION

When an LOCK signal is sent from door request switch (driver side or passenger side), all doors will be locked. When an UNLOCK signal is sent from door request switch (driver side or passenger side) once, driver's door will be unlocked.

Then, if an UNLOCK signal is sent from door request switch (driver side and passenger side) again within 5 seconds, all other door will be unlocked.

HAZARD AND BUZZER REMINDER FUNCTION

During lock, unlock, or trunk opening operation by each request switch, the hazard warning lamps and Intelligent Key warning buzzer will blink or honk as a reminder.

When doors are locked, unlocked by each request switch, IPDM E/R honks Intelligent Key warning buzzer as a reminder and transmits hazard request signal to BCM via CAN communication line.

BCM flashes hazard warning lamps as a reminder.

Operating function of hazard and buzzer reminder

Operation	Hazard warning lamp flash	Intelligent Key warning buzzer honk
Unlock	Once	Once
Lock	Twice	Twice
Trunk open	—	Fourth times

How to change hazard and buzzer reminder mode

Refer to [DLK-51, "INTELLIGENT KEY : CONSULT-III Function \(BCM - INTELLIGENT KEY\)"](#).

AUTO DOOR LOCK FUNCTION

When all doors are locked, ignition switch is in OFF position and key switch is OFF (Intelligent Key is not inserted in key slot), doors are unlocked with door request switch

When BCM does not receive the following signals within 60 seconds, all doors are locked.

- Door switch is ON (door is opened)
- Door is locked
- Ignition switch is ON (ignition switch is pressed)
- Key switch is ON (Intelligent Key is inserted in key slot)

DOOR LOCK FUNCTION

[INTELLIGENT KEY SYSTEM]

< FUNCTION DIAGNOSIS >

Auto door lock mode can be changed by "AUTO LOCK SET" mode in "WORK SUPPORT". Refer to [DLK-51. "INTELLIGENT KEY : CONSULT-III Function \(BCM - INTELLIGENT KEY\)"](#).

ROOM LAMP OPERATION

When the following conditions are met:

- Condition of interior lamp switch is in DOOR position
- Door switch OFF (all the doors are closed)

Intelligent Key system turns on interior lamp (for 15 seconds) by receiving UNLOCK signal from door request switch. For detailed description, refer to [INL-9. "System Description"](#).

LIST OF OPERATION RELATED PARTS

Parts marked with × are the parts related to operation.

Door lock function	Intelligent Key	Key slot	Remote keyless entry receiver	Door switch	Door request switch (Driver, Passenger)	Door lock actuator	Inside key antenna	Outside key antenna (Driver, Passenger)	Intelligent Key warning buzzer	CAN communication system	BCM	Hazard warning lamp	Push-button ignition switch
Door lock/unlock function by request switch	×	×	×	×	×	×	×	×		×	×		
Hazard and buzzer reminder function for door lock/unlock operation									×	×	×	×	
Key reminder function	×	×	×	×	×	×	×	×	×	×	×	×	
Selective unlock function by request switch (Driver side)	×				×	×	×	×		×	×		
Selective unlock function by request switch (Passenger side)	×				×	×	×	×		×	×		
Auto door lock function	×	×		×	×	×				×	×		×

A
B
C
D
E
F
G
H
I
J
L
M
N
O
P

DLK

DOOR REQUEST SWITCH : Component Parts Location

INFOID:000000000961093

DOOR LOCK FUNCTION

< FUNCTION DIAGNOSIS >

[INTELLIGENT KEY SYSTEM]

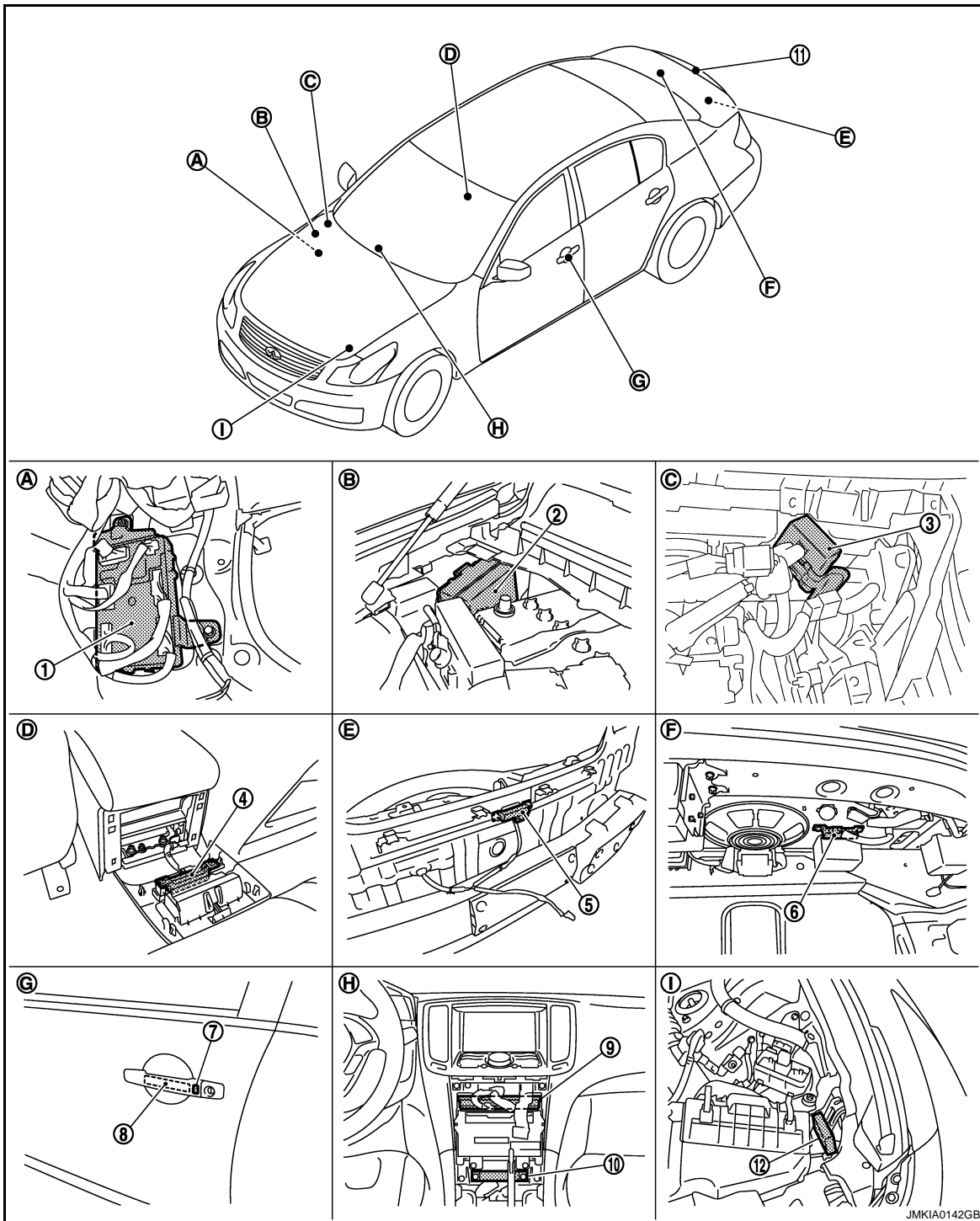

JMKIA0142GB

- | | | |
|--|---|---|
| 1. BCM
M118,M119,M120,M121,M122,M123 | 2. IPDM E/R E5,E6 | 3. Remote keyless entry receiver
M104 |
| 4. Inside key antenna (console) M146 | 5. Outside key antenna (rear bumper)
B63 | 6. Inside key antenna (trunk room)
B49 |
| 7. Front outside handle LH (request switch)
D13 | 8. Front outside handle LH (outside key
antenna) D14 | 9. Unified meter and A/C AMP
M66,M67 |
| 10. Inside key antenna (instrument center)
M131 | 11. Trunk lid request switch B304 | 12. Intelligent Key warning buzzer (en-
gine room) E57 |
| A. Dash side lower (Passenger side). | B. Engine room dash panel (RH). | C. View with instrument assist lower
panel removed. |

DOOR LOCK FUNCTION

< FUNCTION DIAGNOSIS >

[INTELLIGENT KEY SYSTEM]

- D. View with console rear finisher removed. E. View with rear bumper removed. F. View with trunk rear finisher (upper) removed.
- G. View of front door LH. H. Behind cluster lid C. I. View with hood seal assembly removed.

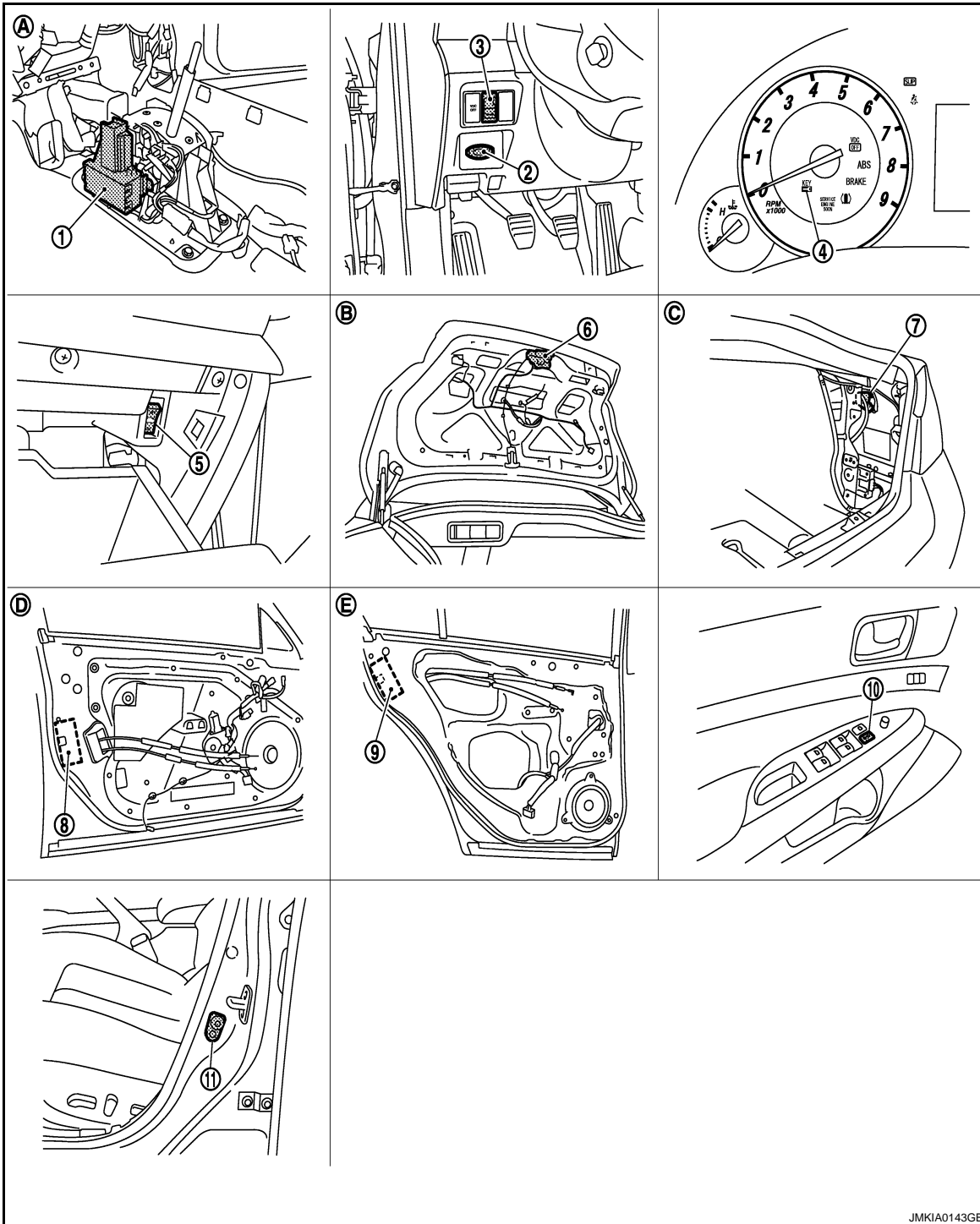

- | | | |
|--|---|---|
| 1. A/T device (detention switch) | 2. Key slot M22 | 3. Trunk lid opener switch M20 |
| 4. Combination meter (Key warning lamp) M53 | 5. Trunk opener cancel switch M105 | 6. Trunk lid lock assembly (trunk lid opener actuator) B303 |
| 7. Fuel lid opener actuator B242 | 8. Front door lock assembly (driver side) D15 | 9. Rear door lock assembly D55 |
| 10. Power window main switch (door lock unlock switch) D8,D9 | 11. Front door switch B16 | |

A
B
C
D
E
F
G
H
I
J
K
L
M
N
O
P

DLK

DOOR LOCK FUNCTION

[INTELLIGENT KEY SYSTEM]

< FUNCTION DIAGNOSIS >

- | | | |
|---|--|---|
| A. View with center console assembly removed. | B. View with trunk lid finisher removed. | C. View with trunk side finisher removed. |
| D. View with front door finisher removed. | E. View with rear door finisher removed. | |

DOOR REQUEST SWITCH : Component Description

INFOID:000000000961094

Item	Function
BCM	Controls the door lock function and room lamp function.
Door lock and unlock switch	Transmits lock or unlock signal to BCM.
Door lock actuator	Receives lock/unlock signal from BCM and locks/unlocks each door.
Door switch	Transmits door open/close condition to BCM.
Remote keyless entry receiver	Receives lock/unlock signal from the Intelligent Key, and then transmits to BCM.
Request switch	Transmits lock/unlock operation to BCM.
Intelligent Key	Transmits button operation to remote keyless entry receiver.
Outside key antenna	Detects if Intelligent Key is outside the vehicle.
Inside key antenna	Detects if Intelligent Key is inside the vehicle.
Fuel lid opener actuator	Performs lock/unlock of the fuel lid.
Intelligent Key warning buzzer	Warns the user of the lock/unlock condition and inappropriate operations with the buzzer sound.

INTELLIGENT KEY

INTELLIGENT KEY : System Diagram

INFOID:000000000961095

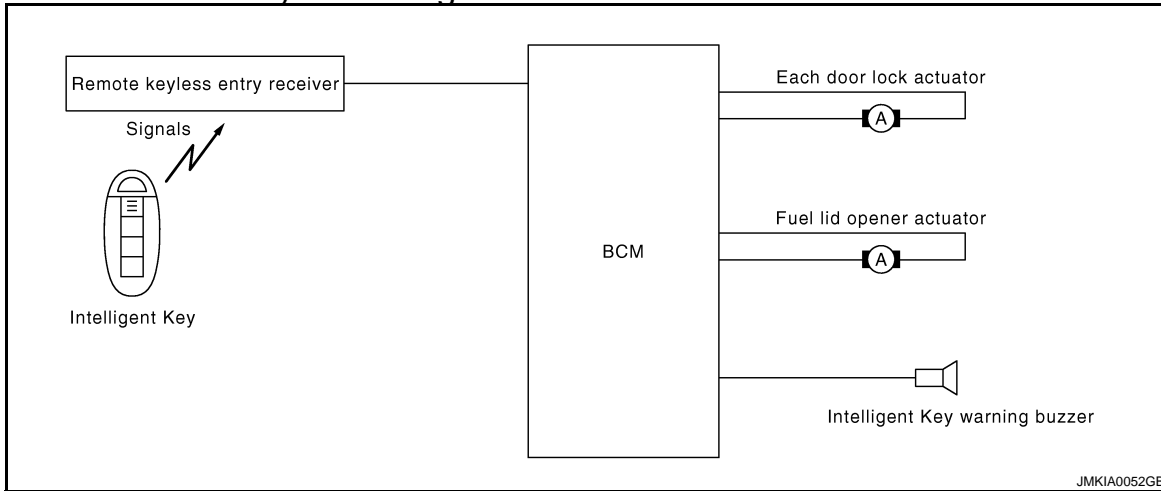

INTELLIGENT KEY : System Description

INFOID:000000000961096

The Intelligent Key has the same functions as the remote control entry system. Therefore, it can be used in the same manner as the remote controller by operating the door lock/unlock button.

OPERATION DESCRIPTION/DOOR LOCK/UNLOCK FUNCTION

- When door lock/unlock button of the Intelligent Key is pressed, lock signal or unlock signal is transmits from Intelligent Key to BCM via remote keyless entry receiver.
- When BCM receives the door lock/unlock signal, it operates door lock actuator, flashes the hazard lamp (lock: 2 time, unlock: 1 times) and horn chirp signal to IPDM E/R at the same time as a reminder.
- IPDM E/R honks horn (lock: 2 time) as a reminder

OPERATION CONDITION

Remote controller operation	Operation condition	Operation
Lock	<ul style="list-style-type: none"> • All doors closed 	All doors lock
Unlock	<ul style="list-style-type: none"> • Intelligent Key is out of key slot 	All doors unlock

DOOR LOCK FUNCTION

< FUNCTION DIAGNOSIS >

[INTELLIGENT KEY SYSTEM]

OPERATION AREA

- Operating Range
- To ensure the Intelligent Key works effectively, use within 80 cm range of each doors, however the operable range may differ according to surroundings.

SELECTIVE UNLOCK FUNCTION

When an LOCK signal is transmitted from Intelligent Key, all doors will be locked.

When an UNLOCK signal is transmitted from Intelligent Key once, driver's door will be unlocked.

Then, if an UNLOCK signal is transmitted from Intelligent Key again within 5 seconds, all other door will be unlocked.

HAZARD AND HORN REMINDER FUNCTION

When doors are locked or unlocked by Intelligent Key, BCM flashes hazard warning lamps as a reminder and sends horn chirp signal to IPDM E/R. IPDM E/R sounds horn as a reminder.

The hazard and horn reminder has a horn chirp mode (C mode) and a non-horn chirp mode (S mode).

Operating function of hazard and horn reminder

	C mode			S mode		
	Lock	Unlock	Trunk open	Lock	Unlock	Trunk open
Intelligent Key operation	Lock	Unlock	Trunk open	Lock	Unlock	Trunk open
Hazard warning lamp flash	Twice	Once	—	Twice	—	—
Horn sound	Once	—	—	—	—	—

Hazard and horn reminder does not operate if any door switch is ON (any door is OPEN).

How to change hazard and horn reminder mode

④ With CONSULT-III

Refer to [DLK-51. "INTELLIGENT KEY : CONSULT-III Function \(BCM - INTELLIGENT KEY\)".](#)

⊗ Without CONSULT-III

When LOCK and UNLOCK signals are sent from the Intelligent Key for more than 2 seconds at the same time, the hazard and horn reminder mode is changed and hazard warning lamp flashes and horn sounds as follows:

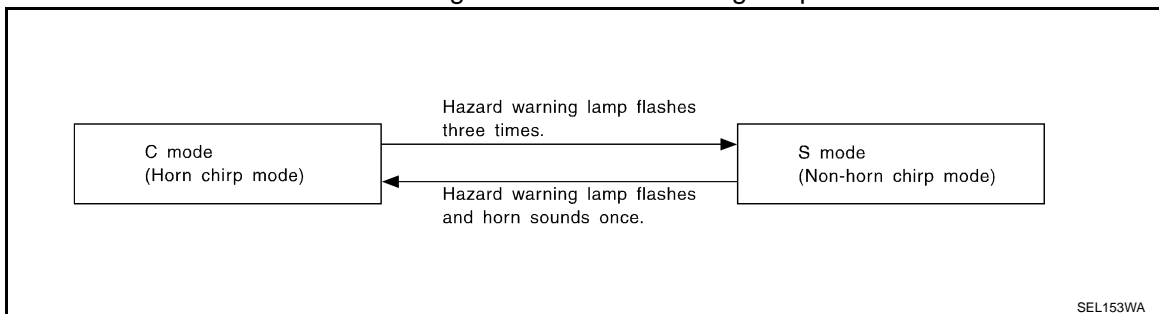

AUTO DOOR LOCK FUNCTION

Auto Door Lock Function

When all doors are locked, ignition switch is OFF (ignition switch is not pressed) and key switch is OFF (Intelligent Key is not inserted in key slot), doors are unlocked with Intelligent Key button. When BCM does not receive the following signals within 30 seconds, all doors are locked.

- Door switch is ON (door is opened)
- Door is locked
- Ignition switch is ON
- Key switch is ON (Intelligent Key is inserted in key slot)

Auto door lock mode can be changed by "AUTO LOCK SET" mode in "WORK SUPPORT". Refer to [DLK-51. "INTELLIGENT KEY : CONSULT-III Function \(BCM - INTELLIGENT KEY\)".](#)

PANIC ALARM FUNCTION

When ignition switch is OFF (ignition switch is not pressed) and key switch is OFF (Intelligent Key is not inserted in key slot), BCM receives PANIC ALARM signal from Intelligent Key.

BCM turns on and off headlamp intermittently and transmits theft warning horn signal to IPDM E/R. Then, IPDM E/R turns on and off horn intermittently.

The headlamp flashes and the horn sounds intermittently.

The alarm automatically turns off:

- After 25 seconds
- When BCM receives any signal from Intelligent Key

DOOR LOCK FUNCTION

< FUNCTION DIAGNOSIS >

[INTELLIGENT KEY SYSTEM]

Panic alarm function mode can be changed by “PANIC ALARM SET” mode in “WORK SUPPORT”. Refer to [DLK-51, "INTELLIGENT KEY : CONSULT-III Function \(BCM - INTELLIGENT KEY\)"](#).

KEYLESS POWER WINDOW DOWN (OPEN) FUNCTION

All power windows open when the unlock button on Intelligent Key is activated and kept pressed for more than 3 seconds with the ignition switch OFF. The windows keep opening if the unlock button is continuously pressed.

The power window opening stops when the following operations are performed:

- When the unlock button is kept pressed more than 15 seconds.
- When the ignition switch is turned ON while the power window opening is operated.
- When the unlock button is released.

While retained power operation activate, Keyless power window down (open) function cannot be operated. Keyless power window down operation mode can be changed by “PW DOWN SET” mode in “WORK SUPPORT”. Refer to [DLK-51, "INTELLIGENT KEY : CONSULT-III Function \(BCM - INTELLIGENT KEY\)"](#).

ROOM LAMP ILLUMINATION OPERATION

When the following conditions are met:

- Condition of interior lamp switch is in DOOR position
- Door switch OFF (all the doors are closed)

Intelligent Key system turns on interior lamp (for 15 seconds) by receiving UNLOCK signal from Intelligent Key. For detailed description, refer to [INL-9, "System Description"](#).

LIST OF OPERATION RELATED PARTS

Parts marked with × are the parts related to operation.

Remote keyless entry functions	Intelligent Key	Key slot	Door request switch (Driver, Passenger)	Door switch	Door lock actuator	Intelligent Key warning buzzer	CAN communication system	BCM	Combination meter	Hazard warning lamp	Horn	IPDM E/R	Head lamp
Door lock/unlock function by remote control button	×	×		×	×		×	×					
Hazard and horn reminder function	×					×	×	×	×	×	×	×	
Selective unlock function	×			×	×		×	×					
Keyless power window down (open) function	×	×					×	×					
Auto door lock function	×	×		×			×	×					
Panic alarm function	×		×				×	×			×	×	×

INTELLIGENT KEY : Component Parts Location

INFOID:000000000961097

DOOR LOCK FUNCTION

< FUNCTION DIAGNOSIS >

[INTELLIGENT KEY SYSTEM]

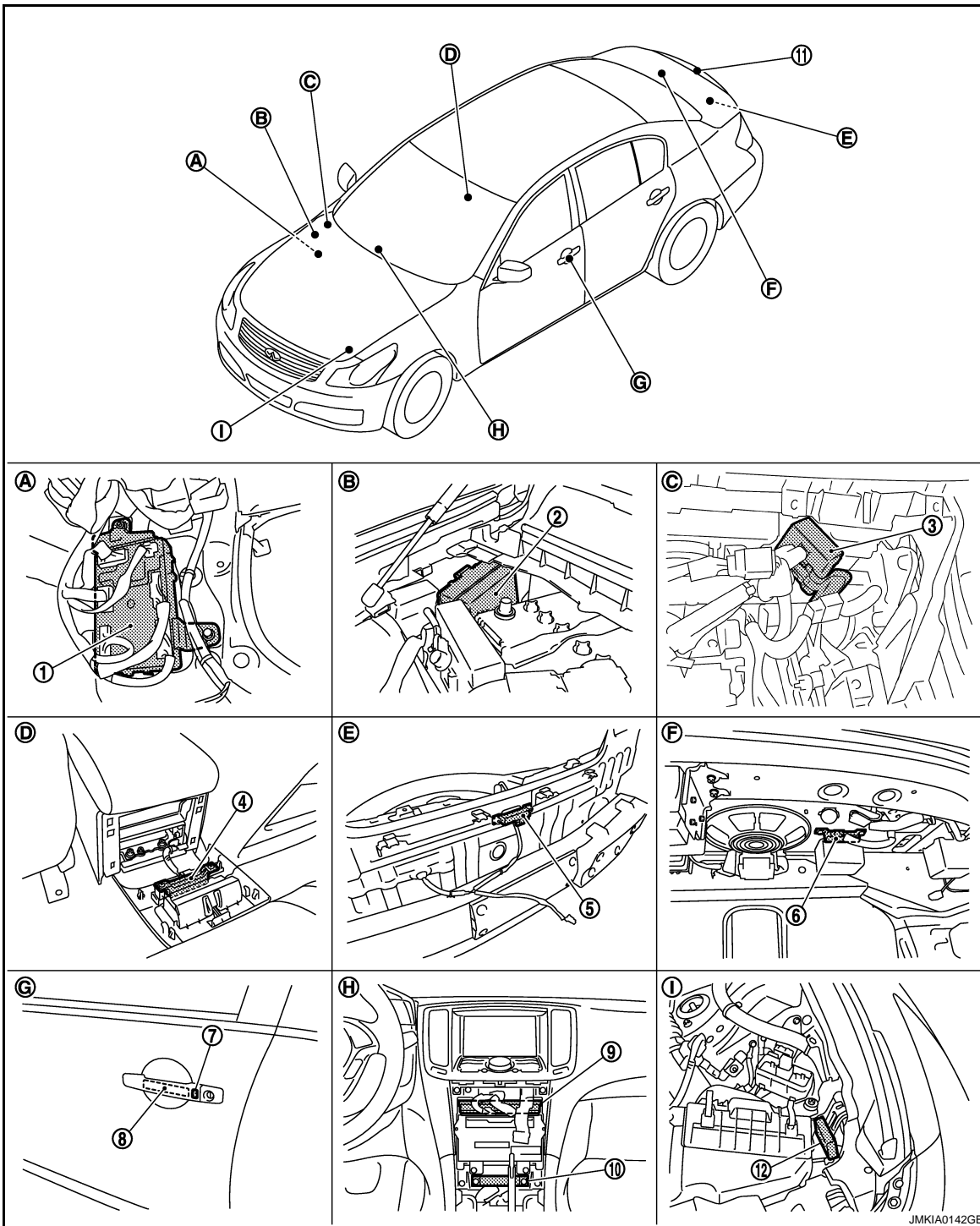

A
B
C
D
E
F
G
H
I
J
DLK

L
M
N

O
P

- | | | |
|--|---|---|
| 1. BCM
M118,M119,M120,M121,M122,M123 | 2. IPDM E/R E5,E6 | 3. Remote keyless entry receiver
M104 |
| 4. Inside key antenna (console) M146 | 5. Outside key antenna (rear bumper)
B63 | 6. Inside key antenna (trunk room)
B49 |
| 7. Front outside handle LH (request switch)
D13 | 8. Front outside handle LH (outside key
antenna) D14 | 9. Unified meter and A/C AMP
M66,M67 |
| 10. Inside key antenna (instrument center)
M131 | 11. Trunk lid request switch B304 | 12. Intelligent Key warning buzzer (en-
gine room) E57 |
| A. Dash side lower (Passenger side). | B. Engine room dash panel (RH). | C. View with instrument assist lower
panel removed. |

DOOR LOCK FUNCTION

< FUNCTION DIAGNOSIS >

[INTELLIGENT KEY SYSTEM]

- D. View with console rear finisher removed. E. View with rear bumper removed. F. View with trunk rear finisher (upper) removed.
- G. View of front door LH. H. Behind cluster lid C. I. View with hood seal assembly removed.

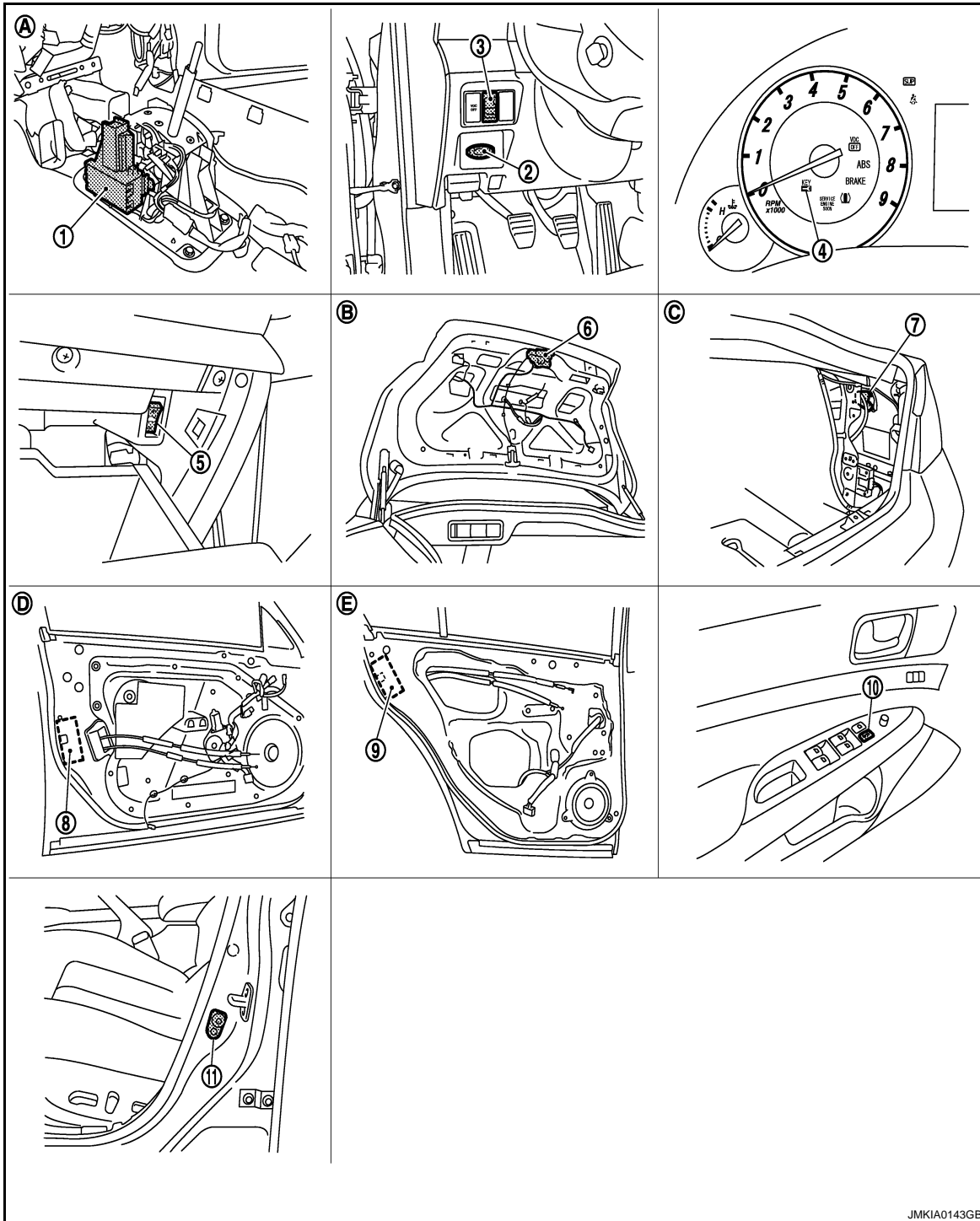

JMKIA0143GB

- | | | |
|--|---|---|
| 1. A/T device (detention switch) | 2. Key slot M22 | 3. Trunk lid opener switch M20 |
| 4. Combination meter (Key warning lamp) M53 | 5. Trunk opener cancel switch M105 | 6. Trunk lid lock assembly (trunk lid opener actuator) B303 |
| 7. Fuel lid opener actuator B242 | 8. Front door lock assembly (driver side) D15 | 9. Rear door lock assembly D55 |
| 10. Power window main switch (door lock unlock switch) D8,D9 | 11. Front door switch B16 | |

DOOR LOCK FUNCTION

< FUNCTION DIAGNOSIS >

[INTELLIGENT KEY SYSTEM]

- A. View with center console assembly removed. B. View with trunk lid finisher removed. C. View with trunk side finisher removed.
D. View with front door finisher removed. E. View with rear door finisher removed.

INTELLIGENT KEY : Component Description

INFOID:0000000000961098

Item	Function
BCM	Controls the door lock function and room lamp function.
Door lock actuator	Receives lock/unlock signal from BCM and locks/unlocks each door.
Remote keyless entry receiver	Receives lock/unlock signal from the Intelligent Key, and then transmits to BCM.
Intelligent Key	Transmits button operation to remote keyless entry receiver.
Fuel lid opener actuator	Performs lock/unlock of the fuel lid.
Intelligent key warning buzzer	Warns the user of the lock/unlock condition and inappropriate operations with the buzzer sound.

A
B
C
D
E
F
G
H
I
J
L
M
N
O
P

DLK

TRUNK OPEN FUNCTION

[INTELLIGENT KEY SYSTEM]

< FUNCTION DIAGNOSIS >

TRUNK OPEN FUNCTION TRUNK LID OPENER SWITCH

TRUNK LID OPENER SWITCH : System Diagram

INFOID:000000000961099

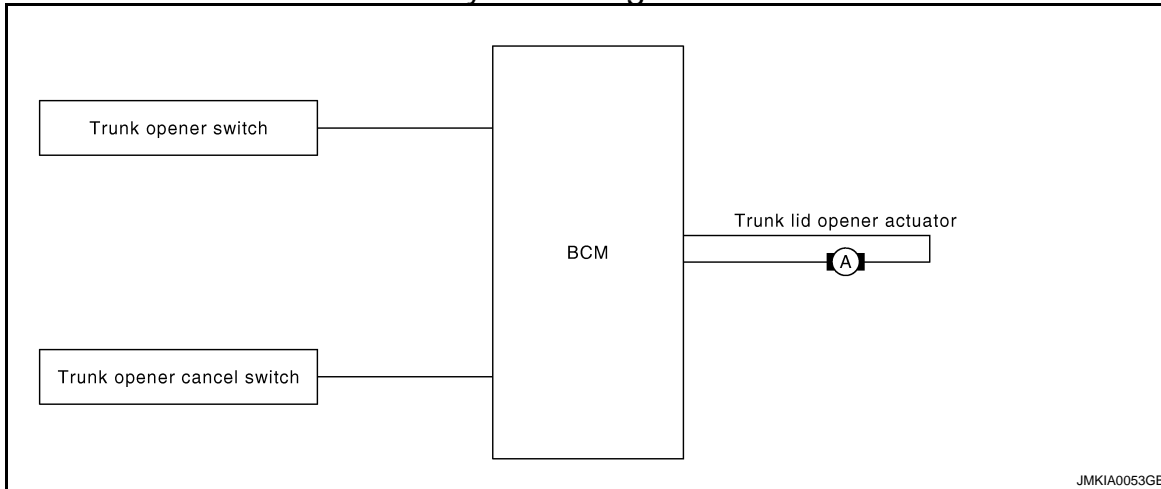

JMKIA0053GB

TRUNK LID OPENER SWITCH : System Description

INFOID:000000000961100

Switch	Input/output signal to BCM	BCM function	Actuator
Trunk lid opener switch	Trunk open signal	Trunk open control	Trunk lid opener actuator
Trunk lid opener cancel switch			
Door key cylinder switch			

TRUNK LID OPENER OPERATION

When trunk lid opener switch is ON, BCM opens trunk opener actuator.

BCM can open trunk lid opener actuator when

- vehicle speed is less than 5 km/h (3MPH)
- vehicle security system is disarmed or pre-armed phase

BCM does not open trunk lid opener actuator when

- trunk lid opener cancel switch is OFF (CANCEL)
- vehicle speed is more than 5 km/h (3MPH)
- vehicle security system is armed or alarm phase
- Intelligent Key is inserted in key slot

TRUNK LID OPENER SWITCH : Component Parts Location

INFOID:000000000961101

TRUNK OPEN FUNCTION

< FUNCTION DIAGNOSIS >

[INTELLIGENT KEY SYSTEM]

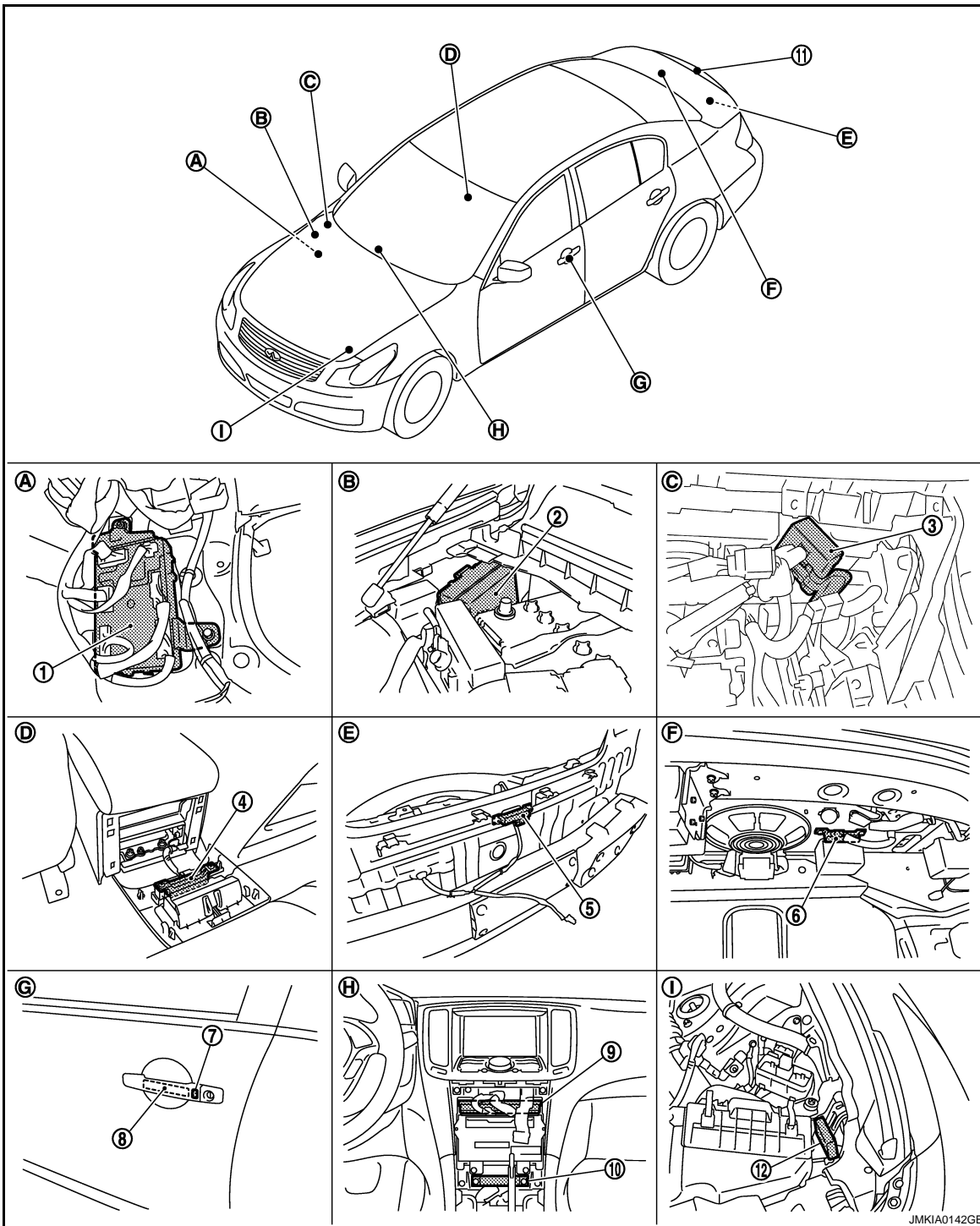

A
B
C
D
E
F
G
H
I
J
K
L
M
N
O
P

DLK

- | | | |
|--|---|---|
| 1. BCM
M118,M119,M120,M121,M122,M123 | 2. IPDM E/R E5,E6 | 3. Remote keyless entry receiver
M104 |
| 4. Inside key antenna (console) M146 | 5. Outside key antenna (rear bumper)
B63 | 6. Inside key antenna (trunk room)
B49 |
| 7. Front outside handle LH (request switch)
D13 | 8. Front outside handle LH (outside key
antenna) D14 | 9. Unified meter and A/C AMP
M66,M67 |
| 10. Inside key antenna (instrument center)
M131 | 11. Trunk lid request switch B304 | 12. Intelligent Key warning buzzer (en-
gine room) E57 |
| A. Dash side lower (Passenger side). | B. Engine room dash panel (RH). | C. View with instrument assist lower
panel removed. |

TRUNK OPEN FUNCTION

< FUNCTION DIAGNOSIS >

[INTELLIGENT KEY SYSTEM]

- D. View with console rear finisher removed. E. View with rear bumper removed. F. View with trunk rear finisher (upper) removed.
- G. View of front door LH. H. Behind cluster lid C. I. View with hood seal assembly removed.

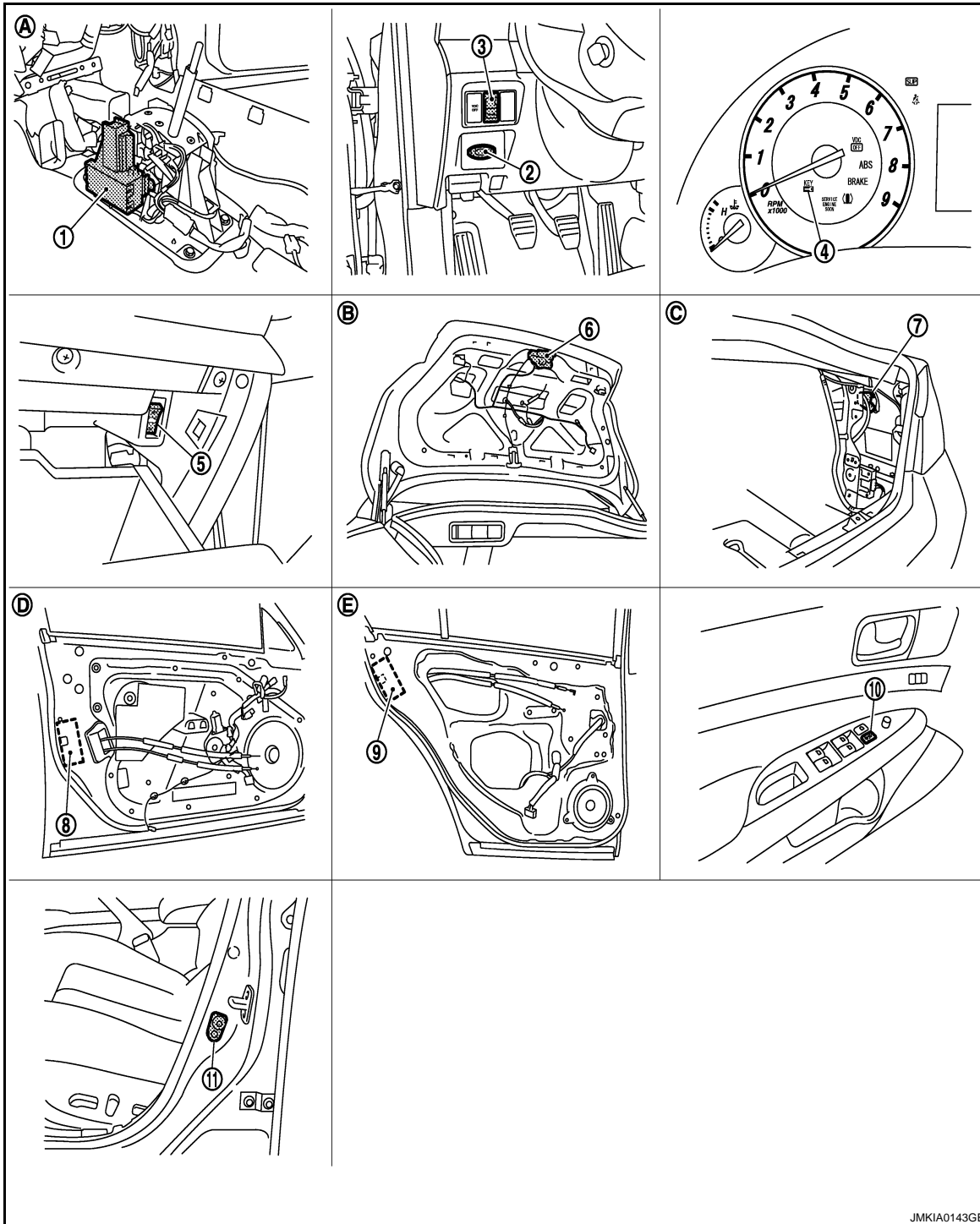

JMKIA0143GB

- | | | |
|--|---|---|
| 1. A/T device (detention switch) | 2. Key slot M22 | 3. Trunk lid opener switch M20 |
| 4. Combination meter (Key warning lamp) M53 | 5. Trunk opener cancel switch M105 | 6. Trunk lid lock assembly (trunk lid opener actuator) B303 |
| 7. Fuel lid opener actuator B242 | 8. Front door lock assembly (driver side) D15 | 9. Rear door lock assembly D55 |
| 10. Power window main switch (door lock unlock switch) D8,D9 | 11. Front door switch B16 | |

TRUNK OPEN FUNCTION

[INTELLIGENT KEY SYSTEM]

< FUNCTION DIAGNOSIS >

- A. View with center console assembly removed.
- B. View with trunk lid finisher removed.
- C. View with trunk side finisher removed.
- D. View with front door finisher removed.
- E. View with rear door finisher removed.

TRUNK LID OPENER SWITCH : Component Description

INFOID:000000000961102

Item	Function
BCM	Transmits trunk open operation to BCM.
Trunk lid opener switch	Transmits trunk open operation to BCM.
Trunk lid opener actuator	Opens the trunk with the open signal from BCM
Trunk lid opener cancel switch	Cancels the trunk open operation.

TRUNK REQUEST SWITCH

TRUNK REQUEST SWITCH : System Diagram

INFOID:000000000961103

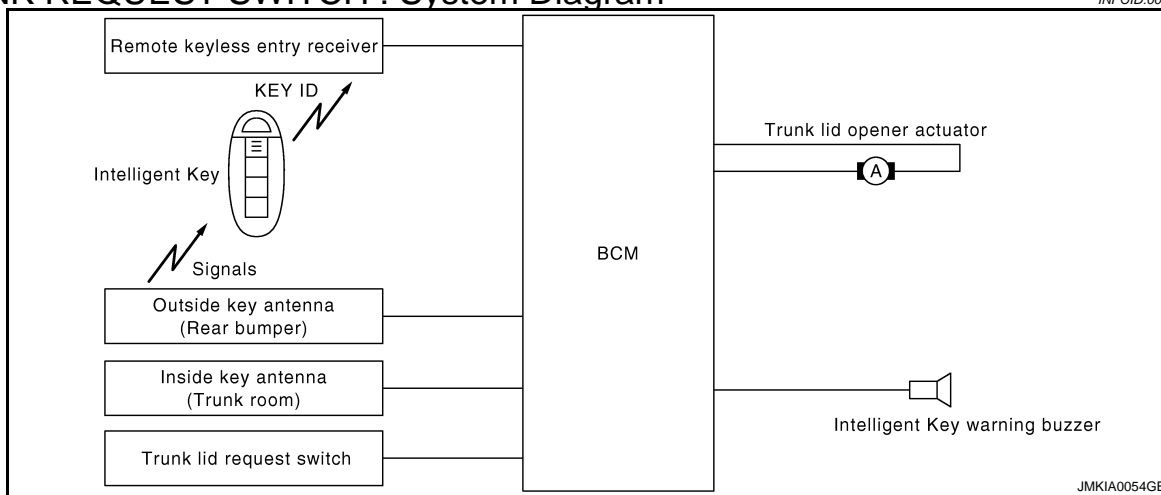

TRUNK REQUEST SWITCH : System Description

INFOID:000000000961104

Only when pressing the request switch, it is possible to open the trunk by carrying the Intelligent Key.

- The Intelligent Key system is a system that makes it possible to open the trunk (trunk open function) by carrying the Intelligent Key which operates based on the results of electronic ID verification using two-way communications between the Intelligent Key and the vehicle. (BCM)

CAUTION:

The driver should always carry the Intelligent Key

- If an action that does not meet the operating conditions of the Intelligent Key system is taken, the buzzer goes off to inform the driver. (Warning chime functions)
- When a trunk open with request switch or remote controller button operation, the hazard lamps flash and the Intelligent Key warning buzzer or horn sounds (Hazard and buzzer/horn reminder function).
- The settings for each function can be changed with the CONSULT-III.
- If an Intelligent Key is lost, a new Intelligent Key can be registered. A maximum of 4 Intelligent Keys can be registered.
- It is possible to perform a diagnosis on the system and register an Intelligent Key with the CONSULT-III.

OPERATION DESCRIPTION/TRUNK OPEN

- When the BCM detects that trunk open request switch is pressed, it starts the outside key antenna (trunk room) and inside key antenna corresponding to the pressed trunk open request switch and transmits the request signal to the Intelligent Key. And then, check that the Intelligent Key is near the trunk.
- If the Intelligent Key is within the outside key antenna (trunk room) detection area, it receives the request signal and transmits the key ID signal to the BCM via remote keyless entry receiver.
- BCM receives the key ID signal and compares it with the registered key ID.
- BCM transmits the trunk open request signal and sounds Intelligent Key warning buzzer 4 times at the same time.

A
B
C
D
E
F
G
H
I
J

DLK

L
M
N
O

P

TRUNK OPEN FUNCTION

[INTELLIGENT KEY SYSTEM]

< FUNCTION DIAGNOSIS >

- When BCM receives the trunk open request signal, it operates the trunk lid opener actuator and opens the trunk.

OPERATION CONDITION

If the following conditions are not satisfied, trunk open operation is not performed even if the request switch is operated.

Each request switch operation	Operation condition
Trunk open operation	<ul style="list-style-type: none"> • Intelligent Key is within outside key antenna (trunk room) detection area* • Trunk cancel switch is ON • Key reminder functions operate (trunk)

*: Even with a registered Intelligent Key remaining inside the vehicle, door locks can be unlocked from outside of the vehicle with a spare Intelligent Key as long as key IDs are different.

OUTSIDE KEY ANTENNA DETECTION AREA

The outside key antenna detection area of trunk open function is in the range of approximately 80 cm (31.50 in) surrounding Trunk opener request switch (1). However, this operating range depends on the ambient conditions.

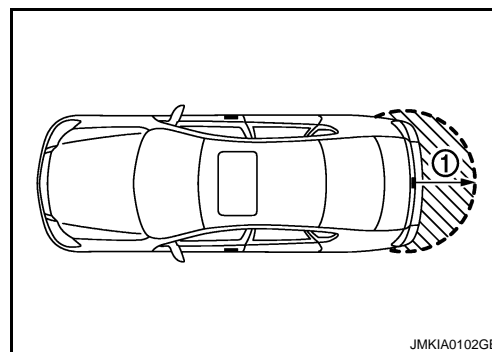

KEY REMINDER FUNCTION

Key remainder function	Operation condition	Operation
Trunk is closed	Right after trunk is closed under the following conditions <ul style="list-style-type: none"> • Intelligent Key is inside trunk room • All doors are closed • All doors are locked 	<ul style="list-style-type: none"> • Trunk open • Honk Intelligent Key warning buzzer

*:If the door closing impact shocks the door lock knob, or contacts against baggage with the door lock knob might activate the door locks accidentally but unlock operation will be perform at these cases.

CAUTION:

- **The above function operates when the Intelligent Key is inside the vehicle. However, there may be times when the Intelligent Key cannot be detected, and this function will not operate when the Intelligent Key is on the instrument panel, rear parcel shelf, or in the glove box. Also, this system sometimes does not operate if the Intelligent Key is in the door pocket for the open door.**
- **When the key reminder function is operated when the trunk is opened/closed and the buzzers sound, if the following operations are performed, the key reminder function is cleared and buzzer sounds are stopped.**
 - Remote controller door lock button operation of Intelligent Key
 - Remote controller door unlock button operation of Intelligent Key
 - When the trunk is closed, the Intelligent Key is not inside the vehicle
 - When any door is open

HAZARD AND BUZZER REMINDER FUNCTION

During trunk opening operation by request switch, the hazard warning lamps and Intelligent Key warning buzzer will flash or honk as a reminder.

When trunk open by each request switch, IPDM E/R honks Intelligent Key warning buzzer as a reminder and transmits hazard request signal to BCM via CAN communication line.

BCM flashes hazard warning lamps as a reminder.

Operating function of hazard and buzzer reminder

Operation	Hazard warning lamp flash	Intelligent Key warning buzzer honk
Trunk open	—	Fourth

How to change hazard and buzzer reminder mode

TRUNK OPEN FUNCTION

[INTELLIGENT KEY SYSTEM]

< FUNCTION DIAGNOSIS >

④ With CONSULT-III

Refer to [DLK-51](#), "INTELLIGENT KEY : CONSULT-III Function (BCM - INTELLIGENT KEY)".

LIST OF OPERATION RELATED PARTS

Parts marked with × are the parts related to operation.

Trunk open function	Intelligent Key	Key slot	Remote keyless entry receiver	Door switch	Trunk room lamp switch	Trunk opener request switch	Trunk lid opener actuator	Inside key antenna	Outside key antenna (Trunk)	Intelligent Key warning buzzer	CAN communication system	BCM	Hazard warning lamp	Trunk lid opener cancel switch
Trunk open function by the trunk opener request switch	×	×	×		×	×	×	×	×		×	×		×
Hazard and buzzer reminder function for door lock/unlock operation										×	×	×	×	
Buzzer reminder for trunk open operation										×	×	×		
Key reminder function	×	×	×	×				×	×	×	×	×	×	

TRUNK REQUEST SWITCH : Component Parts Location

INFOID:000000000961105

A
B
C
D
E
F
G
H
I
J
L
M
N
O
P

DLK

TRUNK OPEN FUNCTION

< FUNCTION DIAGNOSIS >

[INTELLIGENT KEY SYSTEM]

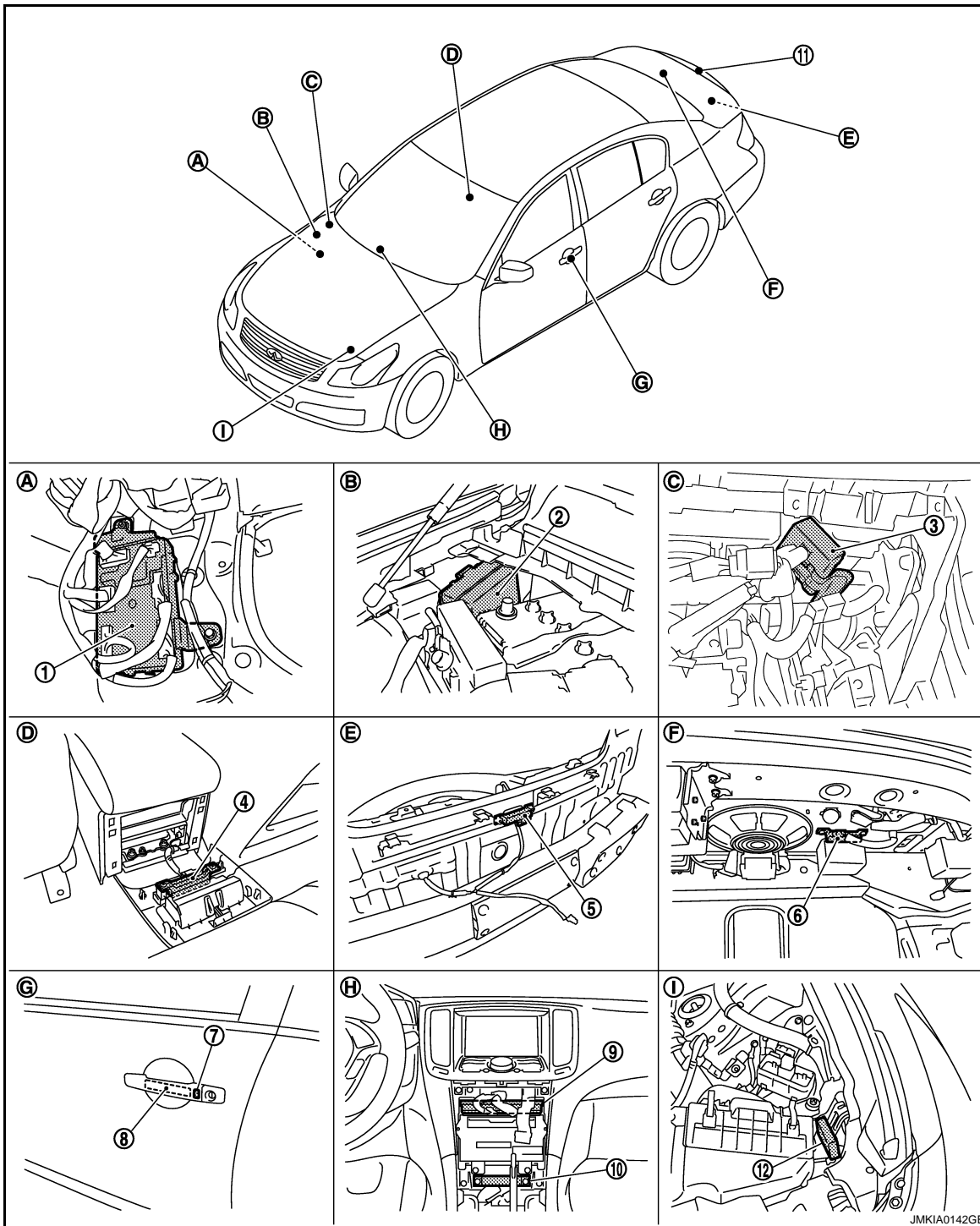

JMKIA0142GB

- | | | |
|--|---|---|
| 1. BCM
M118,M119,M120,M121,M122,M123 | 2. IPDM E/R E5,E6 | 3. Remote keyless entry receiver
M104 |
| 4. Inside key antenna (console) M146 | 5. Outside key antenna (rear bumper)
B63 | 6. Inside key antenna (trunk room)
B49 |
| 7. Front outside handle LH (request switch)
D13 | 8. Front outside handle LH (outside key
antenna) D14 | 9. Unified meter and A/C AMP
M66,M67 |
| 10. Inside key antenna (instrument center)
M131 | 11. Trunk lid request switch B304 | 12. Intelligent Key warning buzzer (en-
gine room) E57 |
| A. Dash side lower (Passenger side). | B. Engine room dash panel (RH). | C. View with instrument assist lower
panel removed. |

TRUNK OPEN FUNCTION

< FUNCTION DIAGNOSIS >

[INTELLIGENT KEY SYSTEM]

- D. View with console rear finisher removed. E. View with rear bumper removed. F. View with trunk rear finisher (upper) removed.
- G. View of front door LH. H. Behind cluster lid C. I. View with hood seal assembly removed.

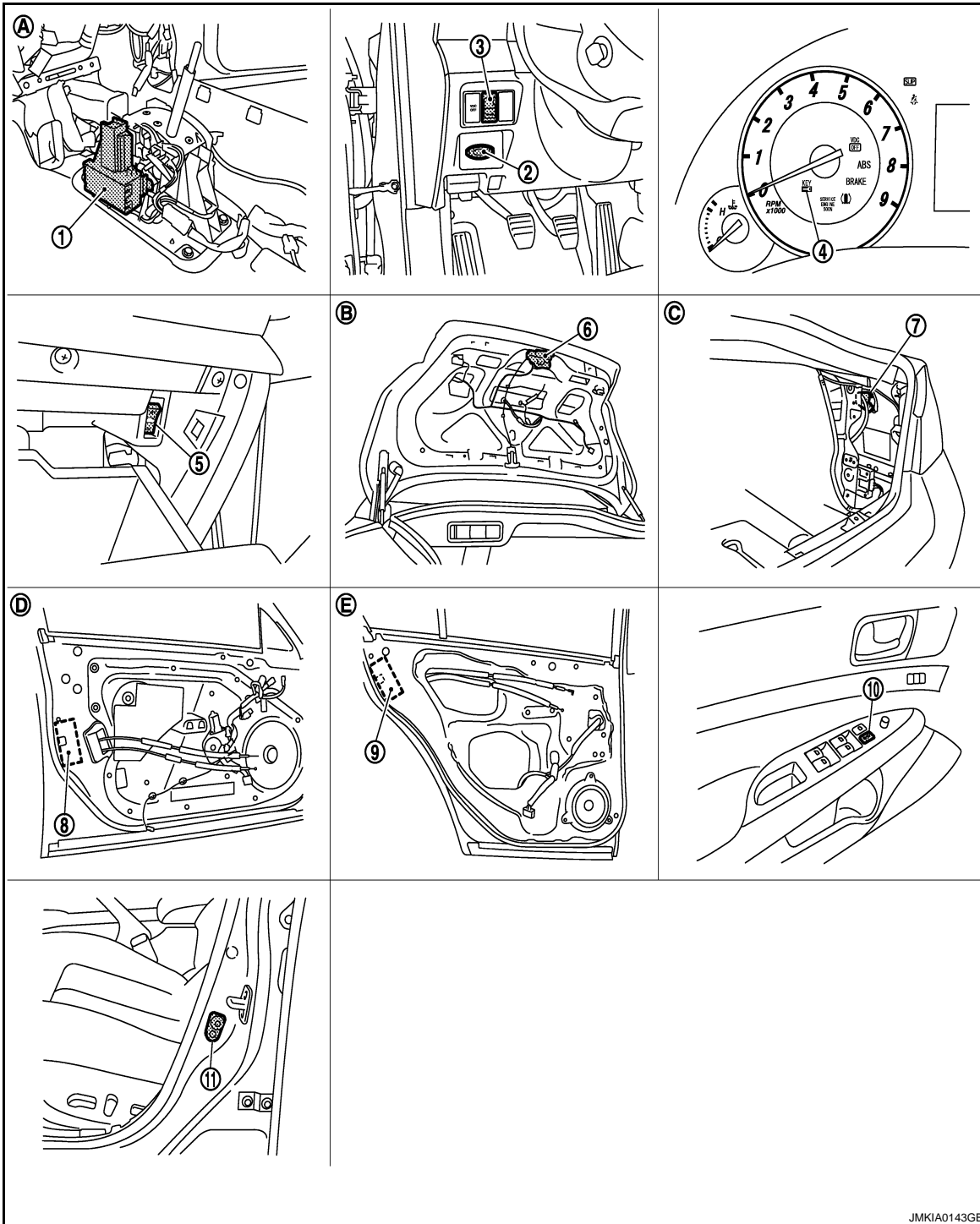

- | | | |
|--|---|---|
| 1. A/T device (detention switch) | 2. Key slot M22 | 3. Trunk lid opener switch M20 |
| 4. Combination meter (Key warning lamp) M53 | 5. Trunk opener cancel switch M105 | 6. Trunk lid lock assembly (trunk lid opener actuator) B303 |
| 7. Fuel lid opener actuator B242 | 8. Front door lock assembly (driver side) D15 | 9. Rear door lock assembly D55 |
| 10. Power window main switch (door lock unlock switch) D8,D9 | 11. Front door switch B16 | |

TRUNK OPEN FUNCTION

[INTELLIGENT KEY SYSTEM]

< FUNCTION DIAGNOSIS >

- A. View with center console assembly removed. B. View with trunk lid finisher removed. C. View with trunk side finisher removed.
 D. View with front door finisher removed. E. View with rear door finisher removed.

TRUNK REQUEST SWITCH : Component Description

INFOID:000000000961106

Item	Function
BCM	Controls trunk open function.
Trunk lid opener actuator	Transmits trunk open operation to BCM.
Remote keyless entry receiver	Receives lock/unlock signal from the Intelligent Key, and then transmits to BCM.
Trunk request switch	Transmits trunk open operation to BCM.
Intelligent Key	Transmits button operation to remote keyless entry receiver.
Outside key antenna	Detects if Intelligent Key is outside the vehicle.
Inside key antenna	Detects if Intelligent Key is inside the vehicle.
Intelligent Key warning buzzer	Warns the user of the lock/unlock condition and inappropriate operations with the buzzer sound.

INTELLIGENT KEY

INTELLIGENT KEY : System Diagram

INFOID:000000000961107

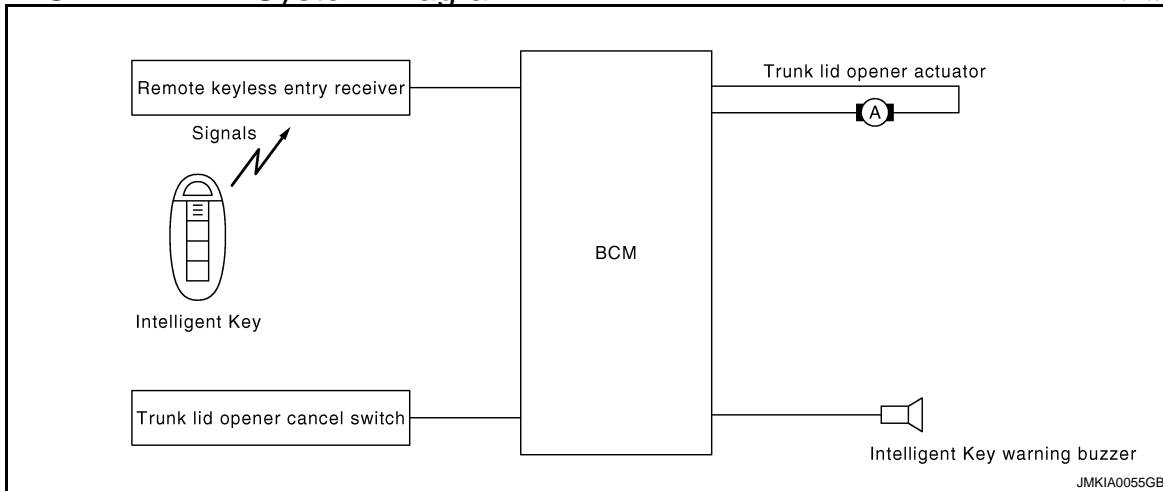

INTELLIGENT KEY : System Description

INFOID:000000000961108

The Intelligent Key has the same functions as the remote control entry system. Therefore, it can be used in the same manner as the remote controller by operating the trunk open button.

OPERATION DESCRIPTION/TRUNK OPEN FUNCTION

- When trunk button of the Intelligent Key is pressed, the trunk open signal is transmitted from the Intelligent Key to the BCM via remote keyless entry receiver.
- When BCM receives the trunk open request signal, it operates the trunk lid opener actuator and opens the trunk.

OPERATION CONDITION

Remote controller operation	Operation condition	Operation
Trunk open	• Press and hold the trunk open button for 0.5 second or more	Trunk open

OPERATION AREA

- Operating Range
- To ensure the Intelligent Key works effectively, use within 80 cm range of each door, however the operable range may differ according to surroundings.

HAZARD AND HORN REMINDER FUNCTION

TRUNK OPEN FUNCTION

< FUNCTION DIAGNOSIS >

[INTELLIGENT KEY SYSTEM]

When doors are locked or unlocked by Intelligent Key, BCM flashes hazard warning lamps as a reminder and transmits horn chirp signal to IPDM E/R. IPDM E/R sounds horn as a reminder. The hazard and horn reminder has a horn chirp mode (C mode) and a non-horn chirp mode (S mode).

Operating function of hazard and horn reminder

	C mode			S mode		
	Lock	Unlock	Trunk open	Lock	Unlock	Trunk open
Hazard warning lamp flash	Twice	Once	—	Twice	—	—
Horn sound	Once	—	—	—	—	—

Hazard and horn reminder does not operate if any door switch is ON (any door is OPEN).

How to change hazard and horn reminder mode

④ With CONSULT-III

Refer to [DLK-51, "INTELLIGENT KEY : CONSULT-III Function \(BCM - INTELLIGENT KEY\)"](#).

⊗ Without CONSULT-III

When LOCK and UNLOCK signals are transmitted from the Intelligent Key for more than 2 seconds at the same time, the hazard and horn reminder mode is changed and hazard warning lamp flashes and horn sounds as follows:

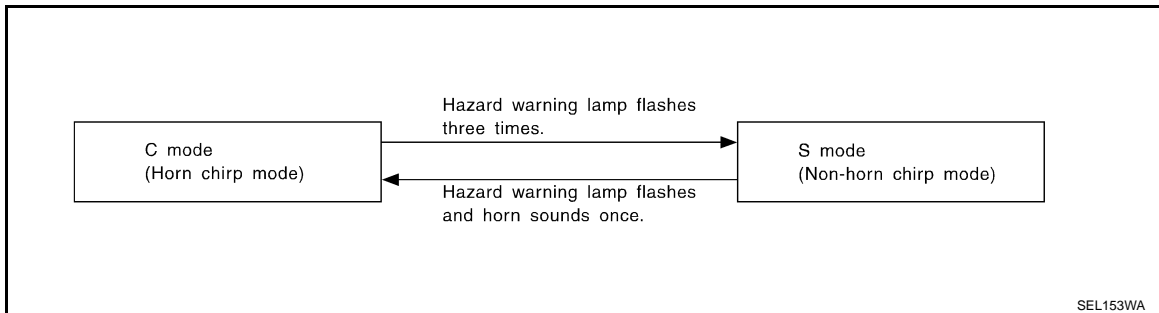

LIST OF OPERATION RELATED PARTS

Parts marked with × are the parts related to operation.

Remote keyless entry functions	Intelligent Key	Key slot	Trunk room lamp switch	Trunk lid opener actuator	Intelligent Key warning buzzer	CAN communication system	BCM	Combination meter	Hazard warning lamp	Horn	IPDM E/R	Head lamp
Trunk open function by remote control button	×	×	×	×		×	×					
Hazard and horn reminder function	×				×	×	×	×	×	×	×	

INTELLIGENT KEY : Component Parts Location

INFOID:000000000961109

TRUNK OPEN FUNCTION

< FUNCTION DIAGNOSIS >

[INTELLIGENT KEY SYSTEM]

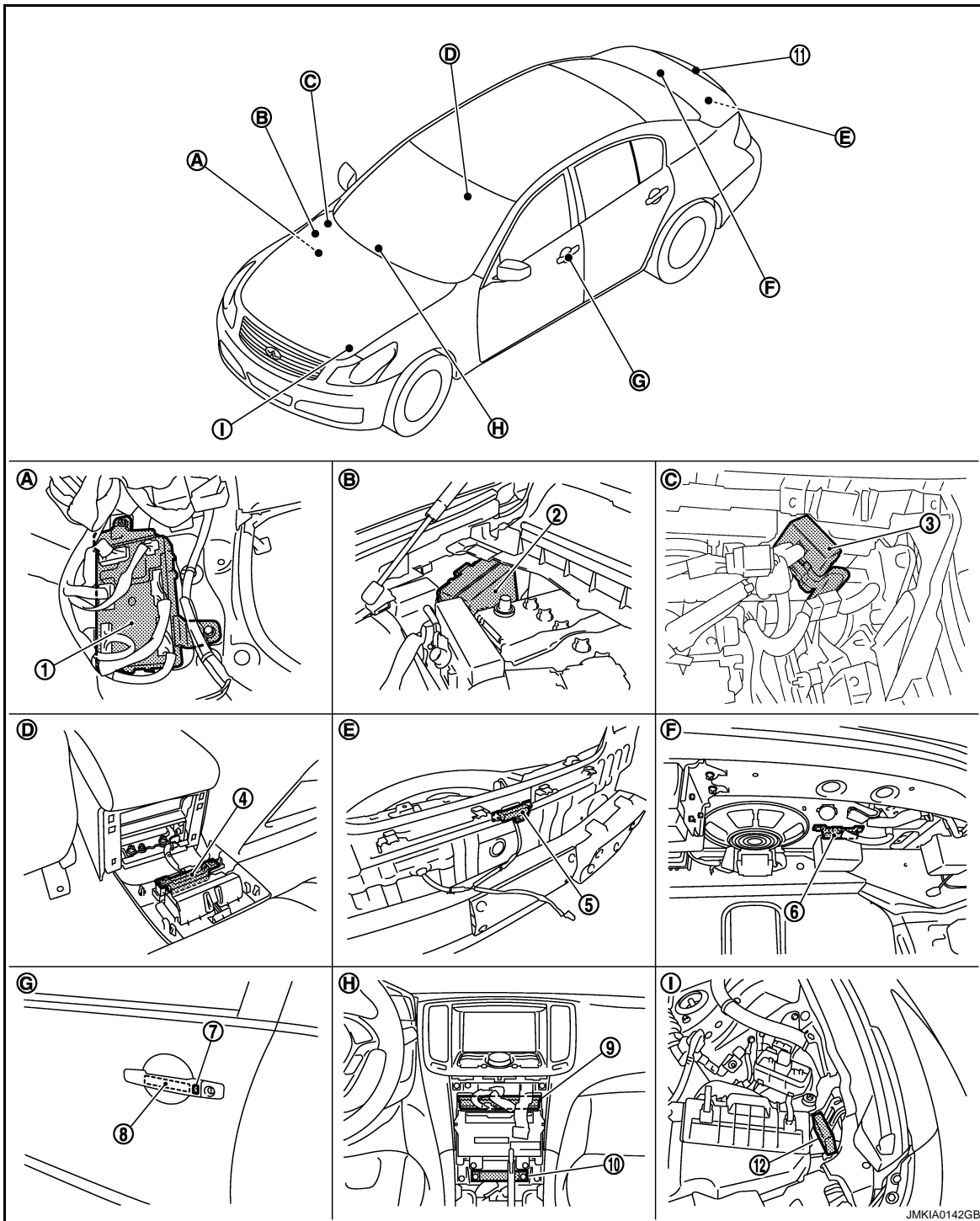

- | | | |
|--|---|---|
| 1. BCM
M118,M119,M120,M121,M122,M123 | 2. IPDM E/R E5,E6 | 3. Remote keyless entry receiver
M104 |
| 4. Inside key antenna (console) M146 | 5. Outside key antenna (rear bumper)
B63 | 6. Inside key antenna (trunk room)
B49 |
| 7. Front outside handle LH (request switch)
D13 | 8. Front outside handle LH (outside key
antenna) D14 | 9. Unified meter and A/C AMP
M66,M67 |
| 10. Inside key antenna (instrument center)
M131 | 11. Trunk lid request switch B304 | 12. Intelligent Key warning buzzer (en-
gine room) E57 |
| A. Dash side lower (Passenger side). | B. Engine room dash panel (RH). | C. View with instrument assist lower
panel removed. |

TRUNK OPEN FUNCTION

< FUNCTION DIAGNOSIS >

[INTELLIGENT KEY SYSTEM]

- D. View with console rear finisher removed. E. View with rear bumper removed. F. View with trunk rear finisher (upper) removed.
- G. View of front door LH. H. Behind cluster lid C. I. View with hood seal assembly removed.

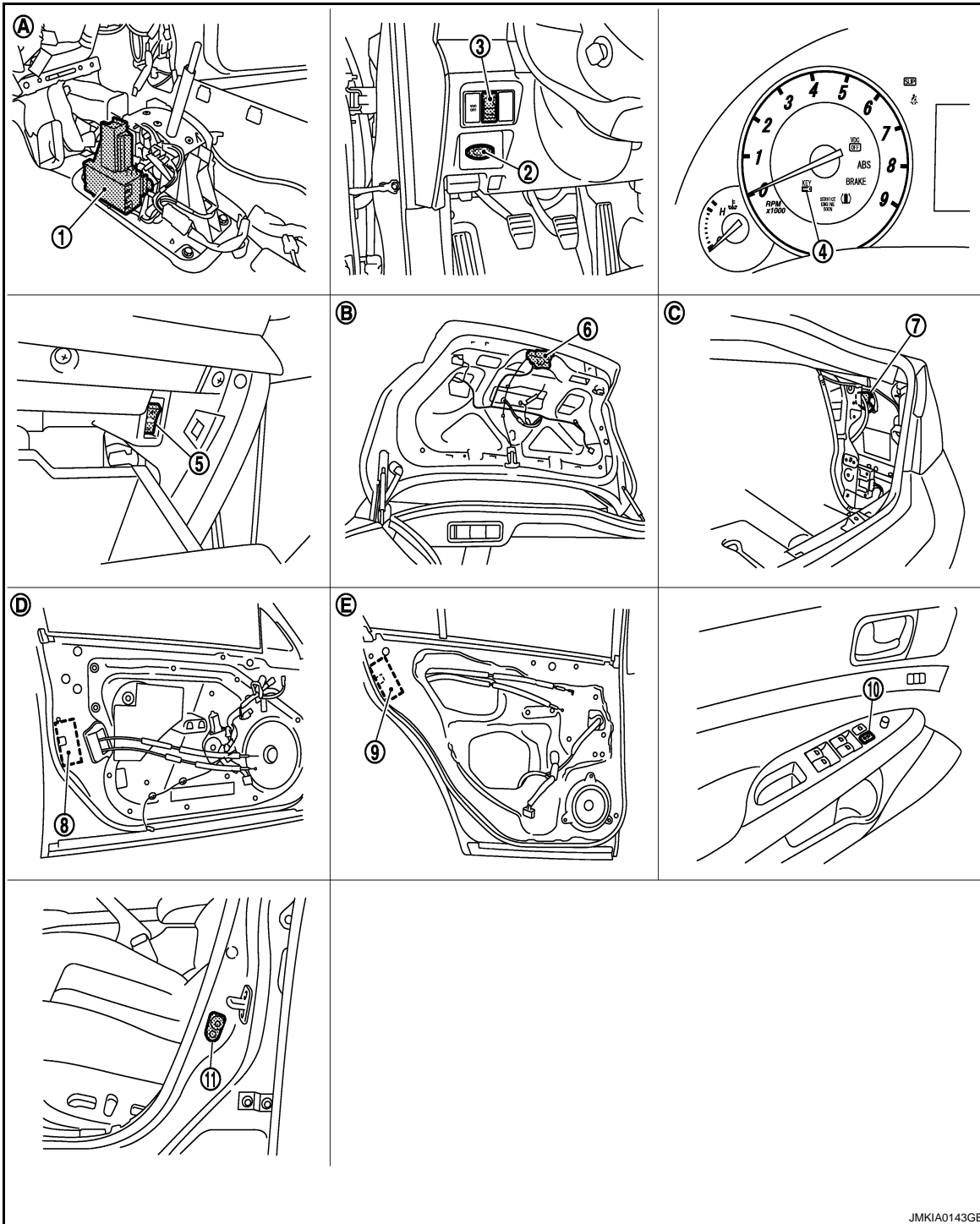

1. A/T device (detention switch) 2. Key slot M22 3. Trunk lid opener switch M20
4. Combination meter (Key warning lamp) M53 5. Trunk opener cancel switch M105 6. Trunk lid lock assembly (trunk lid opener actuator) B303
7. Fuel lid opener actuator B242 8. Front door lock assembly (driver side) D15 9. Rear door lock assembly D55
10. Power window main switch (door lock unlock switch) D8,D9 11. Front door switch B16

A
B
C
D
E
F
G
H
I
J
K
L
M
N
O
P

DLK

TRUNK OPEN FUNCTION

< FUNCTION DIAGNOSIS >

[INTELLIGENT KEY SYSTEM]

- A. View with center console assembly removed. B. View with trunk lid finisher removed. C. View with trunk side finisher removed.
D. View with front door finisher removed. E. View with rear door finisher removed.

INTELLIGENT KEY : Component Description

INFOID:000000000961110

Item	Function
BCM	Controls trunk open function.
Trunk lid opener actuator	Opens the trunk with the open signal from BCM.
Remote keyless entry receiver	Receives trunk open signal from the Intelligent Key, and then transmits to BCM.
Intelligent Key	Transmits button operation to remote keyless entry receiver.
Intelligent Key warning buzzer	Warns the user of the lock/unlock condition and inappropriate operations with the buzzer sound.

WARNING FUNCTION

System Description

INFOID:000000000961111

OPERATION DESCRIPTION

The warning function are as follows and are given to the user as warning information and warnings using combinations of Intelligent Key warning buzzer, KEY warning lamp, key slot illumination and combination meter display in combination meter.

- Intelligent Key system malfunction
- OFF position warning
- P position warning
- ACC warning
- Take away warning
- Door lock operation warning
- Key warning
- Intelligent Key insert information
- Engine start information
- Steering lock information
- Intelligent key low battery warning
- Key ID warning

OPERATION CONDITION

Once the following condition from below is established, alert or warning will be executed.

Warning/Information functions		Operation procedure
Intelligent Key system malfunction		When a malfunction is detected on BCM, "KEY" warning lamp will illuminate.
OFF position warning	For internal	<ul style="list-style-type: none"> • Ignition switch: ACC position. • Door switch (driver side): ON (Door is open).
	For external	OFF position warning (For internal) is in active mode, driver side door has been closed. NOTE: OFF position (For external) active only when each of the sequence has occurred as below: P position warning → ACC warning → OFF position warning (For internal) → OFF position warning (For internal)
P position warning		<ul style="list-style-type: none"> • Shift position: Except P position • Engine is running to stopped (Ignition switch is ON to OFF)
ACC warning		<ul style="list-style-type: none"> • During P position warning is in active mode, shift position has changed P position. • Ignition switch: Except OFF position.
Take away warning	Door is open to close	<ul style="list-style-type: none"> • Ignition switch: Except LOCK position. • Door switch: ON to OFF (Door is open to close). • Intelligent Key can not be detected inside the vehicle.
	Door is open	<ul style="list-style-type: none"> • Door switch: ON (Door is open) • Key ID verification every 5 seconds when registered Intelligent Key can not be detected inside the vehicle.
	Push-ignition switch operation	<ul style="list-style-type: none"> • Ignition switch: Except LOCK position. • Press ignition switch. • Intelligent Key can not be detected inside the vehicle.
	Take away through window	<ul style="list-style-type: none"> • Engine is running. • Key ID verification every 30 seconds when registered Intelligent Key can not be detected inside the vehicle. • After vehicle speed verification, the registered Intelligent Key can not be detect inside the vehicle.
	Intelligent Key is removed from key slot	<ul style="list-style-type: none"> • When Intelligent Key is removed from key slot, Intelligent Key can not be detected inside the vehicle.

WARNING FUNCTION

< FUNCTION DIAGNOSIS >

[INTELLIGENT KEY SYSTEM]

Warning/Information functions		Operation procedure
Door lock operation warning	Request switch operation	When request switch is pushed (lock operation) under the following conditions. <ul style="list-style-type: none"> • Door switch: ON (Any door is open). • Intelligent Key is inside vehicle.
	Intelligent Key button operation	When Intelligent Key button is pushed (lock operation) under the following conditions. <ul style="list-style-type: none"> • Door switch: ON (Any door is open). • For 3 seconds after Intelligent Key is removed from key slot.
Key warning		<ul style="list-style-type: none"> • Ignition switch is OFF position. • Driver side door switch: ON (Driver side door is open). • Intelligent Key is inserted in key slot.
Intelligent Key insert information		<ul style="list-style-type: none"> • Door switch: ON to OFF (Door is open to close). • Ignition switch: OFF to ON position. • Intelligent Key is out of key slot. • Intelligent Key can not be detected inside the vehicle.
Engine start information	Ignition switch is ON position	<ul style="list-style-type: none"> • Ignition switch: ON position. • Shift position: P position • Engine is stopped
	Ignition switch is except ON position	<ul style="list-style-type: none"> • Ignition switch: Except ON position. • Shift position: P position • Intelligent Key is inserted in key slot. • Intelligent Key can be detected inside the vehicle.
Steering lock information		When steering lock can not be released after ignition switch is turned ON.
Intelligent Key low battery warning		When Intelligent Key is low battery, BCM is detected after ignition switch is turned ON.
Key ID warning		When registered intelligent Key can not be detected inside the vehicle after ignition switch is turned ON.

WARNING METHOD

The following table shows the alarm or warning methods with chime.



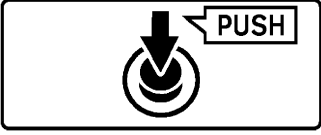

Meter display, "KEY" indicator or key slot illumination when the warning conditions are met.

Warning/Information functions		"KEY" warning lamp	Combination meter display	Key slot illumination	Warning chime	
					Combination meter buzzer	Intelligent Key warning buzzer
Intelligent Key system malfunction		Illuminate	—	—	—	—
OFF position warning	For internal	—	—	—	Activate	—
	For external	—	—	—	—	Activate
P position warning		—	<div style="border: 1px solid black; padding: 5px; text-align: center;">  </div> <small style="display: block; text-align: right;">JMKIA0037GB</small>	—	Activate	—
ACC warning		—	<div style="border: 1px solid black; padding: 5px; text-align: center;">  </div> <small style="display: block; text-align: right;">JMKIA0047GB</small>	—	Activate	—

WARNING FUNCTION

< FUNCTION DIAGNOSIS >

[INTELLIGENT KEY SYSTEM]

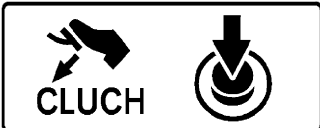
Warning/Information functions		"KEY" warning lamp	Combination meter display	Key slot illumination	Warning chime	
					Combination meter buzzer	Intelligent Key warning buzzer
Take away warning	Door is open to close	—	 <small>JMKIA0036GB</small>	Flash	Activate	Activate
	Door is open	—		Flash	—	—
	Push-ignition switch operation	—		Flash	Activate	—
	Take away through window	—		Flash	Activate	—
	Intelligent Key is removed from key slot	—		Flash	—	—
Door lock operation warning	Request switch operation	—	—	—	—	Activate
	Intelligent Key operation	—	—	—	—	Activate
Key ID warning		—	 <small>JMKIA0036GB</small>	—	—	—
Key warning		—	 <small>JMKIA0035GB</small>	Flash	Activate	—
Intelligent Key insert information		—	 <small>JMKIA0034GB</small>	Flash	—	—
Engine start information	Automatic transmission models	—	 <small>JMKIA0032GB</small>	—	—	—
	Manual transmission models	—	 <small>JMKIA0049GB</small>	—	—	—



A
B
C
D
E
F
G
H
I
J
L
M
N
O
P

DLK

WARNING FUNCTION

< FUNCTION DIAGNOSIS >

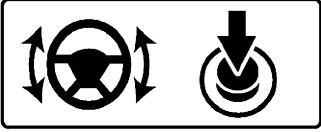
[INTELLIGENT KEY SYSTEM]

Warning/Information functions	"KEY" warning lamp	Combination meter display	Key slot illumination	Warning chime	
				Combination meter buzzer	Intelligent Key warning buzzer
Steering lock information	—	 <small>JMKIA0033GB</small>	—	—	—
Intelligent Key low battery warning	—	 <small>JMKIA0048GB</small>	—	—	—

LIST OF OPERATION RELATED PARTS

Parts marked with × are the parts related to operation.

Warning function		Intelligent Key	Key slot	Ignition switch	Door switch	Door request switch	Inside key antenna	Outside key antenna	Intelligent Key warning buzzer	Combination meter warning buzzer	CAN communication system	BCM	Combination meter display	Key slot illumination	Park position switch	"KEY" warning lamp
Intelligent Key system malfunction											×	×				×
OFF position warning	For internal				×					×	×	×				
	For external				×				×		×	×				
P position warning				×						×	×	×	×		×	
ACC warning				×						×	×	×	×		×	
Take away warning	Door is open or close	×			×		×		×	×	×	×	×	×		
	Door is open	×			×		×				×	×	×	×		
	Push-ignition switch operation	×		×			×			×	×	×	×	×		
	Take away through window	×					×			×	×	×	×	×		
	Intelligent Key is removed from key slot	×	×				×				×	×	×	×		
Door lock operation warning		×	×		×	×	×	×	×		×	×				
Key ID warning		×	×	×			×				×	×	×			
Key warning		×	×		×					×	×	×	×	×		
Intelligent Key insert information		×	×	×	×		×				×	×	×	×		

WARNING FUNCTION

< FUNCTION DIAGNOSIS >

[INTELLIGENT KEY SYSTEM]

Warning function		Intelligent Key	Key slot	Ignition switch	Door switch	Door request switch	Inside key antenna	Outside key antenna	Intelligent Key warning buzzer	Combination meter warning buzzer	CAN communication system	BCM	Combination meter display	Key slot illumination	Park position switch	"KEY" warning lamp
Engine start information	Ignition switch is ON position	×	×	×			×				×	×	×		×	
	Ignition switch is except ON position	×	×	×			×				×	×	×			
Steering lock information				×							×	×	×			
Intelligent Key low battery warning		×					×				×	×	×			

Component Parts Location

INFOID:000000000961112

A
B
C
D
E
F
G
H
I
J
L
M
N
O
P

DLK

WARNING FUNCTION

< FUNCTION DIAGNOSIS >

[INTELLIGENT KEY SYSTEM]

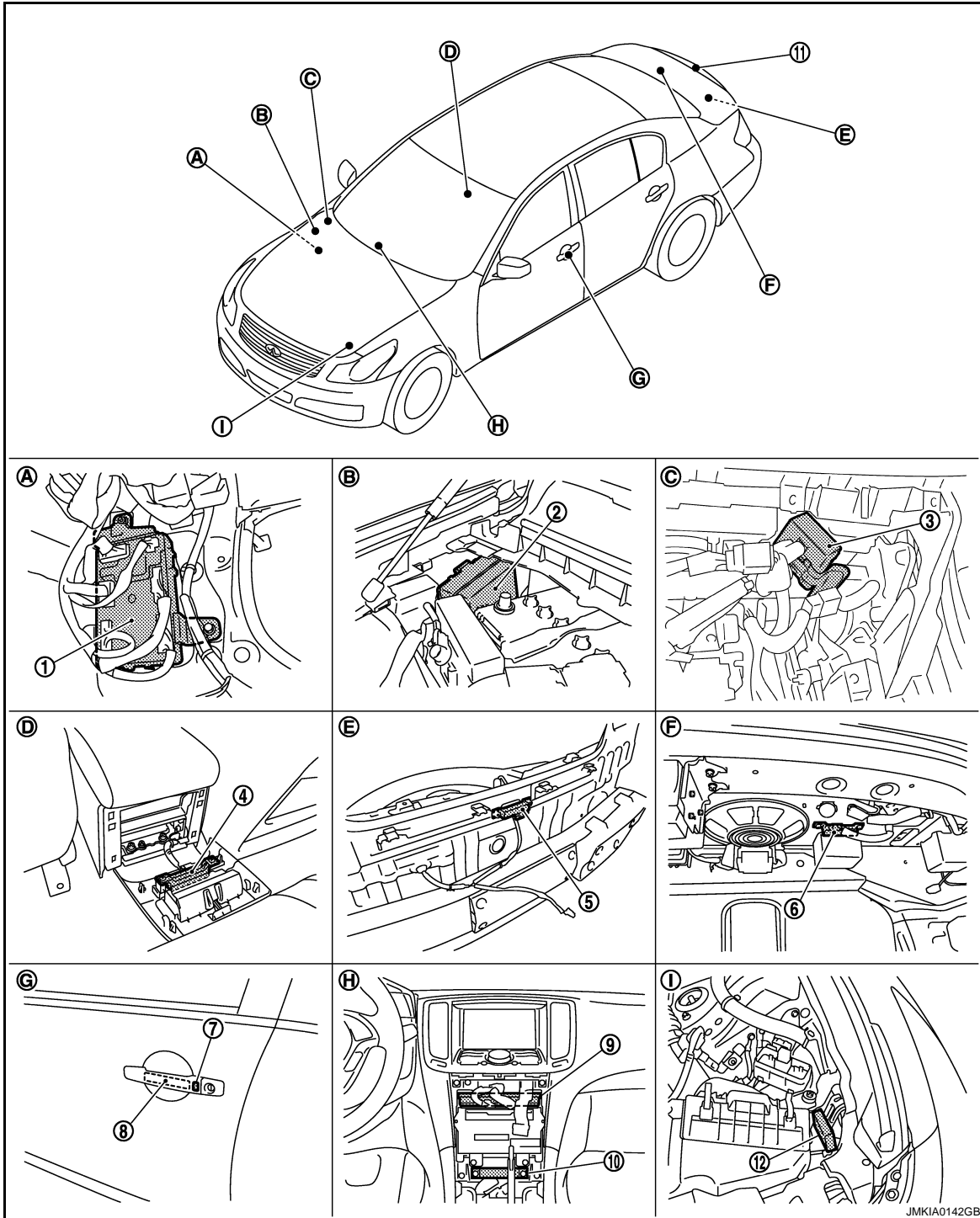

JMKIA0142GB

- | | | |
|--|---|---|
| 1. BCM
M118,M119,M120,M121,M122,M123 | 2. IPDM E/R E5,E6 | 3. Remote keyless entry receiver
M104 |
| 4. Inside key antenna (console) M146 | 5. Outside key antenna (rear bumper)
B63 | 6. Inside key antenna (trunk room)
B49 |
| 7. Front outside handle LH (request switch)
D13 | 8. Front outside handle LH (outside key
antenna) D14 | 9. Unified meter and A/C AMP
M66,M67 |
| 10. Inside key antenna (instrument center)
M131 | 11. Trunk lid request switch B304 | 12. Intelligent Key warning buzzer (en-
gine room) E57 |
| A. Dash side lower (Passenger side). | B. Engine room dash panel (RH). | C. View with instrument assist lower
panel removed. |

WARNING FUNCTION

< FUNCTION DIAGNOSIS >

[INTELLIGENT KEY SYSTEM]

- D. View with console rear finisher removed. E. View with rear bumper removed. F. View with trunk rear finisher (upper) removed.
- G. View of front door LH. H. Behind cluster lid C. I. View with hood seal assembly removed.

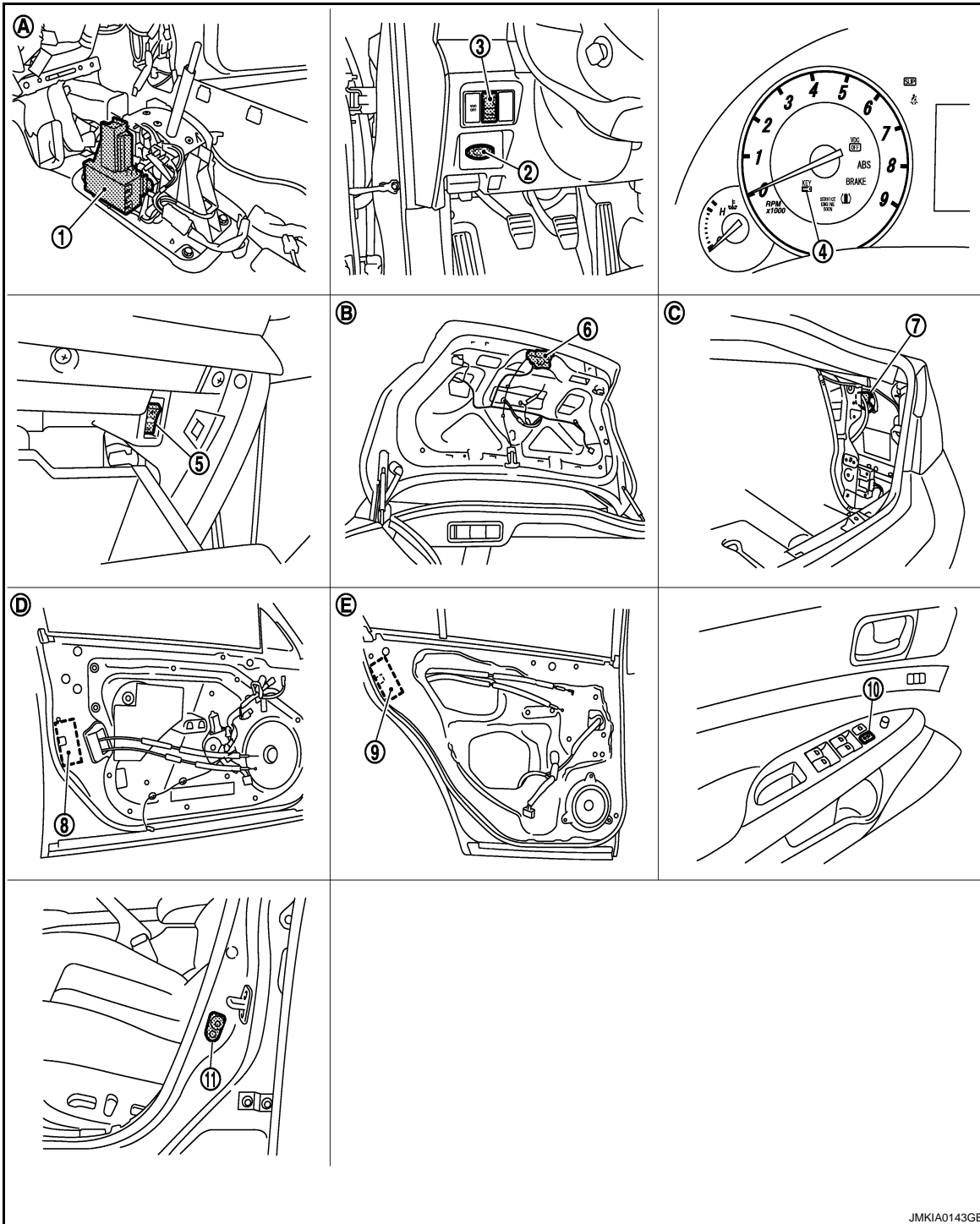

1. A/T device (detention switch) 2. Key slot M22 3. Trunk lid opener switch M20
4. Combination meter (Key warning lamp) M53 5. Trunk opener cancel switch M105 6. Trunk lid lock assembly (trunk lid opener actuator) B303
7. Fuel lid opener actuator B242 8. Front door lock assembly (driver side) D15 9. Rear door lock assembly D55
10. Power window main switch (door lock unlock switch) D8,D9 11. Front door switch B16

A
B
C
D
E
F
G
H
I
J
K
L
M
N
O
P

DLK

WARNING FUNCTION

< FUNCTION DIAGNOSIS >

[INTELLIGENT KEY SYSTEM]

- | | | |
|---|--|---|
| A. View with center console assembly removed. | B. View with trunk lid finisher removed. | C. View with trunk side finisher removed. |
| D. View with front door finisher removed. | E. View with rear door finisher removed. | |

KEY REMINDER FUNCTION

< FUNCTION DIAGNOSIS >

[INTELLIGENT KEY SYSTEM]

KEY REMINDER FUNCTION

System Description

INFOID:000000000961113

Key reminder is the function that prevents the key from being left in the vehicle. Key reminder has the following 3 functions.

Key remainder function	Operation condition	Operation
Driver door closed*	Right after driver side door is closed under the following conditions <ul style="list-style-type: none">• Door lock operation is performed• Driver side door is opened• Driver side door is in unlock state	All doors unlock
Door is open or closed	Right after all doors are closed under the following conditions <ul style="list-style-type: none">• Intelligent Key is inside the vehicle• Any door is opened• All doors are locked by door lock and unlock switch or door lock knob	<ul style="list-style-type: none">• All doors unlock• Honk Intelligent Key warning buzzer
Trunk is closed	Right after trunk is closed under the following conditions <ul style="list-style-type: none">• Intelligent Key is inside trunk room• All doors are closed• All doors are locked	<ul style="list-style-type: none">• Trunk open• Honk Intelligent Key warning buzzer

*:If the door closing impact shocks the door lock knob, or contacts against baggage with the door lock knob might activate the door locks accidentally but unlock operation will be perform in these cases.

CAUTION:

- The above function operates when the Intelligent Key is inside the vehicle. However, there may be times when the Intelligent Key cannot be detected, and this function will not operate when the Intelligent Key is on the instrument panel, rear parcel shelf, or in the glove box. Also, this system sometimes does not operate if the Intelligent Key is in the door pocket for the open door.
- When the key reminder function is operated when the trunk is open/closed and the buzzers sound, if the following operations are performed, the key reminder function is cleared and buzzer sounds are stopped.
 - Remote controller door lock button operation of Intelligent Key
 - Remote controller door unlock button operation of Intelligent Key
 - When the trunk is closed, the Intelligent Key is not inside the vehicle
 - When any door is open

Component Parts Location

INFOID:000000000961114

DLK

KEY REMINDER FUNCTION

< FUNCTION DIAGNOSIS >

[INTELLIGENT KEY SYSTEM]

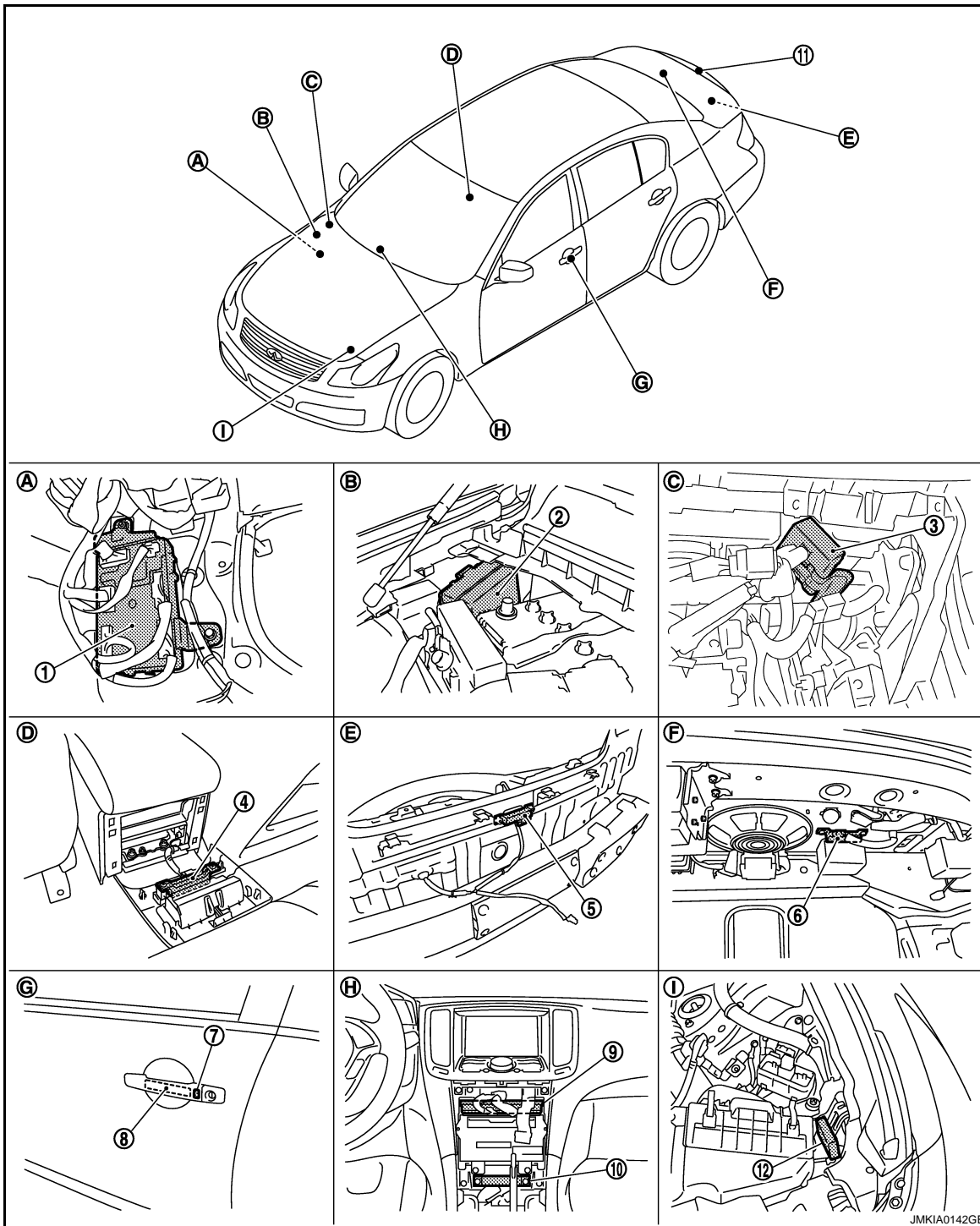

1. BCM
M118,M119,M120,M121,M122,M123

4. Inside key antenna (console) M146

7. Front outside handle LH (request switch)
D13

10. Inside key antenna (instrument center)
M131

A. Dash side lower (Passenger side).

2. IPDM E/R E5,E6

5. Outside key antenna (rear bumper)
B63

8. Front outside handle LH (outside key
antenna) D14

11. Trunk lid request switch B304

B. Engine room dash panel (RH).

3. Remote keyless entry receiver
M104

6. Inside key antenna (trunk room)
B49

9. Unified meter and A/C AMP
M66,M67

12. Intelligent Key warning buzzer (en-
gine room) E57

C. View with instrument assist lower
panel removed.

KEY REMINDER FUNCTION

< FUNCTION DIAGNOSIS >

[INTELLIGENT KEY SYSTEM]

- D. View with console rear finisher removed. E. View with rear bumper removed. F. View with trunk rear finisher (upper) removed.
- G. View of front door LH. H. Behind cluster lid C. I. View with hood seal assembly removed.

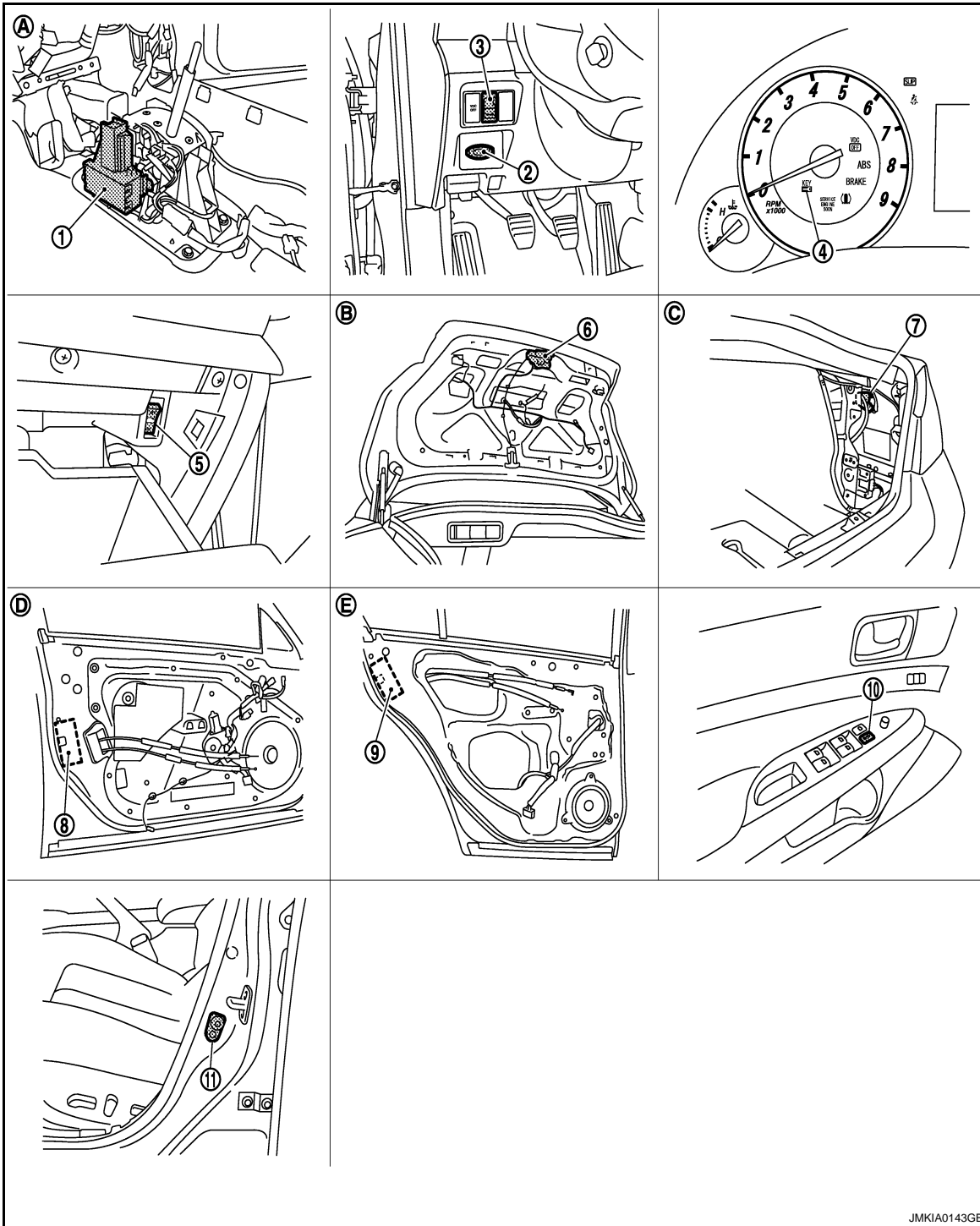

- | | | |
|--|---|---|
| 1. A/T device (detention switch) | 2. Key slot M22 | 3. Trunk lid opener switch M20 |
| 4. Combination meter (Key warning lamp) M53 | 5. Trunk opener cancel switch M105 | 6. Trunk lid lock assembly (trunk lid opener actuator) B303 |
| 7. Fuel lid opener actuator B242 | 8. Front door lock assembly (driver side) D15 | 9. Rear door lock assembly D55 |
| 10. Power window main switch (door lock unlock switch) D8,D9 | 11. Front door switch B16 | |

A
B
C
D
E
F
G
H
I
J
K
L
M
N
O
P

DLK

JMKIA0143GB

KEY REMINDER FUNCTION

< FUNCTION DIAGNOSIS >

[INTELLIGENT KEY SYSTEM]

-
- | | | |
|---|--|---|
| A. View with center console assembly removed. | B. View with trunk lid finisher removed. | C. View with trunk side finisher removed. |
| D. View with front door finisher removed. | E. View with rear door finisher removed. | |

INTEGRATED HOMELINK TRANSMITTER

< FUNCTION DIAGNOSIS >

[INTELLIGENT KEY SYSTEM]

INTEGRATED HOMELINK TRANSMITTER

Component Description

INFOID:000000000961115

Item	Function
Homelink universal transceiver	A maximum of 3 radio signals can be stored and transmitted to operate the garage door, etc.

A
B
C
D
E
F
G
H
I
J
DLK
L
M
N
O
P

DLK

DIAGNOSIS SYSTEM (BCM)

< FUNCTION DIAGNOSIS >

[INTELLIGENT KEY SYSTEM]

DIAGNOSIS SYSTEM (BCM)

COMMON ITEM

COMMON ITEM : CONSULT-III Function (BCM - COMMON ITEM)

INFOID:000000000961116

APPLICATION ITEM

CONSULT-III performs the following functions via CAN communication with BCM.

Diagnosis mode	Function Description
WORK SUPPORT	Changes the setting for each system function.
SELF-DIAG RESULTS	Displays the diagnosis results judged by BCM. Refer to BCS-74, "DTC Index" .
CAN DIAG SUPPORT MNTR	Monitors the reception status of CAN communication viewed from BCM.
DATA MONITOR	The BCM input/output signals are displayed.
ACTIVE TEST	The signals used to activate each device are forcibly supplied from BCM.
ECU IDENTIFICATION	The BCM part number is displayed.
CONFIGURATION	This function is not used even though it is displayed.

SYSTEM APPLICATION

BCM can perform the following functions for each system.

NOTE:

It can perform the diagnosis modes except the following for all sub system selection items.

System	Sub system selection item	Diagnosis mode		
		WORK SUPPORT	DATA MONITOR	ACTIVE TEST
Door lock	DOOR LOCK	×	×	×
Rear window defogger	REAR DEFOGGER		×	×
Warning chime	BUZZER		×	×
Interior room lamp timer	INT LAMP	×	×	×
Exterior lamp	HEAD LAMP	×	×	×
Wiper and washer	WIPER	×	×	×
Turn signal and hazard warning lamps	FLASHER	×	×	×
Air conditioner*	AIR CONDITONER		×	
Intelligent Key system	INTELLIGENT KEY	×	×	×
Combination switch	COMB SW		×	
BCM	BCM	×		
IVIS - NATS	IMMU		×	×
Interior room lamp battery saver	BATTERY SAVER	×	×	×
Trunk open	TRUNK		×	
Vehicle security system	THEFT ALM	×	×	×
RAP system	RETAINED PWR		×	
Signal buffer system	SIGNAL BUFFER		×	×
TPMS	TPMS (AIR PRESSURE MONI-TOR)	×	×	×

*: This item is displayed, but is not used.

DOOR LOCK

DOOR LOCK : CONSULT-III Function (BCM - DOOR LOCK)

INFOID:000000000961117

BCM CONSULT-III FUNCTION

CONSULT-III performs the following functions via CAN communication with BCM.

DIAGNOSIS SYSTEM (BCM)

< FUNCTION DIAGNOSIS >

[INTELLIGENT KEY SYSTEM]

Diagnosis mode	Function Description
WORK SUPPORT	Changes the setting for each system function.
DATA MONITOR	The BCM input/output signals are displayed.
ACTIVE TEST	The signals used to activate each device are forcibly supplied from BCM.

WORK SUPPORT

Monitor item	Description
DOOR LOCK-UNLOCK SET	Selective unlock function mode can be changed to operate (WITH) or not operate (WITHOUT) with this mode.
D/LOCK VHCL SPD AJT	Lock with speed customize function mode can be changed to operate (WITH) or not operate (WITHOUT) with this mode.

DATA MIONITOR

Monitor Item	Contents
REQ SW-DR	Indicated [ON/OFF] condition of door request switch (driver side).
REQ SW-AS	Indicated [ON/OFF] condition of door request switch (passenger side).
REQ SW-BD/TR	Indicated [ON/OFF] condition of trunk opener request switch.
DOOR SW-DR	Indicated [ON/OFF] condition of front door switch (driver side).
DOOR SW-AS	Indicated [ON/OFF] condition of front door switch (passenger side).
DOOR SW-RR	Indicated [ON/OFF] condition of rear door switch RH.
DOOR SW-RL	Indicated [ON/OFF] condition of rear door switch LH.
DOOR SW-BK	NOTE: This item is displayed, but cannot be monitored.
CDL LOCK SW	Indicated [ON/OFF] condition of lock signal from door lock unlock switch.
CDL UNLOCK SW	Indicated [ON/OFF] condition of unlock signal from door lock unlock switch.
KEY CYL LK-SW	Indicated [ON/OFF] condition of lock signal from key cylinder.
KEY CYL UN-SW	Indicated [ON/OFF] condition of unlock signal from key cylinder.

ACTIVE TEST

Test item	Description
DOOR LOCK	<p>This test is able to check door lock/unlock operation.</p> <ul style="list-style-type: none"> The all door lock actuators are locked when "LOCK" on CONSULT-III screen is touched. The all door lock actuators are unlocked when "ALL UNLK" on CONSULT-III screen is touched. The door lock actuator (driver side) is unlocked when "DR UNLK" on CONSULT-III screen is touched. The door lock actuator (passenger side) is unlocked when "AS UNLK" on CONSULT- III screen is touched. The door lock actuator (other) is unlocked when "OTR ULK" on CONSULT-III screen is touched.

INTELLIGENT KEY

INTELLIGENT KEY : CONSULT-III Function (BCM - INTELLIGENT KEY)

INFOID:000000000961118

BCM CONSULT-III FUNCTION

CONSULT-III performs the following functions via CAN communication with BCM.

Diagnosis mode	Function Description
WORK SUPPORT	Changes the setting for each system function.
SELF-DIAG RESULTS	Displays the diagnosis results judged by BCM.

DIAGNOSIS SYSTEM (BCM)

< FUNCTION DIAGNOSIS >

[INTELLIGENT KEY SYSTEM]

Diagnosis mode	Function Description
DATA MONITOR	The BCM input/output signals are displayed.
ACTIVE TEST	The signals used to activate each device are forcibly supplied from BCM.

WORK SUPPORT

Monitor item	Description
REMO CONT ID CONFIR	It can be checked whether Intelligent Key ID code is registered or not in this mode.
LOCK/UNLOCK BY I-KEY	Door lock/unlock function by door request switch (driver side, passenger side and trunk) mode can be changed to operate (ON) or not operate (OFF) in this mode.
ENGINE START BY I-KEY	Engine start function mode can be changed to operate (ON) or not operate (OFF) with this mode.
TRUNK/GLASS HATCH OPEN	Buzzer reminder function mode by trunk opener request switch can be changed to operate (ON) or not operate (OFF) with this mode.
PANIC ALARM SET	<p>Panic alarm button pressing time on Intelligent Key remote control button can be selected from the following with this mode.</p> <ul style="list-style-type: none"> • 0.5 sec. • 1.5 sec. • OFF: Non-operation
PW DOWN SET	<p>Unlock button pressing time on Intelligent Key button can be selected from the following with this mode.</p> <ul style="list-style-type: none"> • 3 sec. • 5 sec. • OFF: Non-operation
TRUNK OPEN DELAY	<p>Trunk button pressing time on Intelligent Key button can be selected from the following with this mode.</p> <ul style="list-style-type: none"> • 0.5 sec. • 1.5 sec. • OFF: Non-operation
LO- BATT OF KEY FOB WARN	Intelligent Key low battery warning mode can be changed to operate (ON) or not operate (OFF) with this mode.
ANTI KEY LOCK IN FUNCTI	Key reminder function mode can be changed to operate (ON) or not operate (OFF) with this mode.
HORN WITH KEYLESS LOCK	Horn reminder function mode by Intelligent Key button can be changed to operate (ON) or not operate (OFF) with this mode.
HAZARD ANSWER BACK	<p>Hazard reminder function mode can be selected from the following with this mode.</p> <ul style="list-style-type: none"> • LOCK ONLY: Door lock operation only • UNLOCK ONLY: Door unlock operation only • LOCK AND UNLOCK: Lock/unlock operation • OFF: Non operation
ANS BACK I-KEY LOCK	<p>Buzzer reminder function (lock operation) mode by door request switch (driver side and passenger side) can be selected from the following with this mode.</p> <ul style="list-style-type: none"> • HORN CHIRP: Sound horn • BUZZER: Sound Intelligent Key warning buzzer • OFF: Non-operation
ANS BACK I-KEY UNLOCK	Buzzer reminder function (unlock operation) mode by door request switch can be changed to operate (ON) or not operate (OFF) with this mode.
SHORT CRANKING OUTPUT	<p>Starter motor can operate during the times below.</p> <ul style="list-style-type: none"> • 70 msec • 100 msec • 200 msec
INSIDE ANT DIAGNOSIS	This function allows inside key antenna self-diagnosis.

SELF-DIAG RESULT

Refer to [BCS-74, "DTC Index"](#).

DATA MONITOR

DIAGNOSIS SYSTEM (BCM)

< FUNCTION DIAGNOSIS >

[INTELLIGENT KEY SYSTEM]

Monitor Item	Condition	
REQ SW-DR	Indicates [ON/OFF] condition of door request switch (driver side).	A
REQ SW-AS	Indicates [ON/OFF] condition of door request switch (passenger side).	
REQ SW-BD/TR	Indicates [ON/OFF] condition of trunk opener request switch.	B
PUSH SW	Indicates [ON/OFF] condition of push-button ignition switch.	
CLUCH SW	Indicates [ON/OFF] condition of clutch switch.	C
BRAKE SW 1	Indicates [ON/OFF] condition of brake switch.	
DETE/CANCL SW	Indicates [ON/OFF] condition of P position.	
SFT P/N SW	Indicates [ON/OFF] condition of P or N position.	D
S/L -LOCK	Indicates [ON/OFF] condition of steering lock (LOCK).	
S/L -UNLOCK	Indicates [ON/OFF] condition of steering lock (UNLOCK).	E
S/L RELAY-F/B	Indicates [ON/OFF] condition of ignition switch.	
UNLK SEN-DR	Indicates [ON/OFF] condition of driver door UNLOCK status.	
PUSH SW -IPDM	Indicates [ON/OFF] condition of push-button ignition switch.	F
IGN RLY1 F/B	Indicates [ON/OFF] condition of ignition relay 1.	
DETE SW -IPDM	Indicates [ON/OFF] condition of P position.	G
SFT PN -IPDM	Indicates [ON/OFF] condition of P or N position.	
SFT P -MET	Indicates [ON/OFF] condition of P position.	
SFT N -MET	Indicates [ON/OFF] condition of N position.	H
ENGINE STATE	Indicates [STOP/START/CRANK/RUN] condition of engine states.	
S/L LOCK-IPDM	Indicates [ON/OFF] condition of steering lock (LOCK).	
S/L UNLOCK-IPDM	Indicates [ON/OFF] condition of steering lock (UNLOCK).	I
S/L RELAY-REQ	Indicates [ON/OFF] condition of steering lock relay.	
VEH SPEED 1	Display the vehicle speed signal received from combination meter by numerical value [Km/h].	J
VEH SPEED 2	Display the vehicle speed signal received from ABS or VDC or CVT by numerical value [Km/h].	
DOOR STAT-DR	Indicates [LOCK/READY/UNLK] condition of driver side door status.	
DOOR STAT-AS	Indicates [LOCK/READY/UNLK] condition of passenger side door status.	DLK
KEY SW -SLOT	Indicates [ON/OFF] condition of key slot.	
RKE OPE COUN1	When remote keyless entry receiver receives the signal transmitted while operating on Intelligent Key, the numerical value start changing.	L
RKE OPE COUN2	NOTE: This item is displayed, but cannot be monitored.	
TRNK/HAT MNTR	Indicates [ON/OFF] condition of trunk lid.	M
RKE-LOCK	Indicates [ON/OFF] condition of LOCK signal from Intelligent Key.	
RKE-UNLOCK	Indicates [ON/OFF] condition of UNLOCK signal from Intelligent Key.	N
RKE-TR/BD	Indicates [ON/OFF] condition of TRUNK OPEN signal from Intelligent Key.	
RKE-PANIC	Indicates [ON/OFF] condition of PANIC button of Intelligent Key.	
RKE-P/W OPEN	Indicates [ON/OFF] condition of P/W DOWN signal from Intelligent Key.	O
RKE-MODE CHG	Indicates [ON/OFF] condition of MODE CHANGE signal from Intelligent Key.	

ACTIVE TEST

Test item	Description
BATTERY SAVER	This test is able to check interior room lamp operation. The interior room lamp will be activated after "ON" on CONSULT-III screen is touched.
PW REMOTO DOWN SET	This test is able to check power window down operation. The power window down will be activated after "ON" on CONSULT-III screen is touched.

DIAGNOSIS SYSTEM (BCM)

< FUNCTION DIAGNOSIS >

[INTELLIGENT KEY SYSTEM]

Test item	Description
OUTSIDE BUZZER	This test is able to check Intelligent Key warning buzzer operation. Intelligent Key warning buzzer sounds when "ON" on CONSULT-III screen is touched.
INSIDE BUZZER	This test is able to check warning chime in combination meter operation. <ul style="list-style-type: none"> • Take away warning chime sounds when "TAKE OUT" on CONSULT-III screen is touched. • Key warning chime sounds when "KEY WARN" on CONSULT-III screen is touched. • P position warning chime sounds when "P RNG WARN" on CONSULT-III screen is touched. • ACC warning chime sounds when "ACC WARN" on CONSULT-III screen is touched.
INDICATOR	This test is able to check warning lamp operation. <ul style="list-style-type: none"> • "KEY" Warning lamp illuminates when "KEY IND ON" on CONSULT-III screen is touched. • "KEY" Warning lamp flashes when "KEY IND FSH" on CONSULT-III screen is touched.
INT LAMP	This test is able to check interior room lamp operation. The interior room lamp will be activated after "ON" on CONSULT-III screen is touched.
LCD	This test is able to check meter display information <ul style="list-style-type: none"> • Engine start information displays when "BRAKE/P" on CONSULT-III screen is touched. • Engine start information displays when "BRAKE/P/ON" on CONSULT-III screen is touched. • Key ID warning displays when "KEY ID NG" on CONSULT-III screen is touched. • Steering lock information displays when "STLCK RELES" on CONSULT-III screen is touched. • P position warning displays when "P RNG IND" on CONSULT-III screen is touched. • Intelligent Key insert information displays when "INSERT KEY" on CONSULT-III screen is touched. • Intelligent Key low battery warning displays when "KEY BAT LOW" on CONSULT-III screen is touched. • Take away through window warning displays when "TK AWAY WDW" on CONSULT-III screen is touched. • Take away warning display when "TAKE AWAY" on CONSULT-III screen is touched. • OFF position warning display when "IGN OFF WARN" on CONSULT-III screen is touched.
TRUNK/GLASS HATCH	This test is able to check trunk lid opener actuator open operation. This actuator opens when "ON" on CONSULT-III screen is touched.
FLASHER	This test is able to check security hazard lamp operation. The hazard lamps will be activated after "ON" on CONSULT-III screen is touched.
HORN	This test is able to check horn operation. The horn will be activated after "ON" on CONSULT-III screen is touched.
IGN CONT2	This test is able to check security hazard lamp operation. The hazard lamps will be activated after "ON" on CONSULT-III screen is touched.
P RANGE	This test is able to check A/T device power supply A/T device power is supplied when "ON" on CONSULT-III screen is touched.
ENGINE SW ILLUMI	This test is able to check push-ignition switch illumination operation. Push-ignition switch illumination illuminates when "ON" on CONSULT-III screen is touched.
LOCK INDICATOR	This test is able to check LOCK indicator in push-ignition switch operation. LOCK indicator in push-ignition switch illuminates when "ON" on CONSULT-III screen is touched.
ACC INDICATOR	This test is able to check ACC indicator in push-ignition switch operation. LOCK indicator in push-ignition switch illuminates when "ON" on CONSULT-III screen is touched.
IGNITION ON IND	This test is able to check INGITION ON indicator in push-ignition switch operation. LOCK indicator in push-ignition switch illuminates when "ON" on CONSULT-III screen is touched.
KEY SLOT ILLUMI	This test is able to check key slot illumination operation. Key slot illumination flash when "ON" on CONSULT-III screen is touched.

TRUNK

TRUNK : CONSULT-III Function (BCM - TRUNK)

INFOID:000000000961119

BCM CONSULT-III FUNCTION

CONSULT-III performs the following functions via CAN communication with BCM.

Diagnosis mode	Function Description
DATA MONITOR	The BCM input/output signals are displayed.
ACTIVE TEST	The signals used to activate each device are forcibly supplied from BCM.

DIAGNOSIS SYSTEM (BCM)

< FUNCTION DIAGNOSIS >

[INTELLIGENT KEY SYSTEM]

DATA MONITOR

Monitor Item	Contents
PUSH SW	Indicates [ON/OFF] condition of push switch.
UNLK SEN -DR	Indicates [ON/OFF] condition of unlock sensor.
VEH SPEED 1	Indicates [Km/h] condition of vehicle speed signal from combination meter.
KEY CYL SW-TR	NOTE: This item is displayed, but cannot be monitored.
TR CANCEL SW	Indicates [ON/OFF] condition of trunk lid opener cancel switch.
TR/BD OPEN SW	Indicates [ON/OFF] condition of trunk lid opener switch.
TRNK/HAT MNTR	Indicates [ON/OFF] condition of trunk room lamp switch.
RKE-TR/BD	Indicates [ON/OFF] condition of trunk open signal from Intelligent Key remote controller button.

ACTIVE TEST

Test item	Description
TRUNK/GLASS HATCH	This test is able to check trunk open operation. Trunk open when "OPEN" on CONSULT-III screen is touched.

A
B
C
D
E
F
G
H
I
J
L
M
N
O
P

DLK

COMPONENT DIAGNOSIS

U1000 CAN COMM CIRCUIT

Description

INFOID:000000000961120

CAN (Controller Area Network) is a serial communication line for real time applications. It is an on-vehicle multiplex communication line with high data communication speed and excellent error detection ability. Modern vehicle is equipped with many electronic control unit, and each control unit shares information and links with other control units during operation (not independent). In CAN communication, control units are connected with 2 communication lines (CAN H-line, CAN L-line) allowing a high rate of information transmission with less wiring. Each control unit transmits/receives data but selectively reads required data only. CAN Communication Signal Chart. Refer to [LAN-28, "CAN Communication Signal Chart"](#).

DTC Logic

INFOID:000000000961121

DTC DETECTION LOGIC

DTC	CONSULT-III display description	DTC Detection Condition	Possible cause
U1000	CAN COMM CIRCUIT	When BCM cannot communicate CAN communication signal continuously for 2 seconds or more.	In CAN communication system, any item (or items) of the following listed below is malfunctioning. <ul style="list-style-type: none"> Transmission Receiving (ECM) Receiving (VDC/TCS/ABS) Receiving (METER/M&A) Receiving (TCM) Receiving (MULTI AV) Receiving (IPDM E/R)

Diagnosis Procedure

INFOID:000000000961122

1. PERFORM SELF DIAGNOSTIC

1. Turn ignition switch ON and wait for 2 second or more.
2. Check "Self Diagnostic Result".

Is "CAN COMM CIRCUIT" displayed?

- YES >> Refer to [LAN-18, "Trouble Diagnosis Flow Chart"](#).
 NO >> Refer to [GI-39, "Intermittent Incident"](#).

U1010 CONTROL UNIT (CAN)

< COMPONENT DIAGNOSIS >

[INTELLIGENT KEY SYSTEM]

U1010 CONTROL UNIT (CAN)

DTC Logic

INFOID:000000000961123

DTC DETECTION LOGIC

DTC	CONSULT-III display description	DTC Detection Condition	Possible cause
U1010	CONTROL UNIT (CAN)	BCM detected internal CAN communication circuit malfunction.	BCM

Diagnosis Procedure

INFOID:000000000961124

1. REPLACE BCM

When DTC [U1010] is detected, replace BCM.

>> Replace BCM.

Special Repair Requirement

INFOID:000000000961125

1. REQUIRED WORK WHEN REPLACING BCM

Initialize IVIS by CONSULT-III. For the details of initialization refer to CONSULT-III operation manual NATS-IVIS/NVIS.

>> Work end.

A
B
C
D
E
F
G
H
I
J
L
M
N
O
P

DLK

B2621 INSIDE KEY ANTENNA 1

< COMPONENT DIAGNOSIS >

[INTELLIGENT KEY SYSTEM]

B2621 INSIDE KEY ANTENNA 1

Description

INFOID:000000000961126

Detects whether Intelligent Key is inside the vehicle.
Installed in the instrument center.

DTC Logic

INFOID:000000000961127

DTC DETECTION LOGIC

DTC No.	Trouble diagnosis name	DTC detecting condition	Possible cause
B2621	INSIDE ANTENNA 1 CIRCUIT	An excessive high or low voltage from inside antenna is sent to BCM.	<ul style="list-style-type: none"> Inside key antenna (instrument center) Between BCM and Inside key antenna (instrument center)

DTC CONFIRMATION PROCEDURE

1. PERFORM DTC CONFIRMATION PROCEDURE

Ⓟ With CONSULT-III

- Perform inside key antenna ("INSIDE ANT DIAGNOSIS") on Work Support" of "INTELLIGENT KEY".
- Perform "INTELLIGENT KEY" Self Diagnostic Result.

Is inside key antenna DTC detected?

- YES >> Refer to [DLK-58, "Diagnosis Procedure"](#).
NO >> Inside key antenna (instrument center) is OK.

Diagnosis Procedure

INFOID:000000000961128

1. CHECK INSIDE KEY ANTENNA INPUT SIGNAL 1

- Turn ignition switch OFF.
- Check signal between BCM connector and ground with oscilloscope.

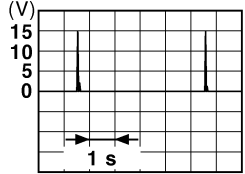
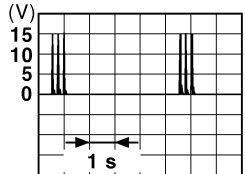
Terminals			(-)	Condition	Signal (Reference value.)
(+) BCM connector		Terminal			
M122	Instrument center	79	Ground	Place Intelligent Key inside the vehicle.	
				Place Intelligent Key outside the vehicle.	

Is the inspection result normal?

- YES >> Check the condition of harness and connector.
NO >> GO TO 2.

2. CHECK INSIDE KEY ANTENNA CIRCUIT

B2621 INSIDE KEY ANTENNA 1

[INTELLIGENT KEY SYSTEM]

< COMPONENT DIAGNOSIS >

1. Disconnect BCM and inside key antenna connector.
2. Check continuity between BCM connector and inside key antenna connector.

BCM connector	Terminal	Inside key antenna connector	Terminal	Continuity
M122	78	M131	Instrument center	Existed
	79		2	
			1	

3. Check continuity between BCM connector and ground.

BCM connector	Terminal	Ground	Continuity
M122	Instrument center	78	Not existed
		79	

Is the inspection result normal?

YES >> GO TO 3.

NO >> Repair or replace harness between BCM and inside key antenna.

3.CHECK INSIDE KEY ANTENNA INPUT SIGNAL 2

1. Replace inside key antenna (instrument center). (New antenna or other antenna)
2. Connect BCM and inside key antenna (instrument center) connector.
3. Check signal between BCM connector and ground with oscilloscope.

Terminals				Condition	Signal (Reference value.)
(+)		(-)			
BCM connector	Terminal				
M122	Instrument center	79	Ground	Place Intelligent Key inside the vehicle.	
				Place Intelligent Key outside the vehicle.	

Is the inspection result normal?

YES >> Replace inside key antenna (instrument center). Refer to [DLK-219. "INSTRUMENT CENTER : Removal and Installation"](#).

NO >> Replace BCM. Refer to [BCS-79. "Removal and Installation"](#).

B2622 INSIDE KEY ANTENNA 2

< COMPONENT DIAGNOSIS >

[INTELLIGENT KEY SYSTEM]

B2622 INSIDE KEY ANTENNA 2

Description

INFOID:000000000961129

Detects whether Intelligent Key is inside the vehicle.
Installed in the console.

DTC Logic

INFOID:000000000961130

DTC DETECTION LOGIC

DTC No.	Trouble diagnosis name	DTC detecting condition	Possible cause
B2622	INSIDE ANTENNA 2 CIRCUIT	An excessive high or low voltage from inside antenna is sent to BCM.	<ul style="list-style-type: none"> Inside key antenna (console) Between BCM ~ Inside key antenna (console)

DTC CONFIRMATION PROCEDURE

1. PERFORM DTC CONFIRMATION PROCEDURE

With CONSULT-III

- Perform inside key antenna ("INSIDE ANT DIAGNOSIS") on "Work Support" of "INTELLIGENT KEY".
- Perform "INTELLIGENT KEY" Self Diagnostic Result.

Is inside key antenna DTC detected?

- YES >> Refer to [DLK-60, "Diagnosis Procedure"](#).
NO >> Inside key antenna (console) is OK.

Diagnosis Procedure

INFOID:000000000961131

1. CHECK INSIDE KEY ANTENNA INPUT SIGNAL 1

- Turn ignition switch OFF.
- Check signal between BCM connector and ground with oscilloscope.

Terminals				Condition	Signal (Reference value.)
(+)		(-)			
BCM connector	Terminal				
M122	Console	73	Ground	Place Intelligent Key inside the vehicle.	
				Place Intelligent Key outside the vehicle.	

Is the inspection result normal?

- YES >> Check the condition of harness and connector.
NO >> GO TO 2.

2. CHECK INSIDE KEY ANTENNA CIRCUIT

- Disconnect BCM and inside key antenna (console) connector.

B2622 INSIDE KEY ANTENNA 2

< COMPONENT DIAGNOSIS >

[INTELLIGENT KEY SYSTEM]

2. Check continuity between BCM connector and inside key antenna connector.

BCM connector	Terminal	Inside key antenna connector	Terminal	Continuity	
M122	72	M146	Console	2	Existed
	73			1	

3. Check continuity between BCM connector and ground.

BCM connector	Terminal	Ground	Continuity
M122	Console	72	Not existed
		73	

Is the inspection result normal?

YES >> GO TO 3.

NO >> Repair or replace harness between BCM and inside key antenna.

3. CHECK INSIDE KEY ANTENNA INPUT SIGNAL 2

1. Replace inside key antenna (console). (New antenna or other antenna)
2. Connect BCM and inside key antenna (console) connector.
3. Check signal between BCM connector and ground with oscilloscope.

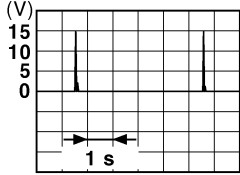
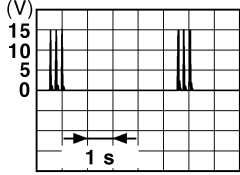
Terminals				Condition	Signal (Reference value.)
(+)		(-)	Terminal		
BCM connector	Terminal				
M122	Console	73	Ground	Place Intelligent Key inside the vehicle.	
				Place Intelligent Key outside the vehicle.	

Is the inspection result normal?

YES >> Replace inside key antenna (console). Refer to [DLK-219, "CONSOLE : Removal and Installation"](#).

NO >> Replace BCM. Refer to [BCS-79, "Removal and Installation"](#).

B2623 INSIDE KEY ANTENNA 3

< COMPONENT DIAGNOSIS >

[INTELLIGENT KEY SYSTEM]

B2623 INSIDE KEY ANTENNA 3

Description

INFOID:000000000961132

Detects whether Intelligent Key is inside the vehicle.
Installed in the trunk room.

DTC Logic

INFOID:000000000961133

DTC DETECTION LOGIC

DTC No.	Trouble diagnosis name	DTC detecting condition	Possible cause
B2623	INSIDE ANTENNA 3 CIRCUIT	An excessive high or low voltage from inside antenna is sent to BCM.	<ul style="list-style-type: none"> Inside key antenna (trunk room) Between BCM ~ Inside key antenna (trunk room)

DTC CONFIRMATION PROCEDURE

1. PERFORM DTC CONFIRMATION PROCEDURE

With CONSULT-III

- Perform inside key antenna ("INSIDE ANT DIAGNOSIS") on "Work Support" of "INTELLIGENT KEY".
- Perform "INTELLIGENT KEY" Self Diagnostic Result.

Is inside key antenna DTC detected?

- YES >> Refer to [DLK-62, "Diagnosis Procedure"](#).
NO >> Inside key antenna (trunk room) is OK.

Diagnosis Procedure

INFOID:000000000961134

1. CHECK INSIDE KEY ANTENNA INPUT SIGNAL 1

- Turn ignition switch OFF.
- Check signal between BCM connector and ground with oscilloscope.

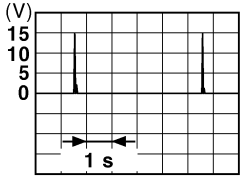
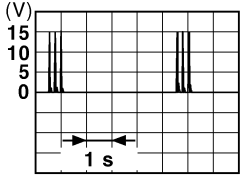
Terminals				Condition	Signal (Reference value.)
(+)		(-)			
BCM connector	Terminal				
M121	Trunk room	35	Ground	Place Intelligent Key inside the vehicle.	 <p>JMKIA0062GB</p>
				Place Intelligent Key outside the vehicle.	 <p>JMKIA0063GB</p>

Is the inspection result normal?

- YES >> Check the condition of harness and connector.
NO >> GO TO 2.

2. CHECK INSIDE KEY ANTENNA CIRCUIT

- Disconnect BCM and inside key antenna (trunk room) connector.

B2623 INSIDE KEY ANTENNA 3

[INTELLIGENT KEY SYSTEM]

< COMPONENT DIAGNOSIS >

2. Check continuity between BCM connector and inside key antenna (trunk room) connector.

BCM connector	Terminal	Inside key antenna connector	Terminal	Continuity	
M121	34	B49	Trunk room	2	Existed
	35			1	

3. Check continuity between BCM connector and ground.

BCM connector	Terminal	Ground	Continuity
M121	Trunk room	34	Not existed
		35	

Is the inspection result normal?

YES >> GO TO 3.

NO >> Repair or replace harness between BCM and inside key antenna (trunk room).

3. CHECK INSIDE KEY ANTENNA INPUT SIGNAL 2

1. Replace inside key antenna (trunk room). (New antenna or other antenna)
2. Connect BCM and inside key antenna (trunk room) connector.
3. Check signal between BCM connector and ground with oscilloscope.

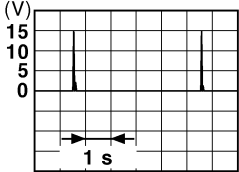
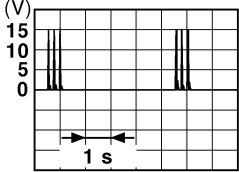
Terminals				Condition	Signal (Reference value.)
(+)		(-)			
BCM connector	Terminal				
M121	Trunk room	35	Ground	Place Intelligent Key inside the vehicle.	
				Place Intelligent Key outside the vehicle.	

Is the inspection result normal?

YES >> Replace inside key antenna (trunk room). Refer to [DLK-219. "TRUNK ROOM : Removal and Installation"](#).

NO >> Replace BCM. Refer to [BCS-79. "Removal and Installation"](#).

POWER SUPPLY AND GROUND CIRCUIT

< COMPONENT DIAGNOSIS >

[INTELLIGENT KEY SYSTEM]

POWER SUPPLY AND GROUND CIRCUIT

Diagnosis Procedure

INFOID:000000000961135

1. CHECK FUSE AND FUSIBLE LINK

Check that the following fuse and fusible link are not fusing.

Terminal No.	Signal name	Fuse and fusible link No.
1	Battery power supply	K
11		10

Is the fuse fusing?

YES >> Replace the blown fuse or fusible link after repairing the affected circuit if a fuse or fusible link is blown.

NO >> GO TO 2.

2. CHECK POWER SUPPLY CIRCUIT

1. Turn ignition switch OFF.
2. Disconnect BCM connectors.
3. Check voltage between BCM harness connector and ground.

Terminals		Voltage (Approx.)
(+)	(-)	
BCM		Ground
Connector	Terminal	
M118	1	
M119	11	Battery voltage

Is the measurement value normal?

YES >> GO TO 3.

NO >> Repair harness or connector.

3. CHECK GROUND CIRCUIT

Check continuity between BCM harness connector and ground.

BCM		Ground	Continuity
Connector	Terminal		
M119	13		Existed

Does continuity exist?

YES >> INSPECTION END

NO >> Repair harness or connector.

DOOR SWITCH

< COMPONENT DIAGNOSIS >

[INTELLIGENT KEY SYSTEM]

DOOR SWITCH

Description

INFOID:000000000961136

Detects door open/close condition.

Component Function Check

INFOID:000000000961137

1.CHECK FUNCTION

With CONSULT-III

Check door switches (“DOOR SW-DR”, “DOOR SW-AS”, “DOOR SW-RL” and “DOOR SW-RR”) in Data Monitor mode with CONSULT-III.

Monitor item	Condition
DOOR SW-DR	CLOSE → OPEN: OFF → ON
DOOR SW-AS	
DOOR SW-RL	
DOOR SW-RR	

Is the inspection result normal?

YES >> Door switch is OK.

NO >> Refer to [DLK-65, "Diagnosis Procedure"](#).

Diagnosis Procedure

INFOID:000000000961138

1.CHECK DOOR SWITCH INPUT SIGNAL

1. Turn ignition switch OFF.
2. Check signal between BCM connector and ground with oscilloscope.

A
B
C
D
E
F
G
H
I
J
L
M
N
O
P

DLK

DOOR SWITCH

< COMPONENT DIAGNOSIS >

[INTELLIGENT KEY SYSTEM]

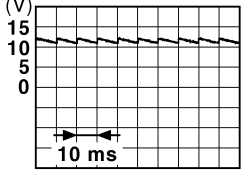
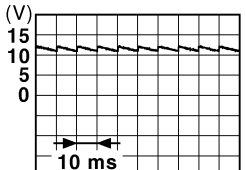
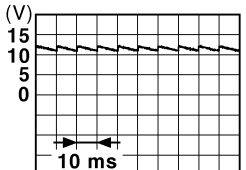
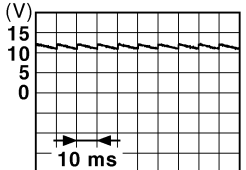
Terminals		(-)	Door condition		Voltage (V) (Approx.)	
(+)						
BCM connector	Terminal					
M123	150	Ground	Driver side	OPEN	0	
				CLOSE	 <small>JPMIA0011GB</small>	
	124		Passenger side	OPEN	0	
				CLOSE	 <small>JPMIA0011GB</small>	
M121	68		Ground	Rear RH	OPEN	0
					CLOSE	 <small>JPMIA0011GB</small>
	69			Rear LH	OPEN	0
					CLOSE	 <small>JPMIA0011GB</small>

Is the inspection result normal?

YES >> GO TO 4.

NO >> GO TO 2.

2. CHECK DOOR SWITCH CIRCUIT

1. Disconnect BCM connector.
2. Check continuity between BCM connector and door switch connector.

BCM connector	Terminal	Door switch connector	Terminal	Continuity
M123	150	B16 (Driver side)	2	Existed
	124	B216 (Passenger side)		
M121	68	B223 (Rear RH)		
	69	B23 (Rear LH)		

3. Check continuity between BCM connector and ground.

DOOR SWITCH

< COMPONENT DIAGNOSIS >

[INTELLIGENT KEY SYSTEM]

BCM connector	Terminal	Ground	Continuity
M123	150		Not existed
	124		
M121	68		
	69		

Is the inspection result normal?

YES >> GO TO 3.

NO >> Repair or replace harness between BCM and door switch.

3.CHECK DOOR SWITCH

Refer to [DLK-67, "Component Inspection"](#).

Is the inspection result normal?

YES >> GO TO 4.

NO >> Replace malfunctioning door switch. Refer to [DLK-218, "Removal and Installation"](#).

4.CHECK INTERMITTENT INCIDENT

Refer to [GI-39, "Intermittent Incident"](#).

>> INSPECTION END

Component Inspection

INFOID:000000000961139

1.CHECK DOOR SWITCH

1. Turn ignition switch OFF.
2. Disconnect door switch connector.
3. Check door switch.

Terminal		Door switch condition	Continuity
Door switch			
2	Ground part of door switch	Pressed	Not existed
		Released	Existed

Is the inspection result normal?

YES >> INSPECTION END.

NO >> Replace malfunction door switch. Refer to [DLK-218, "Removal and Installation"](#).

A
B
C
D
E
F
G
H
I
J
L
M
N
O
P

DLK

DOOR LOCK AND UNLOCK SWITCH

< COMPONENT DIAGNOSIS >

[INTELLIGENT KEY SYSTEM]

DOOR LOCK AND UNLOCK SWITCH

DRIVER SIDE

DRIVER SIDE : Description

INFOID:000000000961140

Transmits door lock/unlock operation to BCM.

DRIVER SIDE : Component Function Check

INFOID:000000000961141

1. CHECK FUNCTION

With CONSULT-III

Check ("CDL LOCK SW ", "CDL UNLOCK SW") in Data Monitor mode with CONSULT-III.

Monitor item	Condition
CDL LOCK SW	LOCK : ON
	UNLOCK : OFF
CDL UNLOCK SW	LOCK : OFF
	UNLOCK : ON

Is the inspection result normal?

YES >> Door lock and unlock switch is OK.

NO >> Refer to [DLK-68, "DRIVER SIDE : Diagnosis Procedure"](#).

DRIVER SIDE : Diagnosis Procedure

INFOID:000000000961142

1. CHECK POWER WINDOW SWITCH OUTPUT SIGNAL

1. Read voltage signal between BCM connector and ground with oscilloscope when door lock and unlock switch (driver side) is turned "LOCK" or "UNLOCK".
2. Check that signals which are shown in the figure below can be detected during 10 second just after door lock and unlock switch (driver side) is turned "LOCK" or "UNLOCK".

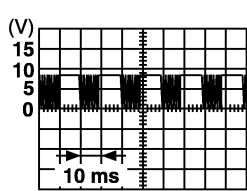
Terminal			Condition	Signal (Reference value)
(+)		(-)		
BCM connector	Terminal			
M123	132	Ground	Door is closed	 <p style="text-align: right; font-size: small;">PIIA1297E</p>

Is the inspection result normal?

YES >> GO TO 4.

NO >> GO TO 2.

2. CHECK POWER WINDOW SWITCH GROUND

1. Turn ignition switch OFF.
2. Disconnect power window main switch connector.
3. Check continuity between power window main switch connector and ground.

Power window main switch connector	Terminal		Continuity
D9	17	Ground	Existed

Is the inspection result normal?

YES >> GO TO 3.

DOOR LOCK AND UNLOCK SWITCH

< COMPONENT DIAGNOSIS >

[INTELLIGENT KEY SYSTEM]

NO >> Repair or replace harness.

3.CHECK POWER WINDOW SERIAL LINK CIRCUIT

1. Disconnect BCM connector.
2. Check continuity between BCM connector and power window main switch connector.

BCM connector	Terminal	Power window main switch connector	Terminal	Continuity
M123	132	D8	14	Existed

Is the inspection result normal?

YES >> GO TO 4.

NO >> Repair or replace harness.

4.CHECK INTERMITTENT INCIDENT

Refer to [GI-39, "Intermittent Incident"](#).

>> INSPECTION END.

DRIVER SIDE : Special Repair Requirement

INFOID:000000000961143

INITIALIZATION PROCEDURE

1. Disconnect battery minus terminal or power window main switch connector. Reconnect it after a minute or more.
2. Turn ignition switch ON.
3. Operate power window switch to fully open the window. (This operation is unnecessary if the window is already fully open)
4. Continue pulling the power window switch UP (AUTO-UP operation). Even after glass stops at fully closed position, keep pulling the switch for 3 seconds or more.
5. Inspect anti-pinch function.

CHECK ANTI-PINCH FUNCTION

1. Fully open the door window.
2. Place a piece of wood near fully closed position.
3. Close door glass completely with AUTO-UP.
 - Check that glass lowers for approximately 150 mm or 2 seconds without pinching piece of wood and stops.
 - Check that glass does not rise when operating the power window main switch while lowering.

CAUTION:

- Do not check with hands and other part of body because they may be pinched. Do not get pinched.
 - Check that AUTO-UP operates before inspection when system initialization is performed.
 - It may switch to fail-safe mode if open/close operation is performed continuously. Perform initial setting in that situation. Refer to [PWC-89, "Fail Safe"](#)
 - Perform initial setting when auto-up operation or anti-pinch function does not operate normally.
 - Finish initial setting. Otherwise, next operation cannot be done.
1. Auto-up operation
 2. Anti-pinch function
 3. Retained power operation when ignition switch is OFF.

PASSENGER SIDE

PASSENGER SIDE : Description

INFOID:000000000961144

Transmits door lock/unlock operation to BCM.

PASSENGER SIDE : Component Function Check

INFOID:000000000961145

1.CHECK FUNCTION

With CONSULT-III

Check ("CDL LOCK SW ", "CDL UNLOCK SW") in Data Monitor mode with CONSULT-III.

A
B
C
D
E
F
G
H
I
J
L
M
N
O
P

DLK

DOOR LOCK AND UNLOCK SWITCH

< COMPONENT DIAGNOSIS >

[INTELLIGENT KEY SYSTEM]

Monitor item	Condition
CDL LOCK SW	LOCK : ON
	UNLOCK : OFF
CDL UNLOCK SW	LOCK : OFF
	UNLOCK : ON

Is the inspection result normal?

- YES >> Door lock and unlock switch is OK.
 NO >> Refer to [DLK-70. "PASSENGER SIDE : Diagnosis Procedure"](#).

PASSENGER SIDE : Diagnosis Procedure

INFOID:000000000961146

1. CHECK POWER WINDOW SWITCH OUTPUT SIGNAL

- Read voltage signal between BCM connector and ground with oscilloscope when door lock and unlock switch (passenger side) is turned "LOCK" or "UNLOCK".
- Check that signals which are shown in the figure below can be detected during 10 second just after door lock and unlock switch (passenger side) is turned "LOCK" or "UNLOCK".

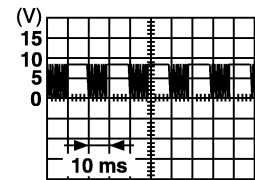
Terminal		Condition	Signal (Reference value)
(+)	(-)		
BCM connector	Terminal		
M123	132	Door is closed	 <p style="text-align: right; font-size: x-small;">PIIA1297E</p>

Is the inspection result normal?

- YES >> GO TO 4.
 NO >> GO TO 2.

2. CHECK POWER WINDOW SWITCH GROUND

- Turn ignition switch OFF.
- Disconnect front power window switch (passenger side) connector.
- Check continuity between front power window switch (passenger side) connector and ground.

Front power window switch (passenger side) connector	Terminal	Continuity
D38	11 Ground	Existed

Is the inspection result normal?

- YES >> GO TO 3.
 NO >> Repair or replace harness.

3. CHECK POWER WINDOW SERIAL LINK CIRCUIT

- Disconnect BCM connector.
- Check continuity between BCM connector and front power window switch (passenger side) connector.

BCM connector	Terminal	Front power window switch (passenger side) connector	Terminal	Continuity
M123	132	D38	16	Existed

Is the inspection result normal?

- YES >> GO TO 4.
 NO >> Repair or replace harness.

DOOR LOCK AND UNLOCK SWITCH

< COMPONENT DIAGNOSIS >

[INTELLIGENT KEY SYSTEM]

4. CHECK INTERMITTENT INCIDENT

Refer to [GI-39. "Intermittent Incident"](#).

YES >> INSPECTION END.

PASSENGER SIDE : Special Repair Requirement

INFOID:000000000961147

INITIALIZATION PROCEDURE

1. Disconnect battery minus terminal or power window main switch connector. Reconnect it after a minute or more.
2. Turn ignition switch ON.
3. Operate power window switch to fully open the window. (This operation is unnecessary if the window is already fully open)
4. Continue pulling the power window switch UP (AUTO-UP operation). Even after glass stops at fully closed position, keep pulling the switch for 3 seconds or more.
5. Inspect anti-pinch function.

CHECK ANTI-PINCH FUNCTION

1. Fully open the door window.
2. Place a piece of wood near fully closed position.
3. Close door glass completely with AUTO-UP.
 - Check that glass lowers for approximately 150 mm or 2 seconds without pinching piece of wood and stops.
 - Check that glass does not rise when operating the power window main switch while lowering.

CAUTION:

- Do not check with hands and other part of body because they may be pinched. Do not get pinched.
 - Check that AUTO-UP operates before inspection when system initialization is performed.
 - It may switch to fail-safe mode if open/close operation is performed continuously. Perform initial setting in that situation. Refer to [PWC-89. "Fail Safe"](#)
 - Perform initial setting when auto-up operation or anti-pinch function does not operate normally.
 - Finish initial setting. Otherwise, next operation cannot be done.
1. Auto-up operation
 2. Anti-pinch function
 3. Retained power operation when ignition switch is OFF.

A
B
C
D
E
F
G
H
I
J
L
M
N
O
P

DLK

KEY SLOT

Description

INFOID:000000000961148

Detect whether Intelligent Key is inserted.
Immobilizer antenna amp checks Intelligent Key transponder.

Component Function Check

INFOID:000000000961149

1.CHECK FUNCTION

 With CONSULT-III

Check key slot ("KEY SW -SLOT") in Data Monitor mode with CONSULT-III.

Monitor item	Condition
KEY SW-SLOT	Key is inserted in key slot: ON
	Key is removed from key slot: OFF

Is the inspection result normal?

- YES >> Key slot is OK.
- NO >> Refer to [DLK-72, "Diagnosis Procedure"](#).

Diagnosis Procedure

INFOID:000000000961150

1.CHECK KEY SLOT POWER SUPPLY CIRCUIT

1. Turn ignition switch OFF.
2. Disconnect key slot connector.
3. Check voltage between slot connector and ground.

Terminals		Voltage (V) (Approx.)
(+)	(-)	
Key slot connector	Terminal	Battery voltage
M22	1 5	

Is the inspection result normal?

- YES >> GO TO 2.
- NO >> Repair or replace key slot power supply circuit.

2.CHECK KEY SLOT GROUND CIRCUIT

Check continuity between key slot connector and ground.

Key slot connector	Terminal	Ground	Continuity
M22	7		Existed

Is the inspection result normal?

- YES >> GO TO 3.
- NO >> Repair or replace key slot ground circuit.

3.CHECK KEY SLOT CIRCUIT

1. Disconnect BCM connector.
2. Check continuity between BCM connector and key slot connector.

BCM connector	Terminal	Key slot connector	Terminal	Continuity
M123	121	M22	11	Existed

3. Check continuity between BCM connector and ground.

KEY SLOT

< COMPONENT DIAGNOSIS >

[INTELLIGENT KEY SYSTEM]

BCM connector	Terminal	Ground	Continuity
M123	121		Not existed

Is the inspection result normal?

YES >> GO TO 4.

NO >> Repair or replace harness between BCM and key slot.

4.CHECK KEY SLOT

Refer to [DLK-73, "Component Inspection"](#).

Is the inspection result normal?

YES >> GO TO 5.

NO >> Replace key slot. Refer to [DLK-223, "Removal and Installation"](#).

5.CHECK INTERMITTENT INCIDENT

Refer to [GI-39, "Intermittent Incident"](#).

>> INSPECTION END

Component Inspection

INFOID:000000000961151

1.CHECK KEY SLOT

Check key slot.

Terminal		Condition	Continuity
Key slot			
1	11	Intelligent Key inserted	Existed
		Intelligent Key removed	Not existed

Is the inspection result normal?

YES >> INSPECTION END.

NO >> Replace key slot. Refer to [DLK-223, "Removal and Installation"](#).

DLK

KEY CYLINDER SWITCH

< COMPONENT DIAGNOSIS >

[INTELLIGENT KEY SYSTEM]

KEY CYLINDER SWITCH

Description

INFOID:000000000961152

Power window main switch detects condition of the door key cylinder switch and transmits to BCM as the LOCK or UNLOCK signals.

Component Function Check

INFOID:000000000961153

1.CHECK DOOR KEY CYLINDER SWITCH INPUT SIGNAL

Check ("KEY CYL LK-SW", "KEY CYL UN-SW") in "DATA MONITOR" mode for "POWER DOOR LOCK SYSTEM" with CONSULT-III. Refer to [DLK-50. "DOOR LOCK : CONSULT-III Function \(BCM - DOOR LOCK\)".](#)

Monitor item	Condition
KEY CYL LK-SW	Lock : ON
	Neutral / Unlock : OFF
KEY CYL UN-SW	Unlock : ON
	Neutral / Lock : OFF

Is the inspection result normal?

- YES >> Key cylinder switch is OK.
NO >> Refer to [DLK-74. "Diagnosis Procedure".](#)

Diagnosis Procedure

INFOID:000000000961154

1.CHECK DOOR KEY CYLINDER SWITCH INPUT SIGNAL

1. Turn ignition switch ON.
2. Check voltage between power window main switch connector and ground.

Terminals		Key position	Voltage (V) (Approx.)	
(+)	(-)			
Power window main switch connector	Terminal	Ground	Lock	0
			Neutral / Unlock	5
D8	4		Unlock	0
			Neutral / Lock	5

Is the inspection result normal?

- YES >> Replace power window main switch. Refer to [PWC-126. "Removal and Installation".](#) After that, Refer to [PWC-16. "POWER WINDOW MAIN SWITCH : Special Repair Requirement".](#)
NO >> GO TO 2.

2.CHECK DOOR KEY CYLINDER SIGNAL CIRCUIT

1. Turn ignition switch OFF.
2. Disconnect power window main switch connector and front door key lock assembly (driver side) (key cylinder switch) connector.
3. Check continuity between power window main switch connector and front door lock assembly (driver side) (key cylinder switch) connector.

Power window main switch connector	Terminal	Front door lock assembly (driver side) (key cylinder switch) connector	Terminal	Continuity
D8	4	D15	6	Existed
	6		5	

4. Check continuity between power window main switch connector and ground.

KEY CYLINDER SWITCH

< COMPONENT DIAGNOSIS >

[INTELLIGENT KEY SYSTEM]

Power window main switch connector	Terminal	Ground	Continuity	
D8	4			Not existed
	6			

Is the inspection result normal?

YES >> GO TO 3.

NO >> Repair or replace harness.

3.CHECK DOOR KEY CYLINDER SWITCH GROUND CIRCUIT

Check continuity between front door lock assembly (driver side) connector and ground.

Front door lock assembly (driver side) connector	Terminal	Ground	Continuity
D15	4		

Is the inspection result normal?

YES >> GO TO 4.

NO >> Repair or replace harness.

4.CHECK DOOR KEY CYLINDER SWITCH

Check door key cylinder switch.

Refer to [DLK-75. "Component Inspection"](#).

Is the inspection result normal?

YES >> Check intermittent incident. Refer to [GI-39. "Intermittent Incident"](#).

NO >> Replace front door lock assembly (driver side) (key cylinder switch). Refer to [DLK-207. "FRONT DOOR LOCK : Removal and Installation"](#). After that, Refer to [DLK-75. "Special Repair Requirement"](#).

Component Inspection

INFOID:000000000961155

COMPONENT INSPECTION

1.CHECK DOOR KEY CYLINDER SWITCH

Check front door lock assembly (driver side) (key cylinder switch).

Terminal		Key position	Continuity
Front door lock assembly (driver side) (key cylinder switch) connector			
5	4	Unlock	Existed
		Neutral / Lock	Not existed
6	4	Lock	Existed
		Neutral / Unlock	Not existed

Is the inspection result normal?

YES >> Key cylinder switch is OK.

NO >> Replace front door lock assembly (driver side) (key cylinder switch). Refer to [DLK-207. "FRONT DOOR LOCK : Removal and Installation"](#). After that, Refer to [DLK-75. "Special Repair Requirement"](#).

Special Repair Requirement

INFOID:000000000961156

1.PERFORM INITIALIZATION PROCEDURE

Perform initialization procedure.

Refer to [PWC-7. "ADDITIONAL SERVICE WHEN REMOVING BATTERY NEGATIVE TERMINAL : Special Repair Requirement"](#).

Is the inspection result normal?

KEY CYLINDER SWITCH

< COMPONENT DIAGNOSIS >

[INTELLIGENT KEY SYSTEM]

YES >> Inspection end.

NO >> Check intermittent incident. Refer to [GI-39, "Intermittent Incident"](#).

UNLOCK SENSOR

< COMPONENT DIAGNOSIS >

[INTELLIGENT KEY SYSTEM]

UNLOCK SENSOR

Description

INFOID:000000000961157

Detects door lock condition of driver door.

Component Function Check

INFOID:000000000961158

1. CHECK FUNCTION

With CONSULT-III

Check unlock sensor ("DOOR STAT SW") in "Data Monitor" mode.

Monitor item	Condition
DOOR STAT SW	Front door lock (driver side) LOCK: OFF
	Front door lock (driver side) UNLOCK: ON

Is the inspection result normal?

YES >> Unlock sensor is OK.

NO >> Refer to [DLK-77, "Diagnosis Procedure"](#).

Diagnosis Procedure

INFOID:000000000961159

1. CHECK UNLOCK SENSOR POWER SUPPLY

Check signal between BCM connector and ground with oscilloscope.

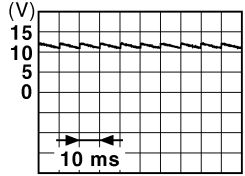
Terminals		Front door lock (driver side) condition	Voltage (V) (Approx.)
(+)	(-)		
BCM connector	Terminal		
M123	119	Locked	
		Unlocked	0

Is the inspection result normal?

YES >> GO TO 6.

NO >> GO TO 2.

2. CHECK UNLOCK SENSOR CIRCUIT

1. Turn ignition switch OFF.
2. Disconnect BCM and front door lock assembly (driver side) connector.
3. Check continuity between BCM connector and front door lock assembly (driver side) connector.

BCM connector	Terminal	Front door lock assembly (driver side) connector	Terminal	Continuity
M123	119	D15	3	Existed

4. Check continuity between BCM connector and ground.

BCM connector	Terminal	Ground	Continuity
M123	119		Not existed

Is the inspection result normal?

YES >> GO TO 3.

A
B
C
D
E
F
G
H
I
J
L
M
N
O
P

DLK

UNLOCK SENSOR

[INTELLIGENT KEY SYSTEM]

< COMPONENT DIAGNOSIS >

NO >> Repair or replace harness between BCM and front door lock assembly (driver side).

3.CHECK UNLOCK SENSOR GROUND CIRCUIT

Check continuity between front door lock assembly (driver side) connector and ground.

Front door lock assembly (driver side) connector	Terminal	Ground	Continuity
D15	4		Existed

Is the inspection result normal?

YES >> GO TO 4.

NO >> Repair or replace harness.

4.CHECK BCM OUTPUT SIGNAL

1. Connect BCM harness connector.
2. Check signal between BCM connector and ground with oscilloscope.

Terminals		Voltage (V) (Approx.)
(+)	(-)	
BCM connector	Terminal	
M123	119	Ground

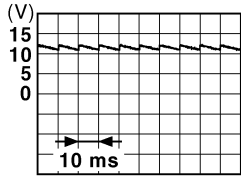

JPMIA0011GB

Is the inspection result normal?

YES >> GO TO 5.

NO >> Replace BCM. [BCS-79, "Removal and Installation"](#)

5.CHECK UNLOCK SENSOR

Refer to [DLK-78, "Component Inspection"](#).

Is the inspection result normal?

YES >> GO TO 6.

NO >> Replace front door lock assembly (driver side). Refer to [DLK-207, "FRONT DOOR LOCK : Removal and Installation"](#).

6.CHECK INTERMITTENT INCIDENT

Refer to [GI-39, "Intermittent Incident"](#).

>> INSPECTION END.

Component Inspection

INFOID:000000000961160

1.CHECK UNLOCK SENSOR

Check unlock sensor.

Terminal		Front door lock assembly (driver side) condition	Continuity
Front door lock assembly (driver side)			
3	4	Unlock	Existed
		Lock	Not existed

Is the inspection result normal?

YES >> INSPECTION END.

UNLOCK SENSOR

< COMPONENT DIAGNOSIS >

[INTELLIGENT KEY SYSTEM]

NO >> Replace front lock assembly (driver side). Refer to [DLK-207, "FRONT DOOR LOCK : Removal and Installation"](#).

A

B

C

D

E

F

G

H

I

J

DLK

L

M

N

O

P

TRUNK LID OPENER SWITCH

< COMPONENT DIAGNOSIS >

[INTELLIGENT KEY SYSTEM]

TRUNK LID OPENER SWITCH

Description

INFOID:000000000961161

Transmits trunk lid open signal to BCM.

Component Function Check

INFOID:000000000961162

1. CHECK TRUNK LID OPENER CANCEL SWITCH

Check trunk lid opener cancel switch position.

Does trunk lid opener cancel switch turn ON (CANCEL)?

- Yes >> Turn off trunk lid opener cancel switch.
- No >> GO TO 2.

2. CHECK FUNCTION

Ⓜ With CONSULT-III

Check trunk lid opener switch ("TR/BD OPEN SW") in "Data Monitor mode with CONSULT-III."

- When trunk lid opener switch is turned to "ON".

Monitor item	Condition
TR/BD OPEN SW	Trunk lid opener switch is pressed: ON
	Trunk lid opener switch is released: OFF

Is the inspection result normal?

- YES >> Trunk lid opener switch is OK.
- NO >> Refer to [DLK-80. "Diagnosis Procedure"](#).

Diagnosis Procedure

INFOID:000000000961163

1. CHECK TRUNK LID OPEN INPUT SIGNAL

1. Remove Intelligent Key from key slot.
2. Turn on trunk lid opener cancel switch.
3. Check voltage between BCM connector and ground.

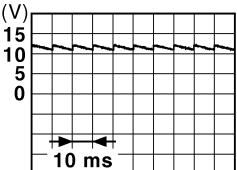
Terminals		Condition of trunk lid opener switch	Voltage (V) (Approx.)
(+)	(-)		
BCM connector	Terminal	ON (press and hold)	0
M121	67	OFF (release)	

JPMIA0011GB

Is the inspection result normal?

- YES >> GO TO 2.
- NO >> GO TO 5.

2. CHECK TRUNK LID OPENER SWITCH CIRCUIT

1. Disconnect BCM connector.
2. Check continuity between BCM connector and trunk lid opener switch connector.

TRUNK LID OPENER SWITCH

< COMPONENT DIAGNOSIS >

[INTELLIGENT KEY SYSTEM]

BCM connector	Terminal	Trunk lid opener switch connector	Terminal	Continuity
M121	67	M20	1	Existed

3. Check continuity between BCM connector and ground.

BCM connector	Terminal	Ground	Continuity
M121	67		Not existed

Is the inspection result normal?

YES >> GO TO 3.

NO >> Repair harness or connector.

3.CHECK TRUNK LID OPENER SWITCH GROUND CIRCUIT

Check continuity between trunk lid opener switch connector and ground.

Trunk lid opener switch	Terminal	Ground	Continuity
M20	2		Existed

Is the inspection result normal?

YES >> GO TO 4.

NO >> Repair or replace harness.

4.CHECK TRUNK LID OPENER SWITCH

Refer to [DLK-81, "Component Inspection"](#).

Is the inspection result normal?

YES >> GO TO 5.

NO >> Replace trunk lid opener switch. Refer to [DLK-225, "Removal and Installation"](#).

5.CHECK INTERMITTENT INCIDENT

Refer to [GI-39, "Intermittent Incident"](#).

>> INSPECTION END.

Component Inspection

INFOID:000000000961164

DLK

1.CHECK TRUNK LID OPENER SWITCH

1. Turn ignition switch OFF.
2. Disconnect trunk lid opener switch connector.
3. Check continuity between trunk lid opener switch connector.

Terminal		Condition	Continuity
Trunk lid opener switch			
1	2	ON (press and hold)	Existed
		OFF (release)	Not existed

Is the inspection result normal?

YES >> INSPECTION END.

NO >> Replace trunk lid opener switch. Refer to [DLK-225, "Removal and Installation"](#).

TRUNK LID OPENER CANCEL SWITCH

< COMPONENT DIAGNOSIS >

[INTELLIGENT KEY SYSTEM]

TRUNK LID OPENER CANCEL SWITCH

Description

INFOID:000000000961165

Cancels trunk lid open operation.

Component Function Check

INFOID:000000000961166

1. CHECK FUNCTION

With CONSULT-III

Check trunk lid opener cancel switch ("TR CANCEL SW") in Data Monitor mode with CONSULT-III.

Monitor item	Condition
TR CANCEL SW	Trunk lid opener cancel switch is turned to "ON": ON
	Trunk lid opener cancel switch is turned to "OFF": OFF

Is the inspection result normal?

- YES >> Trunk lid opener cancel switch is OK.
 NO >> Refer to [DLK-82, "Diagnosis Procedure"](#).

Diagnosis Procedure

INFOID:000000000961167

1. CHECK TRUNK LID OPENER CANCEL SIGNAL

1. Check voltage between BCM connector and ground.

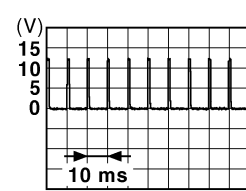
Terminals		Condition of trunk lid opener cancel switch	Voltage (V) (Approx.)
(+)	(-)		
BCM connector	Terminal	ON (press and hold)	0
M123	129	OFF (cancel)	

JPMIA0012GB

Is the inspection result normal?

- YES >> GO TO 2.
 NO >> GO TO 5.

2. CHECK TRUNK LID OPENER CANCEL SWITCH CIRCUIT

1. Disconnect BCM connector.
2. Check continuity between BCM connector and trunk lid opener cancel switch connector.

BCM connector	Terminal	Trunk lid opener cancel switch connector	Terminal	Continuity
M123	129	M105	1	Existed

3. Check continuity between BCM connector and ground.

BCM connector	Terminal	Ground	Continuity
M123	129		Not existed

Is the inspection result normal?

- YES >> GO TO 3.
 NO >> Repair harness or connector.

TRUNK LID OPENER CANCEL SWITCH

< COMPONENT DIAGNOSIS >

[INTELLIGENT KEY SYSTEM]

3.CHECK TRUNK LID OPENER CANCEL SWITCH GROUND CIRCUIT

Check continuity between trunk lid opener switch connector and ground.

Trunk lid opener cancel switch	Terminal	Ground	Continuity
M105	2		Existed

Is the inspection result normal?

YES >> GO TO 4.

NO >> Repair or replace harness.

4.CHECK TRUNK LID OPENER CANCEL SWITCH

Refer to [DLK-83. "Component Inspection"](#).

Is the inspection result normal?

YES >> GO TO 5.

NO >> Replace trunk lid opener cancel switch. Refer to [DLK-226. "Removal and Installation"](#).

5.CHECK INTERMITTENT INCIDENT

Refer to [GI-39. "Intermittent Incident"](#).

>> INSPECTION END.

Component Inspection

INFOID:000000000961168

1.CHECK TRUNK LID OPENER CANCEL SWITCH

1. Disconnect trunk lid opener cancel switch connector.
2. Check continuity between trunk lid opener cancel switch connector.

Terminal		Condition	Continuity
Trunk lid opener switch			
1	2	ON	Existed
		OFF (cancel)	Not existed

Is the inspection result normal?

YES >> INSPECTION END.

NO >> Replace trunk lid opener cancel switch. Refer to [DLK-226. "Removal and Installation"](#).

A
B
C
D
E
F
G
H
I
J
L
M
N
O
P

DLK

TRUNK ROOM LAMP SWITCH

< COMPONENT DIAGNOSIS >

[INTELLIGENT KEY SYSTEM]

TRUNK ROOM LAMP SWITCH

Description

INFOID:000000000961169

Detects trunk open/close condition.

Component Function Check

INFOID:000000000961170

1. CHECK FUNCTION

With CONSULT-III

Check ("TR/HAT MNTR") in Data Monitor mode with CONSULT-III.

Monitor item	Condition
TRNK/HAT MNTR	OPEN : ON
	CLOSE : OFF

Is the inspection result normal?

YES >> Trunk room lamp switch is OK.

NO >> Refer to [DLK-85, "Component Inspection"](#).

Diagnosis Procedure

INFOID:000000000961171

1. CHECK TRUNK ROOM LAMP SWITCH INPUT SIGNAL

- Turn ignition switch OFF.
- Check voltage between BCM connector and ground.

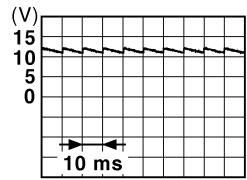
Terminals		Trunk condition	Voltage (V) (Approx.)
(+)	(-)		
BCM connector	Terminal		
M121	50	OPEN	0
		CLOSE	

JPMA0011GB

Is the inspection result normal?

YES >> GO TO 4.

NO >> GO TO 2.

2. CHECK TRUNK ROOM LAMP SWITCH CIRCUIT

- Disconnect BCM connector.
- Check continuity between BCM connector and trunk lid lock assembly (trunk room lamp switch) connector.

BCM connector	Terminal	Trunk lid lock assembly (trunk room lamp switch) connector	Terminal	Continuity
M121	50	B303	1	Existed

- Check continuity between BCM connector and ground.

BCM connector	Terminal	Ground	Continuity
M121	50		Not existed

Is the inspection result normal?

TRUNK ROOM LAMP SWITCH

[INTELLIGENT KEY SYSTEM]

< COMPONENT DIAGNOSIS >

- YES >> GO TO 3.
 NO >> Repair or replace harness between BCM and trunk room lamp switch.

3.CHECK TRUNK ROOM LAMP SWITCH GROUND CIRCUIT

Check continuity between trunk lid lock assembly connector and ground.

Trunk lid lock assembly (trunk room lamp switch) connector	Terminal	Ground	Continuity
B303	2		Existed

Is the inspection result normal?

- YES >> GO TO 4.
 NO >> Repair or replace trunk room lamp switch ground circuit.

4.CHECK BCM OUTPUT SIGNAL

1. Connect BCM connector.
2. Check voltage between BCM connector and ground.

Terminals		Voltage (V) (Approx.)
(+)	(-)	
BCM connector	Terminal	
M121	50	Ground

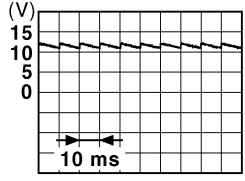

JPMA0011GB

Is the inspection result normal?

- YES >> GO TO 5.
 NO >> Replace BCM. Refer to [BCS-79. "Removal and Installation"](#).

5.CHECK TRUNK ROOM LAMP SWITCH

Refer to [DLK-85. "Component Inspection"](#).

Is the inspection result normal?

- YES >> GO TO 6.
 NO >> Replace trunk lid lock assembly (trunk room lamp switch). Refer to [DLK-216. "TRUNK LID LOCK : Removal and Installation"](#).

6.CHECK INTERMITTENT INCIDENT

Refer to [GI-39. "Intermittent Incident"](#).

>> INSPECTION END.

Component Inspection

INFOID:000000000961172

1.CHECK TRUNK ROOM LAMP SWITCH

1. Turn ignition switch OFF.
2. Disconnect trunk lid lock assembly (trunk room lamp switch) connector.
3. Check trunk room lamp switch.

Terminal		Trunk condition	Continuity
Trunk room lamp switch			
1	2	OPEN	Existed
		CLOSE	Not existed

TRUNK ROOM LAMP SWITCH

< COMPONENT DIAGNOSIS >

[INTELLIGENT KEY SYSTEM]

Is the inspection result normal?

YES >> INSPECTION END.

NO >> Replace trunk lid lock assembly (trunk room lamp switch). Refer to [DLK-216. "TRUNK LID LOCK : Removal and Installation"](#).

DOOR REQUEST SWITCH

< COMPONENT DIAGNOSIS >

[INTELLIGENT KEY SYSTEM]

DOOR REQUEST SWITCH

Description

INFOID:000000000961173

Transmits lock/unlock operation to BCM.

Component Function Check

INFOID:000000000961174

1. CHECK FUNCTION

With CONSULT-III

Check door request switch ("DR REQ SW" or "AS REQ SW") in Data Monitor mode.

Monitor item	Condition
DR REQ SW	Door request switch is pressed: ON
AS REQ SW	Door request switch is released: OFF

Is the inspection result normal?

- YES >> Door request switch is OK.
- NO >> Refer to [DLK-87, "Diagnosis Procedure"](#).

Diagnosis Procedure

INFOID:000000000961175

1. CHECK DOOR REQUEST SWITCH OUTPUT SIGNAL

1. Turn ignition switch OFF.
2. Check voltage between BCM harness connector and ground.

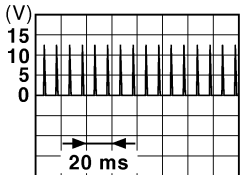
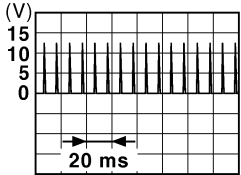
Terminals			Door request switch Condition	Voltage (V) (Approx.)
(+)		(-)		
BCM connector	Terminal			
M122	Door request switch (driver side)	101	Pressed	0
			Released	 <p style="text-align: right; font-size: small;">JMKIA0059GB</p>
	Door request switch (passenger side)	100	Pressed	0
			Released	 <p style="text-align: right; font-size: small;">JMKIA0059GB</p>

Is the inspection result normal?

- YES >> GO TO 6.
- NO >> GO TO 2.

2. CHECK DOOR REQUEST SWITCH CIRCUIT

1. Disconnect BCM and front outside handle connector.
2. Check continuity between BCM connector and front outside handle connector.

A
B
C
D
E
F
G
H
I
J
L
M
N
O
P

DLK

DOOR REQUEST SWITCH

< COMPONENT DIAGNOSIS >

[INTELLIGENT KEY SYSTEM]

BCM connector	Terminal	Front outside handle connector	Terminal	Continuity
M122	101	D13 (driver side)	1	Existed
	100	D43 (passenger side)		

3. Check continuity between BCM connector and ground.

BCM connector	Terminal	Ground	Continuity
M122	101	Ground	Not existed
	100		

Is the inspection result normal?

YES >> GO TO 3.

NO >> Repair or replace harness between BCM and front outside handle.

3. CHECK DOOR REQUEST SWITCH GROUND CIRCUIT

Check continuity between front outside handle connector and ground.

Front outside handle connector	Terminal	Ground	Continuity
D13 (driver side)	2	Ground	Existed
D43 (passenger side)			

Is the inspection result normal?

YES >> GO TO 4.

NO >> Repair or replace front outside handle ground circuit.

4. CHECK BCM OUTPUT SIGNAL

1. Connect BCM connector.

2. Check voltage between BCM connector and ground.

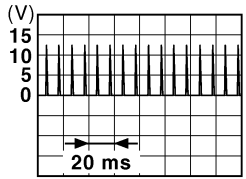
Terminals		Voltage (V) (Approx.)
(+)	(-)	
BCM connector	Terminal	
M122	101	
	100	
	Ground	JMKIA0059GB

Is the inspection result normal?

YES >> GO TO 5.

NO >> Replace BCM. Refer to [BCS-79, "Removal and Installation"](#).

5. CHECK DOOR REQUEST SWITCH

Refer to [DLK-89, "Component Inspection"](#).

Is the inspection result normal?

YES >> GO TO 6.

NO >> Replace malfunctioning front outside handle. Refer to [DLK-201, "FRONT DOOR : Removal and Installation"](#).

6. CHECK INTERMITTENT INCIDENT

Refer to [GI-39, "Intermittent Incident"](#).

DOOR REQUEST SWITCH

[INTELLIGENT KEY SYSTEM]

< COMPONENT DIAGNOSIS >

>> INSPECTION END

Component Inspection

INFOID:000000000961176

1. CHECK DOOR REQUEST SWITCH

Check front outside handle (request switch).

Terminal		Door request switch condition	Continuity
Front outside handle (request switch)			
1	2	Pressed	Existed
		Released	Not existed

Is the inspection result normal?

YES >> INSPECTION END.

NO >> Replace malfunction front outside handle. Refer to [DLK-201. "FRONT DOOR : Removal and Installation"](#).

A
B
C
D
E
F
G
H
I
J
L
M
N
O
P

DLK

TRUNK OPENER REQUEST SWITCH

< COMPONENT DIAGNOSIS >

[INTELLIGENT KEY SYSTEM]

TRUNK OPENER REQUEST SWITCH

Description

INFOID:000000000961177

Performs trunk lid open request when it is pressed.

Component Function Check

INFOID:000000000961178

1.CHECK FUNCTION

With CONSULT-III

Check trunk opener request switch ("REQ SW -BD/TR ") in Data Monitor mode.

Monitor item	Condition
REQ SW -BD/TR	Trunk opener request switch is pressed: ON
	Trunk opener request switch is released: OFF

Is the inspection result normal?

- YES >> Trunk opener request switch is OK.
 NO >> Refer to [DLK-90, "Diagnosis Procedure"](#).

Diagnosis Procedure

INFOID:000000000961179

1.CHECK TRUNK OPENER REQUEST SWITCH OUTPUT SIGNAL

- Turn ignition switch OFF.
- Check voltage between BCM connector and ground.

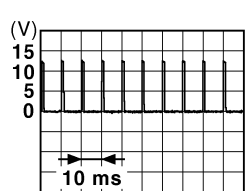
Terminals		Trunk lid opener request switch condition	Voltage (V) (Approx.)
(+)	(-)		
BCM connector	Terminal	Pressed	0
M121	61	Released	 <p>(V) 15 10 5 0</p> <p>10 ms</p>

JPMIA0016GB

Is the inspection result normal?

- YES >> GO TO 6.
 NO >> GO TO 2.

2.CHECK TRUNK OPENER REQUEST SWITCH CIRCUIT

- Disconnect BCM and trunk opener request switch connector.
- Check continuity between BCM connector and trunk opener request switch connector.

BCM connector	Terminal	Trunk request switch connector	Terminal	Continuity
M121	61	B304	1	Existed

- Check continuity between BCM connector and ground.

BCM connector	Terminal	Ground	Continuity
M121	61		Not existed

Is the inspection result normal?

- YES >> GO TO 3.

TRUNK OPENER REQUEST SWITCH

[INTELLIGENT KEY SYSTEM]

< COMPONENT DIAGNOSIS >

NO >> Repair or replace harness between BCM and trunk opener request switch.

3.CHECK TRUNK OPENER REQUEST SWITCH GROUND CIRCUIT

Check continuity between trunk opener request switch connector and ground.

Trunk opener request switch connector	Terminal	Ground	Continuity
B304	2		Existed

Is the inspection result normal?

YES >> GO TO 4.

NO >> Repair or replace trunk opener request switch ground circuit.

4.CHECK BCM OUTPUT SIGNAL

1. Connect BCM connector.
2. Check voltage between BCM connector and ground.

Terminals		Voltage (V) (Approx.)
(+)	(-)	
BCM connector	Terminal	
M121	61	Ground

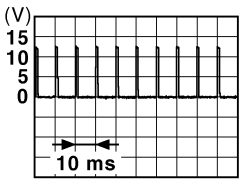

JPMA0016GB

Is the inspection result normal?

YES >> GO TO 5.

NO >> Replace BCM. Refer to [BCS-79, "Removal and Installation"](#).

5.CHECK TRUNK OPENER REQUEST SWITCH

Refer to [DLK-91, "Component Inspection"](#).

Is the inspection result normal?

YES >> GO TO 6.

NO >> Replace trunk opener request switch. Refer to [DLK-224, "Removal and Installation"](#).

6.CHECK INTERMITTENT INCIDENT

Refer to [GI-39, "Intermittent Incident"](#).

>> INSPECTION END.

Component Inspection

INFOID:000000000961180

1.CHECK TRUNK OPENER REQUEST SWITCH

Check trunk opener request switch.

Terminal		Trunk opener request switch condition	Continuity
Trunk opener request switch			
1	2	Pressed	Existed
		Released	Not existed

Is the inspection result normal?

YES >> INSPECTION END.

NO >> Replace trunk opener request switch. Refer to [DLK-224, "Removal and Installation"](#).

DOOR LOCK ACTUATOR

< COMPONENT DIAGNOSIS >

[INTELLIGENT KEY SYSTEM]

DOOR LOCK ACTUATOR DRIVER SIDE

DRIVER SIDE : Description

INFOID:000000000961181

Locks/unlocks the door with the signal from BCM.

DRIVER SIDE : Component Function Check

INFOID:000000000961182

1.CHECK FUNCTION

1. Use CONSULT-III to perform Active Test ("DOOR LOCK").
2. Touch "ALL LOCK" or "ALL UNLOCK" to check that it works normally.

Is the inspection result normal?

- YES >> Door lock actuator is OK.
NO >> Refer to [DLK-92, "DRIVER SIDE : Diagnosis Procedure"](#).

DRIVER SIDE : Diagnosis Procedure

INFOID:000000000961183

1.CHECK OUTPUT SIGNAL

Check voltage between BCM connector and ground.

Terminals		Condition of door lock and unlock switch	Voltage (V) (Approx.)
(+)	(-)		
BCM connector	Terminal		
M119	8	Lock	0 → Battery voltage → 0
	9	Unlock	0 → Battery voltage → 0

Is the inspection result normal?

- YES >> GO TO 2.
NO >> GO TO 3.

2.CHECK DOOR LOCK ACTUATOR CIRCUIT

1. Turn ignition switch OFF.
2. Disconnect BCM and front door lock actuator driver side connector.
3. Check continuity between BCM connector and front door lock actuator driver side connector.

BCM connector	Terminal	Door lock actuator connector	Terminal	Continuity
M119	8	D15	1	Existed
	9		2	

4. Check continuity between BCM connector and ground.

BCM connector	Terminal	Continuity
M119	8	Not existed
	9	

Is the inspection result normal?

- YES >> GO TO 3.
NO >> Repair or replace harness.

3.CHECK INTERMITTENT INCIDENT

Refer to [GI-39, "Intermittent Incident"](#).

>> INSPECTION END.

PASSENGER SIDE

DOOR LOCK ACTUATOR

[INTELLIGENT KEY SYSTEM]

< COMPONENT DIAGNOSIS >

PASSENGER SIDE : Description

INFOID:000000000961184

Locks/unlocks the door with the signal from BCM.

PASSENGER SIDE : Component Function Check

INFOID:000000000961185

1.CHECK FUNCTION

1. Use CONSULT-III to perform Active Test ("DOOR LOCK").
2. Touch "ALL LOCK" or "ALL UNLOCK" to check that it works normally.

Is the inspection result normal?

- YES >> Door lock actuator is OK.
NO >> Refer to [DLK-93. "PASSENGER SIDE : Diagnosis Procedure"](#).

PASSENGER SIDE : Diagnosis Procedure

INFOID:000000000961186

1.CHECK DOOR LOCK ACTUATOR SIGNAL

Check voltage between BCM connector and ground.

Terminals		Condition of door lock and unlock switch	Voltage (V) (Approx.)
(+)	(-)		
BCM connector	Terminal		
M119	8	Lock	0 → Battery voltage → 0
	5	Unlock	0 → Battery voltage → 0

Is the inspection result normal?

- YES >> GO TO 2.
NO >> GO TO 3.

2.CHECK DOOR LOCK ACTUATOR CIRCUIT

1. Disconnect BCM and front door lock actuator passenger side connectors.
2. Check continuity between BCM connector and front door lock actuator passenger side.

BCM connector	Terminal	Door lock actuator connector	Terminal	Continuity
M119	8	D45	2	Existed
	5		1	

3. Check continuity between BCM connector and ground.

BCM connector	Terminal	Continuity
M119	8	Not existed
	5	

Is the inspection result normal?

- YES >> GO TO 3.
NO >> Repair or replace harness.

3.CHECK INTERMITTENT INCIDENT

Refer to [GI-39. "Intermittent Incident"](#).

>> INSPECTION END.

REAR LH

REAR LH : Description

INFOID:000000000961187

Locks/unlocks the door with the signal from BCM.

A
B
C
D
E
F
G
H
I
J
L
M
N
O
P

DLK

DOOR LOCK ACTUATOR

< COMPONENT DIAGNOSIS >

[INTELLIGENT KEY SYSTEM]

REAR LH : Component Function Check

INFOID:000000000961188

1.CHECK FUNCTION

1. Use CONSULT-III to perform Active Test ("DOOR LOCK").
2. Touch "ALL LOCK" or "ALL UNLOCK" to check that it works normally.

Is the inspection result normal?

YES >> Door lock actuator is OK.

NO >> Refer to [DLK-94, "REAR LH : Diagnosis Procedure"](#).

REAR LH : Diagnosis Procedure

INFOID:000000000961189

1.CHECK DOOR LOCK ACTUATOR SIGNAL

Check voltage between BCM connector and ground.

Terminals		Condition of door lock and unlock switch	Voltage (V) (Approx.)
(+)	(-)		
BCM connector	Terminal		
M119	8	Lock	0 → Battery voltage → 0
	10	Unlock	0 → Battery voltage → 0

Is the inspection result normal?

YES >> GO TO 2.

NO >> GO TO 3.

2.CHECK DOOR LOCK ACTUATOR CIRCUIT

1. Disconnect BCM and rear door lock actuator LH connectors.
2. Check continuity between BCM connector and rear door lock actuator LH connectors.

BCM connector	Terminal	Door lock actuator connector	Terminal	Continuity
M119	8	D55	1	Existed
	10		2	

3. Check continuity between BCM connector and ground.

BCM connector	Terminal	Continuity
M119	8	Ground Not existed
	10	

Is the inspection result normal?

YES >> GO TO 3.

NO >> Repair or replace harness.

3.CHECK INTERMITTENT INCIDENT

Refer to [GI-39, "Intermittent Incident"](#).

>> INSPECTION END.

REAR RH

REAR RH : Description

INFOID:000000000961190

Locks/unlocks the door with the signal from BCM.

REAR RH : Component Function Check

INFOID:000000000961191

1.CHECK FUNCTION

DOOR LOCK ACTUATOR

[INTELLIGENT KEY SYSTEM]

< COMPONENT DIAGNOSIS >

1. Use CONSULT-III to perform Active Test ("DOOR LOCK").
2. Touch "ALL LOCK" or "ALL UNLOCK" to check that it works normally.

Is the inspection result normal?

- YES >> Door lock actuator is OK.
NO >> Refer to [DLK-95, "REAR RH : Diagnosis Procedure"](#).

REAR RH : Diagnosis Procedure

INFOID:000000000961192

1. CHECK DOOR LOCK ACTUATOR SIGNAL

Check voltage between BCM connector and ground.

Terminals		Condition of door lock and unlock switch	Voltage (V) (Approx.)
(+)	(-)		
BCM connector	Terminal		
M119	8	Lock	0 → Battery voltage → 0
	10	Unlock	0 → Battery voltage → 0

Is the inspection result normal?

- YES >> GO TO 2.
NO >> GO TO 3.

2. CHECK DOOR LOCK ACTUATOR CIRCUIT

1. Disconnect BCM and rear door lock actuator RH connectors.
2. Check continuity between BCM connector and rear door lock actuator RH connectors.

BCM connector	Terminal	Door lock actuator connector	Terminal	Continuity
M119	8	D75	2	Existed
	10		1	

3. Check continuity between BCM connector and ground.

BCM connector	Terminal	Continuity
M119	8	Ground Not Existed
	10	

Is the inspection result normal?

- YES >> GO TO 3.
NO >> Repair or replace harness.

3. CHECK INTERMITTENT INCIDENT

Refer to [GI-39, "Intermittent Incident"](#).

>> INSPECTION END.

A
B
C
D
E
F
G
H
I
J
L
M
N
O
P

DLK

TRUNK LID OPENER ACTUATOR

< COMPONENT DIAGNOSIS >

[INTELLIGENT KEY SYSTEM]

TRUNK LID OPENER ACTUATOR

Description

INFOID:000000000961193

Performs trunk lid open with signal from BCM.

Component Function Check

INFOID:000000000961194

1.CHECK TRUNK LID OPENER CANCEL SWITCH

Check trunk lid opener cancel switch position.

Does trunk lid opener cancel switch turn OFF (CANCEL)?

- Yes >> Turn on trunk lid opener cancel switch.
- No >> GO TO 2.

2.CHECK FUNCTION

1. Perform Active Test ("TRUNK/GLASS HATCH") with CONSULT-III.
2. Touch "OPEN" and check that trunk lid opens.

Is the inspection result normal?

- YES >> Trunk lid opener actuator is OK.
- NO >> Refer to [DLK-96. "Diagnosis Procedure"](#).

Diagnosis Procedure

INFOID:000000000961195

1.CHECK OUTPUT SIGNAL

Check voltage between BCM connector and ground.

Terminals		Condition of trunk lid opener switch	Voltage (V) (Approx.)
(+)	(-)		
BCM connector	Terminal		
M120	23	ON	0 → Battery voltage → 0

Is the inspection result normal?

- YES >> GO TO 2.
- NO >> GO TO 3.

2.CHECK TRUNK LID OPENER ACTUATOR CIRCUIT

1. Turn ignition switch OFF.
2. Disconnect BCM and trunk lid lock assembly (trunk lid opener actuator) connector.
3. Check continuity between BCM connector and trunk lid lock assembly (trunk lid opener actuator) connector.

BCM connector	Terminal	Trunk lid lock assembly (trunk lid opener actuator) connector	Terminal	Continuity
M120	23	B303	3	Existed

4. Check continuity between BCM connector and ground.

BCM connector	Terminal		Continuity
M120	23	Ground	Not existed

Is the inspection result normal?

- YES >> GO TO 3.
- NO >> Repair or replace harness.

3.CHECK INTERMITTENT INCIDENT

Refer to [GI-39. "Intermittent Incident"](#).

TRUNK LID OPENER ACTUATOR

< COMPONENT DIAGNOSIS >

[INTELLIGENT KEY SYSTEM]

>> INSPECTION END.

A

B

C

D

E

F

G

H

I

J

DLK

L

M

N

O

P

FUEL LID OPENER ACTUATOR

< COMPONENT DIAGNOSIS >

[INTELLIGENT KEY SYSTEM]

FUEL LID OPENER ACTUATOR

Description

INFOID:000000000961196

Linked to door lock actuator, lock/unlock fuel lid.

Component Function Check

INFOID:000000000961197

1.CHECK FUNCTION

1. Use CONSULT-III to perform Active Test ("DOOR LOCK").
2. Touch "ALL LOCK" or "ALL UNLOCK" to check that it works normally.

Is the inspection result normal?

- YES >> Fuel lid opener actuator is OK.
NO >> Refer to [DLK-98, "Diagnosis Procedure"](#).

Diagnosis Procedure

INFOID:000000000961198

1.CHECK OUTPUT SIGNAL

Check voltage between BCM connector and ground.

Terminals		Condition of door lock and unlock switch	Voltage (V) (Approx.)
(+)	(-)		
BCM connector	Terminal		
M119	8	Lock	0 → Battery voltage → 0
	9	Unlock	0 → Battery voltage → 0

Is the inspection result normal?

- YES >> GO TO 2.
NO >> GO TO 3.

2.CHECK FUEL LID OPENER ACTUATOR CIRCUIT

1. Turn ignition switch OFF.
2. Disconnect BCM and fuel lid lock actuator connector.
3. Check continuity between BCM connector and fuel lid lock actuator connector.

BCM connector	Terminal	Fuel lid lock actuator connector	Terminal	Continuity
M119	8	B242	2	Existed
	9		1	

4. Check continuity between BCM connector and ground.

BCM connector	Terminal	Continuity
M119	8	Ground Not existed
	9	

Is the inspection result normal?

- YES >> GO TO 3.
NO >> Repair or replace harness.

3.CHECK INTERMITTENT INCIDENT

Refer to [GI-39, "Intermittent Incident"](#).

>> INSPECTION END.

INTELLIGENT KEY WARNING BUZZER

< COMPONENT DIAGNOSIS >

[INTELLIGENT KEY SYSTEM]

INTELLIGENT KEY WARNING BUZZER

Description

INFOID:000000000961199

Answers back and warns for an inappropriate operation.

Component Function Check

INFOID:000000000961200

1. CHECK FUNCTION

With CONSULT-III

Check Intelligent Key warning buzzer ("OUTSIDE BUZZER") in Active Test mode.

Is the inspection result normal?

- YES >> Intelligent Key warning buzzer (engine room) is OK.
- NO >> Refer to [DLK-99, "Diagnosis Procedure"](#).

Diagnosis Procedure

INFOID:000000000961201

1. CHECK INTELLIGENT KEY WARNING BUZZER

Check voltage between BCM connector and ground.

Terminals		Warning buzzer operation condition	Voltage (V) (Approx.)
(+)			
BCM connector	Terminal		
M121	64	Yes	0
		No	Battery voltage

Is the inspection result normal?

- YES >> GO TO 5.
- NO >> GO TO 2.

2. CHECK INTELLIGENT KEY WARNING BUZZER POWER SUPPLY CIRCUIT

1. Turn ignition switch OFF.
2. Disconnect Intelligent Key warning buzzer connector.
3. Check voltage between Intelligent Key warning buzzer connector and ground.

Terminals		Voltage (V) (Approx.)
(+)		
Intelligent Key warning buzzer connector	Terminal	
E57	1	Battery voltage

Is the inspection result normal?

- YES >> GO TO 3.
- NO >> Repair or replace Intelligent Key warning buzzer power supply circuit.

3. CHECK INTELLIGENT KEY WARNING BUZZER CIRCUIT

1. Disconnect BCM connector.
2. Check continuity between BCM connector and Intelligent Key warning buzzer connector.

BCM connector	Terminal	Intelligent Key warning buzzer connector	Terminal	Continuity
M121	64	E57	1	Existed

3. Check continuity between BCM connector and ground.

BCM connector	Terminal	Ground	Continuity
M121	64		Not existed

A
B
C
D
E
F
G
H
I
J
L
M
N
O
P

DLK

INTELLIGENT KEY WARNING BUZZER

[INTELLIGENT KEY SYSTEM]

< COMPONENT DIAGNOSIS >

Is the inspection result normal?

YES >> GO TO 4.

NO >> Repair or replace harness between BCM and Intelligent Key warning buzzer.

4.CHECK INTELLIGENT KEY WARNING BUZZER

Check [DLK-100. "Component Inspection"](#).

Is the inspection result normal?

YES >> GO TO 5.

NO >> Replace Intelligent Key warning buzzer. Refer to [DLK-222. "Removal and Installation"](#).

5.CHECK INTERMITTENT INCIDENT

Check [GI-39. "Intermittent Incident"](#).

>> INSPECTION END.

Component Inspection

INFOID:000000000961202

1.CHECK INTELLIGENT KEY WARNING BUZZER

Connect battery power supply to Intelligent Key warning buzzer terminals 1 and 3, and check the operation.

1 (BAT+) - 3 (BAT-) : the buzzer sounds

Is the inspection result normal?

YES >> INSPECTION END.

NO >> Replace Intelligent Key warning buzzer. Refer to [DLK-222. "Removal and Installation"](#).

OUTSIDE KEY ANTENNA

< COMPONENT DIAGNOSIS >

[INTELLIGENT KEY SYSTEM]

OUTSIDE KEY ANTENNA

Description

INFOID:000000000961203

Detects whether Intelligent Key is outside the vehicle.
Integrated in front outside handle (driver side, passenger side) and installed in rear bumper.

Component Function Check

INFOID:000000000961204

1. CHECK DOOR REQUEST SWITCH

Check that door request switch operates normally.

Is the inspection result normal?

YES >> GO TO 2.

NO >> Inspect door request switch. Refer to [DLK-87, "Component Function Check"](#).

2. CHECK FUNCTION

Be sure that Intelligent Key is in each outside key antenna detection range.

Does door lock/unlock when each request switch is pressed?

YES >> Outside key antenna is OK.

NO >> Refer to [DLK-101, "Diagnosis Procedure"](#).

Diagnosis Procedure

INFOID:000000000961205

1. CHECK OUTSIDE KEY ANTENNA INPUT SIGNAL 1

- Turn ignition switch OFF.
- Check signal between BCM connector and ground with oscilloscope.

Terminals			(-)	Condition	Signal (Reference value.)	
(+)		BCM connector				Terminal
Driver side	Passenger side					
M122	Driver side	77	Ground	Request switch is pushed	<p>JMKIA0061GB</p>	
	Passenger side	75				<p>JMKIA0060GB</p>
	Rear bumper	39				

Is the inspection result normal?

YES >> GO TO 4.

NO >> GO TO 2.

2. CHECK OUTSIDE KEY ANTENNA CIRCUIT

- Disconnect BCM and front outside handle connector.
- Check continuity between BCM connector and outside key antenna connector.

A
B
C
D
E
F
G
H
I
J
L
M
N
O
P

DLK

OUTSIDE KEY ANTENNA

< COMPONENT DIAGNOSIS >

[INTELLIGENT KEY SYSTEM]

BCM connector	Terminal	Outside key antenna connector	Terminal	Continuity
M122	77	D14 (driver side)	1	Existed
	76		2	
	75	D44 (passenger side)	1	
	74		2	
M121	39	B63 (rear bumper)	1	
	38		2	

3. Check continuity between BCM connector and ground.

BCM connector	Terminal	Continuity
M122	74	Ground Not existed
	75	
	76	
	77	
M121	39	
	38	

Is the inspection result normal?

YES >> GO TO 3.

NO >> Repair or replace harness between BCM and outside key antenna.

3. CHECK OUTSIDE KEY ANTENNA INPUT SIGNAL 2

1. Replace outside key antenna. (New antenna or other antenna)
2. Connect BCM and outside key antenna connector.
3. Check signal between BCM connector and ground with oscilloscope.

Terminals			(-)	Condition	Signal (Reference value.)
(+)		Terminal			
BCM connector	Terminal				
M122	Driver side	77	Ground	Door request switch is pushed	When Intelligent Key is in the antenna detection area.
	Passenger side	75			When Intelligent Key is not in the antenna detection area.
	Rear bumper	39		When Intelligent Key is not in the antenna detection area.	

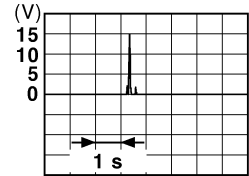
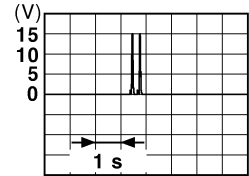

Is the inspection result normal?

YES >> Replace outside key antenna. Refer to [DLK-201, "FRONT DOOR : Removal and Installation"](#) (Driver side and passenger side), [DLK-221, "REAR BUMPER : Removal and Installation"](#) (Rear bumper)

NO >> GO TO 4.

4. CHECK INTERMITTENT INCIDENT

Refer to [GI-39, "Intermittent Incident"](#).

OUTSIDE KEY ANTENNA

< COMPONENT DIAGNOSIS >

[INTELLIGENT KEY SYSTEM]

>> INSPECTION END.

A

B

C

D

E

F

G

H

I

J

DLK

L

M

N

O

P

REMOTE KEYLESS ENTRY RECEIVER

< COMPONENT DIAGNOSIS >

[INTELLIGENT KEY SYSTEM]

REMOTE KEYLESS ENTRY RECEIVER

Description

INFOID:000000000961206

Receives Intelligent Key operation and transmits to BCM.

Component Function Check

INFOID:000000000961207

1.CHECK FUNCTION

With CONSULT-III

Check remote keyless entry receiver ("RKE OPE COUN1") in Data Monitor mode with CONSULT-III.

Monitor item	Condition
RKE OPE COUN1	Checks whether value changes when operating Intelligent Key.

Is the inspection result normal?

- YES >> Remote keyless entry receiver is OK.
 NO >> Refer to [DLK-104, "Diagnosis Procedure"](#).

Diagnosis Procedure

INFOID:000000000961208

1.CHECK REMOTE KEYLESS ENTRY RECEIVER OUTPUT SIGNAL

- Turn ignition switch OFF.
- Check signal between remote keyless entry receiver connector and ground with oscilloscope.

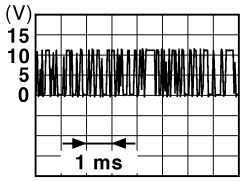
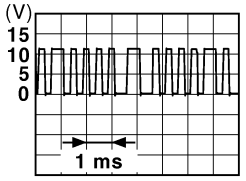
Terminals			Condition	Signal (Reference value)
(+)		(-)		
Remote keyless entry receiver connector	Terminal			
M104	2	Ground	Waiting (All door closed)	 <p>JMKIA0064GB</p>
			When signal is received (All door closed)	 <p>JMKIA0065GB</p>

Is the inspection result normal?

- YES >> GO TO 7.
 NO >> GO TO 2.

2.CHECK REMOTE KEYLESS ENTRY RECEIVER POWER SUPPLY

- Disconnect remote keyless entry receiver connector.
- Check signal between remote keyless entry receiver connector and ground with oscilloscope.

REMOTE KEYLESS ENTRY RECEIVER

< COMPONENT DIAGNOSIS >

[INTELLIGENT KEY SYSTEM]

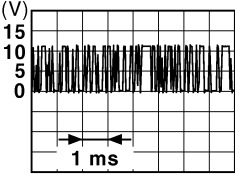
Terminals		Signal (Reference value)
(+)	(-)	
Remote keyless entry receiver connector	Terminal	
M104	4	 <p>(V) 15 10 5 0</p> <p>1 ms</p> <p>JMKIA0064GB</p>

Is the inspection result normal?

YES >> GO TO 4.

NO >> GO TO 3.

3.CHECK REMOTE KEYLESS ENTRY RECEIVER CIRCUIT 1

1. Disconnect BCM connector.
2. Check continuity between BCM connector and remote keyless entry receiver connector.

BCM connector	Terminal	Remote keyless entry receiver connector	Terminal	Continuity
M122	103	M104	4	Existed

3. Check continuity between BCM connector and ground.

BCM connector	Terminal	Ground	Continuity
M122	103		Not existed

Is the inspection result normal?

YES >> GO TO 7.

NO >> Repair or replace harness between BCM and remote keyless entry receiver.

4.CHECK REMOTE KEYLESS ENTRY RECEIVER GROUND CIRCUIT

Check continuity between remote keyless entry receiver connector and ground.

Remote keyless entry receiver connector	Terminal	Ground	Continuity
M104	1		Existed

Is the inspection result normal?

YES >> GO TO 6.

NO >> GO TO 5.

5.CHECK REMOTE KEYLESS ENTRY RECEIVER CIRCUIT 2

Check continuity between BCM connector and remote keyless entry receiver connector.

BCM connector	Terminal	Remote keyless entry receiver connector	Terminal	Continuity
M123	137	M104	1	Existed

Is the inspection result normal?

YES >> GO TO 7.

NO >> Repair or replace harness between BCM and remote keyless entry.

6.CHECK REMOTE KEYLESS ENTRY RECEIVER CIRCUIT 3

1. Check continuity between BCM connector and remote keyless entry receiver connector.

REMOTE KEYLESS ENTRY RECEIVER

< COMPONENT DIAGNOSIS >

[INTELLIGENT KEY SYSTEM]

BCM connector	Terminal	Remote keyless entry receiver connector	Terminal	Continuity
M122	83	M104	2	Existed

2. Check continuity between BCM connector and ground.

BCM connector	Terminal	Ground	Continuity
M122	83		Not existed

Is the inspection result normal?

YES >> GO TO 7.

NO >> Repair or replace harness between BCM and remote keyless entry.

7.CHECK INTERMITTENT INCIDENT

Refer to [GI-39. "Intermittent Incident"](#).

>> INSPECTION END.

INTELLIGENT KEY

Description

INFOID:000000000961209

The following functions are available when having and carrying electronic ID.

- Door lock/unlock and trunk open
- Engine start

Remote control entry function and panic alarm function are available when operating on button.

Component Function Check

INFOID:000000000961210

1. CHECK FUNCTION

With CONSULT-III

Check remote keyless entry receiver ("RKE OPE COUN1") in Data Monitor mode with CONSULT-III.

Monitor item	Condition
RKE OPE COUN1	Check that the numerical value is changing while operating on the Intelligent Key.

Is the inspection result normal?

- YES >> Intelligent Key is OK.
 NO >> Refer to [DLK-107, "Diagnosis Procedure"](#).

Diagnosis Procedure

INFOID:000000000961211

1. CHECK INTELLIGENT KEY BATTERY

Check by connecting a resistance (approximately 300Ω) so that the current value becomes about 10 mA.

Standard : Approx. 2.5 - 3.0V

Is the measurement value within the specification?

- YES >> Replace Intelligent Key.
 NO >> Replace Intelligent Key battery. Refer to [DLK-107, "Component Inspection"](#).

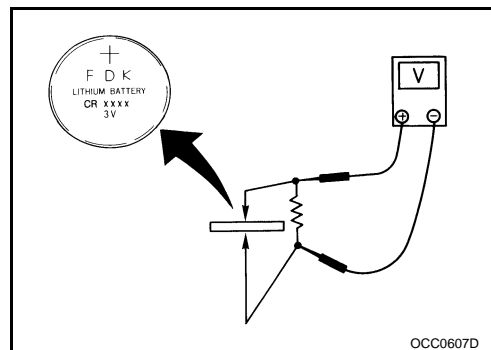

Component Inspection

INFOID:000000000961212

1. REPLACE INTELLIGENT KEY BATTERY

1. Release the lock knob at the back of the Intelligent Key and remove the mechanical key.
2. Insert a flat-blade screwdriver (A) wrapped with a cloth into the slit of the corner and twist it to separate the upper part from the lower part.

CAUTION:

- Do not touch the circuit board or battery terminal.
- The key fob is water-resistant. However, if it does get wet, immediately wipe it dry.

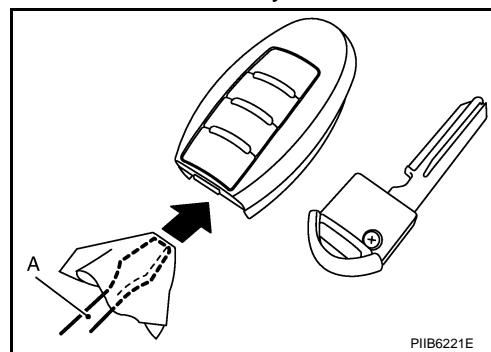

3. Replace the battery with new one.

A
B
C
D
E
F
G
H
I
J
DLK
L
M
N
O
P

INTELLIGENT KEY

< COMPONENT DIAGNOSIS >

4. Align the tips of the upper and lower parts, and then push them together until it is securely closed.

CAUTION:

- When replacing battery, keep dirt, grease, and other foreign materials off the electrode contact area.
- After replacing the battery, check that all Intelligent Key functions work normally.

Is the inspection result normal?

YES >> Intelligent Key is OK.

NO >> Check remote keyless entry receiver. Refer to [DLK-104](#), "[Component Function Check](#)".

Special Repair Requirement

Refer to CONSULT-III Operation Manual NATS-IVIS/NVIS.

[INTELLIGENT KEY SYSTEM]

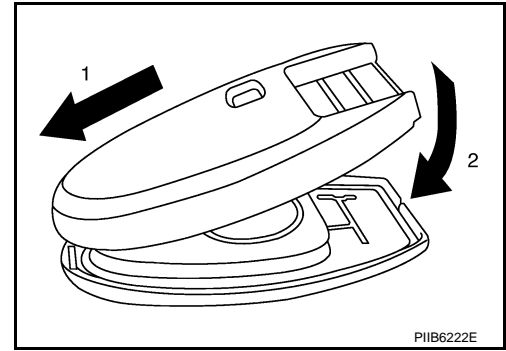

INFOID:000000000961213

KEY SLOT ILLUMINATION

< COMPONENT DIAGNOSIS >

[INTELLIGENT KEY SYSTEM]

KEY SLOT ILLUMINATION

Description

INFOID:000000000961214

Blinks when Intelligent Key insertion is required.

Component Function Check

INFOID:000000000961215

1.CHECK FUNCTION

With CONSULT-III

Check key slot illumination ("KEY SLOT ILLUMI") Active Test mode.

Is the inspection result normal?

YES >> Key slot function is OK.

NO >> Refer to [DLK-109. "Diagnosis Procedure"](#).

Diagnosis Procedure

INFOID:000000000961216

1.CHECK KEY SLOT ILLUMINATION OUTPUT SIGNAL

Check voltage between key slot connector and ground.

Terminals			Condition	Key slot illumination	Voltage (V) (Approx.)
(+)		(-)			
Key slot connector	Terminal				
M22	6	Ground	Intelligent Key inserted	OFF	Battery voltage
			Intelligent Key removed	ON	0

Is the inspection result normal?

YES >> GO TO 6.

NO >> GO TO 2.

2.CHECK KEY SLOT POWER SUPPLY CIRCUIT

1. Turn ignition switch OFF.
2. Disconnect key slot connector.
3. Check voltage between slot connector and ground.

Terminals			Voltage (V) (Approx.)
(+)		(-)	
Key slot connector	Terminal		
M22	1	Ground	Battery voltage
	5		

Is the inspection result normal?

YES >> GO TO 3.

NO >> Repair or replace key slot power supply circuit.

3.CHECK KEY SLOT GROUND CIRCUIT

Check continuity between key slot connector and ground.

Key slot connector	Terminal	Ground	Continuity
M22	7		

Is the inspection result normal?

YES >> GO TO 4.

NO >> Repair or replace key slot ground circuit.

A
B
C
D
E
F
G
H
I
J
L
M
N
O
P

DLK

KEY SLOT ILLUMINATION

< COMPONENT DIAGNOSIS >

[INTELLIGENT KEY SYSTEM]

4. CHECK KEY SLOT CIRCUIT

1. Turn ignition switch OFF.
2. Disconnect BCM and key slot connector.
3. Check continuity between BCM connector and key slot connector.

BCM connector	Terminal	Key slot connector	Terminal	Continuity
M122	92	M22	6	Existed

4. Check continuity between BCM connector and ground.

BCM connector	Terminal	Ground	Continuity
M122	92		Not existed

Is the inspection result normal?

YES >> GO TO 5.

NO >> Repair or replace harness between BCM and key slot.

5. CHECK KEY SLOT

Refer to [DLK-73. "Component Inspection"](#).

Is the inspection result normal?

YES >> GO TO 6.

NO >> Replace key slot. Refer to [DLK-223. "Removal and Installation"](#).

6. CHECK INTERMITTENT INCIDENT

Refer to [GI-39. "Intermittent Incident"](#).

>> INSPECTION END.

HORN FUNCTION

< COMPONENT DIAGNOSIS >

[INTELLIGENT KEY SYSTEM]

HORN FUNCTION

Description

INFOID:000000000961217

Perform answer-back for each operation with horn.

Component Function Check

INFOID:000000000961218

1.CHECK FUNCTION

1. Select "HORN" in "ACTIVE TEST" mode with CONSULT-III.
2. Check the horn (high/low) operation.

Test item		Description	
HORN	ON	Horn relay 1 and 2	ON (for 20 ms)

Is the operation normal?

- YES >> INSPECTION END.
 NO >> Go to [DLK-111, "Diagnosis Procedure"](#).

Diagnosis Procedure

INFOID:000000000961219

1.CHECK HORN FUNCTION

Check horn function with horn switch

Do the horns sound?

- YES >> GO TO 2.
 NO >> Go to [HRN-3, "Wiring Diagram - HORN -"](#).

2.CHECK HORN RELAY POWER SUPPLY

1. Turn ignition switch ON.
2. Perform "ACTIVE TEST" ("HORN") with CONSULT-III.
3. Check voltage between horn relay 1 and 2 harness connector and ground.

Horn relay1/2		Ground	Test item	Voltage (V) (Applox.)	
Connector	Terminal				
E11	1	Ground	HORN	ON	0 → Battery voltage →0
			Other than above	0	
E18	3		HORN	ON	0 → Battery voltage →0
			Other than above	0	

Is the inspection result normal?

- YES >> GO TO 4.
 NO >> GO TO 3.

3.CHECK HORN RELAY CIRCUIT

1. Turn ignition switch OFF.
2. Disconnect IPDM E/R and horn relay 1and 2 connector.
3. Check continuity between IPDM E/R harness connector and horn relay 1and 2 harness connector.

IPDM E/R		Horn relay 1 and 2		Continuity
Connector	Terminal	Connector	Terminal	
E46	44	E11	1	Existed
	45	E10	3	

4. Check continuity between driver seat control unit harness connector and ground.

IPDM E/R		Ground	Continuity
Connector	Terminal		

A
B
C
D
E
F
G
H
I
J
L
M
N
O
P

DLK

HORN FUNCTION

< COMPONENT DIAGNOSIS >

[INTELLIGENT KEY SYSTEM]

E46	44	Ground	Not existed
	45		

Is the inspection result normal?

YES >> GO TO 4.

NO >> Repair or replace harness.

4.CHECK INTERMITTENT INCIDENT

Refer to [GI-39, "Intermittent Incident"](#).

Is the inspection result normal?

YES >> Replace IPDM E/R.Refer to [PCS-33, "Removal and Installation"](#).

NO >> Repair or replace the malfunctioning parts.

COMBINATION METER DISPLAY FUNCTION

< COMPONENT DIAGNOSIS >

[INTELLIGENT KEY SYSTEM]

COMBINATION METER DISPLAY FUNCTION

Description

INFOID:000000000961220

Displays each operation method guide and warning for system malfunction.

Component Function Check

INFOID:000000000961221

1.CHECK FUNCTION

With CONSULT-III

Check the operation with ("LCD") in the Active Test.

Is each warning displayed on meter display?

Is the inspection result normal?

YES >> Meter display is OK.

NO >> Refer to [DLK-113, "Diagnosis Procedure"](#).

Diagnosis Procedure

INFOID:000000000961222

1.CHECK COMBINATION METER

Refer to [MWI-42, "DTC Logic"](#).

Is the inspection result normal?

YES >> GO TO 2.

NO >> Check combination meter. Refer to [MWI-35, "Diagnosis Description"](#).

2.CHECK INTERMITTENT INCIDENT

Refer to [GI-39, "Intermittent Incident"](#).

>> INSPECTION END.

A
B
C
D
E
F
G
H
I
J
L
M
N
O
P

DLK

WARNING CHIME FUNCTION

Description

INFOID:000000000961223

Performs operation method guide and warning with buzzer.

Component Function Check

INFOID:000000000961224

1. CHECK FUNCTION

With CONSULT-III

1. Check the operation with "INSIDE BUZZER" in the Active Test.
2. Touch "TAKE OUT", "KNOB" or "KEY" on screen.

Is the inspection result normal?

- Yes >> Warning buzzer into combination meter is OK.
No >> Refer to [DLK-114, "Diagnosis Procedure"](#).

Diagnosis Procedure

INFOID:000000000961225

1. CHECK METER BUZZER CIRCUIT

Refer to [WCS-20, "Component Function Check"](#).

Is the inspection result normal?

- Yes >> GO TO 2.
No >> Repair or replace meter buzzer circuit.

2. CHECK INTERMITTENT INCIDENT

Refer to [GI-39, "Intermittent Incident"](#).

>> INSPECTION END.

< COMPONENT DIAGNOSIS >

HAZARD FUNCTION**Description**

INFOID:000000000961226

Perform answer-back for each operation with number of blinks.

Component Function Check

INFOID:000000000961227

1.CHECK FUNCTION

Check hazard warning lamp ("FLASHER") in Active Test.

Is the inspection result normal?

YES >> Hazard warning lamp circuit is OK.

NO >> Refer to [DLK-115, "Diagnosis Procedure"](#).**Diagnosis Procedure**

INFOID:000000000961228

1.CHECK HAZARD SWITCH CIRCUITRefer to [EXL-83, "Component Function Check"](#).Is the inspection result normal?

YES >> GO TO 2.

NO >> Repair or replace hazard warning switch circuit.

2.CHECK INTERMITTENT INCIDENTRefer to [GI-39, "Intermittent Incident"](#).

>> INSPECTION END.

A

B

C

D

E

F

G

H

I

J

DLK

L

M

N

O

P

INTEGRATED HOMELINK TRANSMITTER

< COMPONENT DIAGNOSIS >

[INTELLIGENT KEY SYSTEM]

INTEGRATED HOMELINK TRANSMITTER

Description

INFOID:000000000961229

Integrated Homelink Transmitter can store and transmit a maximum of 3 radio signals. Allows operation of garage doors, gates, home and office lighting, entry door locks and security system, etc. Integrated Homelink Transmitter power supply uses vehicle battery, which enables it to maintain every program in case battery is discharged or removed.

Component Function Check

INFOID:000000000961230

1.CHECK FUNCTION

Check that system receiver (garage door opener, etc.) operates with original hand-held transmitter.

Is the inspection result normal?

- YES >> GO TO 2.
NO >> Receiver or hand-held transmitter is malfunctioning.

2.CHECK ILLUMINATE

1. Turn ignition switch "OFF".
2. Does red light of transmitter illuminate when any transmitter button is pressed?

Is the inspection result normal?

- YES >> GO TO 3.
NO >> Refer to [DLK-116, "Diagnosis Procedure"](#).

3.CHECK TRANSMITTER

Check transmitter with Tool*.

*:For details, refer to Technical Service Bulletin.

Is the inspection result normal?

- YES >> Receiver or hand-held transmitter malfunction, not vehicle related.
NO >> Replace auto anti-dazzling inside mirror (homelink universal transceiver). Refer to [MIR-66, "Removal and Installation"](#).

Diagnosis Procedure

INFOID:000000000961231

1.CHECK POWER SUPPLY

1. Disconnect auto anti-dazzling inside mirror (homelink universal transceiver) connector.
2. Check voltage between auto anti-dazzling inside mirror (home link universal transceiver) harness connector and ground.

Auto anti-dazzling inside mirror (Homelink universal transceiver) connector	Terminal		Condition	Voltage (V) (Approx.)
R3	10	Ground	Ignition switch position: LOCK	Battery voltage
	6		Ignition switch position: ON	

Is the inspection result normal?

- YES >> GO TO 2.
NO >> Check the following.
- 10A fuse [No. 3 located in the fuse block (J/B)]
 - 10A fuse [No. 6 located in the fuse block (J/B)]
 - Harness for open or short between fuse and auto anti-dazzling inside mirror (homelink universal transceiver).

2.CHECK GROUND CIRCUIT

Check continuity between auto anti-dazzling inside mirror (homelink universal transceiver) harness connector and ground.

INTEGRATED HOMELINK TRANSMITTER

< COMPONENT DIAGNOSIS >

[INTELLIGENT KEY SYSTEM]

Auto anti-dazzling inside mirror (Homelink universal transceiver) connector	Terminal	Ground	Continuity
M187	8		Existed

Is the inspection result normal?

YES >> GO TO 3.

NO >> Repair harness.

3.CHECK INTERMITTENT INCIDENT

Refer to [GI-39. "Intermittent Incident"](#).

>> INSPECTION END.

A
B
C
D
E
F
G
H
I
J
L
M
N
O
P

DLK

INTEGRATED HOMELINK TRANSMITTER SYSTEM

< COMPONENT DIAGNOSIS >

[INTELLIGENT KEY SYSTEM]

INTEGRATED HOMELINK TRANSMITTER SYSTEM

Wiring Diagram (BCM - INTEGRATED HOMELINK TRANSMITTER SYSTEM)

INFOID:000000000961232

INTEGRATED HOMELINK TRANSMITTER

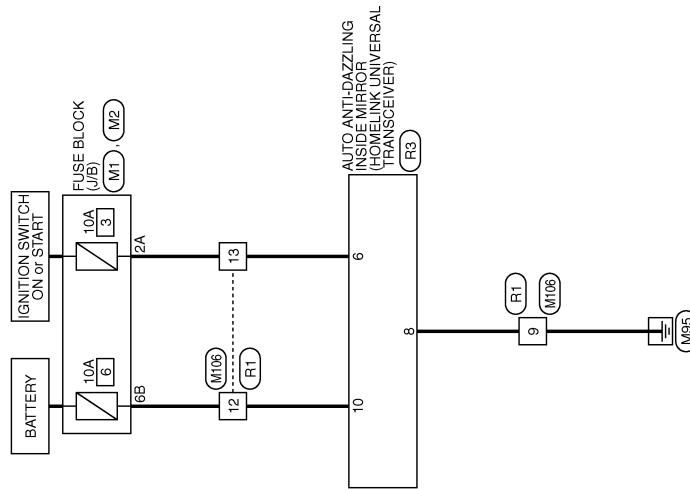

2006/09/15

JCKWA0021GE

INTEGRATED HOMELINK TRANSMITTER SYSTEM

< COMPONENT DIAGNOSIS >

[INTELLIGENT KEY SYSTEM]

INTEGRATED HOMELINK TRANSMITTER

Connector No.	M1
Connector Name	FUSE BLOCK (J/B)
Connector Type	NS08FV-MZ



Terminal No.	Color of Wire	Signal Name
2A	G	-

Connector No.	M2
Connector Name	FUSE BLOCK (J/B)
Connector Type	NS10FV-CS



Terminal No.	Color of Wire	Signal Name
6B	Y	-

Connector No.	M106
Connector Name	WIRE TO WIRE
Connector Type	TK10MY-NSB



Terminal No.	Color of Wire	Signal Name
9	B	-
12	Y	-
13	BR	-

Connector No.	R1
Connector Name	WIRE TO WIRE
Connector Type	TK10FW-NSB



Terminal No.	Color of Wire	Signal Name
9	B	-
12	G	-
13	BR	-

Connector No.	R3
Connector Name	AUTO ANTI-DAZZLING INSIDE MIRROR
Connector Type	TH10FB-NH



Terminal No.	Color of Wire	Signal Name
6	BR	IGN
8	B	GND
10	G	BAT

A
B
C
D
E
F
G
H
I
J
DLK
L
M
N
O
P

BCM (BODY CONTROL MODULE)

< ECU DIAGNOSIS >

[INTELLIGENT KEY SYSTEM]

ECU DIAGNOSIS

BCM (BODY CONTROL MODULE)

Reference Value

INFOID:000000000961233

VALUES ON THE DIAGNOSIS TOOL

Monitor Item	Condition	Value/Status
FR WIPER HI	Other than front wiper switch HI	OFF
	Front wiper switch HI	ON
FR WIPER LOW	Other than front wiper switch LO	OFF
	Front wiper switch LO	ON
FR WASHER SW	Front washer switch OFF	OFF
	Front washer switch ON	ON
FR WIPER INT	Other than front wiper switch INT	OFF
	Front wiper switch INT	ON
FR WIPER STOP	Front wiper is not in STOP position	OFF
	Front wiper is in STOP position	ON
INT VOLUME	Wiper intermittent dial is in a dial position 1 - 7	Wiper intermittent dial position
TURN SIGNAL R	Other than turn signal switch RH	OFF
	Turn signal switch RH	ON
TURN SIGNAL L	Other than turn signal switch LH	OFF
	Turn signal switch LH	ON
TAIL LAMP SW	Other than lighting switch 1ST and 2ND	OFF
	Lighting switch 1ST or 2ND	ON
HI BEAM SW	Other than lighting switch HI	OFF
	Lighting switch HI	ON
HEAD LAMP SW 1	Other than lighting switch 2ND	OFF
	Lighting switch 2ND	ON
HEAD LAMP SW 2	Other than lighting switch 2ND	OFF
	Lighting switch 2ND	ON
PASSING SW	Other than lighting switch PASS	OFF
	Lighting switch PASS	ON
AUTO LIGHT SW	Other than lighting switch AUTO	OFF
	Lighting switch AUTO	ON
FR FOG SW	Front fog lamp switch OFF	OFF
	Front fog lamp switch ON	ON
RR FOG SW	NOTE: The item is indicated, but not monitored.	OFF
DOOR SW-DR	Driver door closed	OFF
	Driver door opened	ON
DOOR SW-AS	Passenger door closed	OFF
	Passenger door opened	ON
DOOR SW-RR	Rear RH door closed	OFF
	Rear RH door opened	ON

BCM (BODY CONTROL MODULE)

< ECU DIAGNOSIS >

[INTELLIGENT KEY SYSTEM]

Monitor Item	Condition	Value/Status	
DOOR SW-RL	Rear LH door closed	OFF	A
	Rear LH door opened	ON	
DOOR SW-BK	NOTE: The item is indicated, but not monitored.	OFF	B
CDL LOCK SW	Other than power door lock switch LOCK	OFF	C
	Power door lock switch LOCK	ON	
CDL UNLOCK SW	Other than power door lock switch UNLOCK	OFF	D
	Power door lock switch UNLOCK	ON	
KEY CYL LK-SW	Other than driver door key cylinder LOCK position	OFF	E
	Driver door key cylinder LOCK position	ON	
KEY CYL UN-SW	Other than driver door key cylinder UNLOCK position	OFF	E
	Driver door key cylinder UNLOCK position	ON	
KEY CYL SW-TR	NOTE: The item is indicated, but not monitored.	OFF	F
HAZARD SW	Hazard switch is not pressed	OFF	G
	Hazard switch is pressed	ON	
REAR DEF SW	NOTE: The item is indicated, but not monitored.	OFF	H
H/L WASH SW	NOTE: The item is indicated, but not monitored.	OFF	H
TR CANCEL SW	Trunk lid opener cancel switch OFF	OFF	I
	Trunk lid opener cancel switch ON	ON	
TR/BD OPEN SW	Trunk lid opener switch OFF	OFF	J
	While the trunk lid opener switch is turned ON	ON	
TRNK/HAT MNTR	Trunk lid closed	OFF	J
	Trunk lid opened	ON	
RKE-LOCK	LOCK button of Intelligent Key is not pressed	OFF	DLK
	LOCK button of Intelligent Key is pressed	ON	
RKE-UNLOCK	UNLOCK button of Intelligent Key is not pressed	OFF	L
	UNLOCK button of Intelligent Key is pressed	ON	
RKE-TR/BD	TRUNK OPEN button of Intelligent Key is not pressed	OFF	M
	TRUNK OPEN button of Intelligent Key is pressed	ON	
RKE-PANIC	PANIC button of Intelligent Key is not pressed	OFF	N
	PANIC button of Intelligent Key is pressed	ON	
RKE-P/W OPEN	UNLOCK button of Intelligent Key is not pressed	OFF	O
	UNLOCK button of Intelligent Key is pressed and held	ON	
RKE-MODE CHG	LOCK/UNLOCK button of Intelligent Key is not pressed and held simultaneously	OFF	O
	LOCK/UNLOCK button of Intelligent Key is pressed and held simultaneously	ON	
OPTICAL SENSOR	Outside of the vehicle bright	Close to 5 V	P
	Outside of the vehicle dark	Close to 0 V	
REQ SW-DR	Driver door request switch is not pressed	OFF	
	Driver door request switch is pressed	ON	
REQ SW-AS	Passenger door request switch is not pressed	OFF	
	Passenger door request switch is pressed	ON	

BCM (BODY CONTROL MODULE)

< ECU DIAGNOSIS >

[INTELLIGENT KEY SYSTEM]

Monitor Item	Condition	Value/Status
REQ SW-BD/TR	Trunk request switch is not pressed	OFF
	Trunk request switch is pressed	ON
PUSH SW	Push-button ignition switch (push switch) is not pressed	OFF
	Push-button ignition switch (push switch) is pressed	ON
IGN RLY2 -F/B	Ignition switch in OFF or ACC position	OFF
	Ignition switch in ON position	ON
ACC RLY -F/B	Ignition switch in OFF position	OFF
	Ignition switch in ACC or ON position	ON
CLUCH SW	The clutch pedal is not depressed	OFF
	The clutch pedal is depressed	ON
BRAKE SW 1	The brake pedal is not depressed	ON
	The brake pedal is depressed	OFF
DETE/CANCL SW	Selector lever in P position	OFF
	Selector lever in any position other than P	ON
SFT PN/N SW	Selector lever in any position other than P and N	OFF
	Selector lever in P or N position	ON
S/L -LOCK	Steering is locked	OFF
	Steering is unlocked	ON
S/L -UNLOCK	Steering is unlocked	OFF
	Steering is locked	ON
S/L RELAY-F/B	Ignition switch is OFF or ACC position	OFF
	Ignition switch is ON position	ON
UNLK SEN-DR	Driver door is unlocked	OFF
	Driver door is locked	ON
PUSH SW -IPDM	Push-button ignition switch (push-switch) is not pressed	OFF
	Push-button ignition switch (push-switch) is pressed	ON
IGN RLY1 -F/B	Ignition switch is OFF or ACC position	OFF
	Ignition switch is ON position	ON
DETE SW -IPDM	Selector lever in P position	OFF
	Selector lever in any position other than P	ON
SFT PN -IPDM	Selector lever in any position other than P and N	OFF
	Selector lever in P or N position	ON
SFT P -MET	Selector lever in any position other than P	OFF
	Selector lever in P position	ON
SFT N -MET	Selector lever in any position other than N	OFF
	Selector lever in N position	ON
ENGINE STATE	Engine stopped	STOP
	While the engine stalls	STALL
	At engine cranking	CRANK
	Engine running	RUN
S/L LOCK-IPDM	Steering is locked	OFF
	Steering is unlocked	ON
S/L UNLK-IPDM	Steering is unlocked	OFF
	Steering is locked	ON

BCM (BODY CONTROL MODULE)

< ECU DIAGNOSIS >

[INTELLIGENT KEY SYSTEM]

Monitor Item	Condition	Value/Status	
S/L RELAY-REQ	Ignition switch in OFF or ACC position	OFF	A
	Ignition switch in ON position	ON	
VEH SPEED 1	While driving	Equivalent to speedometer reading	B
VEH SPEED 2	While driving	Equivalent to speedometer reading	
DOOR STAT-DR	Driver door is locked	LOCK	C
	Wait with selective UNLOCK operation (5 seconds)	READY	
	Driver door is unlocked	UNLK	
DOOR STAT-AS	Passenger door is locked	LOCK	D
	Wait with selective UNLOCK operation (5 seconds)	READY	
	Passenger door is unlocked	UNLK	
ID OK FLAG	Ignition switch in ACC or ON position	RESET	E
	Ignition switch in OFF position	SET	
PRMT ENG STRT	The engine start is prohibited	RESET	F
	The engine start is permitted	SET	
PRMT RKE STRT	NOTE: The item is indicated, but not monitored.	RESET	G
KEY SW -SLOT	Intelligent Key is not inserted into key slot	OFF	H
	Intelligent Key is inserted into key slot	ON	
RKE OPE COUN1	During the operation of Intelligent Key	Operation frequency of Intelligent Key	
RKE OPE COUN2	NOTE: The item is indicated, but not monitored.	—	I
AIR PRESS FL	Ignition switch ON (Only when the signal from the transmitter is received)	Air pressure of front LH tire	J
AIR PRESS FR	Ignition switch ON (Only when the signal from the transmitter is received)	Air pressure of front RH tire	
AIR PRESS RR	Ignition switch ON (Only when the signal from the transmitter is received)	Air pressure of rear RH tire	
AIR PRESS RL	Ignition switch ON (Only when the signal from the transmitter is received)	Air pressure of rear LH tire	DLK
ID REGST FL1	ID of front LH tire transmitter is registered	DONE	L
	ID of front LH tire transmitter is not registered	YET	
ID REGST FR1	ID of front RH tire transmitter is registered	DONE	M
	ID of front RH tire transmitter is not registered	YET	
ID REGST RR1	ID of rear RH tire transmitter is registered	DONE	N
	ID of rear RH tire transmitter is not registered	YET	
ID REGST RL1	ID of rear LH tire transmitter is registered	DONE	O
	ID of rear LH tire transmitter is not registered	YET	
WARNING LAMP	Tire pressure indicator OFF	OFF	P
	Tire pressure indicator ON	ON	
BUZZER	Tire pressure warning alarm is not sounding	OFF	
	Tire pressure warning alarm is sounding	ON	

BCM (BODY CONTROL MODULE)

[INTELLIGENT KEY SYSTEM]

< ECU DIAGNOSIS >

TERMINAL LAYOUT

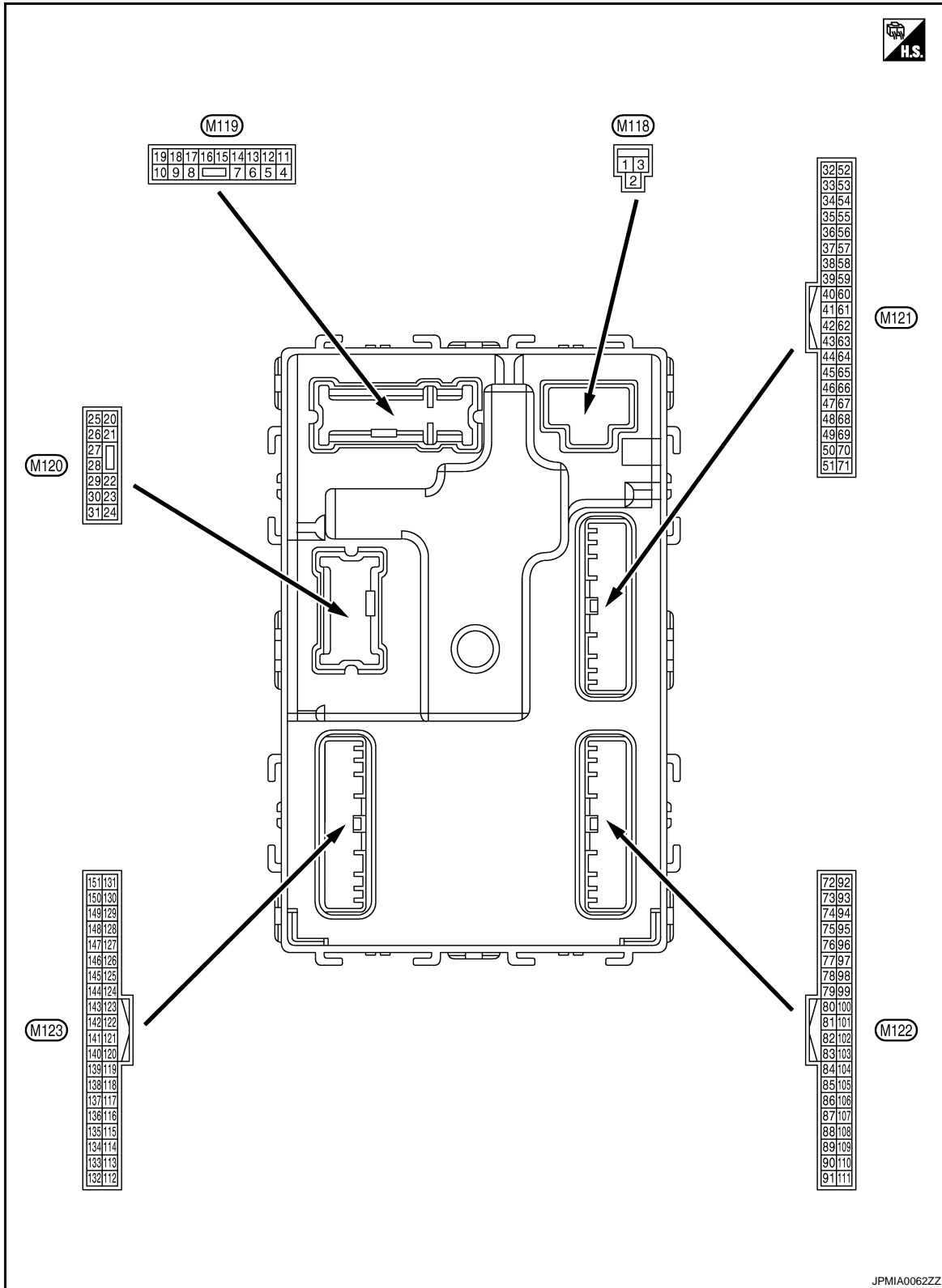

PHYSICAL VALUES

BCM (BODY CONTROL MODULE)

< ECU DIAGNOSIS >

[INTELLIGENT KEY SYSTEM]

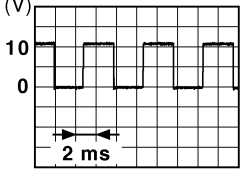
Terminal No. (Wire color)		Description		Condition		Value (Approx.)
		Signal name	Input/ Output			
+	-					
1 (W)	Ground	Battery power supply	Input	Ignition switch OFF		Battery voltage
2 (Y)	Ground	P/W power supply (BAT)	Output	Ignition switch OFF		Battery voltage
3 (O)	Ground	P/W power supply (RAP)	Output	Ignition switch ON		Battery voltage
4 (LG)	Ground	Interior room lamp power supply	Output	After passing the interior room lamp battery saver operation time		0 V
				Any other time after passing the interior room lamp battery saver operation time		Battery voltage
5 (V)	Ground	Passenger door UN- LOCK	Output	Passenger door	UNLOCK (Actuator is activated)	Battery voltage
					Other than UNLOCK (Actuator is not activated)	0 V
7 (Y)	Ground	Step lamp	Output	Step lamp	ON	0 V
					OFF	Battery voltage
8 (V)	Ground	All doors, fuel lid LOCK	Output	All doors, fuel lid	LOCK (Actuator is activated)	Battery voltage
					Other than LOCK (Actuator is not activated)	0 V
9 (G)	Ground	Driver door, fuel lid UNLOCK	Output	Driver door, fuel lid	UNLOCK (Actuator is activated)	Battery voltage
					Other than UNLOCK (Actuator is not activated)	0 V
10 (BR)	Ground	Rear RH door and rear LH door UN- LOCK	Output	Rear RH door and rear LH door	UNLOCK (Actuator is activated)	Battery voltage
					Other than UNLOCK (Actuator is not activated)	0 V
11 (R)	Ground	Battery power supply	Input	Ignition switch OFF		Battery voltage
13 (B)	Ground	Ground	—	Ignition switch ON		0 V
14 (W)	Ground	Push-button ignition switch illumination ground	Output	Tail lamp	OFF	0 V
					ON	<p>NOTE: When the illumination brightening/dimming level is in the neutral position</p>  <p style="text-align: right; font-size: small;">JSNIA0010GB</p>
15 (Y)	Ground	ACC indicator lamp	Output	Ignition switch	OFF	Battery voltage
					ACC or ON	0 V

A
B
C
D
E
F
G
H
I
J
DLK
L
M
N
O
P

BCM (BODY CONTROL MODULE)

[INTELLIGENT KEY SYSTEM]

< ECU DIAGNOSIS >

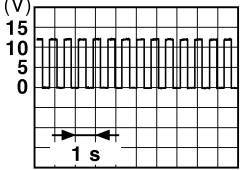
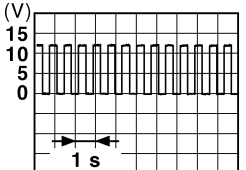
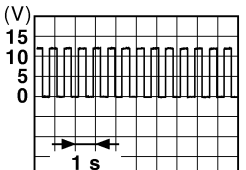
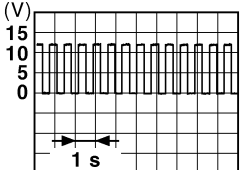
Terminal No. (Wire color)		Description		Condition	Value (Approx.)	
+	-	Signal name	Input/ Output			
17 (W)	Ground	Turn signal (front RH)	Output			Ignition switch ON
				Turn signal switch RH	 <p style="text-align: right; font-size: small;">PKID0926E</p>	
18 (O)	Ground	Turn signal (front LH)	Output	Ignition switch ON	Turn signal switch OFF	0 V
				Turn signal switch LH	 <p style="text-align: right; font-size: small;">PKID0926E</p>	
19 (V)	Ground	Room lamp timer control	Output	Interior room lamp	OFF	Battery voltage
				ON	0 V	
20 (V)	Ground	Turn signal (rear RH)	Output	Ignition switch ON	Turn signal switch OFF	0 V
				Turn signal switch RH	 <p style="text-align: right; font-size: small;">PKID0926E</p>	
23 (G)	Ground	Trunk lid opening.	Output	Trunk lid	Open (Trunk lid opener ac- tuator is activated)	Battery voltage
				Close (Trunk lid opener ac- tuator is not activated)	0 V	
25 (G)	Ground	Turn signal (rear LH)	Output	Ignition switch ON	Turn signal switch OFF	0 V
				Turn signal switch LH	 <p style="text-align: right; font-size: small;">PKID0926E</p>	
30 (R)	Ground	Trunk room lamp	Output	Trunk room lamp	ON	0 V
				OFF	Battery voltage	

BCM (BODY CONTROL MODULE)

< ECU DIAGNOSIS >

[INTELLIGENT KEY SYSTEM]

Terminal No. (Wire color)		Description		Condition	Value (Approx.)
+	-	Signal name	Input/ Output		
34 (SB)	Ground	Trunk room antenna 1 (-)	Output	Ignition switch OFF	<p>JMKIA0062GB</p>
				When Intelligent Key is not in the passenger compart- ment	<p>JMKIA0063GB</p>
35 (V)	Ground	Trunk room antenna 1 (+)	Output	Ignition switch OFF	<p>JMKIA0062GB</p>
				When Intelligent Key is not in the passenger compart- ment	<p>JMKIA0063GB</p>
38 (B)	Ground	Rear bumper anten- na (-)	Output	When the trunk lid request switch is operated with ignition switch OFF	<p>JMKIA0062GB</p>
				When Intelligent Key is not in the antenna detection area	<p>JMKIA0063GB</p>

A
B
C
D
E
F
G
H
I
J
L
M
N
O
P

DLK

BCM (BODY CONTROL MODULE)

< ECU DIAGNOSIS >

[INTELLIGENT KEY SYSTEM]

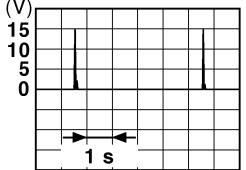
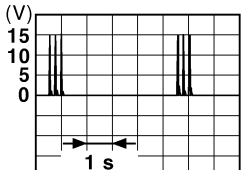
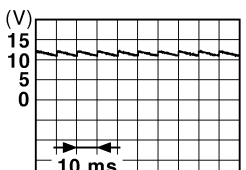
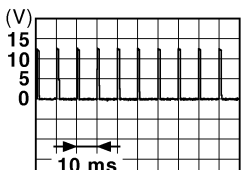
Terminal No. (Wire color)		Description		Condition	Value (Approx.)	
		Signal name	Input/ Output			
+	-					
39 (W)	Ground	Rear bumper antenna (+)	Output	When the trunk lid request switch is operated with ignition switch OFF	When Intelligent Key is in the antenna detection area	
				When Intelligent Key is not in the antenna detection area		
47 (Y)	Ground	Ignition relay (IPDM E/R) control	Output	Ignition switch	OFF or ACC	Battery voltage
					ON	0 V
50 (R)	Ground	Trunk room lamp switch	Input	Trunk room lamp switch	OFF (Trunk is closed)	 <p style="text-align: center;">11.8 V</p>
					ON (Trunk is open)	0 V
52 (SB)	Ground	Starter relay control	Output	Ignition switch OFF (M/T models)	When the clutch pedal is depressed	Battery voltage
					When the clutch pedal is not depressed	0 V
				Ignition switch ON (A/T models)	When selector lever is in P or N position and the brake is depressed	Battery voltage
					When selector lever is in P or N position and the brake is not depressed	0 V
61 (W)	Ground	Trunk request switch	Input	Trunk request switch	ON (Pressed)	0 V
					OFF (Not pressed)	 <p style="text-align: center;">1.0 V</p>
64 (V)	Ground	Request switch buzzer	Output	Request switch buzzer	Sounding	0 V
					Not sounding	Battery voltage

BCM (BODY CONTROL MODULE)

[INTELLIGENT KEY SYSTEM]

< ECU DIAGNOSIS >

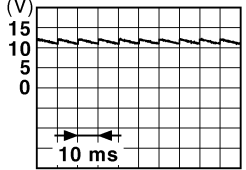
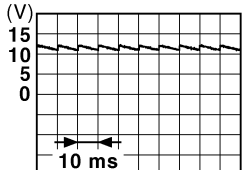
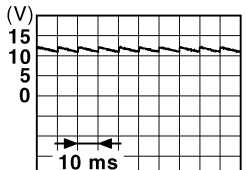
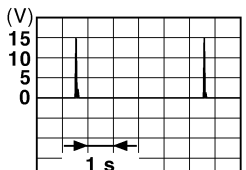
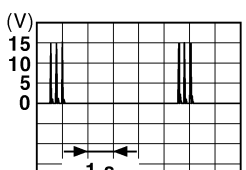
Terminal No. (Wire color)		Description		Condition	Value (Approx.)	
+	-	Signal name	Input/ Output			
67 (GR)	Ground	Trunk lid opener switch	Input	Trunk lid opener switch	Pressed	0 V
					Not pressed	 <p style="text-align: right;">JPMIA0011GB</p> <p style="text-align: center;">11.8 V</p>
68 (BR)	Ground	Rear RH door switch	Input	Rear RH door switch	OFF (When rear RH door closes)	 <p style="text-align: right;">JPMIA0011GB</p> <p style="text-align: center;">11.8 V</p>
					ON (When rear RH door opens)	0 V
69 (R)	Ground	Rear LH door switch	Input	Rear LH door switch	OFF (When rear LH door closes)	 <p style="text-align: right;">JPMIA0011GB</p> <p style="text-align: center;">11.8 V</p>
					ON (When rear LH door opens)	0 V
72 (R)	Ground	Room antenna 2 (-) (center console)	Output	Ignition switch OFF	When Intelligent Key is in the passenger compart- ment	 <p style="text-align: right;">JMKIA0062GB</p>
					When Intelligent Key is not in the passenger compart- ment	 <p style="text-align: right;">JMKIA0063GB</p>

A
B
C
D
E
F
G
H
I
J
L
M
N
O
P

DLK

BCM (BODY CONTROL MODULE)

< ECU DIAGNOSIS >

[INTELLIGENT KEY SYSTEM]

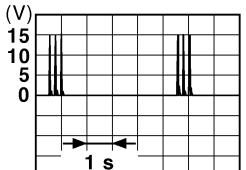
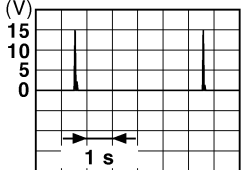
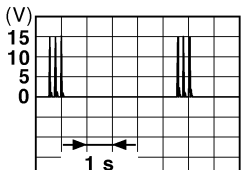
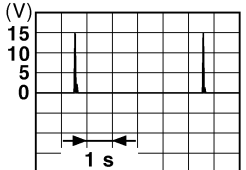
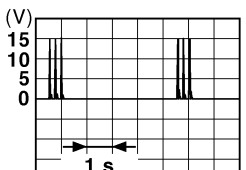
Terminal No. (Wire color)		Description		Condition	Value (Approx.)
+	-	Signal name	Input/ Output		
73 (G)	Ground	Room antenna 2 (+) (center console)	Output		
				When Intelligent Key is not in the passenger compart- ment	 <p style="text-align: right; font-size: small;">JMKIA0063GB</p>
74 (SB)	Ground	Passenger door an- tenna (-)	Output	When the pas- senger door re- quest switch is operated with ig- nition switch OFF	 <p style="text-align: right; font-size: small;">JMKIA0062GB</p>
				When Intelligent Key is not in the antenna detection area	 <p style="text-align: right; font-size: small;">JMKIA0063GB</p>
75 (BR)	Ground	Passenger door an- tenna (+)	Output	When the pas- senger door re- quest switch is operated with ig- nition switch OFF	 <p style="text-align: right; font-size: small;">JMKIA0062GB</p>
				When Intelligent Key is not in the antenna detection area	 <p style="text-align: right; font-size: small;">JMKIA0063GB</p>

BCM (BODY CONTROL MODULE)

[INTELLIGENT KEY SYSTEM]

< ECU DIAGNOSIS >

Terminal No. (Wire color)		Description		Condition	Value (Approx.)
+	-	Signal name	Input/ Output		
76 (V)	Ground	Driver door antenna (-)	Output	When Intelligent Key is in the antenna detection area	<p>JMKIA0062GB</p>
				When Intelligent Key is not in the antenna detection area	<p>JMKIA0063GB</p>
77 (LG)	Ground	Driver door antenna (+)	Output	When Intelligent Key is in the antenna detection area	<p>JMKIA0062GB</p>
				When Intelligent Key is not in the antenna detection area	<p>JMKIA0063GB</p>
78 (Y)	Ground	Room antenna (-) (in- strument panel)	Output	Ignition switch OFF	<p>JMKIA0062GB</p>
				When Intelligent Key is not in the passenger compart- ment	<p>JMKIA0063GB</p>

A
B
C
D
E
F
G
H
I
J
L
M
N
O
P

DLK

BCM (BODY CONTROL MODULE)

< ECU DIAGNOSIS >

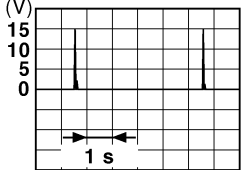
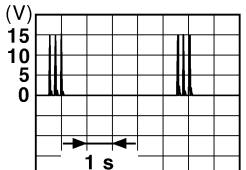
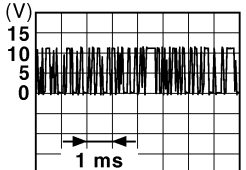
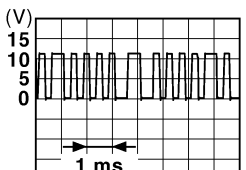

[INTELLIGENT KEY SYSTEM]

Terminal No. (Wire color)		Description		Condition	Value (Approx.)	
+	-	Signal name	Input/ Output			
79 (BR)	Ground	Room antenna (+) (instrument panel)	Output	Ignition switch OFF		
				When Intelligent Key is not in the passenger compart- ment		
80 (GR)	Ground	NATS antenna amp (built in key slot)	Input/ Output	During waiting	Ignition switch is pressed while inserting the Intelli- gent Key into the key slot.	Just after pressing ignition switch. Pointer of tester should move.
81 (W)	Ground	NATS antenna amp (built in key slot)	Input/ Output	During waiting	Ignition switch is pressed while inserting the Intelli- gent Key into the key slot.	Just after pressing ignition switch. Pointer of tester should move.
82 (R)	Ground	Ignition relay (relay box) control	Output	Ignition switch	OFF or ACC	0 V
				ON	Battery voltage	
83 (Y)	Ground	Remote keyless entry receiver signal	Input/ Output	During waiting		
				When operating either button on Intelligent Key		

BCM (BODY CONTROL MODULE)

[INTELLIGENT KEY SYSTEM]

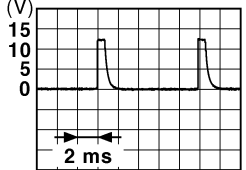
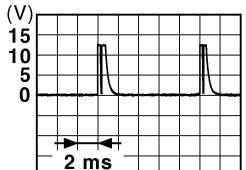
< ECU DIAGNOSIS >

Terminal No. (Wire color)		Description		Condition	Value (Approx.)	
+	-	Signal name	Input/ Output			
87 (BR)	Ground	Combination switch INPUT 5	Input	Combination switch	All switch OFF (Wiper intermittent dial 4)	 <p style="text-align: right; margin-right: 50px;">1.4 V</p>
				Combination switch	Front fog lamp switch ON (Wiper intermittent dial 4)	 <p style="text-align: right; margin-right: 50px;">1.3 V</p>
				Any of the conditions below with all switch OFF <ul style="list-style-type: none"> • Wiper intermittent dial 1 • Wiper intermittent dial 2 • Wiper intermittent dial 6 • Wiper intermittent dial 7 	 <p style="text-align: right; margin-right: 50px;">1.3 V</p>	



A
B
C
D
E
F
G
H
I
J
L
M
N
O
P

DLK

BCM (BODY CONTROL MODULE)

< ECU DIAGNOSIS >

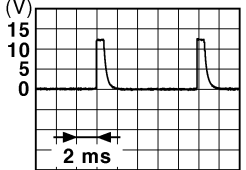
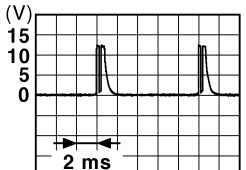
[INTELLIGENT KEY SYSTEM]

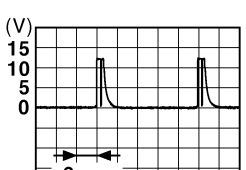
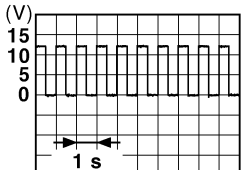
Terminal No. (Wire color)		Description		Condition	Value (Approx.)	
+	-	Signal name	Input/ Output			
88 (V)	Ground	Combination switch INPUT 3	Input	Combination switch	All switch OFF (Wiper intermittent dial 4)	 <small>JPMIA0041GB</small> 1.4 V
					Lighting switch HI (Wiper intermittent dial 4)	 <small>JPMIA0036GB</small> 1.3 V
					Lighting switch 2ND (Wiper intermittent dial 4)	 <small>JPMIA0037GB</small> 1.3 V
					Any of the conditions below with all switches OFF <ul style="list-style-type: none"> • Wiper intermittent dial 1 • Wiper intermittent dial 2 • Wiper intermittent dial 3 	 <small>JPMIA0040GB</small> 1.3 V
89 (BR)	Ground	Push-button ignition switch (push switch)	Input	Push-button igni- tion switch (push switch)	Pressed Not pressed 0 V Battery voltage	
90 (P)	Ground	CAN - L	Input/ Output	—	—	
91 (L)	Ground	CAN - H	Input/ Output	—	—	
92 (LG)	Ground	Key slot illumination	Output	Key slot illumina- tion	OFF	0 V
					Blinking	 <small>JPMIA0015GB</small> 6.5 V
					ON	Battery voltage

BCM (BODY CONTROL MODULE)

< ECU DIAGNOSIS >

[INTELLIGENT KEY SYSTEM]

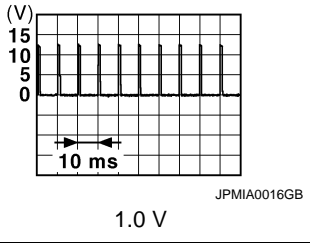
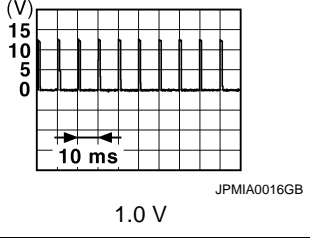
Terminal No. (Wire color)		Description		Condition		Value (Approx.)
		Signal name	Input/ Output			
+	-					
93 (V)	Ground	ON indicator lamp	Output	Ignition switch	OFF or ACC	0 V
					ON	Battery voltage
95 (O)	Ground	ACC relay control	Output	Ignition switch	OFF	0 V
					ACC or ON	Battery voltage
96 (GR)	Ground	A/T device (detention switch) power supply	Output	—		Battery voltage
97 (L)	Ground	Steering lock condition No. 1	Input	Steering lock	LOCK status	0 V
					UNLOCK status	Battery voltage
98 (P)	Ground	Steering lock condition No. 2	Input	Steering lock	LOCK status	Battery voltage
					UNLOCK status	0 V
99 (R)	Ground	Selector lever P position switch	Input	Selector lever	P position	0 V
					Any position other than P	Battery voltage
100 (G)	Ground	Passenger door request switch	Input	Passenger door request switch	ON (Pressed)	0 V
					OFF (Not pressed)	
101 (SB)	Ground	Driver door request switch	Input	Driver door request switch	ON (Pressed)	0 V
					OFF (Not pressed)	
102 (O)	Ground	Blower fan motor relay control	Output	Ignition switch	OFF or ACC	0 V
					ON	Battery voltage
103 (LG)	Ground	Remote keyless entry receiver power supply	Output	Ignition switch OFF		Battery voltage
106 (W)	Ground	Steering wheel lock unit power supply	Output	Ignition switch	OFF or ACC	Battery voltage
					ON	0 V



A
B
C
D
E
F
G
H
I
J
L
M
N
O
P

DLK

BCM (BODY CONTROL MODULE)

< ECU DIAGNOSIS >

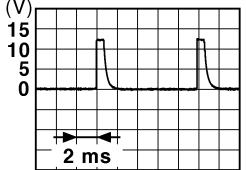
[INTELLIGENT KEY SYSTEM]

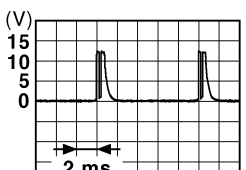
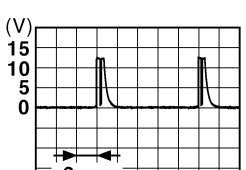
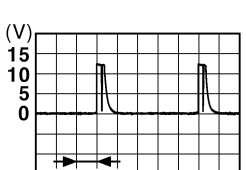
Terminal No. (Wire color)		Description		Condition	Value (Approx.)
+	-	Signal name	Input/ Output		
107 (LG)	Ground	Combination switch INPUT 1	Input	All switch OFF	 1.4 V
				Turn signal switch LH	 1.3 V
				Turn signal switch RH	 1.3 V
				Front wiper switch LO	 1.3 V
				Front washer switch ON	 1.3 V

BCM (BODY CONTROL MODULE)

[INTELLIGENT KEY SYSTEM]

< ECU DIAGNOSIS >

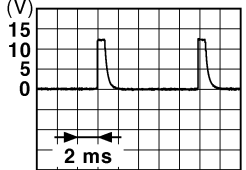
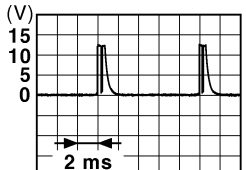
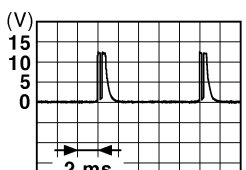
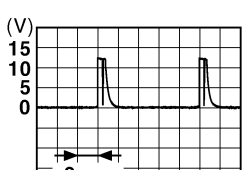
Terminal No. (Wire color)		Description		Condition	Value (Approx.)
+	-	Signal name	Input/ Output		
108 (R)	Ground	Combination switch INPUT 4	Input	Combination switch	All switch OFF (Wiper intermittent dial 4)  <p style="text-align: right; font-size: small;">JPMIA0041GB</p> <p style="text-align: center;">1.4 V</p>
					Lighting switch AUTO (Wiper intermittent dial 4)  <p style="text-align: right; font-size: small;">JPMIA0038GB</p> <p style="text-align: center;">1.3 V</p>
					Lighting switch 1ST (Wiper intermittent dial 4)  <p style="text-align: right; font-size: small;">JPMIA0036GB</p> <p style="text-align: center;">1.3 V</p>
					Any of the conditions below with all switches OFF <ul style="list-style-type: none"> • Wiper intermittent dial 1 • Wiper intermittent dial 5 • Wiper intermittent dial 6  <p style="text-align: right; font-size: small;">JPMIA0039GB</p> <p style="text-align: center;">1.3 V</p>



A
B
C
D
E
F
G
H
I
J
L
M
N
O
P

DLK

BCM (BODY CONTROL MODULE)

< ECU DIAGNOSIS >

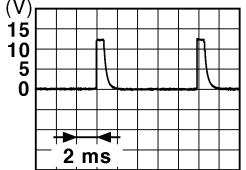
[INTELLIGENT KEY SYSTEM]

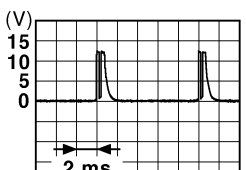
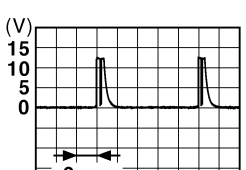
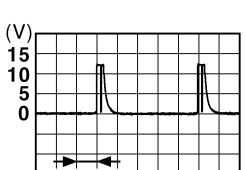
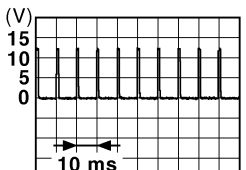
Terminal No. (Wire color)		Description		Condition	Value (Approx.)	
+	-	Signal name	Input/ Output			
109 (Y)	Ground	Combination switch INPUT 2	Input	Combination switch (Wiper intermittent dial 4)	All switch OFF	 <small>JPMIA0041GB</small> 1.4 V
					Lighting switch PASS	 <small>JPMIA0037GB</small> 1.3 V
					Lighting switch 2ND	 <small>JPMIA0036GB</small> 1.3 V
					Front wiper switch INT	 <small>JPMIA0038GB</small> 1.3 V
					Front wiper switch HI	 <small>JPMIA0040GB</small> 1.3 V
					Pressed	0 V
110 (G)	Ground	Hazard switch	Input	Hazard switch	Not pressed	 <small>JPMIA0012GB</small> 1.1 V

BCM (BODY CONTROL MODULE)

< ECU DIAGNOSIS >

[INTELLIGENT KEY SYSTEM]

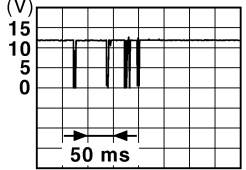
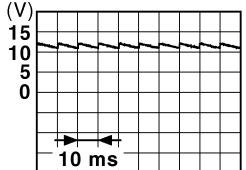
Terminal No. (Wire color)		Description		Condition	Value (Approx.)	
		Signal name	Input/ Output			
+	-					
111 (Y)	Ground	Steering lock unit communication	Input/ Output	Steering lock	LOCK status	Battery voltage
					LOCK or UNLOCK	 <p style="text-align: right; font-size: small;">JMKIA0066GB</p>
					For 15 seconds after UN-LOCK	Battery voltage
					15 seconds or later after UNLOCK	0 V
113 (P)	Ground	Optical sensor signal	Input	Ignition switch ON	When bright outside of the vehicle	Close to 5 V
				When dark outside of the vehicle	Close to 0 V	
114 (R)	Ground	Clutch interlock switch	Input	Clutch interlock switch	OFF (Clutch pedal is not depressed)	0 V
					ON (Clutch pedal is depressed)	Battery voltage
116 (SB)	Ground	Stop lamp switch 1	Input	—	Battery voltage	
118 (P)	Ground	Stop lamp switch 2	Input	Stop lamp switch	OFF (Brake pedal is not depressed)	0 V
					ON (Brake pedal is depressed)	Battery voltage
				ICC brake hold relay (With ICC)	OFF	0 V
					ON	Battery voltage
119 (SB)	Ground	Front door lock assembly driver side (unlock sensor)	Input	Driver door	LOCK status	 <p style="text-align: right; font-size: small;">JPMIA0011GB</p> <p style="text-align: center;">11.8 V</p>
					UNLOCK status	0 V
					When Intelligent Key is inserted into key slot	Battery voltage
121 (R)	Ground	Key slot switch	Input	When Intelligent Key is not inserted into key slot	0 V	
122 (V)	Ground	ACC feedback signal	Input	Ignition switch	OFF	0 V
					ACC or ON	Battery voltage
123 (W)	Ground	IGN feedback signal	Input	Ignition switch	OFF or ACC	0 V
					ON	Battery voltage

A
B
C
D
E
F
G
H
I
J
L
M
N
O
P

DLK

BCM (BODY CONTROL MODULE)

< ECU DIAGNOSIS >

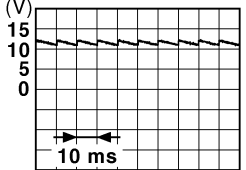
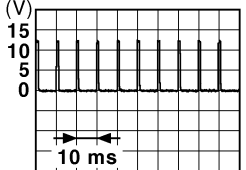
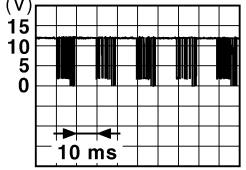
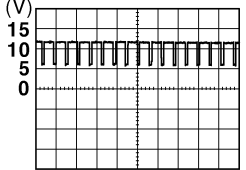

[INTELLIGENT KEY SYSTEM]

Terminal No. (Wire color)		Description		Condition		Value (Approx.)
+	-	Signal name	Input/ Output			
124 (LG)	Ground	Passenger door switch	Input	Passenger door switch	OFF (When passenger door closes)	 <small>JPMIA0011GB</small> 11.8 V
					ON (When passenger door opens)	0 V
129 (O)	Ground	Trunk lid opener cancel switch	Input	Trunk lid opener cancel switch	CANCEL	 <small>JPMIA0012GB</small> 1.1 V
					ON	0 V
132 (V)	Ground	Power window switch communication	Input/ Output	Ignition switch ON	 <small>JPMIA0013GB</small> 10.2 V	
				Ignition switch OFF or ACC	0 V	
133 (W)	Ground	Push-button ignition switch illumination	Output	Push-button ignition switch illumination	ON (When tail lamps OFF)	5.5 V
					ON (When tail lamps ON)	<p>NOTE: The pulse width of this wave is varied by the illumination brightening/dimming level.</p>  <small>JPMIA0159GB</small>
					OFF	0 V
134 (GR)	Ground	LOCK indicator lamp	Output	LOCK indicator lamp	ON	0 V
				OFF	Battery voltage	
137 (O)	Ground	Receiver and sensor ground	Input	Ignition switch ON	OFF	0 V
138 (V)	Ground	Receiver and sensor power supply output	Output	Ignition switch	OFF	0 V
					ACC or ON	5.0 V

BCM (BODY CONTROL MODULE)

[INTELLIGENT KEY SYSTEM]

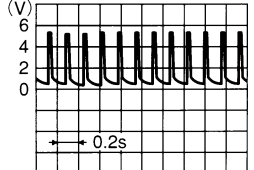
< ECU DIAGNOSIS >

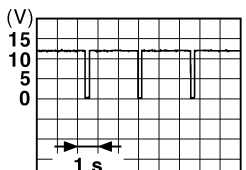
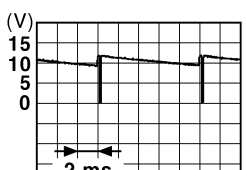
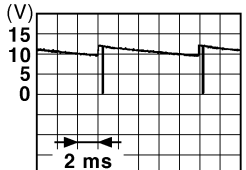
Terminal No. (Wire color)		Description		Condition	Value (Approx.)
		Signal name	Input/ Output		
+	-				
139 (L)	Ground	Tire pressure receiver signal	Input/ Output	Ignition switch ON	Standby state  OCC3881D
					When receiving the signal from the transmitter  OCC3880D
140 (GR)	Ground	Selector lever P/N position signal	Input	Selector lever	P or N position 12.0 V
					Except P and N positions 0 V
141 (G)	Ground	Security indicator signal	Output	Security indicator	ON 0 V
					Blinking  11.3 V JPMIA0014GB
142 (O)	Ground	Combination switch OUTPUT 5	Output	Combination switch (Wiper intermittent dial 4)	All switch OFF 0 V
					Lighting switch 1ST
					Lighting switch HI
					Lighting switch 2ND
					Turn signal switch RH  10.7 V JPMIA0031GB
143 (P)	Ground	Combination switch OUTPUT 1	Output	Combination switch	All switch OFF (Wiper intermittent dial 4) 0 V
					Front wiper switch HI (Wiper intermittent dial 4)
					Any of the conditions below with all switch OFF <ul style="list-style-type: none"> • Wiper intermittent dial 1 • Wiper intermittent dial 2 • Wiper intermittent dial 3 • Wiper intermittent dial 6 • Wiper intermittent dial 7  10.7 V JPMIA0032GB

A
B
C
D
E
F
G
H
I
J
L
M
N
O
P

DLK

BCM (BODY CONTROL MODULE)

< ECU DIAGNOSIS >

[INTELLIGENT KEY SYSTEM]

Terminal No. (Wire color)		Description		Condition	Value (Approx.)	
		Signal name	Input/ Output			
+	-					
144 (G)	Ground	Combination switch OUTPUT 2	Output	Combination switch	All switch OFF (Wiper intermittent dial 4)	0 V
					Front washer switch ON (Wiper intermittent dial 4)	<p style="text-align: right; font-size: small;">JPMIA0033GB</p>
Any of the conditions below with all switches OFF <ul style="list-style-type: none"> • Wiper intermittent dial 1 • Wiper intermittent dial 5 • Wiper intermittent dial 6 					10.7 V	
145 (L)	Ground	Combination switch OUTPUT 3	Output	Combination switch (Wiper intermit- tent dial 4)	All switches OFF	0 V
					Front wiper switch INT	<p style="text-align: right; font-size: small;">JPMIA0034GB</p>
Front wiper switch LO Lighting switch AUTO					10.7 V	
146 (SB)	Ground	Combination switch OUTPUT 4	Output	Combination switch (Wiper intermit- tent dial 4)	All switch OFF	0 V
					Front fog lamp switch ON	<p style="text-align: right; font-size: small;">JPMIA0035GB</p>
Lighting switch 2ND Lighting switch PASS Turn signal switch LH					10.7 V	
149 (W)	Ground	Tire pressure warn- ing check switch	Input	—	5 V	
150 (GR)	Ground	Driver door switch	Input	Driver door switch	OFF (When driver door closes)	<p style="text-align: right; font-size: small;">JPMIA0011GB</p>
					ON (When driver door opens)	
151 (G)	Ground	Rear window defog- ger relay	Output	Rear window de- fogger	Active	0 V
					Not activated	Battery voltage

BCM (BODY CONTROL MODULE)

[INTELLIGENT KEY SYSTEM]

< ECU DIAGNOSIS >

Wiring Diagram — POWER DOOR LOCK SYSTEM —

INFOID:000000000961234

POWER DOOR LOCK SYSTEM

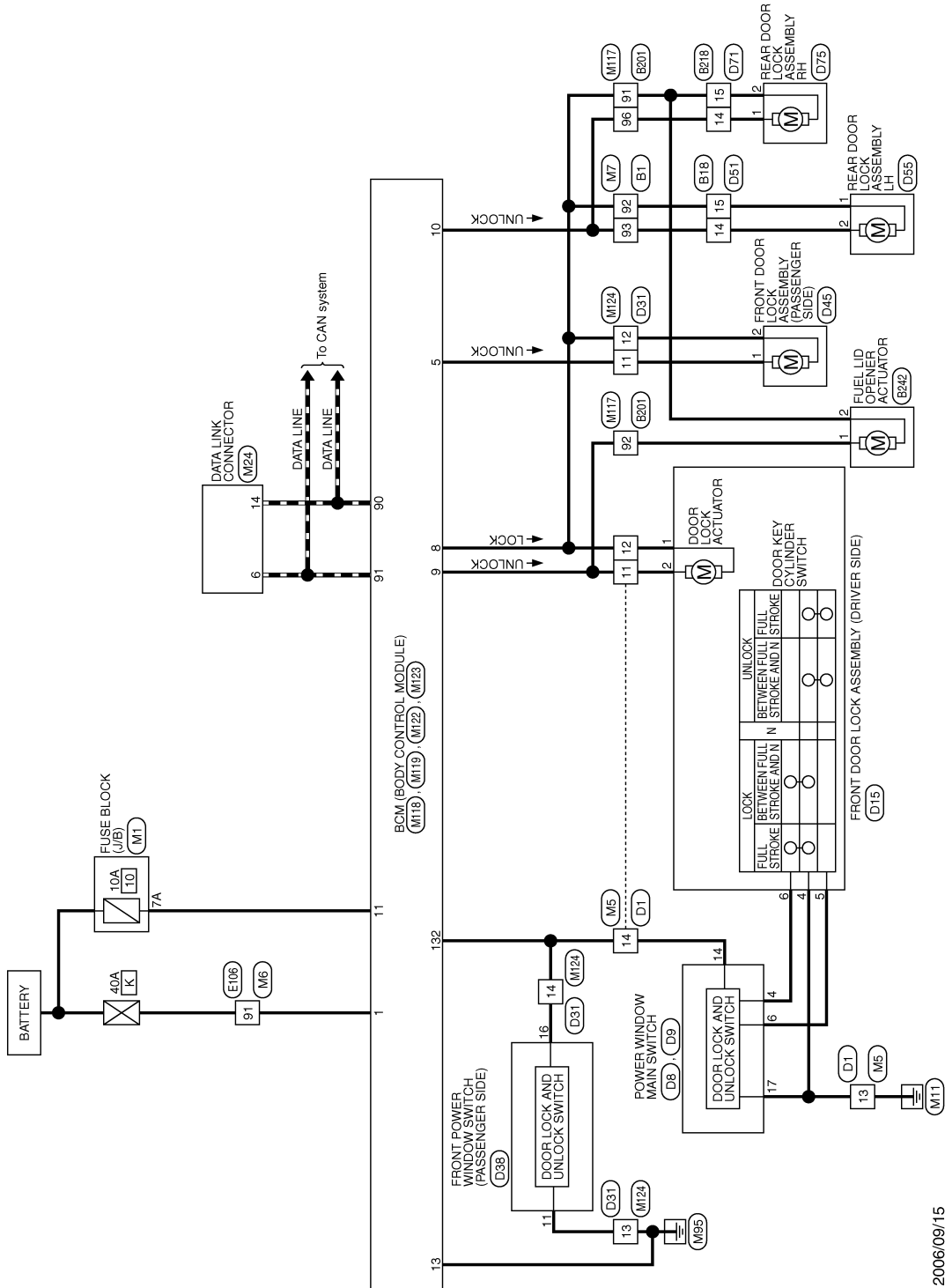

2006/09/15

JCKWA0001GE

A
B
C
D
E
F
G
H
I
J
K
L
M
N
O
P

DLK

BCM (BODY CONTROL MODULE)

< ECU DIAGNOSIS >

[INTELLIGENT KEY SYSTEM]

POWER DOOR LOCK SYSTEM

Connector No.	B1
Connector Name	WIRE TO WIRE
Connector Type	TH80FW-CS16-TM4

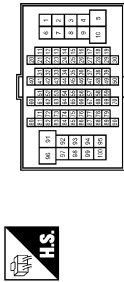

Terminal No.	Color of Wire	Signal Name
92	BR	-
93	G	-

Connector No.	B18
Connector Name	WIRE TO WIRE
Connector Type	TK10FW-NS8



Terminal No.	Color of Wire	Signal Name
14	G	-
15	BR	-

Connector No.	B201
Connector Name	WIRE TO WIRE
Connector Type	TH80FW-CS16-TM4

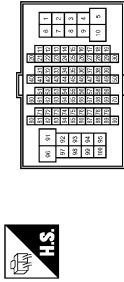

Terminal No.	Color of Wire	Signal Name
91	V	-
92	G	-
96	G	-

Connector No.	B218
Connector Name	WIRE TO WIRE
Connector Type	TK10FW-NS8



Terminal No.	Color of Wire	Signal Name
14	G	-
15	V	-

Connector No.	B242
Connector Name	FUEL LID OPENER ACTUATOR
Connector Type	M04FW-LC



Terminal No.	Color of Wire	Signal Name
1	G	-
2	V	-

Connector No.	D1
Connector Name	WIRE TO WIRE
Connector Type	TH40FW-CS15

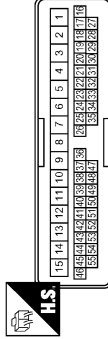

Terminal No.	Color of Wire	Signal Name
11	P	-
12	LG	-
13	B	-
14	V	-

Connector No.	D8
Connector Name	POWER WINDOW MAIN SWITCH
Connector Type	NS10FW-CS

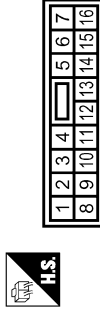

Terminal No.	Color of Wire	Signal Name
4	V	-
6	Y	-
14	V	-

Connector No.	D9
Connector Name	POWER WINDOW MAIN SWITCH
Connector Type	NS30FW-CS



Terminal No.	Color of Wire	Signal Name
17	B	-

JCKWA0002GE

BCM (BODY CONTROL MODULE)

[INTELLIGENT KEY SYSTEM]

< ECU DIAGNOSIS >

POWER DOOR LOCK SYSTEM

Connector No.	D15
Connector Name	FRONT DOOR LOCK ASSEMBLY (DRIVER SIDE)
Connector Type	E06FGY-RS



Connector No.	D31
Connector Name	WIRE TO WIRE
Connector Type	TK40FW-CS15

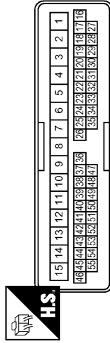

Connector No.	D38
Connector Name	FRONT POWER WINDOW SWITCH (PASSENGER SIDE)
Connector Type	NS10FW-CS

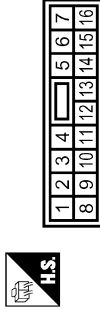

Connector No.	D45
Connector Name	FRONT DOOR LOCK ASSEMBLY (PASSENGER SIDE)
Connector Type	E06FGY-RS



Terminal No.	1	2	4	5	6
Color of Wire	LG	P	B	Y	V
Signal Name	-	-	-	-	-

Terminal No.	11	12	13	14
Color of Wire	P	LG	B	V
Signal Name	-	-	-	-

Terminal No.	11	16
Color of Wire	B	V
Signal Name	-	-

Terminal No.	1	2
Color of Wire	P	LG
Signal Name	-	-

Connector No.	D51
Connector Name	WIRE TO WIRE
Connector Type	TK10MW-RS8



Connector No.	D55
Connector Name	REAR DOOR LOCK ASSEMBLY LH
Connector Type	E06FGY-RS



Connector No.	D71
Connector Name	WIRE TO WIRE
Connector Type	TK10MW-RS8

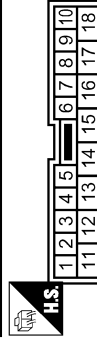

Connector No.	D75
Connector Name	REAR DOOR LOCK ASSEMBLY RH
Connector Type	E06FGY-RS



Terminal No.	14	15
Color of Wire	G	V
Signal Name	-	-

Terminal No.	1	2
Color of Wire	V	G
Signal Name	-	-

Terminal No.	14	15
Color of Wire	G	V
Signal Name	-	-

Terminal No.	1	2
Color of Wire	G	V
Signal Name	-	-

A
B
C
D
E
F
G
H
I
J
DLK
L
M
N
O
P

BCM (BODY CONTROL MODULE)

< ECU DIAGNOSIS >

[INTELLIGENT KEY SYSTEM]

POWER DOOR LOCK SYSTEM

Connector No.	E106
Connector Name	WIRE TO WIRE
Connector Type	TH80FW-CS16-TM4

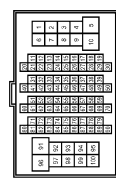

Terminal No.	91	Color of Wire	W	Signal Name	-
--------------	----	---------------	---	-------------	---

Connector No.	M1
Connector Name	FUSE BLOCK (J/B)
Connector Type	NS06FW-M2



Terminal No.	7A	Color of Wire	R	Signal Name	-
--------------	----	---------------	---	-------------	---

Connector No.	M5
Connector Name	WIRE TO WIRE
Connector Type	TH40MW-CS15

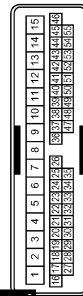

Terminal No.	11	Color of Wire	G	Signal Name	-
12	V	-	-	-	-
13	B	-	-	-	-
14	V	-	-	-	-

Connector No.	M6
Connector Name	WIRE TO WIRE
Connector Type	TH80MW-CS16-TM4



Terminal No.	91	Color of Wire	W	Signal Name	-
--------------	----	---------------	---	-------------	---

Connector No.	M7
Connector Name	WIRE TO WIRE
Connector Type	TH80MW-CS16-TM4

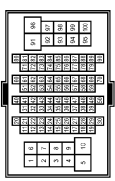

Terminal No.	92	Color of Wire	V	Signal Name	-
93	BR	-	-	-	-

Connector No.	M24
Connector Name	DATA LINK CONNECTOR
Connector Type	BD16FW

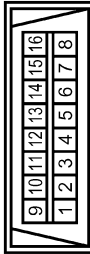

Terminal No.	6	Color of Wire	L	Signal Name	-
14	P	-	-	-	-

Connector No.	M117
Connector Name	WIRE TO WIRE
Connector Type	TH80MW-CS16-TM4

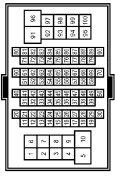

Terminal No.	91	Color of Wire	V	Signal Name	-
92	G	-	-	-	-
96	G	-	-	-	-

Connector No.	M118
Connector Name	BCM (BODY CONTROL MODULE)
Connector Type	M03FB-LC



Terminal No.	1	Color of Wire	W	Signal Name	BAT (F/L)
--------------	---	---------------	---	-------------	-----------

JCKWA0004GE

BCM (BODY CONTROL MODULE)

[INTELLIGENT KEY SYSTEM]

< ECU DIAGNOSIS >

POWER DOOR LOCK SYSTEM

Connector No.	M119
Connector Name	BCM (BODY CONTROL MODULE)
Connector Type	NS16FW-CS

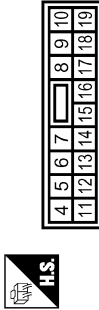

Terminal No.	Color of Wire	Signal Name
5	V	DOOR UNLOCK OUTPUT (AS)
8	V	DOOR LOCK OUTPUT (ALL)
9	G	DOOR UNLOCK OUTPUT (DR)
10	BR	DOOR UNLOCK OUTPUT (RR)
11	R	BAT.(FUSE)
13	B	GND

Connector No.	M122
Connector Name	BCM (BODY CONTROL MODULE)
Connector Type	TH40FB-NH

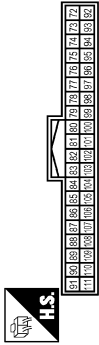

Terminal No.	Color of Wire	Signal Name
90	P	GAN-L
91	L	GAN-H

Connector No.	M123
Connector Name	BCM (BODY CONTROL MODULE)
Connector Type	TH40FC-NH

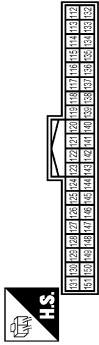

Terminal No.	Color of Wire	Signal Name
132	V	POWER WINDOW SERIAL LINK

Connector No.	M124
Connector Name	WIRE TO WIRE
Connector Type	TH40MW-CS15

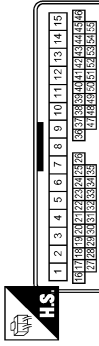

Terminal No.	Color of Wire	Signal Name
11	V	-
12	V	-
13	B	-
14	Y	-

A
B
C
D
E
F
G
H
I
J
DLK
L
M
N
O
P

JCKWA0005GE

BCM (BODY CONTROL MODULE)

[INTELLIGENT KEY SYSTEM]

< ECU DIAGNOSIS >

Wiring Diagram — INTELLIGENT KEY SYSTEM —

INFOID:000000000961235

INTELLIGENT KEY SYSTEM

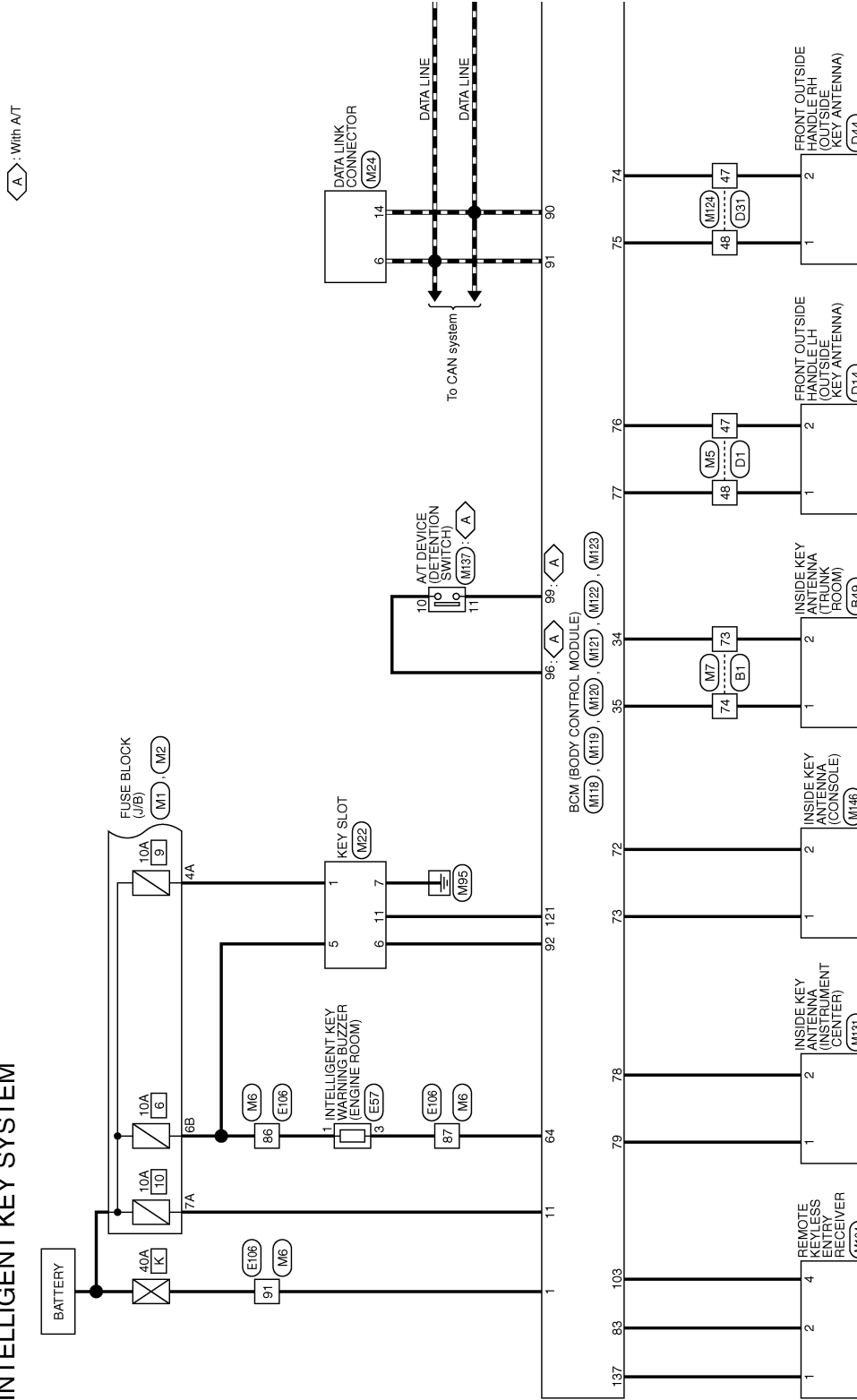

◊ : With A/T

BCM (BODY CONTROL MODULE)

[INTELLIGENT KEY SYSTEM]

< ECU DIAGNOSIS >

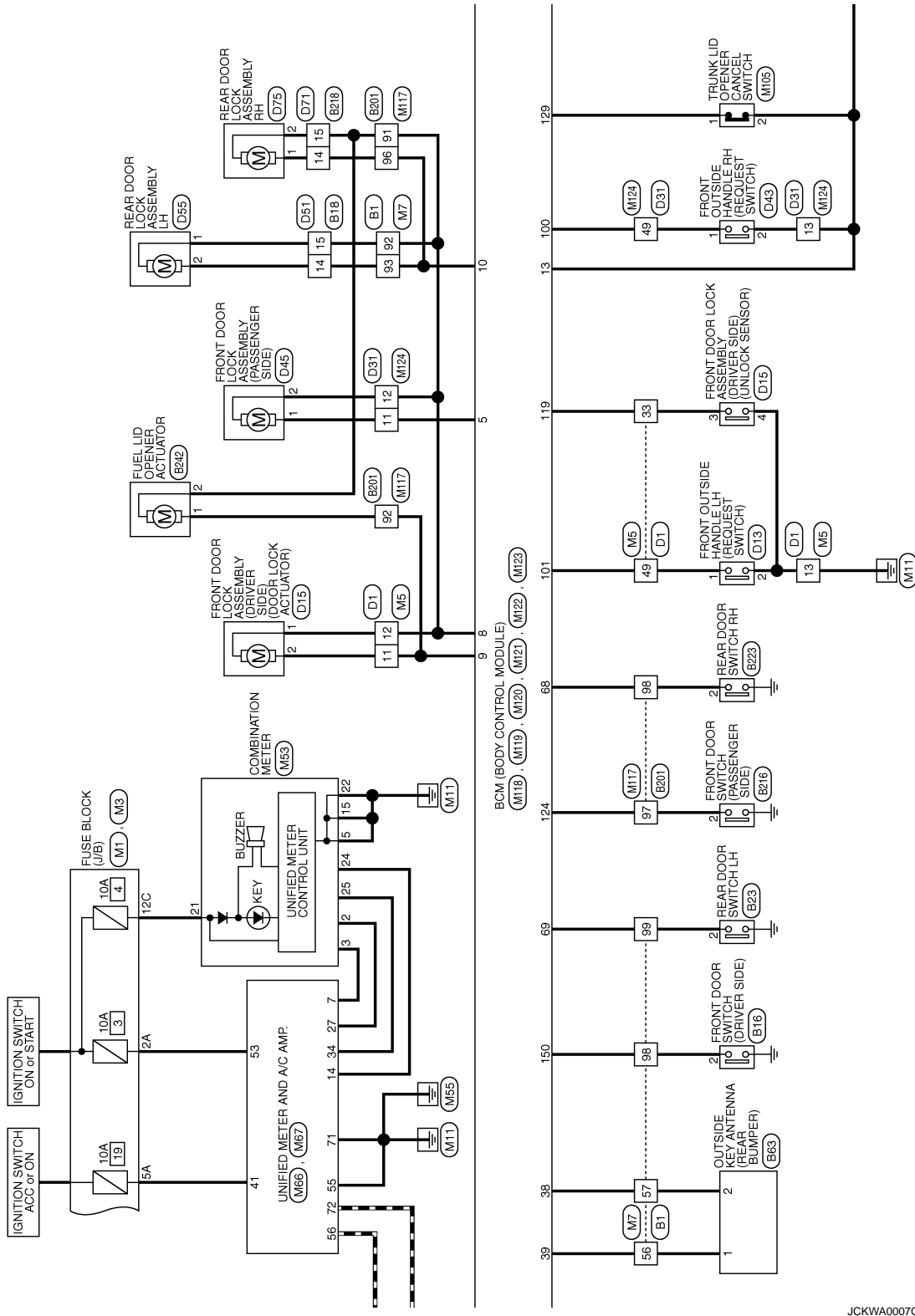

JCKWA0007GE

A
B
C
D
E
F
G
H
I
J
K
L
M
N
O
P

DLK

BCM (BODY CONTROL MODULE)

< ECU DIAGNOSIS >

[INTELLIGENT KEY SYSTEM]

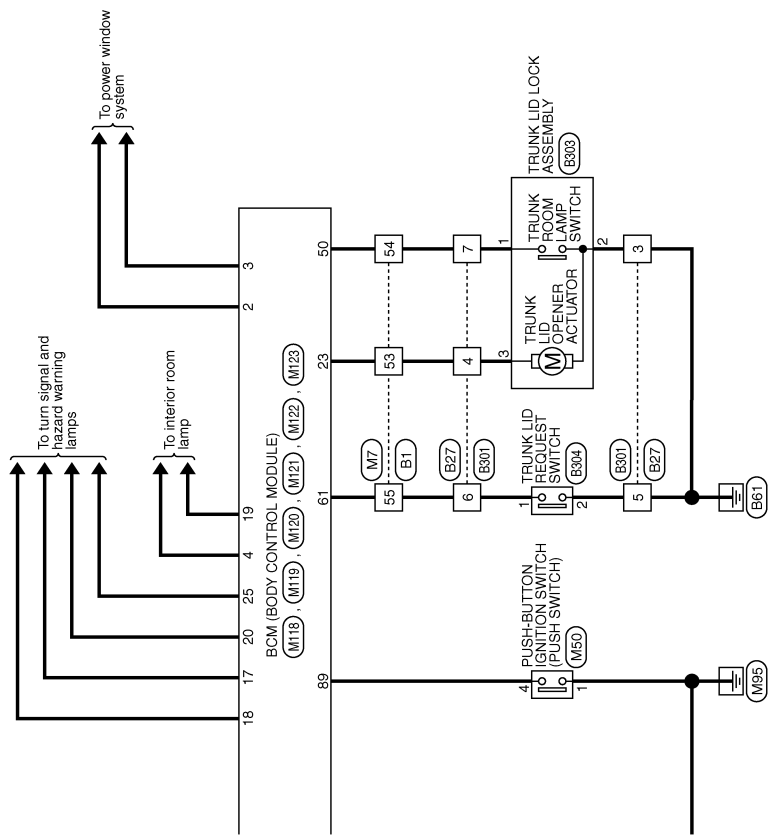







JCKWA0008GE

BCM (BODY CONTROL MODULE)

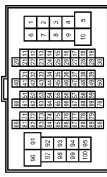
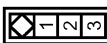
[INTELLIGENT KEY SYSTEM]

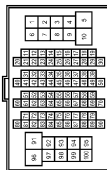
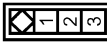
< ECU DIAGNOSIS >

INTELLIGENT KEY SYSTEM

<table border="1"> <tr><td>Connector No.</td><td>B1</td></tr> <tr><td>Connector Name</td><td>WIRE TO WIRE</td></tr> <tr><td>Connector Type</td><td>TH8DFW-CS16-TM4</td></tr> </table>  <table border="1"> <tr><th>Terminal No.</th><th>Color of Wire</th><th>Signal Name</th></tr> <tr><td>53</td><td>Y</td><td>-</td></tr> <tr><td>54</td><td>L</td><td>-</td></tr> <tr><td>55</td><td>W</td><td>-</td></tr> <tr><td>56</td><td>BR</td><td>-</td></tr> <tr><td>57</td><td>R</td><td>-</td></tr> <tr><td>73</td><td>G</td><td>-</td></tr> <tr><td>74</td><td>R</td><td>-</td></tr> <tr><td>92</td><td>BR</td><td>-</td></tr> <tr><td>93</td><td>G</td><td>-</td></tr> <tr><td>98</td><td>V</td><td>-</td></tr> <tr><td>99</td><td>R</td><td>-</td></tr> </table>	Connector No.	B1	Connector Name	WIRE TO WIRE	Connector Type	TH8DFW-CS16-TM4	Terminal No.	Color of Wire	Signal Name	53	Y	-	54	L	-	55	W	-	56	BR	-	57	R	-	73	G	-	74	R	-	92	BR	-	93	G	-	98	V	-	99	R	-	<table border="1"> <tr><td>Connector No.</td><td>B23</td></tr> <tr><td>Connector Name</td><td>REAR DOOR SWITCH LH</td></tr> <tr><td>Connector Type</td><td>A03FW</td></tr> </table>  <table border="1"> <tr><th>Terminal No.</th><th>Color of Wire</th><th>Signal Name</th></tr> <tr><td>2</td><td>R</td><td>-</td></tr> </table>	Connector No.	B23	Connector Name	REAR DOOR SWITCH LH	Connector Type	A03FW	Terminal No.	Color of Wire	Signal Name	2	R	-
Connector No.	B1																																																						
Connector Name	WIRE TO WIRE																																																						
Connector Type	TH8DFW-CS16-TM4																																																						
Terminal No.	Color of Wire	Signal Name																																																					
53	Y	-																																																					
54	L	-																																																					
55	W	-																																																					
56	BR	-																																																					
57	R	-																																																					
73	G	-																																																					
74	R	-																																																					
92	BR	-																																																					
93	G	-																																																					
98	V	-																																																					
99	R	-																																																					
Connector No.	B23																																																						
Connector Name	REAR DOOR SWITCH LH																																																						
Connector Type	A03FW																																																						
Terminal No.	Color of Wire	Signal Name																																																					
2	R	-																																																					
<table border="1"> <tr><td>Connector No.</td><td>B18</td></tr> <tr><td>Connector Name</td><td>WIRE TO WIRE</td></tr> <tr><td>Connector Type</td><td>TK10FW-NSS</td></tr> </table>  <table border="1"> <tr><th>Terminal No.</th><th>Color of Wire</th><th>Signal Name</th></tr> <tr><td>14</td><td>G</td><td>-</td></tr> <tr><td>15</td><td>BR</td><td>-</td></tr> </table>	Connector No.	B18	Connector Name	WIRE TO WIRE	Connector Type	TK10FW-NSS	Terminal No.	Color of Wire	Signal Name	14	G	-	15	BR	-	<table border="1"> <tr><td>Connector No.</td><td>B201</td></tr> <tr><td>Connector Name</td><td>WIRE TO WIRE</td></tr> <tr><td>Connector Type</td><td>TH8DFW-CS16-TM4</td></tr> </table>  <table border="1"> <tr><th>Terminal No.</th><th>Color of Wire</th><th>Signal Name</th></tr> <tr><td>91</td><td>V</td><td>-</td></tr> <tr><td>92</td><td>G</td><td>-</td></tr> <tr><td>95</td><td>G</td><td>-</td></tr> <tr><td>97</td><td>GR</td><td>-</td></tr> <tr><td>98</td><td>BR</td><td>-</td></tr> </table>	Connector No.	B201	Connector Name	WIRE TO WIRE	Connector Type	TH8DFW-CS16-TM4	Terminal No.	Color of Wire	Signal Name	91	V	-	92	G	-	95	G	-	97	GR	-	98	BR	-															
Connector No.	B18																																																						
Connector Name	WIRE TO WIRE																																																						
Connector Type	TK10FW-NSS																																																						
Terminal No.	Color of Wire	Signal Name																																																					
14	G	-																																																					
15	BR	-																																																					
Connector No.	B201																																																						
Connector Name	WIRE TO WIRE																																																						
Connector Type	TH8DFW-CS16-TM4																																																						
Terminal No.	Color of Wire	Signal Name																																																					
91	V	-																																																					
92	G	-																																																					
95	G	-																																																					
97	GR	-																																																					
98	BR	-																																																					
<table border="1"> <tr><td>Connector No.</td><td>B16</td></tr> <tr><td>Connector Name</td><td>FRONT DOOR SWITCH (DRIVER SIDE)</td></tr> <tr><td>Connector Type</td><td>A03FW</td></tr> </table>  <table border="1"> <tr><th>Terminal No.</th><th>Color of Wire</th><th>Signal Name</th></tr> <tr><td>2</td><td>V</td><td>-</td></tr> </table>	Connector No.	B16	Connector Name	FRONT DOOR SWITCH (DRIVER SIDE)	Connector Type	A03FW	Terminal No.	Color of Wire	Signal Name	2	V	-	<table border="1"> <tr><td>Connector No.</td><td>B63</td></tr> <tr><td>Connector Name</td><td>OUTSIDE KEY ANTENNA (REAR BUMPER)</td></tr> <tr><td>Connector Type</td><td>RK02FGY</td></tr> </table>  <table border="1"> <tr><th>Terminal No.</th><th>Color of Wire</th><th>Signal Name</th></tr> <tr><td>1</td><td>BR</td><td>-</td></tr> <tr><td>2</td><td>R</td><td>-</td></tr> </table>	Connector No.	B63	Connector Name	OUTSIDE KEY ANTENNA (REAR BUMPER)	Connector Type	RK02FGY	Terminal No.	Color of Wire	Signal Name	1	BR	-	2	R	-																											
Connector No.	B16																																																						
Connector Name	FRONT DOOR SWITCH (DRIVER SIDE)																																																						
Connector Type	A03FW																																																						
Terminal No.	Color of Wire	Signal Name																																																					
2	V	-																																																					
Connector No.	B63																																																						
Connector Name	OUTSIDE KEY ANTENNA (REAR BUMPER)																																																						
Connector Type	RK02FGY																																																						
Terminal No.	Color of Wire	Signal Name																																																					
1	BR	-																																																					
2	R	-																																																					
<table border="1"> <tr><td>Connector No.</td><td>B49</td></tr> <tr><td>Connector Name</td><td>INSIDE KEY ANTENNA (TRUNK ROOM)</td></tr> <tr><td>Connector Type</td><td>RK02FGY</td></tr> </table>  <table border="1"> <tr><th>Terminal No.</th><th>Color of Wire</th><th>Signal Name</th></tr> <tr><td>1</td><td>R</td><td>-</td></tr> <tr><td>2</td><td>G</td><td>-</td></tr> </table>	Connector No.	B49	Connector Name	INSIDE KEY ANTENNA (TRUNK ROOM)	Connector Type	RK02FGY	Terminal No.	Color of Wire	Signal Name	1	R	-	2	G	-	<table border="1"> <tr><td>Connector No.</td><td>B27</td></tr> <tr><td>Connector Name</td><td>WIRE TO WIRE</td></tr> <tr><td>Connector Type</td><td>NS16MW-CS</td></tr> </table>  <table border="1"> <tr><th>Terminal No.</th><th>Color of Wire</th><th>Signal Name</th></tr> <tr><td>3</td><td>B</td><td>-</td></tr> <tr><td>4</td><td>Y</td><td>-</td></tr> <tr><td>5</td><td>B</td><td>-</td></tr> <tr><td>6</td><td>W</td><td>-</td></tr> <tr><td>7</td><td>L</td><td>-</td></tr> </table>	Connector No.	B27	Connector Name	WIRE TO WIRE	Connector Type	NS16MW-CS	Terminal No.	Color of Wire	Signal Name	3	B	-	4	Y	-	5	B	-	6	W	-	7	L	-															
Connector No.	B49																																																						
Connector Name	INSIDE KEY ANTENNA (TRUNK ROOM)																																																						
Connector Type	RK02FGY																																																						
Terminal No.	Color of Wire	Signal Name																																																					
1	R	-																																																					
2	G	-																																																					
Connector No.	B27																																																						
Connector Name	WIRE TO WIRE																																																						
Connector Type	NS16MW-CS																																																						
Terminal No.	Color of Wire	Signal Name																																																					
3	B	-																																																					
4	Y	-																																																					
5	B	-																																																					
6	W	-																																																					
7	L	-																																																					

A
B
C
D
E
F
G
H
I
J
DLK
L
M
N
O
P

JCKWA0009GE

BCM (BODY CONTROL MODULE)

[INTELLIGENT KEY SYSTEM]

< ECU DIAGNOSIS >

INTELLIGENT KEY SYSTEM

Connector No.	B216
Connector Name	FRONT DOOR SWITCH (PASSENGER SIDE)
Connector Type	AG3FW

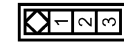

Terminal No.	Color of Wire	Signal Name
2	GR	-

Connector No.	B218
Connector Name	WIRE TO WIRE
Connector Type	TK10FW-NS8

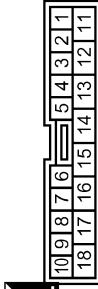

Terminal No.	Color of Wire	Signal Name
14	G	-
15	V	-

Connector No.	B223
Connector Name	REAR DOOR SWITCH RH
Connector Type	A03FW

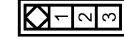

Terminal No.	Color of Wire	Signal Name
2	BR	-

Connector No.	B242
Connector Name	FUEL LID OPENER ACTUATOR
Connector Type	M04FW-LC

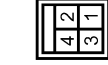

Terminal No.	Color of Wire	Signal Name
1	G	-
2	V	-

Connector No.	B301
Connector Name	WIRE TO WIRE
Connector Type	NS16FW-CS

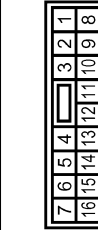

Terminal No.	Color of Wire	Signal Name
3	B	-
4	G	-
5	B	-
6	W	-
7	V	-

Connector No.	B303
Connector Name	TRUNK LID LOCK ASSEMBLY
Connector Type	TE03FW



Terminal No.	Color of Wire	Signal Name
1	V	-
2	B	-
3	G	-

Connector No.	B304
Connector Name	TRUNK LID REQUEST SWITCH
Connector Type	TK02MBR-P



Terminal No.	Color of Wire	Signal Name
1	W	-
2	B	-

Connector No.	D1
Connector Name	WIRE TO WIRE
Connector Type	TH00FW-CS15

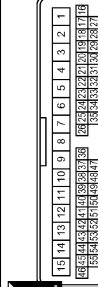

Terminal No.	Color of Wire	Signal Name
11	P	-
12	LG	-
13	B	-
33	L	-
47	V	-
48	P	-
49	W	-

JCKWA0010GE

BCM (BODY CONTROL MODULE)

[INTELLIGENT KEY SYSTEM]

< ECU DIAGNOSIS >

INTELLIGENT KEY SYSTEM

Connector No.	D13
Connector Name	FRONT OUTSIDE HANDLE LH(REQUEST SWITCH)
Connector Type	RK02FL



Terminal No.	Color of Wire	Signal Name
1	W	-
2	B	-

Connector No.	D14
Connector Name	FRONT OUTSIDE HANDLE RH(OUTSIDE KEY ANTENNA)
Connector Type	RK02MGY



Terminal No.	Color of Wire	Signal Name
1	P	-
2	V	-

Connector No.	D15
Connector Name	FRONT DOOR LOCK ASSEMBLY (DRIVER SIDE)
Connector Type	ED0FGY-RS

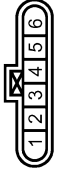

Terminal No.	Color of Wire	Signal Name
1	LG	-
2	P	-
3	L	-
4	B	-

Connector No.	D31
Connector Name	WIRE TO WIRE
Connector Type	TH0MFW-GS15

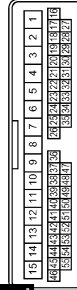

Terminal No.	Color of Wire	Signal Name
11	P	-
12	LG	-
13	B	-
47	V	-
48	P	-
49	W	-

Connector No.	D43
Connector Name	FRONT OUTSIDE HANDLE RH(REQUEST SWITCH)
Connector Type	RK02FL



Terminal No.	Color of Wire	Signal Name
1	W	-
2	B	-

Connector No.	D44
Connector Name	FRONT OUTSIDE HANDLE RH(OUTSIDE KEY ANTENNA)
Connector Type	RK02MGY



Terminal No.	Color of Wire	Signal Name
1	P	-
2	V	-

Connector No.	D45
Connector Name	FRONT DOOR LOCK ASSEMBLY (PASSENGER SIDE)
Connector Type	ED0FGY-RS



Terminal No.	Color of Wire	Signal Name
1	P	-
2	LG	-

Connector No.	D51
Connector Name	WIRE TO WIRE
Connector Type	TK10MW-RS8



Terminal No.	Color of Wire	Signal Name
14	G	-
15	V	-

A
B
C
D
E
F
G
H
I
J
DLK
L
M
N
O
P

BCM (BODY CONTROL MODULE)

< ECU DIAGNOSIS >

[INTELLIGENT KEY SYSTEM]

INTELLIGENT KEY SYSTEM

Connector No.	D55
Connector Name	REAR DOOR LOCK ASSEMBLY LH
Connector Type	E06FGY-RS



Terminal No.	Color of Wire	Signal Name
1	V	-
2	G	-

Connector No.	D71
Connector Name	WIRE TO WIRE
Connector Type	TK10MW-NSB

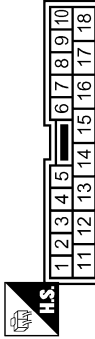

Terminal No.	Color of Wire	Signal Name
14	G	-
15	V	-

Connector No.	D75
Connector Name	REAR DOOR LOCK ASSEMBLY RH
Connector Type	E06FGY-RS



Terminal No.	Color of Wire	Signal Name
1	G	-
2	V	-

Connector No.	E57
Connector Name	INTELLIGENT KEY WARNING BUZZER (ENGINE ROOM)
Connector Type	RK03FBR



Terminal No.	Color of Wire	Signal Name
1	LG	-
3	GR	-

Connector No.	E105
Connector Name	WIRE TO WIRE
Connector Type	THB0FW-GS16-1M4

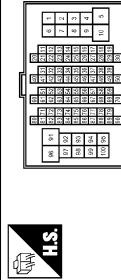

Terminal No.	Color of Wire	Signal Name
86	LG	-
87	GR	-
91	W	-

Connector No.	M1
Connector Name	FUSE BLOCK (J/B)
Connector Type	NS08FW-M2

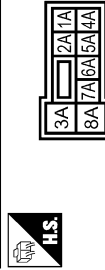

Terminal No.	Color of Wire	Signal Name
2A	G	-
4A	P	-
5A	V	-
7A	R	-

Connector No.	M2
Connector Name	FUSE BLOCK (J/B)
Connector Type	NS10FW-GS

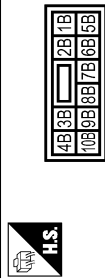

Terminal No.	Color of Wire	Signal Name
6B	Y	-

Connector No.	M3
Connector Name	FUSE BLOCK (J/B)
Connector Type	NS12FW-GS

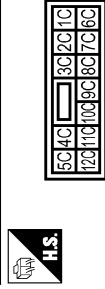

Terminal No.	Color of Wire	Signal Name
12C	R	-







JCKWA0012GE

BCM (BODY CONTROL MODULE)

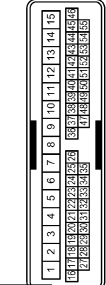
< ECU DIAGNOSIS >

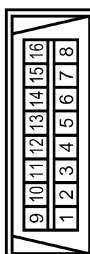
[INTELLIGENT KEY SYSTEM]

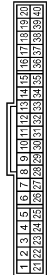
INTELLIGENT KEY SYSTEM

<p>Connector No. M5</p> <p>Connector Name WIRE TO WIRE</p> <p>Connector Type TH40WV-CS15</p> 	<table border="1"> <thead> <tr> <th>Terminal No.</th> <th>Color of Wire</th> <th>Signal Name</th> </tr> </thead> <tbody> <tr><td>11</td><td>G</td><td>-</td></tr> <tr><td>12</td><td>V</td><td>-</td></tr> <tr><td>13</td><td>B</td><td>-</td></tr> <tr><td>33</td><td>SB</td><td>-</td></tr> <tr><td>47</td><td>V</td><td>-</td></tr> <tr><td>48</td><td>LG</td><td>-</td></tr> <tr><td>49</td><td>SB</td><td>-</td></tr> </tbody> </table>	Terminal No.	Color of Wire	Signal Name	11	G	-	12	V	-	13	B	-	33	SB	-	47	V	-	48	LG	-	49	SB	-									
Terminal No.	Color of Wire	Signal Name																																
11	G	-																																
12	V	-																																
13	B	-																																
33	SB	-																																
47	V	-																																
48	LG	-																																
49	SB	-																																
<p>Connector No. M6</p> <p>Connector Name WIRE TO WIRE</p> <p>Connector Type TH80WV-CS18-TM4</p> 	<table border="1"> <thead> <tr> <th>Terminal No.</th> <th>Color of Wire</th> <th>Signal Name</th> </tr> </thead> <tbody> <tr><td>86</td><td>Y</td><td>-</td></tr> <tr><td>87</td><td>V</td><td>-</td></tr> <tr><td>91</td><td>W</td><td>-</td></tr> </tbody> </table>	Terminal No.	Color of Wire	Signal Name	86	Y	-	87	V	-	91	W	-																					
Terminal No.	Color of Wire	Signal Name																																
86	Y	-																																
87	V	-																																
91	W	-																																
<p>Connector No. M7</p> <p>Connector Name WIRE TO WIRE</p> <p>Connector Type TH80WV-CS16-TM4</p> 	<table border="1"> <thead> <tr> <th>Terminal No.</th> <th>Color of Wire</th> <th>Signal Name</th> </tr> </thead> <tbody> <tr><td>53</td><td>G</td><td>-</td></tr> <tr><td>54</td><td>R</td><td>-</td></tr> <tr><td>55</td><td>W</td><td>-</td></tr> <tr><td>56</td><td>W</td><td>-</td></tr> <tr><td>57</td><td>B</td><td>-</td></tr> <tr><td>73</td><td>SB</td><td>-</td></tr> <tr><td>74</td><td>V</td><td>-</td></tr> <tr><td>83</td><td>BR</td><td>-</td></tr> <tr><td>88</td><td>GR</td><td>-</td></tr> <tr><td>89</td><td>R</td><td>-</td></tr> </tbody> </table>	Terminal No.	Color of Wire	Signal Name	53	G	-	54	R	-	55	W	-	56	W	-	57	B	-	73	SB	-	74	V	-	83	BR	-	88	GR	-	89	R	-
Terminal No.	Color of Wire	Signal Name																																
53	G	-																																
54	R	-																																
55	W	-																																
56	W	-																																
57	B	-																																
73	SB	-																																
74	V	-																																
83	BR	-																																
88	GR	-																																
89	R	-																																
<p>Connector No. M24</p> <p>Connector Name DATA LINK CONNECTOR</p> <p>Connector Type BD18FW</p> 	<table border="1"> <thead> <tr> <th>Terminal No.</th> <th>Color of Wire</th> <th>Signal Name</th> </tr> </thead> <tbody> <tr><td>6</td><td>L</td><td>-</td></tr> <tr><td>14</td><td>P</td><td>-</td></tr> </tbody> </table>	Terminal No.	Color of Wire	Signal Name	6	L	-	14	P	-																								
Terminal No.	Color of Wire	Signal Name																																
6	L	-																																
14	P	-																																
<p>Connector No. M25</p> <p>Connector Name WIRE TO WIRE</p> <p>Connector Type TH12FW-NH</p> 	<table border="1"> <thead> <tr> <th>Terminal No.</th> <th>Color of Wire</th> <th>Signal Name</th> </tr> </thead> <tbody> <tr><td>1</td><td>R</td><td>BAT</td></tr> <tr><td>5</td><td>Y</td><td>ILL.BAT</td></tr> <tr><td>6</td><td>LG</td><td>ILL</td></tr> <tr><td>7</td><td>B</td><td>GND</td></tr> <tr><td>11</td><td>R</td><td>KEY SWITCH SIGNAL</td></tr> </tbody> </table>	Terminal No.	Color of Wire	Signal Name	1	R	BAT	5	Y	ILL.BAT	6	LG	ILL	7	B	GND	11	R	KEY SWITCH SIGNAL															
Terminal No.	Color of Wire	Signal Name																																
1	R	BAT																																
5	Y	ILL.BAT																																
6	LG	ILL																																
7	B	GND																																
11	R	KEY SWITCH SIGNAL																																
<p>Connector No. M30</p> <p>Connector Name PUSH-BUTTON IGNITION SWITCH</p> <p>Connector Type TK08EBR</p> 	<table border="1"> <thead> <tr> <th>Terminal No.</th> <th>Color of Wire</th> <th>Signal Name</th> </tr> </thead> <tbody> <tr><td>1</td><td>B</td><td>-</td></tr> <tr><td>4</td><td>BR</td><td>-</td></tr> </tbody> </table>	Terminal No.	Color of Wire	Signal Name	1	B	-	4	BR	-																								
Terminal No.	Color of Wire	Signal Name																																
1	B	-																																
4	BR	-																																
<p>Connector No. M35</p> <p>Connector Name COMBINATION METER</p> <p>Connector Type SAB40FW</p> 	<table border="1"> <thead> <tr> <th>Terminal No.</th> <th>Color of Wire</th> <th>Signal Name</th> </tr> </thead> <tbody> <tr><td>2</td><td>LG</td><td>COMM (METER->METER)</td></tr> <tr><td>3</td><td>GR</td><td>COMM (AMP->METER)</td></tr> <tr><td>5</td><td>B</td><td>GND</td></tr> <tr><td>15</td><td>B</td><td>GND</td></tr> <tr><td>21</td><td>R</td><td>IGN</td></tr> <tr><td>22</td><td>B</td><td>GND</td></tr> <tr><td>24</td><td>BR</td><td>COMM (LCD->AMP)</td></tr> <tr><td>25</td><td>Y</td><td>COMM (AMP->LCD)</td></tr> </tbody> </table>	Terminal No.	Color of Wire	Signal Name	2	LG	COMM (METER->METER)	3	GR	COMM (AMP->METER)	5	B	GND	15	B	GND	21	R	IGN	22	B	GND	24	BR	COMM (LCD->AMP)	25	Y	COMM (AMP->LCD)						
Terminal No.	Color of Wire	Signal Name																																
2	LG	COMM (METER->METER)																																
3	GR	COMM (AMP->METER)																																
5	B	GND																																
15	B	GND																																
21	R	IGN																																
22	B	GND																																
24	BR	COMM (LCD->AMP)																																
25	Y	COMM (AMP->LCD)																																
<p>Connector No. M36</p> <p>Connector Name UNIFIED METER AND A/C AMP.</p> <p>Connector Type TH40FW-NH</p> 	<table border="1"> <thead> <tr> <th>Terminal No.</th> <th>Color of Wire</th> <th>Signal Name</th> </tr> </thead> <tbody> <tr><td>7</td><td>GR</td><td>COMM (AMP->METER)</td></tr> <tr><td>14</td><td>BR</td><td>COMM (LCD->AMP)</td></tr> <tr><td>27</td><td>LG</td><td>COMM (METER->AMP)</td></tr> <tr><td>34</td><td>Y</td><td>COMM (AMP->LCD)</td></tr> </tbody> </table>	Terminal No.	Color of Wire	Signal Name	7	GR	COMM (AMP->METER)	14	BR	COMM (LCD->AMP)	27	LG	COMM (METER->AMP)	34	Y	COMM (AMP->LCD)																		
Terminal No.	Color of Wire	Signal Name																																
7	GR	COMM (AMP->METER)																																
14	BR	COMM (LCD->AMP)																																
27	LG	COMM (METER->AMP)																																
34	Y	COMM (AMP->LCD)																																

A
B
C
D
E
F
G
H
I
J
DLK
L
M
N
O
P

BCM (BODY CONTROL MODULE)

< ECU DIAGNOSIS >

[INTELLIGENT KEY SYSTEM]

INTELLIGENT KEY SYSTEM

Connector No.	M187
Connector Name	UNIFIED METER AND A/C AMP.
Connector Type	TH32FW-NH

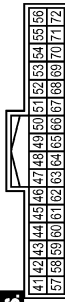

Terminal No.	Color of Wire	Signal Name
41	V	ACC
53	G	IGN
55	B	GND
56	L	CAN-H
71	B	GND
72	P	CAN-L

Connector No.	M104
Connector Name	REMOTE KEYLESS ENTRY RECEIVER
Connector Type	JAB04FB



Terminal No.	Color of Wire	Signal Name
1	O	GND
2	Y	SIGNAL OUTPUT
4	LG	BATTERY

Connector No.	M105
Connector Name	TRUNK LID OPENER CANCEL SWITCH
Connector Type	SD2FW



Terminal No.	Color of Wire	Signal Name
1	O	-
2	B	-

Connector No.	M117
Connector Name	WIRE TO WIRE
Connector Type	TH30MW-CS16-TM4



Terminal No.	Color of Wire	Signal Name
91	V	-
92	G	-
96	G	-
97	LG	-
98	BR	-

Connector No.	M118
Connector Name	BCM (BODY CONTROL MODULE)
Connector Type	M03FB-LC



Terminal No.	Color of Wire	Signal Name
1	W	BAT (F/L)
2	Y	POWER WINDOW POWER SUPPLY(BAT)
3	O	POWER WINDOW POWER SUPPLY(BAP)

Connector No.	M119
Connector Name	BCM (BODY CONTROL MODULE)
Connector Type	NS16FW-CS



Terminal No.	Color of Wire	Signal Name
4	LG	BAT SAVER OUTPUT
5	V	DOOR UNLOCK OUTPUT (AS)
8	V	DOOR LOCK OUTPUT (ALL)
9	G	DOOR UNLOCK OUTPUT (BR)
10	BR	DOOR UNLOCK OUTPUT (RR)
11	R	BAT (FUSE)
17	W	FRONT FLASHER OUTPUT(RIGHT)
18	O	FRONT FLASHER OUTPUT(LEFT)
19	V	ROOM LAMP OUTPUT

Connector No.	M120
Connector Name	BCM (BODY CONTROL MODULE)
Connector Type	NS12FW-CS



Terminal No.	Color of Wire	Signal Name
20	V	REAR FLASHER OUTPUT(RIGHT)
23	G	TRUNK OPENER OUTPUT
25	G	REAR FLASHER OUTPUT(LEFT)

Connector No.	M121
Connector Name	BCM (BODY CONTROL MODULE)
Connector Type	TH40FY-NH

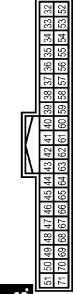

Terminal No.	Color of Wire	Signal Name
34	SB	TRUNK ANT1-
35	V	TRUNK ANT1+
38	B	BACK ANT-
39	W	BACK ANT+
50	R	TRUNK SW
61	W	TRUNK REQUEST SW
64	V	BUZZER
68	BR	DOOR SW (RR RH)
69	R	DOOR SW (RR LH)

JCKWA0014GE

BCM (BODY CONTROL MODULE)

[INTELLIGENT KEY SYSTEM]

< ECU DIAGNOSIS >

INTELLIGENT KEY SYSTEM

Connector No.	M122
Connector Name	BCM (BODY CONTROL MODULE)
Connector Type	TH40FB-NH

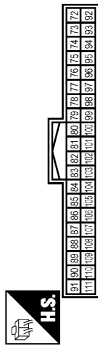

Terminal No.	Color of Wire	Signal Name
72	R	ROOM ANT2-
73	G	ROOM ANT2+
74	SB	AS DOOR ANT-
75	BR	AS DOOR ANT+
76	V	DR DOOR ANT-
77	LG	DR DOOR ANT+
78	Y	ROOM ANT1-
79	BR	ROOM ANT1+
83	Y	KEYLESS TUNER SIGNAL
89	BR	ENG SW
90	P	CAN-L

Connector No.	M131
Connector Name	INSIDE KEY ANTENNA (INSTRUMENT CENTER)
Connector Type	RK02FGY

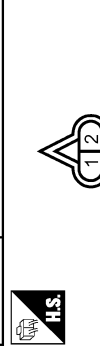

Terminal No.	Color of Wire	Signal Name
1	BR	-
2	Y	-

91	L	CAN-H
92	LG	KEY SLOT ILL
96	GR	A/T DEVICE
99	R	SHIFT P
100	G	AS REQUEST SW
101	SB	DR REQUEST SW
103	LG	KEYLESS TUNER POWER SUPPLY

Connector No.	M123
Connector Name	BCM (BODY CONTROL MODULE)
Connector Type	TH40FC-NH

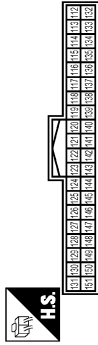

Terminal No.	Color of Wire	Signal Name
119	SB	DR CONDITION SW
121	R	KEY SWITCH SIGNAL
124	LQ	DOOR SW (AS)
129	O	TRUNK CANCEL SW
137	O	SENSOR GND
130	GR	DOOR SW (DR)

Connector No.	M146
Connector Name	INSIDE KEY ANTENNA (CONSOLE)
Connector Type	RK03FGY



Terminal No.	Color of Wire	Signal Name
1	G	-
2	R	-

Connector No.	M124
Connector Name	WIRE TO WIRE
Connector Type	TH40MW-CS15

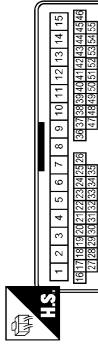

Terminal No.	Color of Wire	Signal Name
11	V	-
12	V	-
13	B	-
47	SB	-
48	BR	-
49	G	-

Connector No.	M137
Connector Name	A/T DEVICE
Connector Type	TH12FW-NH

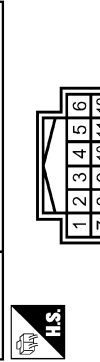

Terminal No.	Color of Wire	Signal Name
10	GR	-
11	R	-

A
B
C
D
E
F
G
H
I
J
K
L
M
N
O
P

DLK

BCM (BODY CONTROL MODULE)

[INTELLIGENT KEY SYSTEM]

< ECU DIAGNOSIS >

Wiring Diagram — TRUNK LID OPENER SYSTEM —

INFOID:000000000961236

TRUNK LID OPENER

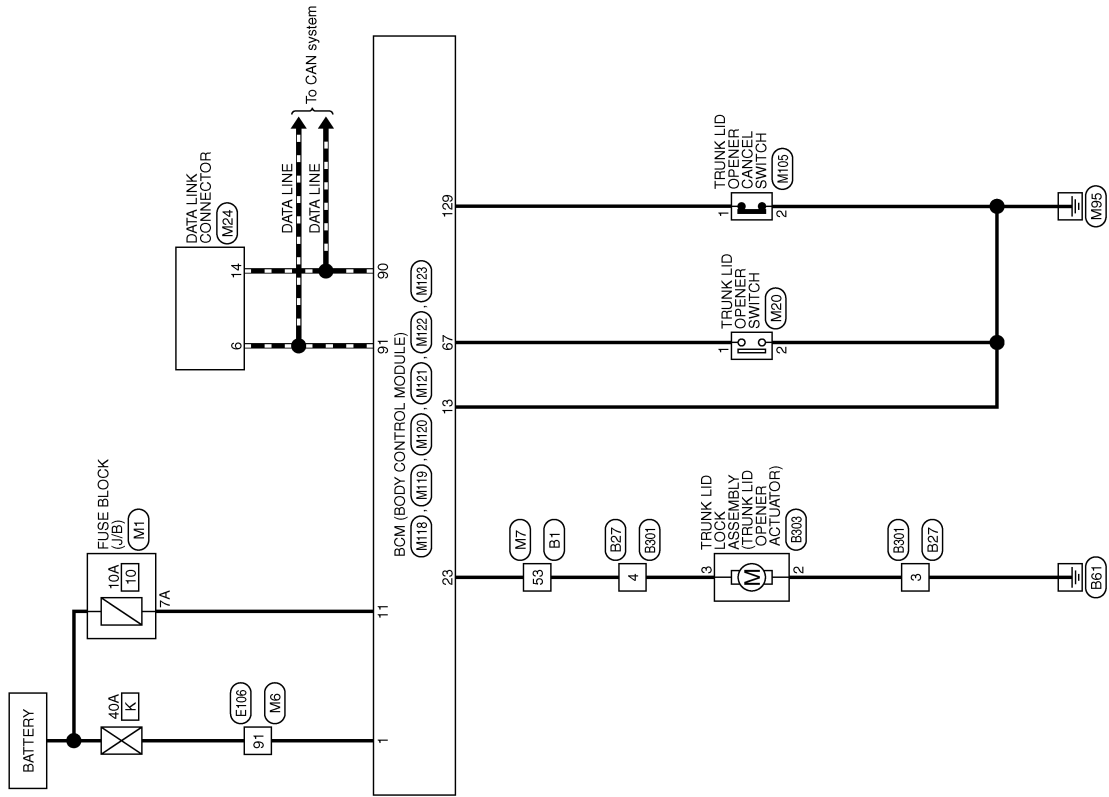

2006/09/15











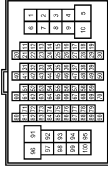





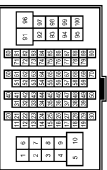

JCKWA0017GE

BCM (BODY CONTROL MODULE)

[INTELLIGENT KEY SYSTEM]

< ECU DIAGNOSIS >

TRUNK LID OPENER

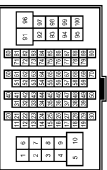
Connector No.	B1	Connector No.	B303	Connector No.	B301	Connector No.	BZ7	Connector No.	E105
Connector Name	WIRE TO WIRE	Connector Name	TRUNK LID LOCK ASSEMBLY	Connector Name	WIRE TO WIRE	Connector Name	WIRE TO WIRE	Connector Name	WIRE TO WIRE
Connector Type	TH80FW-CS16-TM4	Connector Type	TH803FW	Connector Type	NS18FW-CS	Connector Type	NS16MW-CS	Connector Type	TH80FW-CS16-TM4
									
Terminal No.	53	Terminal No.	2	Terminal No.	3	Terminal No.	3	Terminal No.	91
Color of Wire	Y	Color of Wire	B	Color of Wire	B	Color of Wire	B	Color of Wire	W
Signal Name	-	Signal Name	-	Signal Name	-	Signal Name	-	Signal Name	-
Terminal No.	53	Terminal No.	53	Terminal No.	91	Terminal No.	7A	Terminal No.	91
Color of Wire	W	Color of Wire	G	Color of Wire	W	Color of Wire	R	Color of Wire	W
Signal Name	-	Signal Name	-	Signal Name	-	Signal Name	-	Signal Name	-
Connector No.	M7	Connector No.	M6	Connector No.	M1	Connector No.	M7	Connector No.	M7
Connector Name	WIRE TO WIRE	Connector Name	WIRE TO WIRE	Connector Name	FUSE BLOCK (J/B)	Connector Name	WIRE TO WIRE	Connector Name	WIRE TO WIRE
Connector Type	TH80MW-CS16-TM4	Connector Type	TH80MW-CS16-TM4	Connector Type	NS308FW-M2	Connector Type	TH80MW-CS16-TM4	Connector Type	TH80MW-CS16-TM4
									
Terminal No.	53	Terminal No.	91	Terminal No.	7A	Terminal No.	91	Terminal No.	53
Color of Wire	G	Color of Wire	W	Color of Wire	R	Color of Wire	W	Color of Wire	G
Signal Name	-	Signal Name	-	Signal Name	-	Signal Name	-	Signal Name	-

JCKWA0018GE

A
B
C
D
E
F
G
H
I
J
DLK
L
M
N
O
P

BCM (BODY CONTROL MODULE)

< ECU DIAGNOSIS >

[INTELLIGENT KEY SYSTEM]

TRUNK LID OPENER

Connector No.	M20
Connector Name	TRUNK LID OPENER SWITCH
Connector Type	TK0AFW



Terminal No.	Color of Wire	Signal Name
1	GR	-
2	B	-

Connector No.	M24
Connector Name	DATA LINK CONNECTOR
Connector Type	BD16FW

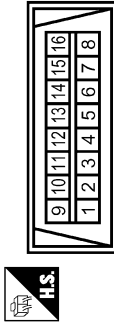

Terminal No.	Color of Wire	Signal Name
6	L	-
14	P	-

Connector No.	M105
Connector Name	TRUNK LID OPENER CANCEL SWITCH
Connector Type	SD2FW



Terminal No.	Color of Wire	Signal Name
1	O	-
2	B	-

Connector No.	M118
Connector Name	BCM (BODY CONTROL MODULE)
Connector Type	M03FB-LC

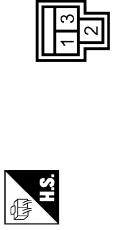

Terminal No.	Color of Wire	Signal Name
1	W	BAT (F/L)

Connector No.	M119
Connector Name	BCM (BODY CONTROL MODULE)
Connector Type	NS16FW-CS



Terminal No.	Color of Wire	Signal Name
11	R	BAT (FUSE)
13	B	GND

Connector No.	M120
Connector Name	BCM (BODY CONTROL MODULE)
Connector Type	NS12FW-CS



Terminal No.	Color of Wire	Signal Name
23	G	TRUNK OPENER OUTPUT

Connector No.	M121
Connector Name	BCM (BODY CONTROL MODULE)
Connector Type	TH40FGY-NH

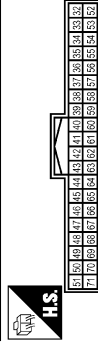

Terminal No.	Color of Wire	Signal Name
67	GR	INTERIOR TRUNK SW

Connector No.	M122
Connector Name	BCM (BODY CONTROL MODULE)
Connector Type	TH40FB-NH

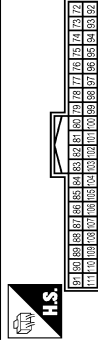

Terminal No.	Color of Wire	Signal Name
90	P	CAN-L
91	L	CAN-H

JCKWA0019GE

BCM (BODY CONTROL MODULE)

< ECU DIAGNOSIS >

[INTELLIGENT KEY SYSTEM]

A
B
C
D
E
F
G
H
I
J
L
M
N
O
P

DLK

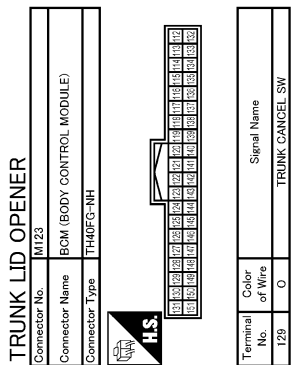

JCKWA0020GE

Fail Safe

INFOID:000000000961237

Display contents of CONSULT	Fail-safe	Cancellation
B2013: ID DISCORD BCM-S/L	Inhibit engine cranking	Erase DTC
B2014: CHAIN OF S/L-BCM	Inhibit engine cranking	Erase DTC
B2190: NATS ANTenna AMP	Inhibit engine cranking	Erase DTC

BCM (BODY CONTROL MODULE)

< ECU DIAGNOSIS >

[INTELLIGENT KEY SYSTEM]

Display contents of CONSULT	Fail-safe	Cancellation
B2191: DIFFERENCE OF KEY	Inhibit engine cranking	Erase DTC
B2192: ID DISCORD BCM-ECM	Inhibit engine cranking	Erase DTC
B2193: CHAIN OF BCM-ECM	Inhibit engine cranking	Erase DTC
B2557: VEHICLE SPEED	Inhibit steering lock	When normal vehicle speed signals have been received from ABS actuator and electric unit (control unit) for 500 ms
B2560: STARTER CONT RELAY	Inhibit engine cranking	500 ms after the following CAN signal communication status has become consistent <ul style="list-style-type: none"> • Starter control relay signal • Starter relay status signal
B2563: HI VOLTAGE	<ul style="list-style-type: none"> • Inhibit engine cranking • Inhibit steering lock 	500 ms after the power supply voltage decreases to less than 18 V
B2601: SHIFT POSITION	Inhibit steering lock	500 ms after the following signal reception status becomes consistent <ul style="list-style-type: none"> • Selector lever P position switch signal • P range signal (CAN)
B2602: SHIFT POSITION	Inhibit steering lock	5 seconds after the following BCM recognition conditions are fulfilled <ul style="list-style-type: none"> • Ignition switch is in the ON position • Selector lever P position switch signal: Except P position (battery voltage) • Vehicle speed: 4 /h or more
B2603: SHIFT POSI STATUS	Inhibit steering lock	500 ms after the following BCM recognition conditions are fulfilled <ul style="list-style-type: none"> • Ignition switch is in the ON position • Selector lever P position switch signal: Except P position (battery voltage) • Selector lever P/N position signal: Except P and N positions (0 V)
B2604: PNP SW	Inhibit steering lock	500 ms after any of the following BCM recognition conditions is fulfilled <ul style="list-style-type: none"> • Status 1 <ul style="list-style-type: none"> - Ignition switch is in the ON position - Selector lever P/N position signal: P and N position (battery voltage) - P range signal or N range signal (CAN): ON • Status 2 <ul style="list-style-type: none"> - Ignition switch is in the ON position - Selector lever P/N position signal: Except P and N positions (0 V) - P range signal and N range signal (CAN): OFF
B2605: PNP SW	Inhibit steering lock	500 ms after any of the following BCM recognition conditions is fulfilled <ul style="list-style-type: none"> • Ignition switch is in the ON position <ul style="list-style-type: none"> - Power position: IGN - Selector lever P/N position signal: Except P and N positions (0 V) - Interlock/PNP switch signal (CAN): OFF • Status 2 <ul style="list-style-type: none"> - Ignition switch is in the ON position - Selector lever P/N position signal: P or N position (battery voltage) - PNP switch signal (CAN): ON
B2606: S/L RELAY	Inhibit engine cranking	500 ms after the following CAN signal communication status has become consistent <ul style="list-style-type: none"> • Steering lock relay signal (Request signal) • Steering lock relay signal (Condition signal)
B2607: S/L RELAY	Inhibit engine cranking	500 ms after the following CAN signal communication status has become consistent <ul style="list-style-type: none"> • Steering lock relay signal (Request signal) • Steering lock relay signal (Condition signal)

BCM (BODY CONTROL MODULE)

[INTELLIGENT KEY SYSTEM]

< ECU DIAGNOSIS >

Display contents of CONSULT	Fail-safe	Cancellation
B2608: STARTER RELAY	Inhibit engine cranking	500 ms after the following signal communication status becomes consistent <ul style="list-style-type: none"> • Starter motor relay control signal • Starter relay status signal (CAN)
B2609: S/L STATUS	<ul style="list-style-type: none"> • Inhibit engine cranking • Inhibit steering lock 	When the following steering lock conditions agree <ul style="list-style-type: none"> • BCM steering lock control status • Steering lock condition No. 1 signal status • Steering lock condition No. 2 signal status
B260A: IGNITION RELAY	Inhibit engine cranking	500 ms after the following conditions are fulfilled <ul style="list-style-type: none"> • IGN relay (IPDM E/R) control signal: OFF (Battery voltage) • Ignition ON signal (CAN to IPDM E/R): OFF (Request signal) • Ignition ON signal (CAN from IPDM E/R): OFF (Condition signal)
B260F: ENG STATE SIG LOST	Maintains the power supply position attained at the time of DTC detection	When any of the following conditions is fulfilled <ul style="list-style-type: none"> • Power position changes to ACC • Receives engine status signal (CAN)
B2612: S/L STATUS	<ul style="list-style-type: none"> • Inhibit engine cranking • Inhibit steering lock 	When any of the following conditions is fulfilled <ul style="list-style-type: none"> • Steering lock unit status signal (CAN) is received normally • The BCM steering lock control status matches the steering lock status recognized by the steering lock unit status signal (CAN from IPDM E/R)
B2617: STARTER RELAY CIRC	Inhibit engine cranking	1 second after the starter motor relay control inside BCM becomes normal
B2618: BCM	Inhibit engine cranking	1 second after the ignition relay (IPDM E/R) control inside BCM becomes normal
B2619: BCM	Inhibit engine cranking	1 second after the steering lock unit power supply output control inside BCM becomes normal
B261E: VEHICLE TYPE	Inhibit engine cranking	BCM initialization
B26E1: ENG STATE NO RECIV	Inhibit engine cranking	When any of the following conditions is fulfilled <ul style="list-style-type: none"> • Power position changes to ACC • Receives engine status signal (CAN)

DTC Inspection Priority Chart

INFOID:000000000961238

If some DTCs are displayed at the same time, perform inspections one by one based on the following priority chart.

Priority	DTC
1	<ul style="list-style-type: none"> • B2562: LOW VOLTAGE • B2563: HI VOLTAGE
2	<ul style="list-style-type: none"> • U1000: CAN COMM CIRCUIT • U1010: CONTROL UNIT (CAN)
3	<ul style="list-style-type: none"> • B2190: NATS ANTENA AMP • B2191: DIFFERENCE OF KEY • B2192: ID DISCORD BCM-ECM • B2193: CHAIN OF BCM-ECM

BCM (BODY CONTROL MODULE)

< ECU DIAGNOSIS >

[INTELLIGENT KEY SYSTEM]

Priority	DTC
4	<ul style="list-style-type: none"> • B2013: ID DISCORD BCM-S/L • B2014: CHAIN OF S/L-BCM • B2553: IGNITION RELAY • B2555: STOP LAMP • B2556: PUSH-BTN IGN SW • B2557: VEHICLE SPEED • B2560: STARTER CONT RELAY • B2601: SHIFT POSITION • B2602: SHIFT POSITION • B2603: SHIFT POSI STATUS • B2604: PNP SW • B2605: PNP SW • B2606: S/L RELAY • B2607: S/L RELAY • B2608: STARTER RELAY • B2609: S/L STATUS • B260A: IGNITION RELAY • B260B: STEERING LOCK UNIT • B260C: STEERING LOCK UNIT • B260D: STEERING LOCK UNIT • B260F: ENG STATE SIG LOST • B2611: ACC RELAY • B2612: S/L STATUS • B2614: ACC RELAY CIRC • B2615: BLOWER RELAY CIRC • B2616: IGN RELAY CIRC • B2617: STARTER RELAY CIRC • B2618: BCM • B2619: BCM • B261A: PUSH-BTN IGN SW • B261E: VEHICLE TYPE • B26E1: ENG STATE NO RECIV • C1729: VHCL SPEED SIG ERR • U0415: VEHICLE SPEED SIG
5	<ul style="list-style-type: none"> • C1704: LOW PRESSURE FL • C1705: LOW PRESSURE FR • C1706: LOW PRESSURE RR • C1707: LOW PRESSURE RL • C1708: [NO DATA] FL • C1709: [NO DATA] FR • C1710: [NO DATA] RR • C1711: [NO DATA] RL • C1712: [CHECKSUM ERR] FL • C1713: [CHECKSUM ERR] FR • C1714: [CHECKSUM ERR] RR • C1715: [CHECKSUM ERR] RL • C1716: [PRESSDATA ERR] FL • C1717: [PRESSDATA ERR] FR • C1718: [PRESSDATA ERR] RR • C1719: [PRESSDATA ERR] RL • C1720: [CODE ERR] FL • C1721: [CODE ERR] FR • C1722: [CODE ERR] RR • C1723: [CODE ERR] RL • C1724: [BATT VOLT LOW] FL • C1725: [BATT VOLT LOW] FR • C1726: [BATT VOLT LOW] RR • C1727: [BATT VOLT LOW] RL • C1734: CONTROL UNIT
6	<ul style="list-style-type: none"> • B2621: INSIDE ANTENNA • B2622: INSIDE ANTENNA • B2623: INSIDE ANTENNA

BCM (BODY CONTROL MODULE)

[INTELLIGENT KEY SYSTEM]

< ECU DIAGNOSIS >

NOTE:

Details of time display

- CRNT: Displays when there is a malfunction now or after returning to the normal condition until turning ignition switch OFF → ON again.
- 1 - 39: Displayed if any previous malfunction is present when current condition is normal. It increases like 1 → 2 → 3...38 → 39 after returning to the normal condition whenever ignition switch OFF → ON. The counter remains at 39 even if the number of cycles exceeds it. It is counted from 1 again when turning ignition switch OFF → ON after returning to the normal condition if the malfunction is detected again.

CONSULT display	Fail-safe	Intelligent Key warning lamp ON	Tire pressure monitor warning lamp ON	Reference page
No DTC is detected. further testing may be required.	—	—	—	—
U1000: CAN COMM CIRCUIT	—	—	—	BCS-33
U1010: CONTROL UNIT (CAN)	—	—	—	BCS-34
U0415: VEHICLE SPEED SIG	—	—	—	BCS-35
B2013: ID DISCORD BCM-S/L	×	—	—	SEC-43
B2014: CHAIN OF S/L-BCM	×	—	—	SEC-44
B2190: NATS ANTENNA AMP	×	—	—	SEC-37
B2191: DIFFERENCE OF KEY	×	—	—	SEC-40
B2192: ID DISCORD BCM-ECM	×	—	—	SEC-41
B2193: CHAIN OF BCM-ECM	×	—	—	SEC-42
B2553: IGNITION RELAY	—	—	—	PCS-48
B2555: STOP LAMP	—	—	—	SEC-47
B2556: PUSH-BTN IGN SW	—	×	—	SEC-49
B2557: VEHICLE SPEED	×	×	—	SEC-51
B2560: STARTER CONT RELAY	×	×	—	SEC-52
B2562: LOW VOLTAGE	—	—	—	BCS-36
B2563: HI VOLTAGE	×	×	—	BCS-37
B2601: SHIFT POSITION	×	×	—	SEC-53
B2602: SHIFT POSITION	×	×	—	SEC-56
B2603: SHIFT POSI STATUS	×	×	—	SEC-58
B2604: PNP SW	×	×	—	SEC-61
B2605: PNP SW	×	×	—	SEC-63
B2606: S/L RELAY	×	×	—	SEC-65
B2607: S/L RELAY	×	×	—	SEC-66
B2608: STARTER RELAY	×	×	—	SEC-68
B2609: S/L STATUS	×	×	—	SEC-70
B260A: IGNITION RELAY	×	×	—	PCS-50
B260B: STEERING LOCK VNIT	—	×	—	SEC-74
B260C: STEERING LOCK VNIT	—	×	—	SEC-75
B260D: STEERING LOCK VNIT	—	×	—	SEC-76
B260F: ENG STATE SIG LOST	×	×	—	SEC-77
B2611: ACC RELAY	—	—	—	PCS-52
B2612: S/L STATUS	×	×	—	SEC-79
B2614: ACC RELAY CIRC	—	×	—	PCS-54
B2615: BLOWER RELAY CIRC	—	×	—	PCS-57

A
B
C
D
E
F
G
H
I
J
DLK
L
M
N
O
P

BCM (BODY CONTROL MODULE)

< ECU DIAGNOSIS >

[INTELLIGENT KEY SYSTEM]

CONSULT display	Fail-safe	Intelligent Key warning lamp ON	Tire pressure monitor warning lamp ON	Reference page
B2616: IGN RELAY CIRC	—	×	—	PCS-60
B2617: STARTER RELAY CIRC	×	×	—	SEC-83
B2618: BCM	×	×	—	PCS-63
B2619: BCM	×	×	—	SEC-85
B261A: PUSH-BTN IGN SW	—	×	—	SEC-86
B261E: VEHICLE TYPE	×	× (Turn ON for 15 seconds)	—	SEC-88
B2621: INSIDE ANTENNA	—	—	—	DLK-58
B2622: INSIDE ANTENNA	—	—	—	DLK-60
B2623: INSIDE ANTENNA	—	—	—	DLK-62
B26E1: ENG STATE NO RES	×	×	—	SEC-78
C1704: LOW PRESSURE FL	—	—	×	WT-14
C1705: LOW PRESSURE FR	—	—	×	WT-14
C1706: LOW PRESSURE RR	—	—	×	WT-14
C1707: LOW PRESSURE RL	—	—	×	WT-14
C1708: [NO DATA] FL	—	—	×	WT-16
C1709: [NO DATA] FR	—	—	×	WT-16
C1710: [NO DATA] RR	—	—	×	WT-16
C1711: [NO DATA] RL	—	—	×	WT-16
C1712: [CHECKSUM ERR] FL	—	—	×	WT-19
C1713: [CHECKSUM ERR] FR	—	—	×	WT-19
C1714: [CHECKSUM ERR] RR	—	—	×	WT-19
C1715: [CHECKSUM ERR] RL	—	—	×	WT-19
C1716: [PRESSDATA ERR] FL	—	—	×	WT-22
C1717: [PRESSDATA ERR] FR	—	—	×	WT-22
C1718: [PRESSDATA ERR] RR	—	—	×	WT-22
C1719: [PRESSDATA ERR] RL	—	—	×	WT-22
C1720: [CODE ERR] FL	—	—	×	WT-24
C1721: [CODE ERR] FR	—	—	×	WT-24
C1722: [CODE ERR] RR	—	—	×	WT-24
C1723: [CODE ERR] RL	—	—	×	WT-24
C1724: [BATT VOLT LOW] FL	—	—	×	WT-27
C1725: [BATT VOLT LOW] FR	—	—	×	WT-27
C1726: [BATT VOLT LOW] RR	—	—	×	WT-27
C1727: [BATT VOLT LOW] RL	—	—	×	WT-27
C1729: VHCL SPEED SIG ERR	—	—	×	WT-30
C1734: CONTROL UNIT	—	—	×	WT-31

SYMPTOM DIAGNOSIS

INTELLIGENT KEY SYSTEM SYMPTOMS

Symptom Table

INFOID:000000000961240

ALL FUNCTIONS OF INTELLIGENT KEY SYSTEM DO NOT OPERATE

NOTE:

- Before performing the diagnosis in the following table, check “WORK FLOW”. Refer to [DLK-6. "Work Flow"](#).
- Check that vehicle is under the condition shown in “Conditions of vehicle” before starting diagnosis, and check each symptom.
- If the following symptoms are detected, check systems shown in the “Diagnosis/service procedure” column in this order.

Conditions of Vehicle (Operating Conditions)

- “ENGINE START BY I-KEY” and “LOCK/UNLOCK BY I-KEY” are ON when setting on CONSULT-III.
- All doors are closed.

Symptom	Diagnosis/service procedure	Reference page
All function of Intelligent Key system does not operate.	1. Check BCM power supply and ground circuit.	DLK-64
	2. Check Intelligent Key battery inspection.	DLK-107
	3. Check remote keyless entry receiver.	DLK-104
	4. Check Intermittent Incident.	GI-39

A
B
C
D
E
F
G
H
I
J
L
M
N
O
P

DLK

DOOR LOCK FUNCTION SYMPTOMS

< SYMPTOM DIAGNOSIS >

[INTELLIGENT KEY SYSTEM]

DOOR LOCK FUNCTION SYMPTOMS

DOOR LOCK AND UNLOCK SWITCH

DOOR LOCK AND UNLOCK SWITCH : Symptom Table

INFOID:000000000961241

DOOR LOCK/UNLOCK FUNCTION MALFUNCTION

NOTE:

- Before performing the diagnosis in the following table, check “WORK FLOW”. Refer to [DLK-6. "Work Flow"](#).
- Check that vehicle is under the condition shown in “Conditions of vehicle” before starting diagnosis, and check each symptom.
- If the following symptoms are detected, check systems shown in the “Diagnosis/service procedure” column in this order.

Conditions of Vehicle (Operating Conditions)

- “LOCK/UNLOCK BY I-KEY” is ON when setting on CONSULT-III.
- Intelligent Key is out of key slot.
- All doors are closed.

Symptom	Diagnosis/service procedure		Reference page
Power door lock does not operate with door lock and unlock switch.	1.	Check BCM Power supply and ground circuit.	DLK-64
	2.	Check door lock and unlock switch.	DLK-68
	3.	Check door lock actuator (driver side)	DLK-92
	4.	Check Intermittent Incident.	GI-39
Power door lock does not operate with door key cylinder operation. (Power door lock operate properly with door lock and unlock switch.)	1.	Check key cylinder switch.	DLK-74
	2.	Replace power window main switch.	INT-10
Specific door lock actuator does not operate.	1.	Driver side	DLK-92
		Passenger side	DLK-93
		Rear LH	DLK-94
		Rear RH	DLK-94
	2.	Check Intermittent Incident.	GI-39
Fuel lid opener actuator does not operate. (All door lock actuators operates normally.)	Check fuel lid lock actuator.		DLK-98

DOOR REQUEST SWITCH

DOOR REQUEST SWITCH : Symptom Table

INFOID:000000000961242

DOOR LOCK/UNLOCK FUNCTION MALFUNCTION

NOTE:

- Before performing the diagnosis in the following table, check “WORK FLOW”. Refer to [DLK-6. "Work Flow"](#).
- Check that vehicle is under the condition shown in “Conditions of vehicle” before starting diagnosis, and check each symptom.
- If the following symptoms” are detected, check systems shown in the “Diagnosis/service procedure” column in this order.

Conditions of Vehicle (Operating Conditions)

- “LOCK/UNLOCK BY I-KEY” is ON when setting on CONSULT-III.
- Intelligent Key is out of key slot.
- All doors are closed.

DOOR LOCK FUNCTION SYMPTOMS

< SYMPTOM DIAGNOSIS >

[INTELLIGENT KEY SYSTEM]

Symptom	Diagnosis/service procedure	Reference page
Door lock/unlock do not operate by door request switch.	1. Check BCM power supply and ground circuit.	DLK-64
	2. Check door switch.	DLK-65
	3. Check key slot.	DLK-72
	4. Check Intermittent Incident.	GI-39
Door lock/unlock does not operate by request switch (driver side).	1. Check door request switch (driver side).	DLK-87
	2. Check outside key antenna (driver side).	DLK-101
	3. Check Intermittent Incident.	GI-39
Door lock/unlock does not operate by request switch (passenger side).	1. Check door request switch (passenger side).	DLK-87
	2. Check outside key antenna (passenger side).	DLK-101
	3. Check Intermittent Incident.	GI-39
Selective unlock function does not operate by door request switch (driver side) (other door lock function operate).	1. Check "DOOR LOCK-UNLOCK SET" setting in "WORK SUPPORT".	DLK-50
	2. Check selective unlock function with a remote controller or door key cylinder.	DLK-13
	3. Check Intermittent Incident.	GI-39
Selective unlock function does not operate by door request switch (passenger side) (other door lock function operate).	1. Check "DOOR LOCK-UNLOCK SET" setting in "WORK SUPPORT".	DLK-50
	2. Check Intermittent Incident.	GI-39
Auto lock function does not operate.	1. Check "AUTO LOCK SET" setting in "WORK SUPPORT".	DLK-50
	2. Check door switch.	DLK-65
	3. Check key slot.	DLK-72
	4. Check Intermittent Incident.	GI-39
Fuel lid opener actuator does not operate. (All door lock actuators operates properly.)	Check fuel lid lock actuator.	DLK-98

INTELLIGENT KEY

INTELLIGENT KEY : Symptom Table

INFOID:000000000961243

REMOTE KEYLESS ENTRY FUNCTION MALFUNCTION

NOTE:

- Before performing the diagnosis in the following table, check "WORK FLOW". Refer to [DLK-6, "Work Flow"](#).
- Check that vehicle is under the condition shown in "Conditions of vehicle" before starting diagnosis, and check each symptom.
- If the following symptoms" are detected, check systems shown in the "Diagnosis/service procedure" column in this order.

Conditions of Vehicle (Operating Conditions)

- Intelligent Key is out of key slot.
- Ignition switch is in OFF or ACC position.
- All doors are closed.
- Retaind power operation does not operate. Refer to [PWC-9, "System Description"](#).

Symptom	Diagnosis/service procedure	Reference page
All of the remote keyless entry functions do not operate.	1. Check Intelligent Key battery inspection.	DLK-107
	2. Check Intermittent Incident.	GI-39

DOOR LOCK FUNCTION SYMPTOMS

< SYMPTOM DIAGNOSIS >

[INTELLIGENT KEY SYSTEM]

Symptom	Diagnosis/service procedure	Reference page
Selective unlock function does not operate by Intelligent Key.	1. Check "DOOR LOCK-UNLOCK SET" setting in "WORK SUPPORT".	DLK-50
	2. Check Intelligent Key battery inspection.	DLK-107
	3. Check Intermittent Incident.	GI-39
Auto lock function does not operate normally.	1. Check "AUTO LOCK SET" setting in "WORK SUPPORT".	DLK-51
	2. Check door switch.	DLK-65
	3. Check key slot.	DLK-72
	4. Check Intermittent Incident.	GI-39
Power window down function does not operate.	1. Check "PW DOWN SET" setting in "WORK SUPPORT".	DLK-107
	2. Check Intelligent Key battery inspection.	DLK-107

TRUNK OPEN FUNCTION SYMPTOMS

< SYMPTOM DIAGNOSIS >

[INTELLIGENT KEY SYSTEM]

TRUNK OPEN FUNCTION SYMPTOMS

TRUNK LID OPENER SWITCH

TRUNK LID OPENER SWITCH : Symptom Table

INFOID:000000000961244

TRUNK OPEN FUNCTION MALFUNCTION

NOTE:

- Before performing the diagnosis in the following table, check “WORK FLOW”. Refer to [DLK-6, "Work Flow"](#).
- Check that vehicle is under the condition shown in “Conditions of vehicle” before starting diagnosis, and check each symptom.
- If the following symptoms” are detected, check systems shown in the “Diagnosis/service procedure” column in this order.

Conditions of Vehicle (Operating Conditions)

- Intelligent Key is out of key slot.
- All doors are closed.

Symptom	Diagnosis/service procedure	Reference page
Trunk open function does not operate by trunk opener switch.	1. Check trunk opener switch.	DLK-80
	2. Check trunk lid opener cancel switch.	DLK-82
	3. Check Intermittent Incident.	GI-39

TRUNK REQUEST SWITCH

TRUNK REQUEST SWITCH : Symptom Table

INFOID:000000000961245

TRUNK OPEN FUNCTION MALFUNCTION

NOTE:

- Before performing the diagnosis in the following table, check “WORK FLOW”. Refer to [DLK-6, "Work Flow"](#).
- Check that vehicle is under the condition shown in “Conditions of vehicle” before starting diagnosis, and check each symptom.
- If the following “symptoms” are detected, check systems shown in the “Diagnosis/service procedure” column in this order.

Conditions of Vehicle (Operating Conditions)

- Intelligent Key is out of key slot.
- All doors are closed.

Symptom	Diagnosis/service procedure	Reference page
Trunk open function does not operate by trunk opener request switch.	1. Check trunk opener request switch.	DLK-90
	2. Check trunk lid opener cancel switch.	DLK-82
	3. Check outside key antenna (trunk room).	DLK-101
	4. Check Intermittent Incident.	GI-39

INTELLIGENT KEY

INTELLIGENT KEY : Symptom Table

INFOID:000000000961246

TRUNK OPEN FUNCTION MALFUNCTION

NOTE:

- Before performing the diagnosis in the following table, check “WORK FLOW”. Refer to [DLK-6, "Work Flow"](#).
- Check that vehicle is under the condition shown in “Conditions of vehicle” before starting diagnosis, and check each symptom.
- If the following symptoms” are detected, check systems shown in the “Diagnosis/service procedure” column in this order.

Conditions of Vehicle (Operating Conditions)

- Intelligent Key is out of key slot.
- All doors are closed.

A

B

C

D

E

F

G

H

I

J

DLK

L

M

N

O

P

TRUNK OPEN FUNCTION SYMPTOMS

< SYMPTOM DIAGNOSIS >

[INTELLIGENT KEY SYSTEM]

Symptom	Diagnosis/service procedure	Reference page
Trunk open function does not operate by Intelligent Key.	1. Check "TRUNK OPEN DELAY" setting in "WORK SUPPORT".	DLK-51
	2. Check trunk open function.	DLK-32
	3. Check trunk room lamp switch.	DLK-84
	4. Check Intelligent Key battery inspection.	DLK-107
	5. Check Intermittent Incident.	GI-39

WARNING FUNCTION SYMPTOMS

< SYMPTOM DIAGNOSIS >

[INTELLIGENT KEY SYSTEM]

WARNING FUNCTION SYMPTOMS

Symptom Table

INFOID:000000000961247

WARNING FUNCTION MALFUNCTION

NOTE:

- Before performing the diagnosis in the following table, check “WORK FLOW”. Refer to [DLK-6, "Work Flow"](#).
- Check that vehicle is under the condition shown in “Conditions of vehicle” before starting diagnosis, and check each symptom.
- If the following “symptoms are detected, check systems shown in the “Diagnosis/service procedure” column in this order.

Conditions of Vehicle (Operating Conditions)

Warning chime functions operating condition is extremely complicated, during operating confirmations, reconfirm the list above twice in order to ensure proper operation.

Symptom		Diagnosis/service procedure	Reference page
OFF position warning does not operate.	For internal	1. Check push button ignition switch position indicator.	PCS-68
		2. Check door switch.	DLK-65
		3. Check warning chime function.	DLK-114
		4. Check Intermittent Incident.	GI-39
	For external	1. Check push button ignition switch position indicator.	PCS-68
		2. Check door switch.	DLK-65
		3. Check Intelligent Key warning buzzer.	DLK-99
		4. Check Intermittent Incident.	GI-39
P position warning does not operate.	1. Check Park position switch.	SEC-58	
	2. Check door switch.	DLK-65	
	3. Check Intelligent Key warning buzzer.	DLK-99	
	4. Check warning chime function.	DLK-114	
	5. Check combination meter display function.	DLK-113	
	6. Check Intermittent Incident.	GI-39	
ACC warning does not operate	1. Check push button ignition switch position indicator.	PCS-68	
	2. Check warning chime function.	DLK-114	
	3. Check combination meter display function.	DLK-113	
	4. Check Intermittent Incident.	GI-39	

A
B
C
D
E
F
G
H
I
J
L
M
N
O
P

DLK

WARNING FUNCTION SYMPTOMS

< SYMPTOM DIAGNOSIS >

[INTELLIGENT KEY SYSTEM]

Symptom	Diagnosis/service procedure		Reference page	
Take away warning does not operate.	Door open to close	1. Check door switch.	DLK-65	
		2. Check inside key antenna.	Instrument center	DLK-58
			Console	DLK-60
			Trunk room	DLK-62
			3. Check Intelligent Key warning buzzer.	DLK-99
			4. Check warning chime function.	DLK-114
			5. Check key slot illumination.	DLK-109
	6. Check combination meter display function.		DLK-113	
	7. Check Intermittent Incident.		GI-39	
	Push-button ignition switch operation		1. Check push button ignition switch position indicator.	PCS-68
		2. Check inside key antenna.	Instrument center	DLK-58
			Console	DLK-60
			Trunk room	DLK-62
			3. Check warning chime function.	DLK-114
			4. Check key slot illumination.	DLK-109
			5. Check combination meter display function.	DLK-113
	6. Check Intermittent Incident.		GI-39	
	Door is open	1. Check push button ignition switch position indicator.	PCS-68	
		2. Check inside key antenna.	Instrument center	DLK-58
			Console	DLK-60
			Trunk room	DLK-62
		3. Check combination meter display function.	DLK-113	
	4. Check Intermittent Incident.	GI-39		
Take away through window	1. Check "TAKE OUT FROM WIN WARN" setting in "WORK SUPPORT".	DLK-51		
	2. Check inside key antenna.	Instrument center	DLK-58	
		Console	DLK-60	
		Trunk room	DLK-62	
		3. Check warning chime function.	DLK-114	
		4. Check key slot illumination.	DLK-109	
		5. Check combination meter display function.	DLK-113	
6. Check Intermittent Incident.		GI-39		
Key warning chime does not operate.	1. Check key slot.	DLK-72		
	2. Check door switch.	DLK-65		
	3. Check warning chime function.	DLK-114		
	4. Check key slot illumination.	DLK-109		
	5. Check combination meter display function.	DLK-113		
	6. Check Intermittent Incident.	GI-39		

WARNING FUNCTION SYMPTOMS

< SYMPTOM DIAGNOSIS >

[INTELLIGENT KEY SYSTEM]

Symptom	Diagnosis/service procedure	Reference page	
Door lock operation warning chime does not operate.	1. Check door switch.	DLK-65	
	2. Check key slot illumination.	DLK-109	
	3. Check Intelligent Key warning buzzer.	DLK-99	
	4. Check inside key antenna.	Instrument center	DLK-58
		Console	DLK-60
		Trunk room	DLK-62
5. Check Intermittent Incident.	GI-39		

A
B
C
D
E
F
G
H
I
J
L
M
N
O
P

DLK

KEY REMINDER FUNCTION SYMPTOMS

< SYMPTOM DIAGNOSIS >

[INTELLIGENT KEY SYSTEM]

KEY REMINDER FUNCTION SYMPTOMS

Symptom Table

INFOID:000000000961248

KEY REMINDER FUNCTION MALFUNCTION

NOTE:

- Before performing the diagnosis in the following table, check “Work flow”. Refer to [DLK-6, "Work Flow"](#).
- If the following symptoms are detected, check systems shown in the “Diagnosis/service procedure” column in this order.

Conditions of Vehicle (Operating Conditions)

- “LOCK/UNLOCK BY I-KEY” is ON when setting on CONSULT-III.
- “ANSWER BACK FUNCTION” is ON when setting on CONSULT-III.
- Ignition switch is in OFF position.
- All doors are closed.
- Intelligent Key is out of key slot.

Symptom	Diagnosis/service procedure	Reference page
Key reminder function does not operate.	1. Check “ANTI KEY LOCK IN FUNCTI”setting in “WORK SUPPORT”.	DLK-51
	2. Check door switch.	DLK-65
	3. Check inside key antenna.	DLK-58
	4. Check unlock sensor.	DLK-77
	5. Check Intelligent Key battery inspection.	DLK-107
	6. Check Intermittent Incident.	GI-39

HAZARD AND BUZZER REMINDER FUNCTION SYMPTOMS

< SYMPTOM DIAGNOSIS >

[INTELLIGENT KEY SYSTEM]

HAZARD AND BUZZER REMINDER FUNCTION SYMPTOMS

Symptom Table

INFOID:000000000961249

HAZARD AND BUZZER REMINDER FUNCTION MALFUNCTION

NOTE:

- Before performing the diagnosis in the following table, check “Work flow”. Refer to [DLK-6, "Work Flow"](#).
- If the following symptoms” are detected, check systems shown in the “Diagnosis/service procedure” column in this order.

Conditions of Vehicle (Operating Conditions)

- “LOCK/UNLOCK BY I-KEY” is ON when setting on CONSULT-III.
- “ANSWER BACK FUNCTION” is ON when setting on CONSULT-III.
- Ignition switch is in OFF position.
- All doors are closed.
- Intelligent Key is out of key slot.

Symptom	Diagnosis/service procedure	Reference page
Hazard reminder does not operate by request switch. (Buzzer reminder operate.)	1. Check “HAZARD ANSWER BACK” setting in “WORK SUPPORT”.	DLK-51
	2. Check hazard function.	DLK-115
	3. Check Intermittent incident.	GI-39
Hazard reminder does not operate by Intelligent Key. (Buzzer reminder operate.)	1. Check “HAZARD ANSWER BACK” setting in “WORK SUPPORT”.	DLK-51
	2. Check hazard function.	DLK-115
	3. Check Intelligent Key battery inspection.	DLK-107
Buzzer reminder does not operate by request switch. (Hazard reminder operate.)	1. Check “ANS BACK I-KEY LOCK” or “ANS BACK I-KEY UNLOCK” setting in “WORK SUPPORT”.	DLK-51
	2. Check Intelligent Key warning buzzer.	DLK-99
	3. Check Intermittent incident.	GI-39
Buzzer reminder does not operate by trunk opener request switch.	1. Check “TRUNK OPEN DELAY” setting in “WORK SUPPORT”.	DLK-51
	2. Check Intelligent Key warning buzzer.	DLK-99
	3. Check trunk open function.	DLK-27
	4. Check Intermittent incident.	GI-39

DLK

HAZARD AND HORN REMINDER FUNCTION SYMPTOMS

< SYMPTOM DIAGNOSIS >

[INTELLIGENT KEY SYSTEM]

HAZARD AND HORN REMINDER FUNCTION SYMPTOMS

Symptom Table

INFOID:000000000961250

HAZARD AND HORN REMINDER FUNCTION MALFUNCTION

NOTE:

- Before performing the diagnosis in the following table, check “Work flow”. Refer to [DLK-6, "Work Flow"](#).
- If the following symptoms” are detected, check systems shown in the “Diagnosis/service procedure” column in this order.

Conditions of Vehicle (Operating Conditions)

- “ANSWER BACK FUNCTION” is ON when setting on CONSULT-III.
- Ignition switch is in OFF position.
- All doors are closed.

Symptom	Diagnosis/service procedure	Reference page
Hazard reminder does not operate by request switch. (Horn reminder operate.)	1. Check “HAZARD ANSWER BACK” setting in “WORK SUPPORT”.	DLK-51
	2. Check hazard function.	DLK-115
	3. Check Intermittent Incident.	GI-39
Hazard reminder does not operate by Intelligent Key. (Horn reminder operate.)	1. Check “HAZARD ANSWER BACK” setting in “WORK SUPPORT”.	DLK-51
	2. Check hazard function.	DLK-115
	3. Check Intelligent Key battery inspection.	
Horn reminder does not operate by request switch. (Hazard reminder operate.)	1. Check “ANSWER BACK WITH I-KEY LOCK” or “ANSWER BACK WITH I-KEY UNLOCK” setting in “WORK SUPPORT”.	DLK-51
	2. Check Intelligent Key warning buzzer.	DLK-99
	3. Check Intermittent Incident.	GI-39
Horn reminder does not operate by Intelligent Key. (Hazard reminder operate.)	1. Check “HORN WITH KEYLESS LOCK” setting in “WORK SUPPORT”.	DLK-51
	2. Check horn function.	DLK-111
	3. Check Intermittent Incident.	GI-39

SQUEAK AND RATTLE TROUBLE DIAGNOSES

< SYMPTOM DIAGNOSIS >

[INTELLIGENT KEY SYSTEM]

SQUEAK AND RATTLE TROUBLE DIAGNOSES

Work Flow

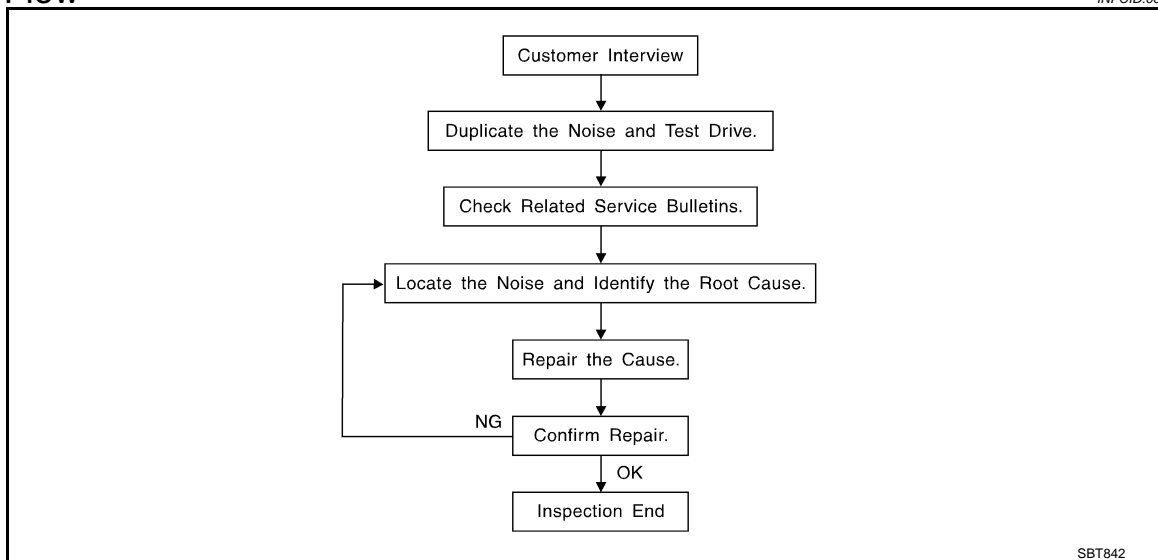

CUSTOMER INTERVIEW

Interview the customer if possible, to determine the conditions that exist when the noise occurs. Use the Diagnostic Worksheet during the interview to document the facts and conditions when the noise occurs and any of customer's comments; refer to [DLK-183, "Diagnostic Worksheet"](#). This information is necessary to duplicate the conditions that exist when the noise occurs.

- The customer may not be able to provide a detailed description or the location of the noise. Attempt to obtain all the facts and conditions that exist when the noise occurs (or does not occur).
- If there is more than one noise in the vehicle, perform a diagnosis and repair the noise that the customer is concerned about. This can be accomplished by performing a cruise test on the vehicle with the customer.
- After identifying the type of noise, isolate the noise in terms of its characteristics. The noise characteristics are provided so the customer, service adviser and technician are all speaking the same language when defining the noise.
- Squeak —(Like tennis shoes on a clean floor)
Squeak characteristics include the light contact/fast movement/brought on by road conditions/hard surfaces=higher pitch noise/softer surfaces=lower pitch noises/edge to surface=chirping
- Creak—(Like walking on an old wooden floor)
Creak characteristics include firm contact/slow movement/twisting with a rotational movement/pitch dependent on materials/often brought on by activity.
- Rattle—(Like shaking a baby rattle)
Rattle characteristics include the fast repeated contact/vibration or similar movement/loose parts/missing clip or fastener/incorrect clearance.
- Knock —(Like a knock on a door)
Knock characteristics include hollow sounding/sometimes repeating/often brought on by driver action.
- Tick—(Like a clock second hand)
Tick characteristics include gentle contacting of light materials/loose components/can be caused by driver action or road conditions.
- Thump—(Heavy, muffled knock noise)
Thump characteristics include softer knock/dead sound often brought on by activity.
- Buzz—(Like a bumblebee)
Buzz characteristics include high frequency rattle/firm contact.
- Often the degree of acceptable noise level will vary depending up on the person. A noise that you may judge as acceptable may be very irritating to the customer.
- Weather conditions, especially humidity and temperature, may have a great effect on noise level.

DUPLICATE THE NOISE AND TEST DRIVE

If possible, drive the vehicle with the customer until the noise is duplicated. Note any additional information on the Diagnostic Worksheet regarding the conditions or location of the noise. This information can be used to duplicate the same conditions when you confirm the repair.

SQUEAK AND RATTLE TROUBLE DIAGNOSES

[INTELLIGENT KEY SYSTEM]

< SYMPTOM DIAGNOSIS >

If the noise can be duplicated easily during the test drive, to help identify the source of the noise, try to duplicate the noise with the vehicle stopped by doing one or all of the following:

- 1) Close a door.
 - 2) Tap or push/pull around the area where the noise appears to be coming from.
 - 3) Rev the engine.
 - 4) Use a floor jack to recreate vehicle "twist".
 - 5) At idle, apply engine load (electrical load, half-clutch on M/T models, drive position on A/T models).
 - 6) Raise the vehicle on a hoist and hit a tire with a rubber hammer.
- Drive the vehicle and attempt to duplicate the conditions the customer states exist when the noise occurs.
 - If it is difficult to duplicate the noise, drive the vehicle slowly on an undulating or rough road to stress the vehicle body.

CHECK RELATED SERVICE BULLETINS

After verifying the customer concern or symptom, check ASIST for Technical Service Bulletins (TSBs) related to that concern or symptom.

If a TSB relates to the symptom, follow the procedure to repair the noise.

LOCATE THE NOISE AND IDENTIFY THE ROOT CAUSE

1. Narrow down the noise to a general area. To help pinpoint the source of the noise, use a listening tool (Chassis Ear: J-39570, Engine Ear and mechanics stethoscope).
2. Narrow down the noise to a more specific area and identify the cause of the noise by:
 - removing the components in the area that you suspect the noise is coming from.
Do not use too much force when removing clips and fasteners, otherwise clips and fastener can be broken or lost during the repair, resulting in the creation of new noise.
 - tapping or pushing/pulling the component that you suspect is causing the noise.
Do not tap or push/pull the component with excessive force, otherwise the noise will be eliminated only temporarily.
 - feeling for a vibration with your hand by touching the component(s) that you suspect is (are) causing the noise.
 - placing a piece of paper between components that you suspect are causing the noise.
 - looking for loose components and contact marks.
Refer to [DLK-181, "Inspection Procedure"](#).

REPAIR THE CAUSE

- If the cause is a loose component, tighten the component securely.
- If the cause is insufficient clearance between components:
 - separate components by repositioning or loosening and retightening the component, if possible.
 - insulate components with a suitable insulator such as urethane pads, foam blocks, felt cloth tape or urethane tape. A Nissan Squeak and Rattle Kit (J-43980) is available through your authorized Nissan Parts Department.

CAUTION:

Do not use excessive force as many components are constructed of plastic and may be damaged.

NOTE:

Always check with the Parts Department for the latest parts information.

The following materials are contained in the Nissan Squeak and Rattle Kit (J-43980). Each item can be ordered separately as needed.

URETHANE PADS [1.5 mm (0.059 in) thick]

Insulates connectors, harness, etc.

76268-9E005: 100 × 135 mm (3.94 × 5.31 in)/76884-71L01: 60 × 85 mm (2.36 × 3.35 in)/76884-71L02: 15 × 25 mm (0.59 × 0.98 in)

INSULATOR (Foam blocks)

Insulates components from contact. Can be used to fill space behind a panel.

73982-9E000: 45 mm (1.77 in) thick, 50 × 50 mm (1.97 × 1.97 in)/73982-

50Y00: 10 mm (0.39 in) thick, 50 × 50 mm (1.97 × 1.97 in)

INSULATOR (Light foam block)

80845-71L00: 30 mm (1.18 in) thick, 30 × 50 mm (1.18 × 1.97in)

FELT CLOTHTAPE

Used to insulate where movement does not occur. Ideal for instrument panel applications.

68370-4B000: 15 × 25 mm (0.59 × 0.98 in) pad/68239-13E00: 5 mm (0.20 in) wide tape roll

The following materials, not found in the kit, can also be used to repair squeaks and rattles.

UHMW (TEFLON) TAPE

SQUEAK AND RATTLE TROUBLE DIAGNOSES

[INTELLIGENT KEY SYSTEM]

< SYMPTOM DIAGNOSIS >

Insulates where slight movement is present. Ideal for instrument panel applications.

SILICONE GREASE

Used in place of UHMW tape that will be visible or not fit. Will only last a few months.

SILICONE SPRAY

Use when grease cannot be applied.

DUCT TAPE

Use to eliminate movement.

CONFIRM THE REPAIR

Confirm that the cause of a noise is repaired by test driving the vehicle. Operate the vehicle under the same conditions as when the noise originally occurred. Refer to the notes on the Diagnostic Worksheet.

Inspection Procedure

INFOID:000000000961252

Refer to Table of Contents for specific component removal and installation information.

INSTRUMENT PANEL

Most incidents are caused by contact and movement between:

1. The cluster lid A and instrument panel
2. Acrylic lens and combination meter housing
3. Instrument panel to front pillar garnish
4. Instrument panel to windshield
5. Instrument panel mounting pins
6. Wiring harnesses behind the combination meter
7. A/C defroster duct and duct joint

These incidents can usually be located by tapping or moving the components to duplicate the noise or by pressing on the components while driving to stop the noise. Most of these incidents can be repaired by applying felt cloth tape or silicon spray (in hard to reach areas). Urethane pads can be used to insulate wiring harness.

CAUTION:

Do not use silicone spray to isolate a squeak or rattle. If you saturate the area with silicone, you will not be able to recheck the repair.

CENTER CONSOLE

Components to pay attention to include:

1. Shifter assembly cover to finisher
2. A/C control unit and cluster lid C
3. Wiring harnesses behind audio and A/C control unit

The instrument panel repair and isolation procedures also apply to the center console.

DOORS

Pay attention to the:

1. Finisher and inner panel making a slapping noise
2. Inside handle escutcheon to door finisher
3. Wiring harnesses tapping
4. Door striker out of alignment causing a popping noise on starts and stops

Tapping or moving the components or pressing on them while driving to duplicate the conditions can isolate many of these incidents. You can usually insulate the areas with felt cloth tape or insulator foam blocks from the Nissan Squeak and Rattle Kit (J-43980) to repair the noise.

TRUNK

Trunk noises are often caused by a loose jack or loose items put into the trunk by the owner.

In addition look for:

1. Trunk lid dumpers out of adjustment
2. Trunk lid striker out of adjustment
3. The trunk lid torsion bars knocking together
4. A loose license plate or bracket

A

B

C

D

E

F

G

H

I

J

DLK

L

M

N

O

P

SQUEAK AND RATTLE TROUBLE DIAGNOSES

< SYMPTOM DIAGNOSIS >

[INTELLIGENT KEY SYSTEM]

Most of these incidents can be repaired by adjusting, securing or insulating the item(s) or component(s) causing the noise.

SUNROOF/HEADLINING

Noises in the sunroof/headlining area can often be traced to one of the following:

1. Sunroof lid, rail, linkage or seals making a rattle or light knocking noise
2. Sunvisor shaft shaking in the holder
3. Front or rear windshield touching headlining and squeaking

Again, pressing on the components to stop the noise while duplicating the conditions can isolate most of these incidents. Repairs usually consist of insulating with felt cloth tape.

SEATS

When isolating seat noise it's important to note the position the seat is in and the load placed on the seat when the noise is present. These conditions should be duplicated when verifying and isolating the cause of the noise.

Cause of seat noise include:

1. Headrest rods and holder
2. A squeak between the seat pad cushion and frame
3. The rear seat back lock and bracket

These noises can be isolated by moving or pressing on the suspected components while duplicating the conditions under which the noise occurs. Most of these incidents can be repaired by repositioning the component or applying urethane tape to the contact area.

UNDERHOOD

Some interior noise may be caused by components under the hood or on the engine wall. The noise is then transmitted into the passenger compartment.

Causes of transmitted under hood noise include:

1. Any component mounted to the engine wall
2. Components that pass through the engine wall
3. Engine wall mounts and connectors
4. Loose radiator mounting pins
5. Hood bumpers out of adjustment
6. Hood striker out of adjustment

These noises can be difficult to isolate since they cannot be reached from the interior of the vehicle. The best method is to secure, move or insulate one component at a time and test drive the vehicle. Also, engine RPM or load can be changed to isolate the noise. Repairs can usually be made by moving, adjusting, securing, or insulating the component causing the noise.

SQUEAK AND RATTLE TROUBLE DIAGNOSES

< SYMPTOM DIAGNOSIS >

[INTELLIGENT KEY SYSTEM]

Diagnostic Worksheet

INFOID:000000000961253



SQUEAK & RATTLE DIAGNOSTIC WORKSHEET

Dear Infiniti Customer:

We are concerned about your satisfaction with your Infiniti vehicle. Repairing a squeak or rattle sometimes can be very difficult. To help us fix your Infiniti right the first time, please take a moment to note the area of the vehicle where the squeak or rattle occurs and under what conditions. You may be asked to take a test drive with a service consultant or technician to ensure we confirm the noise you are hearing.

I. WHERE DOES THE NOISE COME FROM? (circle the area of the vehicle)

The illustrations are for reference only, and may not reflect the actual configuration of your vehicle.

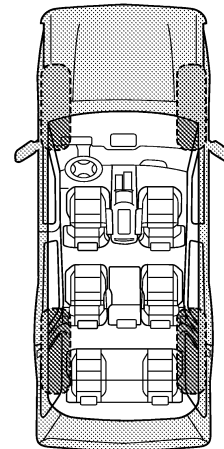
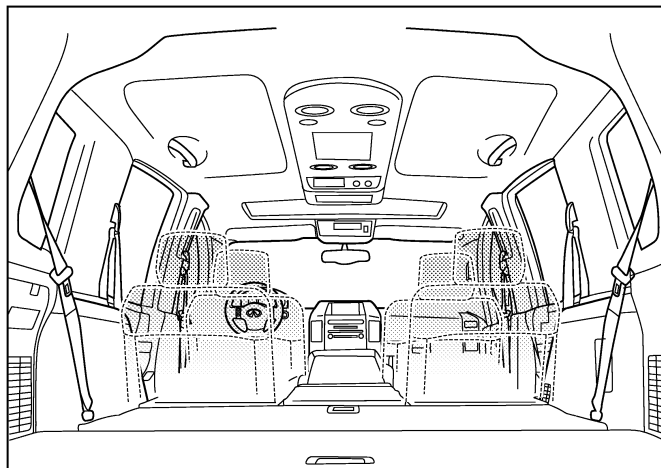
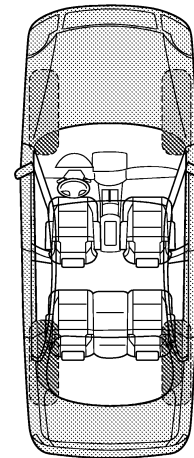
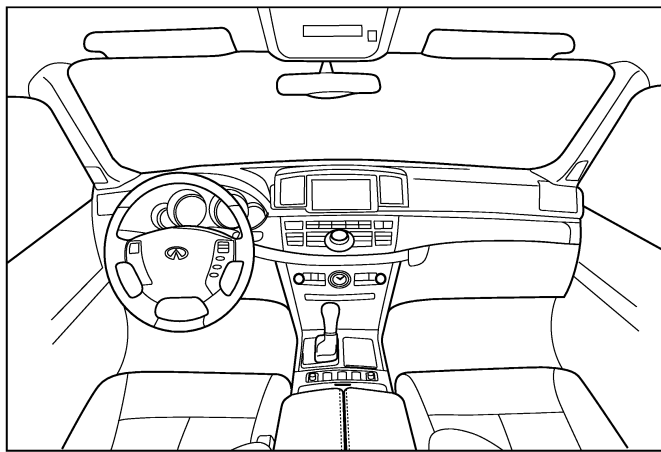

Continue to page 2 of the worksheet and briefly describe the location of the noise or rattle. In addition, please indicate the conditions which are present when the noise occurs.

PIIB8741E

A
B
C
D
E
F
G
H
I
J
DLK
L
M
N
O
P

SQUEAK AND RATTLE TROUBLE DIAGNOSES

< SYMPTOM DIAGNOSIS >

[INTELLIGENT KEY SYSTEM]

SQUEAK & RATTLE DIAGNOSTIC WORKSHEET - page 2

Briefly describe the location where the noise occurs:

II. WHEN DOES IT OCCUR? (please check the boxes that apply)

- | | |
|---|--|
| <input type="checkbox"/> anytime | <input type="checkbox"/> after sitting out in the rain |
| <input type="checkbox"/> 1st time in the morning | <input type="checkbox"/> when it is raining or wet |
| <input type="checkbox"/> only when it is cold outside | <input type="checkbox"/> dry or dusty conditions |
| <input type="checkbox"/> only when it is hot outside | <input type="checkbox"/> other: |

III. WHEN DRIVING:

- through driveways
- over rough roads
- over speed bumps
- only about ____ mph
- on acceleration
- coming to a stop
- on turns: left, right or either (circle)
- with passengers or cargo
- other: _____
- after driving ____ miles or ____ minutes

IV. WHAT TYPE OF NOISE

- squeak (like tennis shoes on a clean floor)
- creak (like walking on an old wooden floor)
- rattle (like shaking a baby rattle)
- knock (like a knock at the door)
- tick (like a clock second hand)
- thump (heavy, muffled knock noise)
- buzz (like a bumble bee)

TO BE COMPLETED BY DEALERSHIP PERSONNEL

Test Drive Notes:

	YES	NO	Initials of person performing
Vehicle test driven with customer	<input type="checkbox"/>	<input type="checkbox"/>	_____
- Noise verified on test drive	<input type="checkbox"/>	<input type="checkbox"/>	_____
- Noise source located and repaired	<input type="checkbox"/>	<input type="checkbox"/>	_____
- Follow up test drive performed to confirm repair	<input type="checkbox"/>	<input type="checkbox"/>	_____

VIN: _____ Customer Name: _____
W.O.# _____ Date: _____

This form must be attached to Work Order

PIIB8742E

< PRECAUTION >

PRECAUTION

PRECAUTIONS

Precaution for Supplemental Restraint System (SRS) "AIR BAG" and "SEAT BELT PRE-TENSIONER"

INFOID:000000000961254

The Supplemental Restraint System such as "AIR BAG" and "SEAT BELT PRE-TENSIONER", used along with a front seat belt, helps to reduce the risk or severity of injury to the driver and front passenger for certain types of collision. This system includes seat belt switch inputs and dual stage front air bag modules. The SRS system uses the seat belt switches to determine the front air bag deployment, and may only deploy one front air bag, depending on the severity of a collision and whether the front occupants are belted or unbelted. Information necessary to service the system safely is included in the SRS and SB section of this Service Manual.

WARNING:

- To avoid rendering the SRS inoperative, which could increase the risk of personal injury or death in the event of a collision which would result in air bag inflation, all maintenance must be performed by an authorized NISSAN/INFINITI dealer.
- Improper maintenance, including incorrect removal and installation of the SRS, can lead to personal injury caused by unintentional activation of the system. For removal of Spiral Cable and Air Bag Module, see the SRS section.
- Do not use electrical test equipment on any circuit related to the SRS unless instructed to in this Service Manual. SRS wiring harnesses can be identified by yellow and/or orange harnesses or harness connectors.

Precaution for Procedure without Cowl Top Cover

INFOID:000000000961255

When performing the procedure after removing cowl top cover, cover the lower end of windshield with urethane, etc.

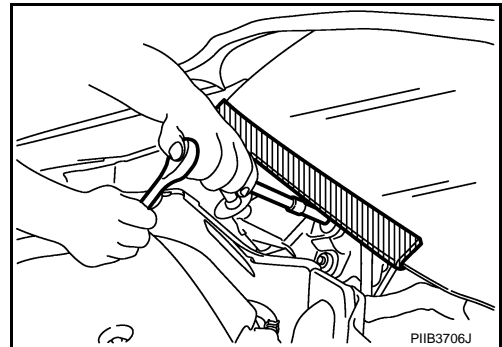

Precaution Necessary for Steering Wheel Rotation after Battery Disconnect

INFOID:000000000961256

NOTE:

- Before removing and installing any control units, first turn the push-button ignition switch to the LOCK position, then disconnect both battery cables.
- After finishing work, confirm that all control unit connectors are connected properly, then re-connect both battery cables.
- Always use CONSULT-III to perform self-diagnosis as a part of each function inspection after finishing work. If a DTC is detected, perform trouble diagnosis according to self-diagnosis results.

This vehicle is equipped with a push-button ignition switch and a steering lock unit.

If the battery is disconnected or discharged, the steering wheel will lock and cannot be turned.

If turning the steering wheel is required with the battery disconnected or discharged, follow the procedure below before starting the repair operation.

OPERATION PROCEDURE

1. Connect both battery cables.

NOTE:

Supply power using jumper cables if battery is discharged.

2. Carry the Intelligent Key or insert it to the key slot and turn the push-button ignition switch to ACC position. (At this time, the steering lock will be released.)

A
B
C
D
E
F
G
H
I
J
DLK
L
M
N
O
P

PRECAUTIONS

[INTELLIGENT KEY SYSTEM]

< PRECAUTION >

3. Disconnect both battery cables. The steering lock will remain released with both battery cables disconnected and the steering wheel can be turned.
4. Perform the necessary repair operation.
5. When the repair work is completed, re-connect both battery cables. With the brake pedal released, turn the push-button ignition switch from ACC position to ON position, then to LOCK position. (The steering wheel will lock when the push-button ignition switch is turned to LOCK position.)
6. Perform self-diagnosis check of all control units using CONSULT-III.

Work

INFOID:000000000961257

- After removing and installing the opening/closing parts, be sure to carry out fitting adjustments to check their operational.
- Check the lubrication level, damage, and wear of each part. If necessary, grease or replace it.

< PREPARATION >

PREPARATION

PREPARATION

Special Service Tools

INFOID:000000000961258

The actual shapes of Kent-Moore tools may differ from those of special service tools illustrated here.

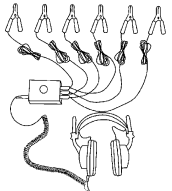
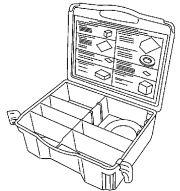
Tool number (Kent-Moore No.) Tool name	Description
(J-39570) Chassis ear  SIIA0993E	Locating the noise
(J-43980) NISSAN Squeak and Rattle Kit  SIIA0994E	Repairing the cause of noise

Commercial Service Tools

INFOID:000000000961259

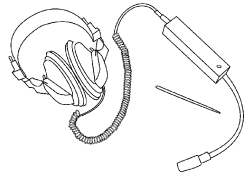
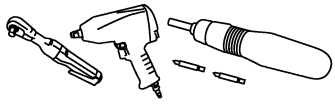
Tool name	Description
Engine ear  SIIA0995E	Locating the noise
Power tool  PIIB1407E	

A
B
C
D
E
F
G
H
I
J
L
M
N
O
P

DLK

ON-VEHICLE MAINTENANCE**PRE-INSPECTION FOR DIAGNOSTIC****Basic Inspection**

INFOID:000000000961260

BASIC INSPECTION**1.CHECK FUNCTION OF INTELLIGENT KEY SYSTEM**

Check all Intelligent Key system operation.

If any of Intelligent Key system does not operate>>Refer to [DLK-167. "Symptom Table"](#).
 If specific function of Intelligent Key system does not operate>>GO TO 2.

2.CHECK POWER DOOR LOCK OPERATION

Check door lock/unlock operation by operating door lock and unlock switch.

Is the inspection result normal?

YES >> GO TO 3.

NO >> Refer to [DLK-168. "DOOR LOCK AND UNLOCK SWITCH : Symptom Table"](#).

3.CHECK DOOR REQUEST SWITCH OPERATION

Check door lock/unlock operation by operating door request switch.

Is the inspection result normal?

YES >> GO TO 4.

NO >> Refer to [DLK-168. "DOOR REQUEST SWITCH : Symptom Table"](#).

4.CHECK TRUNK OPEN OPERATION

Check trunk open operation by the operating trunk opener switch.

Is the inspection result normal?

YES >> GO TO 5.

NO >> Refer to [DLK-171. "TRUNK LID OPENER SWITCH : Symptom Table"](#).

5.CHECK TRUNK OPENER REQUEST SWITCH OPERATION

Check trunk open operation by the operating trunk opener request switch.

Is the inspection result normal?

YES >> GO TO 6.

NO >> Refer to [DLK-171. "TRUNK REQUEST SWITCH : Symptom Table"](#).

6.CHECK REMOTE KEYLESS FUNCTION

Check following operation by operating the Intelligent Key remote control button.

- Door lock/unlock function
- Trunk open function

Is the inspection result normal?

YES >> GO TO 7.

NO >> Refer to [DLK-169. "INTELLIGENT KEY : Symptom Table"](#) (Door lock/unlock function), [DLK-171. "INTELLIGENT KEY : Symptom Table"](#) (Trunk open function).

7.CHECK POWER WINDOW OPERATION

Check power window operation by operating power window main switch.

Is the inspection result normal?

YES >> GO TO 8.

NO >> Refer to [PWC-107. "Diagnosis Procedure"](#).

8.CHECK POWER WINDOW DOWN FUNCTION

Check power window down function by operating Intelligent Key remote control button.

Is the inspection result normal?

PRE-INSPECTION FOR DIAGNOSTIC

[INTELLIGENT KEY SYSTEM]

< ON-VEHICLE MAINTENANCE >

YES >> GO TO 9.

NO >> Refer to [DLK-51, "INTELLIGENT KEY : CONSULT-III Function \(BCM - INTELLIGENT KEY\)"](#).

9. CHECK HAZARD AND BUZZER REMINDER FUNCTION BY REQUEST SWITCH

Check hazard and buzzer reminder function by operating following switches.

- Door request switches
- Trunk opener request switch

Is the inspection result normal?

YES >> GO TO 10.

NO >> Refer to [DLK-177, "Symptom Table"](#).

10. CHECK HAZARD AND HORN REMINDER FUNCTION BY INTELLIGENT KEY BUTTON

Check hazard and horn reminder function by operating Intelligent Key button.

Is the inspection result normal?

YES >> GO TO 11.

NO >> Refer to [DLK-178, "Symptom Table"](#).

11. CHECK WARNING FUNCTION

Check warning function operate properly. Refer to [DLK-173, "Symptom Table"](#).

Is the inspection result normal?

YES >> GO TO 12.

NO >> Refer to [DLK-173, "Symptom Table"](#).

12. CHECK OUT

CHECK OUT.

>> INSPECTION END

A
B
C
D
E
F
G
H
I
J
L
M
N
O
P

DLK

ON-VEHICLE REPAIR

HOOD

HOOD ASSEMBLY

HOOD ASSEMBLY : Exploded View

INFOID:000000000961261

REMOVAL

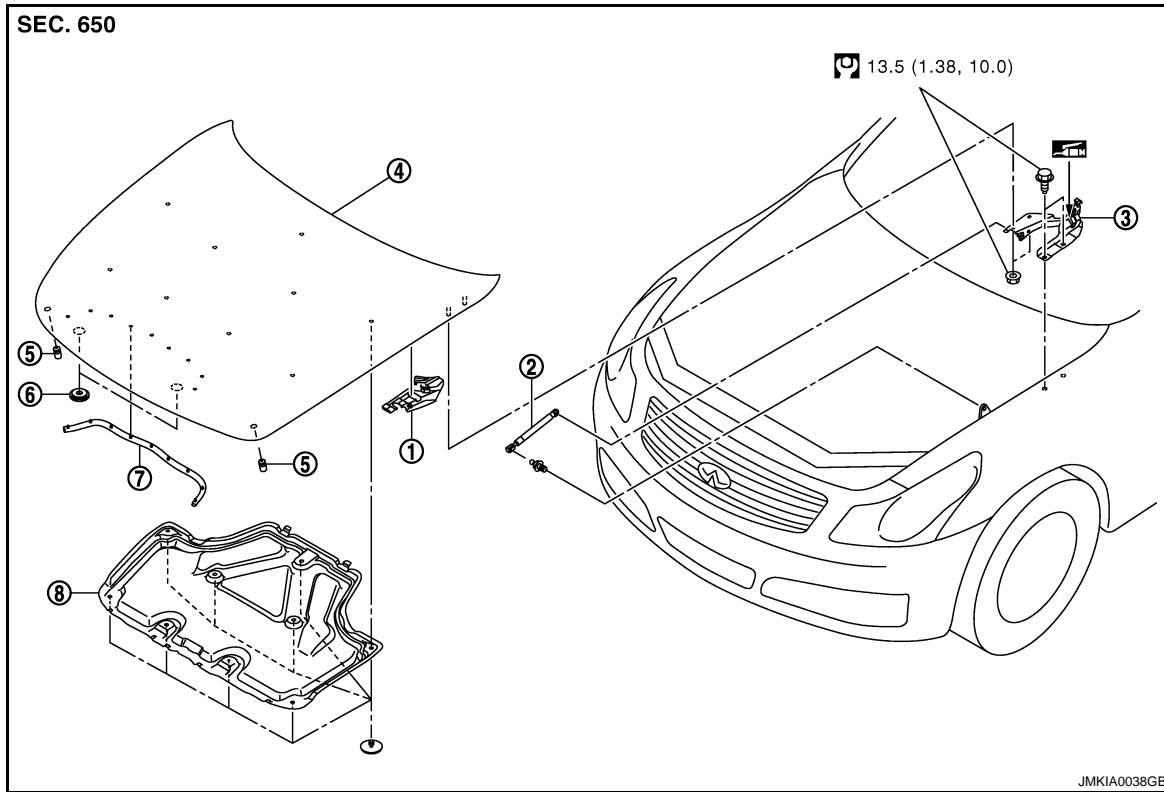

- | | | |
|-----------------------|-----------------------|---------------|
| 1. Hood hinge cover | 2. Hood stay | 3. Hood hinge |
| 4. Hood assembly | 5. Hood bumper rubber | 6. Seal |
| 7. Radiator core seal | 8. Hood insulator | |

Refer to [GI-4. "Components"](#) for symbols in the figure.

ADJUSTMENT

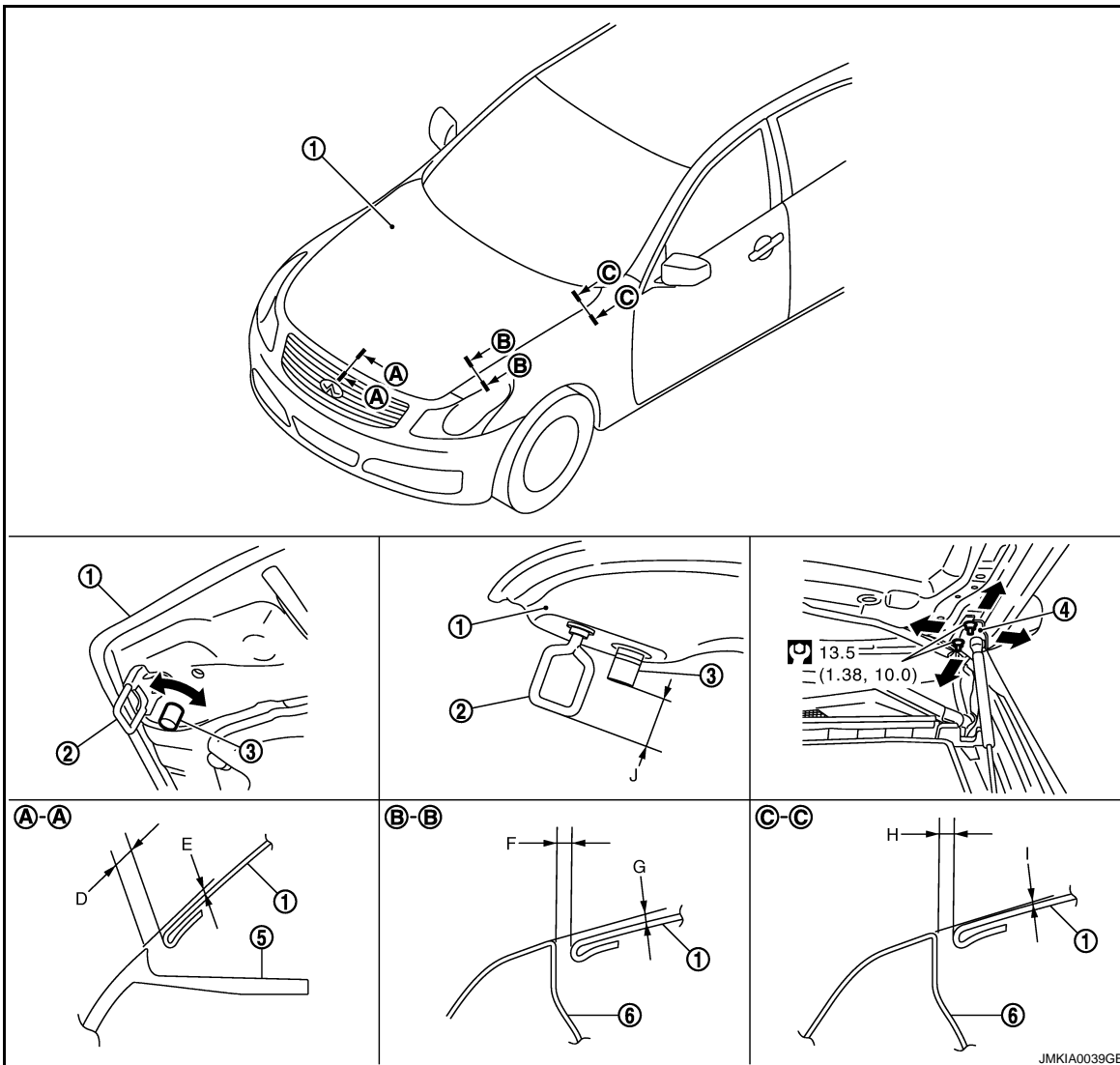

- | | | |
|------------------|-----------------|-----------------------|
| 1. Hood assembly | 2. Striker | 3. Hood bumper rubber |
| 4. Hood hinge | 5. Front bumper | 6. Front fender |

Refer to [GI-4. "Components"](#) for symbols in the figure.

HOOD ASSEMBLY : Removal and Installation

INFOID:000000000961262

CAUTION:

Operate with two workers, because of its heavy weight.

REMOVAL

- Support the hood lock assembly with a proper material to prevent it from falling.
 - WARNING:**
Body injury may occur if no supporting rod is holding the hood open when removing the hood stay.
- Remove the hood hinge cover (RH,LH).
- Remove the washer nozzle and hose nozzle. Refer to [WW-82. "Removal and Installation"](#).
- Remove the stud balls on the hood stays at the hood side.
- Remove the hinge mounting nuts on the hood to remove the hood assembly.
- Remove following parts after removing the hood assembly.
 - Radiator core seal
 - Hood insulator

A
B
C
D
E
F
G
H
I
J
L
M
N
O
P

HOOD

< ON-VEHICLE REPAIR >

[INTELLIGENT KEY SYSTEM]

- Hood bumper rubber

INSTALLATION

Install in the reverse order of removal.

CAUTION:

- Before installing hood hinge, apply anticorrosive agent onto the mounting surface of the vehicle body.
- After installing, perform hood fitting adjustment. Refer to [DLK-192, "HOOD ASSEMBLY : Adjustment"](#).

HOOD ASSEMBLY : Adjustment

INFOID:000000000961263

1. Check the clearance and the surface height between the hood and each part visually and by touching. (Fitting standard dimension in the table below should be satisfied.)

Parts				Standard	Right/left clearance (MAX)
Hood – Front bumper	A – A	D	Clearance	2.6 – 5.6 (0.102 – 0.220)	—
		E	Surface height	-2.0 – 1.0 (-0.079 – 0.039)	—
Hood – Front fender	B – B	F	Clearance	2.5 – 4.5 (0.098 – 0.177)	2.0 (0.079)
		G	Surface height	-2.0 – 1.0 (-0.079 – 0.039)	—
	C – C	H	Clearance	2.5 – 4.5 (0.098 – 0.177)	2.0 (0.079)
		I	Surface height	-1.0 – 1.0 (-0.039 – 0.039)	—
Striker – hood bumper rubber	—	J	Clearance	32.5 – 33.5 (1.280 – 1.319)	—

* Unit: mm (in)

2. In case out of specification, adjust them according to the procedures shown below.
3. Remove the striker and adjust the surface height of hood, front bumper and front fender according to the fitting standard dimension, by rotating hood bumper rubbers.
4. Adjust the clearance of striker, hood bumper rubber according to the fitting standard dimension.
5. Loosen the hood hinge mounting nuts on the hood.
6. Adjust the clearance of hood, front bumper and front fender according to the fitting standard dimension, for the hood.
7. Check that the hood lock primary latch is securely engaged with the striker by dropping hood from approximately 200 mm (7.87 in) height or pressing lightly on the hood.

CAUTION:

Do not drop hood from a height of 300 mm (11.81 in) or more.

8. Install as static closing face of hood is 94 – 490 N·m (9.6 – 50.0 kg·m).

NOTE:

- Exercise vertical force on right side and left side of hood lock.
- Do not press simultaneously both sides.

9. After adjustment tighten hood hinge mounting nuts to the specified torque.

HOOD LOCK CONTROL

HOOD LOCK CONTROL : Exploded View

INFOID:000000000961264

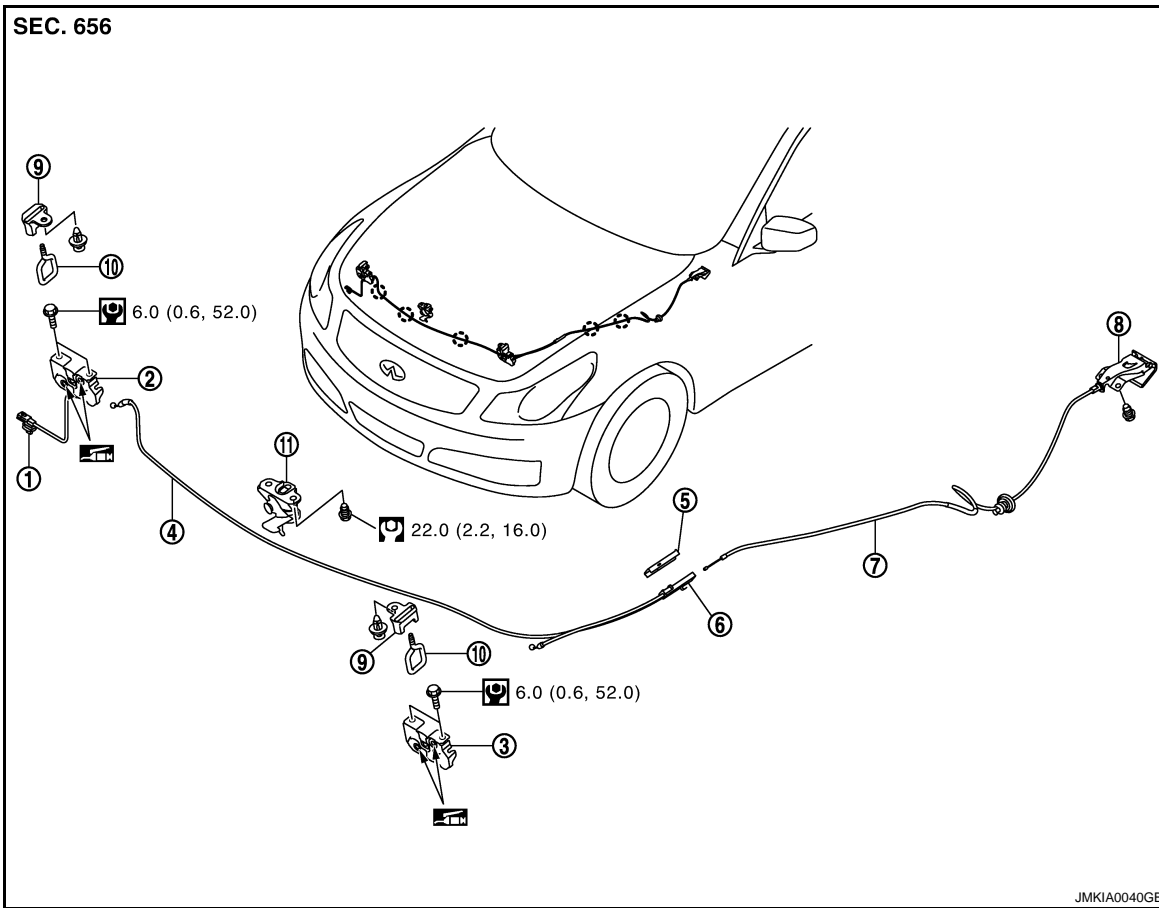

- | | | |
|---------------------------------------|--------------------------------------|--|
| 1. Hood lock switch harness connector | 2. Hood lock (RH) | 3. Hood lock (LH) |
| 4. Hood lock control cable (Front) | 5. Hood lock control cable protector | 6. Hood lock control cable protector cover |
| 7. Hood lock control cable (Rear) | 8. Hood lock opener | 9. Hood lock cover |
| 10. Striker | 11. Secondary latch | |

Clip

Refer to [GI-4, "Components"](#) for symbols in the figure.

HOOD LOCK CONTROL : Removal and Installation

INFOID:000000000961265

REMOVAL

1. Remove the washer tank. Refer to refer to [WW-79, "Removal and Installation"](#).
2. Remove the radiator core support ornament.
 - Remove the radiator core support ornament mounting bolts and clips.

NOTE:

To remove the mounting bolts on both sides of radiator core support ornament, first remove the mounting bolts of front bumper (shown by arrows in the figure) and pull up the bumper edge slightly to get working clearance.

CAUTION:

Do not apply excessive force while pulling front bumper to prevent front bumper and front fender from being damaged.

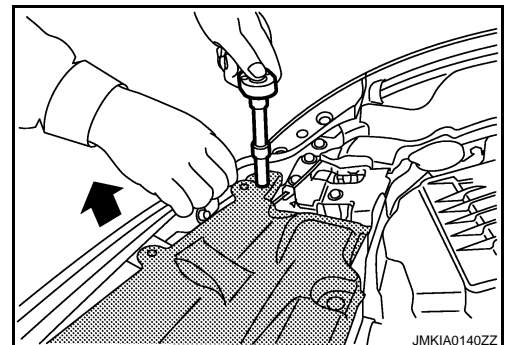

JMKIA0140ZZ

- Hold both sides of radiator core support ornament, pull it upwards and slide it rearwards of the vehicle.

A
B
C
D
E
F
G
H
I
J

DLK

L
M
N
O
P

HOOD

< ON-VEHICLE REPAIR >

[INTELLIGENT KEY SYSTEM]

- Disconnect the harness clip and hood lock control cable clip on radiator core support.

 : Clip

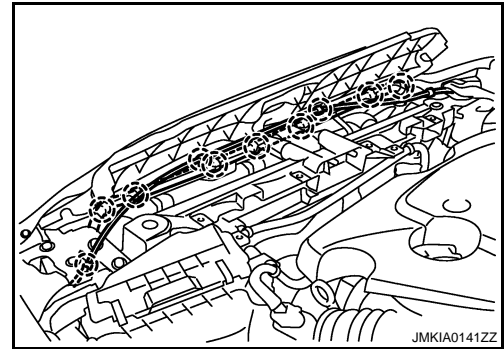

3. Remove the fender protector (LH). Refer to [EXT-22. "Removal and Installation"](#).
4. Disconnect hood lock switch harness connector (RH side).
5. Remove the hood lock bracket mounting bolts, and remove the hood lock bracket assembly. Refer to [DLK-196. "Removal and Installation"](#).
6. Remove the hood lock mounting bolts, and disassemble the hood lock from the hood lock bracket.
7. Disconnect the hood lock control cable from the hood lock and clip it to the hood-ledge.

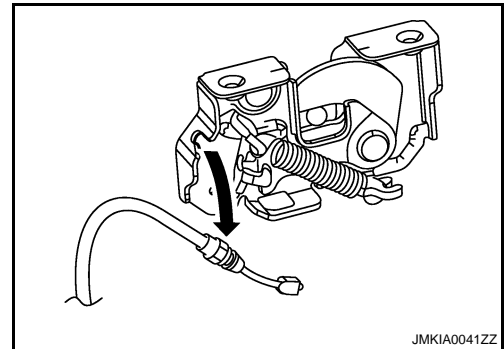

8. Remove the hood lock control cable protector (1) from the headlamp assembly (2).

 : Pawl

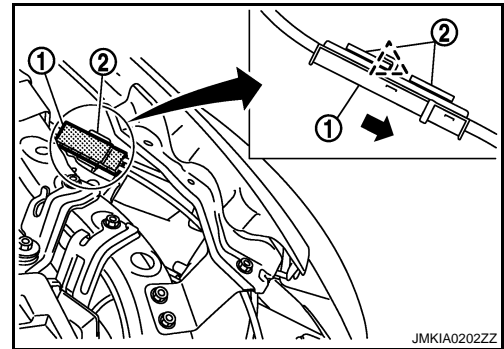

9. Remove the hood lock control cable cover from hood lock control cable protector.
10. Disconnect the hood lock control cable from hood lock control cable protector.

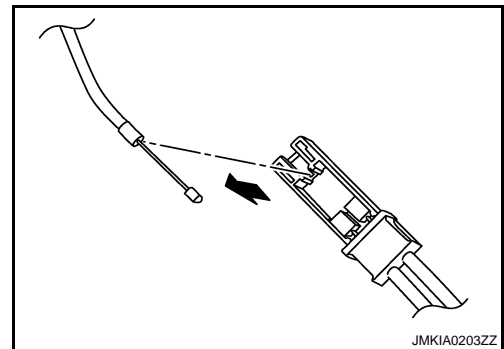

11. Remove the mounting screws and then remove the hood lock opener.
12. Remove the grommet on the dashboard, and pull the hood lock control cable toward the passenger compartment.

CAUTION:

HOOD

< ON-VEHICLE REPAIR >

[INTELLIGENT KEY SYSTEM]

While pulling, do not to damage (peeling) the outside of the hood lock control cable.

INSTALLATION

Install in the reverse order of removal.

CAUTION:

- Do not to bend the cable too much, keeping the radius 100 mm (3.94 in) or more.
- Check that the hood lock control cable is properly engaged with the hood lock.
- After installing, perform hood fitting adjustment. Refer to [DLK-192, "HOOD ASSEMBLY : Adjustment"](#).
- After installing, perform the hood lock control inspection. Refer to [DLK-195, "HOOD LOCK CONTROL : Inspection"](#).

HOOD LOCK CONTROL : Inspection

INFOID:000000000961266

NOTE:

If the hood lock cable is bent or deformed, replace it.

1. Check that the secondary latch is properly engaged with the secondary striker (6.8 mm (0.268 in) shown in the figure) by hood weight.
2. While operating the hood opener, carefully check that the front end of the hood is raised by approximately 20 mm (0.79 in). Also check that the hood opener returns to the original position.
3. Check that the hood opener operating is 49 N (5.0 kg) or below.
4. Install so that static closing face of hood is 94 – 490 N·m (9.6 – 50.0 kg·m).

NOTE:

- Exercise vertical force on right side and left side of hood lock.
 - Do not press simultaneously both sides.
5. Check the hood lock lubrication condition. If necessary, apply body grease to the hood lock.

A
B
C
D
E
F
G
H
I
J
L
M
N
O
P

DLK

RADIATOR CORE SUPPORT

< ON-VEHICLE REPAIR >

[INTELLIGENT KEY SYSTEM]

RADIATOR CORE SUPPORT

Exploded View

INFOID:000000000961267

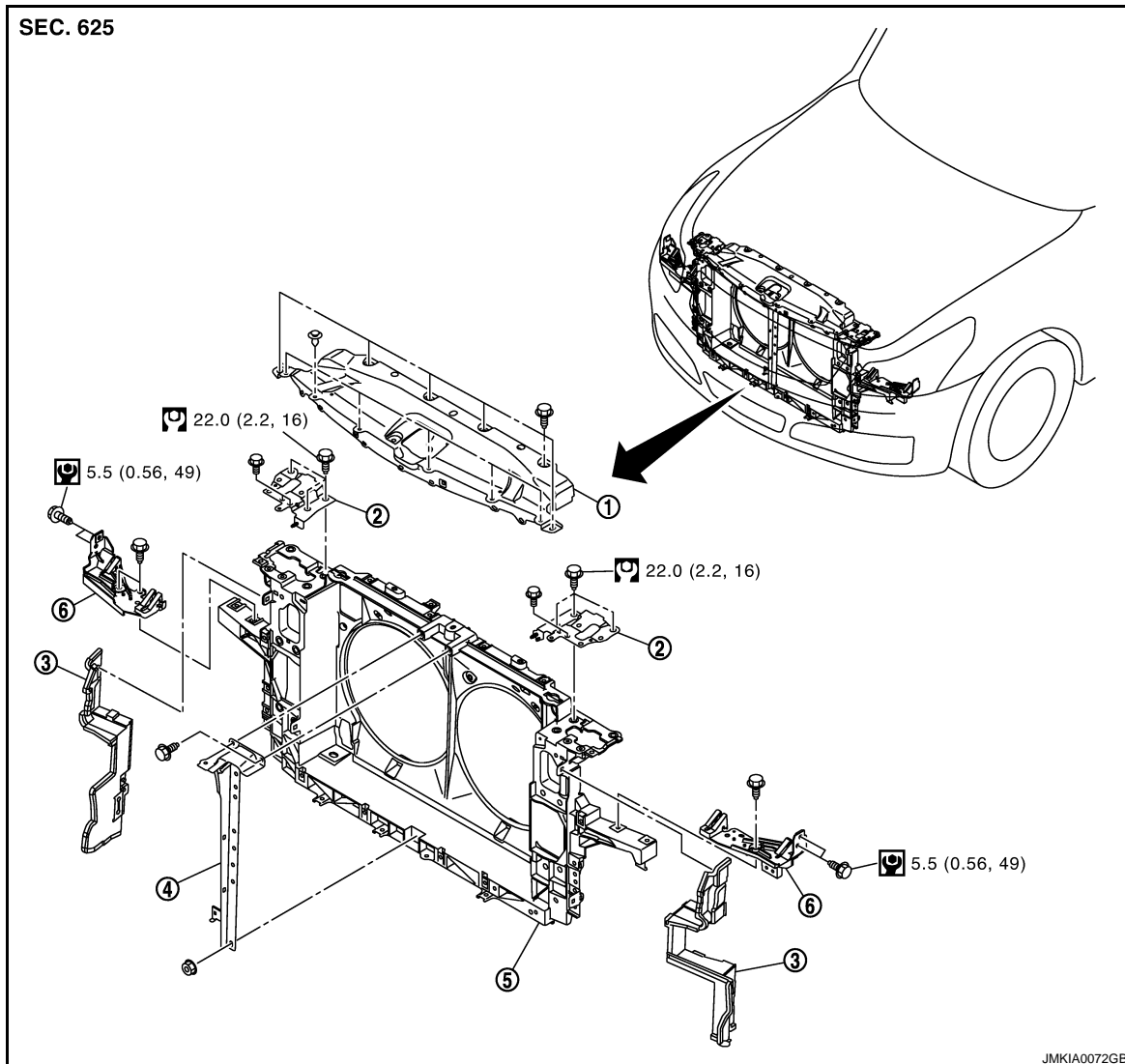

- | | | |
|-----------------------------------|-----------------------------------|----------------------|
| 1. Radiator core support ornament | 2. Hood lock bracket | 3. Air guide |
| 4. Hood lock stay | 5. Radiator core support assembly | 6. Head-lamp bracket |

Refer to [GI-4, "Components"](#) for symbols in the figure.

Removal and Installation

INFOID:000000000961268

REMOVAL

1. Remove the front bumper and front bumper reinforcement. Refer to [EXT-11, "Removal and Installation"](#).
2. Remove the radiator reserve tank. Refer to [CO-14, "Removal and Installation"](#).
3. Remove horn (High/Low). Refer to [HRN-6, "Removal and Installation"](#).
4. Remove the radiator core support ornament.
 - Remove the radiator core support ornament mounting bolts and clips.

NOTE:

RADIATOR CORE SUPPORT

< ON-VEHICLE REPAIR >

[INTELLIGENT KEY SYSTEM]

In the case that only radiator core support ornament is removed (front bumper is not removed), remove them according to the procedures shown below.

- To remove the mounting bolts on both sides of radiator core support ornament, first remove the mounting bolts of front bumper (shown by arrows in the figure) and pull up the bumper edge slightly to get working clearance.

CAUTION:

Do not apply excessive force while pulling front bumper to prevent front bumper and front fender from being damaged.

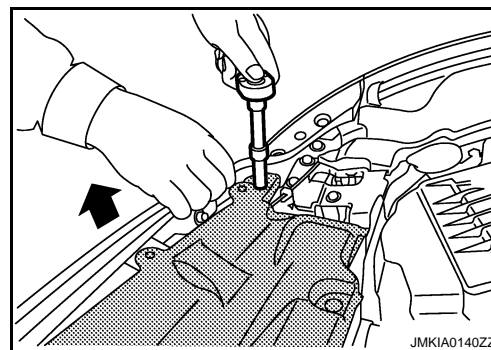

- Hold both sides of radiator core support ornament, pull it upwards and slide it to the rear of the vehicle.
- Disconnect the harness clip and hood lock control cable clip on radiator core support.

 : Clip

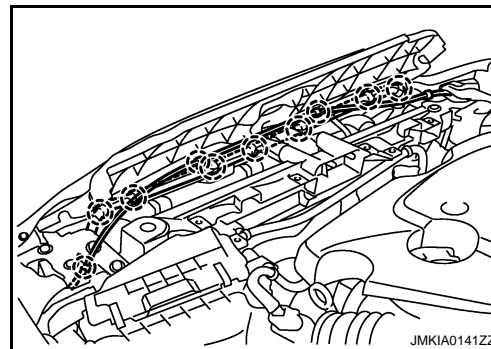

5. Remove the head lamp assembly. Refer to [EXL-185, "Removal and Installation"](#).
6. Remove the hood lock bracket assembly.
7. Remove the washer inlet and washer tank. Refer to [WW-79, "Removal and Installation"](#).
8. Remove the ambient sensor. Refer to [VTL-25, "Removal and Installation"](#).
9. Remove the power steering fluid cooler. Refer to [ST-20, "WITHOUT 4WAS : Removal and Installation"](#) (without 4WAS), [ST-22, "WITH 4WAS : Removal and Installation"](#) (with 4WAS).
10. Remove the air guide mounting clips and then remove air guide.
11. Disconnect the harness connector from liquid tank, and disconnect harness clamp from radiator core support.
12. Remove the ICC sensor integrated unit. Refer to [CCS-110, "Removal and Installation"](#).
13. Remove the hood lock stay.
14. Remove the engine undercover. Refer to [EXT-26, "Removal and Installation"](#).
15. Drain engine coolant from radiator. Refer to [CO-8, "Draining"](#).
16. Remove the radiator upper hose and lower hose on radiator side.
17. Remove the A/T fluid cooler tube on radiator side. Refer to [TM-271, "2WD : Removal and Installation"](#).
18. Disconnect condenser pipe assembly at one touch joint. Refer to [HA-54, "Removal and Installation"](#).
19. Remove the radiator core support assembly mounting bolts, and draw out radiator core support assembly forward of the vehicle.
20. Disconnect the cooling fan and crush zone sensor harness connector and clamp.
21. Remove the radiator core support assembly.
22. Remove the following parts after removing the radiator core support assembly.
 - Head lamp bracket.
 - Cooling fan. Refer to [CO-17, "Removal and Installation"](#).
 - Radiator and condenser assembly. Refer to [CO-14, "Removal and Installation"](#).
 - Crush zone sensor Refer to [SR-14, "Removal and Installation"](#).
 - Crush zone sensor bracket Refer to [SR-14, "Removal and Installation"](#).

INSTALLATION

Install in the reverse order of removal.

CAUTION:

A
B
C
D
E
F
G
H
I
J
L
M
N
O
P

DLK

RADIATOR CORE SUPPORT

< ON-VEHICLE REPAIR >

[INTELLIGENT KEY SYSTEM]

After installation, refill the following parts.

- Power steering fluid. Refer to [ST-10, "Inspection"](#).
- A/T fluid. Refer to [TM-218, "Changing"](#).
- Engine coolant. Refer to [CO-9, "Refilling"](#).

FRONT FENDER

Exploded View

INFOID:000000000961269

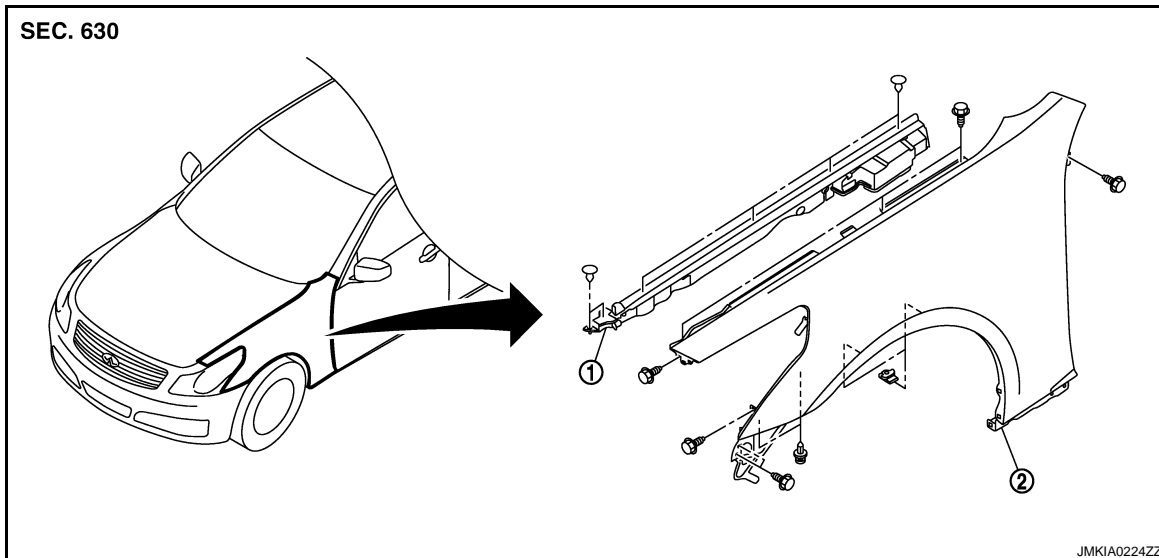

1. Hood seal assembly (side)
2. Front fender

Removal and Installation

INFOID:000000000961270

REMOVAL

1. Remove the front bumper. Refer to [EXT-11, "Removal and Installation"](#).
2. Remove the hood seal assembly (side).
3. Remove the head-lamp. Refer to [EXL-185, "Removal and Installation"](#).
4. Remove the front fender protector. Refer to [EXT-22, "Removal and Installation"](#).
5. Remove the center mudguard. Refer to [EXT-24, "Removal and Installation"](#).
6. Remove the mounting bolt and remove the front fender.

CAUTION:

While removing use a shop cloth to protect body from damaging.

INSTALLATION

Install in the reverse order of removal.

CAUTION:

- After installing, apply touch-up paint (the body color) onto the head of the front fender mounting bolts.
- After installing, check front fender adjustment. Refer to [DLK-192, "HOOD ASSEMBLY : Adjustment"](#) and [DLK-202, "FRONT DOOR : Adjustment"](#).

DOOR

[INTELLIGENT KEY SYSTEM]

< ON-VEHICLE REPAIR >

DOOR

FRONT DOOR

FRONT DOOR : Exploded View

INFOID:000000000961271

REMOVAL

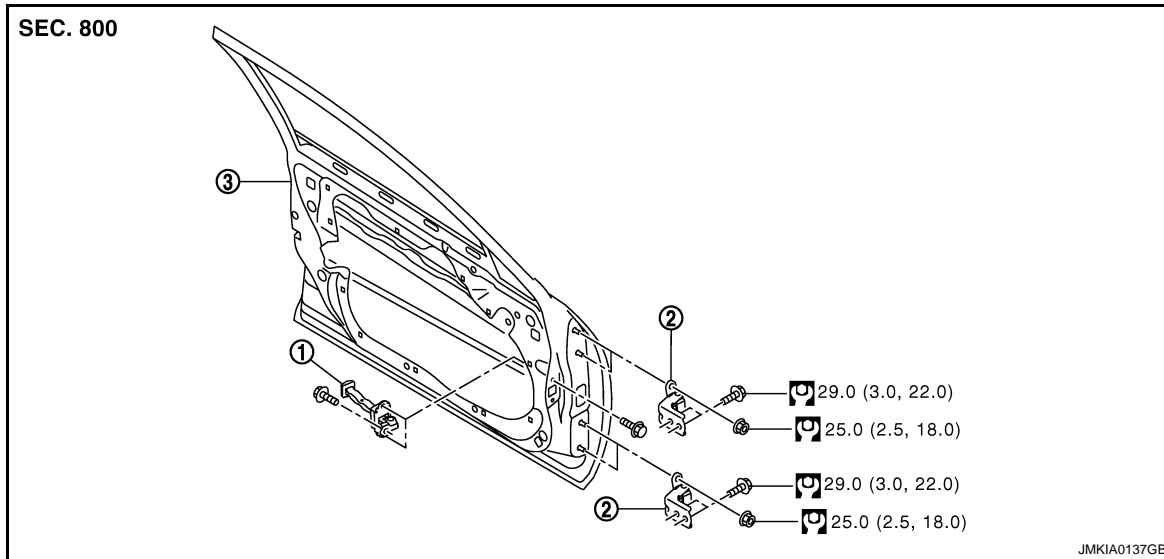

1. Check link

2. Door hinge (upper, lower)

3. Front door panel

Refer to [GI-4, "Components"](#) for symbols in the figure.

ADJUSTMENT

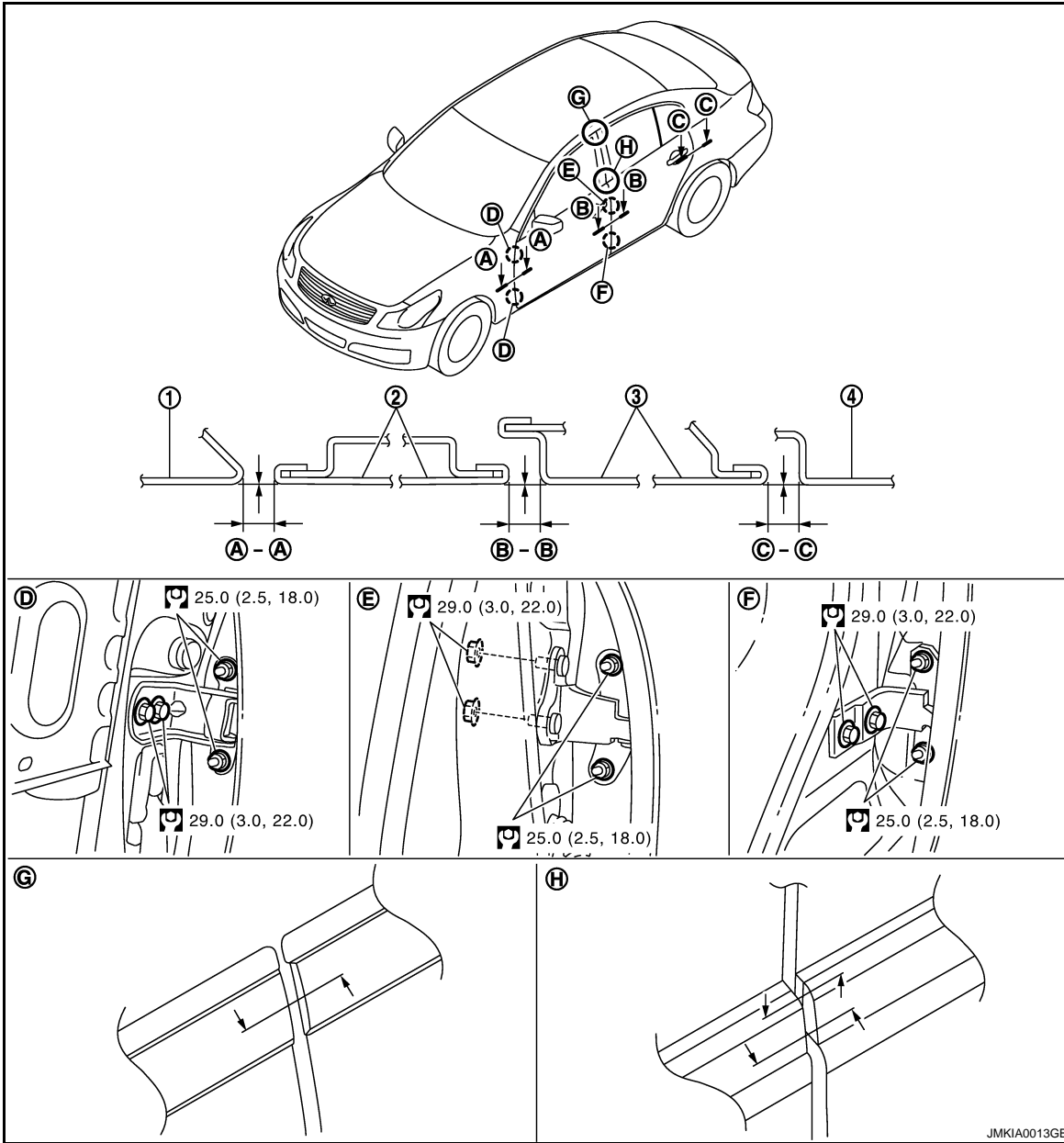

- 1. Front fender
- 2. Front door outer
- 3. Rear door outer
- 4. Rear fender

Refer to [GI-4, "Components"](#) for symbols in the figure.

FRONT DOOR : Removal and Installation

INFOID:000000000961272

REMOVAL

CAUTION:

- When removing and installing the front door assembly, support the door with a jack and cloth to protect the door and body.
- When removing and installing front door assembly, perform the fitting adjustment. Refer to [DLK-202, "FRONT DOOR : Adjustment"](#).
- After installing, apply touch-up paint (the body color) onto the head of the hinge mounting nuts.
- Check the hinge rotating part for poor lubrication. If necessary, apply body grease.
- Operate with two workers, because of its heavy weight.
- Check rear door open/close operation after installation.

1. Pull the lever and disconnect the door harness connector while removing tabs of door harness connector.

A
B
C
D
E
F
G
H
I
J
DLK

L
M
N
O
P

DOOR

< ON-VEHICLE REPAIR >

[INTELLIGENT KEY SYSTEM]

2. Remove the mounting bolts of the check link on the vehicle.

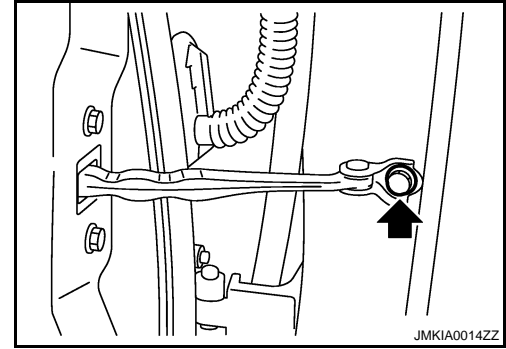

3. Remove the door side hinge mounting nuts, then remove the door assembly.

INSTALLATION

Install in the reverse order of removal.

FRONT DOOR : Adjustment

INFOID:000000000961273

CLEARANCE, SURFACE HEIGHT AND SURFACE MISMATCH ADJUSTMENT

1. Check the clearance and surface height and surface mismatch between the front door and each part visually and by touching.(Fitting standard dimension in the table below should be satisfied.)

Parts	Portion	Clearance	Surface height	Surface mismatch
Front fender – front door	A – A	2.5 – 4.5 (0.098 – 0.177)	-1.0 – 1.0 (-0.039 – 0.039)	—
Front door – rear door	B – B	2.5 – 4.5 (0.098 – 0.177)	-1.0 – 1.0 (-0.039 – 0.039)	—
Front door sash molding – rear door sash molding	G	—	-1.5 – 1.5 (-0.059 – 0.059)	—
Front door outside molding – rear door outside molding	H	—	-1.5 – 1.5 (-0.059 – 0.059)	-1.5 – 1.5 (-0.059 – 0.059)

2. In case out of specification, adjust them according to the procedures shown below.
3. Remove the front fender. Refer to refer to [DLK-199, "Removal and Installation"](#).
4. Loosen the hinge mounting nuts on door side.
5. Adjust the surface height and surface mismatch of the front door according to the fitting standard dimension.
6. Temporarily tighten the hinge mounting nuts on door side.
7. Loosen the hinge mounting bolts on body side.
8. Raise the front door at rear end to adjust clearance of the front door according to the fitting standard dimension.
9. After adjustment tighten bolts and nuts to the specified torque.
10. Install the front fender. Refer to refer to [DLK-199, "Removal and Installation"](#).

STRIKER ADJUSTMENT

DOOR

< ON-VEHICLE REPAIR >

[INTELLIGENT KEY SYSTEM]

Adjust the striker so that it becomes parallel with the lock insertion direction.

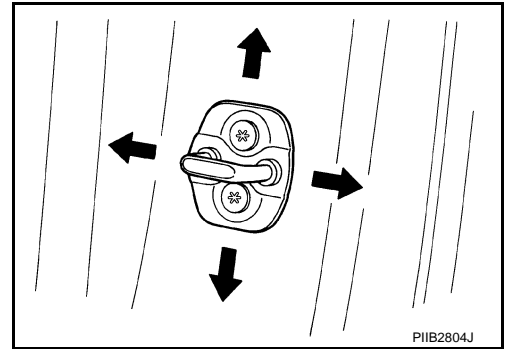

REAR DOOR

REAR DOOR : Exploded View

INFOID:000000000961274

REMOVAL

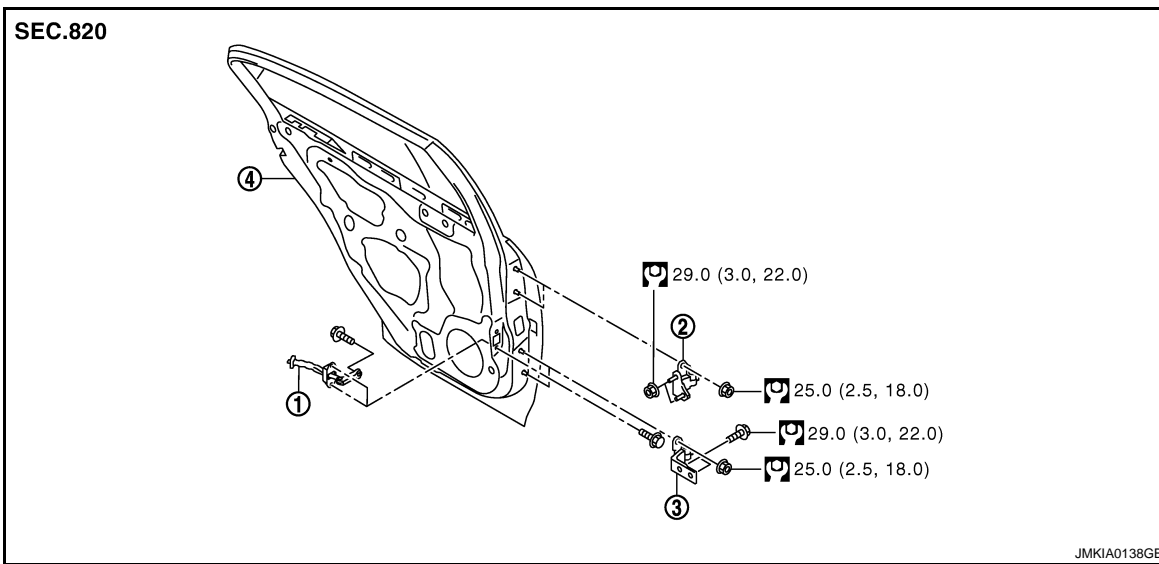

1. Check link
2. Door hinge (upper)
3. Door hinge (lower)
4. Rear door panel

Refer to [GI-4. "Components"](#) for the symbols in the figure.

ADJUSTMENT

A
B
C
D
E
F
G
H
I
J
L
M
N
O
P

DLK

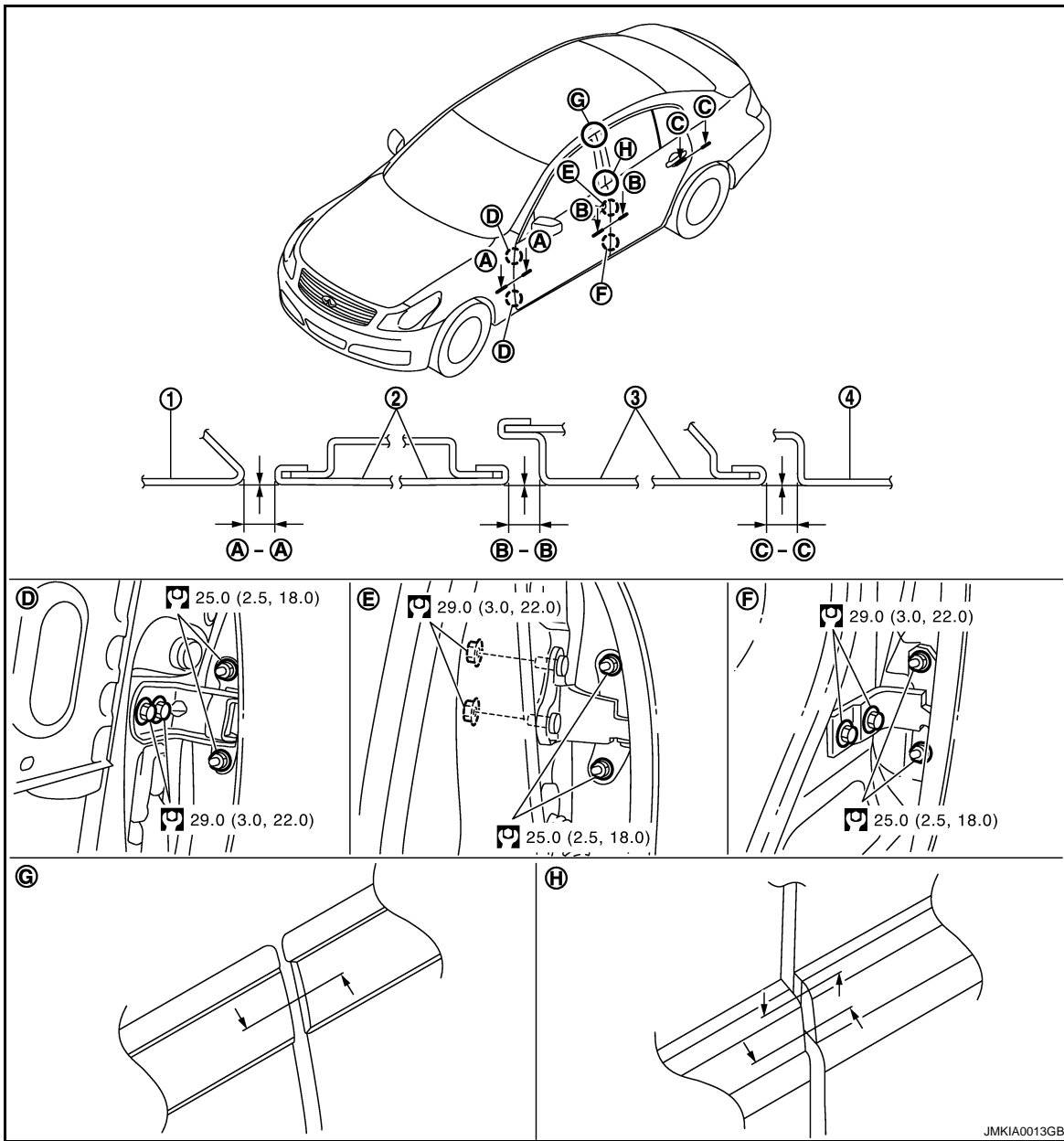

- 1. Front fender
- 4. Rear fender

- 2. Front door outer

- 3. Rear door outer

Refer to [GI-4, "Components"](#) for the symbols in the figure.

REAR DOOR : Removal and Installation

INFOID:000000000961275

REMOVAL

1. Pull out grommet and disconnect rear door harness connector.

DOOR

< ON-VEHICLE REPAIR >

[INTELLIGENT KEY SYSTEM]

- Remove the mounting bolts of the check link on the vehicle.

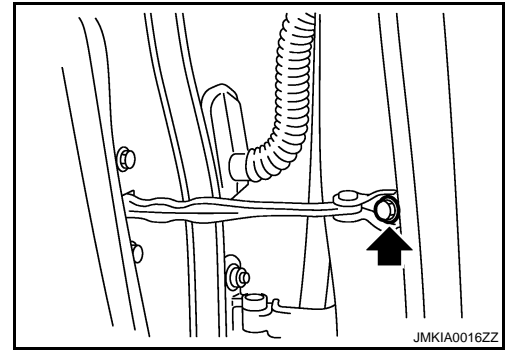

- Remove the door side hinge mounting nuts and remove the door assembly.

CAUTION:

- When removing and installing the rear door assembly, support the door with a jack and cloth to protect the door and body.
- When removing and installing rear door assembly, perform the fitting adjustment. Refer to [DLK-205, "REAR DOOR : Adjustment"](#).
- Check the hinge rotating part for poor lubrication. If necessary, apply body grease.
- After installing, apply touch-up paint (the body color) onto the head of the hinge mounting nuts.
- Operate with two workers, because of its heavy weight.
- Check rear door open/close operation after installation.

INSTALLATION

Install in the reverse order of removal.

REAR DOOR : Adjustment

INFOID:000000000961276

CLEARANCE, SURFACE HEIGHT AND SURFACE MISMATCH ADJUSTMENT

- Check the clearance and surface height and surface mismatch between the rear door and each part visually and by touching. (Fitting standard dimension in the table below should be satisfied.)

Parts	Portion	Clearance	Surface height	Surface mismatch
Front door – rear door	B – B	2.5 – 4.5 (0.098 – 0.177)	-1.0 – 1.0 (-0.039 – 0.039)	—
Rear door – rear fender	C – C	2.5 – 4.5 (0.098 – 0.177)	-1.0 – 1.0 (-0.039 – 0.039)	—
Front door sash molding – rear door weather-strip	G	—	-1.5 – 1.5 (-0.059 – 0.059)	—
Front door outside molding – rear door outside molding	H	—	-1.5 – 1.5 (-0.059 – 0.059)	-1.5 – 1.5 (-0.059 – 0.059)

- In case out of specification, adjust them according to the procedures shown below.
- Remove the center pillar upper garnish and center pillar lower garnish. Refer to [INT-13, "Removal and Installation"](#).
- Loosen the hinge mounting nuts on door side.
- Adjust the surface height and surface mismatch of the rear door according to the fitting standard dimension.
- Temporarily tighten the hinge mounting nuts on door side.
- Loosen the hinge mounting nuts and bolts on body side.
- Raise the rear door at rear end to adjust clearance of the rear door according to the fitting standard dimension.
- After adjustment tighten bolts and nuts to the specified torque.
- Install the center pillar upper garnish and center pillar lower garnish. Refer to [INT-13, "Removal and Installation"](#).

DOOR

< ON-VEHICLE REPAIR >

[INTELLIGENT KEY SYSTEM]

STRIKER ADJUSTMENT

Adjust the striker so that it becomes parallel with the lock insertion direction.

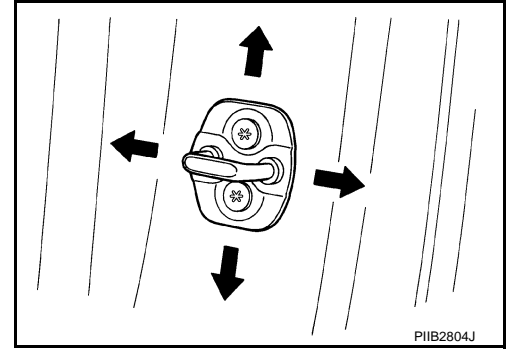

DOOR LOCK

[INTELLIGENT KEY SYSTEM]

< ON-VEHICLE REPAIR >

DOOR LOCK FRONT DOOR LOCK

FRONT DOOR LOCK : Exploded View

INFOID:000000000961277

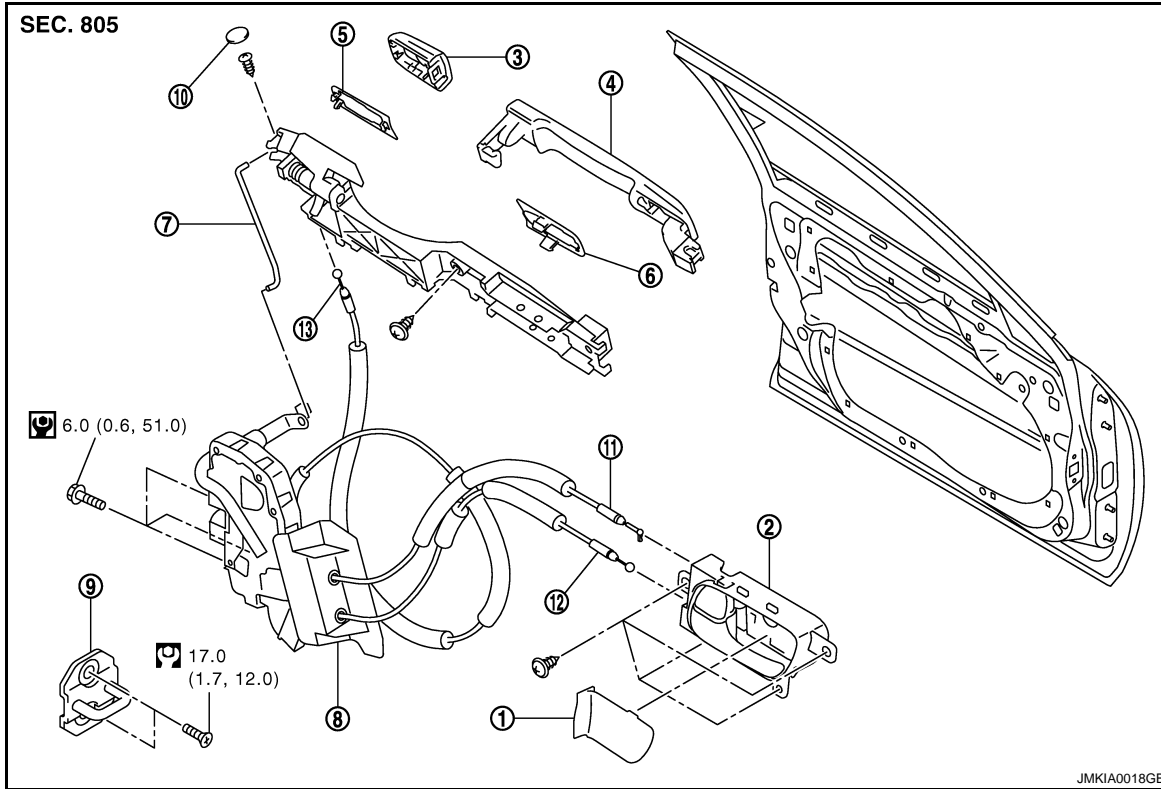

- | | | |
|--|-----------------------|---|
| 1. Inside handle cap | 2. Inside handle | 3. Door key cylinder assembly (Driver side)
Outside handle escutcheon (Passenger side) |
| 4. Outside handle | 5. Rear gasket | 6. Front gasket |
| 7. Key cylinder rod (Driver side only) | 8. Door lock assembly | 9. Striker |
| 10. Grommet | 11. Lock knob cable | 12. Inside handle knob cable |
| 13. Outside handle cable | | |

Refer to [GI-4, "Components"](#) for symbols in the figure.

FRONT DOOR LOCK : Removal and Installation

INFOID:000000000961278

REMOVAL

1. Remove the front door finisher. Refer to [INT-10, "Removal and Installation"](#).
2. Disconnect the inside handle knob cable and lock knob cable from the back side of the front door finisher.

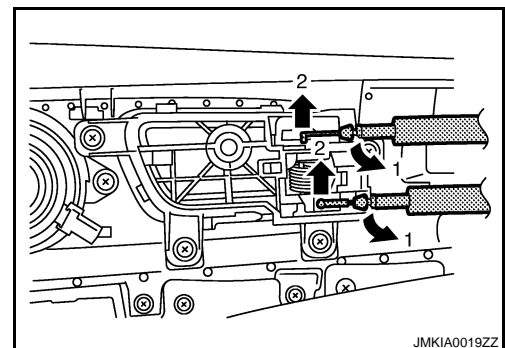

A
B
C
D
E
F
G
H
I
J

DLK

L
M

N

O

P

DOOR LOCK

[INTELLIGENT KEY SYSTEM]

< ON-VEHICLE REPAIR >

3. Remove the front door glass and front door module assembly. Refer to [GW-14. "Removal and Installation"](#), [GW-16. "Removal and Installation"](#).
4. Remove door side grommet, and remove door key cylinder assembly (driver side) and outside handle escutcheon (passenger side) bolts (TORX T30) from grommet hole.

CAUTION:

Do not forcibly remove the TORX bolts (T30).

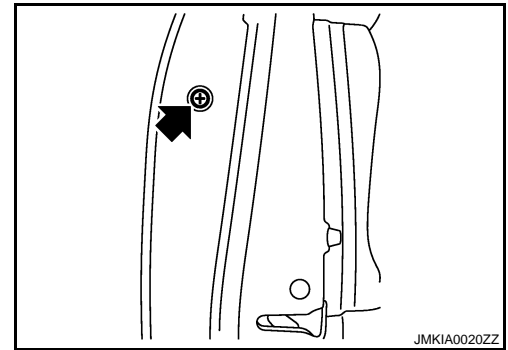

5. Disconnect door antenna and door request switch connector and remove harness clamp. (Models with Intelligent Key system)

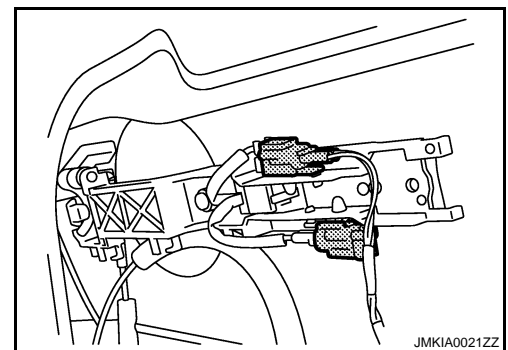

6. Reach in to separate the key cylinder rod connection (on the handle).
7. Disconnect door key cylinder switch harness connector.
8. While pulling the outside handle, remove door key cylinder assembly.

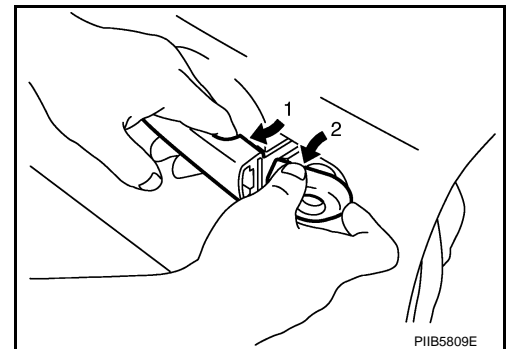

9. Disconnect front door request switch harness connector (with Intelligent Key system).
10. While pulling outside handle, slide toward rear of vehicle to remove outside handle.

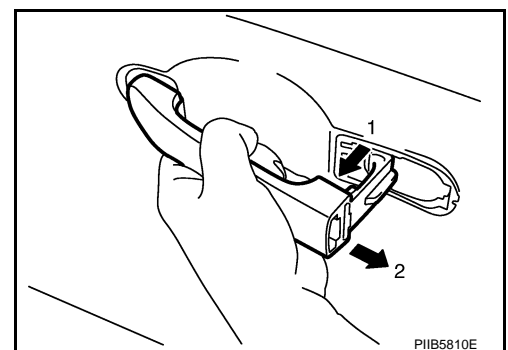

DOOR LOCK

< ON-VEHICLE REPAIR >

[INTELLIGENT KEY SYSTEM]

11. Remove the front gasket and rear gasket.

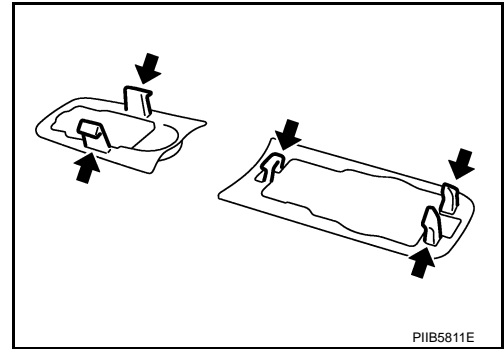

12. Remove the TORX bolts (T30), and remove the door lock assembly.

13. Remove the TORX bolt (T30) of the outside handle bracket.

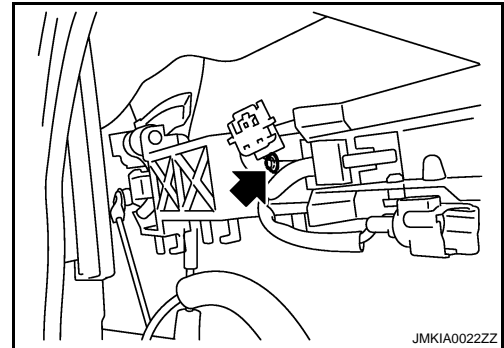

14. While pulling outside handle bracket, slide toward rear of vehicle to remove outside handle bracket.

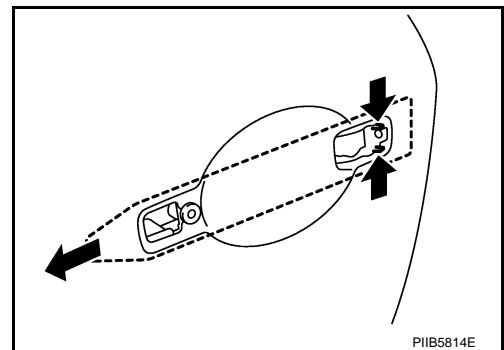

15. Disconnect the door lock actuator connector and remove the door lock assembly.

16. Reach in to separate the outside handle cable connection.

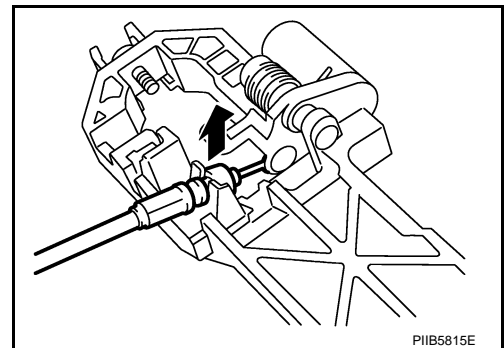

INSTALLATION

Install in the reverse order of removal.

CAUTION:

To install each rod, rotate the rod holder until a click is felt.

REAR DOOR LOCK

REAR DOOR LOCK : Exploded View

A
B
C
D
E
F
G
H
I
J
DLK
L
M
N
O
P

DOOR LOCK

< ON-VEHICLE REPAIR >

[INTELLIGENT KEY SYSTEM]

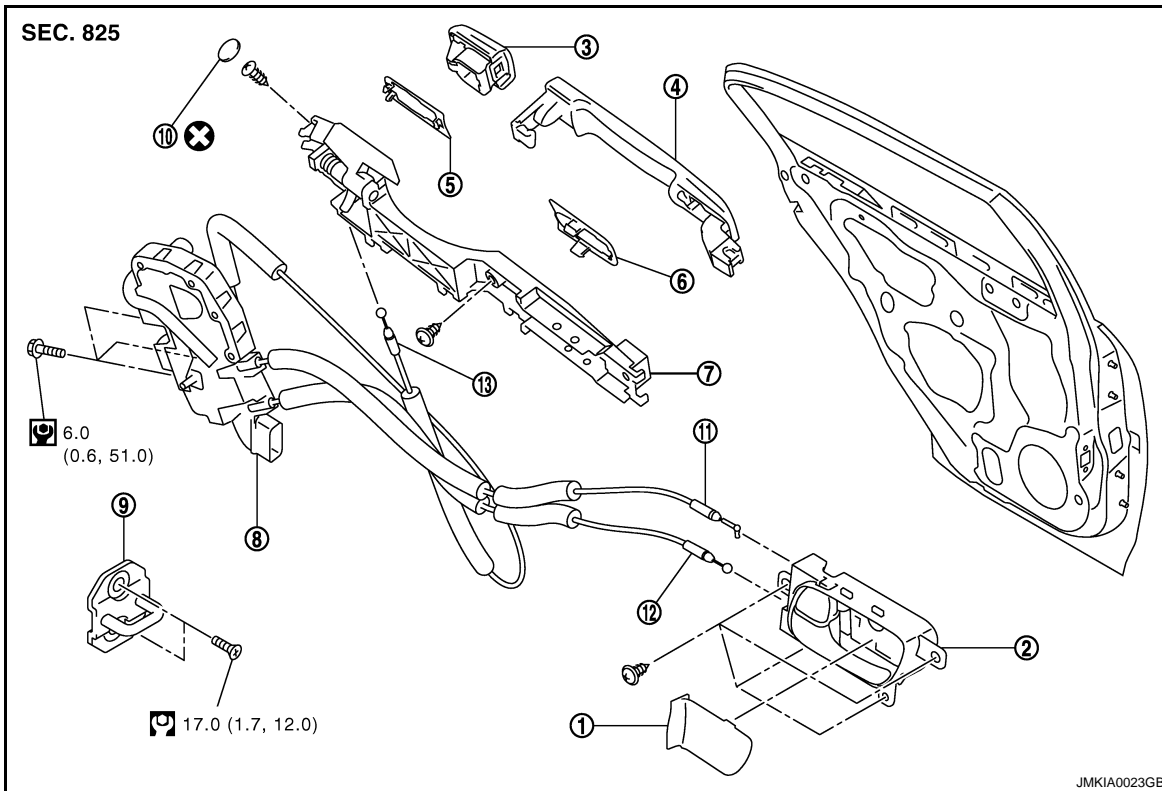

- | | | |
|---------------------------|-----------------------|------------------------------|
| 1. Inside handle cap | 2. Inside handle | 3. Outside handle escutcheon |
| 4. Outside handle | 5. Rear gasket | 6. Front gasket |
| 7. Outside handle bracket | 8. Door lock assembly | 9. Striker |
| 10. Seal | 11. Lock knob cable | 12. Inside handle knob cable |
| 13. Outside handle cable | | |

Refer to [GI-4, "Components"](#) for symbols in the figure.

REAR DOOR LOCK : Removal and Installation

INFOID:000000000961280

REMOVAL

1. Remove the rear door finisher. Refer to [INT-10, "Removal and Installation"](#).
2. Disconnect the inside handle knob cable and lock knob cable from the back side of the rear door finisher.

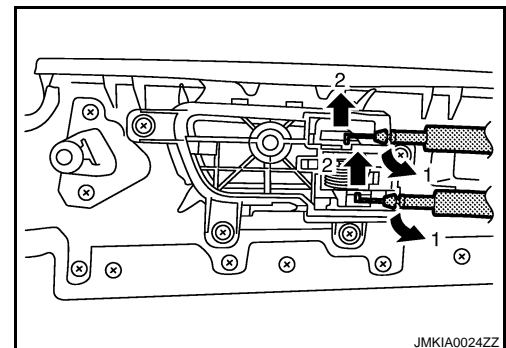

3. Remove the rear door glass. Refer to [GW-19, "Removal and Installation"](#).
4. Remove door side grommet, and remove outside handle escutcheon bolt (TORX T30) from grommet hole.

CAUTION:

DOOR LOCK

< ON-VEHICLE REPAIR >

[INTELLIGENT KEY SYSTEM]

Do not forcibly remove the TORX bolts (T30).

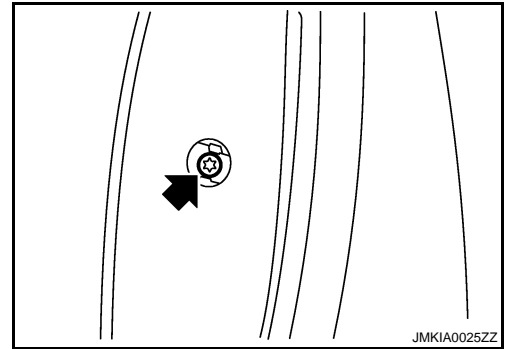

5. While pulling the outside handle, remove outside handle escutcheon.

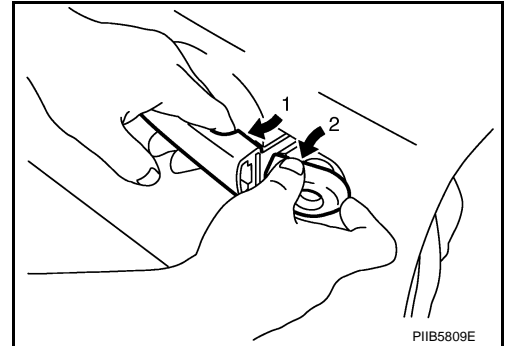

6. While pulling outside handle, slide toward rear of vehicle to remove outside handle.

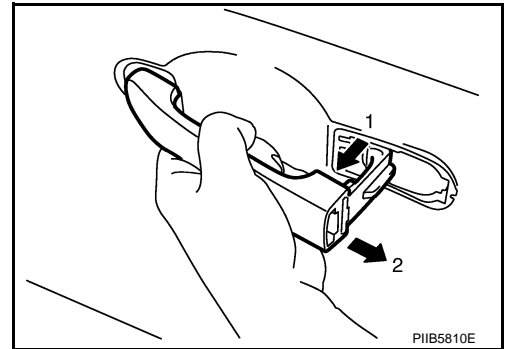

7. Remove the front gasket and rear gasket.

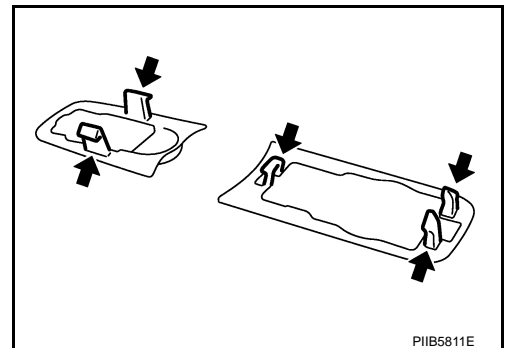

8. Remove the TORX bolts (T30), remove the door lock assembly.

A
B
C
D
E
F
G
H
I
J
DLK
L
M
N
O
P

DOOR LOCK

[INTELLIGENT KEY SYSTEM]

< ON-VEHICLE REPAIR >

9. Remove the TORX bolt (T30), and remove the outside handle bracket.

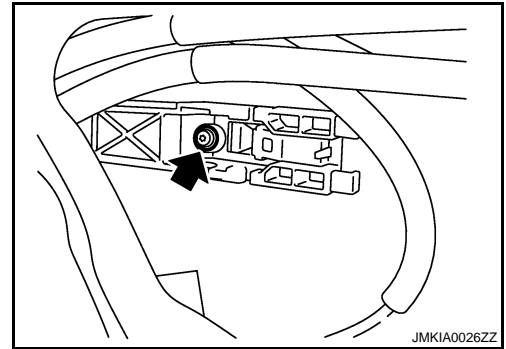

10. While pulling outside handle, slide toward rear of vehicle to remove outside handle.

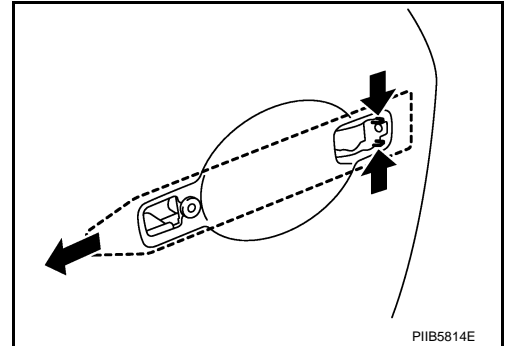

11. Disconnect the door lock actuator connector and remove the door lock assembly.
12. Reach in to separate outside handle cable connection.

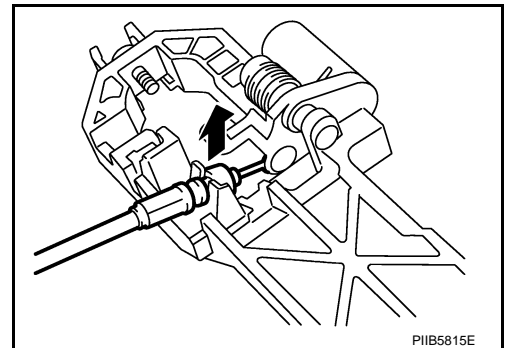

INSTALLATION

Install in the reverse order of removal.

CAUTION:

To install each rod, rotate the rod holder until a click is felt.

< ON-VEHICLE REPAIR >

TRUNK LID

TRUNK LID ASSEMBLY

TRUNK LID ASSEMBLY : Exploded View

INFOID:000000000961281

REMOVAL

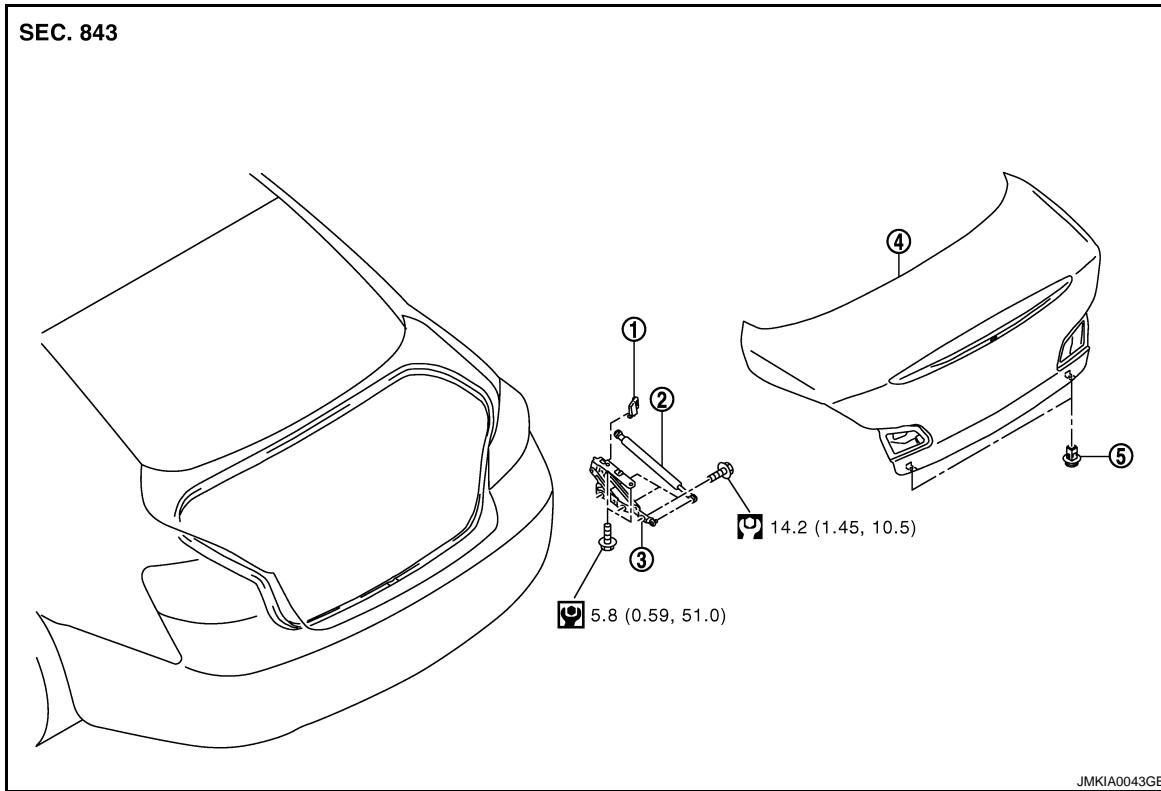

- | | | |
|----------------------------|-------------------|--------------------|
| 1. Trunk lid hinge stopper | 2. Trunk lid stay | 3. Trunk lid hinge |
| 4. Trunk lid assembly | 5. Bumper rubber | |

Refer to [GI-4, "Components"](#) for the symbols in the figure.

ADJUSTMENT

A
B
C
D
E
F
G
H
I
J
L
M
N
O
P

DLK

TRUNK LID

< ON-VEHICLE REPAIR >

[INTELLIGENT KEY SYSTEM]

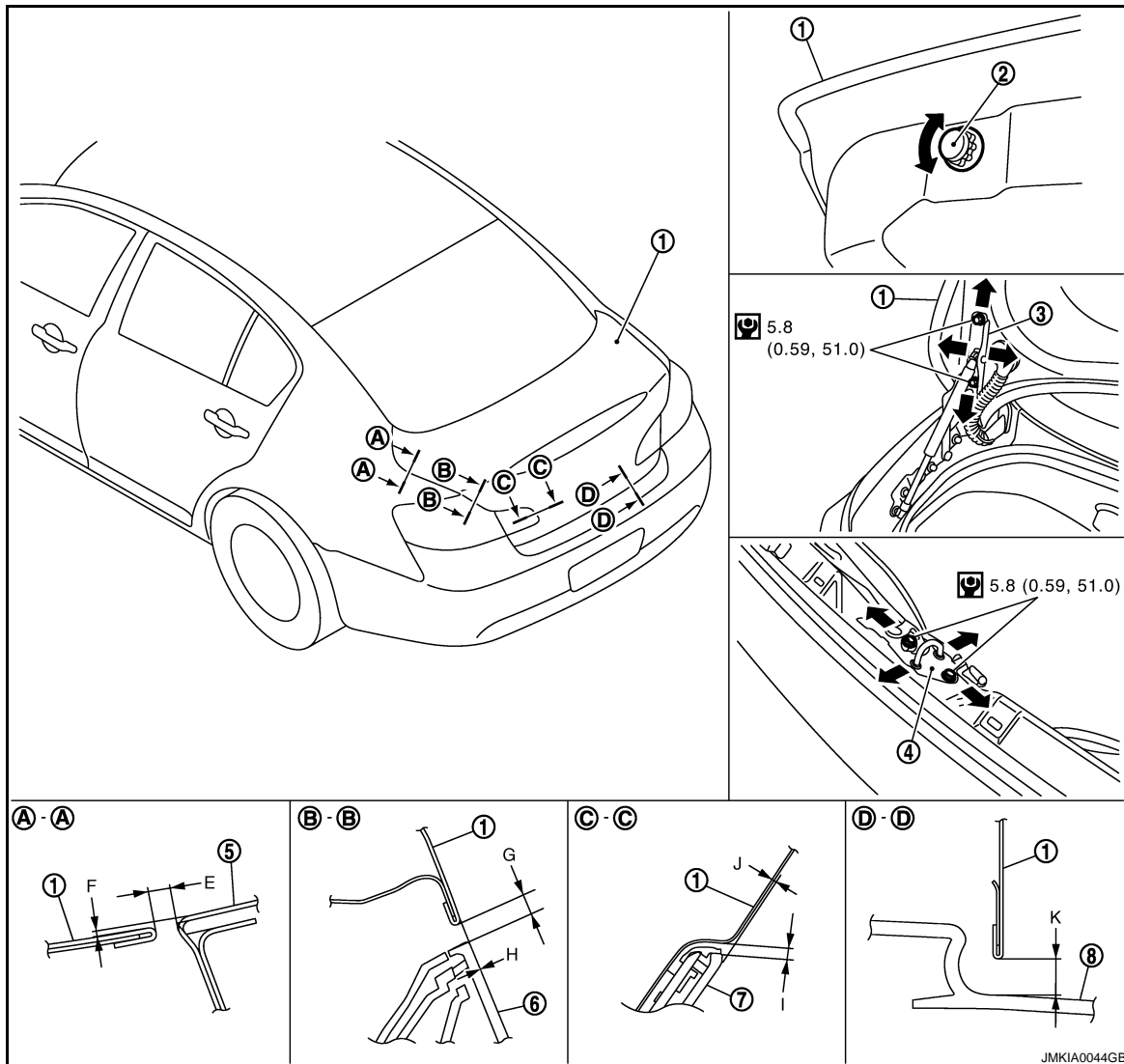

- | | | |
|-----------------------|------------------|--------------------------|
| 1. Trunk lid assembly | 2. Bumper rubber | 3. Trunk lid hinge |
| 4. Trunk lid striker | 5. Rear fender | 6. Rear combination lamp |
| 7. Back up lamp | 8. Rear bumper | |

Refer to [GI-4, "Components"](#) for symbols in the figure.

TRUNK LID ASSEMBLY : Removal and Installation

INFOID:000000000961282

REMOVAL

1. Remove trunk lid finisher. Refer to [INT-27, "Removal and Installation"](#).
2. Disconnect the connectors in the trunk lid, and remove the harness clamps to pull the harness out of the trunk lid.
3. Insert flat-bladed screwdriver into the gap and remove holder.
4. Remove trunk lid stay.

WARNING:

Body injury may occur if no supporting rod is holding the trunk lid open when removing the damper stay.

5. Remove the trunk lid hinge mounting bolts on trunk lid side and remove the trunk lid assembly.

INSTALLATION

Install in the reverse order of removal.

CAUTION:

TRUNK LID

< ON-VEHICLE REPAIR >

[INTELLIGENT KEY SYSTEM]

- After installing, apply touch-up paint (the body color) onto the head of the hinge mounting bolts.
- After installing, check operation.
- After installing, perform fitting adjustment. Refer to [DLK-215, "TRUNK LID ASSEMBLY : Adjustment"](#).

TRUNK LID ASSEMBLY : Adjustment

INFOID:000000000961283

1. Check the clearance and the evenness between the trunk lid and each part visually and by touching. (Fitting standard dimension in the table below should be satisfied.)

Parts	Portion		Standard	Right/left clearance (MAX)
Trunk lid – Rear fender	A – A	E	Clearance 2.5 – 4.5 (0.098 – 0.177)	1.5 (0.059)
		F	Surface height –1.5 – 0.5 (0.059 – 0.020)	1.5 (0.059)
Trunk lid – Rear combination lamp	B – B	G	Clearance 3.9 – 7.1 (0.154 – 0.280)	2.1 (0.083)
		H	Surface height –2.1 – 0.9 (–0.083 – 0.035)	2.0 (0.079)
Trunk lid – Back-up lamp	C – C	I	Clearance 1.7 – 3.7 (0.067 – 0.146)	1.2 (0.047)
		J	Surface height –1.8 – 0.6 (–0.071 – 0.024)	1.5 (0.059)
Trunk lid – Rear bumper	D – D	K	Clearance 4.0 – 8.0 (0.157 – 0.315)	—

* Unit: mm (in)

2. In case out of specification, adjust them according to the procedures shown below.
3. Loosen the bumper rubber.
4. Loosen the striker mounting bolts.
5. Lift up the trunk lid approximately 100 – 150 mm (3.94 – 5.91 in) height then close it lightly and check that it is engaged firmly with the trunk lid closed.
6. Check the clearance and evenness.
7. Finally tighten the trunk lid striker.

TRUNK LID LOCK

TRUNK LID LOCK : Exploded View

INFOID:000000000961284

A
B
C
D
E
F
G
H
I
J
L
M
N
O
P

DLK

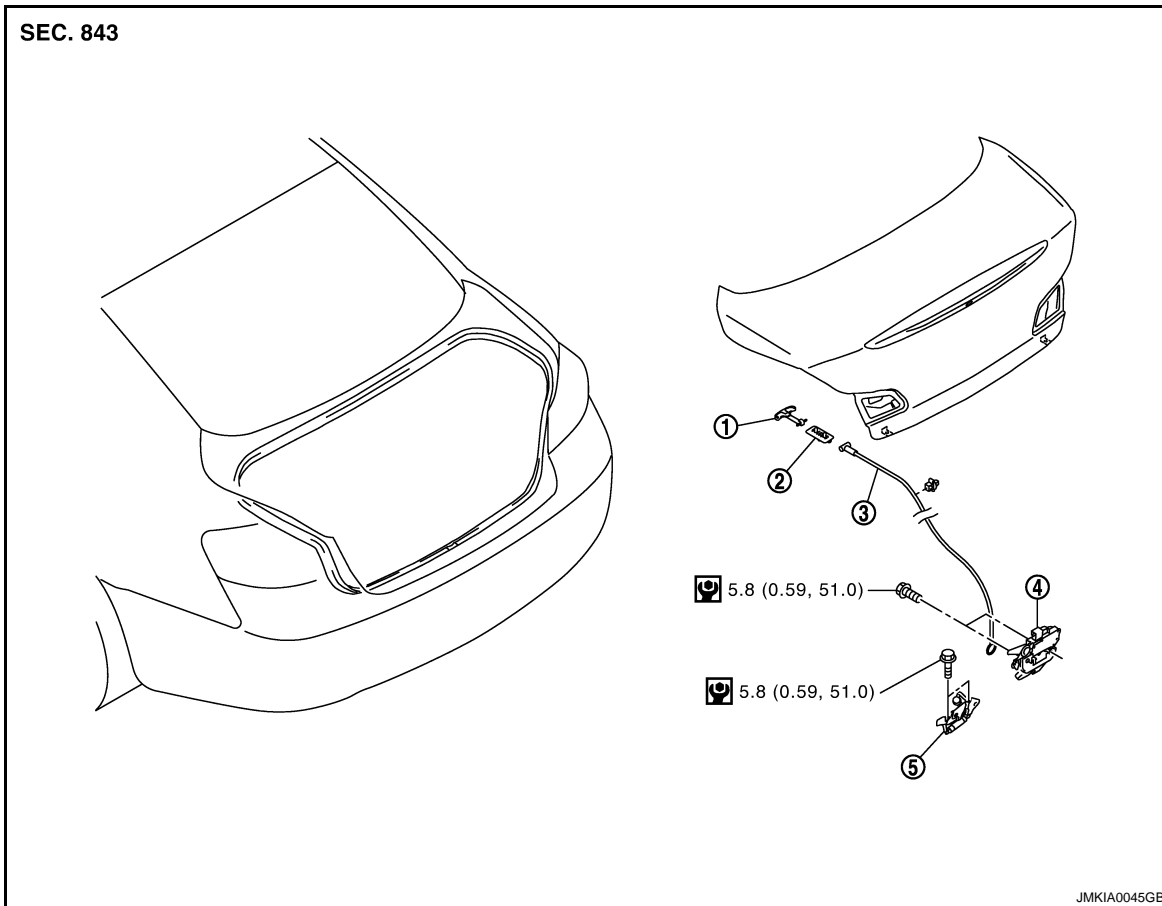

- | | | |
|-------------------------------------|--|----------------------------------|
| 1. Trunk lid emergency opener lever | 2. Trunk lid emergency opener lever holder | 3. Trunk lid opener cable holder |
| 4. Trunk lid lock | 5. Trunk lid striker | |

Refer to [GI-4, "Components"](#) for symbols in the figure.

TRUNK LID LOCK : Removal and Installation

INFOID:000000000961285

REMOVAL

1. Remove the trunk lid finisher. Refer to [INT-27, "Removal and Installation"](#).
2. Remove the trunk lid emergency opener lever.
3. Disconnect the trunk lid opener cable.
4. Disconnect the connector from trunk lid lock.
5. Remove the mounting bolts, and remove the trunk lid lock.

INSTALLATION

Install in the reverse order of removal.

NOTE:

- After installing, perform trunk lid fitting adjustment. Refer to refer to [DLK-215, "TRUNK LID ASSEMBLY : Adjustment"](#).
- After installing, check the operation.

TRUNK LID WEATHERSTRIP

TRUNK LID WEATHERSTRIP : Exploded View

INFOID:000000000961286

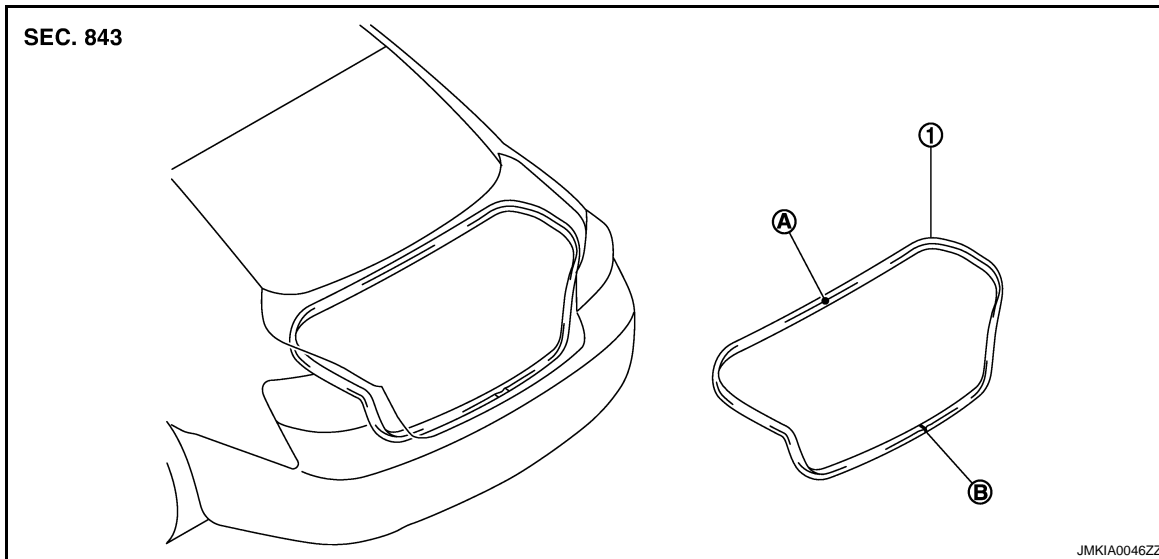

1. Weather-strip

A. Seam (upper)

B. Seam (lower)

TRUNK LID WEATHERSTRIP : Removal and Installation

INFOID:000000000961287

REMOVAL

Pull up and remove engagement with body from weather-strip joint.

CAUTION:

After removal, do not pull strongly on the weather-strip.

INSTALLATION

1. Align the weather-strip seam (upper) with mark of the body panel and weather-strip onto the vehicle.
2. Align the weather-strip seam (lower) with center of the striker and weather-strip onto the vehicle.
3. After installation, pull the weather-strip gently to ensure that there is no loose section.

NOTE:

Check that the weather-strip fits tightly at each corner and trunk rear plate.

A
B
C
D
E
F
G
H
I
J
L
M
N
O
P

DLK

DOOR SWITCH

< ON-VEHICLE REPAIR >

[INTELLIGENT KEY SYSTEM]

DOOR SWITCH

Removal and Installation

INFOID:000000000961288

REMOVAL

1. Remove the door switch mounting bolt (A), and then remove door switch (1).

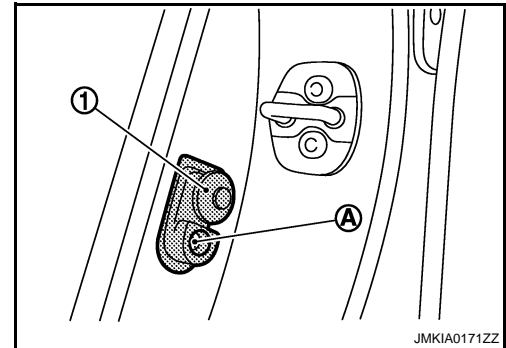

INSTALLATION

Install in the reverse order of removal.

< ON-VEHICLE REPAIR >

INSIDE KEY ANTENNA INSTRUMENT CENTER

INSTRUMENT CENTER : Exploded View

INFOID:000000000961289

Refer to [IP-11, "Exploded View"](#).

INSTRUMENT CENTER : Removal and Installation

INFOID:000000000961290

REMOVAL

1. Remove the console finisher. Refer to [IP-12, "Removal and Installation"](#).
2. Remove the key slot mounting screw (A), and then remove inside key antenna (instrument center) (1).

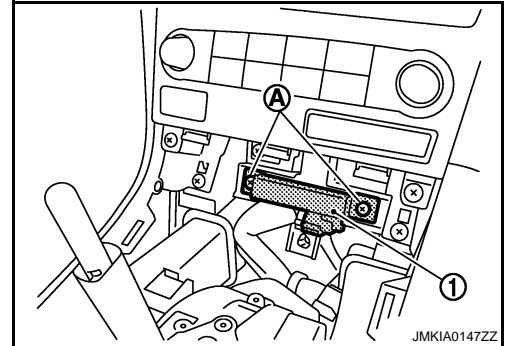

INSTALLATION

Install in the reverse order of removal.

CONSOLE

CONSOLE : Exploded View

INFOID:000000000961291

Refer to [IP-22, "Exploded View"](#).

CONSOLE : Removal and Installation

INFOID:000000000961292

REMOVAL

1. Remove the console ashtray.
2. Remove the console rear finisher (2). Refer to [IP-26, "Disassembly and Assembly"](#).
3. Remove the inside key antenna mounting screw (A), and then remove inside key antenna (console) (1) from console rear finisher (2).

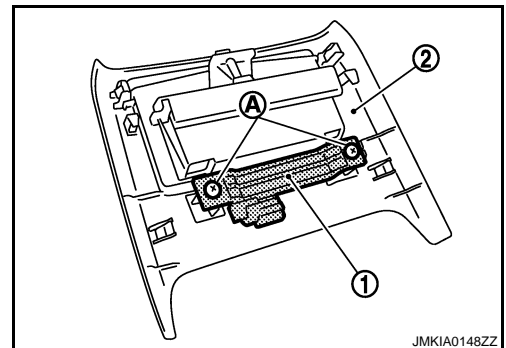

INSTALLATION

Install in the reverse order of removal.

TRUNK ROOM

TRUNK ROOM : Exploded View

INFOID:000000000961293

Refer to [INT-26, "Exploded View"](#).

TRUNK ROOM : Removal and Installation

INFOID:000000000961294

A
B
C
D
E
F
G
H
I
J
L
M
N
O
P

DLK

INSIDE KEY ANTENNA

< ON-VEHICLE REPAIR >

[INTELLIGENT KEY SYSTEM]

REMOVAL

1. Remove the trunk trim. Refer to [INT-27. "Removal and Installation"](#).
2. Remove the inside key antenna (trunk room) mounting nuts (A), and then remove inside key antenna (trunk room) (1).

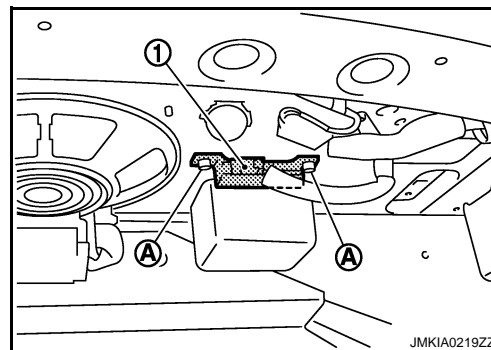

INSTALLATION

Install in the reverse order of removal.

OUTSIDE KEY ANTENNA

[INTELLIGENT KEY SYSTEM]

< ON-VEHICLE REPAIR >

OUTSIDE KEY ANTENNA

DRIVER SIDE

DRIVER SIDE : Exploded View

INFOID:000000000961295

Refer to [DLK-207, "FRONT DOOR LOCK : Exploded View"](#).

DRIVER SIDE : Removal and Installation

INFOID:000000000961296

REMOVAL

Remove the front outside handle LH. Refer to [DLK-207, "FRONT DOOR LOCK : Removal and Installation"](#).

INSTALLATION

Install in the reverse order of removal.

PASSENGER SIDE

PASSENGER SIDE : Exploded View

INFOID:000000000961297

Refer to [DLK-207, "FRONT DOOR LOCK : Exploded View"](#).

PASSENGER SIDE : Removal and Installation

INFOID:000000000961298

REMOVAL

Remove the front outside handle RH. Refer to [DLK-207, "FRONT DOOR LOCK : Removal and Installation"](#).

INSTALLATION

Install in the reverse order of removal.

REAR BUMPER

REAR BUMPER : Exploded View

INFOID:000000000961299

Refer to [EXT-13, "Exploded View"](#).

REAR BUMPER : Removal and Installation

INFOID:000000000961300

REMOVAL

1. Remove the rear bumper. Refer to [EXT-14, "Removal and Installation"](#).
2. Remove the outside key antenna (rear bumper) mounting nuts (A), and then remove outside key antenna (rear bumper) (1).

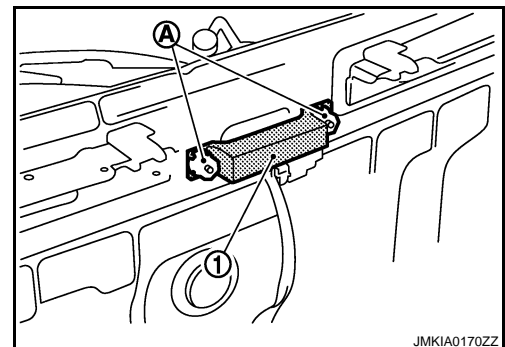

INSTALLATION

Install in the reverse order of removal.

A
B
C
D
E
F
G
H
I
J
L
M
N
O
P

DLK

INTELLIGENT KEY WARNING BUZZER

< ON-VEHICLE REPAIR >

[INTELLIGENT KEY SYSTEM]

INTELLIGENT KEY WARNING BUZZER

Exploded View

INFOID:000000000961301

Refer to [DLK-199. "Exploded View"](#).

Removal and Installation

INFOID:000000000961302

REMOVAL

1. Remove the hood seal assembly (side). Refer to [DLK-199. "Removal and Installation"](#).
2. Remove the Intelligent Key warning buzzer mounting bolt (A), and then remove the Intelligent Key warning buzzer (1).

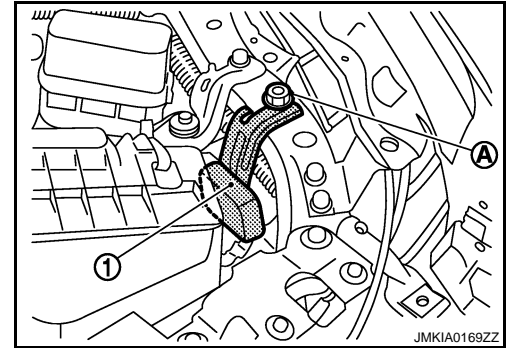

INSTALLATION

Install in the reverse order of removal.

KEY SLOT

Exploded View

INFOID:000000000961303

Refer to [IP-11, "Exploded View"](#).

Removal and Installation

INFOID:000000000961304

REMOVAL

1. Remove the instrument driver lower panel (2). Refer to [IP-12, "Removal and Installation"](#).
2. Disconnect key slot connector.
3. Remove the key slot mounting screw (A), and then remove key slot (1) from instrument driver lower panel (2).

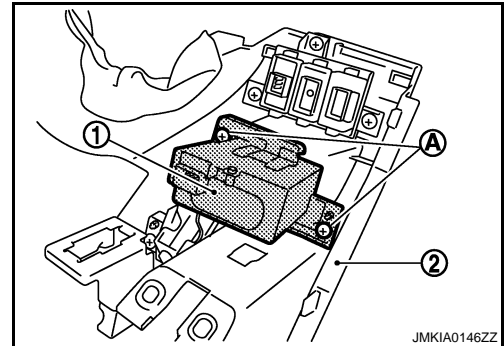

INSTALLATION

Install in the reverse order of removal.

A

B

C

D

E

F

G

H

I

J

DLK

L

M

N

O

P

TRUNK OPENER REQUEST SWITCH

< ON-VEHICLE REPAIR >

[INTELLIGENT KEY SYSTEM]

TRUNK OPENER REQUEST SWITCH

Exploded View

INFOID:000000000961305

Refer to [EXT-35. "Exploded View"](#).

Removal and Installation

INFOID:000000000961306

REMOVAL

1. Remove the trunk lid finisher outer (1). Refer to [EXT-35. "Removal and Installation"](#).
2. Remove the inner bracket mounting screw (A), and then remove inner bracket (2) from trunk lid finisher outer (1).

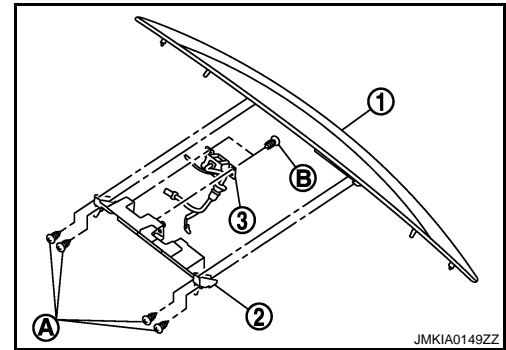

3. Remove the trunk lid request switch mounting screw (B), and then remove trunk lid request switch (3) from inner bracket (2).

INSTALLATION

Install in the reverse order of removal.

TRUNK LID OPENER SWITCH

< ON-VEHICLE REPAIR >

[INTELLIGENT KEY SYSTEM]

TRUNK LID OPENER SWITCH

Exploded View

INFOID:000000000961307

Refer to [IP-11, "Exploded View"](#).

Removal and Installation

INFOID:000000000961308

REMOVAL

1. Remove the instrument driver lower panel. Refer to [IP-12, "Removal and Installation"](#).
2. Remove the trunk lid opener switch (1) from instrument driver lower panel, and then remove pawl (A). Press trunk lid opener switch (1) front side to disengage from instrument driver lower panel.

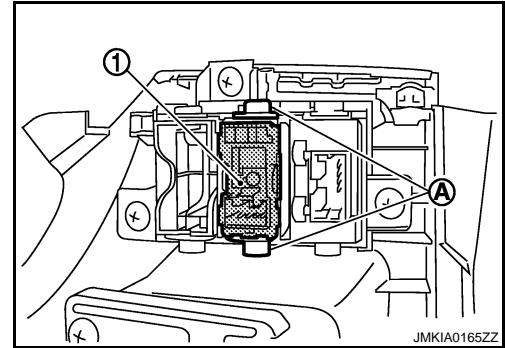

INSTALLATION

Install in the reverse order of removal.

A
B
C
D
E
F
G
H
I
J
L
M
N
O
P

DLK

TRUNK LID OPENER CANCEL SWITCH

< ON-VEHICLE REPAIR >

[INTELLIGENT KEY SYSTEM]

TRUNK LID OPENER CANCEL SWITCH

Exploded View

INFOID:000000000961309

Refer to [IP-11, "Exploded View"](#).

Removal and Installation

INFOID:000000000961310

REMOVAL

1. Remove the instrument assist lower panel. Refer to [IP-12, "Removal and Installation"](#).
2. Remove the trunk lid opener cancel switch (1) instrument assist lower panel, and then remove pawl (A). Press trunk lid opener cancel switch (1) backside to disengage from instrument assist lower panel.

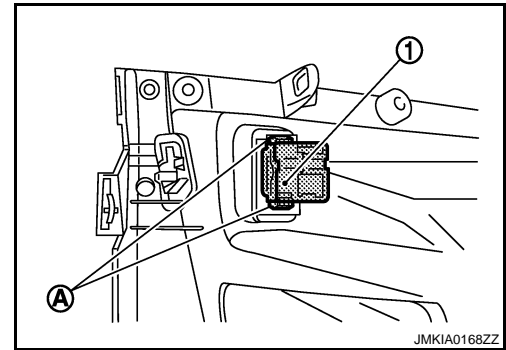

INSTALLATION

Install in the reverse order of removal.

REMOTE KEYLESS ENTRY RECEIVER

< ON-VEHICLE REPAIR >

[INTELLIGENT KEY SYSTEM]

REMOTE KEYLESS ENTRY RECEIVER

Exploded View

INFOID:000000000961311

Refer to [IP-11, "Exploded View"](#).

Removal and Installation

INFOID:000000000961312

REMOVAL

1. Remove the instrument assist lower panel. Refer to [IP-12, "Removal and Installation"](#).
2. Remove the remote keyless entry receiver mounting bolt (A), and then remove remote keyless entry receiver (1).

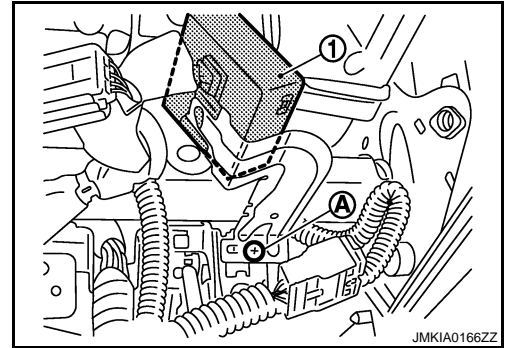

INSTALLATION

Install in the reverse order of removal.

A
B
C
D
E
F
G
H
I
J
L
M
N
O
P

DLK