

SECTION **DEF**  
**DEFOGGER**

A  
B  
C  
D  
E  
F  
G  
H  
I  
J  
K  
DEF  
M  
N  
O  
P

CONTENTS

<b>BASIC INSPECTION</b> .....	3	<b>RETRACTABLE HARD TOP CONTROL UNIT</b> .....	12
<b>DIAGNOSIS AND REPAIR WORKFLOW</b> .....	3	Description .....	12
Work Flow .....	3	Component Function Check .....	12
<b>SYSTEM DESCRIPTION</b> .....	4	Diagnosis Procedure .....	12
<b>REAR WINDOW DEFOGGER SYSTEM</b> .....	4	<b>REAR WINDOW DEFOGGER</b> .....	14
System Diagram .....	4	Description .....	14
System Description .....	4	Component Function Check .....	14
Component Parts Location .....	5	Diagnosis Procedure .....	14
Component Description .....	5	Component Inspection .....	15
<b>DIAGNOSIS SYSTEM (BCM)</b> .....	6	<b>DOOR MIRROR DEFOGGER</b> .....	16
<b>COMMON ITEM</b> .....	6	Description .....	16
COMMON ITEM : CONSULT-III Function (BCM -		Component Function Check .....	16
COMMON ITEM) .....	6	Diagnosis Procedure .....	16
<b>REAR WINDOW DEFOGGER</b> .....	7	<b>DRIVER SIDE DOOR MIRROR DEFOGGER</b> ...	17
REAR WINDOW DEFOGGER : CONSULT-III		Description .....	17
Function (BCM - REAR DEFOGGER) .....	7	Component Function Check .....	17
<b>DTC/CIRCUIT DIAGNOSIS</b> .....	8	Diagnosis Procedure .....	17
<b>POWER SUPPLY AND GROUND CIRCUIT</b> .....	8	Component Inspection .....	18
<b>BCM (BODY CONTROL MODULE)</b> .....	8	<b>PASSENGER SIDE DOOR MIRROR DEFOG-</b>	
BCM (BODY CONTROL MODULE) : Diagnosis		<b>GER</b> .....	19
Procedure .....	8	Description .....	19
<b>REAR WINDOW DEFOGGER SWITCH</b> .....	9	Component Function Check .....	19
Description .....	9	Diagnosis Procedure .....	19
Component Function Check .....	9	Component Inspection .....	20
Diagnosis Procedure .....	9	<b>REAR WINDOW DEFOGGER SYSTEM</b> .....	21
<b>REAR WINDOW DEFOGGER RELAY</b> .....	10	Wiring Diagram - DEFOGGER - .....	21
Description .....	10	<b>ECU DIAGNOSIS INFORMATION</b> .....	26
Component Function Check .....	10	<b>BCM (BODY CONTROL MODULE)</b> .....	26
Diagnosis Procedure .....	10	Reference Value .....	26
Component Inspection .....	11	Wiring Diagram - BCM - .....	49
		Fail-safe .....	54
		DTC Inspection Priority Chart .....	56
		DTC Index .....	58

<b>RETRACTABLE HARD TOP CONTROL UNIT</b> .....	<b>61</b>	<b>DRIVER SIDE</b> .....	<b>97</b>
Reference Value .....	61	DRIVER SIDE : Diagnosis Procedure .....	97
Wiring Diagram - RETRACTABLE HARD TOP SYSTEM - .....	71	<b>PASSENGER SIDE</b> .....	<b>97</b>
Fail-safe .....	86	PASSENGER SIDE : Diagnosis Procedure .....	97
DTC Inspection Priority Chart .....	89	<b>ON IS NOT DISPLAYED WHEN PRESSING REAR WINDOW DEFOGGER SWITCH BUT IT IS OPERATED</b> .....	<b>98</b>
DTC Index .....	92	Diagnosis Procedure .....	98
<b>SYMPTOM DIAGNOSIS</b> .....	<b>95</b>	<b>REAR WINDOW DEFOGGER INDICATOR DOES NOT ILLUMINATE</b> .....	<b>99</b>
<b>REAR WINDOW DEFOGGER AND DOOR MIRROR DEFOGGER DO NOT OPERATE.</b> ....	<b>95</b>	Diagnosis Procedure .....	99
Diagnosis Procedure .....	95	<b>PRECAUTION</b> .....	<b>100</b>
<b>REAR WINDOW DEFOGGER DOES NOT OPERATE BUT BOTH DOOR MIRROR DEFOGGERS OPERATE.</b> .....	<b>96</b>	<b>PRECAUTIONS</b> .....	<b>100</b>
Diagnosis Procedure .....	96	Precaution for Supplemental Restraint System (SRS) "AIR BAG" and "SEAT BELT PRE-TENSIONER" .....	100
<b>DOOR MIRROR DEFOGGER DOES NOT OPERATE BUT REAR WINDOW DEFOGGER OPERATE</b> .....	<b>97</b>	<b>REMOVAL AND INSTALLATION</b> .....	<b>101</b>
<b>BOTH SIDES</b> .....	<b>97</b>	<b>FILAMENT</b> .....	<b>101</b>
BOTH SIDES : Diagnosis Procedure .....	97	Inspection and Repair .....	101

# DIAGNOSIS AND REPAIR WORKFLOW

< BASIC INSPECTION >

## BASIC INSPECTION

### DIAGNOSIS AND REPAIR WORKFLOW

Work Flow

INFOID:000000004372698

DETAILED FLOW

#### 1.OBTAIN INFORMATION ABOUT SYMPTOM

Interview the customer to obtain the malfunction information (conditions and environment when the malfunction occurred) as much as possible when the customer brings the vehicle in.

>> GO TO 2.

#### 2.CHECK DTC

Perform self diagnosis with CONSULT-III

Is any DTC detected?

YES >> Refer to [DEF-58. "DTC Index"](#)

NO >> GO TO 3.

#### 3.REPRODUCE THE MALFUNCTION INFORMATION

Check the malfunction on the vehicle that the customer describes.

Inspect the relation of the symptoms and the condition when the symptoms occur.

>> GO TO 4.

#### 4.IDENTIFY THE MALFUNCTIONING SYSTEM WITH "SYMPTOM DIAGNOSIS"

Use "Symptom diagnosis" from the symptom inspection result in step 3. Then identify where to start performing the diagnosis based on possible causes and symptoms.

>> GO TO 5.

#### 5.IDENTIFY MALFUNCTIONING PARTS WITH "COMPONENT DIAGNOSIS"

Perform the diagnosis with "Component diagnosis" of the applicable system.

>> GO TO 6.

#### 6.REPAIR OR REPLACE THE MALFUNCTIONING PARTS

Repair or replace the specified malfunctioning parts.

>> GO TO 7.

#### 7.FINAL CHECK

Check that malfunctions are not reproduced when obtaining the malfunction information from the customer, referring to the symptom inspection result in step 3.

Are all malfunctions corrected?

YES >> INSPECTION END

NO >> GO TO 4.

A  
B  
C  
D  
E  
F  
G  
H  
I  
J  
K  
DEF  
M  
N  
O  
P

# REAR WINDOW DEFOGGER SYSTEM

< SYSTEM DESCRIPTION >

## SYSTEM DESCRIPTION

### REAR WINDOW DEFOGGER SYSTEM

#### System Diagram

INFOID:000000004372699

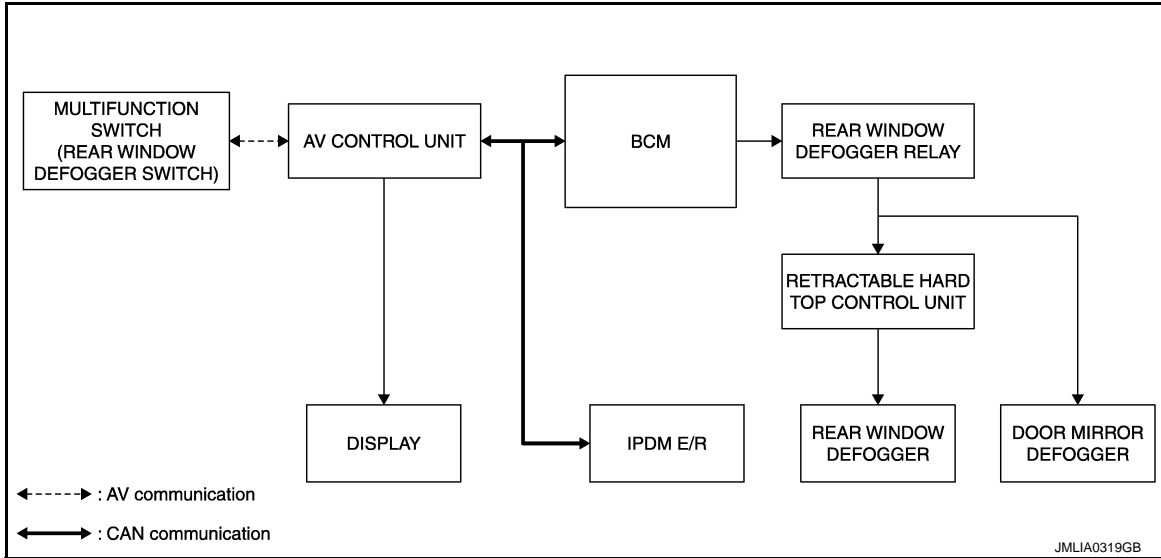

#### System Description

INFOID:000000004372700

#### Operation Description

- Turn rear window defogger switch ON when the ignition switch is turned ON. Then multifunction switch (rear window defogger switch) transmits rear window defogger switch signal to AV control unit via AV communication. AV control unit transmits rear window defogger switch signal to BCM via CAN communication.
- BCM turns rear window defogger relay ON and transmit rear window defogger ON signal to IPDM E/R via CAN communication when rear window defogger switch signal is received.
- Door mirror defogger (with mirror defogger) are supplied with power and operate when rear window defogger relay turns ON.
- Rear window defogger relay sends power supply to retractable hard top control unit.
- Retractable hard top control unit detects roof state and controls rear window defogger operate.
- AV control unit transmit rear window defogger control signal to multifunction switch (rear window defogger switch) via AV communication.
- IPDM E/R transmits rear window defogger control signal to AV control unit via CAN communication.

#### Timer function

- BCM turns rear window defogger relay ON for approximately 15 minutes when rear window defogger switch is turned ON. It makes rear window defogger and door mirror defogger (with mirror defogger) operate.
- Timer is canceled after pressing rear window defogger switch again during timer operation. Then BCM turns rear window defogger relay OFF. The same reaction also occurs during timer operation, if the ignition switch is turned OFF.

# REAR WINDOW DEFOGGER SYSTEM

< SYSTEM DESCRIPTION >

## Component Parts Location

INFOID:000000004372701

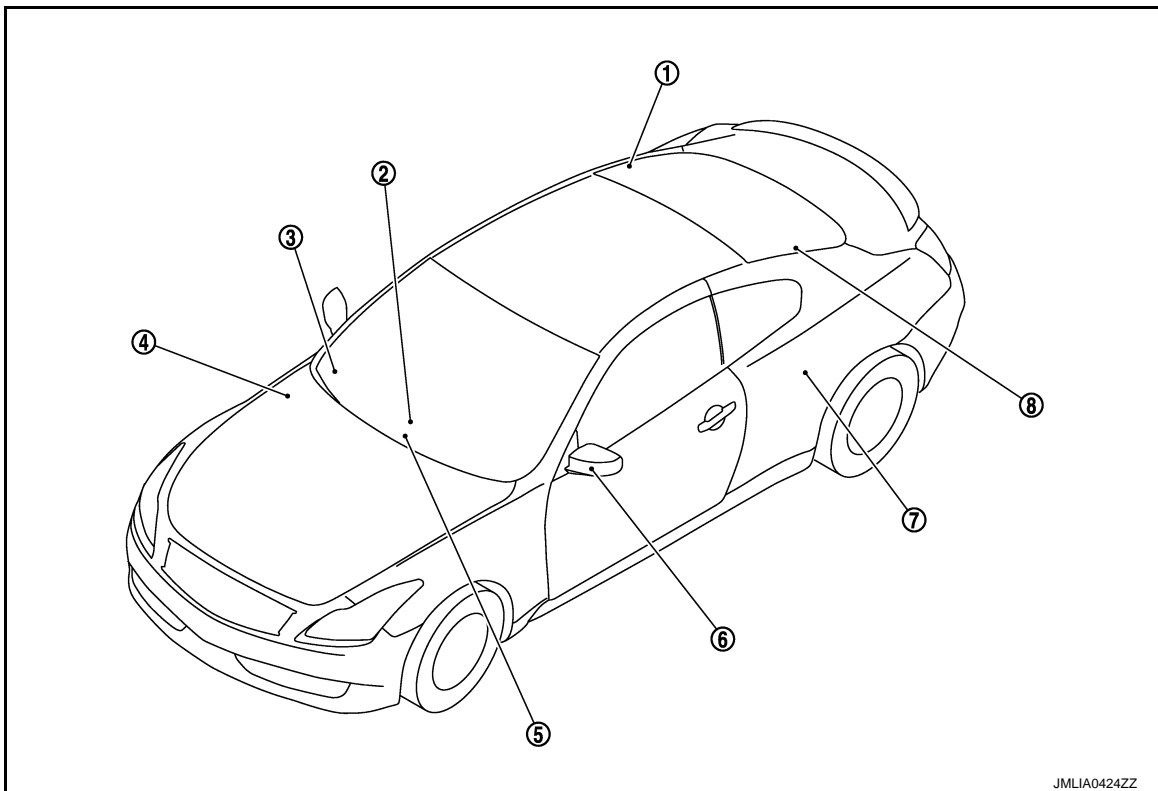

- |  |  |   |
|--|--|---|
| 1. Rear window defogger connector B658   | 2. Rear window defogger switch (built-in multifunction switch M72) | 3. BCM M118, M119, M122, M123<br>Refer to <a href="#">BCS-5, "Component Parts Location"</a> |
| 4. IPDM E/R E6<br>Refer to <a href="#">PCS-4, "Component Parts Location"</a>                           | 5. AV control unit<br>With NAVI M87, M88<br>Without NAVI M83, M85  | 6. Door mirror (driver side) (door mirror defogger) D3                                      |
| 7. Retractable hard top control unit B84<br>Refer to <a href="#">RF-24, "Component Parts Location"</a> | 8. Rear window defogger connector B659                             |   |

## Component Description

INFOID:000000004372702

BCM	<ul style="list-style-type: none"> <li>Operates the rear window defogger with the operation of rear window defogger switch</li> <li>Performs the timer control of rear window defogger</li> </ul>
Rear window defogger relay	Operates the rear window defogger and the door mirror defogger with the control signal from BCM
IPDM E/R	Transmit rear window defogger ON signal to AV control unit via CAN communication
Multifunction switch (Rear window defogger switch)	<ul style="list-style-type: none"> <li>The rear window defogger switch is installed</li> <li>Turns the indicator lamp ON when detecting the operation of rear window defogger</li> </ul>
AV control unit	Displays the rear window defogger ON to the display when detecting the operation of rear window defogger
Rear window defogger	Heats the heating wire with the power supply from the rear window defogger relay to prevent the rear window from fogging up
Door mirror defogger	Heats the heating wire with the power supply from the rear window defogger relay to prevent the door mirror from fogging up

# DIAGNOSIS SYSTEM (BCM)

< SYSTEM DESCRIPTION >

## DIAGNOSIS SYSTEM (BCM)

### COMMON ITEM

### COMMON ITEM : CONSULT-III Function (BCM - COMMON ITEM)

INFOID:000000004372703

### APPLICATION ITEM

CONSULT-III performs the following functions via CAN communication with BCM.

Diagnosis mode	Function Description
Work Support	Changes the setting for each system function.
Self Diagnostic Result	Displays the diagnosis results judged by BCM.
CAN Diag Support Monitor	Monitors the reception status of CAN communication viewed from BCM. Refer to CONSULT-III operation manual.
Data Monitor	The BCM input/output signals are displayed.
Active Test	The signals used to activate each device are forcibly supplied from BCM.
Ecu Identification	The BCM part number is displayed.
Configuration	This function is not used even though it is displayed.

### SYSTEM APPLICATION

BCM can perform the following functions for each system.

#### NOTE:

It can perform the diagnosis modes except the following for all sub system selection items.

×: Applicable item

System	Sub system selection item	Diagnosis mode		
		Work Support	Data Monitor	Active Test
Door lock	DOOR LOCK	×	×	×
Rear window defogger	REAR DEFOGGER		×	×
Warning chime	BUZZER		×	×
Interior room lamp timer	INT LAMP	×	×	×
Exterior lamp	HEAD LAMP	×	×	×
Wiper and washer	WIPER	×	×	×
Turn signal and hazard warning lamps	FLASHER	×	×	×
—	AIR CONDITONER*		×	
Intelligent Key system	INTELLIGENT KEY	×	×	×
Combination switch	COMB SW		×	
Body control system	BCM	×		
IVIS - NATS	IMMU		×	×
Interior room lamp battery saver	BATTERY SAVER	×	×	×
Trunk open	TRUNK		×	
Vehicle security system	THEFT ALM	×	×	×
RAP system	RETAINED PWR		×	
Signal buffer system	SIGNAL BUFFER		×	×
TPMS	TPMS (AIR PRESSURE MONITOR)	×	×	×

\*: This item is displayed, but is not used.

### FREEZE FRAME DATA (FFD) AND IGN COUNTER

#### Freeze Frame Data

The BCM records the following condition at the moment a particular DTC is detected.

- Vehicle Speed
- Odo/Trip Meter

# DIAGNOSIS SYSTEM (BCM)

## < SYSTEM DESCRIPTION >

- Vehicle Condition (BCM detected condition)

CONSULT screen terms	Description
SLEEP>LOCK	While turning BCM status from low power consumption mode to normal mode (Power supply position is "LOCK")
SLEEP>OFF	While turning BCM status from low power consumption mode to normal mode (Power supply position is "OFF".)
LOCK>ACC	While turning power supply position from "LOCK" to "ACC"
ACC>ON	While turning power supply position from "ACC" to "IGN"
RUN>ACC	While turning power supply position from "RUN" to "ACC" (Vehicle is stopping and selector lever is except P position.)
CRANK>RUN	While turning power supply position from "CRANKING" to "RUN" (From cranking up the engine to run it)
RUN>URGENT	While turning power supply position from "RUN" to "ACC" (Emergency stop operation)
ACC>OFF	While turning power supply position from "ACC" to "OFF"
OFF>LOCK	While turning power supply position from "OFF" to "LOCK"
OFF>ACC	While turning power supply position from "OFF" to "ACC"
ON>CRANK	While turning power supply position from "IGN" to "CRANKING"
OFF>SLEEP	While turning BCM status from normal mode (Power supply position is "OFF".) to low power consumption mode
LOCK>SLEEP	While turning BCM status from normal mode (Power supply position is "LOCK".) to low power consumption mode
LOCK	Power supply position is "LOCK" (Ignition switch OFF with steering is locked.)
OFF	Power supply position is "OFF" (Ignition switch OFF with steering is unlocked.)
ACC	Power supply position is "ACC" (Ignition switch ACC)
ON	Power supply position is "IGN" (Ignition switch ON with engine stopped)
ENGINE RUN	Power supply position is "RUN" (Ignition switch ON with engine running)
CRANKING	Power supply position is "CRANKING" (At engine cranking)

### IGN Counter

IGN counter indicates the number of times that ignition switch is turned ON after DTC is detected.

- The number is 0 when a malfunction is detected now.
- The number increases like 1 → 2 → 3...38 → 39 after returning to the normal condition whenever ignition switch OFF → ON.
- The number is fixed to 39 until the self-diagnosis results are erased if it is over 39.

### REAR WINDOW DEFOGGER

#### REAR WINDOW DEFOGGER : CONSULT-III Function (BCM - REAR DEFOGGER)

INFOID:000000004372704

### Data monitor

Monitor Item	Description
REAR DEF SW	This is displayed even when it is not equipped.
PUSH SW	Indicates [ON/OFF] condition of push switch.

### ACTIVE TEST

Test Item	Description
REAR DEFOGGER	This test is able to check rear window defogger operation. Rear window defogger operates when "ON" on CONSULT-III screen is touched.

# POWER SUPPLY AND GROUND CIRCUIT

< DTC/CIRCUIT DIAGNOSIS >

## DTC/CIRCUIT DIAGNOSIS

### POWER SUPPLY AND GROUND CIRCUIT

#### BCM (BODY CONTROL MODULE)

#### BCM (BODY CONTROL MODULE) : Diagnosis Procedure

INFOID:000000004372705

#### 1. CHECK FUSE AND FUSIBLE LINK

Check that the following fuse and fusible link are not blown.

Terminal No.	Signal name	Fuse and fusible link No.
1	Battery power supply	I(40A)
11		10(10A)

Is the inspection result normal?

YES >> Replace the blown fuse or fusible link after repairing the affected circuit if a fuse or fusible link is blown.

NO >> GO TO 2.

#### 2. CHECK POWER SUPPLY CIRCUIT

1. Turn ignition switch OFF.
2. Disconnect BCM connectors.
3. Check voltage between BCM harness connector and ground.

(+)		(-)	Voltage (Approx.)
BCM			
Connector	Terminal	Ground	Battery voltage
M118	1		
M119	11		

Is the inspection result normal?

YES >> GO TO 3.

NO >> Repair harness or connector.

#### 3. CHECK GROUND CIRCUIT

Check continuity between BCM harness connector and ground.

BCM		Ground	Continuity
Connector	Terminal		
M119	13		Existed

Is the inspection result normal?

YES >> INSPECTION END

NO >> Repair harness or connector.



# REAR WINDOW DEFOGGER SWITCH

< DTC/CIRCUIT DIAGNOSIS >

## REAR WINDOW DEFOGGER SWITCH

### Description

INFOID:000000004372706

- The rear window defogger is operated by turning the rear window defogger switch ON.
- The indicator lamp in the rear window defogger illuminates when the rear window defogger is operating.

### Component Function Check

INFOID:000000004372707

#### 1.CHECK REAR WINDOW DEFOGGER SWITCH FUNCTION

Check that the indicator lamp of rear window defogger illuminates when rear window defogger switch ON.

Is the inspection result normal?

- YES >> Rear window defogger switch function is OK.  
NO >> Refer to [DEF-9, "Diagnosis Procedure"](#)

### Diagnosis Procedure

INFOID:000000004372708

#### 1.CHECK MULTIFUNCTION SWITCH (REAR WINDOW DEFOGGER SWITCH)

Does multifunction switch operate normally?

Base audio without navigation. Refer to [AV-25, "Diagnosis Description"](#)

Bose audio without navigation. Refer to [AV-190, "Diagnosis Description"](#)

Bose audio with navigation. Refer to [AV-502, "Diagnosis Description"](#)

Is the inspection result normal?

- YES >> INSPECTION END.  
NO >> Replace multifunction switch (rear window defogger switch). Refer to [AV-161, "Removal and Installation"](#)

A  
B  
C  
D  
E  
F  
G  
H  
I  
J  
K  
DEF  
M  
N  
O  
P



# REAR WINDOW DEFOGGER RELAY

< DTC/CIRCUIT DIAGNOSIS >

## REAR WINDOW DEFOGGER RELAY

### Description

INFOID:000000004372709

Power is supplied to the rear window defogger with BCM control.

### Component Function Check

INFOID:000000004372710

#### 1. CHECK REAR WINDOW DEFOGGER RELAY POWER SUPPLY CIRCUIT

1. Perform Active Test ("REAR DEFOGGER") with CONSULT-III.
2. Touch "ON".
3. Check that the rear window heating wire is getting warmer.

Is the inspection result normal?

- YES >> Rear window defogger relay power supply circuit is OK.  
NO >> Refer to [DEF-10. "Diagnosis Procedure"](#)

### Diagnosis Procedure

INFOID:000000004372711

#### 1. CHECK FUSE

1. Turn ignition switch off.
2. Check the following.
  - 10A fuse (No.3, located in fuse block (J/B))

Is the inspection result normal?

- YES >> GO TO 2.  
NO >> Replace the blown fuse after repairing the affected circuit if a fuse is blown.

#### 2. CHECK REAR WINDOW DEFOGGER CIRCUIT 1

1. Turn ignition switch ON.
2. Check voltage between BCM harness connector and ground.

BCM		Ground	Condition		Voltage (V) (Approx.)
Connector	Terminal				
M123	151	Ground	Rear window defogger switch	ON	0
				OFF	Battery voltage

Is the inspection result normal?

- YES >> GO TO 6.  
NO >> GO TO 3.

#### 3. CHECK REAR WINDOW DEFOGGER CIRCUIT 2

1. Turn ignition switch OFF.
2. Disconnect BCM connector and rear window defogger relay.
3. Check continuity between BCM harness connector and fuse block (J/B) harness connector.

BCM		Fuse block (J/B)		Continuity
Connector	Terminal	Connector	Terminal	
M123	151	M2	4B	Existed

4. Check continuity between BCM harness connector and ground.

BCM		Ground	Continuity
Connector	Terminal		
M123	151		Existed

Is the inspection result normal?

- YES >> GO TO 4.  
NO >> Repair or replace harness.

# REAR WINDOW DEFOGGER RELAY

< DTC/CIRCUIT DIAGNOSIS >

## 4.CHECK REAR WINDOW DEFOGGER RELAY

Check rear window defogger relay.

Refer to [DEF-11, "Component Inspection"](#)

Is the inspection result normal?

YES >> GO TO 5.

NO >> Replace rear window defogger relay.

## 5.CHECK FUSE BLOCK (J/B)

1. Install the rear window defogger relay.
2. Turn ignition switch ON.
3. Check voltage between fuse block (J/B) (fuse block side) and ground.

Fuse block (J/B)		Ground	Voltage (V) (Approx.)
Connector	Terminal		
M2	4B	Ground	Battery voltage

Is the inspection result normal?

YES >> GO TO 6.

NO >> Repair or replace fuse block (J/B).

## 6.CHECK INTERMITTENT INCIDENT

Check intermittent incident.

Refer to [GI-36, "Intermittent Incident"](#)

>> INSPECTION END.

## Component Inspection

INFOID:000000004372712

## 1.CHECK REAR WINDOW DEFOGGER RELAY

1. Turn ignition switch OFF.
2. Disconnect rear window defogger relay.
3. Check rear window defogger relay.

Terminal		Condition	Continuity
Rear window defogger relay			
3	5	12 V direct current supply between terminals 1 and 2.	Existed
		No current supply	Not existed

Is the inspection result normal?

YES >> INSPECTION END.

NO >> Replace rear window defogger relay.

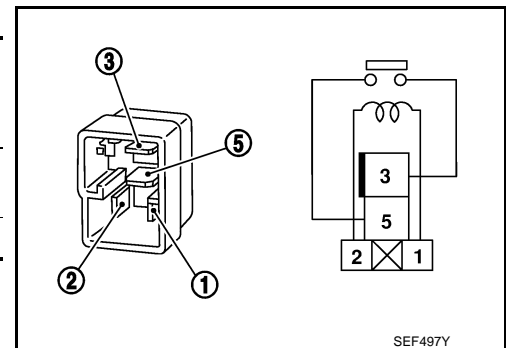

SEF497Y

# RETRACTABLE HARD TOP CONTROL UNIT

< DTC/CIRCUIT DIAGNOSIS >

## RETRACTABLE HARD TOP CONTROL UNIT

### Description

INFOID:000000005175747

Retractable hard top control unit detects roof state and controls rear defogger.

### Component Function Check

INFOID:000000005175748

#### 1.CHECK REAR WINDOW DEFOGGER

1. Perform Active Test ("REAR DEFOGGER") with CONSULT-III.
2. Touch "ON".
3. Check that the rear window heating wire is getting warmer.

Is the inspection result normal?

- YES >> Retractable hard top control unit is OK.  
NO >> Refer to [DEF-12, "Diagnosis Procedure"](#)

### Diagnosis Procedure

INFOID:000000005175749

#### 1.CHECK FUSE

1. Turn ignition switch OFF.
2. Check the following.
  - 20A fuse [No.14, located in fuse block (J/B)]
  - 20A fuse [No.15, located in fuse block (J/B)]

Is the inspection result normal?

- YES >> GO TO 2.  
NO >> Replace the blown fuse after repairing the affected circuit if a fuse is blown.

#### 2.CHECK RETRACTABLE HARD TOP CONTROL UNIT CIRCUIT

1. Disconnect retractable hard top control unit connector and fuse block (J/B) connector.
2. Check continuity between retractable hard top control unit and fuse block (J/B) harness connector.

Fuse block (J/B)		Retractable hard top control unit		Continuity
Connector	Terminal	Connector	Terminal	
B6	10G	B84	70	Existed
	11G		69	

3. Check continuity between retractable hard top control unit and ground.

Fuse block (J/B)		Ground	Continuity
Connector	Terminal		
B6	10G		Existed
	11G		

Is the inspection result normal?

- YES >> GO TO 3.  
NO >> Repair or replace harness and ground.

#### 3.CHECK FUSE BLOCK (J/B)

1. Turn ignition switch ON.
2. Check voltage between fuse block (J/B) (fuse block side) and ground.

# RETRACTABLE HARD TOP CONTROL UNIT

## < DTC/CIRCUIT DIAGNOSIS >

(+)		(-)	Condition	Voltage (V) (Approx.)	
Fuse block (J/B)					
Connector	Terminal				
B6	10G	Ground	Rear window defogger switch	ON	Battery voltage
				OFF	0
	11G		Rear window defogger switch	ON	Battery voltage
				OFF	0

Is the inspection result normal?

YES >> GO TO 4.

NO >> Repair or replace fuse block (J/B).

### 4. CHECK INTERMITTENT INCIDENT

Check intermittent incident.

Refer to [GI-36. "Intermittent Incident"](#)

>> INSPECTION END.

A  
B  
C  
D  
E  
F  
G  
H  
I  
J  
K  
DEF  
M  
N  
O  
P

DEF

# REAR WINDOW DEFOGGER

< DTC/CIRCUIT DIAGNOSIS >

## REAR WINDOW DEFOGGER

### Description

INFOID:000000004372713

Heats the heating wire with the power supply from the retractable hard top control unit to prevent the rear window from fogging up.

### Component Function Check

INFOID:000000004372714

### 1.CHECK REAR WINDOW DEFOGGER

1. Perform Active Test ("REAR DEFOGGER") with CONSULT-III.
2. Touch "ON".
3. Check that the rear window heating wire is getting warmer.

Is the inspection result normal?

- YES >> Rear window defogger is OK.  
NO >> Refer to [DEF-14, "Diagnosis Procedure"](#)

### Diagnosis Procedure

INFOID:000000004372715

### 1.CHECK POWER SUPPLY CIRCUIT

1. Turn ignition switch ON.
2. Check voltage between rear window defogger connector and ground.

(+)		(-)	Condition	Voltage (V) (Approx.)
Connector	Terminal			
B658	1	Ground	Rear window defogger switch	ON Battery voltage
			OFF 0	

Is the inspection result normal

- YES >> GO TO 2.  
NO >> GO TO 3.

### 2.CHECK GROUND CIRCUIT

1. Turn ignition switch OFF.
2. Disconnect rear window defogger connector.
3. Check continuity between rear window defogger harness connector and ground.

Rear window defogger		Ground	Continuity
Connector	Terminal		
B659	2		Existed

Is the inspection result normal?

- YES >> GO TO 4.  
NO >> Repair or replace harness and ground.

### 3.CHECK REAR WINDOW DEFOGGER CIRCUIT 1

1. Turn ignition switch OFF.
2. Disconnect retractable hard top control unit connector and rear window defogger connector.
3. Check continuity between retractable hard top control unit and rear window defogger harness connector.

Retractable hard top control unit		Rear window defogger		Continuity
Connector	Terminal	Connector	Terminal	
B84	71	B658	1	Existed
	72	B659		

# REAR WINDOW DEFOGGER

## < DTC/CIRCUIT DIAGNOSIS >

4. Check continuity between retractable hard top control unit and ground.

Retractable hard top control unit		Ground	Continuity
Connector	Terminal		
B84	71		Existed
	72		

Is the inspection result normal?

YES >> Replace retractable hard top control unit. Refer to [RF-332, "Exploded View"](#).

NO >> Repair or replace harness and ground.

### 4.CHECK FILAMENT

Check filament.

Refer to [DEF-15, "Component Inspection"](#)

Is the inspection result normal?

YES >> GO TO 5.

NO >> Repair filament.

### 5.CHECK INTERMITTENT INCIDENT

Check intermittent incident.

Refer to [GI-36, "Intermittent Incident"](#)

>> INSPECTION END.

## Component Inspection

INFOID:000000004372716

### 1.CHECK FILAMENT

Check the filament for damage or blown.

Refer to [DEF-101, "Inspection and Repair"](#)

Is the inspection result normal?

YES >> INSPECTION END.

NO >> Repair filament.

A  
B  
C  
D  
E  
F  
G  
H  
I  
J  
K

DEF

M  
N  
O  
P

# DOOR MIRROR DEFOGGER

< DTC/CIRCUIT DIAGNOSIS >

## DOOR MIRROR DEFOGGER

### Description

INFOID:000000004372717

Power is supplied to the door mirror defogger with BCM control.

### Component Function Check

INFOID:000000004372718

#### 1.CHECK DOOR MIRROR DEFOGGER

1. Perform Active Test ("REAR DEFOGGER") with CONSULT-III.
2. Touch "ON".
3. Check that both side door mirror glass is getting warmer.

Is the inspection result normal?

- YES >> Door mirror defogger is OK.  
NO >> Refer to [DEF-16. "Diagnosis Procedure"](#)

### Diagnosis Procedure

INFOID:000000004372719

#### 1.CHECK FUSE

1. Turn ignition switch OFF.
2. Check the following.
  - 10A fuse (No.13, located in fuse block (J/B))

Is the inspection result normal?

- YES >> GO TO 2.  
NO >> Replace the blown fuse after repairing the affected circuit if a fuse is blown.

#### 2.CHECK FUSE BLOCK (J/B)

1. Turn ignition switch ON.
2. Check voltage between fuse block (J/B) (fuse block side) and ground.

(+)		(-)	Condition	Voltage (V) (Approx.)	
Fuse block (J/B)					
Connector	Terminal				
M3	9C	Ground	Rear window de-fogger switch	ON	Battery voltage
			OFF	0	
	10C		ON	Battery voltage	
			OFF	0	

Is the inspection result normal?

- YES >> INSPECTION END.  
NO >> Replace fuse block (J/B).



# DRIVER SIDE DOOR MIRROR DEFOGGER

< DTC/CIRCUIT DIAGNOSIS >

## DRIVER SIDE DOOR MIRROR DEFOGGER

### Description

INFOID:000000004372720

Heats the heating wire with the power supply from the rear window defogger relay to prevent the door mirror from fogging up.

### Component Function Check

INFOID:000000004372721

#### 1.CHECK DRIVER SIDE DOOR MIRROR DEFOGGER

1. Perform Active Test ("REAR DEFOGGER") with CONSULT-III.
2. Touch "ON".
3. Check that the driver side door mirror glass is getting warmer.

Is the inspection result normal?

- YES >> Driver side door mirror defogger is OK.  
NO >> Refer to [DEF-17, "Diagnosis Procedure"](#)

### Diagnosis Procedure

INFOID:000000004372722

#### 1.CHECK POWER SUPPLY CIRCUIT

1. Turn ignition switch OFF.
2. Disconnect door mirror (driver side) connector.
3. Turn ignition switch ON.
4. Check voltage between door mirror (driver side) harness connector and ground.

(+)		(-)	Condition	Voltage (V) (Approx.)
Connector	Terminal			
D3	4	Ground	Rear window de-fogger switch	ON Battery voltage
			OFF 0	

Is the inspection result normal?

- YES >> GO TO 4.  
NO >> GO TO 2.

#### 2.CHECK FUSE BLOCK (J/B) OUTPUT SIGNAL

1. Turn ignition switch OFF.
2. Disconnect fuse block (J/B) connector.
3. Turn ignition switch ON.
4. Check voltage between fuse block (J/B) harness connector and ground.

(+)		(-)	Condition	Voltage (V) (Approx.)
Connector	Terminal			
M3	10C	Ground	Rear window de-fogger switch	ON Battery voltage
			OFF 0	

Is the inspection result normal?

- YES >> GO TO 3.  
NO >> Replace fuse block (J/B).

#### 3.CHECK DRIVER SIDE DOOR MIRROR DEFOGGER CIRCUIT

1. Turn ignition switch OFF.
2. Check continuity between fuse block (J/B) harness connector and door mirror (driver side) harness connector.

# DRIVER SIDE DOOR MIRROR DEFOGGER

## < DTC/CIRCUIT DIAGNOSIS >

Fuse block (J/B)		Door mirror (driver side)		Continuity
Connector	Terminal	Connector	Terminal	
M3	10C	D3	4	Existed

3. Check continuity between fuse block (J/B) harness connector and ground.

Fuse block (J/B)		Ground	Continuity
Connector	Terminal		
M3	10C	Ground	Not existed

Is the inspection result normal?

- YES >> GO TO 6.  
NO >> Repair or replace harness.

### 4.CHECK GROUND CIRCUIT

1. Turn ignition switch OFF.
2. Check continuity between door mirror (driver side) harness connector and ground.

Door mirror (driver side)		Ground	Continuity
Connector	Terminal		
D3	8	Ground	Existed

Is the inspection result normal?

- YES >> GO TO 5.  
NO >> Repair or replace harness.

### 5.CHECK DRIVER SIDE DOOR MIRROR DEFOGGER

Check driver side door mirror defogger.  
Refer to [DEF-18, "Component Inspection"](#)

Is the inspection result normal?

- YES >> GO TO 6.  
NO >> Replace door mirror (driver side). Refer to [MIR-20, "DOOR MIRROR ASSEMBLY : Removal and Installation"](#)

### 6.CHECK INTERMITTENT INCIDENT

Check intermittent incident.  
Refer to [GI-36, "Intermittent Incident"](#)

Is the inspection result normal?

>> INSPECTION END.

## Component Inspection

INFOID:000000004372723

### 1.CHECK DRIVER SIDE DOOR MIRROR DEFOGGER

1. Turn ignition switch OFF.
2. Disconnect door mirror (driver side) connector.
3. Check continuity between door mirror terminals.

Door mirror (driver side)			Continuity
Connector	Terminal		
D3	4	8	Existed

Is the inspection result normal?

- YES >> INSPECTION END.  
NO >> Replace door mirror (driver side). Refer to [MIR-20, "DOOR MIRROR ASSEMBLY : Removal and Installation"](#)

# PASSENGER SIDE DOOR MIRROR DEFOGGER

< DTC/CIRCUIT DIAGNOSIS >

## PASSENGER SIDE DOOR MIRROR DEFOGGER

### Description

INFOID:000000004372724

Heats the heating wire with the power supply from the rear window defogger relay to prevent the door mirror from fogging up.

### Component Function Check

INFOID:000000004372725

#### 1.CHECK PASSENGER SIDE DOOR MIRROR DEFOGGER

1. Perform Active Test ("REAR DEFOGGER") with CONSULT-III.
2. Touch "ON".
3. Check that the passenger side door mirror glass is getting warmer.

Is the inspection result normal?

- YES >> Passenger side door mirror defogger is OK.  
 NO >> Refer to [DEF-19, "Diagnosis Procedure"](#)

### Diagnosis Procedure

INFOID:000000004372726

#### 1.CHECK POWER SUPPLY CIRCUIT

1. Turn ignition switch OFF.
2. Disconnect door mirror (passenger side) connector.
3. Turn ignition switch ON.
4. Check voltage between door mirror (passenger side) harness connector and ground.

(+)		(-)	Condition	Voltage (V) (Approx.)
Door mirror (Passenger side) Connector	Terminal			
D33	4	Ground	Rear window de-fogger switch	ON Battery voltage
			OFF	0

Is the inspection result normal?

- YES >> GO TO 4.  
 NO >> GO TO 2.

#### 2.CHECK FUSE BLOCK (J/B) OUTPUT SIGNAL

1. Turn ignition switch OFF.
2. Disconnect fuse block (J/B) connector.
3. Turn ignition switch ON.
4. Check voltage between fuse block (J/B) harness connector and ground.

(+)		(-)	Condition	Voltage (V) (Approx.)
Fuse block (J/B) Connector	Terminal			
M3	9C	Ground	Rear window de-fogger switch	ON Battery voltage
			OFF	0

Is the inspection result normal?

- YES >> GO TO 3.  
 NO >> Replace fuse block (J/B).

#### 3.CHECK PASSENGER SIDE DOOR MIRROR DEFOGGER

1. Turn ignition switch OFF.
2. Check continuity between fuse block (J/B) harness connector and door mirror (passenger side) harness connector.

# PASSENGER SIDE DOOR MIRROR DEFOGGER

## < DTC/CIRCUIT DIAGNOSIS >

Fuse block (J/B)		Door mirror (passenger side)		Continuity
Connector	Terminal	Connector	Terminal	
M3	9C	D33	4	Existed

3. Check continuity between fuse block (J/B) harness connector and ground.

Fuse block (J/B)		Ground	Continuity
Connector	Terminal		
M3	9C	Ground	Not existed

Is the inspection result normal?

YES >> GO TO 6.

NO >> Repair or replace harness.

### 4.CHECK GROUND CIRCUIT

1. Turn ignition switch OFF.
2. Check continuity between door mirror (passenger side) harness connector and ground.

Door mirror (passenger side)		Ground	Continuity
Connector	Terminal		
D33	8	Ground	Existed

Is the inspection result normal?

YES >> GO TO 5.

NO >> Repair or replace harness.

### 5.CHECK PASSENGER SIDE DOOR MIRROR DEFOGGER

Check passenger side door mirror defogger.

Refer to [DEF-20, "Component Inspection"](#)

Is the inspection result normal?

YES >> GO TO 6.

NO >> Replace door mirror (passenger side). Refer to [MIR-20, "DOOR MIRROR ASSEMBLY : Removal and Installation"](#)

### 6.CHECK INTERMITTENT INCIDENT

Check intermittent incident.

Refer to [GI-36, "Intermittent Incident"](#)

>> INSPECTION END.

## Component Inspection

INFOID:000000004372727

### 1.CHECK PASSENGER DOOR MIRROR DEFOGGER

1. Turn ignition switch OFF.
2. Disconnect door mirror (passenger side) connector.
3. Check continuity between door mirror terminals.

Door mirror (passenger side)			Continuity
Connector	Terminal		
D33	4	8	Existed

Is the inspection result normal?

YES >> INSPECTION END.

NO >> Replace door mirror (passenger side). Refer to [MIR-20, "DOOR MIRROR ASSEMBLY : Removal and Installation"](#).

# REAR WINDOW DEFOGGER SYSTEM

< DTC/CIRCUIT DIAGNOSIS >

## REAR WINDOW DEFOGGER SYSTEM

### Wiring Diagram - DEFOGGER -

INFOID:000000005186641

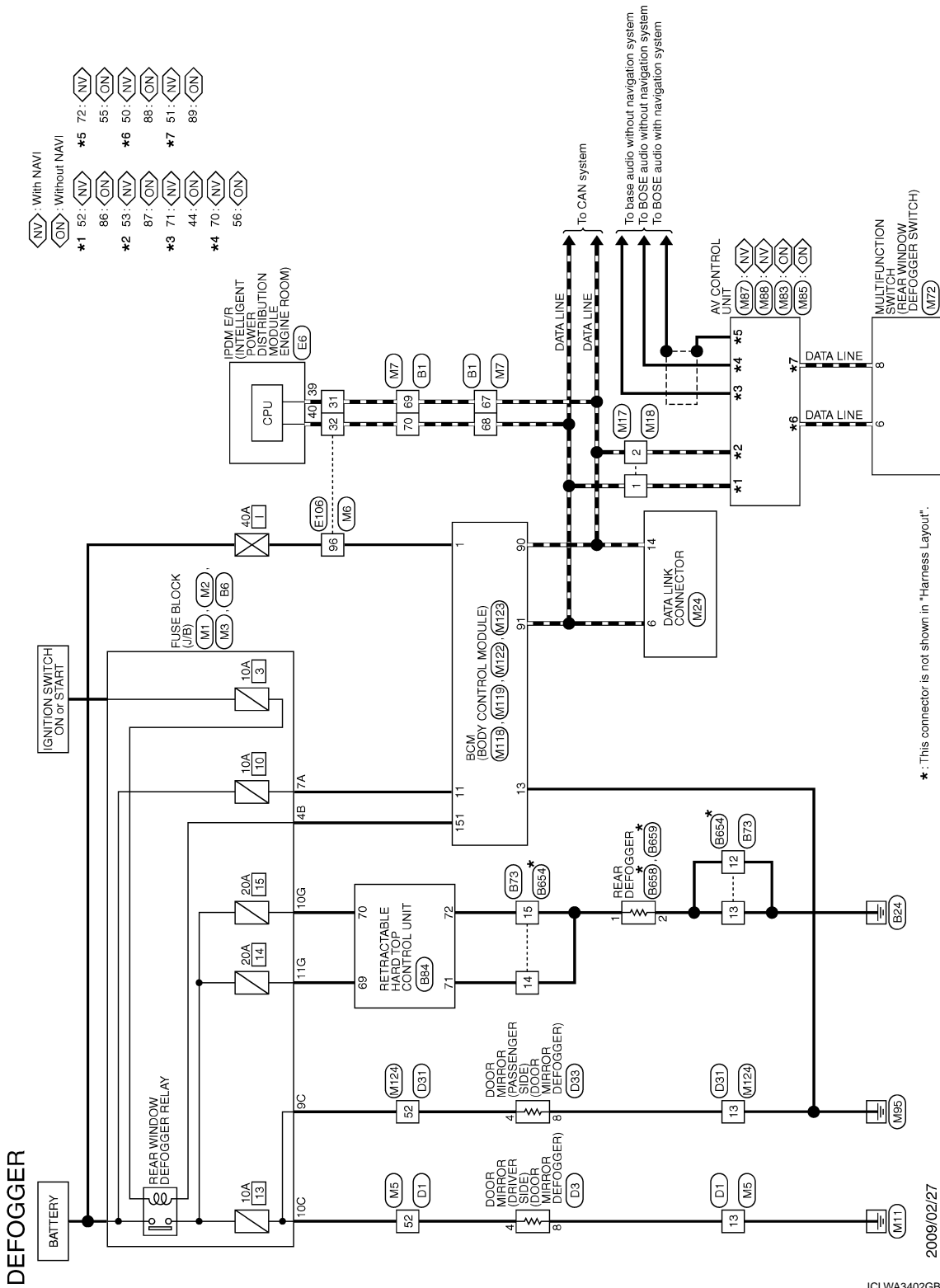

A  
B  
C  
D  
E  
F  
G  
H  
I  
J  
K  
L  
M  
N  
O  
P

DEF

# REAR WINDOW DEFOGGER SYSTEM

## < DTC/CIRCUIT DIAGNOSIS >

### DEFOGGER

Connector No.	B1
Connector Name	WIRE TO WIRE
Connector Type	THBDFW-CS16-TM4

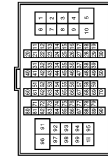

Terminal No.	Color of Wire	Signal Name [Specification]
67	P	-
68	L	-
69	P	-
70	L	-

Connector No.	B6
Connector Name	FUSE BLOCK (J/B)
Connector Type	NS12FBR-CS



Terminal No.	Color of Wire	Signal Name [Specification]
10G	P	-
11G	G	-

Connector No.	B73
Connector Name	WIRE TO WIRE
Connector Type	NS16FY-CS

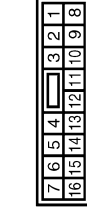

Terminal No.	Color of Wire	Signal Name [Specification]
12	B	-
13	B	-
14	BR	-
15	W	-

Connector No.	B84
Connector Name	RETRACTABLE HARD TOP CONTROL UNIT
Connector Type	NS18FY-CS

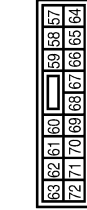

Terminal No.	Color of Wire	Signal Name [Specification]
69	G	REAR WINDOW DEF IN 2
70	P	REAR WINDOW DEF IN 1
71	BR	REAR WINDOW DEF OUT1
72	W	REAR WINDOW DEF OUT2

Connector No.	B684
Connector Name	WIRE TO WIRE
Connector Type	NS18MGY-CS

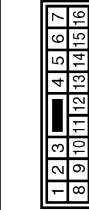

Terminal No.	Color of Wire	Signal Name [Specification]
12	-	-
13	-	-
14	-	-
15	-	-

Connector No.	B688
Connector Name	REAR DEFOGGER
Connector Type	PO1FB-A



Terminal No.	Color of Wire	Signal Name [Specification]
1	-	-

Connector No.	B689
Connector Name	REAR DEFOGGER
Connector Type	PO1FB-A



Terminal No.	Color of Wire	Signal Name [Specification]
2	-	-

Connector No.	D1
Connector Name	WIRE TO WIRE
Connector Type	TH46FY-CS15

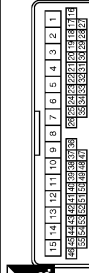

Terminal No.	Color of Wire	Signal Name [Specification]
13	B	-
52	L	-



JCLWA3403GB

# REAR WINDOW DEFOGGER SYSTEM

## < DTC/CIRCUIT DIAGNOSIS >

### DEFOGGER

Connector No.	D3
Connector Name	DOOR MIRROR (DRIVER SIDE)
Connector Type	TH12MW-NH

Terminal No.	4	L	8	B
Color of Wire				
Signal Name [Specification]				

Connector No.	D31
Connector Name	WIRE TO WIRE
Connector Type	TH40FW-CS1.5

Terminal No.	13	B	52	L
Color of Wire				
Signal Name [Specification]				

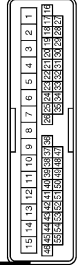
Connector No.	D33
Connector Name	DOOR MIRROR (PASSENGER SIDE)
Connector Type	TH12MW-NH

Terminal No.	4	L	8	B
Color of Wire				
Signal Name [Specification]				

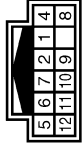
Connector No.	E6
Connector Name	SMART INTELLIGENT POWER DISTRIBUTION MODULE ENGINE ROOM
Connector Type	TH40FW-NH

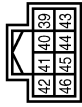

Terminal No.	39	P	40	L
Color of Wire				
Signal Name [Specification]				

Connector No.	E108
Connector Name	WIRE TO WIRE
Connector Type	TH80FW-CS16-TM4

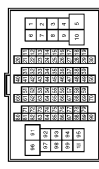

Terminal No.	31	P	32	L	96	W
Color of Wire						
Signal Name [Specification]						

Connector No.	M1
Connector Name	FUSE BLOCK (J/B)
Connector Type	NS06FW-M2



Terminal No.	7A	R
Color of Wire		
Signal Name [Specification]		

Connector No.	M2
Connector Name	FUSE BLOCK (J/B)
Connector Type	NS10FW-CS

Terminal No.	4B	G
Color of Wire		
Signal Name [Specification]		

Connector No.	M3
Connector Name	FUSE BLOCK (J/B)
Connector Type	NS12FW-CS

Terminal No.	9C	O	10C	L
Color of Wire				
Signal Name [Specification]				





JCLWA3404GB

A  
B  
C  
D  
E  
F  
G  
H  
I  
J  
K  
DEF  
M  
N  
O  
P

# REAR WINDOW DEFOGGER SYSTEM

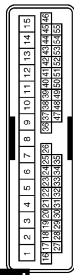
## < DTC/CIRCUIT DIAGNOSIS >

### DEFOGGER

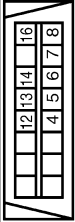
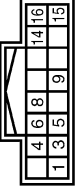
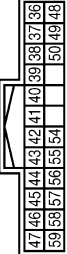
<table border="1"> <tr><td>Connector No.</td><td>M5</td></tr> <tr><td>Connector Name</td><td>WIRE TO WIRE</td></tr> <tr><td>Connector Type</td><td>TH80MW-CS15</td></tr> </table>  <table border="1"> <tr><td>Terminal No.</td><td>13</td><td>B</td></tr> <tr><td>Terminal No.</td><td>52</td><td>L</td></tr> </table> <table border="1"> <tr><td>Color of Wire</td><td></td><td></td></tr> <tr><td>Terminal No.</td><td>13</td><td>B</td></tr> <tr><td>Terminal No.</td><td>52</td><td>L</td></tr> </table> <table border="1"> <tr><td>Signal Name [Specification]</td><td></td><td></td></tr> <tr><td>Terminal No.</td><td>13</td><td>B</td></tr> <tr><td>Terminal No.</td><td>52</td><td>L</td></tr> </table>	Connector No.	M5	Connector Name	WIRE TO WIRE	Connector Type	TH80MW-CS15	Terminal No.	13	B	Terminal No.	52	L	Color of Wire			Terminal No.	13	B	Terminal No.	52	L	Signal Name [Specification]			Terminal No.	13	B	Terminal No.	52	L	<table border="1"> <tr><td>Connector No.</td><td>M6</td></tr> <tr><td>Connector Name</td><td>WIRE TO WIRE</td></tr> <tr><td>Connector Type</td><td>TH80MW-CS16-TM4</td></tr> </table>  <table border="1"> <tr><td>Terminal No.</td><td>31</td><td>P</td></tr> <tr><td>Terminal No.</td><td>32</td><td>L</td></tr> <tr><td>Terminal No.</td><td>96</td><td>W</td></tr> </table> <table border="1"> <tr><td>Color of Wire</td><td></td><td></td></tr> <tr><td>Terminal No.</td><td>31</td><td>P</td></tr> <tr><td>Terminal No.</td><td>32</td><td>L</td></tr> <tr><td>Terminal No.</td><td>96</td><td>W</td></tr> </table> <table border="1"> <tr><td>Signal Name [Specification]</td><td></td><td></td></tr> <tr><td>Terminal No.</td><td>31</td><td>P</td></tr> <tr><td>Terminal No.</td><td>32</td><td>L</td></tr> <tr><td>Terminal No.</td><td>96</td><td>W</td></tr> </table>	Connector No.	M6	Connector Name	WIRE TO WIRE	Connector Type	TH80MW-CS16-TM4	Terminal No.	31	P	Terminal No.	32	L	Terminal No.	96	W	Color of Wire			Terminal No.	31	P	Terminal No.	32	L	Terminal No.	96	W	Signal Name [Specification]			Terminal No.	31	P	Terminal No.	32	L	Terminal No.	96	W	<table border="1"> <tr><td>Connector No.</td><td>M7</td></tr> <tr><td>Connector Name</td><td>WIRE TO WIRE</td></tr> <tr><td>Connector Type</td><td>TH80MW-CS16-TM4</td></tr> </table>  <table border="1"> <tr><td>Terminal No.</td><td>67</td><td>P</td></tr> <tr><td>Terminal No.</td><td>68</td><td>L</td></tr> <tr><td>Terminal No.</td><td>69</td><td>P</td></tr> <tr><td>Terminal No.</td><td>70</td><td>L</td></tr> </table> <table border="1"> <tr><td>Color of Wire</td><td></td><td></td></tr> <tr><td>Terminal No.</td><td>67</td><td>P</td></tr> <tr><td>Terminal No.</td><td>68</td><td>L</td></tr> <tr><td>Terminal No.</td><td>69</td><td>P</td></tr> <tr><td>Terminal No.</td><td>70</td><td>L</td></tr> </table> <table border="1"> <tr><td>Signal Name [Specification]</td><td></td><td></td></tr> <tr><td>Terminal No.</td><td>67</td><td>P</td></tr> <tr><td>Terminal No.</td><td>68</td><td>L</td></tr> <tr><td>Terminal No.</td><td>69</td><td>P</td></tr> <tr><td>Terminal No.</td><td>70</td><td>L</td></tr> </table>	Connector No.	M7	Connector Name	WIRE TO WIRE	Connector Type	TH80MW-CS16-TM4	Terminal No.	67	P	Terminal No.	68	L	Terminal No.	69	P	Terminal No.	70	L	Color of Wire			Terminal No.	67	P	Terminal No.	68	L	Terminal No.	69	P	Terminal No.	70	L	Signal Name [Specification]			Terminal No.	67	P	Terminal No.	68	L	Terminal No.	69	P	Terminal No.	70	L	<table border="1"> <tr><td>Connector No.</td><td>M17</td></tr> <tr><td>Connector Name</td><td>WIRE TO WIRE</td></tr> <tr><td>Connector Type</td><td>TK02FW</td></tr> </table>  <table border="1"> <tr><td>Terminal No.</td><td>1</td><td>L</td></tr> <tr><td>Terminal No.</td><td>2</td><td>P</td></tr> </table> <table border="1"> <tr><td>Color of Wire</td><td></td><td></td></tr> <tr><td>Terminal No.</td><td>1</td><td>L</td></tr> <tr><td>Terminal No.</td><td>2</td><td>P</td></tr> </table> <table border="1"> <tr><td>Signal Name [Specification]</td><td></td><td></td></tr> <tr><td>Terminal No.</td><td>1</td><td>L</td></tr> <tr><td>Terminal No.</td><td>2</td><td>P</td></tr> </table>	Connector No.	M17	Connector Name	WIRE TO WIRE	Connector Type	TK02FW	Terminal No.	1	L	Terminal No.	2	P	Color of Wire			Terminal No.	1	L	Terminal No.	2	P	Signal Name [Specification]			Terminal No.	1	L	Terminal No.	2	P																																																																																																																																																																																				
Connector No.	M5																																																																																																																																																																																																																																																																																																																																									
Connector Name	WIRE TO WIRE																																																																																																																																																																																																																																																																																																																																									
Connector Type	TH80MW-CS15																																																																																																																																																																																																																																																																																																																																									
Terminal No.	13	B																																																																																																																																																																																																																																																																																																																																								
Terminal No.	52	L																																																																																																																																																																																																																																																																																																																																								
Color of Wire																																																																																																																																																																																																																																																																																																																																										
Terminal No.	13	B																																																																																																																																																																																																																																																																																																																																								
Terminal No.	52	L																																																																																																																																																																																																																																																																																																																																								
Signal Name [Specification]																																																																																																																																																																																																																																																																																																																																										
Terminal No.	13	B																																																																																																																																																																																																																																																																																																																																								
Terminal No.	52	L																																																																																																																																																																																																																																																																																																																																								
Connector No.	M6																																																																																																																																																																																																																																																																																																																																									
Connector Name	WIRE TO WIRE																																																																																																																																																																																																																																																																																																																																									
Connector Type	TH80MW-CS16-TM4																																																																																																																																																																																																																																																																																																																																									
Terminal No.	31	P																																																																																																																																																																																																																																																																																																																																								
Terminal No.	32	L																																																																																																																																																																																																																																																																																																																																								
Terminal No.	96	W																																																																																																																																																																																																																																																																																																																																								
Color of Wire																																																																																																																																																																																																																																																																																																																																										
Terminal No.	31	P																																																																																																																																																																																																																																																																																																																																								
Terminal No.	32	L																																																																																																																																																																																																																																																																																																																																								
Terminal No.	96	W																																																																																																																																																																																																																																																																																																																																								
Signal Name [Specification]																																																																																																																																																																																																																																																																																																																																										
Terminal No.	31	P																																																																																																																																																																																																																																																																																																																																								
Terminal No.	32	L																																																																																																																																																																																																																																																																																																																																								
Terminal No.	96	W																																																																																																																																																																																																																																																																																																																																								
Connector No.	M7																																																																																																																																																																																																																																																																																																																																									
Connector Name	WIRE TO WIRE																																																																																																																																																																																																																																																																																																																																									
Connector Type	TH80MW-CS16-TM4																																																																																																																																																																																																																																																																																																																																									
Terminal No.	67	P																																																																																																																																																																																																																																																																																																																																								
Terminal No.	68	L																																																																																																																																																																																																																																																																																																																																								
Terminal No.	69	P																																																																																																																																																																																																																																																																																																																																								
Terminal No.	70	L																																																																																																																																																																																																																																																																																																																																								
Color of Wire																																																																																																																																																																																																																																																																																																																																										
Terminal No.	67	P																																																																																																																																																																																																																																																																																																																																								
Terminal No.	68	L																																																																																																																																																																																																																																																																																																																																								
Terminal No.	69	P																																																																																																																																																																																																																																																																																																																																								
Terminal No.	70	L																																																																																																																																																																																																																																																																																																																																								
Signal Name [Specification]																																																																																																																																																																																																																																																																																																																																										
Terminal No.	67	P																																																																																																																																																																																																																																																																																																																																								
Terminal No.	68	L																																																																																																																																																																																																																																																																																																																																								
Terminal No.	69	P																																																																																																																																																																																																																																																																																																																																								
Terminal No.	70	L																																																																																																																																																																																																																																																																																																																																								
Connector No.	M17																																																																																																																																																																																																																																																																																																																																									
Connector Name	WIRE TO WIRE																																																																																																																																																																																																																																																																																																																																									
Connector Type	TK02FW																																																																																																																																																																																																																																																																																																																																									
Terminal No.	1	L																																																																																																																																																																																																																																																																																																																																								
Terminal No.	2	P																																																																																																																																																																																																																																																																																																																																								
Color of Wire																																																																																																																																																																																																																																																																																																																																										
Terminal No.	1	L																																																																																																																																																																																																																																																																																																																																								
Terminal No.	2	P																																																																																																																																																																																																																																																																																																																																								
Signal Name [Specification]																																																																																																																																																																																																																																																																																																																																										
Terminal No.	1	L																																																																																																																																																																																																																																																																																																																																								
Terminal No.	2	P																																																																																																																																																																																																																																																																																																																																								
<table border="1"> <tr><td>Connector No.</td><td>M18</td></tr> <tr><td>Connector Name</td><td>WIRE TO WIRE</td></tr> <tr><td>Connector Type</td><td>TK02MW</td></tr> </table>  <table border="1"> <tr><td>Terminal No.</td><td>1</td><td>L</td></tr> <tr><td>Terminal No.</td><td>2</td><td>P</td></tr> </table> <table border="1"> <tr><td>Color of Wire</td><td></td><td></td></tr> <tr><td>Terminal No.</td><td>1</td><td>L</td></tr> <tr><td>Terminal No.</td><td>2</td><td>P</td></tr> </table> <table border="1"> <tr><td>Signal Name [Specification]</td><td></td><td></td></tr> <tr><td>Terminal No.</td><td>1</td><td>L</td></tr> <tr><td>Terminal No.</td><td>2</td><td>P</td></tr> </table>	Connector No.	M18	Connector Name	WIRE TO WIRE	Connector Type	TK02MW	Terminal No.	1	L	Terminal No.	2	P	Color of Wire			Terminal No.	1	L	Terminal No.	2	P	Signal Name [Specification]			Terminal No.	1	L	Terminal No.	2	P	<table border="1"> <tr><td>Connector No.</td><td>M24</td></tr> <tr><td>Connector Name</td><td>DATA LINK CONNECTOR</td></tr> <tr><td>Connector Type</td><td>BD16PW</td></tr> </table>  <table border="1"> <tr><td>Terminal No.</td><td>6</td><td>L</td></tr> <tr><td>Terminal No.</td><td>14</td><td>P</td></tr> </table> <table border="1"> <tr><td>Color of Wire</td><td></td><td></td></tr> <tr><td>Terminal No.</td><td>6</td><td>L</td></tr> <tr><td>Terminal No.</td><td>14</td><td>P</td></tr> </table> <table border="1"> <tr><td>Signal Name [Specification]</td><td></td><td></td></tr> <tr><td>Terminal No.</td><td>6</td><td>L</td></tr> <tr><td>Terminal No.</td><td>14</td><td>P</td></tr> </table>	Connector No.	M24	Connector Name	DATA LINK CONNECTOR	Connector Type	BD16PW	Terminal No.	6	L	Terminal No.	14	P	Color of Wire			Terminal No.	6	L	Terminal No.	14	P	Signal Name [Specification]			Terminal No.	6	L	Terminal No.	14	P	<table border="1"> <tr><td>Connector No.</td><td>M27</td></tr> <tr><td>Connector Name</td><td>MULTIFUNCTION SWITCH</td></tr> <tr><td>Connector Type</td><td>TH16PW-NH</td></tr> </table>  <table border="1"> <tr><td>Terminal No.</td><td>4</td><td>G</td></tr> <tr><td>Terminal No.</td><td>6</td><td>R</td></tr> <tr><td>Terminal No.</td><td>8</td><td>R</td></tr> <tr><td>Terminal No.</td><td>13</td><td>L</td></tr> <tr><td>Terminal No.</td><td>14</td><td>L</td></tr> <tr><td>Terminal No.</td><td>15</td><td>L</td></tr> <tr><td>Terminal No.</td><td>16</td><td>L</td></tr> </table> <table border="1"> <tr><td>Color of Wire</td><td></td><td></td></tr> <tr><td>Terminal No.</td><td>4</td><td>G</td></tr> <tr><td>Terminal No.</td><td>6</td><td>R</td></tr> <tr><td>Terminal No.</td><td>8</td><td>R</td></tr> <tr><td>Terminal No.</td><td>13</td><td>L</td></tr> <tr><td>Terminal No.</td><td>14</td><td>L</td></tr> <tr><td>Terminal No.</td><td>15</td><td>L</td></tr> <tr><td>Terminal No.</td><td>16</td><td>L</td></tr> </table> <table border="1"> <tr><td>Signal Name [Specification]</td><td></td><td></td></tr> <tr><td>Terminal No.</td><td>4</td><td>G</td></tr> <tr><td>Terminal No.</td><td>6</td><td>R</td></tr> <tr><td>Terminal No.</td><td>8</td><td>R</td></tr> <tr><td>Terminal No.</td><td>13</td><td>L</td></tr> <tr><td>Terminal No.</td><td>14</td><td>L</td></tr> <tr><td>Terminal No.</td><td>15</td><td>L</td></tr> <tr><td>Terminal No.</td><td>16</td><td>L</td></tr> </table>	Connector No.	M27	Connector Name	MULTIFUNCTION SWITCH	Connector Type	TH16PW-NH	Terminal No.	4	G	Terminal No.	6	R	Terminal No.	8	R	Terminal No.	13	L	Terminal No.	14	L	Terminal No.	15	L	Terminal No.	16	L	Color of Wire			Terminal No.	4	G	Terminal No.	6	R	Terminal No.	8	R	Terminal No.	13	L	Terminal No.	14	L	Terminal No.	15	L	Terminal No.	16	L	Signal Name [Specification]			Terminal No.	4	G	Terminal No.	6	R	Terminal No.	8	R	Terminal No.	13	L	Terminal No.	14	L	Terminal No.	15	L	Terminal No.	16	L	<table border="1"> <tr><td>Connector No.</td><td>M28</td></tr> <tr><td>Connector Name</td><td>AV CONTROL UNIT (WITHOUT NAVI)</td></tr> <tr><td>Connector Type</td><td>TH24FW-NH</td></tr> </table>  <table border="1"> <tr><td>Terminal No.</td><td>47</td><td>L</td></tr> <tr><td>Terminal No.</td><td>48</td><td>L</td></tr> <tr><td>Terminal No.</td><td>49</td><td>L</td></tr> <tr><td>Terminal No.</td><td>50</td><td>L</td></tr> <tr><td>Terminal No.</td><td>51</td><td>L</td></tr> <tr><td>Terminal No.</td><td>52</td><td>L</td></tr> <tr><td>Terminal No.</td><td>53</td><td>L</td></tr> <tr><td>Terminal No.</td><td>54</td><td>L</td></tr> <tr><td>Terminal No.</td><td>55</td><td>L</td></tr> <tr><td>Terminal No.</td><td>56</td><td>L</td></tr> <tr><td>Terminal No.</td><td>57</td><td>L</td></tr> <tr><td>Terminal No.</td><td>58</td><td>L</td></tr> <tr><td>Terminal No.</td><td>59</td><td>L</td></tr> <tr><td>Terminal No.</td><td>60</td><td>L</td></tr> <tr><td>Terminal No.</td><td>61</td><td>L</td></tr> <tr><td>Terminal No.</td><td>62</td><td>L</td></tr> <tr><td>Terminal No.</td><td>63</td><td>L</td></tr> <tr><td>Terminal No.</td><td>64</td><td>L</td></tr> <tr><td>Terminal No.</td><td>65</td><td>L</td></tr> <tr><td>Terminal No.</td><td>66</td><td>L</td></tr> </table> <table border="1"> <tr><td>Color of Wire</td><td></td><td></td></tr> <tr><td>Terminal No.</td><td>47</td><td>L</td></tr> <tr><td>Terminal No.</td><td>48</td><td>L</td></tr> <tr><td>Terminal No.</td><td>49</td><td>L</td></tr> <tr><td>Terminal No.</td><td>50</td><td>L</td></tr> <tr><td>Terminal No.</td><td>51</td><td>L</td></tr> <tr><td>Terminal No.</td><td>52</td><td>L</td></tr> <tr><td>Terminal No.</td><td>53</td><td>L</td></tr> <tr><td>Terminal No.</td><td>54</td><td>L</td></tr> <tr><td>Terminal No.</td><td>55</td><td>L</td></tr> <tr><td>Terminal No.</td><td>56</td><td>L</td></tr> <tr><td>Terminal No.</td><td>57</td><td>L</td></tr> <tr><td>Terminal No.</td><td>58</td><td>L</td></tr> <tr><td>Terminal No.</td><td>59</td><td>L</td></tr> <tr><td>Terminal No.</td><td>60</td><td>L</td></tr> <tr><td>Terminal No.</td><td>61</td><td>L</td></tr> <tr><td>Terminal No.</td><td>62</td><td>L</td></tr> <tr><td>Terminal No.</td><td>63</td><td>L</td></tr> <tr><td>Terminal No.</td><td>64</td><td>L</td></tr> <tr><td>Terminal No.</td><td>65</td><td>L</td></tr> <tr><td>Terminal No.</td><td>66</td><td>L</td></tr> </table> <table border="1"> <tr><td>Signal Name [Specification]</td><td></td><td></td></tr> <tr><td>Terminal No.</td><td>47</td><td>L</td></tr> <tr><td>Terminal No.</td><td>48</td><td>L</td></tr> <tr><td>Terminal No.</td><td>49</td><td>L</td></tr> <tr><td>Terminal No.</td><td>50</td><td>L</td></tr> <tr><td>Terminal No.</td><td>51</td><td>L</td></tr> <tr><td>Terminal No.</td><td>52</td><td>L</td></tr> <tr><td>Terminal No.</td><td>53</td><td>L</td></tr> <tr><td>Terminal No.</td><td>54</td><td>L</td></tr> <tr><td>Terminal No.</td><td>55</td><td>L</td></tr> <tr><td>Terminal No.</td><td>56</td><td>L</td></tr> <tr><td>Terminal No.</td><td>57</td><td>L</td></tr> <tr><td>Terminal No.</td><td>58</td><td>L</td></tr> <tr><td>Terminal No.</td><td>59</td><td>L</td></tr> <tr><td>Terminal No.</td><td>60</td><td>L</td></tr> <tr><td>Terminal No.</td><td>61</td><td>L</td></tr> <tr><td>Terminal No.</td><td>62</td><td>L</td></tr> <tr><td>Terminal No.</td><td>63</td><td>L</td></tr> <tr><td>Terminal No.</td><td>64</td><td>L</td></tr> <tr><td>Terminal No.</td><td>65</td><td>L</td></tr> <tr><td>Terminal No.</td><td>66</td><td>L</td></tr> </table>	Connector No.	M28	Connector Name	AV CONTROL UNIT (WITHOUT NAVI)	Connector Type	TH24FW-NH	Terminal No.	47	L	Terminal No.	48	L	Terminal No.	49	L	Terminal No.	50	L	Terminal No.	51	L	Terminal No.	52	L	Terminal No.	53	L	Terminal No.	54	L	Terminal No.	55	L	Terminal No.	56	L	Terminal No.	57	L	Terminal No.	58	L	Terminal No.	59	L	Terminal No.	60	L	Terminal No.	61	L	Terminal No.	62	L	Terminal No.	63	L	Terminal No.	64	L	Terminal No.	65	L	Terminal No.	66	L	Color of Wire			Terminal No.	47	L	Terminal No.	48	L	Terminal No.	49	L	Terminal No.	50	L	Terminal No.	51	L	Terminal No.	52	L	Terminal No.	53	L	Terminal No.	54	L	Terminal No.	55	L	Terminal No.	56	L	Terminal No.	57	L	Terminal No.	58	L	Terminal No.	59	L	Terminal No.	60	L	Terminal No.	61	L	Terminal No.	62	L	Terminal No.	63	L	Terminal No.	64	L	Terminal No.	65	L	Terminal No.	66	L	Signal Name [Specification]			Terminal No.	47	L	Terminal No.	48	L	Terminal No.	49	L	Terminal No.	50	L	Terminal No.	51	L	Terminal No.	52	L	Terminal No.	53	L	Terminal No.	54	L	Terminal No.	55	L	Terminal No.	56	L	Terminal No.	57	L	Terminal No.	58	L	Terminal No.	59	L	Terminal No.	60	L	Terminal No.	61	L	Terminal No.	62	L	Terminal No.	63	L	Terminal No.	64	L	Terminal No.	65	L	Terminal No.	66	L
Connector No.	M18																																																																																																																																																																																																																																																																																																																																									
Connector Name	WIRE TO WIRE																																																																																																																																																																																																																																																																																																																																									
Connector Type	TK02MW																																																																																																																																																																																																																																																																																																																																									
Terminal No.	1	L																																																																																																																																																																																																																																																																																																																																								
Terminal No.	2	P																																																																																																																																																																																																																																																																																																																																								
Color of Wire																																																																																																																																																																																																																																																																																																																																										
Terminal No.	1	L																																																																																																																																																																																																																																																																																																																																								
Terminal No.	2	P																																																																																																																																																																																																																																																																																																																																								
Signal Name [Specification]																																																																																																																																																																																																																																																																																																																																										
Terminal No.	1	L																																																																																																																																																																																																																																																																																																																																								
Terminal No.	2	P																																																																																																																																																																																																																																																																																																																																								
Connector No.	M24																																																																																																																																																																																																																																																																																																																																									
Connector Name	DATA LINK CONNECTOR																																																																																																																																																																																																																																																																																																																																									
Connector Type	BD16PW																																																																																																																																																																																																																																																																																																																																									
Terminal No.	6	L																																																																																																																																																																																																																																																																																																																																								
Terminal No.	14	P																																																																																																																																																																																																																																																																																																																																								
Color of Wire																																																																																																																																																																																																																																																																																																																																										
Terminal No.	6	L																																																																																																																																																																																																																																																																																																																																								
Terminal No.	14	P																																																																																																																																																																																																																																																																																																																																								
Signal Name [Specification]																																																																																																																																																																																																																																																																																																																																										
Terminal No.	6	L																																																																																																																																																																																																																																																																																																																																								
Terminal No.	14	P																																																																																																																																																																																																																																																																																																																																								
Connector No.	M27																																																																																																																																																																																																																																																																																																																																									
Connector Name	MULTIFUNCTION SWITCH																																																																																																																																																																																																																																																																																																																																									
Connector Type	TH16PW-NH																																																																																																																																																																																																																																																																																																																																									
Terminal No.	4	G																																																																																																																																																																																																																																																																																																																																								
Terminal No.	6	R																																																																																																																																																																																																																																																																																																																																								
Terminal No.	8	R																																																																																																																																																																																																																																																																																																																																								
Terminal No.	13	L																																																																																																																																																																																																																																																																																																																																								
Terminal No.	14	L																																																																																																																																																																																																																																																																																																																																								
Terminal No.	15	L																																																																																																																																																																																																																																																																																																																																								
Terminal No.	16	L																																																																																																																																																																																																																																																																																																																																								
Color of Wire																																																																																																																																																																																																																																																																																																																																										
Terminal No.	4	G																																																																																																																																																																																																																																																																																																																																								
Terminal No.	6	R																																																																																																																																																																																																																																																																																																																																								
Terminal No.	8	R																																																																																																																																																																																																																																																																																																																																								
Terminal No.	13	L																																																																																																																																																																																																																																																																																																																																								
Terminal No.	14	L																																																																																																																																																																																																																																																																																																																																								
Terminal No.	15	L																																																																																																																																																																																																																																																																																																																																								
Terminal No.	16	L																																																																																																																																																																																																																																																																																																																																								
Signal Name [Specification]																																																																																																																																																																																																																																																																																																																																										
Terminal No.	4	G																																																																																																																																																																																																																																																																																																																																								
Terminal No.	6	R																																																																																																																																																																																																																																																																																																																																								
Terminal No.	8	R																																																																																																																																																																																																																																																																																																																																								
Terminal No.	13	L																																																																																																																																																																																																																																																																																																																																								
Terminal No.	14	L																																																																																																																																																																																																																																																																																																																																								
Terminal No.	15	L																																																																																																																																																																																																																																																																																																																																								
Terminal No.	16	L																																																																																																																																																																																																																																																																																																																																								
Connector No.	M28																																																																																																																																																																																																																																																																																																																																									
Connector Name	AV CONTROL UNIT (WITHOUT NAVI)																																																																																																																																																																																																																																																																																																																																									
Connector Type	TH24FW-NH																																																																																																																																																																																																																																																																																																																																									
Terminal No.	47	L																																																																																																																																																																																																																																																																																																																																								
Terminal No.	48	L																																																																																																																																																																																																																																																																																																																																								
Terminal No.	49	L																																																																																																																																																																																																																																																																																																																																								
Terminal No.	50	L																																																																																																																																																																																																																																																																																																																																								
Terminal No.	51	L																																																																																																																																																																																																																																																																																																																																								
Terminal No.	52	L																																																																																																																																																																																																																																																																																																																																								
Terminal No.	53	L																																																																																																																																																																																																																																																																																																																																								
Terminal No.	54	L																																																																																																																																																																																																																																																																																																																																								
Terminal No.	55	L																																																																																																																																																																																																																																																																																																																																								
Terminal No.	56	L																																																																																																																																																																																																																																																																																																																																								
Terminal No.	57	L																																																																																																																																																																																																																																																																																																																																								
Terminal No.	58	L																																																																																																																																																																																																																																																																																																																																								
Terminal No.	59	L																																																																																																																																																																																																																																																																																																																																								
Terminal No.	60	L																																																																																																																																																																																																																																																																																																																																								
Terminal No.	61	L																																																																																																																																																																																																																																																																																																																																								
Terminal No.	62	L																																																																																																																																																																																																																																																																																																																																								
Terminal No.	63	L																																																																																																																																																																																																																																																																																																																																								
Terminal No.	64	L																																																																																																																																																																																																																																																																																																																																								
Terminal No.	65	L																																																																																																																																																																																																																																																																																																																																								
Terminal No.	66	L																																																																																																																																																																																																																																																																																																																																								
Color of Wire																																																																																																																																																																																																																																																																																																																																										
Terminal No.	47	L																																																																																																																																																																																																																																																																																																																																								
Terminal No.	48	L																																																																																																																																																																																																																																																																																																																																								
Terminal No.	49	L																																																																																																																																																																																																																																																																																																																																								
Terminal No.	50	L																																																																																																																																																																																																																																																																																																																																								
Terminal No.	51	L																																																																																																																																																																																																																																																																																																																																								
Terminal No.	52	L																																																																																																																																																																																																																																																																																																																																								
Terminal No.	53	L																																																																																																																																																																																																																																																																																																																																								
Terminal No.	54	L																																																																																																																																																																																																																																																																																																																																								
Terminal No.	55	L																																																																																																																																																																																																																																																																																																																																								
Terminal No.	56	L																																																																																																																																																																																																																																																																																																																																								
Terminal No.	57	L																																																																																																																																																																																																																																																																																																																																								
Terminal No.	58	L																																																																																																																																																																																																																																																																																																																																								
Terminal No.	59	L																																																																																																																																																																																																																																																																																																																																								
Terminal No.	60	L																																																																																																																																																																																																																																																																																																																																								
Terminal No.	61	L																																																																																																																																																																																																																																																																																																																																								
Terminal No.	62	L																																																																																																																																																																																																																																																																																																																																								
Terminal No.	63	L																																																																																																																																																																																																																																																																																																																																								
Terminal No.	64	L																																																																																																																																																																																																																																																																																																																																								
Terminal No.	65	L																																																																																																																																																																																																																																																																																																																																								
Terminal No.	66	L																																																																																																																																																																																																																																																																																																																																								
Signal Name [Specification]																																																																																																																																																																																																																																																																																																																																										
Terminal No.	47	L																																																																																																																																																																																																																																																																																																																																								
Terminal No.	48	L																																																																																																																																																																																																																																																																																																																																								
Terminal No.	49	L																																																																																																																																																																																																																																																																																																																																								
Terminal No.	50	L																																																																																																																																																																																																																																																																																																																																								
Terminal No.	51	L																																																																																																																																																																																																																																																																																																																																								
Terminal No.	52	L																																																																																																																																																																																																																																																																																																																																								
Terminal No.	53	L																																																																																																																																																																																																																																																																																																																																								
Terminal No.	54	L																																																																																																																																																																																																																																																																																																																																								
Terminal No.	55	L																																																																																																																																																																																																																																																																																																																																								
Terminal No.	56	L																																																																																																																																																																																																																																																																																																																																								
Terminal No.	57	L																																																																																																																																																																																																																																																																																																																																								
Terminal No.	58	L																																																																																																																																																																																																																																																																																																																																								
Terminal No.	59	L																																																																																																																																																																																																																																																																																																																																								
Terminal No.	60	L																																																																																																																																																																																																																																																																																																																																								
Terminal No.	61	L																																																																																																																																																																																																																																																																																																																																								
Terminal No.	62	L																																																																																																																																																																																																																																																																																																																																								
Terminal No.	63	L																																																																																																																																																																																																																																																																																																																																								
Terminal No.	64	L																																																																																																																																																																																																																																																																																																																																								
Terminal No.	65	L																																																																																																																																																																																																																																																																																																																																								
Terminal No.	66	L																																																																																																																																																																																																																																																																																																																																								

JCLWA3405GB



# REAR WINDOW DEFOGGER SYSTEM

## < DTC/CIRCUIT DIAGNOSIS >

### DEFOGGER

Connector No.	M85	Connector No.	M118	Connector No.	M88	Connector No.	M87	Connector No.	M85	Connector No.	M119	
Connector Name	AV CONTROL UNIT (WITHOUT NAVI)	BCM (BODY CONTROL MODULE)	BCM (BODY CONTROL MODULE)	AV CONTROL UNIT (WITH NAVI)	TH12FW-NH	AV CONTROL UNIT (WITH NAVI)	TH40FW-NH	AV CONTROL UNIT (WITHOUT NAVI)	TH22FW-NH	BCM (BODY CONTROL MODULE)	BCM (BODY CONTROL MODULE)	
Connector Type	TH22FW-NH	M03FB-LC	M03FB-LC	TH12FW-NH	TH40FW-NH	TH40FW-NH	TH40FW-NH	TH22FW-NH	MS16FW-CS	MS16FW-CS	MS16FW-CS	
Terminal No.	51 50 88 87 86 85 84 83 82 81 80 79 78 77 76 75 74 73 72 71 70 69 68 67 66 65 64 63 62 61 60 59 58 57 56 55 54 53 52 51 50 49 48 47 46 45 44 43 42 41 40 39 38 37 36 35 34 33 32 31 30 29 28 27 26 25 24 23 22 21 20 19 18 17 16 15 14 13 12 11 10 9 8 7 6 5 4 3 2 1	1 3 2	1 3 2	70 71 72	50 51 52 53	90 91	4 5 6 7 8 9 10 11 12 13 14 15 16 17 18 19	86 87 88 89	11 12 13 14 15 16 17 18 19	1 2 3 4 5 6 7 8 9 10 11 12 13 14 15 16 17 18 19 20 21 22 23 24 25 26 27 28 29 30 31 32 33 34 35 36 37 38 39 40 41 42 43 44 45 46 47 48 49 50 51 52 53 54 55 56 57 58 59 60 61 62 63 64 65 66 67 68 69 70 71 72 73 74 75 76 77 78 79 80 81 82 83 84 85 86 87 88 89 90 91	13 52	13 52
Color of Wire	L P G L L R L R L P L	W	W	L P SHIELD	G R L P	P L	L	L P L	L P L	L W	L W	
Signal Name [Specification]	CAN-H CAN-L AV COMM (H) [With BOSE system] AV COMM (H) [Without BOSE system] AV COMM (L) [With BOSE system] AV COMM (L) [Without BOSE system]	BAT (F/L)	BAT (F/L)	COMM (CONT->DISP) COMM (DISP->CONT) SHIELD	AV COMM (H) AV COMM (L) CAN-H CAN-L	CAN-L CAN-H	CAN-L CAN-H	AV COMM (H) AV COMM (L) CAN-H CAN-L	AV COMM (H) AV COMM (L) CAN-H CAN-L	WIRE TO WIRE	REAR WINDOW DEFOGGER RELAY CONT	

JCLWA3406GB

A  
B  
C  
D  
E  
F  
G  
H  
I  
J  
K  
DEF  
M  
N  
O  
P

# BCM (BODY CONTROL MODULE)

< ECU DIAGNOSIS INFORMATION >

## ECU DIAGNOSIS INFORMATION

### BCM (BODY CONTROL MODULE)

Reference Value

INFOID:000000005153398

#### VALUES ON THE DIAGNOSIS TOOL

CONSULT-III MONITOR ITEM

Monitor Item	Condition	Value/Status
FR WIPER HI	Other than front wiper switch HI	Off
	Front wiper switch HI	On
FR WIPER LOW	Other than front wiper switch LO	Off
	Front wiper switch LO	On
FR WASHER SW	Front washer switch OFF	Off
	Front washer switch ON	On
FR WIPER INT	Other than front wiper switch INT/AUTO	Off
	Front wiper switch INT/AUTO	On
FR WIPER STOP	Front wiper is not in STOP position	Off
	Front wiper is in STOP position	On
INT VOLUME	Wiper volume dial is in a dial position 1 - 7	Wiper volume dial position
TURN SIGNAL R	Other than turn signal switch RH	Off
	Turn signal switch RH	On
TURN SIGNAL L	Other than turn signal switch LH	Off
	Turn signal switch LH	On
TAIL LAMP SW	Other than lighting switch 1ST and 2ND	Off
	Lighting switch 1ST or 2ND	On
HI BEAM SW	Other than lighting switch HI	Off
	Lighting switch HI	On
HEAD LAMP SW 1	Other than lighting switch 2ND	Off
	Lighting switch 2ND	On
HEAD LAMP SW 2	Other than lighting switch 2ND	Off
	Lighting switch 2ND	On
PASSING SW	Other than lighting switch PASS	Off
	Lighting switch PASS	On
AUTO LIGHT SW	Other than lighting switch AUTO	Off
	Lighting switch AUTO	On
FR FOG SW	Front fog lamp switch OFF	Off
	Front fog lamp switch ON	On
RR FOG SW	<b>NOTE:</b> The item is indicated, but not monitored.	Off
DOOR SW-DR	Driver door closed	Off
	Driver door opened	On
DOOR SW-AS	Passenger door closed	Off
	Passenger door opened	On
DOOR SW-RR	<b>NOTE:</b> The item is indicated, but not monitored.	Off

## BCM (BODY CONTROL MODULE)

### < ECU DIAGNOSIS INFORMATION >

Monitor Item	Condition	Value/Status	
DOOR SW-RL	<b>NOTE:</b> The item is indicated, but not monitored.	Off	A
DOOR SW-BK	<b>NOTE:</b> The item is indicated, but not monitored.	Off	B
CDL LOCK SW	Other than power door lock switch LOCK	Off	C
	Power door lock switch LOCK	On	
CDL UNLOCK SW	Other than power door lock switch UNLOCK	Off	D
	Power door lock switch UNLOCK	On	
KEY CYL LK-SW	Other than driver door key cylinder LOCK position	Off	E
	Driver door key cylinder LOCK position	On	
KEY CYL UN-SW	Other than driver door key cylinder UNLOCK position	Off	F
	Driver door key cylinder UNLOCK position	On	
KEY CYL SW-TR	<b>NOTE:</b> The item is indicated, but not monitored.	Off	G
HAZARD SW	Hazard switch is OFF	Off	H
	Hazard switch is ON	On	
REAR DEF SW	<b>NOTE:</b> The item is indicated, but not monitored.	Off	I
H/L WASH SW	<b>NOTE:</b> The item is indicated, but not monitored.	Off	J
TR CANCEL SW	Trunk lid opener cancel switch OFF	Off	K
	Trunk lid opener cancel switch ON	On	
TR/BD OPEN SW	Trunk lid opener switch OFF	Off	DEF
	While the trunk lid opener switch is turned ON	On	
TRNK/HAT MNTR	Trunk lid closed	Off	M
	Trunk lid opened	On	
RKE-LOCK	LOCK button of the Intelligent Key is not pressed	Off	N
	LOCK button of the Intelligent Key is pressed	On	
RKE-UNLOCK	UNLOCK button of the Intelligent Key is not pressed	Off	O
	UNLOCK button of the Intelligent Key is pressed	On	
RKE-TR/BD	TRUNK OPEN button of the Intelligent Key is not pressed	Off	P
	TRUNK OPEN button of the Intelligent Key is pressed	On	
RKE-PANIC	PANIC button of the Intelligent Key is not pressed	Off	
	PANIC button of the Intelligent Key is pressed	On	
RKE-P/W OPEN	UNLOCK button of the Intelligent Key is not pressed	Off	
	UNLOCK button of the Intelligent Key is pressed and held	On	
RKE-MODE CHG	LOCK/UNLOCK button of the Intelligent Key is not pressed and held simultaneously	Off	
	LOCK/UNLOCK button of the Intelligent Key is pressed and held simultaneously	On	
OPTICAL SENSOR	Bright outside of the vehicle	Close to 5 V	
	Dark outside of the vehicle	Close to 0 V	
REQ SW -DR	Driver door request switch is not pressed	Off	
	Driver door request switch is pressed	On	
REQ SW -AS	Passenger door request switch is not pressed	Off	
	Passenger door request switch is pressed	On	
REQ SW -RR	<b>NOTE:</b> The item is indicated, but not monitored.	Off	

## BCM (BODY CONTROL MODULE)

### < ECU DIAGNOSIS INFORMATION >

Monitor Item	Condition	Value/Status
REQ SW -RL	<b>NOTE:</b> The item is indicated, but not monitored.	Off
REQ SW -BD/TR	Trunk lid opener request switch is not pressed	Off
	Trunk lid opener request switch is pressed	On
PUSH SW	Push-button ignition switch (push switch) is not pressed	Off
	Push-button ignition switch (push switch) is pressed	On
IGN RLY2 -F/B	Ignition switch in OFF or ACC position	Off
	Ignition switch in ON position	On
ACC RLY -F/B	<b>NOTE:</b> The item is indicated, but not monitored.	Off
CLUCH SW	The clutch pedal is not depressed	Off
	The clutch pedal is depressed	On
BRAKE SW 1	The brake pedal is depressed when No. 7 fuse is blown	Off
	The brake pedal is not depressed when No. 7 fuse is blown, or No. 7 fuse is normal	On
BRAKE SW 2	The brake pedal is not depressed	Off
	The brake pedal is depressed	On
DETE/CANCL SW	<ul style="list-style-type: none"> <li>• Selector lever in P position (Except M/T models)</li> <li>• The clutch pedal is depressed (M/T models)</li> </ul>	Off
	<ul style="list-style-type: none"> <li>• Selector lever in any position other than P (Except M/T models)</li> <li>• The clutch pedal is not depressed (M/T models)</li> </ul>	On
SFT PN/N SW	Selector lever in any position other than P and N	Off
	Selector lever in P or N position	On
S/L -LOCK	Steering is unlocked	Off
	Steering is locked	On
S/L -UNLOCK	Steering is locked	Off
	Steering is unlocked	On
S/L RELAY-F/B	Ignition switch in OFF or ACC position	Off
	Ignition switch in ON position	On
UNLK SEN -DR	Driver door is unlocked	Off
	Driver door is locked	On
PUSH SW -IPDM	Push-button ignition switch (push-switch) is not pressed	Off
	Push-button ignition switch (push-switch) is pressed	On
IGN RLY1 -F/B	Ignition switch in OFF or ACC position	Off
	Ignition switch in ON position	On
DETE SW -IPDM	Selector lever in any position other than P	Off
	Selector lever in P position	On
SFT PN -IPDM	<ul style="list-style-type: none"> <li>• Selector lever in any position other than P and N (Except M/T models)</li> <li>• The clutch pedal is not depressed (M/T models)</li> </ul>	Off
	<ul style="list-style-type: none"> <li>• Selector lever in P or N position</li> <li>• The clutch pedal is depressed</li> </ul>	On
SFT P -MET	Selector lever in any position other than P	Off
	Selector lever in P position	On
SFT N -MET	Selector lever in any position other than N	Off
	Selector lever in N position	On

## BCM (BODY CONTROL MODULE)

### < ECU DIAGNOSIS INFORMATION >

Monitor Item	Condition	Value/Status	
ENGINE STATE	Engine stopped	Stop	A
	While the engine stalls	Stall	
	At engine cranking	Crank	B
	Engine running	Run	
S/L LOCK-IPDM	Steering is unlocked	Off	
	Steering is locked	On	C
S/L UNLK-IPDM	Steering is locked	Off	
	Steering is unlocked	On	D
S/L RELAY-REQ	Steering lock system is not the LOCK condition and the changing condition from LOCK to UNLOCK	Off	
	Steering lock system are not the LOCK condition or the changing condition from LOCK to UNLOCK	On	E
VEH SPEED 1	While driving	Equivalent to speedometer reading	F
VEH SPEED 2	While driving	Equivalent to speedometer reading	
DOOR STAT-DR	Driver door is locked	LOCK	G
	Wait with selective UNLOCK operation (60 seconds)	READY	
	Driver door is unlocked	UNLOCK	
DOOR STAT-AS	Passenger door is locked	LOCK	H
	Wait with selective UNLOCK operation (60 seconds)	READY	
	Passenger door is unlocked	UNLOCK	
ID OK FLAG	Steering is locked	Reset	I
	Steering is unlocked	Set	
PRMT ENG STRT	The engine start is prohibited	Reset	J
	The engine start is permitted	Set	
PRMT RKE STRT	<b>NOTE:</b> The item is indicated, but not monitored.	Reset	K
KEY SW -SLOT	The Intelligent Key is not inserted into key slot	Off	
	The Intelligent Key is inserted into key slot	On	DEF
RKE OPE COUN1	During the operation of the Intelligent Key	Operation frequency of the Intelligent Key	
RKE OPE COUN2	<b>NOTE:</b> The item is indicated, but not monitored.	—	M
CONFIRM ID ALL	The key ID that the key slot receives is not recognized by any key ID registered to BCM.	Yet	
	The key ID that the key slot receives is recognized by any key ID registered to BCM.	Done	N
CONFIRM ID4	The key ID that the key slot receives is not recognized by the fourth key ID registered to BCM.	Yet	O
	The key ID that the key slot receives is recognized by the fourth key ID registered to BCM.	Done	
CONFIRM ID3	The key ID that the key slot receives is not recognized by the third key ID registered to BCM.	Yet	P
	The key ID that the key slot receives is recognized by the third key ID registered to BCM.	Done	

## BCM (BODY CONTROL MODULE)

### < ECU DIAGNOSIS INFORMATION >

Monitor Item	Condition	Value/Status
CONFIRM ID2	The key ID that the key slot receives is not recognized by the second key ID registered to BCM.	Yet
	The key ID that the key slot receives is recognized by the second key ID registered to BCM.	Done
CONFIRM ID1	The key ID that the key slot receives is not recognized by the first key ID registered to BCM.	Yet
	The key ID that the key slot receives is recognized by the first key ID registered to BCM.	Done
TP 4	The ID of fourth Intelligent Key is not registered to BCM	Yet
	The ID of fourth Intelligent Key is registered to BCM	Done
TP 3	The ID of third Intelligent Key is not registered to BCM	Yet
	The ID of third Intelligent Key is registered to BCM	Done
TP 2	The ID of second Intelligent Key is not registered to BCM	Yet
	The ID of second Intelligent Key is registered to BCM	Done
TP 1	The ID of first Intelligent Key is not registered to BCM	Yet
	The ID of first Intelligent Key is registered to BCM	Done
AIR PRESS FL	Ignition switch ON (Only when the signal from the transmitter is received)	Air pressure of front LH tire
AIR PRESS FR	Ignition switch ON (Only when the signal from the transmitter is received)	Air pressure of front RH tire
AIR PRESS RR	Ignition switch ON (Only when the signal from the transmitter is received)	Air pressure of rear RH tire
AIR PRESS RL	Ignition switch ON (Only when the signal from the transmitter is received)	Air pressure of rear LH tire
ID REGST FL1	ID of front LH tire transmitter is registered	Done
	ID of front LH tire transmitter is not registered	Yet
ID REGST FR1	ID of front RH tire transmitter is registered	Done
	ID of front RH tire transmitter is not registered	Yet
ID REGST RR1	ID of rear RH tire transmitter is registered	Done
	ID of rear RH tire transmitter is not registered	Yet
ID REGST RL1	ID of rear LH tire transmitter is registered	Done
	ID of rear LH tire transmitter is not registered	Yet
WARNING LAMP	Tire pressure indicator OFF	Off
	Tire pressure indicator ON	On
BUZZER	Tire pressure warning alarm is not sounding	Off
	Tire pressure warning alarm is sounding	On

# BCM (BODY CONTROL MODULE)

< ECU DIAGNOSIS INFORMATION >

## TERMINAL LAYOUT

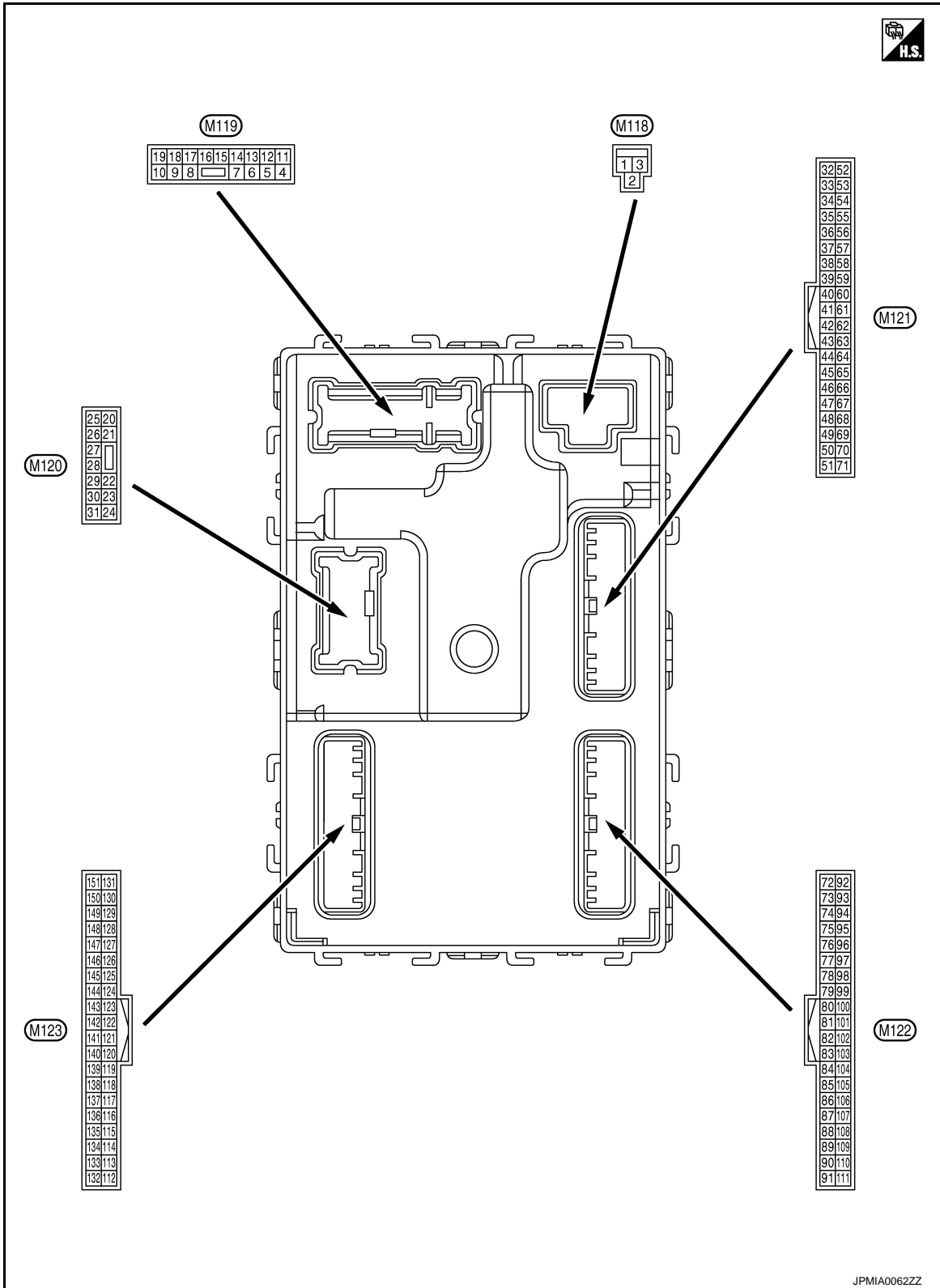

## PHYSICAL VALUES

# BCM (BODY CONTROL MODULE)

## < ECU DIAGNOSIS INFORMATION >

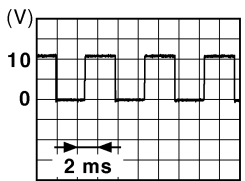
Terminal No. (Wire color)		Description		Condition		Value (Approx.)
		Signal name	Input/ Output			
+	-					
1 (W)	Ground	Battery power supply	Input	Ignition switch OFF		Battery voltage
2 (Y)	Ground	P/W power supply (BAT)	Output	Ignition switch OFF		12 V
3 (O)	Ground	P/W power supply (RAP)	Output	Ignition switch ON		12 V
4 (LG)	Ground	Interior room lamp power supply	Output	Interior room lamp battery saver is activated. (Cuts the interior room lamp power supply)		0 V
				Interior room lamp battery saver is not activated. (Outputs the interior room lamp power supply)		12 V
5 (P)	Ground	Passenger door UN- LOCK	Output	Passenger door	UNLOCK (Actuator is activated)	12 V
					Other than UNLOCK (Actuator is not activated)	0 V
7 (SB)	Ground	Step lamp	Output	Step lamp	ON	0 V
					OFF	12 V
8 (V)	Ground	All doors, fuel lid LOCK	Output	All doors, fuel lid	LOCK (Actuator is activated)	12 V
					Other than LOCK (Actuator is not activated)	0 V
9 (G)	Ground	Driver door, fuel lid UNLOCK	Output	Driver door, fuel lid	UNLOCK (Actuator is activated)	12 V
					Other than UNLOCK (Actuator is not activated)	0 V
11 (R)	Ground	Battery power supply	Input	Ignition switch OFF		Battery voltage
13 (B)	Ground	Ground	—	Ignition switch ON		0 V
14 (W)	Ground	Push-button ignition switch illumination ground	Output	Tail lamp	OFF	0 V
					ON	<p style="text-align: center;"><b>NOTE:</b> When the illumination brightening/dimming level is in the neutral position.</p>  <p style="text-align: right; font-size: small;">JSNIA0010GB</p>
15 (O)	Ground	ACC indicator lamp	Output	Ignition switch	OFF (LOCK indicator is not illuminated)	Battery voltage
					ACC	0 V



# BCM (BODY CONTROL MODULE)

## < ECU DIAGNOSIS INFORMATION >

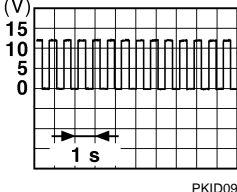
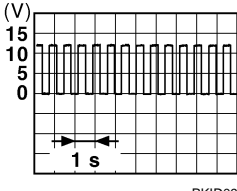
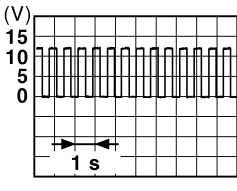
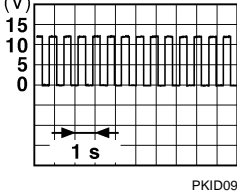
Terminal No. (Wire color)		Description		Condition	Value (Approx.)	
		Signal name	Input/ Output			
+	-					
17 (W)	Ground	Turn signal RH (Front)	Output	Ignition switch ON	Turn signal switch OFF	0 V
					Turn signal switch RH	 6.5 V
18 (O)	Ground	Turn signal LH (Front)	Output	Ignition switch ON	Turn signal switch OFF	0 V
					Turn signal switch LH	 6.5 V
19 (V)	Ground	Room lamp timer control	Output	Interior room lamp	OFF	12 V
					ON	0 V
20 (V)	Ground	Turn signal RH (Rear)	Output	Ignition switch ON	Turn signal switch OFF	0 V
					Turn signal switch RH	 6.5 V
23 (Y)	Ground	Trunk lid open	Output	Trunk lid	OPEN (Trunk lid opener actuator is activated)	12 V
					Other than OPEN (Trunk lid opener actuator is not activated)	0 V
25 (Y)	Ground	Turn signal LH (Rear)	Output	Ignition switch ON	Turn signal switch OFF	0 V
					Turn signal switch LH	 6.5 V
30 (P)	Ground	Trunk room lamp	Output	Trunk room lamp	ON	0 V
					OFF	12 V

A  
B  
C  
D  
E  
F  
G  
H  
I  
J  
K  
DEF  
M  
N  
O  
P

# BCM (BODY CONTROL MODULE)

## < ECU DIAGNOSIS INFORMATION >

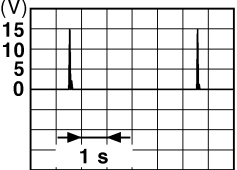
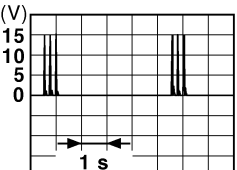
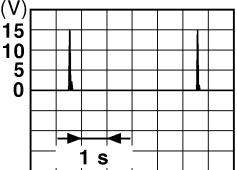
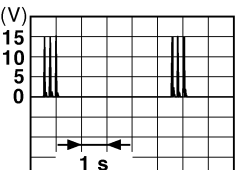
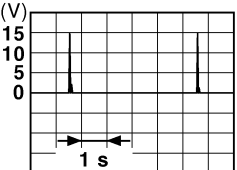
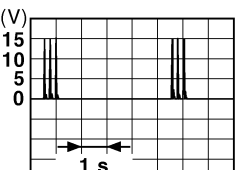
Terminal No. (Wire color)		Description		Condition	Value (Approx.)
+	-	Signal name	Input/ Output		
34 (SB)	Ground	Trunk room antenna (-)	Output	Ignition switch OFF	 <p style="text-align: right; font-size: small;">JMKIA0062GB</p>
				When Intelligent Key is not in the passenger compart- ment	 <p style="text-align: right; font-size: small;">JMKIA0063GB</p>
35 (V)	Ground	Trunk room antenna (+)	Output	Ignition switch OFF	 <p style="text-align: right; font-size: small;">JMKIA0062GB</p>
				When Intelligent Key is not in the passenger compart- ment	 <p style="text-align: right; font-size: small;">JMKIA0063GB</p>
38 (B)	Ground	Rear bumper anten- na (-)	Output	When the trunk lid opener re- quest switch is operated with ignition switch OFF	 <p style="text-align: right; font-size: small;">JMKIA0062GB</p>
				When Intelligent Key is not in the antenna detection area	 <p style="text-align: right; font-size: small;">JMKIA0063GB</p>

# BCM (BODY CONTROL MODULE)

## < ECU DIAGNOSIS INFORMATION >

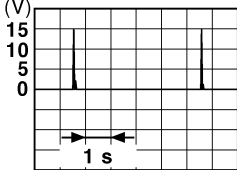
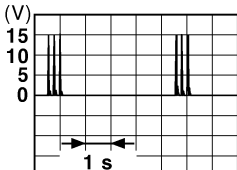
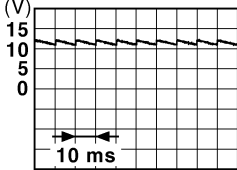
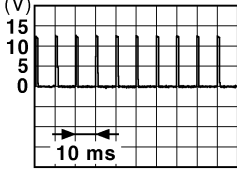
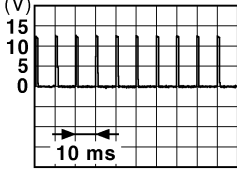
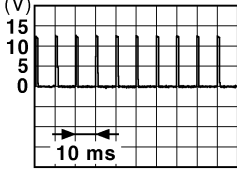
Terminal No. (Wire color)		Description		Condition	Value (Approx.)				
+	-	Signal name	Input/ Output						
39 (W)	Ground	Rear bumper antenna (+)	Output	When Intelligent Key is in the antenna detection area	 <p style="text-align: right; font-size: small;">JMKIA0062GB</p>				
				When the trunk lid opener request switch is operated with ignition switch OFF	 <p style="text-align: right; font-size: small;">JMKIA0063GB</p>				
47 (Y)	Ground	Ignition relay (IPDM E/R) control	Output	Ignition switch	<table border="1" style="width: 100%; border-collapse: collapse;"> <tr> <td>OFF or ACC</td> <td style="text-align: center;">12 V</td> </tr> <tr> <td>ON</td> <td style="text-align: center;">0 V</td> </tr> </table>	OFF or ACC	12 V	ON	0 V
				OFF or ACC	12 V				
ON	0 V								
50 (G)	Ground	Trunk room lamp switch	Input	Trunk room lamp switch	 <p style="text-align: right; font-size: small;">JPMIA0011GB</p>				
				OFF (Trunk lid is closed)	11.8 V				
52 (SB)	Ground	Starter relay control	Output	Ignition switch ON (A/T models)	<table border="1" style="width: 100%; border-collapse: collapse;"> <tr> <td>When selector lever is in P or N position</td> <td style="text-align: center;">12 V</td> </tr> <tr> <td>When selector lever is not in P or N position</td> <td style="text-align: center;">0 V</td> </tr> </table>	When selector lever is in P or N position	12 V	When selector lever is not in P or N position	0 V
				When selector lever is in P or N position	12 V				
			When selector lever is not in P or N position	0 V					
			Ignition switch ON (M/T models)	<table border="1" style="width: 100%; border-collapse: collapse;"> <tr> <td>When the clutch pedal is depressed</td> <td style="text-align: center;">Battery voltage</td> </tr> <tr> <td>When the clutch pedal is not depressed</td> <td style="text-align: center;">0 V</td> </tr> </table>	When the clutch pedal is depressed	Battery voltage	When the clutch pedal is not depressed	0 V	
When the clutch pedal is depressed	Battery voltage								
When the clutch pedal is not depressed	0 V								
61 (SB)	Ground	Trunk lid opener request switch	Input	Trunk lid opener request switch	<table border="1" style="width: 100%; border-collapse: collapse;"> <tr> <td>ON (Pressed)</td> <td style="text-align: center;">0 V</td> </tr> <tr> <td>OFF (Not pressed)</td> <td>  <p style="text-align: right; font-size: small;">JPMIA0016GB</p> </td> </tr> </table>	ON (Pressed)	0 V	OFF (Not pressed)	 <p style="text-align: right; font-size: small;">JPMIA0016GB</p>
				ON (Pressed)	0 V				
OFF (Not pressed)	 <p style="text-align: right; font-size: small;">JPMIA0016GB</p>								
1.0 V									
64 (G)	Ground	Intelligent Key warning buzzer (Engine room)	Output	Intelligent Key warning buzzer (Engine room)	<table border="1" style="width: 100%; border-collapse: collapse;"> <tr> <td>Sounding</td> <td style="text-align: center;">0 V</td> </tr> <tr> <td>Not sounding</td> <td style="text-align: center;">12 V</td> </tr> </table>	Sounding	0 V	Not sounding	12 V
				Sounding	0 V				
Not sounding	12 V								

A  
B  
C  
D  
E  
F  
G  
H  
I  
J  
K  
DEF  
M  
N  
O  
P



# BCM (BODY CONTROL MODULE)

## < ECU DIAGNOSIS INFORMATION >

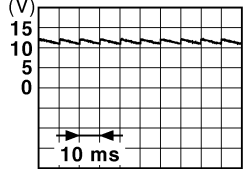
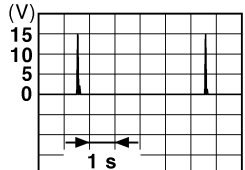
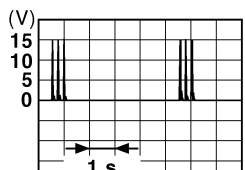
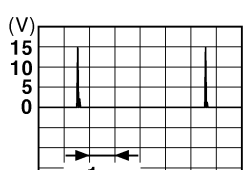
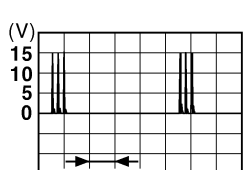
Terminal No. (Wire color)		Description		Condition	Value (Approx.)	
+	-	Signal name	Input/ Output			
67 (GR)	Ground	Trunk lid opener switch	Input	Trunk lid open- er switch	Pressed	0 V
					Not pressed	 <p style="text-align: right; font-size: small;">JPMIA0011GB</p>
72 (R)	Ground	Room antenna 2 (-) (Center console)	Output	Ignition switch OFF	When Intelligent Key is in the passenger compart- ment	 <p style="text-align: right; font-size: small;">JMKIA0062GB</p>
					When Intelligent Key is not in the passenger compart- ment	 <p style="text-align: right; font-size: small;">JMKIA0063GB</p>
73 (G)	Ground	Room antenna 2 (+) (Center console)	Output	Ignition switch OFF	When Intelligent Key is in the passenger compart- ment	 <p style="text-align: right; font-size: small;">JMKIA0062GB</p>
					When Intelligent Key is not in the passenger compart- ment	 <p style="text-align: right; font-size: small;">JMKIA0063GB</p>

# BCM (BODY CONTROL MODULE)

## < ECU DIAGNOSIS INFORMATION >

Terminal No. (Wire color)		Description		Condition	Value (Approx.)
+	-	Signal name	Input/ Output		
74 (SB)	Ground	Passenger door antenna (-)	Output	When Intelligent Key is in the antenna detection area	<p style="text-align: right; font-size: small;">JMkia0062GB</p>
				When the passenger door request switch is operated with ignition switch OFF	<p style="text-align: right; font-size: small;">JMkia0063GB</p>
75 (BR)	Ground	Passenger door antenna (+)	Output	When Intelligent Key is in the antenna detection area	<p style="text-align: right; font-size: small;">JMkia0062GB</p>
				When the passenger door request switch is operated with ignition switch OFF	<p style="text-align: right; font-size: small;">JMkia0063GB</p>
76 (V)	Ground	Driver door antenna (-)	Output	When Intelligent Key is in the antenna detection area	<p style="text-align: right; font-size: small;">JMkia0062GB</p>
				When the driver door request switch is operated with ignition switch OFF	<p style="text-align: right; font-size: small;">JMkia0063GB</p>

A  
B  
C  
D  
E  
F  
G  
H  
I  
J  
K  
M  
N  
O  
P

DEF

# BCM (BODY CONTROL MODULE)

## < ECU DIAGNOSIS INFORMATION >

Terminal No. (Wire color)		Description		Condition	Value (Approx.)
+	-	Signal name	Input/ Output		
77 (LG)	Ground	Driver door antenna (+)	Output	When the driver door request switch is operated with ignition switch OFF	<p style="text-align: right; font-size: small;">JMKIA0062GB</p>
				When Intelligent Key is not in the antenna detection area	<p style="text-align: right; font-size: small;">JMKIA0063GB</p>
78 (Y)	Ground	Room antenna 1 (-) (Instrument panel)	Output	Ignition switch OFF	<p style="text-align: right; font-size: small;">JMKIA0062GB</p>
				When Intelligent Key is not in the passenger compartment	<p style="text-align: right; font-size: small;">JMKIA0063GB</p>
79 (BR)	Ground	Room antenna 1 (+) (Instrument panel)	Output	Ignition switch OFF	<p style="text-align: right; font-size: small;">JMKIA0062GB</p>
				When Intelligent Key is not in the passenger compartment	<p style="text-align: right; font-size: small;">JMKIA0063GB</p>

# BCM (BODY CONTROL MODULE)

## < ECU DIAGNOSIS INFORMATION >

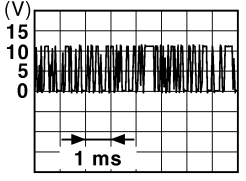
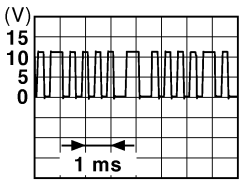
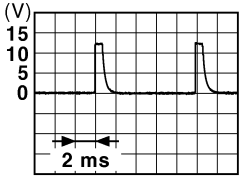
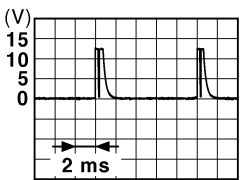
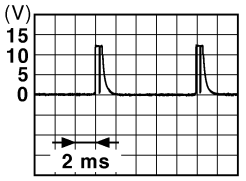
Terminal No. (Wire color)		Description		Condition		Value (Approx.)
+	-	Signal name	Input/ Output			
80 (GR)	Ground	NATS antenna amp.	Input/ Output	During waiting	Ignition switch is pressed while inserting the Intelligent Key into the key slot.	Just after pressing ignition switch. Pointer of tester should move.
81 (W)	Ground	NATS antenna amp.	Input/ Output	During waiting	Ignition switch is pressed while inserting the Intelligent Key into the key slot.	Just after pressing ignition switch. Pointer of tester should move.
82 (R)	Ground	Ignition relay [Fuse block (J/B)] control	Output	Ignition switch	OFF or ACC ON	0 V 12 V
83 (Y)	Ground	Remote keyless entry receiver communication	Input/ Output	During waiting		 <p style="text-align: right; font-size: small;">JMKIA0064GB</p>
				When operating either button on the Intelligent Key		 <p style="text-align: right; font-size: small;">JMKIA0065GB</p>
87 (Y)	Ground	Combination switch INPUT 5	Input	Combination switch	All switches OFF (Wiper volume dial 4)	 <p style="text-align: right; font-size: small;">JPMIA0041GB</p> <p style="text-align: center;">1.4 V</p>
					Front fog lamp switch ON (Wiper volume dial 4)	 <p style="text-align: right; font-size: small;">JPMIA0037GB</p> <p style="text-align: center;">1.3 V</p>
					Any of the conditions below with all switches OFF	<ul style="list-style-type: none"> <li>• Wiper volume dial 1</li> <li>• Wiper volume dial 2</li> <li>• Wiper volume dial 6</li> <li>• Wiper volume dial 7</li> </ul>  <p style="text-align: right; font-size: small;">JPMIA0040GB</p> <p style="text-align: center;">1.3 V</p>

A  
B  
C  
D  
E  
F  
G  
H  
I  
J  
K  
DEF  
M  
N  
O  
P



# BCM (BODY CONTROL MODULE)

## < ECU DIAGNOSIS INFORMATION >

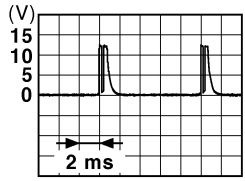
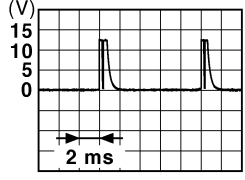
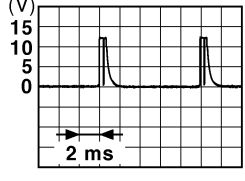
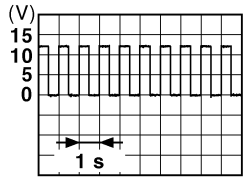
Terminal No. (Wire color)		Description		Condition	Value (Approx.)	
+	-	Signal name	Input/ Output			
88 (O)	Ground	Combination switch INPUT 3	Input	Combination switch	All switches OFF (Wiper volume dial 4)	 <p style="text-align: right; font-size: small;">JPMAI0041GB</p> <p style="text-align: center;">1.4 V</p>
					Lighting switch HI (Wiper volume dial 4)	 <p style="text-align: right; font-size: small;">JPMAI0036GB</p> <p style="text-align: center;">1.3 V</p>
					Lighting switch 2ND (Wiper volume dial 4)	 <p style="text-align: right; font-size: small;">JPMAI0037GB</p> <p style="text-align: center;">1.3 V</p>
					Any of the conditions below with all switches OFF <ul style="list-style-type: none"> <li>• Wiper volume dial 1</li> <li>• Wiper volume dial 2</li> <li>• Wiper volume dial 3</li> </ul>	 <p style="text-align: right; font-size: small;">JPMAI0040GB</p> <p style="text-align: center;">1.3 V</p>
89 (BR)	Ground	Push-button ignition switch (Push switch)	Input	Push-button ignition switch (push switch)	Pressed	0 V
					Not pressed	Battery voltage
90 (P)	Ground	CAN-L	Input/ Output	—	—	
91 (L)	Ground	CAN-H	Input/ Output	—	—	
92 (LG)	Ground	Key slot illumination	Output	Key slot illumina- tion	OFF	0 V
					Blinking	 <p style="text-align: right; font-size: small;">JPMAI0015GB</p> <p style="text-align: center;">6.5 V</p>
					ON	12 V



# BCM (BODY CONTROL MODULE)

## < ECU DIAGNOSIS INFORMATION >

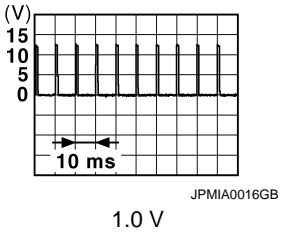
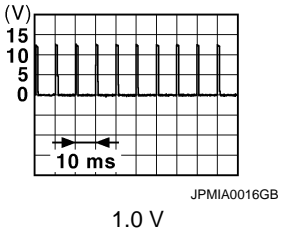
Terminal No. (Wire color)		Description		Condition		Value (Approx.)
		Signal name	Input/ Output			
+	-					
93 (V)	Ground	ON indicator lamp	Output	Ignition switch	OFF (LOCK indicator is not illuminated)	Battery voltage
					ON	0 V
95 (O)	Ground	ACC relay control	Output	Ignition switch	OFF	0 V
					ACC or ON	12 V
96 (GR)	Ground	A/T shift selector (Detention switch) power supply	Output	—		12 V
97 (L)	Ground	Steering lock condition No. 1	Input	Steering lock	LOCK status	0 V
					UNLOCK status	12 V
98 (P)	Ground	Steering lock condition No. 2	Input	Steering lock	LOCK status	12 V
					UNLOCK status	0 V
99 (R)*1 (BR)*2	Ground	Selector lever P position switch	Input	Selector lever	P position	0 V
					Any position other than P	12 V
		ASCD clutch switch (M/T models without ICC)		ASCD clutch switch	OFF (Clutch pedal is depressed)	0 V
					ON (Clutch pedal is not depressed)	12 V
		ICC clutch switch (M/T models with ICC)		ICC clutch switch	OFF (Clutch pedal is depressed)	0 V
					ON (Clutch pedal is not depressed)	12 V
100 (Y)	Ground	Passenger door request switch	Input	Passenger door request switch	ON (Pressed)	0 V
					OFF (Not pressed)	
101 (P)	Ground	Driver door request switch	Input	Driver door request switch	ON (Pressed)	0 V
					OFF (Not pressed)	
102 (O)	Ground	Blower fan motor relay control	Output	Ignition switch	OFF or ACC	0 V
					ON	12 V
103 (L)	Ground	Remote keyless entry receiver power supply	Output	Ignition switch OFF		12 V
106 (W)	Ground	Steering lock unit power supply	Output	Ignition switch	OFF or ACC	12 V
					ON	0 V





A  
B  
C  
D  
E  
F  
G  
H  
I  
J  
K

DEF

M  
N  
O  
P

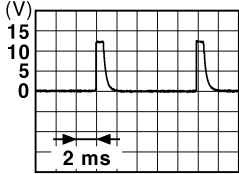

# BCM (BODY CONTROL MODULE)

## < ECU DIAGNOSIS INFORMATION >

Terminal No. (Wire color)		Description		Condition	Value (Approx.)	
		Signal name	Input/ Output			
+	-					
107 (LG)	Ground	Combination switch INPUT 1	Input	Combination switch (Wiper volume dial 4)	All switches OFF	 <p style="text-align: right;">1.4 V</p>
					Turn signal switch LH	 <p style="text-align: right;">1.3 V</p>
					Turn signal switch RH	 <p style="text-align: right;">1.3 V</p>
					Front wiper switch LO	 <p style="text-align: right;">1.3 V</p>
					Front washer switch ON	 <p style="text-align: right;">1.3 V</p>

# BCM (BODY CONTROL MODULE)

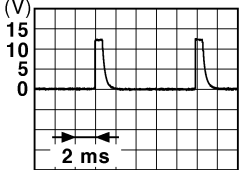
## < ECU DIAGNOSIS INFORMATION >

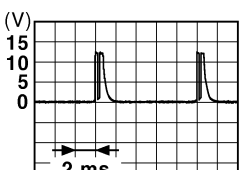
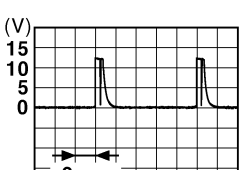
Terminal No. (Wire color)		Description		Condition	Value (Approx.)
+	-	Signal name	Input/ Output		
108 (R)	Ground	Combination switch INPUT 4	Input	Combination switch	All switches OFF (Wiper volume dial 4)  1.4 V
					Lighting switch AUTO (Wiper volume dial 4)  1.3 V
					Lighting switch 1ST (Wiper volume dial 4)  1.3 V
					Any of the conditions below with all switches OFF <ul style="list-style-type: none"> <li>• Wiper volume dial 1</li> <li>• Wiper volume dial 5</li> <li>• Wiper volume dial 6</li> </ul>  1.3 V

A  
B  
C  
D  
E  
F  
G  
H  
I  
J  
K  
DEF  
M  
N  
O  
P

DEF

# BCM (BODY CONTROL MODULE)

## < ECU DIAGNOSIS INFORMATION >

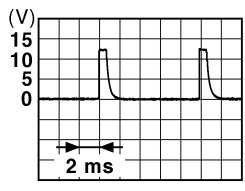
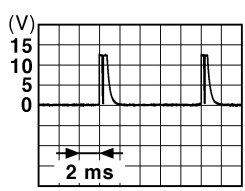
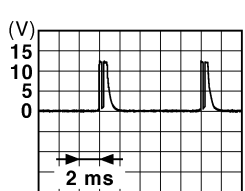
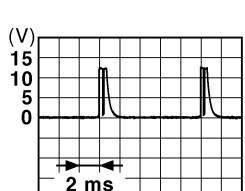
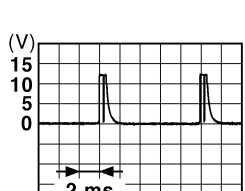
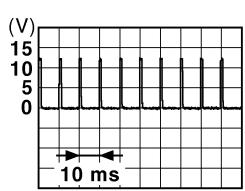
Terminal No. (Wire color)		Description		Condition	Value (Approx.)	
+	-	Signal name	Input/ Output			
109 (W)	Ground	Combination switch INPUT 2	Input	Combination switch (Wiper volume dial 4)	All switches OFF	 <p style="text-align: right;">1.4 V</p>
					Lighting switch PASS	 <p style="text-align: right;">1.3 V</p>
					Lighting switch 2ND	 <p style="text-align: right;">1.3 V</p>
					Front wiper switch INT/ AUTO	 <p style="text-align: right;">1.3 V</p>
					Front wiper switch HI	 <p style="text-align: right;">1.3 V</p>
					ON	0 V
110 (G)	Ground	Hazard switch	Input	Hazard switch	OFF	 <p style="text-align: right;">1.1 V</p>

# BCM (BODY CONTROL MODULE)

## < ECU DIAGNOSIS INFORMATION >

Terminal No. (Wire color)		Description		Condition	Value (Approx.)	
+	-	Signal name	Input/ Output			
111 (Y)	Ground	Steering lock unit communication	Input/ Output	Steering lock	LOCK status	12 V
					LOCK or UNLOCK	<p style="text-align: right; font-size: small;">JMKIA0066GB</p>
					For 15 seconds after UN- LOCK	12 V
				15 seconds or later after UNLOCK	0 V	
112 (R)	Ground	Rain sensor serial link	Input/ Output	Ignition switch ON	<p style="text-align: right; font-size: small;">JPMIA0156GB</p>	
					8.7 V	
113 (O)	Ground	Optical sensor	Input	Ignition switch ON	When bright outside of the vehicle	Close to 5 V
				When dark outside of the vehicle	Close to 0 V	
114 (R)	Ground	Clutch interlock switch	Input	Clutch interlock switch	OFF (Clutch pedal is not depressed)	0 V
					ON (Clutch pedal is de- pressed)	Battery voltage
116 (SB)	Ground	Stop lamp switch 1	Input	—	Battery voltage	
118 (BR)	Ground	Stop lamp switch 2 (Without ICC)	Input	Stop lamp switch	OFF (Brake pedal is not depressed)	0 V
					ON (Brake pedal is de- pressed)	Battery voltage
		Stop lamp switch 2 (With ICC)		Stop lamp switch OFF (Brake pedal is not depressed) and ICC brake hold relay OFF	0 V	
				Stop lamp switch ON (Brake pedal is de- pressed) or ICC brake hold relay ON	Battery voltage	
119 (SB)	Ground	Driver side door lock assembly (Unlock sensor)	Input	Driver door	LOCK status (Unlock sensor switch OFF)	<p style="text-align: right; font-size: small;">JPMIA0012GB</p>
					UNLOCK status (Unlock switch sensor ON)	0 V

A  
B  
C  
D  
E  
F  
G  
H  
I  
J  
K  
DEF  
M  
N  
O  
P



# BCM (BODY CONTROL MODULE)

## < ECU DIAGNOSIS INFORMATION >

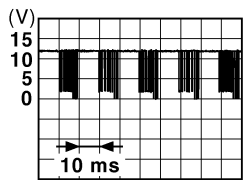
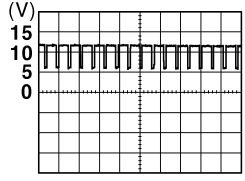
Terminal No. (Wire color)		Description		Condition	Value (Approx.)	
+	-	Signal name	Input/ Output			
121 (SB)	Ground	Key slot switch	Input	When the Intelligent Key is inserted into key slot	12 V	
				When the Intelligent Key is not inserted into key slot	0 V	
123 (W)	Ground	IGN feedback	Input	Ignition switch	OFF or ACC	
					ON	Battery voltage
124 (LG)	Ground	Passenger door switch	Input	Passenger door switch	OFF (Door close)	
					ON (Door open)	0 V
129 (O)	Ground	Trunk lid opener cancel switch	Input	Trunk lid opener cancel switch	CANCEL	
					ON	0 V
132 (V)	Ground	Power window switch and R.H.T. control unit communication	Input/ Output	Ignition switch ON	 <p style="text-align: right; font-size: small;">JPMA0013GB</p>	
				Ignition switch OFF or ACC	12 V	
133 (L)	Ground	Push-button ignition switch illumination	Output	Push-button ignition switch illumination	ON (Tail lamps OFF)	
					ON (Tail lamps ON)	<p style="text-align: center;"><b>NOTE:</b> The pulse width of this wave is varied by the illumination brightening/dimming level.</p>  <p style="text-align: right; font-size: small;">JPMA0159GB</p>
					OFF	0 V
134 (LG)	Ground	LOCK indicator lamp	Output	LOCK indicator lamp	OFF	
					ON	0 V
137 (O)	Ground	Receiver and sensor ground	Input	Ignition switch ON	0 V	

# BCM (BODY CONTROL MODULE)

## < ECU DIAGNOSIS INFORMATION >

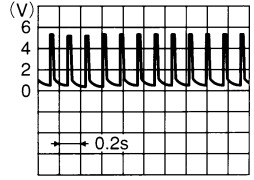
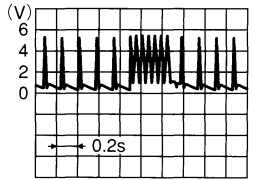
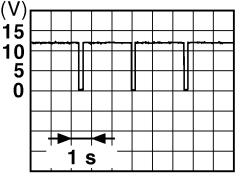
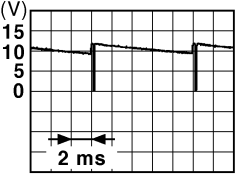
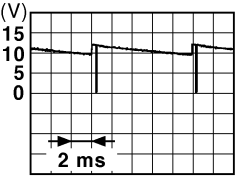
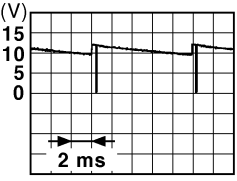
Terminal No. (Wire color)		Description		Condition		Value (Approx.)
		Signal name	Input/ Output			
+	-					
138 (Y)	Ground	Receiver and sensor power supply	Output	Ignition switch	OFF	0 V
					ACC or ON	5.0 V
139 (L)	Ground	Tire pressure receiver communication	Input/ Output	Ignition switch ON	Standby state	 OCC3881D
					When receiving the signal from the transmitter	 OCC3880D
140 (GR)	Ground	Selector lever P/N position (A/T models)	Input	Selector lever	P or N position	12 V
					Except P and N positions	0 V
141 (R)	Ground	Security indicator lamp	Output	Security indicator lamp	ON	0 V
					Blinking	 JPMAI0014GB 11.3 V
142 (BR)	Ground	Combination switch OUTPUT 5	Output	Combination switch (Wiper volume dial 4)	All switches OFF	0 V
					Lighting switch 1ST	 JPMAI0031GB 10.7 V
Lighting switch HI						
Lighting switch 2ND						
143 (P)	Ground	Combination switch OUTPUT 1	Output	Combination switch	Turn signal switch RH	 JPMAI0032GB 10.7 V
					All switches OFF (Wiper volume dial 4)	
143 (P)	Ground	Combination switch OUTPUT 1	Output	Combination switch	Front wiper switch HI (Wiper volume dial 4)	 JPMAI0032GB 10.7 V
					Any of the conditions below with all switches OFF	

A  
B  
C  
D  
E  
F  
G  
H  
I  
J  
K  
L  
M  
N  
O  
P

DEF

# BCM (BODY CONTROL MODULE)

## < ECU DIAGNOSIS INFORMATION >

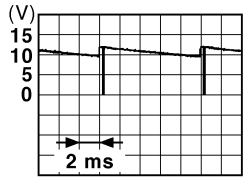
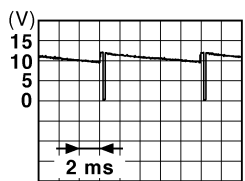
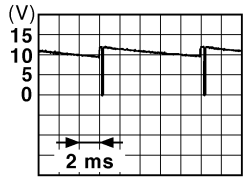
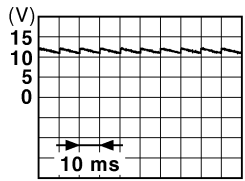
Terminal No. (Wire color)		Description		Condition	Value (Approx.)	
+	-	Signal name	Input/ Output			
144 (O)	Ground	Combination switch OUTPUT 2	Output	Combination switch	All switches OFF (Wiper volume dial 4)	0 V
					Front washer switch ON (Wiper volume dial 4)	 <p style="text-align: right; font-size: small;">JPMAI0033GB</p>
Any of the conditions below with all switches OFF					10.7 V	
<ul style="list-style-type: none"> <li>• Wiper volume dial 1</li> <li>• Wiper volume dial 5</li> <li>• Wiper volume dial 6</li> </ul>						
145 (L)	Ground	Combination switch OUTPUT 3	Output	Combination switch (Wiper volume dial 4)	All switches OFF	0 V
					Front wiper switch INT/ AUTO	 <p style="text-align: right; font-size: small;">JPMAI0034GB</p>
					Front wiper switch LO	
					Lighting switch AUTO	
					10.7 V	
146 (SB)	Ground	Combination switch OUTPUT 4	Output	Combination switch (Wiper volume dial 4)	All switches OFF	0 V
					Front fog lamp switch ON	 <p style="text-align: right; font-size: small;">JPMAI0035GB</p>
					Lighting switch 2ND	
					Lighting switch PASS	
					Turn signal switch LH	
					10.7 V	
149 (W)	Ground	Tire pressure warning check switch	Input	—	12 V	
150 (GR)	Ground	Driver door switch	Input	Driver door switch	OFF (Door close)	 <p style="text-align: right; font-size: small;">JPMAI0011GB</p>
					ON (Door open)	
151 (G)	Ground	Rear window defog- ger relay control	Output	Rear window defogger	Active	0 V
					Not activated	Battery voltage

- \*1: A/T models
- \*2: M/T models



# BCM (BODY CONTROL MODULE)

< ECU DIAGNOSIS INFORMATION >

## Wiring Diagram - BCM -

INFOID:000000005153399

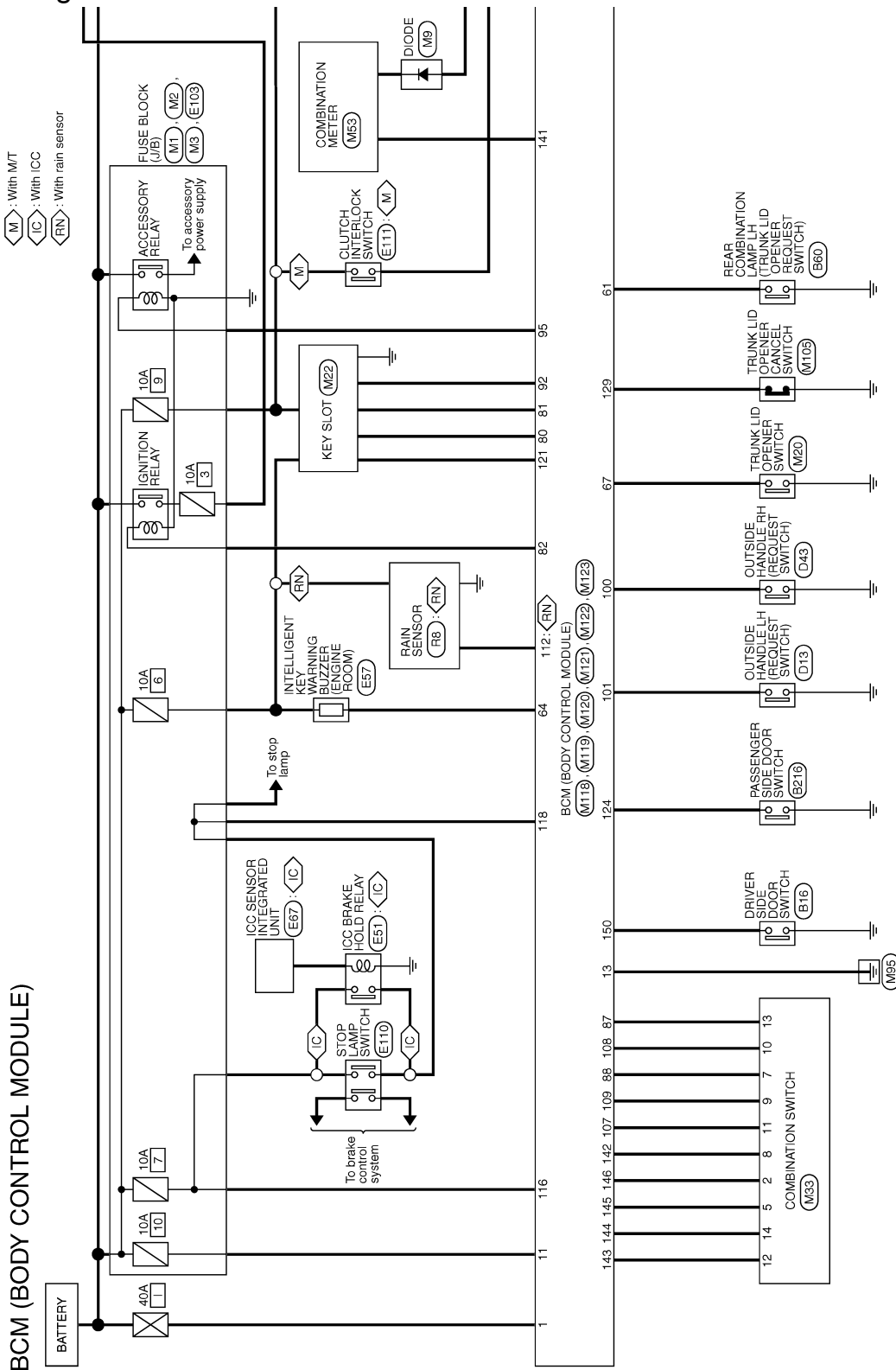

A  
B  
C  
D  
E  
F  
G  
H  
I  
J  
K  
DEF  
M  
N  
O  
P

2009/02/27

JCMWA4249GB

# BCM (BODY CONTROL MODULE)

< ECU DIAGNOSIS INFORMATION >

A : With A/T  
M : With M/T

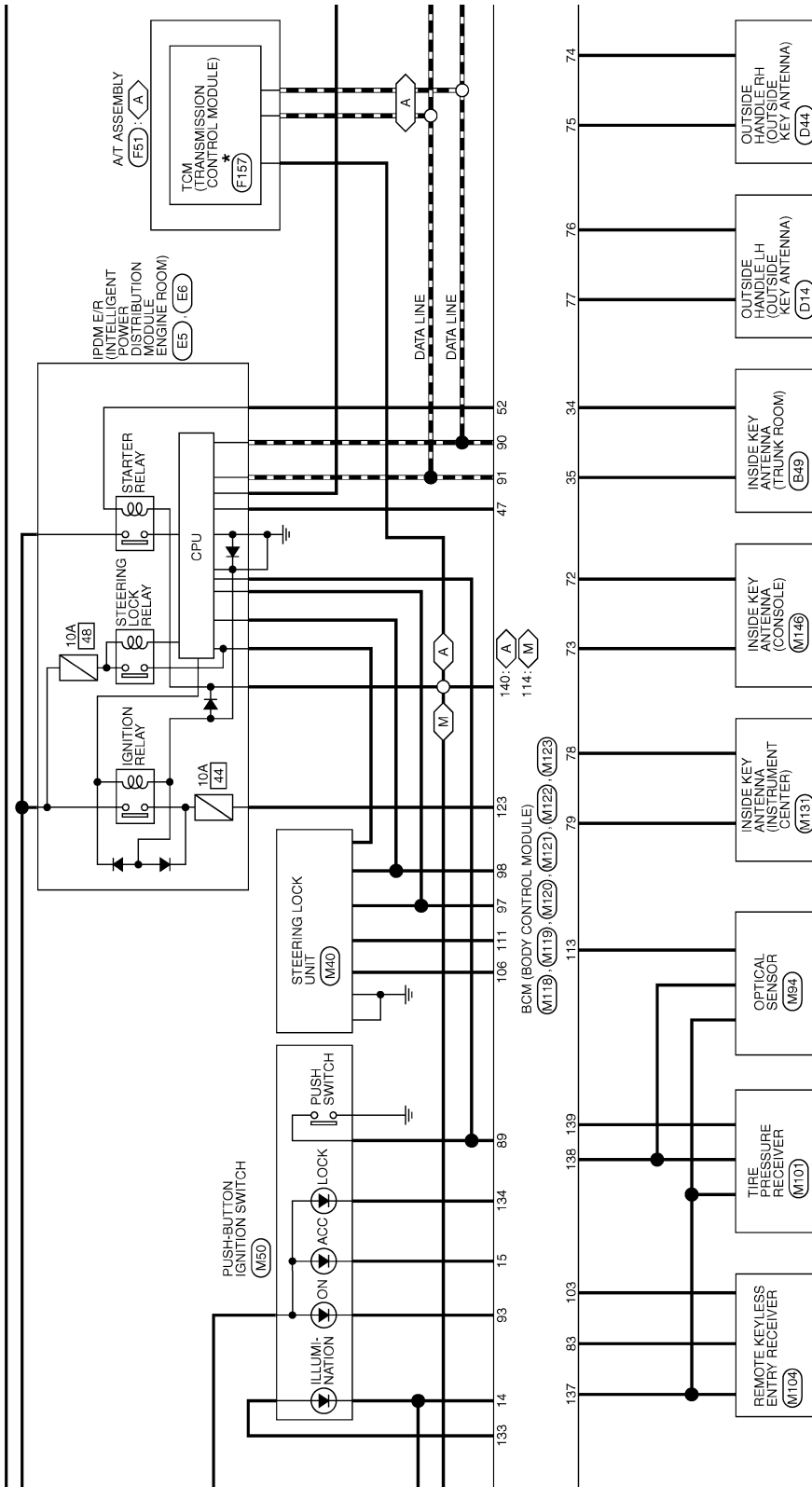

\*: This connector is not shown in "Harness Layout".

JCMWA4250GB

# BCM (BODY CONTROL MODULE)

< ECU DIAGNOSIS INFORMATION >

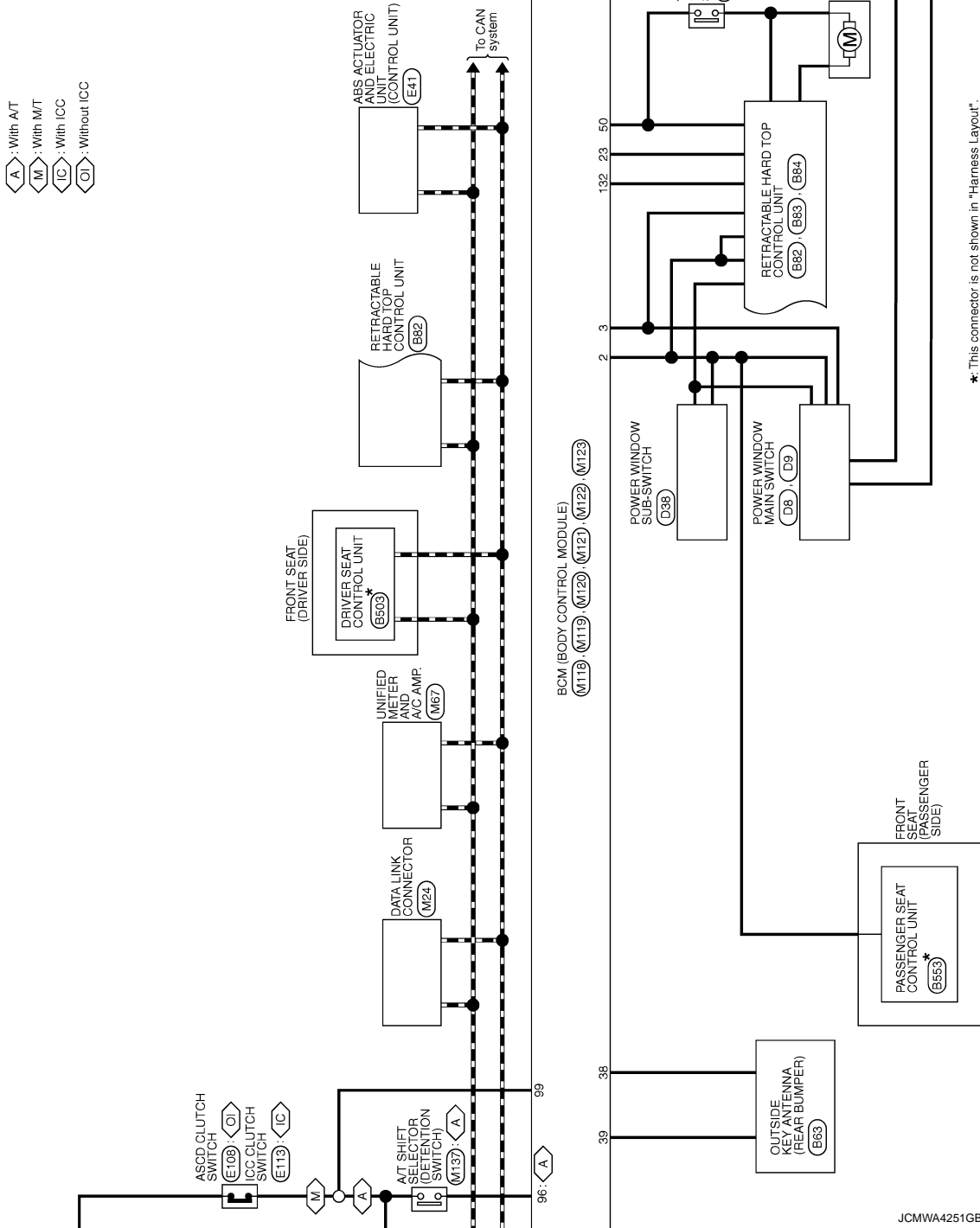

JCMWA4251GB

A  
B  
C  
D  
E  
F  
G  
H  
I  
J  
K  
DEF  
M  
N  
O  
P

# BCM (BODY CONTROL MODULE)

< ECU DIAGNOSIS INFORMATION >

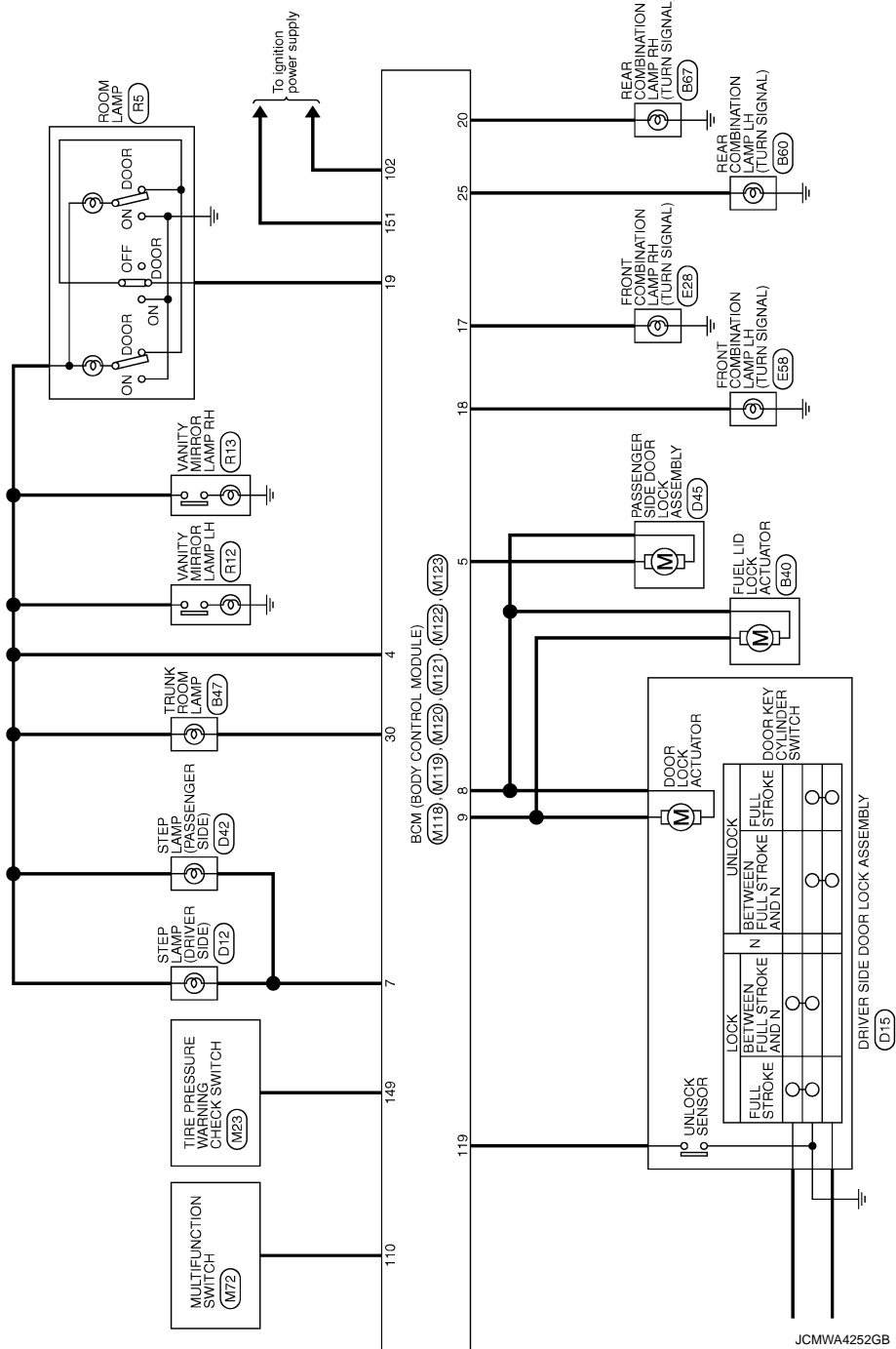

# BCM (BODY CONTROL MODULE)

< ECU DIAGNOSIS INFORMATION >

## BCM (BODY CONTROL MODULE)

Connector No.	M33
Connector Name	COMBINATION SWITCH
Connector Type	TH16FW-NH

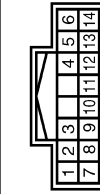

Terminal No.	Color of Wire	Signal Name [Specification]
2	SB	OUTPUT 4
5	L	OUTPUT 3
7	O	INPUT 3
8	BR	OUTPUT 5
9	W	INPUT 2
10	R	INPUT 4
11	LG	INPUT 1
12	P	OUTPUT 1
13	Y	INPUT 5
14	O	OUTPUT 2

Connector No.	M118
Connector Name	BCM (BODY CONTROL MODULE)
Connector Type	IM03FB-LC



Terminal No.	Color of Wire	Signal Name [Specification]
1	W	BAT (E/L)
2	Y	POWER WINDOW POWER SUPPLY (BAT)
3	O	POWER WINDOW POWER SUPPLY (RAP)

Connector No.	M119
Connector Name	BCM (BODY CONTROL MODULE)
Connector Type	NS16FW-CS

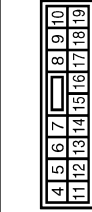

Terminal No.	Color of Wire	Signal Name [Specification]
4	LG	INTERIOR ROOM LAMP POWER SUPPLY
5	P	PASSENGER DOOR UNLOCK OUTPUT
7	SB	STEP LAMP
8	V	ALL DOOR FUEL LID LOCK OUTPUT
9	G	DRIVER DOOR FUEL LID UNLOCK OUTPUT
11	R	BAT (FUSE)
13	B	GND
14	W	PUSH-BUTTON IGNITION SW ILL GND
15	O	ACC IND
17	W	TURN SIGNAL RH (FRONT)
18	O	TURN SIGNAL LH (FRONT)

Connector No.	M120
Connector Name	BCM (BODY CONTROL MODULE)
Connector Type	NS12FW-CS

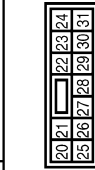

Terminal No.	Color of Wire	Signal Name [Specification]
20	V	TURN SIGNAL RH (REAR)
23	Y	TRUNK LID OPEN OUTPUT
25	Y	TURN SIGNAL LH (REAR)
30	P	TRUNK ROOM LAMP

Connector No.	M121
Connector Name	BCM (BODY CONTROL MODULE)
Connector Type	TH40FY-NH

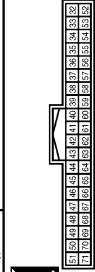

Terminal No.	Color of Wire	Signal Name [Specification]
34	SB	TRUNK ROOM ANT-
35	V	TRUNK ROOM ANT+
38	B	REAR BUMPER ANT-
39	W	REAR BUMPER ANT+
47	Y	IGN RELAY (PDM E/R) CONT
50	G	TRUNK ROOM LAMP SW
52	SB	STARTER RELAY CONT
61	SB	TRUNK LID OPENER PREQUEST SW
64	G	P-KEY WARN BUZZER (ENG ROOM)
67	GR	TRUNK LID OPENER SW

Connector No.	M122
Connector Name	BCM (BODY CONTROL MODULE)
Connector Type	TH40FB-NH

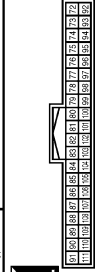

Terminal No.	Color of Wire	Signal Name [Specification]
72	R	ROOM ANT-
73	G	ROOM ANT+
74	SB	PASSENGER DOOR ANT-
75	BR	PASSENGER DOOR ANT+
76	V	DRIVER DOOR ANT-
77	LG	DRIVER DOOR ANT+
78	Y	ROOM ANT1+
79	BR	ROOM ANT1+
80	GR	BAT'S ANTENNA AMP
81	W	BAT'S ANTENNA AMP
82	R	IGN RELAY (F/B) CONT

19	Y	ROOM LAMP TIMER CONTROL
----	---	-------------------------

83	Y	KEYLESS ENTRY RECEIVER COMM
87	Y	COMBI SW INPUT 5
88	O	COMBI SW INPUT 3
89	BR	PUSH SW
90	P	CAN-L
91	L	CAN-H
92	LG	KEY SLOT ILL
93	V	ON IND
95	O	ACC RELAY CONT
96	GR	A/T SHIF SELECTOR POWER SUPPLY
97	L	S/L CONDITION 1
98	P	S/L CONDITION 2
99	BR	ASCD/TCO CLUTCH SW (With M/T)
99	R	SHIFT P (With A/T)
100	Y	PASSENGER DOOR REQUEST SW
101	P	DRIVER DOOR REQUEST SW
102	O	BLOWER FAN MOTOR RELAY CONT
103	L	KEYLESS ENTRY RECEIVER POWER SUPPLY
106	W	S/L LIMIT POWER SUPPLY
107	LG	COMBI SW INPUT 1
108	R	COMBI SW INPUT 4
109	W	COMBI SW INPUT 2
110	G	HAZARD SW
111	Y	S/L UNIT COMM



A B C D E F G H I J K DEF M N O P

# BCM (BODY CONTROL MODULE)

< ECU DIAGNOSIS INFORMATION >

**BCM (BODY CONTROL MODULE)**

Connector No.	M123
Connector Name	BCM (BODY CONTROL MODULE)
Connector Type	THRUFG-NH

Terminal No.	Color of Wire	Signal Name [Specification]
112	R	RAIN SENSOR SERIAL LINK
113	O	OPTICAL SENSOR
114	R	CLUTCH INTERLOCK SW
116	SB	STOP LAMP SW 1
118	BR	STOP LAMP SW 2
119	SB	DR DOOR UNLOCK SENSOR
121	SB	KEY SLOT SW
123	W	IGN F/B
124	LG	PASSENGER DOOR SW
129	O	TRUNK LID OPENER CANCEL SW
132	V	P/W SW & RHT.C/U COMM

133	L	PUSH-BUTTON IGNITION SW ILL POWER
134	LG	LOCK IND
137	O	RECEIVER/SENSOR GND
138	Y	RECEIVER/SENSOR POWER SUPPLY
139	L	TIRE PRESSURE RECEIVER COMM
140	GR	SHIFT UP
141	R	SECURITY INDICATOR LAMP
142	BR	COMET SW OUTPUT 5
143	P	COMET SW OUTPUT 1
144	O	COMET SW OUTPUT 2
145	L	COMET SW OUTPUT 3
146	SB	COMET SW OUTPUT 4
149	W	TIRE PRESSURE WARN CHECK SW
150	GR	DRIVER DOOR SW
151	G	REAR WINDOW DEFOGGER RELAY CONT

JCMWA4254GB

## Fail-safe

INFOID:000000005153400

### FAIL-SAFE CONTROL BY DTC

BCM performs fail-safe control when any DTC are detected.

## BCM (BODY CONTROL MODULE)

### < ECU DIAGNOSIS INFORMATION >

Display contents of CONSULT	Fail-safe	Cancellation	
B2013: ID DISCORD BCM-S/L	Inhibit engine cranking	Erase DTC	A
B2014: CHAIN OF S/L-BCM	Inhibit engine cranking	Erase DTC	
B2190: NATS ANTENNA AMP	Inhibit engine cranking	Erase DTC	B
B2191: DIFFERENCE OF KEY	Inhibit engine cranking	Erase DTC	
B2192: ID DISCORD BCM-ECM	Inhibit engine cranking	Erase DTC	C
B2193: CHAIN OF BCM-ECM	Inhibit engine cranking	Erase DTC	
B2195: ANTI SCANNING	Inhibit engine cranking	Ignition switch ON → OFF	
B2557: VEHICLE SPEED	Inhibit steering lock	When normal vehicle speed signals are received from ABS actuator and electric unit (control unit) for 500 ms	D
B2560: STARTER CONT RELAY	Inhibit engine cranking	500 ms after the following CAN signal communication status becomes consistent <ul style="list-style-type: none"> <li>• Starter control relay signal</li> <li>• Starter relay status signal</li> </ul>	E
B2601: SHIFT POSITION	Inhibit steering lock	500 ms after the following signal reception status becomes consistent <ul style="list-style-type: none"> <li>• Selector lever P position switch signal</li> <li>• P range signal (CAN)</li> </ul>	F
B2602: SHIFT POSITION	Inhibit steering lock	5 seconds after the following BCM recognition conditions are fulfilled <ul style="list-style-type: none"> <li>• Ignition switch is in the ON position</li> <li>• Selector lever P position switch signal: Except P position (battery voltage)</li> <li>• Vehicle speed: 4 km/h (2.5 MPH) or more</li> </ul>	G
B2603: SHIFT POSI STATUS	Inhibit steering lock	500 ms after the following BCM recognition conditions are fulfilled <ul style="list-style-type: none"> <li>• Ignition switch is in the ON position</li> <li>• Selector lever P position switch signal: Except P position (battery voltage)</li> <li>• Selector lever P/N position signal: Except P and N positions (0 V)</li> </ul>	H
B2604: PNP SW	Inhibit steering lock	500 ms after any of the following BCM recognition conditions are fulfilled <ul style="list-style-type: none"> <li>• Status 1 <ul style="list-style-type: none"> <li>- Ignition switch is in the ON position</li> <li>- Selector lever P/N position signal: P and N position (battery voltage)</li> <li>- P range signal or N range signal (CAN): ON</li> </ul> </li> <li>• Status 2 <ul style="list-style-type: none"> <li>- Ignition switch is in the ON position</li> <li>- Selector lever P/N position signal: Except P and N positions (0 V)</li> <li>- P range signal and N range signal (CAN): OFF</li> </ul> </li> </ul>	I
B2605: PNP SW	Inhibit steering lock	500 ms after any of the following BCM recognition conditions are fulfilled <ul style="list-style-type: none"> <li>• Status 1 <ul style="list-style-type: none"> <li>- Ignition switch is in the ON position</li> <li>- Selector lever P/N position signal: Except P and N positions (0 V)</li> <li>- Interlock/PNP switch signal (CAN): OFF</li> </ul> </li> <li>• Status 2 <ul style="list-style-type: none"> <li>- Ignition switch is in the ON position</li> <li>- Selector lever P/N position signal: P or N position (battery voltage)</li> <li>- PNP switch signal (CAN): ON</li> </ul> </li> </ul>	J
B2606: S/L RELAY	Inhibit engine cranking	500 ms after the following CAN signal communication status becomes consistent <ul style="list-style-type: none"> <li>• Steering lock relay signal (Request signal)</li> <li>• Steering lock relay signal (Condition signal)</li> </ul>	K

DEF

## BCM (BODY CONTROL MODULE)

### < ECU DIAGNOSIS INFORMATION >

Display contents of CONSULT	Fail-safe	Cancellation
B2607: S/L RELAY	Inhibit engine cranking	500 ms after the following CAN signal communication status has becomes consistent <ul style="list-style-type: none"> <li>• Steering lock relay signal (Request signal)</li> <li>• Steering lock relay signal (Condition signal)</li> </ul>
B2608: STARTER RELAY	Inhibit engine cranking	500 ms after the following signal communication status becomes consistent <ul style="list-style-type: none"> <li>• Starter motor relay control signal</li> <li>• Starter relay status signal (CAN)</li> </ul>
B2609: S/L STATUS	<ul style="list-style-type: none"> <li>• Inhibit engine cranking</li> <li>• Inhibit steering lock</li> </ul>	When the following steering lock conditions agree <ul style="list-style-type: none"> <li>• BCM steering lock control status</li> <li>• Steering lock condition No. 1 signal status</li> <li>• Steering lock condition No. 2 signal status</li> </ul>
B260A: IGNITION RELAY	Inhibit engine cranking	500 ms after the following conditions are fulfilled <ul style="list-style-type: none"> <li>• IGN relay (IPDM E/R) control signal: OFF (Battery voltage)</li> <li>• Ignition ON signal (CAN to IPDM E/R): OFF (Request signal)</li> <li>• Ignition ON signal (CAN from IPDM E/R): OFF (Condition signal)</li> </ul>
B260F: ENG STATE SIG LOST	Maintains the power supply position attained at the time of DTC detection	When any of the following conditions are fulfilled <ul style="list-style-type: none"> <li>• Power position changes to ACC</li> <li>• Receives engine status signal (CAN)</li> </ul>
B2612: S/L STATUS	<ul style="list-style-type: none"> <li>• Inhibit engine cranking</li> <li>• Inhibit steering lock</li> </ul>	When any of the following conditions are fulfilled <ul style="list-style-type: none"> <li>• Steering lock unit status signal (CAN) is received normally</li> <li>• The BCM steering lock control status matches the steering lock status recognized by the steering lock unit status signal (CAN from IPDM E/R)</li> </ul>
B2617: STARTER RELAY CIRC	Inhibit engine cranking	1 second after the starter motor relay control inside BCM becomes normal
B2618: BCM	Inhibit engine cranking	1 second after the ignition relay (IPDM E/R) control inside BCM becomes normal
B2619: BCM	Inhibit engine cranking	1 second after the steering lock unit power supply output control inside BCM becomes normal
B261E: VEHICLE TYPE	Inhibit engine cranking	BCM initialization
B26E8: CLUTCH SW	Inhibit engine cranking	When any of the following BCM recognition conditions are fulfilled <ul style="list-style-type: none"> <li>• Status 1               <ul style="list-style-type: none"> <li>- Clutch switch signal (CAN from ECM): ON</li> <li>- Clutch interlock switch signal: OFF (0 V)</li> </ul> </li> <li>• Status 2               <ul style="list-style-type: none"> <li>- Clutch switch signal (CAN from ECM): OFF</li> <li>- Clutch interlock switch signal: ON (Battery voltage)</li> </ul> </li> </ul>
B26E9: S/L STATUS	<ul style="list-style-type: none"> <li>• Inhibit engine cranking</li> <li>• Inhibit steering lock</li> </ul>	When BCM transmits the LOCK request signal to steering lock unit, and receives LOCK response signal from steering lock unit, the following conditions are fulfilled <ul style="list-style-type: none"> <li>• Steering condition No. 1 signal: LOCK (0 V)</li> <li>• Steering condition No. 2 signal: LOCK (Battery voltage)</li> </ul>

### HIGH FLASHER OPERATION

BCM detects the turn signal lamp circuit status by the current value.

BCM increases the turn signal lamp blinking speed if the bulb or harness open is detected with the turn signal lamp operating.

#### NOTE:

The blinking speed is normal while activating the hazard warning lamp.

### DTC Inspection Priority Chart

INFOID:000000005153401

If some DTCs are displayed at the same time, perform inspections one by one based on the following priority chart.



# BCM (BODY CONTROL MODULE)

## < ECU DIAGNOSIS INFORMATION >

Priority	DTC	
1	B2562: LOW VOLTAGE	A
2	<ul style="list-style-type: none"> <li>• U1000: CAN COMM</li> <li>• U1010: CONTROL UNIT (CAN)</li> </ul>	B
3	<ul style="list-style-type: none"> <li>• B2190: NATS ANTENNA AMP</li> <li>• B2191: DIFFERENCE OF KEY</li> <li>• B2192: ID DISCORD BCM-ECM</li> <li>• B2193: CHAIN OF BCM-ECM</li> <li>• B2195: ANTI SCANNING</li> </ul>	C
4	<ul style="list-style-type: none"> <li>• B2013: ID DISCORD BCM-S/L</li> <li>• B2014: CHAIN OF S/L-BCM</li> <li>• B2553: IGNITION RELAY</li> <li>• B2555: STOP LAMP</li> <li>• B2556: PUSH-BTN IGN SW</li> <li>• B2557: VEHICLE SPEED</li> <li>• B2560: STARTER CONT RELAY</li> <li>• B2601: SHIFT POSITION</li> <li>• B2602: SHIFT POSITION</li> <li>• B2603: SHIFT POSI STATUS</li> <li>• B2604: PNP SW</li> <li>• B2605: PNP SW</li> <li>• B2606: S/L RELAY</li> <li>• B2607: S/L RELAY</li> <li>• B2608: STARTER RELAY</li> <li>• B2609: S/L STATUS</li> <li>• B260A: IGNITION RELAY</li> <li>• B260B: STEERING LOCK UNIT</li> <li>• B260C: STEERING LOCK UNIT</li> <li>• B260D: STEERING LOCK UNIT</li> <li>• B260F: ENG STATE SIG LOST</li> <li>• B2612: S/L STATUS</li> <li>• B2614: ACC RELAY CIRC</li> <li>• B2615: BLOWER RELAY CIRC</li> <li>• B2616: IGN RELAY CIRC</li> <li>• B2617: STARTER RELAY CIRC</li> <li>• B2618: BCM</li> <li>• B2619: BCM</li> <li>• B261A: PUSH-BTN IGN SW</li> <li>• B261E: VEHICLE TYPE</li> <li>• B26E8: CLUTCH SW</li> <li>• B26E9: S/L STATUS</li> <li>• B26EA: KEY REGISTRATION</li> <li>• C1729: VHCL SPEED SIG ERR</li> <li>• U0415: VEHICLE SPEED SIG</li> </ul>	D E F G H I J K
		DEF
		M
		N
		O
		P

# BCM (BODY CONTROL MODULE)

## < ECU DIAGNOSIS INFORMATION >

Priority	DTC
5	<ul style="list-style-type: none"> <li>• C1704: LOW PRESSURE FL</li> <li>• C1705: LOW PRESSURE FR</li> <li>• C1706: LOW PRESSURE RR</li> <li>• C1707: LOW PRESSURE RL</li> <li>• C1708: [NO DATA] FL</li> <li>• C1709: [NO DATA] FR</li> <li>• C1710: [NO DATA] RR</li> <li>• C1711: [NO DATA] RL</li> <li>• C1712: [CHECKSUM ERR] FL</li> <li>• C1713: [CHECKSUM ERR] FR</li> <li>• C1714: [CHECKSUM ERR] RR</li> <li>• C1715: [CHECKSUM ERR] RL</li> <li>• C1716: [PRESSDATA ERR] FL</li> <li>• C1717: [PRESSDATA ERR] FR</li> <li>• C1718: [PRESSDATA ERR] RR</li> <li>• C1719: [PRESSDATA ERR] RL</li> <li>• C1720: [CODE ERR] FL</li> <li>• C1721: [CODE ERR] FR</li> <li>• C1722: [CODE ERR] RR</li> <li>• C1723: [CODE ERR] RL</li> <li>• C1724: [BATT VOLT LOW] FL</li> <li>• C1725: [BATT VOLT LOW] FR</li> <li>• C1726: [BATT VOLT LOW] RR</li> <li>• C1727: [BATT VOLT LOW] RL</li> <li>• C1734: CONTROL UNIT</li> </ul>
6	<ul style="list-style-type: none"> <li>• B2621: INSIDE ANTENNA</li> <li>• B2622: INSIDE ANTENNA</li> <li>• B2623: INSIDE ANTENNA</li> </ul>

## DTC Index

INFOID:000000005153402

### NOTE:

The details of time display are as follows.

- CRNT: A malfunction is detected now.
- PAST: A malfunction was detected in the past.

IGN counter is displayed on Freeze Frame Data. For details of Freeze Frame Data, refer to [BCS-15. "COMMON ITEM : CONSULT-III Function \(BCM - COMMON ITEM\)".](#)

CONSULT display	Fail-safe	Freeze Frame Data •Vehicle Speed •Odo/Trip Meter •Vehicle condition	Intelligent Key warning lamp ON	Tire pressure monitor warning lamp ON	Refer- ence page
No DTC is detected. further testing may be required.	—	—	—	—	—
U1000: CAN COMM	—	—	—	—	<a href="#">BCS-36</a>
U1010: CONTROL UNIT (CAN)	—	—	—	—	<a href="#">BCS-37</a>
U0415: VEHICLE SPEED SIG	—	—	—	—	<a href="#">BCS-38</a>
B2013: ID DISCORD BCM-S/L	×	×	—	—	<a href="#">SEC-46</a>
B2014: CHAIN OF S/L-BCM	×	×	—	—	<a href="#">SEC-47</a>
B2190: NATS ANTENNA AMP	×	—	—	—	<a href="#">SEC-38</a>
B2191: DIFFERENCE OF KEY	×	—	—	—	<a href="#">SEC-41</a>
B2192: ID DISCORD BCM-ECM	×	—	—	—	<a href="#">SEC-42</a>
B2193: CHAIN OF BCM-ECM	×	—	—	—	<a href="#">SEC-44</a>
B2195: ANTI SCANNING	×	—	—	—	<a href="#">SEC-45</a>
B2553: IGNITION RELAY	—	×	—	—	<a href="#">PCS-47</a>
B2555: STOP LAMP	—	×	—	—	<a href="#">SEC-50</a>

## BCM (BODY CONTROL MODULE)

### < ECU DIAGNOSIS INFORMATION >

CONSULT display	Fail-safe	Freeze Frame Data •Vehicle Speed •Odo/Trip Meter •Vehicle condition	Intelligent Key warning lamp ON	Tire pressure monitor warning lamp ON	Refer- ence page
B2556: PUSH-BTN IGN SW	—	×	×	—	<a href="#">SEC-52</a>
B2557: VEHICLE SPEED	×	×	×	—	<a href="#">SEC-54</a>
B2560: STARTER CONT RELAY	×	×	×	—	<a href="#">SEC-55</a>
B2562: LOW VOLTAGE	—	×	—	—	<a href="#">BCS-39</a>
B2601: SHIFT POSITION	×	×	×	—	<a href="#">SEC-56</a>
B2602: SHIFT POSITION	×	×	×	—	<a href="#">SEC-59</a>
B2603: SHIFT POSI STATUS	×	×	×	—	<a href="#">SEC-61</a>
B2604: PNP SW	×	×	×	—	<a href="#">SEC-64</a>
B2605: PNP SW	×	×	×	—	<a href="#">SEC-66</a>
B2606: S/L RELAY	×	×	×	—	<a href="#">SEC-68</a>
B2607: S/L RELAY	×	×	×	—	<a href="#">SEC-69</a>
B2608: STARTER RELAY	×	×	×	—	<a href="#">SEC-71</a>
B2609: S/L STATUS	×	×	×	—	<a href="#">SEC-73</a>
B260A: IGNITION RELAY	×	×	×	—	<a href="#">PCS-49</a>
B260B: STEERING LOCK UNIT	—	×	×	—	<a href="#">SEC-77</a>
B260C: STEERING LOCK UNIT	—	×	×	—	<a href="#">SEC-78</a>
B260D: STEERING LOCK UNIT	—	×	×	—	<a href="#">SEC-79</a>
B260F: ENG STATE SIG LOST	×	×	×	—	<a href="#">SEC-80</a>
B2612: S/L STATUS	×	×	×	—	<a href="#">SEC-85</a>
B2614: ACC RELAY CIRC	—	×	×	—	<a href="#">PCS-51</a>
B2615: BLOWER RELAY CIRC	—	×	×	—	<a href="#">PCS-54</a>
B2616: IGN RELAY CIRC	—	×	×	—	<a href="#">PCS-57</a>
B2617: STARTER RELAY CIRC	×	×	×	—	<a href="#">SEC-89</a>
B2618: BCM	×	×	×	—	<a href="#">PCS-60</a>
B2619: BCM	×	×	×	—	<a href="#">SEC-91</a>
B261A: PUSH-BTN IGN SW	—	×	×	—	<a href="#">PCS-61</a>
B261E: VEHICLE TYPE	×	×	× (Turn ON for 15 seconds)	—	<a href="#">SEC-92</a>
B2621: INSIDE ANTENNA	—	×	—	—	<a href="#">DLK-61</a>
B2622: INSIDE ANTENNA	—	×	—	—	<a href="#">DLK-63</a>
B2623: INSIDE ANTENNA	—	×	—	—	<a href="#">DLK-65</a>
B26E8: CLUTCH SW	×	×	×	—	<a href="#">SEC-81</a>
B26E9: S/L STATUS	×	×	× (Turn ON for 15 seconds)	—	<a href="#">SEC-83</a>
B26EA: KEY REGISTRATION	—	×	× (Turn ON for 15 seconds)	—	<a href="#">SEC-84</a>
C1704: LOW PRESSURE FL	—	—	—	×	<a href="#">WT-17</a>
C1705: LOW PRESSURE FR	—	—	—	×	
C1706: LOW PRESSURE RR	—	—	—	×	
C1707: LOW PRESSURE RL	—	—	—	×	

A

B

C

D

E

F

G

H

I

J

K

DEF

M

N

O

P

## BCM (BODY CONTROL MODULE)

### < ECU DIAGNOSIS INFORMATION >

CONSULT display	Fail-safe	Freeze Frame Data •Vehicle Speed •Odo/Trip Meter •Vehicle condition	Intelligent Key warning lamp ON	Tire pressure monitor warning lamp ON	Refer- ence page
C1708: [NO DATA] FL	—	—	—	×	<a href="#">WT-19</a>
C1709: [NO DATA] FR	—	—	—	×	
C1710: [NO DATA] RR	—	—	—	×	
C1711: [NO DATA] RL	—	—	—	×	
C1712: [CHECKSUM ERR] FL	—	—	—	×	<a href="#">WT-22</a>
C1713: [CHECKSUM ERR] FR	—	—	—	×	
C1714: [CHECKSUM ERR] RR	—	—	—	×	
C1715: [CHECKSUM ERR] RL	—	—	—	×	
C1716: [PRESSDATA ERR] FL	—	—	—	×	<a href="#">WT-25</a>
C1717: [PRESSDATA ERR] FR	—	—	—	×	
C1718: [PRESSDATA ERR] RR	—	—	—	×	
C1719: [PRESSDATA ERR] RL	—	—	—	×	
C1720: [CODE ERR] FL	—	—	—	×	<a href="#">WT-27</a>
C1721: [CODE ERR] FR	—	—	—	×	
C1722: [CODE ERR] RR	—	—	—	×	
C1723: [CODE ERR] RL	—	—	—	×	
C1724: [BATT VOLT LOW] FL	—	—	—	×	<a href="#">WT-30</a>
C1725: [BATT VOLT LOW] FR	—	—	—	×	
C1726: [BATT VOLT LOW] RR	—	—	—	×	
C1727: [BATT VOLT LOW] RL	—	—	—	×	
C1729: VHCL SPEED SIG ERR	—	—	—	×	<a href="#">WT-33</a>
C1734: CONTROL UNIT	—	—	—	×	<a href="#">WT-35</a>

# RETRACTABLE HARD TOP CONTROL UNIT

< ECU DIAGNOSIS INFORMATION >

## RETRACTABLE HARD TOP CONTROL UNIT

Reference Value

INFOID:000000005175644

VALUES ON THE DIAGNOSIS TOOL

CONSULT-III MONITOR ITEM

Monitor Item	Condition	Status/Value	
LATCH LOCK SEN	State of roof latch	Lock	ON
		Other than above	OFF
		Roof latch lock sensor circuit is short	NG
LATCH STATE SEN	State of roof latch motor	Operate	ON ⇔ OFF
		Stop	ON or OFF
		Roof latch lock sensor circuit is short	NG
LATCH OUT(ULK)	Operation of roof latch motor	Unlock is in operation	ON
		Other than above	OFF
		Roof latch motor (UNLOCK) circuit is short	NG
LATCH OUT(LCK)	Operation of roof latch motor	Lock is in operation	ON
		Other than above	OFF
		Roof latch motor (LOCK) circuit is short	NG
LATCH VALUE	State of roof latch	Lock	0
		Halfway position	1-77
		Unlock	78 or more
LATCH LIMIT SW	State of roof latch	Roof is fully close and roof latch is in LOCK	CLOSE
		Other than above	OPEN
LATCH STATE	State of roof latch	Initialization is not complete	NG
		LOCK	CLOSE
		Halfway position	MID
		UNLOCK	OPEN
PS VALUE(DRAW)	State of parcel shelf	Top	Retractable hard top fully open state: 2246 Retractable hard top fully closed state: 2220
		Bottom	1000
PS VALUE(ROTA)	State of parcel shelf	Vertical	3190
		Horizontal	Retractable hard top fully open state: 1340 Retractable hard top fully closed state: 1000
PS OUT(UP)	Operation of parcel shelf	Up operation is in operation	ON
		Other than above	OFF
		Parcel shelf (UP) circuit is short	NG
PS OUT(DOWN)	Operation of parcel shelf	DOWN operation is in operation	ON
		Other than above	OFF
		Parcel shelf (DOWN) circuit is short	NG
PS OUT(VERT)	Operation of parcel shelf	Vertical operation is in operation	ON
		Other than above	OFF
		Parcel shelf (VERTICAL) circuit is short	NG

A

B

C

D

E

F

G

H

I

J

K

DEF

M

N

O

P

## RETRACTABLE HARD TOP CONTROL UNIT

### < ECU DIAGNOSIS INFORMATION >

Monitor Item	Condition		Status/Value
PS OUT(HORI)	Operation of parcel shelf	Horizontal operation is in operation	ON
		Other than above	OFF
		Parcel shelf (HORIZONTAL) circuit is short	NG
PS STATE(DRAW)	State of parcel shelf	For the details, refer to <a href="#">RF-38. "PARCEL SHELF FUNCTION : System Description"</a>	1-6
		State of parcel shelf status sensor (DRAW) is not recognized	NG
PS STATE(ROTA)	State of parcel shelf	For the details, refer to <a href="#">RF-38. "PARCEL SHELF FUNCTION : System Description"</a>	1-4
		State of parcel shelf status sensor (RO-TATE) is not recognized	NG
ROOF VALUE	Roof status sensor signal		0-1023
PUMP OUT(RH)	Operation of hydraulic pump motor	Turning clockwise	ON
		Other than above	OFF
		Hydraulic pump motor (RH) circuit is short	NG
PUMP OUT(LH)	Operation of hydraulic pump motor	Turning counterclockwise	ON
		Other than above	OFF
		Hydraulic pump motor (LH) circuit is short	NG
SWITCH VLV 1 OUT	Operation of switching valve 1	Operate	ON
		Stop	OFF
		Switching valve 1 circuit is short	NG
SWITCH VLV 2 OUT	Operation of switching valve 2	Operate	ON
		Stop	OFF
		Switching valve 2 circuit is short	NG
ROOF STATE	State of roof	For the details, refer to <a href="#">RF-16. "System Description"</a>	1-42
		State of roof is not recognized	NG
HYDRAULIC STATE	State of hydraulic system	For the details, refer to <a href="#">RF-27. "HYDRAULIC SYSTEM CONTROL FUNCTION : System Description"</a>	1-22
		State of hydraulic system is not recognized	NG
ROOF SW(OPEN)	State of roof open/close switch	OPEN operation is in operation	ON
		Other than above	OFF
ROOF SW(CLOSE)	State of roof open/close switch	CLOSE operation is in operation	ON
		Other than above	OFF
ROOF LINK STATE	State of roof link	For the details, refer to <a href="#">RF-27. "HYDRAULIC SYSTEM CONTROL FUNCTION : System Description"</a>	1-8
		State of roof is not recognized	NG
TRUNK LINK SEN(RH)	State of trunk link lock (RH)	LOCK	ON
		Other than above	OFF
		Trunk link lock (RH) circuit is short or open	NG
TRUNK LINK SEN(LH)	State of trunk link lock (LH)	LOCK	ON
		Other than above	OFF
		Trunk link lock (LH) circuit is short or open	NG
TR ROOM LAMP SW	State of trunk lid (trunk room lamp switch)	Open	ON
		Other than above	OFF

# RETRACTABLE HARD TOP CONTROL UNIT

## < ECU DIAGNOSIS INFORMATION >

Monitor Item	Condition		Status/Value	
TRUNK STATUS SEN	State of trunk lid	Fully OPEN	ON	A
		Other than above	OFF	
		Trunk status sensor circuit is short or open	NG	B
TRUNK OPEN OUT	Operation of trunk lid opener actuator	OPEN operation is in operation	ON	
		Other than above	OFF	C
		Trunk lid opener actuator circuit is short	NG	
FLPD LIMIT SW(DWN)	State of flipper door	Both of flipper door (LH/RH) are in DOWN position	ON	D
		Other than above	OFF	
FLPD LIMIT SW(UP)	State of flipper door	Both of flipper door (LH/RH) are in UP position	ON	E
		Other than above	OFF	
FLPD OUT(UP)	Operation of flipper door	UP operation is in operation	ON	F
		Other than above	OFF	
		Flipper door motor (UP) circuit is short	NG	
FLPD OUT(DWN)	Operation of flipper door	DOWN operation is in operation	ON	G
		Other than above	OFF	
		Flipper door motor (DOWN) circuit is short	NG	
FLPD STATE	State of flipper door	For the details, refer to <a href="#">RF-44, "FLIPPER DOOR FUNCTION : System Description"</a>	1, 2, 4	H
		State of flipper door is not recognized	NG	
R WIN LH OUT(UP)	Operation of rear power window (LH)	UP operation is in operation	ON	I
		Other than above	OFF	
		Rear power window LH (UP) circuit is short	NG	J
R WIN LH OUT(DWN)	Operation of rear power window (LH)	DOWN operation is in operation	ON	
		Other than above	OFF	K
		Rear power window LH (DOWN) circuit is short	NG	
R WIN RH OUT(UP)	Operation of rear power window (RH)	UP operation is in operation	ON	DEF
		Other than above	OFF	
		Rear power window RH (UP) circuit is short	NG	
R WIN RH OUT(DWN)	Operation of rear power window (RH)	DOWN operation is in operation	ON	M
		Other than above	OFF	
		Rear power window RH (DOWN) circuit is short	NG	
REAR DEF ON SIG	State of rear window defogger switch	While operating	ON	N
		Stop	OFF	
REAR DEF OUT	State of rear window defogger system	Operate	ON	O
		Stop	OFF	
		Rear window defogger circuit is short	NG	P
R WIN CURENT(LH)	Current value to rear power window motor (LH)		0-25.5 (A)	
R WIN CURENT(RH)	Current value to rear power window motor (RH)		0-25.5 (A)	
RR WIN STATE(LH)	State of rear power window (LH)	Upper	UP	
		Halfway	MID	
		Lower end	DOWN	

# RETRACTABLE HARD TOP CONTROL UNIT

## < ECU DIAGNOSIS INFORMATION >

Monitor Item	Condition	Status/Value	
RR WIN STATE(RH)	State of rear power window (RH)	Upper	UP
		Halfway	MID
		Lower end	DOWN
RAP SIGNAL	State of RAP	Operate	ON
		Stop	OFF
TR MODE SIGNAL	State of trunk mode signal	Output	ON
		Stop	OFF
ROOF STATE(AUDIO)	State of roof	State of fully open	ON
		Other than above	OFF
		Roof state signal (audio) circuit is short	NG
ROOF BUZZER OUT	State of roof warning buzzer	Operate	ON
		Stop	OFF
		Roof warning buzzer circuit is short	NG
LOCAL COMM 1	State of local communication 1	Normal	OK
		It is in sleep mode	SLEEP
		Communication error	NG
LOCAL COMM 2	State of local communication 2	Normal	OK
		It is in sleep mode	SLEEP
		Communication error	NG
ROOF MODE	Roof operation mode	Normal	OK
		Only close operation is possible	CLOSE
		Operation is stop	STOP
		Operation is inhibited	NG
POP-UP BAR DPLOY	State of pop-up bar	Normal	OK
		State of deployment	NG
POP-UP BAR DIAG	Self-diagnosis result of pop-up bar	Normal	OK
		Malfunctioning is detected	NG
SWITCH VLV COND	Diagnosis result of retractable hard top control unit	Diagnosis result of retractable hard top control unit	OK
		Switching valve (1/2) system is malfunctioning	NG
PWR SOURCE COND	Power supply voltage state of retractable hard top control unit	Normal	OK
		Malfunction	NG
CPU COND	Diagnosis result of retractable hard top control unit	CPU is normal	OK
		CPU is not normal	NG
ROOF COND	Diagnosis result of retractable hard top control unit	Roof position is normal	OK
		Roof position is not normal	NG
SENSOR COND	Diagnosis result of retractable hard top control unit	Hole sensor system is normal	OK
		Hole sensor system is not normal	NG
IGN ON SIG(BCM)	Power position signal (via CAN from BCM)	ON	OK
		Other than above	NG
VHCL STOP-METER	Vehicle speed signal (via CAN from meter and A/C amp.)	0km/h	OK
		Other than above	NG



# RETRACTABLE HARD TOP CONTROL UNIT

## < ECU DIAGNOSIS INFORMATION >

Monitor Item	Condition	Status/Value
CIRCUIT COND	Diagnosis result of retractable hard top control unit	Circuit system is normal OK
		Circuit system is not normal NG
ROOF TIMEOUT	State of roof operation	Normal OK
		Malfunction NG
CAN COMM	CAN communication status	Normal OK
		Malfunction NG
THERMO PROTECT 1	Thermo protection (Stage1)	In non-operation OK
		In operation NG
SHIFT R SIG	Shift position	Other than R position OK
		R position NG
PRMIT ENG ST(BCM)	Permit engine start signal	Signal is not received OK
		Signal is in receiving NG
THERMO PROTECT-2	Thermo protection (Stage2)	In non-operation OK
		In operation NG
TONNEAU SW	Tonneau board	Set OK
		Other than above NG
BRK LAMP SW(BCM)	Brake lamp switch signal (via CAN from BCM)	Brake is depressed OK
		Brake is released NG
THERMO VALUE	Conversion value of thermo protection	0-65535
PWR SOURCE VALUE	Power supply voltage value of retractable hard top control unit	0-20 (V)
ROOF INITIAL(OPEN)	State of performing roof position initialization	Registration of full open position is complete OK
		Registration of full open position is not complete NG
ROOF INITIAL(CLOSE)	State of performing roof position initialization	Registration of full closed position is complete OK
		Registration of full closed position is not complete NG
PSHELF INITIAL(ROTA)	State of performing parcel shelf position initialization	Registration of rotation position is complete OK
		Registration of rotation position is not complete NG
PSHELF INITIAL(DRAW)	State of performing parcel shelf position initialization	Registration of draw position is complete OK
		Registration of draw position is not complete NG

## TERMINAL LAYOUT

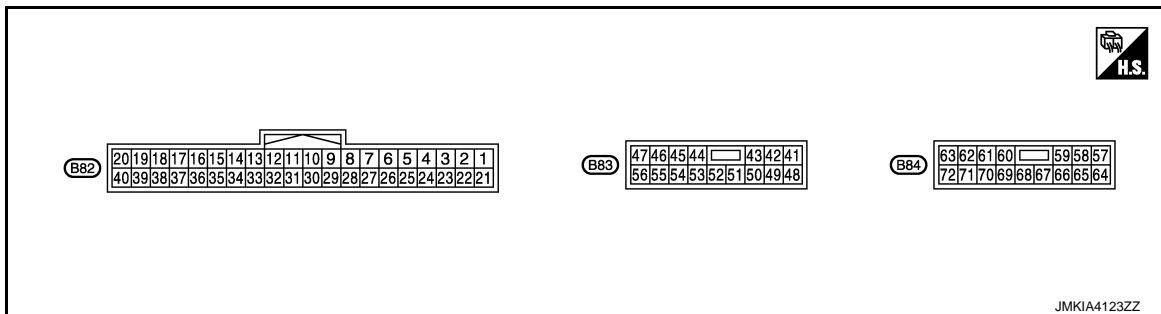

## PHYSICAL VALUES

# RETRACTABLE HARD TOP CONTROL UNIT

## < ECU DIAGNOSIS INFORMATION >

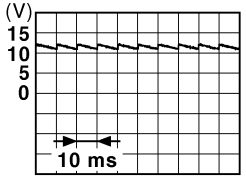
Terminal No. (Wire color)		Description		Condition			Value (Approx.)
+	-	Signal name	Input/ Output				
1 (G)	Ground	Roof open/close switch (OPEN)	Input	Ignition switch ON	Roof open/close switch (OPEN)	Pressed	0 V
						Released	Battery voltage
2 (BR)	Ground	Roof open/close switch (CLOSE)	Input	Ignition switch ON	Roof open/close switch (CLOSE)	Pressed	0 V
						Released	Battery voltage
3 (B)	Ground	Roof open/close switch ground	—	Ignition switch ON	—		0 V
4 (L)	Ground	Tonneau board switch	Input	Ignition switch ON	Tonneau board	Hooked	Battery voltage
						Released	0 V
5 (SB)	Ground	Trunk room lamp switch	Input	Ignition switch ON	Trunk lid	Locked	
						Other than above	0 V
6 (L)	Ground	Roof latch limit switch	Input	Ignition switch ON	Roof	Close	0 V
						Other than above	Battery voltage
7 (W)	Ground	Flipper door limit switch (UP)	Input	Ignition switch ON	Flipper door LH and RH	Top	0 V
						Other than above	Battery voltage
8 (G)	Ground	Flipper door limit switch (DOWN)	Input	Ignition switch ON	Flipper door LH and RH	Bottom	0 V
						Other than above	Battery voltage
11 (W)	Ground	RAP signal	Input	Ignition switch ON	RAP function	Active	Battery voltage
						Inactive	0 V
12 (Y)	Ground	Back up lamp signal	Input	Ignition switch ON	Shift position	R position	Battery voltage
						Other than above	0 V
13 (O)	Ground	Sensor power supply	Output	Ignition switch OFF	—		5 V
14 (P)	Ground	Trunk link sensor (LH)	Input	Ignition switch ON	Trunk link lock (LH)	LOCK	0.3 V
						Other than above	1.5 V
15 (SB)	Ground	Trunk link sensor (RH)	Input	Ignition switch ON	Trunk link lock (RH)	LOCK	0.3 V
						Other than above	1.5 V

# RETRACTABLE HARD TOP CONTROL UNIT

## < ECU DIAGNOSIS INFORMATION >

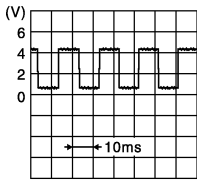
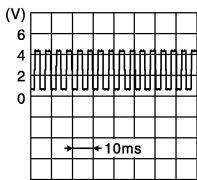
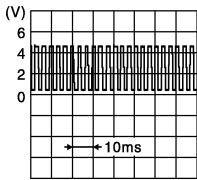
Terminal No. (Wire color)		Description		Condition			Value (Approx.)
+	-	Signal name	Input/ Output				
16 (GR)	Ground	Roof latch status sensor	Input	Ignition switch ON	Roof latch	Operate	 <small>JMKIA4021GB</small>
						Stop	0.5 or 4.5 V
17 (G)	Ground	Roof latch lock sensor	Input	Ignition switch ON	Roof latch	LOCK	1.0 V
						Other than above	3.8 V
18 (LG)	Ground	Trunk status sensor	Input	Ignition switch ON	Trunk lid (front)	Fully open	1.0 V
						Other than above	3.8 V
22 (V)	Ground	Roof status sensor power supply	Output	Ignition switch ON	—		5 V
23 (B)	Ground	Roof status sensor ground	—	Ignition switch ON	—		0 V
24 (GR)	Ground	Parcel shelf status sensor (DRAW)	Input	Ignition switch ON	Parcel shelf motor (DRAW)	Active	 <small>JMKIA4022GB</small>
						Inactive	0.5 V or 5 V
25 (R)	Ground	Parcel shelf status sensor (ROTATION)	Input	Ignition switch ON	Parcel shelf motor (ROTATE)	Active	 <small>JMKIA4023GB</small>
						Inactive	0.5 V or 5 V
26 (P)	Ground	Roof status sensor signal	Input	Ignition switch ON	Roof	Fully close→Fully open	0.5 V→5 V
27 (Y)	Ground	Trunk lid open request signal (BCM)	Output	—	Trunk opener	Operate	0 V →Battery voltage →0 V
						Other than above	0 V
28 (O)	Ground	Flipper door motor ground	—	Ignition switch ON	—		0 V

A  
B  
C  
D  
E  
F  
G  
H  
I  
J  
K  
DEF  
M  
N  
O  
P

# RETRACTABLE HARD TOP CONTROL UNIT

## < ECU DIAGNOSIS INFORMATION >

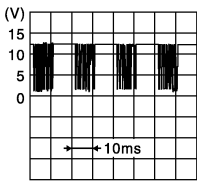
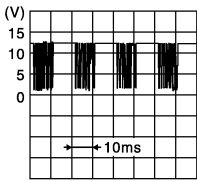
Terminal No. (Wire color)		Description		Condition		Value (Approx.)	
+	-	Signal name	Input/ Output				
29 (V)	Ground	Local communication (BCM)	Input/ Output	Ignition switch ON	—	 <p style="text-align: right; font-size: small;">JMKIA4024GB</p>	
30 (GR)	Ground	Local communication (POWER WINDOW)	Input/ Output	Ignition switch ON	—	 <p style="text-align: right; font-size: small;">JMKIA4024GB</p>	
31 (L)	Ground	CAN-H	Input/ Output	—	—	—	
32 (P)	Ground	CAN-L	Input/ Output	—	—	—	
33 (V)	Ground	Roof status signal (AUDIO)	Output	Ignition switch ON	Retractable hard top	Fully open	Battery voltage
						Other than above	0 V
34 (R)	Ground	Roof status signal (TRUNK)	Input	Ignition switch ON	Trunk	Fully close	Battery voltage
							Other than above
35 (B)	Ground	Roof warning buzzer	Output	Ignition switch ON	Roof warning buzz- er	Sounds	0 V
							Not sounds
36 (Y)	Ground	Hydraulic pump relay (RH)	—	Ignition switch ON	Hydraulic pump mo- tor (RH)	Active	0 V
							Inactive
37 (W)	Ground	Hydraulic pump relay (LH)	—	Ignition switch ON	Hydraulic pump mo- tor (LH)	Active	0 V
							Inactive
38 (BR)	Ground	Hydraulic pump relay ground	—	Ignition switch ON	—	0 V	
41 (SB)	Ground	Parcel shelf motor (UP)	Output	Ignition switch ON	Parcel shelf motor (DRAW-UP)	Active	Battery voltage
							Inactive
42 (W)	Ground	Parcel shelf motor (DOWN)	Output	Ignition switch ON	Parcel shelf motor (DRAW-DOWN)	Active	Battery voltage
							Inactive
43 (BR)	Ground	Hydraulic pump pow- er supply relay	Output	Ignition switch ON	Retractable hard top system	Active	Battery voltage
							Inactive
44 (R)	Ground	Parcel shelf motor (HORIZONTAL)	Output	Ignition switch ON	Parcel shelf motor (ROTATION-HORI- ZONTAL)	Active	Battery voltage
							Inactive
45 (BR)	Ground	Parcel shelf motor (VERTICAL)	Output	Ignition switch ON	Parcel shelf motor (ROTATION-VER- TICAL)	Active	Battery voltage
							Inactive

# RETRACTABLE HARD TOP CONTROL UNIT

## < ECU DIAGNOSIS INFORMATION >

Terminal No. (Wire color)		Description		Condition			Value (Approx.)
+	-	Signal name	Input/ Output				
46 (G)	Ground	Flipper door motor (UP)	Output	Ignition switch ON	Flipper door motor (UP)	Active	Battery voltage
						Inactive	0 V
47 (L)	Ground	Flipper door motor (DOWN)	Output	Ignition switch ON	Flipper door motor (DOWN)	Active	Battery voltage
						Inactive	0 V
48 (R)	Ground	Roof latch motor (OPEN)	Output	Ignition switch ON	Roof latch motor (OPEN)	Active	Battery voltage
						Inactive	0 V
49 (Y)	Ground	Roof latch motor (CLOSE)	Output	Ignition switch ON	Roof latch motor (CLOSE)	Active	Battery voltage
						Inactive	0 V
51 (SB)	Ground	Trunk lid opener ac- tuator	Output	—	Trunk lid opener	Operate	0 V → Battery voltage → 0 V
						Stop	0 V
52 (V)	Ground	Trunk lid opener ac- tuator ground	—	Ignition switch ON	—		0 V
53 (O)	Ground	Rear power window motor LH (UP)	Output	Ignition switch ON	Rear power window motor LH (UP)	Active	Battery voltage
						Inactive	0 V
54 (LG)	Ground	Rear power window motor LH (DOWN)	Output	Ignition switch ON	Rear power window motor LH (DOWN)	Active	Battery voltage
						Inactive	0 V
55 (GR)	Ground	Rear power window motor RH (UP)	Output	Ignition switch ON	Rear power window motor RH (UP)	Active	Battery voltage
						Inactive	0 V
56 (P)	Ground	Rear power window motor RH (DOWN)	Output	Ignition switch ON	Rear power window motor RH (DOWN)	Active	Battery voltage
						Inactive	0 V
57 (Y)	Ground	Power source (ROOF)	Input	—	—		Battery voltage
58 (Y)	Ground	Power source (ROOF)	Input	—	—		Battery voltage
59 (Y)	Ground	Power source (ROOF)	Input	—	—		Battery voltage
60 (B)	Ground	Ground (ROOF)	—	Ignition switch ON	—		0 V
61 (B)	Ground	Ground (ROOF)	—	Ignition switch ON	—		0 V
62 (GR)	Ground	Power source (POWER WINDOW)	Input	—	—		Battery voltage
63 (Y)	Ground	Power source (POWER WINDOW)	Input	—	—		Battery voltage
64 (B)	Ground	Ground (POWER WINDOW)	—	Ignition switch ON	—		0 V
65 (B)	Ground	Ground (POWER WINDOW)	—	Ignition switch ON	—		0 V

A  
B  
C  
D  
E  
F  
G  
H  
I  
J  
K  
DEF  
M  
N  
O  
P

## RETRACTABLE HARD TOP CONTROL UNIT

### < ECU DIAGNOSIS INFORMATION >

Terminal No. (Wire color)		Description		Condition			Value (Approx.)
+	-	Signal name	Input/ Output				
66 (P)	Ground	Switching valve 1	Output	Ignition switch ON	Switching valve 1	Active	Battery voltage
						Inactive	0 V
67 (SB)	Ground	Switching valve 2	Output	Ignition switch ON	Switching valve 2	Active	Battery voltage
						Inactive	0 V
68 (L)	Ground	Switching valve ground	—	Ignition switch ON	—		0 V
69 (G)	Ground	Power source (REAR WINDOW DEFOGGER)	Input	—	—		Battery voltage
70 (P)	Ground	Power source (REAR WINDOW DEFOGGER)	Input	—	—		Battery voltage
71 (BR)	Ground	Rear window defog- ger power supply	Output	Ignition switch ON	Rear defogger switch ON and roof is fully closed		Battery voltage
72 (W)	Ground	Rear window defog- ger power supply	Output	Ignition switch ON	Rear defogger switch ON and roof is fully closed		Battery voltage

# RETRACTABLE HARD TOP CONTROL UNIT

< ECU DIAGNOSIS INFORMATION >

## Wiring Diagram - RETRACTABLE HARD TOP SYSTEM -

INFOID:000000005175645

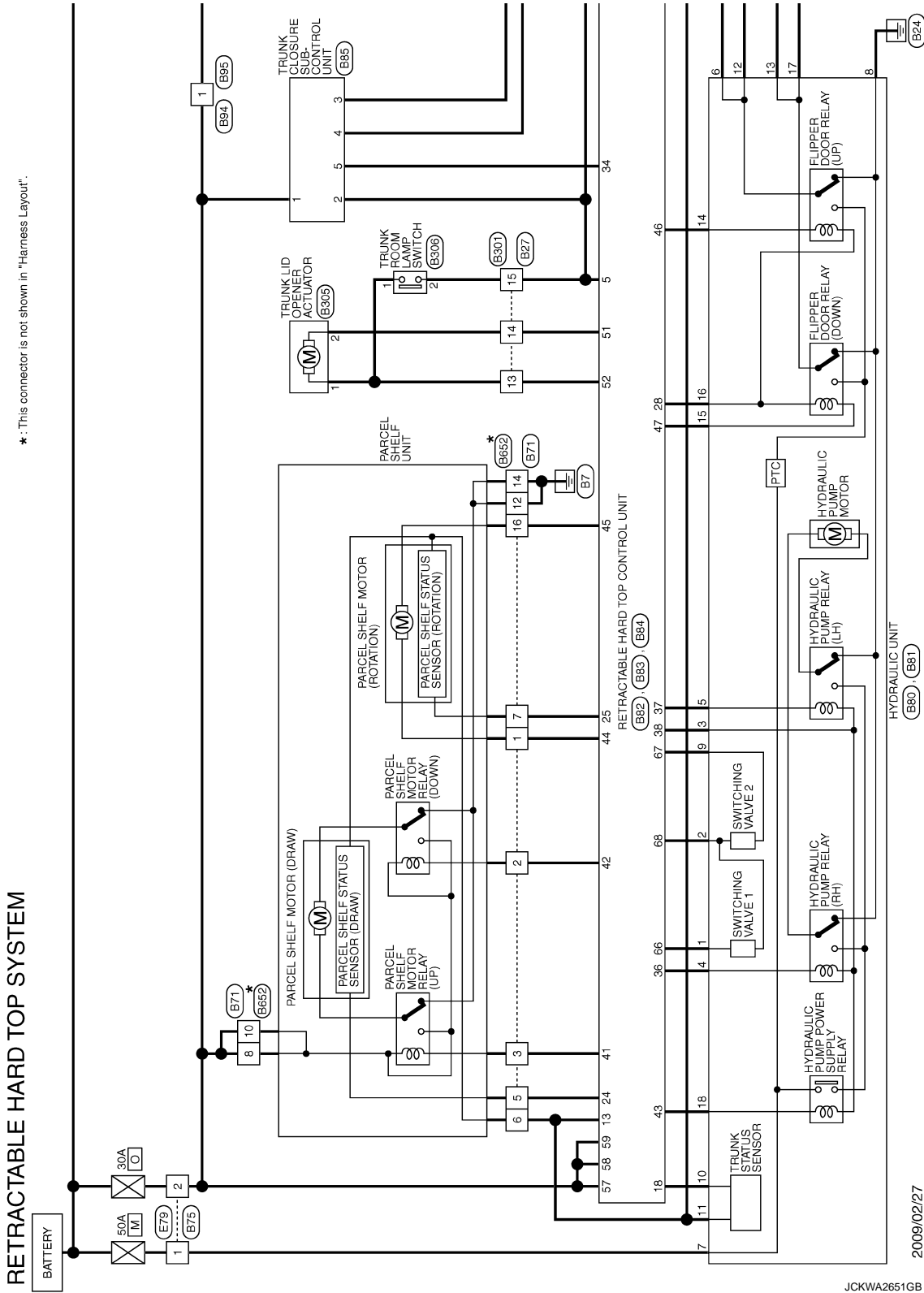

RETRACTABLE HARD TOP SYSTEM

\*: This connector is not shown in "Harness Layout".

2009/02/27

JCKWA2651GB

A  
B  
C  
D  
E  
F  
G  
H  
I  
J  
K  
L  
M  
N  
O  
P

DEF

# RETRACTABLE HARD TOP CONTROL UNIT

< ECU DIAGNOSIS INFORMATION >

\*: This connector is not shown in "Harness Layout".

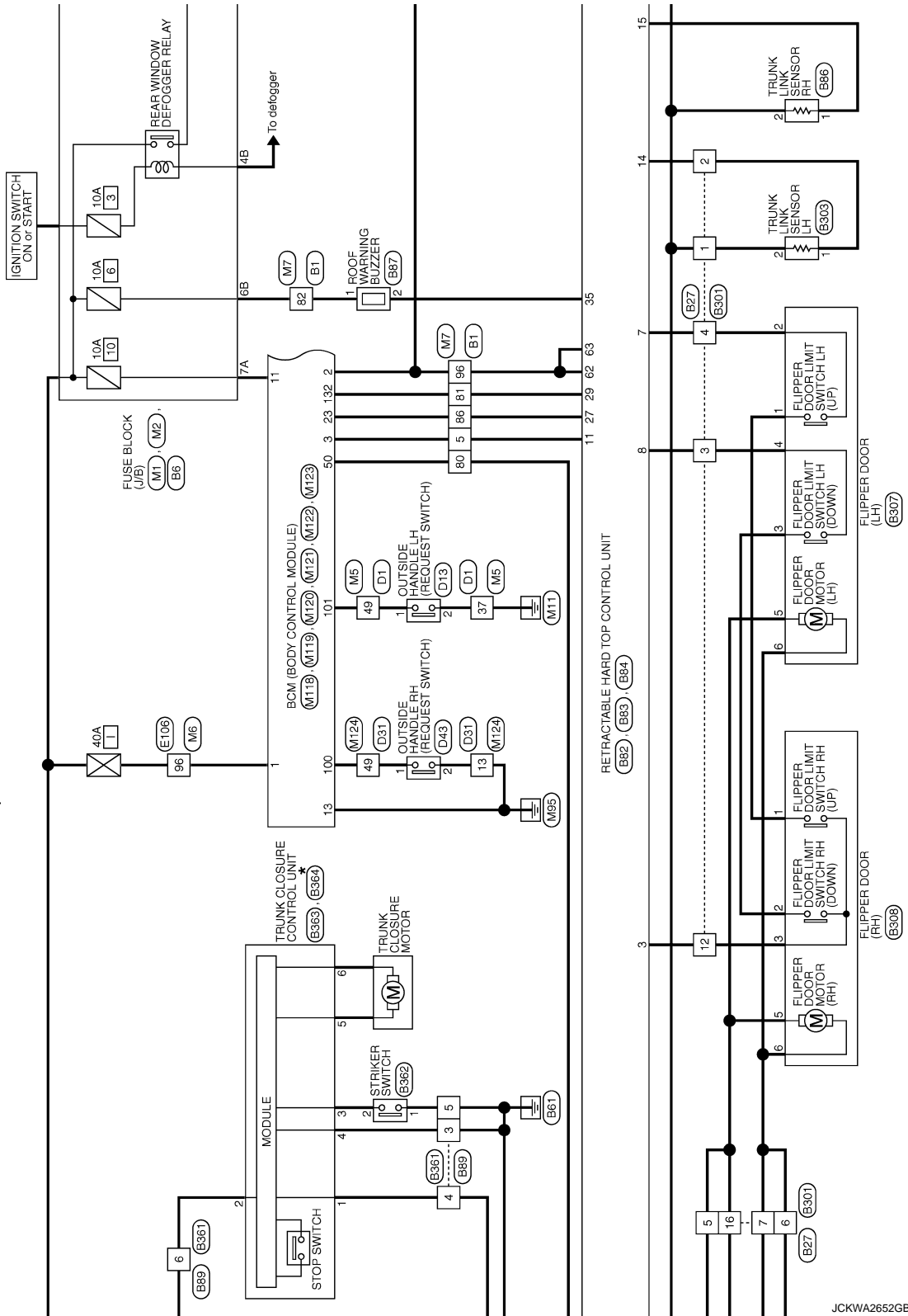

JCKWA2652GB



# RETRACTABLE HARD TOP CONTROL UNIT

< ECU DIAGNOSIS INFORMATION >

A : With A/T  
M : With M/T

\*: This connector is not shown in "Harness Layout".

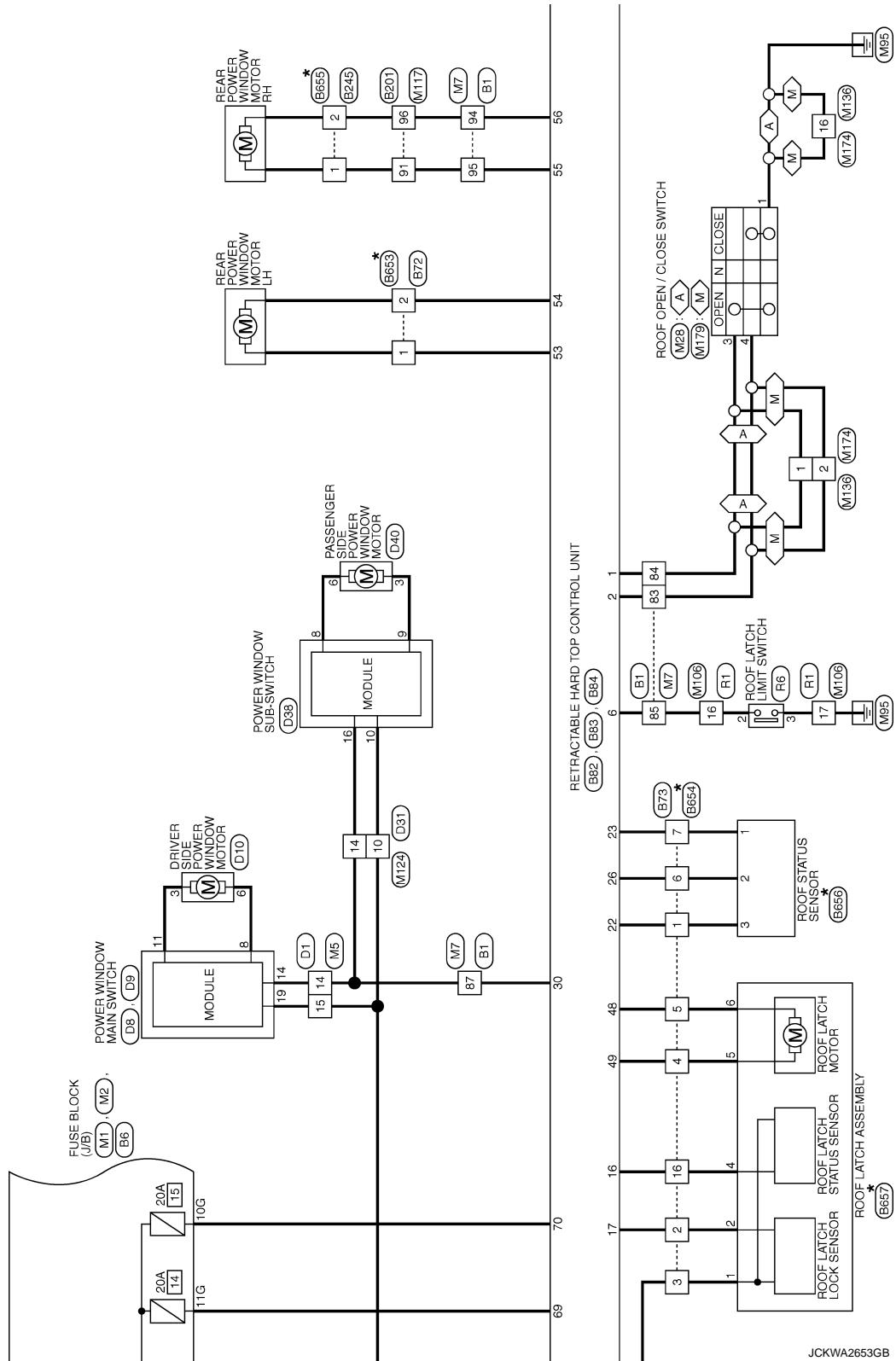

A  
B  
C  
D  
E  
F  
G  
H  
I  
J  
K  
DEF  
M  
N  
O  
P

# RETRACTABLE HARD TOP CONTROL UNIT

< ECU DIAGNOSIS INFORMATION >

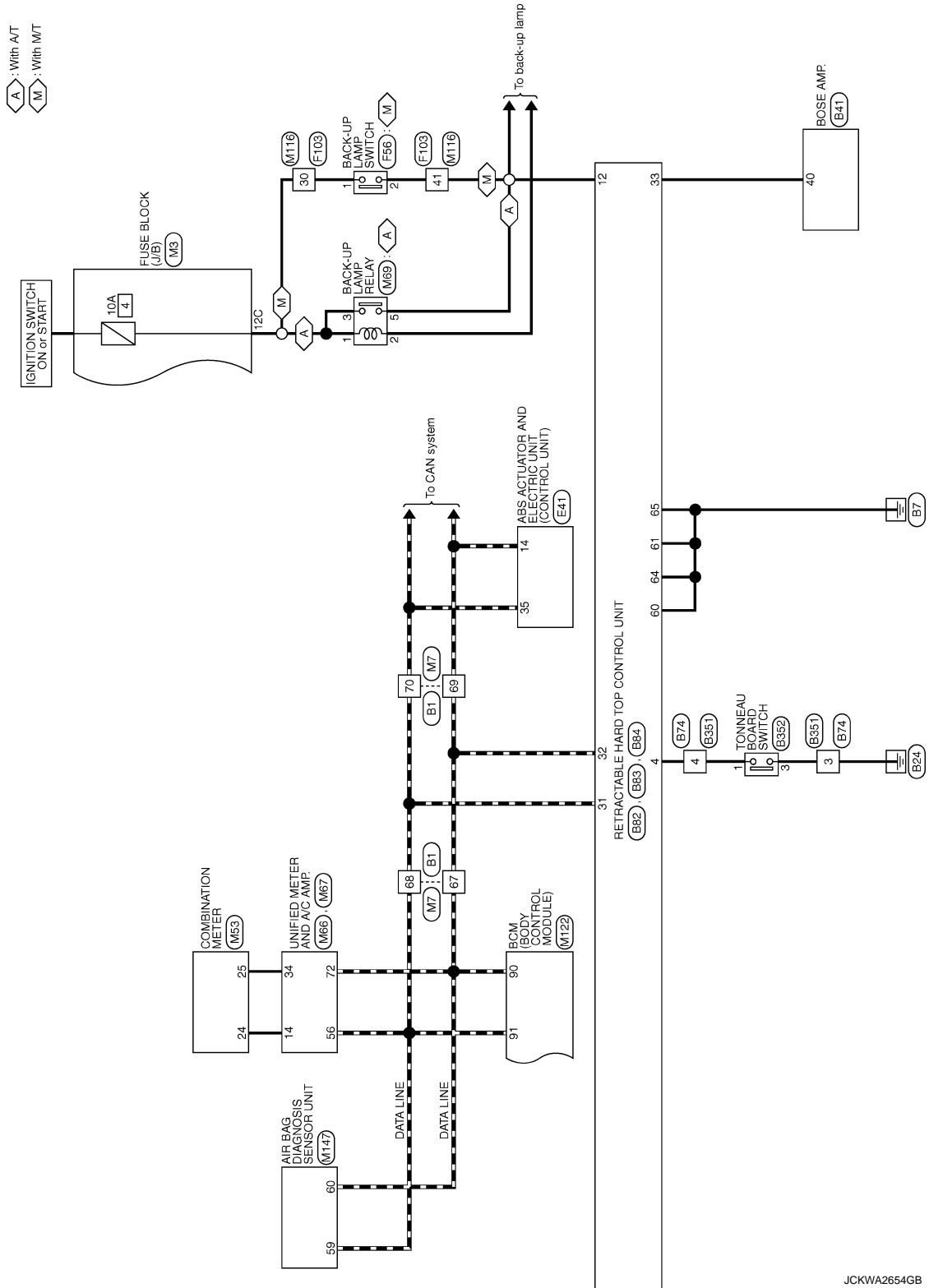

JCKWA2654GB

# RETRACTABLE HARD TOP CONTROL UNIT

< ECU DIAGNOSIS INFORMATION >

## RETRACTABLE HARD TOP SYSTEM

Connector No.	B1
Connector Name	WIRE TO WIRE
Connector Type	TH8DFW-CS16-TM4

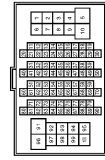

Terminal No.	Color of Wire	Signal Name [Specification]
5	W	-
67	P	-
68	L	-
69	P	-
70	L	-
80	G	-
81	V	-
82	R	-
83	BR	-
84	G	-
85	L	-

Connector No.	B27
Connector Name	WIRE TO WIRE
Connector Type	MS16MW-CS



Terminal No.	Color of Wire	Signal Name [Specification]
1	O	-
2	P	-
3	G	-
4	W	-
5	R	-
6	P	-
7	GR	-
12	B	-
13	V	-
14	SB	-
15	L	-

86	Y	-
87	GR	-
84	P	-
95	GR	-
96	GR	-

Connector No.	B6
Connector Name	FUSE BLOCK (J/B)
Connector Type	NS12FBR-CS

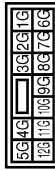

Terminal No.	Color of Wire	Signal Name [Specification]
10G	P	-
11G	G	-

Connector No.	B41
Connector Name	BOSE AMP.
Connector Type	TH4DFW-NH



Terminal No.	40	V	ROOF STATUS SIGNAL (AUDIO)
--------------	----	---	----------------------------

Connector No.	B71
Connector Name	WIRE TO WIRE
Connector Type	NS16FBR-CS



Terminal No.	Color of Wire	Signal Name [Specification]
1	R	-
2	W	-
3	SB	-
5	GR	-
6	O	-
7	R	-
8	Y	-
10	LG	-
12	P	-
14	W	-
16	BR	-

JCKWA2655GB

A  
B  
C  
D  
E  
F  
G  
H  
I  
J  
K  
DEF  
M  
N  
O  
P

# RETRACTABLE HARD TOP CONTROL UNIT

< ECU DIAGNOSIS INFORMATION >

## RETRACTABLE HARD TOP SYSTEM

Connector No.	B72
Connector Name	WIRE TO WIRE
Connector Type	NSD2MW-CS



Terminal No.	Color of Wire	Signal Name [Specification]
1	O	-
2	LG	-

Connector No.	B73
Connector Name	WIRE TO WIRE
Connector Type	NS16FGY-CS

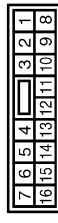

Terminal No.	Color of Wire	Signal Name [Specification]
1	V	-
2	G	-
3	O	-
4	Y	-
5	R	-
6	P	-
7	B	-
16	GR	-

Connector No.	B74
Connector Name	WIRE TO WIRE
Connector Type	1H04MM-NH



Terminal No.	Color of Wire	Signal Name [Specification]
3	B	-
4	L	-

Connector No.	B75
Connector Name	WIRE TO WIRE
Connector Type	M02MW-LC



Terminal No.	Color of Wire	Signal Name [Specification]
1	Y	-
2	Y	-

Connector No.	B80
Connector Name	HYDRAULIC UNIT
Connector Type	NS16FW-CS



Terminal No.	Color of Wire	Signal Name [Specification]
1	P	-
2	L	-
3	BR	-
4	Y	-
5	W	-
6	R	-
9	SB	-
10	LG	-
11	O	-
12	V	-
13	GR	-

Connector No.	B81
Connector Name	HYDRAULIC UNIT
Connector Type	L02FB-MC



Terminal No.	Color of Wire	Signal Name [Specification]
7	Y	-
8	B	-

JCKWA2656GB

# RETRACTABLE HARD TOP CONTROL UNIT

## < ECU DIAGNOSIS INFORMATION >

### RETRACTABLE HARD TOP SYSTEM

Connector No.	B32
Connector Name	RETRACTABLE HARD TOP CONTROL UNIT
Connector Type	TH04FW-NH



Terminal No.	Color of Wire	Signal Name [Specification]
1	G	ROOF OPEN/CLOSE SWITCH (OPEN)
2	BR	ROOF OPEN/CLOSE SWITCH (CLOSE)
3	B	FLIPPER DOOR LIMIT SWITCH GND
4	L	TONNEAU BOARD SWITCH
5	SB	TRUNK ROOM LAMP SWITCH
6	L	ROOF LATCH LIMIT SWITCH
7	W	FLIPPER DOOR LIMIT SWITCH (UP)
8	G	FLIPPER DOOR LIMIT SWITCH (DOWN)
11	W	RETAINED ACC POWER
12	Y	REVERSE SIGNAL
13	O	PARCEL SHELF STATUS SENSOR POWER SUPPLY

Connector No.	B34
Connector Name	RETRACTABLE HARD TOP CONTROL UNIT
Connector Type	NS16FW-CS



Terminal No.	Color of Wire	Signal Name [Specification]
57	Y	BAT
58	Y	BAT
59	Y	BAT
60	B	GND
61	B	GND
62	GR	BAT (POWER WINDOW)
63	Y	BAT (POWER WINDOW)
64	B	GND (POWER WINDOW)
65	B	GND (POWER WINDOW)
66	P	SWITCHING VALVE 1
67	SB	SWITCHING VALVE 2

14	P	TRUNK LINK SENSOR SIGNAL (LH)
15	SR	TRUNK LINK SENSOR SIGNAL (RH)
16	GR	ROOF LATCH STATUS SENSOR SIGNAL
17	G	ROOF LATCH LOCK SENSOR SIGNAL
18	LG	TRUNK STATUS SENSOR SIGNAL
22	V	ROOF STATUS SENSOR POWER SUPPLY
23	B	ROOF STATUS SENSOR GND
24	GR	PARCEL SHELF STATUS SENSOR SIGNAL (DRAW)
25	R	PARCEL SHELF STATUS SENSOR SIGNAL (ROTATION)
26	P	ROOF STATUS SENSOR SIGNAL
27	Y	TRUNK LID OPEN REQUEST SIGNAL
28	O	FLIPPER DOOR RELAY GND
29	V	LOCAL COMMUNICATION (BCM)
30	GR	LOCAL COMMUNICATION (POWER WINDOW)
31	L	CAN-H
32	P	CAN-L
33	V	ROOF STATUS SIGNAL (AUDIO)
34	R	ROOF STATUS SIGNAL (TRUNK)
35	B	ROOF WARNING BUZZER
36	Y	HYDRAULIC MOTOR RELAY (RH)
37	W	HYDRAULIC MOTOR RELAY GND (LH)
38	BR	HYDRAULIC MOTOR RELAY POWER SUPPLY

68	L	SWITCHING VALVE GND
69	G	REAR WINDOW DEF IN 2
70	P	REAR WINDOW DEF IN 1

Connector No.	B33
Connector Name	RETRACTABLE HARD TOP CONTROL UNIT
Connector Type	NS16FBR-CS



Terminal No.	Color of Wire	Signal Name [Specification]
41	SB	PARCEL SHELF MOTOR RELAY (UP)
42	W	PARCEL SHELF MOTOR RELAY GND (DOWN)
43	BR	HYDRAULIC PUMP POWER SUPPLY RELAY
44	R	MOTOR PARCEL SHELF (HORIZONTAL)
45	BR	MOTOR PARCEL SHELF (VERTICAL)
46	G	FLIPPER DOOR RELAY POWER SUPPLY (UP)
47	L	FLIPPER DOOR RELAY POWER SUPPLY (DOWN)
48	R	ROOF LATCH MOTOR (OPEN)
49	Y	ROOF LATCH MOTOR (CLOSE)
51	SB	TRUNK OPENER ACTUATOR
52	V	TRUNK OPENER ACTUATOR GND

Connector No.	B35
Connector Name	TRUNK CLOSURE SUB-CONTROL UNIT
Connector Type	NS06FW-CS

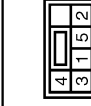

Terminal No.	Color of Wire	Signal Name [Specification]
1	Y	BAT
2	SB	TRUNK ROOM LAMP SWITCH
3	P	CLOSURE CONTROL SIGNAL
4	B	GND
5	R	TRUNK MODE SIGNAL

53	O	REAR POWER WINDOW MOTOR LH (UP)
54	LG	REAR POWER WINDOW MOTOR LH (DOWN)
55	GR	REAR POWER WINDOW MOTOR RH (UP)
56	P	REAR POWER WINDOW MOTOR RH (DOWN)

Connector No.	B36
Connector Name	TRUNK LINK SENSOR RH
Connector Type	TH04FW-NH

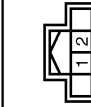

Terminal No.	Color of Wire	Signal Name [Specification]
1	SB	-
2	O	-

JCKWA2657GB

A  
B  
C  
D  
E  
F  
G  
H  
I  
J  
K  
DEF  
M  
N  
O  
P

# RETRACTABLE HARD TOP CONTROL UNIT

< ECU DIAGNOSIS INFORMATION >

## RETRACTABLE HARD TOP SYSTEM

Connector No.	B37
Connector Name	ROOF WARNING BUZZER
Connector Type	RK02EBR



Terminal No.	Color of Wire	Signal Name [Specification]
1	R	
2	B	

Connector No.	B89
Connector Name	WIRE TO WIRE
Connector Type	NS08MW-CS

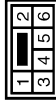

Terminal No.	Color of Wire	Signal Name [Specification]
3	B	
4	P	
5	B	
6	Y	

Connector No.	B04
Connector Name	WIRE TO WIRE
Connector Type	M01MW-LG



Terminal No.	Color of Wire	Signal Name [Specification]
1	Y	

Connector No.	B05
Connector Name	WIRE TO WIRE
Connector Type	M01FW-LG



Terminal No.	Color of Wire	Signal Name [Specification]
1	Y	

Connector No.	B201
Connector Name	WIRE TO WIRE
Connector Type	TH00FW-CS16-TM4



Terminal No.	Color of Wire	Signal Name [Specification]
91	GR	
96	P	

Connector No.	B245
Connector Name	WIRE TO WIRE
Connector Type	NS02MW-CS



Terminal No.	Color of Wire	Signal Name [Specification]
1	GR	
2	P	

Connector No.	B001
Connector Name	WIRE TO WIRE
Connector Type	NS16FW-CS



Terminal No.	Color of Wire	Signal Name [Specification]
1	R	
2	GR	
3	G	
4	W	
5	Y	
6	P	
7	P	
12	B	
13	V	
14	BR	
15	L	

Terminal No.	16	Y	
--------------	----	---	--

JCKWA2658GB

# RETRACTABLE HARD TOP CONTROL UNIT

< ECU DIAGNOSIS INFORMATION >

## RETRACTABLE HARD TOP SYSTEM

Connector No.	B303
Connector Name	TRUNK LINK SENSOR LH
Connector Type	TH04FW-RH

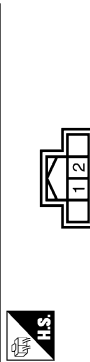

Terminal No.	Color of Wire	Signal Name [Specification]
1	GR	-
2	R	-

Connector No.	B305
Connector Name	TRUNK LID OPENER ACTUATOR
Connector Type	IM02FB-LC



Terminal No.	Color of Wire	Signal Name [Specification]
1	V	V-
2	G	V+

Connector No.	B306
Connector Name	TRUNK ROOM LAMP SWITCH
Connector Type	A02PW



Terminal No.	Color of Wire	Signal Name [Specification]
1	V	SIG-
2	L	SIG+

Connector No.	B307
Connector Name	FLIPPER DOOR (LH)
Connector Type	NS06FB-CS

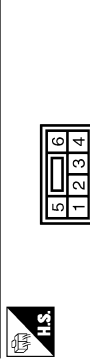

Terminal No.	Color of Wire	Signal Name [Specification]
1	V	SWTCH FD UP
2	W	SWTCH FD UP I
3	Y	SWTCH FD DOWN
4	G	SWTCH FD DOWN I
5	BR	MOTOR FD UP
6	L	MOTOR FD DOWN

Connector No.	B308
Connector Name	FLIPPER DOOR (RH)
Connector Type	MS06FW-CS

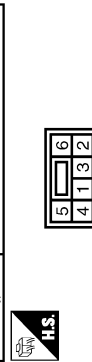

Terminal No.	Color of Wire	Signal Name [Specification]
1	V	SWTCH FD UP I
2	Y	SWTCH FD DOWN I
3	B	SWTCH FD GND COMBINED
5	BR	MOTOR FD UP
6	L	MOTOR FD DOWN

Connector No.	B351
Connector Name	WIRE TO WIRE
Connector Type	TH04FW-RH

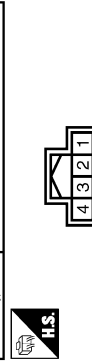

Terminal No.	Color of Wire	Signal Name [Specification]
3	B	-
4	G	-

Connector No.	B352
Connector Name	TONNEAU BOARD SWITCH
Connector Type	A03PW

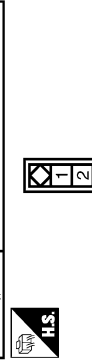

Terminal No.	Color of Wire	Signal Name [Specification]
1	G	-
3	B	-

Connector No.	B361
Connector Name	WIRE TO WIRE
Connector Type	NS06FW-CS

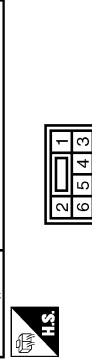

Terminal No.	Color of Wire	Signal Name [Specification]
3	B	-
4	P	-
5	B	-
6	Y	-

A  
B  
C  
D  
E  
F  
G  
H  
I  
J  
K  
DEF  
M  
N  
O  
P

JCKWA2659GB

# RETRACTABLE HARD TOP CONTROL UNIT

< ECU DIAGNOSIS INFORMATION >

## RETRACTABLE HARD TOP SYSTEM

Connector No.	B302
Connector Name	STRIKER SWITCH
Connector Type	RV02EGY



Terminal No.	Color of Wire	Signal Name [Specification]
1	B	SIG-
2	GR	SIG+

Connector No.	B303
Connector Name	TRUNK CLOSURE CONTROL UNIT
Connector Type	NS04FW-CS



Terminal No.	Color of Wire	Signal Name [Specification]
1	P	TRUNK ROOM LAMP SW SIG
2	Y	POWER
3	GR	STRIKER SW SIG
4	B	GND

Connector No.	B304
Connector Name	TRUNK CLOSURE CONTROL UNIT
Connector Type	NS02FW-CS



Terminal No.	Color of Wire	Signal Name [Specification]
5	B	CLOSURE MOTOR GND
6	BR	CLOSURE MOTOR POWER

Connector No.	B652
Connector Name	WIRE TO WIRE
Connector Type	NS10MBR-CS



Terminal No.	Color of Wire	Signal Name [Specification]
1	-	-
2	-	-
3	-	-
4	-	-
5	-	-
6	-	-
7	-	-
8	-	-
9	-	-
10	-	-
11	-	-
12	-	-
13	-	-
14	-	-
15	-	-
16	-	-

Connector No.	B653
Connector Name	WIRE TO WIRE
Connector Type	NS02FW-CS



Terminal No.	Color of Wire	Signal Name [Specification]
1	-	-
2	-	-

Connector No.	B654
Connector Name	WIRE TO WIRE
Connector Type	NS16MGY-CS



Terminal No.	Color of Wire	Signal Name [Specification]
1	-	-
2	-	-
3	-	-
4	-	-
5	-	-
6	-	-
7	-	-
16	-	-

Connector No.	B655
Connector Name	WIRE TO WIRE
Connector Type	NS02FW-CS



Terminal No.	Color of Wire	Signal Name [Specification]
1	-	-
2	-	-

Connector No.	B656
Connector Name	ROOF STATUS SENSOR
Connector Type	1-968700-1



Terminal No.	Color of Wire	Signal Name [Specification]
1	-	-
2	-	-
3	-	-

JCKWA2660GB



# RETRACTABLE HARD TOP CONTROL UNIT

## < ECU DIAGNOSIS INFORMATION >

### RETRACTABLE HARD TOP SYSTEM

Connector No.	D9
Connector Name	POWER WINDOW MAIN SWITCH
Connector Type	NS02FW-CS



Terminal No.	Color of Wire	Signal Name [Specification]
19	Y	-

Connector No.	D8
Connector Name	POWER WINDOW MAIN SWITCH
Connector Type	NS16FW-CS

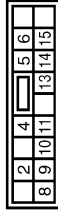

Terminal No.	Color of Wire	Signal Name [Specification]
8	L	-
11	BR	-
14	V	-

Connector No.	D1
Connector Name	WIRE TO WIRE
Connector Type	TH40FW-CS15

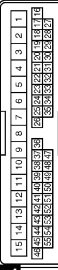

Terminal No.	Color of Wire	Signal Name [Specification]
14	V	-
15	Y	-
37	B	-
49	W	-

Connector No.	B637
Connector Name	ROOF LATCH ASSEMBLY
Connector Type	NS06FW-CS



Terminal No.	Color of Wire	Signal Name [Specification]
1	-	-
2	-	-
4	-	-
5	-	-
6	-	-

Connector No.	D38
Connector Name	POWER WINDOW SUB-SWITCH
Connector Type	NS16FW-CS



Terminal No.	Color of Wire	Signal Name [Specification]
8	L	-
9	V	-
10	W	-
16	Y	-

Connector No.	D21
Connector Name	WIRE TO WIRE
Connector Type	TH40FW-CS15

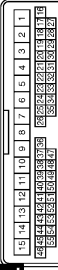

Terminal No.	Color of Wire	Signal Name [Specification]
10	LG	-
13	B	-
14	Y	-
49	W	-

Connector No.	D13
Connector Name	OUTSIDE HANDLE LH (REQUEST SWITCH)
Connector Type	RK02PL



Terminal No.	Color of Wire	Signal Name [Specification]
1	W	-
2	B	-

Connector No.	D10
Connector Name	DRIVER SIDE POWER WINDOW MOTOR
Connector Type	PH00FGY-Z

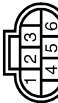

Terminal No.	Color of Wire	Signal Name [Specification]
3	BR	-
6	L	-

A  
B  
C  
D  
E  
F  
G  
H  
I  
J  
K  
DEF  
M  
N  
O  
P

JCKWA2661GB

# RETRACTABLE HARD TOP CONTROL UNIT

## < ECU DIAGNOSIS INFORMATION >

### RETRACTABLE HARD TOP SYSTEM

Connector No.	D40
Connector Name	PASSENGER SIDE POWER WINDOW MOTOR
Connector Type	FHB0FGY-Z



Terminal No.	Color of Wire	Signal Name [Specification]
3	V	
6	L	

Connector No.	D43
Connector Name	OUTSIDE HANDLE RH (REQUEST SWITCH)
Connector Type	RK02FL



Terminal No.	Color of Wire	Signal Name [Specification]
1	W	
2	B	

Connector No.	E41
Connector Name	ABS ACTUATOR AND ELECTRIC UNIT (CONTROL UNIT)
Connector Type	BA442FB-AH24-LH

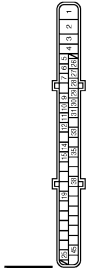

Terminal No.	Color of Wire	Signal Name [Specification]
14	P	CAN-L
35	L	CAN-H

Connector No.	E79
Connector Name	WIRE TO WIRE
Connector Type	M02FW-LG



Terminal No.	Color of Wire	Signal Name [Specification]
1	Y	
2	LG	

Connector No.	E108
Connector Name	WIRE TO WIRE
Connector Type	THB0FW-CS16-TM4

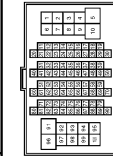

Terminal No.	Color of Wire	Signal Name [Specification]
96	W	

Connector No.	F56
Connector Name	BACK-UP LAMP SWITCH
Connector Type	RK02FB



Terminal No.	Color of Wire	Signal Name [Specification]
1	R	
2	O	

Connector No.	F103
Connector Name	WIRE TO WIRE
Connector Type	TK03FW-NS10

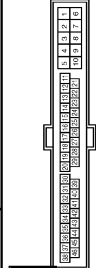

Terminal No.	Color of Wire	Signal Name [Specification]
30	R	
41	O	

Connector No.	M1
Connector Name	FUSE BLOCK (J/B)
Connector Type	NS06FW-M2

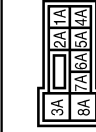

Terminal No.	Color of Wire	Signal Name [Specification]
7A	R	

JCKWA2662GB

# RETRACTABLE HARD TOP CONTROL UNIT

## < ECU DIAGNOSIS INFORMATION >

### RETRACTABLE HARD TOP SYSTEM

Connector No.	M2
Connector Name	FUSE BLOCK (J/B)
Connector Type	NS10FW-CS

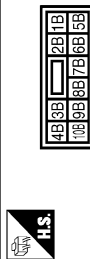

Terminal No.	Color of Wire	Signal Name [Specification]
4B	G	-
6B	Y	-

Connector No.	M3
Connector Name	FUSE BLOCK (J/B)
Connector Type	NS12FW-CS



Terminal No.	Color of Wire	Signal Name [Specification]
12C	R	-

Connector No.	M5
Connector Name	WIRE TO WIRE
Connector Type	TH40MM-CS15

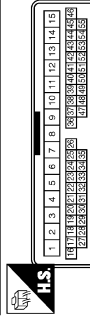

Terminal No.	Color of Wire	Signal Name [Specification]
14	V	-
15	Y	-
37	B	-
49	P	-

Connector No.	M6
Connector Name	WIRE TO WIRE
Connector Type	TH80MM-CS16-TM4



Terminal No.	Color of Wire	Signal Name [Specification]
96	W	-

Connector No.	M7
Connector Name	WIRE TO WIRE
Connector Type	TH80MM-CS16-TM4

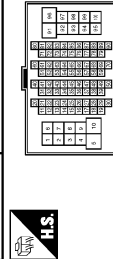

Terminal No.	Color of Wire	Signal Name [Specification]
5	L	-
67	P	-
68	L	-
69	P	-
70	L	-
80	G	-
81	V	-
82	Y	-
83	BR	-
84	V	-
85	L	-

Terminal No.	Color of Wire	Signal Name [Specification]
86	Y	-
87	V	-
94	P	-
95	GR	-
96	Y	-

Connector No.	M8
Connector Name	ROOF OPEN / CLOSE SWITCH (WITH A.T)
Connector Type	TR08FW-IV



Terminal No.	Color of Wire	Signal Name [Specification]
1	B	-
3	V	-
4	BR	-

Connector No.	M9
Connector Name	COMBINATION METER
Connector Type	SAB4UFW

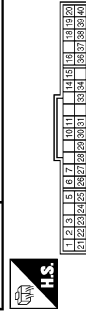

Terminal No.	Color of Wire	Signal Name [Specification]
24	BR	COMMUNICATION SIGNAL (LOD->AMP)
25	Y	COMMUNICATION SIGNAL (AMP->LOD)

JCKWA2663GB

A  
B  
C  
D  
E  
F  
G  
H  
I  
J  
K  
DEF  
M  
N  
O  
P

# RETRACTABLE HARD TOP CONTROL UNIT

## < ECU DIAGNOSIS INFORMATION >

### RETRACTABLE HARD TOP SYSTEM

Connector No.	M66
Connector Name	UNIFIED METER AND A/C AMP.
Connector Type	TH00FW-NH

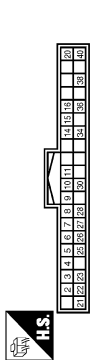

Terminal No.	Color of Wire	Signal Name [Specification]
14	BR	COMMUNICATION SIGNAL (LCD->AMP.)
34	Y	COMMUNICATION SIGNAL (AMP->LCD)

Connector No.	M67
Connector Name	UNIFIED METER AND A/C AMP.
Connector Type	TH32FW-NH

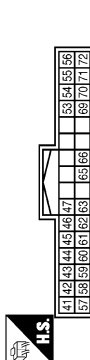

Terminal No.	Color of Wire	Signal Name [Specification]
56	L	CAN-H
72	P	CAN-L

Connector No.	M69
Connector Name	BACK-UP LAMP RELAY
Connector Type	MS02FL-M2-LC

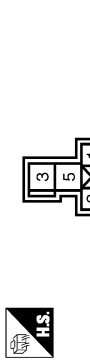

Terminal No.	Color of Wire	Signal Name [Specification]
1	R	
2	W	
3	LG	
5	O	

Connector No.	M106
Connector Name	WIRE TO WIRE
Connector Type	TK10MW-NSB



Terminal No.	Color of Wire	Signal Name [Specification]
16	L	
17	B	

Connector No.	M116
Connector Name	WIRE TO WIRE
Connector Type	TK38MW-NS1.0

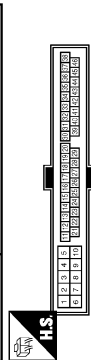

Terminal No.	Color of Wire	Signal Name [Specification]
30	LG	
41	O	

Connector No.	M117
Connector Name	WIRE TO WIRE
Connector Type	TH60MW-CS1F-TM4

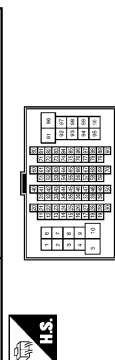

Terminal No.	Color of Wire	Signal Name [Specification]
91	GR	
96	P	

Connector No.	M118
Connector Name	BCM (BODY CONTROL MODULE)
Connector Type	MS03FB-LC

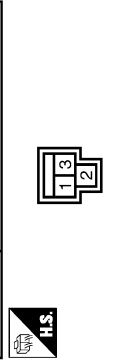

Terminal No.	Color of Wire	Signal Name [Specification]
1	W	BAT (F/L)
2	Y	POWER WINDOW POWER SUPPLY (BAT)
3	O	POWER WINDOW POWER SUPPLY (RAP)

Connector No.	M119
Connector Name	BCM (BODY CONTROL MODULE)
Connector Type	NS10FW-CS

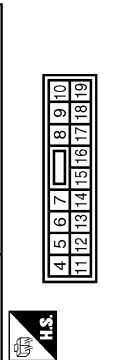

Terminal No.	Color of Wire	Signal Name [Specification]
11	R	BAT (FUSE)
13	B	GND

# RETRACTABLE HARD TOP CONTROL UNIT

< ECU DIAGNOSIS INFORMATION >

## RETRACTABLE HARD TOP SYSTEM

Connector No.	M120
Connector Name	BCM (BODY CONTROL MODULE)
Connector Type	HS12FW-GS



Terminal No.	23	Y	Signal Name [Specification]	TRUNK LID OPEN OUTPUT
--------------	----	---	-----------------------------	-----------------------

Connector No.	M121
Connector Name	BCM (BODY CONTROL MODULE)
Connector Type	TH40FGY-NH

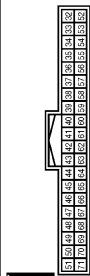

Terminal No.	50	G	Signal Name [Specification]	TRUNK ROOM LAMP SW
--------------	----	---	-----------------------------	--------------------

Connector No.	M122
Connector Name	BCM (BODY CONTROL MODULE)
Connector Type	TH40FB-NH

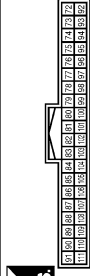

Terminal No.	90	P	Signal Name [Specification]	CAN-L
Terminal No.	91	L	Signal Name [Specification]	CAN-H
Terminal No.	100	Y	Signal Name [Specification]	PASSENGER DOOR REQUEST SW
Terminal No.	101	P	Signal Name [Specification]	DRIVER DOOR REQUEST SW

Connector No.	M123
Connector Name	BCM (BODY CONTROL MODULE)
Connector Type	TH40FG-NH

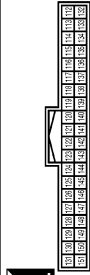

Terminal No.	132	V	Signal Name [Specification]	P/W SW & RHT C/U COMM
--------------	-----	---	-----------------------------	-----------------------

Connector No.	M124
Connector Name	WIRE TO WIRE
Connector Type	TH00MW-CS15

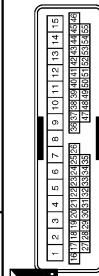

Terminal No.	10	V	Signal Name [Specification]	-
Terminal No.	13	B	Signal Name [Specification]	-
Terminal No.	14	G	Signal Name [Specification]	-
Terminal No.	48	Y	Signal Name [Specification]	-

Connector No.	M136
Connector Name	WIRE TO WIRE
Connector Type	TH24FW-NH

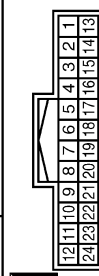

Terminal No.	1	V	Signal Name [Specification]	-
Terminal No.	2	BR	Signal Name [Specification]	-
Terminal No.	16	B	Signal Name [Specification]	-

Connector No.	M147
Connector Name	AIR BAG DIAGNOSIS SENSOR UNIT
Connector Type	NH28FY-EX

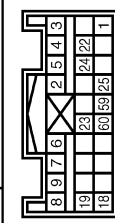

Terminal No.	59	L	Signal Name [Specification]	CAN-H
Terminal No.	60	P	Signal Name [Specification]	CAN-L

Connector No.	M174
Connector Name	WIRE TO WIRE
Connector Type	TH24MW-NH





Terminal No.	1	V	Signal Name [Specification]	-
Terminal No.	2	BR	Signal Name [Specification]	-
Terminal No.	16	B	Signal Name [Specification]	-



A  
B  
C  
D  
E  
F  
G  
H  
I  
J  
K  
DEF  
M  
N  
O  
P

# RETRACTABLE HARD TOP CONTROL UNIT



< ECU DIAGNOSIS INFORMATION >

RETRACTABLE HARD TOP SYSTEM		
Connector No.	M179	
Connector Name	ROOF OPEN / CLOSE SWITCH (WITH M/T)	
Connector Type	TK06FW-TV	
		
Terminal No.	Color of Wire	Signal Name [Specification]
1	B	
3	V	
4	BR	

RETRACTABLE HARD TOP SYSTEM		
Connector No.	R1	
Connector Name	WIRE TO WIRE	
Connector Type	TK10FW-NS	
		
Terminal No.	Color of Wire	Signal Name [Specification]
16	L	
17	B	

RETRACTABLE HARD TOP SYSTEM		
Connector No.	R6	
Connector Name	ROOF LATCH LIMIT SWITCH	
Connector Type	TH04FW-NH	
		
Terminal No.	Color of Wire	Signal Name [Specification]
2	L	
3	B	

## Fail-safe

### FAIL-SAFE CONTROL BY DTC

Retractable hard top control unit performs fail-safe control when any DTC are detected.

JCKWA2666GB

INFOID:000000005175646

# RETRACTABLE HARD TOP CONTROL UNIT

< ECU DIAGNOSIS INFORMATION >

Display contents of CONSULT-III		Fail-safe	Cancellation	
U1000	CAN COMM CIRCUIT	Inhibit retractable hard top operation.	Communication is normal	A
U1010	CONTROL UNIT (CAN)	Inhibit retractable hard top operation.	Communication is normal	B
U0140	LOCAL COMM-1	Inhibit retractable hard top operation.	Communication is normal	
U0215	LOCAL COMM-1	Inhibit retractable hard top operation.	Communication is normal	C
B1701	ROOF CONTROL UNIT	Inhibit retractable hard top operation.	Replace retractable hard top control unit.	
B1702	ROOF CONTROL UNIT	Inhibit retractable hard top operation.	Replace retractable hard top control unit.	
B1709	ROOF SWITCH(OPEN)	Inhibit retractable hard top operation.	Detects roof open/close switch (OPEN) is OFF	D
B170A	ROOF SWITCH(CLOSE)	Inhibit retractable hard top operation.	Detects roof open/close switch (CLOSE) is OFF	
B170B	ROOF SWITCH	Inhibit retractable hard top operation.	Detects roof open/close switch (OPEN/CLOSE) is OFF	E
B170C	TRUNK LINK SENSOR(LH)	Inhibit retractable hard top operation.	Detects normal value	
B170D	TRUNK LINK SENSOR(RH)	Inhibit retractable hard top operation.	Detects normal value	F
B170F	SENSOR POWER SUPPLY	Inhibit retractable hard top operation.	Detects normal value	G
B1710	LATCH STATUS SENSOR	Inhibit retractable hard top operation.	Detects normal value	
B1711	LATCH LOCK SENSOR	Inhibit retractable hard top operation.	Detects normal value	
B1712	TRUNK STATUS SENSOR	Inhibit retractable hard top operation.	Detects normal value	H
B1715	ROOF STATUS SEN PWR	Inhibit retractable hard top operation.	Detects normal value	
B1716	PS STATUS SEN(DRAW)	Inhibit retractable hard top operation.	Detects normal value	I
B1718	PS STATUS SEN(ROTA)	Inhibit retractable hard top operation.	Detects normal value	
B1719	ROOF STATUS SEN	Inhibit retractable hard top operation.	Detects normal value	
B171A	HYDRAULIC PMP(LH)	Inhibit retractable hard top operation.	Detects normal value	J
B171B	HYDRAULIC PMP(RH)	Inhibit retractable hard top operation.	Detects normal value	
B171C	SWITCHING VALVE 1	Inhibit retractable hard top operation.	Detects normal value	
B171D	SWITCHING VALVE 2	Inhibit retractable hard top operation.	Detects normal value	K
B171E	ROOF CONTROL UNIT	Inhibit retractable hard top operation.	Detects normal value	
B171F	ROOF CONTROL UNIT	Inhibit retractable hard top operation.	Detects normal value	DEF
B1720	ROOF CONTROL UNIT	Inhibit retractable hard top operation.	Detects normal value	
B1721	ROOF CONTROL UNIT	Inhibit retractable hard top operation.	Detects normal value	
B1722	ROOF CONTROL UNIT	Inhibit retractable hard top operation.	Detects normal value	M
B1723	ROOF CONTROL UNIT	Inhibit retractable hard top operation.	Detects normal value	
B1724	ROOF CONTROL UNIT	Inhibit retractable hard top operation.	Detects normal value	N
B1725	ROOF CONTROL UNIT	Inhibit retractable hard top operation.	Detects normal value	
B1726	ROOF CONTROL UNIT	Inhibit retractable hard top operation.	Detects normal value	
B1728	ROOF CONTROL UNIT	Inhibit retractable hard top operation.	Detects normal value	O
B1729	ROOF CONTROL UNIT	Inhibit retractable hard top operation.	Detects normal value	
B172A	ROOF CONTROL UNIT	Inhibit retractable hard top operation.	Detects normal value	P
B172B	ROOF STATE SIG(AUDIO)	Inhibit retractable hard top operation.	Detects normal value	
B172C	ROOF STATE SIG(TRUNK)	Inhibit retractable hard top operation.	Detects normal value	
B172D	ROOF WARNING BUZZER	Inhibit retractable hard top operation.	Detects normal value	
B172E	ROOF CONTROL UNIT	Inhibit retractable hard top operation.	Detects normal value	

## RETRACTABLE HARD TOP CONTROL UNIT

### < ECU DIAGNOSIS INFORMATION >

Display contents of CONSULT-III		Fail-safe	Cancellation
B172F	REAR PWR WINDOW(LH)	Inhibit retractable hard top operation.	Detects normal value
B1730	REAR PWR WINDOW(RH)	Inhibit retractable hard top operation.	Detects normal value
B1731	HYDRAULIC STATE 1	Inhibit retractable hard top operation.	Turn ignition switch OFF
B1732	HYDRAULIC STATE 2	Inhibit retractable hard top operation.	Turn ignition switch OFF
B1733	HYDRAULIC STATE 3	Inhibit retractable hard top operation.	Turn ignition switch OFF
B1734	HYDRAULIC STATE 4	Inhibit retractable hard top operation.	Turn ignition switch OFF
B1735	HYDRAULIC STATE 5	Inhibit retractable hard top operation.	Turn ignition switch OFF
B1736	HYDRAULIC STATE 6	Inhibit retractable hard top operation.	Turn ignition switch OFF
B1737	HYDRAULIC STATE 7	Inhibit retractable hard top operation.	Turn ignition switch OFF
B1738	HYDRAULIC STATE 8	Inhibit retractable hard top operation.	Turn ignition switch OFF
B1739	HYDRAULIC STATE 9	Inhibit retractable hard top operation.	Turn ignition switch OFF
B173A	HYDRAULIC STATE 10	Inhibit retractable hard top operation.	Turn ignition switch OFF
B173B	HYDRAULIC STATE 11	Inhibit retractable hard top operation.	Turn ignition switch OFF
B173C	HYDRAULIC STATE 12	Inhibit retractable hard top operation.	Turn ignition switch OFF
B173D	HYDRAULIC STATE 13	Inhibit retractable hard top operation.	Turn ignition switch OFF
B173E	HYDRAULIC STATE 14	Inhibit retractable hard top operation.	Turn ignition switch OFF
B173F	HYDRAULIC STATE 15	Inhibit retractable hard top operation.	Turn ignition switch OFF
B1740	HYDRAULIC STATE 16	Inhibit retractable hard top operation.	Turn ignition switch OFF
B1741	HYDRAULIC STATE 17	Inhibit retractable hard top operation.	Turn ignition switch OFF
B1742	HYDRAULIC STATE 18	Inhibit retractable hard top operation.	Turn ignition switch OFF
B1743	HYDRAULIC STATE 19	Inhibit retractable hard top operation.	Turn ignition switch OFF
B1744	HYDRAULIC STATE 20	Inhibit retractable hard top operation.	Turn ignition switch OFF
B1745	HYDRAULIC STATE 21	Inhibit retractable hard top operation.	Turn ignition switch OFF
B1746	HYDRAULIC STATE 22	Inhibit retractable hard top operation.	Turn ignition switch OFF
B1747	P SHELF (DRAW) STATE 1	Inhibit retractable hard top operation.	Turn ignition switch OFF
B1748	P SHELF (DRAW) STATE 2	Inhibit retractable hard top operation.	Turn ignition switch OFF
B1749	P SHELF (DRAW) STATE 3	Inhibit retractable hard top operation.	Turn ignition switch OFF
B174A	P SHELF (DRAW) STATE 4	Inhibit retractable hard top operation.	Turn ignition switch OFF
B174B	P SHELF (DRAW) STATE 5	Inhibit retractable hard top operation.	Turn ignition switch OFF
B174C	P SHELF (DRAW) STATE 6	Inhibit retractable hard top operation.	Turn ignition switch OFF
B174D	P SHELF (ROT) STATE 1	Inhibit retractable hard top operation.	Turn ignition switch OFF
B174E	P SHELF (ROT) STATE 2	Inhibit retractable hard top operation.	Turn ignition switch OFF
B174F	P SHELF (ROT) STATE 3	Inhibit retractable hard top operation.	Turn ignition switch OFF
B1750	P SHELF (ROT) STATE 4	Inhibit retractable hard top operation.	Turn ignition switch OFF
B1751	ROOF LATCH STATE 1	Inhibit retractable hard top operation.	Turn ignition switch OFF
B1752	ROOF LATCH STATE 2	Inhibit retractable hard top operation.	Turn ignition switch OFF
B1753	ROOF LATCH STATE 3	Inhibit retractable hard top operation.	Turn ignition switch OFF
B1754	FLIPPER DOOR STATE 1	Inhibit retractable hard top operation.	Turn ignition switch OFF
B1755	FLIPPER DOOR STATE 2	Inhibit retractable hard top operation.	Turn ignition switch OFF



# RETRACTABLE HARD TOP CONTROL UNIT

## < ECU DIAGNOSIS INFORMATION >

Display contents of CONSULT-III		Fail-safe	Cancellation
B1756	FLIPPER DOOR STATE 3	Inhibit retractable hard top operation.	Turn ignition switch OFF
B1757	FLIPPER DOOR STATE 4	Inhibit retractable hard top operation.	Turn ignition switch OFF
B1758	THERMO PROTECTION	Inhibit retractable hard top operation.	It is not in thermo protection area (Refer to <a href="#">RF-16. "System Description"</a> )
B175C	PWR SOURCE(ROOF)	Inhibit retractable hard top operation.	Power source is 11.4 (V) or more for 0.5 second
B175D	PWR SOURCE(ROOF)	Inhibit retractable hard top operation.	Power source is 14.5 (V) or more for 4 seconds
B175E	PWR SOURCE(WINDOW)	Inhibit retractable hard top operation and rear power window operation.	Power source (power window) is 9.5 (V) or more
B175F	PWR SOURCE(WINDOW)	Inhibit retractable hard top operation and rear power window operation.	Power source (power window) is 15.5 (V) or more
B1760	ROOF CONTROL UNIT	Inhibit rear window defogger operation.	Detects normal value
B1761	ROOF CONTROL UNIT	Inhibit retractable hard top operation.	Detects normal value
B1762	ROOF STATE	Inhibit retractable hard top operation.	Detects normal value
B1763	HYDRAULIC STATE	Inhibit retractable hard top operation.	Detects normal value
B1764	ROOF LATCH STATE	Inhibit retractable hard top operation.	Detects normal value
B1765	FLIPPER DOOR STATE	Inhibit retractable hard top operation.	Detects normal value

## DTC Inspection Priority Chart

INFOID:000000005175647

If some DTCs are displayed at the same time, perform inspections one by one based on the following priority chart.

Priority	Display contents of CONSULT-III	
1	U1000	CAN COMM CIRCUIT
	U1010	CONTROL UNIT (CAN)
2	B175C	PWR SOURCE(ROOF)
	B175D	PWR SOURCE(ROOF)
	B175E	PWR SOURCE(WINDOW)
	B175F	PWR SOURCE(WINDOW)
3	B1701	ROOF CONTROL UNIT
	B1702	ROOF CONTROL UNIT
	B171E	ROOF CONTROL UNIT
	B171F	ROOF CONTROL UNIT
	B1720	ROOF CONTROL UNIT
	B1721	ROOF CONTROL UNIT
	B1722	ROOF CONTROL UNIT
	B1723	ROOF CONTROL UNIT
	B1724	ROOF CONTROL UNIT
	B1725	ROOF CONTROL UNIT
	B1726	ROOF CONTROL UNIT
	B1728	ROOF CONTROL UNIT
	B1729	ROOF CONTROL UNIT
	B172A	ROOF CONTROL UNIT
	B172E	ROOF CONTROL UNIT
B1760	ROOF CONTROL UNIT	
B1761	ROOF CONTROL UNIT	

# RETRACTABLE HARD TOP CONTROL UNIT

## < ECU DIAGNOSIS INFORMATION >

Priority	Display contents of CONSULT-III	
4	B170F	SENSOR POWER SUPPLY
	U0140	LOCAL COMM-1
5	U0215	LOCAL COMM-1
	B1709	ROOF SWITCH(OPEN)
	B170A	ROOF SWITCH(CLOSE)
	B170B	ROOF SWITCH
	B1758	THERMO PROTECTION
	B171A	HYDRAULIC PMP(LH)
	B171B	HYDRAULIC PMP(RH)
	B171C	SWITCHING VALVE 1
	B171D	SWITCHING VALVE 2
	B172F	REAR PWR WINDOW(LH)
	B1730	REAR PWR WINDOW(RH)
	B1715	ROOF STATE SEN PWR
	B170C	TRUNK LINK SENSOR(LH)
	B170D	TRUNK LINK SENSOR(RH)
	B1710	LATCH STATUS SENSOR
	B1711	LATCH LOCK SENSOR
	B1712	TRUNK STATUS SENSOR
	B1716	PS STATUS SEN(DRAW)
	B1718	PS STATUS SEN(ROTA)
B1719	ROOF STATUS SEN	
6	B172D	ROOF WARNING BUZZER

# RETRACTABLE HARD TOP CONTROL UNIT

< ECU DIAGNOSIS INFORMATION >

Priority	Display contents of CONSULT-III		
7	B1731	HYDRAULIC STATE 1	A
	B1732	HYDRAULIC STATE 2	
	B1733	HYDRAULIC STATE 3	B
	B1734	HYDRAULIC STATE 4	
	B1735	HYDRAULIC STATE 5	
	B1736	HYDRAULIC STATE 6	C
	B1737	HYDRAULIC STATE 7	
	B1738	HYDRAULIC STATE 8	D
	B1739	HYDRAULIC STATE 9	
	B173A	HYDRAULIC STATE 10	
	B173B	HYDRAULIC STATE 11	E
	B173C	HYDRAULIC STATE 12	
	B173D	HYDRAULIC STATE 13	
	B173E	HYDRAULIC STATE 14	F
	B173F	HYDRAULIC STATE 15	
	B1740	HYDRAULIC STATE 16	G
	B1741	HYDRAULIC STATE 17	
	B1742	HYDRAULIC STATE 18	
	B1743	HYDRAULIC STATE 19	H
	B1744	HYDRAULIC STATE 20	
	B1745	HYDRAULIC STATE 21	I
	B1746	HYDRAULIC STATE 22	
	B1747	P SHELF (DRAW) STATE 1	
	B1748	P SHELF (DRAW) STATE 2	J
	B1749	P SHELF (DRAW) STATE 3	
	B174A	P SHELF (DRAW) STATE 4	
	B174B	P SHELF (DRAW) STATE 5	K
	B174C	P SHELF (DRAW) STATE 6	
	B174D	P SHELF (ROT) STATE 1	<b>DEF</b>
	B174E	P SHELF (ROT) STATE 2	
	B174F	P SHELF (ROT) STATE 3	
	B1750	P SHELF (ROT) STATE 4	M
B1751	ROOF LATCH STATE 1		
B1752	ROOF LATCH STATE 2	N	
B1753	ROOF LATCH STATE 3		
B1754	FLIPPER DOOR STATE 1		
B1755	FLIPPER DOOR STATE 2	O	
B1756	FLIPPER DOOR STATE 3		
B1757	FLIPPER DOOR STATE 4	P	
8	B1707	ROOF OPEN STATE	
	B1708	ROOF CLOSE STATE	
9	B1764	ROOF LATCH STATE	
	B1765	FLIPPER DOOR STATE	
10	B1762	ROOF STATE	

# RETRACTABLE HARD TOP CONTROL UNIT

## < ECU DIAGNOSIS INFORMATION >

Priority	Display contents of CONSULT-III	
11	B1763	HYDRAULIC STATE
12	B172B	ROOF STATE SIG(AUDIO)
	B172C	ROOF STATE SIG(TRUNK)

## DTC Index

INFOID:000000005175648

### NOTE:

For details of Freeze Frame Data, refer to [RF-58. "CONSULT-III Function"](#).

Display contents of CONSULT-III		Fail-safe	Freeze Frame Data	Reference page
No DTC is detected. Further testing may be required.		—	—	—
U1000	CAN COMM CIRCUIT	×	×	<a href="#">RF-63</a>
U1010	CONTROL UNIT (CAN)	×	×	<a href="#">RF-64</a>
U0140	LOCAL COMM-1	×	×	<a href="#">RF-65</a>
U0215	LOCAL COMM-2	×	×	<a href="#">RF-66</a>
B1701	ROOF CONTROL UNIT	×	×	<a href="#">RF-68</a>
B1702	ROOF CONTROL UNIT	×	×	<a href="#">RF-69</a>
B1707	ROOF OPEN STATE	—	×	<a href="#">RF-70</a>
B1708	ROOF CLOSE STATE	—	×	<a href="#">RF-72</a>
B1709	ROOF SWITCH(OPEN)	×	×	<a href="#">RF-74</a>
B170A	ROOF SWITCH(CLOSE)	×	×	<a href="#">RF-76</a>
B170B	ROOF SWITCH	×	×	<a href="#">RF-78</a>
B170C	TRUNK LINK SENSOR(LH)	×	×	<a href="#">RF-80</a>
B170D	TRUNK LINK SENSOR(RH)	×	×	<a href="#">RF-82</a>
B170F	SENSOR POWER SUPPLY	×	×	<a href="#">RF-84</a>
B1710	LATCH STATUS SENSOR	×	×	<a href="#">RF-87</a>
B1711	LATCH LOCK SENSOR	×	×	<a href="#">RF-89</a>
B1712	TRUNK STATUS SENSOR	×	×	<a href="#">RF-91</a>
B1715	ROOF STATUS SEN PWR	×	×	<a href="#">RF-93</a>
B1716	PS STATUS SEN(DRAW)	×	×	<a href="#">RF-97</a>
B1718	PS STATUS SEN(ROTA)	×	×	<a href="#">RF-95</a>
B1719	ROOF STATUS SEN	×	×	<a href="#">RF-99</a>
B171A	HYDRAULIC PMP(LH)	×	×	<a href="#">RF-101</a>
B171B	HYDRAULIC PMP(RH)	×	×	<a href="#">RF-103</a>
B171C	SWITCHING VALVE 1	×	×	<a href="#">RF-105</a>
B171D	SWITCHING VALVE 2	×	×	<a href="#">RF-107</a>
B171E	ROOF CONTROL UNIT	×	×	<a href="#">RF-109</a>
B171F	ROOF CONTROL UNIT	×	×	<a href="#">RF-110</a>
B1720	ROOF CONTROL UNIT	×	×	<a href="#">RF-111</a>
B1721	ROOF CONTROL UNIT	×	×	<a href="#">RF-112</a>
B1722	ROOF CONTROL UNIT	×	×	<a href="#">RF-113</a>
B1723	ROOF CONTROL UNIT	×	×	<a href="#">RF-114</a>
B1724	ROOF CONTROL UNIT	×	×	<a href="#">RF-115</a>
B1725	ROOF CONTROL UNIT	×	×	<a href="#">RF-116</a>
B1726	ROOF CONTROL UNIT	×	×	<a href="#">RF-117</a>

# RETRACTABLE HARD TOP CONTROL UNIT

< ECU DIAGNOSIS INFORMATION >

Display contents of CONSULT-III		Fail-safe	Freeze Frame Data	Reference page
B1728	ROOF CONTROL UNIT	×	×	<a href="#">RF-118</a>
B1729	ROOF CONTROL UNIT	×	×	<a href="#">RF-119</a>
B172A	ROOF CONTROL UNIT	×	×	<a href="#">RF-120</a>
B172B	ROOF STATE SIG(AUDIO)	×	×	<a href="#">RF-121</a>
B172C	ROOF STATE SIG(TRUNK)	×	×	<a href="#">RF-123</a>
B172D	ROOF WARNING BUZZER	×	×	<a href="#">RF-125</a>
B172E	ROOF CONTROL UNIT	×	×	<a href="#">RF-127</a>
B172F	REAR PWR WINDOW(LH)	×	×	<a href="#">RF-128</a>
B1730	REAR PWR WINDOW(RH)	×	×	<a href="#">RF-130</a>
B1731	HYDRAULIC STATE 1	×	×	<a href="#">RF-132</a>
B1732	HYDRAULIC STATE 2	×	×	<a href="#">RF-134</a>
B1733	HYDRAULIC STATE 3	×	×	<a href="#">RF-136</a>
B1734	HYDRAULIC STATE 4	×	×	<a href="#">RF-138</a>
B1735	HYDRAULIC STATE 5	×	×	<a href="#">RF-140</a>
B1736	HYDRAULIC STATE 6	×	×	<a href="#">RF-142</a>
B1737	HYDRAULIC STATE 7	×	×	<a href="#">RF-143</a>
B1738	HYDRAULIC STATE 8	×	×	<a href="#">RF-144</a>
B1739	HYDRAULIC STATE 9	×	×	<a href="#">RF-145</a>
B173A	HYDRAULIC STATE 10	×	×	<a href="#">RF-146</a>
B173B	HYDRAULIC STATE 11	×	×	<a href="#">RF-147</a>
B173C	HYDRAULIC STATE 12	×	×	<a href="#">RF-148</a>
B173D	HYDRAULIC STATE 13	×	×	<a href="#">RF-149</a>
B173E	HYDRAULIC STATE 14	×	×	<a href="#">RF-150</a>
B173F	HYDRAULIC STATE 15	×	×	<a href="#">RF-151</a>
B1740	HYDRAULIC STATE 16	×	×	<a href="#">RF-152</a>
B1741	HYDRAULIC STATE 17	×	×	<a href="#">RF-155</a>
B1742	HYDRAULIC STATE 18	×	×	<a href="#">RF-156</a>
B1743	HYDRAULIC STATE 19	×	×	<a href="#">RF-158</a>
B1744	HYDRAULIC STATE 20	×	×	<a href="#">RF-160</a>
B1745	HYDRAULIC STATE 21	×	×	<a href="#">RF-162</a>
B1746	HYDRAULIC STATE 22	×	×	<a href="#">RF-164</a>
B1747	P SHELF (DRAW) STATE 1	×	×	<a href="#">RF-166</a>
B1748	P SHELF (DRAW) STATE 2	×	×	<a href="#">RF-167</a>
B1749	P SHELF (DRAW) STATE 3	×	×	<a href="#">RF-168</a>
B174A	P SHELF (DRAW) STATE 4	×	×	<a href="#">RF-169</a>
B174B	P SHELF (DRAW) STATE 5	×	×	<a href="#">RF-170</a>
B174C	P SHELF (DRAW) STATE 6	×	×	<a href="#">RF-171</a>
B174D	P SHELF (ROT) STATE 1	×	×	<a href="#">RF-172</a>
B174E	P SHELF (ROT) STATE 2	×	×	<a href="#">RF-173</a>
B174F	P SHELF (ROT) STATE 3	×	×	<a href="#">RF-174</a>
B1750	P SHELF (ROT) STATE 4	×	×	<a href="#">RF-175</a>
B1751	ROOF LATCH STATE 1	×	×	<a href="#">RF-176</a>
B1752	ROOF LATCH STATE 2	×	×	<a href="#">RF-177</a>
B1753	ROOF LATCH STATE 3	×	×	<a href="#">RF-178</a>

A

B

C

D

E

F

G

H

I

J

K

DEF

M

N

O

P

# RETRACTABLE HARD TOP CONTROL UNIT

< ECU DIAGNOSIS INFORMATION >

Display contents of CONSULT-III		Fail-safe	Freeze Frame Data	Reference page
B1754	FLIPPER DOOR STATE 1	×	×	<a href="#">RF-179</a>
B1755	FLIPPER DOOR STATE 2	×	×	<a href="#">RF-180</a>
B1756	FLIPPER DOOR STATE 3	×	×	<a href="#">RF-181</a>
B1757	FLIPPER DOOR STATE 4	×	×	<a href="#">RF-182</a>
B1758	THERMO PROTECTION	×	×	<a href="#">RF-183</a>
B175C	PWR SOURCE(ROOF)	×	×	<a href="#">RF-184</a>
B175D	PWR SOURCE(ROOF)	×	×	<a href="#">RF-185</a>
B175E	PWR SOURCE(WINDOW)	×	×	<a href="#">RF-186</a>
B175F	PWR SOURCE(WINDOW)	×	×	<a href="#">RF-188</a>
B1760	ROOF CONTROL UNIT	×	×	<a href="#">RF-190</a>
B1761	ROOF CONTROL UNIT	×	×	<a href="#">RF-191</a>
B1762	ROOF STATE	×	×	<a href="#">RF-192</a>
B1763	HYDRAULIC STATE	×	×	<a href="#">RF-195</a>
B1764	ROOF LATCH STATE	×	×	<a href="#">RF-197</a>
B1765	FLIPPER DOOR STATE	×	×	<a href="#">RF-198</a>

# REAR WINDOW DEFOGGER AND DOOR MIRROR DEFOGGER DO NOT OPERATE.

< SYMPTOM DIAGNOSIS >

## SYMPTOM DIAGNOSIS

REAR WINDOW DEFOGGER AND DOOR MIRROR DEFOGGER DO NOT OPERATE.

### Diagnosis Procedure

INFOID:000000004372734

#### 1. CHECK POWER SUPPLY AND GROUND CIRCUIT

Check power supply and ground circuit.

Refer to [DEF-8. "BCM \(BODY CONTROL MODULE\) : Diagnosis Procedure"](#).

Is the inspection result normal?

YES >> GO TO 2.

NO >> Repair or replace the malfunctioning parts.

#### 2. CHECK REAR WINDOW DEFOGGER SWITCH

Check rear window defogger switch.

Refer to [DEF-9. "Component Function Check"](#).

Is the inspection result normal?

YES >> GO TO 3.

NO >> Repair or replace the malfunctioning parts.

#### 3. CHECK REAR WINDOW DEFOGGER RELAY

Check rear window defogger relay.

Refer to [DEF-10. "Component Function Check"](#).

Is the inspection result normal?

YES >> GO TO 4.

NO >> Repair or replace the malfunctioning parts.

#### 4. CONFIRM THE OPERATION

Confirm the operation again.

Is the inspection result normal?

YES >> Check intermittent incident. Refer to [GI-36. "Intermittent Incident"](#).

NO >> GO TO 1.

A  
B  
C  
D  
E  
F  
G  
H  
I  
J  
K  
M  
N  
O  
P

DEF

# REAR WINDOW DEFOGGER DOES NOT OPERATE BUT BOTH DOOR MIRROR DEFOGGER OPERATE.

< SYMPTOM DIAGNOSIS >

---

REAR WINDOW DEFOGGER DOES NOT OPERATE BUT BOTH DOOR MIRROR DEFOGGER OPERATE.

## Diagnosis Procedure

INFOID:000000004372735

### 1. CHECK RETRACTABLE HARD TOP CONTROL UNIT CIRCUIT

---

Check retractable hard top control unit circuit.  
Refer to [DEF-12, "Component Function Check"](#).

Is the inspection result normal?

- YES >> GO TO 2.
- NO >> Repair or replace the malfunctioning parts.

### 2. CHECK REAR WINDOW DEFOGGER

---

Check rear window defogger.  
Refer to [DEF-14, "Component Function Check"](#).

Is the inspection result normal?

- YES >> GO TO 3.
- NO >> Repair or replace the malfunctioning parts.

### 3. CONFIRM THE OPERATION

---

Confirm the operation again

Is the inspection result normal?

- YES >> Check intermittent incident. Refer to [GI-36, "Intermittent Incident"](#).
- NO >> GO TO 1.



# DOOR MIRROR DEFOGGER DOES NOT OPERATE BUT REAR WINDOW DEFOGGER OPERATE

< SYMPTOM DIAGNOSIS >

## DOOR MIRROR DEFOGGER DOES NOT OPERATE BUT REAR WINDOW DEFOGGER OPERATE

BOTH SIDES

BOTH SIDES : Diagnosis Procedure

INFOID:000000004372736

### 1.CHECK DOOR MIRROR DEFOGGER

Check door mirror defogger.

Refer to [DEF-16, "Component Function Check"](#).

Is the inspection result normal?

YES >> GO TO 2.

NO >> Repair or replace the malfunctioning parts.

### 2.CONFIRM THE OPERATION

Confirm the operation again.

Is the inspection result normal?

YES >> Check intermittent incident. Refer to [GI-36, "Intermittent Incident"](#).

NO >> GO TO 1.

DRIVER SIDE

DRIVER SIDE : Diagnosis Procedure

INFOID:000000004372737

### 1.CHECK DRIVER SIDE DOOR MIRROR DEFOGGER

Check driver side door mirror defogger.

Refer to [DEF-17, "Component Function Check"](#).

Is the inspection result normal?

YES >> GO TO 2.

NO >> Repair or replace the malfunctioning parts.

### 2.CONFIRM THE OPERATION

Confirm the operation again.

Is the inspection result normal?

YES >> Check intermittent incident. Refer to [GI-36, "Intermittent Incident"](#).

NO >> GO TO 1.

PASSENGER SIDE

PASSENGER SIDE : Diagnosis Procedure

INFOID:000000004372738

### 1.CHECK PASSENGER SIDE DOOR MIRROR DEFOGGER.

Check passenger side door mirror defogger.

Refer to [DEF-19, "Component Function Check"](#).

Is the inspection result normal?

YES >> GO TO 2.

NO >> Repair or replace the malfunctioning parts.

### 2.CONFIRM THE OPERATION

Confirm the operation again.

Is the inspection result normal?

YES >> Check intermittent incident. Refer to [GI-36, "Intermittent Incident"](#).

NO >> GO TO 1.

A  
B  
C  
D  
E  
F  
G  
H  
I  
J  
K  
M  
N  
O  
P

DEF

# ON IS NOT DISPLAYED WHEN PRESSING REAR WINDOW DEFOGGER SWITCH BUT IT IS OPERATED

< SYMPTOM DIAGNOSIS >

---

## ON IS NOT DISPLAYED WHEN PRESSING REAR WINDOW DEFOGGER SWITCH BUT IT IS OPERATED

### Diagnosis Procedure

INFOID:000000004372739

#### 1. CHECK AV CONTROL UNIT FUNCTION

---

Check that the AV control unit is operating normally.

Base audio without navigation refer to [AV-12, "Work Flow"](#).

Bose audio without navigation refer to [AV-171, "Work Flow"](#).

Bose audio with navigation refer to [AV-481, "Work Flow"](#).

Is the inspection result normal?

YES >> GO TO 2.

NO >> Repair or replace the malfunctioning parts.

#### 2. CONFIRM THE OPERATION

---

Confirm the operation again.

Is the inspection result normal?

YES >> Check intermittent incident. Refer to [GI-36, "Intermittent Incident"](#) [GI-36, "Intermittent Incident"](#).

NO >> GO TO 1.

# REAR WINDOW DEFOGGER INDICATOR DOES NOT ILLUMINATE

< SYMPTOM DIAGNOSIS >

## REAR WINDOW DEFOGGER INDICATOR DOES NOT ILLUMINATE

### Diagnosis Procedure

INFOID:000000004372740

#### 1. CHECK MULTIFUNCTION SWITCH (REAR WINDOW DEFOGGER SWITCH)

Check rear window defogger operate.

- YES >> Replace multifunction switch (rear window defogger switch). Refer to [AV-161. "Removal and Installation"](#)
- NO >> Check rear window defogger system. Refer to [DEF-3. "Work Flow"](#)

A  
B  
C  
D  
E  
F  
G  
H  
I  
J  
K  
DEF  
M  
N  
O  
P

# PRECAUTIONS

< PRECAUTION >

## PRECAUTION

### PRECAUTIONS

#### Precaution for Supplemental Restraint System (SRS) "AIR BAG" and "SEAT BELT PRE-TENSIONER"

INFOID:000000005186644

The Supplemental Restraint System such as "AIR BAG" and "SEAT BELT PRE-TENSIONER", used along with a front seat belt, helps to reduce the risk or severity of injury to the driver and front passenger for certain types of collision. This system includes seat belt switch inputs and dual stage front air bag modules. The SRS system uses the seat belt switches to determine the front air bag deployment, and may only deploy one front air bag, depending on the severity of a collision and whether the front occupants are belted or unbelted. Information necessary to service the system safely is included in the "SRS AIR BAG" and "SEAT BELT" of this Service Manual.

#### **WARNING:**

- To avoid rendering the SRS inoperative, which could increase the risk of personal injury or death in the event of a collision that would result in air bag inflation, all maintenance must be performed by an authorized NISSAN/INFINITI dealer.
- Improper maintenance, including incorrect removal and installation of the SRS, can lead to personal injury caused by unintentional activation of the system. For removal of Spiral Cable and Air Bag Module, see the "SRS AIR BAG".
- Do not use electrical test equipment on any circuit related to the SRS unless instructed to in this Service Manual. SRS wiring harnesses can be identified by yellow and/or orange harnesses or harness connectors.

#### PRECAUTIONS WHEN USING POWER TOOLS (AIR OR ELECTRIC) AND HAMMERS

#### **WARNING:**

- When working near the Air Bag Diagnosis Sensor Unit or other Air Bag System sensors with the ignition ON or engine running, DO NOT use air or electric power tools or strike near the sensor(s) with a hammer. Heavy vibration could activate the sensor(s) and deploy the air bag(s), possibly causing serious injury.
- When using air or electric power tools or hammers, always switch the ignition OFF, disconnect the battery, and wait at least 3 minutes before performing any service.

# FILAMENT

< REMOVAL AND INSTALLATION >

## REMOVAL AND INSTALLATION

### FILAMENT

#### Inspection and Repair

INFOID:000000004372742

#### INSPECTION

1. When measuring voltage, wrap tin foil around the top of the negative probe. Then press the foil against the wire with your finger.

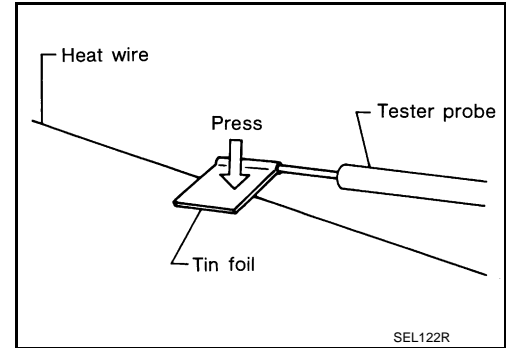

2. Attach probe circuit tester (in Volt range) to middle portion of each filament.

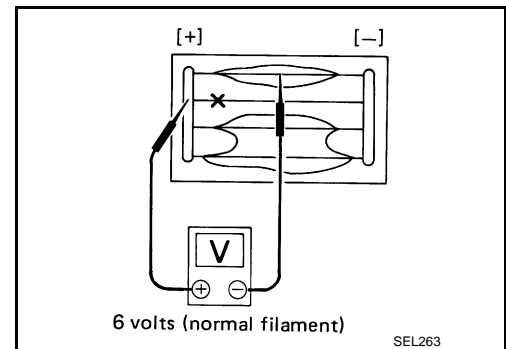

3. If a filament is burned out, circuit tester registers 0 or battery voltage.
4. To locate burned out point, move probe to left and right along filament. Test needle will swing abruptly when probe passes the point.

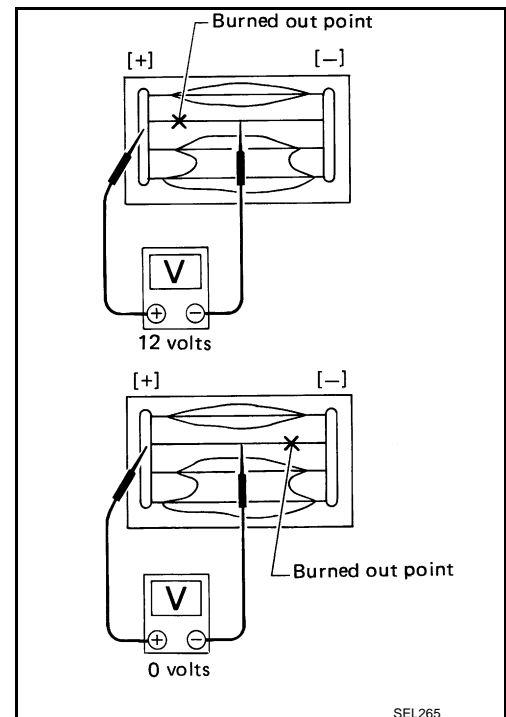

#### REPAIR

##### REPAIR EQUIPMENT

- Conductive silver composition (Dupont No. 4817 or equivalent)

A  
B  
C  
D  
E  
F  
G  
H  
I  
J  
K  
DEF  
M  
N  
O  
P

# FILAMENT

## < REMOVAL AND INSTALLATION >

- Ruler 30 cm (11.8 in) long
- Drawing pen
- Heat gun
- Alcohol
- Cloth

### REPAIRING PROCEDURE

1. Wipe broken heat wire and its surrounding area clean with a cloth dampened in alcohol.
2. Apply a small amount of conductive silver composition to tip of drawing pen. Shake silver composition container before use.
3. Place ruler on glass along broken line. Deposit conductive silver composition on break with drawing pen. Slightly overlap existing heat wire on both sides [preferably 5 mm (0.20 in)] of the break.

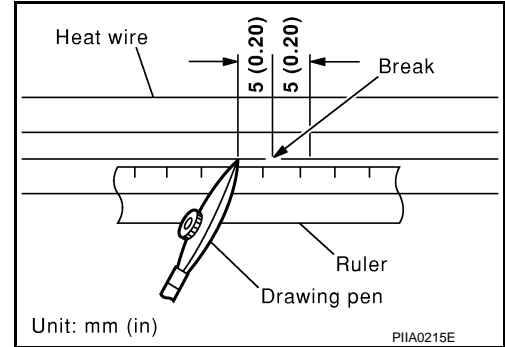

4. After repair has been completed, check repaired wire for continuity. This check should be conducted 10 minutes after silver composition is deposited. Do not touch repaired area while test is being conducted.

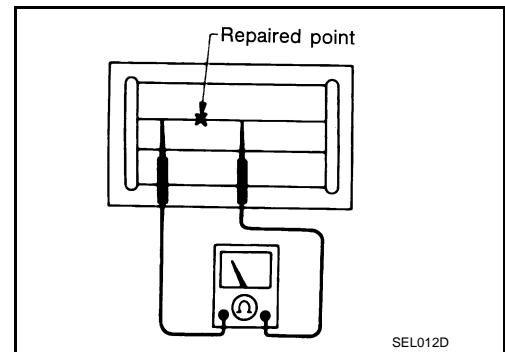

5. Apply a constant stream of hot air directly to the repaired area for approximately 20 minutes with a heat gun. A minimum distance of 3 cm (1.2 in) should be kept between repaired area and hot air outlet. If a heat gun is not available, let the repaired area dry for 24 hours.

