

# SECTION **EXL**

## EXTERIOR LIGHTING SYSTEM

A  
B  
C  
D  
E  
F  
G  
H  
I  
J  
K  
EXL  
M  
N  
O  
P

### CONTENTS

<b>XENON TYPE</b>		
<b>BASIC INSPECTION</b> .....	5	
<b>DIAGNOSIS AND REPAIR WORKFLOW</b> .....	5	
Work Flow .....	5	
<b>INSPECTION AND ADJUSTMENT</b> .....	7	
<b>ADDITIONAL SERVICE WHEN REPLACING CONTROL UNIT (AFS CONTROL UNIT)</b> .....	7	
ADDITIONAL SERVICE WHEN REPLACING CONTROL UNIT (AFS CONTROL UNIT) : Description .....	7	
ADDITIONAL SERVICE WHEN REPLACING CONTROL UNIT (AFS CONTROL UNIT) : Special Repair Requirement .....	7	
<b>ADDITIONAL SERVICE WHEN REPLACING CONTROL UNIT (HEIGHT SENSOR)</b> .....	7	
ADDITIONAL SERVICE WHEN REPLACING CONTROL UNIT (HEIGHT SENSOR) : Description .....	7	
ADDITIONAL SERVICE WHEN REPLACING CONTROL UNIT (HEIGHT SENSOR) : Special Repair Requirement .....	7	
<b>LEVELIZER ADJUSTMENT</b> .....	7	
LEVELIZER ADJUSTMENT : Description .....	7	
LEVELIZER ADJUSTMENT : Special Repair Requirement .....	7	
<b>SYSTEM DESCRIPTION</b> .....	9	
<b>HEADLAMP SYSTEM</b> .....	9	
System Diagram .....	9	
System Description .....	9	
Component Parts Location .....	11	
Component Description .....	11	
<b>AUTO LIGHT SYSTEM</b> .....	13	
System Diagram .....	13	
System Description .....	13	
Component Parts Location .....	14	
Component Description .....	14	
<b>DAYTIME RUNNING LIGHT SYSTEM</b> .....	15	
System Diagram .....	15	
System Description .....	15	
Component Parts Location .....	16	
Component Description .....	16	
<b>ACTIVE ADAPTIVE FRONT-LIGHTING SYSTEM</b> .....	18	
System Diagram .....	18	
System Description .....	18	
Component Parts Location .....	20	
Component Description .....	21	
<b>FRONT FOG LAMP SYSTEM</b> .....	22	
System Diagram .....	22	
System Description .....	22	
Component Parts Location .....	23	
Component Description .....	23	
<b>TURN SIGNAL AND HAZARD WARNING LAMP SYSTEM</b> .....	24	
System Diagram .....	24	
System Description .....	24	
Component Parts Location .....	25	
Component Description .....	25	
<b>PARKING, LICENSE PLATE AND TAIL LAMPS SYSTEM</b> .....	26	
System Diagram .....	26	
System Description .....	26	
Component Parts Location .....	27	
Component Description .....	28	
<b>EXTERIOR LAMP BATTERY SAVER SYSTEM</b> .....	29	
System Diagram .....	29	
System Description .....	29	
Component Parts Location .....	30	
Component Description .....	30	

<b>DIAGNOSIS SYSTEM (BCM)</b> .....	<b>31</b>	<b>B2521 ECU CIRCUIT</b> .....	<b>57</b>
<b>COMMON ITEM</b> .....	<b>31</b>	Description .....	57
COMMON ITEM : CONSULT-III Function (BCM - COMMON ITEM) .....	31	DTC Logic .....	57
<b>HEADLAMP</b> .....	<b>32</b>	Diagnosis Procedure .....	57
HEADLAMP : CONSULT-III Function (BCM - HEAD LAMP) .....	32	<b>C0126 STEERING ANGLE SENSOR SIGNAL..</b>	<b>60</b>
<b>FLASHER</b> .....	<b>34</b>	Description .....	60
FLASHER : CONSULT-III Function (BCM - FLASHER) .....	34	DTC Logic .....	60
<b>DIAGNOSIS SYSTEM (IPDM E/R)</b> .....	<b>36</b>	Diagnosis Procedure .....	60
Diagnosis Description .....	36	<b>C0428 STEERING ANGLE SENSOR CALI- BRATION</b> .....	<b>61</b>
CONSULT-III Function (IPDM E/R) .....	38	Description .....	61
<b>DIAGNOSIS SYSTEM (AFS)</b> .....	<b>41</b>	DTC Logic .....	61
CONSULT-III Function (ADAPTIVE LIGHT) .....	41	Diagnosis Procedure .....	61
<b>DTC/CIRCUIT DIAGNOSIS</b> .....	<b>43</b>	<b>U1000 CAN COMM CIRCUIT</b> .....	<b>62</b>
<b>POWER SUPPLY AND GROUND CIRCUIT</b> ....	<b>43</b>	Description .....	62
<b>BCM</b> .....	<b>43</b>	DTC Logic .....	62
BCM : Diagnosis Procedure .....	43	Diagnosis Procedure .....	62
<b>IPDM E/R (INTELLIGENT POWER DISTRIBUTION MODULE ENGINE ROOM)</b> .....	<b>43</b>	<b>U1010 CONTROL UNIT (CAN)</b> .....	<b>63</b>
IPDM E/R (INTELLIGENT POWER DISTRIBUTION MODULE ENGINE ROOM) : Diagnosis Pro- cedure .....	43	DTC Logic .....	63
<b>AFS CONTROL UNIT</b> .....	<b>44</b>	Diagnosis Procedure .....	63
AFS CONTROL UNIT : Diagnosis Procedure .....	44	<b>EXTERIOR LAMP FUSE</b> .....	<b>64</b>
<b>B2503, B2504 SWIVEL ACTUATOR</b> .....	<b>46</b>	Description .....	64
Description .....	46	Diagnosis Procedure .....	64
DTC Logic .....	46	<b>HEADLAMP (HI) CIRCUIT</b> .....	<b>65</b>
Diagnosis Procedure .....	47	Description .....	65
Component Inspection .....	50	Component Function Check .....	65
<b>B2514 HEIGHT SENSOR UNUSUAL [RR]</b> .....	<b>51</b>	Diagnosis Procedure .....	65
Description .....	51	<b>HEADLAMP (LO) CIRCUIT</b> .....	<b>67</b>
DTC Logic .....	51	Description .....	67
Diagnosis Procedure .....	51	Component Function Check .....	67
Component Inspection .....	53	Diagnosis Procedure .....	67
<b>B2516 SHIFT SIGNAL [P, R]</b> .....	<b>54</b>	<b>XENON HEADLAMP</b> .....	<b>69</b>
Description .....	54	Description .....	69
DTC Logic .....	54	Diagnosis Procedure .....	69
Diagnosis Procedure .....	54	<b>HEADLAMP LEVELIZER CIRCUIT</b> .....	<b>71</b>
<b>B2517 VEHICLE SPEED SIGNAL</b> .....	<b>55</b>	Description .....	71
Description .....	55	Component Function Check .....	71
DTC Logic .....	55	Diagnosis Procedure .....	71
Diagnosis Procedure .....	55	<b>FRONT FOG LAMP CIRCUIT</b> .....	<b>73</b>
<b>B2519 LEVELIZER CALIBRATION</b> .....	<b>56</b>	Component Function Check .....	73
Description .....	56	Diagnosis Procedure .....	73
DTC Logic .....	56	<b>PARKING LAMP CIRCUIT</b> .....	<b>75</b>
Diagnosis Procedure .....	56	Component Function Check .....	75
<b>B2521 ECU CIRCUIT</b> .....	<b>57</b>	Diagnosis Procedure .....	75
Description .....	57	<b>TURN SIGNAL LAMP CIRCUIT</b> .....	<b>77</b>
DTC Logic .....	57	Description .....	77
Diagnosis Procedure .....	57	Component Function Check .....	77
<b>C0126 STEERING ANGLE SENSOR SIGNAL..</b>	<b>60</b>	Diagnosis Procedure .....	77
Description .....	60	<b>OPTICAL SENSOR</b> .....	<b>80</b>
DTC Logic .....	60		
Diagnosis Procedure .....	60		
<b>C0428 STEERING ANGLE SENSOR CALI- BRATION</b> .....	<b>61</b>		
Description .....	61		
DTC Logic .....	61		
Diagnosis Procedure .....	61		
<b>U1000 CAN COMM CIRCUIT</b> .....	<b>62</b>		
Description .....	62		
DTC Logic .....	62		
Diagnosis Procedure .....	62		
<b>U1010 CONTROL UNIT (CAN)</b> .....	<b>63</b>		
DTC Logic .....	63		
Diagnosis Procedure .....	63		
<b>EXTERIOR LAMP FUSE</b> .....	<b>64</b>		
Description .....	64		
Diagnosis Procedure .....	64		
<b>HEADLAMP (HI) CIRCUIT</b> .....	<b>65</b>		
Description .....	65		
Component Function Check .....	65		
Diagnosis Procedure .....	65		
<b>HEADLAMP (LO) CIRCUIT</b> .....	<b>67</b>		
Description .....	67		
Component Function Check .....	67		
Diagnosis Procedure .....	67		
<b>XENON HEADLAMP</b> .....	<b>69</b>		
Description .....	69		
Diagnosis Procedure .....	69		
<b>HEADLAMP LEVELIZER CIRCUIT</b> .....	<b>71</b>		
Description .....	71		
Component Function Check .....	71		
Diagnosis Procedure .....	71		
<b>FRONT FOG LAMP CIRCUIT</b> .....	<b>73</b>		
Component Function Check .....	73		
Diagnosis Procedure .....	73		
<b>PARKING LAMP CIRCUIT</b> .....	<b>75</b>		
Component Function Check .....	75		
Diagnosis Procedure .....	75		
<b>TURN SIGNAL LAMP CIRCUIT</b> .....	<b>77</b>		
Description .....	77		
Component Function Check .....	77		
Diagnosis Procedure .....	77		
<b>OPTICAL SENSOR</b> .....	<b>80</b>		

Description .....	80	Reference Value .....	165	
Component Function Check .....	80	Wiring Diagram - ACTIVE AFS - .....	168	A
Diagnosis Procedure .....	80	Fail Safe .....	174	
<b>HAZARD SWITCH .....</b>	<b>83</b>	DTC Inspection Priority Chart .....	174	
Description .....	83	DTC Index .....	175	B
Component Function Check .....	83	<b>SYMPTOM DIAGNOSIS .....</b>	<b>176</b>	
Diagnosis Procedure .....	83	<b>EXTERIOR LIGHTING SYSTEM SYMPTOMS. ....</b>	<b>176</b>	C
<b>TAIL LAMP CIRCUIT .....</b>	<b>85</b>	Symptom Table .....	176	
Component Function Check .....	85	<b>NORMAL OPERATING CONDITION .....</b>	<b>179</b>	D
Diagnosis Procedure .....	85	Description .....	179	
<b>LICENSE PLATE LAMP CIRCUIT .....</b>	<b>87</b>	<b>BOTH SIDE HEADLAMPS DO NOT SWITCH</b>		
Component Function Check .....	87	<b>TO HIGH BEAM .....</b>	<b>180</b>	E
Diagnosis Procedure .....	87	Description .....	180	
<b>HEADLAMP SYSTEM .....</b>	<b>88</b>	Diagnosis Procedure .....	180	
Wiring Diagram - HEADLAMP - .....	88	<b>BOTH SIDE HEADLAMPS (LO) ARE NOT</b>		F
<b>AUTO LIGHT SYSTEM .....</b>	<b>92</b>	<b>TURNED ON .....</b>	<b>181</b>	
Wiring Diagram - AUTO LIGHT SYSTEM - .....	92	Description .....	181	
<b>DAYTIME RUNNING LIGHT SYSTEM .....</b>	<b>96</b>	Diagnosis Procedure .....	181	G
Wiring Diagram - DAYTIME LIGHT SYSTEM - .....	96	<b>PARKING, LICENSE PLATE AND TAIL</b>		
<b>FRONT FOG LAMP SYSTEM .....</b>	<b>100</b>	<b>LAMPS ARE NOT TURNED ON .....</b>	<b>182</b>	H
Wiring Diagram - FRONT FOG LAMP - .....	100	Description .....	182	
<b>TURN SIGNAL AND HAZARD WARNING</b>		Diagnosis Procedure .....	182	
<b>LAMP SYSTEM .....</b>	<b>103</b>	<b>BOTH SIDE FRONT FOG LAMPS ARE NOT</b>		I
Wiring Diagram - TURN AND HAZARD WARN-		<b>TURNED ON .....</b>	<b>183</b>	
ING LAMPS - .....	103	Description .....	183	
<b>PARKING, LICENSE PLATE AND TAIL</b>		Diagnosis Procedure .....	183	J
<b>LAMPS SYSTEM .....</b>	<b>107</b>	<b>PRECAUTION .....</b>	<b>184</b>	
Wiring Diagram - PARKING LICENSE PLATE		<b>PRECAUTIONS .....</b>	<b>184</b>	K
AND TAIL LAMPS - .....	107	Precaution for Supplemental Restraint System		
<b>STOP LAMP .....</b>	<b>111</b>	(SRS) "AIR BAG" and "SEAT BELT PRE-TEN-		
Wiring Diagram - STOP LAMP - .....	111	SIONER" .....	184	EXL
<b>BACK-UP LAMP .....</b>	<b>114</b>	<b>PERIODIC MAINTENANCE .....</b>	<b>185</b>	
Wiring Diagram - BACK-UP LAMP - .....	114	<b>HEADLAMP AIMING ADJUSTMENT .....</b>	<b>185</b>	M
<b>ECU DIAGNOSIS INFORMATION .....</b>	<b>117</b>	Description .....	185	
<b>BCM (BODY CONTROL MODULE) .....</b>	<b>117</b>	Aiming Adjustment Procedure .....	186	
Reference Value .....	117	<b>FRONT FOG LAMP AIMING ADJUSTMENT . ....</b>	<b>188</b>	N
Wiring Diagram - BCM - .....	140	Description .....	188	
Fail-safe .....	145	Aiming Adjustment Procedure .....	189	O
DTC Inspection Priority Chart .....	147	<b>REMOVAL AND INSTALLATION .....</b>	<b>191</b>	
DTC Index .....	149	<b>FRONT COMBINATION LAMP .....</b>	<b>191</b>	P
<b>IPDM E/R (INTELLIGENT POWER DISTRI-</b>		Exploded View .....	191	
<b>BUTION MODULE ENGINE ROOM) .....</b>	<b>152</b>	Removal and Installation .....	192	
Reference Value .....	152	Replacement .....	193	
Wiring Diagram - IPDM E/R - .....	159	Disassembly and Assembly .....	193	
Fail-safe .....	162	Inspection After Installation .....	194	
DTC Index .....	164	<b>FRONT FOG LAMP .....</b>	<b>195</b>	
<b>AFS CONTROL UNIT .....</b>	<b>165</b>	Exploded View .....	195	

<b>OPTICAL SENSOR</b> .....	<b>196</b>	Removal and Installation .....	202
Exploded View .....	196	<b>REAR COMBINATION LAMP</b> .....	<b>203</b>
Removal and Installation .....	196	Exploded View .....	203
<b>LIGHTING &amp; TURN SIGNAL SWITCH</b> .....	<b>197</b>	Removal and Installation .....	203
Exploded View .....	197	Replacement .....	204
<b>HAZARD SWITCH</b> .....	<b>198</b>	<b>HIGH-MOUNTED STOP LAMP</b> .....	<b>205</b>
Exploded View .....	198	Exploded View .....	205
<b>AFS CONTROL UNIT</b> .....	<b>199</b>	Removal and Installation .....	205
Exploded View .....	199	<b>LICENSE PLATE LAMP</b> .....	<b>206</b>
Removal and Installation .....	199	Exploded View .....	206
<b>STEERING ANGLE SENSOR</b> .....	<b>200</b>	Removal and Installation .....	206
Removal and Installation .....	200	Replacement .....	206
<b>AFS OFF SWITCH</b> .....	<b>201</b>	<b>SERVICE DATA AND SPECIFICATIONS</b>	
Exploded View .....	201	<b>(SDS)</b> .....	<b>208</b>
Removal and Installation .....	201	<b>SERVICE DATA AND SPECIFICATIONS</b>	
<b>HEIGHT SENSOR</b> .....	<b>202</b>	<b>(SDS)</b> .....	<b>208</b>
Exploded View .....	202	Bulb Specifications .....	208

**BASIC INSPECTION**

DIAGNOSIS AND REPAIR WORKFLOW

Work Flow

INFOID:000000004875506

OVERALL SEQUENCE

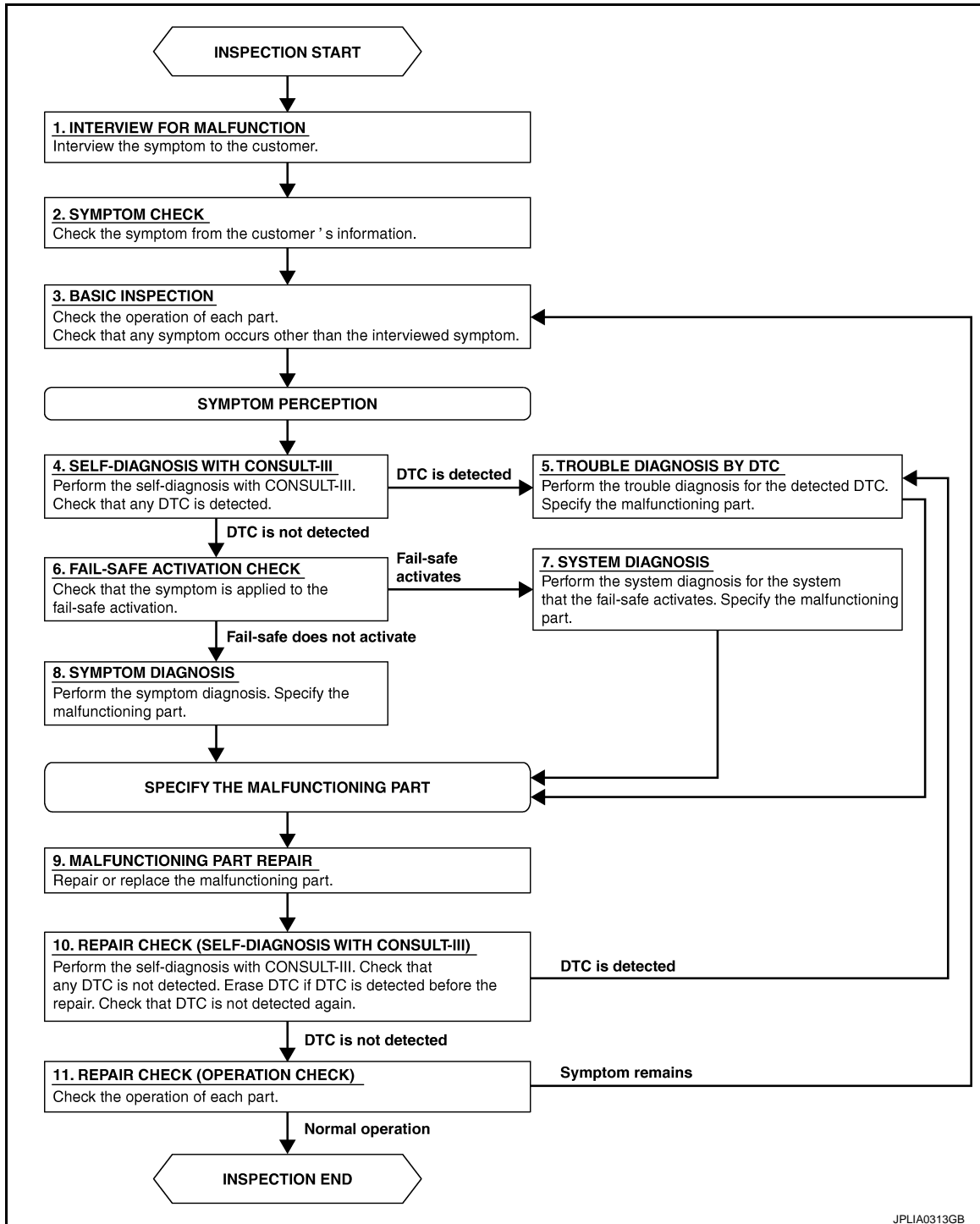

DETAILED FLOW

**1. INTERVIEW FOR MALFUNCTION**

Interview the symptom to the customer.

# DIAGNOSIS AND REPAIR WORKFLOW

[XENON TYPE]

< BASIC INSPECTION >

---

>> GO TO 2.

## 2. SYMPTOM CHECK

---

Check the symptom from the customer's information.

>> GO TO 3.

## 3. BASIC INSPECTION

---

Check the operation of each part. Check that any symptom occurs other than the interviewed symptom.

>> GO TO 4.

## 4. SELF-DIAGNOSIS WITH CONSULT-III

---

Perform the self-diagnosis with CONSULT-III. Check that any DTC is detected.

Is any DTC detected?

YES >> GO TO 5.

NO >> GO TO 6.

## 5. TROUBLE DIAGNOSIS BY DTC

---

Perform the trouble diagnosis for the detected DTC. Specify the malfunctioning part.

>> GO TO 9.

## 6. FAIL-SAFE ACTIVATION CHECK

---

Check that the symptom is applied to the fail-safe activation.

Does the fail-safe activate?

YES >> GO TO 7.

NO >> GO TO 8.

## 7. SYSTEM DIAGNOSIS

---

Perform the system diagnosis for the system that the fail-safe activates. Specify the malfunctioning part.

>> GO TO 9.

## 8. SYMPTOM DIAGNOSIS

---

Perform the symptom diagnosis. Specify the malfunctioning part.

>> GO TO 9.

## 9. MALFUNCTION PART REPAIR

---

Repair or replace the malfunctioning part.

>> GO TO 10.

## 10. REPAIR CHECK (SELF-DIAGNOSIS WITH CONSULT-III)

---

Perform the self-diagnosis with CONSULT-III. Check that any DTC is not detected. Erase DTC if DTC is detected before the repair. Check that DTC is not detected again.

Is any DTC detected?

YES >> GO TO 5.

NO >> GO TO 11.

## 11. REPAIR CHECK (OPERATION CHECK)

---

Check the operation of each part.

Does it operate normally?

YES >> INSPECTION END

NO >> GO TO 3.

# INSPECTION AND ADJUSTMENT

< BASIC INSPECTION >

[XENON TYPE]

## INSPECTION AND ADJUSTMENT

ADDITIONAL SERVICE WHEN REPLACING CONTROL UNIT (AFS CONTROL UNIT)

ADDITIONAL SERVICE WHEN REPLACING CONTROL UNIT (AFS CONTROL UNIT) : Description

INFOID:000000004873748

Perform "LEVELIZER ADJUSTMENT" with CONSULT-III when replacing the AFS control unit.

ADDITIONAL SERVICE WHEN REPLACING CONTROL UNIT (AFS CONTROL UNIT) : Special Repair Requirement

INFOID:000000004873749

### 1.LEVELIZER ADJUSTMENT

Perform "LEVELIZER ADJUSTMENT".

>> Refer to [EXL-7, "LEVELIZER ADJUSTMENT : Special Repair Requirement"](#).

ADDITIONAL SERVICE WHEN REPLACING CONTROL UNIT (HEIGHT SENSOR)

ADDITIONAL SERVICE WHEN REPLACING CONTROL UNIT (HEIGHT SENSOR) : Description

INFOID:000000004873750

Perform "LEVELIZER ADJUSTMENT" with CONSULT-III when replacing the height sensor.

ADDITIONAL SERVICE WHEN REPLACING CONTROL UNIT (HEIGHT SENSOR) : Special Repair Requirement

INFOID:000000004873751

### 1.LEVELIZER ADJUSTMENT

Perform "LEVELIZER ADJUSTMENT".

>> Refer to [EXL-7, "LEVELIZER ADJUSTMENT : Special Repair Requirement"](#).

## LEVELIZER ADJUSTMENT

LEVELIZER ADJUSTMENT : Description

INFOID:000000004873752

Perform "LEVELIZER ADJUSTMENT" when installing, removing, and replacing the height sensor and the suspension components.

LEVELIZER ADJUSTMENT : Special Repair Requirement

INFOID:000000004873753

### 1.CHECK VEHICLE CONDITION

1. Park the vehicle in the straight-forward position.
2. Unload the vehicle (no passenger aboard).

>> GO TO 2.

### 2.LEVELIZER ADJUSTMENT

#### ⓂCONSULT-III WORK SUPPORT

1. Select "LEVELIZER ADJUSTMENT" of ADAPTIVE LIGHT work support item.
2. Select "START".
3. When "ADJUSTMENT IS COMPLETED", select "END".

#### **CAUTION:**

If "CAN NOT BE TESTED" is indicated, AFS control unit detects that the height sensor signal changes. The levelizer adjustment is cancelled. In this case, turn the ignition switch OFF to prevent the vehicle from the height change. Perform the levelizer adjustment again.

A  
B  
C  
D  
E  
F  
G  
H  
I  
J  
K  
EXL  
M  
N  
O  
P

## INSPECTION AND ADJUSTMENT

[XENON TYPE]

< BASIC INSPECTION >

---

Is the levelizer adjustment completed?

YES >> GO TO 3.

NO >> Perform the levelizer adjustment again.

### **3.**SELF-DIAGNOSIS RESULT CHECK

---

Perform self-diagnosis with CONSULT-III. Check that any DTC is not detected.

Is any DTC detected?

YES >> GO TO 2.

NO >> Levelizer adjustment completed



## SYSTEM DESCRIPTION

### HEADLAMP SYSTEM

#### System Diagram

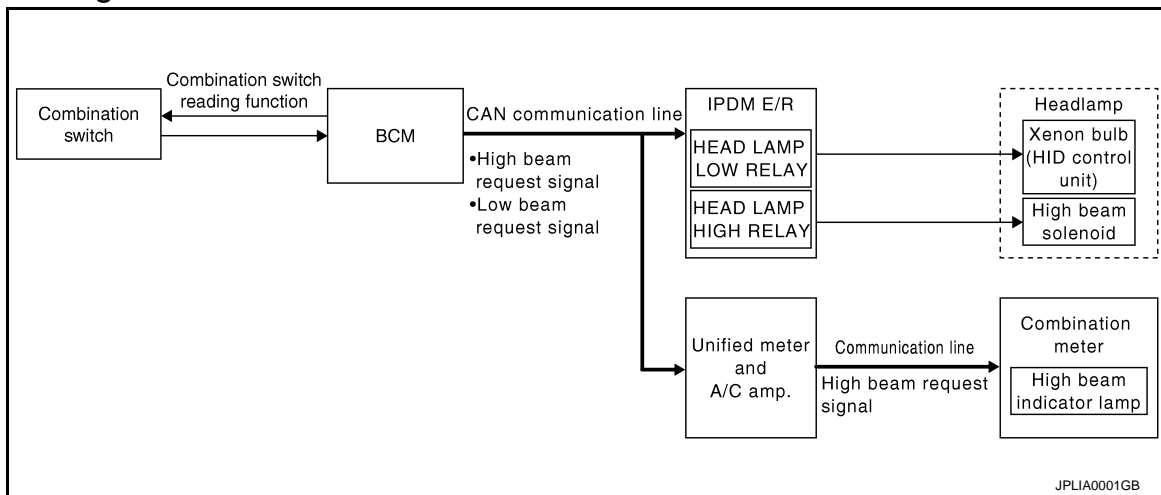

#### System Description

INFOID:0000000004873755

##### OUTLINE

- Mobile valve shade type is adopted. Xenon headlamp switches the high beam and the low beam with one xenon bulb each on right and left.
- Headlamp is controlled by combination switch reading function and headlamp control function of BCM, and relay control function of IPDM E/R.

##### HEADLAMP BASIC OPERATION

- BCM detects the combination switch condition with the combination switch reading function.
- BCM transmits the low beam request signal to IPDM E/R with CAN communication according to the headlamp ON condition.

##### Headlamp ON condition

- Lighting switch 2ND
- Lighting switch PASS
- Lighting switch AUTO, and the auto light function ON judgment
- IPDM E/R turns the integrated headlamp low relay ON, and turns the headlamp ON according to the low beam request signal.

##### HEADLAMP HI/LO SWITCHING OPERATION

- BCM transmits the high beam request signal to IPDM E/R and the combination meter (through unified meter and A/C amp.) with CAN communication according to the high beam switching condition.

##### High beam switching condition

- Lighting switch HI with the headlamp ON
- Lighting switch PASS
- Combination meter turns the high beam indicator lamp ON according to the high beam request signal.
- IPDM E/R turns the integrated headlamp high relay ON, and turns the headlamp ON according to the high beam request signal.

A  
B  
C  
D  
E  
F  
G  
H  
I  
J  
K  
EXL  
M  
N  
O  
P

# HEADLAMP SYSTEM

[XENON TYPE]

## < SYSTEM DESCRIPTION >

- When the headlamp high relay is turned ON, magnetic force is applied to the high beam solenoid (1) by a current. The mobile valve shade (2) is switched to the high beam position.
- When the headlamp high relay is turned OFF, the current stops. The mobile valve shade returns to the low beam position automatically.

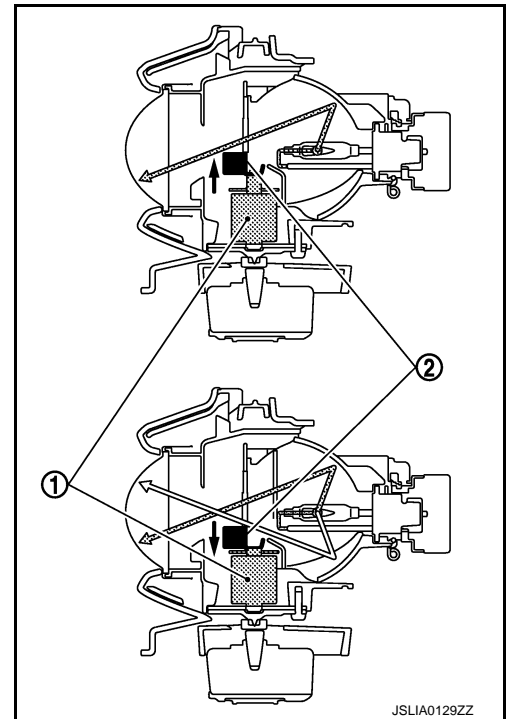

# HEADLAMP SYSTEM

< SYSTEM DESCRIPTION >

[XENON TYPE]

## Component Parts Location

INFOID:000000005062742

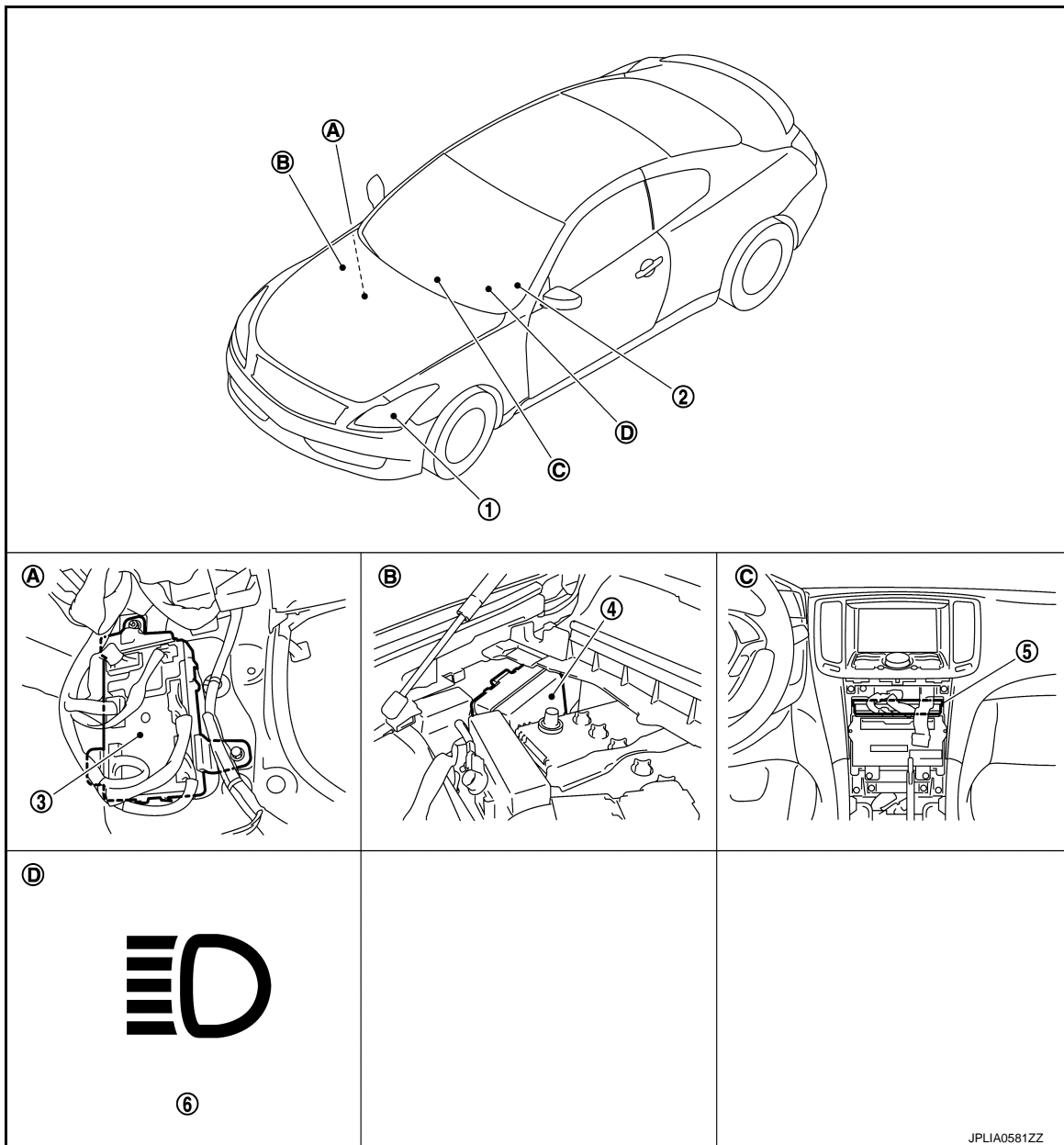

- |                                     |                                |                             |
|-------------------------------------|--------------------------------|-----------------------------|
| 1. Headlamp                         | 2. Combination switch          | 3. BCM                      |
| 4. IPDM E/R                         | 5. Unified meter and A/C amp.  | 6. High beam indicator lamp |
| A. Dash side lower (passenger side) | B. Engine room dash panel (RH) | C. Behind the cluster lid C |
| D. On the combination meter         |                                |                             |

## Component Description

INFOID:0000000004873757

Part	Description
BCM	<ul style="list-style-type: none"> <li>• Detects each switch condition by the combination switch reading function.</li> <li>• Judges that the headlamp is turned ON according to the vehicle condition.</li> <li>- Requests the headlamp relay (HI/LO) ON to IPDM E/R (with CAN communication).</li> <li>- Requests the high beam indicator lamp ON to the combination meter [with CAN communication (through unified meter and A/C amp.)].</li> </ul>
IPDM E/R	Controls the integrated relay, and supplies voltage to the load according to the request from BCM (with CAN communication).

A  
B  
C  
D  
E  
F  
G  
H  
I  
J  
K  
L  
M  
N  
O  
P

EXL

# HEADLAMP SYSTEM

< SYSTEM DESCRIPTION >

[XENON TYPE]

Part	Description	
Combination switch (Lighting & turn signal switch)	Refer to <a href="#">BCS-6. "System Diagram"</a> .	
Combination meter (High beam indicator lamp)	Turns the high beam indicator lamp ON according to the request from BCM [(with CAN communication (through unified meter and A/C amp.))].	
Headlamp assembly	<ul style="list-style-type: none"><li>• HID control unit</li><li>• Xenon bulb</li></ul>	Refer to <a href="#">EXL-69. "Description"</a> .
	High beam solenoid	Refer to <a href="#">EXL-65. "Description"</a> .

## AUTO LIGHT SYSTEM

### System Diagram

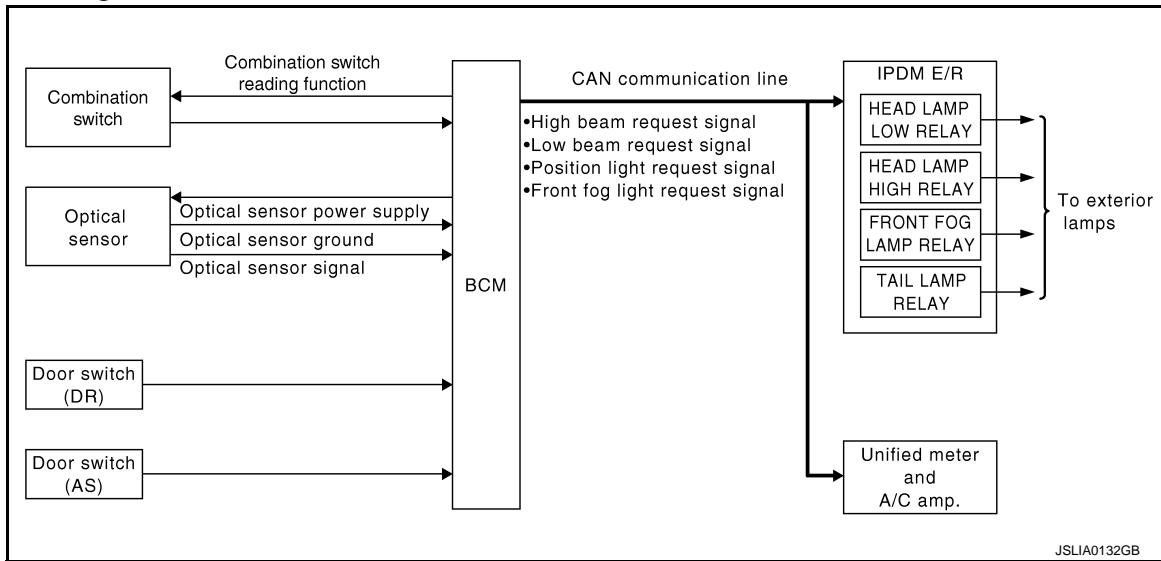

### System Description

INFOID:000000004873759

#### OUTLINE

- Auto light system is controlled by each function of BCM and IPDM E/R.

#### Control by BCM

- Combination switch reading function
- Headlamp control function
- Auto light function
- Delay timer function

#### Control by IPDM E/R

- Relay control function
- Auto light system has the auto light function and the delay timer function.
- Auto light function turns the exterior lamps\* and each illumination ON/OFF automatically according to the outside brightness.
- When auto light system turns the exterior lamps ON with the ignition switch OFF, delay timer function turns the exterior lamps OFF depending on the vehicle condition with the auto light function after a certain period of time.

\*: Headlamp (LO/HI), parking lamp, side marker lamp, tail lamp, and front fog lamp (Headlamp HI and front fog lamp depend on the combination switch condition.)

#### AUTO LIGHT FUNCTION

- BCM detects the combination switch condition with the combination switch reading function.
- BCM supplies voltage to optical sensor when the ignition switch is turned ON or ACC.
- Optical sensor converts outside brightness (lux) to voltage and transmits the optical sensor signal to BCM.
- BCM judges outside brightness from the optical sensor signal and judges ON/OFF condition of the exterior lamp and each illumination according to the outside brightness.
- BCM transmits each request signal to IPDM E/R with CAN communication according to ON/OFF condition by the auto light function.

#### NOTE:

ON/OFF timing differs based on the sensitivity from the setting. The setting can be set by CONSULT-III. Refer to [EXL-32. "HEADLAMP : CONSULT-III Function \(BCM - HEAD LAMP\)".](#)

#### DELAY TIMER FUNCTION

BCM turns the exterior lamp OFF depending on the vehicle condition with the auto light function when the ignition switch is turned OFF.

- Turns the exterior lamp OFF 5 minutes after detecting that any door opens (Door switch ON).
- Turns the exterior lamp OFF a certain period of time\* after closing all doors (Door switch ON→OFF).

# AUTO LIGHT SYSTEM

[XENON TYPE]

## < SYSTEM DESCRIPTION >

- Turns the exterior lamp OFF with the ignition switch ACC or the light switch OFF.
- \*: The preset time is 45 seconds. The timer operating time can be set by CONSULT-III. Refer to [EXL-32, "HEADLAMP : CONSULT-III Function \(BCM - HEAD LAMP\)"](#).

**NOTE:**

When any position other than the light switch AUTO is set, the auto light system function switches to the exterior lamp battery saver function.

## Component Parts Location

INFOID:000000004873760

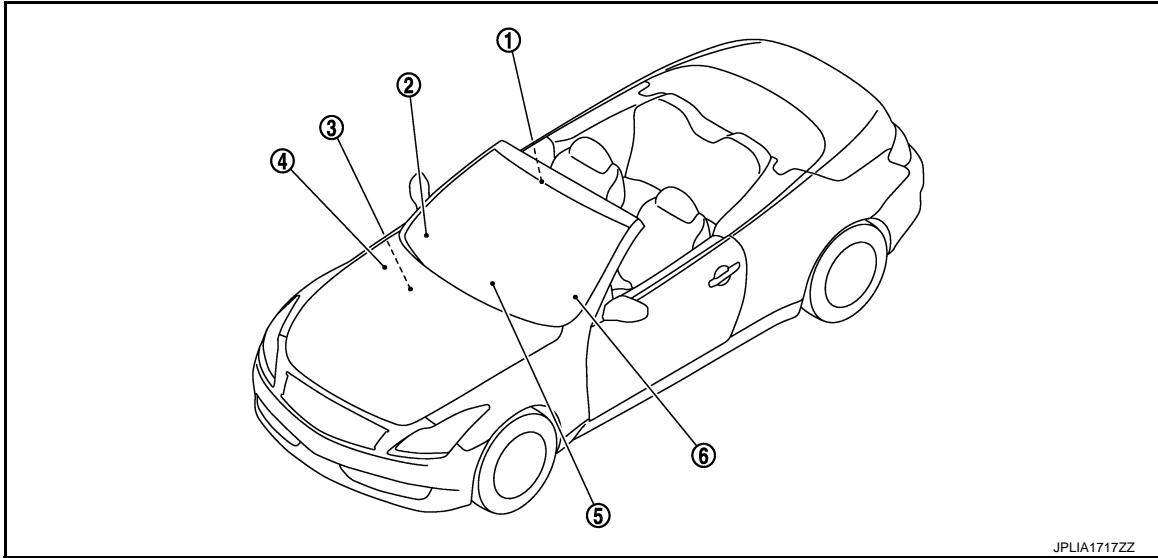

- |   |   |  |
|---|---|--|
| 1. Door switch  | 2. Optical sensor   | 3. BCM<br>Refer to <a href="#">BCS-5, "Component Parts Location"</a> . |
| 4. IPDM E/R<br>Refer to <a href="#">PCS-4, "Component Parts Location"</a> . | 5. Unified meter and A/C amp.<br>Refer to <a href="#">HAC-26, "Component Part Location"</a> . | 6. Combination switch  |

## Component Description

INFOID:000000004873761

Part	Description
BCM	<ul style="list-style-type: none"> <li>• Detects each switch condition by the combination switch reading function.</li> <li>• Judges the outside brightness from the optical sensor signal.</li> <li>• Judges the OFF timing according to the vehicle condition.</li> <li>• Judges the ON/OFF status of the exterior lamp and each illumination according to the outside brightness and the vehicle condition.</li> <li>- Requests ON/OFF of each relay to IPDM E/R (with CAN communication).</li> </ul>
IPDM E/R	Controls the integrated relay, and supplies voltage to the load according to the request from BCM (with CAN communication).
Combination switch (Lighting & turn signal switch)	Refer to <a href="#">BCS-6, "System Diagram"</a> .
Optical sensor	Refer to <a href="#">EXL-80, "Description"</a> .

# DAYTIME RUNNING LIGHT SYSTEM

< SYSTEM DESCRIPTION >

[XENON TYPE]

## DAYTIME RUNNING LIGHT SYSTEM

### System Diagram

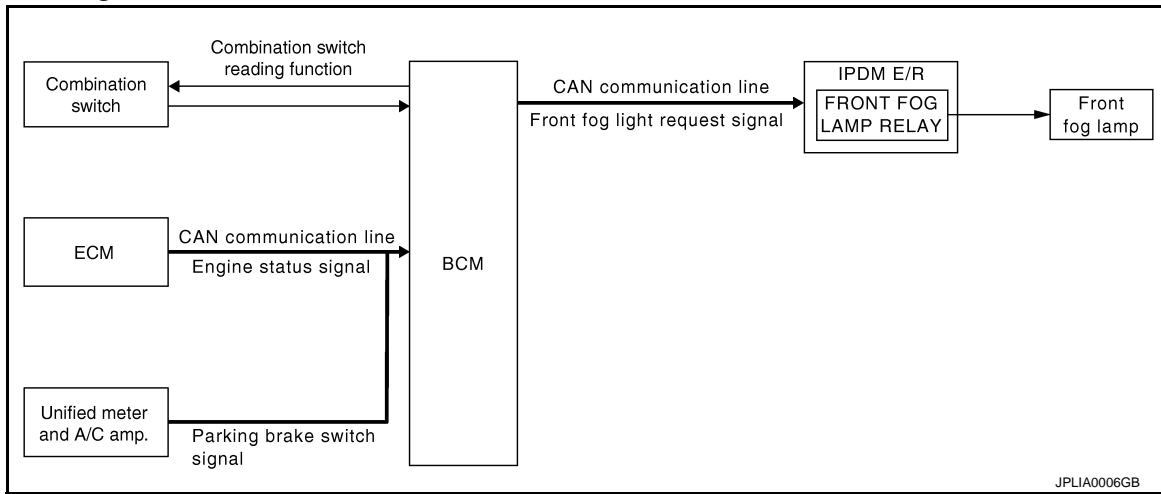

### System Description

INFOID:000000004875501

#### OUTLINE

- Turns the front fog lamp ON as the daytime running light.
- Daytime running light is controlled by daytime running light control function and combination switch reading function of BCM, and relay control function of IPDM E/R.

#### DAYTIME RUNNING LIGHT OPERATION

- BCM detects the combination switch condition by the combination switch reading function.
- BCM detects the vehicle condition depending on the following signals.
  - Engine status signal (received from ECM with CAN communication)
  - Parking brake switch signal (received from unified meter and A/C amp. with CAN communication)
- BCM transmits the front fog light request signal to IPDM E/R with CAN communication according to the daytime running light ON condition.

#### Daytime running light ON condition

- While the engine running with the parking brake released

#### Daytime running light OFF condition

- Engine stopped
- Headlamp ON (passing included)
- IPDM E/R turns the integrated front fog lamp relay ON and turns the front fog lamp ON according to the front fog light request signal.

# DAYTIME RUNNING LIGHT SYSTEM

< SYSTEM DESCRIPTION >

[XENON TYPE]

## Component Parts Location

INFOID:000000005062743

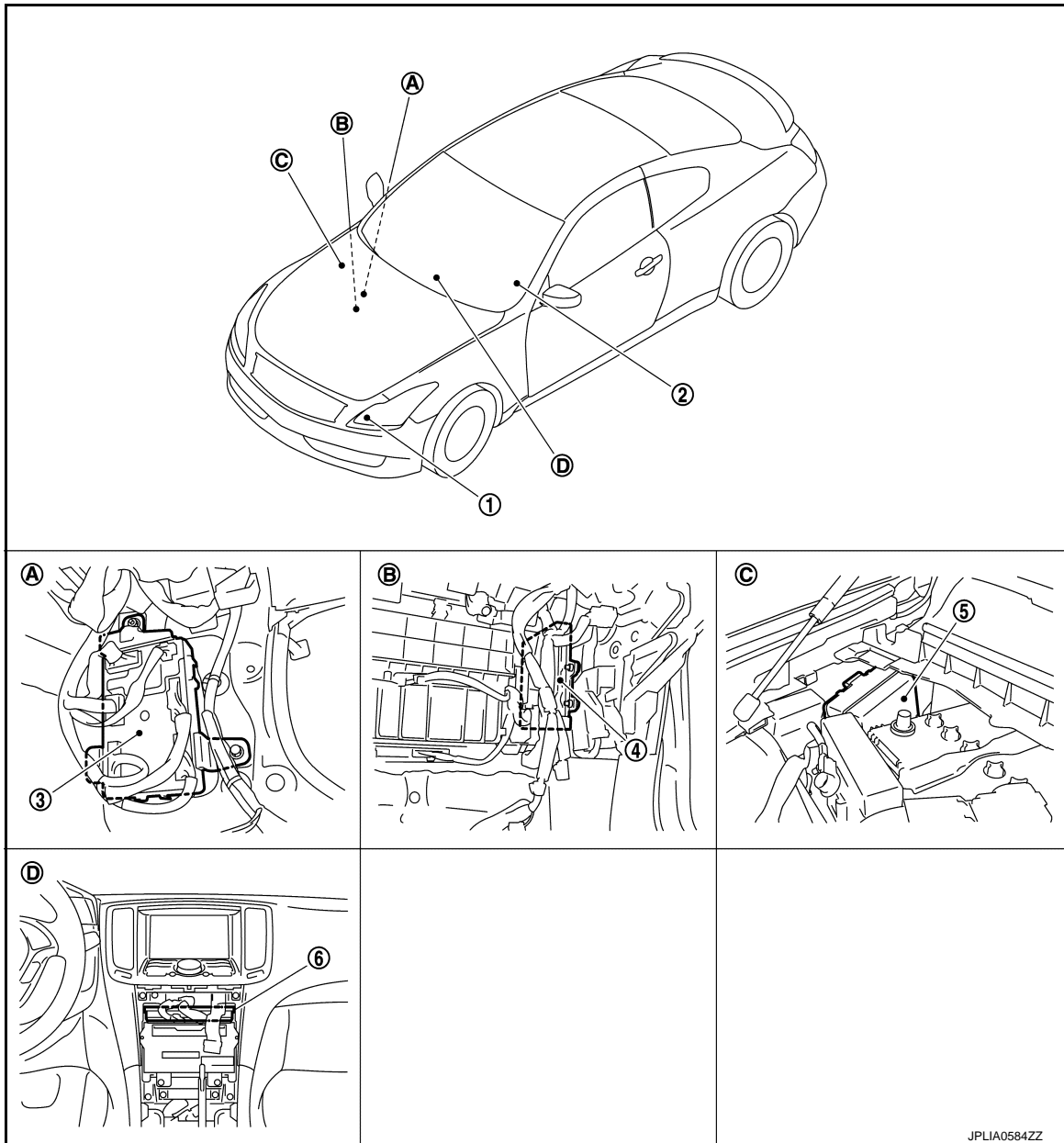

- |  |                         |                                |
|--|-------------------------|--------------------------------|
| 1. Daytime running light<br>(Front fog lamp) | 2. Combination switch   | 3. BCM                         |
| 4. ECM                                       | 5. IPDM E/R             | 6. Unified meter and A/C amp.  |
| A. Dash side lower (passenger side)          | B. Behind the glove box | C. Engine room dash panel (RH) |
| D. Behind the cluster lid C                  |                         |                                |

## Component Description

INFOID:0000000004875503

Part	Description
BCM	<ul style="list-style-type: none"> <li>• Detects each switch condition with the combination switch reading function.</li> <li>• Judges the headlamp ON/OFF status according to the vehicle condition. Requests the front fog lamp relay ON to IPDM E/R (with CAN communication).</li> </ul>
IPDM E/R	Controls the integrated relay and supplies voltage to the load according to the request from BCM (with CAN communication).



# DAYTIME RUNNING LIGHT SYSTEM

< SYSTEM DESCRIPTION >

[XENON TYPE]

Part	Description
Combination switch (Lighting & turn signal switch)	Refer to <a href="#">BCS-6, "System Diagram"</a> .
ECM	Transmits the engine status signal to BCM with CAN communication.
Unified meter and A/C amp.	Transmits the parking brake switch signal to BCM with CAN communication.

A

B

C

D

E

F

G

H

I

J

K

**EXL**

M

N

O

P

# ACTIVE ADAPTIVE FRONT-LIGHTING SYSTEM

< SYSTEM DESCRIPTION >

[XENON TYPE]

## ACTIVE ADAPTIVE FRONT-LIGHTING SYSTEM

### System Diagram

INFOID:000000004875523

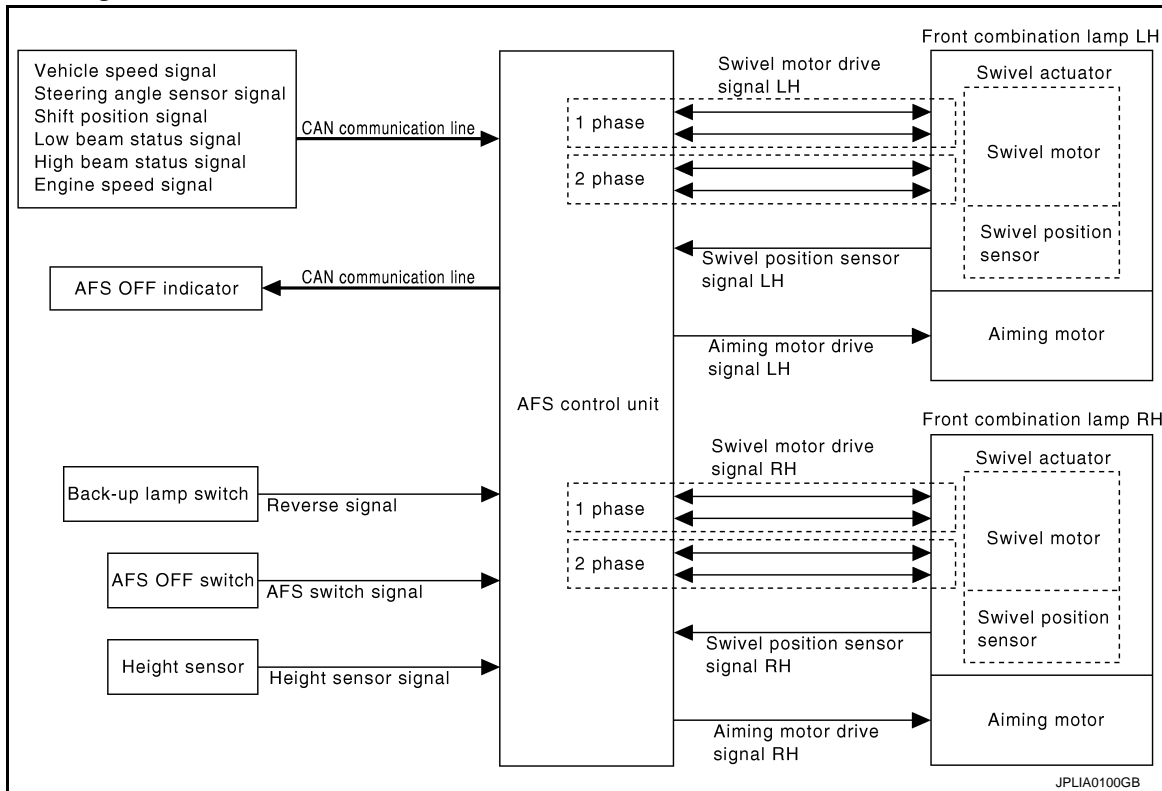

### System Description

INFOID:000000004875524

#### OUTLINE

- AFS (ACTIVE ADAPTIVE FRONT-LIGHTING SYSTEM) is controlled by AFS control unit.
- AFS has AFS control (swivel control) and the headlamp auto aiming control.
  - AFS control swivels the headlamp to the steering direction.
  - Headlamp auto aiming control moves the headlamp light axis up/down according to the vehicle height.

#### AFS (ADAPTIVE FRONT-LIGHTING SYSTEM)

##### AFS Control Description

- AFS control unit controls the headlamp (right) only when the steering wheel is turned rightward, and the headlamp (left) only when the steering wheel is turned leftward.
- AFS control unit detects the vehicle condition necessary for AFS control with the following signals.
  - AFS switch signal
  - Steering angle sensor signal (received from steering angle sensor with CAN communication)
  - Engine speed signal (received from ECM with CAN communication)
  - Shift position signal (received from TCM with CAN communication)
  - Reverse signal (received from back-up lamp switch)
  - Low beam status signal and high beam status signal (received from IPDM E/R with CAN communication)
  - Vehicle speed signal (received from unified meter and A/C amp. with CAN communication)
- When the operation conditions are satisfied, AFS control unit controls the swivel angle depending on the steering angle and the vehicle speed.

##### AFS operation condition

- Swivel actuator initialization completed
- AFS OFF switch OFF
- Headlamp ON
- While the engine running
- Selector lever position other than "P" or "R" (A/T models)
- Shift knob position other than reverse (M/T models)

# ACTIVE ADAPTIVE FRONT-LIGHTING SYSTEM

[XENON TYPE]

## < SYSTEM DESCRIPTION >

- Vehicle speed approximately 25 km/h (15.5 MPH) or more (left swivel only; right swivel activates regardless of the vehicle speed.)

### Swivel Actuator Initialization

- AFS control unit performs the swivel actuator initialization when detecting that the engine starts.
- Swivels the headlamp to the vehicle-center side until it hits the stopper.
- Returns the swivel angle from the stopper. Completes the initialization with regarding the returned position as the swivel angle 0° (straight-forward position).

### Swivel Operation

- AFS control unit transmits the drive signal to the swivel actuator when activation conditions are satisfied. And swivels the headlamp.
- The swivel starts after steering approximately 20° or more from straight-forward position.

#### NOTE:

- The steering angle differs between right turn and left turn.
- The swivel angle becomes the maximum angle toward the driving direction if the steering angle is approximately 90° or more depending on the vehicle speed. The swivel angle is maintained by shutting off the drive signal.
- The swivel starts, and returns to the swivel angle 0° (straight-forward position) when the steering is returned to the straight-forward position.
- AFS control unit returns the swivel angle to the straight-forward position, and stops the swivel regardless of the steering angle if the operation condition is not satisfied while the swivel angle is 0°.

### AFS OFF Indicator Lamp

- AFS control unit transmits AFS OFF indicator lamp signal to the combination meter (through unified meter & A/C amp.) with CAN communication.
- Combination meter turns AFS OFF indicator lamp ON/OFF/blinking according to AFS OFF indicator lamp signal.
- AFS OFF indicator lamp is turned ON for 1 second for the AFS OFF indicator lamp bulb check when the ignition switch is turned ON. AFS OFF indicator lamp is turned OFF within 1 second when the engine starts.
- AFS OFF indicator lamp is turned OFF when AFS OFF switch is turned ON.
- AFS OFF indicator lamp blinks (1 second each) if AFS control unit detects a specific DTC.

#### NOTE:

Combination meter blinks AFS OFF indicator lamp (approximately 1 second each) if AFS OFF indicator lamp signal is not received from AFS control unit.

## HEADLAMP AUTO AIMING

### Headlamp Auto Aiming Control Description

- AFS control unit controls the headlamp light axis height appropriately according to the vehicle height.
- AFS control unit detects the vehicle condition necessary for headlamp auto aiming control with the following signals.
- Height sensor signal
- Engine speed signal (received from ECM with CAN communication)
- Low beam status signal and high beam status signal (received from IPDM E/R with CAN communication)
- Vehicle speed signal (received from unified meter and A/C amp. with CAN communication)

### Headlamp Auto Aiming Operation

- AFS control unit calculates the vehicle pitch angle from the height sensor signal. AFS control unit judges the angle for adjusting the axis gap from the preset position.
- When the operation conditions are satisfied, AFS control unit transmits the aiming motor drive signal for adjusting the headlamp axis height.

### Operation condition

- Headlamp ON
- While the engine running
- Vehicle speed (Control mode is switched according to the driving condition.)
- AFS control unit controls the headlamp axis by changing the aiming motor drive signal output according to the vehicle-rearward height when detecting the following vehicle condition. Output is maintained if other condition than following is detected.

### Correcting condition

- Engine starts.
- Headlamp is turned ON.

A

B

C

D

E

F

G

H

I

J

K

EXL

M

N

O

P

# ACTIVE ADAPTIVE FRONT-LIGHTING SYSTEM

[XENON TYPE]

## < SYSTEM DESCRIPTION >

- Vehicle posture becomes stable after changing the vehicle posture change is detected with the headlamp ON and the vehicle stopped.
- Vehicle speed is maintained with the headlamp ON and the vehicle driven.

### CAUTION:

Adjusted axis position may differ from the preset position although the headlamp auto aiming activates properly if the suspension is replaced or worn.

## Component Parts Location

INFOID:000000004372433

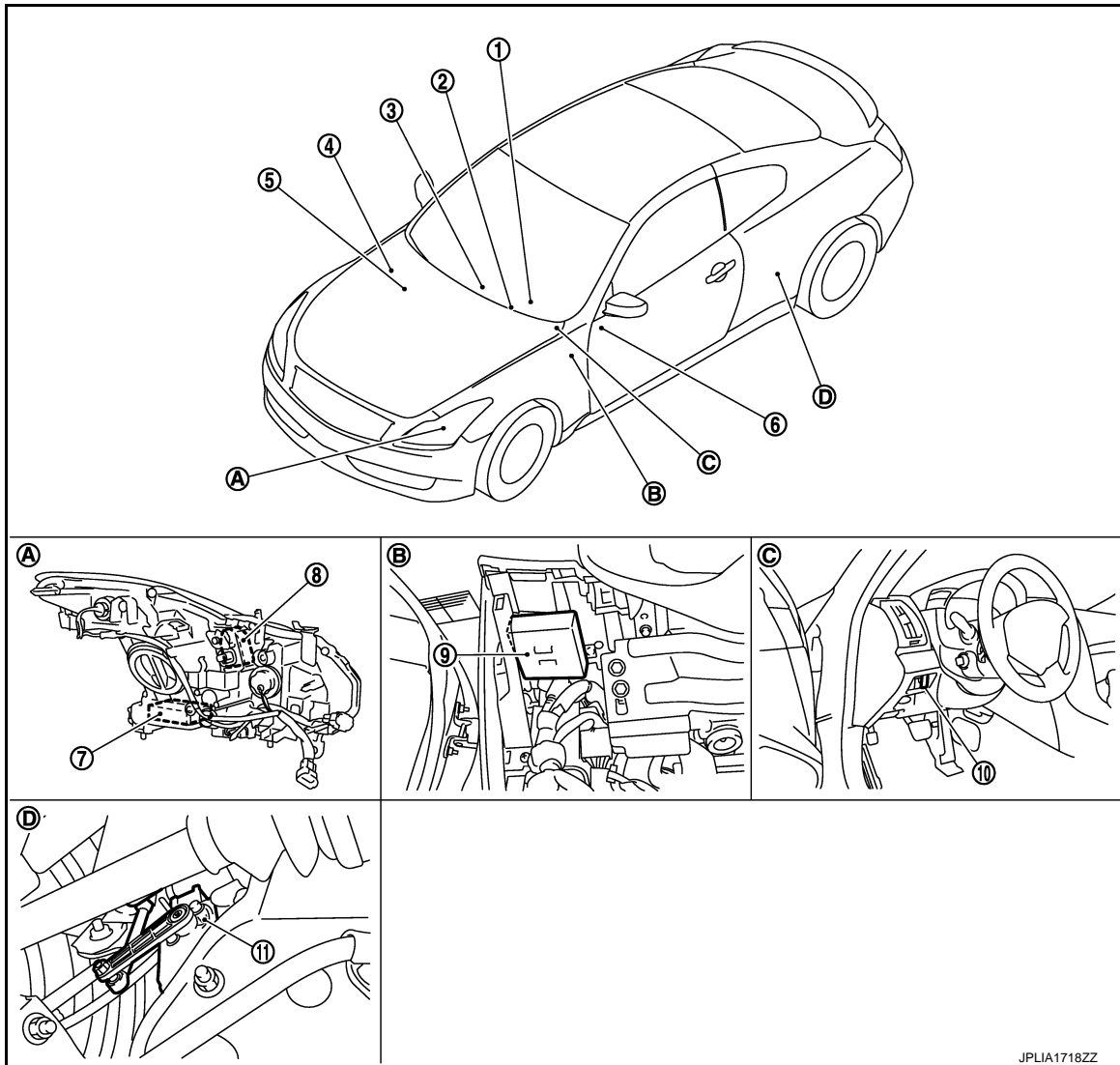

- |   |  |   |
|---|--|---|
| 1. Steering angle sensor  | 2. Combination meter<br>(AFS OFF indicator lamp)                       | 3. Unified meter and A/C amp.<br>Refer to <a href="#">HAC-26, "Component Part Location"</a> . |
| 4. IPDM E/R<br>Refer to <a href="#">PCS-4, "Component Parts Location"</a> . | 5. ECM<br>Refer to <a href="#">EC-25, "Component Parts Location"</a> . | 6. TCM<br>Refer to <a href="#">TM-101, "Component Parts Location"</a> .                       |
| 7. Swivel actuator  | 8. Aiming motor  | 9. AFS control unit   |
| 10. AFS OFF switch  | 11. Height sensor  |   |
| A. Integrated in the front combination lamp                                 | B. Instrument driver lower panel                                       | C. Behind instrument driver lower panel   |
| D. Rear suspension member (LH)  |  |   |

JPLIA1718ZZ

# ACTIVE ADAPTIVE FRONT-LIGHTING SYSTEM

< SYSTEM DESCRIPTION >

[XENON TYPE]

## Component Description

INFOID:000000004875525

Part	Description
AFS control unit	Refer to <a href="#">EXL-57, "Description"</a> .
Swivel actuator	Refer to <a href="#">EXL-46, "Description"</a> .
Aiming motor	Refer to <a href="#">EXL-71, "Description"</a> .
AFS OFF switch	Inputs AFS OFF switch ON/OFF signal to AFS control unit.
Height sensor	Refer to <a href="#">EXL-51, "Description"</a> .
Steering angle sensor	Refer to <a href="#">EXL-60, "Description"</a> .
IPDM E/R	Transmits the headlamp (LO) ON signal and the headlamp (HI) ON signal to AFS control unit with CAN communication.
ECM	Transmits the engine speed signal to AFS control unit with CAN communication.
TCM	Refer to <a href="#">EXL-54, "Description"</a> .
Unified meter and A/C amp.	Refer to <a href="#">EXL-55, "Description"</a> .
Combination meter	Turns AFS OFF indicator lamp ON/OFF/blinking according to AFS control unit request [with CAN communication (through unified meter and A/C amp.)].

A  
B  
C  
D  
E  
F  
G  
H  
I  
J  
K  
EXL  
M  
N  
O  
P

EXL

## FRONT FOG LAMP SYSTEM

### System Diagram

INFOID:000000004876102

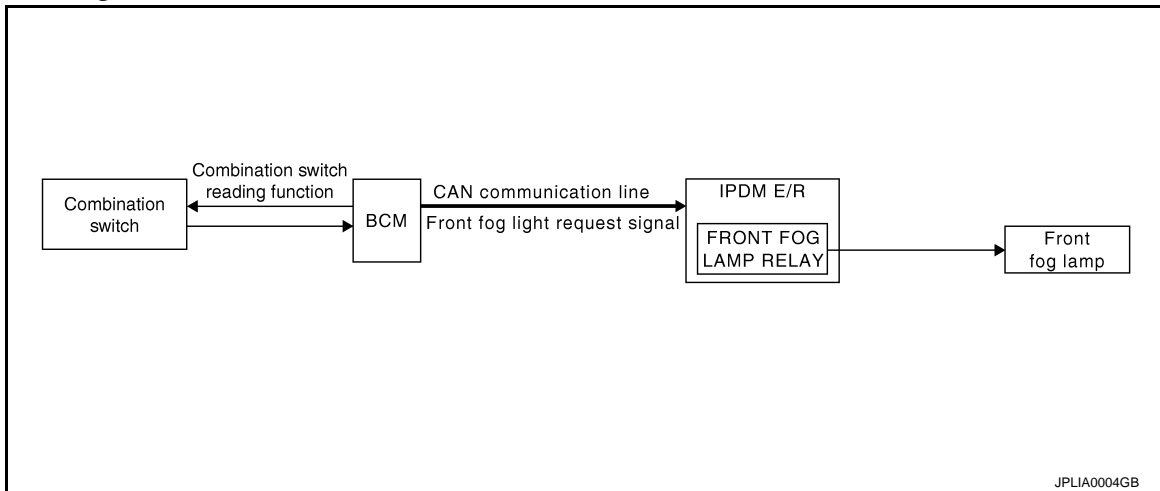

### System Description

INFOID:000000004876103

#### OUTLINE

- Front fog lamp is integrated into the front combination lamp.
- Front fog lamp is controlled by combination switch reading function and front fog lamp control function of BCM, and relay control function of IPDM E/R.

#### NOTE:

For Canada models, the front fog lamp is turned ON as the daytime running light. Refer to [EXL-15, "System Diagram"](#) for the detail.

#### FRONT FOG LAMP OPERATION

- BCM detects the combination switch condition by the combination switch reading function.
- BCM transmits the front fog light request signal to IPDM E/R with CAN communication according to the front fog lamp ON condition.

#### Front fog lamp ON condition

- Front fog lamp switch ON with the headlamp ON (except for the high beam ON)
- IPDM E/R turns the integrated front fog lamp relay ON, and turns the front fog lamp ON according to the front fog light request signal.

# FRONT FOG LAMP SYSTEM

< SYSTEM DESCRIPTION >

[XENON TYPE]

## Component Parts Location

INFOID:000000004876104

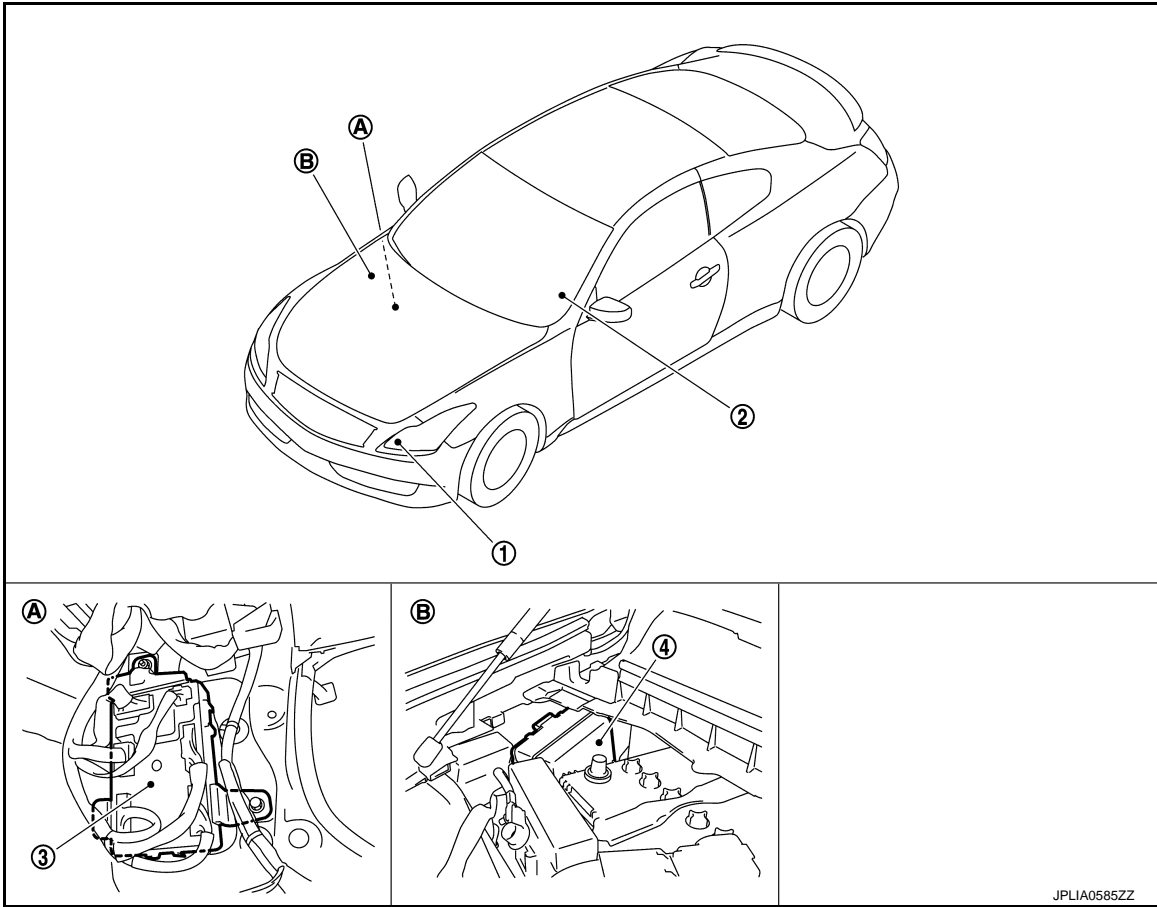

- 1. Front fog lamp
- 2. Combination switch
- 3. BCM
- 4. IPDM E/R
- A. Dash side lower (passenger side)
- B. Engine room dash panel (RH)

## Component Description

INFOID:000000004876105

Part	Description
BCM	<ul style="list-style-type: none"> <li>• Detects each switch condition by the combination switch reading function.</li> <li>• Judges the front fog lamp ON/OFF status according to the vehicle condition. Requests the front fog lamp relay ON to IPDM E/R (with CAN communication).</li> </ul>
IPDM E/R	Controls the integrated relay and supplies voltage to the load according to the request from BCM (with CAN communication).
Combination switch (Lighting & turn signal switch)	Refer to <a href="#">BCS-6, "System Diagram"</a> .

# TURN SIGNAL AND HAZARD WARNING LAMP SYSTEM

< SYSTEM DESCRIPTION >

[XENON TYPE]

## TURN SIGNAL AND HAZARD WARNING LAMP SYSTEM

### System Diagram

INFOID:000000004873766

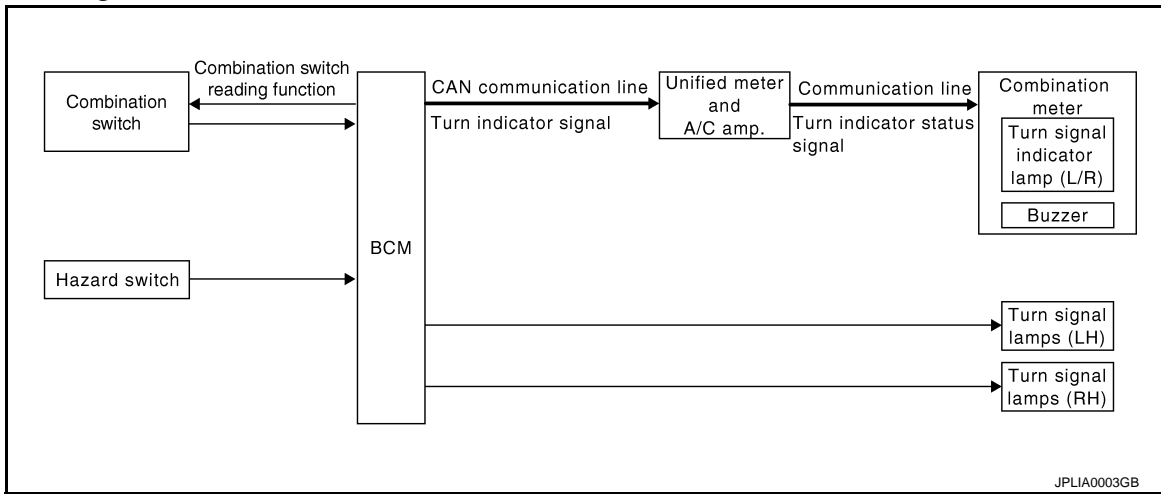

### System Description

INFOID:000000004873767

#### OUTLINE

Turn signal and the hazard warning lamp is controlled by combination switch reading function and the flasher control function of BCM.

#### TURN SIGNAL LAMP OPERATION

- BCM detects the combination switch condition by the combination switch reading function.
- BCM supplies voltage to the right (left) turn signal lamp circuit when the ignition switch is turned ON and the turn signal switch is in the right (left) position. BCM blinks the turn signal lamp.

#### HAZARD WARNING LAMP OPERATION

BCM supplies voltage to both turn signal lamp circuit when the hazard switch is turned ON. BCM blinks the hazard warning lamp.

#### TURN SIGNAL INDICATOR LAMP AND TURN SIGNAL SOUND OPERATION

- BCM transmits the turn indicator signal to the combination meter with CAN communication while the turn signal lamp and the hazard warning lamp operating.
- Combination meter outputs the turn signal sound with the integrated buzzer while blinking the turn signal indicator lamp according to the turn indicator signal.

#### HIGH FLASHER OPERATION (FAIL-SAFE)

- BCM detects the turn signal lamp circuit status from the current value.
- BCM increases the turn signal lamp blinking speed if the bulb or harness open is detected with the turn signal lamp operating.

#### NOTE:

The blinking speed is normal while operating the hazard warning lamp.



# TURN SIGNAL AND HAZARD WARNING LAMP SYSTEM

< SYSTEM DESCRIPTION >

[XENON TYPE]

## Component Parts Location

INFOID:000000004873768

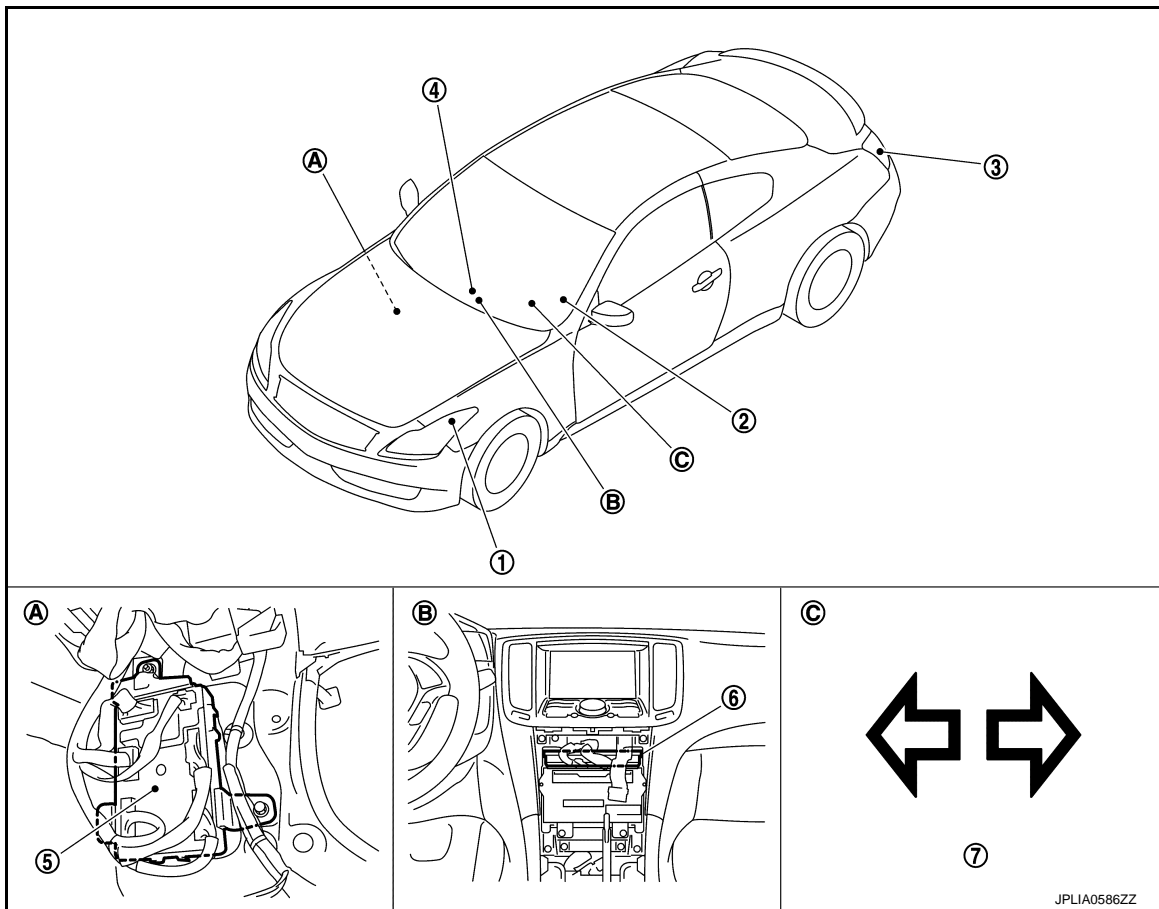

- |                                     |                             |                               |
|-------------------------------------|-----------------------------|-------------------------------|
| 1. Front turn signal lamp           | 2. Combination switch       | 3. Rear turn signal lamp      |
| 4. Hazard warning switch            | 5. BCM                      | 6. Unified meter and A/C amp. |
| 7. Turn signal indicator lamp       |                             |                               |
| A. Dash side lower (passenger side) | B. Behind the cluster lid C | C. On the combination meter   |

## Component Description

INFOID:000000004873769

Part	Description
BCM	<ul style="list-style-type: none"> <li>• Detects each switch condition by the combination switch reading function.</li> <li>• Judges the blinks of the turn signal lamp and the hazard warning lamp from each switch status. The applicable turn signal lamp blinks.</li> <li>- Requests the turn signal indicator lamp blink to the combination meter (with CAN communication).</li> </ul>
Combination switch (Lighting & turn signal switch)	Refer to <a href="#">BCS-6, "System Diagram"</a> .
Hazard switch	Refer to <a href="#">EXL-83, "Description"</a> .
Combination meter (Turn signal indicator lamp & buzzer)	Blinks the turn signal indicator lamp and outputs the turn signal operating sound with integrated buzzer according to the request from BCM [with CAN communication (through unified meter and A/C amp.)].

# PARKING, LICENSE PLATE AND TAIL LAMPS SYSTEM

< SYSTEM DESCRIPTION >

[XENON TYPE]

## PARKING, LICENSE PLATE AND TAIL LAMPS SYSTEM

### System Diagram

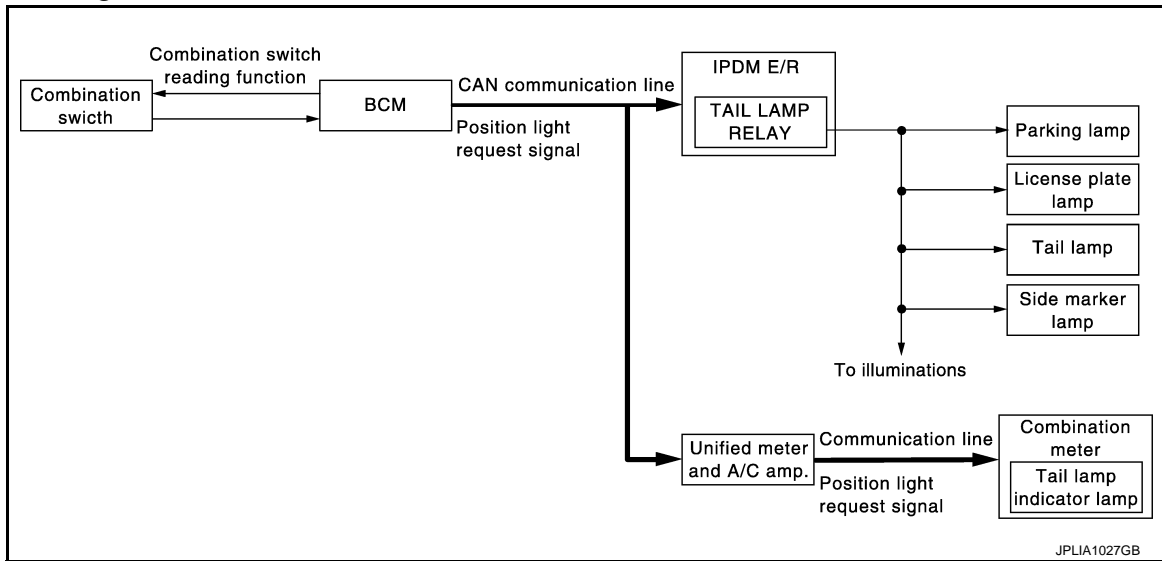

### System Description

INFOID:000000004873775

#### OUTLINE

Parking, license plate, tail and side marker lamps are controlled by combination switch reading function and headlamp control function of BCM, and relay control function of IPDM E/R.

#### PARKING, LICENSE PLATE, TAIL AND SIDE MARKER LAMPS OPERATION

- BCM detects the combination switch condition by the combination switch reading function.
- BCM transmits the position light request signal to IPDM E/R and the combination meter with CAN communication according to the ON/OFF condition of the parking, license plate, tail and side marker lamps.

Parking, license plate, tail and side marker lamps ON condition

- Lighting switch 1ST
- Lighting switch 2ND
- Lighting switch AUTO, and the auto light function ON judgment
- IPDM E/R turns the integrated tail lamp relay ON and turns the parking, license plate, tail and side marker lamps ON according to the position light request signal.
- Combination meter turns the tail lamp indicator lamp ON according to the position light request signal.

# PARKING, LICENSE PLATE AND TAIL LAMPS SYSTEM

< SYSTEM DESCRIPTION >

[XENON TYPE]

## Component Parts Location

INFOID:000000004873776

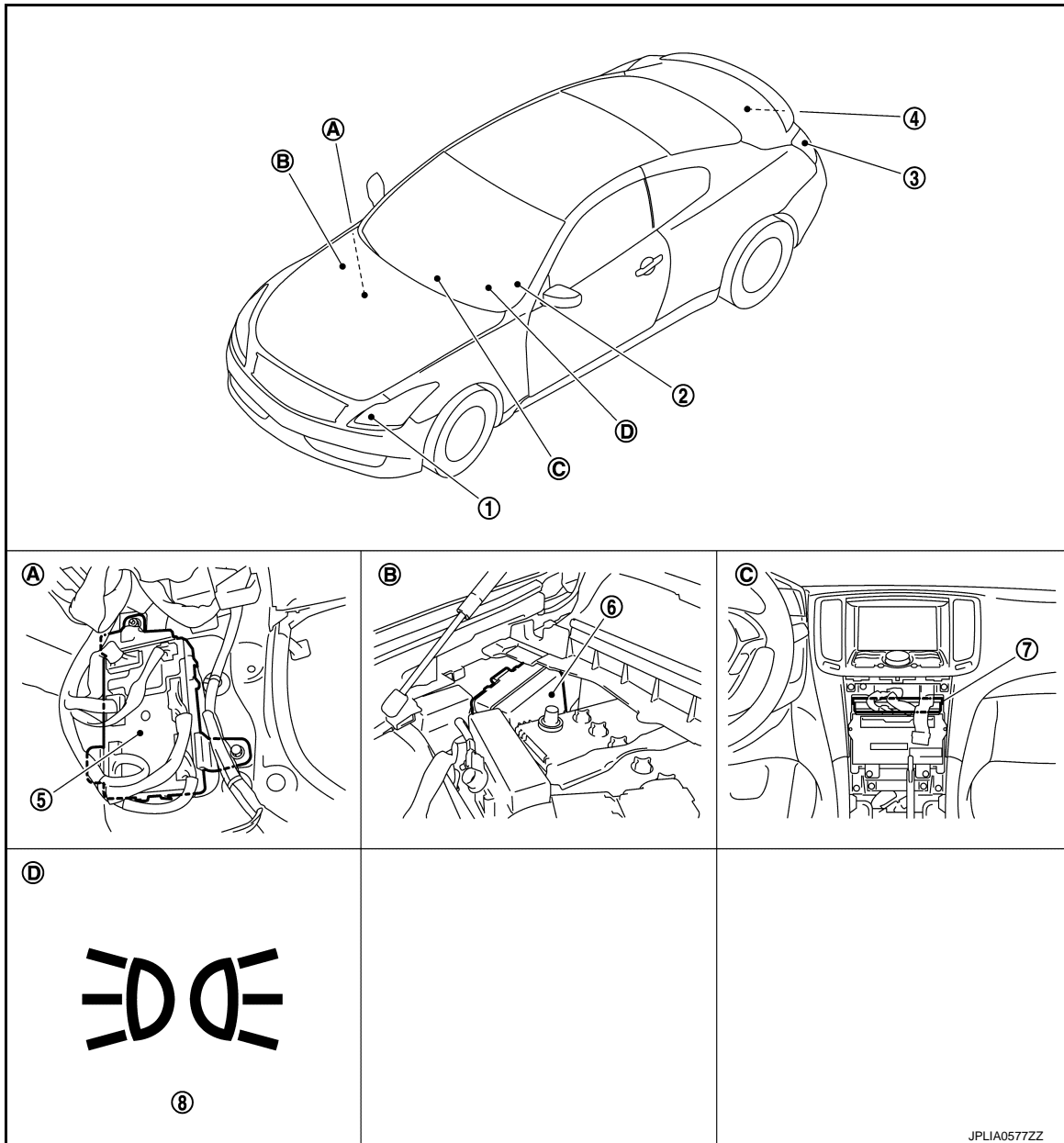

- |   |                                |   |
|---|--------------------------------|---|
| 1. • Parking lamp<br>• Front side marker lamp | 2. Combination switch          | 3. • Tail lamp<br>• Rear side marker lamp |
| 4. License plate lamp                         | 5. BCM                         | 6. IPDM E/R                               |
| 7. Unified meter and A/C amp.                 | 8. Tail lamp indicator lamp    |   |
| A. Dash side lower (passenger side)           | B. Engine room dash panel (RH) | C. Behind the cluster lid C               |
| D. On the combination meter                   |                                |   |

JPLIA0577ZZ

A  
B  
C  
D  
E  
F  
G  
H  
I  
J  
K  
L  
M  
N  
O  
P

EXL

# PARKING, LICENSE PLATE AND TAIL LAMPS SYSTEM

< SYSTEM DESCRIPTION >

[XENON TYPE]

## Component Description

INFOID:000000004873777

Part	Description
BCM	<ul style="list-style-type: none"><li>• Detects each switch condition by the combination switch reading function.</li><li>• Judges the ON/OFF status of the parking, license plate, tail and side marker lamps according to the vehicle condition.</li><li>- Requests the tail lamp relay ON to IPDM E/R (with CAN communication).</li><li>- Requests the tail lamp indicator lamp ON to the combination meter (with CAN communication).</li></ul>
IPDM E/R	Controls the integrated relay and supplies voltage to the load according to the request from BCM (with CAN communication).
Combination switch (Lighting & turn signal switch)	Refer to <a href="#">BCS-6. "System Diagram"</a> .
Combination meter (Tail lamp indicator lamp)	Turns the tail lamp indicator lamp ON according to the request from BCM [with CAN communication (through unified meter and A/C amp.)].

# EXTERIOR LAMP BATTERY SAVER SYSTEM

< SYSTEM DESCRIPTION >

[XENON TYPE]

## EXTERIOR LAMP BATTERY SAVER SYSTEM

### System Diagram

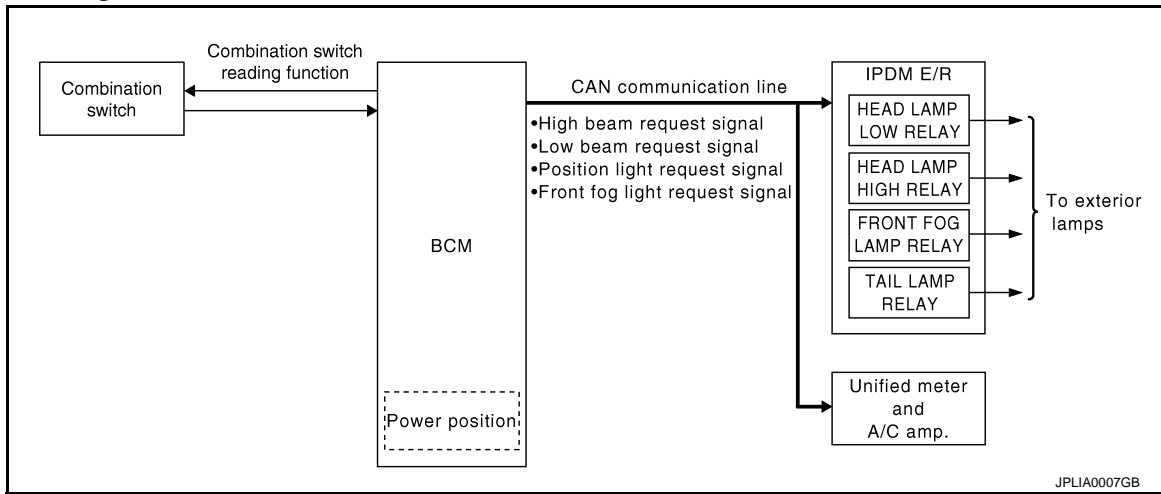

### System Description

INFOID:000000004873783

#### OUTLINE

- Exterior lamp battery saver system is controlled by each function of BCM and IPDM E/R.

##### Control by BCM

- Combination switch reading function
- Headlamp control function
- Exterior lamp battery saver function

##### Control by IPDM E/R

- Relay control function
  - BCM turns the exterior lamp\* OFF after a period of time to prevent the battery from over-discharge when the ignition switch is turned OFF with the exterior lamp ON.
- \*: Headlamp (LO/HI), parking lamp, tail lamp, license plate lamp, side marker lamp and front fog lamp.

#### NOTE:

When the lighting switch is turned AUTO, the exterior lamp battery saver switches to the auto light system. Refer to [EXL-13. "System Diagram"](#).

#### EXTERIOR LAMP BATTERY SAVER ACTIVATION

BCM activates the timer and turns the exterior lamp OFF 5 minutes after the ignition switch is turned from ON → OFF with the exterior lamps ON.

#### NOTE:

- Headlamp control function turns the exterior lamps ON normally when the ignition switch is turned ACC or the engine started (both before and after the exterior lamp battery saver is turned OFF).
- The timer starts at the time that the lighting switch is turned from OFF → 1ST or 2ND with the exterior lamp OFF.

# EXTERIOR LAMP BATTERY SAVER SYSTEM

< SYSTEM DESCRIPTION >

[XENON TYPE]

## Component Parts Location

INFOID:000000004873784

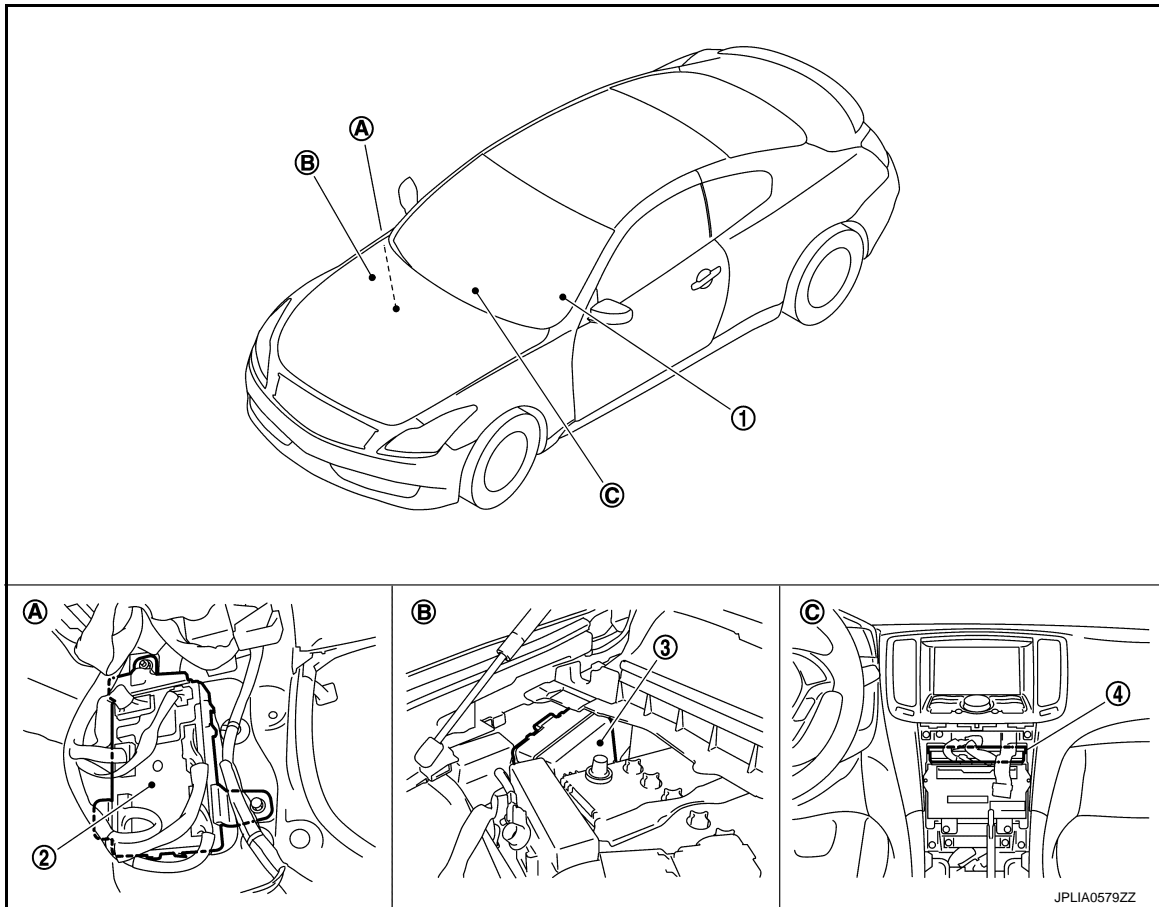

- |                                     |                                |                             |
|-------------------------------------|--------------------------------|-----------------------------|
| 1. Combination switch               | 2. BCM                         | 3. IPDM E/R                 |
| 4. Unified meter and A/C amp.       |                                |                             |
| A. Dash side lower (passenger side) | B. Engine room dash panel (RH) | C. Behind the cluster lid C |

## Component Description

INFOID:000000004873785

Part	Description
BCM	<ul style="list-style-type: none"> <li>• Detects each switch condition by the combination switch reading function.</li> <li>• Judges the exterior lamp OFF according to the vehicle condition. Requests each relay OFF to IPDM E/R (with CAN communication).</li> </ul>
IPDM E/R	Controls the integrated relay according to the request from BCM (with CAN communication).
Combination switch (Lighting & turn signal switch)	Refer to <a href="#">BCS-6. "System Diagram"</a> .

# DIAGNOSIS SYSTEM (BCM)

< SYSTEM DESCRIPTION >

[XENON TYPE]

## DIAGNOSIS SYSTEM (BCM)

### COMMON ITEM

### COMMON ITEM : CONSULT-III Function (BCM - COMMON ITEM)

INFOID:000000005161770

### APPLICATION ITEM

CONSULT-III performs the following functions via CAN communication with BCM.

Diagnosis mode	Function Description
Work Support	Changes the setting for each system function.
Self Diagnostic Result	Displays the diagnosis results judged by BCM.
CAN Diag Support Monitor	Monitors the reception status of CAN communication viewed from BCM. Refer to CONSULT-III operation manual.
Data Monitor	The BCM input/output signals are displayed.
Active Test	The signals used to activate each device are forcibly supplied from BCM.
Ecu Identification	The BCM part number is displayed.
Configuration	This function is not used even though it is displayed.

### SYSTEM APPLICATION

BCM can perform the following functions for each system.

#### NOTE:

It can perform the diagnosis modes except the following for all sub system selection items.

×: Applicable item

System	Sub system selection item	Diagnosis mode		
		Work Support	Data Monitor	Active Test
Door lock	DOOR LOCK	×	×	×
Rear window defogger	REAR DEFOGGER		×	×
Warning chime	BUZZER		×	×
Interior room lamp timer	INT LAMP	×	×	×
—	MULTI REMOTE ENT*1			
Exterior lamp	HEAD LAMP	×	×	×
Wiper and washer	WIPER	×*2	×	×
Turn signal and hazard warning lamps	FLASHER	×	×	×
—	AIR CONDITONER*1			
• Intelligent Key system • Engine start system	INTELLIGENT KEY	×	×	×
Combination switch	COMB SW		×	
Body control system	BCM	×		
IVIS - NATS	IMMU		×	×
Interior room lamp battery saver	BATTERY SAVER	×	×	×
Trunk lid open	TRUNK		×	×
Vehicle security system	THEFT ALM	×	×	×
RAP system	RETAINED PWR		×	
Signal buffer system	SIGNAL BUFFER		×	×
TPMS	TPMS (AIR PRESSURE MONITOR)	×	×	×

#### NOTE:

- \*1: This item is displayed, but is not used.
- \*2: At models with rain sensor this mode is displayed, but is not used.

### FREEZE FRAME DATA (FFD)

# DIAGNOSIS SYSTEM (BCM)

[XENON TYPE]

## < SYSTEM DESCRIPTION >

The BCM records the following vehicle condition at the time a particular DTC is detected, and displays on CONSULT-III.

CONSULT screen item	Indication/Unit	Description	
Vehicle Speed	km/h	Vehicle speed of the moment a particular DTC is detected	
Odo/Trip Meter	km	Total mileage (Odometer value) of the moment a particular DTC is detected	
Vehicle Condition	SLEEP>LOCK	Power position status of the moment a particular DTC is detected	While turning BCM status from low power consumption mode to normal mode (Power supply position is "LOCK".)
	SLEEP>OFF		While turning BCM status from low power consumption mode to normal mode (Power supply position is "OFF".)
	LOCK>ACC		While turning power supply position from "LOCK" to "ACC"
	ACC>ON		While turning power supply position from "ACC" to "IGN"
	RUN>ACC		While turning power supply position from "RUN" to "ACC" (Vehicle is stopping and selector lever is except P position.)
	CRANK>RUN		While turning power supply position from "CRANKING" to "RUN" (From cranking up the engine to run it)
	RUN>URGENT		While turning power supply position from "RUN" to "ACC" (Emergency stop operation)
	ACC>OFF		While turning power supply position from "ACC" to "OFF"
	OFF>LOCK		While turning power supply position from "OFF" to "LOCK"
	OFF>ACC		While turning power supply position from "OFF" to "ACC"
	ON>CRANK		While turning power supply position from "IGN" to "CRANKING"
	OFF>SLEEP		While turning BCM status from normal mode (Power supply position is "OFF".) to low power consumption mode
	LOCK>SLEEP		While turning BCM status from normal mode (Power supply position is "LOCK".) to low power consumption mode
	LOCK		Power supply position is "LOCK" (Ignition switch OFF with steering is locked.)
	OFF		Power supply position is "OFF" (Ignition switch OFF with steering is unlocked.)
	ACC		Power supply position is "ACC" (Ignition switch ACC)
	ON		Power supply position is "IGN" (Ignition switch ON with engine stopped)
	ENGINE RUN		Power supply position is "RUN" (Ignition switch ON with engine running)
CRANKING	Power supply position is "CRANKING" (At engine cranking)		
IGN Counter	0 - 39	The number of times that ignition switch is turned ON after DTC is detected <ul style="list-style-type: none"> <li>• The number is 0 when a malfunction is detected now.</li> <li>• The number increases like 1 → 2 → 3...38 → 39 after returning to the normal condition whenever ignition switch OFF → ON.</li> <li>• The number is fixed to 39 until the self-diagnosis results are erased if it is over 39.</li> </ul>	

## HEADLAMP

### HEADLAMP : CONSULT-III Function (BCM - HEAD LAMP)

INFOID:000000004875519

## WORK SUPPORT

Service item	Setting item	Setting
BATTERY SAVER SET	On*	With the exterior lamp battery saver function
	Off	Without the exterior lamp battery saver function



# DIAGNOSIS SYSTEM (BCM)

< SYSTEM DESCRIPTION >

[XENON TYPE]

Service item	Setting item	Setting	
ILL DELAY SET	MODE 1*	45 sec.	Sets delay timer function timer operation time. (All doors closed)
	MODE 2	Without the function	
	MODE 3	30 sec.	
	MODE 4	60 sec.	
	MODE 5	90 sec.	
	MODE 6	120 sec.	
	MODE 7	150 sec.	
	MODE 8	180 sec.	
CUSTOM A/LIGHT SETTING	MODE 1*	Normal	
	MODE 2	More sensitive setting than normal setting (Turns ON earlier than normal operation.)	
	MODE 3	More sensitive setting than MODE 2 (Turns ON earlier than MODE 2.)	
	MODE 4	Less sensitive setting than normal setting (Turns ON later than normal operation.)	

\*: Factory setting

## DATA MONITOR

Monitor item [Unit]	Description
PUSH SW [On/Off]	The switch status input from push-button ignition switch
ENGINE STATE [Stop/Stall/Crank/Run]	The engine status received from ECM with CAN communication
VEH SPEED 1 [km/h]	The value of the vehicle speed received from unified meter and A/C amp. with CAN communication
KEY SW-SLOT [On/Off]	Key switch status input from key slot
TURN SIGNAL R [On/Off]	Each switch status that BCM judges from the combination switch reading function
TURN SIGNAL L [On/Off]	
TAIL LAMP SW [On/Off]	
HI BEAM SW [On/Off]	
HEAD LAMP SW1 [On/Off]	
HEAD LAMP SW2 [On/Off]	
PASSING SW [On/Off]	
AUTO LIGHT SW [On/Off]	
FR FOG SW [On/Off]	
DOOR SW-DR [On/Off]	
DOOR SW-AS [On/Off]	The switch status input from passenger side door switch
DOOR SW-RR [On/Off]	<b>NOTE:</b> The item is indicated, but not monitored.

# DIAGNOSIS SYSTEM (BCM)

< SYSTEM DESCRIPTION >

[XENON TYPE]

Monitor item [Unit]	Description
DOOR SW- RL [On/Off]	<b>NOTE:</b> The item is indicated, but not monitored.
DOOR SW-BK [On/Off]	<b>NOTE:</b> The item is indicated, but not monitored.
OPTICAL SENSOR [V]	The value of exterior brightness voltage input from the optical sensor

## ACTIVE TEST

Test item	Operation	Description
TAIL LAMP	On	Transmits the position light request signal to IPDM E/R with CAN communication to turn the tail lamp ON.
	Off	Stops the position light request signal transmission.
HEAD LAMP	Hi	Transmits the high beam request signal with CAN communication to turn the headlamp (HI).
	Low	Transmits the low beam request signal with CAN communication to turn the headlamp (LO).
	Off	Stops the high & low beam request signal transmission.
FR FOG LAMP	On	Transmits the front fog light request signal to IPDM E/R with CAN communication to turn the front fog lamp ON.
	Off	Stops the front fog light request signal transmission.
RR FOG LAMP	On	<b>NOTE:</b> The item is indicated, but cannot be tested.
	Off	
CORNERING LAMP	RH	<b>NOTE:</b> The item is indicated, but cannot be tested.
	LH	
	Off	
ILL DIM SIGNAL	On	<b>NOTE:</b> The item is indicated, but cannot be tested.
	Off	

## FLASHER

### FLASHER : CONSULT-III Function (BCM - FLASHER)

INFOID:000000004875520

## WORK SUPPORT

Service item	Setting item	Setting	
HAZARD ANSWER BACK	Lock Only*	With locking only	Sets the hazard warning lamp answer back function when the door is lock/unlock with the request switch or the key fob.
	Unlk Only	With unlocking only	
	Lock/Unlk	With locking/unlocking	
	Off	Without the function	

\*: Factory setting

## DATA MONITOR

Monitor item [Unit]	Description
REQ SW-DR [On/Off]	The switch status input from the request switch (driver side)
REQ SW-AS [On/Off]	The switch status input from the request switch (passenger side)

# DIAGNOSIS SYSTEM (BCM)

< SYSTEM DESCRIPTION >

[XENON TYPE]

Monitor item [Unit]	Description
PUSH SW [On/Off]	The switch status input from the push-button ignition switch
TURN SIGNAL R [On/Off]	Each switch condition that BCM judges from the combination switch reading function
TURN SIGNAL L [On/Off]	
HAZARD SW [On/Off]	The switch status input from the hazard switch
RKE-LOCK [On/Off]	Lock signal status received from the remote keyless entry receiver
RKE-UNLOCK [On/Off]	Unlock signal status received from the remote keyless entry receiver
RKE-PANIC [On/Off]	Panic alarm signal status received from the remote keyless entry receiver

## ACTIVE TEST

Test item	Operation	Description
FLASHER	RH	Outputs the voltage to blink the right side turn signal lamps.
	LH	Outputs the voltage to blink the left side turn signal lamps.
	Off	Stops the voltage to turn the turn signal lamps OFF.

A  
B  
C  
D  
E  
F  
G  
H  
I  
J  
K  
L  
M  
N  
O  
P

EXL

## DIAGNOSIS SYSTEM (IPDM E/R)

### Diagnosis Description

INFOID:000000005161784

#### AUTO ACTIVE TEST

##### Description

In auto active test mode, the IPDM E/R sends a drive signal to the following systems to check their operation.

- Oil pressure warning lamp
- Front wiper (LO, HI)
- Parking lamps
- License plate lamps
- Side maker lamps
- Tail lamps
- Front fog lamps
- Headlamps (LO, HI)
- A/C compressor (magnet clutch)
- Cooling fan (cooling fan control module)

##### Operation Procedure

1. Close the hood and lift the wiper arms from the windshield. (Prevent windshield damage due to wiper operation)  
**NOTE:**  
 When auto active test is performed with hood opened, sprinkle water on windshield beforehand.
2. Turn the ignition switch OFF.
3. Turn the ignition switch ON, and within 20 seconds, press the front door switch (driver side) 10 times. Then turn the ignition switch OFF.  
**CAUTION:**  
**Close passenger door.**
4. Turn the ignition switch ON within 10 seconds. After that the horn sounds once and the auto active test starts.
5. The oil pressure warning lamp starts blinking when the auto active test starts.
6. After a series of the following operations is repeated 3 times, auto active test is completed.

##### NOTE:

When auto active test mode has to be cancelled halfway through test, turn the ignition switch OFF.

##### CAUTION:

- If auto active test mode cannot be actuated, check door switch system. Refer to [DLK-70](#), "[Component Function Check](#)".
- Do not start the engine.

##### Inspection in Auto Active Test Mode

When auto active test mode is actuated, the following 6 steps are repeated 3 times.

Operation sequence	Inspection location	Operation
1	Oil pressure warning lamp	Blinks continuously during operation of auto active test
2	Front wiper	LO for 5 seconds → HI for 5 seconds
3	<ul style="list-style-type: none"> <li>• Parking lamps</li> <li>• License plate lamps</li> <li>• Side maker lamps</li> <li>• Tail lamps</li> <li>• Front fog lamps</li> </ul>	10 seconds
4	Headlamps	LO ↔ HI 5 times
5	A/C compressor (magnet clutch)	ON ↔ OFF 5 times
6*	Cooling fan	MID for 5 seconds → HI for 5 seconds

\*: Outputs duty ratio of 50% for 5 seconds → duty ratio of 100% for 5 seconds on the cooling fan control module.

# DIAGNOSIS SYSTEM (IPDM E/R)

< SYSTEM DESCRIPTION >

[XENON TYPE]

Concept of auto active test

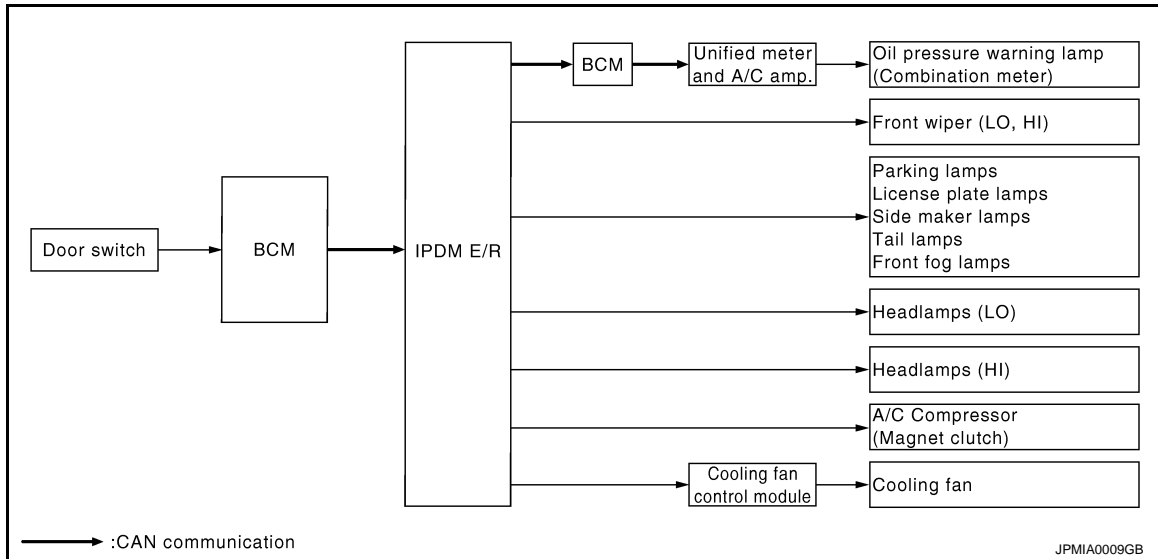

- IPDM E/R starts the auto active test with the door switch signals transmitted by BCM via CAN communication. Therefore, the CAN communication line between IPDM E/R and BCM is considered normal if the auto active test starts successfully.
- The auto active test facilitates troubleshooting if any systems controlled by IPDM E/R cannot be operated.

Diagnosis chart in auto active test mode

Symptom	Inspection contents	Possible cause
Any of the following components do not operate <ul style="list-style-type: none"> <li>• Parking lamps</li> <li>• License plate lamps</li> <li>• Side maker lamps</li> <li>• Tail lamps</li> <li>• Front fog lamps</li> <li>• Headlamp (HI, LO)</li> <li>• Front wiper (HI, LO)</li> </ul>	Perform auto active test. Does the applicable system operate?	YES BCM signal input circuit
		NO <ul style="list-style-type: none"> <li>• Lamp or motor</li> <li>• Lamp or motor ground circuit</li> <li>• Harness or connector between IPDM E/R and applicable system</li> <li>• IPDM E/R</li> </ul>
A/C compressor does not operate	Perform auto active test. Does the magnet clutch operate?	YES <ul style="list-style-type: none"> <li>• Unified meter and A/C amp. signal input circuit</li> <li>• CAN communication signal between unified meter and A/C amp. and ECM</li> <li>• CAN communication signal between ECM and IPDM E/R</li> </ul>
		NO <ul style="list-style-type: none"> <li>• Magnet clutch</li> <li>• Harness or connector between IPDM E/R and magnet clutch</li> <li>• IPDM E/R</li> </ul>
Oil pressure warning lamp does not operate	Perform auto active test. Does the oil pressure warning lamp blink?	YES <ul style="list-style-type: none"> <li>• Harness or connector between IPDM E/R and oil pressure switch</li> <li>• Oil pressure switch</li> <li>• IPDM E/R</li> </ul>
		NO <ul style="list-style-type: none"> <li>• CAN communication signal between IPDM E/R and BCM</li> <li>• CAN communication signal between BCM and unified meter and A/C amp.</li> <li>• Combination meter</li> </ul>

# DIAGNOSIS SYSTEM (IPDM E/R)

[XENON TYPE]

< SYSTEM DESCRIPTION >

Symptom	Inspection contents	Possible cause	
Cooling fan does not operate	Perform auto active test. Does the cooling fan operate?	YES	<ul style="list-style-type: none"> <li>• ECM signal input circuit</li> <li>• CAN communication signal between ECM and IPDM E/R</li> </ul>
		NO	<ul style="list-style-type: none"> <li>• Cooling fan</li> <li>• Harness or connector between cooling fan and cooling fan control module</li> <li>• Cooling fan control module</li> <li>• Harness or connector between IPDM E/R and cooling fan control module</li> <li>• Cooling fan relay</li> <li>• Harness or connector between IPDM E/R and cooling fan relay</li> <li>• IPDM E/R</li> </ul>

## CONSULT-III Function (IPDM E/R)

INFOID:000000005161785

### APPLICATION ITEM

CONSULT-III performs the following functions via CAN communication with IPDM E/R.

Diagnosis mode	Description
Ecu Identification	Allows confirmation of IPDM E/R part number.
Self Diagnostic Result	Displays the diagnosis results judged by IPDM E/R.
Data Monitor	Displays the real-time input/output data from IPDM E/R input/output data.
Active Test	IPDM E/R can provide a drive signal to electronic components to check their operations.
CAN Diag Support Monitor	The results of transmit/receive diagnosis of CAN communication can be read.

### SELF DIAGNOSTIC RESULT

Refer to [PCS-30, "DTC Index"](#).

### DATA MONITOR

Monitor item

Monitor Item [Unit]	MAIN SIGNALS	Description
RAD FAN REQ [%]	×	Displays the value of the cooling fan speed signal received from ECM via CAN communication.
AC COMP REQ [Off/On]	×	Displays the status of the A/C compressor request signal received from ECM via CAN communication.
TAIL&CLR REQ [Off/On]	×	Displays the status of the position light request signal received from BCM via CAN communication.
HL LO REQ [Off/On]	×	Displays the status of the low beam request signal received from BCM via CAN communication.
HL HI REQ [Off/On]	×	Displays the status of the high beam request signal received from BCM via CAN communication.
FR FOG REQ [Off/On]	×	Displays the status of the front fog light request signal received from BCM via CAN communication.
FR WIP REQ [Stop/1LOW/Low/Hi]	×	Displays the status of the front wiper request signal received from BCM via CAN communication.
WIP AUTO STOP [STOP P/ACT P]	×	Displays the status of the front wiper auto stop signal judged by IPDM E/R.
WIP PROT [Off/BLOCK]	×	Displays the status of the front wiper fail-safe operation judged by IPDM E/R.

# DIAGNOSIS SYSTEM (IPDM E/R)

< SYSTEM DESCRIPTION >

[XENON TYPE]

Monitor Item [Unit]	MAIN SIG- NALS	Description	
IGN RLY1 -REQ [Off/On]		Displays the status of the ignition switch ON signal received from BCM via CAN communication.	A
IGN RLY [Off/On]	×	Displays the status of the ignition relay judged by IPDM E/R.	B
PUSH SW [Off/On]		Displays the status of the push-button ignition switch judged by IPDM E/R.	C
INTER/NP SW [Off/On]		Displays the status of the clutch interlock switch (M/T models) or shift position (A/T models) judged by IPDM E/R.	D
ST RLY CONT [Off/On]		Displays the status of the starter relay status signal received from BCM via CAN communication.	E
IHBT RLY -REQ [Off/On]		Displays the status of the starter control relay signal received from BCM via CAN communication.	F
ST/INHI RLY [Off/ ST ON/INHI ON/UNKWN]		Displays the status of the starter relay and starter control relay judged by IPDM E/R.	G
DETENT SW [Off/On]		Displays the status of the A/T shift selector (detention switch) judged by IPDM E/R.	H
S/L RLY -REQ [Off/On]		Displays the status of the steering lock relay request received from BCM via CAN communication.	I
S/L STATE [LOCK/UNLOCK/UNKWN]		Displays the status of the steering lock judged by IPDM E/R.	J
DTRL REQ [Off/On]		<b>NOTE:</b> The item is indicated, but not monitored.	K
OIL P SW [Open/Close]		Displays the status of the oil pressure switch judged by IPDM E/R.	EXL
HOOD SW [Off/On]		Displays the status of the hood switch judged by IPDM E/R.	M
HL WASHER REQ [Off/On]		<b>NOTE:</b> The item is indicated, but not monitored.	N
THFT HRN REQ [Off/On]		Displays the status of the theft warning horn request signal received from BCM via CAN communication.	O
HORN CHIRP [Off/On]		Displays the status of the horn reminder signal received from BCM via CAN communication.	P
CRNRNG LMP REQ [Off/On]		<b>NOTE:</b> The item is indicated, but not monitored.	EXL

## ACTIVE TEST

Test item

Test item	Operation	Description	
CORNERING LAMP	Off	<b>NOTE:</b> The item is indicated, but cannot be tested.	N
	LH		
	RH		
HORN	On	Operates horn relay 1 and horn relay 2 for 20 ms.	O
FRONT WIPER	Off	OFF	P
	Lo	Operates the front wiper relay.	
	Hi	Operates the front wiper relay and front wiper high relay.	
MOTOR FAN	1	OFF	
	2	Outputs 50% pulse duty signal (PWM signal) to the cooling fan control module.	
	3	Outputs 80% pulse duty signal (PWM signal) to the cooling fan control module.	
	4	Outputs 100% pulse duty signal (PWM signal) to the cooling fan control module.	

# DIAGNOSIS SYSTEM (IPDM E/R)

[XENON TYPE]

< SYSTEM DESCRIPTION >

Test item	Operation	Description
HEAD LAMP WASHER	On	<b>NOTE:</b> The item is indicated, but cannot be tested.
EXTERNAL LAMPS	Off	OFF
	TAIL	Operates the tail lamp relay.
	Lo	Operates the headlamp low relay.
	Hi	Operates the headlamp low relay and ON/OFF the headlamp high relay at 1 second intervals.
	Fog	Operates the front fog lamp relay.



# DIAGNOSIS SYSTEM (AFS)

[XENON TYPE]

< SYSTEM DESCRIPTION >

## DIAGNOSIS SYSTEM (AFS)

### CONSULT-III Function (ADAPTIVE LIGHT)

INFOID:000000004875521

#### APPLICATION ITEM

Diagnostic mode	Description
Ecu Identification	Allows confirmation of AFS control unit part number.
Self Diagnostic Result	Displays the diagnosis results judged by AFS control unit.
Work support	Sets each sensor.
Data monitor	Indicates AFS control unit input data in real time.
Active test	Provides the drive signal to the load. Checks operation.

#### WORK SUPPORT

Service item	Description
ST ANG SEN ADJUSTMENT*	—
LEVELIZER ADJUSTMENT	Adjusts the height sensor signal output value (AFS control unit recognized) in the unloaded vehicle condition.

\*: Adjusts the steering angle sensor neutral position on ABS actuator and electrical unit (control unit) side. Refer to [BRC-9. "ADJUSTMENT OF STEERING ANGLE SENSOR NEUTRAL POSITION : Special Repair Requirement"](#).

#### DATA MONITOR

Monitor item [Unit]	Description
STR ANGLS SIG [°]	The steering angle value judged by the steering angle sensor signal received from the steering angle sensor with CAN communication
VHCL SPD [km/h]	The vehicle speed signal value from the unified meter and A/C amp. with CAN communication
SLCT LVR POSI [P - 1]	The selector lever status judged by the position indicator signal received from TCM with CAN communication
HEAD LAMP [On/Off]	The headlamp On/Off status judged by the low beam headlamp (ON) signal received from IPDM E/R with CAN communication
AFS SW [On/Off]	The switch status input from AFS OFF switch
HI SEN OTP RR [V]	The height sensor signal voltage value input from the height sensor
LEV ACTR VLTG [%]	The ratio value to the battery voltage generated by the levelizer activation signal control value judged by AFS control unit
SWVL SEN RH* [°]	The head lamp swivel angle value judged by AFS control unit received from the swivel position sensor signal input from the swivel actuator
SWVL SEN LH* [°]	
SWVL ANGLE RH* [°]	The swivel angle command value to the swivel motor judged by AFS control unit
SWVL ANGLE LH* [°]	

\*: The swivel angle "0°" (feedback value) of the swivel position sensor signal may differ from the swivel angle "0°" of the swivel motor (AFS control unit command value). This causes that the swivel motor initializes the value based on the step number from the stopper.

#### ACTIVE TEST

##### CAUTION:

Start the engine when using "ACTIVE TEST".

# DIAGNOSIS SYSTEM (AFS)

< SYSTEM DESCRIPTION >

[XENON TYPE]

Test item	Operation Item	Description
LOW BEAM TEST RIGHT	Origin Fast	Swivels the right headlamp to the swivel angle 0° in the normal speed.
	Peak Fast	Swivels the right headlamp to the swivel angle approximately 15° in the normal speed.
	Origin Slow	Swivels the right headlamp to the swivel angle 0° in the speed at the initialization.
	Peak Slow	Swivels the right headlamp to the swivel angle approximately 15° in the speed at the initialization.
LOW BEAM TEST LEFT	Origin Fast	Swivels the left headlamp to the swivel angle 0° in the normal speed.
	Peak Fast	Swivels the left headlamp to the swivel angle approximately 17° in the normal speed.
	Origin Slow	Swivels the left headlamp to the swivel angle 0° in the speed at the initialization.
	Peak Slow	Swivels the left headlamp to the swivel angle approximately 17° in the speed at the initialization.
LEVELIZER TEST	Origin	Changes the aiming motor drive signal to approximately 70% of the battery voltage. Moves the headlamp upward and downward.
	Peak	Changes the aiming motor drive signal to approximately 15% of the battery voltage. Moves the headlamp upward and downward.

**NOTE:**

"Fast" operation speed is as three times fast as "Slow".

# POWER SUPPLY AND GROUND CIRCUIT

< DTC/CIRCUIT DIAGNOSIS >

[XENON TYPE]

## DTC/CIRCUIT DIAGNOSIS

### POWER SUPPLY AND GROUND CIRCUIT

#### BCM

#### BCM : Diagnosis Procedure

INFOID:000000005173650

#### 1. CHECK FUSE AND FUSIBLE LINK

Check that the following fuse and fusible link are not blown.

Signal name	Fuse and fusible link No.
Battery power supply	I
	10

#### Is the fuse fusing?

YES >> Replace the blown fuse or fusible link after repairing the affected circuit if a fuse or fusible link is blown.

NO >> GO TO 2.

#### 2. CHECK POWER SUPPLY CIRCUIT

1. Turn ignition switch OFF.
2. Disconnect BCM connectors.
3. Check voltage between BCM harness connector and ground.

Terminals		Voltage (Approx.)
(+)	(-)	
BCM		Ground Battery voltage
Connector	Terminal	
M118	1	
M119	11	

#### Is the measurement value normal?

YES >> GO TO 3.

NO >> Repair harness or connector.

#### 3. CHECK GROUND CIRCUIT

Check continuity between BCM harness connector and ground.

BCM		Ground	Continuity
Connector	Terminal		Existed
M119	13		Existed

#### Does continuity exist?

YES >> INSPECTION END

NO >> Repair harness or connector.

### IPDM E/R (INTELLIGENT POWER DISTRIBUTION MODULE ENGINE ROOM)

#### IPDM E/R (INTELLIGENT POWER DISTRIBUTION MODULE ENGINE ROOM) : Diagnosis Procedure

INFOID:000000005173682

#### 1. CHECK FUSES AND FUSIBLE LINK

Check that the following IPDM E/R fuses or fusible links are not blown.

# POWER SUPPLY AND GROUND CIRCUIT

< DTC/CIRCUIT DIAGNOSIS >

[XENON TYPE]

Signal name	Fuses and fusible link No.
Battery power supply	C
	50
	51

## Is the fuse fusing?

YES >> Replace the blown fuse or fusible link after repairing the affected circuit if a fuse or fusible link is blown.

NO >> GO TO 2.

## 2.CHECK POWER SUPPLY CIRCUIT

1. Turn the ignition switch OFF.
2. Disconnect IPDM E/R connector.
3. Check voltage between IPDM E/R harness connector and the ground.

Terminals		Voltage (Approx.)
(+)	(-)	
IPDM E/R		Battery voltage
Connector	Terminal	
E4	1	

## Is the measurement value normal?

YES >> GO TO 3.

NO >> Repair the harness or connector.

## 3.CHECK GROUND CIRCUIT

Check continuity between IPDM E/R harness connectors and the ground.

IPDM E/R		Ground	Continuity
Connector	Terminal		
E5	12		Existed
E6	41		

## Does continuity exist?

YES >> INSPECTION END

NO >> Repair the harness or connector.

## AFS CONTROL UNIT

### AFS CONTROL UNIT : Diagnosis Procedure

INFOID:000000005173684

## 1.FUSE INSPECTION

Check that the following fuses are not fusing.

Signal name	Connection position	Fuse No.	Capacity
Ignition power supply	FUSE BLOCK (J/B)	3	10 A

## Is the fuse fusing?

YES >> Repair the applicable circuit. And then replace the fuse.

NO >> GO TO 2.

## 2.CHECK POWER SUPPLY CIRCUIT

1. Turn the ignition switch OFF.
2. Disconnect AFS control unit harness connector.
3. Turn the ignition switch ON.
4. Check voltage between AFS control unit harness connector and the ground.

# POWER SUPPLY AND GROUND CIRCUIT

< DTC/CIRCUIT DIAGNOSIS >

[XENON TYPE]

Terminals		Voltage (Approx.)
(+)	(-)	
AFS control unit		Ground
Connector	Terminal	
M16	1	
		Battery voltage

A

B

Is the measurement value normal?

C

YES >> GO TO 3.

NO >> Repair the harness or connector.

## 3.CHECK GROUND CIRCUIT

D

1. Turn the ignition switch OFF.
2. Check continuity between AFS control unit harness connectors and the ground.

E

AFS control unit		Ground	Continuity
Connector	Terminal		
M16	25		Existed

F

Does continuity exist?

YES >> Repair the harness or connector.

NO >> Power supply and ground circuit are normal.

G

H

I

J

K

EXL

M

N

O

P

# B2503, B2504 SWIVEL ACTUATOR

< DTC/CIRCUIT DIAGNOSIS >

[XENON TYPE]

## B2503, B2504 SWIVEL ACTUATOR

### Description

INFOID:000000004875574

#### SWIVEL ACTUATOR

The swivel actuator is installed in the headlamp unit. The swivel actuator consists of the swivel motor and the swivel position sensor.

#### SWIVEL MOTOR

- The swivel motor is the two-phase step motor.
- The swivel motor drives headlamp by exciting the two drive coils according to the drive signal from AFS control unit.
- The rotation direction of the swivel motor is changeable by changing the exciting pattern.

#### SWIVEL POSITION SENSOR

The swivel position sensor detects the headlamp swivel angle to transmit the swivel position sensor signal to AFS control unit.

### DTC Logic

INFOID:000000004875575

#### DTC DETECTION LOGIC

- [B2503] Swivel actuator [RH]
- [B2504] Swivel actuator [LH]

DTC detection condition	DTC erase condition	Possible cause
<p>AFS control unit indicates an applicable DTC when detecting any of the following conditions continuously for 2 seconds or more.</p> <ul style="list-style-type: none"><li>• AFS control unit-recognized swivel position differs extremely from the swivel position sensor-input value while the swivel operating.*</li><li>• The swivel position sensor signal does not change even though AFS control unit transmits the swivel motor driving signal while the swivel operating*.</li><li>• The swivel motor short and open is detected while the swivel operating*.</li><li>• The swivel position sensor power supply is 6 V or more, or 4 V or less.</li><li>• The swivel position sensor signal is 0.25 V or less, or 4.75 V or more.</li></ul>	Ignition switch OFF	<p>Swivel position sensor</p> <ul style="list-style-type: none"><li>• Swivel position sensor</li><li>• Harness and connector</li><li>• AFS control unit</li></ul> <p>Swivel motor</p> <ul style="list-style-type: none"><li>• Swivel motor</li><li>• Harness and connector</li><li>• AFS control unit</li></ul>

\*: Initialization is not included.

### DTC CONFIRMATION PROCEDURE

#### 1. DTC ERASE

Erase the DTC memory of AFS with CONSULT-III.

>> GO TO 2.

#### 2. CONFIRMATION DTC SELECTION

Select "B2503" or "B2504" for confirmation.

##### Which DTC is confirmation?

B2503 >> GO TO 3.

B2504 >> GO TO 4.

#### 3. DTC CONFIRMATION (B2503)

1. Steer to the straight-forward position.
2. Start the engine.
3. Turn AFS OFF switch OFF.
4. Turn the headlamp ON.
5. Shift the selector lever to "N" (A/T models).
6. Shift the shift knob to neutral (M/T models).
7. Steer to the right. (Rotate it once or more.)
8. Perform the self-diagnosis with CONSULT-III.

# B2503, B2504 SWIVEL ACTUATOR

[XENON TYPE]

## < DTC/CIRCUIT DIAGNOSIS >

### Is DTC "B2503" detected?

- YES >> Refer to [EXL-47, "Diagnosis Procedure"](#).
- NO >> Refer to [GI-36, "Intermittent Incident"](#).

### 4. DTC CONFIRMATION (B2504)

1. Steer to the straight-forward position.
2. Start the engine.
3. Turn AFS OFF switch OFF.
4. Turn the headlamp ON.
5. Drive at 25 km/h (15.5 MPH) or more.
6. Steer to the left. (Rotate it once or more.)
7. Stop the vehicle.
8. Perform the self-diagnosis with CONSULT-III.

### Is DTC "B2504" detected?

- YES >> Refer to [EXL-47, "Diagnosis Procedure"](#).
- NO >> Refer to [GI-36, "Intermittent Incident"](#).

## Diagnosis Procedure

INFOID:000000004875576

### 1. CHECK SWIVEL POSITION SENSOR SIGNAL INPUT

1. Turn the ignition switch ON.
2. Check the voltage between the AFS control unit harness connector and the ground.

Terminals			Voltage (Approx.)
(+)	(-)		
AFS control unit			Ground
Connector		Terminal	
RH	M16	9	
LH		29	

### Is the measurement value within the standard value?

- YES >> GO TO 2.
- Less than the standard value >> GO TO 6.
- Higher than the standard value >> GO TO 9.

### 2. CHECK SWIVEL MOTOR

Check the swivel motor. Refer to [EXL-50, "Component Inspection"](#).

### Is the inspection result normal?

- YES >> GO TO 3.
- NO >> Replace the front combination lamp.

### 3. CHECK SWIVEL MOTOR OPEN CIRCUIT

1. Turn the ignition switch OFF.
2. Disconnect AFS control unit connector and the headlamp swivel actuator connector.
3. Check continuity between the AFS control unit harness connector and the headlamp swivel actuator harness connector.

# B2503, B2504 SWIVEL ACTUATOR

< DTC/CIRCUIT DIAGNOSIS >

[XENON TYPE]

AFS control unit		Headlamp swivel actuator		Continuity	
Connector	Terminal	Connector	Terminal		
RH	M16	11	E29	8	Existed
		13		7	
		32		3	
		34		4	
LH		15	E59	3	
		17		4	
		36		8	
		38		7	

Does continuity exist?

YES >> GO TO 4.

NO >> Repair the harnesses or connectors.

## 4. CHECK SWIVEL MOTOR SHORT CIRCUIT

Check continuity between the AFS control unit harness connector and the ground.

AFS control unit		Continuity		
Connector	Terminal			
RH	M16	11	Ground	Not existed
		13		
		32		
		34		
LH		15		
		17		
		36		
		38		

Does continuity exist?

YES >> Repair the harnesses or connectors.

NO >> GO TO 5.

## 5. CHECK SWIVEL MOTOR CIRCUIT VOLTAGE OUTPUT

1. Connect AFS control unit connector.
2. Turn the ignition switch ON.
3. Check the voltage between the AFS control unit harness connector and the ground.



# B2503, B2504 SWIVEL ACTUATOR

< DTC/CIRCUIT DIAGNOSIS >

[XENON TYPE]

Terminals			Voltage (Approx.)
(+)		(-)	
AFS control unit			
Connector		Terminal	Ground  9.5 - 11.5 V
RH	M16	11	
		13	
		32	
		34	
LH		15	
		17	
		36	
		38	

Is the measurement value within the standard value?

YES >> Replace the front combination lamp.

NO >> Replace AFS control unit.

## 6. CHECK SWIVEL POSITION SENSOR SIGNAL OUTPUT

Check the voltage between the AFS control unit harness connector and the ground.

Terminals			Voltage (Approx.)
(+)		(-)	
AFS control unit			
Connector		Terminal	Ground  5 V
RH	M16	4	
LH		24	

Is the measurement value normal?

YES >> GO TO 7.

NO >> GO TO 9.

## 7. CHECK SWIVEL POSITION SENSOR POWER SUPPLY CIRCUIT INPUT VOLTAGE

1. Turn the ignition switch OFF.
2. Disconnect the headlamp swivel actuator connector.
3. Turn the ignition switch ON.
4. Check the voltage between the headlamp swivel actuator harness connector and the ground.

Terminals			Voltage (Approx.)
(+)		(-)	
Headlamp swivel actuator			
Connector		Terminal	Ground  5 V
RH	E29	2	
LH	E59	2	

Is the measurement value normal?

YES >> GO TO 8.

NO >> Repair the harnesses or connectors.

## 8. CHECK SWIVEL POSITION SENSOR SIGNAL OPEN CIRCUIT

1. Turn the ignition switch OFF.
2. Disconnect AFS control unit connector.
3. Check continuity between the AFS control unit harness connector and the headlamp swivel actuator harness connector.

# B2503, B2504 SWIVEL ACTUATOR

< DTC/CIRCUIT DIAGNOSIS >

[XENON TYPE]

AFS control unit		Headlamp swivel actuator		Continuity
Connector	Terminal	Connector	Terminal	
RH	M16	9	E29	Existed
LH		29	E59	

Does continuity exist?

- YES >> Replace the front combination lamp.  
 NO >> Repair the harnesses or connectors.

## 9. CHECK SWIVEL POSITION SENSOR GROUND CIRCUIT VOLTAGE OUTPUT

Check the voltage between the AFS control unit harness connector and the ground.

Terminals			Voltage (Approx.)	
(+)		(-)		
AFS control unit			Ground	
Connector	Terminal	0 V		
RH	M16			2
LH				27

Is the measurement value normal?

- YES >> GO TO 10.  
 NO >> Replace AFS control unit.

## 10. CHECK SWIVEL POSITION SENSOR OPEN GROUND CIRCUIT

- Turn the ignition switch OFF.
- Disconnect AFS control unit connector and the headlamp swivel actuator connector.
- Check continuity between the AFS control unit harness connector and the headlamp swivel actuator harness connector.

AFS control unit		Headlamp swivel actuator		Continuity
Connector	Terminal	Connector	Terminal	
RH	M16	2	E29	Existed
LH		27	E59	

Does continuity exist?

- YES >> Replace the front combination lamp.  
 NO >> Repair the harnesses or connectors.

## Component Inspection

INFOID:000000004875577

### 1. CHECK SWIVEL MOTOR SINGLE PART

- Disconnect the swivel actuator connector.
- Check the resistance among each swivel actuator connector terminal.

Swivel actuator		Resistance (Approx.)
Terminal	Terminal	
3	7	7.2 Ω
4	8	7.2 Ω
3	4	10 MΩ or more

Is the measurement value normal?

- YES >> Swivel actuator is normal.  
 NO >> Replace the front combination lamp.

# B2514 HEIGHT SENSOR UNUSUAL [RR]

< DTC/CIRCUIT DIAGNOSIS >

[XENON TYPE]

## B2514 HEIGHT SENSOR UNUSUAL [RR]

### Description

INFOID:000000004875578

The height sensor is installed to the rear suspension arm. The height sensor detects the suspension arm displacement as the vehicle height change. The height sensor transmits the height sensor signal to AFS control unit.

#### NOTE:

The sensor angle of the unloaded vehicle position is the reference value.

### DTC Logic

INFOID:000000004875579

### DTC DETECTION LOGIC

[B2514] Height sensor unusual [RR]

DTC detection condition	DTC erase condition	Possible cause
An applicable DTC is indicated when any of the following conditions is detected continuously for 2 seconds or more. <ul style="list-style-type: none"> <li>The height sensor power supply is 6 V or more, or 4 V or less.</li> <li>The height sensor signal is 0.25 V or less, or 4.75 V or more.</li> </ul>	Ignition switch OFF	Height sensor <ul style="list-style-type: none"> <li>Height sensor</li> <li>Harness and connector</li> <li>AFS control unit</li> </ul>

### DTC CONFIRMATION PROCEDURE

#### 1. DTC ERASE

Erase the DTC memory of AFS with CONSULT-III.

>> GO TO 2.

#### 2. DTC CONFIRMATION

- Start the engine.
- Turn the headlamp ON.
- Select the self-diagnosis with CONSULT-III.

Is DTC "B2514" detected?

- YES >> Refer to [EXL-51, "Diagnosis Procedure"](#).  
NO >> Refer to [GI-36, "Intermittent Incident"](#).

### Diagnosis Procedure

INFOID:000000004875580

EXL

#### 1. CHECK HEIGHT SENSOR POWER SUPPLY OUTPUT

- Turn the ignition switch ON.
- Check the voltage between the AFS control unit harness connector and the ground.

Terminals		Voltage (Approx.)
(+)	(-)	
AFS control unit		Ground
Connector	Terminal	
M16	6	
		4 - 6 V

Is the measurement value within the standard value?

- YES >> GO TO 2.  
NO >> Replace AFS control unit.

#### 2. CHECK HEIGHT SENSOR POWER SUPPLY INPUT

Check the voltage between the AFS control unit harness connector and the ground.

# B2514 HEIGHT SENSOR UNUSUAL [RR]

[XENON TYPE]

< DTC/CIRCUIT DIAGNOSIS >

Terminals		Voltage (Approx.)
(+)	(-)	
AFS control unit		Ground
Connector	Terminal	
M16	28	
		0.25 - 4.75 V

Is the measurement value within the standard value?

- YES >> Replace AFS control unit.  
Less than the standard value >>GO TO 3.  
Higher than the standard value>>GO TO 6.

## 3.CHECK HEIGHT SENSOR POWER SUPPLY CIRCUIT OUTPUT VOLTAGE

1. Turn the ignition switch OFF.
2. Disconnect the height sensor connector.
3. Turn the ignition switch ON.
4. Check the voltage between the height sensor harness connector and the ground.

Terminals		Voltage (Approx.)
(+)	(-)	
Height sensor		Ground
Connector	Terminal	
B32	1	
		4 - 6 V

Is the measurement value within the standard value?

- YES >> GO TO 4.  
NO >> Repair the harnesses or connectors.

## 4.CHECK HEIGHT SENSOR SIGNAL OPEN CIRCUIT

1. Turn the ignition switch OFF.
2. Disconnect AFS control unit connector.
3. Check continuity between the AFS control unit harness connector and the height sensor harness connector.

AFS control unit		Height sensor		Continuity
Connector	Terminal	Connector	Terminal	
M16	28	B32	2	Existed

Does continuity exist?

- YES >> GO TO 5.  
NO >> Repair the harnesses or connectors.

## 5.CHECK HEIGHT SENSOR SIGNAL SHORT CIRCUIT

Check continuity between the height sensor harness connector and the ground.

Height sensor		Ground	Continuity
Connector	Terminal		
B32	2		Not existed

Does continuity exist?

- YES >> Repair the harnesses or connectors.  
NO >> Replace the height sensor.

## 6.CHECK HEIGHT SENSOR GROUND

Check the voltage between the AFS control unit harness connector and the ground.

# B2514 HEIGHT SENSOR UNUSUAL [RR]

< DTC/CIRCUIT DIAGNOSIS >

[XENON TYPE]

Terminals		Voltage (Approx.)
(+)	(-)	
AFS control unit		Ground
Connector	Terminal	
M16	8	
		0 V

Is the measurement value within the standard value?

- YES >> GO TO 7.  
 NO >> Replace AFS control unit.

## 7.CHECK HEIGHT SENSOR GROUND CIRCUIT

- Turn the ignition switch OFF.
- Disconnect AFS control unit connector and the height sensor connector.
- Check continuity between the AFS control unit harness connector and the height sensor harness connector.

AFS control unit		Height sensor		Continuity
Connector	Terminal	Connector	Terminal	
M16	8	B32	3	Existed

Does continuity exist?

- YES >> Replace the height sensor.  
 NO >> Repair the harnesses or connectors.

## Component Inspection

INFOID:000000004875581

## 1.CHECK HEIGHT SENSOR

- Remove the height sensor (the height sensor connector is connected).
- Start the engine.
- Turn the light switch 2ND.
- Select "HI SEN OTP RR" of AFS data monitor item.
- With moving the sensor lever, check the monitor status.

Monitor item	Condition		Monitor status [Standard value (Approx.)]
HI SEN OTP RR	Sensor lever position	Contact with stopper	0.9 V
		Moving between two positions	Smooth movement
		90° from stopper	4.5 V

Is the output value normal?

- YES >> Height sensor is normal.  
 NO >> Replace the height sensor.

A  
B  
C  
D  
E  
F  
G  
H  
I  
J  
K  
L  
M  
N  
O  
P

EXL

# B2516 SHIFT SIGNAL [P, R]

< DTC/CIRCUIT DIAGNOSIS >

[XENON TYPE]

## B2516 SHIFT SIGNAL [P, R]

### Description

INFOID:000000004875582

AFS control unit receives the shift position signal from TCM with CAN communication.

### DTC Logic

INFOID:000000004875583

### DTC DETECTION LOGIC

[B2516] Shift signal [P, R]

DTC detection condition	DTC erase condition	Possible causes
The shift position signal is not received.	Ignition switch OFF	<ul style="list-style-type: none"><li>• TCM</li><li>• AFS control unit</li></ul>

### DTC CONFIRMATION PROCEDURE

#### 1. DTC ERASE

Erase the DTC memory of AFS with CONSULT-III.

>> GO TO 2.

#### 2. DTC CONFIRMATION

1. Turn the ignition ON.
2. Select the self-diagnosis with CONSULT-III.

Is DTC "B2516" detected?

- YES >> Refer to [EXL-54, "Diagnosis Procedure"](#).  
NO >> Refer to [GI-36, "Intermittent Incident"](#).

### Diagnosis Procedure

INFOID:000000004875584

#### 1. TCM SELF-DIAGNOSIS

Check the self-diagnosis result with CONSULT-III. Check that TCM does not detect any DTCs.

Is any DTC detected?

- YES >> Check TCM. Refer to [TM-242, "DTC Index"](#).  
NO >> GO TO 2.

#### 2. DTC ERASE

Erase the DTC memory of AFS with CONSULT-III.

Is the memory erased?

- YES >> INSPECTION END  
NO >> Replace AFS control unit.

# B2517 VEHICLE SPEED SIGNAL

< DTC/CIRCUIT DIAGNOSIS >

[XENON TYPE]

## B2517 VEHICLE SPEED SIGNAL

### Description

INFOID:000000004875585

AFS control unit receives the vehicle speed signal from the unified meter and A/C amp. with CAN communication.

### DTC Logic

INFOID:000000004875586

### DTC DETECTION LOGIC

[B2517] Vehicle speed signal

DTC detection condition	DTC erase condition	Possible causes
The vehicle speed signal is not received.	Ignition switch OFF	<ul style="list-style-type: none"><li>Unified meter and A/C amp.</li><li>AFS control unit</li></ul>

### DTC CONFIRMATION PROCEDURE

#### 1. DTC ERASE

Erase the DTC memory of AFS with CONSULT-III.

>> GO TO 2.

#### 2. DTC CONFIRMATION

- Turn the ignition ON.
- Select the self-diagnosis with CONSULT-III.

Is DTC "B2517" detected?

- YES >> Refer to [EXL-55. "Diagnosis Procedure"](#).  
NO >> Refer to [GI-36. "Intermittent Incident"](#).

### Diagnosis Procedure

INFOID:000000004875587

#### 1. UNIFIED METER AND A/C AMP. SELF-DIAGNOSIS

Check the self-diagnosis result with CONSULT-III. Check that the unified meter and A/C amp. does not detect any DTCs.

Is any DTC detected?

- YES >> Check the unified meter and A/C amp. Refer to [MWI-102. "DTC Index"](#).  
NO >> GO TO 2.

#### 2. DTC ERASE

Erase the DTC memory of AFS with CONSULT-III.

Is the memory erased?

- YES >> INSPECTION END  
NO >> Replace AFS control unit.

A  
B  
C  
D  
E  
F  
G  
H  
I  
J  
K  
M  
N  
O  
P

EXL

# B2519 LEVELIZER CALIBRATION

< DTC/CIRCUIT DIAGNOSIS >

[XENON TYPE]

## B2519 LEVELIZER CALIBRATION

### Description

INFOID:000000004875588

AFS control unit transmits the height sensor signal from the height sensor.

### DTC Logic

INFOID:000000004875589

[B2519] Levelizer calibration

DTC detection condition	DTC erase condition	Possible causes
The height sensor adjustment position is not recognized.	When the levelizer adjustment is completed	AFS control unit

### Diagnosis Procedure

INFOID:000000004875590

#### 1. LEVELIZER ADJUSTMENT

Perform the levelizer adjustment.

>> Refer to [EXL-7, "LEVELIZER ADJUSTMENT : Special Repair Requirement"](#).



B2521 ECU CIRCUIT

Description

INFOID:000000004875591

AFS control unit judges the vehicle condition from each signal. AFS control unit controls AFS function and the headlamp aiming.

DTC Logic

INFOID:000000004875592

DTC DETECTION LOGIC

[B2521] ECU circuit

Error detection condition	DTC erase condition	Possible cause
<ul style="list-style-type: none"> <li>• AFS control unit indicates an applicable DTC when detecting any of the following conditions continuously for 2 seconds or more.</li> <li>- The swivel position sensor is shorted to the power supply or the ground.</li> <li>- The swivel position sensor signal is shorted to the ground.</li> <li>- The height sensor power supply is shorted to the power supply or the ground.</li> <li>- The height sensor signal is shorted to the ground.</li> <li>• AFS control unit RAM/ROM error</li> </ul>	Ignition switch OFF	Swivel position sensor <ul style="list-style-type: none"> <li>• Swivel position sensor</li> <li>• Harness and connector</li> <li>• AFS control unit</li> </ul> Height sensor <ul style="list-style-type: none"> <li>• Height sensor</li> <li>• Harness and connector</li> <li>• AFS control unit</li> </ul> AFS control unit (RAM/ROM) <ul style="list-style-type: none"> <li>• AFS control unit</li> </ul>

DTC CONFIRMATION PROCEDURE

1. DTC ERASE

Erase the DTC memory of AFS with CONSULT-III.

>> GO TO 2.

2. DTC CONFIRMATION PROCEDURE

1. Turn the ignition ON.
2. Select the self-diagnosis with CONSULT-III.

Is DTC "B2521" detected?

- YES >> Refer to [EXL-57, "Diagnosis Procedure"](#).  
 NO >> Refer to [GI-36, "Intermittent Incident"](#).

Diagnosis Procedure

INFOID:000000004875593

1. CHECK EACH SENSOR POWER SUPPLY

1. Turn the ignition switch ON.
2. Check the voltage between the AFS control unit harness connector and the ground.

Terminals		Voltage (Approx.)
(+)	(-)	
AFS control unit		4 - 6 V
Connector	Terminal	
M16	4	
	6	
	24	
		Ground

Is the measurement value within the standard value?

- YES >> GO TO 2.  
 Less than the standard value >>GO TO 3.  
 Higher than the standard value>>GO TO 4.

A  
B  
C  
D  
E  
F  
G  
H  
I  
J  
K  
M  
N  
O  
P

EXL

< DTC/CIRCUIT DIAGNOSIS >

**2. CHECK EACH SENSOR SIGNAL**

Check the voltage between the AFS control unit harness connector and the ground.

Terminals			Voltage (Approx.)
(+)	(-)		
AFS control unit		Ground	0.25 - 4.75 V
Connector	Terminal		
M16	9		
	28		
	29		

Is the measurement value within the standard value?

- YES >> Replace AFS control unit.
- Less than the standard value >> GO TO 5.
- Higher than the standard value >> GO TO 6.

**3. CHECK EACH SENSOR POWER SUPPLY SHORT CIRCUIT**

1. Turn the ignition switch OFF.
2. Disconnect AFS control unit connector.
3. Check continuity between the AFS control unit harness connector and the ground.

AFS control unit			Continuity
Connector	Terminal		
M16	4	Ground	Not existed
	6		
	24		

Does continuity exist?

- YES >> Repair the harnesses or connectors.
- NO >> Replace AFS control unit.

**4. CHECK EACH SENSOR POWER SUPPLY CIRCUIT**

1. Turn the ignition switch OFF.
2. Disconnect AFS control unit connector.
3. Check the voltage between the AFS control unit harness connector and the ground.

Terminals			Voltage (Approx.)
(+)	(-)		
AFS control unit		Ground	0 V
Connector	Terminal		
M16	4		
	6		
	24		

Is the measurement value normal?

- YES >> Replace AFS control unit.
- NO >> Repair the harnesses or connectors.

**5. CHECK EACH SENSOR SIGNAL SHORT CIRCUIT**

1. Turn the ignition switch OFF.
2. Disconnect AFS control unit connector.
3. Check continuity between the AFS control unit harness connector and the ground.

# B2521 ECU CIRCUIT

< DTC/CIRCUIT DIAGNOSIS >

[XENON TYPE]

AFS control unit		Ground	Continuity
Connector	Terminal		
M16	9	Ground	Not existed
	28		
	29		

Does continuity exist?

- YES >> Repair the harnesses or connectors.  
NO >> Replace AFS control unit.

## 6. CHECK EACH SENSOR SIGNAL SHORT CIRCUIT

1. Turn the ignition switch OFF.
2. Disconnect AFS control unit connector.
3. Turn the ignition switch ON.
4. Check the voltage between the AFS control unit harness connector and the ground.

Terminals		Ground	Voltage (Approx.)
(+)	(-)		
AFS control unit		Ground	0 V
Connector	Terminal		
M16	9		
	28		
	29		

Is the measurement value normal?

- YES >> Replace AFS control unit.  
NO >> Repair the harnesses or connectors.

A  
B  
C  
D  
E  
F  
G  
H  
I  
J  
K  
M  
N  
O  
P

EXL

# C0126 STEERING ANGLE SENSOR SIGNAL

< DTC/CIRCUIT DIAGNOSIS >

[XENON TYPE]

## C0126 STEERING ANGLE SENSOR SIGNAL

### Description

INFOID:000000004875594

AFS control unit receives the steering angle sensor signal from the steering angle sensor with CAN communication.

### DTC Logic

INFOID:000000004875595

### DTC DETECTION LOGIC

[C0126] Steering angle sensor signal

DTC detection condition	DTC erase condition	Possible causes
In any of the following conditions <ul style="list-style-type: none"><li>The steering angle sensor signal is not received.</li><li>The steering angle sensor signal error is received.</li><li>Out-of-standard signal (-900°- +900°) is received.</li></ul>	The ignition switch OFF	<ul style="list-style-type: none"><li>Steering angle sensor</li><li>AFS control unit</li></ul>

### DTC CONFIRMATION PROCEDURE

#### 1. DTC ERASE

Erase the DTC memory of AFS with CONSULT-III.

>> GO TO 2.

#### 2. DTC CONFIRMATION

1. Start the engine.
2. Turn the steering wheel to the maximum right/left.
3. Select the self-diagnosis with CONSULT-III.

Is DTC "C0126" detected?

- YES >> Refer to [EXL-60, "Diagnosis Procedure"](#).  
NO >> Refer to [GI-36, "Intermittent Incident"](#).

### Diagnosis Procedure

INFOID:000000004875596

#### 1. ABS ACTUATOR AND ELECTRICAL UNIT (CONTROL UNIT) SELF-DIAGNOSIS

Check the self-diagnosis result with CONSULT-III. Check that ABS actuator and electrical unit (control unit) does not detect any DTCs.

Is any DTC detected?

- YES >> Check ABS actuator and electrical unit (control unit). Refer to [BRC-93, "DTC Index"](#).  
NO >> GO TO 2.

#### 2. DTC ERASE

Erase DTC memory of AFS with CONSULT-III.

Is the memory erased?

- YES >> INSPECTION END  
NO >> Replace AFS control unit.

# C0428 STEERING ANGLE SENSOR CALIBRATION

< DTC/CIRCUIT DIAGNOSIS >

[XENON TYPE]

## C0428 STEERING ANGLE SENSOR CALIBRATION

### Description

INFOID:000000004875597

AFS control unit receives the steering angle sensor signal from the steering angle sensor with CAN communication.

### DTC Logic

INFOID:000000004875598

[C0428] Steering angle sensor calibration

DTC detection condition	DTC erase condition	Possible causes
The steering angle sensor neutral position is not recognized.	When the steering angle sensor neutral position registration is completed	Steering angle sensor

### Diagnosis Procedure

INFOID:000000004875599

#### 1. STEERING ANGLE SENSOR NEUTRAL POSITION ADJUSTMENT

Perform the steering angle sensor neutral position adjustment.

**CAUTION:**

**Perform the steering angle sensor neutral position adjustment on VDC side. VDC may activate incorrectly.**

>> Refer to [BRC-9, "ADJUSTMENT OF STEERING ANGLE SENSOR NEUTRAL POSITION : Special Repair Requirement"](#).

A  
B  
C  
D  
E  
F  
G  
H  
I  
J  
K  
L  
M  
N  
O  
P

EXL

# U1000 CAN COMM CIRCUIT

< DTC/CIRCUIT DIAGNOSIS >

[XENON TYPE]

## U1000 CAN COMM CIRCUIT

### Description

INFOID:000000004875600

CAN (Controller Area Network) is the serial transmission for real time application. CAN is the multiplex communication for the vehicle with superior data transmission speed and error detection ability. Many electronic control units are equipped on the vehicle. These control units do not operate individually, but associates with other control units by sharing information. In CAN communication, each control unit is connected with two communication lines (CAN-H and CAN-L). Much information is transmitted with fewer communication lines than before. Each control unit transmits/receives data and reads the necessary data only.

### DTC Logic

INFOID:000000004875601

#### DTC DETECTION LOGIC

[U1000] CAN communication circuit

DTC detection condition	DTC erase condition	Possible causes
When AFS control unit does not transmit/receive CAN communication signal continuously for 2 seconds or more	Ignition switch OFF	One or more following items of CAN communication system are error. <ul style="list-style-type: none"><li>• Transmission</li><li>• Reception (ECM)</li><li>• Reception (Unified meter and A/C amp.)</li><li>• Reception (TCM)</li><li>• Reception (Steering angle sensor)</li><li>• Reception (IPDM E/R)</li></ul>

### Diagnosis Procedure

INFOID:000000004875602

#### 1. PERFORM SELF DIAGNOSTIC

1. Turn the ignition switch ON and wait for 2 seconds or more.
2. Check "Self Diagnostic Result".

Is DTC "U1000" displayed?

- YES >> Refer to [LAN-16. "Trouble Diagnosis Flow Chart"](#).  
NO >> Refer to [GI-36. "Intermittent Incident"](#).

# U1010 CONTROL UNIT (CAN)

< DTC/CIRCUIT DIAGNOSIS >

[XENON TYPE]

## U1010 CONTROL UNIT (CAN)

### DTC Logic

INFOID:000000004875603

### DTC DETECTION LOGIC

[U1010] Control unit (CAN)

DTC detection condition	DTC erase condition	Possible cause
AFS control unit detected internal CAN communication circuit malfunction.	Ignition switch OFF	AFS control unit

### Diagnosis Procedure

INFOID:000000004875604

#### 1. REPLACE AFS CONTROL UNIT

When DTC "U1010" is detected, replace AFS control unit.

>> Replace AFS control unit.

A  
B  
C  
D  
E  
F  
G  
H  
I  
J  
K  
M  
N  
O  
P

EXL

# EXTERIOR LAMP FUSE

< DTC/CIRCUIT DIAGNOSIS >

[XENON TYPE]

## EXTERIOR LAMP FUSE

### Description

INFOID:000000004875608

#### Fuse list

Unit	Location	Fuse No.	Capacity
Headlamp HI (LH)	IPDM E/R	#54	10 A
Headlamp HI (RH)	IPDM E/R	#55	10 A
Headlamp LO (LH)	IPDM E/R	#56	15 A
Headlamp LO (RH)	IPDM E/R	#57	15 A
Front fog lamp	IPDM E/R	#58	15 A
<ul style="list-style-type: none"><li>• Parking lamp</li><li>• Front side marker lamp</li></ul>	IPDM E/R	#52	10 A
<ul style="list-style-type: none"><li>• Tail lamp</li><li>• Rear side marker lamp</li><li>• License plate lamp</li><li>• Each illumination</li></ul>	IPDM E/R	#53	10 A
Stop lamp	FUSE BLOCK (J/B)	#7	10 A
Back-up lamp	FUSE BLOCK (J/B)	#4	10 A

### Diagnosis Procedure

INFOID:000000004875609

#### 1. CHECK FUSE

Check that the following fuses are not fusing.

Unit	Location	Fuse No.	Capacity
Headlamp HI (LH)	IPDM E/R	#54	10 A
Headlamp HI (RH)	IPDM E/R	#55	10 A
Headlamp LO (LH)	IPDM E/R	#56	15 A
Headlamp LO (RH)	IPDM E/R	#57	15 A
Front fog lamp	IPDM E/R	#58	15 A
<ul style="list-style-type: none"><li>• Parking lamp</li><li>• Front side marker lamp</li></ul>	IPDM E/R	#52	10 A
<ul style="list-style-type: none"><li>• Tail lamp</li><li>• Rear side marker lamp</li><li>• License plate lamp</li><li>• Each illumination</li></ul>	IPDM E/R	#53	10 A
Stop lamp	FUSE BLOCK (J/B)	#7	10 A
Back-up lamp	FUSE BLOCK (J/B)	#4	10 A

#### Is the fuse fusing?

- YES >> Repair the applicable circuit. And then replace the fuse.  
NO >> The fuse is normal.



# HEADLAMP (HI) CIRCUIT

< DTC/CIRCUIT DIAGNOSIS >

[XENON TYPE]

## HEADLAMP (HI) CIRCUIT

### Description

INFOID:000000004875610

The high beam solenoid drives the mobile valve shade. And the mobile valve shade switches the high beam and low beam of headlamp.

- When the headlamp high relay is turned ON, magnetic force is applied to the high beam solenoid (1) by a current. The mobile valve shade (2) is switched to the high beam position.
- When the headlamp high relay is turned OFF, the current stops. The mobile valve shade returns to the low beam position automatically.

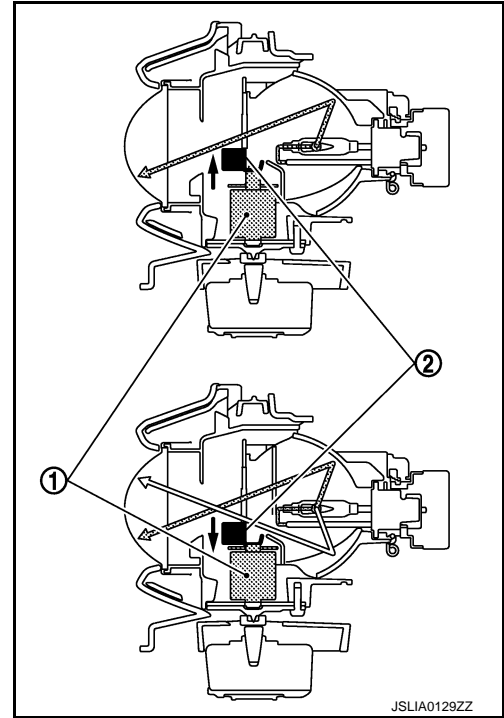

### Component Function Check

INFOID:000000004875611

#### 1. CHECK HEADLAMP (HI) OPERATION

##### IPDM E/R AUTO ACTIVE TEST

1. Start IPDM E/R auto active test. Refer to [PCS-9, "Diagnosis Description"](#).
2. Check that the headlamp switches to the high beam.

##### CONSULT-III ACTIVE TEST

1. Select "EXTERNAL LAMPS" of IPDM E/R active test item.
2. With operating the test items, check that the headlamp switches to the high beam.

**Hi** : Headlamp switches to the high beam.

**Off** : Headlamp OFF

##### NOTE:

HI/LO is repeated 1 second each when using the IPDM E/R auto active test.

Does the headlamp switch to the high beam?

- YES >> Headlamp (HI) circuit is normal.  
NO >> Refer to [EXL-65, "Diagnosis Procedure"](#).

### Diagnosis Procedure

INFOID:000000004875612

#### 1. CHECK HEADLAMP (HI) OUTPUT VOLTAGE

##### CONSULT-III ACTIVE TEST

1. Turn the ignition switch OFF.
2. Disconnect the front combination lamp connector.
3. Turn the ignition switch ON.
4. Select "EXTERNAL LAMPS" of IPDM E/R active test item.
5. With operating the test items, check the voltage between the IPDM E/R harness connector and the ground.

# HEADLAMP (HI) CIRCUIT

[XENON TYPE]

< DTC/CIRCUIT DIAGNOSIS >

Terminals			Test item	Voltage (Approx.)	
(+) (+)		(-) (-)			
IPDM E/R			EXTERNAL LAMPS		
Connector	Terminal				
RH	E8	89	Ground	Hi	Battery voltage
					Off
LH		90		Hi	Battery voltage
				Off	0 V

Is the measurement value normal?

YES >> GO TO 2.

NO >> GO TO 3.

## 2. CHECK HEADLAMP (HI) OPEN CIRCUIT

1. Turn the ignition switch OFF.
2. Disconnect IPDM E/R connector.
3. Check continuity between the IPDM E/R harness connector and the front combination lamp harness connector.

IPDM E/R		Front combination lamp		Continuity
Connector	Terminal	Connector	Terminal	
RH	E8	E28	7	Existed
LH		90	E58	

Does continuity exist?

YES >> Replace the front combination lamp.

NO >> Repair the harnesses or connectors.

## 3. CHECK HEADLAMP (HI) FUSE

1. Turn the ignition switch OFF.
2. Check that the following fuses are not fusing.

Unit	Location	Fuse No.	Capacity
Headlamp HI (RH)	IPDM E/R	#55	10 A
Headlamp HI (LH)	IPDM E/R	#54	10 A

Is the fuse fusing?

YES >> GO TO 4.

NO >> Replace IPDM E/R.

## 4. CHECK FRONT COMBINATION LAMP (HI) SHORT CIRCUIT

1. Disconnect IPDM E/R connector.
2. Check continuity between the IPDM E/R harness connector terminal and the ground.

IPDM E/R		Ground	Continuity
Connector	Terminal		
RH	E8		Not existed
LH			

Does continuity exist?

YES >> Repair the harnesses or connectors. And then replace the fuse.

NO >> Replace the fuse. (Replace IPDM E/R if the fuse is fusing again.)

# HEADLAMP (LO) CIRCUIT

< DTC/CIRCUIT DIAGNOSIS >

[XENON TYPE]

## HEADLAMP (LO) CIRCUIT

### Description

INFOID:000000004875613

Headlamp (LO) circuit is connected to HID control unit integrated in the headlamp. Headlamp (LO) circuit turns xenon headlamp ON.

For the details of HID control unit and the xenon headlamp, refer to [EXL-69, "Description"](#).

### Component Function Check

INFOID:000000004875614

#### 1. CHECK HEADLAMP (LO) OPERATION

##### IPDM E/R AUTO ACTIVE TEST

1. Start IPDM E/R auto active test. Refer to [PCS-9, "Diagnosis Description"](#).
2. Check that the headlamp is turned ON.

##### CONSULT-III ACTIVE TEST

1. Select "EXTERNAL LAMPS" of IPDM E/R active test item.
2. With operating the test items, check that the headlamp is turned ON.

**Lo** : Headlamp ON

**Off** : Headlamp OFF

##### Is the headlamp turned ON?

YES >> Headlamp (LO) is normal.

NO >> Refer to [EXL-67, "Diagnosis Procedure"](#).

### Diagnosis Procedure

INFOID:000000004875615

#### 1. CHECK HEADLAMP (LO) OUTPUT VOLTAGE

##### CONSULT-III ACTIVE TEST

1. Turn the ignition switch OFF.
2. Disconnect the front combination lamp connector.
3. Turn the ignition switch ON.
4. Select "EXTERNAL LAMPS" of IPDM E/R active test item.
5. With operating the test items, check the voltage between the IPDM E/R harness connector and the ground.

Terminals			Test item	Voltage (Approx.)		
(+)	(-)					
IPDM E/R			EXTERNAL LAMPS	Battery voltage		
Connector	Terminal					
RH	E8	83			Lo	Battery voltage
LH		84			Off	0 V
			Lo	Battery voltage		
			Off	0 V		

##### Is the measurement value normal?

YES >> GO TO 2.

NO >> GO TO 3.

#### 2. CHECK HEADLAMP (LO) OPEN CIRCUIT

1. Turn the ignition switch OFF.
2. Disconnect IPDM E/R connector.
3. Check continuity between the IPDM E/R harness connector and the front combination lamp harness connector.

# HEADLAMP (LO) CIRCUIT

[XENON TYPE]

< DTC/CIRCUIT DIAGNOSIS >

IPDM E/R		Front combination lamp		Continuity
Connector	Terminal	Connector	Terminal	
RH	E8	83	E28	Existed
LH		84	E58	

Does continuity exist?

YES >> GO TO 5.

NO >> Repair the harnesses or connectors.

## 3. CHECK HEADLAMP (LO) FUSE

1. Turn the ignition switch OFF.
2. Check that the following fuses are not fusing.

Unit	Lotion	Fuse No.	Capacity
Headlamp LO (RH)	IPDM E/R	#57	15 A
Headlamp LO (LH)	IPDM E/R	#56	15 A

Is the fuse fusing?

YES >> GO TO 4.

NO >> Replace IPDM E/R.

## 4. CHECK HEADLAMP (LO) SHORT CIRCUIT

1. Disconnect IPDM E/R connector.
2. Check continuity between the IPDM E/R harness connector and the ground.

IPDM E/R		Ground	Continuity
Connector	Terminal		
RH	E8		Not existed
LH			

Does continuity exist?

YES >> Repair the harnesses or connectors. And then replace the fuse.

NO >> Replace the fuse. (Replace IPDM E/R if the fuse is fusing again.)

## 5. CHECK HEADLAMP GROUND OPEN CIRCUIT

Check continuity between the front combination lamp harness connector and the ground.

Front combination lamp		Ground	Continuity
Connector	Terminal		
RH	E28		Existed
LH	E58		

Does continuity exist?

YES >> Perform the xenon headlamp diagnosis. Refer to [EXL-69, "Description"](#).

NO >> Repair the harnesses or connectors.

## XENON HEADLAMP

### Description

INFOID:000000004875616

### OUTLINE

- The lamp light source is by the arch discharge by applying high voltage into the xenon gas-filled bulb instead of the halogen bulb filament.
- Sight becomes more natural and brighter because the amount of light are gained adequately and the color of light is sunshine-like white.
- The xenon bulb drops the amount of light, repeats blinking, and illuminates in red if the bulb reaches the service life.

### ILLUMINATION PRINCIPLE

1. Discharging starts in high voltage pulse between bulb electrodes.
2. Xenon gas is activated by current between electrodes. Pale light is emitted.
3. The luminous tube (bulb) temperature elevates. Evaporated halide is activated by discharge. The color of light changes into white.

#### NOTE:

- Brightness and the color of light may change slightly immediately after the headlamp turned ON until the xenon bulb becomes stable. This is not malfunction.
- Illumination time lag may occur between right and left. This is not malfunction.

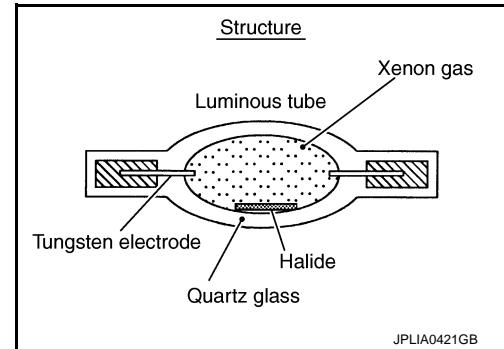

### PRECAUTIONS FOR TROUBLE DIAGNOSIS

Representative malfunction examples are; "Light does not turn ON", "Light blinks", and "Brightness is inadequate." The cause often be the xenon bulb. Such malfunctions, however, are occurred occasionally by HID control unit malfunction or lamp case malfunction. Specify the malfunctioning part with diagnosis procedure.

#### WARNING:

- **Never touch the harness, HID control unit, the inside and metal part of lamp when turning the headlamp ON or operating the light switch.**
- **Never work with wet hands.**

#### CAUTION:

- **Never perform HID control unit circuit diagnosis with a circuit tester or an equivalent.**
- **Temporarily install the headlamp on the vehicle. Connect the battery to the connector (vehicle side) when checking ON/OFF status.**
- **Disconnect the battery negative terminal before disconnecting the lamp socket connector or the harness connector.**
- **Check for fusing of the fusible link(s), open around connector, short, disconnection if the symptom is caused by electric error.**
- **When water infiltrated by the damage of the headlamp housing in the lamp inside, and then water is stuck in the HID control unit connector part, HID control unit detect a power supply short circuit and stop the headlamp function. therefore inspect outside of headlamp for cracks, serious damage or install the resin cap and the bulb socket securely.**

#### NOTE:

- Turn the switch OFF once before turning ON, if the ON/OFF is inoperative.
- The xenon bulb drops the amount of light, repeats blinking, and illuminates in red if the bulb reaches the service life.

### Diagnosis Procedure

INFOID:000000004875617

#### 1. CHECK XENON BULB

Install the normal bulb to the applicable headlamp. Check that the xenon bulb is turned ON.

##### Is the headlamp turned ON?

- YES >> Replace the xenon bulb.
- NO >> GO TO 2.

# XENON HEADLAMP

< DTC/CIRCUIT DIAGNOSIS >

[XENON TYPE]

---

## 2.CHECK INSIDE OF XENON HEADLAMP HOUSING

---

Check the inside of applicable headlamp (upper surface of HID control unit) for exist the water or trace of the water intrusion.

Are there trace of the water intrusion in the headlamp?

YES >> GO TO 3.

NO >> When headlamp control system is normal, Replace the front combination lamp assembly.

## 3.CHECK OUTSIDE OF XENON HEADLAMP HOUSING

---

Check the outside of applicable headlamp for cracks, serious damage or install the resin cap and the bulb socket securely.

Is the outside of headlamp housing abnormality?

YES >> Replace the front combination lamp assembly.

NO >> Dry water fully and then check that the lighting switch is turned ON. Refer to [EXL-194. "Inspection After Installation"](#).

# HEADLAMP LEVELIZER CIRCUIT

< DTC/CIRCUIT DIAGNOSIS >

[XENON TYPE]

## HEADLAMP LEVELIZER CIRCUIT

### Description

INFOID:000000004875618

The headlamp levelizer adjusts the headlamp light axis upward and downward with the aiming motor integrated in the front combination lamp.

### Component Function Check

INFOID:000000004875619

#### 1. CHECK AIMING MOTOR OPERATION

##### CONSULT-III ACTIVE TEST

1. Start the engine.
2. Turn the lighting switch 2ND.
3. Select "LEVELIZER TEST" of ADAPTIVE LIGHT active test item.
4. With operating the test item, check the operation.

Test item	Light axis angle (Reference value)	10 m (32.8 ft)-forward light axis change refer- ence quantity (Approx.)
LEVELIZER TEST		
Origin	0°	—
Peak	2.5°	450 mm (17.9 in)

Is the operation normal?

- YES >> Headlamp levelizer circuit is normal.  
 NO >> Refer to [EXL-71, "Diagnosis Procedure"](#).

### Diagnosis Procedure

INFOID:000000004875620

#### 1. CHECK AIMING MOTOR DRIVE SIGNAL OUTPUT

##### CONSULT-III ACTIVE TEST

1. Start the engine.
2. Turn the light switch 2ND.
3. Select "LEVELIZER TEST" of ADAPTIVE LIGHT active test item.
4. With operating the test item, check the voltage between the AFS control unit harness connector and the ground.

Terminals			Test item	Voltage (Approx.)		
(+)	(-)					
AFS control unit			LEVELIZER TEST			
Connector	Terminal					
RH	M16	19			Origin	8.8 V
		Peak			1.9 V	
LH	M16	40	Origin	8.8 V		
			Peak	1.9 V		

Is the measurement value normal?

- YES >> GO TO 2.  
 NO >> GO TO 3.

#### 2. CHECK AIMING MOTOR DRIVE SIGNAL CIRCUIT INPUT

1. Turn the ignition switch OFF.
2. Disconnect AFS control unit connector and aiming motor connector.
3. Check continuity between AFS control unit harness connector and the aiming motor harness connector.

# HEADLAMP LEVELIZER CIRCUIT

[XENON TYPE]

< DTC/CIRCUIT DIAGNOSIS >

AFS control unit		Aiming motor		Continuity
Connector	Terminal	Connector	Terminal	
RH	M16	E26	1	Existed
LH		40	E56	

Does continuity exist?

- YES >> Replace the front combination lamp.  
NO >> Repair the harnesses and connectors.

## 3. CHECK AIMING MOTOR DRIVE SIGNAL SHORT CIRCUIT

1. Turn the ignition switch OFF.
2. Disconnect AFS control unit connector and aiming motor connector.
3. Check continuity between AFS control unit harness connector and the ground.

AFS control unit		Ground	Continuity
Connector	Terminal		
RH	M16	19	Not existed
LH		40	

Does continuity exist?

- YES >> Repair the harness and connectors.  
NO >> Replace AFS control unit.



# FRONT FOG LAMP CIRCUIT

< DTC/CIRCUIT DIAGNOSIS >

[XENON TYPE]

## FRONT FOG LAMP CIRCUIT

### Component Function Check

INFOID:000000004875621

#### 1. CHECK FRONT FOG LAMP OPERATION

##### IPDM E/R AUTO ACTIVE TEST

1. Activate IPDM E/R auto active test. Refer to [PCS-9, "Diagnosis Description"](#).
2. Check that the front fog lamp is turned ON.

##### CONSULT-III ACTIVE TEST

1. Select "EXTERNAL LAMPS" of IPDM E/R active test item.
2. With operating the test items, Check that the front fog lamp is turned ON.

**Fog** : Front fog lamp ON  
**Off** : Front fog lamp OFF

##### Is the front fog lamp turned ON?

- YES >> Front fog lamp circuit is normal.  
NO >> Refer to [EXL-73, "Diagnosis Procedure"](#).

### Diagnosis Procedure

INFOID:000000004875622

#### 1. CHECK FRONT FOG LAMP FUSE

1. Turn the ignition switch OFF.
2. Check that the following fuses are not fusing.

Unit	Location	Fuse No.	Capacity
Front fog lamp	IPDM E/R	#58	15 A

##### Is the fuse fusing?

- YES >> GO TO 2.  
NO >> GO TO 3.

#### 2. CHECK FRONT FOG LAMP SHORT CIRCUIT

1. Disconnect IPDM E/R connector and the front combination lamp connector.
2. Check continuity between the IPDM E/R harness connector and the ground.

IPDM E/R		Terminal	Ground	Continuity
Connector				Not existed
RH	E8	86		Not existed
LH		87		

##### Does continuity exist?

- YES >> Repair the harnesses or connectors. And then replace the fuse.  
NO >> Replace the fuse. (Replace IPDM E/R if the fuse is fusing again.)

#### 3. CHECK FRONT FOG LAMP BULB

Check the applicable lamp bulb.

##### Is the bulb normal?

- YES >> GO TO 4.  
NO >> Replace the bulb.

#### 4. CHECK FRONT FOG LAMP OUTPUT VOLTAGE

##### CONSULT-III ACTIVE TEST

1. Disconnect the front combination lamp connector.
2. Turn the ignition switch ON.
3. Select "EXTERNAL LAMPS" of IPDM E/R active test item.

# FRONT FOG LAMP CIRCUIT

[XENON TYPE]

## < DTC/CIRCUIT DIAGNOSIS >

4. With operating the test items, check the voltage between the IPDM E/R harness connector and the ground.

Terminals			Test item	Voltage (Approx.)
(+)		(-)		
IPDM E/R			EXTERNAL LAMPS	Battery voltage
Connector	Terminal			
RH	E8	86	Fog	Battery voltage
LH		87	Off	0 V
			Fog	Battery voltage
			Off	0 V

Is the measurement value normal?

YES >> GO TO 5.

NO >> Replace IPDM E/R.

## 5. CHECK FRONT FOG LAMP OPEN CIRCUIT

1. Turn the ignition switch OFF.
2. Disconnect IPDM E/R connector.
3. Check continuity between the IPDM E/R harness connector and the front combination lamp harness connector.

IPDM E/R		Front combination lamp		Continuity
Connector	Terminal	Connector	Terminal	
RH	E8	E28	1	Existed
LH		87	E58	

Does continuity exist?

YES >> GO TO 6.

NO >> Repair the harnesses or connectors.

## 6. CHECK FRONT FOG LAMP GROUND CIRCUIT OPEN CIRCUIT

Check continuity between the front combination lamp harness connector and the ground.

Front combination lamp			Ground	Continuity
Connector	Terminal			
RH	E28	4	Ground	Existed
LH	E58	4		

Does continuity exist?

YES >> Replace the front combination lamp.

NO >> Repair the harnesses or connectors.

# PARKING LAMP CIRCUIT

< DTC/CIRCUIT DIAGNOSIS >

[XENON TYPE]

## PARKING LAMP CIRCUIT

### Component Function Check

INFOID:000000004875623

#### 1. CHECK PARKING LAMP OPERATION

##### IPDM E/R AUTO ACTIVE TEST

1. Activate IPDM E/R auto active test. Refer to [PCS-9, "Diagnosis Description"](#).
2. Check that the parking lamp is turned ON.

##### CONSULT-III ACTIVE TEST

1. Select "EXTERNAL LAMPS" of IPDM E/R active test item.
2. With operating the test items, check that the parking lamp is turned ON.

**TAIL : Parking lamp ON**  
**Off : Parking lamp OFF**

##### Is the parking lamp turned ON?

- YES >> Parking lamp circuit is normal.  
NO >> Refer to [EXL-75, "Diagnosis Procedure"](#).

### Diagnosis Procedure

INFOID:000000004875624

#### 1. CHECK PARKING LAMP FUSE

1. Turn the ignition switch OFF.
2. Check that the following fuse is not fusing.

Unit	Location	Fuse No.	Capacity
<ul style="list-style-type: none"><li>• Parking lamp</li><li>• Front side marker lamp</li></ul>	IPDM E/R	#52	10 A

##### Is the fuse fusing?

- YES >> GO TO 2.  
NO >> GO TO 3.

#### 2. CHECK PARKING LAMP SHORT CIRCUIT

1. Disconnect IPDM E/R connector and the front combination lamp connector.
2. Check continuity between the IPDM E/R harness connector and the ground.

IPDM E/R			Ground	Continuity
Connector	Terminal			
RH	E9	91	Not existed	
LH		92		

##### Does continuity exist?

- YES >> Repair the harnesses or connectors. And then replace the fuse.  
NO >> Replace the fuse. (Replace IPDM E/R if fusing is found again.)

#### 3. CHECK PARKING LAMP BULB AND FRONT SIDE MARKER LAMP

Check the applicable lamp bulb.

##### Is the bulb normal?

- YES >> GO TO 4.  
NO >> Replace the bulb.

#### 4. CHECK PARKING LAMP OUTPUT VOLTAGE

##### CONSULT-III ACTIVE TEST

1. Disconnect the front combination lamp connector.
2. Turn the ignition switch ON.
3. Select "EXTERNAL LAMPS" of IPDM E/R active test item.

A  
B  
C  
D  
E  
F  
G  
H  
I  
J  
K  
M  
N  
O  
P

EXL

# PARKING LAMP CIRCUIT

[XENON TYPE]

## < DTC/CIRCUIT DIAGNOSIS >

4. With operating the test items, check the voltage between the IPDM E/R harness connector and the ground.

Terminals			Test item	Voltage (Approx.)
(+)		(-)		
IPDM E/R			EXTERNAL LAMPS	Battery voltage
Connector	Terminal			
RH	E9	91	TAIL	0 V
LH		92	Off	Battery voltage
			Off	0 V

Is the measurement value normal?

YES >> GO TO 5.

NO >> Replace IPDM E/R.

## 5. CHECK PARKING LAMP OPEN CIRCUIT

1. Turn the ignition switch OFF.
2. Disconnect IPDM E/R connector.
3. Check continuity between the IPDM E/R harness connector and the front combination lamp harness connector.

IPDM E/R		Front combination lamp		Continuity
Connector	Terminal	Connector	Terminal	
RH	E9	E28	8	Existed
LH		92	E58	

Does continuity exist?

YES >> GO TO 6.

NO >> Repair the harnesses or connectors.

## 6. CHECK PARKING LAMP GROUND OPEN CIRCUIT

Check continuity between the front combination lamp harness connector and the ground.

Front combination lamp			Ground	Continuity
Connector	Terminal			
RH	E28	4		Existed
LH	E58	4		

Does continuity exist?

YES >> Replace the front combination lamp.

NO >> Repair the harnesses or connectors.

# TURN SIGNAL LAMP CIRCUIT

< DTC/CIRCUIT DIAGNOSIS >

[XENON TYPE]

## TURN SIGNAL LAMP CIRCUIT

### Description

INFOID:000000004875625

BCM performs the high flasher operation (fail-safe) if any bulb or harness of the turn signal lamp circuit is open.

#### NOTE:

Turn signal lamp blinks at normal speed when using the hazard warning lamp.

### Component Function Check

INFOID:000000004875626

#### 1. CHECK TURN SIGNAL LAMP

##### ⓂCONSULT-III ACTIVE TEST

1. Select "FLASHER" of BCM (FLASHER) active test item.
2. With operating the test items, check that the turn signal lamp blinks.

**LH** : Turn signal lamp LH blinking

**RH** : Turn signal lamp RH blinking

**Off** : The turn signal lamp OFF

#### Does the turn signal lamp blink?

YES >> Turn signal lamp circuit is normal.

NO >> Refer to [EXL-77. "Diagnosis Procedure"](#).

### Diagnosis Procedure

INFOID:000000004875627

#### 1. CHECK TURN SIGNAL LAMP BULB

Check the applicable lamp bulb.

#### Is the bulb normal?

YES >> GO TO 2.

NO >> Replace the bulb.

#### 2. CHECK TURN SIGNAL LAMP OUTPUT VOLTAGE

##### ⓂCONSULT-III ACTIVE TEST

1. Turn the ignition switch OFF.
2. Disconnect the front combination lamp connector or the rear combination lamp connector.
3. Turn the ignition switch ON.
4. Select "FLASHER" of BCM (FLASHER) active test item.
5. With operating the turn signal switch, check the voltage between the BCM harness connector and the ground.

EXL

# TURN SIGNAL LAMP CIRCUIT

[XENON TYPE]

< DTC/CIRCUIT DIAGNOSIS >

Front					
Terminals			Test item	Voltage (Approx.)	
(+)		(-)			
BCM			FLASHER	Voltage (Approx.)	
Connector	Terminal				
RH	M119	17	Ground	RH	
		Off	0 V		
LH	M119	18	Ground	LH	
		Off	0 V		

Rear					
Terminals			Test item	Voltage (Approx.)	
(+)		(-)			
BCM			FLASHER	Voltage (Approx.)	
Connector	Terminal				
RH	M120	20	Ground	RH	
		Off	0 V		
LH	M120	25	Ground	LH	
		Off	0 V		

Is the measurement value normal?

- YES >> GO TO 3.
- NO >> Replace BCM.

### 3. CHECK TURN SIGNAL LAMP OPEN CIRCUIT

1. Turn the ignition switch OFF.
2. Disconnect BCM connector.
3. Check the continuity between the BCM harness connector and the front combination lamp or the rear combination lamp harness connector.

# TURN SIGNAL LAMP CIRCUIT

[XENON TYPE]

## < DTC/CIRCUIT DIAGNOSIS >

Front combination lamp

BCM		Front combination lamp		Continuity
Connector	Terminal	Connector	Terminal	
RH	M119	17	E28	Existed
LH		18	E58	

Rear combination lamp

BCM		Rear combination lamp		Continuity
Connector	Terminal	Connector	Terminal	
RH	M120	20	B67	Existed
LH		25	B60	

### Does continuity exist?

YES >> GO TO 4.

NO >> Repair the harnesses or connectors.

## 4.CHECK TURN SIGNAL LAMP SHORT CIRCUIT

Check continuity between the BCM harness connector and the ground.

Front

BCM		Ground	Continuity
Connector	Terminal		
RH	M119	17	Not existed
LH		18	

Rear

BCM		Ground	Continuity
Connector	Terminal		
RH	M120	20	Not existed
LH		25	

### Does continuity exist?

YES >> Repair the harnesses or connectors.

NO >> GO TO 5.

## 5.CHECK TURN SIGNAL LAMP GROUND OPEN CIRCUIT

Check the voltage between the BCM harness connector and the front combination lamp or the rear combination lamp and the ground.

Front combination lamp

Front combination lamp		Ground	Continuity
Connector	Terminal		
RH	E28	4	Existed
LH	E58	4	

Rear combination lamp

Rear combination lamp		Ground	Continuity
Connector	Terminal		
RH	B67	3	Existed
LH	B60	3	

### Does continuity exist?

YES >> Replace the front combination lamp or the rear combination lamp.

NO >> Repair the harnesses or connectors.

A  
B  
C  
D  
E  
F  
G  
H  
I  
J  
K

EXL

M  
N  
O  
P

# OPTICAL SENSOR

[XENON TYPE]

< DTC/CIRCUIT DIAGNOSIS >

## OPTICAL SENSOR

### Description

INFOID:000000004875628

Optical sensor converts the outside brightness (lux) to voltage and transmits the optical sensor signal to BCM.

### Component Function Check

INFOID:000000004875629

#### 1.CHECK OPTICAL SENSOR SIGNAL BY CONSULT-III

##### CONSULT-III DATA MONITOR

1. Turn the ignition switch ON.
2. Select "OPTICAL SENSOR" of BCM (HEADLAMP) data monitor item.
3. Turn the lighting switch AUTO.
4. With the optical sensor illuminating, check the monitor status.

Monitor item	Condition		Voltage (Approx.)
OPTICAL SENSOR	Optical sensor	When illuminating	3.1 V or more *
		When shutting off light	0.6 V or less

\*: Illuminates the optical sensor. The value may be less than the standard value if brightness is weak.

##### Is the item status normal?

- YES >> Optical sensor is normal.  
NO >> Refer to [EXL-80, "Diagnosis Procedure"](#).

### Diagnosis Procedure

INFOID:000000004875630

#### 1.CHECK OPTICAL SENSOR POWER SUPPLY INPUT

1. Turn the ignition switch ON.
2. Turn the lighting switch AUTO.
3. Check the voltage between the optical sensor harness connector and the ground.

Terminals		Voltage (Approx.)
(+)	(-)	
Optical sensor		5 V
Connector	Terminal	
M94	1	

##### Is the measurement value normal?

- YES >> GO TO 2.  
NO >> GO TO 4.

#### 2.CHECK OPTICAL SENSOR GROUND INPUT

Check the voltage between the optical sensor harness connector and the ground.

Terminals		Voltage (Approx.)
(+)	(-)	
Optical sensor		0 V
Connector	Terminal	
M94	3	

##### Is the measurement value normal?

- YES >> GO TO 3.  
NO >> GO TO 6.



# OPTICAL SENSOR

[XENON TYPE]

< DTC/CIRCUIT DIAGNOSIS >

## 3. CHECK OPTICAL SENSOR SIGNAL OUTPUT

With illuminating the optical sensor, check the voltage between the optical sensor harness connector and the ground.

Terminals		Condition	Voltage (Approx.)
(+)	(-)		
Optical sensor		Optical sensor	
Connector	Terminal		
M94	2	Ground	
		When illuminating	3.1 V or more *
		When shutting off light	0.6 V or less

\*: Illuminate the optical sensor. The value may be less than the standard if brightness is weak.

Is the measurement value normal?

YES >> GO TO 7.

NO >> Replace the optical sensor.

## 4. CHECK OPTICAL SENSOR OPEN CIRCUIT

1. Turn the ignition switch OFF.
2. Disconnect the optical sensor connector and BCM connector.
3. Check continuity between the optical sensor harness connector and the BCM harness connector.

Optical sensor		BCM		Continuity
Connector	Terminal	Connector	Terminal	
M94	1	M123	138	Existed

Does continuity exist?

YES >> GO TO 5.

NO >> Repair the harnesses or connectors.

## 5. CHECK OPTICAL SENSOR SHORT CIRCUIT

Check the continuity between the optical sensor harness connector and the ground.

Optical sensor		Ground	Continuity
Connector	Terminal		
M94	1		Not existed

Does continuity exist?

YES >> Repair the harnesses or connectors.

NO >> Replace BCM.

## 6. CHECK OPTICAL SENSOR GROUND OPEN CIRCUIT

1. Turn the ignition switch OFF.
2. Disconnect the optical sensor connector and BCM connector.
3. Check continuity between the optical sensor harness connector and the BCM harness connector.

Optical sensor		BCM		Continuity
Connector	Terminal	Connector	Terminal	
M94	3	M123	137	Existed

Does continuity exist?

YES >> Replace BCM.

NO >> Repair the harnesses or connectors.

## 7. CHECK OPTICAL SENSOR SIGNAL OPEN CIRCUIT

A  
B  
C  
D  
E  
F  
G  
H  
I  
J  
K  
EXL  
M  
N  
O  
P

# OPTICAL SENSOR

[XENON TYPE]

## < DTC/CIRCUIT DIAGNOSIS >

1. Turn the ignition switch OFF.
2. Disconnect the optical sensor connector and BCM connector.
3. Check continuity between the optical sensor harness connector and the BCM harness connector.

Optical sensor		BCM		Continuity
Connector	Terminal	Connector	Terminal	
M94	2	M123	113	Existed

### Does continuity exist?

YES >> GO TO 8.

NO >> Repair the harnesses or connectors.

## 8. CHECK OPTICAL SENSOR SHORT CIRCUIT

Check the continuity between the optical sensor harness connector and the ground.

Optical sensor		Ground	Continuity
Connector	Terminal		
M94	2		Not existed

### Does continuity exist?

YES >> Repair the harnesses or connectors.

NO >> Replace BCM.

# HAZARD SWITCH

< DTC/CIRCUIT DIAGNOSIS >

[XENON TYPE]

## HAZARD SWITCH

### Description

INFOID:000000004875631

Hazard switch is integrated in the multifunction switch. Hazard switch inputs the signals to BCM when pressing the switch.

### Component Function Check

INFOID:000000004875632

#### 1. CHECK HAZARD SWITCH SIGNAL BY CONSULT-III

##### CONSULT-III DATA MONITOR

1. Turn the ignition switch ON.
2. Select "HAZARD SW" of BCM (FLASHER) data monitor item.
3. With operating the hazard switch, check the monitor status.

Monitor item	Condition		Monitor status
HAZARD SW	Hazard switch	While pressing the switch	On
		While not pressing the switch	Off

##### Is the item status normal?

- YES >> Hazard switch circuit is normal.  
 NO >> Refer to [EXL-83, "Diagnosis Procedure"](#).

### Diagnosis Procedure

INFOID:000000004875633

#### 1. CHECK HAZARD SWITCH SIGNAL INPUT

With operating the hazard switch, check the voltage between the BCM harness connector and the ground.

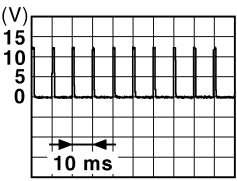
Terminals		Condition	Voltage (Approx.)
(+)	(-)		
BCM		Hazard switch	0 V
Connector	Terminal		
M122	110	While pressing the switch	 <p>JPMIA0012GB</p>
		Ground	

##### Is the measurement value normal?

- YES >> Replace BCM.  
 NO >> GO TO 2.

#### 2. CHECK HAZARD SWITCH SIGNAL OPEN CIRCUIT

1. Turn the ignition switch OFF.
2. Disconnect the multifunction switch connector and BCM connector.
3. Check continuity between the multifunction switch harness connector and the BCM harness connector.

# HAZARD SWITCH

< DTC/CIRCUIT DIAGNOSIS >

[XENON TYPE]

Multifunction switch		BCM		Continuity
Connector	Terminal	Connector	Terminal	
M72	16	M122	110	Existed

Does continuity exist?

YES >> GO TO 3.

NO >> Repair the harnesses or connectors.

### 3.CHECK HAZARD SWITCH SIGNAL SHORT CIRCUIT

Check continuity between the multifunction switch harness connector and the ground.

Multifunction switch		Ground	Continuity
Connector	Terminal		
M72	16		Not existed

Does continuity exist?

YES >> Repair the harnesses or connectors.

NO >> GO TO 4.

### 4.CHECK HAZARD SWITCH GROUND OPEN CIRCUIT

Check continuity between the multifunction switch harness connector and the ground.

Multifunction switch		Ground	Continuity
Connector	Terminal		
M72	9		Existed

Does continuity exist?

YES >> Replace the hazard switch (multifunction switch).

NO >> Repair the harnesses or connectors.

# TAIL LAMP CIRCUIT

< DTC/CIRCUIT DIAGNOSIS >

[XENON TYPE]

## TAIL LAMP CIRCUIT

### Component Function Check

INFOID:000000004875634

#### 1. CHECK TAIL LAMP OPERATION

##### IPDM E/R AUTO ACTIVE TEST

1. Activate IPDM E/R auto active test. Refer to [PCS-9, "Diagnosis Description"](#).
2. Check that the tail lamp is turned ON.

##### CONSULT-III ACTIVE TEST

1. Select "EXTERNAL LAMPS" of IPDM E/R active test item.
2. With operating the test items, check that the tail lamp is turned ON.

**TAIL** : Tail lamp ON  
**Off** : Tail lamp OFF

#### Is the tail lamp turned ON?

- YES >> Tail lamp circuit is normal.  
 NO >> Refer to [EXL-85, "Diagnosis Procedure"](#).

### Diagnosis Procedure

INFOID:000000004875635

#### 1. CHECK TAIL LAMP FUSE

1. Turn the ignition switch OFF.
2. Check that the following fuses are not fusing.

Unit	Location	Fuse No.	Capacity
<ul style="list-style-type: none"> <li>• Tail lamp</li> <li>• Rear side marker lamp</li> <li>• License plate lamp</li> </ul>	IPDM E/R	#53	10 A

#### Is the fuse fusing?

- YES >> Repair the malfunctioning part before replacing the fuse.  
 NO >> GO TO 2.

#### 2. CHECK TAIL LAMP OUTPUT VOLTAGE

##### CONSULT-III ACTIVE TEST

1. Disconnect the rear combination lamp connector.
2. Turn the ignition switch ON.
3. Select "EXTERNAL LAMPS" of IPDM E/R active test item.
4. With operating the test items, check the voltage between the IPDM E/R harness connector and the ground.

Terminals		Test item	Voltage (Approx.)
(+)	(-)		
IPDM E/R		EXTERNAL LAMPS	Battery voltage
Connector	Terminal		
E5	7	TAIL	0 V
		Off	

#### Is the measurement value normal?

- YES >> GO TO 3.  
 NO >> Replace IPDM E/R.

#### 3. CHECK TAIL LAMP OPEN CIRCUIT

1. Turn the ignition switch OFF.
2. Disconnect IPDM E/R connector.

# TAIL LAMP CIRCUIT

**[XENON TYPE]**

**< DTC/CIRCUIT DIAGNOSIS >**

3. Check continuity between the IPDM E/R harness connector and the rear combination lamp harness connector.

IPDM E/R		Rear combination lamp		Continuity	
Connector	Terminal	Connector	Terminal		
RH	E5	7	B67	2	Existed
LH			B60		

Does continuity exist?

YES >> GO TO 4.

NO >> Repair the harnesses or connectors.

**4. CHECK TAIL LAMP GROUND OPEN CIRCUIT**

Check continuity between the rear combination lamp harness connector and the ground.

Rear combination lamp			Ground	Continuity
Connector	Terminal			
RH	B67	3		Existed
LH	B60	3		

Does continuity exist?

YES >> Replace the rear combination lamp.

NO >> Repair the harnesses or connectors.

# LICENSE PLATE LAMP CIRCUIT

< DTC/CIRCUIT DIAGNOSIS >

[XENON TYPE]

## LICENSE PLATE LAMP CIRCUIT

### Component Function Check

INFOID:000000004875636

#### NOTE:

Check the tail lamp circuit if the tail lamp and the license plate lamp are not turned ON.

### 1. CHECK LICENSE PLATE LAMP OPERATION

#### ⊗ IPDM E/R AUTO ACTIVE TEST

1. Activate IPDM E/R auto active test. Refer to [PCS-9, "Diagnosis Description"](#).
2. Check that the license plate lamp is turned ON.

#### Ⓜ CONSULT-III ACTIVE TEST

1. Select "EXTERNAL LAMPS" of IPDM E/R active test item.
2. With operating the lighting switch, check that the license plate lamp is turned ON.

**TAIL : License plate lamp ON**

**Off : License plate lamp OFF**

Is the license plate lamp turned ON?

YES >> License plate lamp circuit is normal.

NO >> Refer to [EXL-87, "Diagnosis Procedure"](#).

### Diagnosis Procedure

INFOID:000000004875637

### 1. CHECK LICENSE PLATE LAMP BULB

Check the applicable lamp bulb.

Is the bulb normal?

YES >> GO TO 2.

NO >> Replace the bulb.

### 2. CHECK LICENSE PLATE LAMP OPEN CIRCUIT

1. Turn the ignition switch OFF.
2. Disconnect IPDM E/R connector and the license plate lamp connector.
3. Check continuity between the IPDM E/R harness connector and the license plate lamp harness connector.

IPDM E/R		License plate lamp		Continuity
Connector	Terminal	Connector	Terminal	
RH	E5	B93	1	Existed
LH		B92	1	

Does continuity exist?

YES >> GO TO 3.

NO >> Repair the harnesses or connectors.

### 3. CHECK LICENSE PLATE LAMP GROUND OPEN CIRCUIT

Check continuity between the license plate lamp harness connector and the ground.

License plate lamp			Ground	Continuity
Connector	Terminal			
RH	B93	2	Existed	
LH	B92	2		

Does continuity exist?

YES >> Replace the license plate lamp.

NO >> Repair the harnesses or connectors.

# HEADLAMP SYSTEM

< DTC/CIRCUIT DIAGNOSIS >

[XENON TYPE]

## HEADLAMP SYSTEM

### Wiring Diagram - HEADLAMP -

INFOID:000000004875638

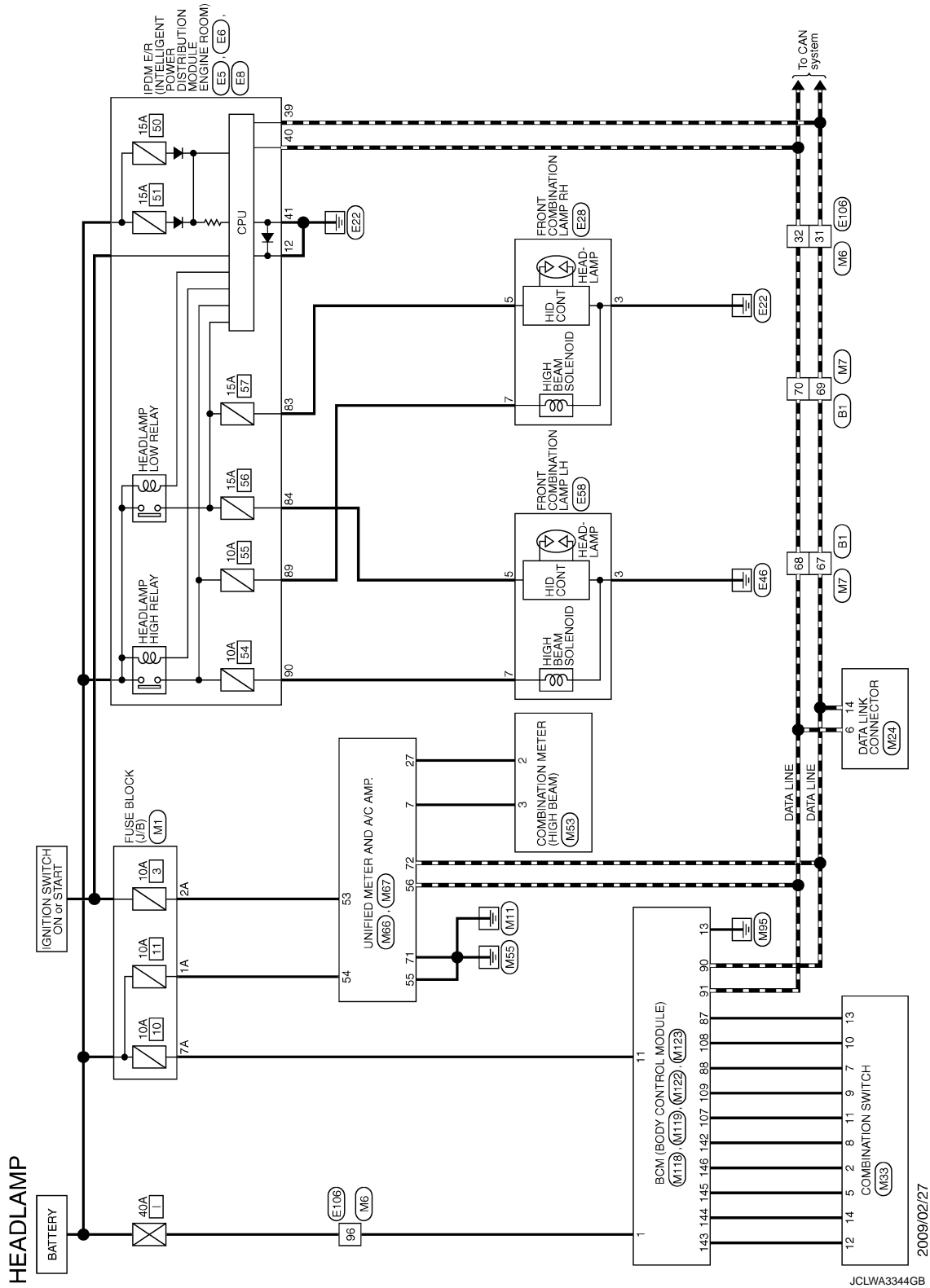



# HEADLAMP SYSTEM

< DTC/CIRCUIT DIAGNOSIS >

[XENON TYPE]

## HEADLAMP

Connector No.	B1
Connector Name	WIRE TO WIRE
Connector Type	TH80FW-CS16-TM4

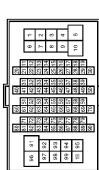

Terminal No.	Color of Wire	Signal Name [Specification]
67	P	-
68	L	-
69	P	-
70	L	-

Connector No.	E5
Connector Name	SOLENOID INTELLIGENT POWER DISTRIBUTION MODULE (ENGINE ROOM)
Connector Type	TH20FW-CS12-M4-TV

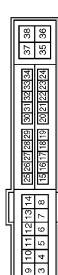

Terminal No.	Color of Wire	Signal Name [Specification]
12	B/W	-

Connector No.	E6
Connector Name	SOLENOID INTELLIGENT POWER DISTRIBUTION MODULE (ENGINE ROOM)
Connector Type	TH80FW-NH



Terminal No.	Color of Wire	Signal Name [Specification]
39	P	-
40	L	-
41	B/W	-

Connector No.	E8
Connector Name	SOLENOID INTELLIGENT POWER DISTRIBUTION MODULE (ENGINE ROOM)
Connector Type	NS08FW-CS

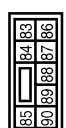

Terminal No.	Color of Wire	Signal Name [Specification]
83	R	-
84	P	-
89	BR	-
90	LG	-

Connector No.	E28
Connector Name	FRONT COMBINATION LAMP RH
Connector Type	RS08FB-PR



Terminal No.	Color of Wire	Signal Name [Specification]
3	B	-
5	R	-
7	BR	-

Connector No.	E5B
Connector Name	FRONT COMBINATION LAMP LH
Connector Type	RS08FB-PR



Terminal No.	Color of Wire	Signal Name [Specification]
3	B	-
5	P	-
7	LG	-

Connector No.	E106
Connector Name	WIRE TO WIRE
Connector Type	TH80FW-CS16-TM4



Terminal No.	Color of Wire	Signal Name [Specification]
31	P	-
32	L	-
96	W	-

Connector No.	M1
Connector Name	FUSE BLOCK (J/B)
Connector Type	NS08FW-M2



Terminal No.	Color of Wire	Signal Name [Specification]
1A	V	-
2A	G	-
7A	R	-

A  
B  
C  
D  
E  
F  
G  
H  
I  
J  
K  
EXL  
M  
N  
O  
P

JCLWA3345GB

# HEADLAMP SYSTEM

< DTC/CIRCUIT DIAGNOSIS >

[XENON TYPE]

## HEADLAMP

Connector No.	M6
Connector Name	WIRE TO WIRE
Connector Type	TH8DW-CS16-TM4

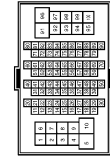

Terminal No.	Color of Wire	Signal Name [Specification]
31	P	-
32	L	-
96	W	-

Connector No.	M7
Connector Name	WIRE TO WIRE
Connector Type	TH8DW-CS16-TM4

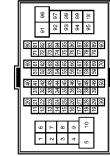

Terminal No.	Color of Wire	Signal Name [Specification]
67	P	-
68	L	-
69	P	-
70	L	-

Connector No.	M24
Connector Name	DATA LINK CONNECTOR
Connector Type	BD16FW

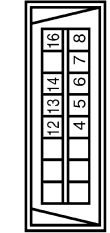

Terminal No.	Color of Wire	Signal Name [Specification]
6	L	-
14	P	-

Connector No.	M33
Connector Name	COMBINATION SWITCH
Connector Type	TH16FW-NH

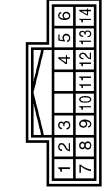

Terminal No.	Color of Wire	Signal Name [Specification]
2	SB	OUTPUT 4
5	L	OUTPUT 3
7	O	INPUT 3
8	BR	OUTPUT 5
9	W	INPUT 2
10	R	INPUT 4
11	LG	INPUT 1
12	P	OUTPUT 1
13	Y	INPUT 5
14	O	OUTPUT 2

Connector No.	M53
Connector Name	COMBINATION METER
Connector Type	SAB4PW

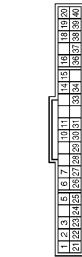

Terminal No.	Color of Wire	Signal Name [Specification]
2	LG	COMMUNICATION SIGNAL (METER->AMP.)
3	GR	COMMUNICATION SIGNAL (AMP->METER)

Connector No.	M66
Connector Name	UNIFIED METER AND A/C AMP.
Connector Type	TH40PW-NH

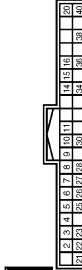

Terminal No.	Color of Wire	Signal Name [Specification]
7	GR	COMMUNICATION SIGNAL (METER->METER)
27	LG	COMMUNICATION SIGNAL (METER->AMP.)

Connector No.	M67
Connector Name	UNIFIED METER AND A/C AMP.
Connector Type	TH42PW-NH



Terminal No.	Color of Wire	Signal Name [Specification]
53	W	IGNITION POWER SUPPLY
54	Y	BATTERY POWER SUPPLY
55	B	GROUND
56	L	CAN-H
71	GR	GROUND
72	P	CAN-L

Connector No.	M118
Connector Name	BCM (BODY CONTROL MODULE)
Connector Type	M03FB-LC



Terminal No.	Color of Wire	Signal Name [Specification]
1	W	BAT (F/L)

JCLWA3346GB

# HEADLAMP SYSTEM

< DTC/CIRCUIT DIAGNOSIS >

[XENON TYPE]

## HEADLAMP

Connector No.	M119
Connector Name	BCM (BODY CONTROL MODULE)
Connector Type	HS16FW-GS



Terminal No.	Color of Wire	Signal Name [Specification]
11	R	BAT (FUSE)
13	B	GND

Connector No.	M122
Connector Name	BCM (BODY CONTROL MODULE)
Connector Type	TH40FB-NH



Terminal No.	Color of Wire	Signal Name [Specification]
87	Y	COMBI SW INPUT 5
88	O	COMBI SW INPUT 3
90	P	CAN-L
91	L	CAN-H
107	LG	COMBI SW INPUT 1
108	R	COMBI SW INPUT 4
109	W	COMBI SW INPUT 2

Connector No.	M123
Connector Name	BCM (BODY CONTROL MODULE)
Connector Type	TH40FG-NH



Terminal No.	Color of Wire	Signal Name [Specification]
142	BR	COMBI SW OUTPUT 5
143	P	COMBI SW OUTPUT 1
144	O	COMBI SW OUTPUT 2
145	L	COMBI SW OUTPUT 3
146	SB	COMBI SW OUTPUT 4

A  
B  
C  
D  
E  
F  
G  
H  
I  
J  
K  
EXL  
M  
N  
O  
P

JCLWA3347GB

# AUTO LIGHT SYSTEM

[XENON TYPE]

< DTC/CIRCUIT DIAGNOSIS >

## AUTO LIGHT SYSTEM

### Wiring Diagram - AUTO LIGHT SYSTEM -

INFOID:000000004875639

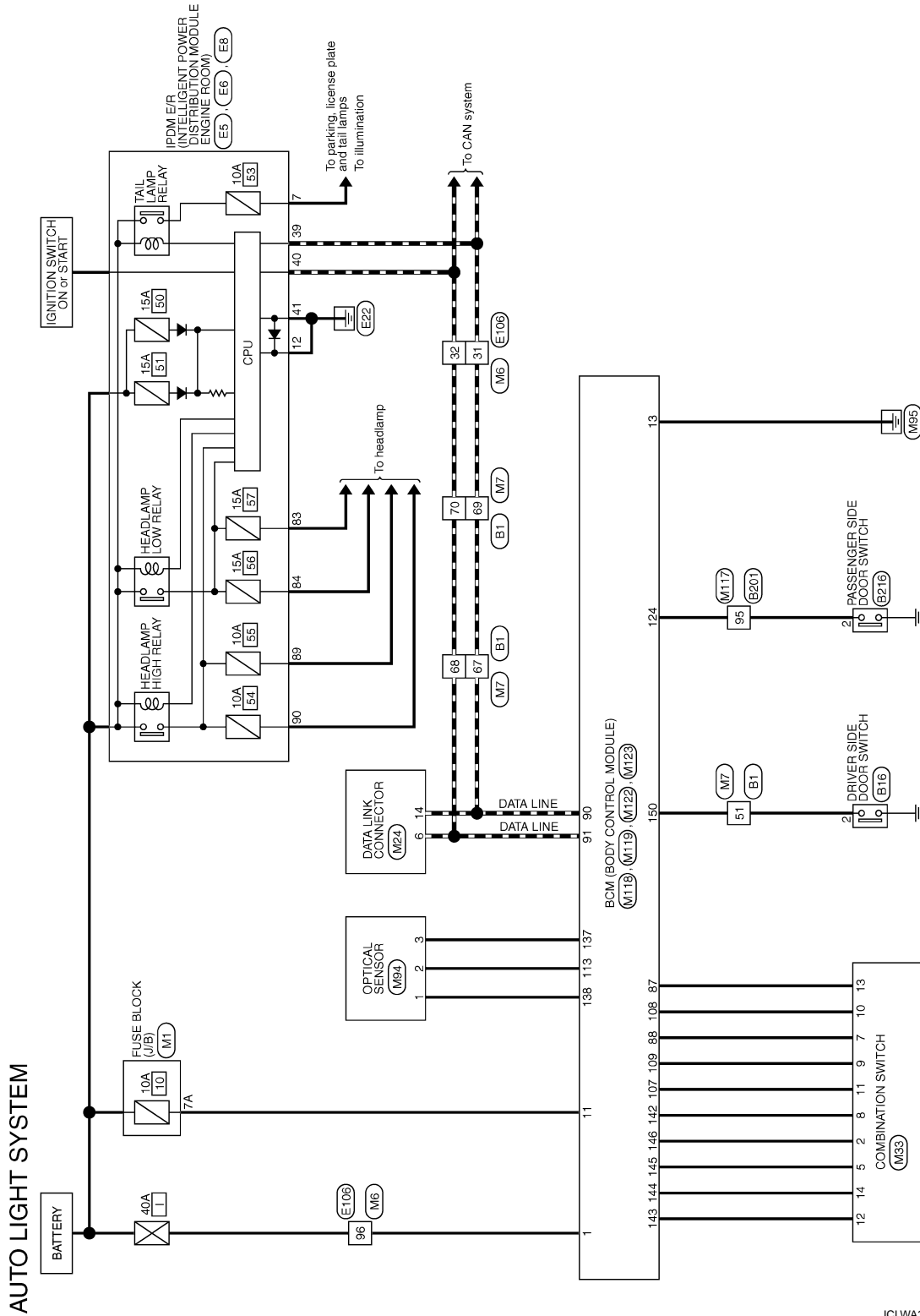









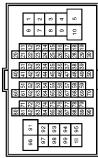

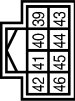

# AUTO LIGHT SYSTEM

< DTC/CIRCUIT DIAGNOSIS >

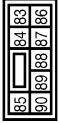
[XENON TYPE]

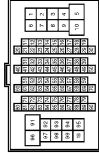
## AUTO LIGHT SYSTEM

<table border="1" style="width: 100%; border-collapse: collapse;"> <tr><td>Connector No.</td><td>B1</td></tr> <tr><td>Connector Name</td><td>WIRE TO WIRE</td></tr> <tr><td>Connector Type</td><td>TH80FW-CS16-TM4</td></tr> </table>  <div style="text-align: center;"></div>	Connector No.	B1	Connector Name	WIRE TO WIRE	Connector Type	TH80FW-CS16-TM4	<table border="1" style="width: 100%; border-collapse: collapse;"> <tr><td>Terminal No.</td><td>51</td></tr> <tr><td>Color of Wire</td><td>SB</td></tr> <tr><td>Terminal No.</td><td>67</td></tr> <tr><td>Color of Wire</td><td>P</td></tr> <tr><td>Terminal No.</td><td>68</td></tr> <tr><td>Color of Wire</td><td>L</td></tr> <tr><td>Terminal No.</td><td>69</td></tr> <tr><td>Color of Wire</td><td>P</td></tr> <tr><td>Terminal No.</td><td>70</td></tr> <tr><td>Color of Wire</td><td>L</td></tr> </table>	Terminal No.	51	Color of Wire	SB	Terminal No.	67	Color of Wire	P	Terminal No.	68	Color of Wire	L	Terminal No.	69	Color of Wire	P	Terminal No.	70	Color of Wire	L	<table border="1" style="width: 100%; border-collapse: collapse;"> <tr><td>Terminal No.</td><td>Signal Name [Specification]</td></tr> <tr><td>51</td><td>-</td></tr> <tr><td>67</td><td>-</td></tr> <tr><td>68</td><td>-</td></tr> <tr><td>69</td><td>-</td></tr> <tr><td>70</td><td>-</td></tr> </table>	Terminal No.	Signal Name [Specification]	51	-	67	-	68	-	69	-	70	-	<table border="1" style="width: 100%; border-collapse: collapse;"> <tr><td>Connector No.</td><td>B21B</td></tr> <tr><td>Connector Name</td><td>PASSENGER SIDE DOOR SWITCH</td></tr> <tr><td>Connector Type</td><td>A03FW</td></tr> </table>  <div style="text-align: center;"></div>	Connector No.	B21B	Connector Name	PASSENGER SIDE DOOR SWITCH	Connector Type	A03FW	<table border="1" style="width: 100%; border-collapse: collapse;"> <tr><td>Terminal No.</td><td>2</td></tr> <tr><td>Color of Wire</td><td>V</td></tr> </table>	Terminal No.	2	Color of Wire	V	<table border="1" style="width: 100%; border-collapse: collapse;"> <tr><td>Terminal No.</td><td>Signal Name [Specification]</td></tr> <tr><td>2</td><td>-</td></tr> </table>	Terminal No.	Signal Name [Specification]	2	-	<table border="1" style="width: 100%; border-collapse: collapse;"> <tr><td>Connector No.</td><td>E5</td></tr> <tr><td>Connector Name</td><td>INTELLIGENT POWER DISTRIBUTION MODULE BULB SOCKET</td></tr> <tr><td>Connector Type</td><td>TH80FW-CS12-M4-IV</td></tr> </table>  <div style="text-align: center;"></div>	Connector No.	E5	Connector Name	INTELLIGENT POWER DISTRIBUTION MODULE BULB SOCKET	Connector Type	TH80FW-CS12-M4-IV	<table border="1" style="width: 100%; border-collapse: collapse;"> <tr><td>Terminal No.</td><td>7</td></tr> <tr><td>Color of Wire</td><td>R</td></tr> <tr><td>Terminal No.</td><td>12</td></tr> <tr><td>Color of Wire</td><td>B/W</td></tr> </table>	Terminal No.	7	Color of Wire	R	Terminal No.	12	Color of Wire	B/W	<table border="1" style="width: 100%; border-collapse: collapse;"> <tr><td>Terminal No.</td><td>Signal Name [Specification]</td></tr> <tr><td>7</td><td>-</td></tr> <tr><td>12</td><td>-</td></tr> </table>	Terminal No.	Signal Name [Specification]	7	-	12	-	<table border="1" style="width: 100%; border-collapse: collapse;"> <tr><td>Connector No.</td><td>E6</td></tr> <tr><td>Connector Name</td><td>INTELLIGENT POWER DISTRIBUTION MODULE BULB SOCKET</td></tr> <tr><td>Connector Type</td><td>TH80FW-NH</td></tr> </table>  <div style="text-align: center;"></div>	Connector No.	E6	Connector Name	INTELLIGENT POWER DISTRIBUTION MODULE BULB SOCKET	Connector Type	TH80FW-NH	<table border="1" style="width: 100%; border-collapse: collapse;"> <tr><td>Terminal No.</td><td>39</td></tr> <tr><td>Color of Wire</td><td>P</td></tr> <tr><td>Terminal No.</td><td>40</td></tr> <tr><td>Color of Wire</td><td>L</td></tr> <tr><td>Terminal No.</td><td>41</td></tr> <tr><td>Color of Wire</td><td>B/W</td></tr> </table>	Terminal No.	39	Color of Wire	P	Terminal No.	40	Color of Wire	L	Terminal No.	41	Color of Wire	B/W	<table border="1" style="width: 100%; border-collapse: collapse;"> <tr><td>Terminal No.</td><td>Signal Name [Specification]</td></tr> <tr><td>39</td><td>-</td></tr> <tr><td>40</td><td>-</td></tr> <tr><td>41</td><td>-</td></tr> </table>	Terminal No.	Signal Name [Specification]	39	-	40	-	41	-	<table border="1" style="width: 100%; border-collapse: collapse;"> <tr><td>Connector No.</td><td>E8</td></tr> <tr><td>Connector Name</td><td>INTELLIGENT POWER DISTRIBUTION MODULE BULB SOCKET</td></tr> <tr><td>Connector Type</td><td>NS80FW-CS</td></tr> </table>  <div style="text-align: center;"></div>	Connector No.	E8	Connector Name	INTELLIGENT POWER DISTRIBUTION MODULE BULB SOCKET	Connector Type	NS80FW-CS	<table border="1" style="width: 100%; border-collapse: collapse;"> <tr><td>Terminal No.</td><td>83</td></tr> <tr><td>Color of Wire</td><td>R</td></tr> <tr><td>Terminal No.</td><td>84</td></tr> <tr><td>Color of Wire</td><td>P</td></tr> <tr><td>Terminal No.</td><td>89</td></tr> <tr><td>Color of Wire</td><td>BR</td></tr> <tr><td>Terminal No.</td><td>90</td></tr> <tr><td>Color of Wire</td><td>LG</td></tr> </table>	Terminal No.	83	Color of Wire	R	Terminal No.	84	Color of Wire	P	Terminal No.	89	Color of Wire	BR	Terminal No.	90	Color of Wire	LG	<table border="1" style="width: 100%; border-collapse: collapse;"> <tr><td>Terminal No.</td><td>Signal Name [Specification]</td></tr> <tr><td>83</td><td>-</td></tr> <tr><td>84</td><td>-</td></tr> <tr><td>89</td><td>-</td></tr> <tr><td>90</td><td>-</td></tr> </table>	Terminal No.	Signal Name [Specification]	83	-	84	-	89	-	90	-	<table border="1" style="width: 100%; border-collapse: collapse;"> <tr><td>Connector No.</td><td>E10B</td></tr> <tr><td>Connector Name</td><td>WIRE TO WIRE</td></tr> <tr><td>Connector Type</td><td>TH80FW-CS16-TM4</td></tr> </table>  <div style="text-align: center;"></div>	Connector No.	E10B	Connector Name	WIRE TO WIRE	Connector Type	TH80FW-CS16-TM4	<table border="1" style="width: 100%; border-collapse: collapse;"> <tr><td>Terminal No.</td><td>31</td></tr> <tr><td>Color of Wire</td><td>P</td></tr> <tr><td>Terminal No.</td><td>32</td></tr> <tr><td>Color of Wire</td><td>L</td></tr> <tr><td>Terminal No.</td><td>95</td></tr> <tr><td>Color of Wire</td><td>W</td></tr> </table>	Terminal No.	31	Color of Wire	P	Terminal No.	32	Color of Wire	L	Terminal No.	95	Color of Wire	W	<table border="1" style="width: 100%; border-collapse: collapse;"> <tr><td>Terminal No.</td><td>Signal Name [Specification]</td></tr> <tr><td>31</td><td>-</td></tr> <tr><td>32</td><td>-</td></tr> <tr><td>95</td><td>-</td></tr> </table>	Terminal No.	Signal Name [Specification]	31	-	32	-	95	-
Connector No.	B1																																																																																																																																																																												
Connector Name	WIRE TO WIRE																																																																																																																																																																												
Connector Type	TH80FW-CS16-TM4																																																																																																																																																																												
Terminal No.	51																																																																																																																																																																												
Color of Wire	SB																																																																																																																																																																												
Terminal No.	67																																																																																																																																																																												
Color of Wire	P																																																																																																																																																																												
Terminal No.	68																																																																																																																																																																												
Color of Wire	L																																																																																																																																																																												
Terminal No.	69																																																																																																																																																																												
Color of Wire	P																																																																																																																																																																												
Terminal No.	70																																																																																																																																																																												
Color of Wire	L																																																																																																																																																																												
Terminal No.	Signal Name [Specification]																																																																																																																																																																												
51	-																																																																																																																																																																												
67	-																																																																																																																																																																												
68	-																																																																																																																																																																												
69	-																																																																																																																																																																												
70	-																																																																																																																																																																												
Connector No.	B21B																																																																																																																																																																												
Connector Name	PASSENGER SIDE DOOR SWITCH																																																																																																																																																																												
Connector Type	A03FW																																																																																																																																																																												
Terminal No.	2																																																																																																																																																																												
Color of Wire	V																																																																																																																																																																												
Terminal No.	Signal Name [Specification]																																																																																																																																																																												
2	-																																																																																																																																																																												
Connector No.	E5																																																																																																																																																																												
Connector Name	INTELLIGENT POWER DISTRIBUTION MODULE BULB SOCKET																																																																																																																																																																												
Connector Type	TH80FW-CS12-M4-IV																																																																																																																																																																												
Terminal No.	7																																																																																																																																																																												
Color of Wire	R																																																																																																																																																																												
Terminal No.	12																																																																																																																																																																												
Color of Wire	B/W																																																																																																																																																																												
Terminal No.	Signal Name [Specification]																																																																																																																																																																												
7	-																																																																																																																																																																												
12	-																																																																																																																																																																												
Connector No.	E6																																																																																																																																																																												
Connector Name	INTELLIGENT POWER DISTRIBUTION MODULE BULB SOCKET																																																																																																																																																																												
Connector Type	TH80FW-NH																																																																																																																																																																												
Terminal No.	39																																																																																																																																																																												
Color of Wire	P																																																																																																																																																																												
Terminal No.	40																																																																																																																																																																												
Color of Wire	L																																																																																																																																																																												
Terminal No.	41																																																																																																																																																																												
Color of Wire	B/W																																																																																																																																																																												
Terminal No.	Signal Name [Specification]																																																																																																																																																																												
39	-																																																																																																																																																																												
40	-																																																																																																																																																																												
41	-																																																																																																																																																																												
Connector No.	E8																																																																																																																																																																												
Connector Name	INTELLIGENT POWER DISTRIBUTION MODULE BULB SOCKET																																																																																																																																																																												
Connector Type	NS80FW-CS																																																																																																																																																																												
Terminal No.	83																																																																																																																																																																												
Color of Wire	R																																																																																																																																																																												
Terminal No.	84																																																																																																																																																																												
Color of Wire	P																																																																																																																																																																												
Terminal No.	89																																																																																																																																																																												
Color of Wire	BR																																																																																																																																																																												
Terminal No.	90																																																																																																																																																																												
Color of Wire	LG																																																																																																																																																																												
Terminal No.	Signal Name [Specification]																																																																																																																																																																												
83	-																																																																																																																																																																												
84	-																																																																																																																																																																												
89	-																																																																																																																																																																												
90	-																																																																																																																																																																												
Connector No.	E10B																																																																																																																																																																												
Connector Name	WIRE TO WIRE																																																																																																																																																																												
Connector Type	TH80FW-CS16-TM4																																																																																																																																																																												
Terminal No.	31																																																																																																																																																																												
Color of Wire	P																																																																																																																																																																												
Terminal No.	32																																																																																																																																																																												
Color of Wire	L																																																																																																																																																																												
Terminal No.	95																																																																																																																																																																												
Color of Wire	W																																																																																																																																																																												
Terminal No.	Signal Name [Specification]																																																																																																																																																																												
31	-																																																																																																																																																																												
32	-																																																																																																																																																																												
95	-																																																																																																																																																																												

A  
B  
C  
D  
E  
F  
G  
H  
I  
J  
K  
EXL  
M  
N  
O  
P

# AUTO LIGHT SYSTEM

< DTC/CIRCUIT DIAGNOSIS >

[XENON TYPE]

## AUTO LIGHT SYSTEM

Connector No.	M1
Connector Name	FUSE BLOCK (J/B)
Connector Type	NSDBFW-M2

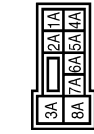

Terminal No.	Color of Wire	Signal Name [Specification]
7A	R	—

Connector No.	M6
Connector Name	WIRE TO WIRE
Connector Type	TH80MW-CS16-TM4

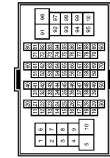

Terminal No.	Color of Wire	Signal Name [Specification]
31	P	—
32	L	—
96	W	—

Connector No.	M7
Connector Name	WIRE TO WIRE
Connector Type	TH80MW-CS16-TM4

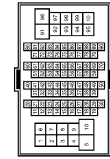

Terminal No.	Color of Wire	Signal Name [Specification]
51	GR	—
67	P	—
68	L	—
69	P	—
70	L	—

Connector No.	M24
Connector Name	DATA LINK CONNECTOR
Connector Type	BD16FW

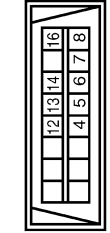

Terminal No.	Color of Wire	Signal Name [Specification]
6	L	—
14	P	—

Connector No.	M33
Connector Name	COMBINATION SWITCH
Connector Type	TH16FW-NH1

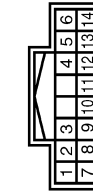

Terminal No.	Color of Wire	Signal Name [Specification]
2	SB	OUTPUT 4
5	L	OUTPUT 3
7	O	INPUT 3
8	BR	OUTPUT 5
9	W	INPUT 2
10	R	INPUT 4
11	LG	INPUT 1
12	P	OUTPUT 1
13	Y	INPUT 5
14	O	OUTPUT 2

Connector No.	M4
Connector Name	OPTICAL SENSOR
Connector Type	TK33FW



Terminal No.	Color of Wire	Signal Name [Specification]
1	Y	POWER
2	O	OUTPUT
3	B	GND

Connector No.	M17
Connector Name	WIRE TO WIRE
Connector Type	TH80MW-CS16-TM4

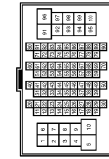

Terminal No.	Color of Wire	Signal Name [Specification]
95	LG	—

Connector No.	M18
Connector Name	BCM (BODY CONTROL MODULE)
Connector Type	M33FB-LC



Terminal No.	Color of Wire	Signal Name [Specification]
1	W	BAT (F/L)

# AUTO LIGHT SYSTEM

< DTC/CIRCUIT DIAGNOSIS >

[XENON TYPE]

A  
B  
C  
D  
E  
F  
G  
H  
I  
J  
K  
EXL  
M  
N  
O  
P

## AUTO LIGHT SYSTEM

Connector No.	M119
Connector Name	BCM (BODY CONTROL MODULE)
Connector Type	HS16FW-GS

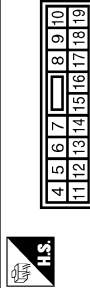

Terminal No.	Color of Wire	Signal Name [Specification]
11	R	BAT (FUSE)
13	B	GND

Connector No.	M122
Connector Name	BCM (BODY CONTROL MODULE)
Connector Type	TH40FB-NH

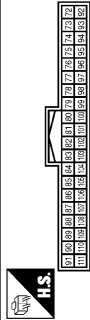

Terminal No.	Color of Wire	Signal Name [Specification]
87	Y	COMBI SW INPUT 5
88	O	COMBI SW INPUT 3
90	P	CAN-L
91	L	CAN-H
107	LG	COMBI SW INPUT 1
108	R	COMBI SW INPUT 4
109	W	COMBI SW INPUT 2

Connector No.	M123
Connector Name	BCM (BODY CONTROL MODULE)
Connector Type	TH40FG-NH

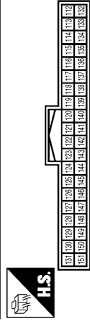

Terminal No.	Color of Wire	Signal Name [Specification]
113	O	OPTICAL SENSOR
124	LG	PASSENGER DOOR SW
137	O	RECEIVER/SENSOR GND
138	Y	RECEIVER/SENSOR POWER SUPPLY
142	BR	COMBI SW OUTPUT 5
143	P	COMBI SW OUTPUT 1
144	O	COMBI SW OUTPUT 2
145	L	COMBI SW OUTPUT 3
146	SB	COMBI SW OUTPUT 4
150	GR	DRIVER DOOR SW

JCLWA3355GB





# DAYTIME RUNNING LIGHT SYSTEM

< DTC/CIRCUIT DIAGNOSIS >

[XENON TYPE]

## DAYTIME LIGHT SYSTEM

Connector No.	B1
Connector Name	WIRE TO WIRE
Connector Type	TH80FW-CS16-TM4

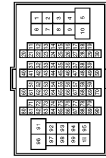

Terminal No.	Color of Wire	Signal Name [Specification]
57	V	-
67	P	-
68	L	-
69	P	-
70	L	-

Connector No.	B14
Connector Name	PARKING BRAKE SWITCH (WITH M/T)
Connector Type	PO1FB-A



Terminal No.	Color of Wire	Signal Name [Specification]
1	V	-

Connector No.	E5
Connector Name	WIRE IN INTELLIGENT POWER DISTRIBUTION MODULE (ENGINE ROOM)
Connector Type	TH20FW-CS1Z-M4-1V

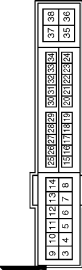

Terminal No.	Color of Wire	Signal Name [Specification]
12	B/W	-

Connector No.	E6
Connector Name	WIRE IN INTELLIGENT POWER DISTRIBUTION MODULE (ENGINE ROOM)
Connector Type	TH80FW-NH

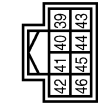

Terminal No.	Color of Wire	Signal Name [Specification]
39	P	-
40	L	-
41	B/W	-

Connector No.	E8
Connector Name	WIRE IN INTELLIGENT POWER DISTRIBUTION MODULE (ENGINE ROOM)
Connector Type	MS08FW-CS

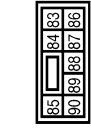

Terminal No.	Color of Wire	Signal Name [Specification]
87	L	-
86	W	-

Connector No.	E2B
Connector Name	FRONT COMBINATION LAMP RH
Connector Type	RS08FB-PR



Terminal No.	Color of Wire	Signal Name [Specification]
1	W	-
4	B/W	-

Connector No.	E5B
Connector Name	FRONT COMBINATION LAMP LH
Connector Type	RS08FB-PR



Terminal No.	Color of Wire	Signal Name [Specification]
1	L	-
4	B/W	-

Connector No.	E10B
Connector Name	WIRE TO WIRE
Connector Type	TH80FW-CS16-TM4

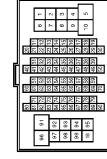

Terminal No.	Color of Wire	Signal Name [Specification]
31	P	-
32	L	-
89	O	-
96	W	-

A  
B  
C  
D  
E  
F  
G  
H  
I  
J  
K  
EXL  
M  
N  
O  
P

# DAYTIME RUNNING LIGHT SYSTEM

< DTC/CIRCUIT DIAGNOSIS >

[XENON TYPE]

## DAYTIME LIGHT SYSTEM

Connector No.	E107
Connector Name	PARKING BRAKE SWITCH (WITH A/T)
Connector Type	TE01FW



Terminal No.	Color of Wire	Signal Name [Specification]
1	O	-

Connector No.	M1
Connector Name	FUSE BLOCK (J/B)
Connector Type	NS08FW-M2



Terminal No.	Color of Wire	Signal Name [Specification]
1A	V	-
2A	G	-
7A	R	-

Connector No.	M6
Connector Name	WIRE TO WIRE
Connector Type	TH80MM-CS16-TM4



Terminal No.	Color of Wire	Signal Name [Specification]
31	P	-
32	L	-
89	O	-
96	W	-

Connector No.	M7
Connector Name	WIRE TO WIRE
Connector Type	TH80MM-CS16-TM4



Terminal No.	Color of Wire	Signal Name [Specification]
57	O	-
67	P	-
68	L	-
69	P	-
70	L	-

Connector No.	M17
Connector Name	WIRE TO WIRE
Connector Type	TK02FW



Terminal No.	Color of Wire	Signal Name [Specification]
1	L	-
2	P	-

Connector No.	M18
Connector Name	WIRE TO WIRE
Connector Type	TK02MW



Terminal No.	Color of Wire	Signal Name [Specification]
1	L	-
2	P	-

Connector No.	M24
Connector Name	DATA LINK CONNECTOR
Connector Type	BD16FW

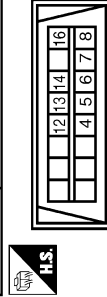

Terminal No.	Color of Wire	Signal Name [Specification]
6	L	-
14	P	-

Connector No.	M33
Connector Name	COMBINATION SWITCH
Connector Type	TH16FW-MH

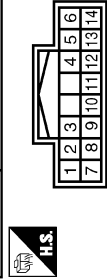

Terminal No.	Color of Wire	Signal Name [Specification]
2	SB	OUTPUT 4
5	L	OUTPUT 3
7	O	INPUT 3
8	BR	OUTPUT 5
9	W	INPUT 2
10	R	INPUT 4
11	LG	INPUT 1
12	P	OUTPUT 1
13	Y	INPUT 5
14	O	OUTPUT 2

JCLWA3350GB

# DAYTIME RUNNING LIGHT SYSTEM

< DTC/CIRCUIT DIAGNOSIS >

[XENON TYPE]

## DAYTIME LIGHT SYSTEM

Connector No.	M53
Connector Name	COMBINATION METER
Connector Type	SAB30FW

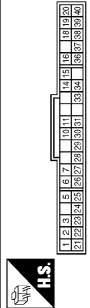

Terminal No.	Color of Wire	Signal Name [Specification]
2	LG	COMMUNICATION SIGNAL (METER->AMP.)
3	GR	COMMUNICATION SIGNAL (AMP->METER)
27	O	PARKING BRAKE SWITCH SIGNAL

Connector No.	M66
Connector Name	UNIFIED METER AND A/C AMP.
Connector Type	TH40FW-NH

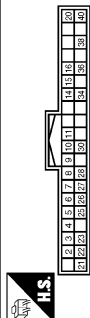

Terminal No.	Color of Wire	Signal Name [Specification]
7	GR	COMMUNICATION SIGNAL (AMP->METER)
27	LG	COMMUNICATION SIGNAL (METER->AMP.)

Connector No.	M67
Connector Name	UNIFIED METER AND A/C AMP.
Connector Type	TH32FW-NH

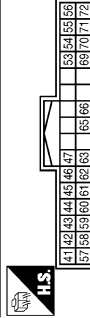

Terminal No.	Color of Wire	Signal Name [Specification]
53	W	IGNITION POWER SUPPLY
54	Y	BATTERY POWER SUPPLY
55	B	GROUND
56	L	CAN-H
71	GR	GROUND
72	P	CAN-L

Connector No.	M107
Connector Name	ECM
Connector Type	RH24FGY-R28-R-LH-Z

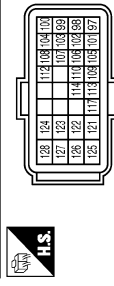

Terminal No.	Color of Wire	Signal Name [Specification]
113	P	VEHCAN-LI
114	L	VEHCAN-HI

Connector No.	M18
Connector Name	BCM (BODY CONTROL MODULE)
Connector Type	M03FE-LC

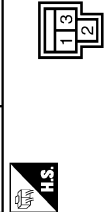

Terminal No.	Color of Wire	Signal Name [Specification]
1	W	BAT (F/L)

Connector No.	M19
Connector Name	BCM (BODY CONTROL MODULE)
Connector Type	NS16FW-CS

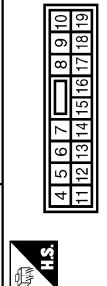

Terminal No.	Color of Wire	Signal Name [Specification]
11	R	BAT (FUSE)
13	B	GND

Connector No.	M22
Connector Name	BCM (BODY CONTROL MODULE)
Connector Type	TH40FB-NH

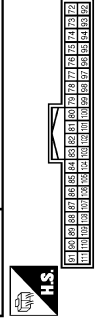

Terminal No.	Color of Wire	Signal Name [Specification]
87	Y	COMBI SW INPUT 5
88	O	COMBI SW INPUT 3
90	P	CAN-L
91	L	CAN-H
107	LG	COMBI SW INPUT 1
108	R	COMBI SW INPUT 4
109	W	COMBI SW INPUT 2

Connector No.	M23
Connector Name	BCM (BODY CONTROL MODULE)
Connector Type	TH40FG-NH

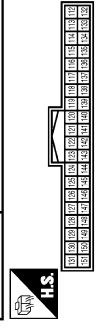

Terminal No.	Color of Wire	Signal Name [Specification]
142	BR	COMBI SW OUTPUT 5
143	P	COMBI SW OUTPUT 1
144	O	COMBI SW OUTPUT 2
145	L	COMBI SW OUTPUT 3
146	SB	COMBI SW OUTPUT 4

A  
B  
C  
D  
E  
F  
G  
H  
I  
J  
K  
EXL  
M  
N  
O  
P

# FRONT FOG LAMP SYSTEM

< DTC/CIRCUIT DIAGNOSIS >

[XENON TYPE]

## FRONT FOG LAMP SYSTEM

Wiring Diagram - FRONT FOG LAMP -

INFOID:000000004875641

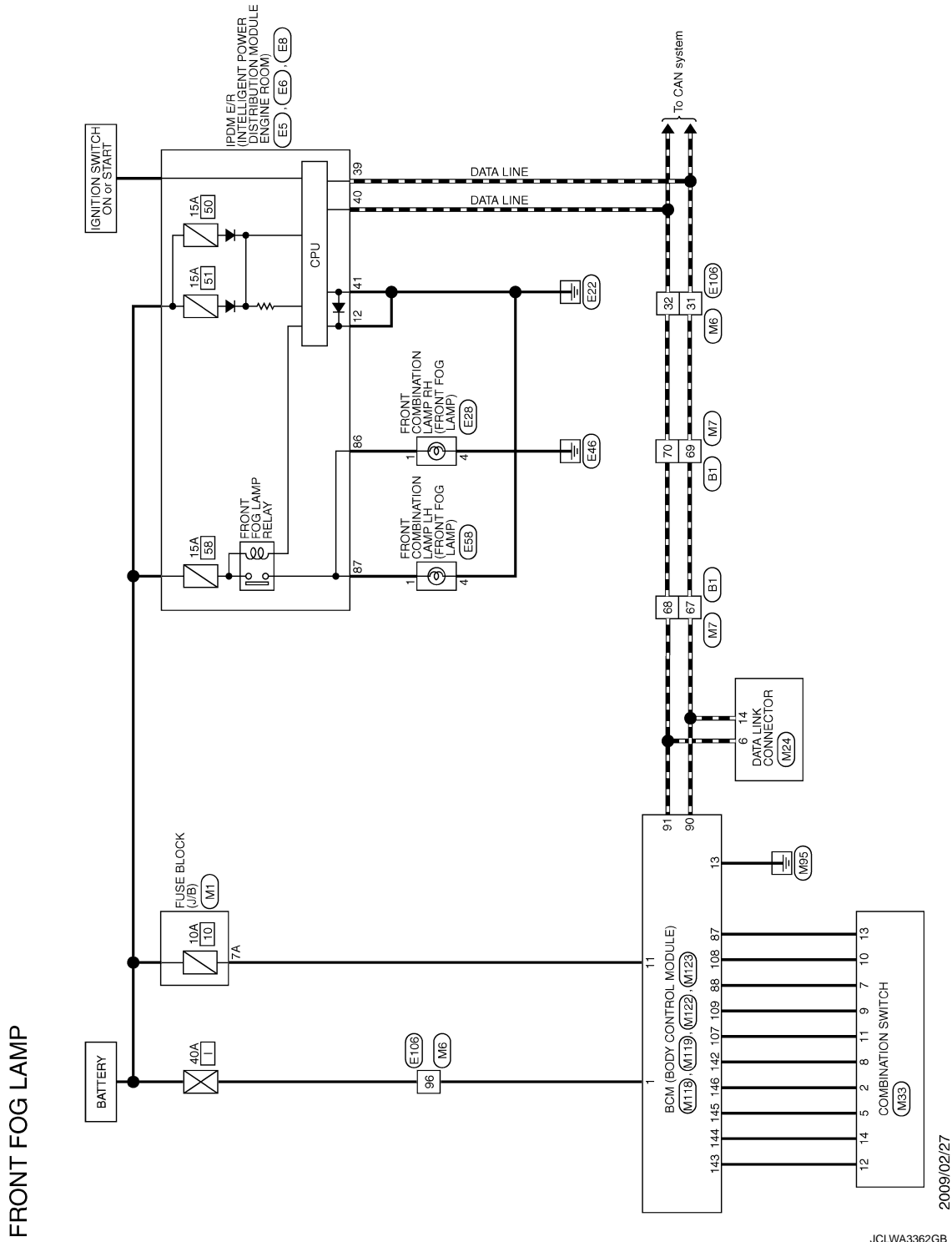

# FRONT FOG LAMP SYSTEM

< DTC/CIRCUIT DIAGNOSIS >

[XENON TYPE]

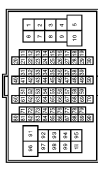

## FRONT FOG LAMP

Connector No.	B1
Connector Name	WIRE TO WIRE
Connector Type	TH80FW-CS16-TM4

Terminal No.	Color of Wire	Signal Name [Specification]
67	P	-
68	L	-
69	P	-
70	L	-

Connector No.	E5
Connector Name	SOLENOID INTELLIGENT POWER DISTRIBUTION MODULE (ENGINE ROOM)
Connector Type	TH20FW-CS12-M4-TV

Terminal No.	Color of Wire	Signal Name [Specification]
12	B/W	-

Connector No.	E6
Connector Name	SOLENOID INTELLIGENT POWER DISTRIBUTION MODULE (ENGINE ROOM)
Connector Type	TH80FW-NH

Terminal No.	Color of Wire	Signal Name [Specification]
39	P	-
40	L	-
41	B/W	-

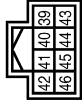
Connector No.	E8
Connector Name	SOLENOID INTELLIGENT POWER DISTRIBUTION MODULE (ENGINE ROOM)
Connector Type	NS08FW-CS

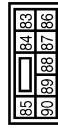

Terminal No.	Color of Wire	Signal Name [Specification]
86	W	-
87	L	-

Connector No.	E28
Connector Name	FRONT COMBINATION LAMP RH
Connector Type	RS08FB-PR

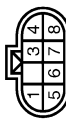
Terminal No.	Color of Wire	Signal Name [Specification]
1	W	-
4	B/W	-

Connector No.	E5B
Connector Name	FRONT COMBINATION LAMP LH
Connector Type	RS08FB-PR



Terminal No.	Color of Wire	Signal Name [Specification]
1	L	-
4	B/W	-

Connector No.	E106
Connector Name	WIRE TO WIRE
Connector Type	TH80FW-CS16-TM4

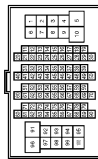
Terminal No.	Color of Wire	Signal Name [Specification]
31	P	-
32	L	-
96	W	-

Connector No.	M1
Connector Name	FUSE BLOCK (J/B)
Connector Type	NS08FW-M2

Terminal No.	Color of Wire	Signal Name [Specification]
7A	R	-

A  
B  
C  
D  
E  
F  
G  
H  
I  
J  
K  
EXL  
M  
N  
O  
P

# FRONT FOG LAMP SYSTEM

< DTC/CIRCUIT DIAGNOSIS >

[XENON TYPE]

## FRONT FOG LAMP

Connector No.	M18
Connector Name	WIRE TO WIRE
Connector Type	TH8DW-CS16-TM4

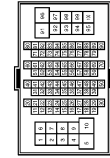

Terminal No.	Color of Wire	Signal Name [Specification]
31	P	-
32	L	-
96	W	-

Connector No.	M7
Connector Name	WIRE TO WIRE
Connector Type	TH8DW-CS16-TM4

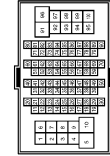

Terminal No.	Color of Wire	Signal Name [Specification]
67	P	-
68	L	-
69	P	-
70	L	-

Connector No.	M24
Connector Name	DATA LINK CONNECTOR
Connector Type	BD16FW

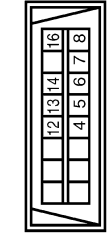

Terminal No.	Color of Wire	Signal Name [Specification]
6	L	-
14	P	-

Connector No.	M33
Connector Name	COMBINATION SWITCH
Connector Type	TH16FW-NH

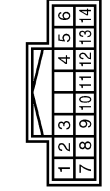

Terminal No.	Color of Wire	Signal Name [Specification]
2	SB	OUTPUT 4
5	L	OUTPUT 3
7	O	INPUT 3
8	BR	OUTPUT 5
9	W	INPUT 2
10	R	INPUT 4
11	LG	INPUT 1
12	P	OUTPUT 1
13	Y	INPUT 5
14	O	OUTPUT 2

Connector No.	M18
Connector Name	BCM (BODY CONTROL MODULE)
Connector Type	M03PE-LC



Terminal No.	Color of Wire	Signal Name [Specification]
1	W	BAT (F/L)

Connector No.	M19
Connector Name	BCM (BODY CONTROL MODULE)
Connector Type	NS16FW-CS



Terminal No.	Color of Wire	Signal Name [Specification]
11	R	BAT (FUSE)
13	B	GND

Connector No.	M22
Connector Name	BCM (BODY CONTROL MODULE)
Connector Type	TH40FB-NH

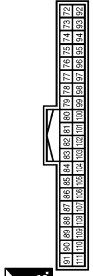

Terminal No.	Color of Wire	Signal Name [Specification]
87	Y	COMBI SW INPUT 5
88	O	COMBI SW INPUT 3
90	P	CAN-L
91	L	CAN-H
107	LG	COMBI SW INPUT 1
108	R	COMBI SW INPUT 4
109	W	COMBI SW INPUT 2

Connector No.	M23
Connector Name	BCM (BODY CONTROL MODULE)
Connector Type	TH40FG-NH

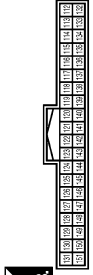

Terminal No.	Color of Wire	Signal Name [Specification]
142	BR	COMBI SW OUTPUT 5
143	P	COMBI SW OUTPUT 1
144	O	COMBI SW OUTPUT 2
145	L	COMBI SW OUTPUT 3
146	SB	COMBI SW OUTPUT 4

JCLWA3364GB

# TURN SIGNAL AND HAZARD WARNING LAMP SYSTEM

< DTC/CIRCUIT DIAGNOSIS >

[XENON TYPE]

## TURN SIGNAL AND HAZARD WARNING LAMP SYSTEM

Wiring Diagram - TURN AND HAZARD WARNING LAMPS -

INFOID:000000004875642

### TURN SIGNAL AND HAZARD WARNING LAMPS

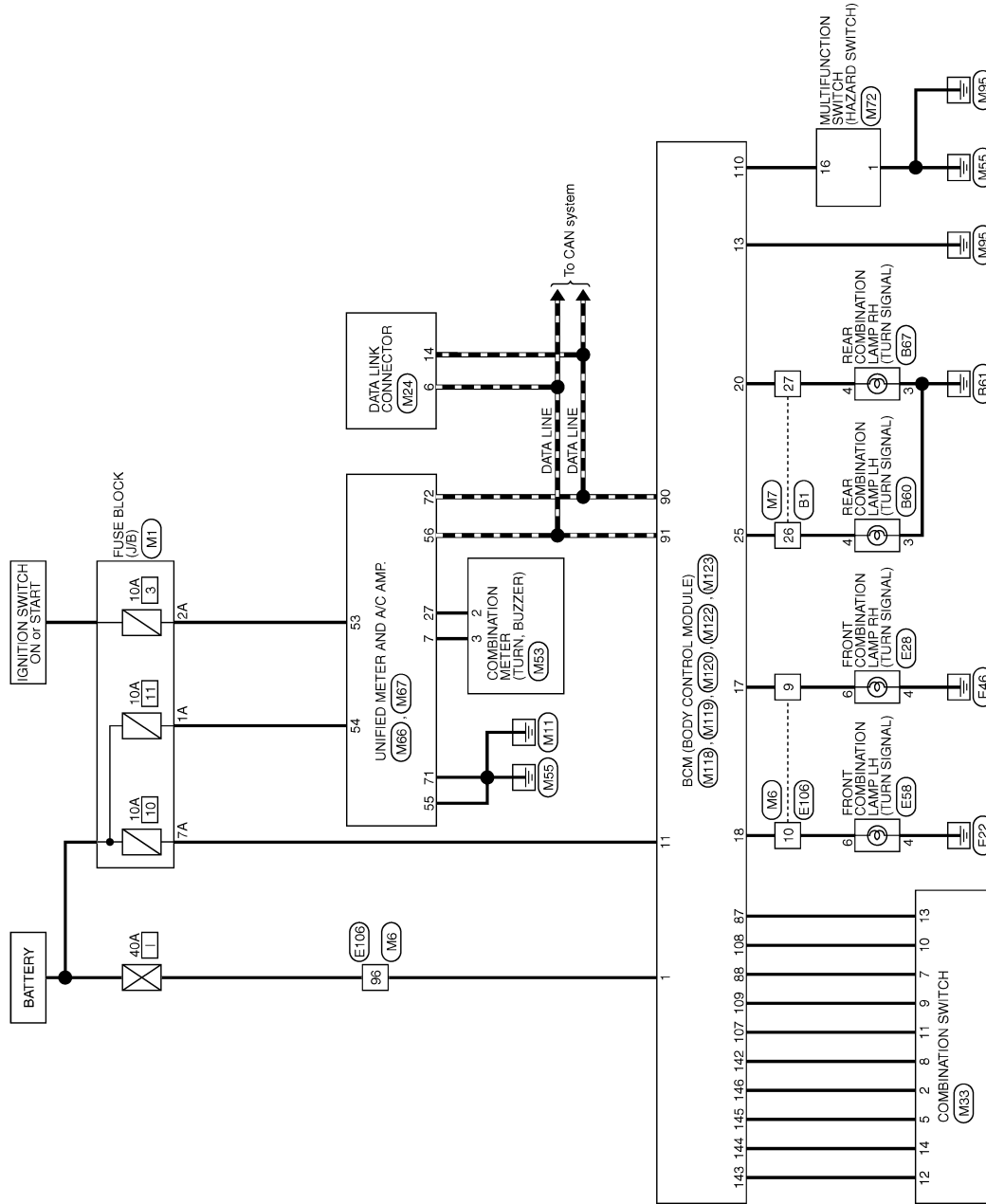

2009/02/27

JCLWA3365GB

A  
B  
C  
D  
E  
F  
G  
H  
I  
J  
K  
L  
M  
N  
O  
P

EXL

# TURN SIGNAL AND HAZARD WARNING LAMP SYSTEM

< DTC/CIRCUIT DIAGNOSIS >

[XENON TYPE]

## TURN SIGNAL AND HAZARD WARNING LAMPS

Connector No.	B1
Connector Name	WIRE TO WIRE
Connector Type	TH80FW-CS16-TM4

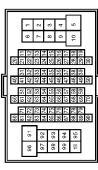
Terminal No.	26	LG		Signal Name [Specification]
27	Y			

Connector No.	B60
Connector Name	REAR COMBINATION LAMP LH
Connector Type	NS08MW-CS

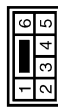

Terminal No.	3	B		Signal Name [Specification]
4	LG			

Connector No.	B67
Connector Name	REAR COMBINATION LAMP RH
Connector Type	NS08MW-CS

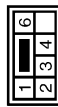
Terminal No.	3	B		Signal Name [Specification]
4	Y			

Connector No.	E28
Connector Name	FRONT COMBINATION LAMP RH
Connector Type	RS08FB-PR

Terminal No.	4	B/W		Signal Name [Specification]
6	LG			

Connector No.	E58
Connector Name	FRONT COMBINATION LAMP LH
Connector Type	RS08FB-PR

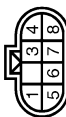

Terminal No.	4	B/W		Signal Name [Specification]
6	GR			

Connector No.	E105
Connector Name	WIRE TO WIRE
Connector Type	TH80FW-CS16-TM4

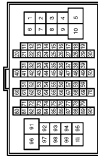
Terminal No.	9	LG		Signal Name [Specification]
10	GR			
96	W			

Connector No.	M1
Connector Name	FUSE BLOCK (J/B)
Connector Type	NS08FW-M2

Terminal No.	1A	V		Signal Name [Specification]
2A	G			
7A	R			

Connector No.	M6
Connector Name	WIRE TO WIRE
Connector Type	TH80MW-CS16-TM4

Terminal No.	9	W		Signal Name [Specification]
10	O			
95	W			

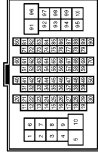
JCLWA3366GB



# TURN SIGNAL AND HAZARD WARNING LAMP SYSTEM

< DTC/CIRCUIT DIAGNOSIS >

[XENON TYPE]

## TURN SIGNAL AND HAZARD WARNING LAMPS

Connector No.	M7
Connector Name	WIRE TO WIRE
Connector Type	TH80WF-CS16-TM4



Terminal No.	Color of Wire	Signal Name [Specification]
26	Y	-
27	V	-

Connector No.	M24
Connector Name	DATA LINK CONNECTOR
Connector Type	BD16FW

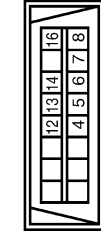

Terminal No.	Color of Wire	Signal Name [Specification]
6	L	-
14	P	-

Connector No.	M33
Connector Name	COMBINATION SWITCH
Connector Type	TH16FW-NH

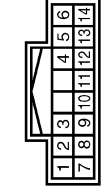

Terminal No.	Color of Wire	Signal Name [Specification]
2	SB	OUTPUT 4
5	L	OUTPUT 3
7	O	INPUT 3
8	BR	OUTPUT 5
9	W	INPUT 2
10	R	INPUT 4
11	LG	INPUT 1
12	P	OUTPUT 1
13	Y	INPUT 5
14	O	OUTPUT 2

Connector No.	M53
Connector Name	COMBINATION METER
Connector Type	SAB40FW

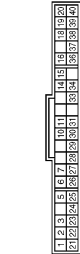

Terminal No.	Color of Wire	Signal Name [Specification]
2	LG	COMMUNICATION SIGNAL (METER->AMP.)
3	GR	COMMUNICATION SIGNAL (AMP->METER)

Connector No.	M68
Connector Name	UNIFIED METER AND A/C AMP.
Connector Type	TH40FW-NH

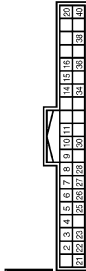

Terminal No.	Color of Wire	Signal Name [Specification]
7	GR	COMMUNICATION SIGNAL (AMP->METER)
27	LG	COMMUNICATION SIGNAL (METER->AMP.)

Connector No.	M67
Connector Name	UNIFIED METER AND A/C AMP.
Connector Type	TH22FW-NH

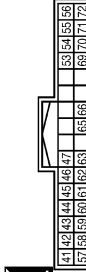

Terminal No.	Color of Wire	Signal Name [Specification]
53	W	IGNITION POWER SUPPLY
54	Y	BATTERY POWER SUPPLY
55	B	GROUND
56	L	CAN-H
71	GR	GROUND
72	P	CAN-L

Connector No.	M72
Connector Name	MULTIFUNCTION SWITCH
Connector Type	TH16FW-NH

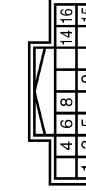

Terminal No.	Color of Wire	Signal Name [Specification]
1	B	GND
16	G	HAZARD ON

Connector No.	M118
Connector Name	BCM (BODY CONTROL MODULE)
Connector Type	MG3FB-LC



Terminal No.	Color of Wire	Signal Name [Specification]
1	W	BAT (F/L)

JCLWA3367GB

A  
B  
C  
D  
E  
F  
G  
H  
I  
J  
K  
L  
M  
N  
O  
P

EXL

# TURN SIGNAL AND HAZARD WARNING LAMP SYSTEM

< DTC/CIRCUIT DIAGNOSIS >

[XENON TYPE]

## TURN SIGNAL AND HAZARD WARNING LAMPS

Connector No.	M119
Connector Name	BCM (BODY CONTROL MODULE)
Connector Type	NS16FW-GS

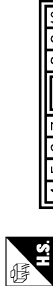

Connector No.	M120
Connector Name	BCM (BODY CONTROL MODULE)
Connector Type	NS12FW-GS



Connector No.	M122
Connector Name	BCM (BODY CONTROL MODULE)
Connector Type	TH40FB-NH



Connector No.	M123
Connector Name	BCM (BODY CONTROL MODULE)
Connector Type	TH40FG-NH

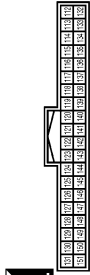

Terminal No.	Color of Wire	Signal Name [Specification]
11	R	BAT (FUSE)
13	B	GND
17	W	TURN SIGNAL RH (FRONT)
18	O	TURN SIGNAL LH (FRONT)

Terminal No.	Color of Wire	Signal Name [Specification]
20	V	TURN SIGNAL RH (REAR)
25	Y	TURN SIGNAL LH (REAR)

Terminal No.	Color of Wire	Signal Name [Specification]
87	Y	COMBI SW INPUT 5
88	O	COMBI SW INPUT 3
90	P	CAN-L
91	L	CAN-H
107	LG	COMBI SW INPUT 1
108	R	COMBI SW INPUT 4
109	W	COMBI SW INPUT 2
110	G	HAZARD SW

Terminal No.	Color of Wire	Signal Name [Specification]
142	BR	COMBI SW OUTPUT 5
143	P	COMBI SW OUTPUT 1
144	O	COMBI SW OUTPUT 2
145	L	COMBI SW OUTPUT 3
146	SB	COMBI SW OUTPUT 4

JCLWA3368GB

# PARKING, LICENSE PLATE AND TAIL LAMPS SYSTEM

< DTC/CIRCUIT DIAGNOSIS >

[XENON TYPE]

## PARKING, LICENSE PLATE AND TAIL LAMPS SYSTEM

### Wiring Diagram - PARKING LICENSE PLATE AND TAIL LAMPS -

INFOID:000000004875643

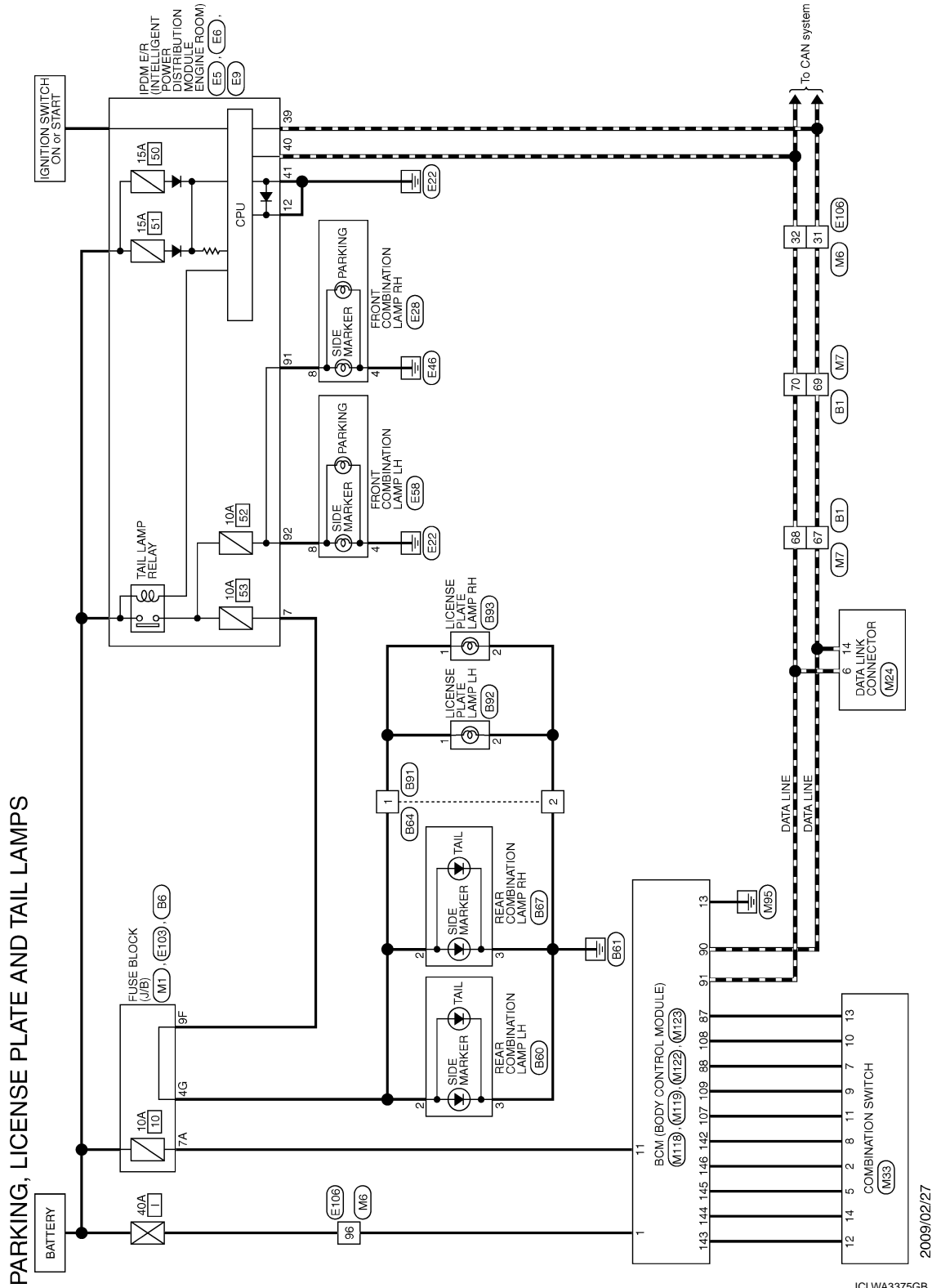

A  
B  
C  
D  
E  
F  
G  
H  
I  
J  
K  
L  
M  
N  
O  
P

EXL

# PARKING, LICENSE PLATE AND TAIL LAMPS SYSTEM

< DTC/CIRCUIT DIAGNOSIS >

[XENON TYPE]

## PARKING, LICENSE PLATE AND TAIL LAMPS

Connector No.	B1
Connector Name	WIRE TO WIRE
Connector Type	THBDFW-GS16-TM4

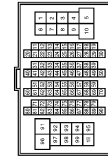

Terminal No.	Color of Wire	Signal Name [Specification]
67	P	-
68	L	-
69	P	-
70	L	-

Connector No.	B6
Connector Name	FUSE BLOCK (J/B)
Connector Type	NS12FER-CS



Terminal No.	Color of Wire	Signal Name [Specification]
4G	R	-

Connector No.	B00
Connector Name	REAR COMBINATION LAMP LH
Connector Type	NS30MW-CS

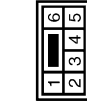

Terminal No.	Color of Wire	Signal Name [Specification]
2	R	-
3	B	-

Connector No.	B04
Connector Name	WIRE TO WIRE
Connector Type	RK02EGY



Terminal No.	Color of Wire	Signal Name [Specification]
1	R	-
2	B	-

Connector No.	B67
Connector Name	REAR COMBINATION LAMP RH
Connector Type	NS30MW-CS

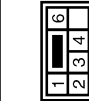

Terminal No.	Color of Wire	Signal Name [Specification]
2	R	-
3	B	-

Connector No.	B01
Connector Name	WIRE TO WIRE
Connector Type	RK02MGY



Terminal No.	Color of Wire	Signal Name [Specification]
1	-	-
2	-	-

Connector No.	B02
Connector Name	LICENSE PLATE LAMP LH
Connector Type	RK02FER



Terminal No.	Color of Wire	Signal Name [Specification]
1	-	-
2	-	-

Connector No.	B03
Connector Name	LICENSE PLATE LAMP RH
Connector Type	RK02FER



Terminal No.	Color of Wire	Signal Name [Specification]
1	-	-
2	-	-

# PARKING, LICENSE PLATE AND TAIL LAMPS SYSTEM

< DTC/CIRCUIT DIAGNOSIS >

[XENON TYPE]

## PARKING, LICENSE PLATE AND TAIL LAMPS

Connector No.	E5
Connector Name	SPARKER INTELLIGENT POWER DISTRIBUTION MODULE (ENGINE ROOM)
Connector Type	TH20FW-CS12-IM4-IV

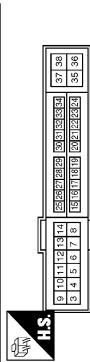

Terminal No.	7	12
Color of Wire	R	B/W
Signal Name [Specification]	-	-

Connector No.	E6
Connector Name	SPARKER INTELLIGENT POWER DISTRIBUTION MODULE (ENGINE ROOM)
Connector Type	TH38FW-NH



Terminal No.	39	40	41
Color of Wire	P	L	B/W
Signal Name [Specification]	-	-	-

Connector No.	E9
Connector Name	SPARKER INTELLIGENT POWER DISTRIBUTION MODULE (ENGINE ROOM)
Connector Type	TH16FW-NH

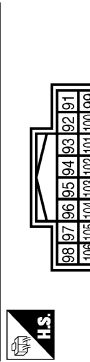

Terminal No.	91	92
Color of Wire	P	O
Signal Name [Specification]	-	-

Connector No.	E28
Connector Name	FRONT COMBINATION LAMP RH
Connector Type	RS08FB-PR



Terminal No.	4	8
Color of Wire	B/W	P
Signal Name [Specification]	-	-

Connector No.	E68
Connector Name	FRONT COMBINATION LAMP LH
Connector Type	RS08FB-PR

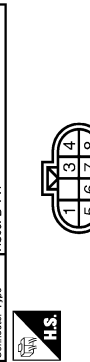

Terminal No.	4	8
Color of Wire	B/W	O
Signal Name [Specification]	-	-

Connector No.	E103
Connector Name	FUSE BLOCK (J/B)
Connector Type	NS16FW-CS



Terminal No.	9F
Color of Wire	R
Signal Name [Specification]	-

Connector No.	E106
Connector Name	WIRE TO WIRE
Connector Type	TH80FW-CS16-TM4



Terminal No.	31	32	96
Color of Wire	P	L	W
Signal Name [Specification]	-	-	-

Connector No.	M1
Connector Name	FUSE BLOCK (J/B)
Connector Type	NS06FW-M2



Terminal No.	7A
Color of Wire	R
Signal Name [Specification]	-

A  
B  
C  
D  
E  
F  
G  
H  
I  
J  
K  
EXL  
M  
N  
O  
P

# PARKING, LICENSE PLATE AND TAIL LAMPS SYSTEM

< DTC/CIRCUIT DIAGNOSIS >

[XENON TYPE]

## PARKING, LICENSE PLATE AND TAIL LAMPS

Connector No.	M18
Connector Name	BCM (BODY CONTROL MODULE)
Connector Type	M03PE-LC

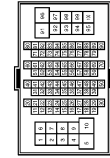

Terminal No.	Color of Wire	Signal Name [Specification]
31	P	-
32	L	-
96	W	-

Connector No.	M7
Connector Name	WIRE TO WIRE
Connector Type	TH80MW-CS16-TM4

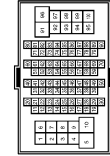

Terminal No.	Color of Wire	Signal Name [Specification]
67	P	-
68	L	-
69	P	-
70	L	-

Connector No.	M24
Connector Name	DATA LINK CONNECTOR
Connector Type	BD16FW

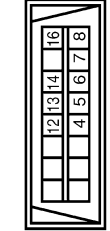

Terminal No.	Color of Wire	Signal Name [Specification]
6	L	-
14	P	-

Connector No.	M33
Connector Name	COMBINATION SWITCH
Connector Type	TH16FW-NH

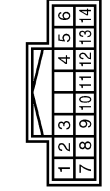

Terminal No.	Color of Wire	Signal Name [Specification]
2	SB	OUTPUT 4
5	L	OUTPUT 3
7	O	INPUT 3
8	BR	OUTPUT 5
9	W	INPUT 2
10	R	INPUT 4
11	LG	INPUT 1
12	P	OUTPUT 1
13	Y	INPUT 5
14	O	OUTPUT 2

Connector No.	M18
Connector Name	BCM (BODY CONTROL MODULE)
Connector Type	M03PE-LC



Terminal No.	Color of Wire	Signal Name [Specification]
1	W	BAT (F/L)

Connector No.	M19
Connector Name	BCM (BODY CONTROL MODULE)
Connector Type	NS16FW-CS

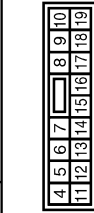

Terminal No.	Color of Wire	Signal Name [Specification]
11	R	BAT (FUSE)
13	B	GND

Connector No.	M22
Connector Name	BCM (BODY CONTROL MODULE)
Connector Type	TH40FB-NH

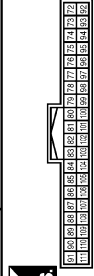

Terminal No.	Color of Wire	Signal Name [Specification]
87	Y	COMBI SW INPUT 5
88	O	COMBI SW INPUT 3
90	P	CAN-L
91	L	CAN-H
107	LG	COMBI SW INPUT 1
108	R	COMBI SW INPUT 4
109	W	COMBI SW INPUT 2

Connector No.	M123
Connector Name	BCM (BODY CONTROL MODULE)
Connector Type	TH40FG-NH

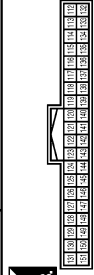

Terminal No.	Color of Wire	Signal Name [Specification]
142	BR	COMBI SW OUTPUT 5
143	P	COMBI SW OUTPUT 1
144	O	COMBI SW OUTPUT 2
145	L	COMBI SW OUTPUT 3
146	SB	COMBI SW OUTPUT 4

# STOP LAMP

< DTC/CIRCUIT DIAGNOSIS >

[XENON TYPE]

## STOP LAMP

### Wiring Diagram - STOP LAMP -

INFOID:000000004875644

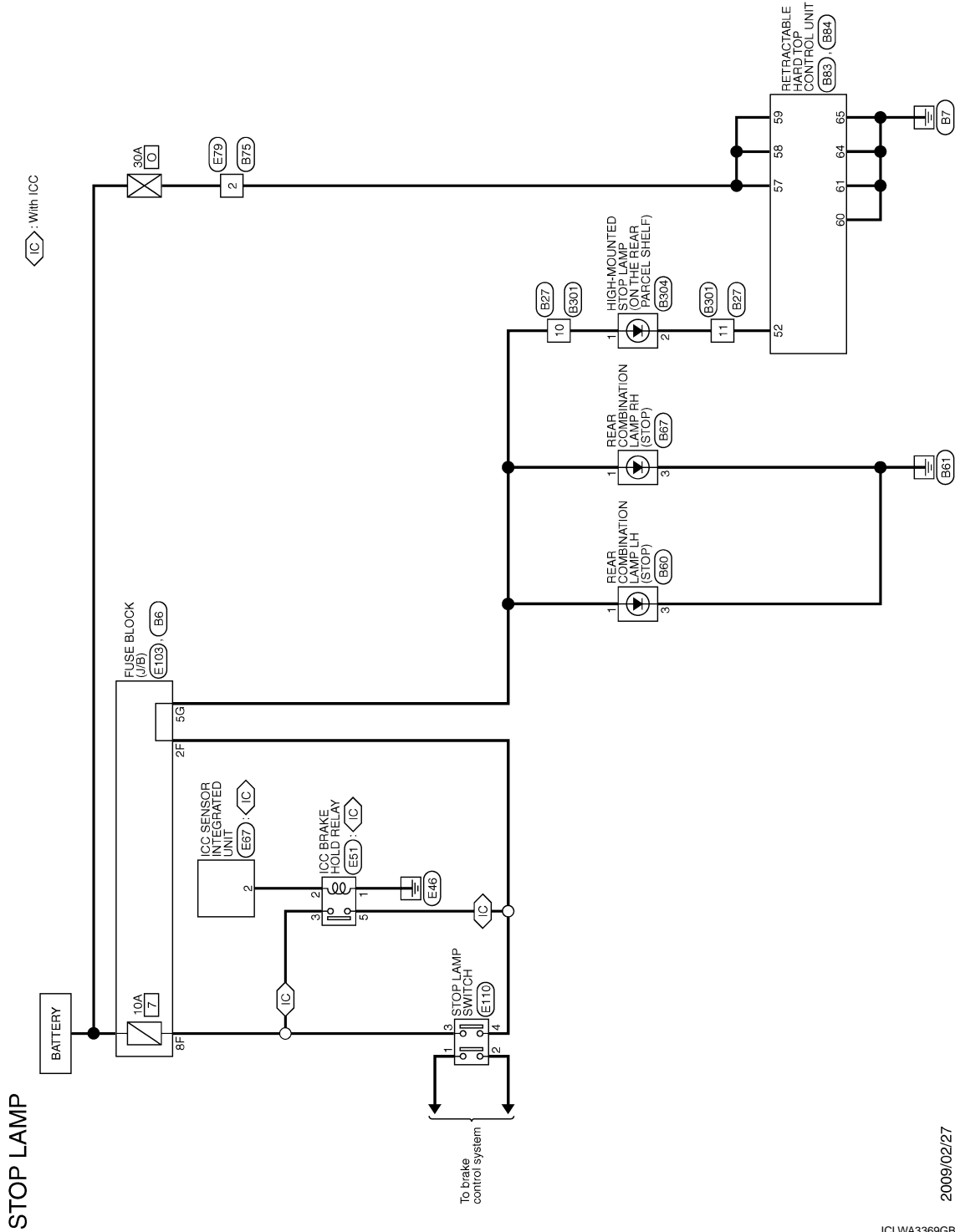

A  
B  
C  
D  
E  
F  
G  
H  
I  
J  
K  
EXL  
M  
N  
O  
P

2009/02/27

JCLWA3369GB

# STOP LAMP

< DTC/CIRCUIT DIAGNOSIS >

[XENON TYPE]

## STOP LAMP

Connector No.	B36
Connector Name	FUSE BLOCK (J/B)
Connector Type	NS12FBF-CS



Connector No.	B27
Connector Name	WIRE TO WIRE
Connector Type	NS16MW-CS

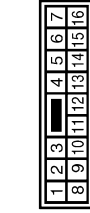

Terminal No.	5G	Color of Wire	LG	Signal Name [Specification]	
--------------	----	---------------	----	-----------------------------	--

Terminal No.	10	Color of Wire	LG	Signal Name [Specification]	
Terminal No.	11	Color of Wire	B	Signal Name [Specification]	

Connector No.	B60
Connector Name	REAR COMBINATION LAMP LH
Connector Type	NS30MM-CS



Terminal No.	1	Color of Wire	G	Signal Name [Specification]	
Terminal No.	3	Color of Wire	B	Signal Name [Specification]	

Connector No.	B67
Connector Name	REAR COMBINATION LAMP RH
Connector Type	NS30MM-CS

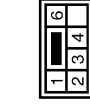

Terminal No.	1	Color of Wire	LG	Signal Name [Specification]	
Terminal No.	3	Color of Wire	B	Signal Name [Specification]	

Connector No.	B75
Connector Name	WIRE TO WIRE
Connector Type	M02MM-LC

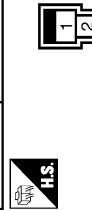

Terminal No.	2	Color of Wire	Y	Signal Name [Specification]	
--------------	---	---------------	---	-----------------------------	--

Connector No.	B83
Connector Name	RETRACTABLE HARD TOP CONTROL UNIT
Connector Type	NS16FBF-CS

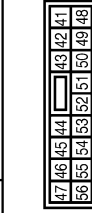

Terminal No.	52	Color of Wire	V	Signal Name [Specification]	TRUNK OPENER ACTUATOR GND
--------------	----	---------------	---	-----------------------------	---------------------------

Connector No.	B84
Connector Name	RETRACTABLE HARD TOP CONTROL UNIT
Connector Type	NS16FPW-CS

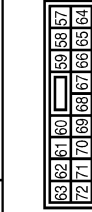

Terminal No.	57	Color of Wire	Y	Signal Name [Specification]	BAT
Terminal No.	58	Color of Wire	Y	Signal Name [Specification]	BAT
Terminal No.	59	Color of Wire	Y	Signal Name [Specification]	BAT
Terminal No.	60	Color of Wire	B	Signal Name [Specification]	GND
Terminal No.	61	Color of Wire	B	Signal Name [Specification]	GND
Terminal No.	64	Color of Wire	B	Signal Name [Specification]	GND (POWER WINDOW)
Terminal No.	65	Color of Wire	B	Signal Name [Specification]	GND (POWER WINDOW)

Connector No.	B301
Connector Name	WIRE TO WIRE
Connector Type	NS16FPY-CS

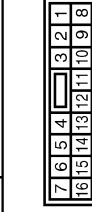

Terminal No.	10	Color of Wire	LG	Signal Name [Specification]	
Terminal No.	11	Color of Wire	B	Signal Name [Specification]	



# STOP LAMP

< DTC/CIRCUIT DIAGNOSIS >

[XENON TYPE]

## STOP LAMP

Connector No.	E304
Connector Name	HIGH-MOUNTED STOP LAMP (ON THE REAR PANEL SWLFP)
Connector Type	TK02M8F-P



Terminal No.	Color of Wire	Signal Name [Specification]
1	LG	-
2	B	-

Connector No.	E51
Connector Name	ICC BRAKE HOLD RELAY
Connector Type	MS02FL-M2



Terminal No.	Color of Wire	Signal Name [Specification]
1	B	-
2	V	-
3	R	-
5	P	-

Connector No.	E67
Connector Name	ICC SENSOR INTEGRATED UNIT
Connector Type	RS06FB-PR



Terminal No.	Color of Wire	Signal Name [Specification]
2	V	BRAKE HOLD RLY DRIVE SIGNAL

Connector No.	E79
Connector Name	WIRE TO WIRE
Connector Type	MS2FW-LC



Terminal No.	Color of Wire	Signal Name [Specification]
2	LG	-

Connector No.	E103
Connector Name	FUSE BLOCK (J/B)
Connector Type	MS16FW-CS



Terminal No.	Color of Wire	Signal Name [Specification]
8F	L	-
2F	W	-

Connector No.	E10
Connector Name	STOP LAMP SWITCH
Connector Type	MS4FW-LC



Terminal No.	Color of Wire	Signal Name [Specification]
1	L	- [With ICC]
1	G	- [Without ICC]
2	SB	- [With ICC]
2	Y	- [Without ICC]
3	L	-
4	W	-

A  
B  
C  
D  
E  
F  
G  
H  
I  
J  
K  
EXL  
M  
N  
O  
P

# BACK-UP LAMP

< DTC/CIRCUIT DIAGNOSIS >

[XENON TYPE]

## BACK-UP LAMP

### Wiring Diagram - BACK-UP LAMP -

INFOID:000000004875645

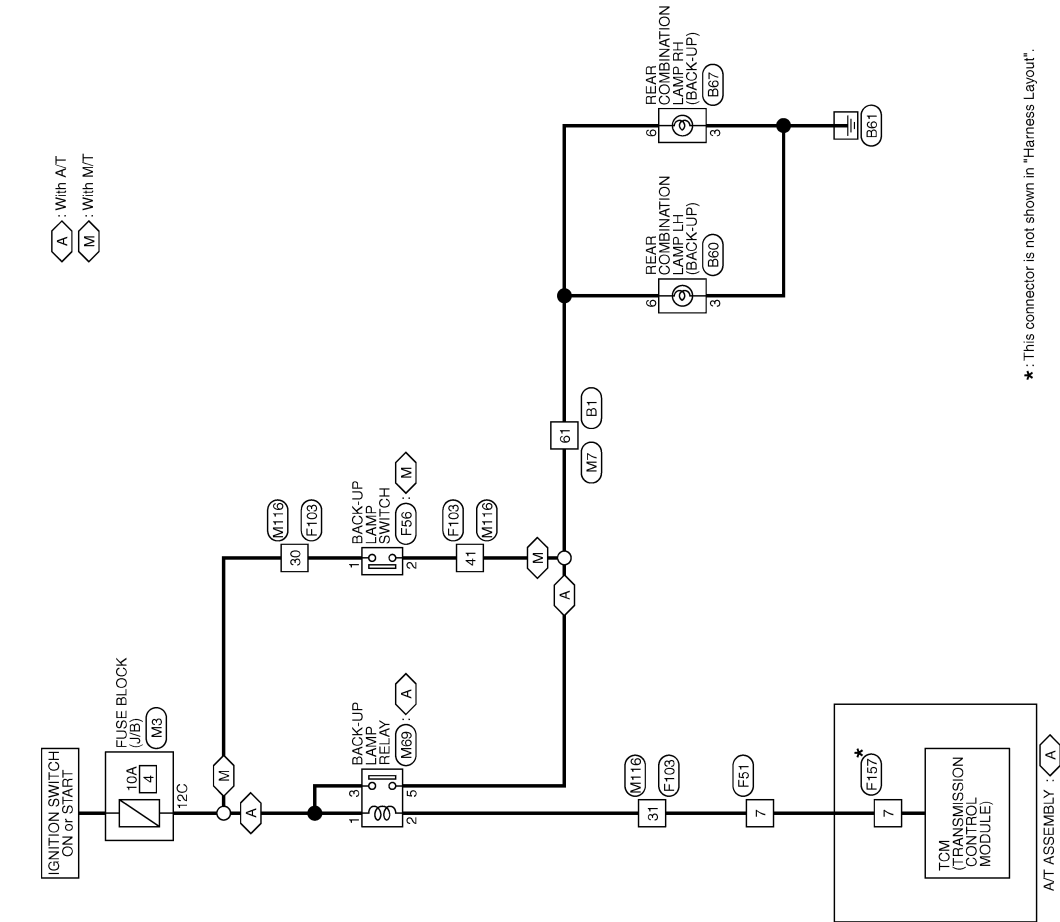

\*: This connector is not shown in "Harness Layout".

BACK-UP LAMP

2009/02/27

JCLWA3372GB

# BACK-UP LAMP

< DTC/CIRCUIT DIAGNOSIS >

[XENON TYPE]

## BACK-UP LAMP

Connector No.	B1
Connector Name	WIRE TO WIRE
Connector Type	TH80FW-CS16-TM4

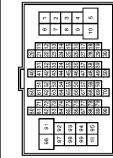

Terminal No.	61	O	-	-
Color of Wire				
Signal Name [Specification]				

Connector No.	B60
Connector Name	REAR COMBINATION LAMP LH
Connector Type	NS36MW-CS

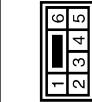

Terminal No.	3	B	O	-
Color of Wire				
Signal Name [Specification]				

Connector No.	B67
Connector Name	REAR COMBINATION LAMP RH
Connector Type	NS36MW-CS

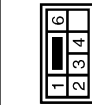

Terminal No.	3	B	O	-
Color of Wire				
Signal Name [Specification]				

Connector No.	F51
Connector Name	A/T ASSEMBLY
Connector Type	RK10FG-DGY



Terminal No.	7	R	-	-
Color of Wire				
Signal Name [Specification]				

Connector No.	F56
Connector Name	BACK-UP LAMP SWITCH
Connector Type	RK02FB



Terminal No.	1	R	-	-
Color of Wire				
Signal Name [Specification]				

Connector No.	F103
Connector Name	WIRE TO WIRE
Connector Type	TK36FW-NS10

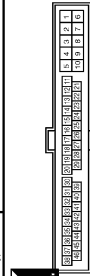

Terminal No.	30	R	R	O
Color of Wire				
Signal Name [Specification]				

Connector No.	F157
Connector Name	TOM (TRANSMISSION CONTROL MODULE)
Connector Type	SP10FG

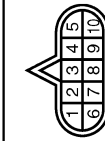

Terminal No.	7	L	-	-
Color of Wire				
Signal Name [Specification]				

Connector No.	M3
Connector Name	FUSE BLOCK (J/B)
Connector Type	NS12FW-CS

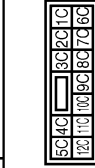

Terminal No.	12C	R	-	-
Color of Wire				
Signal Name [Specification]				

A  
B  
C  
D  
E  
F  
G  
H  
I  
J  
K  
EXL  
M  
N  
O  
P

# BACK-UP LAMP

< DTC/CIRCUIT DIAGNOSIS >

[XENON TYPE]

## BACK-UP LAMP

Connector No.	M7
Connector Name	WIRE TO WIRE
Connector Type	TH80MW-CS16-TM4



Terminal No.	Color of Wire	Signal Name [Specification]
61	O	-

Connector No.	M69
Connector Name	BACK-UP LAMP RELAY
Connector Type	MS32FL-ME-LC

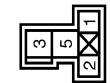

Terminal No.	Color of Wire	Signal Name [Specification]
1	R	-
2	W	-
3	LG	-
5	O	-

Connector No.	M116
Connector Name	WIRE TO WIRE
Connector Type	TK38MW-NS/D



Terminal No.	Color of Wire	Signal Name [Specification]
30	LG	-
31	W	-
41	O	-

JCLWA3374GB

# BCM (BODY CONTROL MODULE)

< ECU DIAGNOSIS INFORMATION >

[XENON TYPE]

## ECU DIAGNOSIS INFORMATION

### BCM (BODY CONTROL MODULE)

#### Reference Value

INFOID:000000005161772

#### VALUES ON THE DIAGNOSIS TOOL

##### CONSULT-III MONITOR ITEM

Monitor Item	Condition	Value/Status
FR WIPER HI	Other than front wiper switch HI	Off
	Front wiper switch HI	On
FR WIPER LOW	Other than front wiper switch LO	Off
	Front wiper switch LO	On
FR WASHER SW	Front washer switch OFF	Off
	Front washer switch ON	On
FR WIPER INT	Other than front wiper switch INT/AUTO	Off
	Front wiper switch INT/AUTO	On
FR WIPER STOP	Front wiper is not in STOP position	Off
	Front wiper is in STOP position	On
INT VOLUME	Wiper volume dial is in a dial position 1 - 7	Wiper volume dial position
TURN SIGNAL R	Other than turn signal switch RH	Off
	Turn signal switch RH	On
TURN SIGNAL L	Other than turn signal switch LH	Off
	Turn signal switch LH	On
TAIL LAMP SW	Other than lighting switch 1ST and 2ND	Off
	Lighting switch 1ST or 2ND	On
HI BEAM SW	Other than lighting switch HI	Off
	Lighting switch HI	On
HEAD LAMP SW 1	Other than lighting switch 2ND	Off
	Lighting switch 2ND	On
HEAD LAMP SW 2	Other than lighting switch 2ND	Off
	Lighting switch 2ND	On
PASSING SW	Other than lighting switch PASS	Off
	Lighting switch PASS	On
AUTO LIGHT SW	Other than lighting switch AUTO	Off
	Lighting switch AUTO	On
FR FOG SW	Front fog lamp switch OFF	Off
	Front fog lamp switch ON	On
RR FOG SW	<b>NOTE:</b> The item is indicated, but not monitored.	Off
DOOR SW-DR	Driver door closed	Off
	Driver door opened	On
DOOR SW-AS	Passenger door closed	Off
	Passenger door opened	On
DOOR SW-RR	<b>NOTE:</b> The item is indicated, but not monitored.	Off

# BCM (BODY CONTROL MODULE)

< ECU DIAGNOSIS INFORMATION >

[XENON TYPE]

Monitor Item	Condition	Value/Status
DOOR SW-RL	<b>NOTE:</b> The item is indicated, but not monitored.	Off
DOOR SW-BK	<b>NOTE:</b> The item is indicated, but not monitored.	Off
CDL LOCK SW	Other than power door lock switch LOCK	Off
	Power door lock switch LOCK	On
CDL UNLOCK SW	Other than power door lock switch UNLOCK	Off
	Power door lock switch UNLOCK	On
KEY CYL LK-SW	Other than driver door key cylinder LOCK position	Off
	Driver door key cylinder LOCK position	On
KEY CYL UN-SW	Other than driver door key cylinder UNLOCK position	Off
	Driver door key cylinder UNLOCK position	On
KEY CYL SW-TR	<b>NOTE:</b> The item is indicated, but not monitored.	Off
HAZARD SW	Hazard switch is OFF	Off
	Hazard switch is ON	On
REAR DEF SW	<b>NOTE:</b> The item is indicated, but not monitored.	Off
H/L WASH SW	<b>NOTE:</b> The item is indicated, but not monitored.	Off
TR CANCEL SW	Trunk lid opener cancel switch OFF	Off
	Trunk lid opener cancel switch ON	On
TR/BD OPEN SW	Trunk lid opener switch OFF	Off
	While the trunk lid opener switch is turned ON	On
TRNK/HAT MNTR	Trunk lid closed	Off
	Trunk lid opened	On
RKE-LOCK	LOCK button of the Intelligent Key is not pressed	Off
	LOCK button of the Intelligent Key is pressed	On
RKE-UNLOCK	UNLOCK button of the Intelligent Key is not pressed	Off
	UNLOCK button of the Intelligent Key is pressed	On
RKE-TR/BD	TRUNK OPEN button of the Intelligent Key is not pressed	Off
	TRUNK OPEN button of the Intelligent Key is pressed	On
RKE-PANIC	PANIC button of the Intelligent Key is not pressed	Off
	PANIC button of the Intelligent Key is pressed	On
RKE-P/W OPEN	UNLOCK button of the Intelligent Key is not pressed	Off
	UNLOCK button of the Intelligent Key is pressed and held	On
RKE-MODE CHG	LOCK/UNLOCK button of the Intelligent Key is not pressed and held simultaneously	Off
	LOCK/UNLOCK button of the Intelligent Key is pressed and held simultaneously	On
OPTICAL SENSOR	Bright outside of the vehicle	Close to 5 V
	Dark outside of the vehicle	Close to 0 V
REQ SW -DR	Driver door request switch is not pressed	Off
	Driver door request switch is pressed	On
REQ SW -AS	Passenger door request switch is not pressed	Off
	Passenger door request switch is pressed	On
REQ SW -RR	<b>NOTE:</b> The item is indicated, but not monitored.	Off

# BCM (BODY CONTROL MODULE)

< ECU DIAGNOSIS INFORMATION >

[XENON TYPE]

Monitor Item	Condition	Value/Status	
REQ SW -RL	<b>NOTE:</b> The item is indicated, but not monitored.	Off	A
REQ SW -BD/TR	Trunk lid opener request switch is not pressed	Off	B
	Trunk lid opener request switch is pressed	On	
PUSH SW	Push-button ignition switch (push switch) is not pressed	Off	C
	Push-button ignition switch (push switch) is pressed	On	
IGN RLY2 -F/B	Ignition switch in OFF or ACC position	Off	D
	Ignition switch in ON position	On	
ACC RLY -F/B	<b>NOTE:</b> The item is indicated, but not monitored.	Off	E
CLUCH SW	The clutch pedal is not depressed	Off	E
	The clutch pedal is depressed	On	
BRAKE SW 1	The brake pedal is depressed when No. 7 fuse is blown	Off	F
	The brake pedal is not depressed when No. 7 fuse is blown, or No. 7 fuse is normal	On	
BRAKE SW 2	The brake pedal is not depressed	Off	G
	The brake pedal is depressed	On	
DETE/CANCL SW	<ul style="list-style-type: none"> <li>• Selector lever in P position (Except M/T models)</li> <li>• The clutch pedal is depressed (M/T models)</li> </ul>	Off	H
	<ul style="list-style-type: none"> <li>• Selector lever in any position other than P (Except M/T models)</li> <li>• The clutch pedal is not depressed (M/T models)</li> </ul>	On	
SFT PN/N SW	Selector lever in any position other than P and N	Off	I
	Selector lever in P or N position	On	
S/L -LOCK	Steering is unlocked	Off	J
	Steering is locked	On	
S/L -UNLOCK	Steering is locked	Off	K
	Steering is unlocked	On	
S/L RELAY-F/B	Ignition switch in OFF or ACC position	Off	K
	Ignition switch in ON position	On	
UNLK SEN -DR	Driver door is unlocked	Off	EXL
	Driver door is locked	On	
PUSH SW -IPDM	Push-button ignition switch (push-switch) is not pressed	Off	M
	Push-button ignition switch (push-switch) is pressed	On	
IGN RLY1 -F/B	Ignition switch in OFF or ACC position	Off	N
	Ignition switch in ON position	On	
DETE SW -IPDM	Selector lever in any position other than P	Off	O
	Selector lever in P position	On	
SFT PN -IPDM	<ul style="list-style-type: none"> <li>• Selector lever in any position other than P and N (Except M/T models)</li> <li>• The clutch pedal is not depressed (M/T models)</li> </ul>	Off	P
	<ul style="list-style-type: none"> <li>• Selector lever in P or N position</li> <li>• The clutch pedal is depressed</li> </ul>	On	
SFT P -MET	Selector lever in any position other than P	Off	P
	Selector lever in P position	On	
SFT N -MET	Selector lever in any position other than N	Off	P
	Selector lever in N position	On	

# BCM (BODY CONTROL MODULE)

< ECU DIAGNOSIS INFORMATION >

[XENON TYPE]

Monitor Item	Condition	Value/Status
ENGINE STATE	Engine stopped	Stop
	While the engine stalls	Stall
	At engine cranking	Crank
	Engine running	Run
S/L LOCK-IPDM	Steering is unlocked	Off
	Steering is locked	On
S/L UNLK-IPDM	Steering is locked	Off
	Steering is unlocked	On
S/L RELAY-REQ	Steering lock system is not the LOCK condition and the changing condition from LOCK to UNLOCK	Off
	Steering lock system are not the LOCK condition or the changing condition from LOCK to UNLOCK	On
VEH SPEED 1	While driving	Equivalent to speedometer reading
VEH SPEED 2	While driving	Equivalent to speedometer reading
DOOR STAT-DR	Driver door is locked	LOCK
	Wait with selective UNLOCK operation (60 seconds)	READY
	Driver door is unlocked	UNLOCK
DOOR STAT-AS	Passenger door is locked	LOCK
	Wait with selective UNLOCK operation (60 seconds)	READY
	Passenger door is unlocked	UNLOCK
ID OK FLAG	Steering is locked	Reset
	Steering is unlocked	Set
PRMT ENG STRT	The engine start is prohibited	Reset
	The engine start is permitted	Set
PRMT RKE STRT	<b>NOTE:</b> The item is indicated, but not monitored.	Reset
KEY SW -SLOT	The Intelligent Key is not inserted into key slot	Off
	The Intelligent Key is inserted into key slot	On
RKE OPE COUN1	During the operation of the Intelligent Key	Operation frequency of the Intelligent Key
RKE OPE COUN2	<b>NOTE:</b> The item is indicated, but not monitored.	—
CONFIRM ID ALL	The key ID that the key slot receives is not recognized by any key ID registered to BCM.	Yet
	The key ID that the key slot receives is recognized by any key ID registered to BCM.	Done
CONFIRM ID4	The key ID that the key slot receives is not recognized by the fourth key ID registered to BCM.	Yet
	The key ID that the key slot receives is recognized by the fourth key ID registered to BCM.	Done
CONFIRM ID3	The key ID that the key slot receives is not recognized by the third key ID registered to BCM.	Yet
	The key ID that the key slot receives is recognized by the third key ID registered to BCM.	Done



# BCM (BODY CONTROL MODULE)

< ECU DIAGNOSIS INFORMATION >

[XENON TYPE]

Monitor Item	Condition	Value/Status
CONFIRM ID2	The key ID that the key slot receives is not recognized by the second key ID registered to BCM.	Yet
	The key ID that the key slot receives is recognized by the second key ID registered to BCM.	Done
CONFIRM ID1	The key ID that the key slot receives is not recognized by the first key ID registered to BCM.	Yet
	The key ID that the key slot receives is recognized by the first key ID registered to BCM.	Done
TP 4	The ID of fourth Intelligent Key is not registered to BCM	Yet
	The ID of fourth Intelligent Key is registered to BCM	Done
TP 3	The ID of third Intelligent Key is not registered to BCM	Yet
	The ID of third Intelligent Key is registered to BCM	Done
TP 2	The ID of second Intelligent Key is not registered to BCM	Yet
	The ID of second Intelligent Key is registered to BCM	Done
TP 1	The ID of first Intelligent Key is not registered to BCM	Yet
	The ID of first Intelligent Key is registered to BCM	Done
AIR PRESS FL	Ignition switch ON (Only when the signal from the transmitter is received)	Air pressure of front LH tire
AIR PRESS FR	Ignition switch ON (Only when the signal from the transmitter is received)	Air pressure of front RH tire
AIR PRESS RR	Ignition switch ON (Only when the signal from the transmitter is received)	Air pressure of rear RH tire
AIR PRESS RL	Ignition switch ON (Only when the signal from the transmitter is received)	Air pressure of rear LH tire
ID REGST FL1	ID of front LH tire transmitter is registered	Done
	ID of front LH tire transmitter is not registered	Yet
ID REGST FR1	ID of front RH tire transmitter is registered	Done
	ID of front RH tire transmitter is not registered	Yet
ID REGST RR1	ID of rear RH tire transmitter is registered	Done
	ID of rear RH tire transmitter is not registered	Yet
ID REGST RL1	ID of rear LH tire transmitter is registered	Done
	ID of rear LH tire transmitter is not registered	Yet
WARNING LAMP	Tire pressure indicator OFF	Off
	Tire pressure indicator ON	On
BUZZER	Tire pressure warning alarm is not sounding	Off
	Tire pressure warning alarm is sounding	On

A  
B  
C  
D  
E  
F  
G  
H  
I  
J  
K  
EXL  
M  
N  
O  
P

# BCM (BODY CONTROL MODULE)

< ECU DIAGNOSIS INFORMATION >

[XENON TYPE]

## TERMINAL LAYOUT

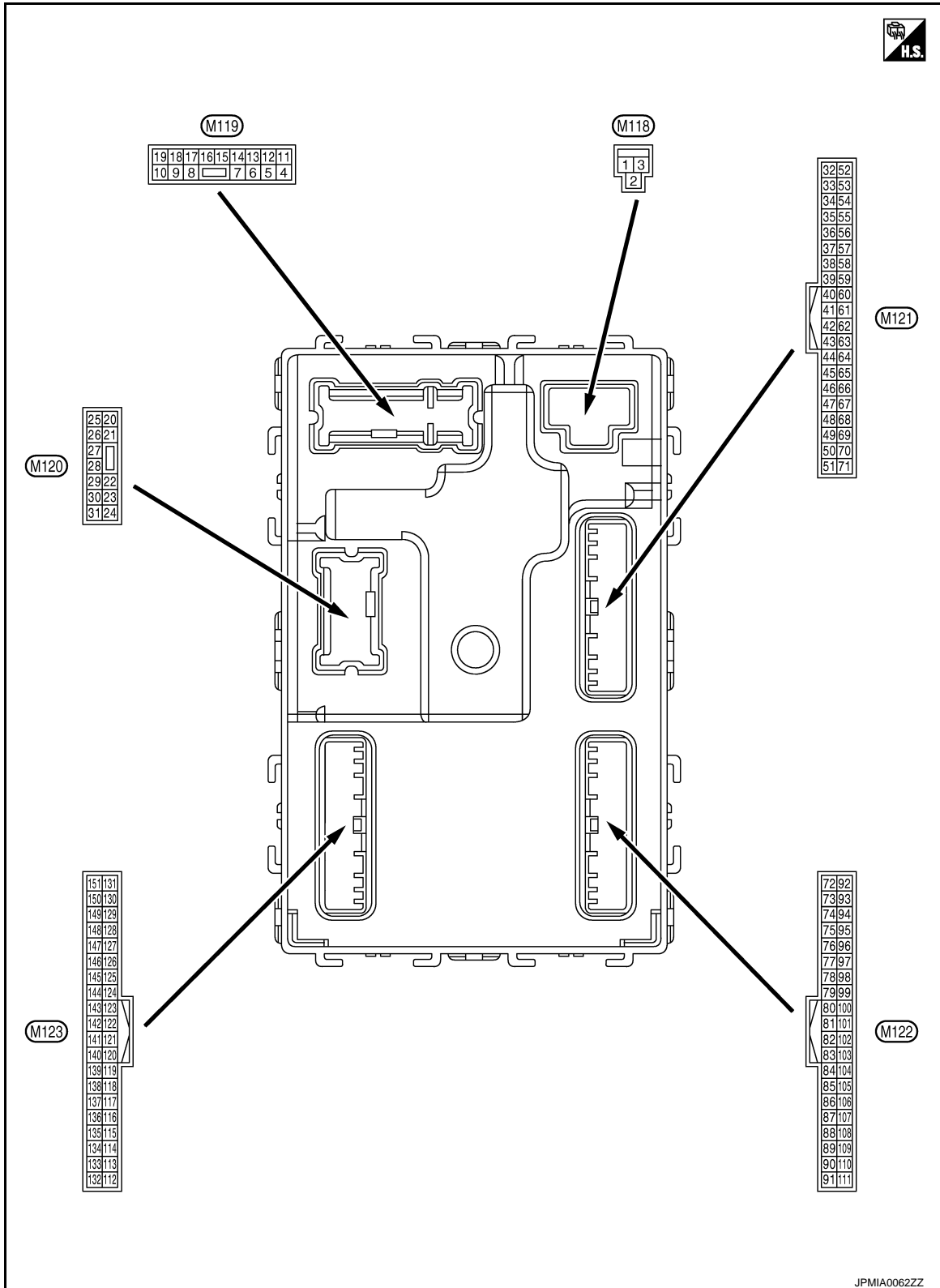

## PHYSICAL VALUES

# BCM (BODY CONTROL MODULE)

< ECU DIAGNOSIS INFORMATION >

[XENON TYPE]

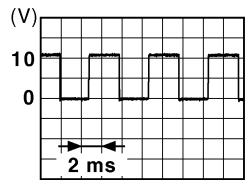
Terminal No. (Wire color)		Description		Condition		Value (Approx.)
		Signal name	Input/ Output			
+	-					
1 (W)	Ground	Battery power supply	Input	Ignition switch OFF		Battery voltage
2 (Y)	Ground	P/W power supply (BAT)	Output	Ignition switch OFF		12 V
3 (O)	Ground	P/W power supply (RAP)	Output	Ignition switch ON		12 V
4 (LG)	Ground	Interior room lamp power supply	Output	Interior room lamp battery saver is activated. (Cuts the interior room lamp power supply)		0 V
				Interior room lamp battery saver is not activated. (Outputs the interior room lamp power supply)		12 V
5 (P)	Ground	Passenger door UN- LOCK	Output	Passenger door	UNLOCK (Actuator is activated)	12 V
					Other than UNLOCK (Ac- tuator is not activated)	0 V
7 (SB)	Ground	Step lamp	Output	Step lamp	ON	0 V
					OFF	12 V
8 (V)	Ground	All doors, fuel lid LOCK	Output	All doors, fuel lid	LOCK (Actuator is activated)	12 V
					Other than LOCK (Actuator is not activated)	0 V
9 (G)	Ground	Driver door, fuel lid UNLOCK	Output	Driver door, fuel lid	UNLOCK (Actuator is activated)	12 V
					Other than UNLOCK (Actuator is not activated)	0 V
11 (R)	Ground	Battery power supply	Input	Ignition switch OFF		Battery voltage
13 (B)	Ground	Ground	—	Ignition switch ON		0 V
14 (W)	Ground	Push-button ignition switch illumination ground	Output	Tail lamp	OFF	<p style="text-align: center;"><b>NOTE:</b> When the illumination brighten- ing/dimming level is in the neutral position.</p>  <p style="text-align: right; font-size: small;">JSNIA0010GB</p>
					ON	
15 (O)	Ground	ACC indicator lamp	Output	Ignition switch	OFF (LOCK indicator is not illuminated)	Battery voltage
					ACC	0 V

A  
B  
C  
D  
E  
F  
G  
H  
I  
J  
K  
EXL  
M  
N  
O  
P

# BCM (BODY CONTROL MODULE)

< ECU DIAGNOSIS INFORMATION >

[XENON TYPE]

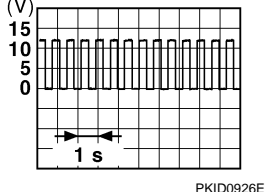
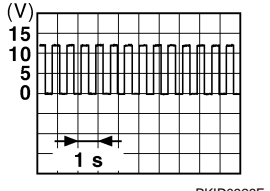
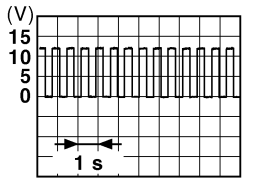
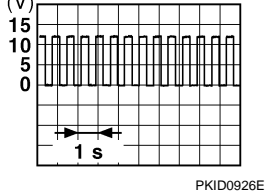
Terminal No. (Wire color)		Description		Condition	Value (Approx.)	
+	-	Signal name	Input/ Output			
17 (W)	Ground	Turn signal RH (Front)	Output	Ignition switch ON	Turn signal switch OFF	0 V
				Turn signal switch RH	 <p style="text-align: right; font-size: small;">PKID0926E</p>	6.5 V
18 (O)	Ground	Turn signal LH (Front)	Output	Ignition switch ON	Turn signal switch OFF	0 V
				Turn signal switch LH	 <p style="text-align: right; font-size: small;">PKID0926E</p>	6.5 V
19 (V)	Ground	Room lamp timer control	Output	Interior room lamp	OFF	12 V
				ON	0 V	
20 (V)	Ground	Turn signal RH (Rear)	Output	Ignition switch ON	Turn signal switch OFF	0 V
				Turn signal switch RH	 <p style="text-align: right; font-size: small;">PKID0926E</p>	6.5 V
23 (Y)	Ground	Trunk lid open	Output	Trunk lid	OPEN (Trunk lid opener actuator is activated)	12 V
				Other than OPEN (Trunk lid opener actuator is not activated)	0 V	
25 (Y)	Ground	Turn signal LH (Rear)	Output	Ignition switch ON	Turn signal switch OFF	0 V
				Turn signal switch LH	 <p style="text-align: right; font-size: small;">PKID0926E</p>	6.5 V
30 (P)	Ground	Trunk room lamp	Output	Trunk room lamp	ON	0 V
				OFF	12 V	

# BCM (BODY CONTROL MODULE)

< ECU DIAGNOSIS INFORMATION >

[XENON TYPE]

Terminal No. (Wire color)		Description		Condition	Value (Approx.)
+	-	Signal name	Input/ Output		
34 (SB)	Ground	Trunk room antenna (-)	Output	Ignition switch OFF	<p style="text-align: right; font-size: small;">JMKIA0062GB</p>
				When Intelligent Key is not in the passenger compart- ment	<p style="text-align: right; font-size: small;">JMKIA0063GB</p>
35 (V)	Ground	Trunk room antenna (+)	Output	Ignition switch OFF	<p style="text-align: right; font-size: small;">JMKIA0062GB</p>
				When Intelligent Key is not in the passenger compart- ment	<p style="text-align: right; font-size: small;">JMKIA0063GB</p>
38 (B)	Ground	Rear bumper anten- na (-)	Output	When the trunk lid opener re- quest switch is operated with ignition switch OFF	<p style="text-align: right; font-size: small;">JMKIA0062GB</p>
				When Intelligent Key is not in the antenna detection area	<p style="text-align: right; font-size: small;">JMKIA0063GB</p>

A  
B  
C  
D  
E  
F  
G  
H  
I  
J  
K  
M  
N  
O  
P

EXL

# BCM (BODY CONTROL MODULE)

< ECU DIAGNOSIS INFORMATION >

[XENON TYPE]

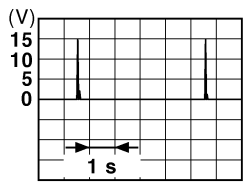
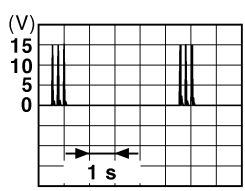
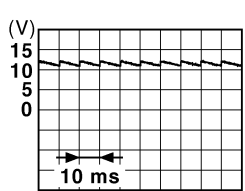
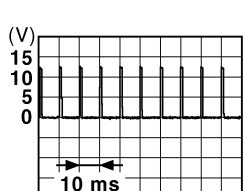
Terminal No. (Wire color)		Description		Condition	Value (Approx.)	
		Signal name	Input/ Output			
+	-					
39 (W)	Ground	Rear bumper antenna (+)	Output	When the trunk lid opener request switch is operated with ignition switch OFF	When Intelligent Key is in the antenna detection area	
				When Intelligent Key is not in the antenna detection area		
47 (Y)	Ground	Ignition relay (IPDM E/R) control	Output	Ignition switch	OFF or ACC ON 12 V 0 V	
50 (G)	Ground	Trunk room lamp switch	Input	Trunk room lamp switch	OFF (Trunk lid is closed) ON (Trunk lid is opened)  11.8 V 0 V	
52 (SB)	Ground	Starter relay control	Output	Ignition switch ON (A/T models)	When selector lever is in P or N position	12 V
				Ignition switch ON (M/T models)	When selector lever is not in P or N position	0 V
				Ignition switch ON (M/T models)	When the clutch pedal is depressed	Battery voltage
				Ignition switch ON (M/T models)	When the clutch pedal is not depressed	0 V
61 (SB)	Ground	Trunk lid opener request switch	Input	Trunk lid opener request switch	ON (Pressed)	0 V
				Trunk lid opener request switch	OFF (Not pressed)	 1.0 V
64 (G)	Ground	Intelligent Key warning buzzer (Engine room)	Output	Intelligent Key warning buzzer (Engine room)	Sounding	0 V
				Intelligent Key warning buzzer (Engine room)	Not sounding	12 V

# BCM (BODY CONTROL MODULE)

< ECU DIAGNOSIS INFORMATION >

[XENON TYPE]

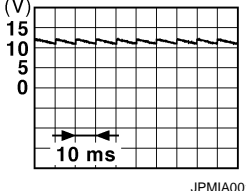
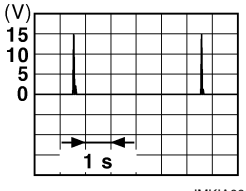
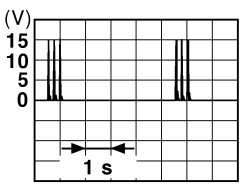
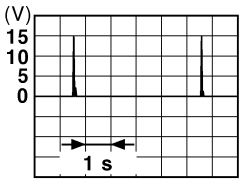
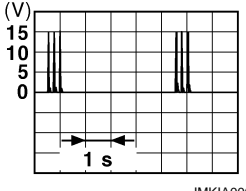
Terminal No. (Wire color)		Description		Condition	Value (Approx.)	
+	-	Signal name	Input/ Output			
67 (GR)	Ground	Trunk lid opener switch	Input	Trunk lid opener switch	Pressed	0 V
				Trunk lid opener switch	Not pressed	 <p style="text-align: center;">11.8 V</p>
72 (R)	Ground	Room antenna 2 (-) (Center console)	Output	Ignition switch OFF	When Intelligent Key is in the passenger compartment	
				Ignition switch OFF	When Intelligent Key is not in the passenger compartment	
73 (G)	Ground	Room antenna 2 (+) (Center console)	Output	Ignition switch OFF	When Intelligent Key is in the passenger compartment	
				Ignition switch OFF	When Intelligent Key is not in the passenger compartment	

A  
B  
C  
D  
E  
F  
G  
H  
I  
J  
K  
EXL  
M  
N  
O  
P

EXL

# BCM (BODY CONTROL MODULE)

< ECU DIAGNOSIS INFORMATION >

[XENON TYPE]

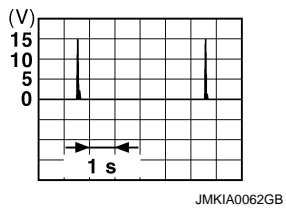
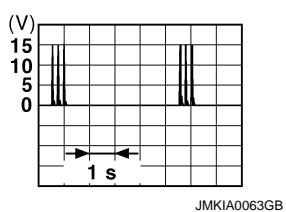
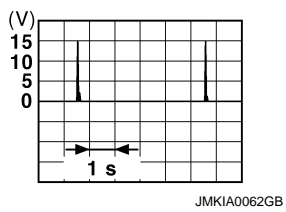
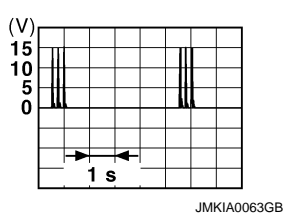
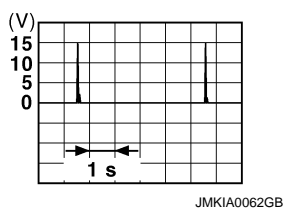
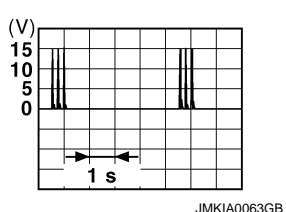
Terminal No. (Wire color)		Description		Condition	Value (Approx.)
		Signal name	Input/ Output		
+	-				
74 (SB)	Ground	Passenger door antenna (-)	Output	When Intelligent Key is in the antenna detection area	
				When the passenger door request switch is operated with ignition switch OFF	
75 (BR)	Ground	Passenger door antenna (+)	Output	When Intelligent Key is in the antenna detection area	
				When the passenger door request switch is operated with ignition switch OFF	
76 (V)	Ground	Driver door antenna (-)	Output	When Intelligent Key is in the antenna detection area	
				When the driver door request switch is operated with ignition switch OFF	



# BCM (BODY CONTROL MODULE)

< ECU DIAGNOSIS INFORMATION >

[XENON TYPE]

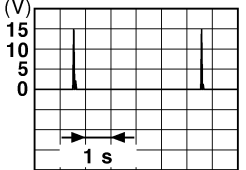
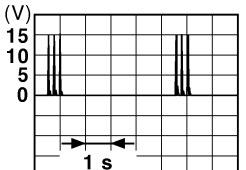
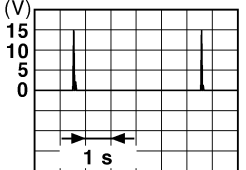
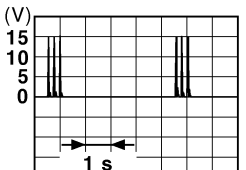
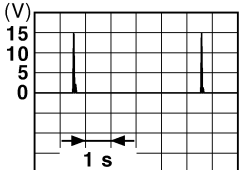
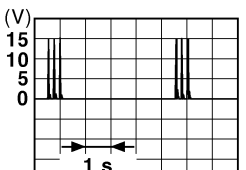
Terminal No. (Wire color)		Description		Condition	Value (Approx.)
		Signal name	Input/ Output		
+	-				
77 (LG)	Ground	Driver door antenna (+)	Output	When the driver door request switch is operated with ignition switch OFF	 <p style="text-align: right; font-size: small;">JMkia0062GB</p>
				When Intelligent Key is not in the antenna detection area	 <p style="text-align: right; font-size: small;">JMkia0063GB</p>
78 (Y)	Ground	Room antenna 1 (-) (Instrument panel)	Output	When Intelligent Key is in the passenger compartment	 <p style="text-align: right; font-size: small;">JMkia0062GB</p>
				When Intelligent Key is not in the passenger compartment	 <p style="text-align: right; font-size: small;">JMkia0063GB</p>
79 (BR)	Ground	Room antenna 1 (+) (Instrument panel)	Output	When Intelligent Key is in the passenger compartment	 <p style="text-align: right; font-size: small;">JMkia0062GB</p>
				When Intelligent Key is not in the passenger compartment	 <p style="text-align: right; font-size: small;">JMkia0063GB</p>

A  
B  
C  
D  
E  
F  
G  
H  
I  
J  
K  
M  
N  
O  
P

EXL

# BCM (BODY CONTROL MODULE)

< ECU DIAGNOSIS INFORMATION >



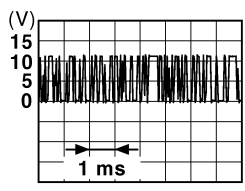
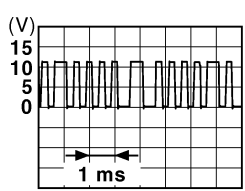
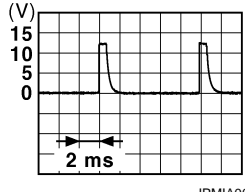
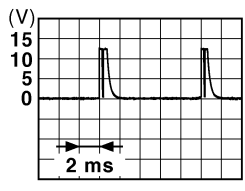
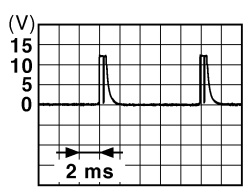

[XENON TYPE]

Terminal No. (Wire color)		Description		Condition		Value (Approx.)
+	-	Signal name	Input/ Output			
80 (GR)	Ground	NATS antenna amp.	Input/ Output	During waiting	Ignition switch is pressed while inserting the Intelligent Key into the key slot.	Just after pressing ignition switch. Pointer of tester should move.
81 (W)	Ground	NATS antenna amp.	Input/ Output	During waiting	Ignition switch is pressed while inserting the Intelligent Key into the key slot.	Just after pressing ignition switch. Pointer of tester should move.
82 (R)	Ground	Ignition relay [Fuse block (J/B)] control	Output	Ignition switch	OFF or ACC ON	0 V 12 V
83 (Y)	Ground	Remote keyless entry receiver communication	Input/ Output	During waiting		 <p style="text-align: right; font-size: small;">JMKIA0064GB</p>
				When operating either button on the Intelligent Key		 <p style="text-align: right; font-size: small;">JMKIA0065GB</p>
87 (Y)	Ground	Combination switch INPUT 5	Input	Combination switch	All switches OFF (Wiper volume dial 4)	 <p style="text-align: right; font-size: small;">JPMIA0041GB</p> <p style="text-align: center;">1.4 V</p>
					Front fog lamp switch ON (Wiper volume dial 4)	 <p style="text-align: right; font-size: small;">JPMIA0037GB</p> <p style="text-align: center;">1.3 V</p>
					Any of the conditions below with all switches OFF	<ul style="list-style-type: none"> <li>• Wiper volume dial 1</li> <li>• Wiper volume dial 2</li> <li>• Wiper volume dial 6</li> <li>• Wiper volume dial 7</li> </ul>  <p style="text-align: right; font-size: small;">JPMIA0040GB</p> <p style="text-align: center;">1.3 V</p>

# BCM (BODY CONTROL MODULE)

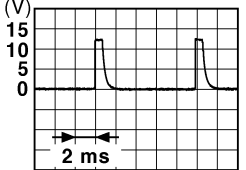
< ECU DIAGNOSIS INFORMATION >

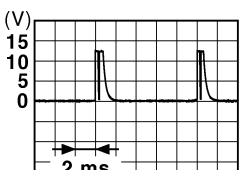
[XENON TYPE]

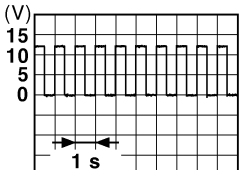
Terminal No. (Wire color)		Description		Condition	Value (Approx.)	
		Signal name	Input/ Output			
+	-					
88 (O)	Ground	Combination switch INPUT 3	Input	Combination switch	All switches OFF (Wiper volume dial 4)	 <small>JPMIA0041GB</small> 1.4 V
					Lighting switch HI (Wiper volume dial 4)	 <small>JPMIA0036GB</small> 1.3 V
					Lighting switch 2ND (Wiper volume dial 4)	 <small>JPMIA0037GB</small> 1.3 V
					Any of the conditions below with all switches OFF • Wiper volume dial 1 • Wiper volume dial 2 • Wiper volume dial 3	 <small>JPMIA0040GB</small> 1.3 V
89 (BR)	Ground	Push-button ignition switch (Push switch)	Input	Push-button ignition switch (push switch)	Pressed Not pressed	0 V Battery voltage
90 (P)	Ground	CAN-L	Input/ Output	—	—	—
91 (L)	Ground	CAN-H	Input/ Output	—	—	—
92 (LG)	Ground	Key slot illumination	Output	Key slot illumina- tion	OFF	0 V
					Blinking	 <small>JPMIA0015GB</small> 6.5 V
					ON	12 V

A  
B  
C  
D  
E  
F  
G  
H  
I  
J  
K

EXL

M  
N  
O  
P

# BCM (BODY CONTROL MODULE)

< ECU DIAGNOSIS INFORMATION >



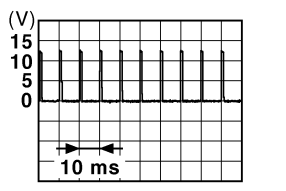
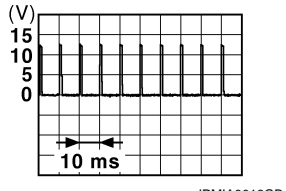

[XENON TYPE]

Terminal No. (Wire color)		Description		Condition		Value (Approx.)
		Signal name	Input/ Output			
+	-					
93 (V)	Ground	ON indicator lamp	Output	Ignition switch	OFF (LOCK indicator is not illuminated)	Battery voltage
					ON	0 V
95 (O)	Ground	ACC relay control	Output	Ignition switch	OFF	0 V
					ACC or ON	12 V
96 (GR)	Ground	A/T shift selector (Detention switch) power supply	Output	—	—	12 V
97 (L)	Ground	Steering lock condition No. 1	Input	Steering lock	LOCK status	0 V
					UNLOCK status	12 V
98 (P)	Ground	Steering lock condition No. 2	Input	Steering lock	LOCK status	12 V
					UNLOCK status	0 V
99 (R)*1 (BR)*2	Ground	Selector lever P position switch	Input	Selector lever	P position	0 V
					Any position other than P	12 V
		ASCD clutch switch (M/T models without ICC)		ASCD clutch switch	OFF (Clutch pedal is depressed)	0 V
					ON (Clutch pedal is not depressed)	12 V
		ICC clutch switch (M/T models with ICC)		ICC clutch switch	OFF (Clutch pedal is depressed)	0 V
					ON (Clutch pedal is not depressed)	12 V
100 (Y)	Ground	Passenger door request switch	Input	Passenger door request switch	ON (Pressed)	0 V
					OFF (Not pressed)	 <p style="text-align: center;">1.0 V</p>
101 (P)	Ground	Driver door request switch	Input	Driver door request switch	ON (Pressed)	0 V
					OFF (Not pressed)	 <p style="text-align: center;">1.0 V</p>
102 (O)	Ground	Blower fan motor relay control	Output	Ignition switch	OFF or ACC	0 V
					ON	12 V
103 (L)	Ground	Remote keyless entry receiver power supply	Output	Ignition switch OFF	—	12 V
106 (W)	Ground	Steering lock unit power supply	Output	Ignition switch	OFF or ACC	12 V
					ON	0 V

# BCM (BODY CONTROL MODULE)

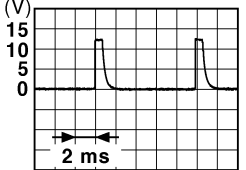
< ECU DIAGNOSIS INFORMATION >

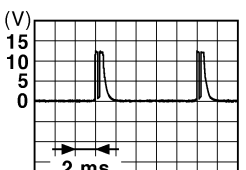
[XENON TYPE]

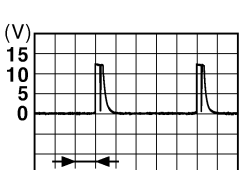
Terminal No. (Wire color)		Description		Condition	Value (Approx.)	
+	-	Signal name	Input/ Output			
107 (LG)	Ground	Combination switch INPUT 1	Input	Combination switch (Wiper volume dial 4)	All switches OFF	 <small>JPMIA0041GB</small> 1.4 V
					Turn signal switch LH	 <small>JPMIA0037GB</small> 1.3 V
					Turn signal switch RH	 <small>JPMIA0036GB</small> 1.3 V
					Front wiper switch LO	 <small>JPMIA0038GB</small> 1.3 V
					Front washer switch ON	 <small>JPMIA0039GB</small> 1.3 V

A  
B  
C  
D  
E  
F  
G  
H  
I  
J  
K  
EXL  
M  
N  
O  
P

# BCM (BODY CONTROL MODULE)

< ECU DIAGNOSIS INFORMATION >



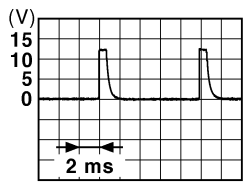
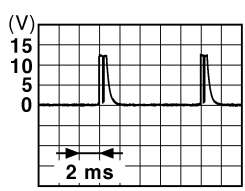
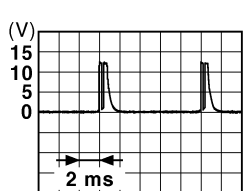
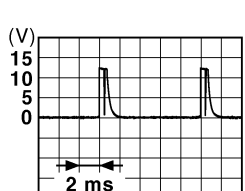

[XENON TYPE]

Terminal No. (Wire color)		Description		Condition	Value (Approx.)
+	-	Signal name	Input/ Output		
108 (R)	Ground	Combination switch INPUT 4	Input	Combination switch	All switches OFF (Wiper volume dial 4) <div style="text-align: right;">  <p style="font-size: small; margin: 0;">JPMIA0041GB</p> <p style="margin: 0;">1.4 V</p> </div>
				Lighting switch AUTO (Wiper volume dial 4)	Lighting switch AUTO (Wiper volume dial 4) <div style="text-align: right;">  <p style="font-size: small; margin: 0;">JPMIA0038GB</p> <p style="margin: 0;">1.3 V</p> </div>
				Lighting switch 1ST (Wiper volume dial 4)	Lighting switch 1ST (Wiper volume dial 4) <div style="text-align: right;">  <p style="font-size: small; margin: 0;">JPMIA0036GB</p> <p style="margin: 0;">1.3 V</p> </div>
				Any of the conditions below with all switches OFF	<ul style="list-style-type: none"> <li>• Wiper volume dial 1</li> <li>• Wiper volume dial 5</li> <li>• Wiper volume dial 6</li> </ul> <div style="text-align: right;">  <p style="font-size: small; margin: 0;">JPMIA0039GB</p> <p style="margin: 0;">1.3 V</p> </div>

# BCM (BODY CONTROL MODULE)

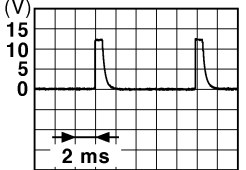
< ECU DIAGNOSIS INFORMATION >

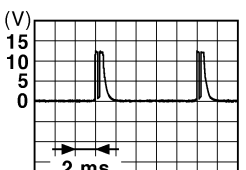
[XENON TYPE]

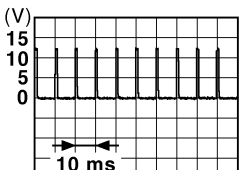
Terminal No. (Wire color)		Description		Condition	Value (Approx.)	
+	-	Signal name	Input/ Output			
109 (W)	Ground	Combination switch INPUT 2	Input	Combination switch (Wiper volume dial 4)	All switches OFF	 1.4 V
					Lighting switch PASS	 1.3 V
					Lighting switch 2ND	 1.3 V
					Front wiper switch INT/ AUTO	 1.3 V
					Front wiper switch HI	 1.3 V
					ON	0 V
110 (G)	Ground	Hazard switch	Input	Hazard switch	OFF	 1.1 V

A  
B  
C  
D  
E  
F  
G  
H  
I  
J  
K  
M  
N  
O  
P

EXL

# BCM (BODY CONTROL MODULE)

< ECU DIAGNOSIS INFORMATION >

[XENON TYPE]

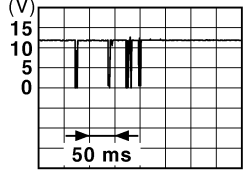
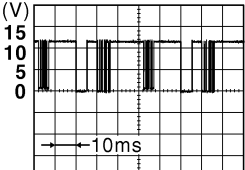
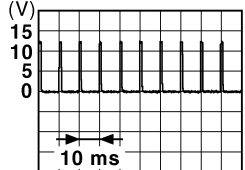
Terminal No. (Wire color)		Description		Condition	Value (Approx.)	
		Signal name	Input/ Output			
+	-					
111 (Y)	Ground	Steering lock unit communication	Input/ Output	Steering lock	LOCK status	12 V
					LOCK or UNLOCK	 <p style="text-align: right; font-size: small;">JMKIA0066GB</p>
					For 15 seconds after UN- LOCK	12 V
				15 seconds or later after UNLOCK	0 V	
112 (R)	Ground	Rain sensor serial link	Input/ Output	Ignition switch ON	 <p style="text-align: right; font-size: small;">JPMIA0156GB</p>	
					8.7 V	
113 (O)	Ground	Optical sensor	Input	Ignition switch ON	When bright outside of the vehicle	Close to 5 V
					When dark outside of the vehicle	Close to 0 V
114 (R)	Ground	Clutch interlock switch	Input	Clutch interlock switch	OFF (Clutch pedal is not depressed)	0 V
					ON (Clutch pedal is de- pressed)	Battery voltage
116 (SB)	Ground	Stop lamp switch 1	Input	—	Battery voltage	
118 (BR)	Ground	Stop lamp switch 2 (Without ICC)	Input	Stop lamp switch	OFF (Brake pedal is not depressed)	0 V
					ON (Brake pedal is de- pressed)	Battery voltage
		Stop lamp switch 2 (With ICC)		Stop lamp switch OFF (Brake pedal is not depressed) and ICC brake hold relay OFF	0 V	
				Stop lamp switch ON (Brake pedal is de- pressed) or ICC brake hold relay ON	Battery voltage	
119 (SB)	Ground	Driver side door lock assembly (Unlock sensor)	Input	Driver door	LOCK status (Unlock sensor switch OFF)	 <p style="text-align: right; font-size: small;">JPMIA0012GB</p>
					UNLOCK status (Unlock switch sensor ON)	1.1 V
					0 V	



# BCM (BODY CONTROL MODULE)

< ECU DIAGNOSIS INFORMATION >

[XENON TYPE]

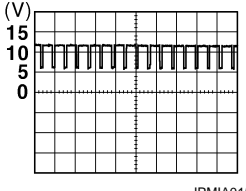
Terminal No. (Wire color)		Description		Condition	Value (Approx.)
		Signal name	Input/ Output		
+	-				
121 (SB)	Ground	Key slot switch	Input	When the Intelligent Key is inserted into key slot	12 V
				When the Intelligent Key is not inserted into key slot	0 V
123 (W)	Ground	IGN feedback	Input	Ignition switch	OFF or ACC
					ON
124 (LG)	Ground	Passenger door switch	Input	Passenger door switch	OFF (Door close)
					ON (Door open)
129 (O)	Ground	Trunk lid opener cancel switch	Input	Trunk lid opener cancel switch	CANCEL
					ON
132 (V)	Ground	Power window switch and R.H.T. control unit communication	Input/ Output	Ignition switch ON	10.2 V
				Ignition switch OFF or ACC	12 V
133 (L)	Ground	Push-button ignition switch illumination	Output	ON (Tail lamps OFF)	9.5 V
				ON (Tail lamps ON)	<p><b>NOTE:</b> The pulse width of this wave is varied by the illumination brightening/dimming level.</p> 
134 (LG)	Ground	LOCK indicator lamp	Output	LOCK indicator lamp	OFF
				ON	0 V
137 (O)	Ground	Receiver and sensor ground	Input	Ignition switch ON	0 V



A  
B  
C  
D  
E  
F  
G  
H  
I  
J  
K  
L  
M  
N  
O  
P

EXL

# BCM (BODY CONTROL MODULE)

< ECU DIAGNOSIS INFORMATION >

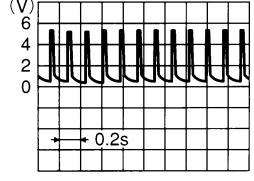
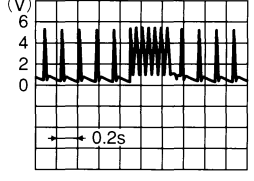
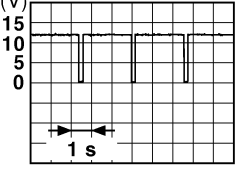
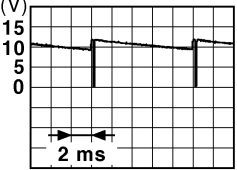
[XENON TYPE]

Terminal No. (Wire color)		Description		Condition		Value (Approx.)
		Signal name	Input/ Output			
+	-					
138 (Y)	Ground	Receiver and sensor power supply	Output	Ignition switch	OFF	0 V
					ACC or ON	5.0 V
139 (L)	Ground	Tire pressure receiver communication	Input/ Output	Ignition switch ON	Standby state	 OCC3881D
					When receiving the signal from the transmitter	 OCC3880D
140 (GR)	Ground	Selector lever P/N position (A/T models)	Input	Selector lever	P or N position	12 V
					Except P and N positions	0 V
141 (R)	Ground	Security indicator lamp	Output	Security indicator lamp	ON	0 V
					Blinking	 JPMIA0014GB 11.3 V
142 (BR)	Ground	Combination switch OUTPUT 5	Output	Combination switch (Wiper volume dial 4)	All switches OFF	0 V
					Lighting switch 1ST	 JPMIA0031GB 10.7 V
					Lighting switch HI	
					Lighting switch 2ND	
Turn signal switch RH						
143 (P)	Ground	Combination switch OUTPUT 1	Output	Combination switch	All switches OFF (Wiper volume dial 4)	0 V
					Front wiper switch HI (Wiper volume dial 4)	 JPMIA0032GB 10.7 V
					Any of the conditions below with all switches OFF <ul style="list-style-type: none"> <li>• Wiper volume dial 1</li> <li>• Wiper volume dial 2</li> <li>• Wiper volume dial 3</li> <li>• Wiper volume dial 6</li> <li>• Wiper volume dial 7</li> </ul>	

# BCM (BODY CONTROL MODULE)

< ECU DIAGNOSIS INFORMATION >

[XENON TYPE]

Terminal No. (Wire color)		Description		Condition	Value (Approx.)		
		Signal name	Input/ Output				
+	-						
144 (O)	Ground	Combination switch OUTPUT 2	Output	Combination switch	All switches OFF (Wiper volume dial 4)	0 V	
					Front washer switch ON (Wiper volume dial 4)		
					Any of the conditions below with all switches OFF		10.7 V
145 (L)	Ground	Combination switch OUTPUT 3	Output	Combination switch (Wiper volume dial 4)	All switches OFF	0 V	
					Front wiper switch INT/ AUTO		
					Front wiper switch LO		10.7 V
					Lighting switch AUTO		
146 (SB)	Ground	Combination switch OUTPUT 4	Output	Combination switch (Wiper volume dial 4)	All switches OFF	0 V	
					Front fog lamp switch ON		
					Lighting switch 2ND		10.7 V
					Lighting switch PASS		
					Turn signal switch LH		
149 (W)	Ground	Tire pressure warning check switch	Input	—	12 V		
150 (GR)	Ground	Driver door switch	Input	Driver door switch	OFF (Door close)		
					ON (Door open)		0 V
151 (G)	Ground	Rear window defog- ger relay control	Output	Rear window defogger	Active	0 V	
					Not activated	Battery voltage	

- \*1: A/T models
- \*2: M/T models

A  
B  
C  
D  
E  
F  
G  
H  
I  
J  
K  
EXL  
M  
N  
O  
P



# BCM (BODY CONTROL MODULE)

< ECU DIAGNOSIS INFORMATION >

[XENON TYPE]

◁ : With A/T  
 ▷ : With M/T

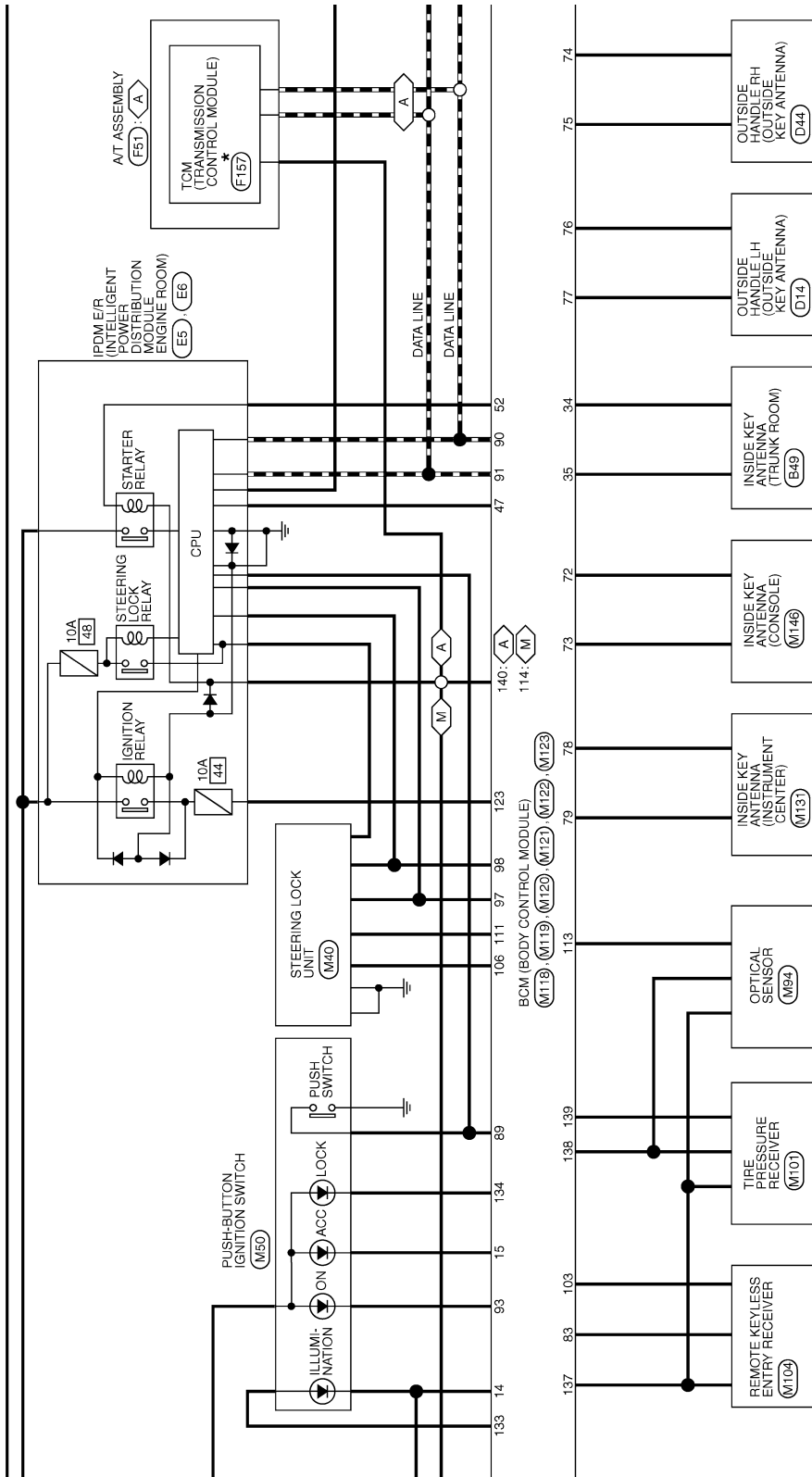

\*: This connector is not shown in "Harness Layout".

A  
 B  
 C  
 D  
 E  
 F  
 G  
 H  
 I  
 J  
 K  
 EXL  
 M  
 N  
 O  
 P

JCMWA4250GB

# BCM (BODY CONTROL MODULE)

< ECU DIAGNOSIS INFORMATION >

[XENON TYPE]

- : With A/T
- : With M/T
- : With ICC
- : Without ICC

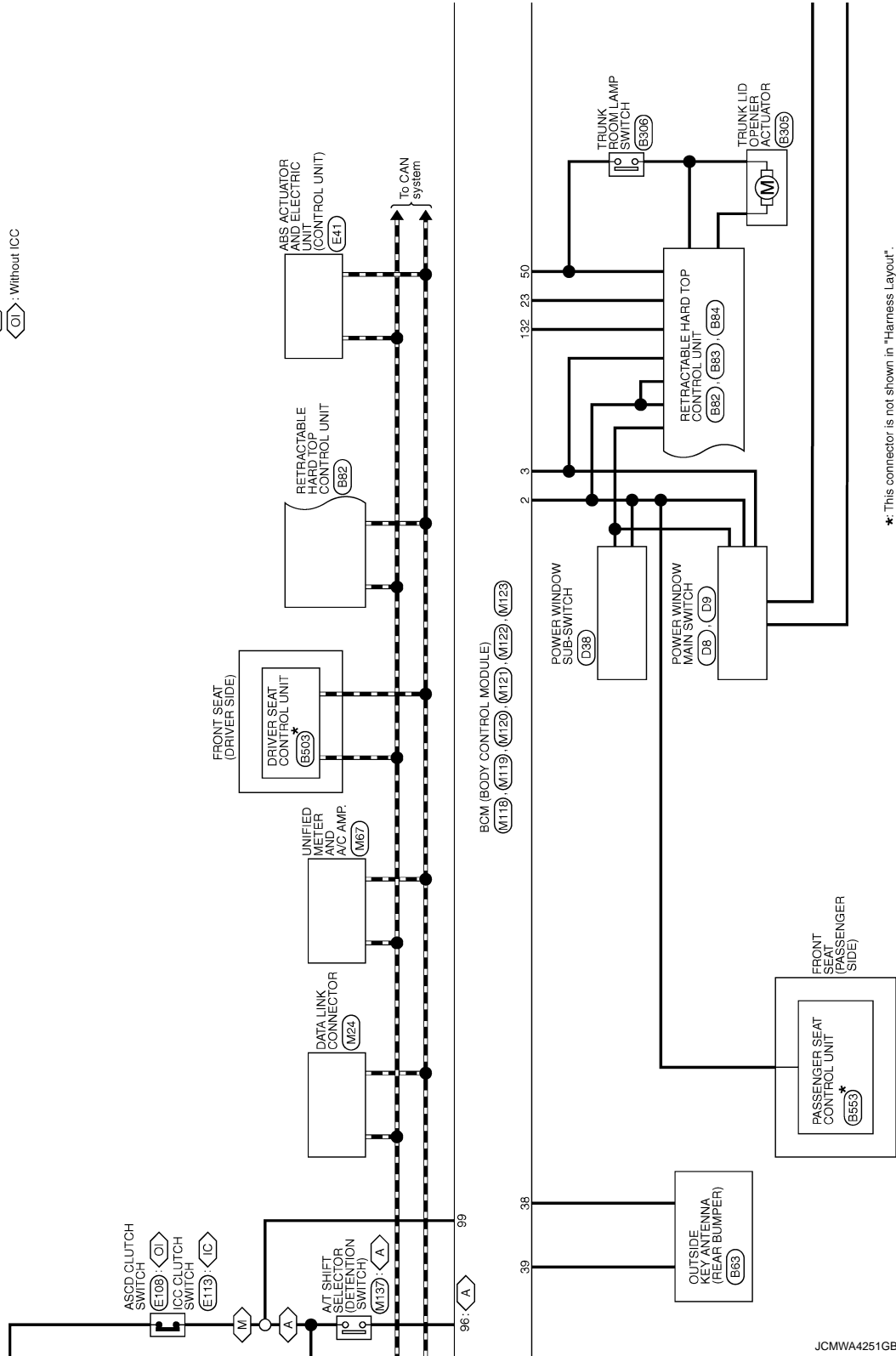

JCMWA4251GB

# BCM (BODY CONTROL MODULE)

< ECU DIAGNOSIS INFORMATION >

[XENON TYPE]

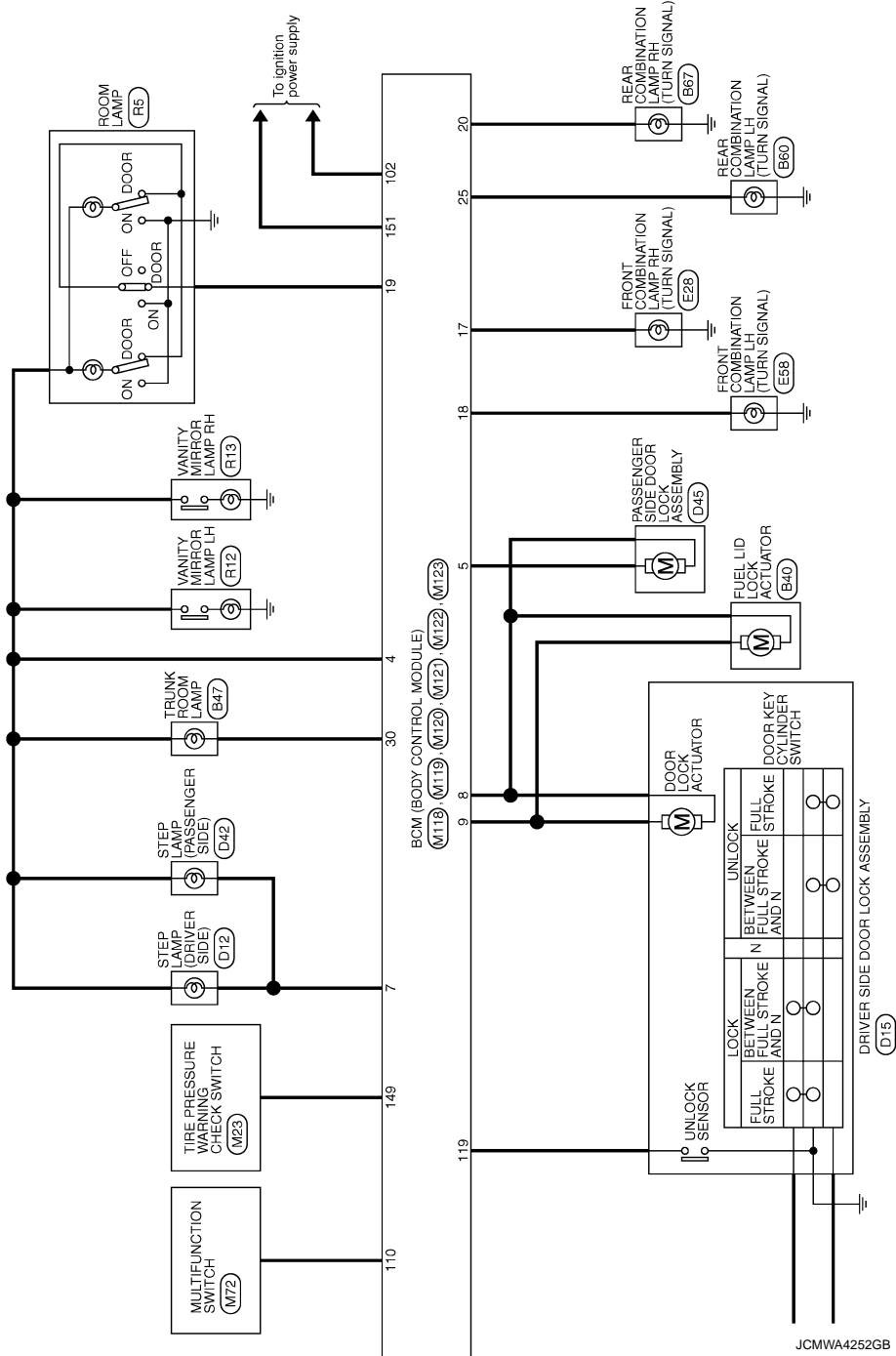

A  
B  
C  
D  
E  
F  
G  
H  
I  
J  
K  
L  
M  
N  
O  
P

EXL

# BCM (BODY CONTROL MODULE)

< ECU DIAGNOSIS INFORMATION >

[XENON TYPE]

## BCM (BODY CONTROL MODULE)

Connector No.	M33
Connector Name	COMBINATION SWITCH
Connector Type	TH16FW-NH

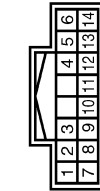

Terminal No.	Color of Wire	Signal Name [Specification]
2	SB	OUTPUT 4
5	L	OUTPUT 3
7	O	INPUT 3
8	BR	OUTPUT 5
9	W	INPUT 2
10	R	INPUT 4
11	LG	INPUT 1
12	P	OUTPUT 1
13	Y	INPUT 5
14	O	OUTPUT 2

Connector No.	M118
Connector Name	BCM (BODY CONTROL MODULE)
Connector Type	M03FB-LC



Terminal No.	Color of Wire	Signal Name [Specification]
1	W	BAT (E/L)
2	Y	POWER WINDOW POWER SUPPLY (BAT)
3	O	POWER WINDOW POWER SUPPLY (RAP)

Connector No.	M119
Connector Name	BCM (BODY CONTROL MODULE)
Connector Type	NS16FW-CS



Terminal No.	Color of Wire	Signal Name [Specification]
4	LG	INTERIOR ROOM LAMP POWER SUPPLY
5	P	PASSENGER DOOR UNLOCK OUTPUT
7	SB	STEP LAMP
8	V	ALL DOOR. FUEL LID LOCK OUTPUT
9	G	DRIVER DOOR. FUEL LID UNLOCK OUTPUT
11	R	BAT. (FUSE)
13	B	GND
14	W	PUSH-BUTTON IGNITION SW ILL GND
15	O	ASC IND
17	W	TURN SIGNAL RH (FRONT)
18	O	TURN SIGNAL LH (FRONT)

Connector No.	M120
Connector Name	BCM (BODY CONTROL MODULE)
Connector Type	NS12PW-CS

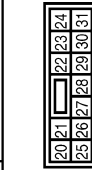

Terminal No.	Color of Wire	Signal Name [Specification]
20	V	TURN SIGNAL RH (REAR)
23	Y	TRUNK LID OPEN OUTPUT
25	Y	TURN SIGNAL LH (REAR)
30	P	TRUNK ROOM LAMP

Connector No.	M121
Connector Name	BCM (BODY CONTROL MODULE)
Connector Type	TH40FGT-NH

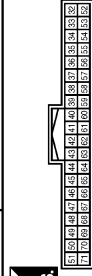

Terminal No.	Color of Wire	Signal Name [Specification]
34	SB	TRUNK ROOM ANT-
35	V	TRUNK ROOM ANT+
38	B	REAR BUMPER ANT-
39	W	REAR BUMPER ANT+
47	Y	IGN RELAY (PDM E/R) CONT
50	G	TRUNK ROOM LAMP SW
52	SB	STARTER RELAY CONT
61	SB	TRUNK LID OPENER REQUEST SW
64	G	1-KEY WARN BUZZER (ENG ROOM)
67	GR	TRUNK LID OPENER SW

Connector No.	M122
Connector Name	BCM (BODY CONTROL MODULE)
Connector Type	TH40FB-NH

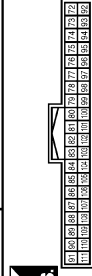

Terminal No.	Color of Wire	Signal Name [Specification]
72	R	ROOM ANT-
73	G	ROOM ANT+
74	SB	PASSENGER DOOR ANT-
75	BR	PASSENGER DOOR ANT+
76	V	DRIVER DOOR ANT-
77	LG	DRIVER DOOR ANT+
78	Y	ROOM ANT+
79	BR	ROOM ANT-
80	GR	MATS ANTENNA AMP
81	W	MATS ANTENNA AMP
82	R	IGN RELAY (P/B) CONT

19	V	ROOM LAMP TIMER CONTROL
----	---	-------------------------

83	Y	KEYLESS ENTRY RECEIVER COMM
87	Y	COMBI SW INPUT 5
88	O	COMBI SW INPUT 3
89	BR	PUSH SW
90	P	CAN-L
91	L	CAN-H
92	LG	KEY SLOT ILL
93	V	ON IND
95	O	ACC RELAY CONT
96	GR	A/T SHIF SELECTOR POWER SUPPLY
97	L	S/L CONDITION 1
98	P	S/L CONDITION 2
99	BR	ASCD/ICC CLUTCH SW [W/P M/T]
100	R	SHIF P [With A/T]
101	P	PASSENGER DOOR REQUEST SW
102	O	DRIVER DOOR REQUEST SW
103	L	BLOWER FAN MOTOR RELAY CONT
106	W	KEYLESS ENTRY RECEIVER POWER SUPPLY
107	LG	S/L UNIT POWER SUPPLY
108	R	COMBI SW INPUT 1
109	W	COMBI SW INPUT 4
110	G	COMBI SW INPUT 2
111	Y	S/L UNIT COMM



# BCM (BODY CONTROL MODULE)

< ECU DIAGNOSIS INFORMATION >

[XENON TYPE]

A  
B  
C  
D  
E  
F  
G  
H  
I  
J  
K  
EXL  
M  
N  
O  
P

**BCM (BODY CONTROL MODULE)**

Connector No.	M123
Connector Name	BCM (BODY CONTROL MODULE)
Connector Type	TH40FG-RH



Terminal No.	Color of Wire	Signal Name [Specification]
112	R	RAIN SENSOR SERIAL LINK
113	O	OPTICAL SENSOR
114	R	CLUTCH INTERLOCK SW
116	SB	STOP LAMP SW 1
118	BR	STOP LAMP SW 2
119	SB	DR DOOR UNLOCK SENSOR
121	SB	KEY SLOT SW
123	W	IGN F/B
124	LG	PASSENGER DOOR SW
129	O	TRUNK LID OPENER CANCEL SW
132	Y	P/W SW & RHT C/U COMM

133	L	PUSH-BUTTON IGNITION SW ILL POWER
134	LG	LOCK IND
137	O	RECEIVER/SENSOR GND
138	Y	RECEIVER/SENSOR POWER SUPPLY
139	L	TIRE PRESSURE RECEIVER COMM
140	GR	SHIFT N/P
141	R	SECURITY INDICATOR LAMP
142	BR	COMBET SW OUTPUT 5
143	P	COMBET SW OUTPUT 1
144	O	COMBET SW OUTPUT 2
145	L	COMBET SW OUTPUT 3
146	SB	COMBET SW OUTPUT 4
149	W	TIRE PRESSURE WARN CHECK SW
150	GR	DRIVER DOOR SW
151	G	REAR WINDOW DEFOGGER RELAY CONT

## Fail-safe

### FAIL-SAFE CONTROL BY DTC

BCM performs fail-safe control when any DTC are detected.

JCMWA4254GB

INFOID:000000005161774

# BCM (BODY CONTROL MODULE)

< ECU DIAGNOSIS INFORMATION >

[XENON TYPE]

Display contents of CONSULT	Fail-safe	Cancellation
B2013: ID DISCORD BCM-S/L	Inhibit engine cranking	Erase DTC
B2014: CHAIN OF S/L-BCM	Inhibit engine cranking	Erase DTC
B2190: NATS ANTENNA AMP	Inhibit engine cranking	Erase DTC
B2191: DIFFERENCE OF KEY	Inhibit engine cranking	Erase DTC
B2192: ID DISCORD BCM-ECM	Inhibit engine cranking	Erase DTC
B2193: CHAIN OF BCM-ECM	Inhibit engine cranking	Erase DTC
B2195: ANTI SCANNING	Inhibit engine cranking	Ignition switch ON → OFF
B2557: VEHICLE SPEED	Inhibit steering lock	When normal vehicle speed signals are received from ABS actuator and electric unit (control unit) for 500 ms
B2560: STARTER CONT RELAY	Inhibit engine cranking	500 ms after the following CAN signal communication status becomes consistent <ul style="list-style-type: none"> <li>• Starter control relay signal</li> <li>• Starter relay status signal</li> </ul>
B2601: SHIFT POSITION	Inhibit steering lock	500 ms after the following signal reception status becomes consistent <ul style="list-style-type: none"> <li>• Selector lever P position switch signal</li> <li>• P range signal (CAN)</li> </ul>
B2602: SHIFT POSITION	Inhibit steering lock	5 seconds after the following BCM recognition conditions are fulfilled <ul style="list-style-type: none"> <li>• Ignition switch is in the ON position</li> <li>• Selector lever P position switch signal: Except P position (battery voltage)</li> <li>• Vehicle speed: 4 km/h (2.5 MPH) or more</li> </ul>
B2603: SHIFT POSI STATUS	Inhibit steering lock	500 ms after the following BCM recognition conditions are fulfilled <ul style="list-style-type: none"> <li>• Ignition switch is in the ON position</li> <li>• Selector lever P position switch signal: Except P position (battery voltage)</li> <li>• Selector lever P/N position signal: Except P and N positions (0 V)</li> </ul>
B2604: PNP SW	Inhibit steering lock	500 ms after any of the following BCM recognition conditions are fulfilled <ul style="list-style-type: none"> <li>• Status 1               <ul style="list-style-type: none"> <li>- Ignition switch is in the ON position</li> <li>- Selector lever P/N position signal: P and N position (battery voltage)</li> <li>- P range signal or N range signal (CAN): ON</li> </ul> </li> <li>• Status 2               <ul style="list-style-type: none"> <li>- Ignition switch is in the ON position</li> <li>- Selector lever P/N position signal: Except P and N positions (0 V)</li> <li>- P range signal and N range signal (CAN): OFF</li> </ul> </li> </ul>
B2605: PNP SW	Inhibit steering lock	500 ms after any of the following BCM recognition conditions are fulfilled <ul style="list-style-type: none"> <li>• Status 1               <ul style="list-style-type: none"> <li>- Ignition switch is in the ON position</li> <li>- Selector lever P/N position signal: Except P and N positions (0 V)</li> <li>- Interlock/PNP switch signal (CAN): OFF</li> </ul> </li> <li>• Status 2               <ul style="list-style-type: none"> <li>- Ignition switch is in the ON position</li> <li>- Selector lever P/N position signal: P or N position (battery voltage)</li> <li>- PNP switch signal (CAN): ON</li> </ul> </li> </ul>
B2606: S/L RELAY	Inhibit engine cranking	500 ms after the following CAN signal communication status becomes consistent <ul style="list-style-type: none"> <li>• Steering lock relay signal (Request signal)</li> <li>• Steering lock relay signal (Condition signal)</li> </ul>

# BCM (BODY CONTROL MODULE)

[XENON TYPE]

< ECU DIAGNOSIS INFORMATION >

Display contents of CONSULT	Fail-safe	Cancellation
B2607: S/L RELAY	Inhibit engine cranking	500 ms after the following CAN signal communication status has becomes consistent <ul style="list-style-type: none"> <li>Steering lock relay signal (Request signal)</li> <li>Steering lock relay signal (Condition signal)</li> </ul>
B2608: STARTER RELAY	Inhibit engine cranking	500 ms after the following signal communication status becomes consistent <ul style="list-style-type: none"> <li>Starter motor relay control signal</li> <li>Starter relay status signal (CAN)</li> </ul>
B2609: S/L STATUS	<ul style="list-style-type: none"> <li>Inhibit engine cranking</li> <li>Inhibit steering lock</li> </ul>	When the following steering lock conditions agree <ul style="list-style-type: none"> <li>BCM steering lock control status</li> <li>Steering lock condition No. 1 signal status</li> <li>Steering lock condition No. 2 signal status</li> </ul>
B260A: IGNITION RELAY	Inhibit engine cranking	500 ms after the following conditions are fulfilled <ul style="list-style-type: none"> <li>IGN relay (IPDM E/R) control signal: OFF (Battery voltage)</li> <li>Ignition ON signal (CAN to IPDM E/R): OFF (Request signal)</li> <li>Ignition ON signal (CAN from IPDM E/R): OFF (Condition signal)</li> </ul>
B260F: ENG STATE SIG LOST	Maintains the power supply position attained at the time of DTC detection	When any of the following conditions are fulfilled <ul style="list-style-type: none"> <li>Power position changes to ACC</li> <li>Receives engine status signal (CAN)</li> </ul>
B2612: S/L STATUS	<ul style="list-style-type: none"> <li>Inhibit engine cranking</li> <li>Inhibit steering lock</li> </ul>	When any of the following conditions are fulfilled <ul style="list-style-type: none"> <li>Steering lock unit status signal (CAN) is received normally</li> <li>The BCM steering lock control status matches the steering lock status recognized by the steering lock unit status signal (CAN from IPDM E/R)</li> </ul>
B2617: STARTER RELAY CIRC	Inhibit engine cranking	1 second after the starter motor relay control inside BCM becomes normal
B2618: BCM	Inhibit engine cranking	1 second after the ignition relay (IPDM E/R) control inside BCM becomes normal
B2619: BCM	Inhibit engine cranking	1 second after the steering lock unit power supply output control inside BCM becomes normal
B261E: VEHICLE TYPE	Inhibit engine cranking	BCM initialization
B26E8: CLUTCH SW	Inhibit engine cranking	When any of the following BCM recognition conditions are fulfilled <ul style="list-style-type: none"> <li>Status 1 <ul style="list-style-type: none"> <li>Clutch switch signal (CAN from ECM): ON</li> <li>Clutch interlock switch signal: OFF (0 V)</li> </ul> </li> <li>Status 2 <ul style="list-style-type: none"> <li>Clutch switch signal (CAN from ECM): OFF</li> <li>Clutch interlock switch signal: ON (Battery voltage)</li> </ul> </li> </ul>
B26E9: S/L STATUS	<ul style="list-style-type: none"> <li>Inhibit engine cranking</li> <li>Inhibit steering lock</li> </ul>	When BCM transmits the LOCK request signal to steering lock unit, and receives LOCK response signal from steering lock unit, the following conditions are fulfilled <ul style="list-style-type: none"> <li>Steering condition No. 1 signal: LOCK (0 V)</li> <li>Steering condition No. 2 signal: LOCK (Battery voltage)</li> </ul>

## HIGH FLASHER OPERATION

BCM detects the turn signal lamp circuit status by the current value.

BCM increases the turn signal lamp blinking speed if the bulb or harness open is detected with the turn signal lamp operating.

### NOTE:

The blinking speed is normal while activating the hazard warning lamp.

## DTC Inspection Priority Chart

INFOID:000000005161775

If some DTCs are displayed at the same time, perform inspections one by one based on the following priority chart.

# BCM (BODY CONTROL MODULE)

< ECU DIAGNOSIS INFORMATION >

[XENON TYPE]

Priority	DTC
1	B2562: LOW VOLTAGE
2	<ul style="list-style-type: none"> <li>• U1000: CAN COMM</li> <li>• U1010: CONTROL UNIT (CAN)</li> </ul>
3	<ul style="list-style-type: none"> <li>• B2190: NATS ANTENNA AMP</li> <li>• B2191: DIFFERENCE OF KEY</li> <li>• B2192: ID DISCORD BCM-ECM</li> <li>• B2193: CHAIN OF BCM-ECM</li> <li>• B2195: ANTI SCANNING</li> </ul>
4	<ul style="list-style-type: none"> <li>• B2013: ID DISCORD BCM-S/L</li> <li>• B2014: CHAIN OF S/L-BCM</li> <li>• B2553: IGNITION RELAY</li> <li>• B2555: STOP LAMP</li> <li>• B2556: PUSH-BTN IGN SW</li> <li>• B2557: VEHICLE SPEED</li> <li>• B2560: STARTER CONT RELAY</li> <li>• B2601: SHIFT POSITION</li> <li>• B2602: SHIFT POSITION</li> <li>• B2603: SHIFT POSI STATUS</li> <li>• B2604: PNP SW</li> <li>• B2605: PNP SW</li> <li>• B2606: S/L RELAY</li> <li>• B2607: S/L RELAY</li> <li>• B2608: STARTER RELAY</li> <li>• B2609: S/L STATUS</li> <li>• B260A: IGNITION RELAY</li> <li>• B260B: STEERING LOCK UNIT</li> <li>• B260C: STEERING LOCK UNIT</li> <li>• B260D: STEERING LOCK UNIT</li> <li>• B260F: ENG STATE SIG LOST</li> <li>• B2612: S/L STATUS</li> <li>• B2614: ACC RELAY CIRC</li> <li>• B2615: BLOWER RELAY CIRC</li> <li>• B2616: IGN RELAY CIRC</li> <li>• B2617: STARTER RELAY CIRC</li> <li>• B2618: BCM</li> <li>• B2619: BCM</li> <li>• B261A: PUSH-BTN IGN SW</li> <li>• B261E: VEHICLE TYPE</li> <li>• B26E8: CLUTCH SW</li> <li>• B26E9: S/L STATUS</li> <li>• B26EA: KEY REGISTRATION</li> <li>• C1729: VHCL SPEED SIG ERR</li> <li>• U0415: VEHICLE SPEED SIG</li> </ul>

# BCM (BODY CONTROL MODULE)

< ECU DIAGNOSIS INFORMATION >

[XENON TYPE]

Priority	DTC	
5	<ul style="list-style-type: none"> <li>• C1704: LOW PRESSURE FL</li> <li>• C1705: LOW PRESSURE FR</li> <li>• C1706: LOW PRESSURE RR</li> <li>• C1707: LOW PRESSURE RL</li> <li>• C1708: [NO DATA] FL</li> <li>• C1709: [NO DATA] FR</li> <li>• C1710: [NO DATA] RR</li> <li>• C1711: [NO DATA] RL</li> <li>• C1712: [CHECKSUM ERR] FL</li> <li>• C1713: [CHECKSUM ERR] FR</li> <li>• C1714: [CHECKSUM ERR] RR</li> <li>• C1715: [CHECKSUM ERR] RL</li> <li>• C1716: [PRESSDATA ERR] FL</li> <li>• C1717: [PRESSDATA ERR] FR</li> <li>• C1718: [PRESSDATA ERR] RR</li> <li>• C1719: [PRESSDATA ERR] RL</li> <li>• C1720: [CODE ERR] FL</li> <li>• C1721: [CODE ERR] FR</li> <li>• C1722: [CODE ERR] RR</li> <li>• C1723: [CODE ERR] RL</li> <li>• C1724: [BATT VOLT LOW] FL</li> <li>• C1725: [BATT VOLT LOW] FR</li> <li>• C1726: [BATT VOLT LOW] RR</li> <li>• C1727: [BATT VOLT LOW] RL</li> <li>• C1734: CONTROL UNIT</li> </ul>	A B C D E F G
6	<ul style="list-style-type: none"> <li>• B2621: INSIDE ANTENNA</li> <li>• B2622: INSIDE ANTENNA</li> <li>• B2623: INSIDE ANTENNA</li> </ul>	H

## DTC Index

INFOID:000000005161776

### NOTE:

The details of time display are as follows.

- CRNT: A malfunction is detected now.
- PAST: A malfunction was detected in the past.

IGN counter is displayed on Freeze Frame Data. For details of Freeze Frame Data, refer to [BCS-15. "COMMON ITEM : CONSULT-III Function \(BCM - COMMON ITEM\)"](#).

CONSULT display	Fail-safe	Freeze Frame Data •Vehicle Speed •Odo/Trip Meter •Vehicle condition	Intelligent Key warning lamp ON	Tire pressure monitor warning lamp ON	Refer- ence page
No DTC is detected. further testing may be required.	—	—	—	—	—
U1000: CAN COMM	—	—	—	—	<a href="#">BCS-36</a>
U1010: CONTROL UNIT (CAN)	—	—	—	—	<a href="#">BCS-37</a>
U0415: VEHICLE SPEED SIG	—	—	—	—	<a href="#">BCS-38</a>
B2013: ID DISCORD BCM-S/L	×	×	—	—	<a href="#">SEC-46</a>
B2014: CHAIN OF S/L-BCM	×	×	—	—	<a href="#">SEC-47</a>
B2190: NATS ANTENNA AMP	×	—	—	—	<a href="#">SEC-38</a>
B2191: DIFFERENCE OF KEY	×	—	—	—	<a href="#">SEC-41</a>
B2192: ID DISCORD BCM-ECM	×	—	—	—	<a href="#">SEC-42</a>
B2193: CHAIN OF BCM-ECM	×	—	—	—	<a href="#">SEC-44</a>
B2195: ANTI SCANNING	×	—	—	—	<a href="#">SEC-45</a>
B2553: IGNITION RELAY	—	×	—	—	<a href="#">PCS-47</a>
B2555: STOP LAMP	—	×	—	—	<a href="#">SEC-50</a>

# BCM (BODY CONTROL MODULE)

< ECU DIAGNOSIS INFORMATION >

[XENON TYPE]

CONSULT display	Fail-safe	Freeze Frame Data •Vehicle Speed •Odo/Trip Meter •Vehicle condition	Intelligent Key warning lamp ON	Tire pressure monitor warning lamp ON	Refer- ence page
B2556: PUSH-BTN IGN SW	—	×	×	—	<a href="#">SEC-52</a>
B2557: VEHICLE SPEED	×	×	×	—	<a href="#">SEC-54</a>
B2560: STARTER CONT RELAY	×	×	×	—	<a href="#">SEC-55</a>
B2562: LOW VOLTAGE	—	×	—	—	<a href="#">BCS-39</a>
B2601: SHIFT POSITION	×	×	×	—	<a href="#">SEC-56</a>
B2602: SHIFT POSITION	×	×	×	—	<a href="#">SEC-59</a>
B2603: SHIFT POSI STATUS	×	×	×	—	<a href="#">SEC-61</a>
B2604: PNP SW	×	×	×	—	<a href="#">SEC-64</a>
B2605: PNP SW	×	×	×	—	<a href="#">SEC-66</a>
B2606: S/L RELAY	×	×	×	—	<a href="#">SEC-68</a>
B2607: S/L RELAY	×	×	×	—	<a href="#">SEC-69</a>
B2608: STARTER RELAY	×	×	×	—	<a href="#">SEC-71</a>
B2609: S/L STATUS	×	×	×	—	<a href="#">SEC-73</a>
B260A: IGNITION RELAY	×	×	×	—	<a href="#">PCS-49</a>
B260B: STEERING LOCK UNIT	—	×	×	—	<a href="#">SEC-77</a>
B260C: STEERING LOCK UNIT	—	×	×	—	<a href="#">SEC-78</a>
B260D: STEERING LOCK UNIT	—	×	×	—	<a href="#">SEC-79</a>
B260F: ENG STATE SIG LOST	×	×	×	—	<a href="#">SEC-80</a>
B2612: S/L STATUS	×	×	×	—	<a href="#">SEC-85</a>
B2614: ACC RELAY CIRC	—	×	×	—	<a href="#">PCS-51</a>
B2615: BLOWER RELAY CIRC	—	×	×	—	<a href="#">PCS-54</a>
B2616: IGN RELAY CIRC	—	×	×	—	<a href="#">PCS-57</a>
B2617: STARTER RELAY CIRC	×	×	×	—	<a href="#">SEC-89</a>
B2618: BCM	×	×	×	—	<a href="#">PCS-60</a>
B2619: BCM	×	×	×	—	<a href="#">SEC-91</a>
B261A: PUSH-BTN IGN SW	—	×	×	—	<a href="#">PCS-61</a>
B261E: VEHICLE TYPE	×	×	× (Turn ON for 15 seconds)	—	<a href="#">SEC-92</a>
B2621: INSIDE ANTENNA	—	×	—	—	<a href="#">DLK-61</a>
B2622: INSIDE ANTENNA	—	×	—	—	<a href="#">DLK-63</a>
B2623: INSIDE ANTENNA	—	×	—	—	<a href="#">DLK-65</a>
B26E8: CLUTCH SW	×	×	×	—	<a href="#">SEC-81</a>
B26E9: S/L STATUS	×	×	× (Turn ON for 15 seconds)	—	<a href="#">SEC-83</a>
B26EA: KEY REGISTRATION	—	×	× (Turn ON for 15 seconds)	—	<a href="#">SEC-84</a>
C1704: LOW PRESSURE FL	—	—	—	×	<a href="#">WT-17</a>
C1705: LOW PRESSURE FR	—	—	—	×	
C1706: LOW PRESSURE RR	—	—	—	×	
C1707: LOW PRESSURE RL	—	—	—	×	

# BCM (BODY CONTROL MODULE)

< ECU DIAGNOSIS INFORMATION >

[XENON TYPE]

CONSULT display	Fail-safe	Freeze Frame Data •Vehicle Speed •Odo/Trip Meter •Vehicle condition	Intelligent Key warning lamp ON	Tire pressure monitor warning lamp ON	Refer- ence page
C1708: [NO DATA] FL	—	—	—	×	<a href="#">WT-19</a>
C1709: [NO DATA] FR	—	—	—	×	
C1710: [NO DATA] RR	—	—	—	×	
C1711: [NO DATA] RL	—	—	—	×	<a href="#">WT-22</a>
C1712: [CHECKSUM ERR] FL	—	—	—	×	
C1713: [CHECKSUM ERR] FR	—	—	—	×	
C1714: [CHECKSUM ERR] RR	—	—	—	×	
C1715: [CHECKSUM ERR] RL	—	—	—	×	<a href="#">WT-25</a>
C1716: [PRESSDATA ERR] FL	—	—	—	×	
C1717: [PRESSDATA ERR] FR	—	—	—	×	
C1718: [PRESSDATA ERR] RR	—	—	—	×	<a href="#">WT-27</a>
C1719: [PRESSDATA ERR] RL	—	—	—	×	
C1720: [CODE ERR] FL	—	—	—	×	
C1721: [CODE ERR] FR	—	—	—	×	
C1722: [CODE ERR] RR	—	—	—	×	<a href="#">WT-30</a>
C1723: [CODE ERR] RL	—	—	—	×	
C1724: [BATT VOLT LOW] FL	—	—	—	×	
C1725: [BATT VOLT LOW] FR	—	—	—	×	
C1726: [BATT VOLT LOW] RR	—	—	—	×	<a href="#">WT-33</a>
C1727: [BATT VOLT LOW] RL	—	—	—	×	
C1729: VHCL SPEED SIG ERR	—	—	—	×	<a href="#">WT-35</a>
C1734: CONTROL UNIT	—	—	—	×	<a href="#">WT-35</a>

A  
B  
C  
D  
E  
F  
G  
H  
I  
J  
K  
L  
M  
N  
O  
P

EXL

# IPDM E/R (INTELLIGENT POWER DISTRIBUTION MODULE ENGINE ROOM)

< ECU DIAGNOSIS INFORMATION >

[XENON TYPE]

## IPDM E/R (INTELLIGENT POWER DISTRIBUTION MODULE ENGINE ROOM)

Reference Value

INFOID:000000005161777

### VALUES ON THE DIAGNOSIS TOOL

Monitor Item	Condition		Value/Status
RAD FAN REQ	Engine idle speed	Changes depending on engine coolant temperature, air conditioner operation status, vehicle speed, etc.	0 - 100 %
AC COMP REQ	Engine running	A/C switch OFF	Off
		A/C switch ON (Compressor is operating)	On
TAIL&CLR REQ	Lighting switch OFF		Off
	Lighting switch 1ST, 2ND, HI or AUTO (Light is illuminated)		On
HL LO REQ	Lighting switch OFF		Off
	Lighting switch 2ND HI or AUTO (Light is illuminated)		On
HL HI REQ	Lighting switch OFF		Off
	Lighting switch HI		On
FR FOG REQ	Lighting switch 2ND or AUTO (Light is illuminated)	Front fog lamp switch OFF	Off
		<ul style="list-style-type: none"> <li>• Front fog lamp switch ON</li> <li>• Daytime running light activated (Only for Canada)</li> </ul>	On
FR WIP REQ	Ignition switch ON	Front wiper switch OFF	Stop
		Front wiper switch INT	1LOW
		Front wiper switch LO	Low
		Front wiper switch HI	Hi
WIP AUTO STOP	Ignition switch ON	Front wiper stop position	STOP P
		Any position other than front wiper stop position	ACT P
WIP PROT	Ignition switch ON	Front wiper operates normally	Off
		Front wiper stops at fail-safe operation	BLOCK
IGN RLY1 -REQ	Ignition switch OFF or ACC		Off
	Ignition switch ON		On
IGN RLY	Ignition switch OFF or ACC		Off
	Ignition switch ON		On
PUSH SW	Release the push-button ignition switch		Off
	Press the push-button ignition switch		On
INTER/NP SW	Ignition switch ON	Selector lever in any position other than P or N (A/T models)	Off
		Release clutch pedal (M/T models)	
	Ignition switch ON	Selector lever in P or N position (A/T models)	On
		Depress clutch pedal (M/T models)	
ST RLY CONT	Ignition switch ON		Off
	At engine cranking		On



# IPDM E/R (INTELLIGENT POWER DISTRIBUTION MODULE ENGINE ROOM)

< ECU DIAGNOSIS INFORMATION >

[XENON TYPE]

Monitor Item	Condition	Value/Status
IHBT RLY -REQ	Ignition switch ON	Off
	At engine cranking	On
ST/INHI RLY	Ignition switch ON	Off
	At engine cranking	INHI ON → ST ON
	The status of starter relay or starter control relay cannot be recognized by the battery voltage malfunction, etc. when the starter relay is ON and the starter control relay is OFF	UNKWN
DETENT SW	Ignition switch ON <ul style="list-style-type: none"> <li>• Press the selector button with selector lever in P position</li> <li>• Selector lever in any position other than P</li> </ul>	Off
	Release the selector button with selector lever in P position <b>NOTE:</b> Fixed On for M/T models	On
S/L RLY -REQ	None of the conditions below are present	Off
	<ul style="list-style-type: none"> <li>• Open the driver door after the ignition switch is turned OFF (for a few seconds)</li> <li>• Press the push-button ignition switch when the steering lock is activated</li> <li>• Depress the clutch pedal when the steering lock is activated</li> </ul>	On
S/L STATE	Steering lock is activated	LOCK
	Steering lock is deactivated	UNLOCK
	[DTC: B210A] is detected	UNKWN
DTRL REQ	<b>NOTE:</b> The item is indicated, but not monitored.	Off
OIL P SW	Ignition switch OFF, ACC or engine running	Open
	Ignition switch ON	Close
HOOD SW	Close the hood	Off
	Open the hood	On
HL WASHER REQ	<b>NOTE:</b> The item is indicated, but not monitored.	Off
THFT HRN REQ	Not operation	Off
	<ul style="list-style-type: none"> <li>• Panic alarm is activated</li> <li>• Horn is activated with VEHICLE SECURITY (THEFT WARNING) SYSTEM</li> </ul>	On
HORN CHIRP	Not operating	Off
	Door locking with Intelligent Key (horn chirp mode)	On
CRNRNG LMP REQ	<b>NOTE:</b> The item is indicated, but not monitored.	Off

A  
B  
C  
D  
E  
F  
G  
H  
I  
J  
K  
EXL  
M  
N  
O  
P

# IPDM E/R (INTELLIGENT POWER DISTRIBUTION MODULE ENGINE ROOM)

< ECU DIAGNOSIS INFORMATION >

[XENON TYPE]

## TERMINAL LAYOUT

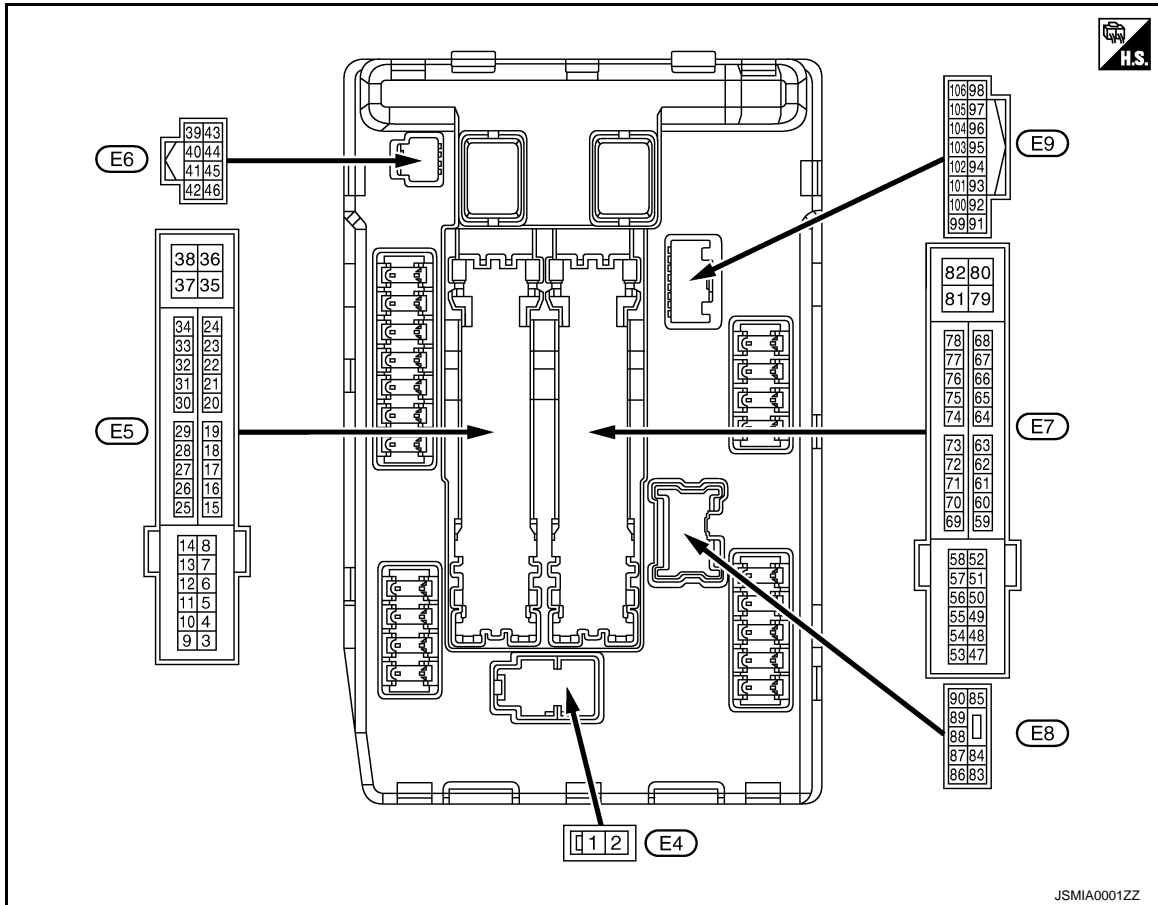

## PHYSICAL VALUES

Terminal No. (Wire color)		Description		Condition		Value (Approx.)
+	-	Signal name	Input/ Output			
1 (W)	Ground	Battery power supply	Input	Ignition switch OFF		Battery voltage
2 (L)	Ground	Battery power supply	Input	Ignition switch OFF		Battery voltage
4 (V)	Ground	Front wiper LO	Output	Ignition switch OFF	Front wiper switch OFF	0 V
				Ignition switch ON	Front wiper switch LO	Battery voltage
5 (L)	Ground	Front wiper HI	Output	Ignition switch OFF	Front wiper switch OFF	0 V
				Ignition switch ON	Front wiper switch HI	Battery voltage
7 (R)	Ground	Tail, license plate lamps & illuminations	Output	Ignition switch OFF	Lighting switch OFF	0 V
				Ignition switch ON	Lighting switch 1ST	Battery voltage
11 (BR)	Ground	Steering lock unit power supply	Output	Ignition switch OFF	A few seconds after opening the driver door	Battery voltage
				Ignition switch LOCK	Press the push-button ignition switch	Battery voltage
				Ignition switch ACC or ON		0 V
12 (B/W)	Ground	Ground	—	Ignition switch ON		0 V

# IPDM E/R (INTELLIGENT POWER DISTRIBUTION MODULE ENGINE ROOM)

< ECU DIAGNOSIS INFORMATION >

[XENON TYPE]

Terminal No. (Wire color)		Description		Condition		Value (Approx.)
+	-	Signal name	Input/ Output			
13 (Y)	Ground	Fuel pump power supply	Output	Approximately 1 second or more after turning the ignition switch ON		0 V
				<ul style="list-style-type: none"> <li>• Approximately 1 second after turning the ignition switch ON</li> <li>• Engine running</li> </ul>		Battery voltage
16 (LG)	Ground	Front wiper auto stop	Input	Ignition switch ON	Front wiper stop position	0 V
				Ignition switch ON	Any position other than front wiper stop position	Battery voltage
19 (W)	Ground	Ignition relay power supply	Output	Ignition switch OFF		0 V
				Ignition switch ON		Battery voltage
25 (G)	Ground	Ignition relay power supply	Output	Ignition switch OFF		0 V
				Ignition switch ON		Battery voltage
26*1 (R)	Ground	Ignition relay power supply	Output	Ignition switch OFF		0 V
				Ignition switch ON		Battery voltage
27 (O)	Ground	Ignition relay monitor	Input	Ignition switch OFF or ACC		Battery voltage
				Ignition switch ON		0 V
28 (L)	Ground	Push-button ignition switch	Input	Press the push-button ignition switch		0 V
				Release the push-button ignition switch		Battery voltage
30 (GR)	Ground	Starter relay control	Input	A/T models	Selector lever in any position other than P or N (Ignition switch ON)	0 V
					Selector lever P or N (Ignition switch ON)	Battery voltage
				M/T models	Release the clutch pedal	0 V
					Depress the clutch pedal	Battery voltage
32 (V)	Ground	Steering lock unit condition-1	Input	Steering lock is activated		0 V
				Steering lock is deactivated		Battery voltage
33 (P)	Ground	Steering lock unit condition-2	Input	Steering lock is activated		Battery voltage
				Steering lock is deactivated		0 V
36 (G)	Ground	Battery power supply	Input	Ignition switch OFF		Battery voltage
39 (P)	—	CAN-L	Input/ Output	—		—
40 (L)	—	CAN-H	Input/ Output	—		—
41 (B/W)	Ground	Ground	—	Ignition switch ON		0 V
42 (Y)	Ground	Cooling fan relay control	Input	Ignition switch OFF or ACC		0 V
				Ignition switch ON		0.7 V
43*2 (SB)	Ground	A/T shift selector (Detention switch)	Input	Ignition switch ON	Press the selector button (selector lever P)	Battery voltage
					<ul style="list-style-type: none"> <li>• Selector lever in any position other than P</li> <li>• Release the selector button (selector lever P)</li> </ul>	
44 (W)	Ground	Horn relay control	Input	The horn is deactivated		Battery voltage
				The horn is activated		0 V

A  
B  
C  
D  
E  
F  
G  
H  
I  
J  
K  
EXL  
M  
N  
O  
P

# IPDM E/R (INTELLIGENT POWER DISTRIBUTION MODULE ENGINE ROOM)

< ECU DIAGNOSIS INFORMATION >

[XENON TYPE]

Terminal No. (Wire color)		Description		Condition		Value (Approx.)
+	-	Signal name	Input/ Output			
45 (G)	Ground	Anti theft horn relay control	Input	The horn is deactivated		Battery voltage
				The horn is activated		0 V
46 (R)	Ground	Starter relay control	Input	A/T models	Selector lever in any position other than P or N (Ignition switch ON)	0 V
					Selector lever P or N (Ignition switch ON)	Battery voltage
				M/T models	Release the clutch pedal	0 V
					Depress the clutch pedal	Battery voltage
48 (BR)	Ground	A/C relay power supply	Output	Engine running	A/C switch OFF	0 V
					A/C switch ON (A/C compressor is operating)	Battery voltage
49 (O)	Ground	ECM relay power supply	Output	Ignition switch OFF (More than a few seconds after turning ignition switch OFF)		0 V
				<ul style="list-style-type: none"> <li>Ignition switch ON</li> <li>Ignition switch OFF (For a few seconds after turning ignition switch OFF)</li> </ul>		Battery voltage
51 (Y)	Ground	Ignition relay power supply	Output	Ignition switch OFF		0 V
				Ignition switch ON		Battery voltage
53 (W)	Ground	ECM relay power supply	Output	Ignition switch OFF (More than a few seconds after turning ignition switch OFF)		0 V
				<ul style="list-style-type: none"> <li>Ignition switch ON</li> <li>Ignition switch OFF (For a few seconds after turning ignition switch OFF)</li> </ul>		Battery voltage
54 (P)	Ground	Throttle control motor relay power supply	Output	Ignition switch OFF (More than a few seconds after turning ignition switch OFF)		0 V
				<ul style="list-style-type: none"> <li>Ignition switch ON</li> <li>Ignition switch OFF (For a few seconds after turning ignition switch OFF)</li> </ul>		Battery voltage
55 (SB)	Ground	ECM power supply	Output	Ignition switch OFF		Battery voltage
56 (LG)	Ground	Ignition relay power supply	Output	Ignition switch OFF		0 V
				Ignition switch ON		Battery voltage
57 (G)	Ground	Ignition relay power supply	Output	Ignition switch OFF		0 V
				Ignition switch ON		Battery voltage
58*2 (R)	Ground	Ignition relay power supply	Output	Ignition switch OFF		0 V
				Ignition switch ON		Battery voltage
69 (BR)	Ground	ECM relay control	Output	Ignition switch OFF (More than a few seconds after turning ignition switch OFF)		Battery voltage
				<ul style="list-style-type: none"> <li>Ignition switch ON</li> <li>Ignition switch OFF (For a few seconds after turning ignition switch OFF)</li> </ul>		0 - 1.5 V

# IPDM E/R (INTELLIGENT POWER DISTRIBUTION MODULE ENGINE ROOM)

< ECU DIAGNOSIS INFORMATION >

[XENON TYPE]

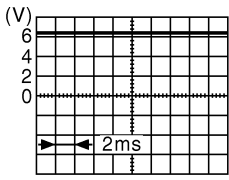
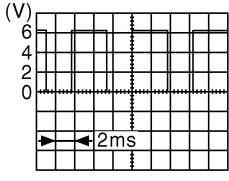
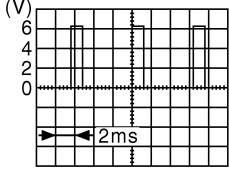
Terminal No. (Wire color)		Description		Condition		Value (Approx.)
		Signal name	Input/ Output			
70 (O)	Ground	Throttle control motor re- lay control	Output	Ignition switch ON → OFF	0 - 1.0 V ↓ Battery voltage ↓ 0 V	
				Ignition switch ON	0 - 1.0 V	
73*3 (P)	Ground	Ignition relay power supply	Output	Ignition switch OFF	0 V	
				Ignition switch ON	Battery voltage	
74 (G)	Ground	Ignition relay power supply	Output	Ignition switch OFF	0 V	
				Ignition switch ON	Battery voltage	
75 (SB)	Ground	Oil pressure switch	Input	Ignition switch ON	Engine stopped	0 V
				Engine running	Battery voltage	
76 (Y)	Ground	Power generation com- mand signal	Output	Ignition switch ON	 <p style="text-align: right; font-size: small;">JPMIA0001GB</p> <p style="text-align: center;">6.3 V</p>	
				40% is set on "ACTIVE TEST", "AL- TERNATOR DUTY" of "ENGINE"	 <p style="text-align: right; font-size: small;">JPMIA0002GB</p> <p style="text-align: center;">3.8 V</p>	
				80% is set on "ACTIVE TEST", "AL- TERNATOR DUTY" of "ENGINE"	 <p style="text-align: right; font-size: small;">JPMIA0003GB</p> <p style="text-align: center;">1.4 V</p>	
77 (R)	Ground	Fuel pump relay control	Output	<ul style="list-style-type: none"> <li>• Approximately 1 second after turning the ignition switch ON</li> <li>• Engine running</li> </ul>	0 - 1.0 V	
				Approximately 1 second or more after turning the ignition switch ON	Battery voltage	
80 (W)	Ground	Starter motor	Output	At engine cranking	Battery voltage	
83 (R)	Ground	Headlamp LO (RH)	Output	Ignition switch ON	Lighting switch OFF	0 V
				Lighting switch 2ND	Battery voltage	
84 (P)	Ground	Headlamp LO (LH)	Output	Ignition switch ON	Lighting switch OFF	0 V
				Lighting switch 2ND	Battery voltage	

A  
B  
C  
D  
E  
F  
G  
H  
I  
J  
K  
EXL  
M  
N  
O  
P

# IPDM E/R (INTELLIGENT POWER DISTRIBUTION MODULE ENGINE ROOM)

< ECU DIAGNOSIS INFORMATION >

[XENON TYPE]

Terminal No. (Wire color)		Description		Condition		Value (Approx.)
+	-	Signal name	Input/ Output			
86 (W)	Ground	Front fog lamp (RH)	Output	Lighting switch 2ND	Front fog lamp switch OFF	0 V
					<ul style="list-style-type: none"> <li>• Front fog lamp switch ON</li> <li>• Daytime running light activated (Only for Canada)</li> </ul>	Battery voltage
87 (L)	Ground	Front fog lamp (LH)	Output	Lighting switch 2ND	Front fog lamp switch OFF	0 V
					<ul style="list-style-type: none"> <li>• Front fog lamp switch ON</li> <li>• Daytime running light activated (Only for Canada)</li> </ul>	Battery voltage
88 (G)	Ground	Washer pump power supply	Output	Ignition switch ON		Battery voltage
89 (BR)	Ground	Headlamp HI (RH)	Output	Ignition switch ON	Lighting switch OFF	0 V
					<ul style="list-style-type: none"> <li>• Lighting switch HI</li> <li>• Lighting switch PASS</li> </ul>	Battery voltage
90 (LG)	Ground	Headlamp HI (LH)	Output	Ignition switch ON	Lighting switch OFF	0 V
					<ul style="list-style-type: none"> <li>• Lighting switch HI</li> <li>• Lighting switch PASS</li> </ul>	Battery voltage
91 (P)	Ground	Parking lamp (RH)	Output	Ignition switch ON	Lighting switch OFF	0 V
					Lighting switch 1ST	Battery voltage
92 (O)	Ground	Parking lamp (LH)	Output	Ignition switch ON	Lighting switch OFF	0 V
					Lighting switch 1ST	Battery voltage
97 (V)	Ground	Cooling fan control	Output	Engine idling		0 - 5 V
104 (LG)	Ground	Hood switch	Input	Close the hood		Battery voltage
				Open the hood		0 V

\*1: Only for the models with ICC system

\*2: A/T models only

\*3: M/T models only

# IPDM E/R (INTELLIGENT POWER DISTRIBUTION MODULE ENGINE ROOM)

< ECU DIAGNOSIS INFORMATION >

[XENON TYPE]

## Wiring Diagram - IPDM E/R -

INFOID:000000005161778

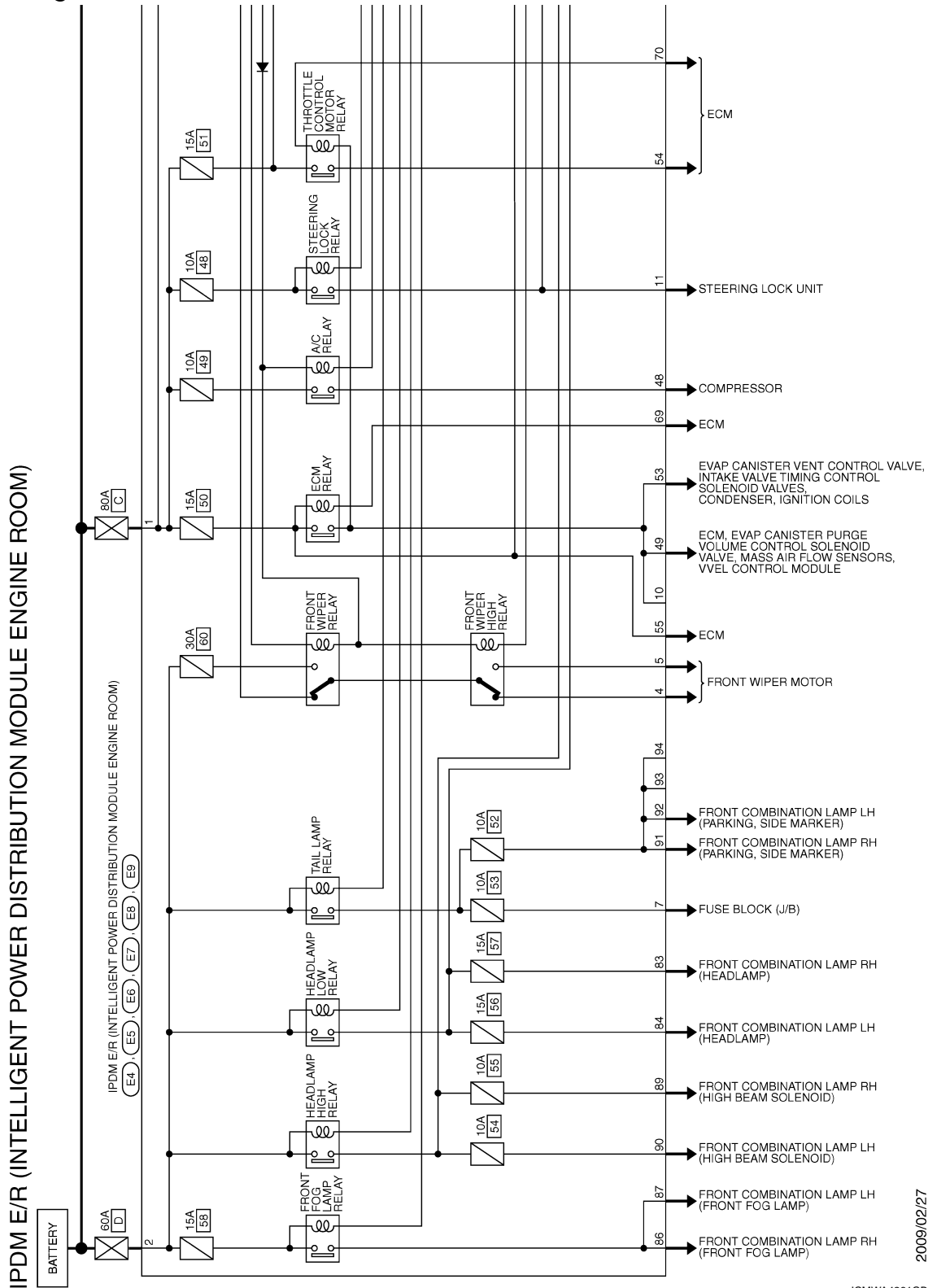

A  
B  
C  
D  
E  
F  
G  
H  
I  
J  
K  
EXL  
M  
N  
O  
P

2009/02/27

JCMWA4261GB

# IPDM E/R (INTELLIGENT POWER DISTRIBUTION MODULE ENGINE ROOM)

< ECU DIAGNOSIS INFORMATION >

[XENON TYPE]

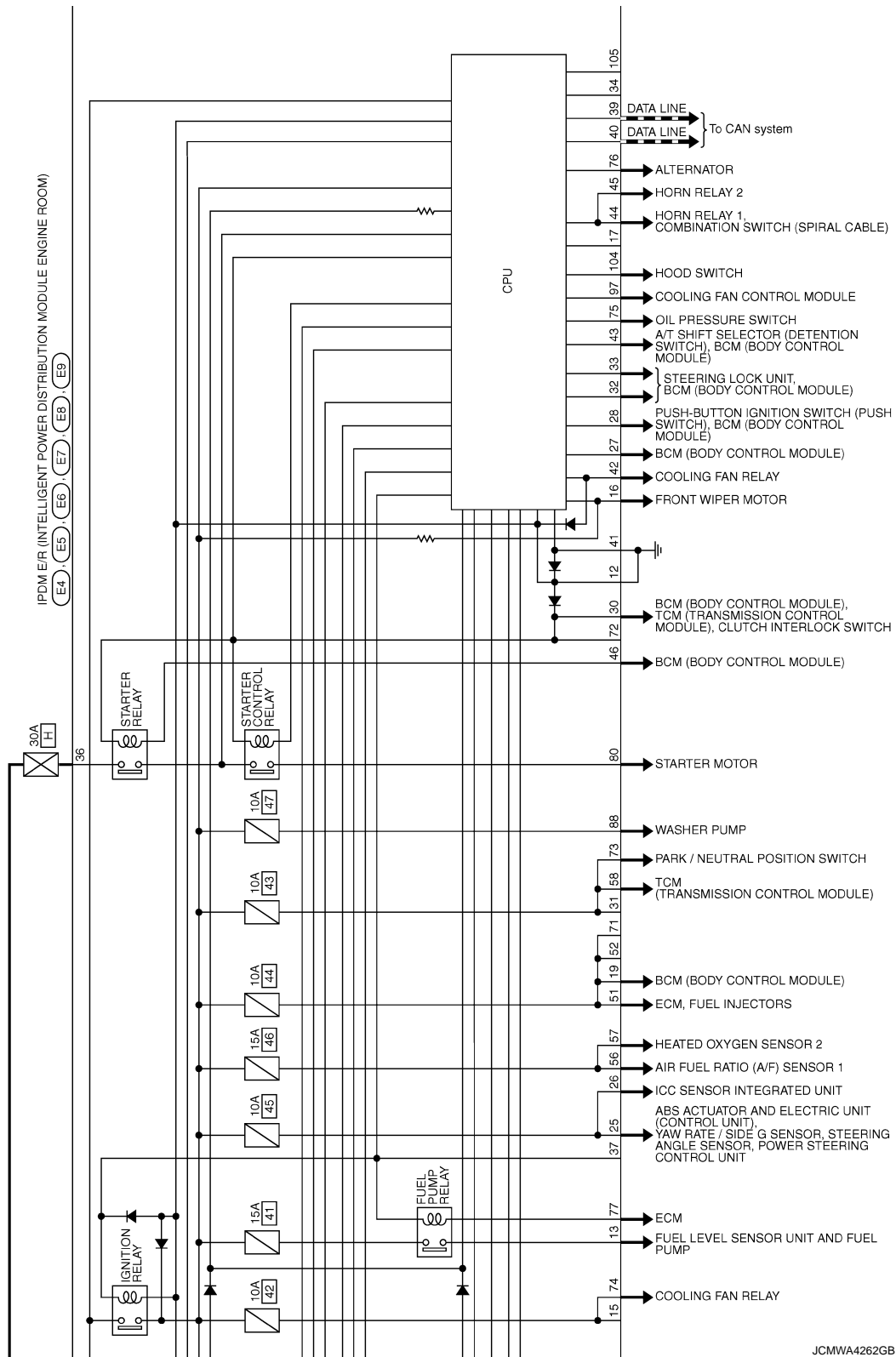

JCMWA4262GB



A  
 B  
 C  
 D  
 E  
 F  
 G  
 H  
 I  
 J  
 K  
 EXL  
 M  
 N  
 O  
 P

IPDM E/R  
 (INTELLIGENT POWER  
 DISTRIBUTION MODULE  
 ENGINE ROOM)  
 (E4) (E5) (E6)  
 (E7) (E8) (E9)

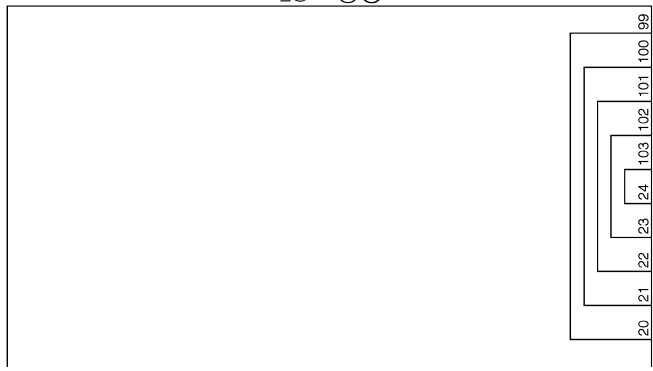

JCMWA4263GB

# IPDM E/R (INTELLIGENT POWER DISTRIBUTION MODULE ENGINE ROOM)

< ECU DIAGNOSIS INFORMATION >

[XENON TYPE]

## IPDM E/R (INTELLIGENT POWER DISTRIBUTION MODULE ENGINE ROOM)

Connector No.	E4
Connector Name	IPDM E/R (INTELLIGENT POWER DISTRIBUTION MODULE ENGINE ROOM)
Connector Type	LDZF-MC



Terminal No.	Color of Wire	Signal Name [Specification]
1	W	
2	L	

Connector No.	E5
Connector Name	IPDM E/R (INTELLIGENT POWER DISTRIBUTION MODULE ENGINE ROOM)
Connector Type	TH20FW-CS12-M4-TV



Terminal No.	Color of Wire	Signal Name [Specification]
4	V	
5	L	
7	R	
11	BR	
12	B/W	
13	Y	
16	LG	
19	W	
25	G	
26	R	
27	O	

Connector No.	E7
Connector Name	IPDM E/R (INTELLIGENT POWER DISTRIBUTION MODULE ENGINE ROOM)
Connector Type	TH20FW-CS12-M4

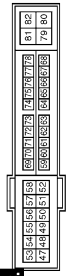

Terminal No.	Color of Wire	Signal Name [Specification]
48	BR	
49	O	
51	Y	
53	W	
54	P	
55	SB	
56	LG	
57	G	
58	R	
59	BR	
70	O	

28	L
30	GR
32	V
33	P
36	G

Connector No.	E6
Connector Name	IPDM E/R (INTELLIGENT POWER DISTRIBUTION MODULE ENGINE ROOM)
Connector Type	TH10FW-NH



Terminal No.	Color of Wire	Signal Name [Specification]
39	P	
40	L	
41	B/W	
42	Y	
43	SB	
44	W	
45	G	
46	R	

Connector No.	E8
Connector Name	IPDM E/R (INTELLIGENT POWER DISTRIBUTION MODULE ENGINE ROOM)
Connector Type	NS30FW-CS

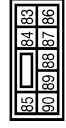

Terminal No.	Color of Wire	Signal Name [Specification]
83	R	
84	P	
86	W	
87	L	
88	G	
89	BR	
90	LG	

Connector No.	E9
Connector Name	IPDM E/R (INTELLIGENT POWER DISTRIBUTION MODULE ENGINE ROOM)
Connector Type	TH10FW-NH



Terminal No.	Color of Wire	Signal Name [Specification]
91	P	
92	O	
97	V	
104	LG	

### Fail-safe

### CAN COMMUNICATION CONTROL

When CAN communication with ECM and BCM is impossible, IPDM E/R performs fail-safe control. After CAN communication recovers normally, it also returns to normal control.

If No CAN Communication Is Available With ECM

JCMWA4264GB

INFOID:000000005161779

# IPDM E/R (INTELLIGENT POWER DISTRIBUTION MODULE ENGINE ROOM)

< ECU DIAGNOSIS INFORMATION >

[XENON TYPE]

Control part	Fail-safe operation
Cooling fan	<ul style="list-style-type: none"> <li>Outputs the pulse duty signal (PWM signal) 100% when the ignition switch is turned ON</li> <li>Outputs the pulse duty signal (PWM signal) 0% when the ignition switch is turned OFF</li> </ul>
A/C compressor	A/C relay OFF
Alternator	Outputs the power generation command signal (PWM signal) 0%

If No CAN Communication Is Available With BCM

Control part	Fail-safe operation
Headlamp	<ul style="list-style-type: none"> <li>Turns ON the headlamp low relay when the ignition switch is turned ON</li> <li>Turns OFF the headlamp low relay when the ignition switch is turned OFF</li> <li>Headlamp high relay OFF</li> </ul>
<ul style="list-style-type: none"> <li>Parking lamps</li> <li>Side maker lamp</li> <li>License plate lamps</li> <li>Illuminations</li> <li>Tail lamps</li> </ul>	<ul style="list-style-type: none"> <li>Turns ON the tail lamp relay when the ignition switch is turned ON</li> <li>Turns OFF the tail lamp relay when the ignition switch is turned OFF</li> </ul>
Front wiper	<ul style="list-style-type: none"> <li>The status just before activation of fail-safe control is maintained until the ignition switch is turned OFF while the front wiper is operating at LO or HI speed.</li> <li>The wiper is operated at LO speed until the ignition switch is turned OFF if the fail-safe control is activated while the front wiper is set in the INT mode and the front wiper motor is operating.</li> </ul>
Horn	Horn relay OFF
Ignition relay	The status just before activation of fail-safe is maintained.
Starter motor	Starter control relay OFF
Steering lock unit	Steering lock relay OFF

## IGNITION RELAY MALFUNCTION DETECTION FUNCTION

- IPDM E/R monitors the voltage at the contact circuit and excitation coil circuit of the ignition relay inside it.
- IPDM E/R judges the ignition relay error if the voltage differs between the contact circuit and the excitation coil circuit.
- If the ignition relay cannot turn OFF due to contact seizure, it activates the tail lamp relay for 10 minutes to alert the user to the ignition relay malfunction when the ignition switch is turned OFF.

Voltage judgment		IPDM E/R judgment	Operation
Ignition relay contact side	Ignition relay excitation coil side		
ON	ON	Ignition relay ON normal	—
OFF	OFF	Ignition relay OFF normal	—
ON	OFF	Ignition relay ON stuck	<ul style="list-style-type: none"> <li>Detects DTC "B2098: IGN RELAY ON"</li> <li>Turns ON the tail lamp relay for 10 minutes</li> </ul>
OFF	ON	Ignition relay OFF stuck	Detects DTC "B2099: IGN RELAY OFF"

## FRONT WIPER CONTROL

IPDM E/R detects front wiper stop position by a front wiper stop position signal. When a front wiper stop position signal is in the conditions listed below, IPDM E/R stops power supply to wiper after repeating a front wiper 10 seconds activation and 20 seconds stop five times.

Ignition switch	Front wiper switch	Front wiper stop position signal
ON	OFF	The front wiper stop position signal (stop position) cannot be input for 10 seconds.
	ON	The front wiper stop position signal does not change for 10 seconds.

# IPDM E/R (INTELLIGENT POWER DISTRIBUTION MODULE ENGINE ROOM)

[XENON TYPE]

< ECU DIAGNOSIS INFORMATION >

## NOTE:

This operation status can be confirmed on the IPDM E/R “Data Monitor” that displays “BLOCK” for the item “WIP PROT” while the wiper is stopped.

## STARTER MOTOR PROTECTION FUNCTION

IPDM E/R turns OFF the starter control relay to protect the starter motor when the starter control relay remains active for 90 seconds.

## DTC Index

INFOID:000000005161780

## NOTE:

- The details of time display are as follows.
  - CRNT: A malfunction is detected now.
  - PAST: A malfunction was detected in the past.
- IGN counter is displayed on FFD (Freeze Frame data).
  - The number is 0 when is detected now.
  - The number increases like 1 → 2 ... 38 → 39 after returning to the normal condition whenever IGN OFF → ON.
  - The number is fixed to 39 until the self-diagnosis results are erased if it is over 39.

×: Applicable

CONSULT display	Fail-safe	Refer to
No DTC is detected. further testing may be required.	—	—
U1000: CAN COMM CIRCUIT	×	<a href="#">PCS-14</a>
B2098: IGN RELAY ON	×	<a href="#">PCS-15</a>
B2099: IGN RELAY OFF	—	<a href="#">PCS-16</a>
B2108: STRG LCK RELAY ON	—	<a href="#">SEC-95</a>
B2109: STRG LCK RELAY OFF	—	<a href="#">SEC-97</a>
B210A: STRG LCK STATE SW	—	<a href="#">SEC-98</a>
B210B: START CONT RLY ON	—	<a href="#">SEC-102</a>
B210C: START CONT RLY OFF	—	<a href="#">SEC-103</a>
B210D: STARTER RELAY ON	—	<a href="#">SEC-104</a>
B210E: STARTER RELAY OFF	—	<a href="#">SEC-105</a>
B210F: INTRLCK/PNP SW ON	—	<a href="#">SEC-107</a>
B2110: INTRLCK/PNP SW OFF	—	<a href="#">SEC-109</a>

# AFS CONTROL UNIT

< ECU DIAGNOSIS INFORMATION >

[XENON TYPE]

## AFS CONTROL UNIT

### Reference Value

INFOID:000000004875448

### VALUES ON THE DIAGNOSIS TOOL

#### CONSULT-III MONITOR ITEM

Monitor Item	Condition		Value/Status
STR ANGLE SIG	Steering	Straight-forward	Approx. 0°
		Steering	Approx. -900° - +900°
VHCL SPD	Driving at 40 km/h		40 km/h
SLCT LVR POSI	Selector lever operation		P - 1
HEAD LAMP	Light switch	2ND	On
		Other than 2ND	Off
AFS SW	AFS switch	ON	On
		OFF	Off
HI SEN OTP RR	Vehicle rear height	Unloaded vehicle condition	Approx. 2.5 V
		Low (Leveling operation downward edge)	Standard suspension models: Approx. 1.7 V
			Sport suspension models: Approx. 1.9 V
LEV ACTR VLTG	Headlamp leveling	Unloaded vehicle condition	Approx. 70.0%
		Low (Leveling operation downward edge)	Standard suspension models: Approx. 46.6%
			Sport suspension models: Approx. 51.7%
SWVL SEN RH	Right headlamp swivel activation	Standard position	Approx. 0°
		Activation	Positive degree (+°)
SWVL SEN LH	Left headlamp swivel activation	Standard position	Approx. 0°
		Activation	Positive degree (+°)
SWVL ANGLE RH	Right headlamp swivel activation	Standard position	Approx. 0°
		Activation	Positive degree (+°)
SWVL ANGLE LH	Left headlamp swivel activation	Standard position	Approx. 0°
		Activation	Positive degree (+°)

#### TERMINAL LAYOUT

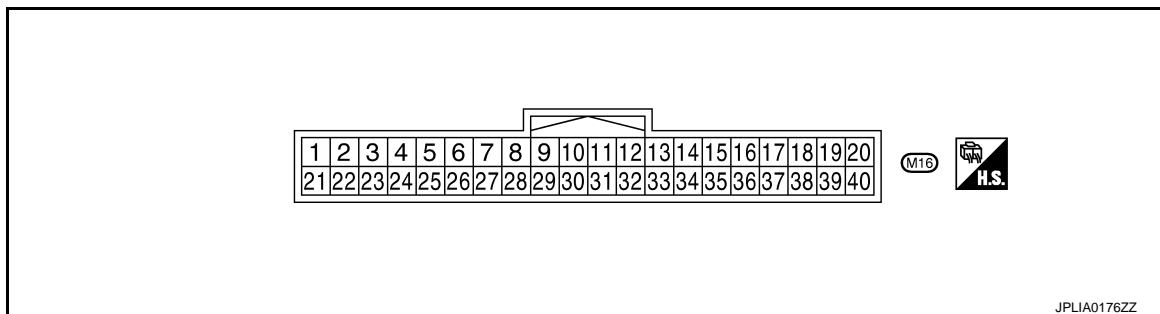

#### PHYSICAL VALUES

# AFS CONTROL UNIT

< ECU DIAGNOSIS INFORMATION >

[XENON TYPE]

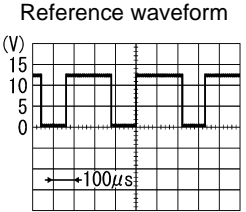
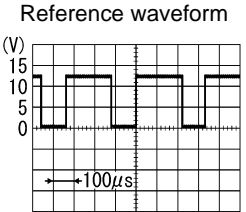
Terminal No. (Wire color)		Description		Condition		Value (Approx.)	
+	-	Signal name	Input/ output				
1 (R)	Ground	Ignition power supply	Input	The ignition switch ON		Battery voltage	
2 (P)	Ground	Right swivel position sensor ground	Input	The ignition switch ON		0 V	
3 (GR)	Ground	AFS switch signal	Input	AFS switch	ON	0 V	
					OFF	Battery voltage	
4 (Y)	Ground	Right swivel position sensor power supply	Output	The ignition switch ON		5 V	
6 (W)	Ground	Height sensor power supply	Output	The ignition switch ON		5 V	
7 (P)	Ground	CAN-L	Input/ output	—		—	
8 (B)	Ground	Height sensor ground	Input	The ignition switch ON		0 V	
9 (GR)	Ground	Right swivel position sensor signal	Output	Right headlamp swivel angle	0°	0.7 V	
					15°	2.8 V	
11 (R)	Ground	Right swivel motor 1-phase (-)	Output	Right headlamp swivel	Activation	Reference waveform 	
						8 - 12 V	
13 (L)	Ground	Right swivel motor 2-phase (-)	Output	Right headlamp swivel	Stopped	9.5 - 11.5 V	
15 (G)	Ground	Left swivel motor 1-phase (+)	Output	Left headlamp swivel	Activation	Reference waveform 	
						8 - 12 V	
17 (W)	Ground	Left swivel motor 2-phase (+)	Output	Left headlamp swivel	Stopped	9.5 - 11.5 V	
19 (SB)	Ground	Right levelizer signal	Output	Right headlamp leveling	Unloaded vehicle condition	8.8 V	
					Leveling operation downward edge	Standard suspension models:	5.8 V
						Sport suspension models:	6.5 V
24 (V)	Ground	Left swivel position sensor power supply	Output	The ignition switch ON		5 V	
25 (GR)	Ground	Ground	—	The ignition switch ON		0 V	
27 (BR)	Ground	Left swivel position sensor ground	Input	The ignition switch ON		0 V	

# AFS CONTROL UNIT

< ECU DIAGNOSIS INFORMATION >

[XENON TYPE]

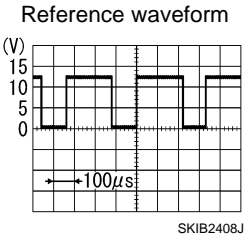
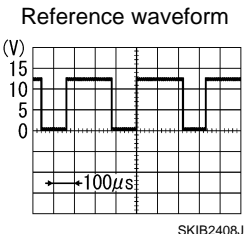
Terminal No. (Wire color)		Description		Condition		Value (Approx.)	
+	-	Signal name	Input/ output				
28 (SB)	Ground	Height sensor signal	Output	Vehicle rear height	Unloaded vehicle condition	2.5 V	
					Low (Leveling operation downward edge)	1.4 V	
29 (LG)	Ground	Left swivel position sensor signal	Output	Left headlamp swivel angle	0°	0.7 V	
					17°	3.0 V	
30 (L)	Ground	CAN-H	Input/ output	—		—	
32 (G)	Ground	Right swivel motor 2-phase (+)	Output	Right headlamp swivel	Activation	Reference waveform 	
						8 - 12 V	
34 (W)	Ground	Right swivel motor 1-phase (+)	Output	Right headlamp swivel	Stopped	9.5 - 11.5 V	
36 (R)	Ground	Left swivel motor 2-phase (-)	Output	Left headlamp swivel	Activation	Reference waveform 	
						8 - 12 V	
37* (O)	Ground	Reverse signal	Input	Back-up lamp switch	ON	Battery voltage	
					OFF	0 V	
38 (B)	Ground	Left swivel motor 1-phase (-)	Output	Left headlamp swivel	Stopped	9.5 - 11.5 V	
40 (O)	Ground	Left levelizer signal	Output	Left headlamp leveling	Unloaded vehicle condition	8.8 V	
					Leveling operation downward edge	Standard suspension models:	5.8 V
						Sport suspension models:	6.5 V

\*: A/T models

A  
B  
C  
D  
E  
F  
G  
H  
I  
J  
K  
EXL  
M  
N  
O  
P

# AFS CONTROL UNIT

< ECU DIAGNOSIS INFORMATION >

[XENON TYPE]

## Wiring Diagram - ACTIVE AFS -

INFOID:000000004875449

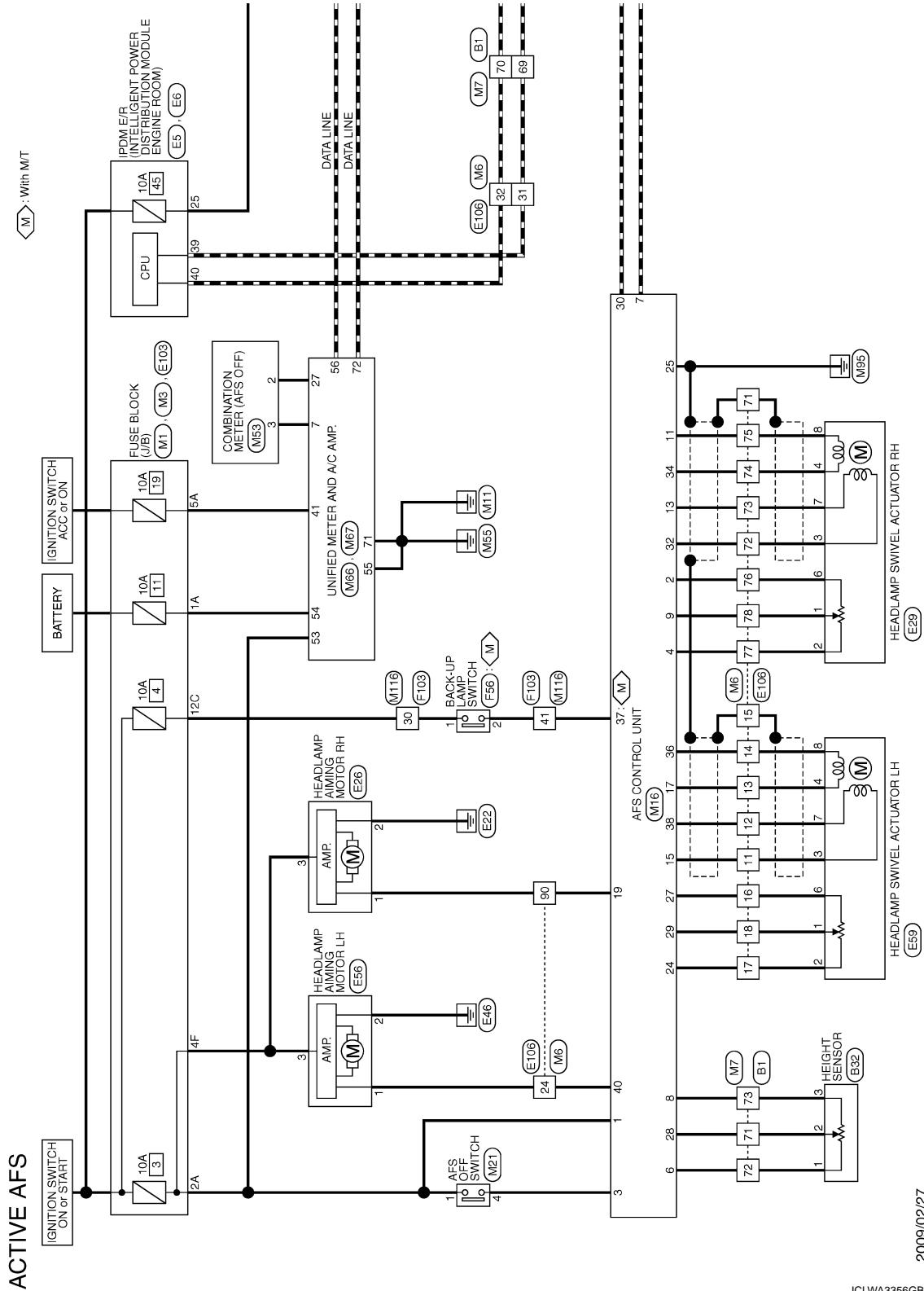

2009/02/27

JCLWA3356GB



# AFS CONTROL UNIT

< ECU DIAGNOSIS INFORMATION >

[XENON TYPE]

⬠: With A/T

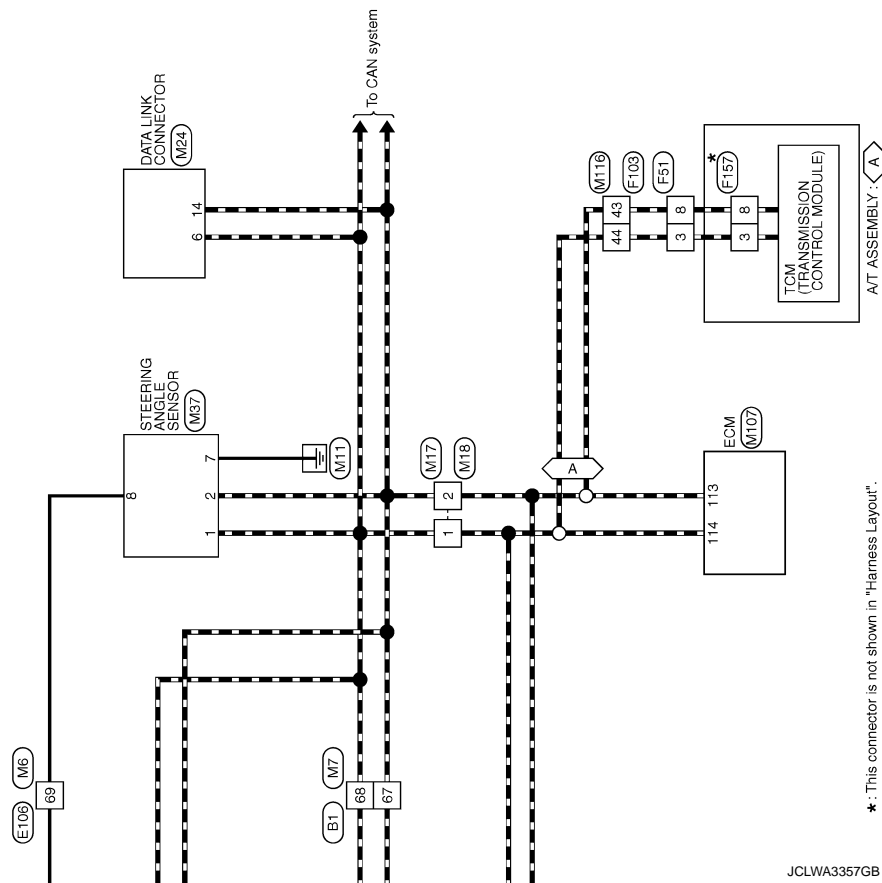

JCLWA3357GB

A  
B  
C  
D  
E  
F  
G  
H  
I  
J  
K  
EXL  
M  
N  
O  
P

# AFS CONTROL UNIT

< ECU DIAGNOSIS INFORMATION >

[XENON TYPE]

## ACTIVE AFS

Connector No.	B1
Connector Name	WIRE TO WIRE
Connector Type	TH8DFW-CS16-TM4

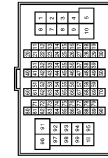

Terminal No.	Color of Wire	Signal Name [Specification]
67	P	-
68	L	-
69	P	-
70	L	-
71	SB	-
72	O	-
73	GR	-

Connector No.	E32
Connector Name	HEIGHT SENSOR
Connector Type	RH03FB



Terminal No.	Color of Wire	Signal Name [Specification]
1	O	-
2	SB	-
3	GR	-

Connector No.	E5
Connector Name	BOWE B INTELLIGENT POWER DISTRIBUTION MODULE ENGINE ROOM
Connector Type	TH2DFW-CS1Z-M4-1V

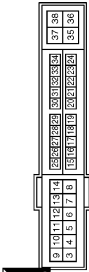

Terminal No.	Color of Wire	Signal Name [Specification]
25	G	-

Connector No.	E6
Connector Name	BOWE B INTELLIGENT POWER DISTRIBUTION MODULE ENGINE ROOM
Connector Type	TH8DFW-NH

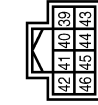

Terminal No.	Color of Wire	Signal Name [Specification]
39	P	-
40	L	-

Connector No.	E26
Connector Name	HEADLAMP AIMING MOTOR RH
Connector Type	RV03FB



Terminal No.	Color of Wire	Signal Name [Specification]
1	SB	-
2	B	-
3	G	-

Connector No.	E29
Connector Name	HEADLAMP SWIVEL ACTUATOR RH
Connector Type	RS08FGY-PR



Terminal No.	Color of Wire	Signal Name [Specification]
1	LG	-
2	Y	-
3	W	-
4	G	-
6	BR	-
7	B	-
8	R	-

Connector No.	E56
Connector Name	HEADLAMP AIMING MOTOR LH
Connector Type	RV03FB



Terminal No.	Color of Wire	Signal Name [Specification]
1	O	-
2	B	-
3	G	-

Connector No.	E59
Connector Name	HEADLAMP SWIVEL ACTUATOR LH
Connector Type	RS08FGY-PR



Terminal No.	Color of Wire	Signal Name [Specification]
1	BR	-
2	V	-
3	W	-
4	R	-
6	O	-
7	B	-
8	G	-

# AFS CONTROL UNIT

< ECU DIAGNOSIS INFORMATION >

[XENON TYPE]

## ACTIVE AFS

Connector No.	E103
Connector Name	FUSE BLOCK (J/B)
Connector Type	NS16FW-GS

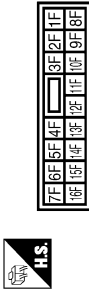

Terminal No.	4F	Color of Wire	G	Signal Name [Specification]	-
--------------	----	---------------	---	-----------------------------	---

Connector No.	E105
Connector Name	WIRE TO WIRE
Connector Type	THEORFW-CS16-TM4

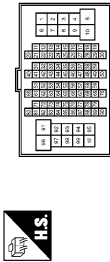

Terminal No.	11	Color of Wire	W	Signal Name [Specification]	-
12	B	-	-	-	-
13	R	-	-	-	-
14	G	-	-	-	-
15	SHIELD	-	-	-	-
16	O	-	-	-	-
17	V	-	-	-	-
18	BR	-	-	-	-
24	O	-	-	-	-
31	P	-	-	-	-
32	L	-	-	-	-

Connector No.	F56
Connector Name	BACK-UP LAMP SWITCH
Connector Type	RK02FB



Terminal No.	1	Color of Wire	R	Signal Name [Specification]	-
2	O	-	-	-	-

69	W	-	-
71	SHIELD	-	-
72	W	-	-
73	B	-	-
74	G	-	-
75	R	-	-
76	BR	-	-
77	Y	-	-
78	LG	-	-
90	SB	-	-

Terminal No.	3	Color of Wire	L	Signal Name [Specification]	-
8	P	-	-	-	-

Connector No.	F157
Connector Name	TOM (TRANSMISSION CONTROL MODULE)
Connector Type	SP10FG



Terminal No.	3	Color of Wire	R	Signal Name [Specification]	CAN-H
8	BR	-	-	-	CAN-L

Connector No.	F51
Connector Name	A/T ASSEMBLY
Connector Type	RK10FG-DGY



Connector No.	M1
Connector Name	FUSE BLOCK (J/B)
Connector Type	NS06FW-M2



Terminal No.	1A	Color of Wire	V	Signal Name [Specification]	-
2A	G	-	-	-	-
5A	L	-	-	-	-

A  
B  
C  
D  
E  
F  
G  
H  
I  
J  
K  
EXL  
M  
N  
O  
P

# AFS CONTROL UNIT

< ECU DIAGNOSIS INFORMATION >

[XENON TYPE]

## ACTIVE AFS

Connector No.	M3
Connector Name	FUSE BLOCK (J/E)
Connector Type	NS12FW-GS

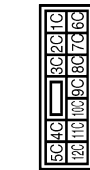

Terminal No.	Color of Wire	Signal Name [Specification]
12C	R	-

Connector No.	M6
Connector Name	WIRE TO WIRE
Connector Type	TH80MW-CS(G-TM4)

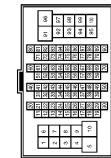

Terminal No.	Color of Wire	Signal Name [Specification]
11	G	-
12	B	-
13	W	-
14	R	-
15	SHIELD	-
16	BR	-
17	V	-
18	LG	-
24	O	-
31	P	-
32	L	-

Connector No.	M16
Connector Name	AFS CONTROL UNIT
Connector Type	TH40FW-NH

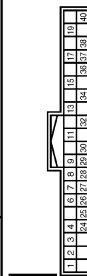

Terminal No.	Color of Wire	Signal Name [Specification]
1	R	IGN
2	P	PSG-R
3	GR	SW
4	Y	PSV-R
6	W	HSV-R
7	P	CAN-L
8	B	HSG-R
9	GR	PS-R
11	R	SMR-1 (-)
13	L	SMR-2 (-)
15	G	SMR-1 (+)

69	G	-
71	SHIELD	-
72	G	-
73	L	-
74	W	-
75	R	-
76	P	-
77	Y	-
78	GR	-
90	SB	-

Terminal No.	Color of Wire	Signal Name [Specification]
67	P	-
68	L	-
69	P	-
70	L	-
71	SB	-
72	W	-
73	B	-

Connector No.	M17
Connector Name	WIRE TO WIRE
Connector Type	TK02FW



Terminal No.	Color of Wire	Signal Name [Specification]
1	L	-
2	P	-

Connector No.	M18
Connector Name	WIRE TO WIRE
Connector Type	TK02MW



Terminal No.	Color of Wire	Signal Name [Specification]
1	L	-
2	P	-

JCLWA3360GB

# AFS CONTROL UNIT

< ECU DIAGNOSIS INFORMATION >

[XENON TYPE]

## ACTIVE AFS

Connector No.	M21
Connector Name	AFS OFF SWITCH
Connector Type	TK08FW-TV



Terminal No.	Color of Wire	Signal Name [Specification]
1	Y	-
4	GR	-

Connector No.	M24
Connector Name	DATA LINK CONNECTOR
Connector Type	BD16FW



Terminal No.	Color of Wire	Signal Name [Specification]
6	L	-
14	P	-

Connector No.	M37
Connector Name	STEERING ANGLE SENSOR
Connector Type	TH08FW-NH

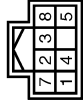

Terminal No.	Color of Wire	Signal Name [Specification]
1	L	CAN-H
2	P	CAN-L
7	B	GND
8	G	IGN

Connector No.	M53
Connector Name	COMBINATION METER
Connector Type	SAB08FW

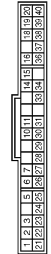

Terminal No.	Color of Wire	Signal Name [Specification]
2	LG	COMMUNICATION SIGNAL (METER->METER)
3	GR	COMMUNICATION SIGNAL (AMP->METER)

Connector No.	M68
Connector Name	UNIFIED METER AND A/C AMP.
Connector Type	TH08FW-NH



Terminal No.	Color of Wire	Signal Name [Specification]
7	GR	COMMUNICATION SIGNAL (AMP->METER)
27	LG	COMMUNICATION SIGNAL (METER->AMP)

Connector No.	M67
Connector Name	UNIFIED METER AND A/C AMP.
Connector Type	TH22FW-NH

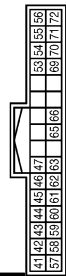

Terminal No.	Color of Wire	Signal Name [Specification]
41	L	ACC POWER SUPPLY
53	W	IGNITION POWER SUPPLY
54	Y	BATTERY POWER SUPPLY
55	B	GROUND
56	L	CAN-H
71	GR	GROUND
72	P	CAN-L

Connector No.	M107
Connector Name	ECM
Connector Type	FR24FGY-R2S-R-LH-Z

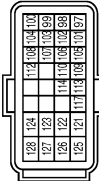

Terminal No.	Color of Wire	Signal Name [Specification]
113	P	VEH-CAN-LI
114	L	VEH-CAN-HI

Connector No.	M116
Connector Name	WIRE TO WIRE
Connector Type	TK38MW-NS10



Terminal No.	Color of Wire	Signal Name [Specification]
30	LG	-
41	O	-
43	P	-
44	L	-

JCLWA3361GB

A  
B  
C  
D  
E  
F  
G  
H  
I  
J  
K  
EXL  
M  
N  
O  
P

# AFS CONTROL UNIT

< ECU DIAGNOSIS INFORMATION >

[XENON TYPE]

## Fail Safe

INFOID:000000004875450

DTC	Fail-safe	AFS OFF indicator lamp	Cancellation
U1000: CAN COMM CIRCUIT	<ul style="list-style-type: none"> <li>Right and left swivel motors stop at the position when DTC is detected.</li> <li>Right and left aiming motors stop at the position when DTC is detected.</li> </ul>	Blinks 1 second each.	The ignition switch OFF
U1010: CONTROL UNIT (CAN)	<ul style="list-style-type: none"> <li>Right and left swivel motors stop at the position when DTC is detected.</li> <li>Right and left aiming motors stop at the position when DTC is detected.</li> </ul>	Blinks 1 second each.	The ignition switch OFF
B2503: SWIVEL ACTUATOR [RH]	<ul style="list-style-type: none"> <li>Right swivel motors stop at the position when DTC is detected.</li> <li>The signal, approximately 2 V decreased from the levelizer signal when DTC detected, is output.</li> </ul>	Blinks 1 second each.	The ignition switch OFF
B2504: SWIVEL ACTUATOR [LH]	<ul style="list-style-type: none"> <li>Left swivel motors stop at the position when DTC is detected.</li> <li>The signal, approximately 2 V decreased from the levelizer signal when DTC detected, is output.</li> </ul>	Blinks 1 second each.	The ignition switch OFF
B2514: HI SEN UNUSUAL [RR]	<ul style="list-style-type: none"> <li>Right and left aiming motors stop at the position when DTC is detected.</li> </ul>	—	The ignition switch OFF
C0126: ST ANG SEN SIG	<ul style="list-style-type: none"> <li>Right and left swivel motor swivel angle returns to 0° and fixed.</li> </ul>	Blinks 1 second each.	The ignition switch OFF
B2516: SHIFT SIG [P, R]	<ul style="list-style-type: none"> <li>Right and left swivel motor swivel angle returns to 0° and fixed.</li> </ul>	Blinks 1 second each.	The ignition switch OFF
B2517: VEHICLE SPEED SIG	<ul style="list-style-type: none"> <li>Right and left swivel motor swivel angle returns to 0° and fixed.</li> <li>Right and left aiming motors stop at the position when DTC is detected.</li> </ul>	Blinks 1 second each.	The ignition switch OFF
B2519: LEVELIZER CALIB	<ul style="list-style-type: none"> <li>Right and left aiming motors stop at the position when DTC is detected.</li> </ul>	—	When the levelizer adjustment is completed.
C0428: ST ANGLE SEN CALIB	<ul style="list-style-type: none"> <li>Right and left swivel motor swivel angle returns to 0° and fixed.</li> </ul>	Blinks 1 second each.	When the steering angle sensor neutral position registration is completed
B2521: ECU CIRC	<ul style="list-style-type: none"> <li>Right and left swivel motors stop at the position when DTC is detected.</li> <li>Right and left aiming motors stop at the position when DTC is detected.</li> </ul>	Blinks 1 second each.	The ignition switch OFF

## DTC Inspection Priority Chart

INFOID:000000004875451

If some DTCs are displayed at the same time, perform inspections one by one based on the following priority chart.

Priority	Detected items (DTC)
1	<ul style="list-style-type: none"> <li>U1000: CAN COMM CIRCUIT</li> <li>U1010: CONTROL UNIT (CAN)</li> </ul>

# AFS CONTROL UNIT

< ECU DIAGNOSIS INFORMATION >

[XENON TYPE]

Priority	Detected items (DTC)
2	<ul style="list-style-type: none"> <li>• B2519: LEVELIZER CALIB</li> <li>• B2521: ECU CIRC</li> <li>• C0428: ST ANG SEN CALIB</li> </ul>
3	<ul style="list-style-type: none"> <li>• B2503: SWIVEL ACTUATOR [RH]</li> <li>• B2504: SWIVEL ACTUATOR [LH]</li> <li>• B2514: HI SEN UNUSUAL [RR]</li> <li>• B2516: SHIFT SIG [P, R]</li> <li>• B2517: VEHICLE SPEED SIG</li> <li>• C0126: ST ANG SEN SIG</li> </ul>

## DTC Index

INFOID:000000004875452

×: Applicable

CONSULT indication	Fail-safe	AFS OFF indicator lamp	Reference
U1000: CAN COMM CIRCUIT	×	×	<a href="#">EXL-62, "Description"</a>
U1010: CONTROL UNIT (CAN)	×	×	<a href="#">EXL-63, "DTC Logic"</a>
B2503: SWIVEL ACTUATOR [RH]	×	×	<a href="#">EXL-46, "Description"</a>
B2504: SWIVEL ACTUATOR [LH]	×	×	<a href="#">EXL-46, "Description"</a>
B2514: HI SEN UNUSUAL [RR]	×		<a href="#">EXL-51, "Description"</a>
B2516: SHIFT SIG [P, R]	×	×	<a href="#">EXL-54, "Description"</a>
B2517: VEHICLE SPEED SIG	×	×	<a href="#">EXL-55, "Description"</a>
B2519: LEVELIZER CALIB	×		<a href="#">EXL-56, "Description"</a>
B2521: ECU CIRC	×	×	<a href="#">EXL-57, "Description"</a>
C0126: ST ANG SEN SIG	×	×	<a href="#">EXL-60, "Description"</a>
C0428: ST ANGLE SEN CALIB	×	×	<a href="#">EXL-61, "Description"</a>

A  
B  
C  
D  
E  
F  
G  
H  
I  
J  
K  
L  
M  
N  
O  
P

EXL

# EXTERIOR LIGHTING SYSTEM SYMPTOMS

< SYMPTOM DIAGNOSIS >

[XENON TYPE]

## SYMPTOM DIAGNOSIS

### EXTERIOR LIGHTING SYSTEM SYMPTOMS

#### Symptom Table

INFOID:000000004372543

**CAUTION:**

**Perform the self-diagnosis with CONSULT-III before the symptom diagnosis. Perform the trouble diagnosis if any DTC is detected.**

Symptom		Possible cause	Inspection item
Headlamp does not switch to the high beam.	One side	<ul style="list-style-type: none"> <li>Fuse</li> <li>Harness between IPDM E/R and the front combination lamp</li> <li>Front combination lamp (High beam solenoid)</li> <li>IPDM E/R</li> </ul>	Headlamp (HI) circuit Refer to <a href="#">EXL-65</a> .
	Both sides	<b>Symptom diagnosis</b> "BOTH SIDE HEADLAMPS DO NOT SWITCH TO HIGH BEAM" Refer to <a href="#">EXL-180</a> .	
High beam indicator lamp is not turned ON. (Headlamp switches to the high beam.)		<ul style="list-style-type: none"> <li>Combination meter</li> <li>Unified meter and A/C amp.</li> </ul>	<ul style="list-style-type: none"> <li>Unified meter and A/C amp. Data monitor "HI-BEAM IND"</li> <li>BCM (HEAD LAMP) Active test "HEADLAMP"</li> </ul>
Headlamp does not switch to the low beam.	One side	Front combination lamp (High beam solenoid)	—
	Both sides	<ul style="list-style-type: none"> <li>Combination switch</li> <li>Harness between the combination switch and BCM</li> <li>BCM</li> </ul>	Combination switch Refer to <a href="#">BCS-80</a> .
		High beam request signal <ul style="list-style-type: none"> <li>BCM</li> <li>IPDM E/R</li> </ul>	IPDM E/R Data monitor "HL HI REQ"
		IPDM E/R	—
Headlamp is not turned ON.	One side	<ul style="list-style-type: none"> <li>Fuse</li> <li>Xenon bulb</li> <li>Harness between IPDM E/R and the front combination lamp</li> <li>Front combination lamp (xenon headlamp)</li> <li>IPDM E/R</li> </ul>	Headlamp (LO) circuit Refer to <a href="#">EXL-67</a> .
	Both sides	<b>Symptom diagnosis</b> "BOTH SIDE HEADLAMPS (LO) ARE NOT TURNED ON" Refer to <a href="#">EXL-181</a> .	
Headlamp is not turned OFF.	When the ignition switch is turned ON		
	The ignition switch is turned OFF (After activating the battery saver).	IPDM E/R	—
Headlamp is not turned ON/OFF with the lighting switch AUTO.		<ul style="list-style-type: none"> <li>Combination switch</li> <li>Harness between the combination switch and BCM</li> <li>BCM</li> </ul>	Combination switch Refer to <a href="#">BCS-80</a> .
		<ul style="list-style-type: none"> <li>Optical sensor</li> <li>Harness between the optical sensor and BCM</li> <li>BCM</li> </ul>	Optical sensor Refer to <a href="#">EXL-80</a> .



# EXTERIOR LIGHTING SYSTEM SYMPTOMS

< SYMPTOM DIAGNOSIS >

[XENON TYPE]

Symptom		Possible cause	Inspection item
Front fog lamp is not turned ON.	One side	<ul style="list-style-type: none"> <li>Front fog lamp bulb</li> <li>Harness between IPDM E/R and the front combination lamp</li> <li>Front combination lamp</li> <li>IPDM E/R</li> </ul>	Front fog lamp circuit Refer to <a href="#">EXL-73</a> .
	Both side	<b>Symptom diagnosis</b> "BOTH SIDE FRONT FOG LAMPS ARE NOT TURNED ON" Refer to <a href="#">EXL-183</a> .	
Front fog lamp is not turned ON.			
Parking lamp is not turned ON.		<ul style="list-style-type: none"> <li>Fuse</li> <li>Parking lamp bulb</li> <li>Harness between IPDM E/R and the front combination lamp</li> <li>Front combination lamp</li> <li>IPDM E/R</li> </ul>	Parking lamp circuit Refer to <a href="#">EXL-75</a> .
Tail lamp is not turned ON.		<ul style="list-style-type: none"> <li>Harness between IPDM E/R and the rear combination lamp</li> <li>Rear combination lamp</li> </ul>	Tail lamp circuit Refer to <a href="#">EXL-85</a> .
License plate lamp is not turned ON.		<ul style="list-style-type: none"> <li>Harness between IPDM E/R and the license plate lamp</li> <li>License plate lamp</li> </ul>	License plate lamp circuit Refer to <a href="#">EXL-87</a> .
Tail lamp and the license plate lamp are not turned ON.		<ul style="list-style-type: none"> <li>Fuse</li> <li>Harness between IPDM E/R and the rear combination lamp</li> <li>IPDM E/R</li> </ul>	Tail lamp circuit Refer to <a href="#">EXL-85</a> .
<ul style="list-style-type: none"> <li>Parking lamp, the tail lamp and the license plate lamp are not turned ON.</li> <li>Parking lamp, the tail lamp and the license plate lamp are not turned OFF. (Each illumination is turned ON/OFF.)</li> </ul>		<b>Symptom diagnosis</b> "PARKING, LICENSE PLATE AND TAIL LAMPS ARE NOT TURNED ON" Refer to <a href="#">EXL-182</a> .	
Turn signal lamp does not blink.	Indicator lamp is normal. (The applicable side performs the high flasher activation.)	<ul style="list-style-type: none"> <li>Harness between BCM and each turn signal lamp</li> <li>Turn signal lamp bulb</li> </ul>	Turn signal lamp circuit Refer to <a href="#">EXL-77</a> .
	Indicator lamp is included	<ul style="list-style-type: none"> <li>Combination switch</li> <li>Harness between the combination switch and BCM</li> <li>BCM</li> </ul>	Combination switch Refer to <a href="#">BCS-80</a> .
Turn signal indicator lamp does not blink. (The turn signal indicator lamp is normal.)	One side	Combination meter —	
	Both sides (Always)	<ul style="list-style-type: none"> <li>Turn signal indicator lamp signal</li> <li>- Unified meter and A/C amp.</li> <li>- BCM</li> <li>Combination meter</li> </ul>	<ul style="list-style-type: none"> <li>Unified meter and A/C amp. Data monitor "TURN IND"</li> <li>BCM (FLASHER) Active test "FLASHER"</li> </ul>
	Both sides (Only when activating the hazard warning lamp with the ignition switch OFF)	<ul style="list-style-type: none"> <li>The combination meter power supply and the ground circuit</li> <li>Combination meter</li> </ul>	Combination meter Power supply and the ground circuit Refer to <a href="#">MWI-50</a> .
<ul style="list-style-type: none"> <li>Hazard warning lamp does not activate.</li> <li>Hazard warning lamp continues activating. (Turn signal is normal.)</li> </ul>		<ul style="list-style-type: none"> <li>Hazard switch</li> <li>Harness between the hazard switch and BCM</li> <li>BCM</li> </ul>	Hazard switch Refer to <a href="#">EXL-83</a> .

A  
B  
C  
D  
E  
F  
G  
H  
I  
J  
K  
M  
N  
O  
P

EXL

## EXTERIOR LIGHTING SYSTEM SYMPTOMS

< SYMPTOM DIAGNOSIS >

[XENON TYPE]

Symptom	Possible cause	Inspection item
Headlamp auto aiming does not activate. (AFS is normal.)	<ul style="list-style-type: none"><li>• Harness between AFS control unit and aiming motor</li><li>• Front combination lamp (Aiming motor)</li><li>• AFS control unit</li></ul>	Headlamp levelizer circuit Refer to <a href="#">EXL-71</a> .
AFS OFF indicator lamp is not turned ON.	<ul style="list-style-type: none"><li>• AFS OFF indicator lamp signal</li><li>- Unified meter and A/C amp.</li><li>- AFS control unit</li><li>• Combination meter</li></ul>	Unified meter and A/C amp. Data monitor "AFS OFF IND"

# NORMAL OPERATING CONDITION

< SYMPTOM DIAGNOSIS >

[XENON TYPE]

## NORMAL OPERATING CONDITION

### Description

INFOID:000000004372544

#### XENON HEADLAMP

- Brightness and the color of light may change slightly immediately after turning the headlamp ON until the xenon bulb becomes stable. This is normal.
- Illumination time lag may occur between right and left. This is normal.

#### AUTO LIGHT SYSTEM

The headlamp may not be turned ON/OFF immediately after passing dark area or bright area (short tunnel, sky bridge, shadowed area etc.) while using the auto light system. This causes for the control difference. This is normal.

A  
B  
C  
D  
E  
F  
G  
H  
I  
J  
K  
EXL  
M  
N  
O  
P

EXL

# BOTH SIDE HEADLAMPS DO NOT SWITCH TO HIGH BEAM

< SYMPTOM DIAGNOSIS >

[XENON TYPE]

## BOTH SIDE HEADLAMPS DO NOT SWITCH TO HIGH BEAM

### Description

INFOID:000000004372545

The headlamp (both sides) does not switch to the high beam when setting to the lighting switch HI or PASS.

### Diagnosis Procedure

INFOID:000000004372546

#### 1.COMBINATION SWITCH INSPECTION

Check the combination switch. Refer to [BCS-80, "Symptom Table"](#).

Is the combination switch normal?

YES >> GO TO 2.

NO >> Repair or replace the malfunctioning part.

#### 2.CHECK HEADLAMP (HI) REQUEST SIGNAL INPUT

##### ⓑCONSULT-III DATA MONITOR

1. Select "HL HI REQ" of IPDM E/R data monitor item.
2. With operating the lighting switch, check the monitor status.

Monitor item	Condition		Monitor status
HL HI REQ	Lighting switch (2ND)	HI or PASS	On
		Except for HI or PASS	Off

Is the item status normal?

YES >> GO TO 3.

NO >> Replace BCM.

#### 3.HEADLAMP (HI) CIRCUIT INSPECTION

Check the headlamp (HI) circuit. Refer to [EXL-65](#).

Is the headlamp (HI) circuit normal?

YES >> Replace IPDM E/R.

NO >> Repair or replace the malfunctioning part.

# BOTH SIDE HEADLAMPS (LO) ARE NOT TURNED ON

< SYMPTOM DIAGNOSIS >

[XENON TYPE]

## BOTH SIDE HEADLAMPS (LO) ARE NOT TURNED ON

### Description

INFOID:000000004372547

The headlamps (both sides) are not turned ON in any condition.

### Diagnosis Procedure

INFOID:000000004372548

#### 1.COMBINATION SWITCH INSPECTION

Check the combination switch. Refer to [BCS-80. "Symptom Table"](#).

Is the combination switch normal?

YES >> GO TO 2.

NO >> Repair or replace the malfunctioning part.

#### 2.CHECK HEADLAMP (LO) REQUEST SIGNAL INPUT

 CONSULT-III DATA MONITOR

1. Select "HL LO REQ" of IPDM E/R data monitor item.

2. With operating the lighting switch, check the monitor status.

Monitor item	Condition	Monitor status	
HL LO REQ	Lighting switch	2ND	On
		OFF	Off

Is the item status normal?

YES >> GO TO 3.

NO >> Replace BCM.

#### 3.HEADLAMP (LO) CIRCUIT INSPECTION

Check the headlamp (LO) circuit. Refer to [EXL-67](#).

Is the headlamp (LO) circuit normal?

YES >> Replace IPDM E/R.

NO >> Repair or replace the malfunctioning part.

A  
B  
C  
D  
E  
F  
G  
H  
I  
J  
K  
EXL  
M  
N  
O  
P

# PARKING, LICENSE PLATE AND TAIL LAMPS ARE NOT TURNED ON

< SYMPTOM DIAGNOSIS >

[XENON TYPE]

## PARKING, LICENSE PLATE AND TAIL LAMPS ARE NOT TURNED ON

### Description

INFOID:000000004372549

The parking, license plate, tail, side marker lamps and each illumination are not turned ON in any condition.

### Diagnosis Procedure

INFOID:000000004372550

#### 1.COMBINATION SWITCH INSPECTION

Check the combination switch. Refer to [BCS-80, "Symptom Table"](#).

Is the combination switch normal?

YES >> GO TO 2.

NO >> Repair or replace the malfunctioning part.

#### 2.CHECK TAIL LAMP RELAY REQUEST SIGNAL INPUT

##### ⓅCONSULT-III DATA MONITOR

1. Select "TAIL & CLR REQ" of IPDM E/R data monitor item.
2. With operating the lighting switch, check the monitor status.

Monitor item	Condition	Monitor status	
TAIL & CLR REQ	Lighting switch	1ST	On
		OFF	Off

Is the item status normal?

YES >> GO TO 3.

NO >> Replace BCM.

#### 3.TAIL LAMP CIRCUIT INSPECTION

Check the tail lamp circuit. Refer to [EXL-85](#).

Is the tail lamp circuit normal?

YES >> Replace IPDM E/R.

NO >> Repair or replace the malfunctioning part.

# BOTH SIDE FRONT FOG LAMPS ARE NOT TURNED ON

< SYMPTOM DIAGNOSIS >

[XENON TYPE]

## BOTH SIDE FRONT FOG LAMPS ARE NOT TURNED ON

### Description

INFOID:000000004372551

The front fog lamps are not turned ON in any condition.

### Diagnosis Procedure

INFOID:000000004372552

#### 1.COMBINATION SWITCH INSPECTION

Check the combination switch. Refer to [BCS-80. "Symptom Table"](#).

Is the combination switch normal?

YES >> GO TO 2.

NO >> Repair or replace the malfunctioning part.

#### 2.CHECK FRONT FOG LAMP REQUEST SIGNAL INPUT

 CONSULT-III DATA MONITOR

1. Select "FR FOG REQ" of IPDM E/R data monitor item.
2. With operating the front fog lamp switch, check the monitor status.

Monitor item	Condition	Monitor status	
FR FOG REQ	Front fog lamp switch (Lighting switch 2ND)	ON	On
		OFF	Off

Is the item status normal?

YES >> GO TO 3.

NO >> Replace BCM.

#### 3.FRONT FOG LAMP CIRCUIT INSPECTION

Check the front fog lamp circuit. Refer to [EXL-73](#).

Is the front fog lamp circuit normal?

YES >> Replace IPDM E/R.

NO >> Repair or replace the malfunctioning part.

A  
B  
C  
D  
E  
F  
G  
H  
I  
J  
K  
EXL  
M  
N  
O  
P

## PRECAUTION

### PRECAUTIONS

#### Precaution for Supplemental Restraint System (SRS) "AIR BAG" and "SEAT BELT PRE-TENSIONER"

INFOID:000000005161782

The Supplemental Restraint System such as "AIR BAG" and "SEAT BELT PRE-TENSIONER", used along with a front seat belt, helps to reduce the risk or severity of injury to the driver and front passenger for certain types of collision. This system includes seat belt switch inputs and dual stage front air bag modules. The SRS system uses the seat belt switches to determine the front air bag deployment, and may only deploy one front air bag, depending on the severity of a collision and whether the front occupants are belted or unbelted. Information necessary to service the system safely is included in the "SRS AIR BAG" and "SEAT BELT" of this Service Manual.

**WARNING:**

- To avoid rendering the SRS inoperative, which could increase the risk of personal injury or death in the event of a collision that would result in air bag inflation, all maintenance must be performed by an authorized NISSAN/INFINITI dealer.
- Improper maintenance, including incorrect removal and installation of the SRS, can lead to personal injury caused by unintentional activation of the system. For removal of Spiral Cable and Air Bag Module, see the "SRS AIR BAG".
- Do not use electrical test equipment on any circuit related to the SRS unless instructed to in this Service Manual. SRS wiring harnesses can be identified by yellow and/or orange harnesses or harness connectors.

#### PRECAUTIONS WHEN USING POWER TOOLS (AIR OR ELECTRIC) AND HAMMERS

**WARNING:**

- When working near the Air Bag Diagnosis Sensor Unit or other Air Bag System sensors with the ignition ON or engine running, DO NOT use air or electric power tools or strike near the sensor(s) with a hammer. Heavy vibration could activate the sensor(s) and deploy the air bag(s), possibly causing serious injury.
- When using air or electric power tools or hammers, always switch the ignition OFF, disconnect the battery, and wait at least 3 minutes before performing any service.



# HEADLAMP AIMING ADJUSTMENT

< PERIODIC MAINTENANCE >

[XENON TYPE]

## PERIODIC MAINTENANCE

### HEADLAMP AIMING ADJUSTMENT

#### Description

INFOID:000000004875648

#### PREPARATION BEFORE ADJUSTING

##### NOTE:

- For details, refer to the regulations in your own country.
- Perform aiming if the vehicle front body has been repaired and/or the headlamp assembly has been replaced.

Before performing aiming adjustment, check the following.

- Adjust the tire pressure to the specification.
- Fill with fuel, engine coolant and each oil.
- Maintain the unloaded vehicle condition. (Remove luggage from the passenger compartment and the trunk room.)

##### NOTE:

Do not remove the temporary tire, jack and on-vehicle tool.

- Wipe out dirt on the headlamp.

##### CAUTION:

**Never use organic solvent (thinner, gasoline etc.)**

- Ride alone on the driver seat.

#### AIMING ADJUSTMENT SCREW

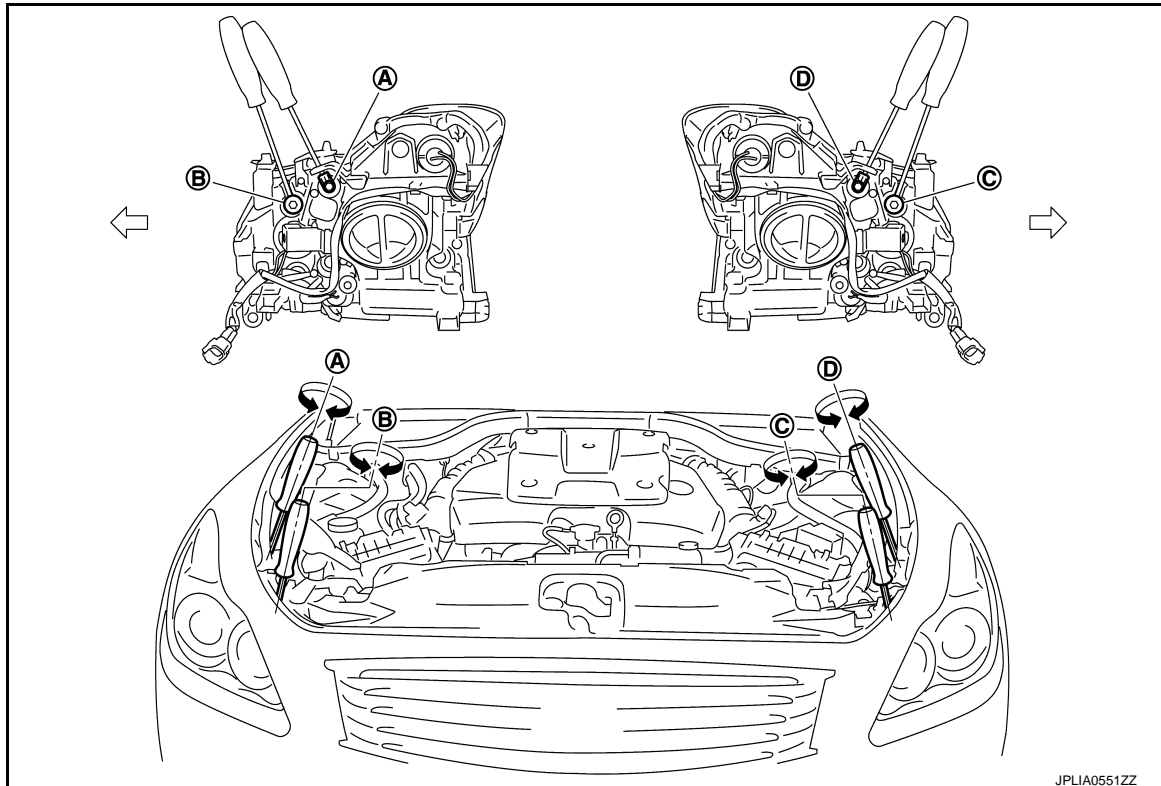

A Headlamp (RH) adjustment screw

B. Front fog lamp (RH) adjustment screw

C. Front fog lamp (LH) adjustment screw

D. Headlamp (LH) adjustment screw

↔: Vehicle center

##### NOTE:

The figure is the vehicle without AFS. Each adjustment screw is applied to the vehicle with AFS.

# HEADLAMP AIMING ADJUSTMENT

< PERIODIC MAINTENANCE >

[XENON TYPE]

With AFS

Adjustment screw		Screw driver rotation	Facing direction
A	Headlamp (RH)	Clockwise	UP
		Counterclockwise	DOWN
B	Front fog lamp (RH)	Clockwise	DOWN
		Counterclockwise	UP
C	Front fog lamp (LH)	Clockwise	DOWN
		Counterclockwise	UP
D	Headlamp (LH)	Clockwise	UP
		Counterclockwise	DOWN

Without AFS

Adjustment screw		Screw driver rotation	Facing direction
A	Headlamp (RH)	Clockwise	DOWN
		Counterclockwise	UP
B	Front fog lamp (RH)	Clockwise	DOWN
		Counterclockwise	UP
C	Front fog lamp (LH)	Clockwise	DOWN
		Counterclockwise	UP
D	Headlamp (LH)	Clockwise	DOWN
		Counterclockwise	UP

## Aiming Adjustment Procedure

INFOID:000000004875649

- Place the screen.

**NOTE:**

- Stop the vehicle facing the wall.
- Place the board on a plain road vertically.

- Face the vehicle with the screen. Maintain 10 m (32.8 ft) between the headlamp center and the screen.

- Start the engine. Turn the headlamp (LO) ON.

**NOTE:**

Shut off the headlamp light with the board to prevent from illuminating the adjustment screen.

**CAUTION:**

**Never cover the lens surface with a tape etc. The lens is made of resin.**

- Measure the distance (X) between the horizontal center line of headlamp (H) and the cutoff line (A) within the light axis measurement range (R) from the vertical center line ahead of headlamp (V).

**Light axis measurement range (R) : 350 ± 175 mm (13.78 ± 6.89 in)**

Low beam distribution on the screen

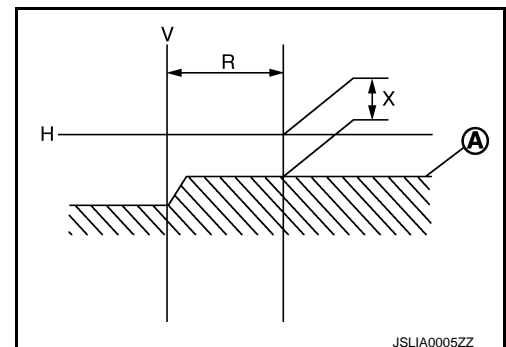

- Adjust the cutoff line height (X) with the aiming adjustment screw so as to enter in the adjustment range (M–N) according to the horizontal center line of headlamp (H).

# HEADLAMP AIMING ADJUSTMENT

< PERIODIC MAINTENANCE >

[XENON TYPE]

unit: mm (in)

Horizontal center line of headlamp (H)	Highest cutoff line height (M)	Lowest cutoff line height (N)
700 (27.56) or less	4 (0.16)	30 (1.18)
701(27.60) – 800 (31.50)	4 (0.16)	30 (1.18)
801 (31.54) or more	17 (0.67)	44 (1.73)

Side view

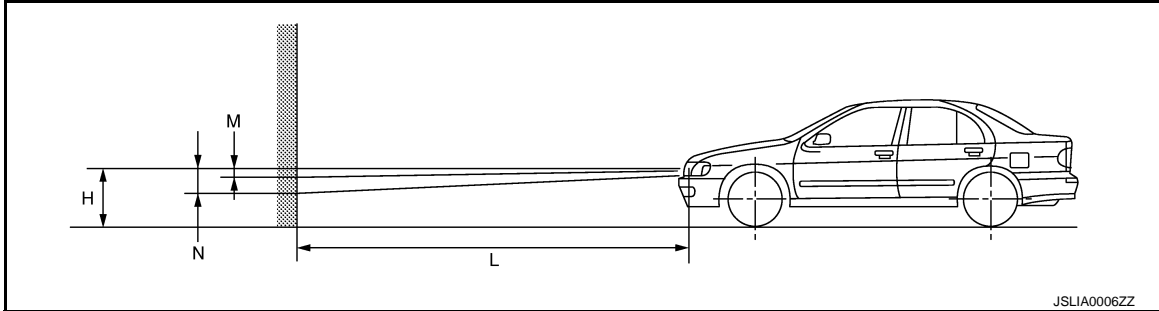

Distance between the headlamp center and the screen (L) : 10 m (32.8 ft)

A  
B  
C  
D  
E  
F  
G  
H  
I  
J  
K  
L  
M  
N  
O  
P

EXL

# FRONT FOG LAMP AIMING ADJUSTMENT

< PERIODIC MAINTENANCE >

[XENON TYPE]

## FRONT FOG LAMP AIMING ADJUSTMENT

### Description

INFOID:000000004875650

### PREPARATION BEFORE ADJUSTING

#### NOTE:

- For details, refer to the regulations in your own country.
- Perform aiming if the vehicle front body has been repaired and/or the headlamp assembly has been replaced.

Before performing aiming adjustment, check the following.

- Adjust the tire pressure to the specification.
- Fill with fuel, engine coolant and each oil.
- Maintain the unloaded vehicle condition. (Remove luggage from the passenger compartment and the trunk room.)

#### NOTE:

Do not remove the temporary tire, jack and on-vehicle tool.

- Wipe out dirt on the headlamp.

#### CAUTION:

**Never use organic solvent (thinner, gasoline etc.)**

- Ride alone on the driver seat.

### AIMING ADJUSTMENT SCREW

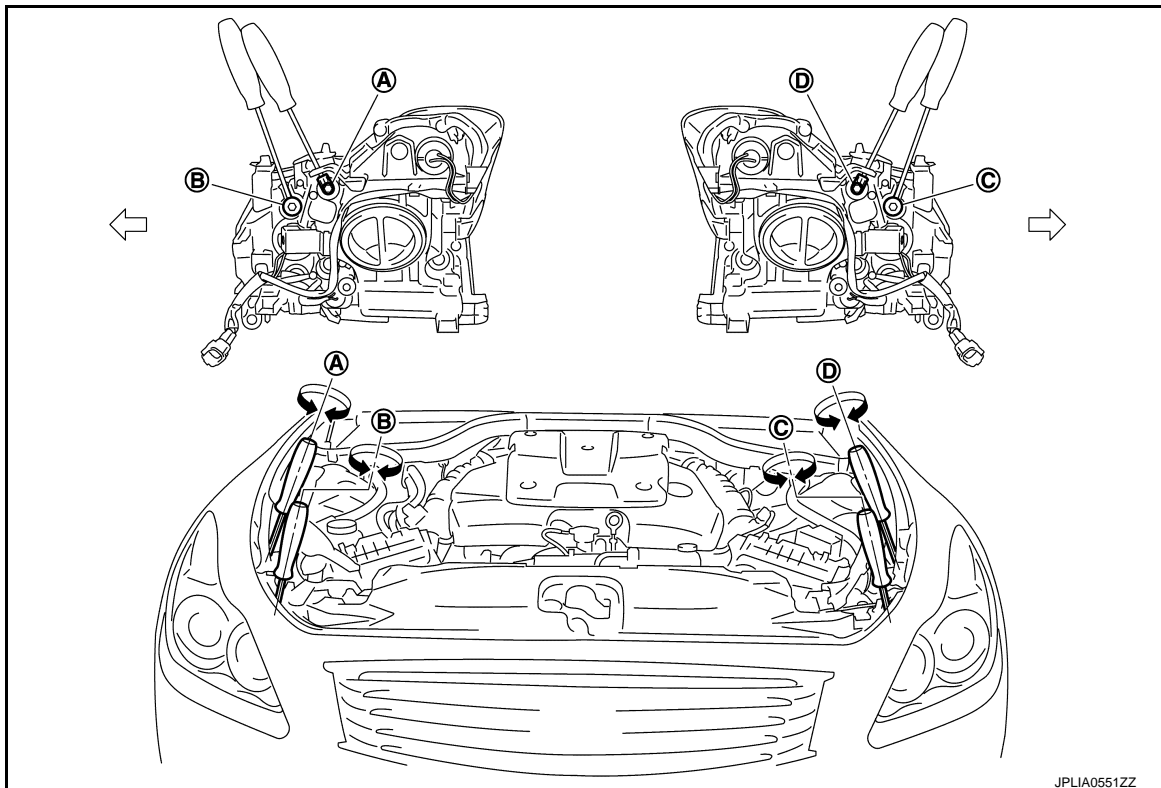

A Headlamp (RH) adjustment screw

B. Front fog lamp (RH) adjustment screw

C. Front fog lamp (LH) adjustment screw

D. Headlamp (LH) adjustment screw

↔: Vehicle center

#### NOTE:

The figure is the vehicle without AFS. Each adjustment screw is applied to the vehicle with AFS.

# FRONT FOG LAMP AIMING ADJUSTMENT

< PERIODIC MAINTENANCE >

[XENON TYPE]

With AFS

	Adjustment screw	Screw driver rotation	Facing direction
A	Headlamp (RH)	Clockwise	UP
		Counterclockwise	DOWN
B	Front fog lamp (RH)	Clockwise	DOWN
		Counterclockwise	UP
C	Front fog lamp (LH)	Clockwise	DOWN
		Counterclockwise	UP
D	Headlamp (LH)	Clockwise	UP
		Counterclockwise	DOWN

Without AFS

	Adjustment screw	Screw driver rotation	Facing direction
A	Headlamp (RH)	Clockwise	DOWN
		Counterclockwise	UP
B	Front fog lamp (RH)	Clockwise	DOWN
		Counterclockwise	UP
C	Front fog lamp (LH)	Clockwise	DOWN
		Counterclockwise	UP
D	Headlamp (LH)	Clockwise	DOWN
		Counterclockwise	UP

## Aiming Adjustment Procedure

INFOID:000000004875651

1. Place the screen.
  - NOTE:**
  - Stop the vehicle facing the wall.
  - Place the board on a plain road vertically.
2. Face the vehicle with the screen. Maintain 10 m (32.8 ft) between the front fog lamp center and the screen.
3. Start the engine. Turn the front fog lamp ON.
  - NOTE:**
  - Shut off the headlamp light with the board to prevent from illuminating the adjustment screen.
  - CAUTION:**
  - Never cover the lens surface with a tape etc. The lens is made of resin.**
4. Adjust the cutoff line height (A) with the aiming adjustment screw so that the distance (X) between the horizontal center line of front fog lamp (H) and (A) becomes 200 mm (7.87 in).

Front fog lamp light distribution on the screen

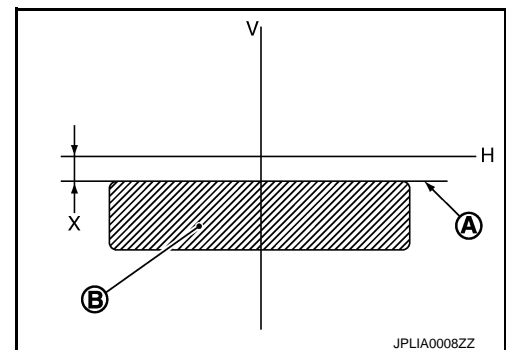

- A : Cutoff line
- B : High illuminance area
- H : Horizontal center line of front fog lamp

# FRONT FOG LAMP AIMING ADJUSTMENT

< PERIODIC MAINTENANCE >

[XENON TYPE]

---

V : Vertical center line of front fog lamp

X : Cutoff line height

# FRONT COMBINATION LAMP

< REMOVAL AND INSTALLATION >

[XENON TYPE]

## REMOVAL AND INSTALLATION

### FRONT COMBINATION LAMP

Exploded View

INFOID:000000004875652

#### REMOVAL

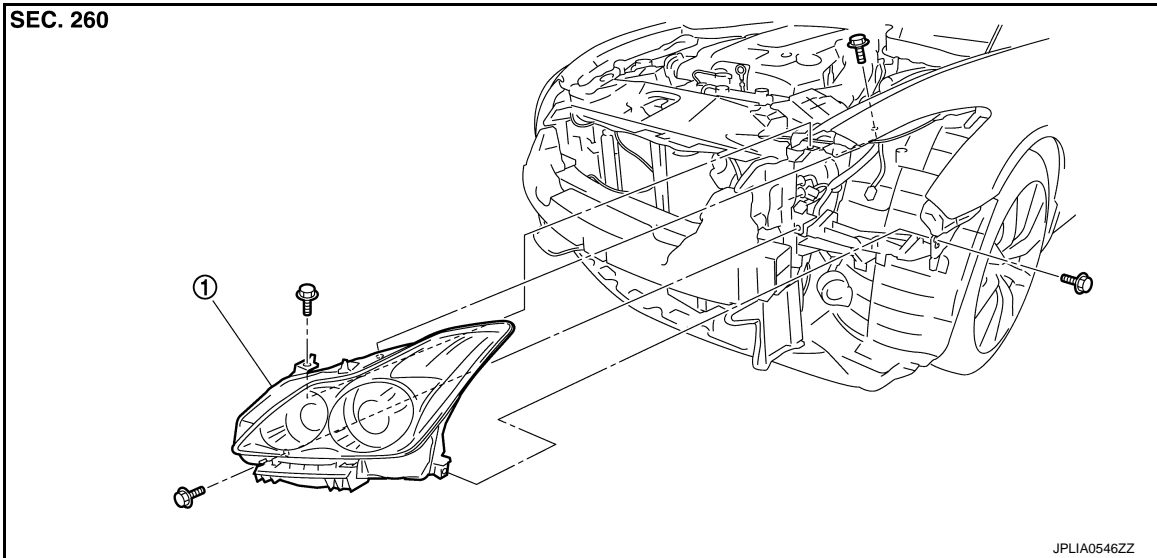

1. Front combination lamp

#### DISASSEMBLY

Without AFS

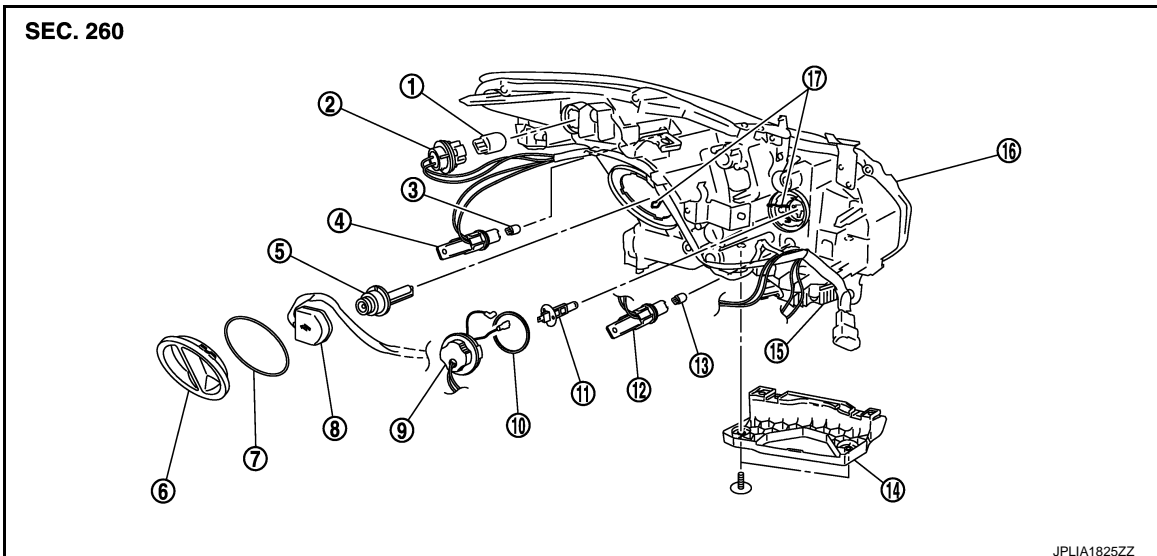

- |                                 |                                       |                              |
|---------------------------------|---------------------------------------|------------------------------|
| 1. Front turn signal lamp bulb  | 2. Front turn signal lamp bulb socket | 3. Side marker lamp bulb     |
| 4. Side marker lamp bulb socket | 5. Xenon bulb                         | 6. Resin cap                 |
| 7. Seal packing                 | 8. Xenon bulb socket                  | 9. Resin cap                 |
| 10. Seal packing                | 11. Front fog lamp bulb               | 12. Parking lamp bulb socket |
| 13. Parking lamp bulb           | 14. Seal packing                      | 15. Bumper bracket           |
| 16. HID control unit            | 17. Headlamp housing assembly         | 18. Retaining spring         |

**CAUTION:**

A  
B  
C  
D  
E  
F  
G  
H  
I  
J  
K  
EXL  
M  
N  
O  
P

# FRONT COMBINATION LAMP

< REMOVAL AND INSTALLATION >

[XENON TYPE]

**HID control unit and xenon bulb socket cannot be disassembled.**

With AFS

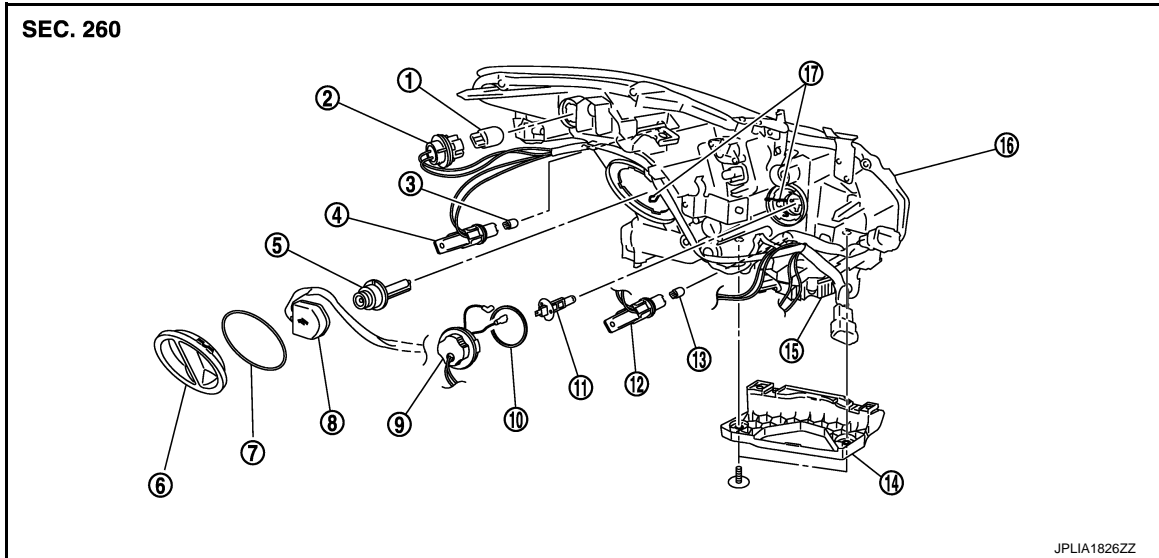

- |                                 |                                       |                              |
|---------------------------------|---------------------------------------|------------------------------|
| 1. Front turn signal lamp bulb  | 2. Front turn signal lamp bulb socket | 3. Side marker lamp bulb     |
| 4. Side marker lamp bulb socket | 5. Xenon bulb                         | 6. Resin cap                 |
| 7. Seal packing                 | 8. Xenon bulb socket                  | 9. Resin cap                 |
| 10. Seal packing                | 11. Front fog lamp bulb               | 12. Parking lamp bulb socket |
| 13. Parking lamp bulb           | 14. Seal packing                      | 15. Bumper bracket           |
| 16. HID control unit            | 17. Headlamp housing assembly         | 18. Retaining spring         |

**CAUTION:**

**HID control unit and xenon bulb socket cannot be disassembled.**

## Removal and Installation

INFOID:000000004875653

### REMOVAL

**CAUTION:**

**Disconnect the battery negative terminal or remove the fuse.**

1. Remove the front bumper fascia. Refer to [EXT-12, "Exploded View"](#).
2. Remove the mounting bolts.
3. Remove the holding clip (A)\* and the harness clip (B).  
\*: Left side only
4. Pull out the headlamp assembly forward the vehicle.
5. Disconnect the connector before removing the headlamp housing assembly.

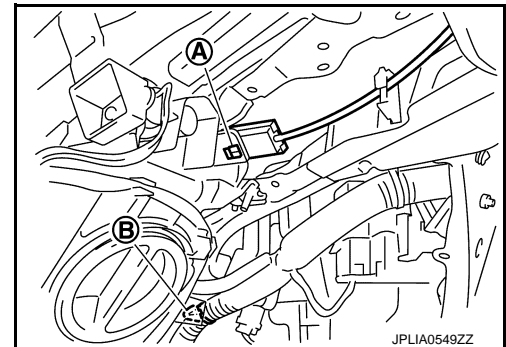

### INSTALLATION

Install in the reverse order of removal.

**NOTE:**

- After installation, perform aiming adjustment. Refer to [EXL-185, "Description"](#).
- After installation, check that headlamp lighting. Refer to [EXL-194, "Inspection After Installation"](#).



# FRONT COMBINATION LAMP

< REMOVAL AND INSTALLATION >

[XENON TYPE]

## Replacement

INFOID:000000004875654

### CAUTION:

- Disconnect the battery negative terminal or remove the fuse.
- After installing the bulb, install the resin cap and the bulb socket securely for watertightness.
- Never touch the glass of bulb directly by hand. Keep grease and other oily matters away from it.
- Never touch bulb by hand while it is lit or right after being turned off.
- Never leave bulb out of lamp reflector for a long time because dust, moisture smoke, etc. may affect the performance of lamp. When replacing bulb, be sure to replace it with new one.

### HEADLAMP BULB

1. Remove the fender protector. Keep a service area. Refer to [EXT-24, "FENDER PROTECTOR : Exploded View"](#).
2. Rotate the resin cap counterclockwise and unlock it.
3. Rotate the bulb socket counterclockwise and unlock it.
4. Remove the retaining spring lock. Remove the bulb from the headlamp housing assembly.

### CAUTION:

Never break the xenon bulb ceramic tube when replacing the bulb.

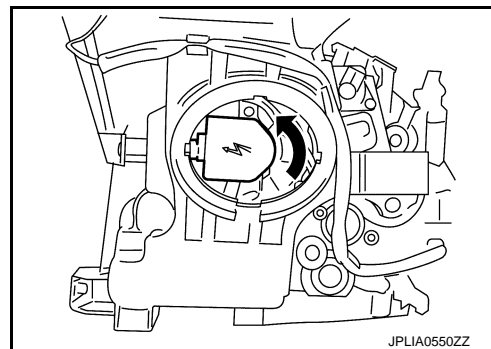

### PARKING LAMP BULB

1. Remove the air cleaner case. Refer to [EM-27, "Exploded View"](#).
2. Rotate the bulb socket counterclockwise and unlock it.
3. Remove the bulb from the bulb socket.

### FRONT TURN SIGNAL LAMP BULB

1. Remove the fender protector. Keep a service area. Refer to [EXT-24, "FENDER PROTECTOR : Exploded View"](#).
2. Rotate the bulb socket counterclockwise and unlock it.
3. Remove the bulb from the bulb socket.

### FRONT FOG LAMP BULB

1. Remove the air cleaner case. Refer to [EM-27, "Exploded View"](#).
2. Rotate the resin cap counterclockwise and unlock it.
3. Disconnect front fog lamp bulb terminals.
4. Remove the retaining spring lock. Remove the bulb.

### SIDE MARKER LAMP BULB

1. Remove the fender protector. Keep a service area. Refer to [EXT-24, "FENDER PROTECTOR : Exploded View"](#).
2. Rotate the bulb socket counterclockwise and unlock it.
3. Remove the bulb from the bulb socket.

## Disassembly and Assembly

INFOID:000000004875655

### DISASSEMBLY

1. Rotate the resin cap counterclockwise and unlock it.
2. Rotate the xenon bulb socket counterclockwise and unlock it.
3. Remove the retaining spring lock. Remove the xenon bulb.
4. Remove the bumper bracket.
5. Rotate the parking lamp bulb socket counterclockwise and unlock it.

A  
B  
C  
D  
E  
F  
G  
H  
I  
J  
K  
EXL  
M  
N  
O  
P

# FRONT COMBINATION LAMP

[XENON TYPE]

## < REMOVAL AND INSTALLATION >

6. Remove the bulb from the parking lamp bulb socket.
7. Rotate the front turn signal lamp bulb socket counterclockwise and unlock it.
8. Remove the bulb from the front turn signal lamp bulb socket.
9. Rotate the side marker lamp bulb socket counterclockwise and unlock it.
10. Remove the bulb from the side marker lamp bulb socket.
11. Rotate the resin cap counterclockwise and unlock it.
12. Disconnect front fog lamp bulb terminals.
13. Remove the retaining spring lock. Remove the bulb.

## ASSEMBLY

Assemble in the reverse order of disassembly.

### **CAUTION:**

- After installing the bulb, install the resin cap and the bulb socket securely for watertightness.
- After installation, check that headlamp lighting. Refer to [EXL-194, "Inspection After Installation"](#).

## Inspection After Installation

INFOID:000000005151177

### **CAUTION:**

Temporarily install the headlamp on the vehicle. Connect the battery to the connector (vehicle side) when checking ON/OFF status.

## XENON HEADLAMP LIGHTING CHECK

Check the following item, when there is abnormality replace the xenon headlamp assembly.

1. Xenon bulb is cold condition (turn OFF more than 10 minutes), and repetition does headlamp turned ON/OFF, check that a headlamp illuminated it surely.
2. Headlamp is turn ON until the xenon bulb becomes stable condition (for about 5 minutes) from cold condition, check that there are not on and off light, abnormality such as blinking.
3. Xenon bulb is warm condition (turn ON more than 15 minutes and turn OFF for 1 minute), and repetition does headlamp turned ON/OFF, check that a headlamp illuminated it surely.
4. Headlamp is turn ON for about 30 minutes, check that there are not on and off light, abnormality such as blinking whether brightness of right and left does not have a difference.

# FRONT FOG LAMP

< REMOVAL AND INSTALLATION >

[XENON TYPE]

## FRONT FOG LAMP

### Exploded View

INFOID:000000004875656

The front fog lamp is integrated in the front combination lamp. Refer to [EXL-191. "Exploded View"](#).

- A
- B
- C
- D
- E
- F
- G
- H
- I
- J
- K
- EXL
- M
- N
- O
- P

# OPTICAL SENSOR

< REMOVAL AND INSTALLATION >

[XENON TYPE]

## OPTICAL SENSOR

Exploded View

INFOID:000000004875657

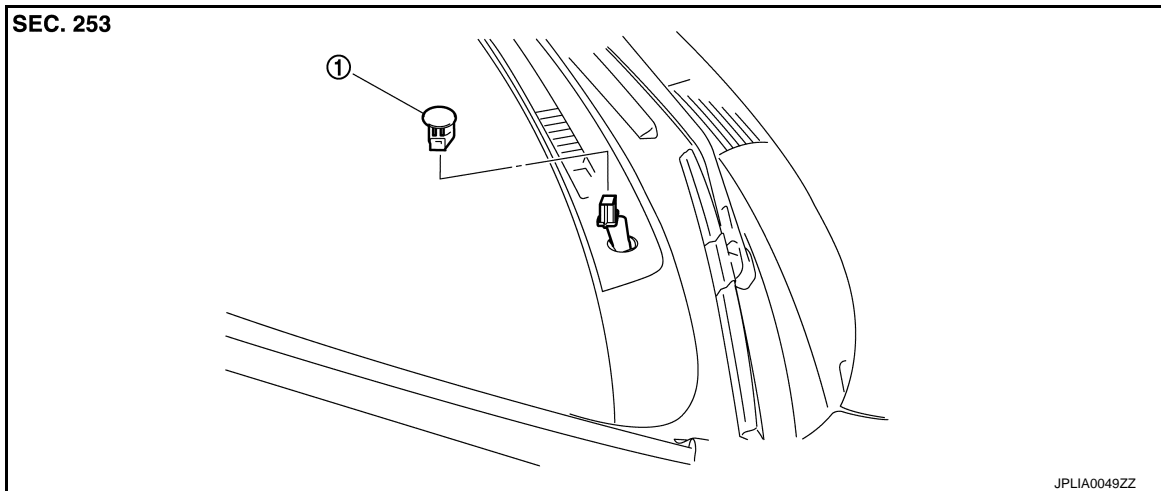

1. Optical sensor

## Removal and Installation

INFOID:000000004875658

### REMOVAL

1. Insert an appropriate tool between the optical sensor and the instrument upper panel. Pull out the optical sensor upward.
2. Disconnect the connector. Remove the optical sensor.

### INSTALLATION

Install in the reverse order of removal.

# LIGHTING & TURN SIGNAL SWITCH

< REMOVAL AND INSTALLATION >

[XENON TYPE]

## LIGHTING & TURN SIGNAL SWITCH

### Exploded View

INFOID:000000004875659

The lighting & turn signal switch is integrated in the combination switch. [BCS-83, "Exploded View"](#).

- A
- B
- C
- D
- E
- F
- G
- H
- I
- J
- K
- EXL
- M
- N
- O
- P

## HAZARD SWITCH

< REMOVAL AND INSTALLATION >

[XENON TYPE]

---

### HAZARD SWITCH

#### Exploded View

INFOID:000000004875660

The hazard switch is integrated in the multifunction switch. Refer to [AV-161, "Exploded View"](#).

# AFS CONTROL UNIT

< REMOVAL AND INSTALLATION >

[XENON TYPE]

## AFS CONTROL UNIT

### Exploded View

INFOID:000000004875661

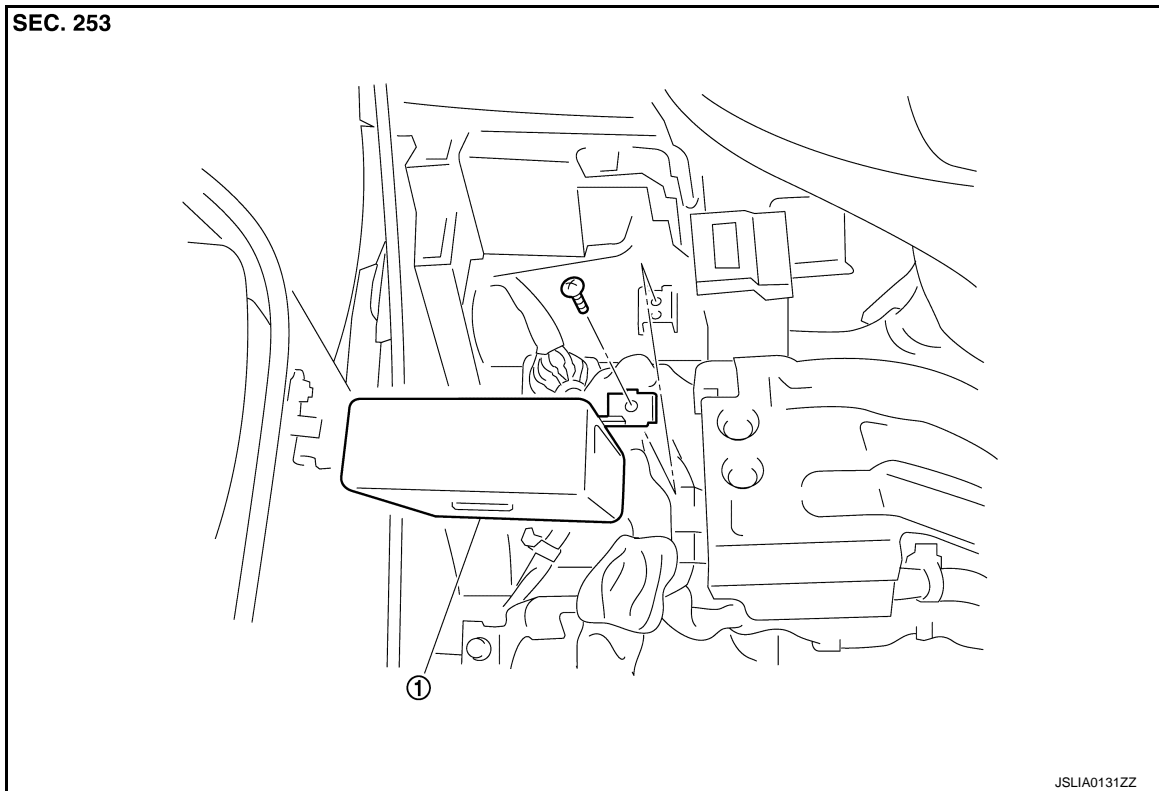

1. AFS control unit

### Removal and Installation

INFOID:000000004875662

#### REMOVAL

1. Remove the instrument lower panel LH. Refer to [IP-12, "Exploded View"](#).
2. Remove the instrument finisher A. Refer to [IP-12, "Exploded View"](#).
3. Remove AFS control unit mounting screw.
4. Disconnect AFS control unit connector.
5. Remove AFS control unit.

#### INSTALLATION

Install in the reverse order of removal.

A  
B  
C  
D  
E  
F  
G  
H  
I  
J  
K  
EXL  
M  
N  
O  
P

## STEERING ANGLE SENSOR

[XENON TYPE]

< REMOVAL AND INSTALLATION >

---

### STEERING ANGLE SENSOR

#### Removal and Installation

INFOID:000000004875663

Refer to [BRC-111. "Exploded View"](#).



# AFS OFF SWITCH

< REMOVAL AND INSTALLATION >

[XENON TYPE]

## AFS OFF SWITCH

Exploded View

INFOID:000000004875664

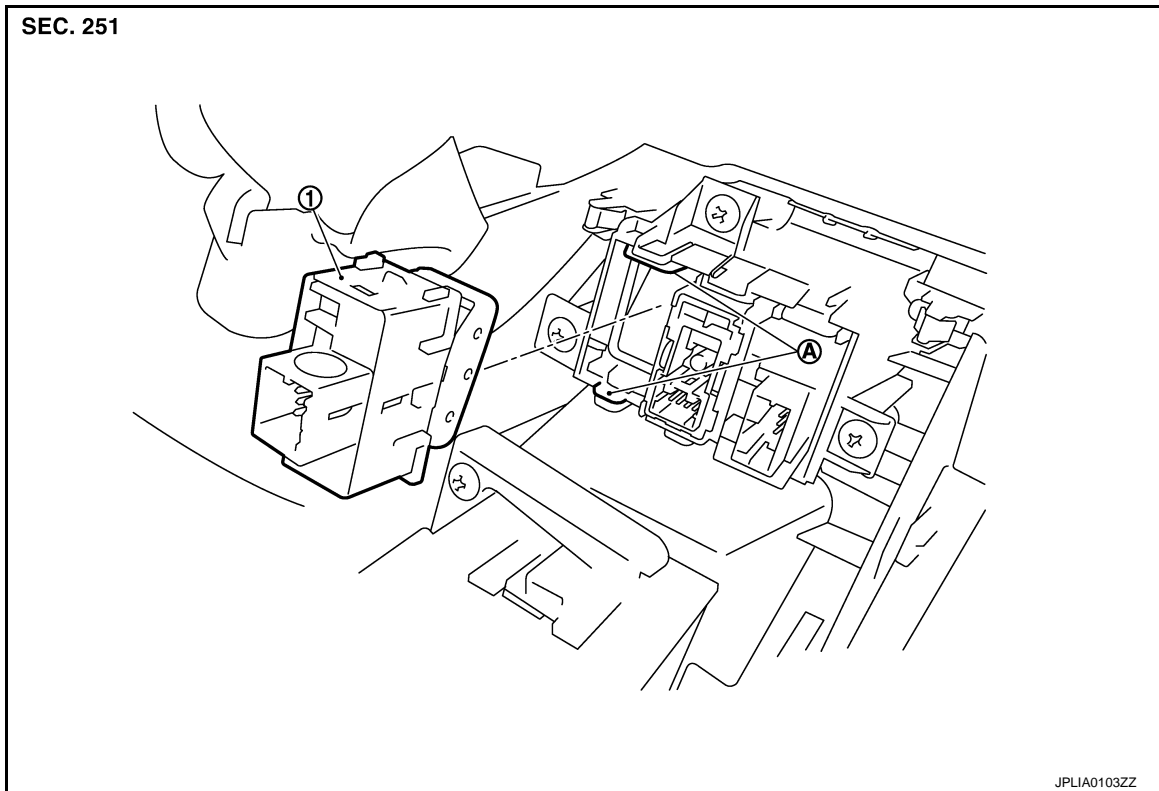

- 1. AFS OFF switch
- A Pawls

## Removal and Installation

INFOID:000000004875665

### REMOVAL

1. Remove the instrument lower panel LH. Refer to [IP-12. "Exploded View"](#).
2. Widen the pawls. And then remove AFS OFF switch.

### INSTALLATION

Install in the reverse order of removal.

A  
B  
C  
D  
E  
F  
G  
H  
I  
J  
K  
EXL  
M  
N  
O  
P

# HEIGHT SENSOR

< REMOVAL AND INSTALLATION >

[XENON TYPE]

## HEIGHT SENSOR

Exploded View

INFOID:000000004875666

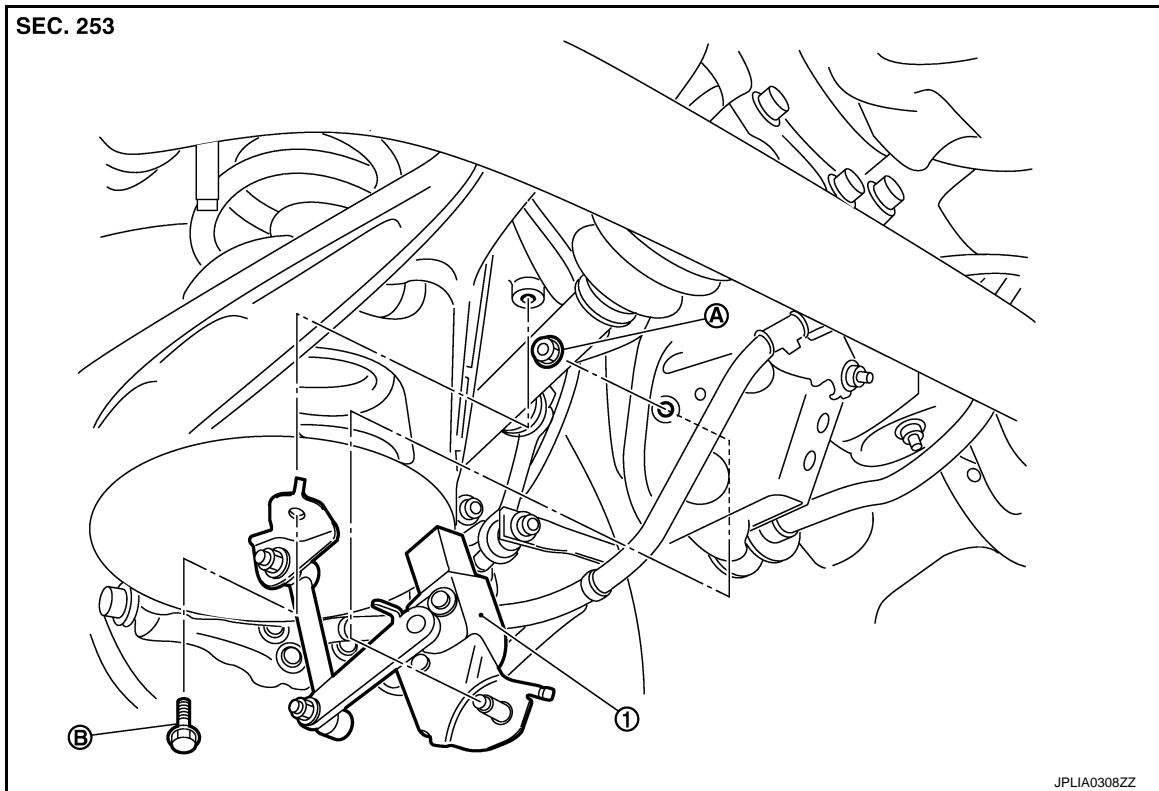

- 1. Height sensor
- A Height sensor mounting nut
- B. Height sensor lever link bracket mounting bolt

## Removal and Installation

INFOID:000000004875667

### REMOVAL

1. Remove the height sensor mounting nut.
2. Remove the height sensor lever link bracket mounting bolt.
3. Disconnect the height sensor connector.
4. Disconnect the height sensor.

### INSTALLATION

Install in the reverse order of removal.

#### **CAUTION:**

**Perform the levelizer adjustment when removing the height sensor. Refer to [EXL-7, "ADDITIONAL SERVICE WHEN REPLACING CONTROL UNIT \(HEIGHT SENSOR\) : Special Repair Requirement"](#).**



# REAR COMBINATION LAMP

[XENON TYPE]

< REMOVAL AND INSTALLATION >

## INSTALLATION

Install in the reverse order of removal.

### **CAUTION:**

- Seal packing cannot be reused.
- Securely install the grommet.

## Replacement

INFOID:000000004875670

### **CAUTION:**

- Disconnect the battery negative terminal or remove the fuse.
- Never touch the glass of bulb directly by hand. Keep grease and other oily matters away from it.
- Never touch bulb by hand while it is lit or right after being turned off.
- Never leave bulb out of lamp reflector for a long time because dust, moisture smoke, etc. may affect the performance of lamp. When replacing bulb, be sure to replace it with new one.

## REAR TURN SIGNAL LAMP BULB

1. Remove the rear combination lamp assembly.
2. Turn the rear turn signal lamp bulb socket counterclockwise and unlock it.
3. Remove the bulb from the socket.

## BACK-UP LAMP BULB

1. Remove the rear combination lamp assembly.
2. Turn the bulb socket counterclockwise and unlock it.
3. Remove the bulb from the socket.

# HIGH-MOUNTED STOP LAMP

< REMOVAL AND INSTALLATION >

[XENON TYPE]

## HIGH-MOUNTED STOP LAMP

Exploded View

INFOID:000000004875671

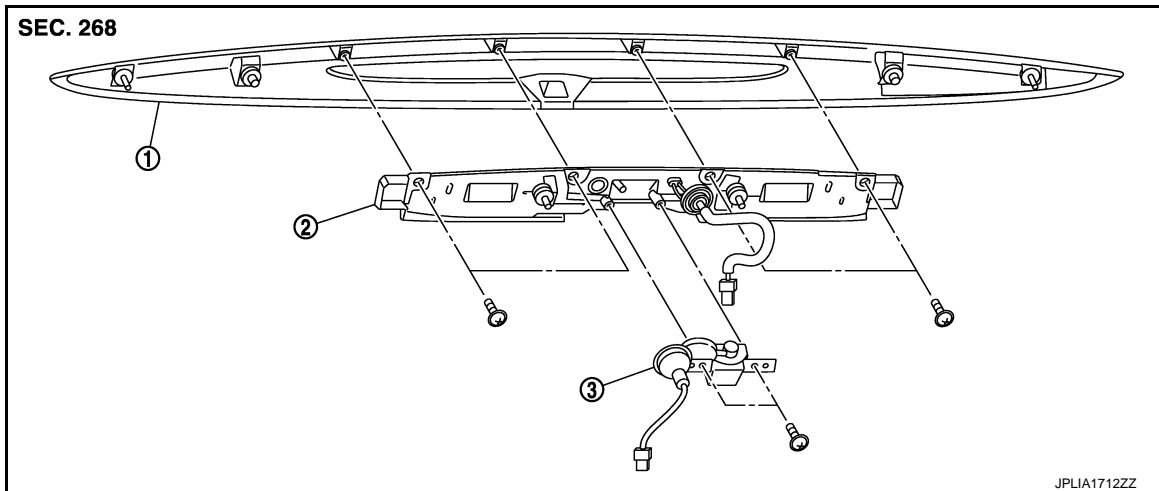

1. Rear trunk lid finisher outer

2. High-mounted stop lamp

3. Rear view camera

## Removal and Installation

INFOID:000000004875672

### REMOVAL

1. Remove the trunk lid finisher outer. Refer to [EXT-36. "Exploded View"](#).
2. Remove the screws and remove the high-mounted stop lamp from trunk finisher.
3. Cut the two-sided tape by the any appropriate tool.

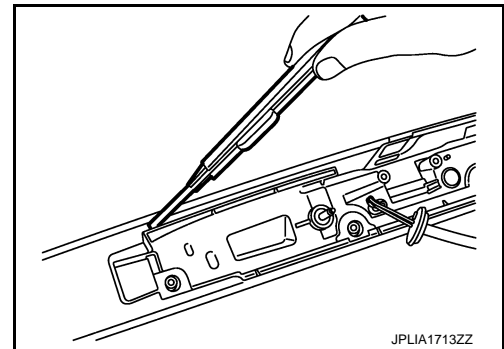

### INSTALLATION

Install in the reverse order of removal.

A  
B  
C  
D  
E  
F  
G  
H  
I  
J  
K  
EXL  
M  
N  
O  
P

# LICENSE PLATE LAMP

< REMOVAL AND INSTALLATION >

[XENON TYPE]

## LICENSE PLATE LAMP

### Exploded View

INFOID:000000004875675

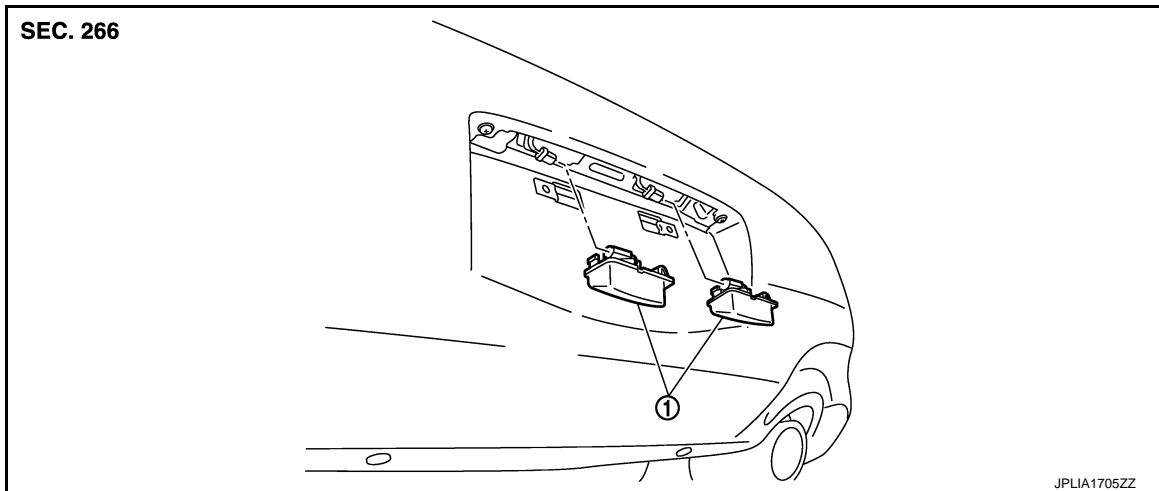

1. License plate lamp

### Removal and Installation

INFOID:000000004875676

#### **CAUTION:**

**Disconnect the battery negative terminal or the fuse.**

#### REMOVAL

1. Remove the license plate lamp in numerical order.
2. Disconnect the connector.
3. Remove license plate lamp.

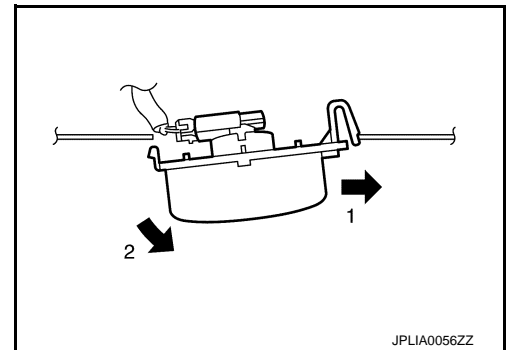

#### INSTALLATION

1. Connect the connector.
2. Fix the pawl side. And then push the resin clip side.

#### Replacement

INFOID:000000004875677

#### **CAUTION:**

- **Disconnect the battery negative terminal or remove the fuse.**
- **Never touch the glass of bulb directly by hand. Keep grease and other oily matters away from it.**
- **Never touch bulb by hand while it is lit or right after being turned off.**
- **Never leave bulb out of lamp reflector for a long time because dust, moisture smoke, etc. may affect the performance of lamp. When replacing bulb, be sure to replace it with new one.**

#### LICENSE PLATE LAMP BULB

1. Remove license plate lamp.

# LICENSE PLATE LAMP

## < REMOVAL AND INSTALLATION >

[XENON TYPE]

2. Turn the bulb socket (1) counterclockwise and unlock it.
3. Remove the bulb (2) from the socket.

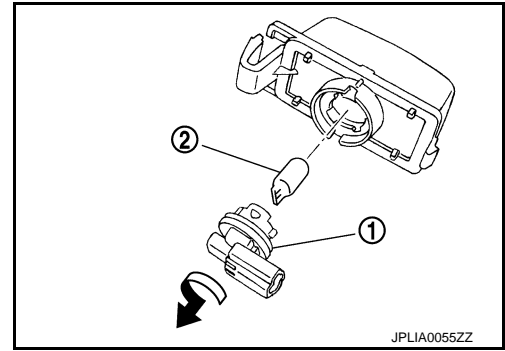

A

B

C

D

E

F

G

H

I

J

K

EXL

M

N

O

P

# SERVICE DATA AND SPECIFICATIONS (SDS)

< SERVICE DATA AND SPECIFICATIONS (SDS)

[XENON TYPE]

## SERVICE DATA AND SPECIFICATIONS (SDS)

### SERVICE DATA AND SPECIFICATIONS (SDS)

#### Bulb Specifications

INFOID:000000004875647

Item	Type	Wattage (W)	
Front combination lamp	Headlamp (HI/LO)	D2S (Xenon)	35
	Front turn signal lamp	WY21W (Amber)	21
	Parking lamp	W5W	5
	Front fog lamp	H1	55
	Front side marker lamp	W5W	5
Rear combination lamp	Stop lamp/Tail lamp	LED	—
	Rear turn signal lamp	W21W	21
	Rear side marker lamp	LED	—
	Back-up lamp	W16W	16
License plate lamp	W5W	5	
High-mounted stop lamp	LED	—	