

SECTION **EX**  
EXHAUST SYSTEM

A  
EX

CONTENTS

|                                |   |                                       |   |   |
|--------------------------------|---|---------------------------------------|---|---|
| <b>PRECAUTION</b> .....        | 2 | <b>PERIODIC MAINTENANCE</b> .....     | 4 | F |
| <b>PRECAUTIONS</b> .....       | 2 | <b>EXHAUST SYSTEM</b> .....           | 4 |   |
| Removal and Installation ..... | 2 | Inspection .....                      | 4 | G |
| <b>PREPARATION</b> .....       | 3 | <b>REMOVAL AND INSTALLATION</b> ..... | 5 |   |
| <b>PREPARATION</b> .....       | 3 | <b>EXHAUST SYSTEM</b> .....           | 5 | H |
| Special Service Tool .....     | 3 | Exploded View .....                   | 5 |   |
| Commercial Service Tool .....  | 3 | Removal and Installation .....        | 6 |   |
|                                |   | Inspection .....                      | 6 | I |

D  
E  
F  
G  
H  
I  
J  
K  
L  
M  
N  
O  
P

## PRECAUTIONS

< PRECAUTION >

---

### PRECAUTION

#### PRECAUTIONS

##### Removal and Installation

*INFOID:000000005634631*

**CAUTION:**

- Be sure to use genuine exhaust system parts or equivalents which are specially designed for heat resistance, corrosion resistance, and shape.
- Perform the operation with the exhaust system fully cooled down because the system will be hot just after engine stops.
- Be careful not to cut your hand on the heat insulator edge.

# PREPARATION

< PREPARATION >

## PREPARATION

### PREPARATION

#### Special Service Tool

INFOID:000000005634632

A

EX

The actual shapes of Kent-Moore tools may differ from those of special service tools illustrated here.

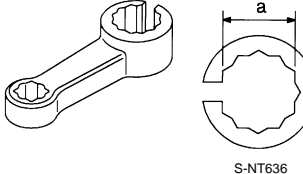
| Tool number<br>(Kent-Moore No.)<br>Tool name  | Description  |
|---|--|
| KV10114400<br>(J-38365)<br>Heated oxygen sensor wrench<br><br> | Loosening or tightening heated oxygen sensor 2<br><b>For 22 mm (0.87 in) (a) width hexagon nut</b> |



C

D

E

#### Commercial Service Tool

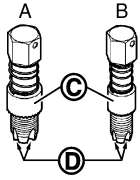
INFOID:000000005634633

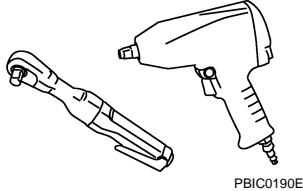
| (Kent-Moore No.)<br>Tool name   | Description   |
|---|---|
| Heated oxygen sensor thread cleaner<br><br>   | Reconditioning the exhaust system threads before installing a new heated oxygen sensor (Use with anti-seize lubricant shown below.)<br><b>A: For zirconia heated oxygen sensor [18 mm (0.71 in) dia.]</b><br><b>B: For titania heated oxygen sensor [12 mm (0.47 in) dia.]</b><br><b>C: Mating surface shave cylinder</b><br><b>D: Flutes</b> |
| ( — )<br>Anti-seize lubricant (Permatex 133AR or equivalent meeting MIL specification MIL-A-907)<br><br> | Lubricating heated oxygen sensor thread cleaner when reconditioning exhaust system threads  |
| ( — )<br>Power tool<br><br>  | Loosening bolts and nuts  |

F

G

H

I

J

K

L

M

N

O

P

# EXHAUST SYSTEM

< PERIODIC MAINTENANCE >

## PERIODIC MAINTENANCE

### EXHAUST SYSTEM

#### Inspection

INFOID:000000005634634

Check exhaust pipes, muffler and mounting for improper attachment, leakage, cracks, damage or deterioration.

- If anything is found, repair or replace damaged parts.

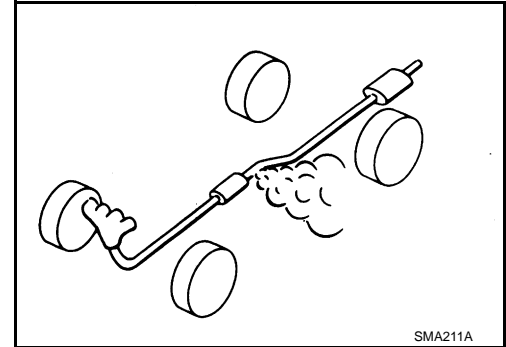

# EXHAUST SYSTEM

< REMOVAL AND INSTALLATION >

## REMOVAL AND INSTALLATION

### EXHAUST SYSTEM

Exploded View

INFOID:000000005634635

A

EX

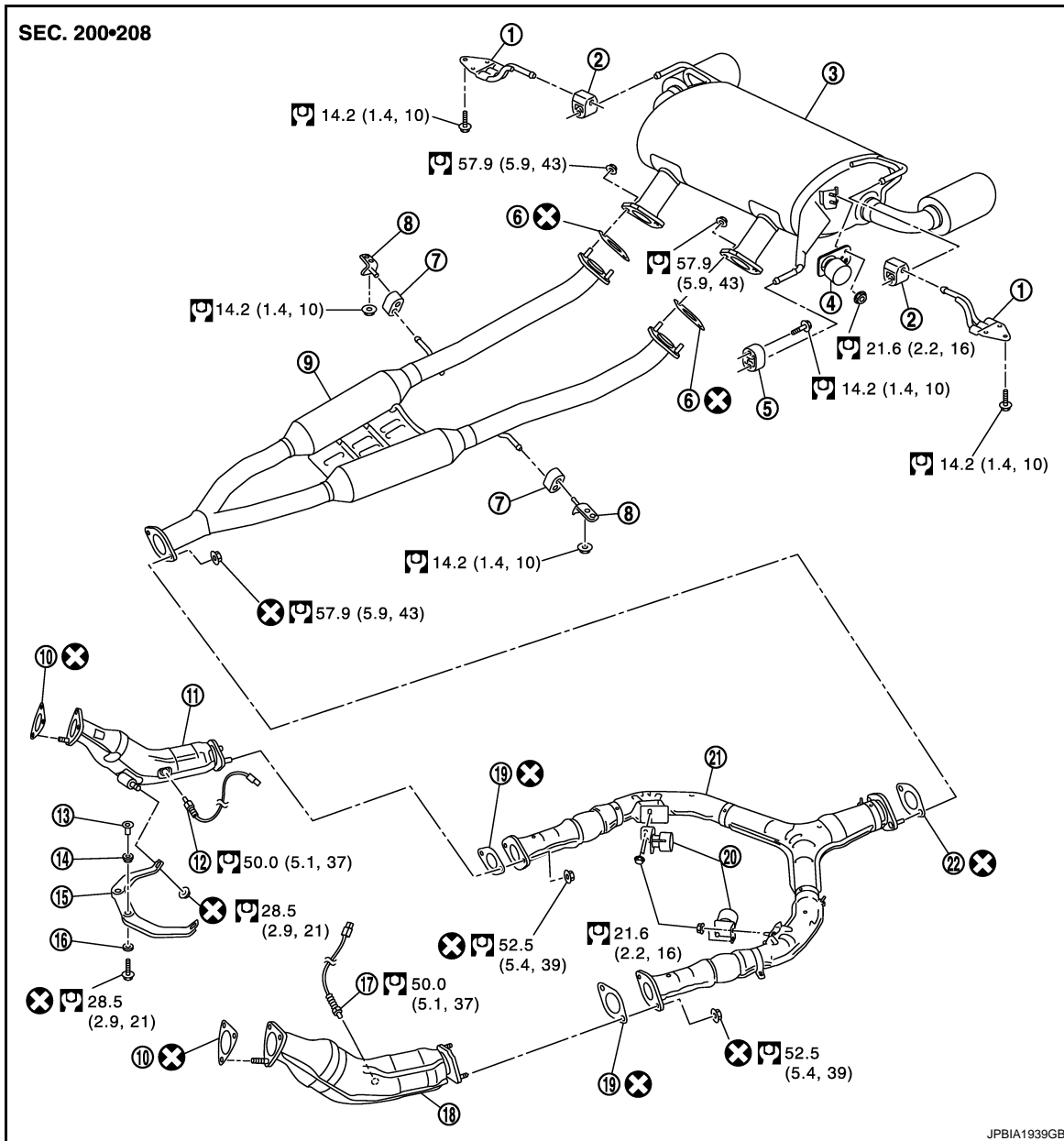

C

D

E

F

G

H

I

J

K

L

M

N

- |                     |                                     |                                     |
|---------------------|-------------------------------------|-------------------------------------|
| 1. Mounting bracket | 2. Mounting rubber                  | 3. Main muffler                     |
| 4. Dynamic damper   | 5. Mounting rubber                  | 6. Gasket                           |
| 7. Mounting rubber  | 8. Mounting bracket                 | 9. Center muffler                   |
| 10. Gasket          | 11. Three way catalyst (bank 1)     | 12. Heated oxygen sensor 2 (bank 1) |
| 13. Collar          | 14. Grommet                         | 15. Exhaust mounting bracket        |
| 16. Grommet         | 17. Heated oxygen sensor 2 (bank 2) | 18. Three way catalyst (bank 2)     |
| 19. Gasket          | 20. Dynamic damper                  | 21. Exhaust front tube              |
| 22. Gasket          |                                     |                                     |

Refer to [GI-4, "Components"](#) for symbols in the figure.

O

P

# EXHAUST SYSTEM

## < REMOVAL AND INSTALLATION >

### Removal and Installation

INFOID:000000005634636

#### REMOVAL

- Disconnect each joint and mounting using power tool.
- Remove heated oxygen sensor 2 as follows:
  - Using heated oxygen sensor wrench [SST: KV10114400 (J-38365)] (C), removal heated oxygen sensor 2.

A : Bank 1

B : Bank 2

↶ : Vehicle front

#### CAUTION:

Be careful not to damage heated oxygen sensor 2.

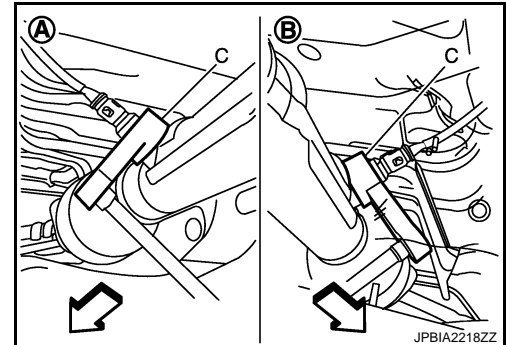

#### INSTALLATION

Note the following, and install in the reverse order of removal.

- Check for deformation of the grommets (14 and 16 of Components).
- Insert the collar (13 of Components) vertically.
- Temporarily tighten nuts and bolts when installing exhaust pipe assembly. Tighten them to the specified torque when connecting the vehicle rear to the vehicle front.

#### CAUTION:

- Always replace exhaust tube gaskets with new ones when reassembling.
- Discard any heated oxygen sensor 2 which has been dropped onto a hard surface such as a concrete floor. Use a new one.
- Before installing a new heated oxygen sensor 2, clean exhaust system threads using the heated oxygen sensor thread cleaner [commercial service tool: J-43897-18 or J-43897-12], and apply the anti-seize lubricant (commercial service tool).
- Never over torque heated oxygen sensor 2. Doing so may cause damage to heated oxygen sensor 2, resulting in the "MIL" coming on.
- If heat insulator is badly deformed, repair or replace it. If deposits such as mud pile up on the heat insulator, remove them.
- When installing heat insulator avoid large gaps or interference between heat insulator and each exhaust pipe.
- Remove deposits from the sealing surface of each connection. Connect them securely to avoid gases leakage.
- Temporarily tighten mounting nuts on the exhaust manifold side and mounting bolts on the vehicle side. Check each part for unusual interference, and then tighten them to the specified torque.
- When installing each mounting rubber, avoid twisting or unusual extension in up/down and right/left directions.

#### Inspection

INFOID:000000005634637

#### INSPECTION AFTER INSTALLATION

- Check clearance between tail tube and rear bumper is even.
- With engine running, check exhaust tube joints for gas leakage and unusual noises.
- Check to ensure that mounting brackets and mounting rubbers are installed properly and free from undue stress. Improper installation could result in excessive noise and vibration.