

SECTION **SRC**

SRS AIRBAG CONTROL SYSTEM

A
B
C
D
E
F
G
I
J
K
L
M
N
O
P

CONTENTS

<p>BASIC INSPECTION 6</p> <p>DIAGNOSIS AND REPAIR WORK FLOW 6</p> <p style="padding-left: 20px;">Work Flow6</p> <p>SYSTEM DESCRIPTION 9</p> <p>SRS AIR BAG SYSTEM 9</p> <p style="padding-left: 20px;">System Diagram9</p> <p style="padding-left: 20px;">System Description9</p> <p style="padding-left: 20px;">Component Parts Location 11</p> <p style="padding-left: 20px;">Component Description 12</p> <p>OCCUPANT CLASSIFICATION SYSTEM13</p> <p style="padding-left: 20px;">System Diagram 13</p> <p style="padding-left: 20px;">System Description 13</p> <p style="padding-left: 20px;">Component Parts Location 14</p> <p style="padding-left: 20px;">Component Description 14</p> <p>ON BOARD DIAGNOSTIC (OBD) SYSTEM15</p> <p style="padding-left: 20px;">Diagnosis Description 15</p> <p style="padding-left: 20px;">Diagnosis with Air Bag Warning Lamp 15</p> <p>DIAGNOSIS SYSTEM (AIR BAG)21</p> <p style="padding-left: 20px;">CONSULT-III Function 21</p> <p>DTC/CIRCUIT DIAGNOSIS22</p> <p>U1000 CAN COMM CIRCUIT22</p> <p style="padding-left: 20px;">Description22</p> <p style="padding-left: 20px;">DTC Logic22</p> <p style="padding-left: 20px;">Diagnosis Procedure22</p> <p>U1010 CONTROL UNIT (CAN)23</p> <p style="padding-left: 20px;">DTC Logic23</p> <p style="padding-left: 20px;">Diagnosis Procedure23</p> <p>B1001, B1002, B1003, B1004, B1005 DIAGNOSIS SENSOR UNIT24</p> <p style="padding-left: 20px;">Description24</p> <p style="padding-left: 20px;">DTC Logic24</p> <p style="padding-left: 20px;">Diagnosis Procedure24</p>	<p>B1006, B1007, B1008, B1009, B1010 DIAGNOSIS SENSOR UNIT26</p> <p style="padding-left: 20px;">Description26</p> <p style="padding-left: 20px;">DTC Logic26</p> <p style="padding-left: 20px;">Diagnosis Procedure26</p> <p>B1011, B1012, B1013, B1014, B1015 DIAGNOSIS SENSOR UNIT28</p> <p style="padding-left: 20px;">Description28</p> <p style="padding-left: 20px;">DTC Logic28</p> <p style="padding-left: 20px;">Diagnosis Procedure28</p> <p>B1017, B1020, B1021 OCCUPANT SYSTEM CONTROL UNIT30</p> <p style="padding-left: 20px;">Description30</p> <p style="padding-left: 20px;">DTC Logic30</p> <p style="padding-left: 20px;">Diagnosis Procedure30</p> <p>B1018 OCCUPANT SYSTEM SENSOR32</p> <p style="padding-left: 20px;">Description32</p> <p style="padding-left: 20px;">DTC Logic32</p> <p style="padding-left: 20px;">Diagnosis Procedure32</p> <p>B1022 OCCUPANT SYSTEM CONTROL UNIT34</p> <p style="padding-left: 20px;">Description34</p> <p style="padding-left: 20px;">DTC Logic34</p> <p style="padding-left: 20px;">Diagnosis Procedure34</p> <p>B1023 PASSENGER AIR BAG OFF INDICATOR36</p> <p style="padding-left: 20px;">Description36</p> <p style="padding-left: 20px;">DTC Logic36</p> <p style="padding-left: 20px;">Diagnosis Procedure36</p> <p>B1025, B1032, B1048 OCCUPANT SYSTEM SENSOR38</p> <p style="padding-left: 20px;">Description38</p> <p style="padding-left: 20px;">DTC Logic38</p> <p style="padding-left: 20px;">Diagnosis Procedure38</p>
---	--

SRC

B1026, B1027, B1028, B1029, B1030, B1031 DIAGNOSIS SENSOR UNIT	40	Description	62
Description	40	DTC Logic	62
DTC Logic	40	Diagnosis Procedure	62
Diagnosis Procedure	40		
B1033, B1034 CRASH ZONE SENSOR	42	B1066, B1071 PASSENGER AIR BAG MOD- ULE	64
Description	42	Description	64
DTC Logic	42	DTC Logic	64
Diagnosis Procedure	42	Diagnosis Procedure	64
B1035 CRASH ZONE SENSOR	44	B1067, B1072 PASSENGER AIR BAG MOD- ULE	66
Description	44	Description	66
DTC Logic	44	DTC Logic	66
Diagnosis Procedure	44	Diagnosis Procedure	66
B1036 CRASH ZONE SENSOR	46	B1068, B1073 PASSENGER AIR BAG MOD- ULE	68
Description	46	Description	68
DTC Logic	46	DTC Logic	68
Diagnosis Procedure	46	Diagnosis Procedure	68
B1037, B1039, B1041 CRASH ZONE SEN- SOR	48	B1074, B1075, B1076, B1077, B1078, B1079 DIAGNOSIS SENSOR UNIT	70
Description	48	Description	70
DTC Logic	48	DTC Logic	70
Diagnosis Procedure	48	Diagnosis Procedure	70
B1042, B1043, B1044, B1045, B1046, B1047 DIAGNOSIS SENSOR UNIT	50	B1080, B1096 DRIVER AIR BAG MODULE	72
Description	50	Description	72
DTC Logic	50	DTC Logic	72
Diagnosis Procedure	50	Diagnosis Procedure	72
B1049, B1054 DRIVER AIR BAG MODULE	52	B1081 SEAT BELT PRE-TENSIONER RH	74
Description	52	Description	74
DTC Logic	52	DTC Logic	74
Diagnosis Procedure	52	Diagnosis Procedure	74
B1050, B1055 DRIVER AIR BAG MODULE	54	B1082 SEAT BELT PRE-TENSIONER RH	76
Description	54	Description	76
DTC Logic	54	DTC Logic	76
Diagnosis Procedure	54	Diagnosis Procedure	76
B1051, B1056 DRIVER AIR BAG MODULE	56	B1083 SEAT BELT PRE-TENSIONER RH	78
Description	56	Description	78
DTC Logic	56	DTC Logic	78
Diagnosis Procedure	56	Diagnosis Procedure	78
B1052, B1057 DRIVER AIR BAG MODULE	58	B1084 SEAT BELT PRE-TENSIONER RH	80
Description	58	Description	80
DTC Logic	58	DTC Logic	80
Diagnosis Procedure	58	Diagnosis Procedure	80
B1058, B1059, B1060, B1061, B1062, B1063 DIAGNOSIS SENSOR UNIT	60	B1086 SEAT BELT PRE-TENSIONER LH	82
Description	60	Description	82
DTC Logic	60	DTC Logic	82
Diagnosis Procedure	60	Diagnosis Procedure	82
B1065, B1070 PASSENGER AIR BAG MOD- ULE	62	B1087 SEAT BELT PRE-TENSIONER LH	84
		Description	84
		DTC Logic	84

Diagnosis Procedure	84	Description	108	
B1088 SEAT BELT PRE-TENSIONER LH	86	DTC Logic	108	A
Description	86	Diagnosis Procedure	108	
DTC Logic	86	B1130 SIDE AIR BAG MODULE RH	110	B
Diagnosis Procedure	86	Description	110	
B1089 SEAT BELT PRE-TENSIONER LH	88	DTC Logic	110	
Description	88	Diagnosis Procedure	110	C
DTC Logic	88	B1131 SIDE AIR BAG MODULE RH	112	D
Diagnosis Procedure	88	Description	112	
B1090, B1091, B1092, B1093, B1094, B1095		DTC Logic	112	
DIAGNOSIS SENSOR UNIT	90	Diagnosis Procedure	112	D
Description	90	B1132 SIDE AIR BAG MODULE RH	114	E
DTC Logic	90	Description	114	
Diagnosis Procedure	90	DTC Logic	114	
B1106, B1107, B1108, B1109, B1110, B1111		Diagnosis Procedure	114	E
DIAGNOSIS SENSOR UNIT	92	B1134 SIDE AIR BAG MODULE LH	116	F
Description	92	Description	116	
DTC Logic	92	DTC Logic	116	
Diagnosis Procedure	92	Diagnosis Procedure	116	G
B1113, B1114 SATELLITE SENSOR RH	94	B1135 SIDE AIR BAG MODULE LH	118	
Description	94	Description	118	
DTC Logic	94	DTC Logic	118	
Diagnosis Procedure	94	Diagnosis Procedure	118	
B1115 SATELLITE SENSOR RH	96	B1136 SIDE AIR BAG MODULE LH	120	I
Description	96	Description	120	
DTC Logic	96	DTC Logic	120	
Diagnosis Procedure	96	Diagnosis Procedure	120	J
B1116 SATELLITE SENSOR RH	98	B1137 SIDE AIR BAG MODULE LH	122	
Description	98	Description	122	
DTC Logic	98	DTC Logic	122	
Diagnosis Procedure	98	Diagnosis Procedure	122	K
B1118, B1119 SATELLITE SENSOR LH	100	B1138, B1139, B1140, B1141, B1142, B1143		L
Description	100	DIAGNOSIS SENSOR UNIT	124	
DTC Logic	100	Description	124	
Diagnosis Procedure	100	DTC Logic	124	
B1120 SATELLITE SENSOR LH	102	Diagnosis Procedure	124	M
Description	102	B1144 DIAGNOSIS SENSOR UNIT	126	
DTC Logic	102	Description	126	
Diagnosis Procedure	102	DTC Logic	126	
B1121 SATELLITE SENSOR LH	104	Diagnosis Procedure	126	N
Description	104	B1145 CURTAIN AIR BAG MODULE RH	127	O
DTC Logic	104	Description	127	
Diagnosis Procedure	104	DTC Logic	127	
B1122, B1123, B1124, B1125, B1126, B1127		Diagnosis Procedure	127	P
DIAGNOSIS SENSOR UNIT	106	B1146 CURTAIN AIR BAG MODULE RH	129	
Description	106	Description	129	
DTC Logic	106	DTC Logic	129	
Diagnosis Procedure	106	Diagnosis Procedure	129	
B1129 SIDE AIR BAG MODULE RH	108	B1147 CURTAIN AIR BAG MODULE RH	131	
		Description	131	

SRC

DTC Logic	131	B1211 ROLLOVER DETECTION	153
Diagnosis Procedure	131	Description	153
B1148 CURTAIN AIR BAG MODULE RH	133	DTC Logic	153
Description	133	Diagnosis Procedure	153
DTC Logic	133	B1212, B1213, B1214 SATELLITE SENSOR	
Diagnosis Procedure	133	RH	154
B1150 CURTAIN AIR BAG MODULE LH	135	Description	154
Description	135	DTC Logic	154
DTC Logic	135	Diagnosis Procedure	154
Diagnosis Procedure	135	B1215, B1216, B1217 SATELLITE SENSOR	
B1151 CURTAIN AIR BAG MODULE LH	137	LH	156
Description	137	Description	156
DTC Logic	137	DTC Logic	156
Diagnosis Procedure	137	Diagnosis Procedure	156
B1152 CURTAIN AIR BAG MODULE LH	139	B1218, B1219, B1220, B1221, B1222, B1223	
Description	139	DIAGNOSIS SENSOR UNIT	158
DTC Logic	139	Description	158
Diagnosis Procedure	139	DTC Logic	158
B1153 CURTAIN AIR BAG MODULE LH	141	Diagnosis Procedure	158
Description	141	B1239 DIAGNOSIS SENSOR UNIT	160
DTC Logic	141	Description	160
Diagnosis Procedure	141	DTC Logic	160
B1154, B1155, B1156, B1157, B1158, B1159		Diagnosis Procedure	160
DIAGNOSIS SENSOR UNIT	143	B1257 DOOR-MOUNTED CURTAIN AIR BAG	
Description	143	MODULE RH	161
DTC Logic	143	Description	161
Diagnosis Procedure	143	DTC Logic	161
B1170, B1171, B1172, B1173, B1174, B1175		Diagnosis Procedure	161
DIAGNOSIS SENSOR UNIT	145	B1258 DOOR-MOUNTED CURTAIN AIR BAG	
Description	145	MODULE RH	163
DTC Logic	145	Description	163
Diagnosis Procedure	145	DTC Logic	163
B1186, B1187, B1188, B1189, B1190, B1191		Diagnosis Procedure	163
DIAGNOSIS SENSOR UNIT	147	B1259 DOOR-MOUNTED CURTAIN AIR BAG	
Description	147	MODULE RH	165
DTC Logic	147	Description	165
Diagnosis Procedure	147	DTC Logic	165
B1202, B1203, B1204, B1205, B1206, B1207		Diagnosis Procedure	165
DIAGNOSIS SENSOR UNIT	149	B1260 DOOR-MOUNTED CURTAIN AIR BAG	
Description	149	MODULE RH	167
DTC Logic	149	Description	167
Diagnosis Procedure	149	DTC Logic	167
B1209 FRONTAL COLLISION DETECTION .	151	Diagnosis Procedure	167
Description	151	B1262 DOOR-MOUNTED CURTAIN AIR BAG	
DTC Logic	151	MODULE LH	169
Diagnosis Procedure	151	Description	169
B1210 SIDE COLLISION DETECTION	152	DTC Logic	169
Description	152	Diagnosis Procedure	169
DTC Logic	152	B1263 DOOR-MOUNTED CURTAIN AIR BAG	
Diagnosis Procedure	152	MODULE LH	171

Description	171	B1296 POP-UP ROLL BAR LH	189	
DTC Logic	171	Description	189	A
Diagnosis Procedure	171	DTC Logic	189	
		Diagnosis Procedure	189	
B1264 DOOR-MOUNTED CURTAIN AIR BAG		B1297 POP-UP ROLL BAR LH	191	B
MODULE LH	173	Description	191	
Description	173	DTC Logic	191	C
DTC Logic	173	Diagnosis Procedure	191	
Diagnosis Procedure	173			
B1265 DOOR-MOUNTED CURTAIN AIR BAG		B1298 POP-UP ROLL BAR	193	D
MODULE LH	175	Description	193	
Description	175	DTC Logic	193	
DTC Logic	175	Diagnosis Procedure	193	
Diagnosis Procedure	175			
B1289 POP-UP ROLL BAR RH	177	ECU DIAGNOSIS INFORMATION	195	E
Description	177	DIAGNOSIS SENSOR UNIT	195	
DTC Logic	177	DTC Index	195	F
Diagnosis Procedure	177	Wiring Diagram - SRS AIR BAG CONTROL SYS- TEM -	199	
B1290 POP-UP ROLL BAR RH	179	SYMPTOM DIAGNOSIS	208	G
Description	179	SRS AIR BAG WARNING LAMP DOES NOT		
DTC Logic	179	TURN OFF	208	
Diagnosis Procedure	179	Diagnosis Procedure	208	SRC
B1291 POP-UP ROLL BAR RH	181	SRS AIR BAG WARNING LAMP DOES NOT		
Description	181	TURN ON	209	I
DTC Logic	181	Diagnosis Procedure	209	
Diagnosis Procedure	181	PRECAUTION	210	J
B1292 POP-UP ROLL BAR RH	183	PRECAUTIONS	210	
Description	183	Precaution for Supplemental Restraint System (SRS) "AIR BAG" and "SEAT BELT PRE-TEN- SIONER"	210	K
DTC Logic	183	Service Procedure Precautions for Models with a Pop-up Roll Bar	210	L
Diagnosis Procedure	183	Service	210	
B1294 POP-UP ROLL BAR LH	185	Occupant Classification System Precaution	211	M
Description	185	Precaution for Battery Service	211	
DTC Logic	185			
Diagnosis Procedure	185			
B1295 POP-UP ROLL BAR LH	187			
Description	187			
DTC Logic	187			
Diagnosis Procedure	187			

DIAGNOSIS AND REPAIR WORK FLOW

< BASIC INSPECTION >

BASIC INSPECTION

DIAGNOSIS AND REPAIR WORK FLOW

Work Flow

INFOID:000000005631411

OVERALL SEQUENCE

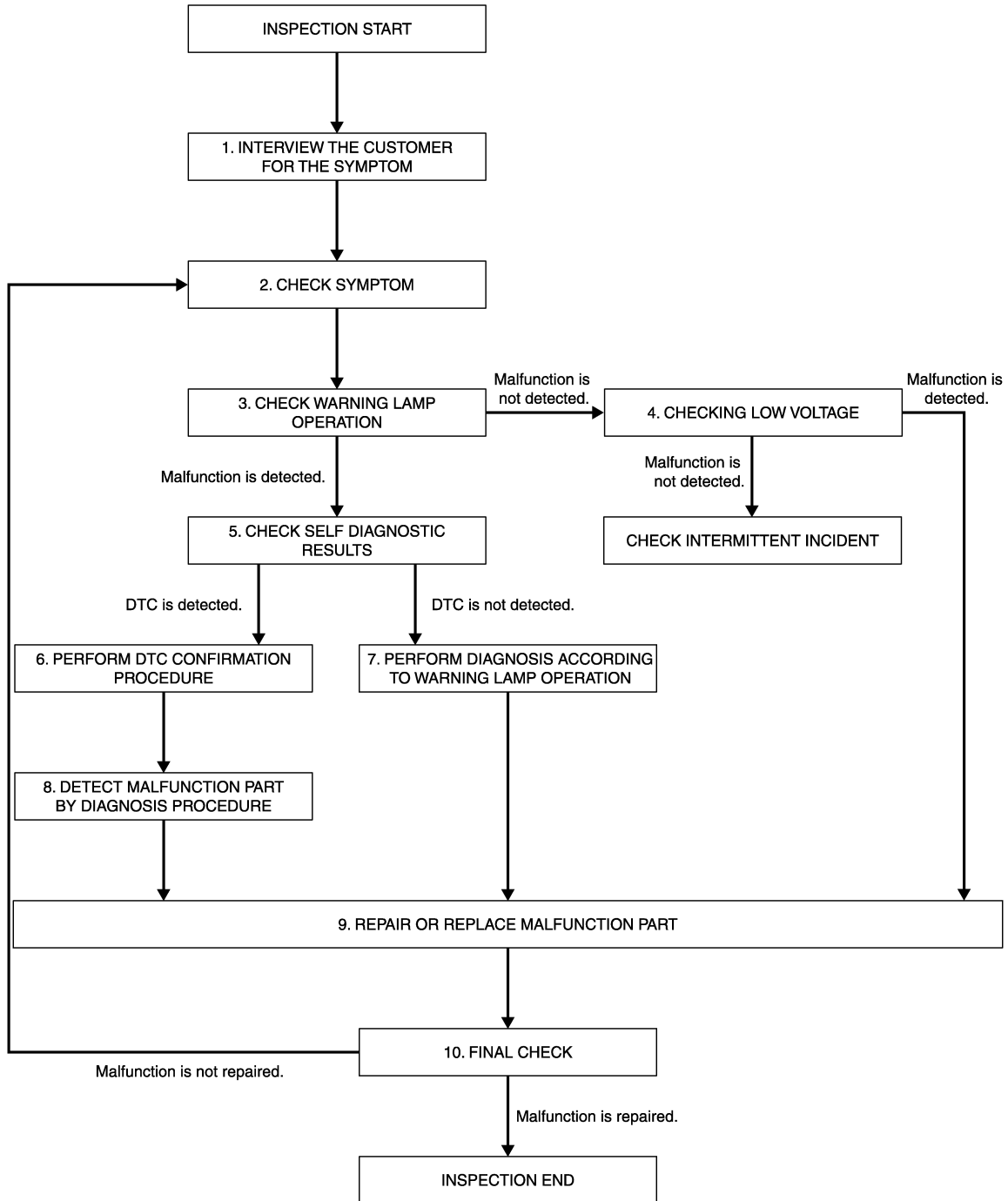

JMHIA1324GB

DETAILED FLOW

DIAGNOSIS AND REPAIR WORK FLOW

< BASIC INSPECTION >

1. INTERVIEW THE CUSTOMER FOR THE SYMPTOM

Interview the customer for the symptom (the condition and the environment when the incident/malfunction occurs).

>> GO TO 2.

2. CHECK SYMPTOM

Check the symptom from the customer information.

>> GO TO 3.

3. CHECK WARNING LAMP OPERATION

Check air bag warning lamp operation in the user mode. Refer to [SRC-15, "Diagnosis with Air Bag Warning Lamp"](#).

Are any malfunction detected?

YES >> GO TO 5.

NO >> GO TO 4.

4. CHECK LOW VOLTAGE

Check low voltage with CONSULT-III (Special function). Refer to [SRC-21, "CONSULT-III Function"](#).

Are any malfunction detected?

YES >> GO TO 9.

NO >> Check intermittent incident. Refer to [GI-37, "Intermittent Incident"](#).

5. CHECK SELF DIAGNOSTIC RESULTS

Check self diagnostic result with CONSULT-III or diagnosis mode.

If it is impossible to switch to diagnosis mode, follow the same procedure that DTC is not detected.

NOTE:

Perform the following procedure if DTC is detected.

- Record DTC (Print them out with CONSULT-III.)
- Erase self diagnostic result.
- Study the relationship between the malfunction that DTC or air bag warning lamp indicates and the symptom that the customer describes.
- Check related service bulletins for information.

Is DTC detected?

YES >> GO TO 6.

NO >> GO TO 7.

6. PERFORM DTC CONFIRMATION PROCEDURE

Perform DTC CONFIRMATION PROCEDURE for the DTC.

>> GO TO 8.

7. PERFORM DIAGNOSIS ACCORDING TO WARNING LAMP OPERATION

1. Check air bag warning lamp operation in the user mode. Refer to [SRC-15, "Diagnosis with Air Bag Warning Lamp"](#).
2. Perform Diagnosis Procedure for the air bag warning lamp operation. Refer to [SRC-15, "Diagnosis with Air Bag Warning Lamp"](#) (USER MODE).

>> GO TO 9.

8. DETECT MALFUNCTIONING PART BY DIAGNOSTIC PROCEDURE

Inspect according to Diagnostic Procedure of the DTC.

>> GO TO 9.

A
B
C
D
E
F
G
I
J
K
L
M
N
O
P

SRC

DIAGNOSIS AND REPAIR WORK FLOW

< BASIC INSPECTION >

9. REPAIR OR REPLACE THE MALFUNCTION PART

Repair or replace the malfunctioning part.

>> GO TO 10.

10. FINAL CHECK

Check self diagnostic result and air bag warning lamp operation in the user mode.

Is the malfunction repaired?

YES >> INSPECTION END
NO >> GO TO 2.

SRS AIR BAG SYSTEM

< SYSTEM DESCRIPTION >

SYSTEM DESCRIPTION

SRS AIR BAG SYSTEM

System Diagram

INFOID:0000000005631412

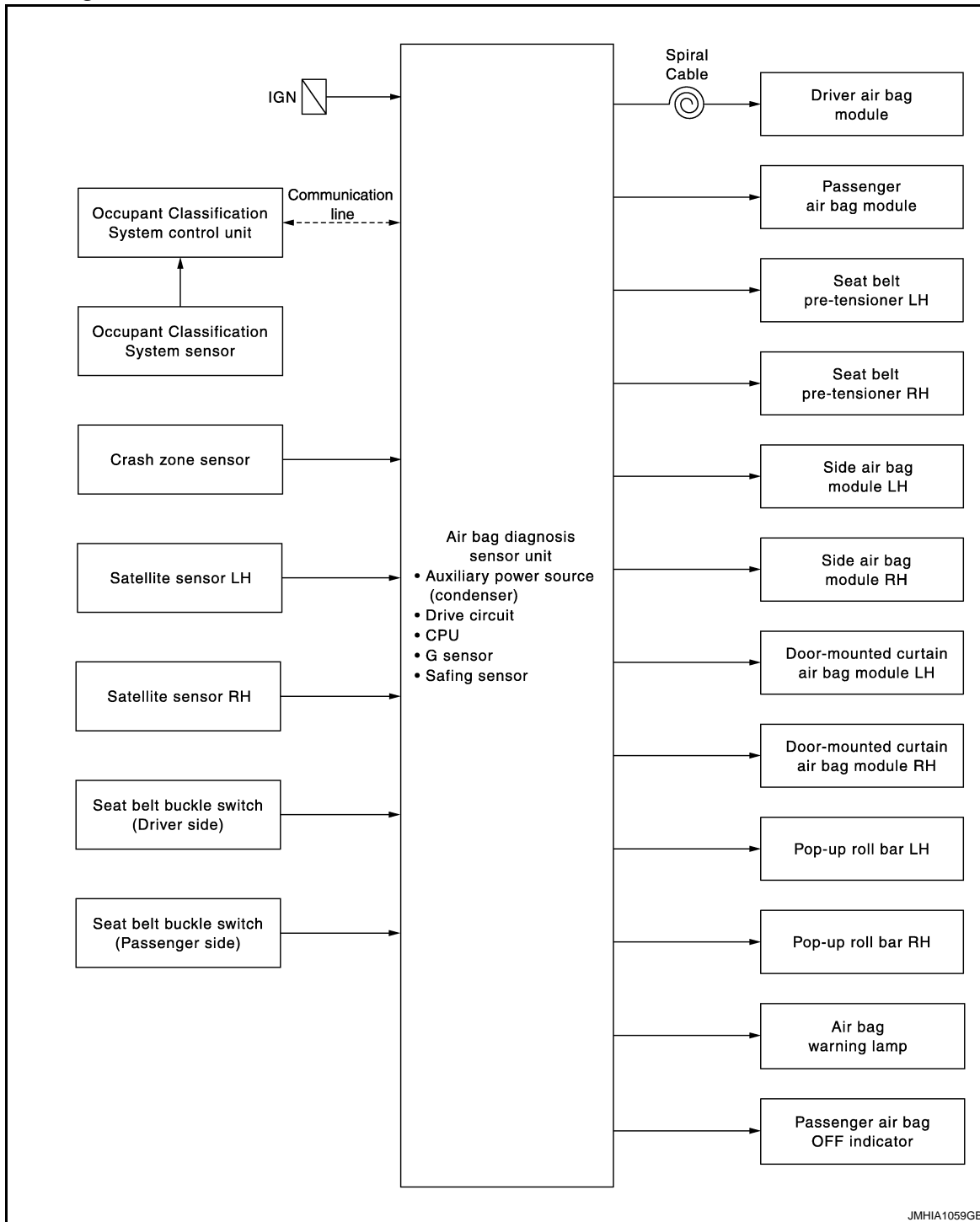

A
B
C
D
E
F
G
SRC
I
J
K
L
M
N
O
P

System Description

INFOID:0000000005631413

Supplemental Restraint System (SRS) activates air bag module and seat belt pre-tensioner when it detects a frontal collision or a side collision that is more than the specified limit. Together with other safety devices, it reduces the impact that occupant receives when vehicle collision occurs.

Air bag diagnosis sensor unit supplies power supply to air bag module and pre-tensioner seat belt when deceleration that is more than the specified limit is detected by G sensor in air bag diagnosis sensor unit, crash

SRS AIR BAG SYSTEM

< SYSTEM DESCRIPTION >

zone sensor, or satellite sensor. Air bag module is composed of electric igniter (squib), filter, pyrotechnic material, and gas generating material. When air bag module receives a signal from air bag diagnosis sensor unit, air bag module ignites pyrotechnic material using electric igniter (squib) so that gas generating material generates high temperature nitrogen gas. The gas through filter activates air bag. At the same time, pre-tensioner seat belt receives power supply from air bag diagnosis sensor unit, gasgenerator is activated, and then gas is generated. Balls in pipe are moved according to generated gas pressure and strike pinion gear on ELR shaft. ELR shaft rotates and retracts seat belt.

When diagnosis sensor unit detects a rollover of the vehicle, electric igniter (squib) receives power supply, pyrotechnic material is ignited, and then piston is projected.

Piston rotates lever and lever rotation releases stopper. When stopper is released, pop-up roll bar is deployed by spring force.

AIR BAG DIAGNOSIS SENSOR UNIT FUNCTIONS

Air bag diagnosis sensor unit has the following functions.

- Detects a collision and supplies the energy for deploying air bag and seat belt pre-tensioner.
- Detects and records electrical malfunction in air bag system and seat belt pre-tensioner system, and blinking air bag warning lamp.
- Detects and records the deployment of air bag and seat belt pre-tensioner, and turns ON air bag warning lamp.
- Indicates malfunctioning portion via the number of blinks from the air bag warning lamp in the diagnosis mode.
- Indicates the malfunction record via CONSULT-III.
- Suppresses the deployment of passenger air bag when passenger seat is empty or occupied by child or child-seat.
- When passenger seat is occupied by child or child seat, turns ON passenger air bag OFF indicator.
- When judges that passenger seat is occupied by a adult or a child and passenger seat belt is not fasten, turns ON seat belt warning lamp. Further information for the seat belt warning system, refer to [SBC-9. "System Description"](#).

COLLISION MODES

The operation of SRS is different depending on the collision modes applications. For example, the driver air bag module, passenger air bag module, and seat belt pre-tensioner are activated in a frontal collision but not in a side collision.

SRS configurations that are activated for the following collision modes.

×: Apply —: Not apply

SRS configuration	Frontal collision	Left side collision	Right side collision	Roll over
Driver air bag module	×	—	—	—
Passenger air bag module	×	—	—	—
Seat belt pre-tensioner LH	×	—	—	×
Seat belt pre-tensioner RH	×	—	—	×
Side air bag module LH	—	×	—	—
Side air bag module RH	—	—	×	—
Door-mounted curtain air bag module LH	—	×	—	×
Door-mounted curtain air bag module RH	—	—	×	×
Pop-up roll bar LH	—	—	—	×
Pop-up roll bar RH	—	—	—	×

SRS AIR BAG SYSTEM

< SYSTEM DESCRIPTION >

Component Parts Location

INFOID:000000005631414

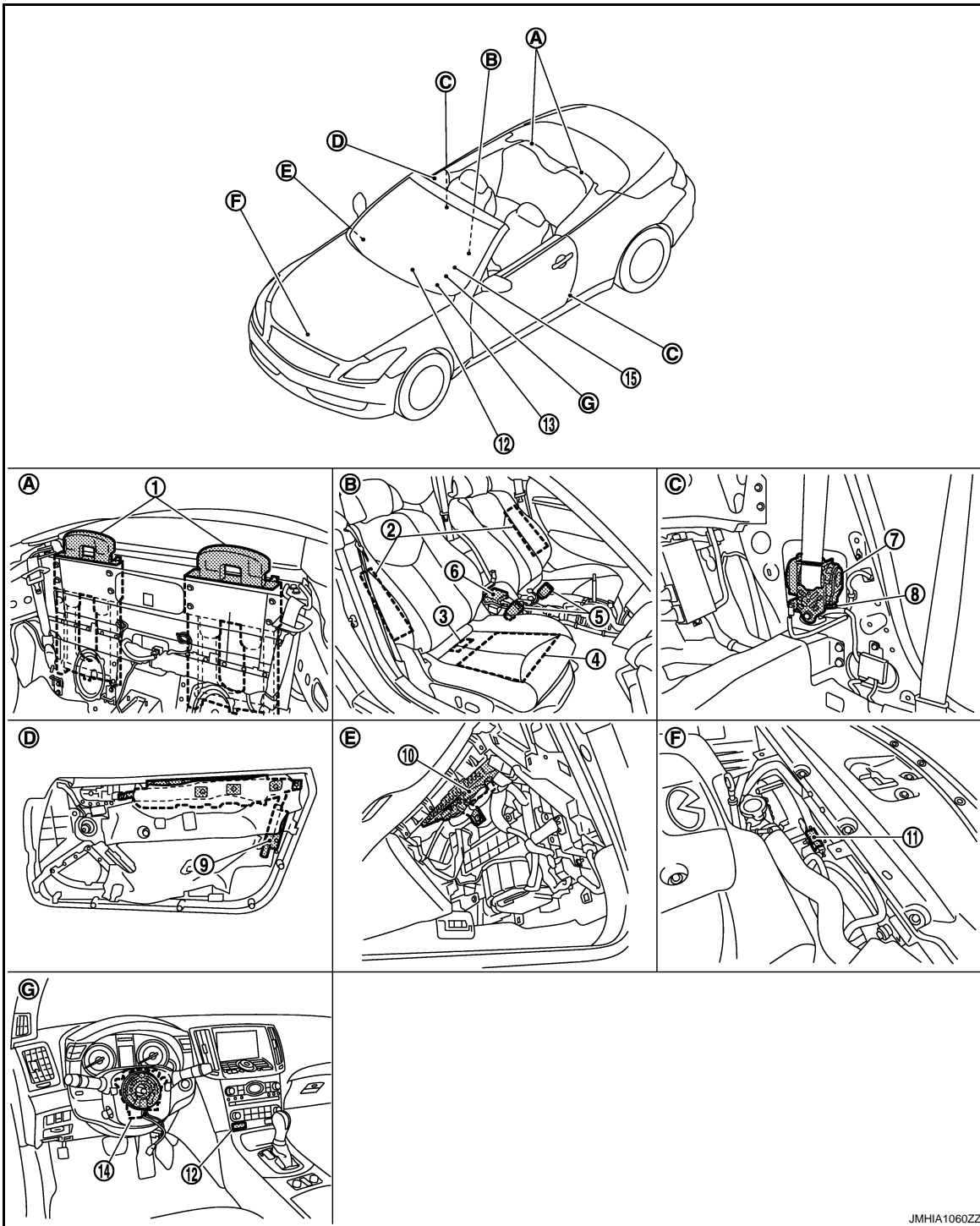

- | | | |
|--|--|--|
| <p>1. Pop-up roll bar LH/RH</p> <ul style="list-style-type: none"> • LH D18 • RH D48 | <p>2. Side air bag module LH/RH</p> <ul style="list-style-type: none"> • LH B12 • RH B212 | <p>3. Occupant Classification System control unit B214</p> |
| <p>4. Occupant Classification System seat sensor mat</p> | <p>5. Seat belt buckle switch (Driver side/ Passenger side)</p> <ul style="list-style-type: none"> • Driver side B13 • Passenger side B213 | <p>6. Air bag diagnosis sensor unit B15, B215, M147</p> |

JMHIA1060ZZ

A
B
C
D
E
F
G
H
I
J
K
L
M
N
O
P

SRC

SRS AIR BAG SYSTEM

< SYSTEM DESCRIPTION >

- | | | |
|--|--|---|
| <p>7. Seat belt pre-tensioner LH/RH</p> <ul style="list-style-type: none"> • LH B19 • RH B219 <p>10. Passenger air bag module 1/2</p> <ul style="list-style-type: none"> • 1 M156 • 2 M157 <p>13. Combination meter M53</p> <p>A. Behind rear seat assembly</p> <p>D. Behind door finisher assembly</p> <p>G. View with steering wheel removed</p> | <p>8. Satellite sensor LH/RH</p> <ul style="list-style-type: none"> • LH B20 • RH B220 <p>11. Crash zone sensor E36</p> <p>14. Combination switch (spiral cable) M35</p> <p>B. View with center console assembly removed</p> <p>E. Behind glove box assembly</p> | <p>9. Door-mounted curtain air bag module LH/RH</p> <ul style="list-style-type: none"> • LH B18 • RH B218 <p>12. Passenger air bag OFF indicator M73</p> <p>15. Driver air bag module M301, M302</p> <p>C. Behind rear side finisher</p> <p>F. Radiator core support assembly</p> |
|--|--|---|

Component Description

INFOID:000000005631415

Component	Function
Air bag diagnosis sensor unit	<ul style="list-style-type: none"> • Detects a collision and supplies power supply for deployment to air bag module and pre-tensioner seat belt. • It detects a rollover acceleration, supplies power source to pop-up roll bar, and have pop-up roll bar deploy.
Air bag module <ul style="list-style-type: none"> • Driver • Passenger • Side • Door-mounted curtain 	Receives signal from air bag diagnosis sensor unit and deploys air bag.
Seat belt pre-tensioner	Receives signal from air bag diagnosis sensor unit and deploys seat belt pre-tensioner.
Seat belt buckle switch	Controls deployment timing based on seat belt fastened or unfastened condition.
Crash zone sensor	Transmits signal to air bag diagnosis sensor unit when a frontal collision occurs.
Satellite sensor (LH/RH)	Transmits signal to air bag diagnosis sensor unit when a side collision occurs.
Occupant Classification System control unit	Detects passenger seat occupant and judges whether or not passenger seat air bag is deployed.
Combination meter (air bag warning lamp)	Indicates air bag malfunctioning and deployment by blinking and illuminating air bag warning lamp.
Passenger air bag OFF indicator	Indicates whether or not passenger air bag is in the activation mode based on the judgement of Occupant Classification System.
Combination switch (spiral cable)	Supplies power supply to driver air bag module on steering wheel.
Pop-up roll bar	It receives signal from diagnosis sensor unit and deploys.

OCCUPANT CLASSIFICATION SYSTEM

< SYSTEM DESCRIPTION >

OCCUPANT CLASSIFICATION SYSTEM

System Diagram

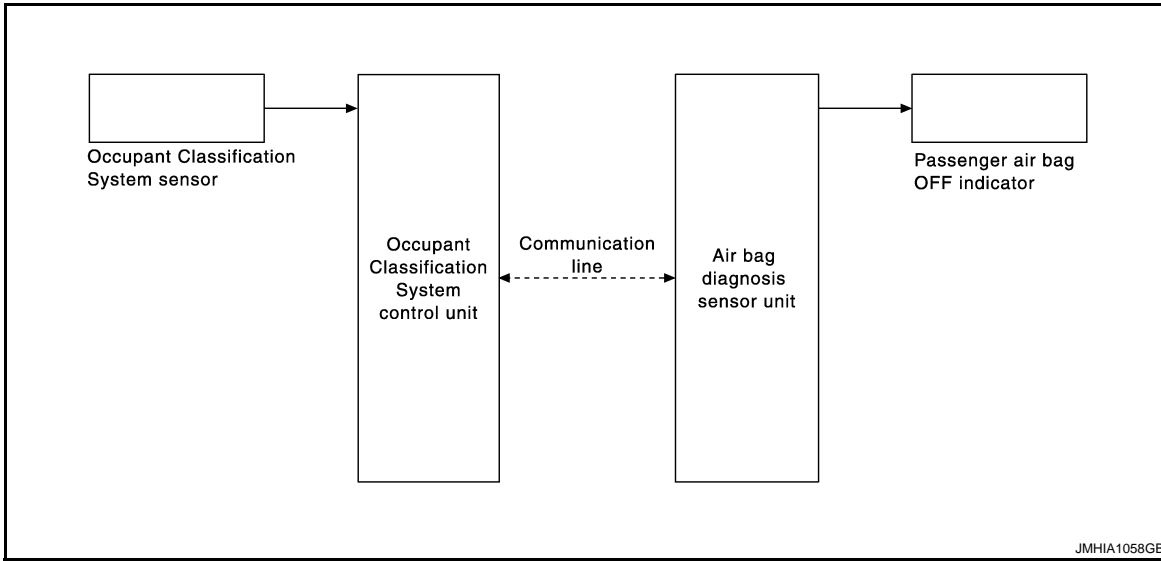

System Description

INFOID:000000005631417

Occupant Classification System has the following functions.

- Suppresses the deployment of passenger air bag when passenger seat is empty, or when occupied by child and child-seat.
- Turns on passenger air bag OFF indicator when passenger seat is occupied by child-seat and child.
- Indicates malfunction portion via the number of blinks from the air bag warning lamp in the diagnosis mode.
- Indicates the malfunctioning record via CONSULT-III.

Status (passenger seat)	Passenger air bag	Passenger air bag OFF indicator	Air bag warning lamp
Empty	Suppress	OFF	OFF
Child/child-seat	Suppress	ON	OFF
Adult	Enable to deploy	OFF	OFF
Malfunction	Suppress	ON	Blinking

A
B
C
D
E
F
G
I
J
K
L
M
N
O
P

SRC

OCCUPANT CLASSIFICATION SYSTEM

< SYSTEM DESCRIPTION >

Component Parts Location

INFOID:000000005631418

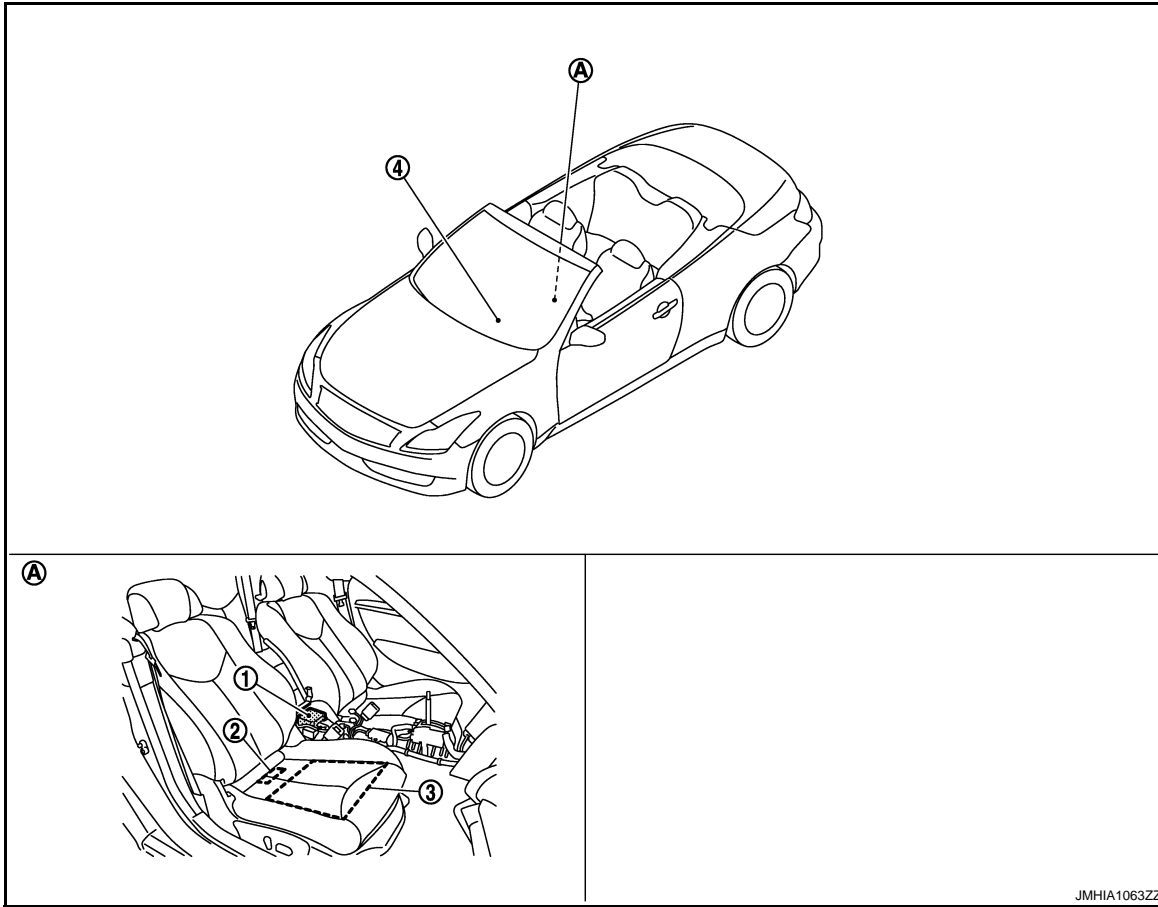

JMHIA1063ZZ

- | | | |
|---|--|--|
| 1. Air bag diagnosis sensor unit
B15, B215, M147 | 2. Occupant Classification System
control unit B214 | 3. Occupant Classification System seat
sensor mat |
| 4. Passenger air bag OFF indica-
tor M73 | | |
| A. View with center console as-
sembly removed | B. Passenger seat | |

Component Description

INFOID:000000005631419

Component parts	Outline of function
Occupant Classification System seat sensor mat	Detects if the passenger seat is empty or occupied. It is integrated into the seat cushion and detects the occupants with occupant classification system control unit that classifies the occupants.
Occupant Classification System control unit	Transmits the passenger seat status (occupied or empty) to air bag diagnosis sensor unit. It is installed in the passenger seat cushion.
Passenger air bag OFF indicator	Turns the passenger air bag OFF indicator lamp ON when the passenger seat is occupied by a child or a child-seat.
Air bag diagnosis sensor unit	<ul style="list-style-type: none"> Performs the deploy judgement of passenger air bag based on the information from Occupant Classification System control unit. Passenger air bag OFF indicator turns ON or turns OFF when passenger state signal detected by Occupant Classification System control unit is received.

ON BOARD DIAGNOSTIC (OBD) SYSTEM

< SYSTEM DESCRIPTION >

ON BOARD DIAGNOSTIC (OBD) SYSTEM

Diagnosis Description

INFOID:000000005631420

CAUTION:

- **Never use electrical test equipment on any circuit related to the SRS unless instructed in this Service Manual. SRS wiring harnesses can be identified by yellow and/or orange harnesses or harness connectors.**
- **Never repair, splice or modify the SRS wiring harness. If the harness is damaged, replace it with a new one.**
- **Keep ground portion clean.**

DIAGNOSIS FUNCTION

- The SRS self-diagnostic results can be read with air bag warning lamp and/or CONSULT-III.
- The user mode is exclusively prepared for the customer (driver). This mode warns the driver of a system malfunction through the operation of the air bag warning lamp.
- The diagnosis mode allows the technician to locate and inspect the malfunctioning part.
- The mode applications for the air bag warning lamp and CONSULT-III are as per the following items.

×: Application, —: Not application

Diagnosis tool	User mode	Diagnosis mode
Air bag warning lamp	×	×
CONSULT-III	—	×

Diagnosis with Air Bag Warning Lamp

INFOID:000000005631421

SELF DIAGNOSIS FUNCTION

There are two self diagnosis functions with air bag warning lamp per the following items.

- USER MODE
- DIAGNOSIS MODE

CHANGE DIAGNOSIS MODE

- Diagnosis mode changes from user mode to diagnosis mode when changing operation is performed.
- In user mode, when SRS air bag warning lamp is not blinking, changing to diagnosis mode by ignition switch operation is not possible.
- In diagnosis mode, when repair is complete and system is normal, the mode changes to user mode when ignition switch is turned from OFF to ON.

PROCEDURE TO CHANGE DIAGNOSIS MODE

1. Turn ignition switch from OFF to ON.
2. SRS air bag lamp turns ON for 7 second and turns OFF, then turn ignition switch OFF within 1second after the lamp turns OFF.
3. After turning ignition switch OFF, wait for 3 seconds or more.
4. Repeat operation 1 to 3 for 2 times so that operation 1 to 3 is repeated for 3times in total.
5. Turn ignition switch from OFF to ON. Diagnosis mode changes.

USER MODE

In USER MODE, air bag warning lamp on combination meter blinks when a malfunction is detected and warns the customer (driver).

How to Read Air Bag Warning Lamp

1. Turn the ignition switch from OFF to ON, and check that the air bag warning lamp blinks.
2. Compare the air bag warning lamp blinking pattern with the examples.



Air Bag Warning Lamp Examples

A
B
C
D
E
F
G
I
J
K
L
M
N
O
P

SRC

ON BOARD DIAGNOSTIC (OBD) SYSTEM

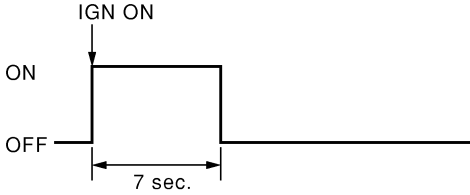
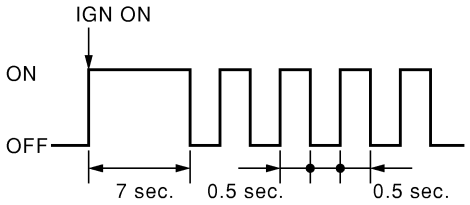
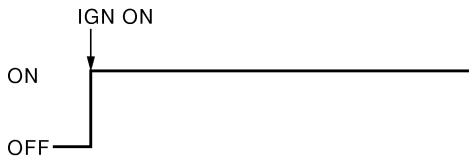
< SYSTEM DESCRIPTION >

Air bag warning lamp operation (user mode)	SRS condition	Reference item
 <p style="text-align: right;">SHIA0011E</p>	<ul style="list-style-type: none"> No malfunction is detected No further action is necessary 	<p style="text-align: center;">—</p>
 <p style="text-align: right;">SHIA0012E</p>	<ul style="list-style-type: none"> The system is malfunctioning Self diagnostic result is not erased after repair <p>Battery voltage is low (less than 9 V)</p> <p>Intermittent malfunction is detected in the past</p>	<p>Erase "Self Diagnostic Result" Refer to SRC-21, "CONSULT-III Function", How to Erase Self-diagnostic Result</p> <p>Check "CAUSE OF WARNING" in "Special Function" with CONSULT-III Refer to SRC-21, "CONSULT-III Function"</p> <p>Go to GI-37, "Intermittent Incident"</p>
 <p style="text-align: right;">SHIA0013E</p>	<ul style="list-style-type: none"> Air bag is deployed Seat belt pre-tensioner is deployed Pop-up roll bar is deployed <ul style="list-style-type: none"> Air bag diagnosis sensor unit is malfunctioning Air bag power supply circuit is malfunctioning Air bag warning lamp circuit is malfunctioning 	<p>Go to SRC-151, "Diagnosis Procedure" or SRC-152, "Diagnosis Procedure"</p> <p>Go to SRC-208, "Diagnosis Procedure"</p>
 <p style="text-align: right;">SHIA0014E</p>	<ul style="list-style-type: none"> Air bag diagnosis sensor unit is malfunctioning Air bag warning lamp circuit is malfunctioning 	<p>Go to SRC-209, "Diagnosis Procedure"</p>

DIAGNOSIS MODE

The diagnosis mode can only be switched when a malfunction is detected in the user mode. Malfunctioning system is indicated according to blinking pattern of air bag warning lamp.

How to Read Air Bag Warning Lamp

- Follow the procedures of "PROCEDURE TO CHANGE DIAGNOSIS MODE", and switch to the diagnosis mode.
- Turn ignition switch ON. Check the blinking pattern of air bag warning lamp.
There are 2 blinking patterns for the air bag warning lamp as per the following items.
 - Front air bag system: 3 second blink followed by a 0.5 second blink repeated.

ON BOARD DIAGNOSTIC (OBD) SYSTEM

< SYSTEM DESCRIPTION >

- Side air bag system: Two 1.5 second blinks followed by a 0.5 second blink repeated.

Front air bag system

Number of 0.5 second blinks	Malfunctioning items	Blinking pattern
0	<ul style="list-style-type: none"> • Self-diagnostic result is not erased after repair • Intermittent malfunction is detected in the past 	Refer to the following items <ul style="list-style-type: none"> • Refer to How to Erase Self-diagnostic Result • GI-37, "Intermittent Incident"
1	Seat belt pre-tensioner LH	Refer to the following items <ul style="list-style-type: none"> • SRC-82, "DTC Logic" • SRC-84, "DTC Logic" • SRC-86, "DTC Logic" • SRC-88, "DTC Logic"
2	Driver air bag module	Refer to the following items <ul style="list-style-type: none"> • SRC-52, "DTC Logic" • SRC-54, "DTC Logic" • SRC-56, "DTC Logic" • SRC-58, "DTC Logic" • SRC-72, "DTC Logic"
3	Seat belt pre-tensioner RH	Refer to the following items <ul style="list-style-type: none"> • SRC-74, "DTC Logic" • SRC-76, "DTC Logic" • SRC-78, "DTC Logic" • SRC-80, "DTC Logic"
5	Occupant Classification System control unit	Refer to the following items <ul style="list-style-type: none"> • SRC-30, "DTC Logic" • SRC-32, "DTC Logic" • SRC-34, "DTC Logic" • SRC-38, "DTC Logic"
6	Crash zone sensor	Refer to the following items <ul style="list-style-type: none"> • SRC-42, "DTC Logic" • SRC-44, "DTC Logic" • SRC-46, "DTC Logic" • SRC-48, "DTC Logic"
7	Air bag diagnosis sensor unit	Refer to the following items <ul style="list-style-type: none"> • SRC-24, "DTC Logic" • SRC-26, "DTC Logic" • SRC-28, "DTC Logic" • SRC-40, "DTC Logic" • SRC-50, "DTC Logic" • SRC-60, "DTC Logic" • SRC-70, "DTC Logic" • SRC-90, "DTC Logic" • SRC-92, "DTC Logic" • SRC-106, "DTC Logic" • SRC-124, "DTC Logic" • SRC-143, "DTC Logic" • SRC-145, "DTC Logic" • SRC-147, "DTC Logic" • SRC-149, "DTC Logic" • SRC-158, "DTC Logic" • SRC-160, "DTC Logic"
8	Passenger air bag module	Refer to the following items <ul style="list-style-type: none"> • SRC-62, "DTC Logic" • SRC-64, "DTC Logic" • SRC-66, "DTC Logic" • SRC-68, "DTC Logic"
11	Passenger air bag OFF indicator	Refer to SRC-36, "DTC Logic" .
17	Air bag diagnosis sensor unit	Refer to SRC-126, "DTC Logic"

A

B

C

D

E

F

G

SRC

I

J

K

L

M

N

O

P

ON BOARD DIAGNOSTIC (OBD) SYSTEM

< SYSTEM DESCRIPTION >

Side air bag system

Number of 0.5-second blinks	Malfunctioning items	Blinking pattern
1	Side air bag module RH	Refer to the following items <ul style="list-style-type: none"> • SRC-108, "DTC Logic" • SRC-110, "DTC Logic" • SRC-112, "DTC Logic" • SRC-114, "DTC Logic"
2	Side air bag module LH	Refer to the following items <ul style="list-style-type: none"> • SRC-116, "DTC Logic" • SRC-118, "DTC Logic" • SRC-120, "DTC Logic" • SRC-122, "DTC Logic"
3	Satellite sensor RH	Refer to the following items <ul style="list-style-type: none"> • SRC-94, "DTC Logic" • SRC-96, "DTC Logic" • SRC-98, "DTC Logic" • SRC-154, "DTC Logic"
4	Satellite sensor LH	Refer to the following items <ul style="list-style-type: none"> • SRC-100, "DTC Logic" • SRC-102, "DTC Logic" • SRC-104, "DTC Logic" • SRC-156, "DTC Logic"
5	Curtain air bag module RH	Refer to the following items <ul style="list-style-type: none"> • SRC-127, "DTC Logic" • SRC-129, "DTC Logic" • SRC-131, "DTC Logic" • SRC-133, "DTC Logic"
6	Curtain air bag module LH	Refer to the following items <ul style="list-style-type: none"> • SRC-135, "DTC Logic" • SRC-137, "DTC Logic" • SRC-139, "DTC Logic" • SRC-141, "DTC Logic"
14	Door-mounted curtain air bag module RH	Refer to the following items <ul style="list-style-type: none"> • SRC-161, "DTC Logic" • SRC-163, "DTC Logic" • SRC-165, "DTC Logic" • SRC-167, "DTC Logic"
15	Door-mounted curtain air bag module LH	Refer to the following items <ul style="list-style-type: none"> • SRC-169, "DTC Logic" • SRC-171, "DTC Logic" • SRC-173, "DTC Logic" • SRC-175, "DTC Logic"
18	Pop-up roll bar RH	Refer to the following items <ul style="list-style-type: none"> • SRC-177, "DTC Logic" • SRC-179, "DTC Logic" • SRC-181, "DTC Logic" • SRC-183, "DTC Logic"
19	Pop-up roll bar LH	Refer to the following items <ul style="list-style-type: none"> • SRC-185, "DTC Logic" • SRC-187, "DTC Logic" • SRC-189, "DTC Logic" • SRC-191, "DTC Logic"

How to Erase Self-diagnostic Result

After a malfunction is repaired, turn the ignition switch OFF for one second or more, then turn ignition switch ON. The diagnosis mode returns to the user mode. At that time the self-diagnostic result is cleared.

EXAMPLE OF AIR BAG WARNING LAMP OPERATION IN THE DIAGNOSIS MODE

System Normal

ON BOARD DIAGNOSTIC (OBD) SYSTEM

< SYSTEM DESCRIPTION >

When system is normal.

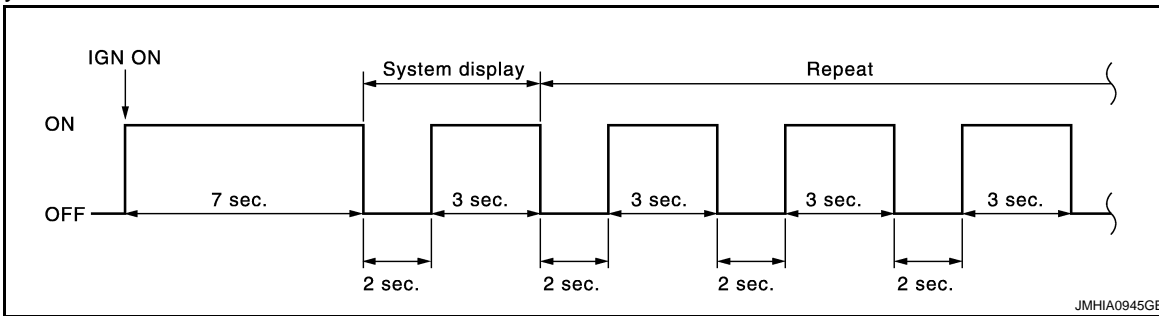

Single System Malfunction

- Front air bag system

When air bag diagnosis sensor unit system (Item display 1) is malfunctioning.

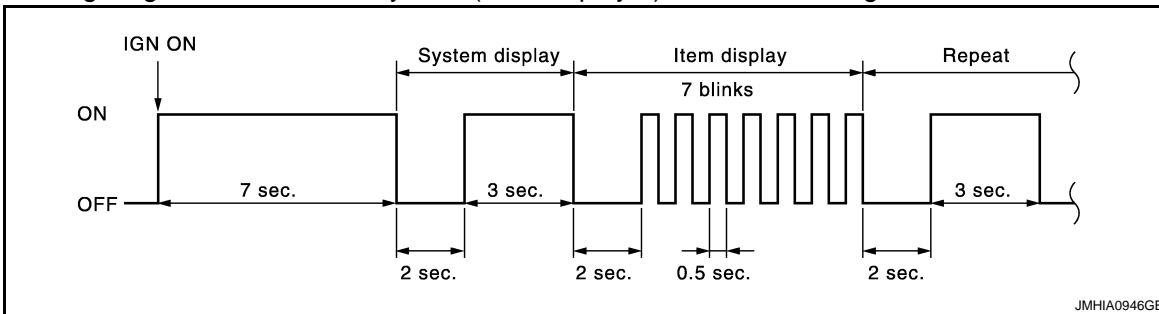

- Side air bag system

When curtain air bag module LH system (Item display 1) is malfunctioning.

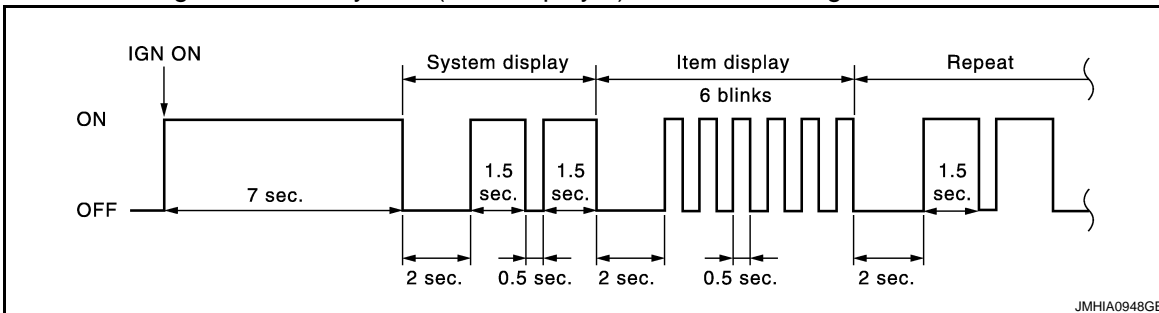

Multiple Systems Malfunction

- Front air bag system

When driver air bag module (Item display 1) and air bag diagnosis sensor unit system (Item display 2) are malfunctioning.

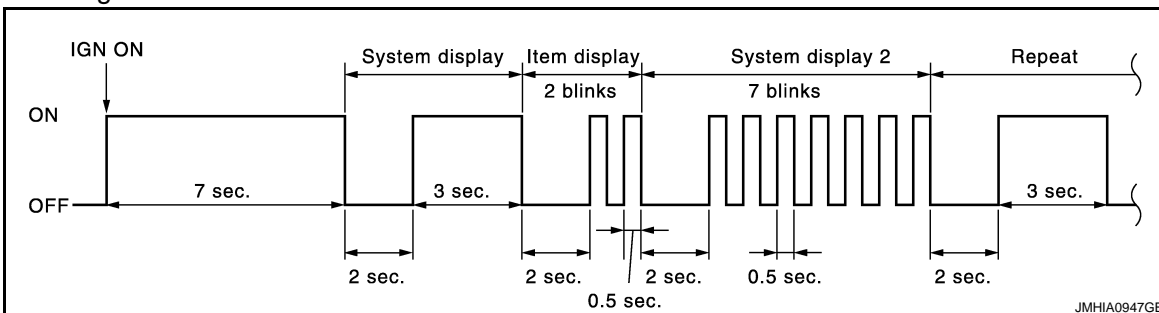

- Side air bag system

A
B
C
D
E
F
G
I
J
K
L
M
N
O
P

SRC

ON BOARD DIAGNOSTIC (OBD) SYSTEM

< SYSTEM DESCRIPTION >

When satellite sensor LH (Item display1) and curtain air bag module LH system (Item display 2) are malfunctioning.

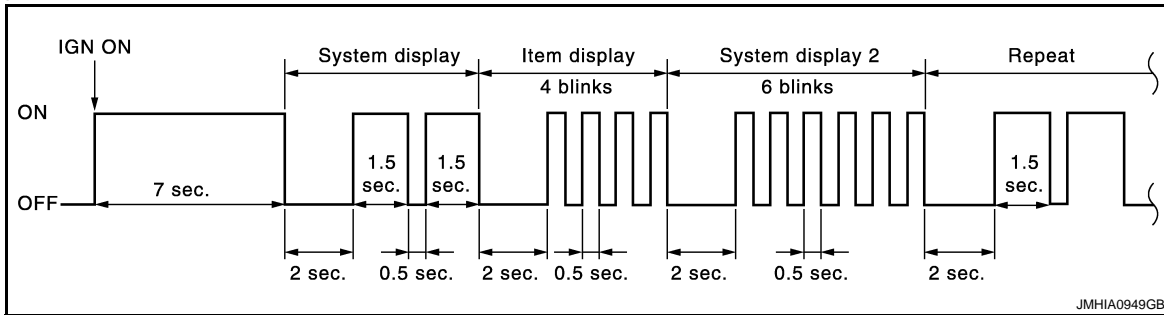

- Front air bag system and side air bag system

When driver air bag module (Item display 1) and satellite sensor RH (Item display2) are malfunctioning.

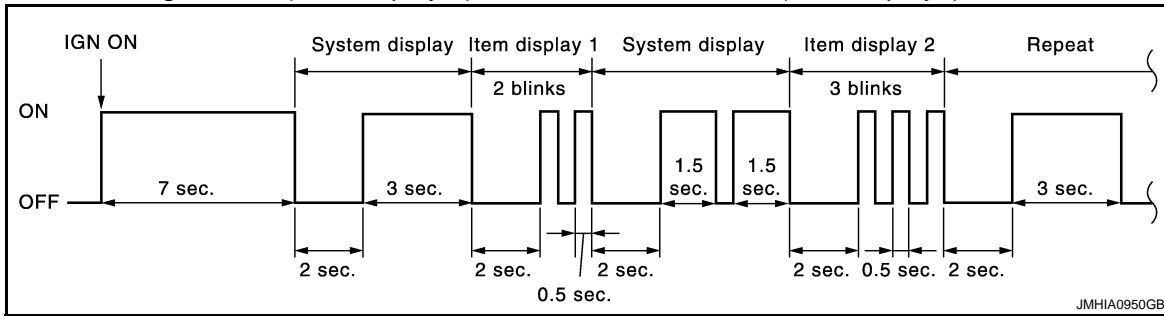

DIAGNOSIS SYSTEM (AIR BAG)

< SYSTEM DESCRIPTION >

DIAGNOSIS SYSTEM (AIR BAG)

CONSULT-III Function

INFOID:000000005631422

APPLICATION ITEM

CONSULT-III performs the following functions.

Diagnosis mode		Description
Ecu Identification		Air bag diagnosis sensor unit ECU discriminated number (identification number) is displayed. Air bag diagnosis sensor unit has individual ECU discriminated number (identification number) based on model and equipment.
Self Diagnostic Result		The current self diagnosis results (also indicated with the number of air bag warning lamp blinks in the diagnosis mode) are displayed on CONSULT-III screen in real time. This refers to a malfunctioning part requiring repairs. Refer to SRC-195, "DTC Index" .
Function Test	CAR COMPUTER DIAG.	Test result is indicated using "OK" or "NG" so that the customer recognizes easily.
Special function	SELF-DIAG [PAST]	Diagnosis results previously stored in the memory are displayed on CONSULT-III screen. The stored results are not erased until memory erasing is executed.
	TROUBLE DIAG RECORD	With TROUBLE DIAG RECORD, diagnosis results previously erased by a reset operation can be displayed on CONSULT-III screen.
	SELF-DIAG RESULT [CAN]	CAN diagnosis result is displayed.
	CAUSE OF WARNING	It displays the cause of warning lamp illumination that is not recorded in memory.

SRC

HOW TO ERASE SELF DIAGNOSTIC RESULTS

- "Self Diagnostic Result"
A current self-diagnostic result is displayed on CONSULT-III screen in real time. After the malfunction is repaired completely, no malfunction is detected on "Self Diagnostic Result".
- "SELF-DIAG [PAST]"
Return to "Self Diagnostic Result" CONSULT-III screen by touching the "BACK" key of CONSULT-III and select "Self Diagnostic Result" in SELECT DIAG MODE. Touch "Erase" in "Self Diagnostic Result" mode.
NOTE:
If the memory of the malfunction in "SELF-DIAG [PAST]" is not erased, the user mode shows the system malfunction by the illumination of the warning lamp even if the malfunction is repaired completely.
- "TROUBLE DIAG RECORD"
The memory of "TROUBLE DIAG RECORD" cannot be erased.
- "SELF-DIAG RESULT [CAN]"
Self-diagnosis result can be erased when touching "Erase".
Self-diagnosis result other than "SELF-DIAG RESULT [CAN]" is erased.

SPECIAL FUNCTION

CAUSE OF WARNING

This item indicates IGN low voltage condition.

The air bag warning lamp blink in user mode when the battery voltage is lowered to the voltage value (less than 9 V) at which the SRS cannot be operated normally. The air bag warning lamp turns OFF after the battery voltage returns to normal status after blinking.

In such a case, the DTC memory is not performed and changing to the self-diagnostic mode by IGN operation cannot be performed while the air bag warning lamp illuminates. "NO DTC" is displayed even if the malfunctioning parts are checked by CONSULT-III.

This function records the following items.

Display contents of CONSULT-III		Description
Air bag	IGN VOLT COND	"LOW" is displayed when IGN low voltage is detected. If not, "OK" is displayed.
	IGN VOLT TIME	Times of IGN low voltage is detected.
	LOW V RECORDED	Times of IGN ON after IGN low voltage is detected.

U1000 CAN COMM CIRCUIT

< DTC/CIRCUIT DIAGNOSIS >

DTC/CIRCUIT DIAGNOSIS

U1000 CAN COMM CIRCUIT

Description

INFOID:000000005631423

CAN (Controller Area Network) is a serial communication line for real time applications. It is an on-vehicle multiplex communication line with high data communication speed and excellent error detection ability. Modern vehicle is equipped with many electronic control unit, and each control unit shares information and links with other control units during operation (not independent). In CAN communication, control units are connected with 2 communication lines (CAN H-line, CAN L-line) allowing a high rate of information transmission with less wiring. Each control unit transmits/receives data but selectively reads required data only. CAN Communication Signal Chart. Refer to [LAN-25, "CAN System Specification Chart"](#).

DTC Logic

INFOID:000000005631424

DTC DETECTION LOGIC

DTC	CONSULT-III display description	DTC Detection Condition	Possible cause
U1000	CAN COMM CIRCUIT	When air bag diagnosis snsor unit cannot communicate CAN communication signal continuously for 2 seconds or more.	CAN communication system

Diagnosis Procedure

INFOID:000000005631425

1.PERFORM SELF DIAGNOSTIC

1. Turn ignition switch ON and wait for 2 seconds or more.
2. Check "SELF-DIAG RESULT [CAN]".

Is DTC "U1000" displayed?

- YES >> Refer to [LAN-16, "Trouble Diagnosis Flow Chart"](#).
NO >> Refer to [GI-37, "Intermittent Incident"](#).

U1010 CONTROL UNIT (CAN)

< DTC/CIRCUIT DIAGNOSIS >

U1010 CONTROL UNIT (CAN)

DTC Logic

INFOID:000000005631426

DTC DETECTION LOGIC

DTC	CONSULT-III display description	DTC Detection Condition	Possible cause
U1010	CONTROL UNIT (CAN)	Air bag diagnosis sensor unit detected internal CAN communication circuit malfunction.	Air bag diagnosis sensor unit

Diagnosis Procedure

INFOID:000000005631427

1. REPLACE AIR BAG DIAGNOSIS SENSOR UNIT

When DTC "U1010" is detected, replace Air bag diagnosis sensor unit.

>> Replace Air bag diagnosis sensor unit. Refer to [SR-29, "Exploded View"](#).

A
B
C
D
E
F
G
I
J
K
L
M
N
O
P

SRC

B1001, B1002, B1003, B1004, B1005 DIAGNOSIS SENSOR UNIT

< DTC/CIRCUIT DIAGNOSIS >

B1001, B1002, B1003, B1004, B1005 DIAGNOSIS SENSOR UNIT

Description

INFOID:000000005631428

- It detects a shock that is more than the specified level and monitors whether the driver and passenger air bags, side air bag, curtain air bag, and pre-tensioner seat belts operate normally.
- It contains the "G" sensors for both frontal and side collisions and spare battery function in case of main battery damage in collision.

DTC Logic

INFOID:000000005631429

DTC DETECTION LOGIC

DTC	Display contents of CONSULT-III	DTC detecting condition	Possible cause
B1001 B1002 B1003 B1004 B1005	CONTROL UNIT	Air bag diagnosis sensor unit is malfunctioning	Malfunction in air bag diagnosis sensor unit

DTC CONFIRMATION PROCEDURE

1.CHECK SELF-DIAG RESULT

With CONSULT-III

1. Turn ignition switch ON.
2. Perform "AIR BAG" Self Diagnostic Result.

Without CONSULT-III

1. Turn ignition switch ON.
2. Check the air bag warning lamp status. Refer to [SRC-15, "Diagnosis with Air Bag Warning Lamp"](#).

NOTE:

SRS does not enter the diagnosis mode if no malfunction is detected in the user mode.

Is malfunctioning part detected?

- YES >> Refer to [SRC-24, "Diagnosis Procedure"](#).
NO >> INSPECTION END

Diagnosis Procedure

INFOID:000000005631430

WARNING:

- Before servicing, turn ignition switch OFF, disconnect battery negative terminal, and wait 3 minutes or more. (To discharge backup capacitor.)
- Never use unspecified tester or other measuring device.

1.CHECK HARNESS CONNECTOR

Check the harness connector.

Is the inspection result normal?

- YES >> GO TO 2.
NO >> Replace harness connectors.

2.CHECK WIRING HARNESS

Check the wiring harness externals.

Is the inspection result normal?

- YES >> GO TO 3.
NO >> Replace wiring harness.

3.REPLACE AIR BAG DIAGNOSIS SENSOR UNIT

1. Replace air bag diagnosis sensor unit. Refer to [SR-29, "Exploded View"](#).
2. Perform DTC confirmation procedure. Refer to [SRC-24, "DTC Logic"](#).

Is DTC detected?

B1001, B1002, B1003, B1004, B1005 DIAGNOSIS SENSOR UNIT

< DTC/CIRCUIT DIAGNOSIS >

YES >> GO TO 1.

NO >> INSPECTION END

A

B

C

D

E

F

G

SRC

I

J

K

L

M

N

O

P

B1006, B1007, B1008, B1009, B1010 DIAGNOSIS SENSOR UNIT

< DTC/CIRCUIT DIAGNOSIS >

B1006, B1007, B1008, B1009, B1010 DIAGNOSIS SENSOR UNIT

Description

INFOID:000000005631431

- It detects a shock that is more than the specified level and monitors whether the driver and passenger air bags, side air bag, curtain air bag, and pre-tensioner seat belts operate normally.
- It contains the "G" sensors for both frontal and side collisions and spare battery function in case of main battery damage in collision.

DTC Logic

INFOID:000000005631432

DTC DETECTION LOGIC

DTC	Display contents of CONSULT-III	DTC detecting condition	Possible cause
B1006 B1007 B1008 B1009 B1010	CONTROL UNIT	Air bag diagnosis sensor unit is malfunctioning	Malfunction in air bag diagnosis sensor unit

DTC CONFIRMATION PROCEDURE

1. CHECK SELF-DIAG RESULT

With CONSULT-III

1. Turn ignition switch ON.
2. Perform "AIR BAG" Self-Diagnostic Result.

Without CONSULT-III

1. Turn ignition switch ON.
2. Check the air bag warning lamp status. Refer to [SRC-15. "Diagnosis with Air Bag Warning Lamp"](#).

NOTE:

SRS does not enter the diagnosis mode if no malfunction is detected in the user mode.

Is malfunctioning part detected?

- YES >> Refer to [SRC-26. "Diagnosis Procedure"](#).
NO >> INSPECTION END

Diagnosis Procedure

INFOID:000000005631433

WARNING:

- Before servicing, turn ignition switch OFF, disconnect battery negative terminal, and wait 3 minutes or more. (To discharge backup capacitor.)
- Never use unspecified tester or other measuring device.

1. CHECK HARNESS CONNECTOR

Check the harness connector.

Is the inspection result normal?

- YES >> GO TO 2.
NO >> Replace harness connectors.

2. CHECK WIRING HARNESS

Check the wiring harness externals.

Is the inspection result normal?

- YES >> GO TO 3.
NO >> Replace wiring harness.

3. REPLACE AIR BAG DIAGNOSIS SENSOR UNIT

1. Replace air bag diagnosis sensor unit. Refer to [SR-29. "Exploded View"](#)
2. Perform DTC confirmation procedure. Refer to [SRC-26. "DTC Logic"](#)

Is DTC detected?

B1006, B1007, B1008, B1009, B1010 DIAGNOSIS SENSOR UNIT

< DTC/CIRCUIT DIAGNOSIS >

YES >> GO TO 1.

NO >> INSPECTION END

A

B

C

D

E

F

G

SRC

I

J

K

L

M

N

O

P

B1011, B1012, B1013, B1014, B1015 DIAGNOSIS SENSOR UNIT

< DTC/CIRCUIT DIAGNOSIS >

B1011, B1012, B1013, B1014, B1015 DIAGNOSIS SENSOR UNIT

Description

INFOID:000000005631434

- It detects a shock that is more than the specified level and monitors whether the driver and passenger air bags, side air bag, curtain air bag, and pre-tensioner seat belts operate normally.
- It contains the "G" sensors for both frontal and side collisions and spare battery function in case of main battery damage in collision.

DTC Logic

INFOID:000000005631435

DTC DETECTION LOGIC

DTC	Display contents of CONSULT-III	DTC detecting condition	Possible cause
B1011 B1012 B1013 B1014 B1015	CONTROL UNIT	Air bag diagnosis sensor unit is malfunctioning	Malfunction in air bag diagnosis sensor unit

DTC CONFIRMATION PROCEDURE

1. CHECK SELF-DIAG RESULT

With CONSULT-III

1. Turn ignition switch ON.
2. Perform "AIR BAG" Self Diagnostic Result.

Without CONSULT-III

1. Turn ignition switch ON.
2. Check the air bag warning lamp status. Refer to [SRC-15, "Diagnosis with Air Bag Warning Lamp"](#).

NOTE:

SRS does not enter the diagnosis mode if no malfunction is detected in the user mode.

Is malfunctioning part detected?

- YES >> Refer to [SRC-28, "Diagnosis Procedure"](#).
NO >> INSPECTION END

Diagnosis Procedure

INFOID:000000005631436

WARNING:

- Before servicing, turn ignition switch OFF, disconnect battery negative terminal, and wait 3 minutes or more. (To discharge backup capacitor.)
- Never use unspecified tester or other measuring device.

1. CHECK HARNESS CONNECTOR

Check the harness connector.

Is the inspection result normal?

- YES >> GO TO 2.
NO >> Replace harness connectors.

2. CHECK WIRING HARNESS

Check the wiring harness externals.

Is the inspection result normal?

- YES >> GO TO 3.
NO >> Replace wiring harness.

3. REPLACE AIR BAG DIAGNOSIS SENSOR UNIT

1. Replace air bag diagnosis sensor unit. Refer to [SR-29, "Exploded View"](#)
2. Perform DTC confirmation procedure. Refer to [SRC-28, "DTC Logic"](#)

Is DTC detected?

B1011, B1012, B1013, B1014, B1015 DIAGNOSIS SENSOR UNIT

< DTC/CIRCUIT DIAGNOSIS >

YES >> GO TO 1.

NO >> INSPECTION END

A

B

C

D

E

F

G

SRC

I

J

K

L

M

N

O

P

B1017, B1020, B1021 OCCUPANT SYSTEM CONTROL UNIT

< DTC/CIRCUIT DIAGNOSIS >

B1017, B1020, B1021 OCCUPANT SYSTEM CONTROL UNIT

Description

INFOID:000000005631437

This unit classifies occupant in passenger seat and detects electrical malfunctions in Occupant Classification System, and transmits malfunction information to air bag diagnosis sensor unit.

DTC Logic

INFOID:000000005631438

DTC DETECTION LOGIC

DTC	Display contents of CONSULT-III	DTC detecting condition	Possible cause
B1017 B1020 B1021	OCCUPANT SENS C/U [UNIT FAIL]	Occupant Classification System control unit is malfunctioning	<ul style="list-style-type: none">• Disconnection of wiring harness• Malfunction in Occupant Classification System control unit• Malfunction in air bag diagnosis sensor unit

DTC CONFIRMATION PROCEDURE

1. CHECK SELF-DIAG RESULT

With CONSULT-III

1. Turn ignition switch ON.
2. Perform "AIR BAG" Self Diagnostic Result with CONSULT-III.

Without CONSULT-III

1. Turn ignition switch ON.
2. Check the air bag warning lamp status. Refer to [SRC-15, "Diagnosis with Air Bag Warning Lamp"](#).

NOTE:

SRS does not enter the diagnosis mode if no malfunction is detected in the user mode.

Is malfunctioning part detected?

- YES >> Refer to [SRC-30, "Diagnosis Procedure"](#).
NO >> INSPECTION END

Diagnosis Procedure

INFOID:000000005631439

WARNING:

- Before servicing, turn ignition switch OFF, disconnect battery negative terminal, and wait 3 minutes or more. (To discharge backup capacitor.)
- Never use unspecified tester or other measuring device.

DIAGNOSTIC PROCEDURE

1. CHECK HARNESS CONNECTOR

Check the connection of harness connector.

Is the inspection result normal?

- YES >> GO TO 2.
NO >> Replace harness connectors.

2. CHECK WIRING HARNESS

Check the wiring harness externals.

Is the inspection result normal?

- YES >> GO TO 3.
NO >> Replace wiring harness.

3. REPLACE OCCUPANT CLASSIFICATION SYSTEM CONTROL UNIT

1. Replace passenger seat cushion assembly. Refer to [SE-234, "Exploded View"](#).
2. Perform DTC confirmation procedure. Refer to [SRC-30, "DTC Logic"](#).

Is DTC detected?

- YES >> GO TO 4.

B1017, B1020, B1021 OCCUPANT SYSTEM CONTROL UNIT

< DTC/CIRCUIT DIAGNOSIS >

NO >> INSPECTION END

4. REPLACE AIR BAG DIAGNOSIS SENSOR UNIT

1. Replace air bag diagnosis sensor unit. Refer to [SR-29, "Exploded View"](#).
2. Perform DTC confirmation procedure. Refer to [SRC-30, "DTC Logic"](#).

Is DTC detected?

YES >> GO TO 1.

NO >> INSPECTION END

A

B

C

D

E

F

G

SRC

I

J

K

L

M

N

O

P

B1018 OCCUPANT SYSTEM SENSOR

< DTC/CIRCUIT DIAGNOSIS >

B1018 OCCUPANT SYSTEM SENSOR

Description

INFOID:000000005631440

Occupant Classification System sensor detects occupant in passenger seat and transmits it to Occupant Classification System control unit.

DTC Logic

INFOID:000000005631441

DTC DETECTION LOGIC

DTC	Display contents of CONSULT-III	DTC detecting condition	Possible cause
B1018	OCCUPANT SENS [UNIT FAIL]	Occupant Classification System sensor is malfunctioning	<ul style="list-style-type: none">• Disconnection of wiring harness• Malfunction in Occupant Classification System sensor• Malfunction in Occupant Classification System control unit• Malfunction in air bag diagnosis sensor unit

DTC CONFIRMATION PROCEDURE

1. CHECK SELF-DIAG RESULT

With CONSULT-III

1. Turn ignition switch ON.
2. Perform "AIR BAG" Self Diagnostic Result with CONSULT-III.

Without CONSULT-III

1. Turn ignition switch ON.
2. Check the air bag warning lamp status. Refer to [SRC-15, "Diagnosis with Air Bag Warning Lamp"](#).

NOTE:

SRS does not enter the diagnosis mode if no malfunction is detected in the user mode.

Is malfunctioning part detected?

- YES >> Refer to [SRC-32, "Diagnosis Procedure"](#).
NO >> INSPECTION END

Diagnosis Procedure

INFOID:000000005631442

WARNING:

- Before servicing, turn ignition switch OFF, disconnect battery negative terminal, and wait 3 minutes or more. (To discharge backup capacitor.)
- Never use unspecified tester or other measuring device.

DIAGNOSTIC PROCEDURE

1. CHECK HARNESS CONNECTOR

Check the connection of harness connector.

Is the inspection result normal?

- YES >> GO TO 2.
NO >> Replace harness connectors.

2. CHECK WIRING HARNESS

Check the wiring harness externals.

Is the inspection result normal?

- YES >> GO TO 3.
NO >> Replace wiring harness.

3. REPLACE OCCUPANT CLASSIFICATION SYSTEM CONTROL UNIT AND SENSOR

1. Replace passenger seat cushion assembly. Refer to [SE-234, "Exploded View"](#).
2. Perform DTC confirmation procedure. Refer to [SRC-32, "DTC Logic"](#).

Is DTC detected?

- YES >> GO TO 4.

B1018 OCCUPANT SYSTEM SENSOR

< DTC/CIRCUIT DIAGNOSIS >

NO >> INSPECTION END

4. REPLACE AIR BAG DIAGNOSIS SENSOR UNIT

1. Replace air bag diagnosis sensor unit. Refer to [SR-29, "Exploded View"](#).
2. Perform DTC confirmation procedure. Refer to [SRC-32, "DTC Logic"](#).

Is DTC detected?

YES >> GO TO 1.

NO >> INSPECTION END

A

B

C

D

E

F

G

SRC

I

J

K

L

M

N

O

P

B1022 OCCUPANT SYSTEM CONTROL UNIT

< DTC/CIRCUIT DIAGNOSIS >

B1022 OCCUPANT SYSTEM CONTROL UNIT

Description

INFOID:000000005631443

This unit classifies occupant in passenger seat and detects electrical malfunctions in Occupant Classification System, and transmits malfunction information to air bag diagnosis sensor unit.

DTC Logic

INFOID:000000005631444

DTC DETECTION LOGIC

DTC	Display contents of CONSULT-III	DTC detecting condition	Possible cause
B1022	OCCUPANT SENS C/U [COMM FAIL]	<ul style="list-style-type: none">Internal malfunction of Occupant Classification System control unitMalfunction of circuit between Occupant Classification System control unit and Air bag diagnosis sensor unitMalfunction of Air bag diagnosis sensor unit	<ul style="list-style-type: none">Disconnection of wiring harnessMalfunction in Occupant Classification System control unitMalfunction in air bag diagnosis sensor unit

DTC CONFIRMATION PROCEDURE

1. CHECK SELF-DIAG RESULT

With CONSULT-III

- Turn ignition switch ON.
- Perform "AIR BAG" Self Diagnostic Result with CONSULT-III.

Without CONSULT-III

- Turn ignition switch ON.
- Check the air bag warning lamp status. Refer to [SRC-15, "Diagnosis with Air Bag Warning Lamp"](#).

NOTE:

SRS does not enter the diagnosis mode if no malfunction is detected in the user mode.

Is malfunctioning part detected?

- YES >> Refer to [SRC-34, "Diagnosis Procedure"](#).
NO >> INSPECTION END

Diagnosis Procedure

INFOID:000000005631445

WARNING:

- Before servicing, turn ignition switch OFF, disconnect battery negative terminal, and wait 3 minutes or more. (To discharge backup capacitor.)
- Never use unspecified tester or other measuring device.

DIAGNOSTIC PROCEDURE

1. CHECK HARNESS CONNECTOR

Check the connection of harness connector.

Is the inspection result normal?

- YES >> GO TO 2.
NO >> Replace harness connectors.

2. CHECK WIRING HARNESS

Check the wiring harness externals.

Is the inspection result normal?

- YES >> GO TO 3.
NO >> Replace wiring harness.

3. CHECK OCCUPANT CLASSIFICATION SYSTEM CONTROL UNIT

- Replace passenger seat cushion assembly. Refer to [SE-234, "Exploded View"](#).
- Perform DTC confirmation procedure. Refer to [SRC-34, "DTC Logic"](#).

B1022 OCCUPANT SYSTEM CONTROL UNIT

< DTC/CIRCUIT DIAGNOSIS >

Is DTC detected?

YES >> GO TO 4.

NO >> INSPECTION END

4. REPLACE AIR BAG DIAGNOSIS SENSOR UNIT

1. Replace air bag diagnosis sensor unit. Refer to [SR-29, "Exploded View"](#).

2. Perform DTC confirmation procedure. Refer to [SRC-34, "DTC Logic"](#).

Is DTC detected?

YES >> GO TO 1.

NO >> INSPECTION END

A

B

C

D

E

F

G

SRC

I

J

K

L

M

N

O

P

B1023 PASSENGER AIR BAG OFF INDICATOR

< DTC/CIRCUIT DIAGNOSIS >

B1023 PASSENGER AIR BAG OFF INDICATOR

Description

INFOID:000000005631446

Illuminates passenger air bag OFF indicator when the passenger seat is empty or occupied by a child or a child-seat.

DTC Logic

INFOID:000000005631447

DTC DETECTION LOGIC

DTC	Display contents of CONSULT-III	DTC detecting condition	Possible cause
B1023	PASS A/B INDCTR CKT [UNIT FAIL]	Passenger air bag OFF indicator circuit is open or shorted to ground or the circuits are shorted each other	<ul style="list-style-type: none">• Disconnection of wiring harness• Malfunction in passenger air bag OFF indicator• Malfunction in air bag diagnosis sensor unit

DTC CONFIRMATION PROCEDURE

1. CHECK SELF-DIAG RESULT

With CONSULT-III

1. Turn ignition switch ON.
2. Perform "AIR BAG" Self Diagnostic Result with CONSULT-III.

Without CONSULT-III

1. Turn ignition switch ON.
2. Check the air bag warning lamp status. Refer to [SRC-15, "Diagnosis with Air Bag Warning Lamp"](#).

NOTE:

SRS does not enter the diagnosis mode if no malfunction is detected in the user mode.

Is malfunctioning part detected?

- YES >> Refer to [SRC-36, "Diagnosis Procedure"](#).
NO >> INSPECTION END

Diagnosis Procedure

INFOID:000000005631448

WARNING:

- Before servicing, turn ignition switch OFF, disconnect battery negative terminal, and wait 3 minutes or more. (To discharge backup capacitor.)
- Never use unspecified tester or other measuring device.

DIAGNOSTIC PROCEDURE

1. CHECK HARNESS CONNECTOR

Check the connection of harness connector.

Is the inspection result normal?

- YES >> GO TO 2.
NO >> Replace harness connectors.

2. CHECK WIRING HARNESS

Check the wiring harness externals.

Is the inspection result normal?

- YES >> GO TO 3.
NO >> Replace wiring harness.

3. CHECK PASSENGER AIR BAG OFF INDICATOR

1. Replace passenger air bag OFF indicator.
2. Perform DTC confirmation procedure. Refer to [SRC-36, "DTC Logic"](#).

Is DTC detected?

- YES >> GO TO 4.
NO >> INSPECTION END

B1023 PASSENGER AIR BAG OFF INDICATOR

< DTC/CIRCUIT DIAGNOSIS >

4. REPLACE AIR BAG DIAGNOSIS SENSOR UNIT

1. Replace air bag diagnosis sensor unit. Refer to [SR-29, "Exploded View"](#).
2. Perform DTC confirmation procedure. Refer to [SRC-36, "DTC Logic"](#).

Is DTC detected?

YES >> GO TO 1.
NO >> INSPECTION END

A
B
C
D
E
F
G
I
J
K
L
M
N
O
P

SRC

B1025, B1032, B1048 OCCUPANT SYSTEM SENSOR

< DTC/CIRCUIT DIAGNOSIS >

B1025, B1032, B1048 OCCUPANT SYSTEM SENSOR

Description

INFOID:000000005631449

Occupant Classification System sensor detects occupant in passenger seat and transmits it to Occupant Classification System control unit.

DTC Logic

INFOID:000000005631450

DTC DETECTION LOGIC

DTC	Display contents of CONSULT-III	DTC detecting condition	Possible cause
B1025 B1032 B1048	OCS SENSOR	<ul style="list-style-type: none">Internal malfunction of Occupant Classification System control unitMalfunction of circuit between Occupant Classification System control unit and Air bag diagnosis sensor unitMalfunction of Air bag diagnosis sensor unit	<ul style="list-style-type: none">Disconnection of wiring harnessMalfunction in Occupant Classification System control unitMalfunction in air bag diagnosis sensor unit

DTC CONFIRMATION PROCEDURE

1. CHECK SELF-DIAG RESULT

With CONSULT-III

- Turn ignition switch ON.
- Perform "AIR BAG" Self Diagnostic Result with CONSULT-III.

Without CONSULT-III

- Turn ignition switch ON.
- Check the air bag warning lamp status. Refer to [SRC-15. "Diagnosis with Air Bag Warning Lamp"](#).

NOTE:

SRS does not enter the diagnosis mode if no malfunction is detected in the user mode.

Is malfunctioning part detected?

- YES >> Refer to [SRC-38. "Diagnosis Procedure"](#).
NO >> INSPECTION END

Diagnosis Procedure

INFOID:000000005631451

WARNING:

- Before servicing, turn ignition switch OFF, disconnect battery negative terminal, and wait 3 minutes or more. (To discharge backup capacitor.)
- Never use unspecified tester or other measuring device.

DIAGNOSTIC PROCEDURE

1. CHECK HARNESS CONNECTOR

Check the connection of harness connector.

Is the inspection result normal?

- YES >> GO TO 2.
NO >> Replace harness connectors.

2. CHECK WIRING HARNESS

Check the wiring harness externals.

Is the inspection result normal?

- YES >> GO TO 3.
NO >> Replace wiring harness.

3. CHECK OCCUPANT CLASSIFICATION SYSTEM CONTROL UNIT

- Replace passenger seat cushion assembly. Refer to [SE-234. "Exploded View"](#).
- Perform DTC confirmation procedure. Refer to [SRC-38. "DTC Logic"](#).

B1025, B1032, B1048 OCCUPANT SYSTEM SENSOR

< DTC/CIRCUIT DIAGNOSIS >

Is DTC detected?

YES >> GO TO 4.

NO >> INSPECTION END

4. REPLACE AIR BAG DIAGNOSIS SENSOR UNIT

1. Replace air bag diagnosis sensor unit. Refer to [SR-29, "Exploded View"](#).

2. Perform DTC confirmation procedure. Refer to [SRC-38, "DTC Logic"](#).

Is DTC detected?

YES >> GO TO 1.

NO >> INSPECTION END

A

B

C

D

E

F

G

SRC

I

J

K

L

M

N

O

P

B1026, B1027, B1028, B1029, B1030, B1031 DIAGNOSIS SENSOR UNIT

< DTC/CIRCUIT DIAGNOSIS >

B1026, B1027, B1028, B1029, B1030, B1031 DIAGNOSIS SENSOR UNIT

Description

INFOID:000000005631452

- It detects a shock that is more than the specified level and monitors whether the driver and passenger air bags, side air bag, curtain air bag, and pre-tensioner seat belts operate normally.
- It contains the "G" sensors for both frontal and side collisions and spare battery function in case of main battery damage in collision.

DTC Logic

INFOID:000000005631453

DTC DETECTION LOGIC

DTC	Display contents of CONSULT-III	DTC detecting condition	Possible cause
B1026 B1027 B1028 B1029 B1030 B1031	CONTROL UNIT	Air bag diagnosis sensor unit is malfunctioning	Malfunction in air bag diagnosis sensor unit

DTC CONFIRMATION PROCEDURE

1. CHECK SELF-DIAG RESULT

With CONSULT-III

1. Turn ignition switch ON.
2. Perform "AIR BAG" Self Diagnostic Result.

Without CONSULT-III

1. Turn ignition switch ON.
2. Check the air bag warning lamp status. Refer to [SRC-15, "Diagnosis with Air Bag Warning Lamp"](#).

NOTE:

SRS does not enter the diagnosis mode if no malfunction is detected in the user mode.

Is malfunctioning part detected?

- YES >> Refer to [SRC-40, "Diagnosis Procedure"](#).
NO >> INSPECTION END

Diagnosis Procedure

INFOID:000000005631454

WARNING:

- Before servicing, turn ignition switch OFF, disconnect battery negative terminal, and wait 3 minutes or more. (To discharge backup capacitor.)
- Never use unspecified tester or other measuring device.

1. CHECK HARNESS CONNECTOR

Check the harness connector.

Is the inspection result normal?

- YES >> GO TO 2.
NO >> Replace harness connectors.

2. CHECK WIRING HARNESS

Check the wiring harness externals.

Is the inspection result normal?

- YES >> GO TO 3.
NO >> Replace wiring harness.

3. REPLACE AIR BAG DIAGNOSIS SENSOR UNIT

1. Replace air bag diagnosis sensor unit. Refer to [SR-29, "Exploded View"](#).
2. Perform DTC confirmation procedure. Refer to [SRC-40, "DTC Logic"](#).

B1026, B1027, B1028, B1029, B1030, B1031 DIAGNOSIS SENSOR UNIT

< DTC/CIRCUIT DIAGNOSIS >

Is DTC detected?

YES >> GO TO 1.

NO >> INSPECTION END

A

B

C

D

E

F

G

SRC

I

J

K

L

M

N

O

P

B1033, B1034 CRASH ZONE SENSOR

< DTC/CIRCUIT DIAGNOSIS >

B1033, B1034 CRASH ZONE SENSOR

Description

INFOID:000000005631455

Crash zone sensor is a G sensor that outputs voltage signal during deceleration at the time of a vehicle frontal collision that is more than the specified limit is detected.

DTC Logic

INFOID:000000005631456

DTC DETECTION LOGIC

DTC	Display contents of CONSULT-III	DTC detecting condition	Possible cause
B1033 B1034	CRASH ZONE SEN [UNIT FAIL]	Crash zone sensor is malfunctioning	<ul style="list-style-type: none">• Disconnection of wiring harness• Malfunction in crash zone sensor• Malfunction in air bag diagnosis sensor unit

DTC CONFIRMATION PROCEDURE

1. CHECK SELF-DIAG RESULT

With CONSULT-III

1. Turn ignition switch ON.
2. Perform "AIR BAG" Self Diagnostic Result.

Without CONSULT-III

1. Turn ignition switch ON.
2. Check the air bag warning lamp status. Refer to [SRC-15, "Diagnosis with Air Bag Warning Lamp"](#).

NOTE:

SRS does not enter the diagnosis mode if no malfunction is detected in the user mode.

Is malfunctioning part detected?

- YES >> Refer to [SRC-42, "Diagnosis Procedure"](#).
NO >> INSPECTION END

Diagnosis Procedure

INFOID:000000005631457

WARNING:

- Before servicing, turn ignition switch OFF, disconnect battery negative terminal, and wait 3 minutes or more. (To discharge backup capacitor.)
- Never use unspecified tester or other measuring device.

1. CHECK HARNESS CONNECTOR

Check the harness connector.

Is the inspection result normal?

- YES >> GO TO 2.
NO >> Replace harness connectors.

2. CHECK WIRING HARNESS

Check the wiring harness externals.

Is the inspection result normal?

- YES >> GO TO 3.
NO >> Replace wiring harness.

3. REPLACE CRASH ZONE SENSOR

1. Replace crash zone sensor. Refer to [SR-25, "Exploded View"](#).
2. Perform DTC confirmation procedure. Refer to [SRC-42, "DTC Logic"](#).

Is DTC detected?

- YES >> GO TO 4.
NO >> INSPECTION END

4. REPLACE AIR BAG DIAGNOSIS SENSOR UNIT

B1033, B1034 CRASH ZONE SENSOR

< DTC/CIRCUIT DIAGNOSIS >

1. Replace air bag diagnosis sensor unit. Refer to [SR-29, "Exploded View"](#).
2. Perform DTC confirmation procedure. Refer to [SRC-42, "DTC Logic"](#).

Is DTC detected?

YES >> GO TO 1.

NO >> INSPECTION END

A

B

C

D

E

F

G

SRC

I

J

K

L

M

N

O

P

B1035 CRASH ZONE SENSOR

< DTC/CIRCUIT DIAGNOSIS >

B1035 CRASH ZONE SENSOR

Description

INFOID:000000005631458

Crash zone sensor is a G sensor that outputs voltage signal during deceleration at the time of a vehicle frontal collision that is more than the specified limit is detected.

DTC Logic

INFOID:000000005631459

DTC DETECTION LOGIC

DTC	Display contents of CONSULT-III	DTC detecting condition	Possible cause
B1035	CRASH ZONE SEN [COMM FAIL]	Crash zone sensor is malfunctioning	<ul style="list-style-type: none">• Disconnection of wiring harness• Malfunction in crash zone sensor• Malfunction in air bag diagnosis sensor unit

DTC CONFIRMATION PROCEDURE

1.CHECK SELF-DIAG RESULT

With CONSULT-III

1. Turn ignition switch ON.
2. Perform "AIR BAG" Self Diagnostic Result.

Without CONSULT-III

1. Turn ignition switch ON.
2. Check the air bag warning lamp status. Refer to [SRC-15, "Diagnosis with Air Bag Warning Lamp"](#).

NOTE:

SRS does not enter the diagnosis mode if no malfunction is detected in the user mode.

Is malfunctioning part detected?

- YES >> Refer to [SRC-44, "Diagnosis Procedure"](#).
NO >> INSPECTION END

Diagnosis Procedure

INFOID:000000005631460

WARNING:

- Before servicing, turn ignition switch OFF, disconnect battery negative terminal, and wait 3 minutes or more. (To discharge backup capacitor.)
- Never use unspecified tester or other measuring device.

1.CHECK HARNESS CONNECTOR

Check the harness connector.

Is the inspection result normal?

- YES >> GO TO 2.
NO >> Replace harness connectors.

2.CHECK WIRING HARNESS

Check the wiring harness externals.

Is the inspection result normal?

- YES >> GO TO 3.
NO >> Replace wiring harness.

3.REPLACE CRASH ZONE SENSOR

1. Replace crash zone sensor. Refer to [SR-25, "Exploded View"](#).
2. Perform DTC confirmation procedure. Refer to [SRC-44, "DTC Logic"](#).

Is DTC detected?

- YES >> GO TO 4.
NO >> INSPECTION END

4.REPLACE AIR BAG DIAGNOSIS SENSOR UNIT

B1035 CRASH ZONE SENSOR

< DTC/CIRCUIT DIAGNOSIS >

1. Replace air bag diagnosis sensor unit. Refer to [SR-29, "Exploded View"](#).
2. Perform DTC confirmation procedure. Refer to [SRC-44, "DTC Logic"](#).

Is DTC detected?

YES >> GO TO 1.

NO >> INSPECTION END

A

B

C

D

E

F

G

SRC

I

J

K

L

M

N

O

P

B1036 CRASH ZONE SENSOR

< DTC/CIRCUIT DIAGNOSIS >

B1036 CRASH ZONE SENSOR

Description

INFOID:000000005631461

Crash zone sensor is a G sensor that outputs voltage signal during deceleration at the time of a vehicle frontal collision that is more than the specified limit is detected.

DTC Logic

INFOID:000000005631462

DTC DETECTION LOGIC

DTC	Display contents of CONSULT-III	DTC detecting condition	Possible cause
B1036	CRASH ZONE SEN [UNMATCH]	Crash zone sensor is out of the specified specification	Diagnosis sensor unit or crash zone sensor is different from the part specified

DTC CONFIRMATION PROCEDURE

1. CHECK SELF-DIAG RESULT

With CONSULT-III

1. Turn ignition switch ON.
2. Perform "AIR BAG" Self Diagnostic Result.

Without CONSULT-III

1. Turn ignition switch ON.
2. Check the air bag warning lamp status. Refer to [SRC-15. "Diagnosis with Air Bag Warning Lamp"](#).

NOTE:

SRS does not enter the diagnosis mode if no malfunction is detected in the user mode.

Is malfunctioning part detected?

- YES >> Refer to [SRC-46. "Diagnosis Procedure"](#).
NO >> INSPECTION END

Diagnosis Procedure

INFOID:000000005631463

WARNING:

- Before servicing, turn ignition switch OFF, disconnect battery negative terminal, and wait 3 minutes or more. (To discharge backup capacitor.)
- Never use unspecified tester or other measuring device.

1. CHECK HARNESS CONNECTOR

Check the harness connector.

Is the inspection result normal?

- YES >> GO TO 2.
NO >> Replace harness connectors.

2. CHECK WIRING HARNESS

Check the wiring harness externals.

Is the inspection result normal?

- YES >> GO TO 3.
NO >> Replace wiring harness.

3. REPLACE CRASH ZONE SENSOR

1. Replace crash zone sensor. Refer to [SR-25. "Exploded View"](#).
2. Perform DTC confirmation procedure. Refer to [SRC-46. "DTC Logic"](#).

Is DTC detected?

- YES >> GO TO 4.
NO >> INSPECTION END

4. REPLACE AIR BAG DIAGNOSIS SENSOR UNIT

1. Replace air bag diagnosis sensor unit. Refer to [SR-29. "Exploded View"](#).

B1036 CRASH ZONE SENSOR

< DTC/CIRCUIT DIAGNOSIS >

2. Perform DTC confirmation procedure. Refer to [SRC-46. "DTC Logic"](#).

Is DTC detected?

YES >> GO TO 1.

NO >> INSPECTION END

A

B

C

D

E

F

G

SRC

I

J

K

L

M

N

O

P

B1037, B1039, B1041 CRASH ZONE SENSOR

< DTC/CIRCUIT DIAGNOSIS >

B1037, B1039, B1041 CRASH ZONE SENSOR

Description

INFOID:000000005631464

Crash zone sensor is a G sensor that outputs voltage signal during deceleration at the time of a vehicle frontal collision that is more than the specified limit is detected.

DTC Logic

INFOID:000000005631465

DTC DETECTION LOGIC

DTC	Display contents of CONSULT-III	DTC detecting condition	Possible cause
B1037 B1039 B1041	CRASH ZONE SENS1	Crash zone sensor is malfunctioning	<ul style="list-style-type: none">• Disconnection of wiring harness• Malfunction in crash zone sensor• Malfunction in air bag diagnosis sensor unit

DTC CONFIRMATION PROCEDURE

1. CHECK SELF-DIAG RESULT

With CONSULT-III

1. Turn ignition switch ON.
2. Perform "AIR BAG" Self Diagnostic Result.

Without CONSULT-III

1. Turn ignition switch ON.
2. Check the air bag warning lamp status. Refer to [SRC-15, "Diagnosis with Air Bag Warning Lamp"](#).

NOTE:

SRS does not enter the diagnosis mode if no malfunction is detected in the user mode.

Is malfunctioning part detected?

- YES >> Refer to [SRC-48, "Diagnosis Procedure"](#).
NO >> INSPECTION END

Diagnosis Procedure

INFOID:000000005631466

WARNING:

- Before servicing, turn ignition switch OFF, disconnect battery negative terminal, and wait 3 minutes or more. (To discharge backup capacitor.)
- Never use unspecified tester or other measuring device.

1. CHECK HARNESS CONNECTOR

Check the harness connector.

Is the inspection result normal?

- YES >> GO TO 2.
NO >> Replace harness connectors.

2. CHECK WIRING HARNESS

Check the wiring harness externals.

Is the inspection result normal?

- YES >> GO TO 3.
NO >> Replace wiring harness.

3. REPLACE CRASH ZONE SENSOR

1. Replace crash zone sensor. Refer to [SR-25, "Exploded View"](#).
2. Perform DTC confirmation procedure. Refer to [SRC-48, "DTC Logic"](#).

Is DTC detected?

- YES >> GO TO 4.
NO >> INSPECTION END

4. REPLACE AIR BAG DIAGNOSIS SENSOR UNIT

B1037, B1039, B1041 CRASH ZONE SENSOR

< DTC/CIRCUIT DIAGNOSIS >

1. Replace air bag diagnosis sensor unit. Refer to [SR-29, "Exploded View"](#).
2. Perform DTC confirmation procedure. Refer to [SRC-48, "DTC Logic"](#).

Is DTC detected?

YES >> GO TO 1.

NO >> INSPECTION END

A

B

C

D

E

F

G

SRC

I

J

K

L

M

N

O

P

B1042, B1043, B1044, B1045, B1046, B1047 DIAGNOSIS SENSOR UNIT

< DTC/CIRCUIT DIAGNOSIS >

B1042, B1043, B1044, B1045, B1046, B1047 DIAGNOSIS SENSOR UNIT

Description

INFOID:000000005631467

- It detects a shock that is more than the specified level and monitors whether the driver and passenger air bags, side air bag, curtain air bag, and pre-tensioner seat belts operate normally.
- It contains the "G" sensors for both frontal and side collisions and spare battery function in case of main battery damage in collision.

DTC Logic

INFOID:000000005631468

DTC DETECTION LOGIC

DTC	Display contents of CONSULT-III	DTC detecting condition	Possible cause
B1042 B1043 B1044 B1045 B1046 B1047	CONTROL UNIT	Air bag diagnosis sensor unit is malfunctioning	Malfunction in air bag diagnosis sensor unit

DTC CONFIRMATION PROCEDURE

1. CHECK SELF-DIAG RESULT

With CONSULT-III

1. Turn ignition switch ON.
2. Perform "AIR BAG" Self Diagnostic Result.

Without CONSULT-III

1. Turn ignition switch ON.
2. Check the air bag warning lamp status. Refer to [SRC-15, "Diagnosis with Air Bag Warning Lamp"](#).

NOTE:

SRS does not enter the diagnosis mode if no malfunction is detected in the user mode.

Is malfunctioning part detected?

- YES >> Refer to [SRC-50, "Diagnosis Procedure"](#).
NO >> INSPECTION END

Diagnosis Procedure

INFOID:000000005631469

WARNING:

- Before servicing, turn ignition switch OFF, disconnect battery negative terminal, and wait 3 minutes or more. (To discharge backup capacitor.)
- Never use unspecified tester or other measuring device.

1. CHECK HARNESS CONNECTOR

Check the harness connector.

Is the inspection result normal?

- YES >> GO TO 2.
NO >> Replace harness connectors.

2. CHECK WIRING HARNESS

Check the wiring harness externals.

Is the inspection result normal?

- YES >> GO TO 3.
NO >> Replace wiring harness.

3. REPLACE AIR BAG DIAGNOSIS SENSOR UNIT

1. Replace air bag diagnosis sensor unit. Refer to [SR-29, "Exploded View"](#).
2. Perform DTC confirmation procedure. Refer to [SRC-50, "DTC Logic"](#).

B1042, B1043, B1044, B1045, B1046, B1047 DIAGNOSIS SENSOR UNIT

< DTC/CIRCUIT DIAGNOSIS >

Is DTC detected?

YES >> GO TO 1.

NO >> INSPECTION END

A

B

C

D

E

F

G

SRC

I

J

K

L

M

N

O

P

B1049, B1054 DRIVER AIR BAG MODULE

< DTC/CIRCUIT DIAGNOSIS >

B1049, B1054 DRIVER AIR BAG MODULE

Description

INFOID:000000005631470

In case of frontal collision where acceleration is more than the specified level, the ignition materials are ignited by electric ignition system. The system burns the gas generating materials resulting in a chemical reaction. This generates hot gases that flow into the air bag through a filter and expand the bag.

DTC Logic

INFOID:000000005631471

DTC DETECTION LOGIC

DTC	Display contents of CONSULT-III	DTC detecting condition	Possible cause
B1049 B1054	DRIVER AIRBAG MODULE [OPEN]	Driver air bag module circuit is open (including the spiral cable)	<ul style="list-style-type: none">• Disconnection of wiring harness and open• Malfunction in driver air bag module• Malfunction in spiral cable• Malfunction in air bag diagnosis sensor unit

DTC CONFIRMATION PROCEDURE

1. CHECK SELF-DIAG RESULT

With CONSULT-III

1. Turn ignition switch ON.
2. Perform "AIR BAG" Self Diagnostic Result.

Without CONSULT-III

1. Turn ignition switch ON.
2. Check the air bag warning lamp status. Refer to [SRC-15, "Diagnosis with Air Bag Warning Lamp"](#).

NOTE:

SRS does not enter the diagnosis mode if no malfunction is detected in the user mode.

Is malfunctioning part detected?

- YES >> Refer to [SRC-52, "Diagnosis Procedure"](#).
NO >> INSPECTION END

Diagnosis Procedure

INFOID:000000005631472

WARNING:

- Before servicing, turn ignition switch OFF, disconnect battery negative terminal, and wait 3 minutes or more. (To discharge backup capacitor.)
- Never use unspecified tester or other measuring device.

1. CHECK HARNESS CONNECTOR

Check the harness connector.

Is the inspection result normal?

- YES >> GO TO 2.
NO >> Replace harness connector.

2. CHECK WIRING HARNESS

Check the wiring harness externals.

Is the inspection result normal?

- YES >> GO TO 3.
NO >> Replace wiring harness.

3. CHECK SPIRAL CABLE CIRCUIT

1. Turn ignition switch OFF.
2. Disconnect driver air bag module connector and combination switch (spiral cable) connector.
3. Check continuity between driver air bag module harness connector and combination switch (spiral cable) harness connector.

B1049, B1054 DRIVER AIR BAG MODULE

< DTC/CIRCUIT DIAGNOSIS >

Driver air bag module		Combination switch (spiral cable)		Continuity
Connector	Terminal	Connector	Terminal	
M302	10	M35	28	Existed
	11		30	
M301	12		29	
	9		30	

4. Check continuity between driver air bag module harness connector and ground.

Driver side air bag module		Ground	Continuity
Connector	Terminal		
M302	10	Ground	Not existed
	11		
M301	12		
	9		

Is the inspection result normal?

YES >> GO TO 4.

NO >> Replace combination switch (spiral cable). Refer to [SR-14, "Exploded View"](#).

4. REPLACE AIR BAG DIAGNOSIS SENSOR UNIT

1. Replace air bag diagnosis sensor unit. Refer to [SR-29, "Exploded View"](#)
2. Perform DTC confirmation procedure. Refer to [SRC-52, "DTC Logic"](#).

Is DTC detected?

YES >> GO TO 5.

NO >> INSPECTION END

5. REPLACE DRIVER AIR BAG MODULE

1. Replace driver air bag module. Refer to [SR-11, "Exploded View"](#)
2. Perform DTC confirmation procedure. Refer to [SRC-52, "DTC Logic"](#).

Is DTC detected?

YES >> GO TO 1.

NO >> INSPECTION END

A
B
C
D
E
F
G
I
J
K
L
M
N
O
P

SRC

B1050, B1055 DRIVER AIR BAG MODULE

< DTC/CIRCUIT DIAGNOSIS >

B1050, B1055 DRIVER AIR BAG MODULE

Description

INFOID:000000005631473

In case of frontal collision where acceleration is more than the specified level, the ignition materials are ignited by electric ignition system. The system burns the gas generating materials resulting in a chemical reaction. This generates hot gases that flow into the air bag through a filter and expand the bag.

DTC Logic

INFOID:000000005631474

DTC DETECTION LOGIC

DTC	Display contents of CONSULT-III	DTC detecting condition	Possible cause
B1050 B1055	DRIVER AIRBAG MODULE [VB-SHORT]	Driver air bag module circuit is shorted to power supply circuit (including the spiral cable)	<ul style="list-style-type: none">• Disconnection of wiring harness and short• Malfunction in driver air bag module• Malfunction in spiral cable• Malfunction in air bag diagnosis sensor unit

DTC CONFIRMATION PROCEDURE

1. CHECK SELF-DIAG RESULT

With CONSULT-III

1. Turn ignition switch ON.
2. Perform "AIR BAG" Self Diagnostic Result.

Without CONSULT-III

1. Turn ignition switch ON.
2. Check the air bag warning lamp status. Refer to [SRC-15. "Diagnosis with Air Bag Warning Lamp"](#).

NOTE:

SRS does not enter the diagnosis mode if no malfunction is detected in the user mode.

Is malfunctioning part detected?

- YES >> Refer to [SRC-54. "Diagnosis Procedure"](#).
NO >> INSPECTION END

Diagnosis Procedure

INFOID:000000005631475

WARNING:

- Before servicing, turn ignition switch OFF, disconnect battery negative terminal, and wait 3 minutes or more. (To discharge backup capacitor.)
- Never use unspecified tester or other measuring device.

1. CHECK HARNESS CONNECTOR

Check the harness connector.

Is the inspection result normal?

- YES >> GO TO 2.
NO >> Replace harness connector.

2. CHECK WIRING HARNESS

Check the wiring harness externals.

Is the inspection result normal?

- YES >> GO TO 3.
NO >> Replace wiring harness.

3. CHECK SPIRAL CABLE CIRCUIT

1. Turn ignition switch OFF.
2. Disconnect driver air bag module connector and combination switch (spiral cable) connector.
3. Check continuity between driver air bag module harness connector and combination switch (spiral cable) harness connector.

B1050, B1055 DRIVER AIR BAG MODULE

< DTC/CIRCUIT DIAGNOSIS >

Driver air bag module		Combination switch (spiral cable)		Continuity
Connector	Terminal	Connector	Terminal	
M302	10	M35	28	Existed
	11		30	
M301	12		29	
	9		30	

4. Check continuity between driver air bag module harness connector and ground.

Driver side air bag module		Ground	Continuity
Connector	Terminal		
M302	10	Ground	Not existed
	11		
M301	12		
	9		

Is the inspection result normal?

YES >> GO TO 4.

NO >> Replace combination switch (spiral cable). Refer to [SR-14, "Exploded View"](#).

4. REPLACE AIR BAG DIAGNOSIS SENSOR UNIT

1. Replace air bag diagnosis sensor unit. Refer to [SR-14, "Exploded View"](#)
2. Perform DTC confirmation procedure. Refer to [SRC-54, "DTC Logic"](#).

Is DTC detected?

YES >> GO TO 5.

NO >> INSPECTION END

5. REPLACE DRIVER AIR BAG MODULE

1. Replace driver air bag module. Refer to [SR-11, "Exploded View"](#)
2. Perform DTC confirmation procedure. Refer to [SRC-54, "DTC Logic"](#).

Is DTC detected?

YES >> GO TO 1.

NO >> INSPECTION END

B1051, B1056 DRIVER AIR BAG MODULE

< DTC/CIRCUIT DIAGNOSIS >

B1051, B1056 DRIVER AIR BAG MODULE

Description

INFOID:000000005631476

In case of frontal collision where acceleration is more than the specified level, the ignition materials are ignited by electric ignition system. The system burns the gas generating materials resulting in a chemical reaction. This generates hot gases that flow into the air bag through a filter and expand the bag.

DTC Logic

INFOID:000000005631477

DTC DETECTION LOGIC

DTC	Display contents of CONSULT-III	DTC detecting condition	Possible cause
B1051 B1056	DRIVER AIRBAG MODULE [GND-SHORT]	Driver air bag module circuit is shorted to ground (including the spiral cable)	<ul style="list-style-type: none">• Disconnection of wiring harness and short• Malfunction in driver air bag module• Malfunction in spiral cable• Malfunction in air bag diagnosis sensor unit

DTC CONFIRMATION PROCEDURE

1. CHECK SELF-DIAG RESULT

With CONSULT-III

1. Turn ignition switch ON.
2. Perform "AIR BAG" Self Diagnostic Result.

Without CONSULT-III

1. Turn ignition switch ON.
2. Check the air bag warning lamp status. Refer to [SRC-15. "Diagnosis with Air Bag Warning Lamp"](#).

NOTE:

SRS does not enter the diagnosis mode if no malfunction is detected in the user mode.

Is malfunctioning part detected?

- YES >> Refer to [SRC-56. "Diagnosis Procedure"](#).
NO >> INSPECTION END

Diagnosis Procedure

INFOID:000000005631478

WARNING:

- Before servicing, turn ignition switch OFF, disconnect battery negative terminal, and wait 3 minutes or more. (To discharge backup capacitor.)
- Never use unspecified tester or other measuring device.

1. CHECK HARNESS CONNECTOR

Check the harness connector.

Is the inspection result normal?

- YES >> GO TO 2.
NO >> Replace harness connector.

2. CHECK WIRING HARNESS

Check the wiring harness externals.

Is the inspection result normal?

- YES >> GO TO 3.
NO >> Replace wiring harness.

3. CHECK SPIRAL CABLE CIRCUIT

1. Turn ignition switch OFF.
2. Disconnect driver air bag module connector and combination switch (spiral cable) connector.
3. Check continuity between driver air bag module harness connector and combination switch (spiral cable) harness connector.

B1051, B1056 DRIVER AIR BAG MODULE

< DTC/CIRCUIT DIAGNOSIS >

Driver air bag module		Combination switch (spiral cable)		Continuity
Connector	Terminal	Connector	Terminal	
M302	10	M35	28	Existed
	11		30	
M301	12		29	
	9		30	

4. Check continuity between driver air bag module harness connector and ground.

Driver side air bag module		Ground	Continuity
Connector	Terminal		
M302	10	Ground	Not existed
	11		
M301	12		
	9		

Is the inspection result normal?

YES >> GO TO 4.

NO >> Replace combination switch (spiral cable). Refer to [SR-14, "Removal and Installation"](#).

4. REPLACE AIR BAG DIAGNOSIS SENSOR UNIT

1. Replace air bag diagnosis sensor unit. Refer to [SR-29, "Exploded View"](#)
2. Perform DTC confirmation procedure. Refer to [SRC-56, "DTC Logic"](#).

Is DTC detected?

YES >> GO TO 5.

NO >> INSPECTION END

5. REPLACE DRIVER AIR BAG MODULE

1. Replace driver air bag module. Refer to [SR-11, "Exploded View"](#)
2. Perform DTC confirmation procedure. Refer to [SRC-56, "DTC Logic"](#).

Is DTC detected?

YES >> GO TO 1.

NO >> INSPECTION END

A
B
C
D
E
F
G
I
J
K
L
M
N
O
P

SRC

B1052, B1057 DRIVER AIR BAG MODULE

< DTC/CIRCUIT DIAGNOSIS >

B1052, B1057 DRIVER AIR BAG MODULE

Description

INFOID:000000005631479

In case of frontal collision where acceleration is more than the specified level, the ignition materials are ignited by electric ignition system. The system burns the gas generating materials resulting in a chemical reaction. This generates hot gases that flow into the air bag through a filter and expand the bag.

DTC Logic

INFOID:000000005631480

DTC DETECTION LOGIC

DTC	Display contents of CONSULT-III	DTC detecting condition	Possible cause
B1052 B1057	DRIVER AIRBAG MODULE [SHORT]	Driver air bag module circuit are shorted to each other (including the spiral cable)	<ul style="list-style-type: none">• Disconnection of wiring harness and short• Malfunction in driver air bag module• Malfunction in spiral cable• Malfunction in air bag diagnosis sensor unit

DTC CONFIRMATION PROCEDURE

1. CHECK SELF-DIAG RESULT

Ⓟ With CONSULT-III

1. Turn ignition switch ON.
2. Perform "AIR BAG" Self Diagnostic Result.

ⓧ Without CONSULT-III

1. Turn ignition switch ON.
2. Check the air bag warning lamp status. Refer to [SRC-15, "Diagnosis with Air Bag Warning Lamp"](#).

NOTE:

SRS does not enter the diagnosis mode if no malfunction is detected in the user mode.

Is malfunctioning part detected?

- YES >> Refer to [SRC-58, "Diagnosis Procedure"](#).
NO >> INSPECTION END

Diagnosis Procedure

INFOID:000000005631481

WARNING:

- Before servicing, turn ignition switch OFF, disconnect battery negative terminal, and wait 3 minutes or more. (To discharge backup capacitor.)
- Never use unspecified tester or other measuring device.

1. CHECK HARNESS CONNECTOR

Check the harness connector.

Is the inspection result normal?

- YES >> GO TO 2.
NO >> Replace harness connector.

2. CHECK WIRING HARNESS

Check the wiring harness externals.

Is the inspection result normal?

- YES >> GO TO 3.
NO >> Replace wiring harness.

3. CHECK SPIRAL CABLE CIRCUIT

1. Turn ignition switch OFF.
2. Disconnect driver air bag module connector and combination switch (spiral cable) connector.
3. Check continuity between driver air bag module harness connector and combination switch (spiral cable) harness connector.

B1052, B1057 DRIVER AIR BAG MODULE

< DTC/CIRCUIT DIAGNOSIS >

Driver air bag module		Combination switch (spiral cable)		Continuity
Connector	Terminal	Connector	Terminal	
M302	10	M35	28	Existed
	11		30	
M301	12		29	
	9		30	

4. Check continuity between driver air bag module harness connector and ground.

Driver side air bag module		Ground	Continuity
Connector	Terminal		
M302	10	Ground	Not existed
	11		
M301	12		
	9		

Is the inspection result normal?

YES >> GO TO 4.

NO >> Replace combination switch (spiral cable). Refer to [SR-14, "Exploded View"](#).

4. REPLACE AIR BAG DIAGNOSIS SENSOR UNIT

1. Replace air bag diagnosis sensor unit. Refer to [SR-29, "Exploded View"](#)
2. Perform DTC confirmation procedure. Refer to [SRC-58, "DTC Logic"](#).

Is DTC detected?

YES >> GO TO 5.

NO >> INSPECTION END

5. REPLACE DRIVER AIR BAG MODULE

1. Replace driver air bag module. Refer to [SR-11, "Exploded View"](#)
2. Perform DTC confirmation procedure. Refer to [SRC-58, "DTC Logic"](#).

Is DTC detected?

YES >> GO TO 1.

NO >> INSPECTION END

A
B
C
D
E
F
G
I
J
K
L
M
N
O
P

SRC

B1058, B1059, B1060, B1061, B1062, B1063 DIAGNOSIS SENSOR UNIT

< DTC/CIRCUIT DIAGNOSIS >

B1058, B1059, B1060, B1061, B1062, B1063 DIAGNOSIS SENSOR UNIT

Description

INFOID:000000005631482

- It detects a shock that is more than the specified level and monitors whether the driver and passenger air bags, side air bag, curtain air bag, and pre-tensioner seat belts operate normally.
- It contains the "G" sensors for both frontal and side collisions and spare battery function in case of main battery damage in collision.

DTC Logic

INFOID:000000005631483

DTC DETECTION LOGIC

DTC	Display contents of CONSULT-III	DTC detecting condition	Possible cause
B1058 B1059 B1060 B1061 B1062 B1063	CONTROL UNIT	Air bag diagnosis sensor unit is malfunctioning	Malfunction in air bag diagnosis sensor unit

DTC CONFIRMATION PROCEDURE

1. CHECK SELF-DIAG RESULT

With CONSULT-III

1. Turn ignition switch ON.
2. Perform "AIR BAG" Self Diagnostic Result.

Without CONSULT-III

1. Turn ignition switch ON.
2. Check the air bag warning lamp status. Refer to [SRC-15, "Diagnosis with Air Bag Warning Lamp"](#).

NOTE:

SRS does not enter the diagnosis mode if no malfunction is detected in the user mode.

Is malfunctioning part detected?

- YES >> Refer to [SRC-60, "Diagnosis Procedure"](#).
NO >> INSPECTION END

Diagnosis Procedure

INFOID:000000005631484

WARNING:

- Before servicing, turn ignition switch OFF, disconnect battery negative terminal, and wait 3 minutes or more. (To discharge backup capacitor.)
- Never use unspecified tester or other measuring device.

1. CHECK HARNESS CONNECTOR

Check the harness connector.

Is the inspection result normal?

- YES >> GO TO 2.
NO >> Replace harness connectors.

2. CHECK WIRING HARNESS

Check the wiring harness externals.

Is the inspection result normal?

- YES >> GO TO 3.
NO >> Replace wiring harness.

3. REPLACE AIR BAG DIAGNOSIS SENSOR UNIT

1. Replace air bag diagnosis sensor unit. Refer to [SR-29, "Exploded View"](#).
2. Perform DTC confirmation procedure. Refer to [SRC-60, "DTC Logic"](#).

B1058, B1059, B1060, B1061, B1062, B1063 DIAGNOSIS SENSOR UNIT

< DTC/CIRCUIT DIAGNOSIS >

Is DTC detected?

YES >> GO TO 1.

NO >> INSPECTION END

A

B

C

D

E

F

G

SRC

I

J

K

L

M

N

O

P

B1065, B1070 PASSENGER AIR BAG MODULE

< DTC/CIRCUIT DIAGNOSIS >

B1065, B1070 PASSENGER AIR BAG MODULE

Description

INFOID:000000005631485

In case of frontal collision where acceleration is more than the specified level, the ignition materials are ignited by electric ignition system. The system burns the gas generating materials resulting in a chemical reaction. This generates hot gases that flow into the air bag through a filter and expand the bag.

DTC Logic

INFOID:000000005631486

DTC DETECTION LOGIC

DTC	Display contents of CONSULT-III	DTC detecting condition	Possible cause
B1065 B1070	ASSIST A/B MODULE [OPEN]	Passenger air bag module circuit is open	<ul style="list-style-type: none">• Disconnection of wiring harness and open• Malfunction in passenger air bag module• Malfunction in air bag diagnosis sensor unit

DTC CONFIRMATION PROCEDURE

1. CHECK SELF-DIAG RESULT

With CONSULT-III

1. Turn ignition switch ON.
2. Perform "AIR BAG" Self Diagnostic Result.

Without CONSULT-III

1. Turn ignition switch ON.
2. Check the air bag warning lamp status. Refer to [SRC-15. "Diagnosis with Air Bag Warning Lamp"](#).

NOTE:

SRS does not enter the diagnosis mode if no malfunction is detected in the user mode.

Is malfunctioning part detected?

- YES >> Refer to [SRC-62. "Diagnosis Procedure"](#).
NO >> INSPECTION END

Diagnosis Procedure

INFOID:000000005631487

WARNING:

- Before servicing, turn ignition switch OFF, disconnect battery negative terminal, and wait at least 3 minutes or more. (To discharge backup capacitor.)
- Never use unspecified tester or other measuring device.

1. CHECK HARNESS CONNECTOR

Check the harness connector.

Is the inspection result normal?

- YES >> GO TO 2.
NO >> Replace harness connector.

2. CHECK WIRING HARNESS

Check the wiring harness externals.

Is the inspection result normal?

- YES >> GO TO 3.
NO >> Replace wiring harness.

3. REPLACE AIR BAG DIAGNOSIS SENSOR UNIT

1. Replace air bag diagnosis sensor unit. Refer to [SR-29. "Exploded View"](#).
2. Perform DTC confirmation procedure. Refer to [SRC-62. "DTC Logic"](#).

Is DTC detected?

- YES >> GO TO 4.
NO >> INSPECTION END

B1065, B1070 PASSENGER AIR BAG MODULE

< DTC/CIRCUIT DIAGNOSIS >

4. REPLACE PASSENGER AIR BAG MODULE

1. Replace passenger air bag module. Refer to [SR-17, "Exploded View"](#)
2. Perform DTC confirmation procedure. Refer to [SRC-62, "DTC Logic"](#).

Is DTC detected?

YES >> GO TO 1.
NO >> INSPECTION END

A
B
C
D
E
F
G
I
J
K
L
M
N
O
P

SRC

B1066, B1071 PASSENGER AIR BAG MODULE

< DTC/CIRCUIT DIAGNOSIS >

B1066, B1071 PASSENGER AIR BAG MODULE

Description

INFOID:000000005631488

In case of frontal collision where acceleration is more than the specified level, the ignition materials are ignited by electric ignition system. The system burns the gas generating materials resulting in a chemical reaction. This generates hot gases that flow into the air bag through a filter and expand the bag.

DTC Logic

INFOID:000000005631489

DTC DETECTION LOGIC

DTC	Display contents of CONSULT-III	DTC detecting condition	Possible cause
B1066 B1071	ASSIST A/B MODULE [VB-SHORT]	Passenger air bag module circuit is shorted to power supply circuit	<ul style="list-style-type: none">• Disconnection of wiring harness and short• Malfunction in passenger air bag module• Malfunction in air bag diagnosis sensor unit

DTC CONFIRMATION PROCEDURE

1. CHECK SELF-DIAG RESULT

With CONSULT-III

1. Turn ignition switch ON.
2. Perform "AIR BAG" Self Diagnostic Result.

Without CONSULT-III

1. Turn ignition switch ON.
2. Check the air bag warning lamp status. Refer to [SRC-15. "Diagnosis with Air Bag Warning Lamp"](#).

NOTE:

SRS does not enter the diagnosis mode if no malfunction is detected in the user mode.

Is malfunctioning part detected?

- YES >> Refer to [SRC-64. "Diagnosis Procedure"](#).
NO >> INSPECTION END

Diagnosis Procedure

INFOID:000000005631490

WARNING:

- Before servicing, turn ignition switch OFF, disconnect battery negative terminal, and wait at least 3 minutes or more. (To discharge backup capacitor.)
- Never use unspecified tester or other measuring device.

1. CHECK HARNESS CONNECTOR

Check the harness connector.

Is the inspection result normal?

- YES >> GO TO 2.
NO >> Replace harness connector.

2. CHECK WIRING HARNESS

Check the wiring harness externals.

Is the inspection result normal?

- YES >> GO TO 3.
NO >> Replace wiring harness.

3. REPLACE AIR BAG DIAGNOSIS SENSOR UNIT

1. Replace air bag diagnosis sensor unit. Refer to [SR-29. "Exploded View"](#).
2. Perform DTC confirmation procedure. Refer to [SRC-64. "DTC Logic"](#).

Is DTC detected?

- YES >> GO TO 4.
NO >> INSPECTION END

B1066, B1071 PASSENGER AIR BAG MODULE

< DTC/CIRCUIT DIAGNOSIS >

4. REPLACE PASSENGER AIR BAG MODULE

1. Replace passenger air bag module. Refer to [SR-17, "Exploded View"](#).
2. Perform DTC confirmation procedure. Refer to [SRC-64, "DTC Logic"](#).

Is DTC detected?

YES >> GO TO 1.
NO >> INSPECTION END

A
B
C
D
E
F
G
I
J
K
L
M
N
O
P

SRC

B1067, B1072 PASSENGER AIR BAG MODULE

< DTC/CIRCUIT DIAGNOSIS >

B1067, B1072 PASSENGER AIR BAG MODULE

Description

INFOID:000000005631491

In case of frontal collision where acceleration is more than the specified level, the ignition materials are ignited by electric ignition system. The system burns the gas generating materials resulting in a chemical reaction. This generates hot gases that flow into the air bag through a filter and expand the bag.

DTC Logic

INFOID:000000005631492

DTC DETECTION LOGIC

DTC	Display contents of CONSULT-III	DTC detecting condition	Possible cause
B1067 B1072	ASSIST A/B MODULE [GND-SHORT]	Passenger air bag module circuit is shorted to ground	<ul style="list-style-type: none">• Disconnection of wiring harness and short• Malfunction in passenger air bag module• Malfunction in air bag diagnosis sensor unit

DTC CONFIRMATION PROCEDURE

1. CHECK SELF-DIAG RESULT

With CONSULT-III

1. Turn ignition switch ON.
2. Perform "AIR BAG" Self Diagnostic Result.

Without CONSULT-III

1. Turn ignition switch ON.
2. Check the air bag warning lamp status. Refer to [SRC-15. "Diagnosis with Air Bag Warning Lamp"](#).

NOTE:

SRS does not enter the diagnosis mode if no malfunction is detected in the user mode.

Is malfunctioning part detected?

- YES >> Refer to [SRC-66. "Diagnosis Procedure"](#).
NO >> INSPECTION END

Diagnosis Procedure

INFOID:000000005631493

WARNING:

- Before servicing, turn ignition switch OFF, disconnect battery negative terminal, and wait at least 3 minutes or more. (To discharge backup capacitor.)
- Never use unspecified tester or other measuring device.

1. CHECK HARNESS CONNECTOR

Check the harness connector.

Is the inspection result normal?

- YES >> GO TO 2.
NO >> Replace harness connector.

2. CHECK WIRING HARNESS

Check the wiring harness externals.

Is the inspection result normal?

- YES >> GO TO 3.
NO >> Replace wiring harness.

3. REPLACE AIR BAG DIAGNOSIS SENSOR UNIT

1. Replace air bag diagnosis sensor unit. Refer to [SR-29. "Exploded View"](#).
2. Perform DTC confirmation procedure. Refer to [SRC-66. "DTC Logic"](#).

Is DTC detected?

- YES >> GO TO 4.
NO >> INSPECTION END

B1067, B1072 PASSENGER AIR BAG MODULE

< DTC/CIRCUIT DIAGNOSIS >

4. REPLACE PASSENGER AIR BAG MODULE

1. Replace passenger air bag module. Refer to [SR-17, "Exploded View"](#)
2. Perform DTC confirmation procedure. Refer to [SRC-66, "DTC Logic"](#).

Is DTC detected?

YES >> GO TO 1.
NO >> INSPECTION END

A
B
C
D
E
F
G
I
J
K
L
M
N
O
P

SRC

B1068, B1073 PASSENGER AIR BAG MODULE

< DTC/CIRCUIT DIAGNOSIS >

B1068, B1073 PASSENGER AIR BAG MODULE

Description

INFOID:000000005631494

In case of frontal collision where acceleration is more than the specified level, the ignition materials are ignited by electric ignition system. The system burns the gas generating materials resulting in a chemical reaction. This generates hot gases that flow into the air bag through a filter and expand the bag.

DTC Logic

INFOID:000000005631495

DTC DETECTION LOGIC

DTC	Display contents of CONSULT-III	DTC detecting condition	Possible cause
B1068 B1073	ASSIST A/B MODULE [SHORT]	Passenger air bag module circuits are shorted to each other	<ul style="list-style-type: none">• Disconnection of wiring harness and short• Malfunction in passenger air bag module• Malfunction in air bag diagnosis sensor unit

DTC CONFIRMATION PROCEDURE

1. CHECK SELF-DIAG RESULT

With CONSULT-III

1. Turn ignition switch ON.
2. Perform "AIR BAG" Self Diagnostic Result.

Without CONSULT-III

1. Turn ignition switch ON.
2. Check the air bag warning lamp status. Refer to [SRC-15. "Diagnosis with Air Bag Warning Lamp"](#).

NOTE:

SRS does not enter the diagnosis mode if no malfunction is detected in the user mode.

Is malfunctioning part detected?

- YES >> Refer to [SRC-68. "Diagnosis Procedure"](#).
NO >> INSPECTION END

Diagnosis Procedure

INFOID:000000005631496

WARNING:

- Before servicing, turn ignition switch OFF, disconnect battery negative terminal, and wait at least 3 minutes or more. (To discharge backup capacitor.)
- Never use unspecified tester or other measuring device.

1. CHECK HARNESS CONNECTOR

Check the harness connector.

Is the inspection result normal?

- YES >> GO TO 2.
NO >> Replace harness connector.

2. CHECK WIRING HARNESS

Check the wiring harness externals.

Is the inspection result normal?

- YES >> GO TO 3.
NO >> Replace wiring harness.

3. REPLACE AIR BAG DIAGNOSIS SENSOR UNIT

1. Replace air bag diagnosis sensor unit. Refer to [SR-29. "Exploded View"](#).
2. Perform DTC confirmation procedure. Refer to [SRC-68. "DTC Logic"](#).

Is DTC detected?

- YES >> GO TO 4.
NO >> INSPECTION END

B1068, B1073 PASSENGER AIR BAG MODULE

< DTC/CIRCUIT DIAGNOSIS >

4. REPLACE PASSENGER AIR BAG MODULE

1. Replace passenger air bag module. Refer to [SR-17, "Exploded View"](#)
2. Perform DTC confirmation procedure. Refer to [SRC-68, "DTC Logic"](#).

Is DTC detected?

YES >> GO TO 1.
NO >> INSPECTION END

A
B
C
D
E
F
G
I
J
K
L
M
N
O
P

SRC

B1074, B1075, B1076, B1077, B1078, B1079 DIAGNOSIS SENSOR UNIT

< DTC/CIRCUIT DIAGNOSIS >

B1074, B1075, B1076, B1077, B1078, B1079 DIAGNOSIS SENSOR UNIT

Description

INFOID:000000005631497

- It detects a shock that is more than the specified level and monitors whether the driver and passenger air bags, side air bag, curtain air bag, and pre-tensioner seat belts operate normally.
- It contains the "G" sensors for both frontal and side collisions and spare battery function in case of main battery damage in collision.

DTC Logic

INFOID:000000005631498

DTC DETECTION LOGIC

DTC	Display contents of CONSULT-III	DTC detecting condition	Possible cause
B1074 B1075 B1076 B1077 B1078 B1079	CONTROL UNIT	Air bag diagnosis sensor unit is malfunctioning	Malfunction in air bag diagnosis sensor unit

DTC CONFIRMATION PROCEDURE

1. CHECK SELF-DIAG RESULT

Ⓟ With CONSULT-III

1. Turn ignition switch ON.
2. Perform "AIR BAG" Self Diagnostic Result.

Ⓟ Without CONSULT-III

1. Turn ignition switch ON.
2. Check the air bag warning lamp status. Refer to [SRC-15, "Diagnosis with Air Bag Warning Lamp"](#).

NOTE:

SRS does not enter the diagnosis mode if no malfunction is detected in the user mode.

Is malfunctioning part detected?

- YES >> Refer to [SRC-70, "Diagnosis Procedure"](#).
NO >> INSPECTION END

Diagnosis Procedure

INFOID:000000005631499

WARNING:

- Before servicing, turn ignition switch OFF, disconnect battery negative terminal, and wait at least 3 minutes or more. (To discharge backup capacitor.)
- Never use unspecified tester or other measuring device.

1. CHECK HARNESS CONNECTOR

Check the harness connector.

Is the inspection result normal?

- YES >> GO TO 2.
NO >> Replace harness connectors.

2. CHECK WIRING HARNESS

Check the wiring harness externals.

Is the inspection result normal?

- YES >> GO TO 3.
NO >> Replace wiring harness.

3. REPLACE AIR BAG DIAGNOSIS SENSOR UNIT

1. Replace air bag diagnosis sensor unit. Refer to [SR-29, "Exploded View"](#).
2. Perform DTC confirmation procedure. Refer to [SRC-70, "DTC Logic"](#).

B1074, B1075, B1076, B1077, B1078, B1079 DIAGNOSIS SENSOR UNIT

< DTC/CIRCUIT DIAGNOSIS >

Is DTC detected?

YES >> GO TO 1.

NO >> INSPECTION END

A

B

C

D

E

F

G

SRC

I

J

K

L

M

N

O

P

B1080, B1096 DRIVER AIR BAG MODULE

< DTC/CIRCUIT DIAGNOSIS >

B1080, B1096 DRIVER AIR BAG MODULE

Description

INFOID:000000005631500

In case of frontal collision where acceleration is more than the specified level, the ignition materials are ignited by electric ignition system. The system burns the gas generating materials resulting in a chemical reaction. This generates hot gases that flow into the air bag through a filter and expand the bag.

DTC Logic

INFOID:000000005631501

DTC DETECTION LOGIC

DTC	Display contents of CONSULT-III	DTC detecting condition	Possible cause
B1080 B1096	DRIVER AIRBAG MODULE [SHORT]	Driver air bag module circuit are shorted to each other (including the spiral cable)	<ul style="list-style-type: none">• Disconnection of wiring harness and short• Malfunction in driver air bag module• Malfunction in spiral cable• Malfunction in air bag diagnosis sensor unit

DTC CONFIRMATION PROCEDURE

1. CHECK SELF-DIAG RESULT

With CONSULT-III

1. Turn ignition switch ON.
2. Perform "AIR BAG" Self Diagnostic Result.

Without CONSULT-III

1. Turn ignition switch ON.
2. Check the air bag warning lamp status. Refer to [SRC-15. "Diagnosis with Air Bag Warning Lamp"](#).

NOTE:

SRS does not enter the diagnosis mode if no malfunction is detected in the user mode.

Is malfunctioning part detected?

- YES >> Refer to [SRC-72. "Diagnosis Procedure"](#).
NO >> INSPECTION END

Diagnosis Procedure

INFOID:000000005631502

WARNING:

- Before servicing, turn ignition switch OFF, disconnect battery negative terminal, and wait at least 3 minutes or more. (To discharge backup capacitor.)
- Never use unspecified tester or other measuring device.

1. CHECK HARNESS CONNECTOR

Check the harness connector.

Is the inspection result normal?

- YES >> GO TO 2.
NO >> Replace harness connector.

2. CHECK WIRING HARNESS

Check the wiring harness externals.

Is the inspection result normal?

- YES >> GO TO 3.
NO >> Replace wiring harness.

3. CHECK SPIRAL CABLE CIRCUIT

1. Turn ignition switch OFF.
2. Disconnect driver air bag module connector and combination switch (spiral cable) connector.
3. Check continuity between driver air bag module harness connector and combination switch (spiral cable) harness connector.

B1080, B1096 DRIVER AIR BAG MODULE

< DTC/CIRCUIT DIAGNOSIS >

Driver air bag module		Combination switch (spiral cable)		Continuity
Connector	Terminal	Connector	Terminal	
M302	10	M35	28	Existed
	11		30	
M301	12		29	
	9		30	

4. Check continuity between driver air bag module harness connector and ground.

Driver side air bag module		Ground	Continuity
Connector	Terminal		
M302	10	Ground	Not existed
	11		
M301	12		
	9		

Is the inspection result normal?

YES >> GO TO 4.

NO >> Replace combination switch (spiral cable). Refer to [SR-14, "Exploded View"](#).

4. REPLACE AIR BAG DIAGNOSIS SENSOR UNIT

1. Replace air bag diagnosis sensor unit. Refer to [SR-29, "Exploded View"](#)
2. Perform DTC confirmation procedure. Refer to [SRC-72, "DTC Logic"](#).

Is DTC detected?

YES >> GO TO 5.

NO >> INSPECTION END

5. REPLACE DRIVER AIR BAG MODULE

1. Replace driver air bag module. Refer to [SR-11, "Exploded View"](#)
2. Perform DTC confirmation procedure. Refer to [SRC-72, "DTC Logic"](#).

Is DTC detected?

YES >> GO TO 1.

NO >> INSPECTION END

B1081 SEAT BELT PRE-TENSIONER RH

< DTC/CIRCUIT DIAGNOSIS >

B1081 SEAT BELT PRE-TENSIONER RH

Description

INFOID:000000005631503

In the case of a frontal collision that is more than the specified impact level, the air bag diagnosis sensor unit detects the deceleration caused by collision. It restrains the passenger with seat belt easing the stress on passengers chest with load limiter.

DTC Logic

INFOID:000000005631504

DTC DETECTION LOGIC

DTC	Display contents of CONSULT-III	DTC detecting condition	Possible cause
B1081	PRE-TEN FRONT RH [OPEN]	Seat belt pre-tensioner RH circuit is open	<ul style="list-style-type: none">• Disconnection of wiring harness and open• Malfunction in seat belt pre-tensioner RH• Malfunction in air bag diagnosis sensor unit

DTC CONFIRMATION PROCEDURE

1. CHECK SELF-DIAG RESULT

With CONSULT-III

1. Turn ignition switch ON.
2. Perform "AIR BAG" Self Diagnostic Result.

Without CONSULT-III

1. Turn ignition switch ON.
2. Check the air bag warning lamp status. Refer to [SRC-15. "Diagnosis with Air Bag Warning Lamp"](#).

NOTE:

SRS does not enter the diagnosis mode if no malfunction is detected in the user mode.

Is malfunctioning part detected?

- YES >> Refer to [SRC-74. "Diagnosis Procedure"](#).
NO >> INSPECTION END

Diagnosis Procedure

INFOID:000000005631505

WARNING:

- Before servicing, turn ignition switch OFF, disconnect battery negative terminal, and wait at least 3 minutes or more. (To discharge backup capacitor.)
- Never use unspecified tester or other measuring device.

1. CHECK HARNESS CONNECTOR

Check the harness connector.

Is the inspection result normal?

- YES >> GO TO 2.
NO >> Replace harness connector.

2. CHECK WIRING HARNESS

Check the wiring harness externals.

Is the inspection result normal?

- YES >> GO TO 3.
NO >> Replace wiring harness.

3. REPLACE SEAT BELT PRE-TENSIONER

1. Replace seat belt pre-tensioner RH. Refer to [SB-6. "SEAT BELT RETRACTOR : Exploded View"](#).
2. Perform DTC confirmation procedure. Refer to [SRC-74. "DTC Logic"](#).

Is DTC detected?

- YES >> GO TO 4.
NO >> INSPECTION END

B1081 SEAT BELT PRE-TENSIONER RH

< DTC/CIRCUIT DIAGNOSIS >

4. REPLACE AIR BAG DIAGNOSIS SENSOR UNIT

1. Replace air bag diagnosis sensor unit. Refer to [SR-29, "Exploded View"](#).
2. Perform DTC confirmation procedure. Refer to [SRC-74, "DTC Logic"](#).

Is DTC detected?

YES >> GO TO 1.
NO >> INSPECTION END

A
B
C
D
E
F
G
I
J
K
L
M
N
O
P

SRC

B1082 SEAT BELT PRE-TENSIONER RH

< DTC/CIRCUIT DIAGNOSIS >

B1082 SEAT BELT PRE-TENSIONER RH

Description

INFOID:000000005631506

In the case of a frontal collision that is more than the specified impact level, the air bag diagnosis sensor unit detects the deceleration caused by collision. It restrains the passenger with seat belt easing the stress on passengers chest with load limiter.

DTC Logic

INFOID:000000005631507

DTC DETECTION LOGIC

DTC	Display contents of CONSULT-III	DTC detecting condition	Possible cause
B1082	PRE-TEN FRONT RH [VB-SHORT]	Seat belt pre-tensioner RH circuit is shorted to power supply circuit	<ul style="list-style-type: none">• Disconnection of wiring harness and short• Malfunction in seat belt pre-tensioner RH• Malfunction in air bag diagnosis sensor unit

DTC CONFIRMATION PROCEDURE

1. CHECK SELF-DIAG RESULT

With CONSULT-III

1. Turn ignition switch ON.
2. Perform "AIR BAG" Self Diagnostic Result.

Without CONSULT-III

1. Turn ignition switch ON.
2. Check the air bag warning lamp status. Refer to [SRC-15. "Diagnosis with Air Bag Warning Lamp"](#).

NOTE:

SRS does not enter the diagnosis mode if no malfunction is detected in the user mode.

Is malfunctioning part detected?

- YES >> Refer to [SRC-76. "Diagnosis Procedure"](#).
NO >> INSPECTION END

Diagnosis Procedure

INFOID:000000005631508

WARNING:

- Before servicing, turn ignition switch OFF, disconnect battery negative terminal, and wait at least 3 minutes or more. (To discharge backup capacitor.)
- Never use unspecified tester or other measuring device.

1. CHECK HARNESS CONNECTOR

Check the harness connector.

Is the inspection result normal?

- YES >> GO TO 2.
NO >> Replace harness connector.

2. CHECK WIRING HARNESS

Check the wiring harness externals.

Is the inspection result normal?

- YES >> GO TO 3.
NO >> Replace wiring harness.

3. REPLACE SEAT BELT PRE-TENSIONER

1. Replace seat belt pre-tensioner RH. Refer to [SB-6. "SEAT BELT RETRACTOR : Exploded View"](#).
2. Perform DTC confirmation procedure. Refer to [SRC-76. "DTC Logic"](#).

Is DTC detected?

- YES >> GO TO 4.
NO >> INSPECTION END

B1082 SEAT BELT PRE-TENSIONER RH

< DTC/CIRCUIT DIAGNOSIS >

4. REPLACE AIR BAG DIAGNOSIS SENSOR UNIT

1. Replace air bag diagnosis sensor unit. Refer to [SR-29, "Exploded View"](#).
2. Perform DTC confirmation procedure. Refer to [SRC-76, "DTC Logic"](#).

Is DTC detected?

YES >> GO TO 1.
NO >> INSPECTION END

A
B
C
D
E
F
G
I
J
K
L
M
N
O
P

SRC

B1083 SEAT BELT PRE-TENSIONER RH

< DTC/CIRCUIT DIAGNOSIS >

B1083 SEAT BELT PRE-TENSIONER RH

Description

INFOID:000000005631509

In the case of a frontal collision that is more than the specified impact level, the air bag diagnosis sensor unit detects the deceleration caused by collision. It restrains the passenger with seat belt easing the stress on passengers chest with load limiter.

DTC Logic

INFOID:000000005631510

DTC DETECTION LOGIC

DTC	Display contents of CONSULT-III	DTC detecting condition	Possible cause
B1083	PRE-TEN FRONT RH [GND-SHORT]	Seat belt pre-tensioner RH circuit is shorted to ground	<ul style="list-style-type: none">• Disconnection of wiring harness and short• Malfunction in seat belt pre-tensioner RH• Malfunction in air bag diagnosis sensor unit

DTC CONFIRMATION PROCEDURE

1. CHECK SELF-DIAG RESULT

With CONSULT-III

1. Turn ignition switch ON.
2. Perform "AIR BAG" Self Diagnostic Result.

Without CONSULT-III

1. Turn ignition switch ON.
2. Check the air bag warning lamp status. Refer to [SRC-15. "Diagnosis with Air Bag Warning Lamp"](#).

NOTE:

SRS does not enter the diagnosis mode if no malfunction is detected in the user mode.

Is malfunctioning part detected?

- YES >> Refer to [SRC-78. "Diagnosis Procedure"](#).
NO >> INSPECTION END

Diagnosis Procedure

INFOID:000000005631511

WARNING:

- Before servicing, turn ignition switch OFF, disconnect battery negative terminal, and wait at least 3 minutes or more. (To discharge backup capacitor.)
- Never use unspecified tester or other measuring device.

1. CHECK HARNESS CONNECTOR

Check the harness connector.

Is the inspection result normal?

- YES >> GO TO 2.
NO >> Replace harness connector.

2. CHECK WIRING HARNESS

Check the wiring harness externals.

Is the inspection result normal?

- YES >> GO TO 3.
NO >> Replace wiring harness.

3. REPLACE SEAT BELT PRE-TENSIONER

1. Replace seat belt pre-tensioner RH. Refer to [SB-6. "SEAT BELT RETRACTOR : Exploded View"](#).
2. Perform DTC confirmation procedure. Refer to [SRC-78. "DTC Logic"](#).

Is DTC detected?

- YES >> GO TO 4.
NO >> INSPECTION END

B1083 SEAT BELT PRE-TENSIONER RH

< DTC/CIRCUIT DIAGNOSIS >

4. REPLACE AIR BAG DIAGNOSIS SENSOR UNIT

1. Replace air bag diagnosis sensor unit. Refer to [SR-29, "Exploded View"](#).
2. Perform DTC confirmation procedure. Refer to [SRC-78, "DTC Logic"](#).

Is DTC detected?

YES >> GO TO 1.
NO >> INSPECTION END

A
B
C
D
E
F
G
I
J
K
L
M
N
O
P

SRC

B1084 SEAT BELT PRE-TENSIONER RH

< DTC/CIRCUIT DIAGNOSIS >

B1084 SEAT BELT PRE-TENSIONER RH

Description

INFOID:000000005631512

In the case of a frontal collision that is more than the specified impact level, the air bag diagnosis sensor unit detects the deceleration caused by collision. It restrains the passenger with seat belt easing the stress on passengers chest with load limiter.

DTC Logic

INFOID:000000005631513

DTC DETECTION LOGIC

DTC	Display contents of CONSULT-III	DTC detecting condition	Possible cause
B1084	PRE-TEN FRONT RH [SHORT]	Seat belt pre-tensioner RH circuits are shorted to each other	<ul style="list-style-type: none">• Disconnection of wiring harness and short• Malfunction in seat belt pre-tensioner RH• Malfunction in air bag diagnosis sensor unit

DTC CONFIRMATION PROCEDURE

1. CHECK SELF-DIAG RESULT

With CONSULT-III

1. Turn ignition switch ON.
2. Perform "AIR BAG" Self Diagnostic Result.

Without CONSULT-III

1. Turn ignition switch ON.
2. Check the air bag warning lamp status. Refer to [SRC-15. "Diagnosis with Air Bag Warning Lamp"](#).

NOTE:

SRS does not enter the diagnosis mode if no malfunction is detected in the user mode.

Is malfunctioning part detected?

- YES >> Refer to [SRC-80. "Diagnosis Procedure"](#).
NO >> INSPECTION END

Diagnosis Procedure

INFOID:000000005631514

WARNING:

- Before servicing, turn ignition switch OFF, disconnect battery negative terminal, and wait at least 3 minutes or more. (To discharge backup capacitor.)
- Never use unspecified tester or other measuring device.

1. CHECK HARNESS CONNECTOR

Check the harness connector.

Is the inspection result normal?

- YES >> GO TO 2.
NO >> Replace harness connector.

2. CHECK WIRING HARNESS

Check the wiring harness externals.

Is the inspection result normal?

- YES >> GO TO 3.
NO >> Replace wiring harness.

3. REPLACE SEAT BELT PRE-TENSIONER

1. Replace seat belt pre-tensioner RH. Refer to [SB-6. "SEAT BELT RETRACTOR : Exploded View"](#).
2. Perform DTC confirmation procedure. Refer to [SRC-80. "DTC Logic"](#).

Is DTC detected?

- YES >> GO TO 4.
NO >> INSPECTION END

B1084 SEAT BELT PRE-TENSIONER RH

< DTC/CIRCUIT DIAGNOSIS >

4. REPLACE AIR BAG DIAGNOSIS SENSOR UNIT

1. Replace air bag diagnosis sensor unit. Refer to [SR-29, "Exploded View"](#).
2. Perform DTC confirmation procedure. Refer to [SRC-80, "DTC Logic"](#).

Is DTC detected?

YES >> GO TO 1.
NO >> INSPECTION END

A
B
C
D
E
F
G
I
J
K
L
M
N
O
P

SRC

B1086 SEAT BELT PRE-TENSIONER LH

< DTC/CIRCUIT DIAGNOSIS >

B1086 SEAT BELT PRE-TENSIONER LH

Description

INFOID:000000005631515

In the case of a frontal collision that is more than the specified impact level, the air bag diagnosis sensor unit detects the deceleration caused by collision. It restrains the passenger with seat belt easing the stress on passengers chest with load limiter.

DTC Logic

INFOID:000000005631516

DTC DETECTION LOGIC

DTC	Display contents of CONSULT-III	DTC detecting condition	Possible cause
B1086	PRE-TEN FRONT LH [OPEN]	Seat belt pre-tensioner LH circuit is open	<ul style="list-style-type: none">• Disconnection of wiring harness and open• Malfunction in seat belt pre-tensioner LH• Malfunction in air bag diagnosis sensor unit

DTC CONFIRMATION PROCEDURE

1. CHECK SELF-DIAG RESULT

With CONSULT-III

1. Turn ignition switch ON.
2. Perform "AIR BAG" Self Diagnostic Result.

Without CONSULT-III

1. Turn ignition switch ON.
2. Check the air bag warning lamp status. Refer to [SRC-15. "Diagnosis with Air Bag Warning Lamp"](#).

NOTE:

SRS does not enter the diagnosis mode if no malfunction is detected in the user mode.

Is malfunctioning part detected?

- YES >> Refer to [SRC-82. "Diagnosis Procedure"](#).
NO >> INSPECTION END

Diagnosis Procedure

INFOID:000000005631517

WARNING:

- Before servicing, turn ignition switch OFF, disconnect battery negative terminal, and wait at least 3 minutes or more. (To discharge backup capacitor.)
- Never use unspecified tester or other measuring device.

1. CHECK HARNESS CONNECTOR

Check the harness connector.

Is the inspection result normal?

- YES >> GO TO 2.
NO >> Replace harness connector.

2. CHECK WIRING HARNESS

Check the wiring harness externals.

Is the inspection result normal?

- YES >> GO TO 3.
NO >> Replace wiring harness.

3. REPLACE SEAT BELT PRE-TENSIONER

1. Replace seat belt pre-tensioner LH. Refer to [SB-6. "SEAT BELT RETRACTOR : Exploded View"](#).
2. Perform DTC confirmation procedure. Refer to [SRC-82. "DTC Logic"](#).

Is DTC detected?

- YES >> GO TO 4.
NO >> INSPECTION END

B1086 SEAT BELT PRE-TENSIONER LH

< DTC/CIRCUIT DIAGNOSIS >

4. REPLACE AIR BAG DIAGNOSIS SENSOR UNIT

1. Replace air bag diagnosis sensor unit. Refer to [SR-29, "Exploded View"](#).
2. Perform DTC confirmation procedure. Refer to [SRC-82, "DTC Logic"](#).

Is DTC detected?

YES >> GO TO 1.
NO >> INSPECTION END

A
B
C
D
E
F
G
I
J
K
L
M
N
O
P

SRC

B1087 SEAT BELT PRE-TENSIONER LH

< DTC/CIRCUIT DIAGNOSIS >

B1087 SEAT BELT PRE-TENSIONER LH

Description

INFOID:000000005631518

In the case of a frontal collision that is more than the specified impact level, the air bag diagnosis sensor unit detects the deceleration caused by collision. It restrains the passenger with seat belt easing the stress on passengers chest with load limiter.

DTC Logic

INFOID:000000005631519

DTC DETECTION LOGIC

DTC	Display contents of CONSULT-III	DTC detecting condition	Possible cause
B1087	PRE-TEN FRONT LH [VB-SHORT]	Seat belt pre-tensioner LH circuit is shorted to power supply circuit	<ul style="list-style-type: none">• Disconnection of wiring harness and short• Malfunction in seat belt pre-tensioner LH• Malfunction in air bag diagnosis sensor unit

DTC CONFIRMATION PROCEDURE

1. CHECK SELF-DIAG RESULT

With CONSULT-III

1. Turn ignition switch ON.
2. Perform "AIR BAG" Self Diagnostic Result.

Without CONSULT-III

1. Turn ignition switch ON.
2. Check the air bag warning lamp status. Refer to [SRC-15. "Diagnosis with Air Bag Warning Lamp"](#).

NOTE:

SRS does not enter the diagnosis mode if no malfunction is detected in the user mode.

Is malfunctioning part detected?

- YES >> Refer to [SRC-84. "Diagnosis Procedure"](#).
NO >> INSPECTION END

Diagnosis Procedure

INFOID:000000005631520

WARNING:

- Before servicing, turn ignition switch OFF, disconnect battery negative terminal, and wait at least 3 minutes or more. (To discharge backup capacitor.)
- Never use unspecified tester or other measuring device.

1. CHECK HARNESS CONNECTOR

Check the harness connector.

Is the inspection result normal?

- YES >> GO TO 2.
NO >> Replace harness connector.

2. CHECK WIRING HARNESS

Check the wiring harness externals.

Is the inspection result normal?

- YES >> GO TO 3.
NO >> Replace wiring harness.

3. REPLACE SEAT BELT PRE-TENSIONER

1. Replace seat belt pre-tensioner LH. Refer to [SB-6. "SEAT BELT RETRACTOR : Exploded View"](#).
2. Perform DTC confirmation procedure. Refer to [SRC-84. "DTC Logic"](#).

Is DTC detected?

- YES >> GO TO 4.
NO >> INSPECTION END

B1087 SEAT BELT PRE-TENSIONER LH

< DTC/CIRCUIT DIAGNOSIS >

4. REPLACE AIR BAG DIAGNOSIS SENSOR UNIT

1. Replace air bag diagnosis sensor unit. Refer to [SR-29, "Exploded View"](#).
2. Perform DTC confirmation procedure. Refer to [SRC-84, "DTC Logic"](#).

Is DTC detected?

YES >> GO TO 1.
NO >> INSPECTION END

A
B
C
D
E
F
G
I
J
K
L
M
N
O
P

SRC

B1088 SEAT BELT PRE-TENSIONER LH

< DTC/CIRCUIT DIAGNOSIS >

B1088 SEAT BELT PRE-TENSIONER LH

Description

INFOID:000000005631521

In the case of a frontal collision that is more than the specified impact level, the air bag diagnosis sensor unit detects the deceleration caused by collision. It restrains the passenger with seat belt easing the stress on passengers chest with load limiter.

DTC Logic

INFOID:000000005631522

DTC DETECTION LOGIC

DTC	Display contents of CONSULT-III	DTC detecting condition	Possible cause
B1088	PRE-TEN FRONT LH [GND-SHORT]	Seat belt pre-tensioner LH circuit is shorted to ground	<ul style="list-style-type: none">• Disconnection of wiring harness and short• Malfunction in seat belt pre-tensioner LH• Malfunction in air bag diagnosis sensor unit

DTC CONFIRMATION PROCEDURE

1. CHECK SELF-DIAG RESULT

With CONSULT-III

1. Turn ignition switch ON.
2. Perform "AIR BAG" Self Diagnostic Result.

Without CONSULT-III

1. Turn ignition switch ON.
2. Check the air bag warning lamp status. Refer to [SRC-15. "Diagnosis with Air Bag Warning Lamp"](#).

NOTE:

SRS does not enter the diagnosis mode if no malfunction is detected in the user mode.

Is malfunctioning part detected?

- YES >> Refer to [SRC-86. "Diagnosis Procedure"](#).
NO >> INSPECTION END

Diagnosis Procedure

INFOID:000000005631523

WARNING:

- Before servicing, turn ignition switch OFF, disconnect battery negative terminal, and wait at least 3 minutes or more. (To discharge backup capacitor.)
- Never use unspecified tester or other measuring device.

1. CHECK HARNESS CONNECTOR

Check the harness connector.

Is the inspection result normal?

- YES >> GO TO 2.
NO >> Replace harness connector.

2. CHECK WIRING HARNESS

Check the wiring harness externals.

Is the inspection result normal?

- YES >> GO TO 3.
NO >> Replace wiring harness.

3. REPLACE SEAT BELT PRE-TENSIONER

1. Replace seat belt pre-tensioner LH. Refer to [SB-6. "SEAT BELT RETRACTOR : Exploded View"](#).
2. Perform DTC confirmation procedure. Refer to [SRC-86. "DTC Logic"](#).

Is DTC detected?

- YES >> GO TO 4.
NO >> INSPECTION END

B1088 SEAT BELT PRE-TENSIONER LH

< DTC/CIRCUIT DIAGNOSIS >

4. REPLACE AIR BAG DIAGNOSIS SENSOR UNIT

1. Replace air bag diagnosis sensor unit. Refer to [SR-29, "Exploded View"](#).
2. Perform DTC confirmation procedure. Refer to [SRC-86, "DTC Logic"](#).

Is DTC detected?

YES >> GO TO 1.
NO >> INSPECTION END

A
B
C
D
E
F
G
I
J
K
L
M
N
O
P

SRC

B1089 SEAT BELT PRE-TENSIONER LH

< DTC/CIRCUIT DIAGNOSIS >

B1089 SEAT BELT PRE-TENSIONER LH

Description

INFOID:000000005631524

In the case of a frontal collision that is more than the specified impact level, the air bag diagnosis sensor unit detects the deceleration caused by collision. It restrains the passenger with seat belt easing the stress on passengers chest with load limiter.

DTC Logic

INFOID:000000005631525

DTC DETECTION LOGIC

DTC	Display contents of CONSULT-III	DTC detecting condition	Possible cause
B1089	PRE-TEN FRONT LH [SHORT]	Seat belt pre-tensioner LH circuits are shorted to each other	<ul style="list-style-type: none">• Disconnection of wiring harness and short• Malfunction in seat belt pre-tensioner LH• Malfunction in air bag diagnosis sensor unit

DTC CONFIRMATION PROCEDURE

1. CHECK SELF-DIAG RESULT

With CONSULT-III

1. Turn ignition switch ON.
2. Perform "AIR BAG" Self Diagnostic Result.

Without CONSULT-III

1. Turn ignition switch ON.
2. Check the air bag warning lamp status. Refer to [SRC-15. "Diagnosis with Air Bag Warning Lamp"](#).

NOTE:

SRS does not enter the diagnosis mode if no malfunction is detected in the user mode.

Is malfunctioning part detected?

- YES >> Refer to [SRC-88. "Diagnosis Procedure"](#).
NO >> INSPECTION END

Diagnosis Procedure

INFOID:000000005631526

WARNING:

- Before servicing, turn ignition switch OFF, disconnect battery negative terminal, and wait at least 3 minutes or more. (To discharge backup capacitor.)
- Never use unspecified tester or other measuring device.

1. CHECK HARNESS CONNECTOR

Check the harness connector.

Is the inspection result normal?

- YES >> GO TO 2.
NO >> Replace harness connector.

2. CHECK WIRING HARNESS

Check the wiring harness externals.

Is the inspection result normal?

- YES >> GO TO 3.
NO >> Replace wiring harness.

3. REPLACE SEAT BELT PRE-TENSIONER

1. Replace seat belt pre-tensioner LH. Refer to [SB-6. "SEAT BELT RETRACTOR : Exploded View"](#).
2. Perform DTC confirmation procedure. Refer to [SRC-88. "DTC Logic"](#).

Is DTC detected?

- YES >> GO TO 4.
NO >> INSPECTION END

B1089 SEAT BELT PRE-TENSIONER LH

< DTC/CIRCUIT DIAGNOSIS >

4. REPLACE AIR BAG DIAGNOSIS SENSOR UNIT

1. Replace air bag diagnosis sensor unit. Refer to [SR-29, "Exploded View"](#).
2. Perform DTC confirmation procedure. Refer to [SRC-88, "DTC Logic"](#).

Is DTC detected?

YES >> GO TO 1.
NO >> INSPECTION END

A
B
C
D
E
F
G
I
J
K
L
M
N
O
P

SRC

B1090, B1091, B1092, B1093, B1094, B1095 DIAGNOSIS SENSOR UNIT

< DTC/CIRCUIT DIAGNOSIS >

B1090, B1091, B1092, B1093, B1094, B1095 DIAGNOSIS SENSOR UNIT

Description

INFOID:000000005631527

- It detects a shock that is more than the specified level and monitors whether the driver and passenger air bags, side air bag, curtain air bag, and pre-tensioner seat belts operate normally.
- It contains the "G" sensors for both frontal and side collisions and spare battery function in case of main battery damage in collision.

DTC Logic

INFOID:000000005631528

DTC DETECTION LOGIC

DTC	Display contents of CONSULT-III	DTC detecting condition	Possible cause
B1090 B1091 B1092 B1093 B0194 B1095	CONTROL UNIT	Air bag diagnosis sensor unit is malfunctioning	Malfunction in air bag diagnosis sensor unit

DTC CONFIRMATION PROCEDURE

1. CHECK SELF-DIAG RESULT

With CONSULT-III

1. Turn ignition switch ON.
2. Perform "AIR BAG" Self Diagnostic Result.

Without CONSULT-III

1. Turn ignition switch ON.
2. Check the air bag warning lamp status. Refer to [SRC-15, "Diagnosis with Air Bag Warning Lamp"](#).

NOTE:

SRS does not enter the diagnosis mode if no malfunction is detected in the user mode.

Is malfunctioning part detected?

- YES >> Refer to [SRC-90, "Diagnosis Procedure"](#).
NO >> INSPECTION END

Diagnosis Procedure

INFOID:000000005631529

WARNING:

- Before servicing, turn ignition switch OFF, disconnect battery negative terminal, and wait at least 3 minutes or more. (To discharge backup capacitor.)
- Never use unspecified tester or other measuring device.

1. CHECK HARNESS CONNECTOR

Check the harness connector.

Is the inspection result normal?

- YES >> GO TO 2.
NO >> Replace harness connectors.

2. CHECK WIRING HARNESS

Check the wiring harness externals.

Is the inspection result normal?

- YES >> GO TO 3.
NO >> Replace wiring harness.

3. REPLACE AIR BAG DIAGNOSIS SENSOR UNIT

1. Replace air bag diagnosis sensor unit. Refer to [SR-29, "Exploded View"](#).
2. Perform DTC confirmation procedure. Refer to [SRC-90, "DTC Logic"](#).

B1090, B1091, B1092, B1093, B1094, B1095 DIAGNOSIS SENSOR UNIT

< DTC/CIRCUIT DIAGNOSIS >

Is DTC detected?

YES >> GO TO 1.

NO >> INSPECTION END

A

B

C

D

E

F

G

SRC

I

J

K

L

M

N

O

P

B1106, B1107, B1108, B1109, B1110, B1111 DIAGNOSIS SENSOR UNIT

< DTC/CIRCUIT DIAGNOSIS >

B1106, B1107, B1108, B1109, B1110, B1111 DIAGNOSIS SENSOR UNIT

Description

INFOID:000000005631530

- It detects a shock that is more than the specified level and monitors whether the driver and passenger air bags, side air bag, curtain air bag, and pre-tensioner seat belts operate normally.
- It contains the "G" sensors for both frontal and side collisions and spare battery function in case of main battery damage in collision.

DTC Logic

INFOID:000000005631531

DTC DETECTION LOGIC

DTC	Display contents of CONSULT-III	DTC detecting condition	Possible cause
B1106 B1107 B1108 B1109 B1110 B1111	CONTROL UNIT	Air bag diagnosis sensor unit is malfunctioning	Malfunction in air bag diagnosis sensor unit

DTC CONFIRMATION PROCEDURE

1. CHECK SELF-DIAG RESULT

With CONSULT-III

1. Turn ignition switch ON.
2. Perform "AIR BAG" Self Diagnostic Result.

Without CONSULT-III

1. Turn ignition switch ON.
2. Check the air bag warning lamp status. Refer to [SRC-15, "Diagnosis with Air Bag Warning Lamp"](#).

NOTE:

SRS does not enter the diagnosis mode if no malfunction is detected in the user mode.

Is malfunctioning part detected?

- YES >> Refer to [SRC-92, "Diagnosis Procedure"](#).
NO >> INSPECTION END

Diagnosis Procedure

INFOID:000000005631532

WARNING:

- Before servicing, turn ignition switch OFF, disconnect battery negative terminal, and wait at least 3 minutes or more. (To discharge backup capacitor.)
- Never use unspecified tester or other measuring device.

1. CHECK HARNESS CONNECTOR

Check the harness connector.

Is the inspection result normal?

- YES >> GO TO 2.
NO >> Replace harness connectors.

2. CHECK WIRING HARNESS

Check the wiring harness externals.

Is the inspection result normal?

- YES >> GO TO 3.
NO >> Replace wiring harness.

3. REPLACE AIR BAG DIAGNOSIS SENSOR UNIT

1. Replace air bag diagnosis sensor unit. Refer to [SR-29, "Exploded View"](#).
2. Perform DTC confirmation procedure. Refer to [SRC-92, "DTC Logic"](#).

B1106, B1107, B1108, B1109, B1110, B1111 DIAGNOSIS SENSOR UNIT

< DTC/CIRCUIT DIAGNOSIS >

Is DTC detected?

YES >> GO TO 1.

NO >> INSPECTION END

A

B

C

D

E

F

G

SRC

I

J

K

L

M

N

O

P

B1113, B1114 SATELLITE SENSOR RH

< DTC/CIRCUIT DIAGNOSIS >

B1113, B1114 SATELLITE SENSOR RH

Description

INFOID:000000005631533

When air bag diagnosis sensor unit defines both signal voltage of the "G" sensor and the safing algorithm to be that of collision which is more than the specified level, the driving circuit switches on and feeds the electric ignitor of both the front side air bag and side curtain air bag.

DTC Logic

INFOID:000000005631534

DTC DETECTION LOGIC

DTC	Display contents of CONSULT-III	DTC detecting condition	Possible cause
B1113 B1114	SATELLITE SENS RH [UNIT FAIL]	Satellite sensor RH is malfunctioning	<ul style="list-style-type: none">• Disconnection of wiring harness• Malfunction in satellite sensor RH• Malfunction in air bag diagnosis sensor unit

DTC CONFIRMATION PROCEDURE

1. CHECK SELF-DIAG RESULT

With CONSULT-III

1. Turn ignition switch ON.
2. Perform "AIR BAG" Self Diagnostic Result.

Without CONSULT-III

1. Turn ignition switch ON.
2. Check the air bag warning lamp status. Refer to [SRC-15, "Diagnosis with Air Bag Warning Lamp"](#).

NOTE:

SRS does not enter the diagnosis mode if no malfunction is detected in the user mode.

Is malfunctioning part detected?

- YES >> Refer to [SRC-94, "Diagnosis Procedure"](#).
NO >> INSPECTION END

Diagnosis Procedure

INFOID:000000005631535

WARNING:

- Before servicing, turn ignition switch OFF, disconnect battery negative terminal, and wait at least 3 minutes or more. (To discharge backup capacitor.)
- Never use unspecified tester or other measuring device.

1. CHECK HARNESS CONNECTOR

Check the harness connector.

Is the inspection result normal?

- YES >> GO TO 2.
NO >> Replace harness connector.

2. CHECK WIRING HARNESS

Check the wiring harness externals.

Is the inspection result normal?

- YES >> GO TO 3.
NO >> Replace wiring harness.

3. REPLACE SATELLITE SENSOR

1. Replace satellite sensor RH. Refer to [SR-27, "Exploded View"](#).
2. Perform DTC confirmation procedure. Refer to [SRC-94, "DTC Logic"](#).

Is DTC detected?

- YES >> GO TO 4.
NO >> INSPECTION END

B1113, B1114 SATELLITE SENSOR RH

< DTC/CIRCUIT DIAGNOSIS >

4. REPLACE AIR BAG DIAGNOSIS SENSOR UNIT

1. Replace air bag diagnosis sensor unit. Refer to [SR-29, "Exploded View"](#).
2. Perform DTC confirmation procedure. Refer to [SRC-94, "DTC Logic"](#).

Is DTC detected?

YES >> GO TO 1.
NO >> INSPECTION END

A
B
C
D
E
F
G
I
J
K
L
M
N
O
P

SRC

B1115 SATELLITE SENSOR RH

< DTC/CIRCUIT DIAGNOSIS >

B1115 SATELLITE SENSOR RH

Description

INFOID:000000005631536

When air bag diagnosis sensor unit defines both signal voltage of the "G" sensor and the safing algorithm to be that of collision which is more than the specified level, the driving circuit switches on and feeds the electric ignitor of both the front side air bag and side curtain air bag.

DTC Logic

INFOID:000000005631537

DTC DETECTION LOGIC

DTC	Display contents of CONSULT-III	DTC detecting condition	Possible cause
B1115	SATELLITE SENS RH [COMM FAIL]	Satellite sensor RH is malfunctioning	<ul style="list-style-type: none">• Disconnection of wiring harness• Malfunction in satellite sensor RH• Malfunction in air bag diagnosis sensor unit

DTC CONFIRMATION PROCEDURE

1. CHECK SELF-DIAG RESULT

With CONSULT-III

1. Turn ignition switch ON.
2. Perform "AIR BAG" Self Diagnostic Result.

Without CONSULT-III

1. Turn ignition switch ON.
2. Check the air bag warning lamp status. Refer to [SRC-15. "Diagnosis with Air Bag Warning Lamp"](#).

NOTE:

SRS does not enter the diagnosis mode if no malfunction is detected in the user mode.

Is malfunctioning part detected?

- YES >> Refer to [SRC-96. "Diagnosis Procedure"](#).
NO >> INSPECTION END

Diagnosis Procedure

INFOID:000000005631538

WARNING:

- Before servicing, turn ignition switch OFF, disconnect battery negative terminal, and wait at least 3 minutes or more. (To discharge backup capacitor.)
- Never use unspecified tester or other measuring device.

1. CHECK HARNESS CONNECTOR

Check the harness connector.

Is the inspection result normal?

- YES >> GO TO 2.
NO >> Replace harness connector.

2. CHECK WIRING HARNESS

Check the wiring harness externals.

Is the inspection result normal?

- YES >> GO TO 3.
NO >> Replace wiring harness.

3. REPLACE SATELLITE SENSOR

1. Replace satellite sensor RH. Refer to [SR-27. "Exploded View"](#).
2. Perform DTC confirmation procedure. Refer to [SRC-96. "DTC Logic"](#).

Is DTC detected?

- YES >> GO TO 4.
NO >> INSPECTION END

B1115 SATELLITE SENSOR RH

< DTC/CIRCUIT DIAGNOSIS >

4. REPLACE AIR BAG DIAGNOSIS SENSOR UNIT

1. Replace air bag diagnosis sensor unit. Refer to [SR-29, "Exploded View"](#).
2. Perform DTC confirmation procedure. Refer to [SRC-96, "DTC Logic"](#).

Is DTC detected?

YES >> GO TO 1.
NO >> INSPECTION END

A
B
C
D
E
F
G
I
J
K
L
M
N
O
P

SRC

B1116 SATELLITE SENSOR RH

< DTC/CIRCUIT DIAGNOSIS >

B1116 SATELLITE SENSOR RH

Description

INFOID:000000005631539

When air bag diagnosis sensor unit defines both signal voltage of the "G" sensor and the safing algorithm to be that of collision which is more than the specified level, the driving circuit switches on and feeds the electric ignitor of both the front side air bag and side curtain air bag.

DTC Logic

INFOID:000000005631540

DTC DETECTION LOGIC

DTC	Display contents of CONSULT-III	DTC detecting condition	Possible cause
B1116	SATELLITE SENS RH [UNMATCH]	Satellite sensor RH is out of the specified specification	Diagnosis sensor unit or satellite sensor RH is different from the part specified

DTC CONFIRMATION PROCEDURE

1.CHECK SELF-DIAG RESULT

With CONSULT-III

1. Turn ignition switch ON.
2. Perform "AIR BAG" Self Diagnostic Result.

Without CONSULT-III

1. Turn ignition switch ON.
2. Check the air bag warning lamp status. Refer to [SRC-15. "Diagnosis with Air Bag Warning Lamp"](#).

NOTE:

SRS does not enter the diagnosis mode if no malfunction is detected in the user mode.

Is malfunctioning part detected?

- YES >> Refer to [SRC-98. "Diagnosis Procedure"](#).
NO >> INSPECTION END

Diagnosis Procedure

INFOID:000000005631541

WARNING:

- Before servicing, turn ignition switch OFF, disconnect battery negative terminal, and wait at least 3 minutes or more. (To discharge backup capacitor.)
- Never use unspecified tester or other measuring device.

1.CHECK HARNESS CONNECTOR

Check the harness connector.

Is the inspection result normal?

- YES >> GO TO 2.
NO >> Replace harness connector.

2.CHECK WIRING HARNESS

Check the wiring harness externals.

Is the inspection result normal?

- YES >> GO TO 3.
NO >> Replace wiring harness.

3.REPLACE SATELLITE SENSOR

1. Replace satellite sensor RH. Refer to [SR-27. "Exploded View"](#).
2. Perform DTC confirmation procedure. Refer to [SRC-98. "DTC Logic"](#).

Is DTC detected?

- YES >> GO TO 4.
NO >> INSPECTION END

4.REPLACE AIR BAG DIAGNOSIS SENSOR UNIT

B1116 SATELLITE SENSOR RH

< DTC/CIRCUIT DIAGNOSIS >

1. Replace air bag diagnosis sensor unit. Refer to [SR-29, "Exploded View"](#).
2. Perform DTC confirmation procedure. Refer to [SRC-98, "DTC Logic"](#).

Is DTC detected?

YES >> GO TO 1.

NO >> INSPECTION END

A

B

C

D

E

F

G

SRC

I

J

K

L

M

N

O

P

B1118, B1119 SATELLITE SENSOR LH

< DTC/CIRCUIT DIAGNOSIS >

B1118, B1119 SATELLITE SENSOR LH

Description

INFOID:000000005631542

When air bag diagnosis sensor unit defines both signal voltage of the "G" sensor and the safing algorithm to be that of collision which is more than the specified level, the driving circuit switches on and feeds the electric ignitor of both the front side air bag and side curtain air bag.

DTC Logic

INFOID:000000005631543

DTC DETECTION LOGIC

DTC	Display contents of CONSULT-III	DTC detecting condition	Possible cause
B1118 B1119	SATELLITE SENS LH [UNIT FAIL]	Satellite sensor LH is malfunctioning	<ul style="list-style-type: none">• Disconnection of wiring harness• Malfunction in satellite sensor LH• Malfunction in air bag diagnosis sensor unit

DTC CONFIRMATION PROCEDURE

1. CHECK SELF-DIAG RESULT

With CONSULT-III

1. Turn ignition switch ON.
2. Perform "AIR BAG" Self Diagnostic Result.

Without CONSULT-III

1. Turn ignition switch ON.
2. Check the air bag warning lamp status. Refer to [SRC-15. "Diagnosis with Air Bag Warning Lamp"](#).

NOTE:

SRS does not enter the diagnosis mode if no malfunction is detected in the user mode.

Is malfunctioning part detected?

- YES >> Refer to [SRC-100. "Diagnosis Procedure"](#).
NO >> INSPECTION END

Diagnosis Procedure

INFOID:000000005631544

WARNING:

- Before servicing, turn ignition switch OFF, disconnect battery negative terminal, and wait at least 3 minutes or more. (To discharge backup capacitor.)
- Never use unspecified tester or other measuring device.

1. CHECK HARNESS CONNECTOR

Check the harness connector.

Is the inspection result normal?

- YES >> GO TO 2.
NO >> Replace harness connector.

2. CHECK WIRING HARNESS

Check the wiring harness externals.

Is the inspection result normal?

- YES >> GO TO 3.
NO >> Replace wiring harness.

3. REPLACE SATELLITE SENSOR

1. Replace satellite sensor LH. Refer to [SR-27. "Exploded View"](#).
2. Perform DTC confirmation procedure. Refer to [SRC-100. "DTC Logic"](#)

Is DTC detected?

- YES >> GO TO 4.
NO >> INSPECTION END

B1118, B1119 SATELLITE SENSOR LH

< DTC/CIRCUIT DIAGNOSIS >

4. REPLACE AIR BAG DIAGNOSIS SENSOR UNIT

1. Replace air bag diagnosis sensor unit. Refer to [SR-29, "Exploded View"](#).
2. Perform DTC confirmation procedure. Refer to [SRC-100, "DTC Logic"](#).

Is DTC detected?

YES >> GO TO 1.
NO >> INSPECTION END

A
B
C
D
E
F
G
I
J
K
L
M
N
O
P

SRC

B1120 SATELLITE SENSOR LH

< DTC/CIRCUIT DIAGNOSIS >

B1120 SATELLITE SENSOR LH

Description

INFOID:000000005631545

When air bag diagnosis sensor unit defines both signal voltage of the "G" sensor and the safing algorithm to be that of collision which is more than the specified level, the driving circuit switches on and feeds the electric ignitor of both the front side air bag and side curtain air bag.

DTC Logic

INFOID:000000005631546

DTC DETECTION LOGIC

DTC	Display contents of CONSULT-III	DTC detecting condition	Possible cause
B1120	SATELLITE SENS LH [COMM FAIL]	Satellite sensor LH is malfunctioning	<ul style="list-style-type: none">• Disconnection of wiring harness• Malfunction in satellite sensor LH• Malfunction in air bag diagnosis sensor unit

DTC CONFIRMATION PROCEDURE

1. CHECK SELF-DIAG RESULT

With CONSULT-III

1. Turn ignition switch ON.
2. Perform "AIR BAG" Self Diagnostic Result.

Without CONSULT-III

1. Turn ignition switch ON.
2. Check the air bag warning lamp status. Refer to [SRC-15, "Diagnosis with Air Bag Warning Lamp"](#).

NOTE:

SRS does not enter the diagnosis mode if no malfunction is detected in the user mode.

Is malfunctioning part detected?

- YES >> Refer to [SRC-102, "Diagnosis Procedure"](#).
NO >> INSPECTION END

Diagnosis Procedure

INFOID:000000005631547

WARNING:

- Before servicing, turn ignition switch OFF, disconnect battery negative terminal, and wait at least 3 minutes or more. (To discharge backup capacitor.)
- Never use unspecified tester or other measuring device.

1. CHECK HARNESS CONNECTOR

Check the harness connector.

Is the inspection result normal?

- YES >> GO TO 2.
NO >> Replace harness connector.

2. CHECK WIRING HARNESS

Check the wiring harness externals.

Is the inspection result normal?

- YES >> GO TO 3.
NO >> Replace wiring harness.

3. REPLACE SATELLITE SENSOR

1. Replace satellite sensor LH. Refer to [SR-27, "Exploded View"](#).
2. Perform DTC confirmation procedure. Refer to [SRC-102, "DTC Logic"](#).

Is DTC detected?

- YES >> GO TO 4.
NO >> INSPECTION END

B1120 SATELLITE SENSOR LH

< DTC/CIRCUIT DIAGNOSIS >

4. REPLACE AIR BAG DIAGNOSIS SENSOR UNIT

1. Replace air bag diagnosis sensor unit. Refer to [SR-29, "Exploded View"](#).
2. Perform DTC confirmation procedure. Refer to [SRC-102, "DTC Logic"](#).

Is DTC detected?

YES >> GO TO 1.
NO >> INSPECTION END

A

B

C

D

E

F

G

SRC

I

J

K

L

M

N

O

P

B1121 SATELLITE SENSOR LH

< DTC/CIRCUIT DIAGNOSIS >

B1121 SATELLITE SENSOR LH

Description

INFOID:000000005631548

When air bag diagnosis sensor unit defines both signal voltage of the "G" sensor and the safing algorithm to be that of collision which is more than the specified level, the driving circuit switches on and feeds the electric ignitor of both the front side air bag and side curtain air bag.

DTC Logic

INFOID:000000005631549

DTC DETECTION LOGIC

DTC	Display contents of CONSULT-III	DTC detecting condition	Possible cause
B1121	SATELLITE SENS LH [UNMATCH]	Satellite sensor LH is out of the specified specification	Diagnosis sensor unit or satellite sensor RH is different from the part specified

DTC CONFIRMATION PROCEDURE

1. CHECK SELF-DIAG RESULT

With CONSULT-III

1. Turn ignition switch ON.
2. Perform "AIR BAG" Self Diagnostic Result.

Without CONSULT-III

1. Turn ignition switch ON.
2. Check the air bag warning lamp status. Refer to [SRC-15, "Diagnosis with Air Bag Warning Lamp"](#).

NOTE:

SRS does not enter the diagnosis mode if no malfunction is detected in the user mode.

Is malfunctioning part detected?

- YES >> Refer to [SRC-104, "Diagnosis Procedure"](#).
NO >> INSPECTION END

Diagnosis Procedure

INFOID:000000005631550

WARNING:

- Before servicing, turn ignition switch OFF, disconnect battery negative terminal, and wait at least 3 minutes or more. (To discharge backup capacitor.)
- Never use unspecified tester or other measuring device.

1. CHECK HARNESS CONNECTOR

Check the harness connector.

Is the inspection result normal?

- YES >> GO TO 2.
NO >> Replace harness connector.

2. CHECK WIRING HARNESS

Check the wiring harness externals.

Is the inspection result normal?

- YES >> GO TO 3.
NO >> Replace wiring harness.

3. REPLACE SATELLITE SENSOR

1. Replace satellite sensor LH. Refer to [SR-27, "Exploded View"](#).
2. Perform DTC confirmation procedure. Refer to [SRC-104, "DTC Logic"](#).

Is DTC detected?

- YES >> GO TO 4.
NO >> INSPECTION END

4. REPLACE AIR BAG DIAGNOSIS SENSOR UNIT

B1121 SATELLITE SENSOR LH

< DTC/CIRCUIT DIAGNOSIS >

1. Replace air bag diagnosis sensor unit. Refer to [SR-29, "Exploded View"](#).
2. Perform DTC confirmation procedure. Refer to [SRC-104, "DTC Logic"](#).

Is DTC detected?

YES >> GO TO 1.

NO >> INSPECTION END

A

B

C

D

E

F

G

SRC

I

J

K

L

M

N

O

P

B1122, B1123, B1124, B1125, B1126, B1127 DIAGNOSIS SENSOR UNIT

< DTC/CIRCUIT DIAGNOSIS >

B1122, B1123, B1124, B1125, B1126, B1127 DIAGNOSIS SENSOR UNIT

Description

INFOID:000000005631551

- It detects a shock that is more than the specified level and monitors whether the driver and passenger air bags, side air bag, curtain air bag, and pre-tensioner seat belts operate normally.
- It contains the "G" sensors for both frontal and side collisions and spare battery function in case of main battery damage in collision.

DTC Logic

INFOID:000000005631552

DTC DETECTION LOGIC

DTC	Display contents of CONSULT-III	DTC detecting condition	Possible cause
B1122 B1123 B1124 B1125 B1126 B1127	CONTROL UNIT	Air bag diagnosis sensor unit is malfunctioning	Malfunction in air bag diagnosis sensor unit

DTC CONFIRMATION PROCEDURE

1. CHECK SELF-DIAG RESULT

With CONSULT-III

1. Turn ignition switch ON.
2. Perform "AIR BAG" Self Diagnostic Result.

Without CONSULT-III

1. Turn ignition switch ON.
2. Check the air bag warning lamp status. Refer to [SRC-15, "Diagnosis with Air Bag Warning Lamp"](#).

NOTE:

SRS does not enter the diagnosis mode if no malfunction is detected in the user mode.

Is malfunctioning part detected?

YES >> Refer to [SRC-106, "Diagnosis Procedure"](#).

NO >> INSPECTION END

Diagnosis Procedure

INFOID:000000005631553

WARNING:

- Before servicing, turn ignition switch OFF, disconnect battery negative terminal, and wait at least 3 minutes or more. (To discharge backup capacitor.)
- Never use unspecified tester or other measuring device.

1. CHECK HARNESS CONNECTOR

Check the harness connector.

Is the inspection result normal?

YES >> GO TO 2.

NO >> Replace harness connectors.

2. CHECK WIRING HARNESS

Check the wiring harness externals.

Is the inspection result normal?

YES >> GO TO 3.

NO >> Replace wiring harness.

3. REPLACE AIR BAG DIAGNOSIS SENSOR UNIT

1. Replace air bag diagnosis sensor unit. Refer to [SR-29, "Exploded View"](#).
2. Perform DTC confirmation procedure. Refer to [SRC-106, "DTC Logic"](#).

B1122, B1123, B1124, B1125, B1126, B1127 DIAGNOSIS SENSOR UNIT

< DTC/CIRCUIT DIAGNOSIS >

Is DTC detected?

YES >> GO TO 1.

NO >> INSPECTION END

A

B

C

D

E

F

G

SRC

I

J

K

L

M

N

O

P

B1129 SIDE AIR BAG MODULE RH

< DTC/CIRCUIT DIAGNOSIS >

B1129 SIDE AIR BAG MODULE RH

Description

INFOID:000000005631554

In case of side collision where acceleration is more than the specified level, the ignition materials are ignited by electric ignition system. The system burns the gas generating materials resulting in a chemical reaction. This generates hot gases that flow into the air bag through a filter and expand the bag.

DTC Logic

INFOID:000000005631555

DTC DETECTION LOGIC

DTC	Display contents of CONSULT-III	DTC detecting condition	Possible cause
B1129	SIDE MODULE RH [OPEN]	Side air bag module RH circuit is open	<ul style="list-style-type: none">• Disconnection of wiring harness and open• Malfunction in side air bag module RH• Malfunction in air bag diagnosis sensor unit

DTC CONFIRMATION PROCEDURE

1. CHECK SELF-DIAG RESULT

With CONSULT-III

1. Turn ignition switch ON.
2. Perform "AIR BAG" Self Diagnostic Result.

Without CONSULT-III

1. Turn ignition switch ON.
2. Check the air bag warning lamp status. [SRC-15, "Diagnosis with Air Bag Warning Lamp"](#)

NOTE:

SRS does not enter the diagnosis mode if no malfunction is detected in the user mode.

Is malfunctioning part detected?

- YES >> Refer to [SRC-108, "Diagnosis Procedure"](#).
NO >> INSPECTION END

Diagnosis Procedure

INFOID:000000005631556

WARNING:

- Before servicing, turn ignition switch OFF, disconnect battery negative terminal, and wait at least 3 minutes or more. (To discharge backup capacitor.)
- Never use unspecified tester or other measuring device.

1. CHECK HARNESS CONNECTOR

Check the harness connector.

Is the inspection result normal?

- YES >> GO TO 2.
NO >> Replace harness connector.

2. CHECK WIRING HARNESS

Check the wiring harness externals.

Is the inspection result normal?

- YES >> GO TO 3.
NO >> Replace wiring harness.

3. REPLACE AIR BAG DIAGNOSIS SENSOR UNIT

1. Replace air bag diagnosis sensor unit. Refer to [SR-29, "Exploded View"](#).
2. Perform DTC confirmation procedure. Refer to [SRC-108, "DTC Logic"](#).

Is DTC detected?

- YES >> GO TO 4.
NO >> INSPECTION END

B1129 SIDE AIR BAG MODULE RH

< DTC/CIRCUIT DIAGNOSIS >

4. REPLACE SIDE AIR BAG MODULE

1. Replace side air bag module RH. Refer to [SE-234, "Exploded View"](#).
2. Perform DTC confirmation procedure. Refer to [SRC-108, "DTC Logic"](#).

Is DTC detected?

YES >> GO TO 1.
NO >> INSPECTION END

A
B
C
D
E
F
G
I
J
K
L
M
N
O
P

SRC

B1130 SIDE AIR BAG MODULE RH

< DTC/CIRCUIT DIAGNOSIS >

B1130 SIDE AIR BAG MODULE RH

Description

INFOID:000000005631557

In case of side collision where acceleration is more than the specified level, the ignition materials are ignited by electric ignition system. The system burns the gas generating materials resulting in a chemical reaction. This generates hot gases that flow into the air bag through a filter and expand the bag.

DTC Logic

INFOID:000000005631558

DTC DETECTION LOGIC

DTC	Display contents of CONSULT-III	DTC detecting condition	Possible cause
B1130	SIDE MODULE RH [VB-SHORT]	Side air bag module RH circuit is shorted to power supply circuit	<ul style="list-style-type: none">• Disconnection of wiring harness and short• Malfunction in side air bag module RH• Malfunction in air bag diagnosis sensor unit

DTC CONFIRMATION PROCEDURE

1. CHECK SELF-DIAG RESULT

With CONSULT-III

1. Turn ignition switch ON.
2. Perform "AIR BAG" Self Diagnostic Result.

Without CONSULT-III

1. Turn ignition switch ON.
2. Check the air bag warning lamp status. Refer to [SRC-15. "Diagnosis with Air Bag Warning Lamp"](#).

NOTE:

SRS does not enter the diagnosis mode if no malfunction is detected in the user mode.

Is malfunctioning part detected?

- YES >> Refer to [SRC-110. "Diagnosis Procedure"](#).
NO >> INSPECTION END

Diagnosis Procedure

INFOID:000000005631559

WARNING:

- Before servicing, turn ignition switch OFF, disconnect battery negative terminal, and wait at least 3 minutes or more. (To discharge backup capacitor.)
- Never use unspecified tester or other measuring device.

1. CHECK HARNESS CONNECTOR

Check the harness connector.

Is the inspection result normal?

- YES >> GO TO 2.
NO >> Replace harness connector.

2. CHECK WIRING HARNESS

Check the wiring harness externals.

Is the inspection result normal?

- YES >> GO TO 3.
NO >> Replace wiring harness.

3. REPLACE AIR BAG DIAGNOSIS SENSOR UNIT

1. Replace air bag diagnosis sensor unit. Refer to [SR-29. "Exploded View"](#).
2. Perform DTC confirmation procedure. Refer to [SRC-110. "DTC Logic"](#).

Is DTC detected?

- YES >> GO TO 4.
NO >> INSPECTION END

B1130 SIDE AIR BAG MODULE RH

< DTC/CIRCUIT DIAGNOSIS >

4. REPLACE SIDE AIR BAG MODULE

1. Replace side air bag module RH. Refer to [SE-234, "Exploded View"](#).
2. Perform DTC confirmation procedure. Refer to [SRC-110, "DTC Logic"](#).

Is DTC detected?

YES >> GO TO 1.
NO >> INSPECTION END

A
B
C
D
E
F
G
I
J
K
L
M
N
O
P

SRC

B1131 SIDE AIR BAG MODULE RH

< DTC/CIRCUIT DIAGNOSIS >

B1131 SIDE AIR BAG MODULE RH

Description

INFOID:000000005631560

In case of side collision where acceleration is more than the specified level, the ignition materials are ignited by electric ignition system. The system burns the gas generating materials resulting in a chemical reaction. This generates hot gases that flow into the air bag through a filter and expand the bag.

DTC Logic

INFOID:000000005631561

DTC DETECTION LOGIC

DTC	Display contents of CONSULT-III	DTC detecting condition	Possible cause
B1131	SIDE MODULE RH [GND-SHORT]	Side air bag module RH circuit is shorted to ground	<ul style="list-style-type: none">• Disconnection of wiring harness and short• Malfunction in side air bag module RH• Malfunction in air bag diagnosis sensor unit

DTC CONFIRMATION PROCEDURE

1. CHECK SELF-DIAG RESULT

With CONSULT-III

1. Turn ignition switch ON.
2. Perform "AIR BAG" Self Diagnostic Result.

Without CONSULT-III

1. Turn ignition switch ON.
2. Check the air bag warning lamp status. Refer to [SRC-15. "Diagnosis with Air Bag Warning Lamp"](#).

NOTE:

SRS does not enter the diagnosis mode if no malfunction is detected in the user mode.

Is malfunctioning part detected?

- YES >> Refer to [SRC-112. "Diagnosis Procedure"](#).
NO >> INSPECTION END

Diagnosis Procedure

INFOID:000000005631562

WARNING:

- Before servicing, turn ignition switch OFF, disconnect battery negative terminal, and wait at least 3 minutes or more. (To discharge backup capacitor.)
- Never use unspecified tester or other measuring device.

1. CHECK HARNESS CONNECTOR

Check the harness connector.

Is the inspection result normal?

- YES >> GO TO 2.
NO >> Replace harness connector.

2. CHECK WIRING HARNESS

Check the wiring harness externals.

Is the inspection result normal?

- YES >> GO TO 3.
NO >> Replace wiring harness.

3. REPLACE AIR BAG DIAGNOSIS SENSOR UNIT

1. Replace air bag diagnosis sensor unit. Refer to [SR-29. "Exploded View"](#).
2. Perform DTC confirmation procedure. Refer to [SRC-112. "DTC Logic"](#).

Is DTC detected?

- YES >> GO TO 4.
NO >> INSPECTION END

B1131 SIDE AIR BAG MODULE RH

< DTC/CIRCUIT DIAGNOSIS >

4. REPLACE SIDE AIR BAG MODULE

1. Replace side air bag module RH. Refer to [SE-234, "Exploded View"](#).
2. Perform DTC confirmation procedure. Refer to [SRC-112, "DTC Logic"](#).

Is DTC detected?

YES >> GO TO 1.
NO >> INSPECTION END

A
B
C
D
E
F
G
I
J
K
L
M
N
O
P

SRC

B1132 SIDE AIR BAG MODULE RH

< DTC/CIRCUIT DIAGNOSIS >

B1132 SIDE AIR BAG MODULE RH

Description

INFOID:000000005631563

In case of side collision where acceleration is more than the specified level, the ignition materials are ignited by electric ignition system. The system burns the gas generating materials resulting in a chemical reaction. This generates hot gases that flow into the air bag through a filter and expand the bag.

DTC Logic

INFOID:000000005631564

DTC DETECTION LOGIC

DTC	Display contents of CONSULT-III	DTC detecting condition	Possible cause
B1132	SIDE MODULE RH [SHORT]	Side air bag module RH circuits are shorted to each other	<ul style="list-style-type: none">• Disconnection of wiring harness and short• Malfunction in side air bag module RH• Malfunction in air bag diagnosis sensor unit

DTC CONFIRMATION PROCEDURE

1. CHECK SELF-DIAG RESULT

With CONSULT-III

1. Turn ignition switch ON.
2. Perform "AIR BAG" Self Diagnostic Result.

Without CONSULT-III

1. Turn ignition switch ON.
2. Check the air bag warning lamp status. Refer to [SRC-15, "Diagnosis with Air Bag Warning Lamp"](#).

NOTE:

SRS does not enter the diagnosis mode if no malfunction is detected in the user mode.

Is malfunctioning part detected?

- YES >> Refer to [SRC-114, "Diagnosis Procedure"](#).
NO >> INSPECTION END

Diagnosis Procedure

INFOID:000000005631565

WARNING:

- Before servicing, turn ignition switch OFF, disconnect battery negative terminal, and wait at least 3 minutes or more. (To discharge backup capacitor.)
- Never use unspecified tester or other measuring device.

1. CHECK HARNESS CONNECTOR

Check the harness connector.

Is the inspection result normal?

- YES >> GO TO 2.
NO >> Replace harness connector.

2. CHECK WIRING HARNESS

Check the wiring harness externals.

Is the inspection result normal?

- YES >> GO TO 3.
NO >> Replace wiring harness.

3. REPLACE AIR BAG DIAGNOSIS SENSOR UNIT

1. Replace air bag diagnosis sensor unit. Refer to [SR-29, "Exploded View"](#).
2. Perform DTC confirmation procedure. Refer to [SRC-114, "DTC Logic"](#).

Is DTC detected?

- YES >> GO TO 4.
NO >> INSPECTION END

B1132 SIDE AIR BAG MODULE RH

< DTC/CIRCUIT DIAGNOSIS >

4. REPLACE SIDE AIR BAG MODULE

1. Replace side air bag module RH. Refer to [SE-234, "Exploded View"](#).
2. Perform DTC confirmation procedure. Refer to [SRC-114, "DTC Logic"](#).

Is DTC detected?

YES >> GO TO 1.
NO >> INSPECTION END

A
B
C
D
E
F
G
I
J
K
L
M
N
O
P

SRC

B1134 SIDE AIR BAG MODULE LH

< DTC/CIRCUIT DIAGNOSIS >

B1134 SIDE AIR BAG MODULE LH

Description

INFOID:000000005631566

In case of side collision where acceleration is more than the specified level, the ignition materials are ignited by electric ignition system. The system burns the gas generating materials resulting in a chemical reaction. This generates hot gases that flow into the air bag through a filter and expand the bag.

DTC Logic

INFOID:000000005631567

DTC DETECTION LOGIC

DTC	Display contents of CONSULT-III	DTC detecting condition	Possible cause
B1134	SIDE MODULE LH [OPEN]	Side air bag module LH circuit is open	<ul style="list-style-type: none">• Disconnection of wiring harness and open• Malfunction in side air bag module LH• Malfunction in air bag diagnosis sensor unit

DTC CONFIRMATION PROCEDURE

1. CHECK SELF-DIAG RESULT

With CONSULT-III

1. Turn ignition switch ON.
2. Perform "AIR BAG" Self Diagnostic Result.

Without CONSULT-III

1. Turn ignition switch ON.
2. Check the air bag warning lamp status. Refer to [SRC-15. "Diagnosis with Air Bag Warning Lamp"](#).

NOTE:

SRS does not enter the diagnosis mode if no malfunction is detected in the user mode.

Is malfunctioning part detected?

- YES >> Refer to [SRC-116. "Diagnosis Procedure"](#).
NO >> INSPECTION END

Diagnosis Procedure

INFOID:000000005631568

WARNING:

- Before servicing, turn ignition switch OFF, disconnect battery negative terminal, and wait at least 3 minutes or more. (To discharge backup capacitor.)
- Never use unspecified tester or other measuring device.

1. CHECK HARNESS CONNECTOR

Check the harness connector.

Is the inspection result normal?

- YES >> GO TO 2.
NO >> Replace harness connector.

2. CHECK WIRING HARNESS

Check the wiring harness externals.

Is the inspection result normal?

- YES >> GO TO 3.
NO >> Replace wiring harness.

3. REPLACE AIR BAG DIAGNOSIS SENSOR UNIT

1. Replace air bag diagnosis sensor unit. Refer to [SR-29. "Exploded View"](#).
2. Perform DTC confirmation procedure. Refer to [SRC-116. "DTC Logic"](#).

Is DTC detected?

- YES >> GO TO 4.
NO >> INSPECTION END

B1134 SIDE AIR BAG MODULE LH

< DTC/CIRCUIT DIAGNOSIS >

4. REPLACE SIDE AIR BAG MODULE

1. Replace side air bag module LH. Refer to [SE-234, "Exploded View"](#).
2. Perform DTC confirmation procedure. Refer to [SRC-116, "DTC Logic"](#).

Is DTC detected?

YES >> GO TO 1.
NO >> INSPECTION END

A
B
C
D
E
F
G
I
J
K
L
M
N
O
P

SRC

B1135 SIDE AIR BAG MODULE LH

< DTC/CIRCUIT DIAGNOSIS >

B1135 SIDE AIR BAG MODULE LH

Description

INFOID:000000005631569

In case of side collision where acceleration is more than the specified level, the ignition materials are ignited by electric ignition system. The system burns the gas generating materials resulting in a chemical reaction. This generates hot gases that flow into the air bag through a filter and expand the bag.

DTC Logic

INFOID:000000005631570

DTC DETECTION LOGIC

DTC	Display contents of CONSULT-III	DTC detecting condition	Possible cause
B1135	SIDE MODULE LH [VB-SHORT]	Side air bag module LH circuit is shorted to power supply circuit	<ul style="list-style-type: none">• Disconnection of wiring harness and short• Malfunction in side air bag module LH• Malfunction in air bag diagnosis sensor unit

DTC CONFIRMATION PROCEDURE

1. CHECK SELF-DIAG RESULT

With CONSULT-III

1. Turn ignition switch ON.
2. Perform "AIR BAG" Self Diagnostic Result.

Without CONSULT-III

1. Turn ignition switch ON.
2. Check the air bag warning lamp status. Refer to [SRC-15. "Diagnosis with Air Bag Warning Lamp"](#).

NOTE:

SRS does not enter the diagnosis mode if no malfunction is detected in the user mode.

Is malfunctioning part detected?

- YES >> Refer to [SRC-118. "Diagnosis Procedure"](#).
NO >> INSPECTION END

Diagnosis Procedure

INFOID:000000005631571

WARNING:

- Before servicing, turn ignition switch OFF, disconnect battery negative terminal, and wait at least 3 minutes or more. (To discharge backup capacitor.)
- Never use unspecified tester or other measuring device.

1. CHECK HARNESS CONNECTOR

Check the harness connector.

Is the inspection result normal?

- YES >> GO TO 2.
NO >> Replace harness connector.

2. CHECK WIRING HARNESS

Check the wiring harness externals.

Is the inspection result normal?

- YES >> GO TO 3.
NO >> Replace wiring harness.

3. REPLACE AIR BAG DIAGNOSIS SENSOR UNIT

1. Replace air bag diagnosis sensor unit. Refer to [SR-29. "Exploded View"](#).
2. Perform DTC confirmation procedure. Refer to [SRC-118. "DTC Logic"](#).

Is DTC detected?

- YES >> GO TO 4.
NO >> INSPECTION END

B1135 SIDE AIR BAG MODULE LH

< DTC/CIRCUIT DIAGNOSIS >

4. REPLACE SIDE AIR BAG MODULE

1. Replace side air bag module LH. Refer to [SE-234, "Exploded View"](#).
2. Perform DTC confirmation procedure. Refer to [SRC-118, "DTC Logic"](#).

Is DTC detected?

YES >> GO TO 1.
NO >> INSPECTION END

A
B
C
D
E
F
G
I
J
K
L
M
N
O
P

SRC

B1136 SIDE AIR BAG MODULE LH

< DTC/CIRCUIT DIAGNOSIS >

B1136 SIDE AIR BAG MODULE LH

Description

INFOID:000000005631572

In case of side collision where acceleration is more than the specified level, the ignition materials are ignited by electric ignition system. The system burns the gas generating materials resulting in a chemical reaction. This generates hot gases that flow into the air bag through a filter and expand the bag.

DTC Logic

INFOID:000000005631573

DTC DETECTION LOGIC

DTC	Display contents of CONSULT-III	DTC detecting condition	Possible cause
B1136	SIDE MODULE LH [GND-SHORT]	Side air bag module LH circuit is shorted to ground	<ul style="list-style-type: none">• Disconnection of wiring harness and short• Malfunction in side air bag module LH• Malfunction in air bag diagnosis sensor unit

DTC CONFIRMATION PROCEDURE

1. CHECK SELF-DIAG RESULT

With CONSULT-III

1. Turn ignition switch ON.
2. Perform "AIR BAG" Self Diagnostic Result.

Without CONSULT-III

1. Turn ignition switch ON.
2. Check the air bag warning lamp status. Refer to [SRC-15. "Diagnosis with Air Bag Warning Lamp"](#).

NOTE:

SRS does not enter the diagnosis mode if no malfunction is detected in the user mode.

Is malfunctioning part detected?

- YES >> Refer to [SRC-120. "Diagnosis Procedure"](#).
NO >> INSPECTION END

Diagnosis Procedure

INFOID:000000005631574

WARNING:

- Before servicing, turn ignition switch OFF, disconnect battery negative terminal, and wait at least 3 minutes or more. (To discharge backup capacitor.)
- Never use unspecified tester or other measuring device.

1. CHECK HARNESS CONNECTOR

Check the harness connector.

Is the inspection result normal?

- YES >> GO TO 2.
NO >> Replace harness connector.

2. CHECK WIRING HARNESS

Check the wiring harness externals.

Is the inspection result normal?

- YES >> GO TO 3.
NO >> Replace wiring harness.

3. REPLACE AIR BAG DIAGNOSIS SENSOR UNIT

1. Replace air bag diagnosis sensor unit. Refer to [SR-29. "Exploded View"](#).
2. Perform DTC confirmation procedure. Refer to [SRC-120. "DTC Logic"](#).

Is DTC detected?

- YES >> GO TO 4.
NO >> INSPECTION END

B1136 SIDE AIR BAG MODULE LH

< DTC/CIRCUIT DIAGNOSIS >

4. REPLACE SIDE AIR BAG MODULE

1. Replace side air bag module LH. Refer to [SE-234, "Exploded View"](#).
2. Perform DTC confirmation procedure. Refer to [SRC-120, "DTC Logic"](#).

Is DTC detected?

YES >> GO TO 1.
NO >> INSPECTION END

A
B
C
D
E
F
G
I
J
K
L
M
N
O
P

SRC

B1137 SIDE AIR BAG MODULE LH

< DTC/CIRCUIT DIAGNOSIS >

B1137 SIDE AIR BAG MODULE LH

Description

INFOID:000000005631575

In case of side collision where acceleration is more than the specified level, the ignition materials are ignited by electric ignition system. The system burns the gas generating materials resulting in a chemical reaction. This generates hot gases that flow into the air bag through a filter and expand the bag.

DTC Logic

INFOID:000000005631576

DTC DETECTION LOGIC

DTC	Display contents of CONSULT-III	DTC detecting condition	Possible cause
B1137	SIDE MODULE LH [SHORT]	Side air bag module LH circuits are shorted to each other	<ul style="list-style-type: none">• Disconnection of wiring harness and short• Malfunction in side air bag module LH• Malfunction in air bag diagnosis sensor unit

DTC CONFIRMATION PROCEDURE

1. CHECK SELF-DIAG RESULT

With CONSULT-III

1. Turn ignition switch ON.
2. Perform "AIR BAG" Self Diagnostic Result.

Without CONSULT-III

1. Turn ignition switch ON.
2. Check the air bag warning lamp status. Refer to [SRC-15. "Diagnosis with Air Bag Warning Lamp"](#).

NOTE:

SRS does not enter the diagnosis mode if no malfunction is detected in the user mode.

Is malfunctioning part detected?

- YES >> Refer to [SRC-122. "Diagnosis Procedure"](#).
NO >> INSPECTION END

Diagnosis Procedure

INFOID:000000005631577

WARNING:

- Before servicing, turn ignition switch OFF, disconnect battery negative terminal, and wait at least 3 minutes or more. (To discharge backup capacitor.)
- Never use unspecified tester or other measuring device.

1. CHECK HARNESS CONNECTOR

Check the harness connector.

Is the inspection result normal?

- YES >> GO TO 2.
NO >> Replace harness connector.

2. CHECK WIRING HARNESS

Check the wiring harness externals.

Is the inspection result normal?

- YES >> GO TO 3.
NO >> Replace wiring harness.

3. REPLACE AIR BAG DIAGNOSIS SENSOR UNIT

1. Replace air bag diagnosis sensor unit. Refer to [SR-29. "Exploded View"](#).
2. Perform DTC confirmation procedure. Refer to [SRC-122. "DTC Logic"](#).

Is DTC detected?

- YES >> GO TO 4.
NO >> INSPECTION END

B1137 SIDE AIR BAG MODULE LH

< DTC/CIRCUIT DIAGNOSIS >

4. REPLACE SIDE AIR BAG MODULE

1. Replace side air bag module LH. Refer to [SE-234, "Exploded View"](#).
2. Perform DTC confirmation procedure. Refer to [SRC-122, "DTC Logic"](#).

Is DTC detected?

YES >> GO TO 1.
NO >> INSPECTION END

A
B
C
D
E
F
G
I
J
K
L
M
N
O
P

SRC

B1138, B1139, B1140, B1141, B1142, B1143 DIAGNOSIS SENSOR UNIT

< DTC/CIRCUIT DIAGNOSIS >

B1138, B1139, B1140, B1141, B1142, B1143 DIAGNOSIS SENSOR UNIT

Description

INFOID:000000005631578

- It detects a shock that is more than the specified level and monitors whether the driver and passenger air bags, side air bag, curtain air bag, and pre-tensioner seat belts operate normally.
- It contains the "G" sensors for both frontal and side collisions and spare battery function in case of main battery damage in collision.

DTC Logic

INFOID:000000005631579

DTC DETECTION LOGIC

DTC	Display contents of CONSULT-III	DTC detecting condition	Possible cause
B1138 B1139 B1140 B1141 B1142 B1143	CONTROL UNIT	Air bag diagnosis sensor unit is malfunctioning	Malfunction in air bag diagnosis sensor unit

DTC CONFIRMATION PROCEDURE

1. CHECK SELF-DIAG RESULT

With CONSULT-III

1. Turn ignition switch ON.
2. Perform "AIR BAG" Self Diagnostic Result.

Without CONSULT-III

1. Turn ignition switch ON.
2. Check the air bag warning lamp status. Refer to [SRC-15, "Diagnosis with Air Bag Warning Lamp"](#).

NOTE:

SRS does not enter the diagnosis mode if no malfunction is detected in the user mode.

Is malfunctioning part detected?

YES >> Refer to [SRC-124, "Diagnosis Procedure"](#).

NO >> INSPECTION END

Diagnosis Procedure

INFOID:000000005631580

WARNING:

- Before servicing, turn ignition switch OFF, disconnect battery negative terminal, and wait at least 3 minutes or more. (To discharge backup capacitor.)
- Never use unspecified tester or other measuring device.

1. CHECK HARNESS CONNECTOR

Check the harness connector.

Is the inspection result normal?

YES >> GO TO 2.

NO >> Replace harness connectors.

2. CHECK WIRING HARNESS

Check the wiring harness externals.

Is the inspection result normal?

YES >> GO TO 3.

NO >> Replace wiring harness.

3. REPLACE AIR BAG DIAGNOSIS SENSOR UNIT

1. Replace air bag diagnosis sensor unit. Refer to [SR-29, "Exploded View"](#).
2. Perform DTC confirmation procedure. Refer to [SRC-124, "DTC Logic"](#).

B1138, B1139, B1140, B1141, B1142, B1143 DIAGNOSIS SENSOR UNIT

< DTC/CIRCUIT DIAGNOSIS >

Is DTC detected?

YES >> GO TO 1.

NO >> INSPECTION END

A

B

C

D

E

F

G

SRC

I

J

K

L

M

N

O

P

B1144 DIAGNOSIS SENSOR UNIT

< DTC/CIRCUIT DIAGNOSIS >

B1144 DIAGNOSIS SENSOR UNIT

Description

INFOID:000000005631581

- It detects a shock that is more than the specified level and monitors whether the driver and passenger air bags, side air bag, curtain air bag, and pre-tensioner seat belts operate normally.
- It contains the "G" sensors for both frontal and side collisions and spare battery function in case of main battery damage in collision.

DTC Logic

INFOID:000000005631582

DTC DETECTION LOGIC

DTC	Display contents of CONSULT-III	DTC detecting condition	Possible cause
B1144	CONTROL UNIT	Air bag diagnosis sensor unit is malfunctioning or out of the specification	<ul style="list-style-type: none">• Malfunction in air bag diagnosis sensor unit• Configuration in air bag diagnosis sensor unit does not match the vehicles specification

DTC CONFIRMATION PROCEDURE

1. CHECK SELF-DIAG RESULT

With CONSULT-III

1. Turn ignition switch ON.
2. Perform "AIR BAG" Self Diagnostic Result.

Without CONSULT-III

1. Turn ignition switch ON.
2. Check the air bag warning lamp status. Refer to [SRC-15. "Diagnosis with Air Bag Warning Lamp"](#).

NOTE:

SRS does not enter the diagnosis mode if no malfunction is detected in the user mode.

Is malfunctioning part detected?

- YES >> Refer to [SRC-126. "Diagnosis Procedure"](#).
NO >> INSPECTION END

Diagnosis Procedure

INFOID:000000005631583

WARNING:

- **Before servicing, turn ignition switch OFF, disconnect battery negative terminal, and wait at least 3 minutes or more. (To discharge backup capacitor.)**
- **Never use unspecified tester or other measuring device.**

1. CHECK HARNESS CONNECTOR

Check the harness connector.

Is the inspection result normal?

- YES >> GO TO 2.
NO >> Replace harness connectors.

2. CHECK WIRING HARNESS

Check the wiring harness externals.

Is the inspection result normal?

- YES >> GO TO 3.
NO >> Replace wiring harness.

3. REPLACE AIR BAG DIAGNOSIS SENSOR UNIT

1. Replace air bag diagnosis sensor unit. Refer to [SR-29. "Exploded View"](#).
2. Perform DTC confirmation procedure. Refer to [SRC-126. "DTC Logic"](#).

Is DTC detected?

- YES >> GO TO 1.
NO >> INSPECTION END

B1145 CURTAIN AIR BAG MODULE RH

< DTC/CIRCUIT DIAGNOSIS >

B1145 CURTAIN AIR BAG MODULE RH

Description

INFOID:000000005631584

In case of side collision where acceleration is more than the specified level, the ignition materials are ignited by electric ignition system. The system burns the gas generating materials resulting in a chemical reaction. This generates hot gases that flow into the air bag through a filter and expand the bag.

DTC Logic

INFOID:000000005631585

DTC DETECTION LOGIC

DTC	Display contents of CONSULT-III	DTC detecting condition	Possible cause
B1145	CURTAIN MODULE RH [OPEN]	Curtain air bag module RH circuit is open	<ul style="list-style-type: none">• Disconnection of wiring harness and open• Malfunction in side curtain air bag module RH• Malfunction in air bag diagnosis sensor unit

DTC CONFIRMATION PROCEDURE

1. CHECK SELF-DIAG RESULT

With CONSULT-III

1. Turn ignition switch ON.
2. Perform "AIR BAG" Self Diagnostic Result.

Without CONSULT-III

1. Turn ignition switch ON.
2. Check the air bag warning lamp status. Refer to [SRC-15. "Diagnosis with Air Bag Warning Lamp"](#).

NOTE:

SRS does not enter the diagnosis mode if no malfunction is detected in the user mode.

Is malfunctioning part detected?

- YES >> Refer to [SRC-127. "Diagnosis Procedure"](#).
NO >> INSPECTION END

Diagnosis Procedure

INFOID:000000005631586

WARNING:

- Before servicing, turn ignition switch OFF, disconnect battery negative terminal, and wait at least 3 minutes or more. (To discharge backup capacitor.)
- Never use unspecified tester or other measuring device.

1. CHECK HARNESS CONNECTOR

Check the harness connector.

Is the inspection result normal?

- YES >> GO TO 2.
NO >> Replace harness connector.

2. CHECK WIRING HARNESS

Check the wiring harness externals.

Is the inspection result normal?

- YES >> GO TO 3.
NO >> Replace wiring harness.

3. REPLACE AIR BAG DIAGNOSIS SENSOR UNIT

1. Replace air bag diagnosis sensor unit. Refer to [SR-29. "Exploded View"](#).
2. Perform DTC confirmation procedure. Refer to [SRC-127. "DTC Logic"](#).

Is DTC detected?

- YES >> GO TO 4.
NO >> INSPECTION END

B1145 CURTAIN AIR BAG MODULE RH

< DTC/CIRCUIT DIAGNOSIS >

4. REPLACE CURTAIN AIR BAG MODULE

1. Replace curtain air bag module RH. Refer to [INT-21, "Exploded View"](#)
2. Perform DTC confirmation procedure. Refer to [SRC-127, "DTC Logic"](#).

Is DTC detected?

- YES >> GO TO 1.
NO >> INSPECTION END

B1146 CURTAIN AIR BAG MODULE RH

< DTC/CIRCUIT DIAGNOSIS >

B1146 CURTAIN AIR BAG MODULE RH

Description

INFOID:000000005631587

In case of side collision where acceleration is more than the specified level, the ignition materials are ignited by electric ignition system. The system burns the gas generating materials resulting in a chemical reaction. This generates hot gases that flow into the air bag through a filter and expand the bag.

DTC Logic

INFOID:000000005631588

DTC DETECTION LOGIC

DTC	Display contents of CONSULT-III	DTC detecting condition	Possible cause
B1146	CURTAIN MODULE RH [VB-SHORT]	Curtain air bag module RH circuit is shorted to power supply circuit	<ul style="list-style-type: none"> Disconnection of wiring harness and short Malfunction in curtain air bag module RH Malfunction in air bag diagnosis sensor unit

DTC CONFIRMATION PROCEDURE

1. CHECK SELF-DIAG RESULT

With CONSULT-III

- Turn ignition switch ON.
- Perform "AIR BAG" Self Diagnostic Result.

Without CONSULT-III

- Turn ignition switch ON.
- Check the air bag warning lamp status. Refer to [SRC-15, "Diagnosis with Air Bag Warning Lamp"](#).

NOTE:

SRS does not enter the diagnosis mode if no malfunction is detected in the user mode.

Is malfunctioning part detected?

- YES >> Refer to [SRC-129, "Diagnosis Procedure"](#).
 NO >> INSPECTION END

Diagnosis Procedure

INFOID:000000005631589

WARNING:

- Before servicing, turn ignition switch OFF, disconnect battery negative terminal, and wait at least 3 minutes or more. (To discharge backup capacitor.)
- Never use unspecified tester or other measuring device.

1. CHECK HARNESS CONNECTOR

Check the harness connector.

Is the inspection result normal?

- YES >> GO TO 2.
 NO >> Replace harness connector.

2. CHECK WIRING HARNESS

Check the wiring harness externals.

Is the inspection result normal?

- YES >> GO TO 3.
 NO >> Replace wiring harness.

3. REPLACE AIR BAG DIAGNOSIS SENSOR UNIT

- Replace air bag diagnosis sensor unit. Refer to [SR-29, "Exploded View"](#).
- Perform DTC confirmation procedure. Refer to [SRC-129, "DTC Logic"](#).

Is DTC detected?

- YES >> GO TO 4.
 NO >> INSPECTION END

B1146 CURTAIN AIR BAG MODULE RH

< DTC/CIRCUIT DIAGNOSIS >

4. REPLACE CURTAIN AIR BAG MODULE

1. Replace curtain air bag module RH. Refer to [INT-21, "Exploded View"](#)
2. Perform DTC confirmation procedure. Refer to [SRC-129, "DTC Logic"](#).

Is DTC detected?

- YES >> GO TO 1.
NO >> INSPECTION END

B1147 CURTAIN AIR BAG MODULE RH

< DTC/CIRCUIT DIAGNOSIS >

B1147 CURTAIN AIR BAG MODULE RH

Description

INFOID:000000005631590

In case of side collision where acceleration is more than the specified level, the ignition materials are ignited by electric ignition system. The system burns the gas generating materials resulting in a chemical reaction. This generates hot gases that flow into the air bag through a filter and expand the bag.

DTC Logic

INFOID:000000005631591

DTC DETECTION LOGIC

DTC	Display contents of CONSULT-III	DTC detecting condition	Possible cause
B1147	CURTAIN MODULE RH [GND-SHORT]	Curtain air bag module RH circuit is shorted to ground	<ul style="list-style-type: none">• Disconnection of wiring harness and short• Malfunction in curtain air bag module RH• Malfunction in air bag diagnosis sensor unit

DTC CONFIRMATION PROCEDURE

1. CHECK SELF-DIAG RESULT

With CONSULT-III

1. Turn ignition switch ON.
2. Perform "AIR BAG" Self Diagnostic Result.

Without CONSULT-III

1. Turn ignition switch ON.
2. Check the air bag warning lamp status. Refer to [SRC-15, "Diagnosis with Air Bag Warning Lamp"](#).

NOTE:

SRS does not enter the diagnosis mode if no malfunction is detected in the user mode.

Is malfunctioning part detected?

- YES >> Refer to [SRC-131, "Diagnosis Procedure"](#).
NO >> INSPECTION END

Diagnosis Procedure

INFOID:000000005631592

WARNING:

- Before servicing, turn ignition switch OFF, disconnect battery negative terminal, and wait at least 3 minutes or more. (To discharge backup capacitor.)
- Never use unspecified tester or other measuring device.

1. CHECK HARNESS CONNECTOR

Check the harness connector.

Is the inspection result normal?

- YES >> GO TO 2.
NO >> Replace harness connector.

2. CHECK WIRING HARNESS

Check the wiring harness externals.

Is the inspection result normal?

- YES >> GO TO 3.
NO >> Replace wiring harness.

3. REPLACE AIR BAG DIAGNOSIS SENSOR UNIT

1. Replace air bag diagnosis sensor unit. Refer to [SR-29, "Exploded View"](#).
2. Perform DTC confirmation procedure. Refer to [SRC-131, "DTC Logic"](#).

Is DTC detected?

- YES >> GO TO 4.
NO >> INSPECTION END

B1147 CURTAIN AIR BAG MODULE RH

< DTC/CIRCUIT DIAGNOSIS >

4. REPLACE CURTAIN AIR BAG MODULE

1. Replace curtain air bag module RH. Refer to [INT-21, "Exploded View"](#)
2. Perform DTC confirmation procedure. Refer to [SRC-131, "DTC Logic"](#).

Is DTC detected?

- YES >> GO TO 1.
NO >> INSPECTION END

B1148 CURTAIN AIR BAG MODULE RH

< DTC/CIRCUIT DIAGNOSIS >

B1148 CURTAIN AIR BAG MODULE RH

Description

INFOID:000000005631593

In case of side collision where acceleration is more than the specified level, the ignition materials are ignited by electric ignition system. The system burns the gas generating materials resulting in a chemical reaction. This generates hot gases that flow into the air bag through a filter and expand the bag.

DTC Logic

INFOID:000000005631594

DTC DETECTION LOGIC

DTC	Display contents of CONSULT-III	DTC detecting condition	Possible cause
B1148	CURTAIN MODULE RH [SHORT]	Curtain air bag module RH circuits are shorted to each other	<ul style="list-style-type: none">Disconnection of wiring harness and shortMalfunction in curtain air bag module RHMalfunction in air bag diagnosis sensor unit

DTC CONFIRMATION PROCEDURE

1. CHECK SELF-DIAG RESULT

With CONSULT-III

- Turn ignition switch ON.
- Perform "AIR BAG" Self Diagnostic Result.

Without CONSULT-III

- Turn ignition switch ON.
- Check the air bag warning lamp status. Refer to [SRC-15, "Diagnosis with Air Bag Warning Lamp"](#).

NOTE:

SRS does not enter the diagnosis mode if no malfunction is detected in the user mode.

Is malfunctioning part detected?

- YES >> Refer to [SRC-133, "Diagnosis Procedure"](#).
NO >> INSPECTION END

Diagnosis Procedure

INFOID:000000005631595

WARNING:

- Before servicing, turn ignition switch OFF, disconnect battery negative terminal, and wait at least 3 minutes or more. (To discharge backup capacitor.)
- Never use unspecified tester or other measuring device.

1. CHECK HARNESS CONNECTOR

Check the harness connector.

Is the inspection result normal?

- YES >> GO TO 2.
NO >> Replace harness connector.

2. CHECK WIRING HARNESS

Check the wiring harness externals.

Is the inspection result normal?

- YES >> GO TO 3.
NO >> Replace wiring harness.

3. REPLACE AIR BAG DIAGNOSIS SENSOR UNIT

- Replace air bag diagnosis sensor unit. Refer to [SR-29, "Exploded View"](#).
- Perform DTC confirmation procedure. Refer to [SRC-133, "DTC Logic"](#).

Is DTC detected?

- YES >> GO TO 4.
NO >> INSPECTION END

B1148 CURTAIN AIR BAG MODULE RH

< DTC/CIRCUIT DIAGNOSIS >

4. REPLACE CURTAIN AIR BAG MODULE

1. Replace curtain air bag module RH. Refer to [INT-21, "Exploded View"](#)
2. Perform DTC confirmation procedure. Refer to [SRC-133, "DTC Logic"](#).

Is DTC detected?

- YES >> GO TO 1.
NO >> INSPECTION END

B1150 CURTAIN AIR BAG MODULE LH

< DTC/CIRCUIT DIAGNOSIS >

B1150 CURTAIN AIR BAG MODULE LH

Description

INFOID:000000005631596

In case of side collision where acceleration is more than the specified level, the ignition materials are ignited by electric ignition system. The system burns the gas generating materials resulting in a chemical reaction. This generates hot gases that flow into the air bag through a filter and expand the bag.

DTC Logic

INFOID:000000005631597

DTC DETECTION LOGIC

DTC	Display contents of CONSULT-III	DTC detecting condition	Possible cause
B1150	CURTAIN MODULE LH [OPEN]	Curtain air bag module LH circuit is open	<ul style="list-style-type: none"> • Disconnection of wiring harness and open • Malfunction in curtain air bag module LH • Malfunction in air bag diagnosis sensor unit

DTC CONFIRMATION PROCEDURE

1. CHECK SELF-DIAG RESULT

With CONSULT-III

1. Turn ignition switch ON.
2. Perform "AIR BAG" Self Diagnostic Result.

Without CONSULT-III

1. Turn ignition switch ON.
2. Check the air bag warning lamp status. Refer to [SRC-15. "Diagnosis with Air Bag Warning Lamp"](#).

NOTE:

SRS does not enter the diagnosis mode if no malfunction is detected in the user mode.

Is malfunctioning part detected?

- YES >> Refer to [SRC-135. "Diagnosis Procedure"](#).
 NO >> INSPECTION END

Diagnosis Procedure

INFOID:000000005631598

WARNING:

- Before servicing, turn ignition switch OFF, disconnect battery negative terminal, and wait at least 3 minutes or more. (To discharge backup capacitor.)
- Never use unspecified tester or other measuring device.

1. CHECK HARNESS CONNECTOR

Check the harness connector.

Is the inspection result normal?

- YES >> GO TO 2.
 NO >> Replace harness connector.

2. CHECK WIRING HARNESS

Check the wiring harness externals.

Is the inspection result normal?

- YES >> GO TO 3.
 NO >> Replace wiring harness.

3. REPLACE AIR BAG DIAGNOSIS SENSOR UNIT

1. Replace air bag diagnosis sensor unit. Refer to [SR-29. "Exploded View"](#).
2. Perform DTC confirmation procedure. Refer to [SRC-135. "DTC Logic"](#).

Is DTC detected?

- YES >> GO TO 4.
 NO >> INSPECTION END

B1150 CURTAIN AIR BAG MODULE LH

< DTC/CIRCUIT DIAGNOSIS >

4. REPLACE CURTAIN AIR BAG MODULE

1. Replace curtain air bag module LH. Refer to [INT-21, "Exploded View"](#)
2. Perform DTC confirmation procedure. Refer to [SRC-135, "DTC Logic"](#).

Is DTC detected?

- YES >> GO TO 1.
NO >> INSPECTION END

B1151 CURTAIN AIR BAG MODULE LH

< DTC/CIRCUIT DIAGNOSIS >

B1151 CURTAIN AIR BAG MODULE LH

Description

INFOID:000000005631599

In case of side collision where acceleration is more than the specified level, the ignition materials are ignited by electric ignition system. The system burns the gas generating materials resulting in a chemical reaction. This generates hot gases that flow into the air bag through a filter and expand the bag.

DTC Logic

INFOID:000000005631600

DTC DETECTION LOGIC

DTC	Display contents of CONSULT-III	DTC detecting condition	Possible cause
B1151	CURTAIN MODULE LH [VB-SHORT]	Curtain air bag module LH circuit is shorted to power supply circuit	<ul style="list-style-type: none">• Disconnection of wiring harness and short• Malfunction in curtain air bag module LH• Malfunction in air bag diagnosis sensor unit

DTC CONFIRMATION PROCEDURE

1. CHECK SELF-DIAG RESULT

With CONSULT-III

1. Turn ignition switch ON.
2. Perform "AIR BAG" Self Diagnostic Result.

Without CONSULT-III

1. Turn ignition switch ON.
2. Check the air bag warning lamp status. Refer to [SRC-15, "Diagnosis with Air Bag Warning Lamp"](#).

NOTE:

SRS does not enter the diagnosis mode if no malfunction is detected in the user mode.

Is malfunctioning part detected?

- YES >> Refer to [SRC-137, "Diagnosis Procedure"](#).
NO >> INSPECTION END

Diagnosis Procedure

INFOID:000000005631601

WARNING:

- Before servicing, turn ignition switch OFF, disconnect battery negative terminal, and wait at least 3 minutes or more. (To discharge backup capacitor.)
- Never use unspecified tester or other measuring device.

1. CHECK HARNESS CONNECTOR

Check the harness connector.

Is the inspection result normal?

- YES >> GO TO 2.
NO >> Replace harness connector.

2. CHECK WIRING HARNESS

Check the wiring harness externals.

Is the inspection result normal?

- YES >> GO TO 3.
NO >> Replace wiring harness.

3. REPLACE AIR BAG DIAGNOSIS SENSOR UNIT

1. Replace air bag diagnosis sensor unit. Refer to [SR-29, "Exploded View"](#).
2. Perform DTC confirmation procedure. Refer to [SRC-137, "DTC Logic"](#).

Is DTC detected?

- YES >> GO TO 4.
NO >> INSPECTION END

B1151 CURTAIN AIR BAG MODULE LH

< DTC/CIRCUIT DIAGNOSIS >

4. REPLACE CURTAIN AIR BAG MODULE

1. Replace curtain air bag module LH. Refer to [INT-21, "Exploded View"](#)
2. Perform DTC confirmation procedure. Refer to [SRC-137, "DTC Logic"](#).

Is DTC detected?

- YES >> GO TO 1.
NO >> INSPECTION END

B1152 CURTAIN AIR BAG MODULE LH

< DTC/CIRCUIT DIAGNOSIS >

B1152 CURTAIN AIR BAG MODULE LH

Description

INFOID:000000005631602

In case of side collision where acceleration is more than the specified level, the ignition materials are ignited by electric ignition system. The system burns the gas generating materials resulting in a chemical reaction. This generates hot gases that flow into the air bag through a filter and expand the bag.

DTC Logic

INFOID:000000005631603

DTC DETECTION LOGIC

DTC	Display contents of CONSULT-III	DTC detecting condition	Possible cause
B1152	CURTAIN MODULE LH [GND-SHORT]	Curtain air bag module LH circuit is shorted to ground	<ul style="list-style-type: none"> • Disconnection of wiring harness and short • Malfunction in curtain air bag module LH • Malfunction in air bag diagnosis sensor unit

DTC CONFIRMATION PROCEDURE

1. CHECK SELF-DIAG RESULT

With CONSULT-III

1. Turn ignition switch ON.
2. Perform "AIR BAG" Self Diagnostic Result.

Without CONSULT-III

1. Turn ignition switch ON.
2. Check the air bag warning lamp status. Refer to [SRC-15, "Diagnosis with Air Bag Warning Lamp"](#).

NOTE:

SRS does not enter the diagnosis mode if no malfunction is detected in the user mode.

Is malfunctioning part detected?

- YES >> Refer to [SRC-139, "Diagnosis Procedure"](#).
 NO >> INSPECTION END

Diagnosis Procedure

INFOID:000000005631604

WARNING:

- Before servicing, turn ignition switch OFF, disconnect battery negative terminal, and wait at least 3 minutes or more. (To discharge backup capacitor.)
- Never use unspecified tester or other measuring device.

1. CHECK HARNESS CONNECTOR

Check the harness connector.

Is the inspection result normal?

- YES >> GO TO 2.
 NO >> Replace harness connector.

2. CHECK WIRING HARNESS

Check the wiring harness externals.

Is the inspection result normal?

- YES >> GO TO 3.
 NO >> Replace wiring harness.

3. REPLACE AIR BAG DIAGNOSIS SENSOR UNIT

1. Replace air bag diagnosis sensor unit. Refer to [SR-29, "Exploded View"](#).
2. Perform DTC confirmation procedure. Refer to [SRC-139, "DTC Logic"](#).

Is DTC detected?

- YES >> GO TO 4.
 NO >> INSPECTION END

B1152 CURTAIN AIR BAG MODULE LH

< DTC/CIRCUIT DIAGNOSIS >

4. REPLACE CURTAIN AIR BAG MODULE

1. Replace curtain air bag module LH. Refer to [INT-21, "Exploded View"](#)
2. Perform DTC confirmation procedure. Refer to [SRC-139, "DTC Logic"](#).

Is DTC detected?

- YES >> GO TO 1.
NO >> INSPECTION END

B1153 CURTAIN AIR BAG MODULE LH

< DTC/CIRCUIT DIAGNOSIS >

B1153 CURTAIN AIR BAG MODULE LH

Description

INFOID:000000005631605

In case of side collision where acceleration is more than the specified level, the ignition materials are ignited by electric ignition system. The system burns the gas generating materials resulting in a chemical reaction. This generates hot gases that flow into the air bag through a filter and expand the bag.

DTC Logic

INFOID:000000005631606

DTC DETECTION LOGIC

DTC	Display contents of CONSULT-III	DTC detecting condition	Possible cause
B1153	CURTAIN MODULE LH [SHORT]	Curtain air bag module LH circuits are shorted to each other	<ul style="list-style-type: none">• Disconnection of wiring harness and short• Malfunction in curtain air bag module LH• Malfunction in air bag diagnosis sensor unit

DTC CONFIRMATION PROCEDURE

1. CHECK SELF-DIAG RESULT

With CONSULT-III

1. Turn ignition switch ON.
2. Perform "AIR BAG" Self Diagnostic Result.

Without CONSULT-III

1. Turn ignition switch ON.
2. Check the air bag warning lamp status. Refer to [SRC-15. "Diagnosis with Air Bag Warning Lamp"](#).

NOTE:

SRS does not enter the diagnosis mode if no malfunction is detected in the user mode.

Is malfunctioning part detected?

- YES >> Refer to [SRC-141. "Diagnosis Procedure"](#).
NO >> INSPECTION END

Diagnosis Procedure

INFOID:000000005631607

WARNING:

- Before servicing, turn ignition switch OFF, disconnect battery negative terminal, and wait at least 3 minutes or more. (To discharge backup capacitor.)
- Never use unspecified tester or other measuring device.

1. CHECK HARNESS CONNECTOR

Check the harness connector.

Is the inspection result normal?

- YES >> GO TO 2.
NO >> Replace harness connector.

2. CHECK WIRING HARNESS

Check the wiring harness externals.

Is the inspection result normal?

- YES >> GO TO 3.
NO >> Replace wiring harness.

3. REPLACE AIR BAG DIAGNOSIS SENSOR UNIT

1. Replace air bag diagnosis sensor unit. Refer to [SR-29. "Exploded View"](#).
2. Perform DTC confirmation procedure. Refer to [SRC-141. "DTC Logic"](#).

Is DTC detected?

- YES >> GO TO 4.
NO >> INSPECTION END

B1153 CURTAIN AIR BAG MODULE LH

< DTC/CIRCUIT DIAGNOSIS >

4. REPLACE CURTAIN AIR BAG MODULE

1. Replace curtain air bag module LH. Refer to [INT-21, "Exploded View"](#)
2. Perform DTC confirmation procedure. Refer to [SRC-141, "DTC Logic"](#).

Is DTC detected?

- YES >> GO TO 1.
NO >> INSPECTION END

B1154, B1155, B1156, B1157, B1158, B1159 DIAGNOSIS SENSOR UNIT

< DTC/CIRCUIT DIAGNOSIS >

B1154, B1155, B1156, B1157, B1158, B1159 DIAGNOSIS SENSOR UNIT

Description

INFOID:000000005631608

- It detects a shock that is more than the specified level and monitors whether the driver and passenger air bags, side air bag, curtain air bag, and pre-tensioner seat belts operate normally.
- It contains the "G" sensors for both frontal and side collisions and spare battery function in case of main battery damage in collision.

DTC Logic

INFOID:000000005631609

DTC DETECTION LOGIC

DTC	Display contents of CONSULT-III	DTC detecting condition	Possible cause
B1154 B1155 B1156 B1157 B1158 B1159	CONTROL UNIT	Air bag diagnosis sensor unit is malfunctioning	Malfunction in air bag diagnosis sensor unit

DTC CONFIRMATION PROCEDURE

1. CHECK SELF-DIAG RESULT

With CONSULT-III

1. Turn ignition switch ON.
2. Perform "AIR BAG" Self Diagnostic Result.

Without CONSULT-III

1. Turn ignition switch ON.
2. Check the air bag warning lamp status. Refer to [SRC-15, "Diagnosis with Air Bag Warning Lamp"](#).

NOTE:

SRS does not enter the diagnosis mode if no malfunction is detected in the user mode.

Is malfunctioning part detected?

YES >> Refer to [SRC-143, "Diagnosis Procedure"](#).

NO >> INSPECTION END

Diagnosis Procedure

INFOID:000000005631610

WARNING:

- Before servicing, turn ignition switch OFF, disconnect battery negative terminal, and wait at least 3 minutes or more. (To discharge backup capacitor.)
- Never use unspecified tester or other measuring device.

1. CHECK HARNESS CONNECTOR

Check the harness connector.

Is the inspection result normal?

YES >> GO TO 2.

NO >> Replace harness connectors.

2. CHECK WIRING HARNESS

Check the wiring harness externals.

Is the inspection result normal?

YES >> GO TO 3.

NO >> Replace wiring harness.

3. REPLACE AIR BAG DIAGNOSIS SENSOR UNIT

1. Replace air bag diagnosis sensor unit. Refer to [SR-29, "Exploded View"](#).
2. Perform DTC confirmation procedure. Refer to [SRC-143, "DTC Logic"](#).

B1154, B1155, B1156, B1157, B1158, B1159 DIAGNOSIS SENSOR UNIT

< DTC/CIRCUIT DIAGNOSIS >

Is DTC detected?

YES >> GO TO 1.

NO >> INSPECTION END

B1170, B1171, B1172, B1173, B1174, B1175 DIAGNOSIS SENSOR UNIT

< DTC/CIRCUIT DIAGNOSIS >

B1170, B1171, B1172, B1173, B1174, B1175 DIAGNOSIS SENSOR UNIT

Description

INFOID:0000000005631611

- It detects a shock that is more than the specified level and monitors whether the driver and passenger air bags, side air bag, curtain air bag, and pre-tensioner seat belts operate normally.
- It contains the "G" sensors for both frontal and side collisions and spare battery function in case of main battery damage in collision.

DTC Logic

INFOID:0000000005631612

DTC DETECTION LOGIC

DTC	Display contents of CONSULT-III	DTC detecting condition	Possible cause
B1170 B1171 B1172 B1173 B1174 B1175	CONTROL UNIT	Air bag diagnosis sensor unit is malfunctioning	Malfunction in air bag diagnosis sensor unit

DTC CONFIRMATION PROCEDURE

1. CHECK SELF-DIAG RESULT

With CONSULT-III

1. Turn ignition switch ON.
2. Perform "AIR BAG" Self Diagnostic Result.

Without CONSULT-III

1. Turn ignition switch ON.
2. Check the air bag warning lamp status. Refer to [SRC-15, "Diagnosis with Air Bag Warning Lamp"](#).

NOTE:

SRS does not enter the diagnosis mode if no malfunction is detected in the user mode.

Is malfunctioning part detected?

- YES >> Refer to [SRC-145, "Diagnosis Procedure"](#).
NO >> INSPECTION END

Diagnosis Procedure

INFOID:0000000005631613

WARNING:

- Before servicing, turn ignition switch OFF, disconnect battery negative terminal, and wait at least 3 minutes or more. (To discharge backup capacitor.)
- Never use unspecified tester or other measuring device.

1. CHECK HARNESS CONNECTOR

Check the harness connector.

Is the inspection result normal?

- YES >> GO TO 2.
NO >> Replace harness connectors.

2. CHECK WIRING HARNESS

Check the wiring harness externals.

Is the inspection result normal?

- YES >> GO TO 3.
NO >> Replace wiring harness.

3. REPLACE AIR BAG DIAGNOSIS SENSOR UNIT

1. Replace air bag diagnosis sensor unit. Refer to [SR-29, "Exploded View"](#).
2. Perform DTC confirmation procedure. Refer to [SRC-145, "DTC Logic"](#).

B1170, B1171, B1172, B1173, B1174, B1175 DIAGNOSIS SENSOR UNIT

< DTC/CIRCUIT DIAGNOSIS >

Is DTC detected?

YES >> GO TO 1.

NO >> INSPECTION END

B1186, B1187, B1188, B1189, B1190, B1191 DIAGNOSIS SENSOR UNIT

< DTC/CIRCUIT DIAGNOSIS >

B1186, B1187, B1188, B1189, B1190, B1191 DIAGNOSIS SENSOR UNIT

Description

INFOID:000000005631614

- It detects a shock that is more than the specified level and monitors whether the driver and passenger air bags, side air bag, curtain air bag, and pre-tensioner seat belts operate normally.
- It contains the "G" sensors for both frontal and side collisions and spare battery function in case of main battery damage in collision.

DTC Logic

INFOID:000000005631615

DTC DETECTION LOGIC

DTC	Display contents of CONSULT-III	DTC detecting condition	Possible cause
B1186 B1187 B1188 B1189 B1190 B1191	CONTROL UNIT	Air bag diagnosis sensor unit is malfunctioning	Malfunction in air bag diagnosis sensor unit

DTC CONFIRMATION PROCEDURE

1. CHECK SELF-DIAG RESULT

With CONSULT-III

1. Turn ignition switch ON.
2. Perform "AIR BAG" Self Diagnostic Result.

Without CONSULT-III

1. Turn ignition switch ON.
2. Check the air bag warning lamp status. Refer to [SRC-15, "Diagnosis with Air Bag Warning Lamp"](#).

NOTE:

SRS does not enter the diagnosis mode if no malfunction is detected in the user mode.

Is malfunctioning part detected?

- YES >> Refer to [SRC-147, "Diagnosis Procedure"](#).
NO >> INSPECTION END

Diagnosis Procedure

INFOID:000000005631616

WARNING:

- Before servicing, turn ignition switch OFF, disconnect battery negative terminal, and wait at least 3 minutes or more. (To discharge backup capacitor.)
- Never use unspecified tester or other measuring device.

1. CHECK HARNESS CONNECTOR

Check the harness connector.

Is the inspection result normal?

- YES >> GO TO 2.
NO >> Replace harness connectors.

2. CHECK WIRING HARNESS

Check the wiring harness externals.

Is the inspection result normal?

- YES >> GO TO 3.
NO >> Replace wiring harness.

3. REPLACE AIR BAG DIAGNOSIS SENSOR UNIT

1. Replace air bag diagnosis sensor unit. Refer to [SR-29, "Exploded View"](#).
2. Perform DTC confirmation procedure. Refer to [SRC-147, "DTC Logic"](#).

B1186, B1187, B1188, B1189, B1190, B1191 DIAGNOSIS SENSOR UNIT

< DTC/CIRCUIT DIAGNOSIS >

Is DTC detected?

YES >> GO TO 1.

NO >> INSPECTION END

B1202, B1203, B1204, B1205, B1206, B1207 DIAGNOSIS SENSOR UNIT

< DTC/CIRCUIT DIAGNOSIS >

B1202, B1203, B1204, B1205, B1206, B1207 DIAGNOSIS SENSOR UNIT

Description

INFOID:000000005631617

- It detects a shock that is more than the specified level and monitors whether the driver and passenger air bags, side air bag, curtain air bag, and pre-tensioner seat belts operate normally.
- It contains the "G" sensors for both frontal and side collisions and spare battery function in case of main battery damage in collision.

DTC Logic

INFOID:000000005631618

DTC DETECTION LOGIC

DTC	Display contents of CONSULT-III	DTC detecting condition	Possible cause
B1202 B1203 B1204 B1205 B1206 B1207	CONTROL UNIT	Air bag diagnosis sensor unit is malfunctioning	Malfunction in air bag diagnosis sensor unit

DTC CONFIRMATION PROCEDURE

1. CHECK SELF-DIAG RESULT

With CONSULT-III

1. Turn ignition switch ON.
2. Perform "AIR BAG" Self Diagnostic Result.

Without CONSULT-III

1. Turn ignition switch ON.
2. Check the air bag warning lamp status. Refer to [SRC-15, "Diagnosis with Air Bag Warning Lamp"](#).

NOTE:

SRS does not enter the diagnosis mode if no malfunction is detected in the user mode.

Is malfunctioning part detected?

- YES >> Refer to [SRC-149, "Diagnosis Procedure"](#).
NO >> INSPECTION END

Diagnosis Procedure

INFOID:000000005631619

WARNING:

- Before servicing, turn ignition switch OFF, disconnect battery negative terminal, and wait at least 3 minutes or more. (To discharge backup capacitor.)
- Never use unspecified tester or other measuring device.

1. CHECK HARNESS CONNECTOR

Check the harness connector.

Is the inspection result normal?

- YES >> GO TO 2.
NO >> Replace harness connectors.

2. CHECK WIRING HARNESS

Check the wiring harness externals.

Is the inspection result normal?

- YES >> GO TO 3.
NO >> Replace wiring harness.

3. REPLACE AIR BAG DIAGNOSIS SENSOR UNIT

1. Replace air bag diagnosis sensor unit. Refer to [SR-29, "Exploded View"](#).
2. Perform DTC confirmation procedure. Refer to [SRC-149, "DTC Logic"](#).

B1202, B1203, B1204, B1205, B1206, B1207 DIAGNOSIS SENSOR UNIT

< DTC/CIRCUIT DIAGNOSIS >

Is DTC detected?

YES >> GO TO 1.

NO >> INSPECTION END

B1209 FRONTAL COLLISION DETECTION

< DTC/CIRCUIT DIAGNOSIS >

B1209 FRONTAL COLLISION DETECTION

Description

INFOID:000000005631620

The air bags and seat belt pre-tensioners for driver and passenger are activated by the air bag diagnosis sensor unit signal transmitted at the time of the frontal collision.

DTC Logic

INFOID:000000005631621

DTC DETECTION LOGIC

DTC	Display contents of CONSULT-III	DTC detecting condition	Possible cause
B1209	FRONTAL COLLISION DETECTION	Seat belt pre-tensioner, driver side air bag and passenger air bag are deployed	—

DTC CONFIRMATION PROCEDURE

1. CHECK SELF-DIAG RESULT

With CONSULT-III

1. Turn ignition switch ON.
2. Perform "AIR BAG" Self Diagnostic Result.

Without CONSULT-III

1. Turn ignition switch ON.
2. Check the air bag warning lamp status. Refer to [SRC-15, "Diagnosis with Air Bag Warning Lamp"](#).

NOTE:

SRS does not enter the diagnosis mode if no malfunction is detected in the user mode.

Is malfunctioning part detected?

- YES >> Refer to [SRC-151, "Diagnosis Procedure"](#).
NO >> INSPECTION END

Diagnosis Procedure

INFOID:000000005809865

WARNING:

- Before servicing, turn ignition switch OFF, disconnect battery negative terminal, and wait at least 3 minutes or more. (To discharge backup capacitor.)
- Never use unspecified tester or other measuring device.

1. PERFORM COLLISION DIAGNOSIS

Perform collision diagnosis. Refer to [SR-5, "FOR FRONTAL COLLISION : When SRS is activated in a collision"](#) or [SR-6, "FOR FRONTAL COLLISION : When SRS is not activated in a collision"](#).

Is collision diagnosis complete?

- YES >> GO TO 2.
NO >> INSPECTION END

2. FINAL INSPECTION

Perform "AIR BAG" Self Diagnostic Result.

Is the inspection result normal?

- YES >> INSPECTION END
NO >> Perform diagnosis of applicable DTC. Refer to [SRC-195, "DTC Index"](#).

B1210 SIDE COLLISION DETECTION

< DTC/CIRCUIT DIAGNOSIS >

B1210 SIDE COLLISION DETECTION

Description

INFOID:000000005631623

The side air bag and curtain air bag are activated by the air bag diagnosis sensor unit signal transmitted at the time of side collision.

DTC Logic

INFOID:000000005631624

DTC DETECTION LOGIC

DTC	Display contents of CONSULT-III	DTC detecting condition	Possible cause
B1210	SIDE COLLISION DETECTION	Side air bag and curtain air bag are deployed	—

DTC CONFIRMATION PROCEDURE

1. CHECK SELF-DIAG RESULT

With CONSULT-III

1. Turn ignition switch ON.
2. Perform "AIR BAG" Self Diagnostic Result.

Without CONSULT-III

1. Turn ignition switch ON.
2. Check the air bag warning lamp status. Refer to [SRC-15, "Diagnosis with Air Bag Warning Lamp"](#).

NOTE:

SRS does not enter the diagnosis mode if no malfunction is detected in the user mode.

Is malfunctioning part detected?

- YES >> Refer to [SRC-152, "Diagnosis Procedure"](#).
NO >> INSPECTION END

Diagnosis Procedure

INFOID:000000005809866

WARNING:

- Before servicing, turn ignition switch OFF, disconnect battery negative terminal, and wait at least 3 minutes or more. (To discharge backup capacitor.)
- Never use unspecified tester or other measuring device.

1. PERFORM COLLISION DIAGNOSIS

Perform collision diagnosis. Refer to [SR-7, "FOR SIDE AND ROLLOVER COLLISION : When SRS is activated in a collision"](#) or [SR-8, "FOR SIDE AND ROLLOVER COLLISION : When SRS is not activated in a collision"](#).

Is collision diagnosis complete?

- YES >> GO TO 2.
NO >> INSPECTION END

2. FINAL INSPECTION

Perform "AIR BAG" Self Diagnostic Result.

Is the inspection result normal?

- YES >> INSPECTION END
NO >> Perform diagnosis of applicable DTC. Refer to [SRC-195, "DTC Index"](#).

B1211 ROLLOVER DETECTION

< DTC/CIRCUIT DIAGNOSIS >

B1211 ROLLOVER DETECTION

Description

INFOID:000000005631626

The seat belt pre-tensioner, door-mounted curtain air bag and pop-up roll bar are activated by the air bag diagnosis sensor unit signal at the time of rollover.

DTC Logic

INFOID:000000005631627

DTC DETECTION LOGIC

DTC	Display contents of CONSULT-III	DTC detecting condition	Possible cause
B1211	ROLLOVER DETECTION	Seat belt pre-tensioner and curtain air bag module are deployed because of rollover detection	—

DTC CONFIRMATION PROCEDURE

1. CHECK SELF-DIAG RESULT

With CONSULT-III

1. Turn ignition switch ON.
2. Perform "AIR BAG" Self Diagnostic Result.

Without CONSULT-III

1. Turn ignition switch ON.
2. Check the air bag warning lamp status. Refer to [SRC-15. "Diagnosis with Air Bag Warning Lamp"](#).

NOTE:

SRS does not enter the diagnosis mode if no malfunction is detected in the user mode.

Is malfunctioning part detected?

- YES >> Refer to [SRC-153. "Diagnosis Procedure"](#).
NO >> INSPECTION END

Diagnosis Procedure

INFOID:000000005809867

WARNING:

- Before servicing, turn ignition switch OFF, disconnect battery negative terminal, and wait at least 3 minutes or more. (To discharge backup capacitor.)
- Never use unspecified tester or other measuring device.

1. PERFORM COLLISION DIAGNOSIS

Perform collision diagnosis. Refer to [SR-7. "FOR SIDE AND ROLLOVER COLLISION : When SRS is activated in a collision"](#) or [SR-8. "FOR SIDE AND ROLLOVER COLLISION : When SRS is not activated in a collision"](#).

Is collision diagnosis complete?

- YES >> GO TO 2.
NO >> INSPECTION END

2. FINAL INSPECTION

Perform "AIR BAG" Self Diagnostic Result.

Is the inspection result normal?

- YES >> INSPECTION END
NO >> Perform diagnosis of applicable DTC. Refer to [SRC-195. "DTC Index"](#).

B1212, B1213, B1214 SATELLITE SENSOR RH

< DTC/CIRCUIT DIAGNOSIS >

B1212, B1213, B1214 SATELLITE SENSOR RH

Description

INFOID:000000005631629

Satellite sensor is a G sensor that outputs voltage signal during deceleration at the time of a vehicle side collision that is more than the specified limit is detected.

DTC Logic

INFOID:000000005631630

DTC DETECTION LOGIC

DTC	Display contents of CONSULT-III	DTC detecting condition	Possible cause
B1212 B1213 B1214	RH1 SAT-SENS	Satellite sensor RH is malfunctioning	<ul style="list-style-type: none">• Disconnection of wiring harness• Malfunction in satellite sensor RH• Malfunction in air bag diagnosis sensor unit

DTC CONFIRMATION PROCEDURE

1. CHECK SELF-DIAG RESULT

With CONSULT-III

1. Turn ignition switch ON.
2. Perform "AIR BAG" Self Diagnostic Result.

Without CONSULT-III

1. Turn ignition switch ON.
2. Check the air bag warning lamp status. Refer to [SRC-15, "Diagnosis with Air Bag Warning Lamp"](#).

NOTE:

SRS does not enter the diagnosis mode if no malfunction is detected in the user mode.

Is malfunctioning part detected?

- YES >> Refer to [SRC-154, "Diagnosis Procedure"](#).
NO >> INSPECTION END

Diagnosis Procedure

INFOID:000000005631631

WARNING:

- Before servicing, turn ignition switch OFF, disconnect battery negative terminal, and wait at least 3 minutes or more. (To discharge backup capacitor.)
- Never use unspecified tester or other measuring device.

1. CHECK HARNESS CONNECTOR

Check the harness connector.

Is the inspection result normal?

- YES >> GO TO 2.
NO >> Replace harness connector.

2. CHECK WIRING HARNESS

Check the wiring harness externals.

Is the inspection result normal?

- YES >> GO TO 3.
NO >> Replace wiring harness.

3. REPLACE SATELLITE SENSOR

1. Replace satellite sensor RH. Refer to [SR-27, "Exploded View"](#).
2. Perform DTC confirmation procedure. Refer to [SRC-154, "DTC Logic"](#).

Is DTC detected?

- YES >> GO TO 4.
NO >> INSPECTION END

4. REPLACE AIR BAG DIAGNOSIS SENSOR UNIT

B1212, B1213, B1214 SATELLITE SENSOR RH

< DTC/CIRCUIT DIAGNOSIS >

1. Replace air bag diagnosis sensor unit. Refer to [SR-29, "Exploded View"](#).
2. Perform DTC confirmation procedure. Refer to [SRC-154, "DTC Logic"](#).

Is DTC detected?

YES >> GO TO 1.

NO >> INSPECTION END

A

B

C

D

E

F

G

SRC

I

J

K

L

M

N

O

P

B1215, B1216, B1217 SATELLITE SENSOR LH

< DTC/CIRCUIT DIAGNOSIS >

B1215, B1216, B1217 SATELLITE SENSOR LH

Description

INFOID:000000005631632

Satellite sensor is a G sensor that outputs voltage signal during deceleration at the time of a vehicle side collision that is more than the specified limit is detected.

DTC Logic

INFOID:000000005631633

DTC DETECTION LOGIC

DTC	Display contents of CONSULT-III	DTC detecting condition	Possible cause
B1215 B1216 B1217	LH1 SAT-SENS	Satellite sensor LH is malfunctioning	<ul style="list-style-type: none">• Disconnection of wiring harness• Malfunction in satellite sensor LH• Malfunction in air bag diagnosis sensor unit

DTC CONFIRMATION PROCEDURE

1. CHECK SELF-DIAG RESULT

With CONSULT-III

1. Turn ignition switch ON.
2. Perform "AIR BAG" Self Diagnostic Result.

Without CONSULT-III

1. Turn ignition switch ON.
2. Check the air bag warning lamp status. Refer to [SRC-15. "Diagnosis with Air Bag Warning Lamp"](#).

NOTE:

SRS does not enter the diagnosis mode if no malfunction is detected in the user mode.

Is malfunctioning part detected?

- YES >> Refer to [SRC-156. "Diagnosis Procedure"](#).
NO >> INSPECTION END

Diagnosis Procedure

INFOID:000000005631634

WARNING:

- Before servicing, turn ignition switch OFF, disconnect battery negative terminal, and wait at least 3 minutes or more. (To discharge backup capacitor.)
- Never use unspecified tester or other measuring device.

1. CHECK HARNESS CONNECTOR

Check the harness connector.

Is the inspection result normal?

- YES >> GO TO 2.
NO >> Replace harness connector.

2. CHECK WIRING HARNESS

Check the wiring harness externals.

Is the inspection result normal?

- YES >> GO TO 3.
NO >> Replace wiring harness.

3. REPLACE SATELLITE SENSOR

1. Replace satellite sensor LH. Refer to [SR-27. "Exploded View"](#).
2. Perform DTC confirmation procedure. Refer to [SRC-156. "DTC Logic"](#)

Is DTC detected?

- YES >> GO TO 4.
NO >> INSPECTION END

4. REPLACE AIR BAG DIAGNOSIS SENSOR UNIT

B1215, B1216, B1217 SATELLITE SENSOR LH

< DTC/CIRCUIT DIAGNOSIS >

1. Replace air bag diagnosis sensor unit. Refer to [SR-29, "Exploded View"](#).
2. Perform DTC confirmation procedure. Refer to [SRC-156, "DTC Logic"](#).

Is DTC detected?

YES >> GO TO 1.

NO >> INSPECTION END

A

B

C

D

E

F

G

SRC

I

J

K

L

M

N

O

P

B1218, B1219, B1220, B1221, B1222, B1223 DIAGNOSIS SENSOR UNIT

< DTC/CIRCUIT DIAGNOSIS >

B1218, B1219, B1220, B1221, B1222, B1223 DIAGNOSIS SENSOR UNIT

Description

INFOID:000000005631635

- It detects a shock that is more than the specified level and monitors whether the driver and passenger air bags, side air bag, curtain air bag, and pre-tensioner seat belts operate normally.
- It contains the "G" sensors for both frontal and side collisions and spare battery function in case of main battery damage in collision.

DTC Logic

INFOID:000000005631636

DTC DETECTION LOGIC

DTC	Display contents of CONSULT-III	DTC detecting condition	Possible cause
B1218 B1219 B1220 B1221 B1222 B1223	CONTROL UNIT	Air bag diagnosis sensor unit is malfunctioning	Malfunction in air bag diagnosis sensor unit

DTC CONFIRMATION PROCEDURE

1. CHECK SELF-DIAG RESULT

With CONSULT-III

1. Turn ignition switch ON.
2. Perform "AIR BAG" Self Diagnostic Result.

Without CONSULT-III

1. Turn ignition switch ON.
2. Check the air bag warning lamp status. Refer to [SRC-15, "Diagnosis with Air Bag Warning Lamp"](#).

NOTE:

SRS does not enter the diagnosis mode if no malfunction is detected in the user mode.

Is malfunctioning part detected?

- YES >> Refer to [SRC-158, "Diagnosis Procedure"](#).
NO >> INSPECTION END

Diagnosis Procedure

INFOID:000000005631637

WARNING:

- Before servicing, turn ignition switch OFF, disconnect battery negative terminal, and wait at least 3 minutes or more. (To discharge backup capacitor.)
- Never use unspecified tester or other measuring device.

1. CHECK HARNESS CONNECTOR

Check the harness connector.

Is the inspection result normal?

- YES >> GO TO 2.
NO >> Replace harness connectors.

2. CHECK WIRING HARNESS

Check the wiring harness externals.

Is the inspection result normal?

- YES >> GO TO 3.
NO >> Replace wiring harness.

3. REPLACE AIR BAG DIAGNOSIS SENSOR UNIT

1. Replace air bag diagnosis sensor unit. Refer to [SR-29, "Exploded View"](#).
2. Perform DTC confirmation procedure. Refer to [SRC-158, "DTC Logic"](#).

B1218, B1219, B1220, B1221, B1222, B1223 DIAGNOSIS SENSOR UNIT

< DTC/CIRCUIT DIAGNOSIS >

Is DTC detected?

YES >> GO TO 1.

NO >> INSPECTION END

A

B

C

D

E

F

G

SRC

I

J

K

L

M

N

O

P

B1239 DIAGNOSIS SENSOR UNIT

< DTC/CIRCUIT DIAGNOSIS >

B1239 DIAGNOSIS SENSOR UNIT

Description

INFOID:000000005631638

- It detects a shock that is more than the specified level and monitors whether the driver and passenger air bags, side air bag, curtain air bag, and pre-tensioner seat belts operate normally.
- It contains the "G" sensors for both frontal and side collisions and spare battery function in case of main battery damage in collision.

DTC Logic

INFOID:000000005631639

DTC DETECTION LOGIC

DTC	Display contents of CONSULT-III	DTC detecting condition	Possible cause
B1239	CONTROL UNIT	Air bag diagnosis sensor unit is malfunctioning	Malfunction in air bag diagnosis sensor unit

DTC CONFIRMATION PROCEDURE

1.CHECK SELF-DIAG RESULT

With CONSULT-III

1. Turn ignition switch ON.
2. Perform "AIR BAG" Self Diagnostic Result.

Without CONSULT-III

1. Turn ignition switch ON.
2. Check the air bag warning lamp status. Refer to [SRC-15, "Diagnosis with Air Bag Warning Lamp"](#).

NOTE:

SRS does not enter the diagnosis mode if no malfunction is detected in the user mode.

Is malfunctioning part detected?

- YES >> Refer to [SRC-160, "Diagnosis Procedure"](#).
NO >> INSPECTION END

Diagnosis Procedure

INFOID:000000005631640

WARNING:

- **Before servicing, turn ignition switch OFF, disconnect battery negative terminal, and wait at least 3 minutes or more. (To discharge backup capacitor.)**
- **Never use unspecified tester or other measuring device.**

1.CHECK HARNESS CONNECTOR

Check the harness connector.

Is the inspection result normal?

- YES >> GO TO 2.
NO >> Replace harness connectors.

2.CHECK WIRING HARNESS

Check the wiring harness externals.

Is the inspection result normal?

- YES >> GO TO 3.
NO >> Replace wiring harness.

3.REPLACE AIR BAG DIAGNOSIS SENSOR UNIT

1. Replace air bag diagnosis sensor unit. Refer to [SR-29, "Exploded View"](#).
2. Perform DTC confirmation procedure. Refer to [SRC-160, "DTC Logic"](#).

Is DTC detected?

- YES >> GO TO 1.
NO >> INSPECTION END

B1257 DOOR-MOUNTED CURTAIN AIR BAG MODULE RH

< DTC/CIRCUIT DIAGNOSIS >

B1257 DOOR-MOUNTED CURTAIN AIR BAG MODULE RH

Description

INFOID:000000005631641

In case of side collision where acceleration is more than the specified level, the ignition materials are ignited by electric ignition system. The system burns the gas generating materials resulting in a chemical reaction. This generates hot gases that flow into the air bag through a filter and expand the bag.

DTC Logic

INFOID:000000005631642

DTC DETECTION LOGIC

DTC	Display contents of CONSULT-III	DTC detecting condition	Possible cause
B1257	FR-RH DOOR MNT MODULE [OPEN]	Door-mounted curtain air bag module RH circuit is open	<ul style="list-style-type: none">• Disconnection of wiring harness and open• Malfunction in side door-mounted curtain air bag module RH• Malfunction in air bag diagnosis sensor unit

DTC CONFIRMATION PROCEDURE

1. CHECK SELF-DIAG RESULT

With CONSULT-III

1. Turn ignition switch ON.
2. Perform "AIR BAG" Self Diagnostic Result.

Without CONSULT-III

1. Turn ignition switch ON.
2. Check the air bag warning lamp status. Refer to [SRC-15, "Diagnosis with Air Bag Warning Lamp"](#).

NOTE:

SRS does not enter the diagnosis mode if no malfunction is detected in the user mode.

Is malfunctioning part detected?

- YES >> Refer to [SRC-161, "Diagnosis Procedure"](#).
NO >> INSPECTION END

Diagnosis Procedure

INFOID:000000005631643

WARNING:

- Before servicing, turn ignition switch OFF, disconnect battery negative terminal, and wait at least 3 minutes or more. (To discharge backup capacitor.)
- Never use unspecified tester or other measuring device.

1. CHECK HARNESS CONNECTOR

Check the harness connector.

Is the inspection result normal?

- YES >> GO TO 2.
NO >> Replace harness connector.

2. CHECK WIRING HARNESS

Check the wiring harness externals.

Is the inspection result normal?

- YES >> GO TO 3.
NO >> Replace wiring harness.

3. REPLACE AIR BAG DIAGNOSIS SENSOR UNIT

1. Replace air bag diagnosis sensor unit. Refer to [SR-29, "Exploded View"](#).
2. Perform DTC confirmation procedure. Refer to [SRC-161, "DTC Logic"](#).

Is DTC detected?

- YES >> GO TO 4.
NO >> INSPECTION END

B1257 DOOR-MOUNTED CURTAIN AIR BAG MODULE RH

< DTC/CIRCUIT DIAGNOSIS >

4. REPLACE DOOR-MOUNTED CURTAIN AIR BAG MODULE

1. Replace door-mounted curtain air bag module RH. Refer to [SR-19, "Exploded View"](#)
2. Perform DTC confirmation procedure. Refer to [SRC-161, "DTC Logic"](#).

Is DTC detected?

- YES >> GO TO 1.
NO >> INSPECTION END

B1258 DOOR-MOUNTED CURTAIN AIR BAG MODULE RH

< DTC/CIRCUIT DIAGNOSIS >

B1258 DOOR-MOUNTED CURTAIN AIR BAG MODULE RH

Description

INFOID:000000005631644

In case of side collision where acceleration is more than the specified level, the ignition materials are ignited by electric ignition system. The system burns the gas generating materials resulting in a chemical reaction. This generates hot gases that flow into the air bag through a filter and expand the bag.

DTC Logic

INFOID:000000005631645

DTC DETECTION LOGIC

DTC	Display contents of CONSULT-III	DTC detecting condition	Possible cause
B1258	FR-RH DOOR MNT MODULE [VB-SHORT]	Door-mounted curtain air bag module RH circuit is shorted to power supply circuit	<ul style="list-style-type: none">Disconnection of wiring harness and shortMalfuction in door-mounted curtain air bag module RHMalfuction in air bag diagnosis sensor unit

DTC CONFIRMATION PROCEDURE

1.CHECK SELF-DIAG RESULT

With CONSULT-III

- Turn ignition switch ON.
- Perform "AIR BAG" Self Diagnostic Result.

Without CONSULT-III

- Turn ignition switch ON.
- Check the air bag warning lamp status. Refer to [SRC-15, "Diagnosis with Air Bag Warning Lamp"](#).

NOTE:

SRS does not enter the diagnosis mode if no malfunction is detected in the user mode.

Is malfunctioning part detected?

- YES >> Refer to [SRC-163, "Diagnosis Procedure"](#).
NO >> INSPECTION END

Diagnosis Procedure

INFOID:000000005631646

WARNING:

- Before servicing, turn ignition switch OFF, disconnect battery negative terminal, and wait at least 3 minutes or more. (To discharge backup capacitor.)
- Never use unspecified tester or other measuring device.

1.CHECK HARNESS CONNECTOR

Check the harness connector.

Is the inspection result normal?

- YES >> GO TO 2.
NO >> Replace harness connector.

2.CHECK WIRING HARNESS

Check the wiring harness externals.

Is the inspection result normal?

- YES >> GO TO 3.
NO >> Replace wiring harness.

3.REPLACE AIR BAG DIAGNOSIS SENSOR UNIT

- Replace air bag diagnosis sensor unit. Refer to [SR-29, "Exploded View"](#).
- Perform DTC confirmation procedure. Refer to [SRC-163, "DTC Logic"](#).

Is DTC detected?

- YES >> GO TO 4.
NO >> INSPECTION END

B1258 DOOR-MOUNTED CURTAIN AIR BAG MODULE RH

< DTC/CIRCUIT DIAGNOSIS >

4. REPLACE DOOR-MOUNTED CURTAIN AIR BAG MODULE

1. Replace door-mounted curtain air bag module RH. Refer to [SR-19, "Exploded View"](#)
2. Perform DTC confirmation procedure. Refer to [SRC-163, "DTC Logic"](#).

Is DTC detected?

- YES >> GO TO 1.
NO >> INSPECTION END

B1259 DOOR-MOUNTED CURTAIN AIR BAG MODULE RH

< DTC/CIRCUIT DIAGNOSIS >

B1259 DOOR-MOUNTED CURTAIN AIR BAG MODULE RH

Description

INFOID:000000005631647

In case of side collision where acceleration is more than the specified level, the ignition materials are ignited by electric ignition system. The system burns the gas generating materials resulting in a chemical reaction. This generates hot gases that flow into the air bag through a filter and expand the bag.

DTC Logic

INFOID:000000005631648

DTC DETECTION LOGIC

DTC	Display contents of CONSULT-III	DTC detecting condition	Possible cause
B1259	FR-RH DOOR MNT MODULE [GND-SHORT]	Door-mounted curtain air bag module RH circuit is shorted to ground	<ul style="list-style-type: none">• Disconnection of wiring harness and short• Malfunction in door-mounted curtain air bag module RH• Malfunction in air bag diagnosis sensor unit

DTC CONFIRMATION PROCEDURE

1.CHECK SELF-DIAG RESULT

With CONSULT-III

1. Turn ignition switch ON.
2. Perform "AIR BAG" Self Diagnostic Result.

Without CONSULT-III

1. Turn ignition switch ON.
2. Check the air bag warning lamp status. Refer to [SRC-15, "Diagnosis with Air Bag Warning Lamp"](#).

NOTE:

SRS does not enter the diagnosis mode if no malfunction is detected in the user mode.

Is malfunctioning part detected?

- YES >> Refer to [SRC-165, "Diagnosis Procedure"](#).
NO >> INSPECTION END

Diagnosis Procedure

INFOID:000000005631649

WARNING:

- Before servicing, turn ignition switch OFF, disconnect battery negative terminal, and wait at least 3 minutes or more. (To discharge backup capacitor.)
- Never use unspecified tester or other measuring device.

1.CHECK HARNESS CONNECTOR

Check the harness connector.

Is the inspection result normal?

- YES >> GO TO 2.
NO >> Replace harness connector.

2.CHECK WIRING HARNESS

Check the wiring harness externals.

Is the inspection result normal?

- YES >> GO TO 3.
NO >> Replace wiring harness.

3.REPLACE AIR BAG DIAGNOSIS SENSOR UNIT

1. Replace air bag diagnosis sensor unit. Refer to [SR-29, "Exploded View"](#).
2. Perform DTC confirmation procedure. Refer to [SRC-165, "DTC Logic"](#).

Is DTC detected?

- YES >> GO TO 4.
NO >> INSPECTION END

B1259 DOOR-MOUNTED CURTAIN AIR BAG MODULE RH

< DTC/CIRCUIT DIAGNOSIS >

4. REPLACE DOOR-MOUNTED CURTAIN AIR BAG MODULE

1. Replace door-mounted curtain air bag module RH. Refer to [SR-19, "Exploded View"](#)
2. Perform DTC confirmation procedure. Refer to [SRC-165, "DTC Logic"](#).

Is DTC detected?

- YES >> GO TO 1.
NO >> INSPECTION END

B1260 DOOR-MOUNTED CURTAIN AIR BAG MODULE RH

< DTC/CIRCUIT DIAGNOSIS >

B1260 DOOR-MOUNTED CURTAIN AIR BAG MODULE RH

Description

INFOID:000000005631650

In case of side collision where acceleration is more than the specified level, the ignition materials are ignited by electric ignition system. The system burns the gas generating materials resulting in a chemical reaction. This generates hot gases that flow into the air bag through a filter and expand the bag.

DTC Logic

INFOID:000000005631651

DTC DETECTION LOGIC

DTC	Display contents of CONSULT-III	DTC detecting condition	Possible cause
B1260	FR-RH DOOR MNT MODULE [SHORT]	Door-mounted curtain air bag module RH circuits are shorted to each other	<ul style="list-style-type: none">Disconnection of wiring harness and shortMalfunction in door-mounted curtain air bag module RHMalfunction in air bag diagnosis sensor unit

DTC CONFIRMATION PROCEDURE

1.CHECK SELF-DIAG RESULT

With CONSULT-III

- Turn ignition switch ON.
- Perform "AIR BAG" Self Diagnostic Result.

Without CONSULT-III

- Turn ignition switch ON.
- Check the air bag warning lamp status. Refer to [SRC-15, "Diagnosis with Air Bag Warning Lamp"](#).

NOTE:

SRS does not enter the diagnosis mode if no malfunction is detected in the user mode.

Is malfunctioning part detected?

- YES >> Refer to [SRC-167, "Diagnosis Procedure"](#).
NO >> INSPECTION END

Diagnosis Procedure

INFOID:000000005631652

WARNING:

- Before servicing, turn ignition switch OFF, disconnect battery negative terminal, and wait at least 3 minutes or more. (To discharge backup capacitor.)
- Never use unspecified tester or other measuring device.

1.CHECK HARNESS CONNECTOR

Check the harness connector.

Is the inspection result normal?

- YES >> GO TO 2.
NO >> Replace harness connector.

2.CHECK WIRING HARNESS

Check the wiring harness externals.

Is the inspection result normal?

- YES >> GO TO 3.
NO >> Replace wiring harness.

3.REPLACE AIR BAG DIAGNOSIS SENSOR UNIT

- Replace air bag diagnosis sensor unit. Refer to [SR-29, "Exploded View"](#).
- Perform DTC confirmation procedure. Refer to [SRC-167, "DTC Logic"](#).

Is DTC detected?

- YES >> GO TO 4.
NO >> INSPECTION END

B1260 DOOR-MOUNTED CURTAIN AIR BAG MODULE RH

< DTC/CIRCUIT DIAGNOSIS >

4. REPLACE DOOR-MOUNTED CURTAIN AIR BAG MODULE

1. Replace door-mounted curtain air bag module RH. Refer to [SR-19, "Exploded View"](#)
2. Perform DTC confirmation procedure. Refer to [SRC-167, "DTC Logic"](#).

Is DTC detected?

- YES >> GO TO 1.
NO >> INSPECTION END

B1262 DOOR-MOUNTED CURTAIN AIR BAG MODULE LH

< DTC/CIRCUIT DIAGNOSIS >

B1262 DOOR-MOUNTED CURTAIN AIR BAG MODULE LH

Description

INFOID:000000005631653

In case of side collision where acceleration is more than the specified level, the ignition materials are ignited by electric ignition system. The system burns the gas generating materials resulting in a chemical reaction. This generates hot gases that flow into the air bag through a filter and expand the bag.

DTC Logic

INFOID:000000005631654

DTC DETECTION LOGIC

DTC	Display contents of CONSULT-III	DTC detecting condition	Possible cause
B1262	FR-LH DOOR MNT MODULE [OPEN]	Door-mounted curtain air bag module LH circuit is open	<ul style="list-style-type: none">• Disconnection of wiring harness and open• Malfunction in door-mounted curtain air bag module LH• Malfunction in air bag diagnosis sensor unit

DTC CONFIRMATION PROCEDURE

1. CHECK SELF-DIAG RESULT

With CONSULT-III

1. Turn ignition switch ON.
2. Perform "AIR BAG" Self Diagnostic Result.

Without CONSULT-III

1. Turn ignition switch ON.
2. Check the air bag warning lamp status. Refer to [SRC-15, "Diagnosis with Air Bag Warning Lamp"](#).

NOTE:

SRS does not enter the diagnosis mode if no malfunction is detected in the user mode.

Is malfunctioning part detected?

- YES >> Refer to [SRC-169, "Diagnosis Procedure"](#).
NO >> INSPECTION END

Diagnosis Procedure

INFOID:000000005631655

WARNING:

- Before servicing, turn ignition switch OFF, disconnect battery negative terminal, and wait at least 3 minutes or more. (To discharge backup capacitor.)
- Never use unspecified tester or other measuring device.

1. CHECK HARNESS CONNECTOR

Check the harness connector.

Is the inspection result normal?

- YES >> GO TO 2.
NO >> Replace harness connector.

2. CHECK WIRING HARNESS

Check the wiring harness externals.

Is the inspection result normal?

- YES >> GO TO 3.
NO >> Replace wiring harness.

3. REPLACE AIR BAG DIAGNOSIS SENSOR UNIT

1. Replace air bag diagnosis sensor unit. Refer to [SR-29, "Exploded View"](#).
2. Perform DTC confirmation procedure. Refer to [SRC-169, "DTC Logic"](#).

Is DTC detected?

- YES >> GO TO 4.
NO >> INSPECTION END

B1262 DOOR-MOUNTED CURTAIN AIR BAG MODULE LH

< DTC/CIRCUIT DIAGNOSIS >

4. REPLACE DOOR-MOUNTED CURTAIN AIR BAG MODULE

1. Replace door-mounted curtain air bag module LH. Refer to [SR-19, "Exploded View"](#)y
2. Perform DTC confirmation procedure. Refer to [SRC-169, "DTC Logic"](#).

Is DTC detected?

- YES >> GO TO 1.
NO >> INSPECTION END

B1263 DOOR-MOUNTED CURTAIN AIR BAG MODULE LH

< DTC/CIRCUIT DIAGNOSIS >

B1263 DOOR-MOUNTED CURTAIN AIR BAG MODULE LH

Description

INFOID:000000005631656

In case of side collision where acceleration is more than the specified level, the ignition materials are ignited by electric ignition system. The system burns the gas generating materials resulting in a chemical reaction. This generates hot gases that flow into the air bag through a filter and expand the bag.

DTC Logic

INFOID:000000005631657

DTC DETECTION LOGIC

DTC	Display contents of CONSULT-III	DTC detecting condition	Possible cause
B1263	FR-LH DOOR MNT MODULE [VB-SHORT]	Door-mounted curtain air bag module LH circuit is shorted to power supply circuit	<ul style="list-style-type: none"> Disconnection of wiring harness and short Malfunction in door-mounted curtain air bag module LH Malfunction in air bag diagnosis sensor unit

DTC CONFIRMATION PROCEDURE

1.CHECK SELF-DIAG RESULT

With CONSULT-III

- Turn ignition switch ON.
- Perform "AIR BAG" Self Diagnostic Result.

Without CONSULT-III

- Turn ignition switch ON.
- Check the air bag warning lamp status. Refer to [SRC-15, "Diagnosis with Air Bag Warning Lamp"](#).

NOTE:

SRS does not enter the diagnosis mode if no malfunction is detected in the user mode.

Is malfunctioning part detected?

- YES >> Refer to [SRC-171, "Diagnosis Procedure"](#).
 NO >> INSPECTION END

Diagnosis Procedure

INFOID:000000005631658

WARNING:

- Before servicing, turn ignition switch OFF, disconnect battery negative terminal, and wait at least 3 minutes or more. (To discharge backup capacitor.)
- Never use unspecified tester or other measuring device.

1.CHECK HARNESS CONNECTOR

Check the harness connector.

Is the inspection result normal?

- YES >> GO TO 2.
 NO >> Replace harness connector.

2.CHECK WIRING HARNESS

Check the wiring harness externals.

Is the inspection result normal?

- YES >> GO TO 3.
 NO >> Replace wiring harness.

3.REPLACE AIR BAG DIAGNOSIS SENSOR UNIT

- Replace air bag diagnosis sensor unit. Refer to [SR-29, "Exploded View"](#).
- Perform DTC confirmation procedure. Refer to [SRC-171, "DTC Logic"](#).

Is DTC detected?

- YES >> GO TO 4.
 NO >> INSPECTION END

B1263 DOOR-MOUNTED CURTAIN AIR BAG MODULE LH

< DTC/CIRCUIT DIAGNOSIS >

4. REPLACE DOOR-MOUNTED CURTAIN AIR BAG MODULE

1. Replace door-mounted curtain air bag module LH. Refer to [SR-19, "Exploded View"](#)
2. Perform DTC confirmation procedure. Refer to [SRC-171, "DTC Logic"](#).

Is DTC detected?

- YES >> GO TO 1.
NO >> INSPECTION END

B1264 DOOR-MOUNTED CURTAIN AIR BAG MODULE LH

< DTC/CIRCUIT DIAGNOSIS >

B1264 DOOR-MOUNTED CURTAIN AIR BAG MODULE LH

Description

INFOID:000000005631659

In case of side collision where acceleration is more than the specified level, the ignition materials are ignited by electric ignition system. The system burns the gas generating materials resulting in a chemical reaction. This generates hot gases that flow into the air bag through a filter and expand the bag.

DTC Logic

INFOID:000000005631660

DTC DETECTION LOGIC

DTC	Display contents of CONSULT-III	DTC detecting condition	Possible cause
B1264	FR-LH DOOR MNT MODULE [GND-SHORT]	Door-mounted curtain air bag module LH circuit is shorted to ground	<ul style="list-style-type: none">• Disconnection of wiring harness and short• Malfunction in door-mounted curtain air bag module LH• Malfunction in air bag diagnosis sensor unit

DTC CONFIRMATION PROCEDURE

1. CHECK SELF-DIAG RESULT

With CONSULT-III

1. Turn ignition switch ON.
2. Perform "AIR BAG" Self Diagnostic Result.

Without CONSULT-III

1. Turn ignition switch ON.
2. Check the air bag warning lamp status. Refer to [SRC-15, "Diagnosis with Air Bag Warning Lamp"](#).

NOTE:

SRS does not enter the diagnosis mode if no malfunction is detected in the user mode.

Is malfunctioning part detected?

- YES >> Refer to [SRC-173, "Diagnosis Procedure"](#).
NO >> INSPECTION END

Diagnosis Procedure

INFOID:000000005631661

WARNING:

- Before servicing, turn ignition switch OFF, disconnect battery negative terminal, and wait at least 3 minutes or more. (To discharge backup capacitor.)
- Never use unspecified tester or other measuring device.

1. CHECK HARNESS CONNECTOR

Check the harness connector.

Is the inspection result normal?

- YES >> GO TO 2.
NO >> Replace harness connector.

2. CHECK WIRING HARNESS

Check the wiring harness externals.

Is the inspection result normal?

- YES >> GO TO 3.
NO >> Replace wiring harness.

3. REPLACE AIR BAG DIAGNOSIS SENSOR UNIT

1. Replace air bag diagnosis sensor unit. Refer to [SR-29, "Exploded View"](#).
2. Perform DTC confirmation procedure. Refer to [SRC-173, "DTC Logic"](#).

Is DTC detected?

- YES >> GO TO 4.
NO >> INSPECTION END

B1264 DOOR-MOUNTED CURTAIN AIR BAG MODULE LH

< DTC/CIRCUIT DIAGNOSIS >

4. REPLACE DOOR-MOUNTED CURTAIN AIR BAG MODULE

1. Replace door-mounted curtain air bag module LH. Refer to [SR-19, "Exploded View"](#)
2. Perform DTC confirmation procedure. Refer to [SRC-173, "DTC Logic"](#).

Is DTC detected?

- YES >> GO TO 1.
NO >> INSPECTION END

B1265 DOOR-MOUNTED CURTAIN AIR BAG MODULE LH

< DTC/CIRCUIT DIAGNOSIS >

B1265 DOOR-MOUNTED CURTAIN AIR BAG MODULE LH

Description

INFOID:000000005631662

In case of side collision where acceleration is more than the specified level, the ignition materials are ignited by electric ignition system. The system burns the gas generating materials resulting in a chemical reaction. This generates hot gases that flow into the air bag through a filter and expand the bag.

DTC Logic

INFOID:000000005631663

DTC DETECTION LOGIC

DTC	Display contents of CONSULT-III	DTC detecting condition	Possible cause
B1265	FR-LH DOOR MNT MODULE [SHORT]	Door-mounted curtain air bag module LH circuits are shorted to each other	<ul style="list-style-type: none"> • Disconnection of wiring harness and short • Malfunction in door-mounted curtain air bag module LH • Malfunction in air bag diagnosis sensor unit

DTC CONFIRMATION PROCEDURE

1. CHECK SELF-DIAG RESULT

With CONSULT-III

1. Turn ignition switch ON.
2. Perform "AIR BAG" Self Diagnostic Result.

Without CONSULT-III

1. Turn ignition switch ON.
2. Check the air bag warning lamp status. Refer to [SRC-15, "Diagnosis with Air Bag Warning Lamp"](#).

NOTE:

SRS does not enter the diagnosis mode if no malfunction is detected in the user mode.

Is malfunctioning part detected?

- YES >> Refer to [SRC-175, "Diagnosis Procedure"](#).
 NO >> INSPECTION END

Diagnosis Procedure

INFOID:000000005631664

WARNING:

- Before servicing, turn ignition switch OFF, disconnect battery negative terminal, and wait at least 3 minutes or more. (To discharge backup capacitor.)
- Never use unspecified tester or other measuring device.

1. CHECK HARNESS CONNECTOR

Check the harness connector.

Is the inspection result normal?

- YES >> GO TO 2.
 NO >> Replace harness connector.

2. CHECK WIRING HARNESS

Check the wiring harness externals.

Is the inspection result normal?

- YES >> GO TO 3.
 NO >> Replace wiring harness.

3. REPLACE AIR BAG DIAGNOSIS SENSOR UNIT

1. Replace air bag diagnosis sensor unit. Refer to [SR-29, "Exploded View"](#).
2. Perform DTC confirmation procedure. Refer to [SRC-175, "DTC Logic"](#).

Is DTC detected?

- YES >> GO TO 4.
 NO >> INSPECTION END

B1265 DOOR-MOUNTED CURTAIN AIR BAG MODULE LH

< DTC/CIRCUIT DIAGNOSIS >

4. REPLACE DOOR-MOUNTED CURTAIN AIR BAG MODULE

1. Replace door-mounted curtain air bag module LH. Refer to [SR-19, "Exploded View"](#)
2. Perform DTC confirmation procedure. Refer to [SRC-175, "DTC Logic"](#).

Is DTC detected?

YES >> GO TO 1.

NO >> INSPECTION END

B1289 POP-UP ROLL BAR RH

< DTC/CIRCUIT DIAGNOSIS >

B1289 POP-UP ROLL BAR RH

Description

INFOID:000000005631665

When diagnosis sensor unit detects acceleration that the vehicle rolls over in the lateral direction, pop-up roll bar is activated so that the heads of rear passengers are protected.

DTC Logic

INFOID:000000005631666

DTC DETECTION LOGIC

DTC	Display contents of CONSULT-III	DTC detecting condition	Possible cause
B1289	RH POP-UP BAR [OPEN]	Pop-up roll bar RH circuit is open	<ul style="list-style-type: none">• Disconnection of wiring harness and open• Malfunction in pop-up roll bar RH• Malfunction in air bag diagnosis sensor unit

DTC CONFIRMATION PROCEDURE

1. CHECK SELF-DIAG RESULT

With CONSULT-III

1. Turn ignition switch ON.
2. Perform "AIR BAG" Self Diagnostic Result.

Without CONSULT-III

1. Turn ignition switch ON.
2. Check the air bag warning lamp status. Refer to [SRC-15. "Diagnosis with Air Bag Warning Lamp"](#).

NOTE:

SRS does not enter the diagnosis mode if no malfunction is detected in the user mode.

Is malfunctioning part detected?

- YES >> Refer to [SRC-177. "Diagnosis Procedure"](#).
NO >> INSPECTION END

Diagnosis Procedure

INFOID:000000005631667

WARNING:

- Before servicing, turn ignition switch OFF, disconnect battery negative terminal, and wait at least 3 minutes or more. (To discharge backup capacitor.)
- Never use unspecified tester or other measuring device.

1. CHECK HARNESS CONNECTOR

Check the harness connector.

Is the inspection result normal?

- YES >> GO TO 2.
NO >> Replace harness connector.

2. CHECK WIRING HARNESS

Check the wiring harness externals.

Is the inspection result normal?

- YES >> GO TO 3.
NO >> Replace wiring harness.

3. REPLACE AIR BAG DIAGNOSIS SENSOR UNIT

1. Replace air bag diagnosis sensor unit. Refer to [SR-29. "Exploded View"](#).
2. Perform DTC confirmation procedure. Refer to [SRC-177. "DTC Logic"](#).

Is DTC detected?

- YES >> GO TO 4.
NO >> INSPECTION END

4. REPLACE POP-UP ROLL BAR

A
B
C
D
E
F
G
I
J
K
L
M
N
O
P

SRC

B1289 POP-UP ROLL BAR RH

< DTC/CIRCUIT DIAGNOSIS >

1. Replace pop-up roll bar RH. Refer to [SR-21, "Exploded View"](#).
2. Perform DTC confirmation procedure. Refer to [SRC-177, "DTC Logic"](#).

Is DTC detected?

YES >> GO TO 1.

NO >> INSPECTION END

B1290 POP-UP ROLL BAR RH

< DTC/CIRCUIT DIAGNOSIS >

B1290 POP-UP ROLL BAR RH

Description

INFOID:000000005631668

When diagnosis sensor unit detects acceleration that the vehicle rolls over in the lateral direction, pop-up roll bar is activated so that the heads of rear passengers are protected.

DTC Logic

INFOID:000000005631669

DTC DETECTION LOGIC

DTC	Display contents of CONSULT-III	DTC detecting condition	Possible cause
B1290	RH POP-UP BAR [VB-SHORT]	Pop-up roll bar RH circuit is shorted to power supply circuit	<ul style="list-style-type: none">• Disconnection of wiring harness and short• Malfunction in pop-up roll bar RH• Malfunction in air bag diagnosis sensor unit

DTC CONFIRMATION PROCEDURE

1.CHECK SELF-DIAG RESULT

With CONSULT-III

1. Turn ignition switch ON.
2. Perform "AIR BAG" Self Diagnostic Result.

Without CONSULT-III

1. Turn ignition switch ON.
2. Check the air bag warning lamp status. Refer to [SRC-15. "Diagnosis with Air Bag Warning Lamp"](#).

NOTE:

SRS does not enter the diagnosis mode if no malfunction is detected in the user mode.

Is malfunctioning part detected?

- YES >> Refer to [SRC-179. "Diagnosis Procedure"](#).
NO >> INSPECTION END

Diagnosis Procedure

INFOID:000000005631670

WARNING:

- Before servicing, turn ignition switch OFF, disconnect battery negative terminal, and wait at least 3 minutes or more. (To discharge backup capacitor.)
- Never use unspecified tester or other measuring device.

1.CHECK HARNESS CONNECTOR

Check the harness connector.

Is the inspection result normal?

- YES >> GO TO 2.
NO >> Replace harness connector.

2.CHECK WIRING HARNESS

Check the wiring harness externals.

Is the inspection result normal?

- YES >> GO TO 3.
NO >> Replace wiring harness.

3.REPLACE AIR BAG DIAGNOSIS SENSOR UNIT

1. Replace air bag diagnosis sensor unit. Refer to [SR-29. "Exploded View"](#).
2. Perform DTC confirmation procedure. Refer to [SRC-179. "DTC Logic"](#).

Is DTC detected?

- YES >> GO TO 4.
NO >> INSPECTION END

4.REPLACE POP-UP ROLL BAR

B1290 POP-UP ROLL BAR RH

< DTC/CIRCUIT DIAGNOSIS >

1. Replace pop-up roll bar RH. Refer to [SR-21, "Exploded View"](#).
2. Perform DTC confirmation procedure. Refer to [SRC-179, "DTC Logic"](#).

Is DTC detected?

- YES >> GO TO 1.
NO >> INSPECTION END

B1291 POP-UP ROLL BAR RH

< DTC/CIRCUIT DIAGNOSIS >

B1291 POP-UP ROLL BAR RH

Description

INFOID:000000005631671

When diagnosis sensor unit detects acceleration that the vehicle rolls over in the lateral direction, pop-up roll bar is activated so that the heads of rear passengers are protected.

DTC Logic

INFOID:000000005631672

DTC DETECTION LOGIC

DTC	Display contents of CONSULT-III	DTC detecting condition	Possible cause
B1291	RH POP-UP BAR [GND-SHORT]	Pop-up roll bar RH circuit is shorted to ground	<ul style="list-style-type: none">• Disconnection of wiring harness and short• Malfunction in pop-up roll bar RH• Malfunction in air bag diagnosis sensor unit

DTC CONFIRMATION PROCEDURE

1. CHECK SELF-DIAG RESULT

With CONSULT-III

1. Turn ignition switch ON.
2. Perform "AIR BAG" Self Diagnostic Result.

Without CONSULT-III

1. Turn ignition switch ON.
2. Check the air bag warning lamp status. Refer to [SRC-15. "Diagnosis with Air Bag Warning Lamp"](#).

NOTE:

SRS does not enter the diagnosis mode if no malfunction is detected in the user mode.

Is malfunctioning part detected?

- YES >> Refer to [SRC-181. "Diagnosis Procedure"](#).
NO >> INSPECTION END

Diagnosis Procedure

INFOID:000000005631673

WARNING:

- Before servicing, turn ignition switch OFF, disconnect battery negative terminal, and wait at least 3 minutes or more. (To discharge backup capacitor.)
- Never use unspecified tester or other measuring device.

1. CHECK HARNESS CONNECTOR

Check the harness connector.

Is the inspection result normal?

- YES >> GO TO 2.
NO >> Replace harness connector.

2. CHECK WIRING HARNESS

Check the wiring harness externals.

Is the inspection result normal?

- YES >> GO TO 3.
NO >> Replace wiring harness.

3. REPLACE AIR BAG DIAGNOSIS SENSOR UNIT

1. Replace air bag diagnosis sensor unit. Refer to [SR-29. "Exploded View"](#).
2. Perform DTC confirmation procedure. Refer to [SRC-181. "DTC Logic"](#).

Is DTC detected?

- YES >> GO TO 4.
NO >> INSPECTION END

4. REPLACE POP-UP ROLL BAR

B1291 POP-UP ROLL BAR RH

< DTC/CIRCUIT DIAGNOSIS >

1. Replace pop-up roll bar RH. Refer to [SR-21, "Exploded View"](#).
2. Perform DTC confirmation procedure. Refer to [SRC-181, "DTC Logic"](#).

Is DTC detected?

- YES >> GO TO 1.
NO >> INSPECTION END

B1292 POP-UP ROLL BAR RH

< DTC/CIRCUIT DIAGNOSIS >

B1292 POP-UP ROLL BAR RH

Description

INFOID:000000005631674

When diagnosis sensor unit detects acceleration that the vehicle rolls over in the lateral direction, pop-up roll bar is activated so that the heads of rear passengers are protected.

DTC Logic

INFOID:000000005631675

DTC DETECTION LOGIC

DTC	Display contents of CONSULT-III	DTC detecting condition	Possible cause
B1292	RH POP-UP BAR [SHORT]	Pop-up roll bar RH circuits are shorted to each other	<ul style="list-style-type: none">• Disconnection of wiring harness and short• Malfunction in pop-up roll bar RH• Malfunction in air bag diagnosis sensor unit

DTC CONFIRMATION PROCEDURE

1. CHECK SELF-DIAG RESULT

With CONSULT-III

1. Turn ignition switch ON.
2. Perform "AIR BAG" Self Diagnostic Result.

Without CONSULT-III

1. Turn ignition switch ON.
2. Check the air bag warning lamp status. Refer to [SRC-15. "Diagnosis with Air Bag Warning Lamp"](#).

NOTE:

SRS does not enter the diagnosis mode if no malfunction is detected in the user mode.

Is malfunctioning part detected?

- YES >> Refer to [SRC-183. "Diagnosis Procedure"](#).
NO >> INSPECTION END

Diagnosis Procedure

INFOID:000000005631676

WARNING:

- Before servicing, turn ignition switch OFF, disconnect battery negative terminal, and wait at least 3 minutes or more. (To discharge backup capacitor.)
- Never use unspecified tester or other measuring device.

1. CHECK HARNESS CONNECTOR

Check the harness connector.

Is the inspection result normal?

- YES >> GO TO 2.
NO >> Replace harness connector.

2. CHECK WIRING HARNESS

Check the wiring harness externals.

Is the inspection result normal?

- YES >> GO TO 3.
NO >> Replace wiring harness.

3. REPLACE AIR BAG DIAGNOSIS SENSOR UNIT

1. Replace air bag diagnosis sensor unit. Refer to [SR-29. "Exploded View"](#).
2. Perform DTC confirmation procedure. Refer to [SRC-183. "DTC Logic"](#).

Is DTC detected?

- YES >> GO TO 4.
NO >> INSPECTION END

4. REPLACE POP-UP ROLL BAR

B1292 POP-UP ROLL BAR RH

< DTC/CIRCUIT DIAGNOSIS >

1. Replace pop-up roll bar RH. Refer to [SR-21, "Exploded View"](#).
2. Perform DTC confirmation procedure. Refer to [SRC-183, "DTC Logic"](#).

Is DTC detected?

- YES >> GO TO 1.
NO >> INSPECTION END

B1294 POP-UP ROLL BAR LH

< DTC/CIRCUIT DIAGNOSIS >

B1294 POP-UP ROLL BAR LH

Description

INFOID:000000005631677

When diagnosis sensor unit detects acceleration that the vehicle rolls over in the lateral direction, pop-up roll bar is activated so that the heads of rear passengers are protected.

DTC Logic

INFOID:000000005631678

DTC DETECTION LOGIC

DTC	Display contents of CONSULT-III	DTC detecting condition	Possible cause
B1294	LH POP-UP BAR [OPEN]	Pop-up roll bar LH circuit is open	<ul style="list-style-type: none">• Disconnection of wiring harness and open• Malfunction in pop-up roll bar LH• Malfunction in air bag diagnosis sensor unit

DTC CONFIRMATION PROCEDURE

1.CHECK SELF-DIAG RESULT

With CONSULT-III

1. Turn ignition switch ON.
2. Perform "AIR BAG" Self Diagnostic Result.

Without CONSULT-III

1. Turn ignition switch ON.
2. Check the air bag warning lamp status. Refer to [SRC-15. "Diagnosis with Air Bag Warning Lamp"](#).

NOTE:

SRS does not enter the diagnosis mode if no malfunction is detected in the user mode.

Is malfunctioning part detected?

- YES >> Refer to [SRC-185. "Diagnosis Procedure"](#).
NO >> INSPECTION END

Diagnosis Procedure

INFOID:000000005631679

WARNING:

- Before servicing, turn ignition switch OFF, disconnect battery negative terminal, and wait at least 3 minutes or more. (To discharge backup capacitor.)
- Never use unspecified tester or other measuring device.

1.CHECK HARNESS CONNECTOR

Check the harness connector.

Is the inspection result normal?

- YES >> GO TO 2.
NO >> Replace harness connector.

2.CHECK WIRING HARNESS

Check the wiring harness externals.

Is the inspection result normal?

- YES >> GO TO 3.
NO >> Replace wiring harness.

3.REPLACE AIR BAG DIAGNOSIS SENSOR UNIT

1. Replace air bag diagnosis sensor unit. Refer to [SR-29. "Exploded View"](#).
2. Perform DTC confirmation procedure. Refer to [SRC-185. "DTC Logic"](#).

Is DTC detected?

- YES >> GO TO 4.
NO >> INSPECTION END

4.REPLACE POP-UP ROLL BAR

B1294 POP-UP ROLL BAR LH

< DTC/CIRCUIT DIAGNOSIS >

1. Replace pop-up roll bar LH. Refer to [SR-21, "Exploded View"](#).
2. Perform DTC confirmation procedure. Refer to [SRC-185, "DTC Logic"](#).

Is DTC detected?

- YES >> GO TO 1.
NO >> INSPECTION END

B1295 POP-UP ROLL BAR LH

< DTC/CIRCUIT DIAGNOSIS >

B1295 POP-UP ROLL BAR LH

Description

INFOID:000000005631680

When diagnosis sensor unit detects acceleration that the vehicle rolls over in the lateral direction, pop-up roll bar is activated so that the heads of rear passengers are protected.

DTC Logic

INFOID:000000005631681

DTC DETECTION LOGIC

DTC	Display contents of CONSULT-III	DTC detecting condition	Possible cause
B1295	LH POP-UP BAR [VB-SHORT]	Pop-up roll bar LH circuit is shorted to power supply circuit	<ul style="list-style-type: none">• Disconnection of wiring harness and short• Malfunction in pop-up roll bar LH• Malfunction in air bag diagnosis sensor unit

DTC CONFIRMATION PROCEDURE

1.CHECK SELF-DIAG RESULT

With CONSULT-III

1. Turn ignition switch ON.
2. Perform "AIR BAG" Self Diagnostic Result.

Without CONSULT-III

1. Turn ignition switch ON.
2. Check the air bag warning lamp status. Refer to [SRC-15. "Diagnosis with Air Bag Warning Lamp"](#).

NOTE:

SRS does not enter the diagnosis mode if no malfunction is detected in the user mode.

Is malfunctioning part detected?

- YES >> Refer to [SRC-187. "Diagnosis Procedure"](#).
NO >> INSPECTION END

Diagnosis Procedure

INFOID:000000005631682

WARNING:

- Before servicing, turn ignition switch OFF, disconnect battery negative terminal, and wait at least 3 minutes or more. (To discharge backup capacitor.)
- Never use unspecified tester or other measuring device.

1.CHECK HARNESS CONNECTOR

Check the harness connector.

Is the inspection result normal?

- YES >> GO TO 2.
NO >> Replace harness connector.

2.CHECK WIRING HARNESS

Check the wiring harness externals.

Is the inspection result normal?

- YES >> GO TO 3.
NO >> Replace wiring harness.

3.REPLACE AIR BAG DIAGNOSIS SENSOR UNIT

1. Replace air bag diagnosis sensor unit. Refer to [SR-29. "Exploded View"](#).
2. Perform DTC confirmation procedure. Refer to [SRC-187. "DTC Logic"](#).

Is DTC detected?

- YES >> GO TO 4.
NO >> INSPECTION END

4.REPLACE POP-UP ROLL BAR

B1295 POP-UP ROLL BAR LH

< DTC/CIRCUIT DIAGNOSIS >

1. Replace pop-up roll bar LH. Refer to [SR-21, "Exploded View"](#).
2. Perform DTC confirmation procedure. Refer to [SRC-187, "DTC Logic"](#).

Is DTC detected?

- YES >> GO TO 1.
NO >> INSPECTION END

B1296 POP-UP ROLL BAR LH

< DTC/CIRCUIT DIAGNOSIS >

B1296 POP-UP ROLL BAR LH

Description

INFOID:000000005631683

When diagnosis sensor unit detects acceleration that the vehicle rolls over in the lateral direction, pop-up roll bar is activated so that the heads of rear passengers are protected.

DTC Logic

INFOID:000000005631684

DTC DETECTION LOGIC

DTC	Display contents of CONSULT-III	DTC detecting condition	Possible cause
B1296	LH POP-UP BAR [GND-SHORT]	Pop-up roll bar LH circuit is shorted to ground	<ul style="list-style-type: none">• Disconnection of wiring harness and short• Malfunction in pop-up roll bar LH• Malfunction in air bag diagnosis sensor unit

DTC CONFIRMATION PROCEDURE

1. CHECK SELF-DIAG RESULT

With CONSULT-III

1. Turn ignition switch ON.
2. Perform "AIR BAG" Self Diagnostic Result.

Without CONSULT-III

1. Turn ignition switch ON.
2. Check the air bag warning lamp status. Refer to [SRC-15. "Diagnosis with Air Bag Warning Lamp"](#).

NOTE:

SRS does not enter the diagnosis mode if no malfunction is detected in the user mode.

Is malfunctioning part detected?

- YES >> Refer to [SRC-189. "Diagnosis Procedure"](#).
NO >> INSPECTION END

Diagnosis Procedure

INFOID:000000005631685

WARNING:

- Before servicing, turn ignition switch OFF, disconnect battery negative terminal, and wait at least 3 minutes or more. (To discharge backup capacitor.)
- Never use unspecified tester or other measuring device.

1. CHECK HARNESS CONNECTOR

Check the harness connector.

Is the inspection result normal?

- YES >> GO TO 2.
NO >> Replace harness connector.

2. CHECK WIRING HARNESS

Check the wiring harness externals.

Is the inspection result normal?

- YES >> GO TO 3.
NO >> Replace wiring harness.

3. REPLACE AIR BAG DIAGNOSIS SENSOR UNIT

1. Replace air bag diagnosis sensor unit. Refer to [SR-29. "Exploded View"](#).
2. Perform DTC confirmation procedure. Refer to [SRC-189. "DTC Logic"](#).

Is DTC detected?

- YES >> GO TO 4.
NO >> INSPECTION END

4. REPLACE POP-UP ROLL BAR

B1296 POP-UP ROLL BAR LH

< DTC/CIRCUIT DIAGNOSIS >

1. Replace pop-up roll bar LH. Refer to [SR-21, "Exploded View"](#).
2. Perform DTC confirmation procedure. Refer to [SRC-189, "DTC Logic"](#).

Is DTC detected?

- YES >> GO TO 1.
NO >> INSPECTION END

B1297 POP-UP ROLL BAR LH

< DTC/CIRCUIT DIAGNOSIS >

B1297 POP-UP ROLL BAR LH

Description

INFOID:000000005631686

When diagnosis sensor unit detects acceleration that the vehicle rolls over in the lateral direction, pop-up roll bar is activated so that the heads of rear passengers are protected.

DTC Logic

INFOID:000000005631687

DTC DETECTION LOGIC

DTC	Display contents of CONSULT-III	DTC detecting condition	Possible cause
B1297	LH POP-UP BAR [SHORT]	Pop-up roll bar LH circuits are shorted to each other	<ul style="list-style-type: none">• Disconnection of wiring harness and short• Malfunction in pop-up roll bar LH• Malfunction in air bag diagnosis sensor unit

DTC CONFIRMATION PROCEDURE

1.CHECK SELF-DIAG RESULT

With CONSULT-III

1. Turn ignition switch ON.
2. Perform "AIR BAG" Self Diagnostic Result.

Without CONSULT-III

1. Turn ignition switch ON.
2. Check the air bag warning lamp status. Refer to [SRC-15. "Diagnosis with Air Bag Warning Lamp"](#).

NOTE:

SRS does not enter the diagnosis mode if no malfunction is detected in the user mode.

Is malfunctioning part detected?

- YES >> Refer to [SRC-191. "Diagnosis Procedure"](#).
NO >> INSPECTION END

Diagnosis Procedure

INFOID:000000005631688

WARNING:

- Before servicing, turn ignition switch OFF, disconnect battery negative terminal, and wait at least 3 minutes or more. (To discharge backup capacitor.)
- Never use unspecified tester or other measuring device.

1.CHECK HARNESS CONNECTOR

Check the harness connector.

Is the inspection result normal?

- YES >> GO TO 2.
NO >> Replace harness connector.

2.CHECK WIRING HARNESS

Check the wiring harness externals.

Is the inspection result normal?

- YES >> GO TO 3.
NO >> Replace wiring harness.

3.REPLACE AIR BAG DIAGNOSIS SENSOR UNIT

1. Replace air bag diagnosis sensor unit. Refer to [SR-29. "Exploded View"](#).
2. Perform DTC confirmation procedure. Refer to [SRC-191. "DTC Logic"](#).

Is DTC detected?

- YES >> GO TO 4.
NO >> INSPECTION END

4.REPLACE POP-UP ROLL BAR

B1297 POP-UP ROLL BAR LH

< DTC/CIRCUIT DIAGNOSIS >

1. Replace pop-up roll bar LH. Refer to [SR-21, "Exploded View"](#).
2. Perform DTC confirmation procedure. Refer to [SRC-191, "DTC Logic"](#).

Is DTC detected?

- YES >> GO TO 1.
NO >> INSPECTION END

B1298 POP-UP ROLL BAR

< DTC/CIRCUIT DIAGNOSIS >

B1298 POP-UP ROLL BAR

Description

INFOID:000000005631689

The pop-up roll bar is activated by the air bag diagnosis sensor unit signal at the time of rollover.

DTC Logic

INFOID:000000005631690

DTC DETECTION LOGIC

DTC	Display contents of CONSULT-III	DTC detecting condition	Possible cause
B1298	POP-UP BAR [DEPLOYED]	Pop-up roll bar is deployed	—

DTC CONFIRMATION PROCEDURE

1.CHECK SELF-DIAG RESULT

With CONSULT-III

1. Turn ignition switch ON.
2. Perform "AIR BAG" Self Diagnostic Result.

Without CONSULT-III

1. Turn ignition switch ON.
2. Check the air bag warning lamp status. Refer to [SRC-15, "Diagnosis with Air Bag Warning Lamp"](#).

NOTE:

SRS does not enter the diagnosis mode if no malfunction is detected in the user mode.

Is malfunctioning part detected?

- YES >> Refer to [SRC-193, "Diagnosis Procedure"](#).
NO >> INSPECTION END

Diagnosis Procedure

INFOID:000000005631691

WARNING:

- Before servicing, turn ignition switch OFF, disconnect battery negative terminal, and wait at least 3 minutes or more. (To discharge backup capacitor)
- Never use unspecified tester or other measuring device.

DIAGNOSTIC PROCEDURE

1.CHECK POP-UP ROLL BAR

Check whether or not pop-up roll bar is activated in the past.

Is activation detected?

- YES >> Replace pop-up roll bar. Refer to [SR-21, "Exploded View"](#).
NO >> GO TO 2.

2.CHECK HARNESS CONNECTOR

Check the harness connector.

Is the inspection result normal?

- YES >> GO TO 3.
NO >> Replace harness connectors.

3.CHECK WIRING HARNESS

Check the wiring harness externals.

Is the inspection result normal?

- YES >> GO TO 4.
NO >> Replace wiring harness.

4.FINAL CHECK

Perform "AIR BAG" Self Diagnostic Result with CONSULT-III and/or air bag warning lamp status.

Is the inspection result normal?

A
B
C
D
E
F
G
I
J
K
L
M
N
O
P

SRC

B1298 POP-UP ROLL BAR

< DTC/CIRCUIT DIAGNOSIS >

YES >> INSPECTION END

NO >> Check the intermittent incident. Refer to [GI-37, "Intermittent Incident"](#).

DIAGNOSIS SENSOR UNIT

< ECU DIAGNOSIS INFORMATION >

ECU DIAGNOSIS INFORMATION

DIAGNOSIS SENSOR UNIT

DTC Index

INFOID:000000005631692

DTC	Diagnostic item	Explanation	Reference page
—	NO DTC IS DETECTED.	Low battery voltage (Less than 9 V)	SRC-21, "CONSULT-III Function" .
		When malfunction is indicated by the "AIR BAG" warning lamp in the user mode	Self-diagnostic result is not erased after repair
			Intermittent malfunction is detected in the past
		No malfunction is detected	—
U1000	CAN COMM CIRCUIT	CAN communication system malfunction	SRC-22, "DTC Logic"
U1010	CONTROL UNIT (CAN)	Air bag diagnosis sensor unit is malfunctioning	SRC-23, "DTC Logic"
B1001-B1015	CONTROL UNIT	Air bag diagnosis sensor unit is malfunctioning	<ul style="list-style-type: none"> SRC-24, "DTC Logic". SRC-26, "DTC Logic". SRC-28, "DTC Logic".
B1017 B1020 B1021	OCCUPANT SENS C/U [UNIT FAIL]	Malfunction occurs in Occupant Classification System control unit	SRC-30, "DTC Logic" .
B1018	OCCUPANT SENS [UNIT FAIL]	Malfunction occurs in Occupant Classification System sensor	SRC-32, "DTC Logic" .
B1022	OCCUPANT SENS C/U [COMM FAIL]	Malfunction occurs in Occupant Classification System control unit, circuit of Occupant Classification System control unit air bag diagnosis sensor unit, or air bag diagnosis sensor unit	SRC-34, "DTC Logic" .
B1023	PASS A/B INDCTR CKT	Passenger air bag OFF indicator circuit is open or shorted to ground or the circuits are shorted each other	SRC-36, "DTC Logic" .
B1025 B1032 B1048	OCS SENSOR	Malfunction occurs in Occupant Classification System control unit, circuit of Occupant Classification System control unit air bag diagnosis sensor unit, or air bag diagnosis sensor unit	SRC-38, "DTC Logic" .
B1026-B1031	CONTROL UNIT	Air bag diagnosis sensor unit is malfunctioning or out of the specified specification	SRC-40, "DTC Logic" .
B1033 B1034	CRASH ZONE SEN [UNIT FAIL]	Crash zone sensor is malfunctioning	SRC-42, "DTC Logic" .
B1035	CRASH ZONE SEN [COMM FAIL]	Crash zone sensor is malfunctioning	SRC-44, "DTC Logic" .
B1036	CRASH ZONE SEN [UNMATCH]	Crash zone sensor is out of the specified specification	SRC-46, "DTC Logic" .
B1037 B1039 B1041	CRASH ZONE SEN1	Crash zone sensor is malfunctioning	SRC-48, "DTC Logic" .
B1042-B1047	CONTROL UNIT	Air bag diagnosis sensor unit is malfunctioning	SRC-50, "DTC Logic" .

A

B

C

D

E

F

G

SRC

I

J

K

L

M

N

O

P

DIAGNOSIS SENSOR UNIT

< ECU DIAGNOSIS INFORMATION >

DTC	Diagnostic item	Explanation	Reference page
B1049 B1054	DRIVER AIRBAG MODULE [OPEN]	Driver air bag module circuit is open (including the spiral cable)	SRC-52, "DTC Logic" .
B1050 B1055	DRIVER AIRBAG MODULE [VB-SHORT]	Driver air bag module circuit is shorted to power supply circuit (including the spiral cable)	SRC-54, "DTC Logic" .
B1051 B1056	DRIVER AIRBAG MODULE [GND-SHORT]	Driver air bag module circuit is shorted to ground (including the spiral cable)	SRC-56, "DTC Logic" .
B1052 B1057	DRIVER AIRBAG MODULE [SHORT]	Driver air bag module circuits are shorted to each other (including spiral cable)	SRC-58, "DTC Logic" .
B1058-B1063	CONTROL UNIT	Air bag diagnosis sensor unit is malfunctioning	SRC-60, "DTC Logic" .
B1065 B1070	ASSIST A/B MODULE [OPEN]	Passenger air bag module circuit is open	SRC-62, "DTC Logic" .
B1066 B1071	ASSIST A/B MODULE [VB-SHORT]	Passenger air bag module circuit is shorted to power supply circuit	SRC-64, "DTC Logic" .
B1067 B1072	ASSIST A/B MODULE [GND-SHORT]	Passenger air bag module circuit is shorted to ground	SRC-66, "DTC Logic" .
B1068 B1073	ASSIST A/B MODULE [SHORT]	Passenger air bag module circuits are shorted to each other	SRC-68, "DTC Logic" .
B1074-B1079	CONTROL UNIT	Air bag diagnosis sensor unit is malfunctioning	SRC-70, "DTC Logic" .
B1080 B1096	DRIVER AIRBAG MODULE [SHORT]	Driver air bag module circuits are shorted to each other (including spiral cable)	SRC-72, "DTC Logic" .
B1081	PRE-TEN FRONT RH [OPEN]	Seat belt pre-tensioner RH circuit is open	SRC-74, "DTC Logic" .
B1082	PRE-TEN FRONT RH [VB-SHORT]	Seat belt pre-tensioner RH circuit is shorted to power supply circuit	SRC-76, "DTC Logic" .
B1083	PRE-TEN FRONT RH [GND-SHORT]	Seat belt pre-tensioner RH circuit is shorted to ground	SRC-78, "DTC Logic" .
B1084	PRE-TEN FRONT RH [SHORT]	Seat belt pre-tensioner RH circuits are shorted to each other	SRC-80, "DTC Logic" .
B1086	PRE-TEN FRONT LH [OPEN]	Seat belt pre-tensioner LH circuit is open	SRC-82, "DTC Logic" .
B1087	PRE-TEN FRONT LH [VB-SHORT]	Seat belt pre-tensioner LH circuit is shorted to power supply circuit	SRC-84, "DTC Logic" .
B1088	PRE-TEN FRONT LH [GND-SHORT]	Seat belt pre-tensioner LH circuit is shorted to ground	SRC-86, "DTC Logic" .
B1089	PRE-TEN FRONT LH [SHORT]	Seat belt pre-tensioner LH circuits are shorted to each other	SRC-88, "DTC Logic" .
B1090-B1095	CONTROL UNIT	Air bag diagnosis sensor unit is malfunctioning	SRC-90, "DTC Logic" .
B1106-B1111	CONTROL UNIT	Air bag diagnosis sensor unit is malfunctioning	SRC-92, "DTC Logic" .
B1113 B1114	SATELLITE SENS RH [UNIT FAIL]	Satellite sensor RH is malfunctioning	SRC-94, "DTC Logic" .
B1115	SATELLITE SENS RH [COMM FAIL]	Satellite sensor RH is malfunctioning	SRC-96, "DTC Logic" .
B1116	SATELLITE SENS RH [UNMATCH]	Satellite sensor RH is out of the specified specification	SRC-98, "DTC Logic" .
B1118 B1119	SATELLITE SENS LH [UNIT FAIL]	Satellite sensor LH is malfunctioning	SRC-100, "DTC Logic" .
B1120	SATELLITE SENS LH [COMM FAIL]	Satellite sensor RH is malfunctioning	SRC-102, "DTC Logic" .

DIAGNOSIS SENSOR UNIT

< ECU DIAGNOSIS INFORMATION >

DTC	Diagnostic item	Explanation	Reference page
B1121	SATELLITE SENS LH [UNMATCH]	Satellite sensor RH is out of the specified specification	SRC-104, "DTC Logic" .
B1122-B1127	CONTROL UNIT	Air bag diagnosis sensor unit is malfunctioning	SRC-106, "DTC Logic" .
B1129	SIDE MODULE RH [OPEN]	Side air bag module RH circuit is open	SRC-108, "DTC Logic" .
B1130	SIDE MODULE RH [VB-SHORT]	Side air bag module RH circuit is shorted to power supply circuit	SRC-110, "DTC Logic" .
B1131	SIDE MODULE RH [GND-SHORT]	Side air bag module RH circuit is shorted to ground	SRC-112, "DTC Logic" .
B1132	SIDE MODULE RH [SHORT]	Seat belt pre-tensioner RH circuits are shorted to each other	SRC-114, "DTC Logic" .
B1134	SIDE MODULE LH [OPEN]	Side air bag module LH circuit is open	SRC-116, "DTC Logic" .
B1135	SIDE MODULE LH [VB-SHORT]	Side air bag module LH circuit is shorted to power supply circuit	SRC-118, "DTC Logic" .
B1136	SIDE MODULE LH [GND-SHORT]	Side air bag module LH circuit is shorted to ground	SRC-120, "DTC Logic" .
B1137	SIDE MODULE LH [SHORT]	Side air bag module LH circuits are shorted to each other	SRC-122, "DTC Logic" .
B1138-B1143	CONTROL UNIT	Air bag diagnosis sensor unit is malfunctioning	SRC-124, "DTC Logic" .
B1144	CONTROL UNIT	Air bag diagnosis sensor unit is malfunctioning or out of the specified specification	SRC-126, "DTC Logic" .
B1145	CURTAIN MODULE RH [OPEN]	Curtain air bag module RH circuit is open	SRC-127, "DTC Logic" .
B1146	CURTAIN MODULE RH [VB-SHORT]	Curtain air bag module RH circuit is shorted to power supply circuit	SRC-129, "DTC Logic" .
B1147	CURTAIN MODULE RH [GND-SHORT]	Curtain air bag module RH circuit is shorted to ground	SRC-131, "DTC Logic" .
B1148	CURTAIN MODULE RH [SHORT]	Curtain air bag module RH circuits are shorted to each other	SRC-133, "DTC Logic" .
B1150	CURTAIN MODULE LH [OPEN]	Curtain air bag module LH circuit is open	SRC-135, "DTC Logic" .
B1151	CURTAIN MODULE LH [VB-SHORT]	Curtain air bag module LH circuit is shorted to power supply circuits	SRC-137, "DTC Logic" .
B1152	CURTAIN MODULE LH [GND-SHORT]	Curtain air bag module LH circuit is shorted to ground	SRC-139, "DTC Logic" .
B1153	CURTAIN MODULE LH [SHORT]	Curtain air bag module LH circuits are shorted to each other	SRC-141, "DTC Logic" .
B1154-B1159	CONTROL UNIT	Air bag diagnosis sensor unit is malfunctioning	SRC-143, "DTC Logic" .
B1170-B1175	CONTROL UNIT	Air bag diagnosis sensor unit is malfunctioning	SRC-145, "DTC Logic" .
B1186-B1191	CONTROL UNIT	Air bag diagnosis sensor unit is malfunctioning	SRC-147, "DTC Logic" .
B1202-B1207	CONTROL UNIT	Air bag diagnosis sensor unit is malfunctioning	SRC-149, "DTC Logic" .
B1209	FRONTAL COLLISION DETECTION	Seat belt pre-tensioner, driver side air bag and passenger air bag are deployed	SRC-151, "DTC Logic" .
B1210	SIDE COLLISION DETECTION	Side air bag and curtain air bag are deployed	SRC-152, "DTC Logic" .

A

B

C

D

E

F

G

SRC

I

J

K

L

M

N

O

P

DIAGNOSIS SENSOR UNIT

< ECU DIAGNOSIS INFORMATION >

DTC	Diagnostic item	Explanation	Reference page
B1211	ROLLOVER DETECTION	Seat belt pre-tensioner side curtain air bag module are deployed because of rollover detection	SRC-153, "DTC Logic" .
B1212-B1214	RH1 SAT-SENS	Satellite sensor RH is malfunctioning	SRC-154, "DTC Logic" .
B1215-B1217	LH1 SAT-SENS	Satellite sensor LH is malfunctioning	SRC-156, "DTC Logic" .
B1218-B1223	CONTROL UNIT	Air bag diagnosis sensor unit is malfunctioning	SRC-158, "DTC Logic" .
B1239	CONTROL UNIT	Air bag diagnosis sensor unit is malfunctioning	SRC-160, "DTC Logic"
B1257	FR-RH DOOR MNT MODULE [OPEN]	Door mounted curtain air bag RH circuit is open	SRC-161, "DTC Logic"
B1258	FR-RH DOOR MNT MODULE [VB-SHORT]	Door mounted curtain air bag RH circuit is shorted to power supply circuit	SRC-163, "DTC Logic"
B1259	FR-RH DOOR MNT MODULE [GND-SHORT]	Door mounted curtain air bag RH circuit is shorted to ground	SRC-165, "DTC Logic"
B1260	FR-RH DOOR MNT MODULE [SHORT]	Door mounted curtain air bag RH circuit are shorted to each other	SRC-167, "DTC Logic"
B1262	FR-RH DOOR MNT MODULE [OPEN]	Door mounted curtain air bag LH circuit is open	SRC-169, "DTC Logic"
B1263	FR-LH DOOR MNT MODULE [VB-SHORT]	Door mounted curtain air bag LH circuit is shorted to power supply circuit	SRC-171, "DTC Logic"
B1264	FR-LH DOOR MNT MODULE [GND-SHORT]	Door mounted curtain air bag LH circuit is shorted to ground	SRC-173, "DTC Logic"
B1265	FR-LH DOOR MNT MODULE [SHORT]	Door mounted curtain air bag LH circuit are shorted to each other	SRC-175, "DTC Logic"
B1289	RH POP-UP BAR [OPEN]	Pop-up bar RH circuit is open	SRC-177, "DTC Logic"
B1290	RH POP-UP BAR [VB-SHORT]	Pop-up bar RH circuit is shorted to power supply circuit	SRC-179, "DTC Logic"
B1291	RH POP-UP BAR [GND-SHORT]	Pop-up bar RH circuit is shorted to ground	SRC-181, "DTC Logic"
B1292	RH POP-UP BAR [SHORT]	Pop-up bar RH circuit are shorted to each other	SRC-183, "DTC Logic"
B1294	LH POP-UP BAR [OPEN]	Pop-up bar LH circuit is open	SRC-185, "DTC Logic"
B1295	LH POP-UP BAR [VB-SHORT]	Pop-up bar LH circuit is shorted to power supply circuit	SRC-187, "DTC Logic"
B1296	LH POP-UP BAR [GND-SHORT]	Pop-up bar LH circuit is shorted to ground	SRC-189, "DTC Logic"
B1297	LH POP-UP BAR [SHORT]	Pop-up bar LH circuit are shorted to each other	SRC-191, "DTC Logic"
B1298	POP-UP BAR [DEPLOYED]	Pop-up bar is deployed	SRC-193, "DTC Logic"

DIAGNOSIS SENSOR UNIT

< ECU DIAGNOSIS INFORMATION >

Wiring Diagram - SRS AIR BAG CONTROL SYSTEM -

INFOID:000000005631693

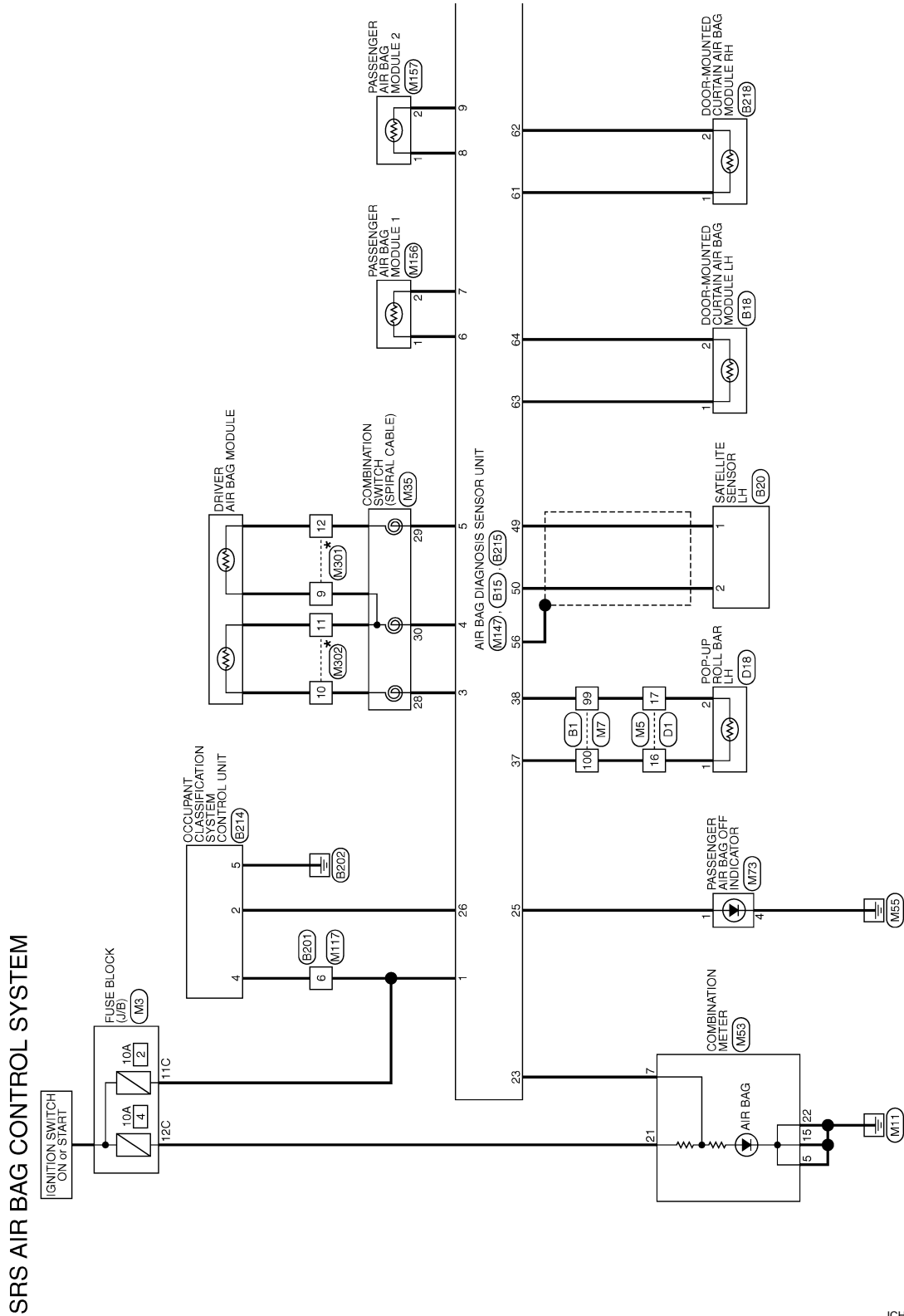

*: This connector is not shown in "Harness Layout".

2009/11/10

JCHWM0617GI

A
B
C
D
E
F
G
SRC
I
J
K
L
M
N
O
P

DIAGNOSIS SENSOR UNIT

< ECU DIAGNOSIS INFORMATION >

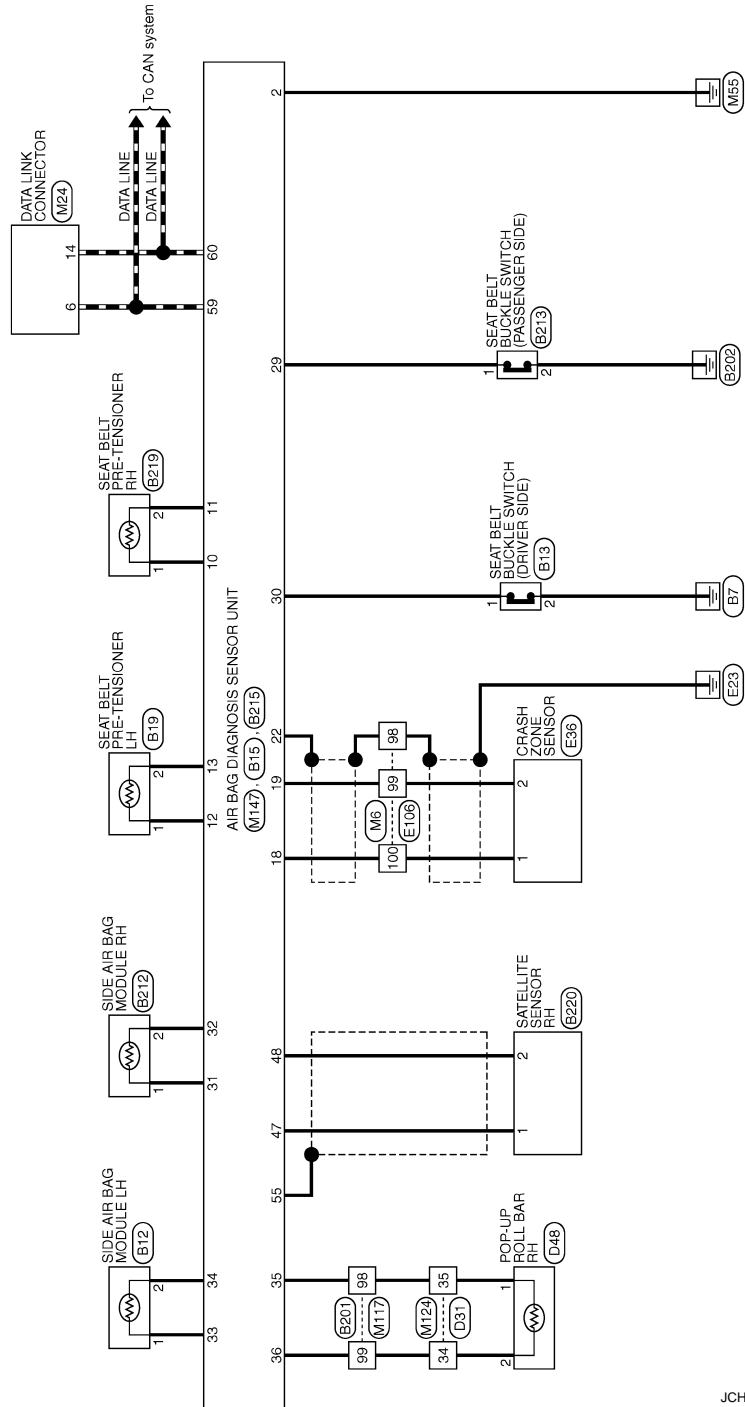

JCHWM0618GI

DIAGNOSIS SENSOR UNIT

< ECU DIAGNOSIS INFORMATION >

SRS AIR BAG CONTROL SYSTEM

Connector No.	B1
Connector Name	WIRE TO WIRE
Connector Type	TH80PW-CS16-TM4

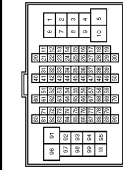

Terminal No.	Color of Wire	Signal Name [Specification]
1	W	
2	L	
3	R	
4	V	
5	W	
6	B	
7	G	
8	G	
9	G	
10	BR	
11	SHIELD	
12	Y	
13	Y	
14	L	
15	R	
16	W	
17	BR	
20	G	
21	SB	
22	GR	
23	W	
24	SB	
25	BR	
26	LG	
27	Y	
28	R	
29	V	
31	SHIELD	
32	G	
33	R	
34	BG	
35	GR	
36	BR	
37	P	- [With climate controlled seat]
37	Y	- [Without climate controlled seat]
38	V	- [With climate controlled seat]
38	Y	- [Without climate controlled seat]
39	GR	
40	SHIELD	
41	L	
42	P	
43	SHIELD	

44	SB	-
45	V	-
46	W	-
47	SB	-
48	LG	-
49	LG	- [With BOSE system]
49	Y	- [Without BOSE system]
50	SB	- [With BOSE system]
50	LG	- [Without BOSE system]
51	SB	-
52	G	-
53	LG	-
54	BR	-
55	Y	-
56	W	-
57	V	-
60	R	-
61	BG	-
62	B	-
63	L	-
64	P	-
65	B	-
66	SB	-
67	P	-
68	L	-
69	P	-
70	L	-
80	G	-
81	V	-
82	R	-
83	BR	-
84	G	-
85	L	-
86	Y	-
87	GR	-
91	R	-
93	BG	-
94	P	-
95	GR	-
96	GR	-
97	SR	-
99	Y	-
100	Y/B	-

Connector No.	B12
Connector Name	SIDE AIR BAG MODULE LH
Connector Type	TK02FY-EX-1V



Terminal No.	Color of Wire	Signal Name [Specification]
1	Y	
2	Y	

Connector No.	B13
Connector Name	SEAT BELT BUCKLE SWITCH (DRIVER SIDE)
Connector Type	A03FW

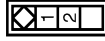

Terminal No.	Color of Wire	Signal Name [Specification]
1	W	
2	B	

Connector No.	B15
Connector Name	AIR BAG DIAGNOSIS SENSOR UNIT
Connector Type	NH02FY-2V-EX

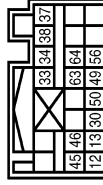

Terminal No.	Color of Wire	Signal Name [Specification]
12	Y	PLH (+)
13	Y	PLH (-)

30	SB	LH BUCKLE SW INPUT
33	Y	SLH (+)
34	Y	SLH (-)
37	Y/B	CLH (+)
38	Y	CLH (-)
49	L	SATELLITE LH (+)
50	P	SATELLITE LH (-)
56	SHIELD	GND
63	Y	ELH (+)
64	Y/B	ELH (-)

Connector No.	B18
Connector Name	DOOR-MOUNTED CURTAIN AIR BAG MODULE LH
Connector Type	TK02FY-EX-1V



Terminal No.	Color of Wire	Signal Name [Specification]
1	Y	
2	Y/B	

Connector No.	B19
Connector Name	SEAT BELT PRE-TENSIONER LH
Connector Type	AG02FY



Terminal No.	Color of Wire	Signal Name [Specification]
1	Y	
2	Y	

JCHWM06196I

A
B
C
D
E
F
G
H
I
J
K
L
M
N
O
P

SRC

DIAGNOSIS SENSOR UNIT

< ECU DIAGNOSIS INFORMATION >

SRS AIR BAG CONTROL SYSTEM

Connector No.	B20
Connector Name	SATELLITE SENSOR LH
Connector Type	TK02FY-TV-EX-LC



Terminal No.	Color of Wire	Signal Name [Specification]
1	P	-
2	L	-

Connector No.	B201
Connector Name	WIRE TO WIRE
Connector Type	TH08FW-CS16-TM4

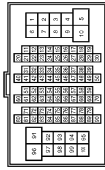

Terminal No.	Color of Wire	Signal Name [Specification]
1	W	-
3	B	-
5	W	-
6	R	-
7	B	-
7	G	- [With climate controlled seat]
8	BG	- [Without climate controlled seat]
9	GR	-
10	LG	-
40	GR	-
41	LG	-
42	BG	-
43	R	-
44	SHIELD	-
45	G	-
47	G	-
48	Y	-
48	SHIELD	-
50	P	-
51	SB	-

52	LG	-
53	L	-
54	G	-
55	GR	-
56	LG	-
57	G	-
58	R	-
67	L	-
68	P	-
80	G	-
81	R	-
82	W	-
83	B	-
84	SHIELD	-
85	O	-
86	BR	-
87	Y	-
88	SHIELD	-
89	SB	-
90	V	-
91	GR	-
92	P	- [With BOSE system]
92	Y	- [Without BOSE system]
93	L	-
94	SB	-
95	V	-
96	P	-
97	L	- [With BOSE system]
97	LG	- [Without BOSE system]
98	Y/B	-
99	Y	-

Connector No.	B212
Connector Name	SIDE AIR BAG MODULE RH
Connector Type	TK02FY-EX-TV



Terminal No.	Color of Wire	Signal Name [Specification]
1	Y	-
2	Y	-

Connector No.	B213
Connector Name	SEAT BELT BUCKLE SWITCH (PASSENGER SIDE)
Connector Type	A03FW

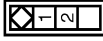

Terminal No.	Color of Wire	Signal Name [Specification]
1	LG	-
2	B	-

Connector No.	B214
Connector Name	DRIVER CLASSIFICATION SYSTEM CONTROL UNIT
Connector Type	TH08FW-NH

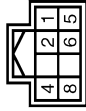

Terminal No.	Color of Wire	Signal Name [Specification]
2	V	COMMUNICATION
4	R	IGN
5	B	GND

Connector No.	B215
Connector Name	AIR BAG DIAGNOSIS SENSOR UNIT
Connector Type	NH02FY-TV-EX

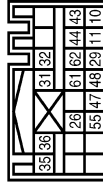

Terminal No.	Color of Wire	Signal Name [Specification]
10	Y	PRH (+)

11	Y	PRH (-)
26	V	ODS INPUT
29	LG	RH BUCKLE SW INPUT
31	V	SRI (-)
32	Y	SRI (-)
35	Y/B	CRH (-)
36	Y	CRH (-)
47	G	SATELLITE RH (+)
48	R	SATELLITE RH (-)
55	SHIELD	GND
61	Y	ERH (+)
62	Y/B	ERH (-)

Connector No.	B218
Connector Name	DOOR-MOUNTED CURTAIN AIR BAG MODULE RH
Connector Type	TK02FY-EX-TV



Terminal No.	Color of Wire	Signal Name [Specification]
1	Y	-
2	Y/B	-

Connector No.	B219
Connector Name	SEAT BELT PRE-TENSIONER RH
Connector Type	A0302FY



Terminal No.	Color of Wire	Signal Name [Specification]
1	Y	-
2	Y	-

DIAGNOSIS SENSOR UNIT

< ECU DIAGNOSIS INFORMATION >

SRS AIR BAG CONTROL SYSTEM

Connector No.	B220
Connector Name	SATELLITE SENSOR RH
Connector Type	HK02FY-IV-EX-LC



Terminal No.	Color of Wire	Signal Name [Specification]
1	G	-
2	R	-

Connector No.	D1
Connector Name	WIRE TO WIRE
Connector Type	TH02FW-CS15

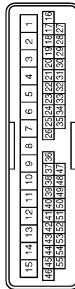

Terminal No.	Color of Wire	Signal Name [Specification]
4	BR	-
5	P	- [With A/T]
6	B	- [With M/T]
8	SB	-
7	R	-
8	G	-
9	P	-
10	LG	-
11	W	-
12	L	-
13	B	-
14	V	-
15	Y	-
16	Y/B	-
17	Y	-
20	V	-
21	R	-
22	P	-
23	O	-
24	Y	-

25	SB	-
26	GR	-
27	GR	-
28	LG	-
29	G	-
30	Y	-
31	W	-
32	BR	-
33	L	-
34	R	-
35	V	-
37	B	-
38	O	-
39	GR	-
40	G	-
41	Y	-
42	LG	-
43	BR	-
44	V	-
45	P	-
46	W	-
47	V	-
48	P	-
49	W	-
50	SB	-
51	R	-
52	L	-

Connector No.	D18
Connector Name	POP-UP ROLL BAR LH
Connector Type	AGB02FY



Terminal No.	Color of Wire	Signal Name [Specification]
1	Y/B	-
2	Y	-

Connector No.	B31
Connector Name	WIRE TO WIRE
Connector Type	TH02FW-CS15



Terminal No.	Color of Wire	Signal Name [Specification]
6	BR	-
7	R	-
8	G	-
9	P	-
10	LG	-
11	W	-
12	L	-
13	B	-
14	Y	-
15	W	-
34	Y	-
35	Y/B	-
39	O	-
40	GR	-
41	Y	-
42	LG	-
43	BR	-
44	V	-
45	P	-
46	W	-
47	V	-
48	P	-
49	W	-
50	SB	-
51	R	-
52	L	-
53	O	-
54	GR	-
55	G	-

Connector No.	D48
Connector Name	POP-UP ROLL BAR RH
Connector Type	AGB02FY



Terminal No.	Color of Wire	Signal Name [Specification]
1	Y/B	-
2	Y	-

Connector No.	E26
Connector Name	CRASH ZONE SENSOR
Connector Type	HK02FY-IV-EX-LC



Terminal No.	Color of Wire	Signal Name [Specification]
1	P	-
2	L	-

A
B
C
D
E
F
G
H
I
J
K
L
M
N
O
P

SRC

DIAGNOSIS SENSOR UNIT

< ECU DIAGNOSIS INFORMATION >

SRS AIR BAG CONTROL SYSTEM

Connector No.	E106
Connector Name	WIRE TO WIRE
Connector Type	THB07V-CS16-TM4



Terminal No.	Color of Wire	Signal Name [Specification]
1	GR	-
2	GR	-
3	BG	-
4	B/W	-
5	G	-
6	BG	-
7	LG	-
8	G	-
10	W	-
11	V	-
12	R	-
13	L	-
14	GR	-
15	P	-
16	W	-
17	V	-
18	BG	-
19	GR	-
20	LG	-
30	R	-
31	L	-
32	BG	-
33	P	-
34	V	-
35	BR	-
36	W	-
37	Y	-
38	R	-
39	B	-
40	G	-
41	W	-
42	LG	-
43	SB	-
44	GR	-
45	BG	-
46	LG	-
47	V	-
48	L	-

59	B	-
66	LG	-
67	SR	-
68	R	-
69	W	-
70	G	-
80	W	-
81	P	-
82	G	-
83	V	-
84	L	-
85	BG	-
86	LG	-
87	Y	-
88	GR	-
89	W	-
90	W	-
91	G	-
92	B	-
93	GR	-
94	G	-
95	Y	-
97	BR	-
98	SHIELD	-
99	L	-
100	P	-

Connector No.	M3
Connector Name	FUSE BLOCK (J/B)
Connector Type	NS12FW-CS

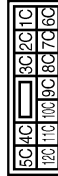

Terminal No.	Color of Wire	Signal Name [Specification]
6C	R	-
7C	B	-
8C	W	-
9C	BG	-
10C	L	-
11C	LG	-
12C	R	-

Connector No.	M5
Connector Name	WIRE TO WIRE
Connector Type	TH40MW-CS15

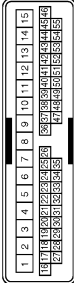

Terminal No.	Color of Wire	Signal Name [Specification]
4	R	-
5	B	-
6	BG	-
7	W	-
8	B	-
9	G	-
10	V	-
11	W	-
12	L	-
13	B	-
14	GR	-
15	Y	-
16	Y/B	-
17	Y	-
20	BG	-
21	W	-
22	P	-
23	BG	-
24	V	-
25	BR	-
26	R	-
27	P	-
28	LG	-
29	SB	-
30	G	-
31	V	-
32	BR	-
33	GR	-
34	G	-
35	L	-
37	B	-
38	G	- [With automatic drive positioner]
38	L	- [Without automatic drive positioner]
39	BR	- [With automatic drive positioner]
39	L	- [Without automatic drive positioner]
40	Y	-
41	BR	- [With automatic drive positioner]
41	G	- [Without automatic drive positioner]

42	R	-
43	G	-
44	V	-
45	GR	-
46	BR	-
47	V	-
48	LG	-
49	P	-
50	SB	-
51	GR	-
52	L	-

DIAGNOSIS SENSOR UNIT

< ECU DIAGNOSIS INFORMATION >

SRS AIR BAG CONTROL SYSTEM

Connector No.	M6
Connector Name	WIRE TO WIRE
Connector Type	TH80MW-CS(E)-TM4

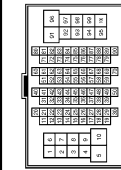

Terminal No.	Color of Wire	Signal Name [Specification]
1	BG	-
3	R	-
4	G	-
5	G	-
6	BR	-
7	BR	-
8	Y	-
10	W	-
11	GR	-
12	R	-
13	L	-
14	G	-
15	P	-
16	W	-
17	BR	-
18	V	-
19	BG	-
20	L	-
30	R	-
31	L	-
32	Y	-
33	GR	-
34	P	-
35	BR	-
36	BR	-
37	Y	-
38	LG	-
39	SB	-
40	G	-
41	W	-
42	LG	-
43	P	-
44	GR	-
45	R	-
46	Y	-
47	P	-
48	P	-

49	L	-
59	B	-
66	Y	-
67	G	-
68	R	-
69	W	-
70	G	-
80	SB	-
81	R	-
82	V	-
83	W	-
84	L	-
85	BG	-
86	G	-
87	V	-
88	B	-
89	SB	-
90	G	-
91	W	-
92	B	-
93	G	-
94	L	-
95	BR	-
97	P	-
98	SHIELD	-
99	V	-
100	SB	-

Connector No.	M7
Connector Name	WIRE TO WIRE
Connector Type	TH80MW-CS(E)-TM4

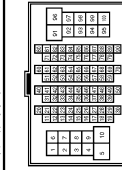

Terminal No.	Color of Wire	Signal Name [Specification]
1	BG	-
2	LG	-
3	G	-
4	V	-
5	L	-
6	B	-
9	L	-
10	BR	-
12	SHIELD	-

13	V	-
14	BR	-
15	GR	-
16	LG	-
17	L	-
20	BR	-
21	G	-
22	R	-
23	SB	-
24	B	-
25	W	-
26	Y	-
27	V	-
28	P	-
29	V	-
31	SHIELD	-
32	G	-
33	R	-
34	BG	-
35	GR	-
36	GR	-
37	P	-
37	L	-
38	V	-
38	GR	-
40	SHIELD	-
41	L	-
42	P	-
43	SHIELD	-
44	Y	-
45	BR	-
46	SB	-
47	SB	-
48	LG	-
48	LG	-
49	LG	-
49	SB	-
50	SB	-
50	LG	-
51	R	-
52	V	-
53	P	-
54	BR	-
55	Y	-
55	BG	-
56	L	-
57	V	-
60	LG	-
61	BG	-
62	B	-
9	L	-
63	V	-
64	SB	-
65	BR	-

66	Y	-
67	P	-
68	L	-
69	P	-
70	L	-
80	G	-
81	LG	-
82	Y	-
83	BR	-
84	V	-
85	L	-
86	Y	-
87	GR	-
91	R	-
93	G	-
94	P	-
95	GR	-
96	Y	-
97	SB	-
99	Y	-
100	Y/B	-

Connector No.	M24
Connector Name	DATA LINK CONNECTOR
Connector Type	ED16FW

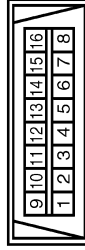

Terminal No.	Color of Wire	Signal Name [Specification]
3	LG	-
4	B	-
5	BR	-
6	L	-
7	V	-
8	G	-
11	SB	-
14	P	-
16	R	-

A
B
C
D
E
F
G
H
I
J
K
L
M
N
O
P

SRC

DIAGNOSIS SENSOR UNIT

< ECU DIAGNOSIS INFORMATION >

SRS AIR BAG CONTROL SYSTEM

Connector No.	M35
Connector Name	COMBINATION SWITCH (SPIRAL CABLE)
Connector Type	TK06Y-EX-1V



Terminal No.	Color of Wire	Signal Name [Specification]
23	R	-
28	Y	-
29	Y	-
30	Y	-

Connector No.	M53
Connector Name	COMBINATION METER
Connector Type	SAB40FW



Terminal No.	Color of Wire	Signal Name [Specification]
1	V	BATTERY POWER SUPPLY
2	LG	COMMUNICATION SIGNAL (METER->AMP)
3	GR	COMMUNICATION SIGNAL (AMP->METER)
3	B	GROUND
6	W	ALTERNATOR SIGNAL
7	LG	AIR BAG SIGNAL
10	R	SECURITY SIGNAL
15	B	GROUND
16	B	METER CONTROL SWITCH GROUND
18	GR	ILL GND
19	B	ILL GND
20	R	ILL
21	R	IGNITION SIGNAL
22	B	GROUND
24	SB	COMMUNICATION SIGNAL (LCD->AMP)
25	B	COMMUNICATION SIGNAL (AMP->LCD)
26	R	VEHICLE SPEED SIGNAL (8-PUL SET)
27	Y	PARKING BRAKE SWITCH SIGNAL

28	SB	BRAKE FLUID LEVEL SWITCH SIGNAL
29	L	SEAT BELT BUCKLE SW SIGNAL (DRIVER SIDE)
30	G	SEAT BELT BUCKLE SWITCH SIGNAL (PASSENGER SIDE)
31	L	WASHER LEVEL SWITCH SIGNAL
33	R	ILLUMINATION CONTROL SIGNAL
36	LG	SELECT SWITCH SIGNAL
37	SB	ENTER SWITCH SIGNAL
38	L	TRIP A/B RESET SWITCH SIGNAL
39	P	ILLUMINATION CONTROL SWITCH (-)
40	BG	ILLUMINATION CONTROL SWITCH (+)

Connector No.	M73
Connector Name	PASSENGER AIR BAG OFF INDICATOR
Connector Type	TH40MW-FH



Terminal No.	Color of Wire	Signal Name [Specification]
1	R	-
4	B	-

Connector No.	M117
Connector Name	WIRE TO WIRE
Connector Type	TH80MW-CS10-TM4

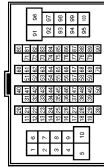

Terminal No.	Color of Wire	Signal Name [Specification]
1	Y	-
3	B	-
5	SB	-
6	R	-
7	G	-
8	SB	-
9	GR	-
10	LG	-

Connector No.	M124
Connector Name	WIRE TO WIRE
Connector Type	TH40MW-CS15

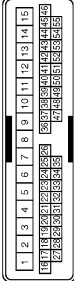

Terminal No.	Color of Wire	Signal Name [Specification]
6	BG	-
7	R	-
8	G	-
9	P	-
10	V	-
11	SB	- [With BOSE system]
11	GR	- [Without BOSE system]
12	BR	-
13	B	-
14	G	-
15	W	-
34	Y	-
35	Y/B	-
38	W	-
39	BG	-
40	SB	-
41	BR	- [With automatic drive positioner]
41	G	- [Without automatic drive positioner]
42	R	-
43	L	-
44	Y	-
45	R	-
46	W	-
48	W	-
47	SS	-
48	BR	-
49	Y	-
50	P	-
51	LG	-
52	BG	-
53	Y	-
54	L	-
55	L	-

40	Y	-
41	G	-
42	LG	-
43	B	-
44	SHIELD	-
45	G	-
47	P	-
48	L	-
49	SHIELD	-
50	V	-
51	SB	-
52	BG	-
53	L	-
54	G	-
55	Y	-
56	LG	-
57	SB	-
58	LG	-
67	SB	-
68	LG	-
80	W	-
81	B	-
82	R	-
83	G	-
84	SHIELD	-
85	G	-
86	L	-
87	P	-
88	SHIELD	-
89	Y	-
90	W	-
91	GR	-
92	P	-
93	W	-
94	BG	-
95	BG	-
96	P	-
97	L	-
98	Y/B	-
99	Y	-

DIAGNOSIS SENSOR UNIT

< ECU DIAGNOSIS INFORMATION >

A
B
C
D
E
F
G
H
I
J
K
L
M
N
O
P

SRC

SRS AIR BAG CONTROL SYSTEM

Connector No.	M147
Connector Name	AIR BAG DIAGNOSIS SENSOR UNIT
Connector Type	1H28FY-EX

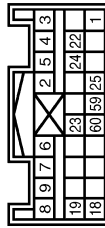

Terminal No.	Color of Wire	Signal Name [Specification]
1	LG	IGN
2	B	GND
3	Y	DRI (+)
4	Y	DRI (-) DRZ (-)
5	Y	DRZ (+)
6	Y	ASI (+)
7	Y	ASI (-)
8	Y	ASZ (+)
9	Y	ASZ (-)
18	SB	ECZS (+)
19	V	ECZS (-)
22	SHIELD	GND
23	LG	AIRBAG W/L
24	G	SEAT BELT
25	R	CUTOFF TELLTALE
59	L	CAN-H
60	P	CAN-L



Connector No.	M156
Connector Name	PASSENGER AIR BAG MODULE 1
Connector Type	JCA02PB

Terminal No.	Color of Wire	Signal Name [Specification]
1	Y	-
2	Y	-

Connector No.	M157
Connector Name	PASSENGER AIR BAG MODULE 2
Connector Type	JCA02FOR



Terminal No.	Color of Wire	Signal Name [Specification]
1	Y	-
2	Y	-

Connector No.	M201
Connector Name	DRIVER AIR BAG MODULE
Connector Type	JCA02FOR



Terminal No.	Color of Wire	Signal Name [Specification]
9	-	-
12	-	-

Connector No.	M302
Connector Name	DRIVER AIR BAG MODULE
Connector Type	JCA02FY-2V



Terminal No.	Color of Wire	Signal Name [Specification]
10	-	-
11	-	-

SRS AIR BAG WARNING LAMP DOES NOT TURN OFF

< SYMPTOM DIAGNOSIS >

SYMPTOM DIAGNOSIS

SRS AIR BAG WARNING LAMP DOES NOT TURN OFF

Diagnosis Procedure

INFOID:000000005631694

1. CHECK AIR BAG MODULE AND SEAT BELT PRE-TENSIONER

Check the deployment of air bag module and seat belt pre-tensioner.

Is air bag module deployed?

YES >> Replace the malfunctioning parts.

NO >> GO TO 2.

2. CHECK AIR BAG FUSE

Check 10A fuse [No.2, located in fuse block (J/B)].

Is the inspection result normal?

YES >> GO TO 3.

NO >> Replace the fuse.

3. CHECK HARNESS CONNECTOR

Check the harness connector.

Is the inspection result normal?

YES >> GO TO 4.

NO >> Replace harness connectors.

4. CHECK WIRING HARNESS

Check the wiring harness externals.

Is the inspection result normal?

YES >> GO TO 5.

NO >> Replace wiring harness.

5. REPLACE AIR BAG DIAGNOSIS SENSOR UNIT

1. Replace air bag diagnosis sensor unit. Refer to [SR-29, "Exploded View"](#).

2. Check air bag warning lamp operation.

Is the inspection result normal?

YES >> INSPECTION END

NO >> GO TO 6.

6. REPLACE COMBINATION METER

1. Replace combination meter. Refer to [MWI-129, "Exploded View"](#).

2. Check air bag warning lamp operation.

Is the inspection result normal?

YES >> INSPECTION END

NO >> GO TO 1.

SRS AIR BAG WARNING LAMP DOES NOT TURN ON

< SYMPTOM DIAGNOSIS >

SRS AIR BAG WARNING LAMP DOES NOT TURN ON

Diagnosis Procedure

INFOID:000000005631695

1.CHECK COMBINATION METER POWER SPPLY AND GROUND CIRCUIT

Check combination meter unit power supply and ground circuit. Refer to [MWI-48, "COMBINATION METER : Diagnosis Procedure"](#).

Is the inspection result normal?

YES >> GO TO 2.

NO >> Repair or replace the malfunctioning parts.

2.CHECK HARNESS CONNECTOR

Check the harness connector.

Is the inspection result normal?

YES >> GO TO 3.

NO >> Replace harness connectors.

3.CHECK WIRING HARNESS

Check the wiring harness externals.

Is the inspection result normal?

YES >> GO TO 4.

NO >> Replace wiring harness.

4.CHECK AIR BAG DIAGNOSIS SENSOR UNIT

Disconnect air bag diagnosis sensor unit connector and turn ignition switch ON.

Does air bag warning lamp turn ON?

YES >> Replace air bag diagnosis sensor unit. Refer to [SR-29, "Exploded View"](#).

NO >> Replace combination meter. Refer to [MWI-130, "Removal and Installation"](#).

A
B
C
D
E
F
G
SRC
I
J
K
L
M
N
O
P

PRECAUTIONS

< PRECAUTION >

PRECAUTION

PRECAUTIONS

Precaution for Supplemental Restraint System (SRS) "AIR BAG" and "SEAT BELT PRE-TENSIONER"

INFOID:000000005631696

The Supplemental Restraint System such as "AIR BAG" and "SEAT BELT PRE-TENSIONER", used along with a front seat belt, helps to reduce the risk or severity of injury to the driver and front passenger for certain types of collision. This system includes seat belt switch inputs and dual stage front air bag modules. The SRS system uses the seat belt switches to determine the front air bag deployment, and may only deploy one front air bag, depending on the severity of a collision and whether the front occupants are belted or unbelted. Information necessary to service the system safely is included in the "SRS AIR BAG" and "SEAT BELT" of this Service Manual.

WARNING:

- To avoid rendering the SRS inoperative, which could increase the risk of personal injury or death in the event of a collision which would result in air bag inflation, all maintenance must be performed by an authorized NISSAN/INFINITI dealer.
- Improper maintenance, including incorrect removal and installation of the SRS, can lead to personal injury caused by unintentional activation of the system. For removal of Spiral Cable and Air Bag Module, see the "SRS AIR BAG".
- Do not use electrical test equipment on any circuit related to the SRS unless instructed to in this Service Manual. SRS wiring harnesses can be identified by yellow and/or orange harnesses or harness connectors.

PRECAUTIONS WHEN USING POWER TOOLS (AIR OR ELECTRIC) AND HAMMERS

WARNING:

- When working near the Air Bag Diagnosis Sensor Unit or other Air Bag System sensors with the ignition ON or engine running, DO NOT use air or electric power tools or strike near the sensor(s) with a hammer. Heavy vibration could activate the sensor(s) and deploy the air bag(s), possibly causing serious injury.
- When using air or electric power tools or hammers, always switch the ignition OFF, disconnect the battery, and wait at least 3 minutes before performing any service.

Service Procedure Precautions for Models with a Pop-up Roll Bar

INFOID:000000005631697

WARNING:

- Risk of passenger injury or death may increase if the pop-up roll bar does not deploy during a roll over collision. In order to reduce the chance of an incident where the pop-up roll bar is inoperative, all maintenance must be performed by a NISSAN or INFINITI dealer.
- Before removing and installing the pop-up roll bar component parts and harness, always turn the ignition switch OFF, disconnect the battery negative terminal, and wait for 3 minutes or more. (The purpose of this operation is to discharge electricity that is accumulated in the auxiliary power supply circuit in the air bag diagnosis sensor unit.)
- When repairing, removing, and installing a pop-up roll bar, always refer to SRS AIR BAG and SRS AIR BAG CONTROL warnings in the Service Manual.

Service

INFOID:000000005631698

- Never use electrical test equipment to check SRS circuits unless instructed to in this Service Manual.
- Before servicing the SRS, turn ignition switch OFF, disconnect battery negative terminal and wait 3 minutes or more.
For approximately 3 minutes after the cables are removed, it is still possible for the air bag and seat belt pretensioner to deploy. Therefore, never work on any SRS connectors or wires until at least 3 minutes have passed.
- Diagnosis sensor unit must always be installed with their arrow marks "←" pointing towards the front of the vehicle for proper operation. Also check diagnosis sensor unit for cracks, deformities or rust before installation and replace as required.
- The spiral cable must be aligned with the neutral position since its rotations are limited. Never turn steering wheel and column after removal of steering gear.

PRECAUTIONS

< PRECAUTION >

- Handle air bag module carefully. Always place driver and front passenger air bag modules with the pad side facing upward and seat mounted front side air bag module standing with the stud bolt side facing down. A
- Conduct self-diagnosis to check entire SRS for proper function after replacing any components.
- After air bag inflates, the front instrument panel assembly should be replaced if damaged.
- Always replace instrument panel pad following front passenger air bag deployment. B
- Never solder the harness when making repairs. Check that harness is not pinched and that there is no contact with other components.
- Never allow harness to come in contact with oil, grease, waste oil, or water.
- Never insert foreign materials, such as a screwdriver, into the harness connector. (This is to prevent accidental activation caused by static electricity.) C
- Always use CONSULT-III or SRS air bag warning lamp to perform the circuit diagnosis. (Never use an electric tester such as a circuit tester.) D
- Never enter in the deployment area of the pop-up roll bar. Never put an object in the deployment area of the pop-up roll bar. (This is to prevent injury in case of an unintentional deployment.)
- When handling a pop-up roll bar, always grip the frame and handle carefully.
- Never reuse a pop-up roll bar that has previously deployed. E
- Modification of the pop-up roll bar may cause unintentional deployment or a malfunction. Never disassemble or modify the pop-up roll bar.
- Never allow the pop-up roll bar to be impacted (by dropping or otherwise). Always replace the pop-up roll bar if impacted. F
- When repairing the surrounding area of the pop-up roll bar, be careful not to apply excessive heat when welding or otherwise. Remove the pop-up roll bar in advance, if necessary. Be careful when modifying the mounting area or installing other parts because an incorrect procedure may cause damage or a malfunction. G
- Never disassemble the pop-up roll bar.
- Never expose the pop-up roll bar to temperatures exceeding 90 °C (194 °F).
- Never allow oil, grease, detergent, or water to come in contact with the pop-up roll bar.

SRC

Occupant Classification System Precaution

INFOID:000000005631699

Replace Occupant Classification System control unit and passenger front seat cushion as an assembly. Refer to [SE-234, "Exploded View"](#). I

Precaution for Battery Service

INFOID:000000005631700

Before disconnecting the battery, lower both the driver and passenger windows. This will prevent any interference between the window edge and the vehicle when the door is opened/closed. During normal operation, the window slightly raises and lowers automatically to prevent any window to vehicle interference. The automatic window function will not work with the battery disconnected. J
K
L

L

M

N

O

P