

SECTION PCS

POWER CONTROL SYSTEM

A
B
C
D
E
F
G
H
I
J
K
L
PCS
N
O
P

CONTENTS

<p>IPDM E/R</p> <p>SYSTEM DESCRIPTION 3</p> <p>RELAY CONTROL SYSTEM 3</p> <p> System Diagram 3</p> <p> System Description 3</p> <p> Component Parts Location 4</p> <p>POWER CONTROL SYSTEM 6</p> <p> System Diagram 6</p> <p> System Description 6</p> <p>SIGNAL BUFFER SYSTEM 7</p> <p> System Diagram 7</p> <p> System Description 7</p> <p>POWER CONSUMPTION CONTROL SYSTEM 8</p> <p> System Diagram 8</p> <p> System Description 8</p> <p> Component Parts Location 9</p> <p>DIAGNOSIS SYSTEM (IPDM E/R) 10</p> <p> Diagnosis Description 10</p> <p> CONSULT-III Function (IPDM E/R) 12</p> <p>DTC/CIRCUIT DIAGNOSIS 15</p> <p>U1000 CAN COMM CIRCUIT 15</p> <p> Description 15</p> <p> DTC Logic 15</p> <p> Diagnosis Procedure 15</p> <p>B2098 IGNITION RELAY ON STUCK 16</p> <p> Description 16</p> <p> DTC Logic 16</p> <p> Diagnosis Procedure 16</p> <p>B2099 IGNITION RELAY OFF STUCK 17</p> <p> Description 17</p> <p> DTC Logic 17</p>	<p> Diagnosis Procedure 17</p> <p>POWER SUPPLY AND GROUND CIRCUIT 18</p> <p> Diagnosis Procedure 18</p> <p>ECU DIAGNOSIS INFORMATION 19</p> <p>IPDM E/R (INTELLIGENT POWER DISTRIBUTION MODULE ENGINE ROOM) 19</p> <p> Reference Value 19</p> <p> Wiring Diagram - IPDM E/R - 26</p> <p> Fail-safe 29</p> <p> DTC Index 31</p> <p>PRECAUTION 32</p> <p>PRECAUTIONS 32</p> <p> Precaution for Supplemental Restraint System (SRS) "AIR BAG" and "SEAT BELT PRE-TENSIONER" 32</p> <p> Precautions Necessary for Steering Wheel Rotation After Battery Disconnection 32</p> <p> Precaution for Battery Service 33</p> <p> Precaution for Procedure without Cowl Top Cover... 33</p> <p>REMOVAL AND INSTALLATION 34</p> <p>IPDM E/R (INTELLIGENT POWER DISTRIBUTION MODULE ENGINE ROOM) 34</p> <p> Exploded View 34</p> <p> Removal and Installation 34</p> <p style="text-align: center;">POWER DISTRIBUTION SYSTEM</p> <p>BASIC INSPECTION 36</p> <p>DIAGNOSIS AND REPAIR WORK FLOW 36</p> <p> Work Flow 36</p> <p>SYSTEM DESCRIPTION 39</p> <p>POWER DISTRIBUTION SYSTEM 39</p> <p> System Description 39</p>
--	---

Component Parts Location	41	BCM	65
Component Description	42	BCM : Diagnosis Procedure	65
DIAGNOSIS SYSTEM (BCM)	43	PUSH-BUTTON IGNITION SWITCH	66
COMMON ITEM	43	Description	66
COMMON ITEM : CONSULT-III Function (BCM - COMMON ITEM)	43	Component Function Check	66
INTELLIGENT KEY	44	Diagnosis Procedure	66
INTELLIGENT KEY : CONSULT-III Function (BCM - INTELLIGENT KEY)	44	Component Inspection	67
DTC/CIRCUIT DIAGNOSIS	49	PUSH-BUTTON IGNITION SWITCH POSI- TION INDICATOR	68
B2553 IGNITION RELAY	49	Description	68
Description	49	Component Function Check	68
DTC Logic	49	Diagnosis Procedure	68
Diagnosis Procedure	49	POWER DISTRIBUTION SYSTEM	70
B260A IGNITION RELAY	51	Wiring Diagram - PDS (POWER DISTRIBUTION SYSTEM) -	70
Description	51	ECU DIAGNOSIS INFORMATION	78
DTC Logic	51	BCM (BODY CONTROL MODULE)	78
Diagnosis Procedure	51	Reference Value	78
B2614 ACC RELAY CIRCUIT	53	Wiring Diagram - BCM -	101
Description	53	Fail-safe	106
DTC Logic	53	DTC Inspection Priority Chart	108
Diagnosis Procedure	53	DTC Index	109
Component Inspection	54	PRECAUTION	112
B2615 BLOWER RELAY CIRCUIT	56	PRECAUTIONS	112
Description	56	Precaution for Supplemental Restraint System (SRS) "AIR BAG" and "SEAT BELT PRE-TEN- SIONER"	112
DTC Logic	56	Precautions Necessary for Steering Wheel Rota- tion After Battery Disconnection	112
Diagnosis Procedure	56	SYMPTOM DIAGNOSIS	114
Component Inspection	57	PUSH-BUTTON IGNITION SWITCH DOES NOT OPERATE	114
B2616 IGNITION RELAY CIRCUIT	59	Description	114
Description	59	Diagnosis Procedure	114
DTC Logic	59	PUSH-BUTTON IGNITION SWITCH POSI- TION INDICATOR DOES NOT ILLUMINATE	115
Diagnosis Procedure	59	Description	115
Component Inspection	60	Diagnosis Procedure	115
B2618 BCM	62	REMOVAL AND INSTALLATION	116
Description	62	PUSH BUTTON IGNITION SWITCH	116
DTC Logic	62	Removal and Installation	116
Diagnosis Procedure	62		
B261A PUSH-BUTTON IGNITION SWITCH	63		
Description	63		
DTC Logic	63		
Diagnosis Procedure	63		
POWER SUPPLY AND GROUND CIRCUIT	65		

RELAY CONTROL SYSTEM

< SYSTEM DESCRIPTION >

[IPDM E/R]

SYSTEM DESCRIPTION

RELAY CONTROL SYSTEM

System Diagram

INFOID:000000006469770

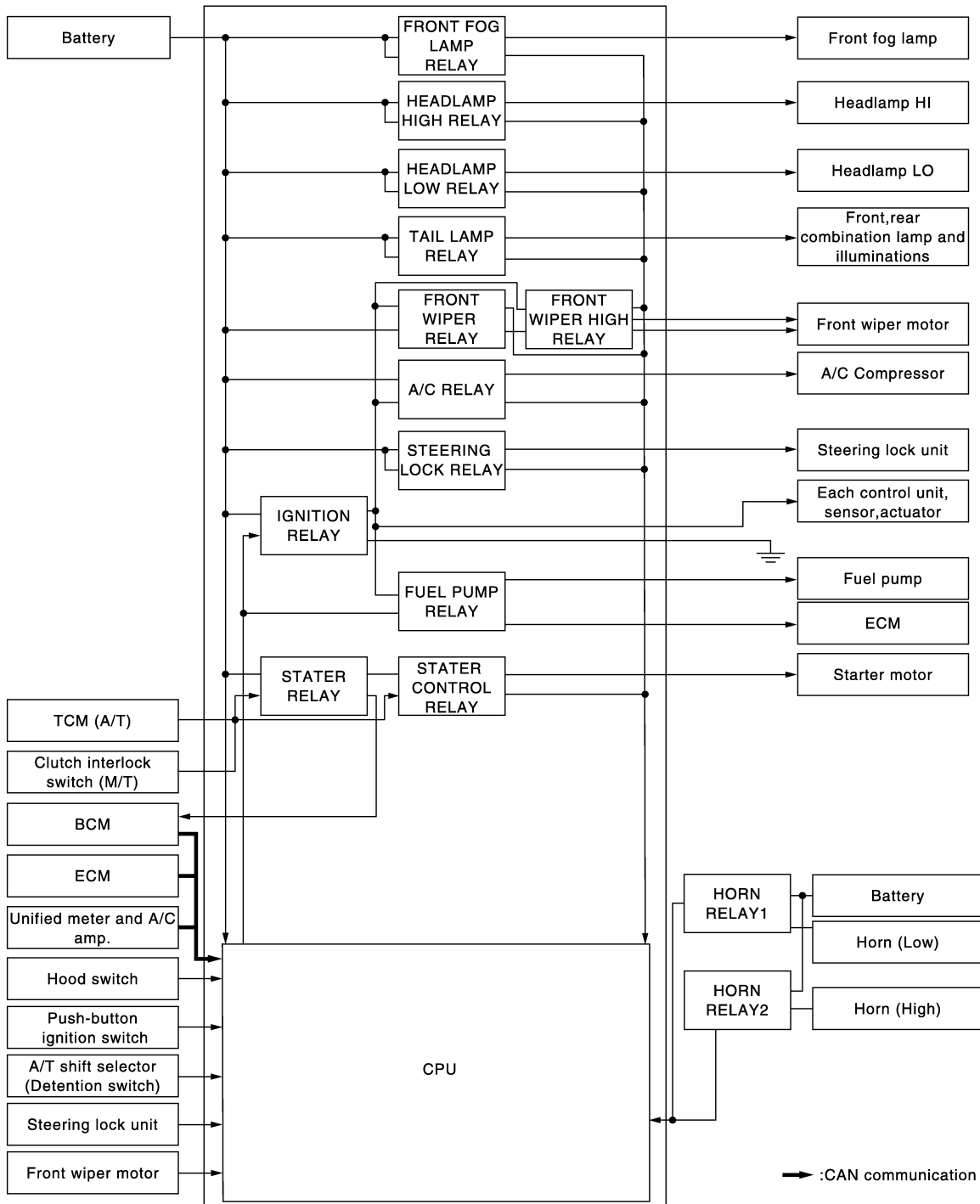

JPMIA1564GB

NOTE:

Steering lock relay and steering lock unit, as shown in the system diagram, are for models with steering lock unit only.

System Description

INFOID:000000006469771

IPDM E/R activates the internal control circuit to perform the relay ON-OFF control according to the input signals from various sensors and the request signals received from control units via CAN communication.

CAUTION:

A
B
C
D
E
F
G
H
I
J
K
L
M
N
O
P

PCS

RELAY CONTROL SYSTEM

< SYSTEM DESCRIPTION >

[IPDM E/R]

IPDM E/R integrated relays cannot be removed.

Control relay	Input/output	Transmit unit	Control part	Reference page
<ul style="list-style-type: none"> Headlamp low relay Headlamp high relay 	<ul style="list-style-type: none"> Low beam request signal High beam request signal 	BCM (CAN)	<ul style="list-style-type: none"> Headlamp low Headlamp high 	EXL-6
Front fog lamp relay	Front fog light request signal	BCM (CAN)	Front fog lamp	EXL-16
Tail lamp relay	Position light request signal	BCM (CAN)	<ul style="list-style-type: none"> Parking lamp Side marker lamp License plate lamp Tail lamp 	EXL-21
			Illuminations	INL-10
<ul style="list-style-type: none"> Front wiper relay Front wiper high relay 	Front wiper request signal	BCM (CAN)	Front wiper	WW-9
	Front wiper stop position signal	Front wiper motor		
<ul style="list-style-type: none"> Horn relay 1 Horn relay 2 	<ul style="list-style-type: none"> Theft warning horn request signal Horn reminder signal 	BCM (CAN)	<ul style="list-style-type: none"> Horn (low) Horn (high) 	SEC-20
<ul style="list-style-type: none"> Starter relay^{NOTE} Starter control relay 	Starter control relay signal	BCM (CAN)	Starter motor	SEC-107 , SEC-105
	Steering lock unit condition signal	Steering lock unit		
	Starter relay control signal	TCM Clutch interlock switch		
Steering lock relay*	Steering lock relay signal	BCM (CAN)	Steering lock unit*	SEC-98
	Steering lock unit condition signal	Steering lock unit		
	A/T shift selector (Detention switch) signal	A/T shift selector (Detention switch)		
A/C relay	A/C compressor request signal	ECM (CAN)	A/C compressor (magnet clutch)	HAC-43
Ignition relay	Ignition switch ON signal	BCM (CAN)	Ignition relay	PCS-16
	Vehicle speed signal	Unified meter and A/C amp. (CAN)		
	Push-button ignition switch signal	Push-button ignition switch		

*: For models with steering lock unit only.

NOTE:

BCM controls the starter relay.

Component Parts Location

INFOID:000000006469772

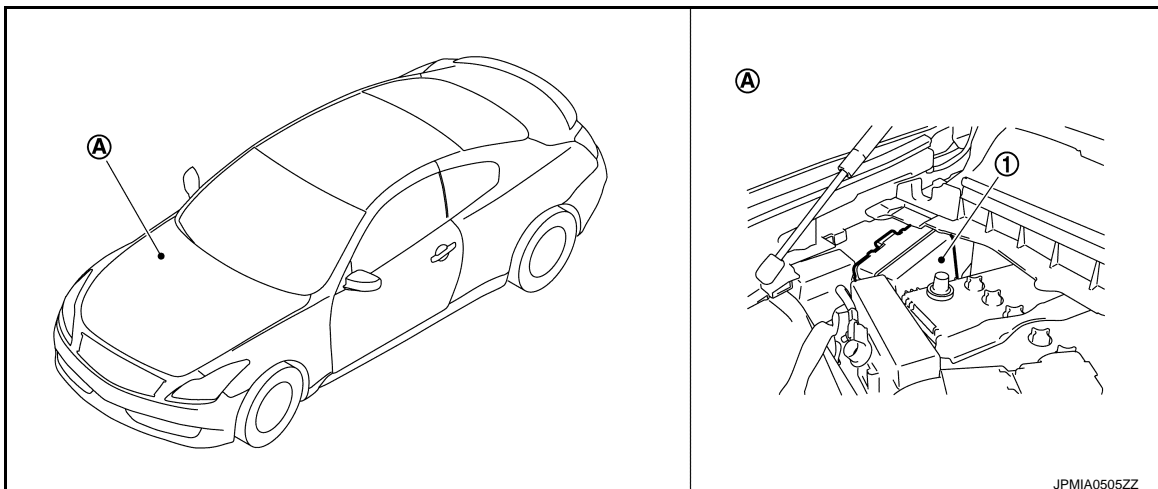

JPMIA0505ZZ

RELAY CONTROL SYSTEM

< SYSTEM DESCRIPTION >

[IPDM E/R]

- 1. IPDM E/R
- A. Engine room dash panel (RH)

A

B

C

D

E

F

G

H

I

J

K

L

PCS

N

O

P

POWER CONTROL SYSTEM

System Diagram

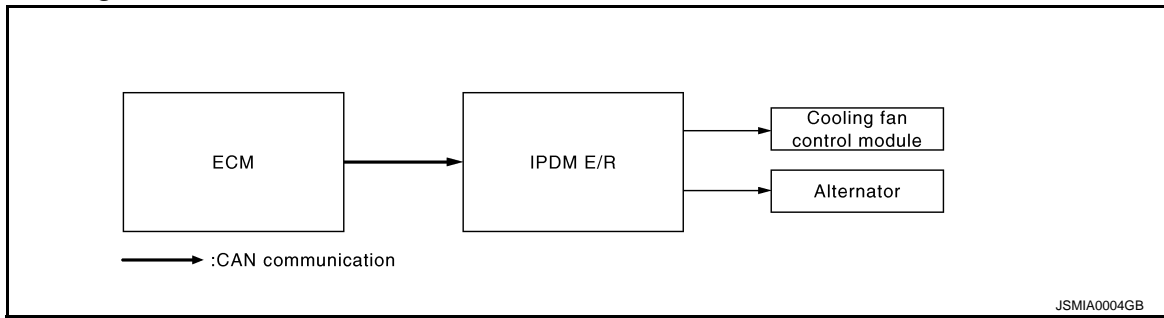

System Description

INFOID:000000006469774

COOLING FAN CONTROL

IPDM E/R outputs pulse duty signal (PWM signal) to the cooling fan control module according to the status of the cooling fan speed request signal received from ECM via CAN communication. Refer to [EC-84, "System Diagram"](#).

ALTERNATOR CONTROL

IPDM E/R outputs power generation command signal (PWM signal) to the alternator according to the status of the power generation command value signal received from ECM via CAN communication. Refer to [CHG-8, "System Diagram"](#).

SIGNAL BUFFER SYSTEM

< SYSTEM DESCRIPTION >

[IPDM E/R]

SIGNAL BUFFER SYSTEM

System Diagram

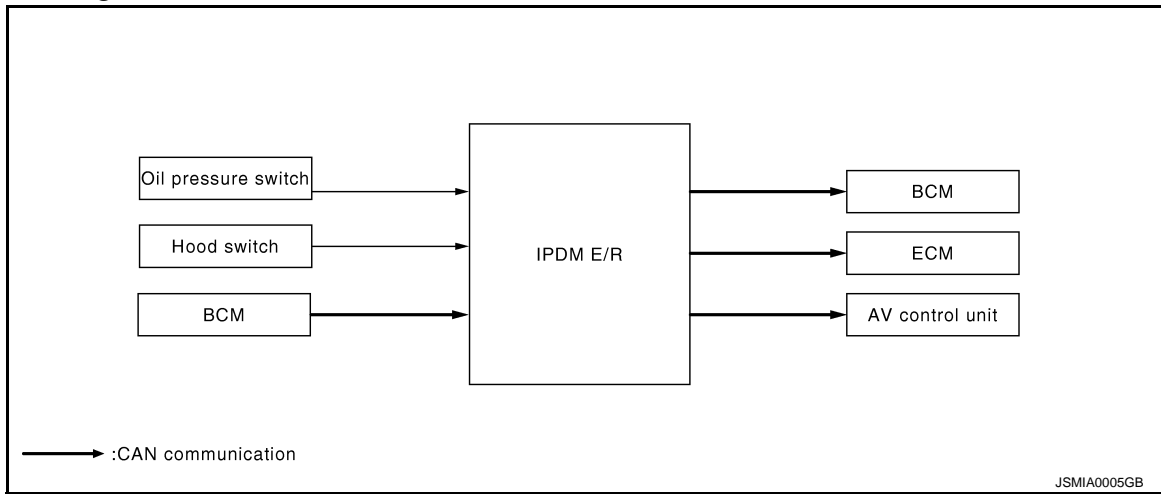

System Description

INFOID:000000006469776

- IPDM E/R reads the status of the oil pressure switch and transmits the oil pressure switch signal to BCM via CAN communication. Refer to [MWI-24, "WARNING LAMPS/INDICATOR LAMPS : System Diagram"](#).
- IPDM E/R reads the status of the hood switch and transmits the hood switch signal to BCM via CAN communication. Refer to [SEC-116, "Description"](#).
- IPDM E/R receives the rear window defogger control signal from BCM via CAN communication and transmits it to ECM and AV control unit via CAN communication. Refer to [DEF-4, "System Diagram"](#).

PCS

POWER CONSUMPTION CONTROL SYSTEM

System Diagram

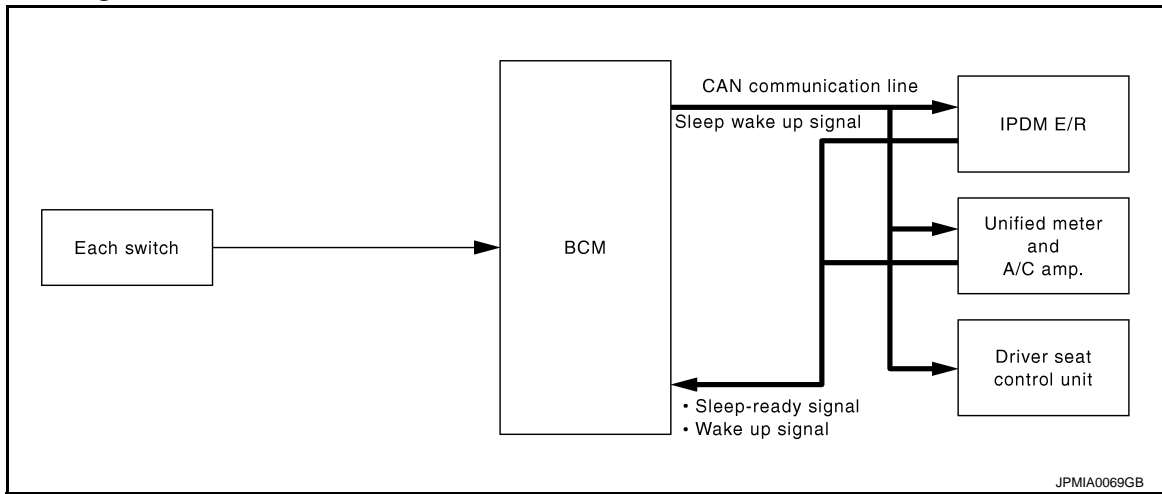

System Description

INFOID:000000006469778

OUTLINE

- IPDM E/R incorporates a power consumption control function that reduces the power consumption according to the vehicle status.
- IPDM E/R changes its status (control mode) with the sleep wake up signal received from BCM via CAN communication.

Normal mode (wake-up)

- CAN communication is normally performed with other control units.
- Individual unit control by IPDM E/R is normally performed.

Low power consumption mode (sleep)

- Low power consumption control is active.
- CAN transmission is stopped.

SLEEP MODE ACTIVATION

- IPDM E/R judges that the sleep-ready conditions are fulfilled when the ignition switch is OFF and none of the conditions below are present. Then it transmits a sleep-ready signal (ready) to BCM via CAN communication.
 - Outputting signals to actuators
 - Switches or relays operating
 - Hood switch status is kept 50 ms or less.
 - Output requests are being received from control units via CAN communication.
- IPDM E/R stops CAN communication and enters the low power consumption mode when it receives a sleep wake up signal (sleep) from BCM and the sleep-ready conditions are fulfilled.

WAKE-UP OPERATION

- IPDM E/R changes from the low power consumption mode to the normal mode when it receives a sleep wake-up signal (wake up) from BCM or any of the following conditions is fulfilled. In addition, it transmits a sleep-ready signal (not-ready) to BCM via CAN communication to report the CAN communication start.
 - Ignition switch ON
 - The hood switch status changes.
 - An output request is received from a control unit via CAN communication.

POWER CONSUMPTION CONTROL SYSTEM

< SYSTEM DESCRIPTION >

[IPDM E/R]

Component Parts Location

INFOID:000000006469779

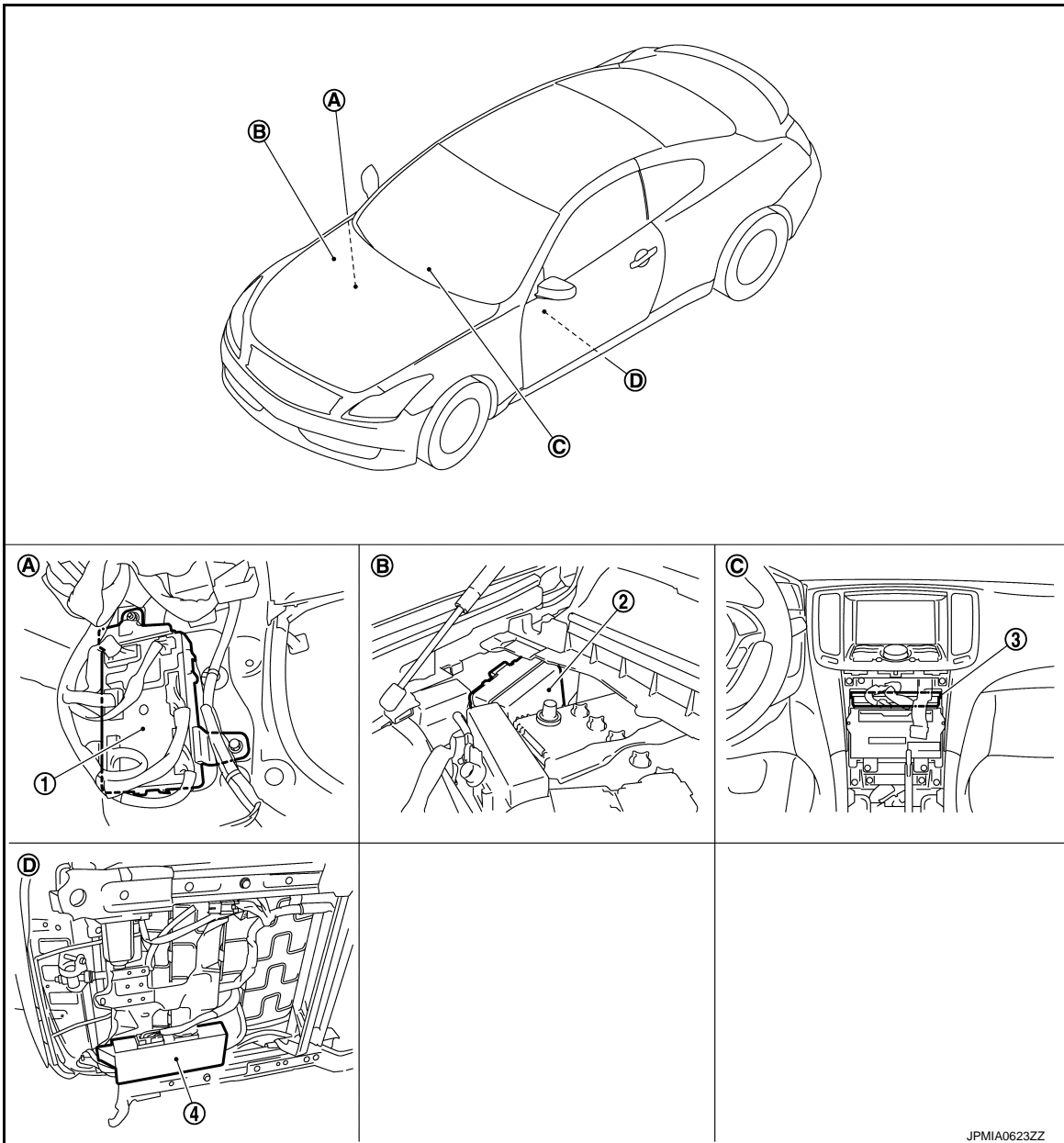

- | | | |
|---|--------------------------------|-------------------------------|
| 1. BCM | 2. IPDM E/R | 3. Unified meter and A/C amp. |
| 4. Driver seat control unit | | |
| A. Dash side lower (passenger side) | B. Engine room dash panel (RH) | C. Behind Cluster lid C |
| D. Backside of the seat cushion (driver seat) | | |

DIAGNOSIS SYSTEM (IPDM E/R)

Diagnosis Description

INFOID:000000006469780

AUTO ACTIVE TEST

Description

In auto active test mode, the IPDM E/R sends a drive signal to the following systems to check their operation.

- Oil pressure warning lamp
- Front wiper (LO, HI)
- Parking lamps
- License plate lamps
- Side maker lamps
- Tail lamps
- Front fog lamps
- Headlamps (LO, HI)
- A/C compressor (magnet clutch)
- Cooling fan (cooling fan control module)

Operation Procedure

1. Close the hood and lift the wiper arms from the windshield. (Prevent windshield damage due to wiper operation)
NOTE:
 When auto active test is performed with hood opened, sprinkle water on windshield beforehand.
2. Turn the ignition switch OFF.
3. Turn the ignition switch ON, and within 20 seconds, press the front door switch (driver side) 10 times. Then turn the ignition switch OFF.
CAUTION:
Close passenger door.
4. Turn the ignition switch ON within 10 seconds. After that the horn sounds once and the auto active test starts.
5. The oil pressure warning lamp starts blinking when the auto active test starts.
6. After a series of the following operations is repeated 3 times, auto active test is completed.

NOTE:

When auto active test mode has to be cancelled halfway through test, turn the ignition switch OFF.

CAUTION:

- **If auto active test mode cannot be actuated, check door switch system. Refer to [DLK-71, "Component Function Check"](#).**
- **Do not start the engine.**

Inspection in Auto Active Test Mode

When auto active test mode is actuated, the following 6 steps are repeated 3 times.

Operation sequence	Inspection location	Operation
1	Oil pressure warning lamp	Blinks continuously during operation of auto active test
2	Front wiper	LO for 5 seconds → HI for 5 seconds
3	<ul style="list-style-type: none"> • Parking lamps • License plate lamps • Side maker lamps • Tail lamps • Front fog lamps 	10 seconds
4	Headlamps	LO ↔ HI 5 times
5	A/C compressor (magnet clutch)	ON ↔ OFF 5 times
6*	Cooling fan	MID for 5 seconds → HI for 5 seconds

*: Outputs duty ratio of 50% for 5 seconds → duty ratio of 100% for 5 seconds on the cooling fan control module.

DIAGNOSIS SYSTEM (IPDM E/R)

< SYSTEM DESCRIPTION >

[IPDM E/R]

Concept of auto active test

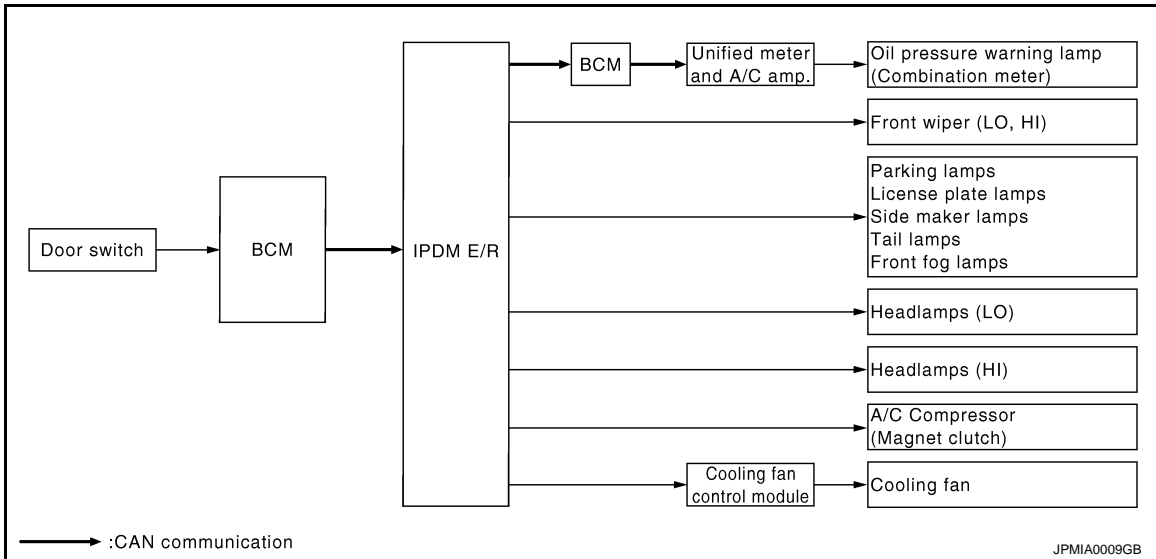

- IPDM E/R starts the auto active test with the door switch signals transmitted by BCM via CAN communication. Therefore, the CAN communication line between IPDM E/R and BCM is considered normal if the auto active test starts successfully.
- The auto active test facilitates troubleshooting if any systems controlled by IPDM E/R cannot be operated.

Diagnosis chart in auto active test mode

Symptom	Inspection contents	Possible cause
Any of the following components do not operate <ul style="list-style-type: none"> • Parking lamps • License plate lamps • Side maker lamps • Tail lamps • Front fog lamps • Headlamp (HI, LO) • Front wiper (HI, LO) 	Perform auto active test. Does the applicable system operate?	YES BCM signal input circuit
		NO <ul style="list-style-type: none"> • Lamp or motor • Lamp or motor ground circuit • Harness or connector between IPDM E/R and applicable system • IPDM E/R
A/C compressor does not operate	Perform auto active test. Does the magnet clutch operate?	YES <ul style="list-style-type: none"> • Unified meter and A/C amp. signal input circuit • CAN communication signal between unified meter and A/C amp. and ECM • CAN communication signal between ECM and IPDM E/R
		NO <ul style="list-style-type: none"> • Magnet clutch • Harness or connector between IPDM E/R and magnet clutch • IPDM E/R
Oil pressure warning lamp does not operate	Perform auto active test. Does the oil pressure warning lamp blink?	YES <ul style="list-style-type: none"> • Harness or connector between IPDM E/R and oil pressure switch • Oil pressure switch • IPDM E/R
		NO <ul style="list-style-type: none"> • CAN communication signal between IPDM E/R and BCM • CAN communication signal between BCM and unified meter and A/C amp. • Combination meter

DIAGNOSIS SYSTEM (IPDM E/R)

< SYSTEM DESCRIPTION >

[IPDM E/R]

Symptom	Inspection contents	Possible cause
Cooling fan does not operate	Perform auto active test. Does the cooling fan operate?	<p style="text-align: center;">YES</p> <ul style="list-style-type: none"> • ECM signal input circuit • CAN communication signal between ECM and IPDM E/R
		<p style="text-align: center;">NO</p> <ul style="list-style-type: none"> • Cooling fan • Harness or connector between cooling fan and cooling fan control module • Cooling fan control module • Harness or connector between IPDM E/R and cooling fan control module • Cooling fan relay • Harness or connector between IPDM E/R and cooling fan relay • IPDM E/R

CONSULT-III Function (IPDM E/R)

INFOID:000000006469781

APPLICATION ITEM

CONSULT-III performs the following functions via CAN communication with IPDM E/R.

Diagnosis mode	Description
Ecu Identification	Allows confirmation of IPDM E/R part number.
Self Diagnostic Result	Displays the diagnosis results judged by IPDM E/R.
Data Monitor	Displays the real-time input/output data from IPDM E/R input/output data.
Active Test	IPDM E/R can provide a drive signal to electronic components to check their operations.
CAN Diag Support Monitor	The results of transmit/receive diagnosis of CAN communication can be read.

SELF DIAGNOSTIC RESULT

Refer to [PCS-31, "DTC Index"](#).

DATA MONITOR

Monitor item

Monitor Item [Unit]	MAIN SIG- NALS	Description
RAD FAN REQ [%]	×	Displays the value of the cooling fan speed signal received from ECM via CAN communication.
AC COMP REQ [Off/On]	×	Displays the status of the A/C compressor request signal received from ECM via CAN communication.
TAIL&CLR REQ [Off/On]	×	Displays the status of the position light request signal received from BCM via CAN communication.
HL LO REQ [Off/On]	×	Displays the status of the low beam request signal received from BCM via CAN communication.
HL HI REQ [Off/On]	×	Displays the status of the high beam request signal received from BCM via CAN communication.
FR FOG REQ [Off/On]	×	Displays the status of the front fog light request signal received from BCM via CAN communication.
FR WIP REQ [Stop/1LOW/Low/Hi]	×	Displays the status of the front wiper request signal received from BCM via CAN communication.
WIP AUTO STOP [STOP P/ACT P]	×	Displays the status of the front wiper auto stop signal judged by IPDM E/R.
WIP PROT [Off/BLOCK]	×	Displays the status of the front wiper fail-safe operation judged by IPDM E/R.

DIAGNOSIS SYSTEM (IPDM E/R)

< SYSTEM DESCRIPTION >

[IPDM E/R]

Monitor Item [Unit]	MAIN SIG- NALS	Description	
IGN RLY1 -REQ [Off/On]		Displays the status of the ignition switch ON signal received from BCM via CAN communication.	A
IGN RLY [Off/On]	×	Displays the status of the ignition relay judged by IPDM E/R.	B
PUSH SW [Off/On]		Displays the status of the push-button ignition switch judged by IPDM E/R.	C
INTER/NP SW [Off/On]		Displays the status of the clutch interlock switch (M/T models) or shift position (A/T models) judged by IPDM E/R.	D
ST RLY CONT [Off/On]		Displays the status of the starter relay status signal received from BCM via CAN communication.	E
IHBT RLY -REQ [Off/On]		Displays the status of the starter control relay signal received from BCM via CAN communication.	F
ST/INHI RLY [Off/ ST ON/INHI ON/UNKWN]		Displays the status of the starter relay and starter control relay judged by IPDM E/R.	G
DETENT SW [Off/On]		Displays the status of the A/T shift selector (detention switch) judged by IPDM E/R.	H
S/L RLY -REQ [Off/On]		Displays the status of the steering lock relay request received from BCM via CAN communication. NOTE: For models without steering lock unit, this item is not monitored.	I
S/L STATE [LOCK/UNLOCK/UNKWN]		Displays the status of the steering lock judged by IPDM E/R. NOTE: For models without steering lock unit, this item is not monitored.	J
DTRL REQ [Off/On]		NOTE: The item is indicated, but not monitored.	K
OIL P SW [Open/Close]		Displays the status of the oil pressure switch judged by IPDM E/R.	L
HOOD SW [Off/On]		Displays the status of the hood switch judged by IPDM E/R.	M
HL WASHER REQ [Off/On]		NOTE: The item is indicated, but not monitored.	N
THFT HRN REQ [Off/On]		Displays the status of the theft warning horn request signal received from BCM via CAN communication.	O
HORN CHIRP [Off/On]		Displays the status of the horn reminder signal received from BCM via CAN communication.	P
CRNRNG LMP REQ [Off/On]		NOTE: The item is indicated, but not monitored.	Q

PCS

ACTIVE TEST

Test item

Test item	Operation	Description	
CORNERING LAMP	Off	NOTE: The item is indicated, but cannot be tested.	R
	LH		S
	RH		T
HORN	On	Operates horn relay 1 and horn relay 2 for 20 ms.	U
FRONT WIPER	Off	OFF	V
	Lo	Operates the front wiper relay.	W
	Hi	Operates the front wiper relay and front wiper high relay.	X

N
O
P

DIAGNOSIS SYSTEM (IPDM E/R)

< SYSTEM DESCRIPTION >

[IPDM E/R]

Test item	Operation	Description
MOTOR FAN	1	OFF
	2	Outputs 50% pulse duty signal (PWM signal) to the cooling fan control module.
	3	Outputs 80% pulse duty signal (PWM signal) to the cooling fan control module.
	4	Outputs 100% pulse duty signal (PWM signal) to the cooling fan control module.
HEAD LAMP WASHER	On	NOTE: The item is indicated, but cannot be tested.
EXTERNAL LAMPS	Off	OFF
	TAIL	Operates the tail lamp relay.
	Lo	Operates the headlamp low relay.
	Hi	Operates the headlamp low relay and ON/OFF the headlamp high relay at 1 second intervals.
	Fog	Operates the front fog lamp relay.

DTC/CIRCUIT DIAGNOSIS

U1000 CAN COMM CIRCUIT

Description

INFOID:000000006469782

CAN (Controller Area Network) is a serial communication line for real time applications. It is an on-vehicle multiplex communication line with high data communication speed and excellent error detection ability. Modern vehicle is equipped with many electronic control unit, and each control unit shares information and links with other control units during operation (not independent). In CAN communication, control units are connected with 2 communication lines (CAN-H line, CAN-L line) allowing a high rate of information transmission with less wiring. Each control unit transmits/receives data but selectively reads required data only.

CAN Communication Signal Chart. Refer to [LAN-23, "CAN Communication Signal Chart"](#).

DTC Logic

INFOID:000000006469783

DTC DETECTION LOGIC

DTC	CONSULT-III display description	DTC Detection Condition	Possible cause
U1000	CAN COMM CIRCUIT	When IPDM E/R cannot communicate CAN communication signal continuously for 2 seconds or more	CAN communication system

Diagnosis Procedure

INFOID:000000006469784

1. PERFORM SELF DIAGNOSTIC

1. Turn the ignition switch ON and wait for 2 seconds or more.
2. Check "Self Diagnostic Result" of IPDM E/R.

Is DTC "U1000" displayed?

- YES >> Refer to [LAN-14, "Trouble Diagnosis Flow Chart"](#).
- NO >> Refer to [GI-43, "Intermittent Incident"](#).

PCS

B2098 IGNITION RELAY ON STUCK

< DTC/CIRCUIT DIAGNOSIS >

[IPDM E/R]

B2098 IGNITION RELAY ON STUCK

Description

INFOID:000000006469785

- IPDM E/R operates the ignition relay when it receives an ignition switch ON signal from BCM via CAN communication.
- Turn the ignition relay OFF by pressing the push-button ignition switch once when the vehicle speed is 4 km/h (2.5 MPH) or less.
- Turn the ignition relay OFF with the following operation when the vehicle speed is more than 4 km/h (2.5 MPH) or when an abnormal condition occurs in CAN communication from the unified meter and A/C amp.(Emergency OFF)
 - Press and hold the push-button ignition switch for 2 seconds or more.
 - Press the push-button ignition switch 3 times within 1.5 seconds.

NOTE:

The ignition relay does not turn ON for 3 seconds after emergency OFF even if the push-button ignition switch is pressed.

DTC Logic

INFOID:000000006469786

DTC DETECTION LOGIC

DTC	CONSULT-III display description	DTC Detection Condition	Possible causes
B2098	IGN RELAY ON	The ignition relay ON is detected for 1 second at ignition switch OFF (CPU monitors the status at the contact and excitation coil circuits of the ignition relay inside it)	Ignition relay malfunction

Diagnosis Procedure

INFOID:000000006469787

1.PERFORM SELF DIAGNOSIS

1. Turn the ignition switch ON.
2. Erase "Self Diagnostic Result" of IPDM E/R.
3. Turn the ignition switch OFF, and wait for 1 second or more.
4. Turn the ignition switch ON. Check "Self Diagnostic Result" again.

Is DTC "B2098" displayed?

- YES >> Replace IPDM E/R.
NO >> Refer to [GI-43, "Intermittent Incident"](#).

B2099 IGNITION RELAY OFF STUCK

< DTC/CIRCUIT DIAGNOSIS >

[IPDM E/R]

B2099 IGNITION RELAY OFF STUCK

Description

INFOID:000000006469788

- IPDM E/R operates the ignition relay when it receives an ignition switch ON signal from BCM via CAN communication.
- Turn the ignition relay OFF by pressing the push-button ignition switch once when the vehicle speed is 4 km/h (2.5 MPH) or less.
- Turn the ignition relay OFF with the following operation when the vehicle speed is more than 4 km/h (2.5 MPH) or when an abnormal condition occurs in CAN communication from the unified meter and A/C amp.(Emergency OFF)
 - Press and hold the push-button ignition switch for 2 seconds or more.
 - Press the push-button ignition switch 3 times within 1.5 seconds.

NOTE:

The ignition relay does not turn ON for 3 seconds after emergency OFF even if the push-button ignition switch is pressed.

DTC Logic

INFOID:000000006469789

DTC DETECTION LOGIC

DTC	CONSULT-III display description	DTC Detection Condition	Possible causes
B2099	IGN RELAY OFF	The ignition relay OFF is detected for 1 second at ignition switch ON (CPU monitors the status at the contact and excitation coil circuits of the ignition relay inside it)	Ignition relay malfunction

NOTE:

When IPDM E/R power supply voltage is low (Approx. 7 - 8 V for about 1 second), the "DTC: B2099" may be detected.

Diagnosis Procedure

INFOID:000000006469790

1. PERFORM SELF DIAGNOSIS

1. Turn the ignition switch ON.
2. Erase "Self Diagnostic Result".
3. Turn the ignition switch OFF.
4. Turn the ignition switch ON. Check "Self Diagnostic Result" again.

Is DTC "B2099" displayed?

- YES >> Replace IPDM E/R.
- NO >> Refer to [GI-43, "Intermittent Incident"](#).

A
B
C
D
E
F
G
H
I
J
K
L
N
O
P

PCS

POWER SUPPLY AND GROUND CIRCUIT

< DTC/CIRCUIT DIAGNOSIS >

[IPDM E/R]

POWER SUPPLY AND GROUND CIRCUIT

Diagnosis Procedure

INFOID:000000006469791

1. CHECK FUSES AND FUSIBLE LINK

Check that the following IPDM E/R fuses or fusible links are not blown.

Signal name	Fuses and fusible link No.
Battery power supply	C
	50
	51

Is the fuse fusing?

YES >> Replace the blown fuse or fusible link after repairing the affected circuit if a fuse or fusible link is blown.

NO >> GO TO 2.

2. CHECK POWER SUPPLY CIRCUIT

1. Turn the ignition switch OFF.
2. Disconnect IPDM E/R connector.
3. Check voltage between IPDM E/R harness connector and the ground.

Terminals		Voltage (Approx.)
(+)	(-)	
IPDM E/R		Battery voltage
Connector	Terminal	
E4	1	

Is the measurement value normal?

YES >> GO TO 3.

NO >> Repair the harness or connector.

3. CHECK GROUND CIRCUIT

Check continuity between IPDM E/R harness connectors and the ground.

IPDM E/R		Ground	Continuity
Connector	Terminal		
E5	12		Existed
E6	41		

Does continuity exist?

YES >> INSPECTION END

NO >> Repair the harness or connector.

IPDM E/R (INTELLIGENT POWER DISTRIBUTION MODULE ENGINE ROOM)

< ECU DIAGNOSIS INFORMATION >

[IPDM E/R]

ECU DIAGNOSIS INFORMATION

IPDM E/R (INTELLIGENT POWER DISTRIBUTION MODULE ENGINE ROOM)

Reference Value

INFOID:000000006469792

VALUES ON THE DIAGNOSIS TOOL

Monitor Item	Condition		Value/Status
RAD FAN REQ	Engine idle speed	Changes depending on engine coolant temperature, air conditioner operation status, vehicle speed, etc.	0 - 100 %
AC COMP REQ	Engine running	A/C switch OFF	Off
		A/C switch ON (Compressor is operating)	On
TAIL&CLR REQ	Lighting switch OFF		Off
	Lighting switch 1ST, 2ND, HI or AUTO (Light is illuminated)		On
HL LO REQ	Lighting switch OFF		Off
	Lighting switch 2ND HI or AUTO (Light is illuminated)		On
HL HI REQ	Lighting switch OFF		Off
	Lighting switch HI		On
FR FOG REQ	Lighting switch 2ND or AUTO (Light is illuminated)	Front fog lamp switch OFF	Off
		<ul style="list-style-type: none"> • Front fog lamp switch ON • Daytime running light activated (Only for Canada) 	On
FR WIP REQ	Ignition switch ON	Front wiper switch OFF	Stop
		Front wiper switch INT	1LOW
		Front wiper switch LO	Low
		Front wiper switch HI	Hi
WIP AUTO STOP	Ignition switch ON	Front wiper stop position	STOP P
		Any position other than front wiper stop position	ACT P
WIP PROT	Ignition switch ON	Front wiper operates normally	Off
		Front wiper stops at fail-safe operation	BLOCK
IGN RLY1 -REQ	Ignition switch OFF or ACC		Off
	Ignition switch ON		On
IGN RLY	Ignition switch OFF or ACC		Off
	Ignition switch ON		On
PUSH SW	Release the push-button ignition switch		Off
	Press the push-button ignition switch		On
INTER/NP SW	Ignition switch ON	Selector lever in any position other than P or N (A/T models)	Off
		Release clutch pedal (M/T models)	
	Ignition switch ON	Selector lever in P or N position (A/T models)	On
		Depress clutch pedal (M/T models)	

A
B
C
D
E
F
G
H
I
J
K
L

PCS

N
O
P

IPDM E/R (INTELLIGENT POWER DISTRIBUTION MODULE ENGINE ROOM)

< ECU DIAGNOSIS INFORMATION >

[IPDM E/R]

Monitor Item	Condition	Value/Status
ST RLY CONT	Ignition switch ON	Off
	At engine cranking	On
IHBT RLY -REQ	Ignition switch ON	Off
	At engine cranking	On
ST/INHI RLY	Ignition switch ON	Off
	At engine cranking	INHI ON → ST ON
	The status of starter relay or starter control relay cannot be recognized by the battery voltage malfunction, etc. when the starter relay is ON and the starter control relay is OFF	UNKWN
DETENT SW	Ignition switch ON	Off
	Release the selector button with selector lever in P position NOTE: Fixed On for M/T models	On
S/L RLY -REQ NOTE: For models without steering lock unit, this item is not monitored.	None of the conditions below are present	Off
	<ul style="list-style-type: none"> • Open the driver door after the ignition switch is turned OFF (for a few seconds) • Press the push-button ignition switch when the steering lock is activated • Depress the clutch pedal when the steering lock is activated 	On
S/L STATE NOTE: For models without steering lock unit, this item is not monitored.	Steering lock is activated	LOCK
	Steering lock is deactivated	UNLOCK
	[DTC: B210A] is detected	UNKWN
DTRL REQ	NOTE: The item is indicated, but not monitored.	Off
OIL P SW	Ignition switch OFF, ACC or engine running	Open
	Ignition switch ON	Close
HOOD SW	Close the hood	Off
	Open the hood	On
HL WASHER REQ	NOTE: The item is indicated, but not monitored.	Off
THFT HRN REQ	Not operation	Off
	<ul style="list-style-type: none"> • Panic alarm is activated • Horn is activated with VEHICLE SECURITY (THEFT WARNING) SYSTEM 	On
HORN CHIRP	Not operating	Off
	Door locking with Intelligent Key (horn chirp mode)	On
CRNRNG LMP REQ	NOTE: The item is indicated, but not monitored.	Off

IPDM E/R (INTELLIGENT POWER DISTRIBUTION MODULE ENGINE ROOM)

< ECU DIAGNOSIS INFORMATION >

[IPDM E/R]

TERMINAL LAYOUT

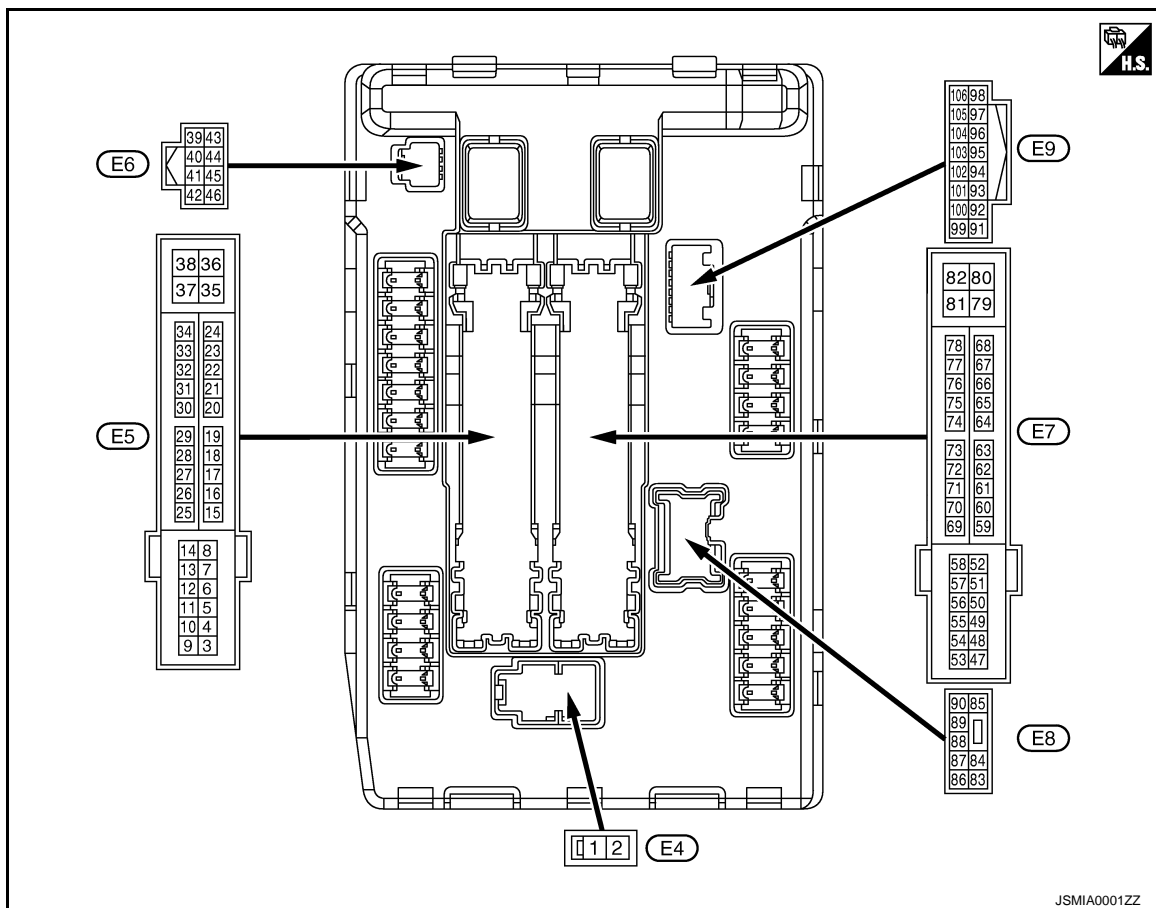

PHYSICAL VALUES

Terminal No. (Wire color)		Description		Condition		Value (Approx.)
+	-	Signal name	Input/ Output			
1 (W)	Ground	Battery power supply	Input	Ignition switch OFF		Battery voltage
2 (L)	Ground	Battery power supply	Input	Ignition switch OFF		Battery voltage
4 (V)	Ground	Front wiper LO	Output	Ignition switch OFF	Front wiper switch OFF	0 V
				Ignition switch ON	Front wiper switch LO	Battery voltage
5 (L)	Ground	Front wiper HI	Output	Ignition switch OFF	Front wiper switch OFF	0 V
				Ignition switch ON	Front wiper switch HI	Battery voltage
6*5 (SB)	Ground	Daytime running light relay	Input	Ignition switch OFF		Battery voltage
7 (R)	Ground	Tail, license plate lamps & illuminations	Output	Ignition switch OFF	Lighting switch OFF	0 V
				Ignition switch ON	Lighting switch 1ST	Battery voltage
11*4 (BR)	Ground	Steering lock unit power supply	Output	Ignition switch OFF	A few seconds after opening the driver door	Battery voltage
				Ignition switch LOCK	Press the push-button ignition switch	Battery voltage
				Ignition switch ACC or ON		0 V

IPDM E/R (INTELLIGENT POWER DISTRIBUTION MODULE ENGINE ROOM)

< ECU DIAGNOSIS INFORMATION >

[IPDM E/R]

Terminal No. (Wire color)		Description		Condition	Value (Approx.)	
+	-	Signal name	Input/ Output			
12 (B/W)	Ground	Ground	—	Ignition switch ON	0 V	
13 (Y)	Ground	Fuel pump power supply	Output	Approximately 1 second or more after turning the ignition switch ON	0 V	
				<ul style="list-style-type: none"> • Approximately 1 second after turning the ignition switch ON • Engine running 	Battery voltage	
16 (LG)	Ground	Front wiper auto stop	Input	Ignition switch ON	Front wiper stop position	0 V
					Any position other than front wiper stop position	Battery voltage
19 (W)	Ground	Ignition relay power supply	Output	Ignition switch OFF	0 V	
				Ignition switch ON	Battery voltage	
25 (G)	Ground	Ignition relay power supply	Output	Ignition switch OFF	0 V	
				Ignition switch ON	Battery voltage	
26*1 (R)	Ground	Ignition relay power supply	Output	Ignition switch OFF	0 V	
				Ignition switch ON	Battery voltage	
27 (BG)	Ground	Ignition relay monitor	Input	Ignition switch OFF or ACC	Battery voltage	
				Ignition switch ON	0 V	
28 (L)	Ground	Push-button ignition switch	Input	Press the push-button ignition switch	0 V	
				Release the push-button ignition switch	Battery voltage	
30 (GR)	Ground	Starter relay control	Input	A/T models	Selector lever in any position other than P or N (Ignition switch ON)	0 V
					Selector lever P or N (Ignition switch ON)	Battery voltage
				M/T models	Release the clutch pedal	0 V
					Depress the clutch pedal	Battery voltage
32*4 (V)	Ground	Steering lock unit condition-1	Input	Steering lock is activated	0 V	
				Steering lock is deactivated	Battery voltage	
33*4 (P)	Ground	Steering lock unit condition-2	Input	Steering lock is activated	Battery voltage	
				Steering lock is deactivated	0 V	
36 (G)	Ground	Battery power supply	Input	Ignition switch OFF	Battery voltage	
39 (P)	—	CAN-L	Input/ Output	—	—	
40 (L)	—	CAN-H	Input/ Output	—	—	
41 (B/W)	Ground	Ground	—	Ignition switch ON	0 V	
42 (Y)	Ground	Cooling fan relay control	Input	Ignition switch OFF or ACC	0 V	
				Ignition switch ON	0.7 V	
43*2 (SB)	Ground	A/T shift selector (Detention switch)	Input	Ignition switch ON	Press the selector button (selector lever P)	Battery voltage
					<ul style="list-style-type: none"> • Selector lever in any position other than P • Release the selector button (selector lever P) 	0 V

IPDM E/R (INTELLIGENT POWER DISTRIBUTION MODULE ENGINE ROOM)

< ECU DIAGNOSIS INFORMATION >

[IPDM E/R]

Terminal No. (Wire color)		Description		Condition	Value (Approx.)	
+	-	Signal name	Input/ Output			
44 (LG)	Ground	Horn relay control	Input	The horn is deactivated	Battery voltage	
				The horn is activated	0 V	
45 (G)	Ground	Anti theft horn relay control	Input	The horn is deactivated	Battery voltage	
				The horn is activated	0 V	
46 (W)	Ground	Starter relay control	Input	A/T models	Selector lever in any position other than P or N (Ignition switch ON)	0 V
					Selector lever P or N (Ignition switch ON)	Battery voltage
				M/T models	Release the clutch pedal	0 V
					Depress the clutch pedal	Battery voltage
48 (BR)	Ground	A/C relay power supply	Output	Engine running	A/C switch OFF	0 V
					A/C switch ON (A/C compressor is operating)	Battery voltage
49 (BG)	Ground	ECM relay power supply	Output		Ignition switch OFF (More than a few seconds after turning ignition switch OFF)	0 V
					<ul style="list-style-type: none"> • Ignition switch ON • Ignition switch OFF (For a few seconds after turning ignition switch OFF) 	Battery voltage
51 (Y)	Ground	Ignition relay power supply	Output		Ignition switch OFF	0 V
					Ignition switch ON	Battery voltage
53 (W)	Ground	ECM relay power supply	Output		Ignition switch OFF (More than a few seconds after turning ignition switch OFF)	0 V
					<ul style="list-style-type: none"> • Ignition switch ON • Ignition switch OFF (For a few seconds after turning ignition switch OFF) 	Battery voltage
54 (P)	Ground	Throttle control motor relay power supply	Output		Ignition switch OFF (More than a few seconds after turning ignition switch OFF)	0 V
					<ul style="list-style-type: none"> • Ignition switch ON • Ignition switch OFF (For a few seconds after turning ignition switch OFF) 	Battery voltage
55 (SB)	Ground	ECM power supply	Output		Ignition switch OFF	Battery voltage
56 (LG)	Ground	Ignition relay power supply	Output		Ignition switch OFF	0 V
					Ignition switch ON	Battery voltage
57 (G)	Ground	Ignition relay power supply	Output		Ignition switch OFF	0 V
					Ignition switch ON	Battery voltage
58*2 (GR)	Ground	Ignition relay power supply	Output		Ignition switch OFF	0 V
					Ignition switch ON	Battery voltage

A
B
C
D
E
F
G
H
I
J
K
L
N
O
P

PCS

IPDM E/R (INTELLIGENT POWER DISTRIBUTION MODULE ENGINE ROOM)

< ECU DIAGNOSIS INFORMATION >

[IPDM E/R]

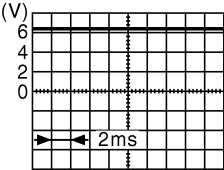
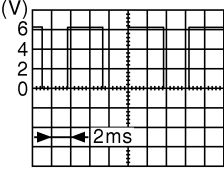
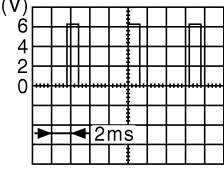
Terminal No. (Wire color)		Description		Condition	Value (Approx.)
+	-	Signal name	Input/ Output		
69 (BR)	Ground	ECM relay control	Output	Ignition switch OFF (More than a few seconds after turning ignition switch OFF)	Battery voltage
				<ul style="list-style-type: none"> • Ignition switch ON • Ignition switch OFF (For a few seconds after turning ignition switch OFF) 	0 - 1.5 V
70 (BG)	Ground	Throttle control motor relay control	Output	Ignition switch ON → OFF	0 - 1.0 V ↓ Battery voltage ↓ 0 V
				Ignition switch ON	0 - 1.0 V
73*3 (P)	Ground	Ignition relay power supply	Output	Ignition switch OFF	0 V
				Ignition switch ON	Battery voltage
74 (G)	Ground	Ignition relay power supply	Output	Ignition switch OFF	0 V
				Ignition switch ON	Battery voltage
75 (SB)	Ground	Oil pressure switch	Input	Ignition switch ON	0 V
				Engine stopped	Battery voltage
76 (Y)	Ground	Power generation command signal	Output	Ignition switch ON	 <p style="text-align: right; font-size: small;">JPMIA0001GB</p> <p style="text-align: center;">6.3 V</p>
				40% is set on "ACTIVE TEST", "ALTERNATOR DUTY" of "ENGINE"	 <p style="text-align: right; font-size: small;">JPMIA0002GB</p> <p style="text-align: center;">3.8 V</p>
				80% is set on "ACTIVE TEST", "ALTERNATOR DUTY" of "ENGINE"	 <p style="text-align: right; font-size: small;">JPMIA0003GB</p> <p style="text-align: center;">1.4 V</p>
77 (R)	Ground	Fuel pump relay control	Output	<ul style="list-style-type: none"> • Approximately 1 second after turning the ignition switch ON • Engine running 	0 - 1.0 V
				Approximately 1 second or more after turning the ignition switch ON	Battery voltage
80 (W)	Ground	Starter motor	Output	At engine cranking	Battery voltage

IPDM E/R (INTELLIGENT POWER DISTRIBUTION MODULE ENGINE ROOM)

< ECU DIAGNOSIS INFORMATION >

[IPDM E/R]

Terminal No. (Wire color)		Description		Condition		Value (Approx.)
		Signal name	Input/ Output			
83 (R)	Ground	Headlamp LO (RH)	Output	Ignition switch ON	Lighting switch OFF	0 V
					Lighting switch 2ND	Battery voltage
84 (P)	Ground	Headlamp LO (LH)	Output	Ignition switch ON	Lighting switch OFF	0 V
					Lighting switch 2ND	Battery voltage
86 (W)	Ground	Front fog lamp (RH)	Output	Lighting switch 2ND	Front fog lamp switch OFF	0 V
					<ul style="list-style-type: none"> • Front fog lamp switch ON • Daytime running light activated (Only for Canada) 	Battery voltage
87 (L)	Ground	Front fog lamp (LH)	Output	Lighting switch 2ND	Front fog lamp switch OFF	0 V
					<ul style="list-style-type: none"> • Front fog lamp switch ON • Daytime running light activated (Only for Canada) 	Battery voltage
88 (G)	Ground	Washer pump power supply	Output	Ignition switch ON		Battery voltage
89 (BR)	Ground	Headlamp HI (RH)	Output	Ignition switch ON	Lighting switch OFF	0 V
					<ul style="list-style-type: none"> • Lighting switch HI • Lighting switch PASS 	Battery voltage
90 (LG)	Ground	Headlamp HI (LH)	Output	Ignition switch ON	Lighting switch OFF	0 V
					<ul style="list-style-type: none"> • Lighting switch HI • Lighting switch PASS 	Battery voltage
91 (P)	Ground	Parking lamp (RH)	Output	Ignition switch ON	Lighting switch OFF	0 V
					Lighting switch 1ST	Battery voltage
92 (BG)	Ground	Parking lamp (LH)	Output	Ignition switch ON	Lighting switch OFF	0 V
					Lighting switch 1ST	Battery voltage
97 (V)	Ground	Cooling fan control	Output	Engine idling		0 - 5 V
104 (LG)	Ground	Hood switch	Input	Close the hood		Battery voltage
				Open the hood		0 V
105*5 (L)	Ground	Daytime running light relay control	Output	<ul style="list-style-type: none"> • Park- ing lamp • Li- cense plate lamp • Tail lamp 	Turned OFF	Battery voltage
					Turned ON	0 V

*1: Only for the models with ICC system

*2: A/T models only

*3: M/T models only

*4: Models with steering lock unit

*5: Models with daytime running light system

IPDM E/R (INTELLIGENT POWER DISTRIBUTION MODULE ENGINE ROOM)

< ECU DIAGNOSIS INFORMATION >

[IPDM E/R]

Wiring Diagram - IPDM E/R -

INFOID:000000006469793

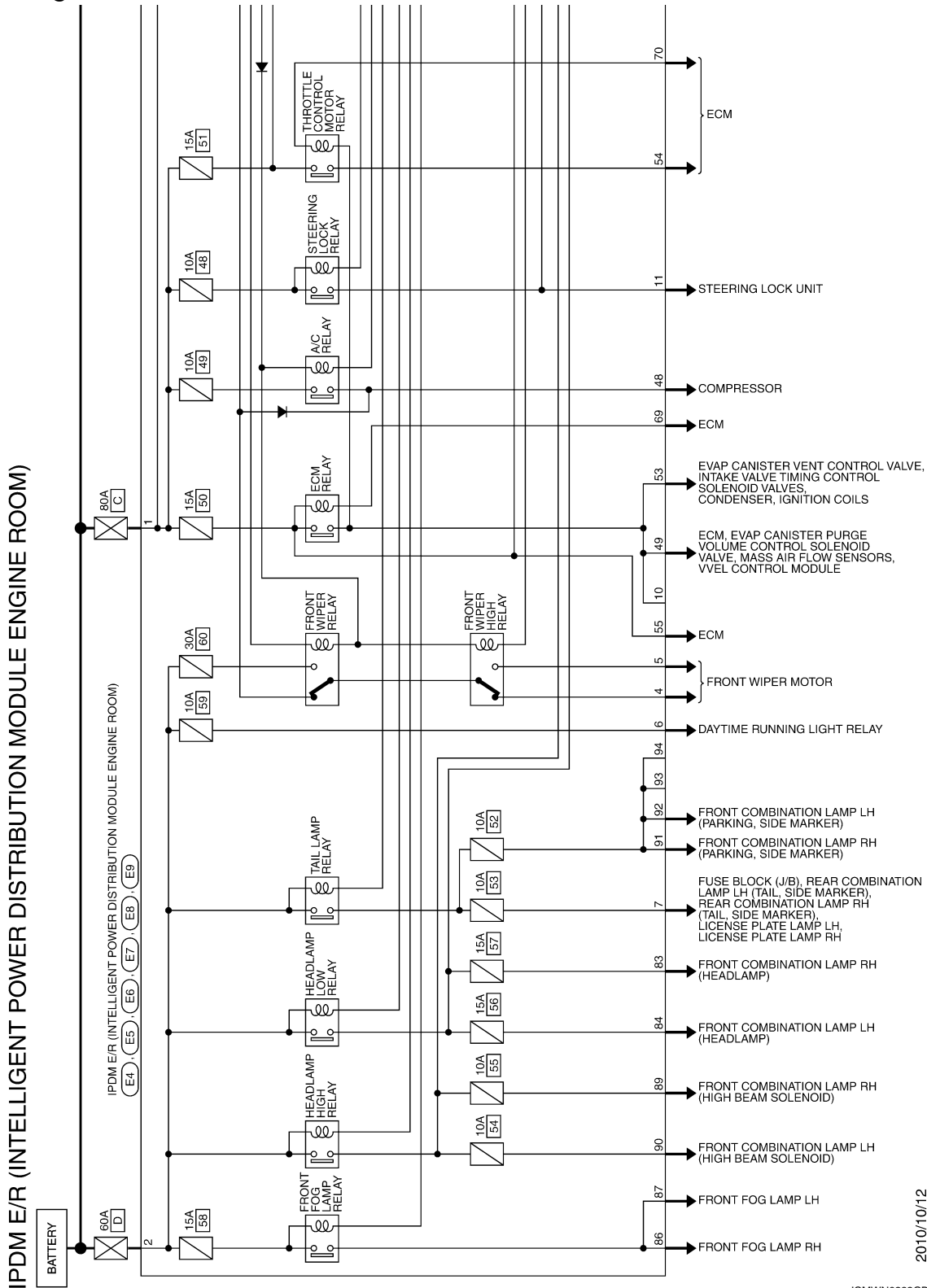

2010/10/12

JCMWN0262GB

IPDM E/R (INTELLIGENT POWER DISTRIBUTION MODULE ENGINE ROOM)

< ECU DIAGNOSIS INFORMATION >

[IPDM E/R]

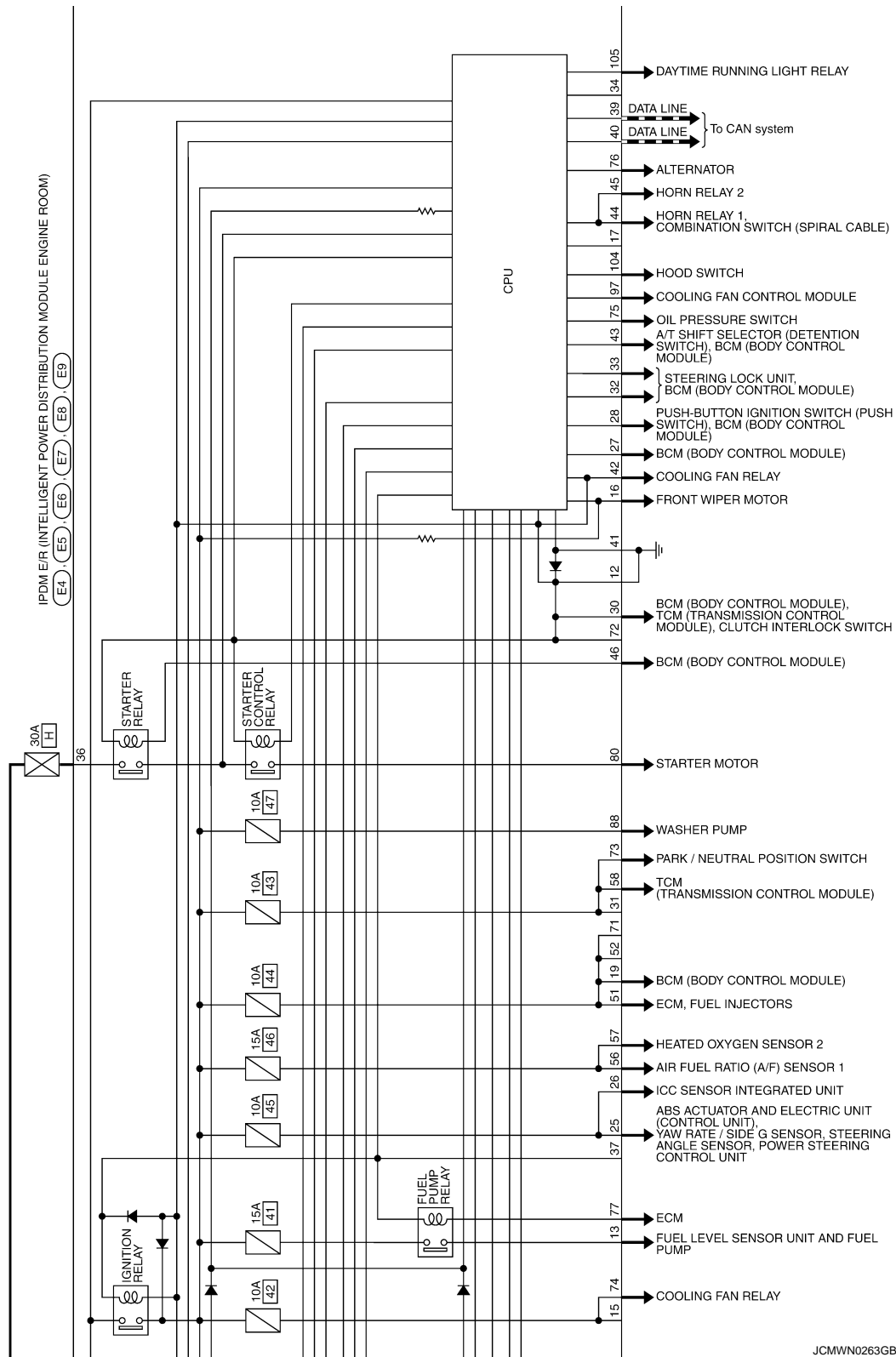

JCMWN0263GB

A
B
C
D
E
F
G
H
I
J
K
L
PCS
N
O
P

IPDM E/R
(INTELLIGENT POWER
DISTRIBUTION MODULE
ENGINE ROOM)
E4 E5 E6
E7 E8 E9

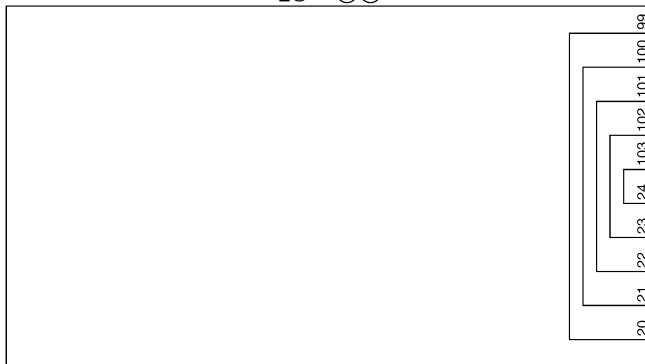

JCMWN0264GB

A
B
C
D
E
F
G
H
I
J
K
L
N
O
P

IPDM E/R (INTELLIGENT POWER DISTRIBUTION MODULE ENGINE ROOM)			IPDM E/R (INTELLIGENT POWER DISTRIBUTION MODULE ENGINE ROOM)			IPDM E/R (INTELLIGENT POWER DISTRIBUTION MODULE ENGINE ROOM)			IPDM E/R (INTELLIGENT POWER DISTRIBUTION MODULE ENGINE ROOM)		
Connector No.	E4		Connector No.	E6		Connector No.	E7		Connector No.	E8	
Connector Name	IPDM E/R (INTELLIGENT POWER DISTRIBUTION MODULE ENGINE ROOM)		Connector Name	IPDM E/R (INTELLIGENT POWER DISTRIBUTION MODULE ENGINE ROOM)		Connector Name	IPDM E/R (INTELLIGENT POWER DISTRIBUTION MODULE ENGINE ROOM)		Connector Name	IPDM E/R (INTELLIGENT POWER DISTRIBUTION MODULE ENGINE ROOM)	
Connector Type	LOGPE-MC		Connector Type	TH20FW-NH		Connector Type	TH20FW-CS12-M4		Connector Type	TH18FW-NH	
Terminal No.	1	2	Terminal No.	39	40	41	42	43	44	45	46
Color of Wire	W	L	Color of Wire	P	L	B/W	Y	SB	LG	G	W
Signal Name [Specification]			Signal Name [Specification]								
Connector No.	E5		Terminal No.	47	48	49	50	51	52	53	54
Connector Name	IPDM E/R (INTELLIGENT POWER DISTRIBUTION MODULE ENGINE ROOM)		Color of Wire	Y	BR	EG	W	P	SB	LG	G
Connector Type	TH20FW-CS12-M4-1V		Signal Name [Specification]								
Terminal No.	4	5	Terminal No.	87	88	89	90	91	92	93	94
Color of Wire	V	L	Color of Wire	Y	P	BG	L	P	BG	V	LG
Signal Name [Specification]			Signal Name [Specification]								
Connector No.	E9		Terminal No.	95	96	97	98	99	100	101	102
Connector Name	IPDM E/R (INTELLIGENT POWER DISTRIBUTION MODULE ENGINE ROOM)		Color of Wire	W	W	L	L	L	L	L	L
Connector Type	TH20FW-CS12-M4-1V		Signal Name [Specification]								

Fail-safe

CAN COMMUNICATION CONTROL

When CAN communication with ECM and BCM is impossible, IPDM E/R performs fail-safe control. After CAN communication recovers normally, it also returns to normal control.

If No CAN Communication Is Available With ECM

JCMWN0265GB
 INFOID:000000006469794

IPDM E/R (INTELLIGENT POWER DISTRIBUTION MODULE ENGINE ROOM)

< ECU DIAGNOSIS INFORMATION >

[IPDM E/R]

Control part	Fail-safe operation
Cooling fan	<ul style="list-style-type: none"> • Outputs the pulse duty signal (PWM signal) 100% when the ignition switch is turned ON • Outputs the pulse duty signal (PWM signal) 0% when the ignition switch is turned OFF
A/C compressor	A/C relay OFF
Alternator	Outputs the power generation command signal (PWM signal) 0%

If No CAN Communication Is Available With BCM

Control part	Fail-safe operation
Headlamp	<ul style="list-style-type: none"> • Turns ON the headlamp low relay when the ignition switch is turned ON • Turns OFF the headlamp low relay when the ignition switch is turned OFF • Headlamp high relay OFF
<ul style="list-style-type: none"> • Parking lamps • Side maker lamp • License plate lamps • Illuminations • Tail lamps 	<ul style="list-style-type: none"> • Turns ON the tail lamp relay when the ignition switch is turned ON • Turns OFF the tail lamp relay when the ignition switch is turned OFF
Front wiper	<ul style="list-style-type: none"> • The status just before activation of fail-safe control is maintained until the ignition switch is turned OFF while the front wiper is operating at LO or HI speed. • The wiper is operated at LO speed until the ignition switch is turned OFF if the fail-safe control is activated while the front wiper is set in the INT mode and the front wiper motor is operating.
Horn	Horn relay OFF
Ignition relay	The status just before activation of fail-safe is maintained.
Starter motor	Starter control relay OFF
Steering lock unit*	Steering lock relay OFF

*: For models with steering lock unit

IGNITION RELAY MALFUNCTION DETECTION FUNCTION

- IPDM E/R monitors the voltage at the contact circuit and excitation coil circuit of the ignition relay inside it.
- IPDM E/R judges the ignition relay error if the voltage differs between the contact circuit and the excitation coil circuit.
- If the ignition relay cannot turn OFF due to contact seizure, it activates the tail lamp relay for 10 minutes to alert the user to the ignition relay malfunction when the ignition switch is turned OFF.

Voltage judgment		IPDM E/R judgment	Operation
Ignition relay contact side	Ignition relay excitation coil side		
ON	ON	Ignition relay ON normal	—
OFF	OFF	Ignition relay OFF normal	—
ON	OFF	Ignition relay ON stuck	<ul style="list-style-type: none"> • Detects DTC "B2098: IGN RELAY ON" • Turns ON the tail lamp relay for 10 minutes
OFF	ON	Ignition relay OFF stuck	Detects DTC "B2099: IGN RELAY OFF"

FRONT WIPER CONTROL

IPDM E/R detects front wiper stop position by a front wiper stop position signal.

When a front wiper stop position signal is in the conditions listed below, IPDM E/R stops power supply to wiper after repeating a front wiper 10 seconds activation and 20 seconds stop five times.

Ignition switch	Front wiper switch	Front wiper stop position signal
ON	OFF	The front wiper stop position signal (stop position) cannot be input for 10 seconds.
	ON	The front wiper stop position signal does not change for 10 seconds.

IPDM E/R (INTELLIGENT POWER DISTRIBUTION MODULE ENGINE ROOM)

< ECU DIAGNOSIS INFORMATION >

[IPDM E/R]

NOTE:

This operation status can be confirmed on the IPDM E/R “Data Monitor” that displays “BLOCK” for the item “WIP PROT” while the wiper is stopped.

STARTER MOTOR PROTECTION FUNCTION

IPDM E/R turns OFF the starter control relay to protect the starter motor when the starter control relay remains active for 90 seconds.

DTC Index

INFOID:000000006469795

NOTE:

- The details of time display are as follows.
- CRNT: A malfunction is detected now.
- PAST: A malfunction was detected in the past.
- IGN counter is displayed on FFD (Freeze Frame data).
- The number is 0 when is detected now.
- The number increases like 1 → 2 ... 38 → 39 after returning to the normal condition whenever IGN OFF → ON.
- The number is fixed to 39 until the self-diagnosis results are erased if it is over 39.

×: Applicable

CONSULT display	Fail-safe	Refer to
No DTC is detected. further testing may be required.	—	—
U1000: CAN COMM CIRCUIT	×	PCS-15
B2098: IGN RELAY ON	×	PCS-16
B2099: IGN RELAY OFF	—	PCS-17
B2108: S/L RELAY ON*	—	SEC-98
B2109: S/L RELAY OFF*	—	SEC-100
B210A: S/L STATE SW*	—	SEC-101
B210B: START CONT RLY ON	—	SEC-105
B210C: START CONT RLY OFF	—	SEC-106
B210D: STARTER RELAY ON	—	SEC-107
B210E: STARTER RELAY OFF	—	SEC-108
B210F: INTRLCK/PNP SW ON	—	SEC-110
B2110: INTRLCK/PNP SW OFF	—	SEC-112

*: For models without steering lock unit, this DTC is not applied.

PCS

PRECAUTION

PRECAUTIONS

Precaution for Supplemental Restraint System (SRS) "AIR BAG" and "SEAT BELT PRE-TENSIONER"

INFOID:000000006965071

The Supplemental Restraint System such as "AIR BAG" and "SEAT BELT PRE-TENSIONER", used along with a front seat belt, helps to reduce the risk or severity of injury to the driver and front passenger for certain types of collision. This system includes seat belt switch inputs and dual stage front air bag modules. The SRS system uses the seat belt switches to determine the front air bag deployment, and may only deploy one front air bag, depending on the severity of a collision and whether the front occupants are belted or unbelted. Information necessary to service the system safely is included in the "SRS AIR BAG" and "SEAT BELT" of this Service Manual.

WARNING:

Always observe the following items for preventing accidental activation.

- To avoid rendering the SRS inoperative, which could increase the risk of personal injury or death in the event of a collision that would result in air bag inflation, all maintenance must be performed by an authorized NISSAN/INFINITI dealer.
- Improper maintenance, including incorrect removal and installation of the SRS, can lead to personal injury caused by unintentional activation of the system. For removal of Spiral Cable and Air Bag Module, see "SRS AIR BAG".
- Never use electrical test equipment on any circuit related to the SRS unless instructed to in this Service Manual. SRS wiring harnesses can be identified by yellow and/or orange harnesses or harness connectors.

PRECAUTIONS WHEN USING POWER TOOLS (AIR OR ELECTRIC) AND HAMMERS

WARNING:

Always observe the following items for preventing accidental activation.

- When working near the Air Bag Diagnosis Sensor Unit or other Air Bag System sensors with the ignition ON or engine running, never use air or electric power tools or strike near the sensor(s) with a hammer. Heavy vibration could activate the sensor(s) and deploy the air bag(s), possibly causing serious injury.
- When using air or electric power tools or hammers, always switch the ignition OFF, disconnect the battery, and wait at least 3 minutes before performing any service.

Precautions Necessary for Steering Wheel Rotation After Battery Disconnection

INFOID:000000006965249

CAUTION:

Comply with the following cautions to prevent any error and malfunction.

- Before removing and installing any control units, first turn the ignition switch to the LOCK position, then disconnect both battery cables.
- After finishing work, confirm that all control unit connectors are connected properly, then re-connect both battery cables.
- Always use CONSULT to perform self-diagnosis as a part of each function inspection after finishing work. If a DTC is detected, perform trouble diagnosis according to self-diagnosis results.

For vehicle with steering lock unit, if the battery is disconnected or discharged, the steering wheel will lock and cannot be turned.

If turning the steering wheel is required with the battery disconnected or discharged, follow the operation procedure below before starting the repair operation.

OPERATION PROCEDURE

1. Connect both battery cables.

NOTE:

Supply power using jumper cables if battery is discharged.

2. Turn the ignition switch to ACC position.
(At this time, the steering lock will be released.)
3. Disconnect both battery cables. The steering lock will remain released with both battery cables disconnected and the steering wheel can be turned.

PRECAUTIONS

[IPDM E/R]

< PRECAUTION >

4. Perform the necessary repair operation.
5. When the repair work is completed, re-connect both battery cables. With the brake pedal released, turn the ignition switch from ACC position to ON position, then to LOCK position. (The steering wheel will lock when the ignition switch is turned to LOCK position.)
6. Perform self-diagnosis check of all control units using CONSULT.

Precaution for Battery Service

INFOID:000000006965250

Before disconnecting the battery, lower both the driver and passenger windows. This will prevent any interference between the window edge and the vehicle when the door is opened/closed. During normal operation, the window slightly raises and lowers automatically to prevent any window to vehicle interference. The automatic window function will not work with the battery disconnected.

Precaution for Procedure without Cowl Top Cover

INFOID:000000006965251

When performing the procedure after removing cowl top cover, cover the lower end of windshield with urethane, etc to prevent damage to windshield.

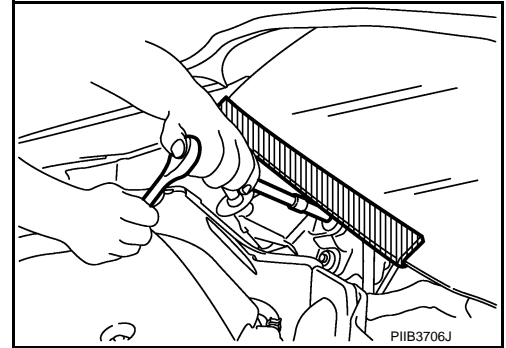

A
B
C
D
E
F
G
H
I
J
K
L

PCS

N
O
P

REMOVAL AND INSTALLATION

IPDM E/R (INTELLIGENT POWER DISTRIBUTION MODULE ENGINE ROOM)

Exploded View

INFOID:000000006469800

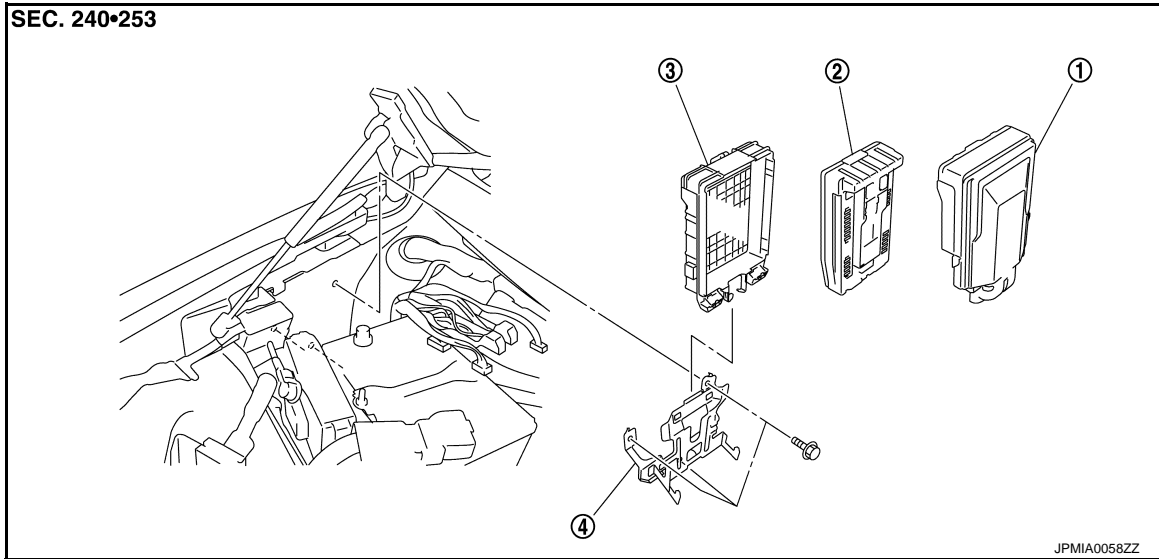

1. IPDM E/R cover A

2. IPDM E/R

3. IPDM E/R cover B

4. Bracket

Removal and Installation

INFOID:000000006469801

CAUTION:

IPDM E/R integrated relays are not serviceable parts, and must not be removed from the unit.

REMOVAL

1. Disconnect the battery cable from the negative terminal.
2. Remove the cowl top cover (RH). Refer to [EXT-23, "Exploded View"](#).
3. Pull up the IPDM E/R assembly while pressing the pawls (A) on the back of the IPDM E/R cover B (1).

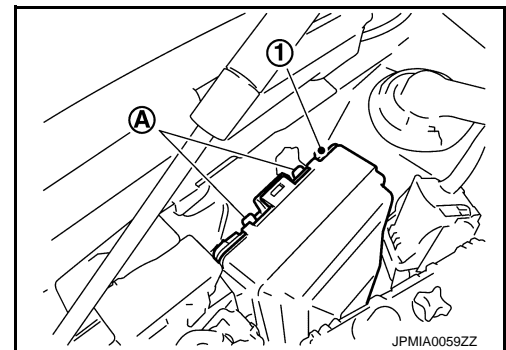

IPDM E/R (INTELLIGENT POWER DISTRIBUTION MODULE ENGINE ROOM)

[IPDM E/R]

< REMOVAL AND INSTALLATION >

4. Remove the IPDM E/R cover A (1). While pressing the pawls (A) at the lower end of the IPDM E/R cover A
5. Disconnect the harness connector and remove the IPDM E/R (2).

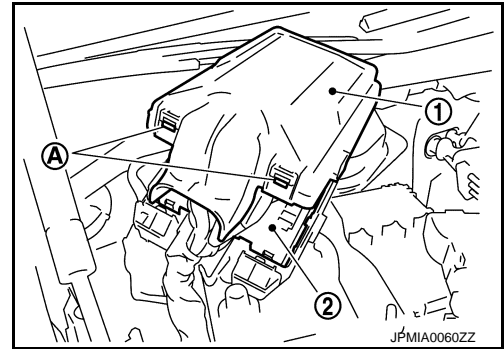

6. Remove the bolts (A) and remove the bracket (1) from the vehicle.

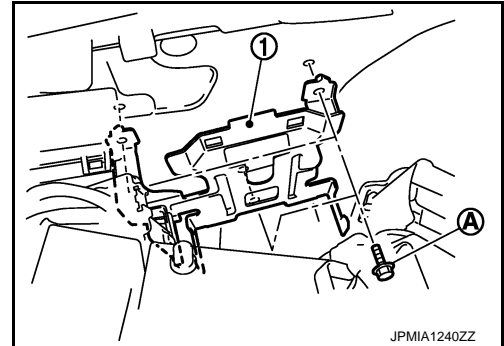

INSTALLATION

Install in the reverse order of removal.

A
B
C
D
E
F
G
H
I
J
K
L

PCS

N
O
P

DIAGNOSIS AND REPAIR WORK FLOW

< BASIC INSPECTION >

[POWER DISTRIBUTION SYSTEM]

BASIC INSPECTION

DIAGNOSIS AND REPAIR WORK FLOW

Work Flow

INFOID:000000006469802

OVERALL SEQUENCE

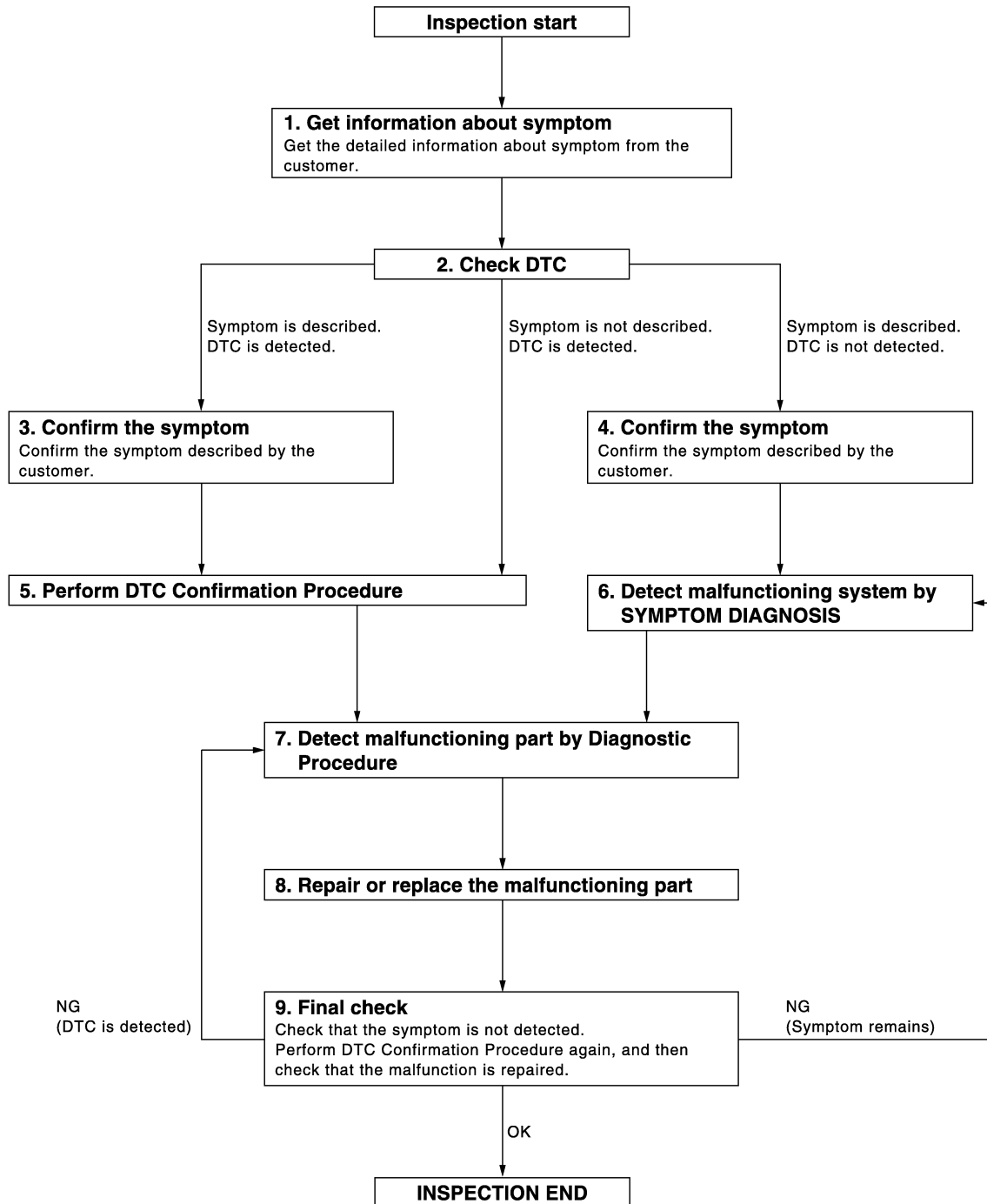

DETAILED FLOW

JMKIA3449GB

DIAGNOSIS AND REPAIR WORK FLOW

< BASIC INSPECTION >

[POWER DISTRIBUTION SYSTEM]

1.GET INFORMATION ABOUT SYMPTOM

Get detailed information from the customer about the symptom (the condition and the environment when the incident/malfunction occurs).

>> GO TO 2.

2.CHECK DTC

1. Check DTC for BCM and IPDM E/R.
2. Perform the following procedure if DTC is displayed.
 - Record DTC and freeze frame data (Print them out with CONSULT-III.)
 - Erase DTC.
 - Study the relationship between the cause detected by DTC and the symptom described by the customer.
3. Check related service bulletins for information.

Are any symptoms described and any DTC detected?

- Symptom is described, DTC is displayed>>GO TO 3.
- Symptom is described, DTC is not displayed>>GO TO 4.
- Symptom is not described, DTC is displayed>>GO TO 5.

3.CONFIRM THE SYMPTOM

Confirm the symptom described by the customer.
Connect CONSULT-III to the vehicle in the "DATA MONITOR" mode and check real time diagnosis results.
Verify relation between the symptom and the condition when the symptom is detected.

>> GO TO 5.

4.CONFIRM THE SYMPTOM

Confirm the symptom described by the customer.
Connect CONSULT-III to the vehicle in the "DATA MONITOR" mode and check real time diagnosis results.
Verify relation between the symptom and the condition when the symptom is detected.

>> GO TO 6.

5.PERFORM DTC CONFIRMATION PROCEDURE

Perform DTC Confirmation Procedure for the displayed DTC, and then check that DTC is detected again.
At this time, always connect CONSULT-III to the vehicle, and check diagnostic results in real time.
If two or more DTCs are detected, refer to [BCS-74. "DTC Inspection Priority Chart"](#) (BCM), and determine trouble diagnosis order.

NOTE:

Perform Component Function Check if DTC Confirmation Procedure is not included in Service Manual. This simplified check procedure is an effective alternative, although DTC cannot be detected during this check.
If the result of Component Function Check is NG, it is the same as the detection of DTC by DTC Confirmation Procedure.

Is DTC detected?

- YES >> GO TO 7.
- NO >> Refer to [GI-43. "Intermittent Incident"](#).

6.DETECT MALFUNCTIONING SYSTEM BY SYMPTOM DIAGNOSIS

Detect malfunctioning system according to SYMPTOM DIAGNOSIS based on the confirmed symptom in step 4, and determine the trouble diagnosis order based on possible causes and symptom.

>> GO TO 7.

7.DETECT MALFUNCTIONING PART BY DIAGNOSTIC PROCEDURE

Inspect according to Diagnostic Procedure of the system.

NOTE:

The Diagnostic Procedure described based on open circuit inspection. A short circuit inspection is also required for the circuit check in the Diagnostic Procedure.

A
B
C
D
E
F
G
H
I
J
K
L
N
O
P

PCS

DIAGNOSIS AND REPAIR WORK FLOW

< BASIC INSPECTION >

[POWER DISTRIBUTION SYSTEM]

Is malfunctioning part detected?

YES >> GO TO 8.

NO >> Check voltage of related BCM terminals using CONSULT-III.

8. REPAIR OR REPLACE THE MALFUNCTIONING PART

1. Repair or replace the malfunctioning part.
2. Reconnect parts or connectors disconnected during Diagnostic Procedure again after repair and replacement.
3. Check DTC. If DTC is displayed, erase it.

>> GO TO 9.

9. FINAL CHECK

When DTC was detected in step 2, perform DTC Confirmation Procedure or Component Function Check again, and then check that the malfunction is repaired securely.

When symptom was described by the customer, refer to confirmed symptom in step 3 or 4, and check that the symptom is not detected.

Does the symptom reappear?

YES (DTC is detected)>>GO TO 7.

YES (Symptom remains)>>GO TO 6.

NO >> INSPECTION END

SYSTEM DESCRIPTION

POWER DISTRIBUTION SYSTEM

System Description

INFOID:000000006469803

SYSTEM DESCRIPTION

- PDS (POWER DISTRIBUTION SYSTEM) is the system that BCM controls with the operation of the push-button ignition switch and performs the power distribution to each power circuit. This system is used instead of the mechanical power supply changing mechanism with the operation of the conventional key cylinder.
- The push-button ignition switch can be operated when Intelligent Key is in the following condition. Refer to Engine Start Function for details.
 - Intelligent Key is in the detection area of the interior antenna
 - Insert Intelligent Key in to the key slot
- The push-button ignition switch operation is input to BCM as a signal. BCM changes the power supply position according to the status and operates the following relays to supply power to each power circuit.
 - Ignition relay (inside IPDM E/R)
 - Ignition relay (inside fuse block)
 - ACC relay
 - Blower relay
- The power supply position changes due to the conditions of push-button ignition switch operation, brake pedal, clutch pedal, selector lever and vehicle speed.

NOTE:

- The power supply position can be confirmed with the lighting of the indicators near the push-button ignition switch.
- For models without steering lock unit, power supply position changes from "OFF" to "LOCK" when steering lock conditions are satisfied.

BATTERY SAVER SYSTEM

When all the following conditions are met for 60 minutes, the battery saver system will cut off the power supply to prevent battery discharge.

- The ignition switch is in the ACC position
- All doors are closed
- Selector lever is in the P position

Reset Condition of Battery Saver System

A/T models

In order to prevent the battery from discharging, the battery saver system will cut off the power supply when all doors are closed, the selector lever is on P position and the ignition switch is left on ACC position for 1 hour. If any of the following conditions are met the battery saver system is released and the steering will change automatically to lock position from OFF position.

- Opening any door
- Operating with request switch on door lock
- Operating with Intelligent Key on door lock

Press push-button ignition switch and ignition switch will change to ACC position from OFF position.

M/T models

If any of the conditions above is met the battery saver system is released but the steering will not lock. In this case, the steering operation OFF to LOCK is prohibited.

STEERING LOCK OPERATION (MODELS WITH STEERING LOCK UNIT)

Steering is locked by steering lock unit when ignition switch is in the OFF position, selector lever is in the P position and any of the following conditions are met.

- Opening door
- Closing door
- Door is locked with request switch
- Door is locked with Intelligent Key

NOTE:

For models without steering lock unit, power supply position changes to LOCK even through the steering lock operation is not performed.

POWER SUPPLY POSITION CHANGE TABLE BY PUSH-BUTTON IGNITION SWITCH OPERATION

A
B
C
D
E
F
G
H
I
J
K
L
N
O
P

PCS

POWER DISTRIBUTION SYSTEM

< SYSTEM DESCRIPTION >

[POWER DISTRIBUTION SYSTEM]

The power supply position changing operation can be performed with the following operations.

NOTE:

- When an Intelligent Key is within the detection area of inside key antenna and when it is inserted to the key slot, it is equivalent to the operations below.
- When starting the engine, the BCM monitors under the engine start conditions,

A/T models

- Brake pedal operating condition
- Selector lever position
- Vehicle speed

M/T models

- Clutch pedal operating condition
- Vehicle speed

Vehicle speed: less than 4 km/h (2.5 MPH)

Power supply position	Engine start/stop condition			Push-button ignition switch operation frequency
	A/T models		M/T models	
	Selector lever position	Brake pedal operation condition	Clutch pedal operation condition	
LOCK → ACC	—	Not depressed	Not depressed	1
LOCK → ACC → ON	—	Not depressed	Not depressed	2
LOCK → ACC → ON → OFF	—	Not depressed	Not depressed	3
LOCK → START ACC → START ON → START	P or N position	Depressed	Depressed	1
Engine is running → OFF	—	—	—	1

Vehicle speed: 4 km/h (2.5 MPH) or more

Power supply position	Engine start/stop condition			Push-button ignition switch operation frequency
	A/T models		M/T models	
	Selector lever position	Brake pedal operation condition	Clutch pedal operation condition	
Engine is running → ACC	—	—	—	Emergency stop operation
Engine stall return operation while driving	N position	Not depressed	Depressed	1

Emergency stop operation

- Press and hold the push-button ignition switch for 2 seconds or more.
- Press the push-button ignition switch 3 times or more within 1.5 seconds.

POWER DISTRIBUTION SYSTEM

< SYSTEM DESCRIPTION >

[POWER DISTRIBUTION SYSTEM]

Component Parts Location

INFOID:000000006469804

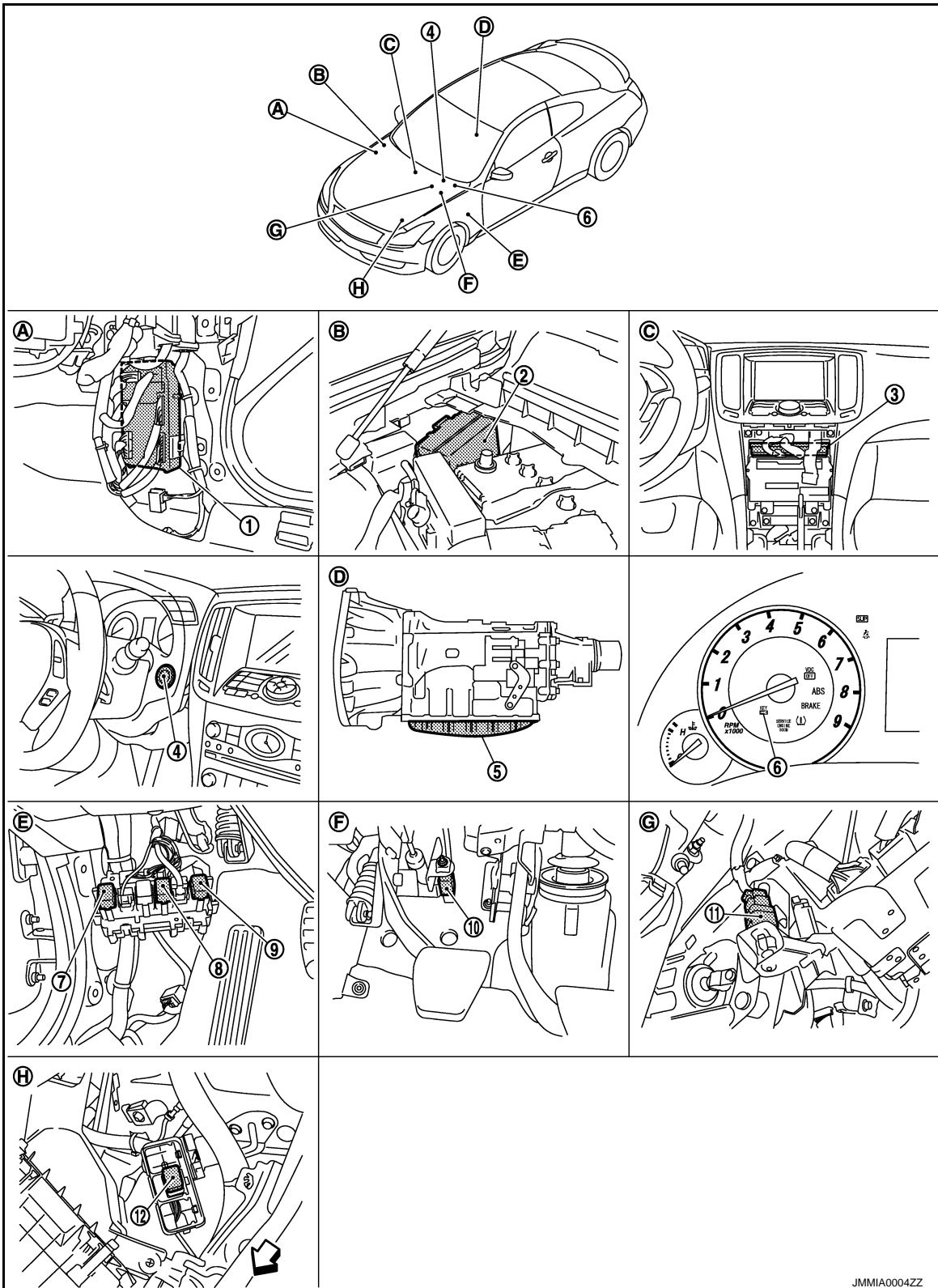

A
B
C
D
E
F
G
H
I
J
K
L
N
O
P

PCS

- | | | |
|-------------------------------------|---------------------------|---|
| 1. BCM M118, M119, M121, M122, M123 | 2. IPDM E/R E5, E6, E7 | 3. Unified meter and A/C AMP. M66, M67 |
| 4. Push-button ignition switch M50 | 5. TCM F157 | 6. Combination meter (Key warning lamp) M53 |
| 7. Ignition relay | 8. Accessory relay | 9. Blower relay |
| 10. Clutch interlock switch E111 | 11. Stop lamp switch E110 | 12. ICC brake hold relay |

POWER DISTRIBUTION SYSTEM

< SYSTEM DESCRIPTION >

[POWER DISTRIBUTION SYSTEM]

- A. Dash side lower (Passenger side). B. Engine room dash panel (RH). C. Behind cluster lid C.
D. Inside of A/T (built into A/T). E. View with dash side LH removed. F. View with instrument driver lower cover removed.
G. View with instrument driver lower cover removed. H. Left view of engine room

Component Description

INFOID:000000006469805

BCM	Reference
IPDM E/R	PCS-6
Ignition relay (Built-in IPDM E/R)	PCS-49
Ignition relay (Built-in fuse block)	PCS-49
Accessory relay	PCS-53
Blower relay	PCS-56
Stop lamp switch	SEC-53
Transmission range switch (A/T models)	SEC-67
Clutch interlock switch (M/T models)	SEC-84
Push-button ignition switch	PCS-63

DIAGNOSIS SYSTEM (BCM)

[POWER DISTRIBUTION SYSTEM]

< SYSTEM DESCRIPTION >

DIAGNOSIS SYSTEM (BCM)

COMMON ITEM

COMMON ITEM : CONSULT-III Function (BCM - COMMON ITEM)

INFOID:0000000006956320

APPLICATION ITEM

CONSULT-III performs the following functions via CAN communication with BCM.

Diagnosis mode	Function Description
Work Support	Changes the setting for each system function.
Self Diagnostic Result	Displays the diagnosis results judged by BCM.
CAN Diag Support Monitor	Monitors the reception status of CAN communication viewed from BCM. Refer to CONSULT-III operation manual.
Data Monitor	The BCM input/output signals are displayed.
Active Test	The signals used to activate each device are forcibly supplied from BCM.
Ecu Identification	The BCM part number is displayed.
Configuration	This function is not used even though it is displayed.

SYSTEM APPLICATION

BCM can perform the following functions for each system.

NOTE:

It can perform the diagnosis modes except the following for all sub system selection items.

x: Applicable item

System	Sub system selection item	Diagnosis mode		
		Work Support	Data Monitor	Active Test
Door lock	DOOR LOCK	x	x	x
Rear window defogger	REAR DEFOGGER		x	x
Warning chime	BUZZER		x	x
Interior room lamp timer	INT LAMP	x	x	x
—	MULTI REMOTE ENT*1			
Exterior lamp	HEAD LAMP	x	x	x
Wiper and washer	WIPER	x*2	x	x
Turn signal and hazard warning lamps	FLASHER	x	x	x
—	AIR CONDITONER*1			
• Intelligent Key system • Engine start system	INTELLIGENT KEY	x	x	x
Combination switch	COMB SW		x	
Body control system	BCM	x		
IVIS - NATS	IMMU		x	x
Interior room lamp battery saver	BATTERY SAVER	x	x	x
Trunk lid open	TRUNK		x	x
Vehicle security system	THEFT ALM	x	x	x
RAP system	RETAINED PWR		x	
Signal buffer system	SIGNAL BUFFER		x	x
TPMS	TPMS (AIR PRESSURE MONITOR)	x	x	x

NOTE:

- *1: This item is displayed, but is not used.
- *2: At models with rain sensor this mode is displayed, but is not used.

FREEZE FRAME DATA (FFD)

DIAGNOSIS SYSTEM (BCM)

[POWER DISTRIBUTION SYSTEM]

< SYSTEM DESCRIPTION >

The BCM records the following vehicle condition at the time a particular DTC is detected, and displays on CONSULT-III.

CONSULT screen item	Indication/Unit	Description	
Vehicle Speed	km/h	Vehicle speed of the moment a particular DTC is detected	
Odo/Trip Meter	km	Total mileage (Odometer value) of the moment a particular DTC is detected	
Vehicle Condition	SLEEP>LOCK	Power supply position status of the moment a particular DTC is detected*	While turning BCM status from low power consumption mode to normal mode (Power supply position is "LOCK"*)
	SLEEP>OFF		While turning BCM status from low power consumption mode to normal mode (Power supply position is "OFF".)
	LOCK>ACC		While turning power supply position from "LOCK"* to "ACC"
	ACC>ON		While turning power supply position from "ACC" to "IGN"
	RUN>ACC		While turning power supply position from "RUN" to "ACC" (Except emergency stop operation)
	CRANK>RUN		While turning power supply position from "CRANKING" to "RUN" (From cranking up the engine to run it)
	RUN>URGENT		While turning power supply position from "RUN" to "ACC" (Emergency stop operation)
	ACC>OFF		While turning power supply position from "ACC" to "OFF"
	OFF>LOCK		While turning power supply position from "OFF" to "LOCK"*
	OFF>ACC		While turning power supply position from "OFF" to "ACC"
	ON>CRANK		While turning power supply position from "IGN" to "CRANKING"
	OFF>SLEEP		While turning BCM status from normal mode (Power supply position is "OFF".) to low power consumption mode
	LOCK>SLEEP		While turning BCM status from normal mode (Power supply position is "LOCK"*.) to low power consumption mode
	LOCK		Power supply position is "LOCK" (Ignition switch OFF with steering is locked.)*
	OFF		Power supply position is "OFF" (Ignition switch OFF with steering is unlocked.)
	ACC		Power supply position is "ACC" (Ignition switch ACC)
	ON		Power supply position is "IGN" (Ignition switch ON with engine stopped)
	ENGINE RUN		Power supply position is "RUN" (Ignition switch ON with engine running)
CRANKING	Power supply position is "CRANKING" (At engine cranking)		
IGN Counter	0 - 39	The number of times that ignition switch is turned ON after DTC is detected <ul style="list-style-type: none"> • The number is 0 when a malfunction is detected now. • The number increases like 1 → 2 → 3...38 → 39 after returning to the normal condition whenever ignition switch OFF → ON. • The number is fixed to 39 until the self-diagnosis results are erased if it is over 39. 	

NOTE:

*: For models without steering lock unit, power supply position changes from "OFF" to "LOCK" when steering lock conditions are satisfied.

INTELLIGENT KEY

INTELLIGENT KEY : CONSULT-III Function (BCM - INTELLIGENT KEY)

INFOID:000000006956344

WORK SUPPORT

DIAGNOSIS SYSTEM (BCM)

< SYSTEM DESCRIPTION >

[POWER DISTRIBUTION SYSTEM]

Monitor item	Description	A
CONFIRM KEY FOB ID	It can be checked whether Intelligent Key ID code is registered or not in this mode	A
AUTO LOCK SET	Auto door lock time can be changed in this mode <ul style="list-style-type: none"> • MODE 1: 1 minute • MODE 2: 5 minutes • MODE 3: 30 seconds • MODE 4: 2 minutes 	B
LOCK/UNLOCK BY I-KEY	Door lock/unlock function by door request switch (driver side and passenger side) mode can be changed to operate (ON) or not operate (OFF) in this mode	C
ENGINE START BY I-KEY	Engine start function mode can be changed to operate (ON) or not operate (OFF) with this mode	D
TRUNK/GLASS HATCH OPEN	Buzzer reminder function mode by trunk lid opener request switch can be changed to operate (ON) or not operate (OFF) with this mode	E
PANIC ALARM SET	Panic alarm button pressing time on Intelligent Key remote control button can be selected from the following with this mode <ul style="list-style-type: none"> • MODE 1: 0.5 sec • MODE 2: Non-operation • MODE 3: 1.5 sec 	F
PW DOWN SET	Unlock button pressing time on Intelligent Key button can be selected from the following with this mode <ul style="list-style-type: none"> • MODE 1: 3 sec • MODE 2: Non-operation • MODE 3: 5 sec 	G
TRUNK OPEN DELAY	Trunk button pressing on Intelligent Key button can be selected as per the following in this mode <ul style="list-style-type: none"> • MODE 1: Press and hold • MODE 2: Press twice • MODE 3: Press and hold, or press twice 	H
LO- BATT OF KEY FOB WARN	Intelligent Key low battery warning mode can be changed to operate (ON) or not operate (OFF) with this mode	I
ANTI KEY LOCK IN FUNCTI	Key reminder function mode can be changed to operate (ON) or not operate (OFF) with this mode	J
HAZARD ANSWER BACK	Hazard reminder function mode can be selected from the following with this mode <ul style="list-style-type: none"> • LOCK ONLY: Door lock operation only • UNLOCK ONLY: Door unlock operation only • LOCK/UNLOCK: Lock/unlock operation • OFF: Non-operation 	K
ANS BACK I-KEY LOCK	Buzzer reminder function (lock operation) mode by door request switch (driver side and passenger side) can be selected from the following with this mode <ul style="list-style-type: none"> • Horn chirp: Sound horn • Buzzer: Sound Intelligent Key warning buzzer • OFF: Non-operation 	L
ANS BACK I-KEY UNLOCK	Buzzer reminder function (unlock operation) mode by door request switch can be changed to operate (ON) or not operate (OFF) with this mode	PCS
SHORT CRANKING OUTPUT	Starter motor can operate during the times below <ul style="list-style-type: none"> • 70 msec • 100 msec • 200 msec 	N
INSIDE ANT DIAGNOSIS	This function allows inside key antenna self-diagnosis	O
HORN WITH KEYLESS LOCK	Horn reminder function mode by Intelligent Key button can be changed to operate (ON) or not operate (OFF) with this mode	P

SELF-DIAG RESULT

Refer to [PCS-109, "DTC Index"](#).

DATA MONITOR

DIAGNOSIS SYSTEM (BCM)

< SYSTEM DESCRIPTION >

[POWER DISTRIBUTION SYSTEM]

Monitor Item	Condition
REQ SW -DR	Indicates [ON/OFF] condition of door request switch (driver side)
REQ SW -AS	Indicates [ON/OFF] condition of door request switch (passenger side)
REQ SW -BD/TR	Indicates [ON/OFF] condition of trunk lid opener request switch
PUSH SW	Indicates [ON/OFF] condition of push-button ignition switch
IGN RLY2 -F/B	Indicates [ON/OFF] condition of ignition relay 2
ACC RLY-FB	NOTE: This item is displayed, but cannot be monitored
CLUTCH SW*1	Indicates [ON/OFF] condition of clutch switch
BRAKE SW 1	Indicates [ON/OFF]*3 condition of brake switch power supply
BRAKE SW 2	Indicates [ON/OFF] condition of brake switch
DETE/CANCL SW*2	Indicates [ON/OFF] condition of P position
SFT PN/N SW*2	Indicates [ON/OFF] condition of P or N position
S/L -LOCK	Indicates [ON/OFF] condition of steering lock unit (LOCK)
S/L -UNLOCK	Indicates [ON/OFF] condition of steering lock unit (UNLOCK)
S/L RELAY -F/B	Indicates [ON/OFF] condition of steering lock relay
UNLK SEN -DR	Indicates [ON/OFF] condition of driver door UNLOCK status
PUSH SW -IPDM	Indicates [ON/OFF] condition of push-button ignition switch
IGN RLY1 -F/B	Indicates [ON/OFF] condition of ignition relay 1
DETE SW -IPDM*2	Indicates [ON/OFF] condition of P position
SFT PN -IPDM*2	Indicates [ON/OFF] condition of P or N position
SFT P -MET*2	Indicates [ON/OFF] condition of P position
SFT N -MET*2	Indicates [ON/OFF] condition of N position
ENGINE STATE	Indicates [STOP/STALL/CRANK/RUN] condition of engine states
S/L LOCK-IPDM	Indicates [ON/OFF] condition of steering lock unit (LOCK)
S/L UNLK-IPDM	Indicates [ON/OFF] condition of steering lock unit (UNLOCK)
S/L RELAY-REQ	Indicates [ON/OFF] condition of steering lock relay
VEH SPEED 1	Display the vehicle speed signal received from combination meter by numerical value [Km/h]
VEH SPEED 2	Display the vehicle speed signal received from ABS or VDC or TCM by numerical value [Km/h]
DOOR STAT-DR	Indicates [LOCK/READY/UNLOCK] condition of driver side door status
DOOR STAT-AS	Indicates [LOCK/READY/UNLOCK] condition of passenger side door status
ID OK FLAG	Indicates [SET/RESET] condition of key ID
PRMT ENG STRT	Indicates [SET/RESET] condition of engine start possibility
PRMT RKE STRT	NOTE: This item is displayed, but cannot be monitored
KEY SW -SLOT	Indicates [ON/OFF] condition of key slot
TRNK/HAT MNTR	Indicates [ON/OFF] condition of trunk lid
RKE-LOCK	Indicates [ON/OFF] condition of LOCK signal from Intelligent Key
RKE-UNLOCK	Indicates [ON/OFF] condition of UNLOCK signal from Intelligent Key
RKE-TR/BD	Indicates [ON/OFF] condition of TRUNK LID OPEN signal from Intelligent Key
RKE-PANIC	Indicates [ON/OFF] condition of PANIC button of Intelligent Key
RKE-P/W OPEN	Indicates [ON/OFF] condition of P/W DOWN signal from Intelligent Key
RKE-MODE CHG	Indicates [ON/OFF] condition of MODE CHANGE signal from Intelligent Key
RKE OPE COUN1	When remote keyless entry receiver receives the signal transmitted while operating on Intelligent Key, the numerical value start changing

DIAGNOSIS SYSTEM (BCM)

< SYSTEM DESCRIPTION >

[POWER DISTRIBUTION SYSTEM]

Monitor Item	Condition
RKE OPE COUN2	NOTE: This item is displayed, but cannot be monitored
REVERSE SW*1	Indicates [ON/OFF] condition of R position

*1: It is displayed but does not operate on A/T models.

*2: It is displayed but does not operate on M/T models.

*3: OFF is displayed when brake pedal is depressed while brake switch power supply is OFF.

ACTIVE TEST

Test item	Description
BATTERY SAVER	This test is able to check interior room lamp operation The interior room lamp is activated after "On" on CONSULT-III screen is touched
PW REMOTO DOWN SET	This test is able to check power window down operation The power window down is activated after "On" on CONSULT-III screen is touched
OUTSIDE BUZZER	This test is able to check Intelligent Key warning buzzer operation The Intelligent Key warning buzzer is activated after "On" on CONSULT-III screen is touched
INSIDE BUZZER	This test is able to check warning chime in combination meter operation <ul style="list-style-type: none"> • Take away warning chime sounds when "Take out" on CONSULT-III screen is touched • Key warning chime sounds when "Key" on CONSULT-III screen is touched • OFF position warning chime sounds when "Knob" on CONSULT-III screen is touched
INDICATOR	This test is able to check warning lamp operation <ul style="list-style-type: none"> • "KEY" Warning lamp illuminates when "KEY ON" on CONSULT-III screen is touched • "KEY" Warning lamp blinks when "KEY IND" on CONSULT-III screen is touched
INT LAMP	This test is able to check interior room lamp operation The interior room lamp is activated after "On" on CONSULT-III screen is touched
LCD	This test is able to check meter display information <ul style="list-style-type: none"> • Engine start information displays when "BP N" on CONSULT-III screen is touched • Engine start information displays when "BP I" on CONSULT-III screen is touched • Key ID warning displays when "ID NG" on CONSULT-III screen is touched • Steering lock information displays when "ROTAT" on CONSULT-III screen is touched • P position warning displays when "SFT P" on CONSULT-III screen is touched • Intelligent Key insert information displays when "INSRT" on CONSULT-III screen is touched • Intelligent Key low battery warning displays when "BATT" on CONSULT-III screen is touched • Take away through window warning displays when "NO KY" on CONSULT-III screen is touched • Take away warning display when "OUTKEY" on CONSULT-III screen is touched • OFF position warning display when "LK WN" on CONSULT-III screen is touched
TRUNK/GLASS HATCH	This test is able to check trunk lid opener actuator open operation This actuator opens when "Open" on CONSULT-III screen is touched
FLASHER	This test is able to check security hazard lamp operation The hazard lamps are activated after "LH/RH/Off" on CONSULT-III screen is touched
HORN	This test is able to check horn operation The horn is activated after "On" on CONSULT-III screen is touched
P RANGE	This test is able to check control device power supply Control device power is supplied when "On" on CONSULT-III screen is touched
ENGINE SW ILLUMI	This test is able to check push-ignition switch illumination operation Push-ignition switch illumination illuminates when "On" on CONSULT-III screen is touched
LOCK INDICATOR	This test is able to check LOCK indicator in push-ignition switch operation LOCK indicator in push-ignition switch illuminates when "On" on CONSULT-III screen is touched
ACC INDICATOR	This test is able to check ACC indicator in push-ignition switch operation ACC indicator in push-ignition switch illuminates when "On" on CONSULT-III screen is touched

A
B
C
D
E
F
G
H
I
J
K
L

PCS

N
O
P

DIAGNOSIS SYSTEM (BCM)

[POWER DISTRIBUTION SYSTEM]

< SYSTEM DESCRIPTION >

Test item	Description
IGNITION ON IND	This test is able to check on indicator in push-ignition switch operation ON indicator in push-ignition switch illuminates when "On" on CONSULT-III screen is touched
KEY SLOT ILLUMI	This test is able to check key slot illumination operation Key slot illumination blinks when "On" on CONSULT-III screen is touched
TRUNK/BACK DOOR	This test is able to check trunk lid opener actuator open operation This actuator opens when "Open" on CONSULT-III screen is touched

B2553 IGNITION RELAY

< DTC/CIRCUIT DIAGNOSIS >

[POWER DISTRIBUTION SYSTEM]

DTC/CIRCUIT DIAGNOSIS

B2553 IGNITION RELAY

Description

INFOID:000000006469808

BCM turns ON the following relays to ignition power supply to each ECU when the ignition switch is turned ON.

- Ignition relay (inserted into fuse block)
- Ignition relay (built into IPDM E/R)
- Blower relay

BCM checks any ignition relay ON request for consistency with the actual ignition relay operation status.

DTC Logic

INFOID:000000006469809

DTC DETECTION LOGIC

DTC No.	Trouble diagnosis name	DTC detecting condition	Possible cause
B2553	IGNITION RELAY	BCM detects a difference of signal for 2 seconds or more between the following items. <ul style="list-style-type: none"> • Ignition relay (fuse block) ON/OFF operation • Ignition relay (fuse block) feedback. 	<ul style="list-style-type: none"> • Harness or connectors (ignition relay feedback circuit is open or short) • BCM • IPDM E/R

DTC CONFIRMATION PROCEDURE

1. PERFORM DTC CONFIRMATION PROCEDURE

1. Turn ignition switch ON under the following conditions, and wait for 2 seconds or more.

A/T models

- Selector lever is in the P or N position
- Do not depress brake pedal

M/T models

- Do not depress clutch pedal
2. Check "Self-diagnostic result" with CONSULT-III.

Is DTC detected?

- YES >> Go to [PCS-49. "Diagnosis Procedure"](#).
 NO >> INSPECTION END

Diagnosis Procedure

INFOID:000000006469810

1. CHECK DTC WITH IPDM E/R

Check "Self-diagnostic result" with CONSULT-III. Refer to [PCS-31. "DTC Index"](#).

Is the inspection result normal?

- YES >> GO TO 2.
 NO >> Repair or replace the malfunctioning parts.

2. CHECK IGNITION RELAY FEEDBACK INPUT SIGNAL

1. Turn ignition switch OFF.
2. Disconnect BCM connector.
3. Check voltage between BCM harness connector and ground.

(+)		(-)	Condition	Voltage (V) (Approx.)
BCM				
Connector	Terminal			
M123	123	Ground	Ignition switch	0
				Battery voltage

B2553 IGNITION RELAY

[POWER DISTRIBUTION SYSTEM]

< DTC/CIRCUIT DIAGNOSIS >

Is the inspection result normal?

YES >> Replace BCM. Refer to [BCS-81, "Removal and Installation"](#).

NO >> GO TO 3.

3. CHECK IGNITION RELAY FEEDBACK CIRCUIT

1. Disconnect IPDM E/R connector.
2. Check continuity between BCM harness connector and IPDM E/R harness connector.

BCM		IPDM E/R		Continuity
Connector	Terminal	Connector	Terminal	
M123	123	E5	19	Existed

3. Check continuity between BCM harness connector and ground.

BCM		Ground	Continuity
Connector	Terminal		
M123	123		Not existed

Is the inspection result normal?

YES >> Replace IPDM E/R. Refer to [PCS-34, "Removal and Installation"](#).

NO >> Repair or replace harness.

B260A IGNITION RELAY

< DTC/CIRCUIT DIAGNOSIS >

[POWER DISTRIBUTION SYSTEM]

B260A IGNITION RELAY

Description

INFOID:000000006469811

BCM turns ON the following relays to ignition power supply to each ECU when the ignition switch is turned ON.

- Ignition relay (inserted into fuse block)
- Ignition relay (built into IPDM E/R)
- Blower relay

BCM checks any ignition relay ON request for consistency with the actual ignition relay operation status.

DTC Logic

INFOID:000000006469812

DTC DETECTION LOGIC

NOTE:

- If DTC B260A is displayed with DTC U1000, first perform the trouble diagnosis for DTC U1000. Refer to [BCS-35, "DTC Logic"](#).
- If DTC B260A is displayed with DTC U1010, first perform the trouble diagnosis for DTC U1010. Refer to [BCS-36, "DTC Logic"](#).
- If DTC B260A is displayed with DTC B261A, first perform the trouble diagnosis for DTC B261A. Refer to [PCS-63, "DTC Logic"](#).

DTC No.	Trouble diagnosis name	DTC detecting condition	Possible cause
B260A	IGNITION RELAY	BCM detects a difference of signal for 2 second or more between the following items. <ul style="list-style-type: none"> • Ignition relay (IPDM E/R) operation request • Ignition relay feedback from IPDM E/R (CAN). 	<ul style="list-style-type: none"> • Harness or connectors (Ignition relay operation circuit is open or shorted.) • BCM • IPDM E/R

DTC CONFIRMATION PROCEDURE

1. PERFORM DTC CONFIRMATION PROCEDURE

1. Turn ignition switch ON under the following conditions, and wait for at least 2 seconds.

A/T models

- Selector lever is in the P or N position
- Do not depress brake pedal

M/T models

- Do not depress clutch pedal
2. Check "Self-diagnostic result" with CONSULT-III.

Is DTC detected?

- YES >> Go to [PCS-51, "Diagnosis Procedure"](#).
- NO >> INSPECTION END

Diagnosis Procedure

INFOID:000000006469813

1. CHECK DTC WITH IPDM E/R

Check "Self-diagnostic result" with CONSULT-III. Refer to [PCS-31, "DTC Index"](#).

Is DTC detected?

- YES >> Repair or replace the malfunctioning parts.
- NO >> GO TO 2.

2. CHECK IGNITION RELAY INPUT SIGNAL

1. Turn ignition switch OFF.
2. Disconnect BCM connector.
3. Check voltage between BCM harness connector and ground.

B260A IGNITION RELAY

< DTC/CIRCUIT DIAGNOSIS >

[POWER DISTRIBUTION SYSTEM]

(+)		(-)	Voltage (V) (Approx.)
BCM			
Connector	Terminal		
M121	47	Ground	Battery voltage

Is the inspection result normal?

YES >> Replace BCM. Refer to [BCS-81, "Removal and Installation"](#).

NO >> GO TO 3.

3. CHECK IGNITION RELAY (IPDM E/R) CIRCUIT

1. Disconnect IPDM E/R connector.
2. Check continuity between IPDM E/R harness connector and BCM harness connector.

IPDM E/R		BCM		Continuity
Connector	Terminal	Connector	Terminal	
E5	27	M121	47	Existed

3. Check continuity between IPDM E/R harness connector and ground.

IPDM E/R		Ground	Continuity
Connector	Terminal		
E5	27		Not existed

Is the inspection result normal?

YES >> Replace IPDM E/R. Refer to [PCS-34, "Removal and Installation"](#).

NO >> Repair or replace harness.

B2614 ACC RELAY CIRCUIT

< DTC/CIRCUIT DIAGNOSIS >

[POWER DISTRIBUTION SYSTEM]

B2614 ACC RELAY CIRCUIT

Description

INFOID:000000006469814

BCM controls the various electrical components and simultaneously supplies power according to the power supply position.
BCM checks the power supply position internally.

DTC Logic

INFOID:000000006469815

DTC DETECTION LOGIC

DTC No.	Trouble diagnosis name	DTC detecting condition	Possible cause
B2614	ACC relay circuit	An immediate operation of ACC relay is requested by BCM, but there is no response for more than 1 second.	<ul style="list-style-type: none"> Harness or connectors (ACC relay circuit is open or shorted) ACC relay

DTC CONFIRMATION PROCEDURE

1. PERFORM DTC CONFIRMATION PROCEDURE

- Turn the power supply position to ACC under the following conditions, and wait for 1 second or more.

A/T models

- Selector lever is in the P or N position
- Do not depress brake pedal

M/T models

- Do not depress clutch pedal
- Check "Self-diagnostic result" with CONSULT-III.

Is DTC detected?

- YES >> Go to [PCS-53, "Diagnosis Procedure"](#).
NO >> INSPECTION END

Diagnosis Procedure

INFOID:000000006469816

1. CHECK ACCESSORY RELAY POWER SUPPLY-1

- Turn ignition switch OFF.
- Disconnect accessory relay.
- Check voltage between accessory relay harness connector and ground.

(+)	(-)	Condition	Voltage (V) (Approx.)
Accessory relay Terminal			
1	Ground	Ignition switch	OFF 0
			ACC or ON Battery voltage

Is the inspection result normal?

- YES >> GO TO 3.
NO >> GO TO 2.

2. CHECK ACCESSORY RELAY POWER SUPPLY CIRCUIT

- Turn ignition switch OFF.
- Disconnect BCM connector.
- Check continuity between accessory relay harness connector and BCM harness connector.

B2614 ACC RELAY CIRCUIT

< DTC/CIRCUIT DIAGNOSIS >

[POWER DISTRIBUTION SYSTEM]

Accessory relay Terminal	BCM		Continuity
	Connector	Terminal	
1	M122	95	Existed

4. Check continuity between accessory relay harness connector and ground.

Accessory relay Terminal	Ground	Continuity
1		Not existed

Is the inspection result normal?

YES >> GO TO 6.

NO >> Repair or replace harness.

3.CHECK ACCESSORY RELAY GROUND CIRCUIT

1. Turn ignition switch OFF.
2. Check continuity between accessory relay harness connector and ground.

Accessory relay Terminal	Ground	Continuity
2		Existed

Is the inspection result normal?

YES >> GO TO 4.

NO >> Repair accessory relay ground circuit.

4.CHECK ACCESSORY RELAY POWER SUPPLY CIRCUIT-2

1. Turn ignition switch ACC.
2. Check voltage between accessory relay harness connector and ground.

(+) Accessory relay Terminal	(-)	Voltage (V) (Approx.)
5	Ground	Battery voltage

Is the inspection result normal?

YES >> GO TO 5.

NO >> Check continuity open or short between accessory relay and battery.

5.CHECK ACCESSORY RELAY

Refer to [PCS-54, "Component Inspection"](#).

Is the inspection result normal?

YES >> GO TO 6.

NO >> Replace accessory relay.

6.CHECK INTERMITTENT INCIDENT

Refer to [GI-43, "Intermittent Incident"](#).

>> INSPECTION END

Component Inspection

INFOID:000000006469817

1.CHECK ACCESSORY RELAY

1. Turn ignition switch OFF.
2. Remove accessory relay.

B2614 ACC RELAY CIRCUIT

[POWER DISTRIBUTION SYSTEM]

< DTC/CIRCUIT DIAGNOSIS >

3. Check the continuity between accessory relay terminals.

Terminals	Condition	Continuity
3 and 5	12 V direct current supply between terminals 1 and 2	Existed
	No current supply	Not existed

Is the inspection result normal?

YES >> INSPECTION END

NO >> Replace accessory relay

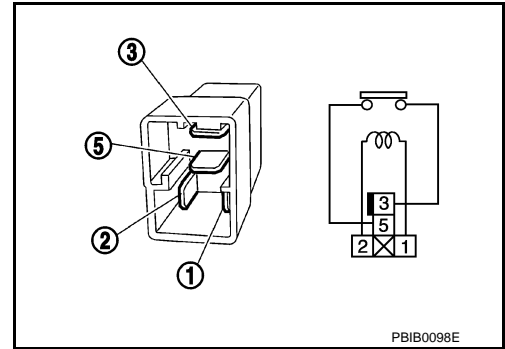

A
B
C
D
E
F
G
H
I
J
K
L
N
O
P

PCS

B2615 BLOWER RELAY CIRCUIT

< DTC/CIRCUIT DIAGNOSIS >

[POWER DISTRIBUTION SYSTEM]

B2615 BLOWER RELAY CIRCUIT

Description

INFOID:000000006469818

BCM controls the various electrical components and simultaneously supplies power according to the power supply position.

DTC Logic

INFOID:000000006469819

DTC DETECTION LOGIC

DTC No.	Trouble diagnosis name	DTC detecting condition	Possible cause
B2615	Blower relay circuit	BCM detects a difference of signal for 1 second or more between the following items. <ul style="list-style-type: none"> Blower relay ON/OFF request Blower relay feedback 	<ul style="list-style-type: none"> Harness or connectors (Blower relay circuit is open or shorted) Blower relay

DTC CONFIRMATION PROCEDURE

1. PERFORM DTC CONFIRMATION PROCEDURE

- Turn ignition switch ON under the following conditions, and wait for 1 second or more.

A/T models

- Selector lever is in the P or N position
- Do not depress brake pedal

M/T models

- Do not depress clutch pedal
- Check "Self-diagnostic result" with CONSULT-III.

Is DTC detected?

- YES >> Go to [PCS-56. "Diagnosis Procedure"](#).
NO >> INSPECTION END

Diagnosis Procedure

INFOID:000000006469820

1. CHECK BLOWER RELAY POWER SUPPLY

- Turn ignition switch OFF.
- Disconnect blower relay.
- Check voltage between blower relay harness connector and ground.

(+)	(-)	Condition	Voltage (V) (Approx.)
Blower relay Terminal			
1	Ground	Ignition switch	0
			Battery voltage

Is the inspection result normal?

- YES >> GO TO 3.
NO >> GO TO 2.

2. CHECK BLOWER RELAY POWER SUPPLY CIRCUIT

- Turn ignition switch OFF.
- Disconnect BCM connector.
- Check continuity between blower relay harness connector and BCM harness connector.

B2615 BLOWER RELAY CIRCUIT

< DTC/CIRCUIT DIAGNOSIS >

[POWER DISTRIBUTION SYSTEM]

Blower relay Terminal	BCM		Continuity
	Connector	Terminal	
1	M122	102	Existed

4. Check continuity between blower relay harness connector and ground.

Blower relay Terminal	Ground	Continuity
1		Not existed

Is the inspection result normal?

YES >> GO TO 6.

NO >> Repair or replace harness.

3.CHECK BLOWER RELAY GROUND CIRCUIT

- Turn ignition switch OFF.
- Check continuity between blower relay harness connector and ground.

Blower relay Terminal	Ground	Continuity
2		Existed

Is the inspection result normal?

YES >> GO TO 4.

NO >> Repair blower relay ground circuit.

4.CHECK BLOWER RELAY POWER SUPPLY CIRCUIT-2

- Turn ignition switch ON or ACC.
- Check voltage between blower relay harness connector and ground.

(+) Blower relay Terminal	(-)	Voltage (V) (Approx.)
5	Ground	Battery voltage

Is the inspection result normal?

YES >> GO TO 5.

NO >> Check continuity open or short between blower relay and battery.

5.CHECK BLOWER RELAY

Refer to [PCS-57, "Component Inspection"](#).

Is the inspection result normal?

YES >> GO TO 6.

NO >> Replace blower relay.

6.CHECK INTERMITTENT INCIDENT

Refer to [GI-43, "Intermittent Incident"](#).

>> INSPECTION END

Component Inspection

INFOID:000000006469821

1.CHECK BLOWER RELAY

- Turn ignition switch OFF.
- Remove blower relay.

A
B
C
D
E
F
G
H
I
J
K
L
N
O
P

PCS

B2615 BLOWER RELAY CIRCUIT

< DTC/CIRCUIT DIAGNOSIS >

[POWER DISTRIBUTION SYSTEM]

3. Check the continuity between blower relay terminals.

Terminals	Condition	Continuity
3 and 5	12 V direct current supply between terminals 1 and 2	Existed
	No current supply	Not existed

Is the inspection result normal?

- YES >> INSPECTION END
- NO >> Replace blower relay

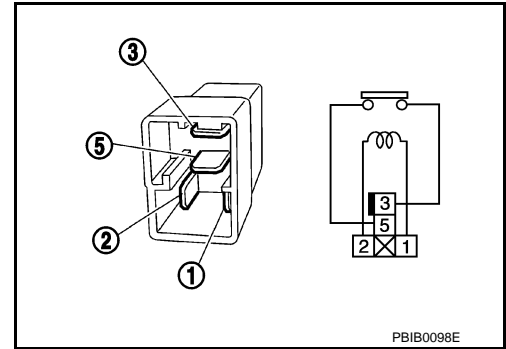

B2616 IGNITION RELAY CIRCUIT

< DTC/CIRCUIT DIAGNOSIS >

[POWER DISTRIBUTION SYSTEM]

B2616 IGNITION RELAY CIRCUIT

Description

INFOID:000000006469822

BCM controls the various electrical components and simultaneously supplies power according to the power supply position.

DTC Logic

INFOID:000000006469823

DTC DETECTION LOGIC

DTC No.	Trouble diagnosis name	DTC detecting condition	Possible cause
B2616	Ignition relay circuit	An immediate operation of ignition relay (fuse block) is requested by BCM, but there is no response for more than 1 second	<ul style="list-style-type: none"> Harness or connectors (Ignition relay circuit is open or shorted) Ignition relay (Fuse block)

DTC CONFIRMATION PROCEDURE

1. PERFORM DTC CONFIRMATION PROCEDURE

- Turn ignition switch ON under the following conditions, and wait for 1 second or more.

A/T models

- Selector lever is in the P or N position
- Do not depress brake pedal

M/T models

- Do not depress clutch pedal
- Check "Self-diagnostic result" with CONSULT-III.

Is DTC detected?

- YES >> Go to [PCS-59, "Diagnosis Procedure"](#).
 NO >> INSPECTION END

Diagnosis Procedure

INFOID:000000006469824

1. CHECK IGNITION RELAY POWER SUPPLY

- Turn ignition switch OFF.
- Disconnect ignition relay.
- Check voltage between ignition relay harness connector and ground.

(+)	(-)	Condition	Voltage (V) (Approx.)
Ignition relay Terminal			
1	Ground	Ignition switch	0
			Battery voltage

PCS

Is the inspection result normal?

- YES >> GO TO 3.
 NO >> GO TO 2.

2. CHECK IGNITION RELAY POWER SUPPLY CIRCUIT

- Turn ignition switch OFF.
- Disconnect BCM connector.
- Check continuity between ignition relay harness connector and BCM harness connector.

B2616 IGNITION RELAY CIRCUIT

< DTC/CIRCUIT DIAGNOSIS >

[POWER DISTRIBUTION SYSTEM]

Ignition relay Terminal	BCM		Continuity
	Connector	Terminal	
1	M122	82	Existed

4. Check continuity between ignition relay harness connector and ground.

Ignition relay Terminal	Ground	Continuity
1		Not existed

Is the inspection result normal?

YES >> GO TO 6.

NO >> Repair or replace harness.

3.CHECK IGNITION RELAY GROUND CIRCUIT

1. Turn ignition switch OFF.
2. Check continuity between ignition relay harness connector and ground.

Ignition relay Terminal	Ground	Continuity
2		Existed

Is the inspection result normal?

YES >> GO TO 4.

NO >> Repair ignition relay ground circuit.

4.CHECK IGNITION RELAY POWER SUPPLY CIRCUIT-2

1. Turn ignition switch ON.
2. Check voltage between ignition relay harness connector and ground.

(+) Ignition relay Terminal	(-)	Voltage (V) (Approx.)
5	Ground	Battery voltage

Is the inspection result normal?

YES >> GO TO 5.

NO >> Check continuity open or short between ignition relay and battery.

5.CHECK IGNITION RELAY

Refer to [PCS-60, "Component Inspection"](#).

Is the inspection result normal?

YES >> GO TO 6.

NO >> Replace ignition relay.

6.CHECK INTERMITTENT INCIDENT

Refer to [GI-43, "Intermittent Incident"](#).

>> INSPECTION END

Component Inspection

INFOID:000000006469825

1.CHECK IGNITION RELAY

1. Turn ignition switch OFF.
2. Remove ignition relay.

B2616 IGNITION RELAY CIRCUIT

[POWER DISTRIBUTION SYSTEM]

< DTC/CIRCUIT DIAGNOSIS >

3. Check the continuity between ignition relay terminals.

Terminals	Condition	Continuity
3 and 5	12 V direct current supply between terminals 1 and 2	Existed
	No current supply	Not existed

Is the inspection result normal?

- YES >> INSPECTION END
- NO >> Replace Ignition relay

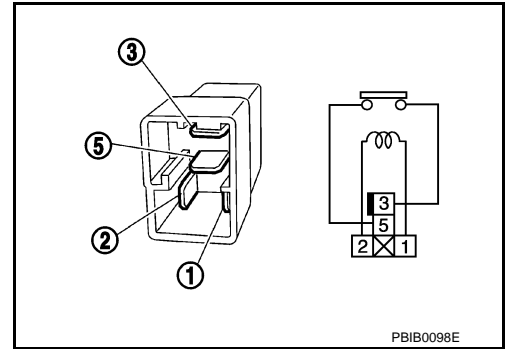

A
B
C
D
E
F
G
H
I
J
K
L
N
O
P

PCS

B2618 BCM**Description**

INFOID:000000006469826

BCM controls the various electrical components and simultaneously supplies power according to the power supply position.
 BCM checks the power supply position internally.

DTC Logic

INFOID:000000006469827

DTC DETECTION LOGIC**NOTE:**

- If DTC B2618 is displayed with DTC U1000, first perform the trouble diagnosis for DTC U1000. Refer to [BCS-35, "DTC Logic"](#).
- If DTC B2618 is displayed with DTC U1010, first perform the trouble diagnosis for DTC U1010. Refer to [BCS-36, "DTC Logic"](#).

DTC No.	Trouble diagnosis name	DTC detecting condition	Possible cause
B2618	BCM	An immediate operation of ignition relay (IPDM E/R) is requested by BCM, but there is no response for more than 1 second	BCM

DTC CONFIRMATION PROCEDURE**1. PERFORM DTC CONFIRMATION PROCEDURE**

1. Turn ignition switch ON under the following conditions, and wait for 1 second or more.

A/T models

- Selector lever is in the P or N position
- Do not depress brake pedal

M/T models

- Do not depress clutch pedal
2. Check "Self-diagnostic result" with CONSULT-III.

Is DTC detected?

- YES >> Go to [PCS-62, "Diagnosis Procedure"](#).
 NO >> INSPECTION END

Diagnosis Procedure

INFOID:000000006469828

1. INSPECTION START

1. Turn ignition switch ON.
2. Select "Self-diagnostic result" mode with CONSULT-III.
3. Touch "ERASE".
4. **Perform DTC Confirmation Procedure.**
See [PCS-62, "DTC Logic"](#).

Is the 1st trip DTC B2618 displayed again?

- YES >> Replace BCM. Refer to [BCS-81, "Removal and Installation"](#).
 NO >> INSPECTION END

B261A PUSH-BUTTON IGNITION SWITCH

< DTC/CIRCUIT DIAGNOSIS >

[POWER DISTRIBUTION SYSTEM]

B261A PUSH-BUTTON IGNITION SWITCH

Description

INFOID:000000006469829

BCM transmits the change in the power supply position with the push-button ignition switch to IPDM E/R via CAN communication line. IPDM E/R transmits the power supply position status via CAN communication line to BCM.

DTC Logic

INFOID:000000006469830

DTC DETECTION LOGIC

DTC No.	Trouble diagnosis name	DTC detecting condition	Possible cause
B261A	PUSH-BUTTON IGNITION SWITCH	BCM detects a difference of signal for 1 second or more between the following items. <ul style="list-style-type: none"> Power supply position by push-button ignition switch Power supply position from IPDM E/R (CAN) 	<ul style="list-style-type: none"> Harness or connectors (Push-button ignition switch circuit is open or shorted.) BCM IPDM E/R

DTC CONFIRMATION PROCEDURE

1. PERFORM DTC CONFIRMATION PROCEDURE

- Press the push-button ignition switch under the following conditions, and wait for 1 second or more.

A/T models

- Selector lever is in the P or N position
- Do not depress brake pedal

M/T models

- Do not depress clutch pedal
- Check "Self-diagnostic result" with CONSULT-III.

Is DTC detected?

- YES >> Go to [PCS-63, "Diagnosis Procedure"](#).
 NO >> INSPECTION END

Diagnosis Procedure

INFOID:000000006469831

1. CHECK BCM OUTPUT

- Turn ignition switch OFF.
- Disconnect push-button ignition switch connector and IPDM E/R connector.
- Check voltage between IPDM E/R harness connector and ground.

(+)		(-)	Voltage (V) (Approx.)
IPDM E/R			
Connector	Terminal	Ground	Battery voltage
E5	28		

Is the inspection result normal?

- YES >> Replace IPDM E/R. Refer to [PCS-34, "Removal and Installation"](#).
 NO >> GO TO 2.

2. CHECK PUSH-BUTTON IGNITION SWITCH CIRCUIT

- Disconnect BCM connector.
- Check continuity between IPDM E/R harness connector and BCM harness connector.

With steering lock unit

IPDM E/R		BCM		Continuity
Connector	Terminal	Connector	Terminal	
E5	28	M122	89	Existed

B261A PUSH-BUTTON IGNITION SWITCH

< DTC/CIRCUIT DIAGNOSIS >

[POWER DISTRIBUTION SYSTEM]

Without steering lock unit

IPDM E/R		BCM		Continuity
Connector	Terminal	Connector	Terminal	
E5	28	M121	60	Existed

3. Check continuity between IPDM E/R harness connector and ground.

IPDM E/R		Ground	Continuity
Connector	Terminal		
E5	28		Not existed

Is the inspection result normal?

- YES >> Replace BCM. Refer to [BCS-81, "Removal and Installation"](#).
NO >> Repair or replace harness.

POWER SUPPLY AND GROUND CIRCUIT

< DTC/CIRCUIT DIAGNOSIS >

[POWER DISTRIBUTION SYSTEM]

POWER SUPPLY AND GROUND CIRCUIT

BCM

BCM : Diagnosis Procedure

INFOID:000000006469832

1. CHECK FUSE AND FUSIBLE LINK

Check that the following fuse and fusible link are not blown.

Signal name	Fuse and fusible link No.
Battery power supply	K
	10

Is the fuse fusing?

YES >> Replace the blown fuse or fusible link after repairing the affected circuit if a fuse or fusible link is blown.

NO >> GO TO 2.

2. CHECK POWER SUPPLY CIRCUIT

1. Turn ignition switch OFF.
2. Disconnect BCM connectors.
3. Check voltage between BCM harness connector and ground.

Terminals		Voltage (Approx.)
(+)	(-)	
BCM		Ground Battery voltage
Connector	Terminal	
M118	1	
M119	11	

Is the measurement value normal?

YES >> GO TO 3.

NO >> Repair harness or connector.

3. CHECK GROUND CIRCUIT

Check continuity between BCM harness connector and ground.

BCM		Ground	Continuity
Connector	Terminal		
M119	13		Existed

Does continuity exist?

YES >> INSPECTION END

NO >> Repair harness or connector.

PUSH-BUTTON IGNITION SWITCH

< DTC/CIRCUIT DIAGNOSIS >

[POWER DISTRIBUTION SYSTEM]

PUSH-BUTTON IGNITION SWITCH

Description

INFOID:000000006469833

BCM transmits the change in the power supply position with the push-button ignition switch to IPDM E/R via CAN communication line. IPDM E/R transmits the power supply position status via CAN communication line to BCM.

Component Function Check

INFOID:000000006469834

1. CHECK FUNCTION

1. Select "PUSH SW" in "Data Monitor" mode with CONSULT-III.
2. Check the push-button ignition switch signal under the following conditions.

Test item	Condition	Status
PUSH SW	Push-button ignition switch is pressed	ON
	Push-button ignition switch is not pressed	OFF

Is the indication normal?

YES >> INSPECTION END.

NO >> Go to [PCS-66, "Diagnosis Procedure"](#).

Diagnosis Procedure

INFOID:000000006469835

1. CHECK PUSH-BUTTON IGNITION SWITCH OUTPUT SIGNAL

1. Turn ignition switch OFF.
2. Disconnect push-button ignition switch connector and IPDM E/R connector.
3. Check voltage between push-button ignition switch harness connector and ground.

(+)		(-)	Voltage (V) (Approx.)
Push-button ignition switch			
Connector	Terminal	Ground	Battery voltage
M50	4		

Is the inspection result normal?

YES >> GO TO 3.

NO >> GO TO 2.

2. CHECK PUSH-BUTTON IGNITION SWITCH CIRCUIT

1. Disconnect BCM connector.
2. Check continuity between BCM harness connector and push-button ignition switch harness connector.

With steering lock unit

BCM		Push-button ignition switch		Continuity
Connector	Terminal	Connector	Terminal	
M122	89	M50	4	Existed

Without steering lock unit

BCM		Push-button ignition switch		Continuity
Connector	Terminal	Connector	Terminal	
M121	60	M50	4	Existed

3. Check continuity between BCM harness connector and ground.

With steering lock unit

BCM		Ground	Continuity
Connector	Terminal		
M122	89		Not existed

PUSH-BUTTON IGNITION SWITCH

< DTC/CIRCUIT DIAGNOSIS >

[POWER DISTRIBUTION SYSTEM]

Without steering lock unit

BCM		Ground	Continuity
Connector	Terminal		
M121	60		Not existed

Is the inspection result normal?

YES >> Replace BCM. Refer to [BCS-81, "Removal and Installation"](#).

NO >> Repair or replace harness.

3.CHECK PUSH-BUTTON IGNITION SWITCH GROUND CIRCUIT

Check continuity between push-button ignition switch harness connector and ground.

Push-button ignition switch		Ground	Continuity
Connector	Terminal		
M50	1		Existed

Is the inspection result normal?

YES >> GO TO 4.

NO >> Repair or replace harness.

4.CHECK PUSH-BUTTON IGNITION SWITCH

Refer to [PCS-67, "Component Inspection"](#).

Is the inspection result normal?

YES >> GO TO 5.

NO >> Replace push-button ignition switch. Refer to [PCS-116, "Removal and Installation"](#).

5.CHECK INTERMITTENT INCIDENT

Refer to [GI-43, "Intermittent Incident"](#).

>> INSPECTION END

Component Inspection

INFOID:000000006469836

1.CHECK PUSH-BUTTON IGNITION SWITCH

1. Turn ignition switch OFF.
2. Disconnect push-button ignition switch connector.
3. Check continuity between push-button ignition switch terminals.

Push-button ignition switch		Condition	Continuity
Terminal			
1	4	Pressed	Existed
		Not pressed	Not existed

Is the inspection result normal?

YES >> INSPECTION END

NO >> Replace push-button ignition switch. Refer to [PCS-116, "Removal and Installation"](#).

A
B
C
D
E
F
G
H
I
J
K
L
N
O
P

PCS

PUSH-BUTTON IGNITION SWITCH POSITION INDICATOR

< DTC/CIRCUIT DIAGNOSIS >

[POWER DISTRIBUTION SYSTEM]

PUSH-BUTTON IGNITION SWITCH POSITION INDICATOR

Description

INFOID:000000006469837

Push-button ignition switch changes the power supply position.
BCM maintains the power supply position status.
BCM changes the power supply position with the operation of the push-button ignition switch.

Component Function Check

INFOID:000000006469838

1.CHECK FUNCTION

Check push-button ignition switch ("LOCK INDICATOR", "ACC INDICATOR" and "IGNITION ON IND") in Active Test Mode with CONSULT-III.

Test item		Description	
LOCK INDICATOR	ON	Position indicator	Illuminates
ACC INDICATOR IGNITION ON IND	OFF		Does not illuminate

Is the inspection result normal?

- YES >> INSPECTION END.
NO >> Refer to [PCS-68, "Diagnosis Procedure"](#).

Diagnosis Procedure

INFOID:000000006469839

1.CHECK PUSH-BUTTON IGNITION SWITCH INPUT SIGNAL

1. Turn ignition switch OFF.
2. Disconnect push-button ignition switch connector.
3. Check voltage between push-button ignition switch harness connector and ground.

(+)		(-)	Voltage (V) (Approx.)
Push-button ignition switch			
Connector	Terminal	Ground	Battery voltage
M50	8		

Is the inspection normal?

- YES >> GO TO 2.
NO-1 >> Check 10 A fuse [No.9, located in fuse block (J/B)].
NO-2 >> Check harness for open or short between push-button ignition switch and fuse.

2.CHECK BCM INPUT

1. Connect push-button ignition switch connector.
2. Disconnect BCM connector.
3. Check voltage between BCM connector and ground.

(+)		(-)	Voltage (V) (Approx.)
BCM			
Connector	Terminal	Ground	Battery voltage
M119	15		
M122	93		
M123	134		

Is the inspection normal?

- YES >> Replace BCM. Refer to [BCS-81, "Removal and Installation"](#).
NO >> GO TO 3.

3.CHECK PUSH-BUTTON IGNITION SWITCH CIRCUIT

1. Disconnect push-button ignition switch connector.

PUSH-BUTTON IGNITION SWITCH POSITION INDICATOR

< DTC/CIRCUIT DIAGNOSIS >

[POWER DISTRIBUTION SYSTEM]

2. Check continuity between BCM harness connector and push-button ignition switch harness connector.

Indicator	BCM		Push-button ignition switch		Continuity
	Connector	Terminal	Connector	Terminal	
LOCK	M123	134	M50	5	Existed
ACC	M119	15		6	
ON	M122	93		7	

3. Check continuity between BCM harness connector and ground.

Indicator	BCM		Ground	Continuity
	Connector	Terminal		
LOCK	M123	134	Ground	Not existed
ACC	M119	15		
ON	M122	93		

Is the inspection normal?

- YES >> Replace push-button ignition switch. Refer to [PCS-116, "Removal and Installation"](#).
NO >> Repair or replace harness.

A
B
C
D
E
F
G
H
I
J
K
L
N
O
P

PCS

POWER DISTRIBUTION SYSTEM

< DTC/CIRCUIT DIAGNOSIS >

[POWER DISTRIBUTION SYSTEM]

POWER DISTRIBUTION SYSTEM

Wiring Diagram - PDS (POWER DISTRIBUTION SYSTEM) -

INFOID:000000006469840

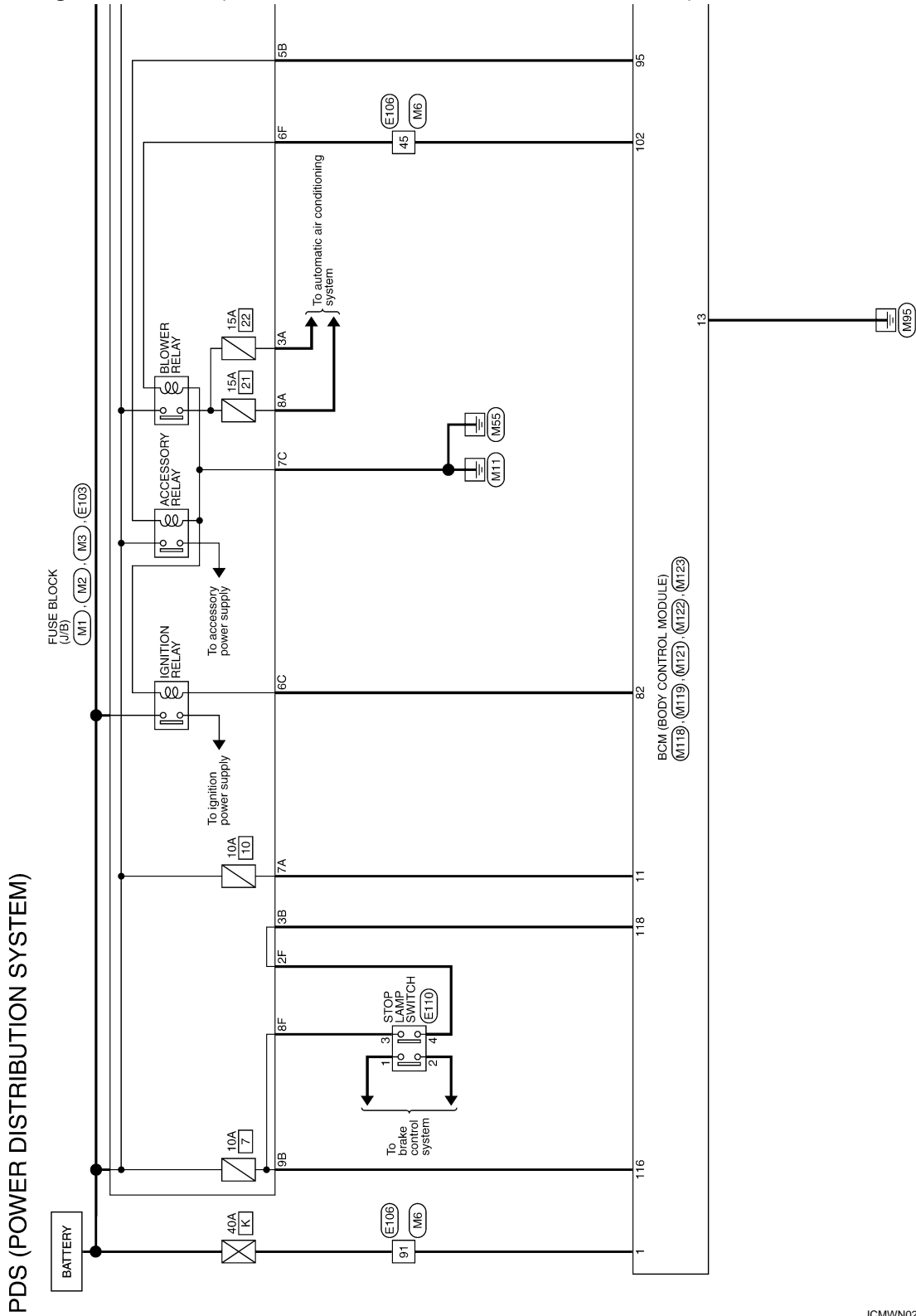

POWER DISTRIBUTION SYSTEM

< DTC/CIRCUIT DIAGNOSIS >

[POWER DISTRIBUTION SYSTEM]

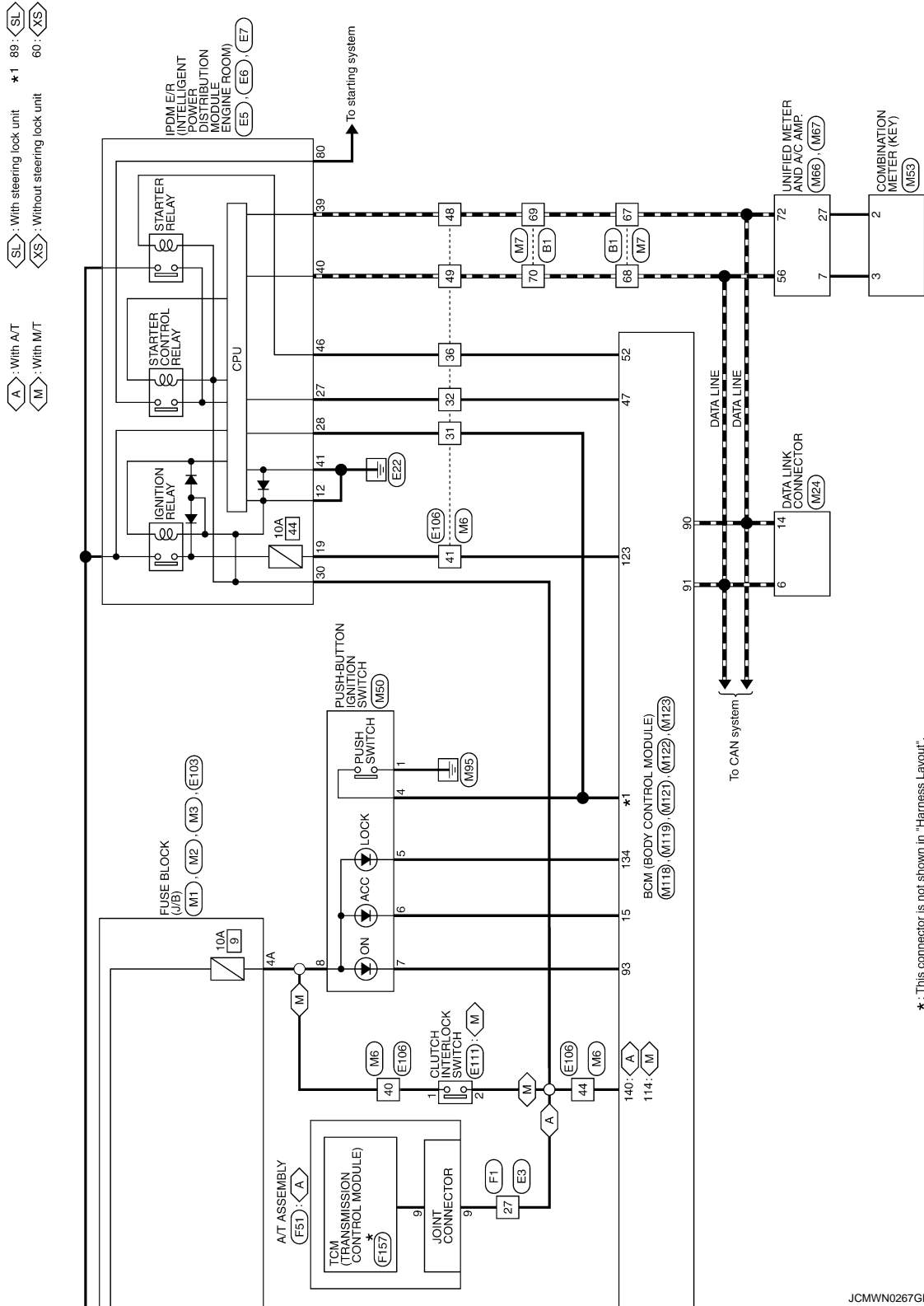

JCMWN0267GB

A
B
C
D
E
F
G
H
I
J
K
L
M
N
O
P

PCS

POWER DISTRIBUTION SYSTEM

< DTC/CIRCUIT DIAGNOSIS >

[POWER DISTRIBUTION SYSTEM]

PDS (POWER DISTRIBUTION SYSTEM)

Connector No.	B1
Connector Name	WIRE TO WIRE
Connector Type	TH2DFW-CS16-TM4



Terminal No.	Color of Wire	Signal Name [Specification]
1	W	-
2	L	-
3	R	-
4	V	-
5	W	-
6	B	-
7	G	-
8	G	-
9	BR	-
10	BR	-
11	SHIELD	-
12	Y	-
13	Y	-
14	L	-
15	R	-
16	W	-
17	BR	-
20	G	-
21	SB	-
22	GR	-
23	W	-
24	SB	-
25	BR	-
26	LG	-
27	Y	-
28	R	-
29	Y	-
31	SHIELD	-
32	G	-
33	R	-
34	BG	-
35	GR	-
36	BR	-
37	P	- [With climate controlled seat]
37	Y	- [Without climate controlled seat]
38	Y	- [With climate controlled seat]
38	GR	- [Without climate controlled seat]
40	SHIELD	-
41	L	-
42	P	-
43	SHIELD	-

Connector No.	E3
Connector Name	WIRE TO WIRE
Connector Type	SAA38MF-RS8-S1Z3

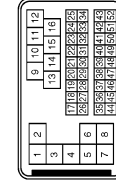

Terminal No.	Color of Wire	Signal Name [Specification]
1	L/Y	-
2	SHIELD	-
3	L/B	-
4	SHIELD	-
5	BR	-
6	G	-
7	W	-
8	W	-
9	W	-
10	Y	-
11	P	-
12	SB	-
13	BR	-
14	G	-
15	R	-
16	LG	-
17	P	-
18	Y	-
19	BG	-
20	B	-
21	SB	-
22	W	-
23	L	-
24	G	-
25	V	-
26	GR	-
27	GR	-
28	V	-
29	V	-
30	R	-
31	BR	-
32	Y	-
33	G	-
34	BG	-
37	SHIELD	-
38	L	-
39	P	-
40	R	-
41	W	-
42	LG	-

43	G	-
46	SHIELD	-
47	W	-
48	BR	-
49	G	-
50	B	-
51	SB	-
52	R	-

Connector No.	E5
Connector Name	IPDM E/R INTELLIGENT POWER DISTRIBUTION MODULE (ENGINE ROOM)
Connector Type	TH2DFW-CS12-M4-1V



Terminal No.	Color of Wire	Signal Name [Specification]
4	V	-
5	L	-
6	SS	-
7	R	-
11	BR	-
12	B/W	-
13	Y	-
16	LG	-
19	W	-
25	G	-
26	R	-
27	BG	-
28	Y	-
30	GR	-
32	V	-
33	P	-
36	G	-

POWER DISTRIBUTION SYSTEM

< DTC/CIRCUIT DIAGNOSIS >

[POWER DISTRIBUTION SYSTEM]

PDS (POWER DISTRIBUTION SYSTEM)

Connector No.	E6
Connector Name	IGNITION INTELLIGENT POWER DISTRIBUTION MODULE ENGINE ROOM
Connector Type	TH80PW-NH

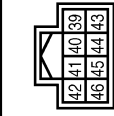

Terminal No.	Color of Wire	Signal Name [Specification]
39	P	-
40	L	-
41	B/W	-
42	Y	-
43	SB	-
44	LG	-
45	G	-
46	W	-

Connector No.	E7
Connector Name	IGNITION INTELLIGENT POWER DISTRIBUTION MODULE ENGINE ROOM
Connector Type	TH20PW-CS12-M4

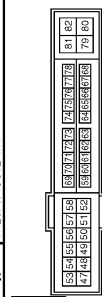

Terminal No.	Color of Wire	Signal Name [Specification]
48	BR	-
49	EG	-
51	Y	-
53	W	-
54	P	-
55	SB	-
56	LG	-
57	G	-
58	GR	-
60	BR	-
70	EG	-
73	P	-
74	G	-
75	SB	-

Terminal No.	76	Y	-
Terminal No.	77	R	-
Terminal No.	80	W	-

Connector No.	E103
Connector Name	FUSE BLOCK (J/B)
Connector Type	NS16FW-CS

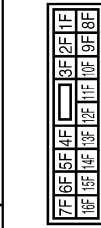

Terminal No.	Color of Wire	Signal Name [Specification]
1F	SB	-
2F	V	-
4F	G	-
6F	EG	-
8F	L	-
9F	R	-

Connector No.	E106
Connector Name	WIRE TO WIRE
Connector Type	TH80PW-CS16-TM4

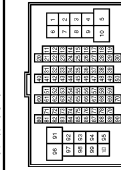

Terminal No.	Color of Wire	Signal Name [Specification]
1	GR	-
3	BG	-
4	B/W	-
5	G	-
6	BG	-
7	LG	-
8	G	-
9	R	-
10	W	-
11	V	-
12	R	-

13	L	-
14	GR	-
15	R	-
16	W	-
17	V	-
18	BG	-
19	GR	-
20	LG	-
30	R	-
31	L	-
32	BG	-
33	P	-
34	V	-
35	BR	-
36	W	-
37	Y	-
38	R	-
39	B	-
40	G	-
41	W	-
42	LG	-
43	SB	-
44	GR	-
45	EG	-
46	LG	-
47	V	-
48	P	-
49	L	-
59	B	-
66	LG	-
67	SB	-
68	R	-
69	W	-
70	G	-
80	W	-
81	P	-
82	G	-
83	V	-
84	L	-
85	BG	-
86	LG	-
87	Y	-
88	GR	-
89	W	-
90	W	-
91	G	-
92	B	-
93	GR	-
94	L	-
95	Y	-
96	Y	-
97	BR	-
98	SHIELD	-

Terminal No.	99	L	-
Terminal No.	100	P	-

Connector No.	E110
Connector Name	STOP LAMP SWITCH
Connector Type	MM4PW-LC

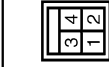

Terminal No.	Color of Wire	Signal Name [Specification]
1	L	-
2	V	-
3	L	- [With ICC]
3	Y	- [Without ICC]
4	SB	- [With ICC]
4	W	- [Without ICC]

Connector No.	E111
Connector Name	CLUTCH INTERLOCK SWITCH
Connector Type	S02FL



Terminal No.	Color of Wire	Signal Name [Specification]
1	G	-
2	GR	-

A
B
C
D
E
F
G
H
I
J
K
L
N
O
P

PCS

JCMWN0269GB

POWER DISTRIBUTION SYSTEM

< DTC/CIRCUIT DIAGNOSIS >

[POWER DISTRIBUTION SYSTEM]

PDS (POWER DISTRIBUTION SYSTEM)

Connector No.	F1
Connector Name	WIRE TO WIRE
Connector Type	SA33PE-RS8-S1Z3

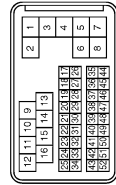

Terminal No.	Color of Wire	Signal Name [Specification]
1	L/Y	-
2	SHIELD	-
3	L/B	-
4	SHIELD	-
5	BR	-
7	G	-
8	W	-
9	W	-
10	G	-
11	R	-
12	P	-
13	L	-
14	LG	-
15	R	-
16	Y	-
17	W	-
18	LG	-
19	P	-
20	O	-
21	BR	-
22	G	-
23	Y	-
24	LG	-
25	V	-
27	GR	-
28	BR	-
29	L	-
30	R	-
31	P	-
32	W	-
33	SB	-
34	O	-
37	SHIELD	-
38	W	-
39	Y	-
40	G	-
41	B	-
42	GR	-

43	R	-
46	SHIELD	-
47	W/L	-
48	LG	-
49	O/L	-
30	L/Y	-
51	W	-
52	L/G	-

Connector No.	F51
Connector Name	A/T ASSEMBLY
Connector Type	RK10FC-DGY



Terminal No.	Color of Wire	Signal Name [Specification]
1	Y	-
2	R	-
3	L	-
4	V	-
5	B	-
6	Y	-
7	R	-
8	P	-
9	GR	-
10	B	-

Connector No.	F157
Connector Name	TGM (TRANSMISSION CONTROL MODULE)
Connector Type	SP10FG



Terminal No.	Color of Wire	Signal Name [Specification]
1	-	VIGM
2	-	BATT

3	-	CAN-H
4	-	K-LINE
5	-	GND
8	-	VIGN
7	-	REV LAMP RLY
8	-	CAN-L
9	-	STARTER RLY
10	-	GND

Connector No.	M1
Connector Name	FUSE BLOCK (J/B)
Connector Type	NS08FW-MZ



Terminal No.	Color of Wire	Signal Name [Specification]
1A	V	-
2A	G	-
3A	L	-
4A	P	-
5A	BR	-
6A	Y	-
7A	GR	-
8A	L	-

Connector No.	M2
Connector Name	FUSE BLOCK (J/B)
Connector Type	NS10FW-CS



Terminal No.	Color of Wire	Signal Name [Specification]
1B	R	-
3B	P	-
4B	G	-
5B	BG	-

6B	Y	-
7B	P	-
8B	R	-
9B	SB	-

Connector No.	M3
Connector Name	FUSE BLOCK (J/B)
Connector Type	NS12FW-CS



Terminal No.	Color of Wire	Signal Name [Specification]
6C	R	-
7C	B	-
8C	W	-
9C	BG	-
10C	L	-
11C	LG	-
12C	R	-

JCMWN0270GB

POWER DISTRIBUTION SYSTEM

< DTC/CIRCUIT DIAGNOSIS >

[POWER DISTRIBUTION SYSTEM]

PDS (POWER DISTRIBUTION SYSTEM)

Connector No.	M6
Connector Name	WIRE TO WIRE
Connector Type	TH80MW-CS (F-TM4)

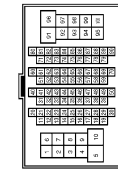

Terminal No.	Color of Wire	Signal Name [Specification]
1	EG	
3	R	
4	G	
5	G	
6	BR	
7	BR	
8	Y	
9	R	
10	W	
11	GR	
12	R	
13	L	
14	G	
15	P	
16	W	
17	BR	
18	V	
19	EG	
20	L	
30	R	
31	Y	
32	Y	
33	GR	
34	P	
35	BR	
36	BR	
37	Y	
38	LG	
39	SB	
40	G	
41	W	
42	LG	
43	P	
44	GR	
44	R	- [With A/T]
45	EG	- [With M/T]
46	G	
47	G	
47	P	

48	P	
49	L	
50	B	
50	Y	
57	R	
58	R	
69	W	
70	G	
80	SB	
81	R	
82	V	
83	W	
84	L	
85	BG	
86	G	
87	V	
88	B	
89	SR	
90	G	
91	W	
92	B	
93	G	
94	L	
95	BR	
97	P	
98	SHIELD	
99	V	
100	SB	

Connector No.	M7
Connector Name	WIRE TO WIRE
Connector Type	TH80MW-CS (F-TM4)

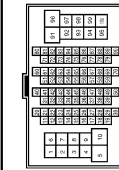

Terminal No.	Color of Wire	Signal Name [Specification]
1	EG	
2	LG	
3	G	
4	V	
5	L	
6	B	
9	L	
10	BR	

12	SHIELD	
13	V	
14	BR	
15	GR	
16	LG	
17	L	
20	BR	
21	G	
22	R	
23	SB	
24	B	
25	W	
26	Y	
27	V	
28	P	
29	V	
31	SHIELD	
32	G	
33	G	
34	BG	
35	GR	
36	BR	
37	P	
37	L	
38	V	
38	GR	
40	SHIELD	
41	L	
42	P	
43	SHIELD	
44	Y	
45	BR	
46	SB	
47	SB	
48	LG	
48	LG	
48	LG	
48	SB	
50	SB	
50	LG	
51	R	
52	V	
53	P	
54	BR	
55	Y	
55	BG	
56	L	
57	V	
58	R	
60	LG	
61	BG	
62	B	
63	V	

64	SR	
65	BR	
66	Y	
67	P	
68	L	
69	P	
70	L	
80	G	
81	LG	
82	Y	
83	BR	
84	V	
85	L	
86	Y	
87	GR	
91	R	
93	G	
94	P	
95	GR	
96	Y	
97	SB	
99	Y	
100	Y/B	

Connector No.	M24
Connector Name	DATA LINK CONNECTOR
Connector Type	BD10FW

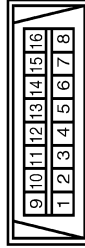

Terminal No.	Color of Wire	Signal Name [Specification]
3	LG	
4	B	
5	BR	
6	L	
7	V	
8	G	
11	SB	
14	P	
16	R	

JCMWN0271GB

A
B
C
D
E
F
G
H
I
J
K
L
PCS
N
O
P

POWER DISTRIBUTION SYSTEM

< DTC/CIRCUIT DIAGNOSIS >

[POWER DISTRIBUTION SYSTEM]

PDS (POWER DISTRIBUTION SYSTEM)

Connector No.	M50
Connector Name	PUSH-BUTTON IGNITION SWITCH
Connector Type	TK08BR



Terminal No.	Color of Wire	Signal Name [Specification]
1	B	-
2	W	-
3	Y	-
4	BR	-
5	LG	-
6	BG	-
7	V	-
8	P	-

Connector No.	M53
Connector Name	COMBINATION METER
Connector Type	SAB40FW

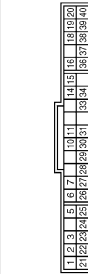

Terminal No.	Color of Wire	Signal Name [Specification]
1	V	BATTERY POWER SUPPLY
2	LG	COMMUNICATION SIGNAL (METER->AMP.)
3	GR	COMMUNICATION SIGNAL (AMP->METER)
5	B	GROUND
6	W	ALTERNATOR SIGNAL
7	LG	AIR BAG SIGNAL
10	R	SECURITY SIGNAL
15	B	GROUND
16	B	METER CONTROL SWITCH GROUND
18	GR	ILL GND
19	B	ILL GND
20	R	ILL
21	R	IGNITION SIGNAL
22	B	GROUND

Terminal No.	Color of Wire	Signal Name [Specification]
24	SB	COMMUNICATION SIGNAL (LCD->AMP.)
25	B	COMMUNICATION SIGNAL (AMP->LCD)
26	R	VEHICLE SPEED SIGNAL (8-PULSE)
27	V	PARKING BRAKE SWITCH SIGNAL
28	SB	BRAKE FLUID LEVEL SWITCH SIGNAL
29	L	SEAT BELT BUCKLE SW SIGNAL (DRIVER SIDE)
30	G	SEAT BELT BUCKLE SWITCH SIGNAL (PASSENGER SIDE)
31	L	WASHER LEVEL SWITCH SIGNAL
33	R	ILLUMINATION CONTROL SIGNAL
36	LG	SELECT SWITCH SIGNAL
37	SB	ENTER SWITCH SIGNAL
38	L	TRIP A/B RESET SWITCH SIGNAL
39	P	ILLUMINATION CONTROL SWITCH (-)
40	BG	ILLUMINATION CONTROL SWITCH (+)

Connector No.	M66
Connector Name	UNIFIED METER AND A/C AMP.
Connector Type	TH40FW-NH

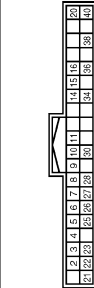

Terminal No.	Color of Wire	Signal Name [Specification]
4	G	STOP LAMP SWITCH
5	L	MANUAL MODE SHIFT UP SIGNAL
6	BG	PADDLE SHIFTER UP SIGNAL
7	GR	COMMUNICATION SIGNAL (AMP->METER)
8	L	VEHICLE SPEED (2-PULSE)
9	SB	SEAT BELT BUCKLE SWITCH SIGNAL (DRIVER SIDE)
10	W	MANUAL MODE SIGNAL
11	G	NON-MANUAL MODE SIGNAL
14	SB	COMMUNICATION SIGNAL (LCD->AMP.)
20	G	IGN ON / OFF SIGNAL
25	V	MANUAL MODE SHIFT DOWN SIGNAL
26	G	PADDLE SHIFTER DOWN SIGNAL
27	LG	COMMUNICATION SIGNAL (METER->AMP.)
28	R	VEHICLE SPEED (8-PULSE)
30	V	PARKING BRAKE SWITCH SIGNAL
34	B	COMMUNICATION SIGNAL (AMP->LCD)
38	P	BLOWER MOTOR CONTROL SIGNAL

Connector No.	M67
Connector Name	UNIFIED METER AND A/C AMP.
Connector Type	TH2FW-NH

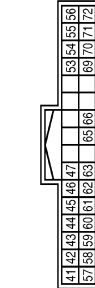

Terminal No.	Color of Wire	Signal Name [Specification]
41	BR	ACC POWER SUPPLY
42	BR	FUEL LEVEL SENSOR SIGNAL
43	R	INTAKE SENSOR SIGNAL
44	LG	IN-VEHICLE SENSOR SIGNAL
45	V	AMBIENT SENSOR SIGNAL
46	BG	SUNLOAD SENSOR SIGNAL
47	G	EXHAUST GAS OXIDE SENSOR SIGNAL
53	W	IGNITION POWER SUPPLY
54	BG	BATTERY POWER SUPPLY
55	B	GROUND
56	L	CAN-H
57	LG	BRAKE FLUID LEVEL SWITCH SIGNAL
58	Y	FUEL LEVEL SENSOR GROUND
59	GR	INTAKE SENSOR GROUND
60	L	IN-VEHICLE SENSOR GROUND
61	R	AMBIENT SENSOR GROUND
62	SB	SUNLOAD SENSOR GROUND
63	L	ION CONTROL MODE OUTPUT SIGNAL
65	BG	ECV SIGNAL
69	R	A/C CLAN SIGNAL
70	R	EACH DOOR MOTOR POWER SUPPLY
71	GR	GROUND
72	P	CAN-L

Connector No.	MT18
Connector Name	BCM (BODY CONTROL MODULE)
Connector Type	M03FB-LC



Terminal No.	Color of Wire	Signal Name [Specification]
1	W	BAT (F/L)
2	V	POWER WINDOW POWER SUPPLY (BAT)
3	BG	POWER WINDOW POWER SUPPLY (R&P)

Connector No.	MT19
Connector Name	BCM (BODY CONTROL MODULE)
Connector Type	NS18FW-CS

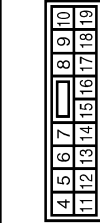

Terminal No.	Color of Wire	Signal Name [Specification]
4	LG	INTERIOR ROOM LAMP POWER SUPPLY
5	P	PASSENGER DOOR UNLOCK OUTPUT
7	SB	STEP LAMP
8	V	ALL DOOR FUEL LID LOCK OUTPUT
9	G	DRIVER DOOR FUEL LID UNLOCK OUTPUT
11	GR	BAT (FUSE)
13	B	GND
14	W	PUSH-BUTTON IGNITION SW ILL GND
15	BG	ACC IND
17	BR	TURN SIGNAL-RH (FRONT)
18	BG	TURN SIGNAL-LH (FRONT)
19	V	ROOM LAMP TIMER CONTROL

POWER DISTRIBUTION SYSTEM

< DTC/CIRCUIT DIAGNOSIS >

[POWER DISTRIBUTION SYSTEM]

A
B
C
D
E
F
G
H
I
J
K
L
N
O
P

PDS (POWER DISTRIBUTION SYSTEM)

Connector No.	MI21
Connector Name	BCM (BODY CONTROL MODULE)
Connector Type	TH40FG-NH

Terminal No.	Color of Wire	Signal Name [Specification]
34	SB	TRUNK ROOM ANT-
35	V	TRUNK ROOM ANT+
38	B	REAR BUMPER ANT-
39	W	REAR BUMPER ANT+
43	Y	IGN RELAY (RDM E/B) CONT
50	G	TRUNK ROOM LAMP SW
52	BR	STARTER RELAY CONT
60	BR	PUSH SW
61	SB	TRUNK LID OPENER REQUEST SW
64	G	I-KEY WARN BUZZER (ENG ROOM)
67	GR	TRUNK LID OPENER SW

Terminal No.	Color of Wire	Signal Name [Specification]
34	SB	TRUNK ROOM ANT-
35	V	TRUNK ROOM ANT+
38	B	REAR BUMPER ANT-
39	W	REAR BUMPER ANT+
43	Y	IGN RELAY (RDM E/B) CONT
50	G	TRUNK ROOM LAMP SW
52	BR	STARTER RELAY CONT
60	BR	PUSH SW
61	SB	TRUNK LID OPENER REQUEST SW
64	G	I-KEY WARN BUZZER (ENG ROOM)
67	GR	TRUNK LID OPENER SW

Connector No.	MI22
Connector Name	BCM (BODY CONTROL MODULE)
Connector Type	TH40FB-NH

Terminal No.	Color of Wire	Signal Name [Specification]
72	R	ROOM ANT 2-
73	G	ROOM ANT 2+
74	SB	PASSENGER DOOR ANT-
75	BR	PASSENGER DOOR ANT+
76	V	DRIVER DOOR ANT-
77	LG	DRIVER DOOR ANT+
78	Y	ROOM ANT 1-
79	BR	ROOM ANT 1+
80	GR	NATS ANTENNA AMP
81	W	NATS ANTENNA AMP
82	R	IGN RELAY (F/B) CONT

Terminal No.	Color of Wire	Signal Name [Specification]
112	BR	RAIN SENSOR SERIAL LINK
113	G	OPTICAL SENSOR
114	R	CLUTCH INTERLOCK SW
116	SB	STOP LAMP SW 1
118	BR	STOP LAMP SW 2
119	GR	DR DOOR UNLOCK SENSOR
121	SB	KEY SLOT SW
123	W	IGN F/B
124	BG	PASSENGER DOOR SW
129	BG	TRUNK LID OPENER CANCEL SW
132	LG	P/W SW & RHT C/U COMM
133	Y	PUSH-BUTTON IGNITION SW/ILL POWER

Terminal No.	Color of Wire	Signal Name [Specification]
83	Y	KEYLESS ENTRY RECEIVER COMM
87	Y	COMBI SW INPUT 5
88	BG	COMBI SW INPUT 3
89	BR	PUSH SW
90	P	CAN-L
91	L	CAN-H
92	LG	KEY SLOT ILL
93	V	ON IND
95	BG	ACC RELAY CONT
96	GR	A/T SHIFT SELECTOR POWER SUPPLY
97	L	S/L CONDITION 1
98	SB	S/L CONDITION 2
99	R	ASGD CLUTCH SW [Wh M/T]
99	R	SHIFT P [Wh A/T]
100	Y	PASSENGER DOOR REQUEST SW
101	P	DRIVER DOOR REQUEST SW
102	BG	BLOWER FAN MOTOR RELAY CONT
103	LG	KEYLESS ENTRY RECEIVER POWER SUPPLY
106	W	S/L UNIT POWER SUPPLY
107	LG	COMBI SW INPUT 1
108	R	COMBI SW INPUT 4
109	W	COMBI SW INPUT 2
110	G	HAZARD SW
111	Y	S/L UNIT COMM

Terminal No.	Color of Wire	Signal Name [Specification]
134	LG	LOCK IND
137	BG	RECEIVER / SENSOR CMD
138	Y	RECEIVER / SENSOR POWER SUPPLY
139	L	TIRE PRESSURE RECEIVER COMM
140	GR	SHIFT IN/P
141	R	SECURITY INDICATOR LAMP
142	BR	COMBI SW OUTPUT 5
143	V	COMBI SW OUTPUT 1
144	G	COMBI SW OUTPUT 2
145	L	COMBI SW OUTPUT 3
146	SB	COMBI SW OUTPUT 4
150	R	DRIVER DOOR SW
151	G	REAR WINDOW DEFOGGER RELAY CONT

Connector No.	MI23
Connector Name	BCM (BODY CONTROL MODULE)
Connector Type	TH40FG-NH

Terminal No.	Color of Wire	Signal Name [Specification]
112	BR	RAIN SENSOR SERIAL LINK
113	G	OPTICAL SENSOR
114	R	CLUTCH INTERLOCK SW
116	SB	STOP LAMP SW 1
118	BR	STOP LAMP SW 2
119	GR	DR DOOR UNLOCK SENSOR
121	SB	KEY SLOT SW
123	W	IGN F/B
124	BG	PASSENGER DOOR SW
129	BG	TRUNK LID OPENER CANCEL SW
132	LG	P/W SW & RHT C/U COMM
133	Y	PUSH-BUTTON IGNITION SW/ILL POWER

Terminal No.	Color of Wire	Signal Name [Specification]
112	BR	RAIN SENSOR SERIAL LINK
113	G	OPTICAL SENSOR
114	R	CLUTCH INTERLOCK SW
116	SB	STOP LAMP SW 1
118	BR	STOP LAMP SW 2
119	GR	DR DOOR UNLOCK SENSOR
121	SB	KEY SLOT SW
123	W	IGN F/B
124	BG	PASSENGER DOOR SW
129	BG	TRUNK LID OPENER CANCEL SW
132	LG	P/W SW & RHT C/U COMM
133	Y	PUSH-BUTTON IGNITION SW/ILL POWER

BCM (BODY CONTROL MODULE)

< ECU DIAGNOSIS INFORMATION >

[POWER DISTRIBUTION SYSTEM]

ECU DIAGNOSIS INFORMATION

BCM (BODY CONTROL MODULE)

Reference Value

INFOID:000000006956321

VALUES ON THE DIAGNOSIS TOOL

CONSULT-III MONITOR ITEM

Monitor Item	Condition	Value/Status
FR WIPER HI	Other than front wiper switch HI	Off
	Front wiper switch HI	On
FR WIPER LOW	Other than front wiper switch LO	Off
	Front wiper switch LO	On
FR WASHER SW	Front washer switch OFF	Off
	Front washer switch ON	On
FR WIPER INT	Other than front wiper switch INT/AUTO	Off
	Front wiper switch INT/AUTO	On
FR WIPER STOP	Front wiper is not in STOP position	Off
	Front wiper is in STOP position	On
INT VOLUME	Wiper volume dial is in a dial position 1 - 7	Wiper volume dial position
TURN SIGNAL R	Other than turn signal switch RH	Off
	Turn signal switch RH	On
TURN SIGNAL L	Other than turn signal switch LH	Off
	Turn signal switch LH	On
TAIL LAMP SW	Other than lighting switch 1ST and 2ND	Off
	Lighting switch 1ST or 2ND	On
HI BEAM SW	Other than lighting switch HI	Off
	Lighting switch HI	On
HEAD LAMP SW 1	Other than lighting switch 2ND	Off
	Lighting switch 2ND	On
HEAD LAMP SW 2	Other than lighting switch 2ND	Off
	Lighting switch 2ND	On
PASSING SW	Other than lighting switch PASS	Off
	Lighting switch PASS	On
AUTO LIGHT SW	Other than lighting switch AUTO	Off
	Lighting switch AUTO	On
FR FOG SW	Front fog lamp switch OFF	Off
	Front fog lamp switch ON	On
RR FOG SW	NOTE: The item is indicated, but not monitored.	Off
DOOR SW-DR	Driver door closed	Off
	Driver door opened	On
DOOR SW-AS	Passenger door closed	Off
	Passenger door opened	On
DOOR SW-RR	NOTE: The item is indicated, but not monitored.	Off

BCM (BODY CONTROL MODULE)

< ECU DIAGNOSIS INFORMATION >

[POWER DISTRIBUTION SYSTEM]

Monitor Item	Condition	Value/Status	
DOOR SW-RL	NOTE: The item is indicated, but not monitored.	Off	A
DOOR SW-BK	NOTE: The item is indicated, but not monitored.	Off	B
CDL LOCK SW	Other than power door lock switch LOCK	Off	C
	Power door lock switch LOCK	On	
CDL UNLOCK SW	Other than power door lock switch UNLOCK	Off	D
	Power door lock switch UNLOCK	On	
KEY CYL LK-SW	Other than driver door key cylinder LOCK position	Off	E
	Driver door key cylinder LOCK position	On	
KEY CYL UN-SW	Other than driver door key cylinder UNLOCK position	Off	F
	Driver door key cylinder UNLOCK position	On	
KEY CYL SW-TR	NOTE: The item is indicated, but not monitored.	Off	G
HAZARD SW	Hazard switch is OFF	Off	H
	Hazard switch is ON	On	
REAR DEF SW	NOTE: The item is indicated, but not monitored.	Off	I
H/L WASH SW	NOTE: The item is indicated, but not monitored.	Off	J
TR CANCEL SW	Trunk lid opener cancel switch OFF	Off	K
	Trunk lid opener cancel switch ON	On	
TR/BD OPEN SW	Trunk lid opener switch OFF	Off	L
	While the trunk lid opener switch is turned ON	On	
TRNK/HAT MNTR	Trunk lid closed	Off	PCS
	Trunk lid opened	On	
RKE-LOCK	LOCK button of the Intelligent Key is not pressed	Off	N
	LOCK button of the Intelligent Key is pressed	On	
RKE-UNLOCK	UNLOCK button of the Intelligent Key is not pressed	Off	O
	UNLOCK button of the Intelligent Key is pressed	On	
RKE-TR/BD	TRUNK OPEN button of the Intelligent Key is not pressed	Off	P
	TRUNK OPEN button of the Intelligent Key is pressed	On	
RKE-PANIC	PANIC button of the Intelligent Key is not pressed	Off	N
	PANIC button of the Intelligent Key is pressed	On	
RKE-P/W OPEN	UNLOCK button of the Intelligent Key is not pressed	Off	O
	UNLOCK button of the Intelligent Key is pressed and held	On	
RKE-MODE CHG	LOCK/UNLOCK button of the Intelligent Key is not pressed and held simultaneously	Off	P
	LOCK/UNLOCK button of the Intelligent Key is pressed and held simultaneously	On	
OPTICAL SENSOR	Bright outside of the vehicle	Close to 5 V	P
	Dark outside of the vehicle	Close to 0 V	
REQ SW -DR	Driver door request switch is not pressed	Off	P
	Driver door request switch is pressed	On	
REQ SW -AS	Passenger door request switch is not pressed	Off	P
	Passenger door request switch is pressed	On	
REQ SW -RR	NOTE: The item is indicated, but not monitored.	Off	P

BCM (BODY CONTROL MODULE)

< ECU DIAGNOSIS INFORMATION >

[POWER DISTRIBUTION SYSTEM]

Monitor Item	Condition	Value/Status
REQ SW -RL	NOTE: The item is indicated, but not monitored.	Off
REQ SW -BD/TR	Trunk lid opener request switch is not pressed	Off
	Trunk lid opener request switch is pressed	On
PUSH SW	Push-button ignition switch (push switch) is not pressed	Off
	Push-button ignition switch (push switch) is pressed	On
IGN RLY2 -F/B	Ignition switch in OFF or ACC position	Off
	Ignition switch in ON position	On
ACC RLY -F/B	NOTE: The item is indicated, but not monitored.	Off
CLUCH SW	The clutch pedal is not depressed	Off
	The clutch pedal is depressed	On
BRAKE SW 1	The brake pedal is depressed when No. 7 fuse is blown	Off
	The brake pedal is not depressed when No. 7 fuse is blown, or No. 7 fuse is normal	On
BRAKE SW 2	The brake pedal is not depressed	Off
	The brake pedal is depressed	On
DETE/CANCL SW	<ul style="list-style-type: none"> • Selector lever in P position (Except M/T models) • The clutch pedal is depressed (M/T models) 	Off
	<ul style="list-style-type: none"> • Selector lever in any position other than P (Except M/T models) • The clutch pedal is not depressed (M/T models) 	On
SFT PN/N SW	Selector lever in any position other than P and N	Off
	Selector lever in P or N position	On
S/L -LOCK NOTE: For models without steering lock unit, this item is not monitored.	Steering is unlocked	Off
	Steering is locked	On
S/L -UNLOCK NOTE: For models without steering lock unit, this item is not monitored.	Steering is locked	Off
	Steering is unlocked	On
S/L RELAY-F/B NOTE: For models without steering lock unit, this item is not monitored.	Ignition switch in OFF or ACC position	Off
	Ignition switch in ON position	On
UNLK SEN -DR	Driver door is unlocked	Off
	Driver door is locked	On
PUSH SW -IPDM	Push-button ignition switch (push-switch) is not pressed	Off
	Push-button ignition switch (push-switch) is pressed	On
IGN RLY1 -F/B	Ignition switch in OFF or ACC position	Off
	Ignition switch in ON position	On
DETE SW -IPDM	Selector lever in any position other than P	Off
	Selector lever in P position	On
SFT PN -IPDM	<ul style="list-style-type: none"> • Selector lever in any position other than P and N (Except M/T models) • The clutch pedal is not depressed (M/T models) 	Off
	<ul style="list-style-type: none"> • Selector lever in P or N position • The clutch pedal is depressed 	On

BCM (BODY CONTROL MODULE)

< ECU DIAGNOSIS INFORMATION >

[POWER DISTRIBUTION SYSTEM]

Monitor Item	Condition	Value/Status	
SFT P -MET	Selector lever in any position other than P	Off	A
	Selector lever in P position	On	
SFT N -MET	Selector lever in any position other than N	Off	B
	Selector lever in N position	On	
ENGINE STATE	Engine stopped	Stop	
	While the engine stalls	Stall	C
	At engine cranking	Crank	
	Engine running	Run	D
S/L LOCK-IPDM NOTE: For models without steering lock unit, this item is not monitored.	Steering is unlocked	Off	E
	Steering is locked	On	
S/L UNLK-IPDM NOTE: For models without steering lock unit, this item is not monitored.	Steering is locked	Off	F
	Steering is unlocked	On	
S/L RELAY-REQ NOTE: For models without steering lock unit, this item is not monitored.	Steering lock system is not the LOCK condition and the changing condition from LOCK to UNLOCK	Off	G
	Steering lock system are not the LOCK condition or the changing condition from LOCK to UNLOCK	On	H
VEH SPEED 1	While driving	Equivalent to speedometer reading	I
VEH SPEED 2	While driving	Equivalent to speedometer reading	
DOOR STAT-DR	Driver door is locked	LOCK	J
	Wait with selective UNLOCK operation (60 seconds)	READY	
	Driver door is unlocked	UNLOCK	
DOOR STAT-AS	Passenger door is locked	LOCK	K
	Wait with selective UNLOCK operation (60 seconds)	READY	
	Passenger door is unlocked	UNLOCK	L
ID OK FLAG	Driver side door is open after ignition switch is turned OFF (Selector lever is in the P position except for M/T models)	Reset	
	Ignition switch ON	Set	PCS
PRMT ENG STRT	The engine start is prohibited	Reset	
	The engine start is permitted	Set	
PRMT RKE STRT	NOTE: The item is indicated, but not monitored.	Reset	N
KEY SW -SLOT	The Intelligent Key is not inserted into key slot	Off	O
	The Intelligent Key is inserted into key slot	On	
RKE OPE COUN1	During the operation of the Intelligent Key	Operation frequency of the Intelligent Key	
RKE OPE COUN2	NOTE: The item is indicated, but not monitored.	—	P
CONFRM ID ALL	The key ID that the key slot receives is not recognized by any key ID registered to BCM.	Yet	
	The key ID that the key slot receives is recognized by any key ID registered to BCM.	Done	

BCM (BODY CONTROL MODULE)

< ECU DIAGNOSIS INFORMATION >

[POWER DISTRIBUTION SYSTEM]

Monitor Item	Condition	Value/Status
CONFIRM ID4	The key ID that the key slot receives is not recognized by the fourth key ID registered to BCM.	Yet
	The key ID that the key slot receives is recognized by the fourth key ID registered to BCM.	Done
CONFIRM ID3	The key ID that the key slot receives is not recognized by the third key ID registered to BCM.	Yet
	The key ID that the key slot receives is recognized by the third key ID registered to BCM.	Done
CONFIRM ID2	The key ID that the key slot receives is not recognized by the second key ID registered to BCM.	Yet
	The key ID that the key slot receives is recognized by the second key ID registered to BCM.	Done
CONFIRM ID1	The key ID that the key slot receives is not recognized by the first key ID registered to BCM.	Yet
	The key ID that the key slot receives is recognized by the first key ID registered to BCM.	Done
TP 4	The ID of fourth Intelligent Key is not registered to BCM	Yet
	The ID of fourth Intelligent Key is registered to BCM	Done
TP 3	The ID of third Intelligent Key is not registered to BCM	Yet
	The ID of third Intelligent Key is registered to BCM	Done
TP 2	The ID of second Intelligent Key is not registered to BCM	Yet
	The ID of second Intelligent Key is registered to BCM	Done
TP 1	The ID of first Intelligent Key is not registered to BCM	Yet
	The ID of first Intelligent Key is registered to BCM	Done
AIR PRESS FL	Ignition switch ON (Only when the signal from the transmitter is received)	Air pressure of front LH tire
AIR PRESS FR	Ignition switch ON (Only when the signal from the transmitter is received)	Air pressure of front RH tire
AIR PRESS RR	Ignition switch ON (Only when the signal from the transmitter is received)	Air pressure of rear RH tire
AIR PRESS RL	Ignition switch ON (Only when the signal from the transmitter is received)	Air pressure of rear LH tire
ID REGST FL1	ID of front LH tire transmitter is registered	Done
	ID of front LH tire transmitter is not registered	Yet
ID REGST FR1	ID of front RH tire transmitter is registered	Done
	ID of front RH tire transmitter is not registered	Yet
ID REGST RR1	ID of rear RH tire transmitter is registered	Done
	ID of rear RH tire transmitter is not registered	Yet
ID REGST RL1	ID of rear LH tire transmitter is registered	Done
	ID of rear LH tire transmitter is not registered	Yet
WARNING LAMP	Tire pressure indicator OFF	Off
	Tire pressure indicator ON	On
BUZZER	Tire pressure warning alarm is not sounding	Off
	Tire pressure warning alarm is sounding	On

BCM (BODY CONTROL MODULE)

< ECU DIAGNOSIS INFORMATION >

[POWER DISTRIBUTION SYSTEM]

TERMINAL LAYOUT

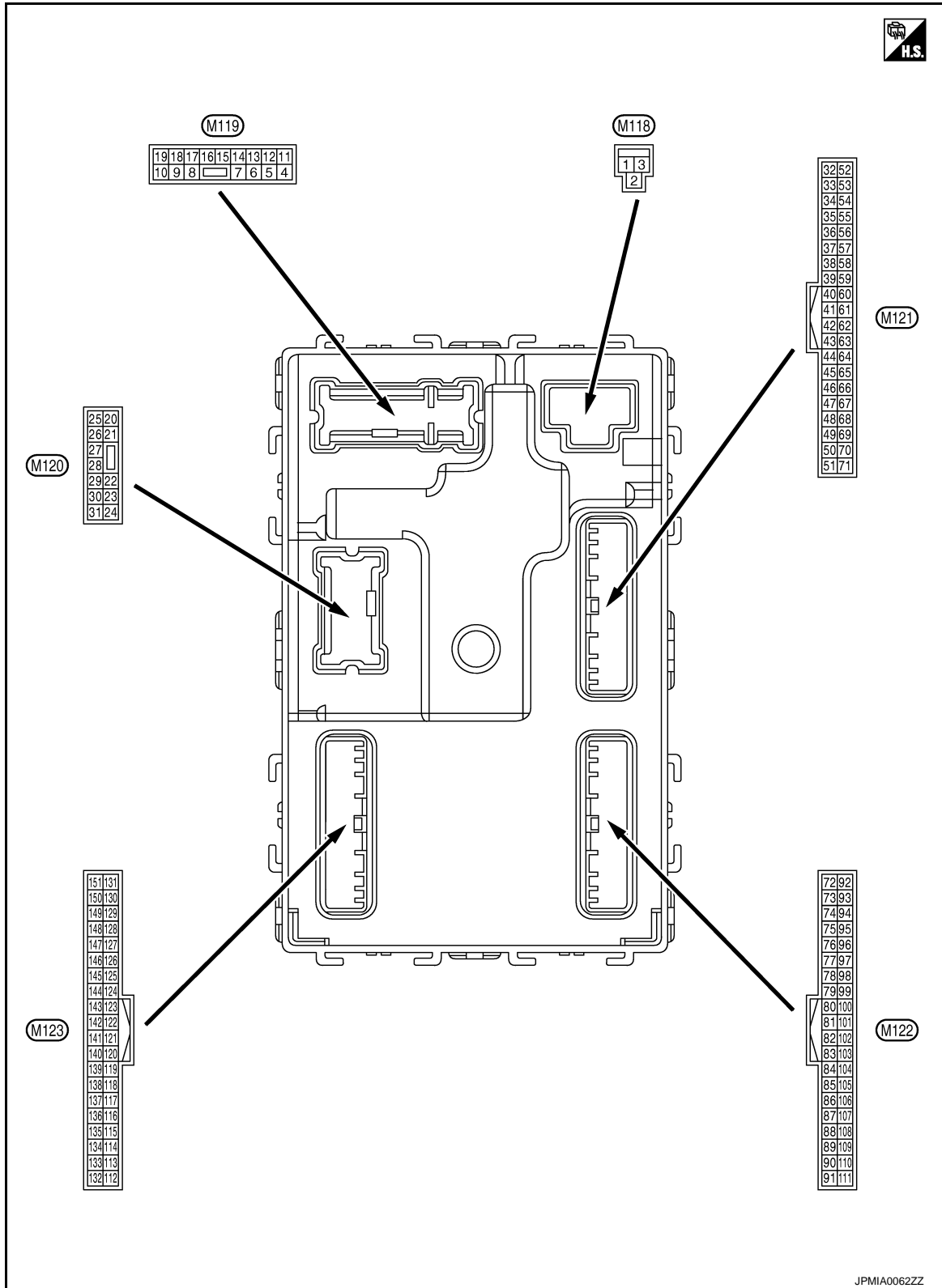

A
B
C
D
E
F
G
H
I
J
K
L
PCS
N
O
P

PHYSICAL VALUES

BCM (BODY CONTROL MODULE)

< ECU DIAGNOSIS INFORMATION >

[POWER DISTRIBUTION SYSTEM]

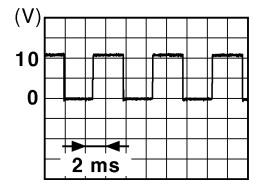
Terminal No. (Wire color)		Description		Condition		Value (Approx.)
		Signal name	Input/ Output			
+	-					
1 (W)	Ground	Battery power supply	Input	Ignition switch OFF		Battery voltage
2 (Y)	Ground	P/W power supply (BAT)	Output	Ignition switch OFF		12 V
3 (BG)	Ground	P/W power supply (RAP)	Output	Ignition switch ON		12 V
4 (LG)	Ground	Interior room lamp power supply	Output	Interior room lamp battery saver is activated. (Cuts the interior room lamp power supply)		0 V
				Interior room lamp battery saver is not activated. (Outputs the interior room lamp power supply)		12 V
5 (P)	Ground	Passenger door UN- LOCK	Output	Passenger door	UNLOCK (Actuator is activated)	12 V
					Other than UNLOCK (Actuator is not activated)	0 V
7 (SB)	Ground	Step lamp	Output	Step lamp	ON	0 V
					OFF	12 V
8 (V)	Ground	All doors, fuel lid LOCK	Output	All doors, fuel lid	LOCK (Actuator is activated)	12 V
					Other than LOCK (Actuator is not activated)	0 V
9 (G)	Ground	Driver door, fuel lid UNLOCK	Output	Driver door, fuel lid	UNLOCK (Actuator is activated)	12 V
					Other than UNLOCK (Actuator is not activated)	0 V
11 (GR)	Ground	Battery power supply	Input	Ignition switch OFF		Battery voltage
13 (B)	Ground	Ground	—	Ignition switch ON		0 V
14 (W)	Ground	Push-button ignition switch illumination ground	Output	Tail lamp	OFF	0 V
					ON	<p style="text-align: center;">NOTE: When the illumination brightening/dimming level is in the neutral position.</p>  <p style="text-align: right; font-size: small;">JSNIA0010GB</p>
15 (BG)	Ground	ACC indicator lamp	Output	Ignition switch	OFF (LOCK indicator is not illuminated)	Battery voltage
					ACC	0 V

BCM (BODY CONTROL MODULE)

< ECU DIAGNOSIS INFORMATION >

[POWER DISTRIBUTION SYSTEM]

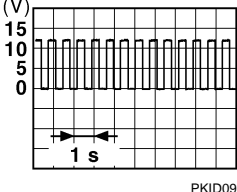
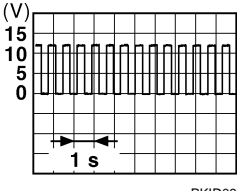
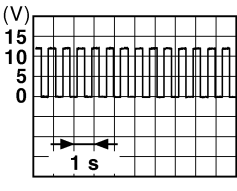
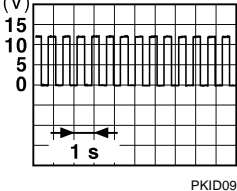
Terminal No. (Wire color)		Description		Condition	Value (Approx.)	
		Signal name	Input/ Output			
+	-					
17 (BR)	Ground	Turn signal RH (Front)	Output	Ignition switch ON	Turn signal switch OFF	0 V
					Turn signal switch RH	
18 (BG)	Ground	Turn signal LH (Front)	Output	Ignition switch ON	Turn signal switch OFF	0 V
					Turn signal switch LH	
19 (V)	Ground	Room lamp timer control	Output	Interior room lamp	OFF	12 V
					ON	0 V
20 (V)	Ground	Turn signal RH (Rear)	Output	Ignition switch ON	Turn signal switch OFF	0 V
					Turn signal switch RH	
23 (Y)	Ground	Trunk lid open	Output	Trunk lid	OPEN (Trunk lid opener actuator is activated)	12 V
					Other than OPEN (Trunk lid opener actuator is not activated)	0 V
25 (Y)	Ground	Turn signal LH (Rear)	Output	Ignition switch ON	Turn signal switch OFF	0 V
					Turn signal switch LH	
30 (P)	Ground	Trunk room lamp	Output	Trunk room lamp	ON	0 V
					OFF	12 V

A
B
C
D
E
F
G
H
I
J
K
L
N
O
P

PCS

BCM (BODY CONTROL MODULE)

< ECU DIAGNOSIS INFORMATION >

[POWER DISTRIBUTION SYSTEM]

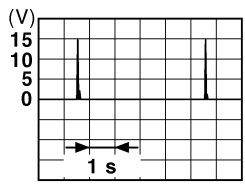
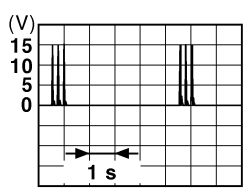
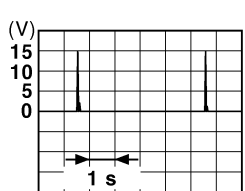
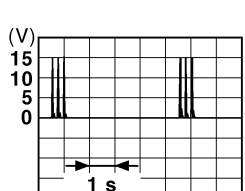
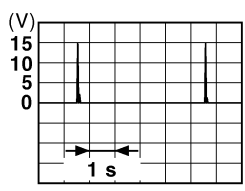
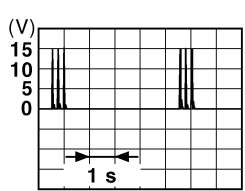
Terminal No. (Wire color)		Description		Condition	Value (Approx.)
+	-	Signal name	Input/ Output		
34 (SB)	Ground	Trunk room antenna (-)	Output	Ignition switch OFF	When Intelligent Key is in the passenger compart- ment  <p style="text-align: right; font-size: small;">JMKIA0062GB</p>
				Ignition switch OFF	When Intelligent Key is not in the passenger compart- ment  <p style="text-align: right; font-size: small;">JMKIA0063GB</p>
35 (V)	Ground	Trunk room antenna (+)	Output	Ignition switch OFF	When Intelligent Key is in the passenger compart- ment  <p style="text-align: right; font-size: small;">JMKIA0062GB</p>
				Ignition switch OFF	When Intelligent Key is not in the passenger compart- ment  <p style="text-align: right; font-size: small;">JMKIA0063GB</p>
38 (B)	Ground	Rear bumper anten- na (-)	Output	When the trunk lid opener re- quest switch is operated with ignition switch OFF	When Intelligent Key is in the antenna detection area  <p style="text-align: right; font-size: small;">JMKIA0062GB</p>
				When the trunk lid opener re- quest switch is operated with ignition switch OFF	When Intelligent Key is not in the antenna detection area  <p style="text-align: right; font-size: small;">JMKIA0063GB</p>

BCM (BODY CONTROL MODULE)

< ECU DIAGNOSIS INFORMATION >

[POWER DISTRIBUTION SYSTEM]

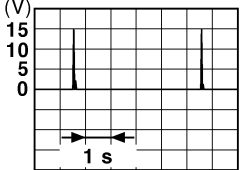
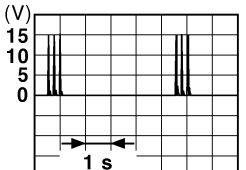
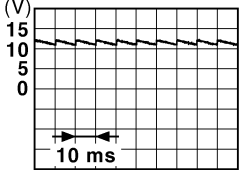
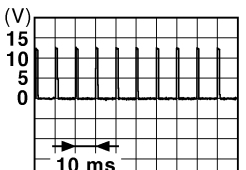
Terminal No. (Wire color)		Description		Condition	Value (Approx.)	
		Signal name	Input/ Output			
+	-					
39 (W)	Ground	Rear bumper antenna (+)	Output	When Intelligent Key is in the antenna detection area	 <small>JMKIA0062GB</small>	
				When the trunk lid opener request switch is operated with ignition switch OFF	 <small>JMKIA0063GB</small>	
47 (Y)	Ground	Ignition relay (IPDM E/R) control	Output	Ignition switch	OFF or ACC	12 V
					ON	0 V
50 (G)	Ground	Trunk room lamp switch	Input	Trunk room lamp switch	OFF (Trunk lid is closed)	 <small>JPMIA0011GB</small>
						ON (Trunk lid is opened)
52 (BR)	Ground	Starter relay control	Output	Ignition switch ON (A/T models)	When selector lever is in P or N position	12 V
					When selector lever is not in P or N position	0 V
				Ignition switch ON (M/T models)	When the clutch pedal is depressed	Battery voltage
					When the clutch pedal is not depressed	0 V
60*1 (BR)	Ground	Push-button ignition switch (Push switch)	Input	Push-button ignition switch (push switch)	Pressed	0 V
					Not pressed	Battery voltage
61 (SB)	Ground	Trunk lid opener request switch	Input	Trunk lid opener request switch	ON (Pressed)	0 V
					OFF (Not pressed)	 <small>JPMIA0016GB</small>
64 (G)	Ground	Intelligent Key warning buzzer (Engine room)	Output	Intelligent Key warning buzzer (Engine room)	Sounding	0 V
					Not sounding	12 V

A
B
C
D
E
F
G
H
I
J
K
L
N
O
P

PCS

BCM (BODY CONTROL MODULE)

< ECU DIAGNOSIS INFORMATION >

[POWER DISTRIBUTION SYSTEM]

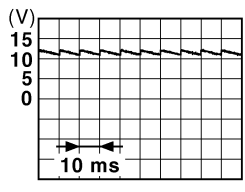
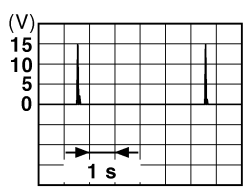
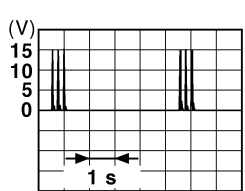
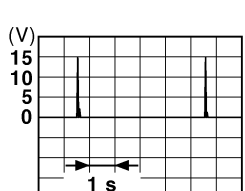
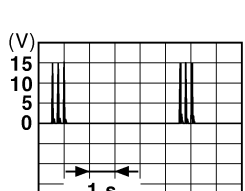
Terminal No. (Wire color)		Description		Condition	Value (Approx.)	
+	-	Signal name	Input/ Output			
67 (GR)	Ground	Trunk lid opener switch	Input	Trunk lid open- er switch	Pressed	0 V
				Not pressed	 <p style="text-align: center;">11.8 V</p>	
72 (R)	Ground	Room antenna 2 (-) (Center console)	Output	Ignition switch OFF	When Intelligent Key is in the passenger compart- ment	
				When Intelligent Key is not in the passenger compart- ment		
73 (G)	Ground	Room antenna 2 (+) (Center console)	Output	Ignition switch OFF	When Intelligent Key is in the passenger compart- ment	
				When Intelligent Key is not in the passenger compart- ment		

BCM (BODY CONTROL MODULE)

< ECU DIAGNOSIS INFORMATION >

[POWER DISTRIBUTION SYSTEM]

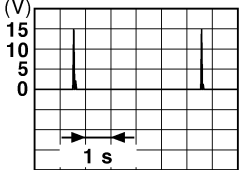
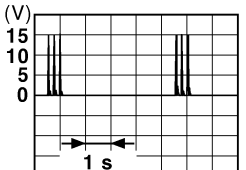
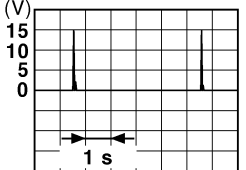
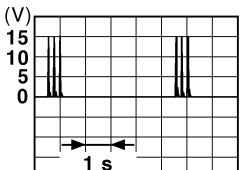
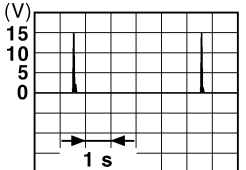
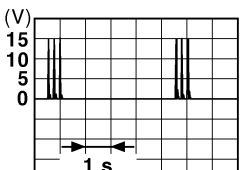
Terminal No. (Wire color)		Description		Condition	Value (Approx.)
		Signal name	Input/ Output		
+	-				
74 (SB)	Ground	Passenger door antenna (-)	Output	When Intelligent Key is in the antenna detection area	 <p style="text-align: right; font-size: small;">JMkia0062GB</p>
				When the passenger door request switch is operated with ignition switch OFF	 <p style="text-align: right; font-size: small;">JMkia0063GB</p>
75 (BR)	Ground	Passenger door antenna (+)	Output	When Intelligent Key is in the antenna detection area	 <p style="text-align: right; font-size: small;">JMkia0062GB</p>
				When the passenger door request switch is operated with ignition switch OFF	 <p style="text-align: right; font-size: small;">JMkia0063GB</p>
76 (V)	Ground	Driver door antenna (-)	Output	When Intelligent Key is in the antenna detection area	 <p style="text-align: right; font-size: small;">JMkia0062GB</p>
				When the driver door request switch is operated with ignition switch OFF	 <p style="text-align: right; font-size: small;">JMkia0063GB</p>

A
B
C
D
E
F
G
H
I
J
K
L
N
O
P

PCS

BCM (BODY CONTROL MODULE)

< ECU DIAGNOSIS INFORMATION >

[POWER DISTRIBUTION SYSTEM]

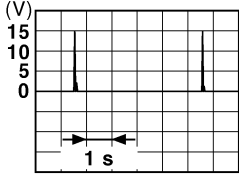
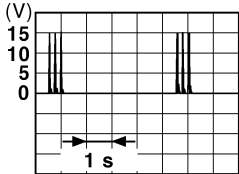
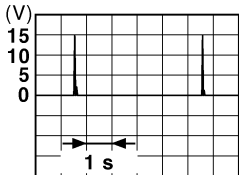
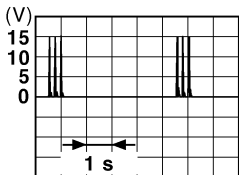
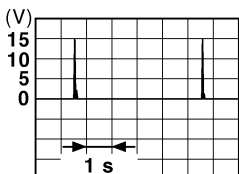
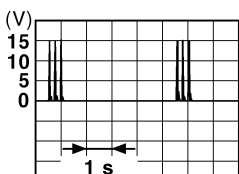
Terminal No. (Wire color)		Description		Condition	Value (Approx.)
+	-	Signal name	Input/ Output		
77 (LG)	Ground	Driver door antenna (+)	Output	When the driver door request switch is operated with ignition switch OFF	When Intelligent Key is in the antenna detection area  <p style="text-align: right; font-size: small;">JMKIA0062GB</p>
				When Intelligent Key is not in the antenna detection area	 <p style="text-align: right; font-size: small;">JMKIA0063GB</p>
78 (Y)	Ground	Room antenna 1 (-) (Instrument panel)	Output	Ignition switch OFF	When Intelligent Key is in the passenger compartment  <p style="text-align: right; font-size: small;">JMKIA0062GB</p>
				When Intelligent Key is not in the passenger compartment	 <p style="text-align: right; font-size: small;">JMKIA0063GB</p>
79 (BR)	Ground	Room antenna 1 (+) (Instrument panel)	Output	Ignition switch OFF	When Intelligent Key is in the passenger compartment  <p style="text-align: right; font-size: small;">JMKIA0062GB</p>
				When Intelligent Key is not in the passenger compartment	 <p style="text-align: right; font-size: small;">JMKIA0063GB</p>

BCM (BODY CONTROL MODULE)

< ECU DIAGNOSIS INFORMATION >

[POWER DISTRIBUTION SYSTEM]

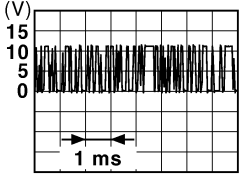
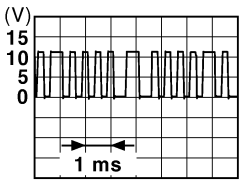
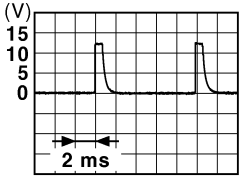
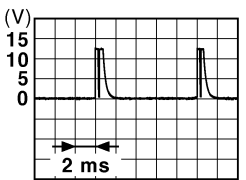
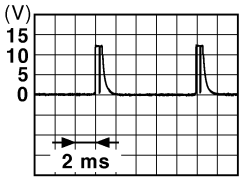
Terminal No. (Wire color)		Description		Condition		Value (Approx.)
+	-	Signal name	Input/ Output			
80 (GR)	Ground	NATS antenna amp.	Input/ Output	During waiting	Ignition switch is pressed while inserting the Intelligent Key into the key slot.	Just after pressing ignition switch. Pointer of tester should move.
81 (W)	Ground	NATS antenna amp.	Input/ Output	During waiting	Ignition switch is pressed while inserting the Intelligent Key into the key slot.	Just after pressing ignition switch. Pointer of tester should move.
82 (R)	Ground	Ignition relay [Fuse block (J/B)] control	Output	Ignition switch	OFF or ACC	0 V
					ON	12 V
83 (Y)	Ground	Remote keyless entry receiver communication	Input/ Output	During waiting		 <p style="text-align: right; font-size: small;">JMKIA0064GB</p>
				When operating either button on the Intelligent Key		 <p style="text-align: right; font-size: small;">JMKIA0065GB</p>
87 (Y)	Ground	Combination switch INPUT 5	Input	Combination switch	All switches OFF (Wiper volume dial 4)	 <p style="text-align: right; font-size: small;">JPMIA0041GB</p> <p style="text-align: center;">1.4 V</p>
					Front fog lamp switch ON (Wiper volume dial 4)	 <p style="text-align: right; font-size: small;">JPMIA0037GB</p> <p style="text-align: center;">1.3 V</p>
					Any of the conditions below with all switches OFF	<ul style="list-style-type: none"> • Wiper volume dial 1 • Wiper volume dial 2 • Wiper volume dial 6 • Wiper volume dial 7  <p style="text-align: right; font-size: small;">JPMIA0040GB</p> <p style="text-align: center;">1.3 V</p>

A
B
C
D
E
F
G
H
I
J
K
L
PCS
N
O
P

BCM (BODY CONTROL MODULE)

< ECU DIAGNOSIS INFORMATION >

[POWER DISTRIBUTION SYSTEM]

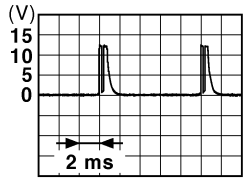
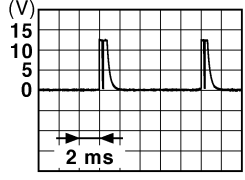
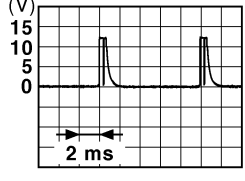
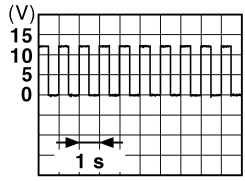
Terminal No. (Wire color)		Description		Condition	Value (Approx.)	
		Signal name	Input/ Output			
+	-					
88 (BG)	Ground	Combination switch INPUT 3	Input	Combination switch	All switches OFF (Wiper volume dial 4)	 <small>JPMIA0041GB</small> 1.4 V
					Lighting switch HI (Wiper volume dial 4)	 <small>JPMIA0036GB</small> 1.3 V
					Lighting switch 2ND (Wiper volume dial 4)	 <small>JPMIA0037GB</small> 1.3 V
					Any of the conditions below with all switches OFF <ul style="list-style-type: none"> • Wiper volume dial 1 • Wiper volume dial 2 • Wiper volume dial 3 	 <small>JPMIA0040GB</small> 1.3 V
89*2 (BR)	Ground	Push-button ignition switch (Push switch)	Input	Push-button ignition switch (push switch)	Pressed	0 V
					Not pressed	Battery voltage
90 (P)	Ground	CAN-L	Input/ Output	—	—	
91 (L)	Ground	CAN-H	Input/ Output	—	—	
92 (LG)	Ground	Key slot illumination	Output	Key slot illumina- tion	OFF	0 V
					Blinking	 <small>JPMIA0015GB</small> 6.5 V
					ON	12 V

BCM (BODY CONTROL MODULE)

< ECU DIAGNOSIS INFORMATION >

[POWER DISTRIBUTION SYSTEM]

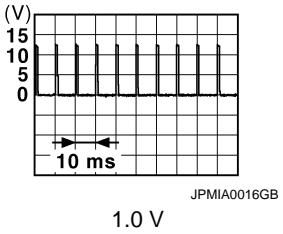
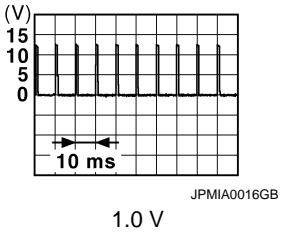

Terminal No. (Wire color)		Description		Condition		Value (Approx.)
		Signal name	Input/ Output			
+	-					
93 (V)	Ground	ON indicator lamp	Output	Ignition switch	OFF (LOCK indicator is not illuminated)	Battery voltage
					ON	0 V
95 (BG)	Ground	ACC relay control	Output	Ignition switch	OFF	0 V
					ACC or ON	12 V
96 (GR)	Ground	A/T shift selector (Detention switch) power supply	Output	—		12 V
97*2 (L)	Ground	Steering lock condition No. 1	Input	Steering lock	LOCK status	0 V
					UNLOCK status	12 V
98*2 (SB)	Ground	Steering lock condition No. 2	Input	Steering lock	LOCK status	12 V
					UNLOCK status	0 V
99 (R)	Ground	Selector lever P position switch	Input	Selector lever	P position	0 V
					Any position other than P	12 V
		ASCD clutch switch (M/T models without ICC)		ASCD clutch switch	OFF (Clutch pedal is depressed)	0 V
					ON (Clutch pedal is not depressed)	12 V
		ICC clutch switch (M/T models with ICC)		ICC clutch switch	OFF (Clutch pedal is depressed)	0 V
					ON (Clutch pedal is not depressed)	12 V
100 (Y)	Ground	Passenger door request switch	Input	Passenger door request switch	ON (Pressed)	0 V
					OFF (Not pressed)	
101 (P)	Ground	Driver door request switch	Input	Driver door request switch	ON (Pressed)	0 V
					OFF (Not pressed)	
102 (BG)	Ground	Blower fan motor relay control	Output	Ignition switch	OFF or ACC	0 V
					ON	12 V
103 (LG)	Ground	Remote keyless entry receiver power supply	Output	Ignition switch OFF		12 V
106*2 (W)	Ground	Steering lock unit power supply	Output	Ignition switch	OFF or ACC	12 V
					ON	0 V

A
B
C
D
E
F
G
H
I
J
K
L
PCS
N
O
P

BCM (BODY CONTROL MODULE)

< ECU DIAGNOSIS INFORMATION >

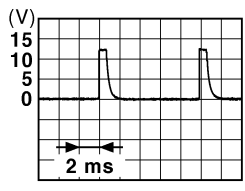
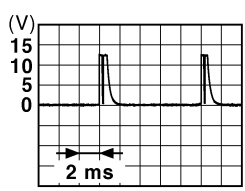

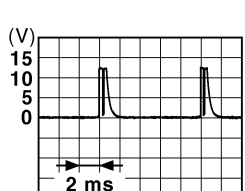
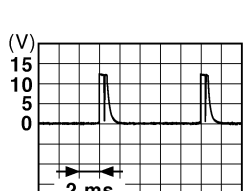
[POWER DISTRIBUTION SYSTEM]

Terminal No. (Wire color)		Description		Condition	Value (Approx.)
+	-	Signal name	Input/ Output		
107 (LG)	Ground	Combination switch INPUT 1	Input	All switches OFF	 1.4 V
				Turn signal switch LH	 1.3 V
				Turn signal switch RH	 1.3 V
				Front wiper switch LO	 1.3 V
				Front washer switch ON	 1.3 V

BCM (BODY CONTROL MODULE)

< ECU DIAGNOSIS INFORMATION >

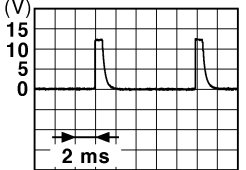
[POWER DISTRIBUTION SYSTEM]

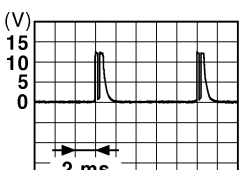
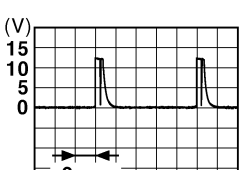
Terminal No. (Wire color)		Description		Condition	Value (Approx.)
		Signal name	Input/ Output		
+	-				
108 (R)	Ground	Combination switch INPUT 4	Input	Combination switch	<div style="display: flex; flex-direction: column; align-items: center;"> <div style="text-align: left; margin-bottom: 5px;">All switches OFF (Wiper volume dial 4)</div>  <div style="text-align: right; margin-top: 5px;">1.4 V</div> </div>
				Lighting switch AUTO (Wiper volume dial 4)	<div style="display: flex; flex-direction: column; align-items: center;"> <div style="text-align: left; margin-bottom: 5px;">Lighting switch AUTO (Wiper volume dial 4)</div>  <div style="text-align: right; margin-top: 5px;">1.3 V</div> </div>
				Lighting switch 1ST (Wiper volume dial 4)	<div style="display: flex; flex-direction: column; align-items: center;"> <div style="text-align: left; margin-bottom: 5px;">Lighting switch 1ST (Wiper volume dial 4)</div>  <div style="text-align: right; margin-top: 5px;">1.3 V</div> </div>
				Any of the conditions below with all switches OFF	<div style="display: flex; flex-direction: column; align-items: center;"> <div style="text-align: left; margin-bottom: 5px;">Any of the conditions below with all switches OFF</div> <ul style="list-style-type: none"> • Wiper volume dial 1 • Wiper volume dial 5 • Wiper volume dial 6  <div style="text-align: right; margin-top: 5px;">1.3 V</div> </div>

A
B
C
D
E
F
G
H
I
J
K
L

PCS

N
O
P

BCM (BODY CONTROL MODULE)

< ECU DIAGNOSIS INFORMATION >

[POWER DISTRIBUTION SYSTEM]

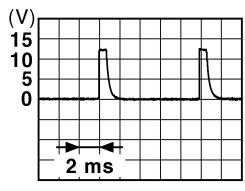
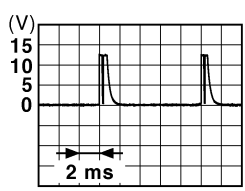
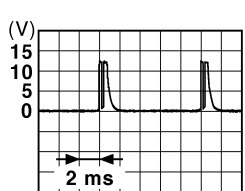
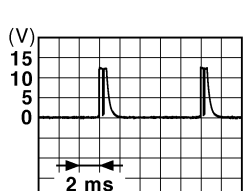
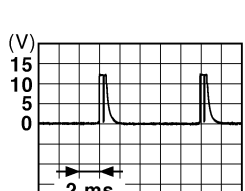
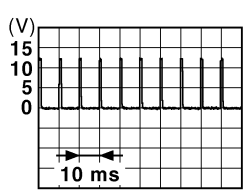
Terminal No. (Wire color)		Description		Condition	Value (Approx.)	
+	-	Signal name	Input/ Output			
109 (W)	Ground	Combination switch INPUT 2	Input	Combination switch (Wiper volume dial 4)	All switches OFF	 <small>JPMIA0041GB</small> 1.4 V
					Lighting switch PASS	 <small>JPMIA0037GB</small> 1.3 V
					Lighting switch 2ND	 <small>JPMIA0036GB</small> 1.3 V
					Front wiper switch INT/ AUTO	 <small>JPMIA0038GB</small> 1.3 V
					Front wiper switch HI	 <small>JPMIA0040GB</small> 1.3 V
					ON	0 V
110 (G)	Ground	Hazard switch	Input	Hazard switch	OFF	 <small>JPMIA0012GB</small> 1.1 V

BCM (BODY CONTROL MODULE)

< ECU DIAGNOSIS INFORMATION >

[POWER DISTRIBUTION SYSTEM]

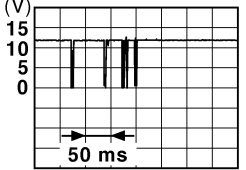
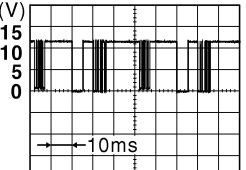
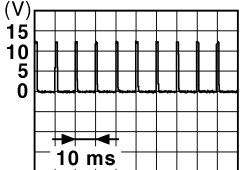
Terminal No. (Wire color)		Description		Condition	Value (Approx.)	
		Signal name	Input/ Output			
+	-					
111*2 (Y)	Ground	Steering lock unit communication	Input/ Output	Steering lock	LOCK status	12 V
					LOCK or UNLOCK	 <p style="text-align: right; font-size: small;">JMKIA0066GB</p>
					For 15 seconds after UNLOCK	12 V
					15 seconds or later after UNLOCK	0 V
112 (BR)	Ground	Rain sensor serial link	Input/ Output	Ignition switch ON	 <p style="text-align: right; font-size: small;">JPMIA0156GB</p>	
8.7 V						
113 (G)	Ground	Optical sensor	Input	Ignition switch ON	When bright outside of the vehicle	Close to 5 V
				When dark outside of the vehicle	Close to 0 V	
114 (R)	Ground	Clutch interlock switch	Input	Clutch interlock switch	OFF (Clutch pedal is not depressed)	0 V
				ON (Clutch pedal is depressed)	Battery voltage	
116 (SB)	Ground	Stop lamp switch 1	Input	—	Battery voltage	
118 (BR)	Ground	Stop lamp switch 2 (Without ICC)	Input	Stop lamp switch	OFF (Brake pedal is not depressed)	0 V
					ON (Brake pedal is depressed)	Battery voltage
		Stop lamp switch 2 (With ICC)		Stop lamp switch OFF (Brake pedal is not depressed) and ICC brake hold relay OFF	0 V	
				Stop lamp switch ON (Brake pedal is depressed) or ICC brake hold relay ON	Battery voltage	
119 (GR)	Ground	Driver side door lock assembly (Unlock sensor)	Input	Driver door	LOCK status (Unlock sensor switch OFF)	 <p style="text-align: right; font-size: small;">JPMIA0012GB</p>
						1.1 V
				UNLOCK status (Unlock switch sensor ON)	0 V	

A
B
C
D
E
F
G
H
I
J
K
L
N
O
P

PCS

BCM (BODY CONTROL MODULE)

< ECU DIAGNOSIS INFORMATION >

[POWER DISTRIBUTION SYSTEM]

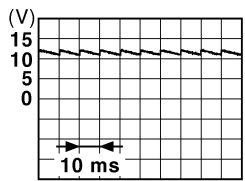
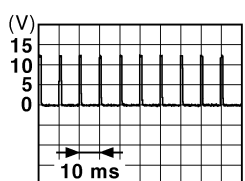
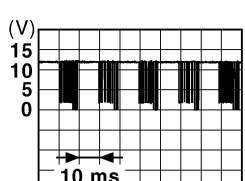
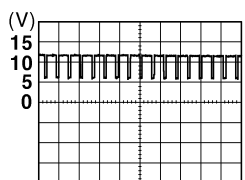
Terminal No. (Wire color)		Description		Condition	Value (Approx.)	
		Signal name	Input/ Output			
+	-					
121 (SB)	Ground	Key slot switch	Input	When the Intelligent Key is inserted into key slot	12 V	
				When the Intelligent Key is not inserted into key slot	0 V	
123 (W)	Ground	IGN feedback	Input	Ignition switch	OFF or ACC	0 V
					ON	Battery voltage
124 (BG)	Ground	Passenger door switch	Input	Passenger door switch	OFF (Door close)	 <small>JPMIA0011GB</small> 11.8 V
					ON (Door open)	0 V
129 (BG)	Ground	Trunk lid opener cancel switch	Input	Trunk lid opener cancel switch	CANCEL	 <small>JPMIA0012GB</small> 1.1 V
					ON	0 V
132 (LG)	Ground	Power window switch and R.H.T. control unit communication	Input/ Output	Ignition switch ON	 <small>JPMIA0013GB</small> 10.2 V	
				Ignition switch OFF or ACC	12 V	
133 (Y)	Ground	Push-button ignition switch illumination	Output	Push-button ignition switch illumination	ON (Tail lamps OFF)	9.5 V
					ON (Tail lamps ON)	<p style="text-align: center;">NOTE:</p> The pulse width of this wave is varied by the illumination brightening/dimming level.  <small>JPMIA0159GB</small>
					OFF	0 V
134 (LG)	Ground	LOCK indicator lamp	Output	LOCK indicator lamp	OFF	Battery voltage
					ON	0 V
137 (BG)	Ground	Receiver and sensor ground	Input	Ignition switch ON	0 V	

BCM (BODY CONTROL MODULE)

< ECU DIAGNOSIS INFORMATION >

[POWER DISTRIBUTION SYSTEM]

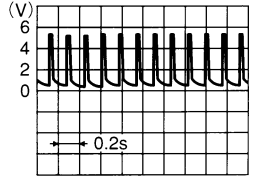
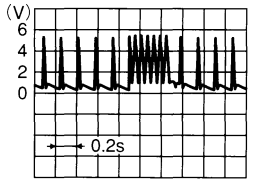
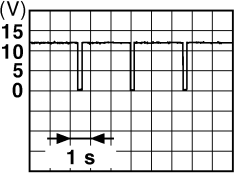
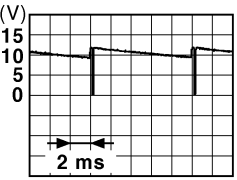
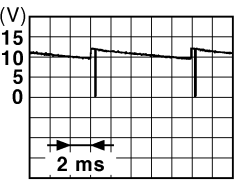
Terminal No. (Wire color)		Description		Condition		Value (Approx.)
		Signal name	Input/ Output			
+	-					
138 (Y)	Ground	Receiver and sensor power supply	Output	Ignition switch	OFF	0 V
					ACC or ON	5.0 V
139 (L)	Ground	Tire pressure receiver communication	Input/ Output	Ignition switch ON	Standby state	 OCC3881D
					When receiving the signal from the transmitter	 OCC3880D
140 (GR)	Ground	Selector lever P/N position (A/T models)	Input	Selector lever	P or N position	12 V
					Except P and N positions	0 V
141 (R)	Ground	Security indicator lamp	Output	Security indicator lamp	ON	0 V
					Blinking	 JPMAI0014GB
					OFF	12 V
142 (BR)	Ground	Combination switch OUTPUT 5	Output	Combination switch (Wiper volume dial 4)	All switches OFF	0 V
					Lighting switch 1ST	 JPMAI0031GB
					Lighting switch HI	
					Lighting switch 2ND	
					Turn signal switch RH	
Turn signal switch RH	10.7 V					
143 (V)	Ground	Combination switch OUTPUT 1	Output	Combination switch	All switches OFF (Wiper volume dial 4)	0 V
					Front wiper switch HI (Wiper volume dial 4)	 JPMAI0032GB
					Any of the conditions below with all switches OFF <ul style="list-style-type: none"> • Wiper volume dial 1 • Wiper volume dial 2 • Wiper volume dial 3 • Wiper volume dial 6 • Wiper volume dial 7 	

A
B
C
D
E
F
G
H
I
J
K
L
N
O
P

PCS

BCM (BODY CONTROL MODULE)

< ECU DIAGNOSIS INFORMATION >

[POWER DISTRIBUTION SYSTEM]

Terminal No. (Wire color)		Description		Condition	Value (Approx.)	
		Signal name	Input/ Output			
+	-					
144 (G)	Ground	Combination switch OUTPUT 2	Output	Combination switch	All switches OFF (Wiper volume dial 4)	0 V
					Front washer switch ON (Wiper volume dial 4)	
					Any of the conditions below with all switches OFF <ul style="list-style-type: none"> • Wiper volume dial 1 • Wiper volume dial 5 • Wiper volume dial 6 	
145 (L)	Ground	Combination switch OUTPUT 3	Output	Combination switch (Wiper volume dial 4)	All switches OFF	0 V
					Front wiper switch INT/ AUTO	
					Lighting switch AUTO	
146 (SB)	Ground	Combination switch OUTPUT 4	Output	Combination switch (Wiper volume dial 4)	All switches OFF	0 V
					Front fog lamp switch ON	
					Lighting switch 2ND	
					Lighting switch PASS	
Turn signal switch LH						
150 (R)	Ground	Driver door switch	Input	Driver door switch	OFF (Door close)	
					ON (Door open)	0 V
151 (G)	Ground	Rear window defogger relay control	Output	Rear window defogger	Active	0 V
					Not activated	Battery voltage

*1: Without steering lock unit

*2: With steering lock unit

BCM (BODY CONTROL MODULE)

[POWER DISTRIBUTION SYSTEM]

< ECU DIAGNOSIS INFORMATION >

Wiring Diagram - BCM -

INFOID:000000006956322

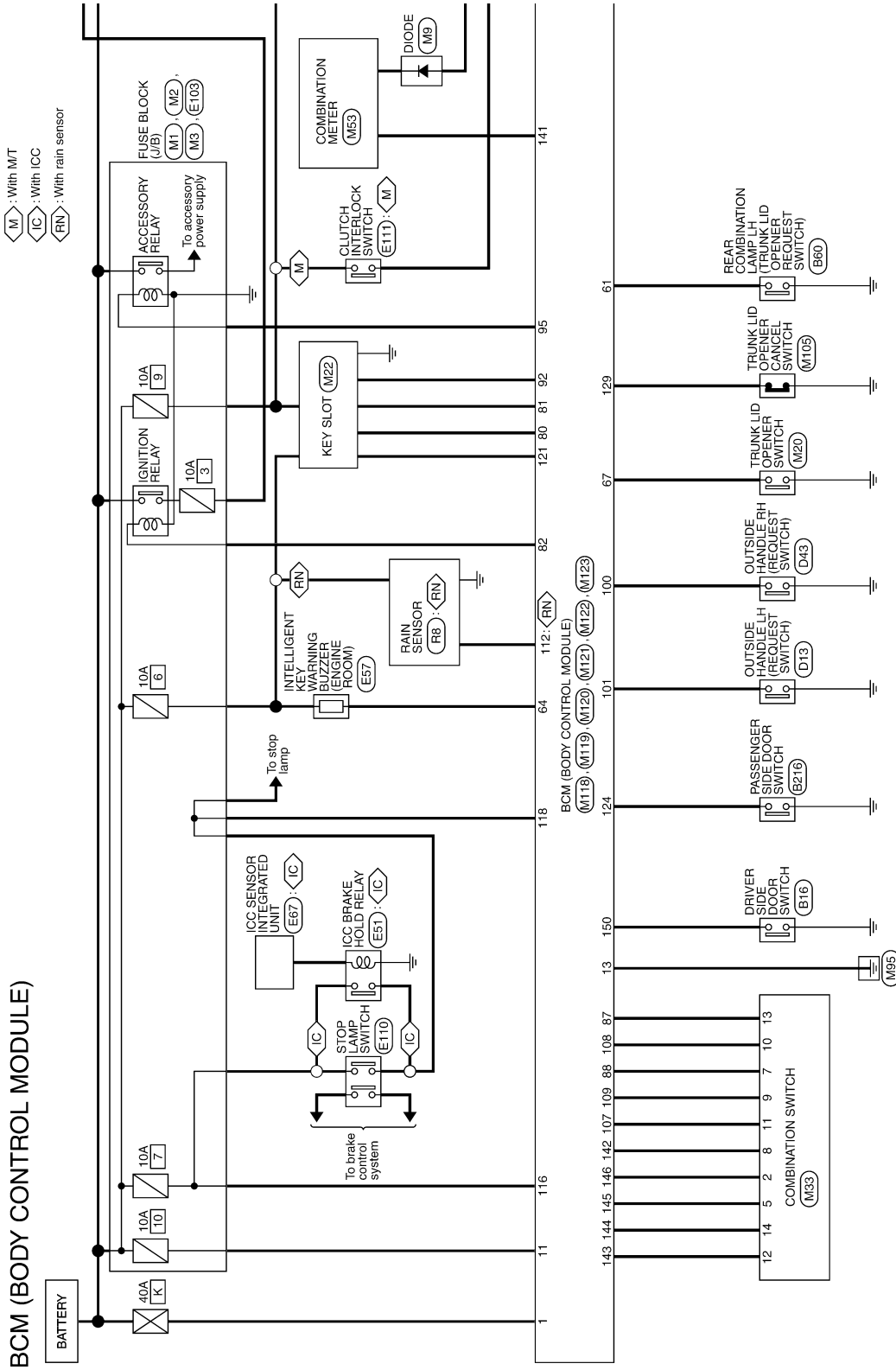

2010/10/12

JCMWN0248GB

A
B
C
D
E
F
G
H
I
J
K
L
N
O
P

PCS

BCM (BODY CONTROL MODULE)

[POWER DISTRIBUTION SYSTEM]

< ECU DIAGNOSIS INFORMATION >

- SL : With steering lock unit
- XS : Without steering lock unit
- A : With A/T
- M : With M/T
- *1
- 89
- 60

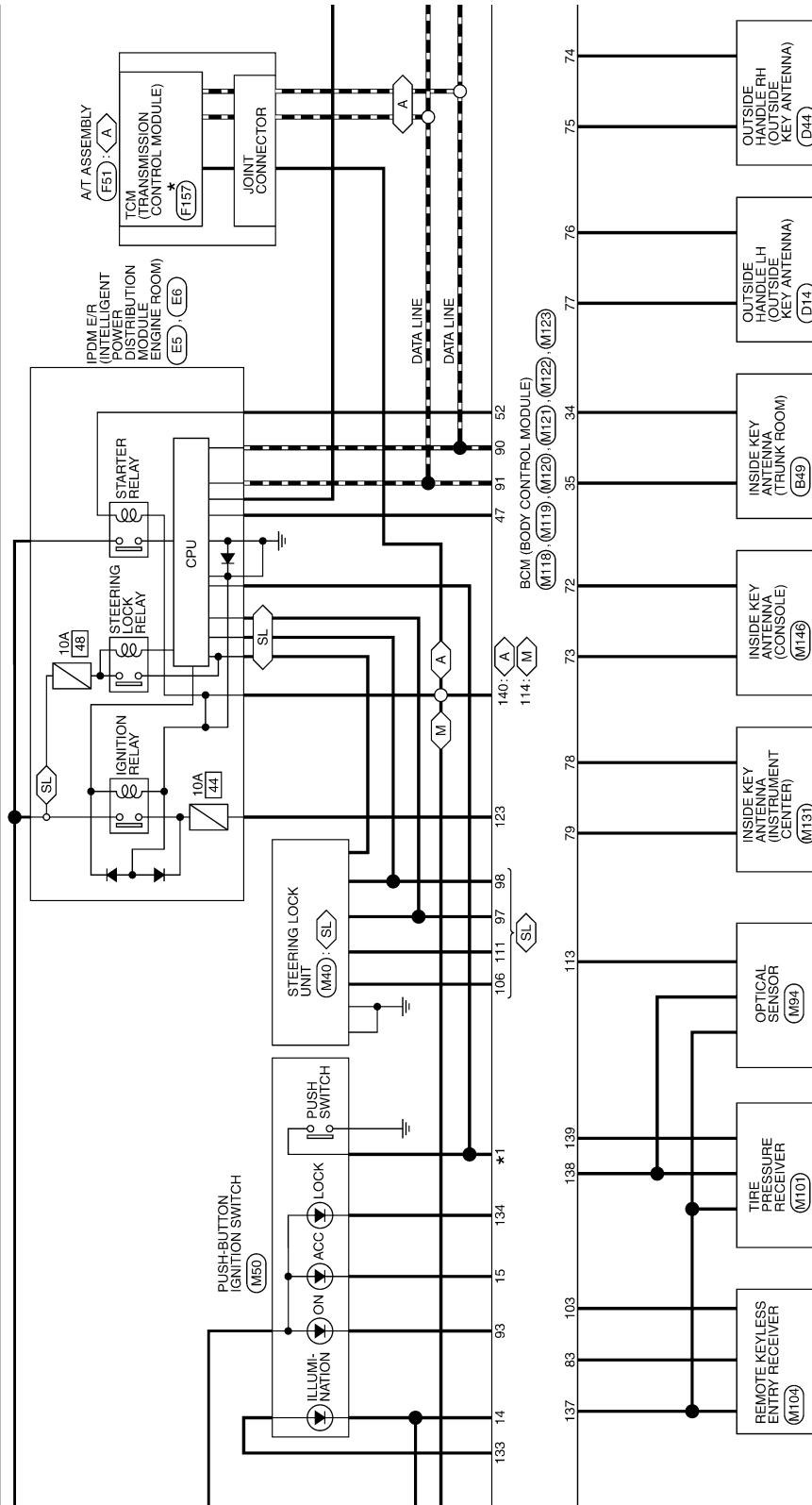

*1: This connector is not shown in "Harness Layout".

JCMWN0249GB

BCM (BODY CONTROL MODULE)

< ECU DIAGNOSIS INFORMATION >

[POWER DISTRIBUTION SYSTEM]

◊ A : With A/T
◊ M : With M/T

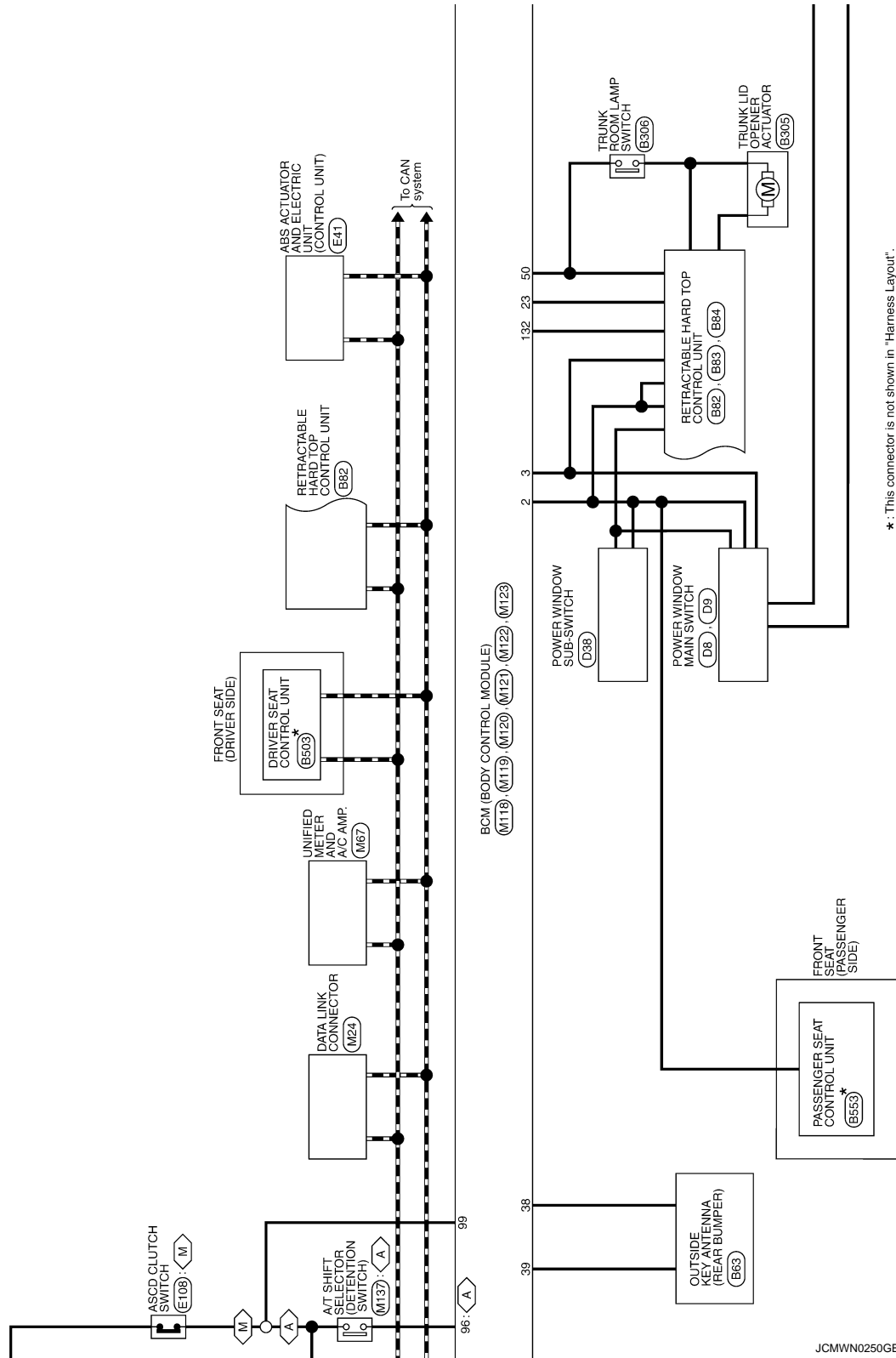

*: This connector is not shown in "Harness Layout".

JCMWN0250GB

A
B
C
D
E
F
G
H
I
J
K
L
N
O
P

PCS

BCM (BODY CONTROL MODULE)

< ECU DIAGNOSIS INFORMATION >

[POWER DISTRIBUTION SYSTEM]

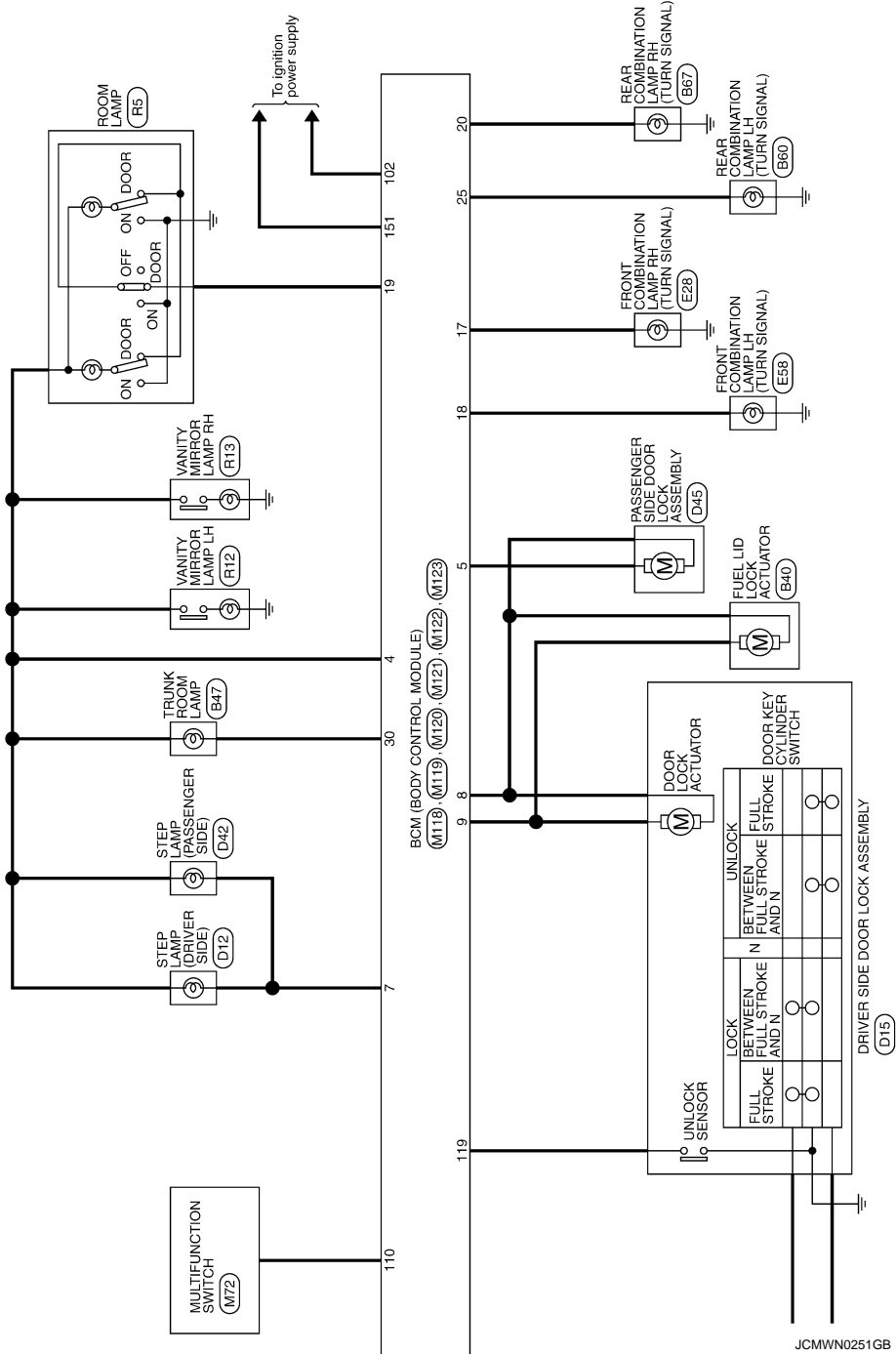

BCM (BODY CONTROL MODULE)

< ECU DIAGNOSIS INFORMATION >

[POWER DISTRIBUTION SYSTEM]

BCM (BODY CONTROL MODULE)

Connector No.	M33
Connector Name	COMBINATION SWITCH
Connector Type	TH16FV-NH

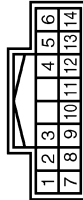

Terminal No.	Color of Wire	Signal Name [Specification]
1	P	FR WASHER (-)
2	SB	OUTPUT 4
3	L	OUTPUT 3
4	B	GND
5	EG	INPUT 3
6	BR	OUTPUT 5
7	W	INPUT 2
8	R	INPUT 4
9	LG	INPUT 1
10	V	OUTPUT 1
11	Y	INPUT 5
12	G	OUTPUT 2
13		
14		

Connector No.	M18
Connector Name	BCM (BODY CONTROL MODULE)
Connector Type	M03FB-LG



Terminal No.	Color of Wire	Signal Name [Specification]
1	W	BAT (F/L)
2	Y	POWER WINDOW POWER SUPPLY (BAT)
3	EG	POWER WINDOW POWER SUPPLY (RAP)

Connector No.	M119
Connector Name	BCM (BODY CONTROL MODULE)
Connector Type	NS16FF-CS



Terminal No.	Color of Wire	Signal Name [Specification]
4	LG	INTERIOR ROOM LAMP POWER SUPPLY
5	P	PASSENGER DOOR UNLOCK OUTPUT
6	SB	STEP LAMP
7	V	ALL DOOR FUEL LID LOCK OUTPUT
8	G	DRIVER DOOR FUEL LID UNLOCK OUTPUT
9	GR	BAT (FUSE)
10	B	GND
11	W	PUSH BUTTON IGNITION SW ILL GND
12	EG	ACC IND
13	BR	TURN SIGNAL RH (FRONT)
14	Y	TURN SIGNAL LH (FRONT)
15	LG	ROOM LAMP TIMER CONTROL
16	EG	
17	V	
18		
19		

Connector No.	M120
Connector Name	BCM (BODY CONTROL MODULE)
Connector Type	NS12FF-CS



Terminal No.	Color of Wire	Signal Name [Specification]
20	V	TURN SIGNAL RH (REAR)
21	Y	TRUNK LID OPEN OUTPUT
22	Y	TURN SIGNAL LH (REAR)
23	P	TRUNK ROOM LAMP

Connector No.	M121
Connector Name	BCM (BODY CONTROL MODULE)
Connector Type	TH40FGY-NH



Terminal No.	Color of Wire	Signal Name [Specification]
34	SB	TRUNK ROOM ANT-
35	V	REAR BUMPER ANT-
36	B	REAR BUMPER ANT+
37	W	IGN RELAY (BDM E/P) CONT
38	Y	TRUNK ROOM LAMP SW
39	G	STARTER RELAY CONT
40	BR	PUSH SW
41	SB	TRUNK LID OPENER REQUEST SW
42	G	I-KEY WARN BUZZER (ENG ROOM)
43	GR	TRUNK LID OPENER SW

Connector No.	M122
Connector Name	BCM (BODY CONTROL MODULE)
Connector Type	TH40FB-NH



Terminal No.	Color of Wire	Signal Name [Specification]
72	R	ROOM ANT 2-
73	G	ROOM ANT 2+
74	SB	PASSENGER DOOR ANT-
75	BR	PASSENGER DOOR ANT+
76	V	DRIVER DOOR ANT-
77	LG	DRIVER DOOR ANT+
78	Y	ROOM ANT 1-
79	BR	ROOM ANT 1+
80	GR	NATS ANTENNA AMP
81	W	NATS ANTENNA AMP
82	R	IGN RELAY (E/P) CONT

83	Y	KEYLESS ENTRY RECEIVER COMM
87	Y	COMBI SW INPUT 5
88	EG	COMBI SW INPUT 3
89	BR	PUSH SW
90	P	CAN-L
91	L	CAN-H
92	LG	KEY SLOT ILL
93	V	ACC RELAY CONT
95	EG	ACC RELAY CONT
96	GR	A/T SHIFT SELECTOR POWER SUPPLY
97	L	S/L CONDITION 1
98	SB	S/L CONDITION 2
99	R	ASGD CLUTCH SW [With M/T]
99	R	SHIFT P [With A/T]
100	Y	PASSENGER DOOR REQUEST SW
101	P	DRIVER DOOR REQUEST SW
102	EG	BLOWER FAN MOTOR RELAY CONT
103	LG	KEYLESS ENTRY RECEIVER POWER SUPPLY
106	W	S/L UNIT POWER SUPPLY
107	LG	COMBI SW INPUT 1
108	R	COMBI SW INPUT 4
109	W	COMBI SW INPUT 2
110	G	HAZARD SW
111	Y	S/L UNIT COMM

A
B
C
D
E
F
G
H
I
J
K
L
N
O
P

PCS

JCMWN0252GB

BCM (BODY CONTROL MODULE)

< ECU DIAGNOSIS INFORMATION >

[POWER DISTRIBUTION SYSTEM]

BCM (BODY CONTROL MODULE)	
Connector No.	M123
Connector Name	BCM (BODY CONTROL MODULE)
Connector Type	TH40FG-1N1



Terminal No.	Color of Wire	Signal Name [Specification]
112	BR	RAIN SENSOR SERIAL LINK
113	G	OPTICAL SENSOR
114	R	CLUTCH INTERLOCK SW
116	SB	STOP LAMP SW 1
118	BR	STOP LAMP SW 2
119	GR	DR DOOR UNLOCK SENSOR
121	SB	KEY SLOT SW
123	W	IGN P/B
124	EG	PASSENGER DOOR SW
129	EG	TRUNK LID OPENER CANCEL SW
132	LG	P/W SW & RHT C/U COMM
133	Y	PUSH-BUTTON IGNITION SW ILL POWER
134	LG	LOCK IND
137	BG	RECEIVER / SENSOR GND
138	Y	RECEIVER / SENSOR POWER SUPPLY
139	L	TIRE PRESSURE RECEIVER COMM
140	GR	SHIFT N/P
141	R	SECURITY INDICATOR LAMP
142	BR	COMBI SW OUTPUT 5
143	V	COMBI SW OUTPUT 1
144	G	COMBI SW OUTPUT 2
145	L	COMBI SW OUTPUT 3
146	SB	COMBI SW OUTPUT 4
150	R	DRIVER DOOR SW
151	G	REAR WINDOW DEFOGGER RELAY CONT

JCMWN0253GB

INFOID:000000006956323

Fail-safe

FAIL-SAFE CONTROL BY DTC

BCM performs fail-safe control when any DTC are detected.

BCM (BODY CONTROL MODULE)

< ECU DIAGNOSIS INFORMATION >

[POWER DISTRIBUTION SYSTEM]

Display contents of CONSULT	Fail-safe	Cancellation	A
B2013: ID DISCORD BCM-S/L	Inhibit engine cranking	Erase DTC	A
B2014: CHAIN OF S/L-BCM	Inhibit engine cranking	Erase DTC	B
B2190: NATS ANTENNA AMP	Inhibit engine cranking	Erase DTC	B
B2191: DIFFERENCE OF KEY	Inhibit engine cranking	Erase DTC	C
B2192: ID DISCORD BCM-ECM	Inhibit engine cranking	Erase DTC	C
B2193: CHAIN OF BCM-ECM	Inhibit engine cranking	Erase DTC	D
B2195: ANTI-SCANNING	Inhibit engine cranking	Ignition switch ON → OFF	D
B2557: VEHICLE SPEED	Inhibit steering lock	When normal vehicle speed signals are received from ABS actuator and electric unit (control unit) for 500 ms	E
B2560: STARTER CONT RELAY	Inhibit engine cranking	500 ms after the following CAN signal communication status becomes consistent <ul style="list-style-type: none"> • Starter control relay signal • Starter relay status signal 	E
B2601: SHIFT POSITION	Inhibit steering lock	500 ms after the following signal reception status becomes consistent <ul style="list-style-type: none"> • Selector lever P position switch signal • P range signal (CAN) 	F
B2602: SHIFT POSITION	Inhibit steering lock	5 seconds after the following BCM recognition conditions are fulfilled <ul style="list-style-type: none"> • Ignition switch is in the ON position • Selector lever P position switch signal: Except P position (12 V) • Vehicle speed: 4 km/h (2.5 MPH) or more 	G
B2603: SHIFT POSI STATUS	Inhibit steering lock	500 ms after the following BCM recognition conditions are fulfilled <ul style="list-style-type: none"> • Ignition switch is in the ON position • Selector lever P position switch signal: Except P position (12 V) • Selector lever P/N position signal: Except P and N positions (0 V) 	H
B2604: PNP/CLUTCH SW	Inhibit steering lock	500 ms after any of the following BCM recognition conditions are fulfilled <ul style="list-style-type: none"> • Status 1 <ul style="list-style-type: none"> - Ignition switch is in the ON position - Selector lever P/N position signal: P and N position (12 V) - P range signal or N range signal (CAN): ON • Status 2 <ul style="list-style-type: none"> - Ignition switch is in the ON position - Selector lever P/N position signal: Except P and N positions (0 V) - P range signal and N range signal (CAN): OFF 	I
B2605: PNP/CLUTCH SW	Inhibit steering lock	500 ms after any of the following BCM recognition conditions are fulfilled <ul style="list-style-type: none"> • Status 1 <ul style="list-style-type: none"> - Ignition switch is in the ON position - Selector lever P/N position signal: Except P and N positions (0 V) - Interlock/PNP switch signal (CAN): OFF • Status 2 <ul style="list-style-type: none"> - Ignition switch is in the ON position - Selector lever P/N position signal: P or N position (12 V) - PNP switch signal (CAN): ON 	J
B2606: S/L RELAY	Inhibit engine cranking	500 ms after the following CAN signal communication status becomes consistent <ul style="list-style-type: none"> • Steering lock relay signal (Request signal) • Steering lock relay signal (Condition signal) 	K
B2607: S/L RELAY	Inhibit engine cranking	500 ms after the following CAN signal communication status has becomes consistent <ul style="list-style-type: none"> • Steering lock relay signal (Request signal) • Steering lock relay signal (Condition signal) 	L

PCS

N

O

P

BCM (BODY CONTROL MODULE)

< ECU DIAGNOSIS INFORMATION >

[POWER DISTRIBUTION SYSTEM]

Display contents of CONSULT	Fail-safe	Cancellation
B2608: STARTER RELAY	Inhibit engine cranking	500 ms after the following signal communication status becomes consistent <ul style="list-style-type: none"> • Starter motor relay control signal • Starter relay status signal (CAN)
B2609: S/L STATUS	<ul style="list-style-type: none"> • Inhibit engine cranking • Inhibit steering lock 	When the following steering lock conditions agree <ul style="list-style-type: none"> • BCM steering lock control status • Steering lock condition No. 1 signal status • Steering lock condition No. 2 signal status
B260A: IGNITION RELAY	Inhibit engine cranking	500 ms after the following conditions are fulfilled <ul style="list-style-type: none"> • IGN relay (IPDM E/R) control signal: OFF (12 V) • Ignition ON signal (CAN to IPDM E/R): OFF (Request signal) • Ignition ON signal (CAN from IPDM E/R): OFF (Condition signal)
B260F: ENG STATE SIG LOST	Maintains the power supply position attained at the time of DTC detection	When any of the following conditions are fulfilled <ul style="list-style-type: none"> • Power position changes to ACC • Receives engine status signal (CAN)
B2612: S/L STATUS	<ul style="list-style-type: none"> • Inhibit engine cranking • Inhibit steering lock 	When any of the following conditions are fulfilled <ul style="list-style-type: none"> • Steering lock unit status signal (CAN) is received normally • The BCM steering lock control status matches the steering lock status recognized by the steering lock unit status signal (CAN from IPDM E/R)
B2617: BCM	Inhibit engine cranking	1 second after the starter motor relay control inside BCM becomes normal
B2618: BCM	Inhibit engine cranking	1 second after the ignition relay (IPDM E/R) control inside BCM becomes normal
B2619: BCM	Inhibit engine cranking	1 second after the steering lock unit power supply output control inside BCM becomes normal
B261E: VEHICLE TYPE	Inhibit engine cranking	BCM initialization
B26E8: CLUTCH SW	Inhibit engine cranking	When any of the following BCM recognition conditions are fulfilled <ul style="list-style-type: none"> • Status 1 <ul style="list-style-type: none"> - Clutch switch signal (CAN from ECM): ON - Clutch interlock switch signal: OFF (0 V) • Status 2 <ul style="list-style-type: none"> - Clutch switch signal (CAN from ECM): OFF - Clutch interlock switch signal: ON (Battery voltage)
B26E9: S/L STATUS	<ul style="list-style-type: none"> • Inhibit engine cranking • Inhibit steering lock 	When BCM transmits the LOCK request signal to steering lock unit, and receives LOCK response signal from steering lock unit, the following conditions are fulfilled <ul style="list-style-type: none"> • Steering condition No. 1 signal: LOCK (0 V) • Steering condition No. 2 signal: LOCK (12 V)

DTC Inspection Priority Chart

INFOID:000000006956324

If some DTCs are displayed at the same time, perform inspections one by one based on the following priority chart.

Priority	DTC
1	B2562: LOW VOLTAGE
2	<ul style="list-style-type: none"> • U1000: CAN COMM • U1010: CONTROL UNIT (CAN)
3	<ul style="list-style-type: none"> • B2190: NATS ANTENNA AMP • B2191: DIFFERENCE OF KEY • B2192: ID DISCORD BCM-ECM • B2193: CHAIN OF BCM-ECM • B2195: ANTI-SCANNING

BCM (BODY CONTROL MODULE)

< ECU DIAGNOSIS INFORMATION >

[POWER DISTRIBUTION SYSTEM]

Priority	DTC	
4	• B2013: ID DISCORD BCM-S/L	A
	• B2014: CHAIN OF S/L-BCM	
	• B2553: IGNITION RELAY	B
	• B2555: STOP LAMP	
	• B2556: PUSH-BTN IGN SW	
	• B2557: VEHICLE SPEED	
	• B2560: STARTER CONT RELAY	C
	• B2601: SHIFT POSITION	
	• B2602: SHIFT POSITION	
	• B2603: SHIFT POSI STATUS	
	• B2604: PNP/CLUTCH SW	D
	• B2605: PNP/CLUTCH SW	
	• B2606: S/L RELAY	
	• B2607: S/L RELAY	
	• B2608: STARTER RELAY	E
	• B2609: S/L STATUS	
	• B260A: IGNITION RELAY	
	• B260B: STEERING LOCK UNIT	F
	• B260C: STEERING LOCK UNIT	
	• B260D: STEERING LOCK UNIT	
	• B260F: ENG STATE SIG LOST	
	• B2612: S/L STATUS	G
	• B2614: BCM	
	• B2615: BCM	
	• B2616: BCM	
	• B2617: BCMC	H
• B2618: BCM		
• B2619: BCM		
• B261A: PUSH-BTN IGN SW	I	
• B261E: VEHICLE TYPE		
• B26E8: CLUTCH SW		
• B26E9: S/L STATUS		
• B26EA: KEY REGISTRATION	J	
• C1729: VHCL SPEED SIG ERR		
• U0415: VEHICLE SPEED		
5	• C1704: LOW PRESSURE FL	K
	• C1705: LOW PRESSURE FR	
	• C1706: LOW PRESSURE RR	
	• C1707: LOW PRESSURE RL	
	• C1708: [NO DATA] FL	L
	• C1709: [NO DATA] FR	
	• C1710: [NO DATA] RR	
	• C1711: [NO DATA] RL	
	• C1716: [PRESSDATA ERR] FL	
	• C1717: [PRESSDATA ERR] FR	
	• C1718: [PRESSDATA ERR] RR	
	• C1719: [PRESSDATA ERR] RL	
• C1734: CONTROL UNIT		
6	• B2621: INSIDE ANTENNA	N
	• B2622: INSIDE ANTENNA	
	• B2623: INSIDE ANTENNA	

PCS

DTC Index

INFOID:000000006956325

NOTE:

The details of time display are as follows.

- CRNT: A malfunction is detected now.
- PAST: A malfunction was detected in the past.

IGN counter is displayed on Freeze Frame Data. For details of Freeze Frame Data, refer to [PCS-43. "COMMON ITEM : CONSULT-III Function \(BCM - COMMON ITEM\)".](#)

BCM (BODY CONTROL MODULE)

< ECU DIAGNOSIS INFORMATION >

[POWER DISTRIBUTION SYSTEM]

CONSULT display	Fail-safe	Freeze Frame Data •Vehicle Speed •Odo/Trip Meter •Vehicle condition	Intelligent Key warning lamp ON	Tire pressure monitor warning lamp ON	Refer- ence page
No DTC is detected. further testing may be required.	—	—	—	—	—
U1000: CAN COMM	—	—	—	—	BCS-35
U1010: CONTROL UNIT (CAN)	—	—	—	—	BCS-36
U0415: VEHICLE SPEED	—	—	—	—	BCS-37
B2013: ID DISCORD BCM-S/L*	×	×	—	—	SEC-49
B2014: CHAIN OF S/L-BCM*	×	×	—	—	SEC-50
B2190: NATS ANTENNA AMP	×	—	—	—	SEC-41
B2191: DIFFERENCE OF KEY	×	—	—	—	SEC-44
B2192: ID DISCORD BCM-ECM	×	—	—	—	SEC-45
B2193: CHAIN OF BCM-ECM	×	—	—	—	SEC-47
B2195: ANTI-SCANNING	×	—	—	—	SEC-48
B2553: IGNITION RELAY	—	×	—	—	PCS-49
B2555: STOP LAMP	—	×	—	—	SEC-53
B2556: PUSH-BTN IGN SW	—	×	×	—	SEC-55
B2557: VEHICLE SPEED	×	×	×	—	SEC-57
B2560: STARTER CONT RELAY	×	×	×	—	SEC-58
B2562: LOW VOLTAGE	—	×	—	—	BCS-38
B2601: SHIFT POSITION	×	×	×	—	SEC-59
B2602: SHIFT POSITION	×	×	×	—	SEC-62
B2603: SHIFT POSI STATUS	×	×	×	—	SEC-64
B2604: PNP/CLUTCH SW	×	×	×	—	SEC-67
B2605: PNP/CLUTCH SW	×	×	×	—	SEC-69
B2606: S/L RELAY*	×	×	×	—	SEC-71
B2607: S/L RELAY*	×	×	×	—	SEC-72
B2608: STARTER RELAY	×	×	×	—	SEC-74
B2609: S/L STATUS*	×	×	×	—	SEC-76
B260A: IGNITION RELAY	×	×	×	—	PCS-51
B260B: STEERING LOCK UNIT*	—	×	×	—	SEC-80
B260C: STEERING LOCK UNIT*	—	×	×	—	SEC-81
B260D: STEERING LOCK UNIT*	—	×	×	—	SEC-82
B260F: ENG STATE SIG LOST	×	×	×	—	SEC-83
B2612: S/L STATUS*	×	×	×	—	SEC-88
B2614: BCM	—	×	×	—	PCS-53
B2615: BCM	—	×	×	—	PCS-56
B2616: BCM	—	×	×	—	PCS-59
B2617: BCM	×	×	×	—	SEC-92
B2618: BCM	×	×	×	—	PCS-62
B2619: BCM*	×	×	×	—	SEC-94
B261A: PUSH-BTN IGN SW	—	×	×	—	PCS-63
B261E: VEHICLE TYPE	×	×	× (Turn ON for 15 seconds)	—	SEC-95

BCM (BODY CONTROL MODULE)

< ECU DIAGNOSIS INFORMATION >

[POWER DISTRIBUTION SYSTEM]

CONSULT display	Fail-safe	Freeze Frame Data •Vehicle Speed •Odo/Trip Meter •Vehicle condition	Intelligent Key warning lamp ON	Tire pressure monitor warning lamp ON	Refer- ence page
B2621: INSIDE ANTENNA	—	×	—	—	DLK-62
B2622: INSIDE ANTENNA	—	×	—	—	DLK-64
B2623: INSIDE ANTENNA	—	×	—	—	DLK-66
B26E8: CLUTCH SW	×	×	×	—	SEC-84
B26E9: S/L STATUS*	×	×	× (Turn ON for 15 seconds)	—	SEC-86
B26EA: KEY REGISTRATION	—	×	× (Turn ON for 15 seconds)	—	SEC-87
C1704: LOW PRESSURE FL	—	—	—	×	WT-24
C1705: LOW PRESSURE FR	—	—	—	×	
C1706: LOW PRESSURE RR	—	—	—	×	
C1707: LOW PRESSURE RL	—	—	—	×	
C1708: [NO DATA] FL	—	—	—	×	WT-26
C1709: [NO DATA] FR	—	—	—	×	
C1710: [NO DATA] RR	—	—	—	×	
C1711: [NO DATA] RL	—	—	—	×	
C1716: [PRESSDATA ERR] FL	—	—	—	×	WT-29
C1717: [PRESSDATA ERR] FR	—	—	—	×	
C1718: [PRESSDATA ERR] RR	—	—	—	×	
C1719: [PRESSDATA ERR] RL	—	—	—	×	
C1729: VHCL SPEED SIG ERR	—	—	—	×	WT-30
C1734: CONTROL UNIT	—	—	—	×	WT-31

*: For models without steering lock unit, this DTC is not applied.

A
B
C
D
E
F
G
H
I
J
K
L
N
O
P

PCS

PRECAUTION

PRECAUTIONS

Precaution for Supplemental Restraint System (SRS) "AIR BAG" and "SEAT BELT PRE-TENSIONER"

INFOID:000000008167115

The Supplemental Restraint System such as "AIR BAG" and "SEAT BELT PRE-TENSIONER", used along with a front seat belt, helps to reduce the risk or severity of injury to the driver and front passenger for certain types of collision. This system includes seat belt switch inputs and dual stage front air bag modules. The SRS system uses the seat belt switches to determine the front air bag deployment, and may only deploy one front air bag, depending on the severity of a collision and whether the front occupants are belted or unbelted. Information necessary to service the system safely is included in the "SRS AIR BAG" and "SEAT BELT" of this Service Manual.

WARNING:

Always observe the following items for preventing accidental activation.

- To avoid rendering the SRS inoperative, which could increase the risk of personal injury or death in the event of a collision that would result in air bag inflation, all maintenance must be performed by an authorized NISSAN/INFINITI dealer.
- Improper maintenance, including incorrect removal and installation of the SRS, can lead to personal injury caused by unintentional activation of the system. For removal of Spiral Cable and Air Bag Module, see "SRS AIR BAG".
- Never use electrical test equipment on any circuit related to the SRS unless instructed to in this Service Manual. SRS wiring harnesses can be identified by yellow and/or orange harnesses or harness connectors.

PRECAUTIONS WHEN USING POWER TOOLS (AIR OR ELECTRIC) AND HAMMERS

WARNING:

Always observe the following items for preventing accidental activation.

- When working near the Air Bag Diagnosis Sensor Unit or other Air Bag System sensors with the ignition ON or engine running, never use air or electric power tools or strike near the sensor(s) with a hammer. Heavy vibration could activate the sensor(s) and deploy the air bag(s), possibly causing serious injury.
- When using air or electric power tools or hammers, always switch the ignition OFF, disconnect the battery, and wait at least 3 minutes before performing any service.

Precautions Necessary for Steering Wheel Rotation After Battery Disconnection

INFOID:000000008167116

CAUTION:

Comply with the following cautions to prevent any error and malfunction.

- Before removing and installing any control units, first turn the ignition switch to the LOCK position, then disconnect both battery cables.
- After finishing work, confirm that all control unit connectors are connected properly, then re-connect both battery cables.
- Always use CONSULT to perform self-diagnosis as a part of each function inspection after finishing work. If a DTC is detected, perform trouble diagnosis according to self-diagnosis results.

For vehicle with steering lock unit, if the battery is disconnected or discharged, the steering wheel will lock and cannot be turned.

If turning the steering wheel is required with the battery disconnected or discharged, follow the operation procedure below before starting the repair operation.

OPERATION PROCEDURE

1. Connect both battery cables.

NOTE:

Supply power using jumper cables if battery is discharged.

2. Turn the ignition switch to ACC position.
(At this time, the steering lock will be released.)
3. Disconnect both battery cables. The steering lock will remain released with both battery cables disconnected and the steering wheel can be turned.

PRECAUTIONS

< PRECAUTION >

[POWER DISTRIBUTION SYSTEM]

4. Perform the necessary repair operation.
5. When the repair work is completed, re-connect both battery cables. With the brake pedal released, turn the ignition switch from ACC position to ON position, then to LOCK position. (The steering wheel will lock when the ignition switch is turned to LOCK position.)
6. Perform self-diagnosis check of all control units using CONSULT.

A

B

C

D

E

F

G

H

I

J

K

L

PCS

N

O

P

PUSH-BUTTON IGNITION SWITCH DOES NOT OPERATE

< SYMPTOM DIAGNOSIS >

[POWER DISTRIBUTION SYSTEM]

SYMPTOM DIAGNOSIS

PUSH-BUTTON IGNITION SWITCH DOES NOT OPERATE

Description

INFOID:000000006469848

Check that vehicle is under the condition shown in “Conditions of vehicle” before starting diagnosis, and check each symptom.

NOTE:

The engine start function, door lock function, power distribution system, and NATS-IVIS/NVIS in the Intelligent Key system are closely related to each other regarding control. The vehicle security function can operate only when the door lock and power distribution system are operating normally.

Conditions of Vehicle (Operating Conditions)

- “ENGINE START BY I-KEY” in “WORK SUPPORT” is ON when setting on CONSULT-III.
- Intelligent Key is not inserted in key slot.
- One or more of Intelligent Keys with registered Intelligent Key ID is in the vehicle.

Diagnosis Procedure

INFOID:000000006469849

1.PERFORM WORK SUPPORT

Perform “INSIDE ANT DIAGNOSIS” on Work Support of “INTELLIGENT KEY”.

Refer to [DLK-52. "INTELLIGENT KEY : CONSULT-III Function \(BCM - INTELLIGENT KEY\)"](#).

>> GO TO 2.

2.PERFORM SELF-DIAGNOSTIC RESULT

Perform Self-Diagnostic Result of “BCM”.

Is DTC detected?

YES >> Refer to [DLK-62. "DTC Logic"](#) (instrument center), [DLK-64. "DTC Logic"](#) (console) or [DLK-66. "DTC Logic"](#) (trunk room).

NO >> GO TO 3.

3.CHECK PUSH-BUTTON IGNITION SWITCH

Check push-button ignition switch.

Refer to [PCS-66. "Component Function Check"](#).

Is the operation normal?

YES >> GO TO 4.

NO >> Repair or replace malfunctioning parts.

4.CONFIRM THE OPERATION

Confirm the operation again.

Is the inspection normal?

YES >> Check intermittent incident. Refer to [GI-43. "Intermittent Incident"](#).

NO >> GO TO 1.

PUSH-BUTTON IGNITION SWITCH POSITION INDICATOR DOES NOT ILLUMINATE

< SYMPTOM DIAGNOSIS >

[POWER DISTRIBUTION SYSTEM]

PUSH-BUTTON IGNITION SWITCH POSITION INDICATOR DOES NOT ILLUMINATE

Description

INFOID:000000006469850

- Before performing the diagnosis in the following table, check "Work Flow". Refer to [PCS-36, "Work Flow"](#).
- Check that vehicle is under the condition shown in "Conditions of vehicle" before starting diagnosis, and check each symptom.

Conditions of Vehicle (Operating Conditions)

- "ENGINE START BY I-KEY" in "WORK SUPPORT" is ON when setting on CONSULT-III.
- One or more of Intelligent Keys with registered Intelligent Key ID is in the vehicle.

Diagnosis Procedure

INFOID:000000006469851

1. CHECK PUSH-BUTTON IGNITION SWITCH INDICATOR

Check push-button ignition switch indicator.

Refer to [PCS-68, "Component Function Check"](#).

Is the inspection result normal?

YES >> GO TO 2.

NO >> Repair or replace the malfunctioning parts.

2. CONFIRM THE OPERATION

Confirm the operation again.

Is the result normal?

YES >> Check intermittent incident. Refer to [GI-43, "Intermittent Incident"](#).

NO >> GO TO 1.

A
B
C
D
E
F
G
H
I
J
K
L

PCS

N
O
P

PUSH BUTTON IGNITION SWITCH

< REMOVAL AND INSTALLATION >

[POWER DISTRIBUTION SYSTEM]

REMOVAL AND INSTALLATION

PUSH BUTTON IGNITION SWITCH

Removal and Installation

INFOID:000000006469852

REMOVAL

1. Remove the cluster lid A assembly. Refer to [JP-13. "A/T MODELS : Removal and Installation"](#) (A/T models), [JP-24. "M/T MODELS : Removal and Installation"](#) (M/T models).
2. Remove the push-button ignition switch (1) from cluster lid A assembly, and then remove pawl (A). Press push-button ignition switch (1) back to disengage from cluster lid A assembly.

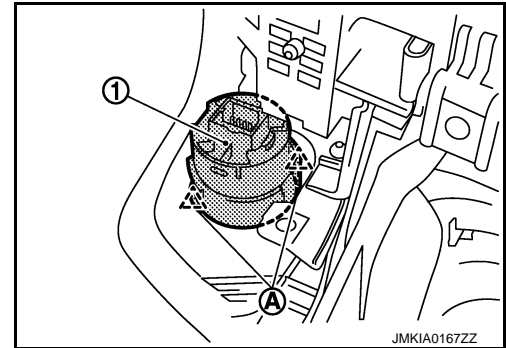

INSTALLATION

Install in the reverse order of removal.