

SECTION **ADP**

AUTOMATIC DRIVE POSITIONER

A
B
C
D
E
F
G
H
I
K
L
M
N
O
P

CONTENTS

<p>BASIC INSPECTION 6</p> <p>DIAGNOSIS AND REPAIR WORKFLOW 6</p> <p style="padding-left: 20px;">Work Flow6</p> <p>INSPECTION AND ADJUSTMENT 9</p> <p>ADDITIONAL SERVICE WHEN REMOVING BATTERY NEGATIVE TERMINAL9</p> <p style="padding-left: 20px;">ADDITIONAL SERVICE WHEN REMOVING BATTERY NEGATIVE TERMINAL : Description9</p> <p style="padding-left: 20px;">ADDITIONAL SERVICE WHEN REMOVING BATTERY NEGATIVE TERMINAL : Special Repair Requirement9</p> <p>ADDITIONAL SERVICE WHEN REPLACING CONTROL UNIT9</p> <p style="padding-left: 20px;">ADDITIONAL SERVICE WHEN REPLACING CONTROL UNIT : Description9</p> <p style="padding-left: 20px;">ADDITIONAL SERVICE WHEN REPLACING CONTROL UNIT : Special Repair Requirement9</p> <p>SYSTEM INITIALIZATION 10</p> <p style="padding-left: 20px;">SYSTEM INITIALIZATION : Description 10</p> <p style="padding-left: 20px;">SYSTEM INITIALIZATION : Special Repair Requirement 10</p> <p>MEMORY STORING 10</p> <p style="padding-left: 20px;">MEMORY STORING : Description 10</p> <p style="padding-left: 20px;">MEMORY STORING : Special Repair Requirement 10</p> <p>SYSTEM SETTING 11</p> <p style="padding-left: 20px;">SYSTEM SETTING : Description 11</p> <p style="padding-left: 20px;">SYSTEM SETTING : Special Repair Requirement 11</p> <p>SYSTEM DESCRIPTION 13</p> <p>AUTOMATIC DRIVE POSITIONER SYSTEM..... 13</p> <p>AUTOMATIC DRIVE POSITIONER SYSTEM 13</p>	<p>AUTOMATIC DRIVE POSITIONER SYSTEM :</p> <p style="padding-left: 20px;">System Diagram13</p> <p>AUTOMATIC DRIVE POSITIONER SYSTEM :</p> <p style="padding-left: 20px;">System Description14</p> <p>AUTOMATIC DRIVE POSITIONER SYSTEM :</p> <p style="padding-left: 20px;">Component Parts Location15</p> <p>AUTOMATIC DRIVE POSITIONER SYSTEM :</p> <p style="padding-left: 20px;">Component Description17</p> <p>MANUAL FUNCTION19</p> <p style="padding-left: 20px;">MANUAL FUNCTION : System Diagram19</p> <p style="padding-left: 20px;">MANUAL FUNCTION : System Description19</p> <p style="padding-left: 20px;">MANUAL FUNCTION : Component Parts Location21</p> <p style="padding-left: 20px;">MANUAL FUNCTION : Component Description23</p> <p>SEAT SYNCHRONIZATION FUNCTION24</p> <p style="padding-left: 20px;">SEAT SYNCHRONIZATION FUNCTION : System Diagram24</p> <p style="padding-left: 20px;">SEAT SYNCHRONIZATION FUNCTION : System Description24</p> <p style="padding-left: 20px;">SEAT SYNCHRONIZATION FUNCTION : Component Parts Location26</p> <p style="padding-left: 20px;">SEAT SYNCHRONIZATION FUNCTION : Component Description28</p> <p>MEMORY FUNCTION29</p> <p style="padding-left: 20px;">MEMORY FUNCTION : System Diagram29</p> <p style="padding-left: 20px;">MEMORY FUNCTION : System Description29</p> <p style="padding-left: 20px;">MEMORY FUNCTION : Component Parts Location31</p> <p style="padding-left: 20px;">MEMORY FUNCTION : Component Description.....33</p> <p>INTELLIGENT KEY INTERLOCK FUNCTION34</p> <p style="padding-left: 20px;">INTELLIGENT KEY INTERLOCK FUNCTION : System Diagram34</p> <p style="padding-left: 20px;">INTELLIGENT KEY INTERLOCK FUNCTION : System Description34</p> <p style="padding-left: 20px;">INTELLIGENT KEY INTERLOCK FUNCTION : Component Parts Location36</p> <p style="padding-left: 20px;">INTELLIGENT KEY INTERLOCK FUNCTION : Component Description38</p>
---	--

ADP

POWER WALK-IN FUNCTION	38	DRIVER SEAT CONTROL UNIT	64
POWER WALK-IN FUNCTION : System Diagram..	39	DRIVER SEAT CONTROL UNIT :	
POWER WALK-IN FUNCTION : System Description	39	Diagnosis Procedure	64
POWER WALK-IN FUNCTION : Component Parts Location	41	DRIVER SEAT CONTROL UNIT : Special Repair Requirement	65
POWER WALK-IN FUNCTION : Component Description	43		
DIAGNOSIS SYSTEM (DRIVER SEAT C/U)	45	AUTOMATIC DRIVE POSITIONER CONTROL UNIT	65
Diagnosis Description	45	AUTOMATIC DRIVE POSITIONER CONTROL UNIT : Diagnosis Procedure	65
CONSULT-III Function	45	AUTOMATIC DRIVE POSITIONER CONTROL UNIT : Special Repair Requirement	66
DTC/CIRCUIT DIAGNOSIS	48	SLIDING SWITCH	67
U1000 CAN COMM CIRCUIT	48	Description	67
Description	48	Component Function Check	67
DTC Logic	48	Diagnosis Procedure	67
Diagnosis Procedure	48	Component Inspection	68
Special Repair Requirement	48	RECLINING SWITCH	69
B2112 SLIDING MOTOR	49	Description	69
Description	49	Component Function Check	69
DTC Logic	49	Diagnosis Procedure	69
Diagnosis Procedure	49	Component Inspection	70
B2113 RECLINING MOTOR	51	LIFTING SWITCH (FRONT)	71
Description	51	Description	71
DTC Logic	51	Component Function Check	71
Diagnosis Procedure	51	Diagnosis Procedure	71
B2118 TILT SENSOR	53	Component Inspection	72
Description	53	LIFTING SWITCH (REAR)	73
DTC Logic	53	Description	73
Diagnosis Procedure	53	Component Function Check	73
B2119 TELESCOPIC SENSOR	56	Diagnosis Procedure	73
Description	56	Component Inspection	74
DTC Logic	56	FORWARD SWITCH	75
Diagnosis Procedure	56	Description	75
B2126 DETENT SW	59	Component Function Check	75
Description	59	Diagnosis Procedure	75
DTC Logic	59	Component Inspection	76
Diagnosis Procedure	59	SEAT BELT BUCKLE SWITCH	77
B2127 PARKING BRAKE SWITCH	61	Description	77
Description	61	Component Function Check	77
DTC Logic	61	Diagnosis Procedure	77
Diagnosis Procedure	61	Component Inspection	78
Component Inspection	62	SLIDING LIMIT SWITCH	79
B2128 UART COMMUNICATION LINE	63	Description	79
Description	63	Component Function Check	79
DTC Logic	63	Diagnosis Procedure	79
Diagnosis Procedure	63	Component Inspection	80
POWER SUPPLY AND GROUND CIRCUIT	64	POWER WALK-IN SWITCH	81
BCM	64	Description	81
BCM : Diagnosis Procedure	64	Component Function Check	81
		Diagnosis Procedure	81
		Component Inspection	82

TILT SWITCH	83	TILT SENSOR	109	
Description	83	Description	109	A
Component Function Check	83	Component Function Check	109	
Diagnosis Procedure	83	Diagnosis Procedure	109	
Component Inspection	84			
TELESCOPIC SWITCH	85	TELESCOPIC SENSOR	112	B
Description	85	Description	112	
Component Function Check	85	Component Function Check	112	C
Diagnosis Procedure	85	Diagnosis Procedure	112	
Component Inspection	86			
SEAT MEMORY SWITCH	87	MIRROR SENSOR	115	
Description	87			D
Component Function Check	87	DRIVER SIDE	115	
Diagnosis Procedure	87	DRIVER SIDE : Description	115	
Component Inspection	88	DRIVER SIDE : Component Function Check	115	E
		DRIVER SIDE : Diagnosis Procedure	115	
DOOR MIRROR REMOTE CONTROL SWITCH	90	PASSENGER SIDE	117	F
		PASSENGER SIDE : Description	117	
MIRROR SWITCH	90	PASSENGER SIDE :		
MIRROR SWITCH : Description	90	Component Function Check	117	G
MIRROR SWITCH : Component Function Check	90	PASSENGER SIDE : Diagnosis Procedure	117	
MIRROR SWITCH : Diagnosis Procedure	90			
MIRROR SWITCH : Component Inspection	91	SLIDING MOTOR	120	H
		Description	120	
CHANGEOVER SWITCH	92	Component Function Check	120	
CHANGEOVER SWITCH : Description	92	Diagnosis Procedure	120	
CHANGEOVER SWITCH : Component Function Check	92			
CHANGEOVER SWITCH : Diagnosis Procedure	92	RECLINING MOTOR	122	I
CHANGEOVER SWITCH : Component Inspection	93	Description	122	
		Component Function Check	122	
POWER SEAT SWITCH GROUND CIRCUIT	95	Diagnosis Procedure	122	
Diagnosis Procedure	95			
		LIFTING MOTOR (FRONT)	124	ADP
TILT & TELESCOPIC SWITCH GROUND CIRCUIT	96	Description	124	
Diagnosis Procedure	96	Component Function Check	124	K
		Diagnosis Procedure	124	
SLIDING SENSOR	97	LIFTING MOTOR (REAR)	126	L
Description	97	Description	126	
Component Function Check	97	Component Function Check	126	
Diagnosis Procedure	97	Diagnosis Procedure	126	
RECLINING SENSOR	100	TILT MOTOR	128	M
Description	100	Description	128	
Component Function Check	100	Component Function Check	128	
Diagnosis Procedure	100	Diagnosis Procedure	128	N
LIFTING SENSOR (FRONT)	103	TELESCOPIC MOTOR	130	
Description	103	Description	130	O
Component Function Check	103	Component Function Check	130	
Diagnosis Procedure	103	Diagnosis Procedure	130	
LIFTING SENSOR (REAR)	106	DOOR MIRROR MOTOR	132	P
Description	106	Description	132	
Component Function Check	106	Component Function Check	132	
Diagnosis Procedure	106	Diagnosis Procedure	132	
		SEAT MEMORY INDICATOR	134	
		Description	134	
		Component Function Check	134	
		Diagnosis Procedure	134	

DOOR MIRROR SYSTEM	136	STEERING TILT	221
Wiring Diagram - DOOR MIRROR (WITH AUTO- MATIC DRIVE POSITIONER) -	136	STEERING TILT : Description	221
ECU DIAGNOSIS INFORMATION	145	STEERING TILT : Diagnosis Procedure	221
DRIVER SEAT CONTROL UNIT (WITH AU- TOMATIC DRIVE POSITIONER)	145	STEERING TELESCOPIC	222
Reference Value	145	STEERING TELESCOPIC : Description	222
Wiring Diagram - AUTOMATIC DRIVE POSI- TIONER CONTROL SYSTEM -	151	STEERING TELESCOPIC : Diagnosis Procedure. 222	
Fail Safe	164	DOOR MIRROR	222
DTC Index	165	DOOR MIRROR : Description	223
AUTOMATIC DRIVE POSITIONER CON- TROL UNIT	166	DOOR MIRROR : Diagnosis Procedure	223
Reference Value	166	MEMORY FUNCTION DOES NOT OPERATE. 224	
Wiring Diagram - AUTOMATIC DRIVE POSI- TIONER CONTROL SYSTEM -	170	ALL COMPONENT	224
BCM (BODY CONTROL MODULE)	184	ALL COMPONENT : Description	224
Reference Value	184	ALL COMPONENT : Diagnosis Procedure	224
Wiring Diagram - BCM -	207	SEAT SLIDING	224
Fail-safe	212	SEAT SLIDING : Description	224
DTC Inspection Priority Chart	214	SEAT SLIDING : Diagnosis Procedure	224
DTC Index	215	SEAT RECLINING	225
SYMPTOM DIAGNOSIS	218	SEAT RECLINING : Description	225
MANUAL FUNCTION DOES NOT OPERATE 218		SEAT RECLINING : Diagnosis Procedure	225
ALL COMPONENT	218	SEAT LIFTING (FRONT)	225
ALL COMPONENT : Description	218	SEAT LIFTING (FRONT) : Description	225
ALL COMPONENT : Diagnosis Procedure	218	SEAT LIFTING (FRONT) : Diagnosis Procedure . 225	
POWER SEAT	218	SEAT LIFTING (REAR)	225
POWER SEAT : Description	218	SEAT LIFTING (REAR) : Description	226
POWER SEAT : Diagnosis Procedure	218	SEAT LIFTING (REAR) : Diagnosis Procedure ... 226	
STEERING POSITION FUNCTION DOES NOT OPERATE	218	STEERING TELESCOPIC	226
STEERING POSITION FUNCTION DOES NOT OPERATE : Description	218	STEERING TELESCOPIC : Description	226
STEERING POSITION FUNCTION DOES NOT OPERATE : Diagnosis Procedure	219	STEERING TELESCOPIC : Diagnosis Procedure. 226	
SEAT SLIDING	219	STEERING TILT	226
SEAT SLIDING : Description	219	STEERING TILT : Description	226
SEAT SLIDING : Diagnosis Procedure	219	STEERING TILT : Diagnosis Procedure	227
SEAT RECLINING	219	DOOR MIRROR	227
SEAT RECLINING : Description	219	DOOR MIRROR : Description	227
SEAT RECLINING : Diagnosis Procedure	220	DOOR MIRROR : Diagnosis Procedure	227
SEAT LIFTING (FRONT)	220	MEMORY INDICATE DOES NOT ILLUMI- NATE	228
SEAT LIFTING (FRONT) : Description	220	Diagnosis Procedure	228
SEAT LIFTING (FRONT) : Diagnosis Procedure ..220		SEAT SYNCHRONIZATION FUNCTION DOES NOT OPERATE	229
SEAT LIFTING (REAR)	221	Diagnosis Procedure	229
SEAT LIFTING (REAR) : Description	221	POWER WALK-IN FUNCTION DOES NOT OPERATE	230
SEAT LIFTING (REAR) : Diagnosis Procedure221		Diagnosis Procedure	230
STEERING TILT	221	INTELLIGENT KEY INTERLOCK FUNCTION DOES NOT OPERATE	232
STEERING TILT : Description	221	Diagnosis Procedure	232
STEERING TILT : Diagnosis Procedure	221	NORMAL OPERATING CONDITION	233

Description	233	
PRECAUTION	234	
PRECAUTIONS	234	
Precaution for Supplemental Restraint System (SRS) "AIR BAG" and "SEAT BELT PRE-TENSIONER"	234	
Service Procedure Precautions for Models with a Pop-up Roll Bar	234	
Precaution for Battery Service	234	
Service	234	
Work	235	
REMOVAL AND INSTALLATION	236	
DRIVER SEAT CONTROL UNIT	236	
Exploded View	236	
Removal and Installation	236	
AUTOMATIC DRIVE POSITIONER CONTROL UNIT	237	A
Exploded View	237	
Removal and Installation	237	
SEAT MEMORY SWITCH	238	B
Exploded View	238	
Removal and Installation	238	
POWER SEAT SWITCH	239	C
Exploded View	239	
Removal and Installation	239	
SIDE SUPPORT SWITCH	240	D
Exploded View	240	
Removal and Installation	240	
TILT&TELESCOPIC SWITCH	241	E
Exploded View	241	
Removal and Installation	241	
		F
		G
		H
		I
		ADP
		K
		L
		M
		N
		O
		P

DIAGNOSIS AND REPAIR WORKFLOW

< BASIC INSPECTION >

BASIC INSPECTION

DIAGNOSIS AND REPAIR WORKFLOW

Work Flow

INFOID:000000006471446

OVERALL SEQUENCE

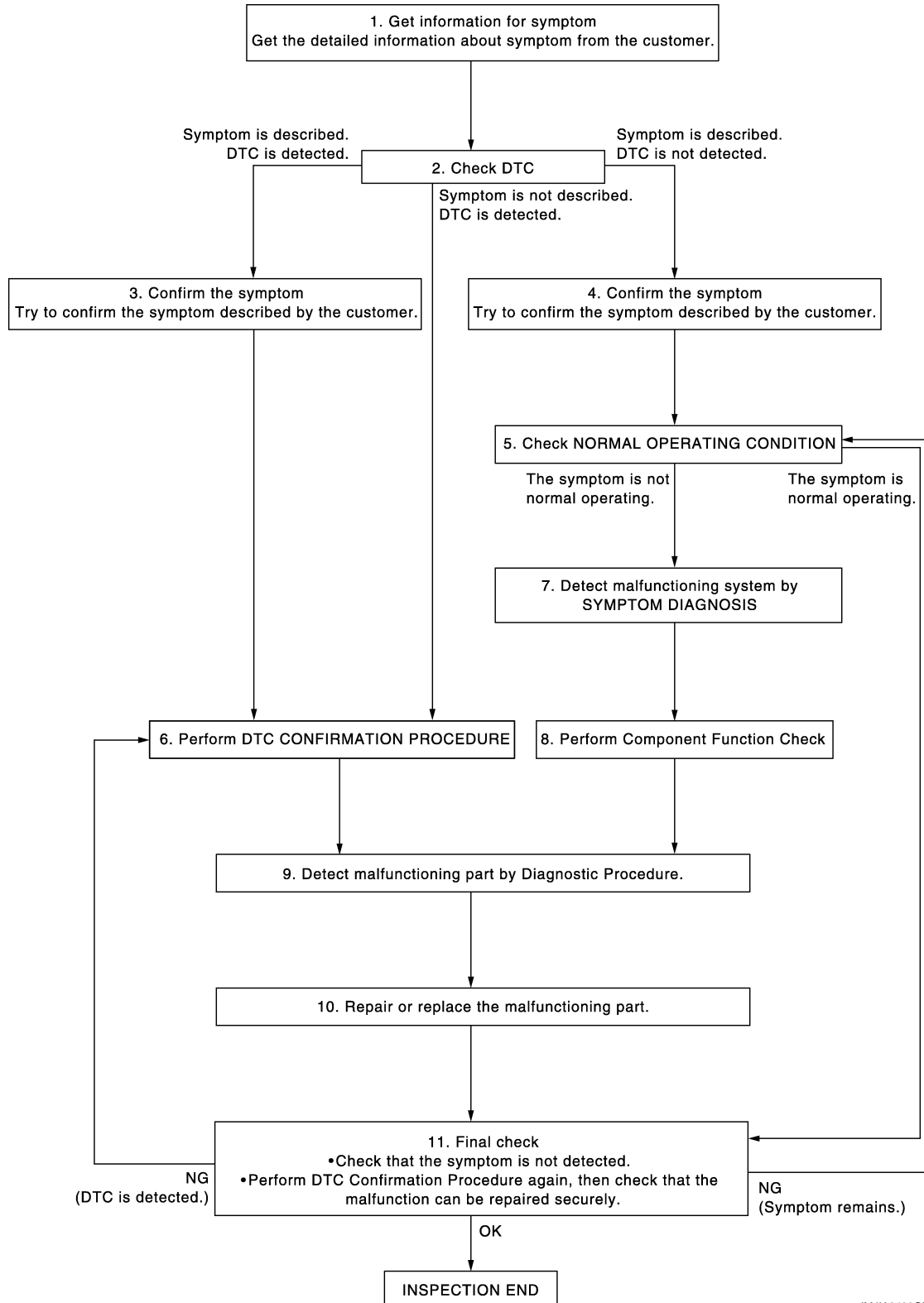

JMJIA2428GB

DETAILED FLOW

DIAGNOSIS AND REPAIR WORKFLOW

< BASIC INSPECTION >

1.GET INFORMATION FOR SYMPTOM

Get the detailed information from the customer about the symptom (the condition and the environment when the incident/malfunction occurred).

>> GO TO 2.

2.CHECK DTC WITH AUTOMATIC DRIVE POSITIONER SYSTEM

Check "Self Diagnostic Result" with CONSULT-III. Refer to [ADP-165, "DTC Index"](#)

Is any symptom described and any DTC is displayed?

Symptom is described, DTC is displayed.>>GO TO 3.

Symptom is not described, DTC is displayed.>>GO TO 6.

Symptom is described, DTC is not displayed.>>GO TO 4.

3.CONFIRM THE SYMPTOM

Try to confirm the symptom described by the customer.

>> GO TO 6.

4.CONFIRM THE SYMPTOM

Try to confirm the symptom described by the customer.

>> GO TO 5.

5.CHECK NORMAL OPERATING CONDITION

Check normal operating condition. Refer to [ADP-233, "Description"](#).

Is the incident normal operation?

YES >> INSPECTION END

NO >> GO TO 7.

6.PERFORM DTC CONFIRMATION PROCEDURE

Perform the confirmation procedure for the detected DTC.

Is the DTC displayed?

YES >> GO TO 8.

NO >> Check intermittent incident. Refer to [GI-43, "Intermittent Incident"](#).

7.DETECT MALFUNCTIONING SYSTEM BY SYMPTOM DIAGNOSIS

Detect malfunctioning system according to SYMPTOM DIAGNOSIS based on the confirmed symptom in step 4, and determine the trouble diagnosis order based on possible causes and symptom.

>> GO TO 8.

8.PERFORM COMPONENT FUNCTION CHECK

Perform the component function check for the isolated malfunctioning point.

>> GO TO 9.

9.DETECT MALFUNCTIONING PART BY DIAGNOSTIC PROCEDURE

Isolate the malfunctioning point by performing the diagnosis procedure relevant to the symptom during the component diagnosis.

>> GO TO 10.

10.REPARE OR REPLACE

Repair or replace the malfunctioning part.

A
B
C
D
E
F
G
H
I
K
L
M
N
O
P

ADP

DIAGNOSIS AND REPAIR WORKFLOW

< BASIC INSPECTION >

>> GO TO 11.

11.FINAL CHECK

Perform the DTC confirmation procedure (if DTC is detected) or component function check (if no DTC is detected) again, and then check that the malfunction can be repaired securely.

Are all malfunctions corrected?

YES >> INSPECTION END

Symptom is detected.>> GO TO 5.

DTC is detected.>> GO TO 6.

INSPECTION AND ADJUSTMENT

< BASIC INSPECTION >

INSPECTION AND ADJUSTMENT

ADDITIONAL SERVICE WHEN REMOVING BATTERY NEGATIVE TERMINAL

ADDITIONAL SERVICE WHEN REMOVING BATTERY NEGATIVE TERMINAL : Description

INFOID:000000006471447

Each function is reset to the following condition when the battery terminal is disconnected.

Function	Condition	Procedure
Memory (Seat, steering, mirror)	Erased	Perform memory storing
Intelligent Key interlock	Erased	Perform memory storing
Seat synchronization	OFF	—

NOTE:

When disconnecting the battery terminal or replacing the driver seat control unit, DTC, registered items of memory storing, and details of system setting detected in the past are erased. Perform operation after checking the contents.

ADDITIONAL SERVICE WHEN REMOVING BATTERY NEGATIVE TERMINAL : Special Repair Requirement

INFOID:000000006471448

1.SYSTEM INITIALIZATION

Perform system initialization. Refer to [ADP-10, "SYSTEM INITIALIZATION : Description"](#).

>> GO TO 2.

2.SYSTEM SETTING

Perform system setting. Refer to [ADP-11, "SYSTEM SETTING : Description"](#).

>> GO TO 3.

3.MEMORY STORING

Perform memory storing. Refer to [ADP-10, "MEMORY STORING : Description"](#).

>> END

ADDITIONAL SERVICE WHEN REPLACING CONTROL UNIT

ADDITIONAL SERVICE WHEN REPLACING CONTROL UNIT : Description

INFOID:000000006471449

Each function is reset to the following condition when the driver seat control unit is replaced.

Function	Condition	Procedure
Memory (Seat, steering, mirror)	Erased	Perform memory storing
Intelligent Key interlock	Erased	Perform memory storing
Seat synchronization	OFF	—

NOTE:

When disconnecting the battery terminal or replacing the driver seat control unit, DTC, registered items of memory storing, and details of system setting detected in the past are erased. Perform operation after checking the contents.

ADDITIONAL SERVICE WHEN REPLACING CONTROL UNIT : Special Repair Requirement

INFOID:000000006471450

1.SYSTEM INITIALIZATION

INSPECTION AND ADJUSTMENT

< BASIC INSPECTION >

Perform system initialization. Refer to [ADP-10, "SYSTEM INITIALIZATION : Description"](#).

>> GO TO 2.

2.SYSTEM SETTING

Perform system setting. Refer to [ADP-11, "SYSTEM SETTING : Description"](#).

>> GO TO 3.

3.MEMORY STORING

Perform memory storing. Refer to [ADP-10, "MEMORY STORING : Description"](#).

>> END

SYSTEM INITIALIZATION

SYSTEM INITIALIZATION : Description

INFOID:000000006471451

When disconnecting battery negative terminal or replacing control unit, always perform the system initialization. Otherwise, the backward operation for power walk-in function does not activate normally.

SYSTEM INITIALIZATION : Special Repair Requirement

INFOID:000000006471452

INITIALIZATION PROCEDURE

1. STEP-1

Slide the seat to the front edge.

NOTE:

- STEP-1 is the initialization procedure for power walk-in function.
- If the seat sliding position is already at the front edge, slide the seat rearward once, and then slide it to the front edge again.

>> END

MEMORY STORING

MEMORY STORING : Description

INFOID:000000006471453

Always perform the memory storage when the battery terminal is disconnected or the driver seat control unit is replaced. The memory function and Intelligent Key interlock function will not operate normally if no memory storage is performed.

MEMORY STORING : Special Repair Requirement

INFOID:000000006471454

Memory Storage Procedure

Two positions for the driver seat, steering column and outside mirror can be stored for memory operation by following procedure.

1.STEP 1

Shift AT selector lever to P position (AT model) or applied parking brake (MT model).

>> GO TO 2.

2.STEP 2

Turn ignition switch ON.

>> GO TO 3.

3.STEP 3

Adjust driver seat, steering column and outside mirror position manually.

INSPECTION AND ADJUSTMENT

< BASIC INSPECTION >

>> GO TO 4.

4.STEP 4

1. Push set switch.

NOTE:

- Memory indicator for which driver seat position is already retained in memory is illuminated for 5 seconds.
- Memory indicator for which driver seat position is not retained in memory is illuminated for 0.5 second.

2. Push the memory switch (1 or 2) for at least 1 second within 5 seconds after pushing the set switch.

NOTE:

If memory is stored in the same memory switch, the previous memory will be deleted.

Do you need linking of Intelligent Key?

YES >> GO TO 6.

NO >> GO TO 5.

5.STEP 5

Confirm the operation of each part with memory operation.

>> END

6.STEP 6

Turn ignition switch OFF (LOCK).

>> GO TO 7.

7.STEP 7

- Press and release set switch. Memory switch indicator is illuminated for 5 seconds. During memory switch indicator is illuminated, press Intelligent Key unlock button while pressing memory switch 1 or 2.

NOTE:

Memory switch indicator lamp blinks for 5 seconds when registration is complete.

>> GO TO 8.

8.STEP 8

Confirm the operation of each part with memory operation and Intelligent Key interlock operation.

>> END

SYSTEM SETTING

SYSTEM SETTING : Description

INFOID:000000006471455

The setting of the automatic driving positioner system can be changed using the set switch.

SYSTEM SETTING : Special Repair Requirement

INFOID:000000006471456

SETTING PROCEDURE

1.STEP-1

Set the vehicle to the following condition.

- Ignition position: ACC
- A/T selector lever: P position (A/T models)
- Parking brake: Applied only (M/T models)

>> GO TO 2.

2.STEP-2

Press set switch and hold for more than 10 seconds, then confirm blinking of the memory switch indicator.

A

B

C

D

E

F

G

H

I

ADP

K

L

M

N

O

P

INSPECTION AND ADJUSTMENT

< BASIC INSPECTION >

- Seat synchronization are ON : Memory switch indicator blink two times.
- Seat synchronization are OFF : Memory switch indicator blink once.

NOTE:

- After memory setting registration, by pushing set switch for approximately 10 seconds, memory switch indicator lamp turns 4 seconds. turns OFF, blinks 1 or 2 times, and then the switching operation is complete. Push and hold set switch during the switching operation.

>> END.

AUTOMATIC DRIVE POSITIONER SYSTEM

< SYSTEM DESCRIPTION >

SYSTEM DESCRIPTION

AUTOMATIC DRIVE POSITIONER SYSTEM

AUTOMATIC DRIVE POSITIONER SYSTEM

AUTOMATIC DRIVE POSITIONER SYSTEM : System Diagram

INFOID:000000006471457

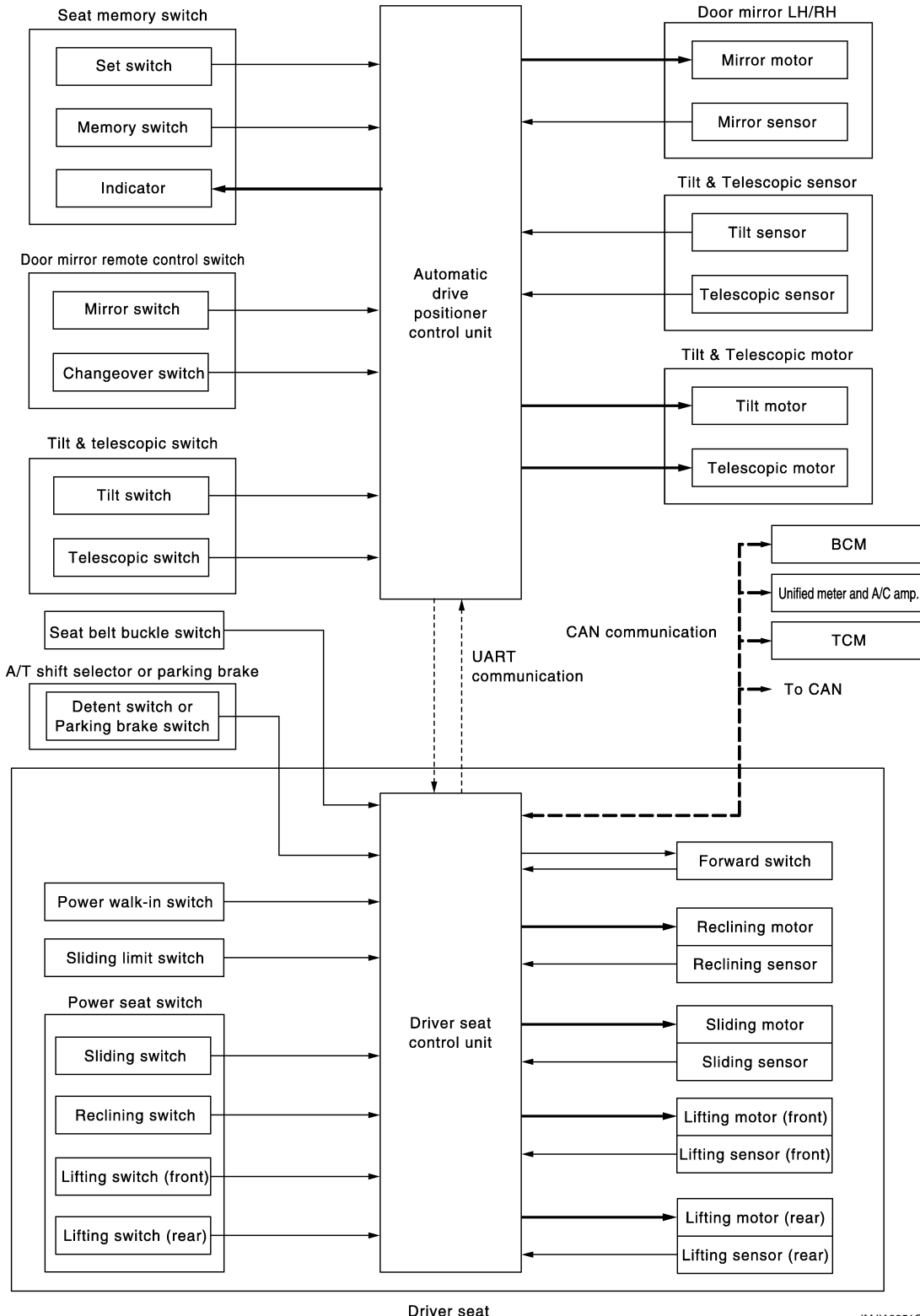

A

B

C

D

E

F

G

H

I

ADP

K

L

M

N

O

P

Driver seat

JMJIA3251GB

AUTOMATIC DRIVE POSITIONER SYSTEM

< SYSTEM DESCRIPTION >

AUTOMATIC DRIVE POSITIONER SYSTEM : System Description

INFOID:000000006471458

OUTLINE

The system automatically moves the driver seat, steering column and door mirror position by the driver seat control unit and the automatic drive positioner control unit. The driver seat control unit corresponds with the automatic drive positioner control unit by UART communication.

Function	Description
Manual function	The driving position (seat, steering column and door mirror position) can be adjusted by using the power seat switch, tilt & telescopic switch or door mirror remote control switch.
Seat synchronization function	The positions of the steering column and door mirror are adjusted to the proper position automatically while linking with manual operation [seat sliding, seat lifting (rear) or seat reclining].
Memory function	The seat, steering column and outside mirror move to the stored driving position by pressing seat memory switch (1 or 2).
Power walk-in function	The seat is made to advance when the seat back of driver seat is folded down and press the walk-in switch. The seat is made to retreat to former position when the seat back of driver seat is folded up and press the walk-in switch.
Intelligent Key interlock function	Perform memory operation, exiting operation and entry operation by Intelligent Key unlock operation or driver side door request switch unlock operation.

NOTE:

The lumbar support system and the side support system are controlled independently with no link to the automatic drive positioner system.

AUTOMATIC DRIVE POSITIONER SYSTEM

< SYSTEM DESCRIPTION >

AUTOMATIC DRIVE POSITIONER SYSTEM : Component Parts Location INFOID:000000006471459

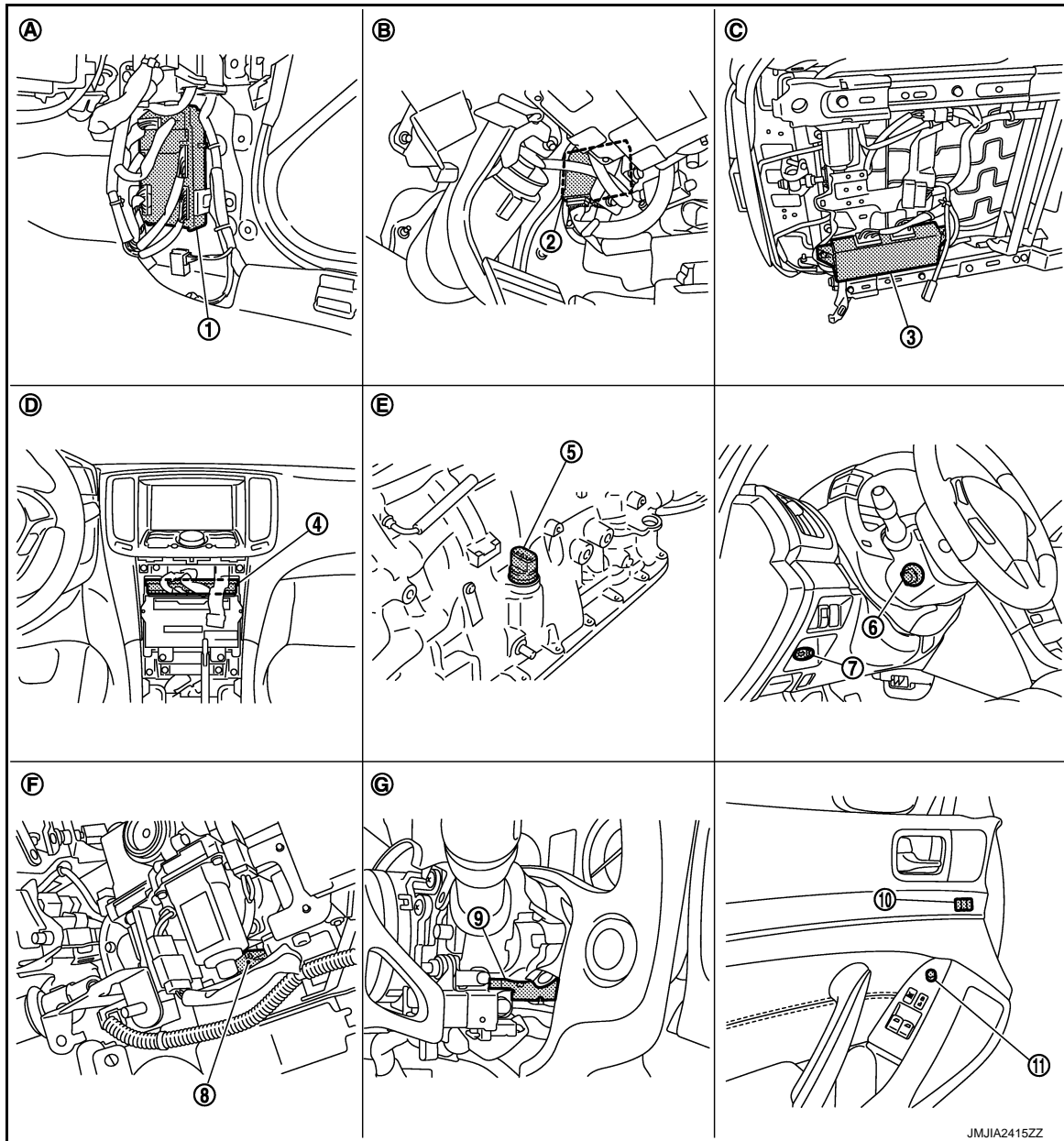

- | | | |
|--|--|--|
| 1. BCM | 2. Automatic drive positioner control unit | 3. Driver seat control unit |
| 4. Unified meter and A/C amp. | 5. A/T assembly | 6. Tilt & telescopic switch |
| 7. Key slot | 8. Tilt sensor | 9. Telescopic sensor |
| 10. Seat memory switch | 11. Door mirror remote control switch | |
| A. Dash side lower (passenger side) | B. View with instrument driver lower panel removed | C. Backside of seat cushion (driver side) |
| D. Behind cluster lid C | E. A/T assembly (TCM is built in A/T assembly) | F. View with instrument driver lower panel removed |
| G. View with steering column cover lower and upper removed | | |

A
B
C
D
E
F
G
H
I
ADP
K
L
M
N
O
P

AUTOMATIC DRIVE POSITIONER SYSTEM

< SYSTEM DESCRIPTION >

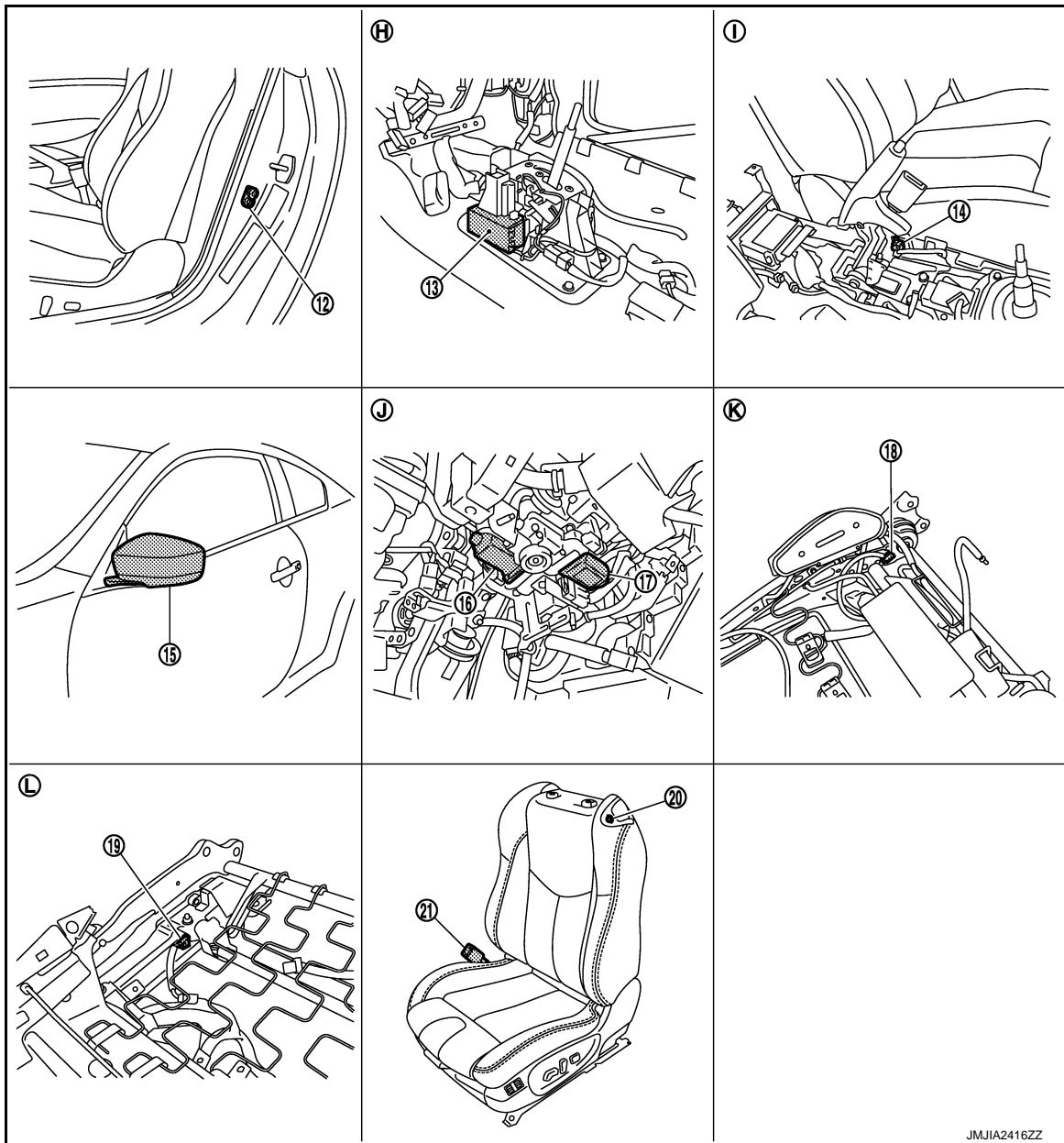

JMJIA2416ZZ

- | | | |
|--|--|--|
| 12. Driver side door switch | 13. A/T shift selector (detention switch) | 14. Parking brake switch |
| 15. Door mirror (driver side) | 16. Telescopic motor | 17. Tilt motor |
| 18. Forward switch | 19. Sliding limit switch | 20. Power walk-in switch |
| 21. Seat belt buckle switch (driver side) | | |
| H. View with center console assembly is removed. | I. View with center console assembly is removed. | J. View with instrument driver lower panel is removed. |
| K. View with seat back pad is removed. | L. View with seat cushion pad is removed. | |

AUTOMATIC DRIVE POSITIONER SYSTEM

< SYSTEM DESCRIPTION >

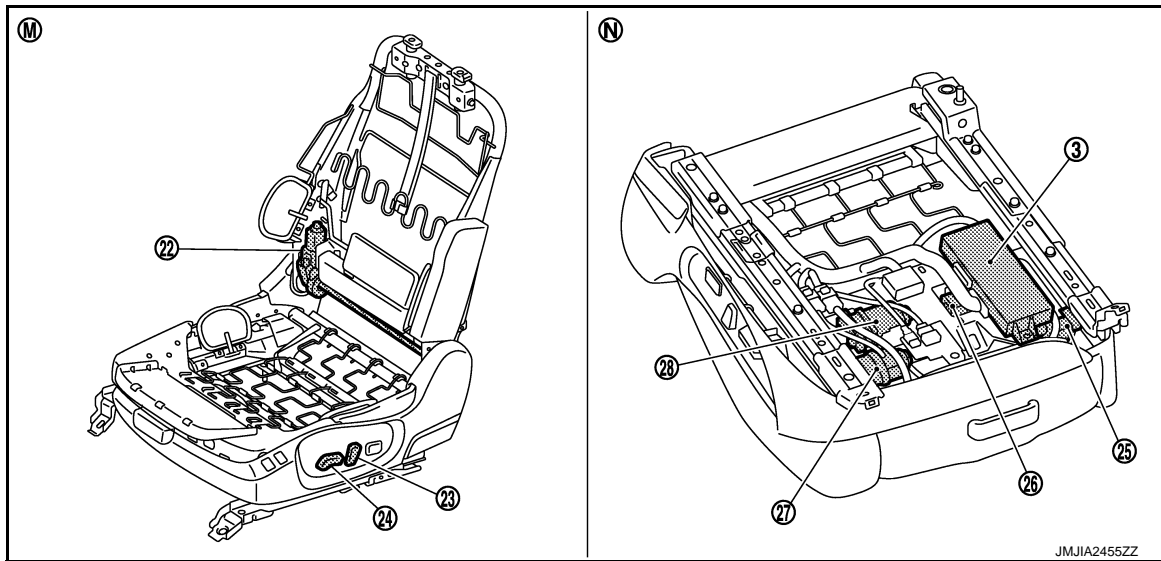

- | | | |
|--------------------------|---|--|
| 22. Reclining motor | 23. Reclining switch
(Power seat switch) | 24. Sliding, lifting switch
(Power seat switch) |
| 25. Sliding sensor | 26. Lifting motor (front) | 27. Sliding motor |
| 28. Lifting motor (rear) | | |
- M. View with seat cushion pad and seat-back pad are removed. N. Backside of seat cushion

AUTOMATIC DRIVE POSITIONER SYSTEM : Component Description

INFOID:000000006471460

CONTROL UNITS

Item	Function
Driver seat control unit	<ul style="list-style-type: none"> • Main units of automatic drive positioner system. • It is connected to the CAN. • It communicates with the automatic drive positioner control unit via UART communication.
Automatic drive positioner control unit	<ul style="list-style-type: none"> • It communicates with the driver seat control unit via UART communication. • Perform various controls with the instructions of driver seat control unit. • Perform the controls of the tilt & telescopic, door mirror and the seat memory switch.
BCM	Transmit the following status to the driver seat control unit via CAN communication. <ul style="list-style-type: none"> • Driver door: OPEN/CLOSE • Ignition switch position: ACC/ON • Door lock: UNLOCK (with Intelligent Key or driver side door request switch operation) • Key ID • Key switch: Insert/Pull out Intelligent Key • Starter: CRANKING/OTHER
Unified meter and A/C amp.	Transmit the vehicle speed signal to the driver seat control unit via CAN communication.
TCM	Transmit the shift position signal (P range) to the driver seat control unit via CAN communication.

INPUT PARTS

Switches

Item	Function
Key slot	The key switch is installed to detect the key inserted/removed status.
Driver side door switch	Detect front door (driver side) open/close status.

A
B
C
D
E
F
G
H
I
K
L
M
N
O
P

ADP

AUTOMATIC DRIVE POSITIONER SYSTEM

< SYSTEM DESCRIPTION >

Item	Function
A/T shift selector (detention switch)	Detect the P range position of A/T selector lever. (A/T models)
Parking break switch	Detect the parking brake status. (M/T models)
Set switch	The registration and system setting can be performed with its operation.
Memory switch 1/2	The registration and operation can be performed with its operation.
Power seat switch	The following switch is installed. <ul style="list-style-type: none"> • Reclining switch • Lifting switch (front) • Lifting switch (rear) • Sliding switch The specific parts can be operated with the operation of each switch.
Power walk-in switch	Perform the power walk-in operation by operating the power walk-in switch.
Sliding limit switch	Detect the front end position of seat sliding during the power walk-in function forward operation.
Seat belt buckle switch	Detect the seat belt fastening/releasing condition.
Forward switch	Detect the folded up/folded down condition of seatback that is the operation condition of power walk-in function.
Tilt & telescopic switch	The following switch is installed. <ul style="list-style-type: none"> • Tilt switch • Telescopic switch The specific parts can be operated with the operation of each switch.
Door mirror remote control switch	The following switch is installed. <ul style="list-style-type: none"> • Mirror switch • Changeover switch The specific parts can be operated with the operation of each switch.

Sensors

Item	Function
Door mirror sensor (driver side/passenger side)	Detect the upward/downward and leftward/rightward position of outside mirror face.
Tilt & telescopic sensor	Detect the upward/downward and forward/backward position of steering column.
Lifting sensor (front)	Detect the upward/downward position of seat lifting (front).
Lifting sensor (rear)	Detect the upward/downward position of seat lifting (rear).
Reclining sensor	Detect the tilt of seatback.
Sliding sensor	Detect the forward/backward position of seat.

OUTPUT PARTS

Item	Function
Door mirror motor (driver side/passenger side)	Move the outside mirror face upward/downward and leftward/rightward.
Tilt & telescopic motor	Move the steering column upward/downward and frontward/rearward.
Lifting motor (front)	Move the seat lifting (front) upward/downward.
Lifting motor (rear)	Move the seat lifting (rear) upward/downward.
Reclining motor	Tilt and raise up the seatback.
Sliding motor	Slide the seat forward/backward.
Memory indicator	Illuminates or blinks according to the registration/operation status.

SLEEP MODE

- The seat control unit adopts the sleep mode to reduce the electric power consumption.
- The sleep mode is activated when all of the following condition are fulfilled.
 1. Ignition switch turn OFF (steering LOCK position)
 2. No load is applied to the seat control

AUTOMATIC DRIVE POSITIONER SYSTEM

< SYSTEM DESCRIPTION >

3. The seat control unit 45seconds timer is not activated
4. Set switch and memory switch (1 and 2) turn OFF

WAKE-UP MODE

- The sleep mode is cancelled when any status change is detected for the followings.
 1. CAN communication
 2. Power seat switch
 3. Set switch and memory switch (1 and 2)
 4. Power walk-in switch
 5. Door mirror switch
 6. Steering column switch

MANUAL FUNCTION

MANUAL FUNCTION : System Diagram

INFOID:000000006471461

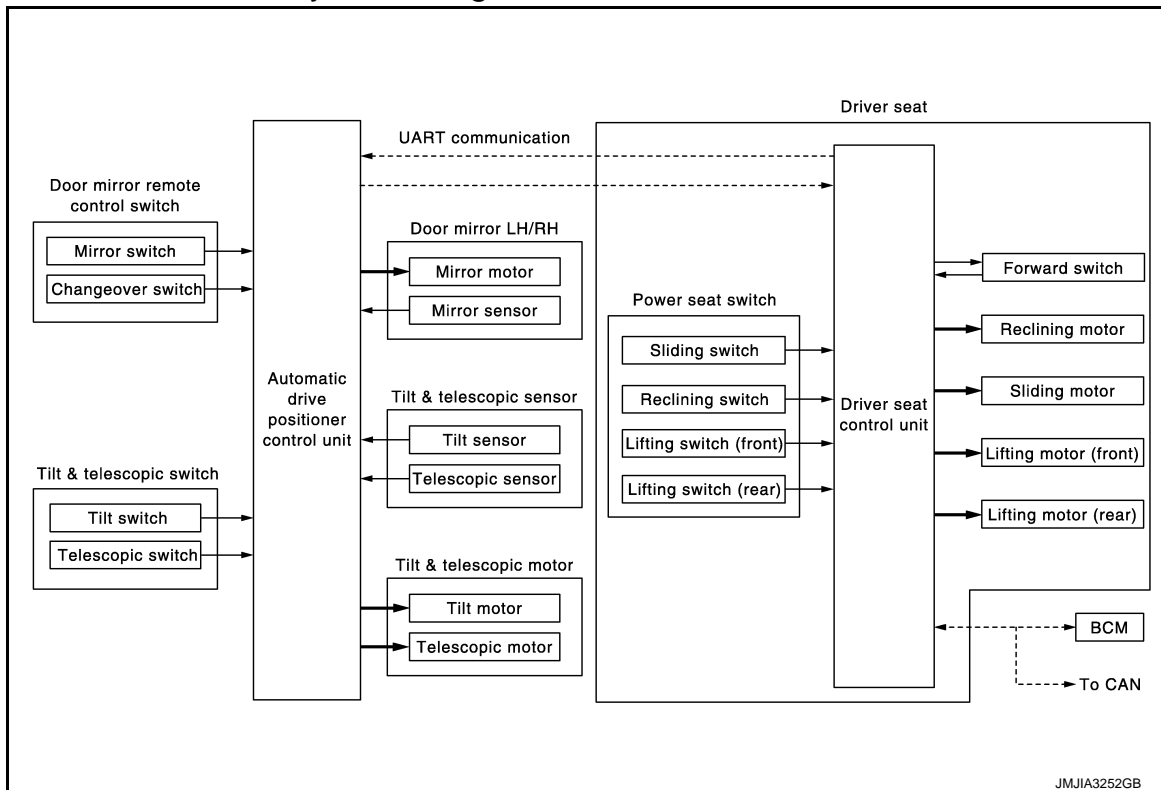

JMJIA3252GB

MANUAL FUNCTION : System Description

INFOID:000000006471462

OUTLINE

The driving position (seat, steering column and door mirror position) can be adjusted manually with power seat switch, tilt & telescopic switch and door mirror remote control switch.

OPERATION PROCEDURE

1. Operate power seat switch, tilt & telescopic switch or door mirror remote control switch.
2. The driver seat, steering column or door mirror operates according to the operation of each switch.

DETAIL FLOW

Seat

AUTOMATIC DRIVE POSITIONER SYSTEM

< SYSTEM DESCRIPTION >

Order	Input	Output	Control unit condition
1	Power seat switch (sliding, lifting, reclining)	—	The power seat switch signal is inputted to the driver seat control unit when the power seat switch is operated.
2	—	Motors (sliding, lifting, reclining)	The driver seat control unit outputs signals to each motor according to the power seat switch input signal.

Tilt & Telescopic

Order	Input	Output	Control unit condition
1	Tilt & telescopic switch	—	The tilt & telescopic switch signals are inputted to the automatic drive positioner control unit when the tilt & telescopic switch are operated.
2	—	Motors (Tilt, telescopic)	The automatic drive positioner control unit actuates each motor according to the operation of the tilt & telescopic switch.
3	Sensors (Tilt, telescopic)	—	The automatic drive positioner control unit recognizes any operation limit of each actuator via each sensor and will not operate the actuator anymore at that time.*

*: Tilt does not operate upward when tilt sensor value is less than 1.1 V, tilt does not operate downward when the sensor value is more than 3.9 V. Telescopic does not operate backward when telescopic sensor value is less than 0.5 V, telescopic does not operate forward when the sensor value is more than 4.5 V.

Door Mirror

Order	Input	Output	Control unit condition
1	Door mirror remote control switch	—	The door mirror remote control switch signal is inputted to the automatic drive positioner control unit when the door mirror remote control switch is operated.
2	—	Motors (Door mirror motor)	The automatic drive positioner control unit actuates each motor according to the signal from the door mirror remote control switch.
3	Sensors (Mirror)	—	The automatic drive positioner control unit monitors the input of mirror sensor. It stops the operation if the input reaches the operation limit.

NOTE:

The door mirrors can be operated manually when ignition switch is in either ACC or ON position. The ignition switch signal (ACC/ON) is transmitted from BCM to the driver seat control unit via CAN communication and from the driver seat control unit to the automatic drive positioner control unit via UART communication.

AUTOMATIC DRIVE POSITIONER SYSTEM

< SYSTEM DESCRIPTION >

MANUAL FUNCTION : Component Parts Location

INFOID:000000006471463

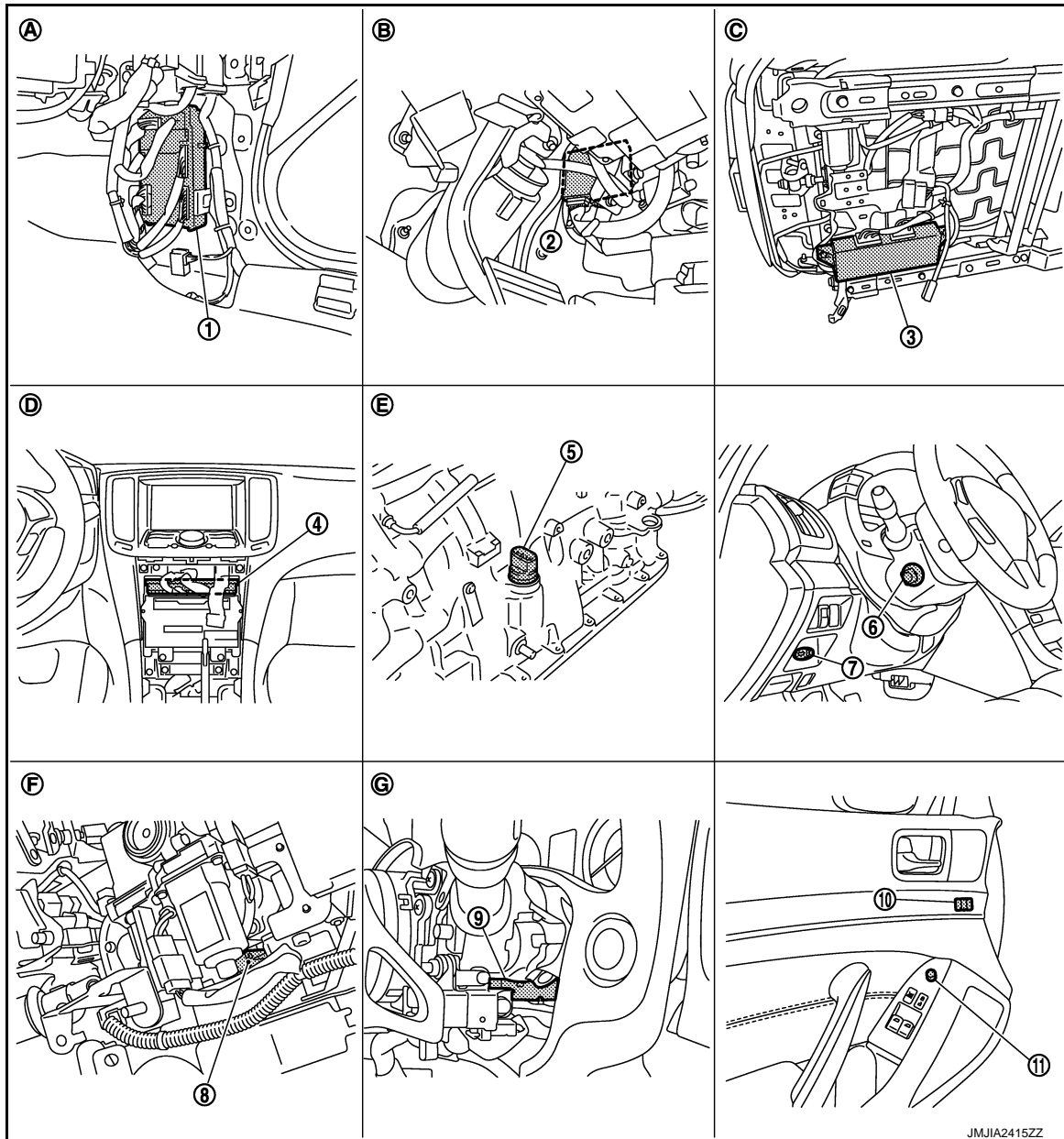

- | | | |
|--|--|--|
| 1. BCM | 2. Automatic drive positioner control unit | 3. Driver seat control unit |
| 4. Unified meter and A/C amp. | 5. A/T assembly | 6. Tilt & telescopic switch |
| 7. Key slot | 8. Tilt sensor | 9. Telescopic sensor |
| 10. Seat memory switch | 11. Door mirror remote control switch | |
| A. Dash side lower (passenger side) | B. View with instrument driver lower panel removed | C. Backside of seat cushion (driver side) |
| D. Behind cluster lid C | E. A/T assembly (TCM is built in A/T assembly) | F. View with instrument driver lower panel removed |
| G. View with steering column cover lower and upper removed | | |

A
B
C
D
E
F
G
H
I
ADP
K
L
M
N
O
P

AUTOMATIC DRIVE POSITIONER SYSTEM

< SYSTEM DESCRIPTION >

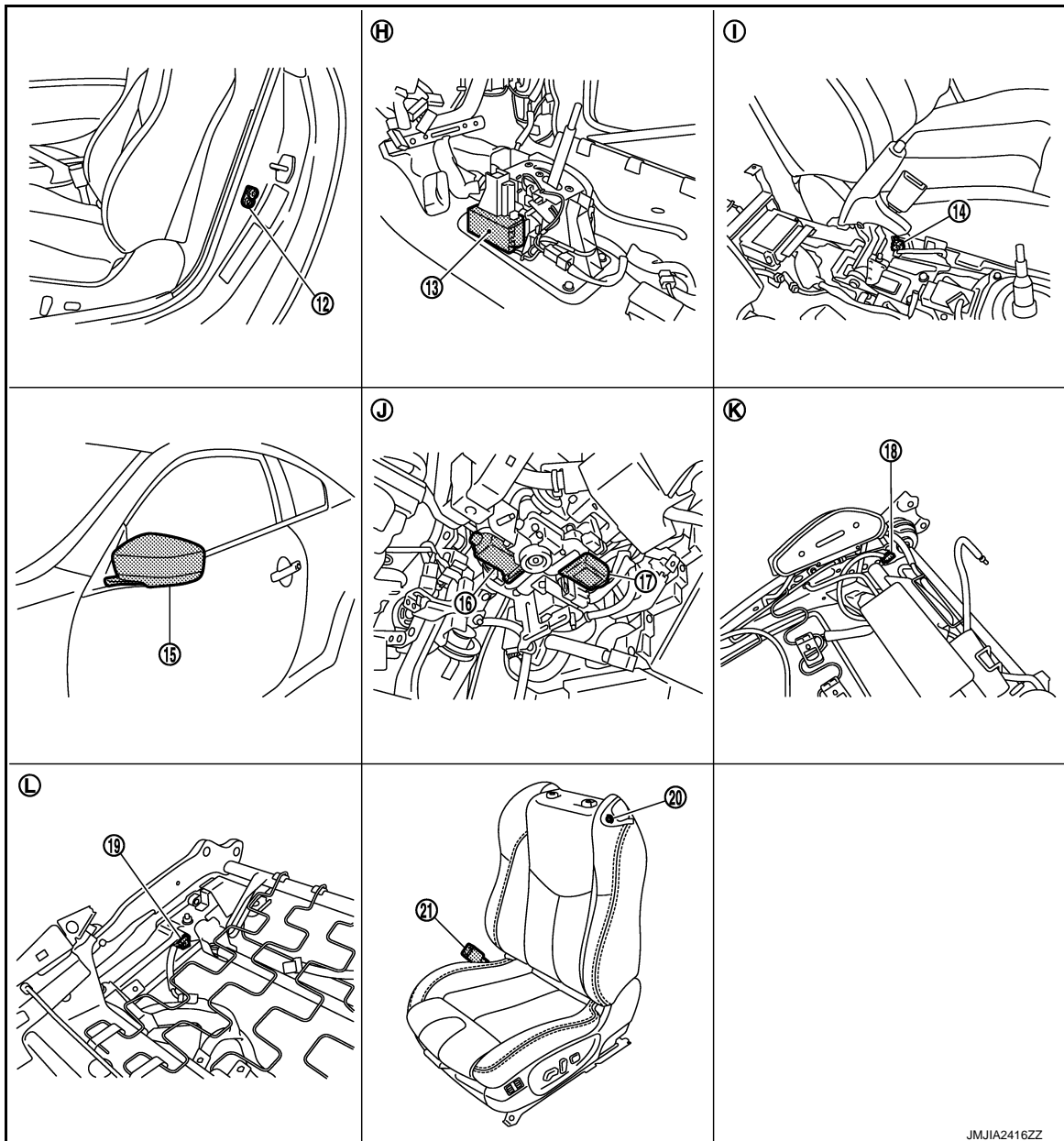

JMJIA2416ZZ

- | | | |
|--|--|--|
| 12. Driver side door switch | 13. A/T shift selector (detention switch) | 14. Parking brake switch |
| 15. Door mirror (driver side) | 16. Telescopic motor | 17. Tilt motor |
| 18. Forward switch | 19. Sliding limit switch | 20. Power walk-in switch |
| 21. Seat belt buckle switch (driver side) | | |
| H. View with center console assembly is removed. | I. View with center console assembly is removed. | J. View with instrument driver lower panel is removed. |
| K. View with seat back pad is removed. | L. View with seat cushion pad is removed. | |

AUTOMATIC DRIVE POSITIONER SYSTEM

< SYSTEM DESCRIPTION >

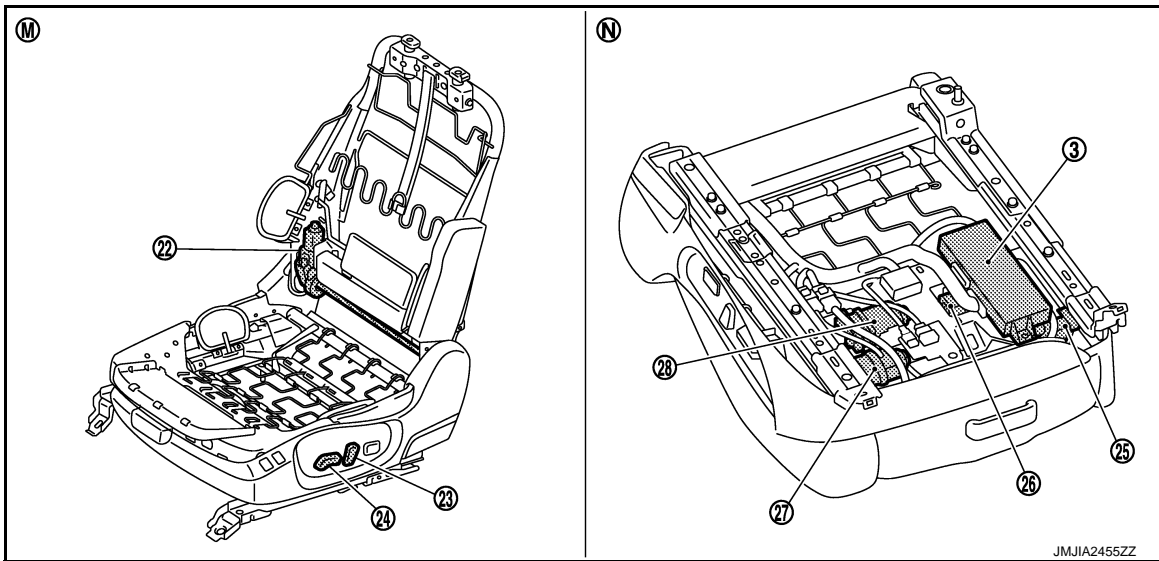

- | | | |
|--------------------------|--|--|
| 22. Reclining motor | 23. Reclining switch
(Power seat switch) | 24. Sliding, lifting switch
(Power seat switch) |
| 25. Sliding sensor | 26. Lifting motor (front) | 27. Sliding motor |
| 28. Lifting motor (rear) | N. Backside of seat cushion
back pad are removed. | |

MANUAL FUNCTION : Component Description

INFOID:000000006471464

CONTROL UNITS

Item	Function
Driver seat control unit	<ul style="list-style-type: none"> Operates the specific seat motor with the signal from the power seat switch. Transmits the ignition switch signal (ACC/ON) via UART communication to the automatic drive positioner control unit.
Automatic drive positioner control unit	Operates the specific motor with the signal from tilt & telescopic switch or door mirror remote control switch.
BCM	Recognizes the following status and transmits it to the driver seat control unit via CAN communication. <ul style="list-style-type: none"> Ignition position: ACC/ON

INPUT PARTS

Switches

Item	Function
Power seat switch	The following switch is installed. <ul style="list-style-type: none"> Reclining switch Lifting switch (front) Lifting switch (rear) Sliding switch The specific parts can be operated with the operation of each switch.
Tilt & telescopic switch	The following switch is installed. <ul style="list-style-type: none"> Tilt switch Telescopic switch The specific parts can be operated with the operation of each switch.

AUTOMATIC DRIVE POSITIONER SYSTEM

< SYSTEM DESCRIPTION >

Item	Function
Forward switch	Detect folded down or folded up of the seat back.
Door mirror remote control switch	The following switch is installed. <ul style="list-style-type: none"> • Mirror switch • Changeover switch The specific parts can be operated with the operation of each switch.

Sensors

Item	Function
Tilt & telescopic sensor	Detect the upward/downward & forward/backward position of steering column.
Door mirror sensor (driver side / passenger side)	Detect the upward/downward and leftward/rightward position of outside mirror face.

OUTPUT PARTS

Item	Function
Door mirror motor (driver side/passenger side)	Move the outside mirror face upward/downward and leftward/rightward.
Tilt & telescopic motor	Move the steering column upward/downward and forward/backward.
Lifting motor (front)	Move the seat lifter (front) upward/downward.
Lifting motor (rear)	Move the seat lifter (rear) upward/downward.
Reclining motor	Tilt and raise up the seatback.
Sliding motor	Slide the seat forward/backward.

SEAT SYNCHRONIZATION FUNCTION

SEAT SYNCHRONIZATION FUNCTION : System Diagram

INFOID:000000006471465

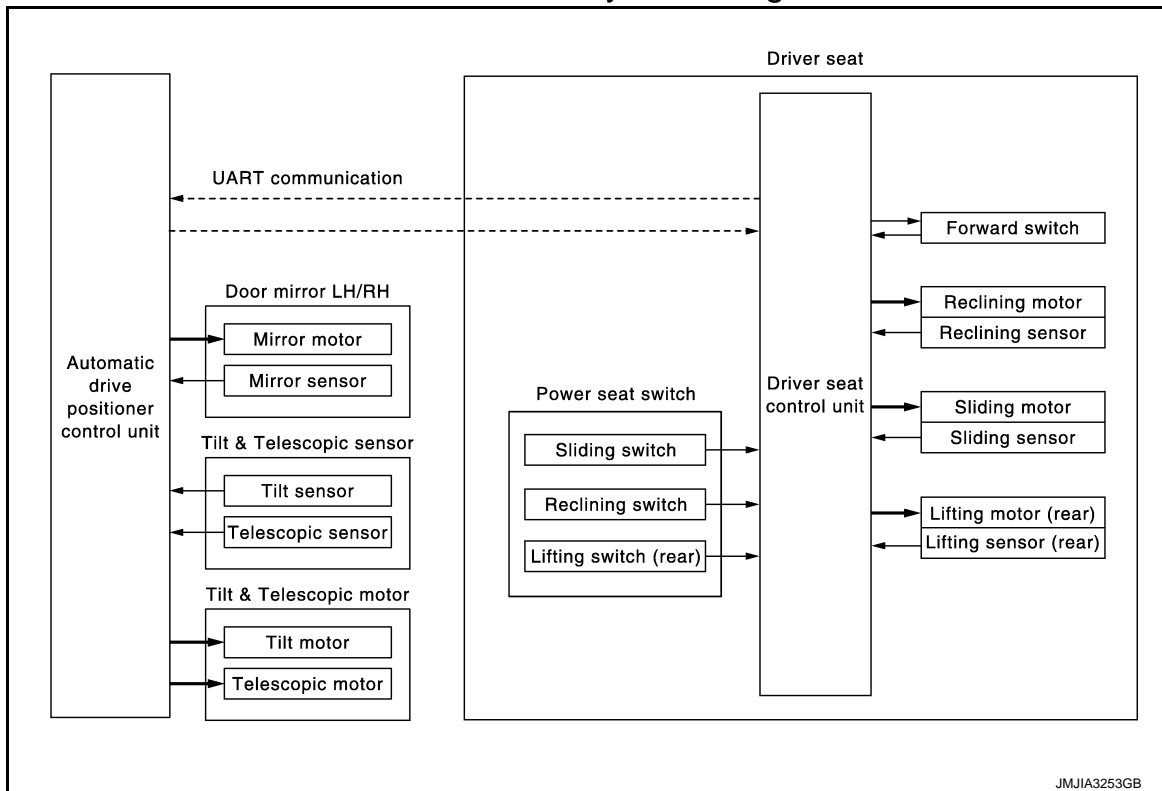

SEAT SYNCHRONIZATION FUNCTION : System Description

INFOID:000000006471466

OUTLINE

AUTOMATIC DRIVE POSITIONER SYSTEM

< SYSTEM DESCRIPTION >

The steering column position and door mirror position is adjusted to the position automatically according to the direction and distance of seat movement when performing the manual operation of sliding, reclining or lifting (rear). This function saves adjusting the mirror and steering column when adjusting the seat.

NOTE:

This function is set to OFF before delivery. (initial setting)

For the system setting procedure. Refer to [ADP-11. "SYSTEM SETTING : Description"](#).

OPERATION PROCEDURE

1. Turn ignition switch ON.
2. Adjust seat position [sliding, reclining, lifting (rear)].
3. The steering and outside mirror is adjusted automatically.

NOTE:

- The seat synchronization function will not operate if seat adjusting value is more than limit value.

Item	Limit value
Seat sliding	76 mm
Seat reclining	9.1 degrees
Seat lifter (rear)	20 mm

- The seat synchronization function will not operate if the steering column or door mirror moves to the operating end while this function is operating. Perform memory function or drive the vehicle at vehicle speed of 7 km/h or more once to activate this function again.
- If the seat position is uncomfortable after the adjustment, seat position can be adjusted easily by memory operation.

OPERATION CONDITION

Satisfy all of the following items. The seat synchronization function is not performed if these items are not satisfied.

Item	Request status
System setting	ON
Ignition position	ON
Seat back	Folded up
A/T selector lever (A/T models)	P position
Parking break (M/T models)	Applied
Switch inputs <ul style="list-style-type: none"> • Power seat switch • Tilt & telescopic switch • Door mirror remote control switch • Set switch • Memory switch 	OFF (Not operated)

DETAIL FLOW

When performing the sliding, reclining or lifting (rear) operation in manual function, the driver seat control unit performs the seat synchronization function as follows.

Order	Input	Output	Control unit condition
1	Sensors [Sliding, reclining, lifting (rear)]	—	The driver seat control unit judges the direction and distance of seat movement according to the signal input from each seat sensor during manual operation.
2	—	Motors (Tilt, telescopic, outside mirror)	Driver seat control unit requests the operation to position according to the direction and distance of seat movement to the automatic drive positioner control unit via UART communication. The automatic drive positioner control unit operates each motor.
	Sensors (Tilt, telescopic, outside mirror)	—	Driver seat control unit stops the operation of each motor when the value of each sensor that is input to automatic drive positioner control unit via UART communication reaches the target address.

AUTOMATIC DRIVE POSITIONER SYSTEM

< SYSTEM DESCRIPTION >

SEAT SYNCHRONIZATION FUNCTION : Component Parts Location

INFOID:000000006471467

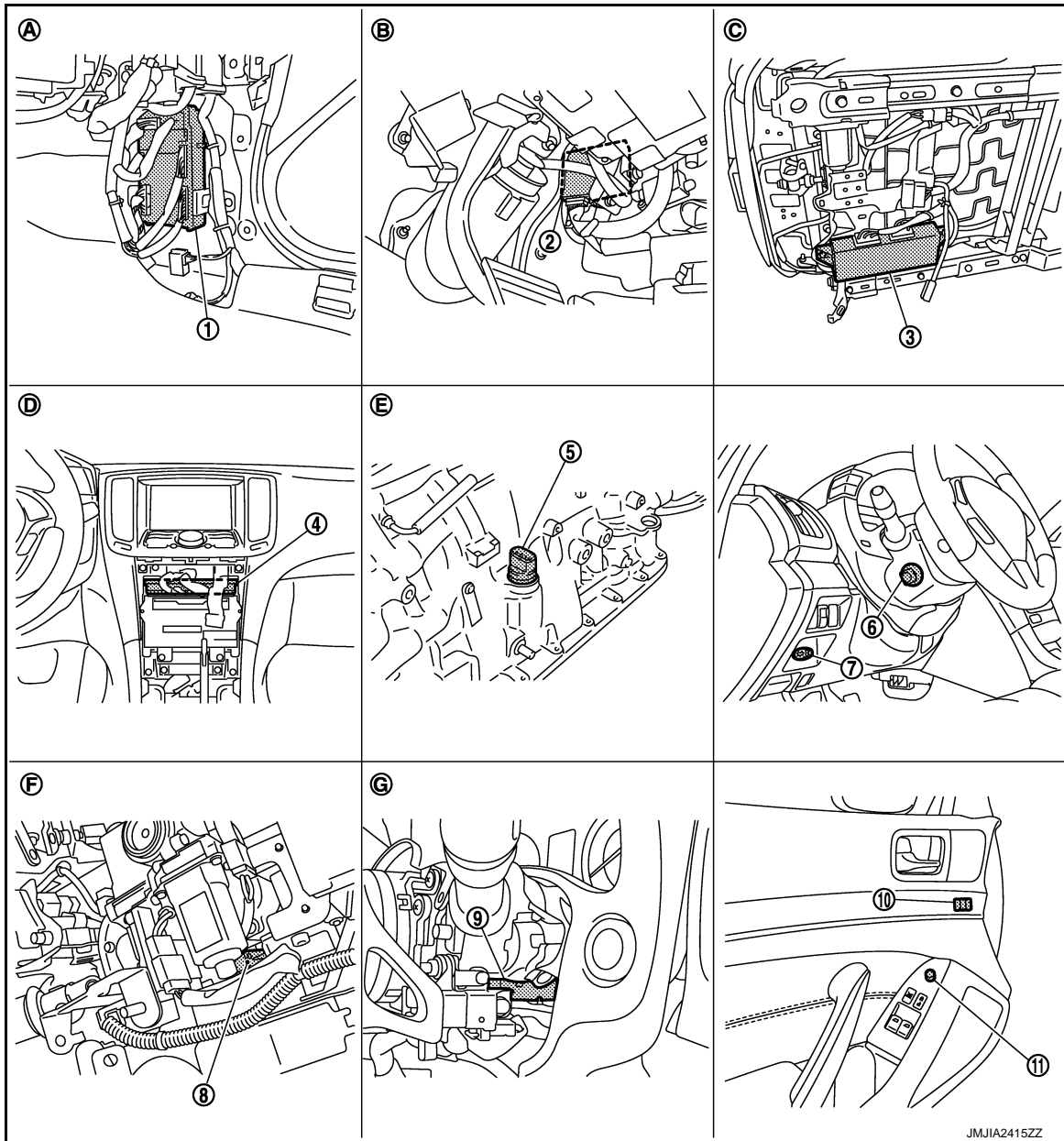

JMJIA2415ZZ

- | | | |
|--|--|--|
| 1. BCM | 2. Automatic drive positioner control unit | 3. Driver seat control unit |
| 4. Unified meter and A/C amp. | 5. A/T assembly | 6. Tilt & telescopic switch |
| 7. Key slot | 8. Tilt sensor | 9. Telescopic sensor |
| 10. Seat memory switch | 11. Door mirror remote control switch | |
| A. Dash side lower (passenger side) | B. View with instrument driver lower panel removed | C. Backside of seat cushion (driver side) |
| D. Behind cluster lid C | E. A/T assembly (TCM is built in A/T assembly) | F. View with instrument driver lower panel removed |
| G. View with steering column cover lower and upper removed | | |

AUTOMATIC DRIVE POSITIONER SYSTEM

< SYSTEM DESCRIPTION >

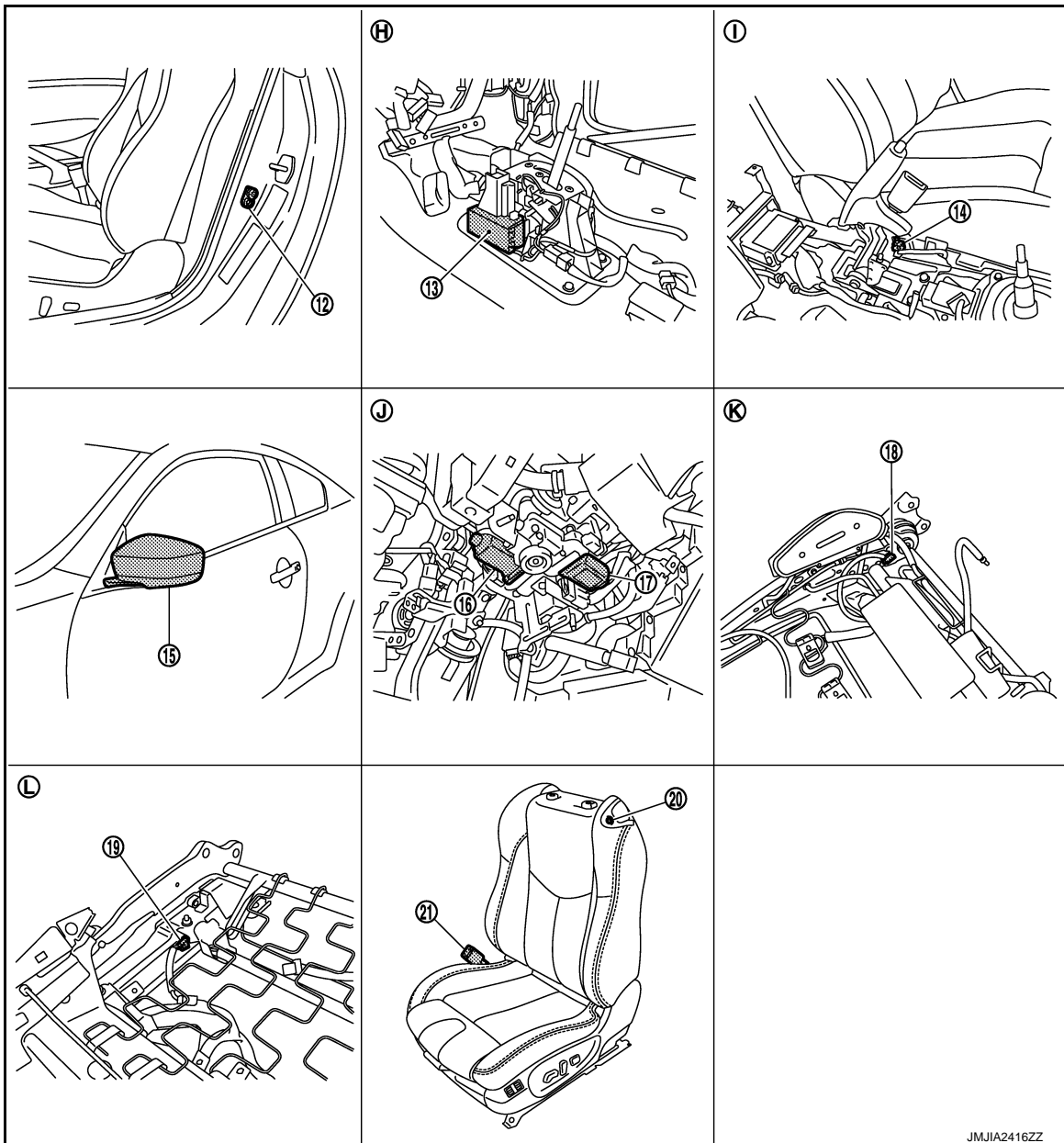

- | | | |
|--|--|--|
| 12. Driver side door switch | 13. A/T shift selector (detention switch) | 14. Parking brake switch |
| 15. Door mirror (driver side) | 16. Telescopic motor | 17. Tilt motor |
| 18. Forward switch | 19. Sliding limit switch | 20. Power walk-in switch |
| 21. Seat belt buckle switch (driver side) | | |
| H. View with center console assembly is removed. | I. View with center console assembly is removed. | J. View with instrument driver lower panel is removed. |
| K. View with seat back pad is removed. | L. View with seat cushion pad is removed. | |

JMJIA2416ZZ

A
B
C
D
E
F
G
H
I
ADP
K
L
M
N
O
P

AUTOMATIC DRIVE POSITIONER SYSTEM

< SYSTEM DESCRIPTION >

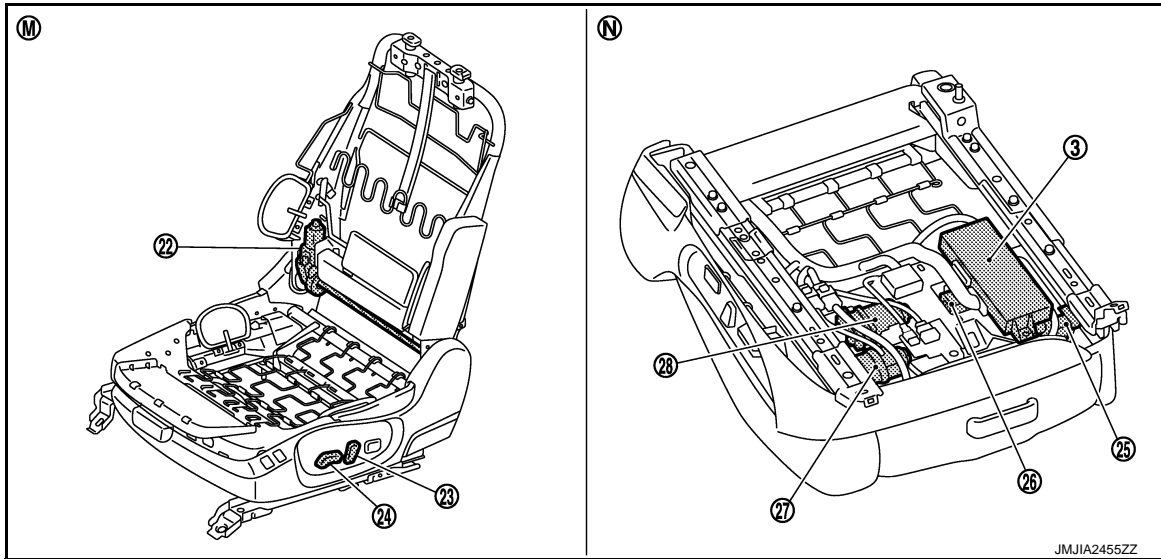

- | | | |
|--|---|--|
| 22. Reclining motor | 23. Reclining switch
(Power seat switch) | 24. Sliding, lifting switch
(Power seat switch) |
| 25. Sliding sensor | 26. Lifting motor (front) | 27. Sliding motor |
| 28. Lifting motor (rear) | | |
| M. View with seat cushion pad and seat-back pad are removed. | N. Backside of seat cushion | |

SEAT SYNCHRONIZATION FUNCTION : Component Description

INFOID:000000006471468

CONTROL UNITS

Item	Function
Driver seat control unit	Operates the specific seat motor with the signal from the power seat switch.
Automatic drive positioner control unit	Operates the steering motor and door mirror with the signal from the driver seat control unit.

INPUT PARTS

Switches

Item	Function
Power seat switch	The following switch is installed. <ul style="list-style-type: none"> • Reclining switch • Lifting switch (front) • Lifting switch (rear) • Sliding switch The specific parts can be operated with the operation of each switch.
Forward switch	Detect folded down or folded up of the seat back.

Sensors

Item	Function
Door mirror sensor (driver side/passenger side)	Detect the upward/downward and leftward/rightward position of outside mirror face.
Tilt & telescopic sensor	Detect the upward/downward and forward/backward position of steering column.
Lifting sensor (rear)	Detect the upward/downward position of seat lifter (rear).
Reclining sensor	Detect the tilt of seatback.
Sliding sensor	Detect the frontward/rearward position of seat.

AUTOMATIC DRIVE POSITIONER SYSTEM

< SYSTEM DESCRIPTION >

OUTPUT PARTS

Item	Function
Door mirror motor (driver side/passenger side)	Move the outside mirror face upward/downward and leftward/rightward.
Tilt & telescopic motor	Move the steering column upward/downward and forward/backward.
Lifting motor (rear)	Move the seat lifter (rear) upward/downward.
Reclining motor	Tilt and raise up the seatback.
Sliding motor	Slide the seat forward/backward.

MEMORY FUNCTION

MEMORY FUNCTION : System Diagram

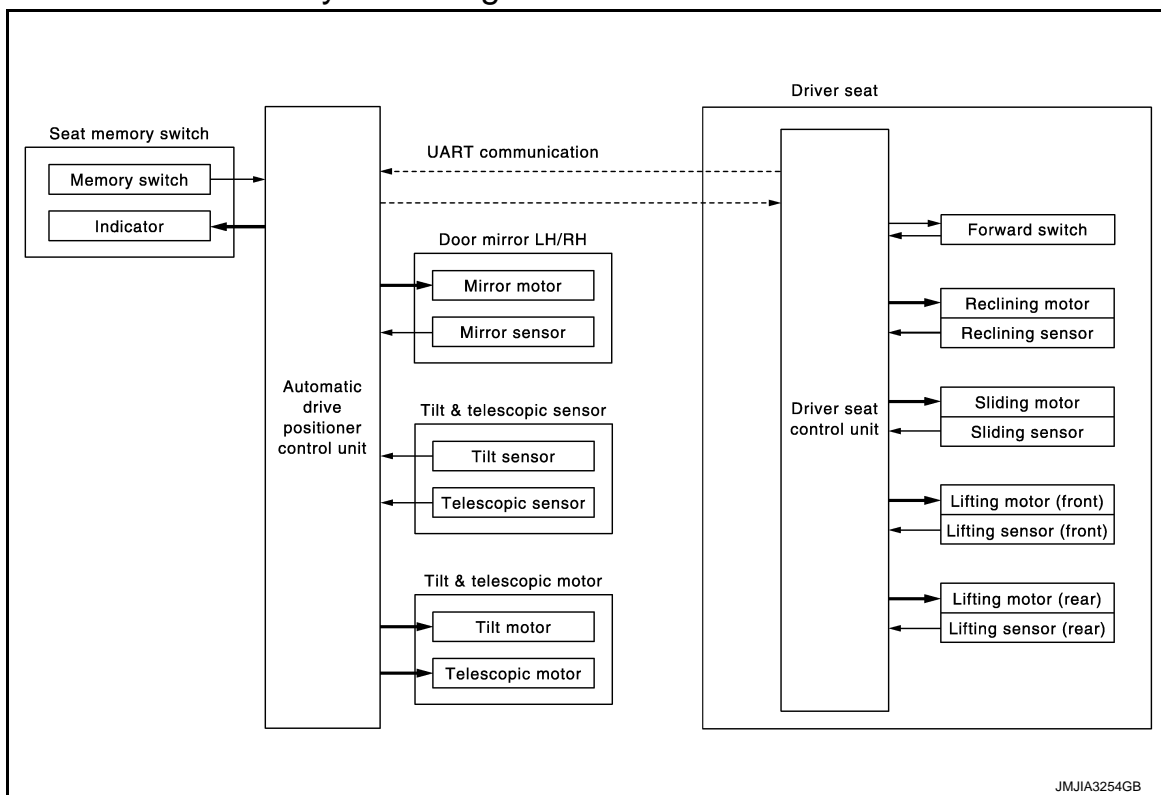

MEMORY FUNCTION : System Description

INFOID:000000006471470

OUTLINE

The driver seat control unit can store the optimum driving positions (seat, steering column and door mirror position) for 2 people. If the front seat position is changed, one-touch (pressing desired memory switch for more than 0.5 second) operation allows changing to the other driving position.

NOTE:

Further information for the memory storing procedure. Refer to [ADP-10. "MEMORY STORING : Description"](#).

OPERATION PROCEDURE

1. Turn ignition switch ON
2. Press desired memory switch for more than 0.5 second.
3. Driver seat, steering and door mirror will move to the memorized position.

OPERATION CONDITION

Satisfy all of the following items. The memory function is not performed if these items are not satisfied.

AUTOMATIC DRIVE POSITIONER SYSTEM

< SYSTEM DESCRIPTION >

Item	Request status
Ignition position	ON
Seat back	Folded up
A/T selector lever (A/T models)	P position
Parking break (M/T models)	Applied
Switch inputs <ul style="list-style-type: none"> • Power seat switch • Tilt & telescopic switch • Door mirror control switch • Set switch • Memory switch 	OFF (Not operated)

DETAIL FLOW

Order	Input	Output	Control unit condition
1	Memory switch	—	The memory switch signal is inputted to the automatic drive positioner control unit when memory switch 1 or 2 is operated. Memory switch signal is output to driver seat control unit via UART communication.
2	—	Motors (Seat, steering, door mirror)	Driver seat control unit operates each motor of seat when it recognizes the memory switch pressed for 0.5 second or more and requests each motor operation to automatic drive positioner control unit via UART communication. The automatic drive positioner control unit operates each motor.
		Memory switch Indicator	Driver seat control unit requests the flashing of memory indicator to automatic drive positioner control unit via UART communication while either of the motors is operating. The automatic drive positioner control unit illuminates the memory indicator.
3	Sensors (Seat, steering, door mirror)	—	Driver seat control unit judges the operating seat position with each seat sensor input. The positions of the steering column and outside mirror are monitored with each sensor signal that is input from auto drive positioner control unit via UART communication. Driver seat control unit stops the operation of each motor when each part reaches the recorded address.
4	—	Memory switch Indicator	Driver seat control unit requests the illumination of memory indicator to auto drive positioner control unit via UART communication after all motors stop. The auto driving positioner control unit illuminates the memory indicator for 5 seconds.

AUTOMATIC DRIVE POSITIONER SYSTEM

< SYSTEM DESCRIPTION >

MEMORY FUNCTION : Component Parts Location

INFOID:000000006471471

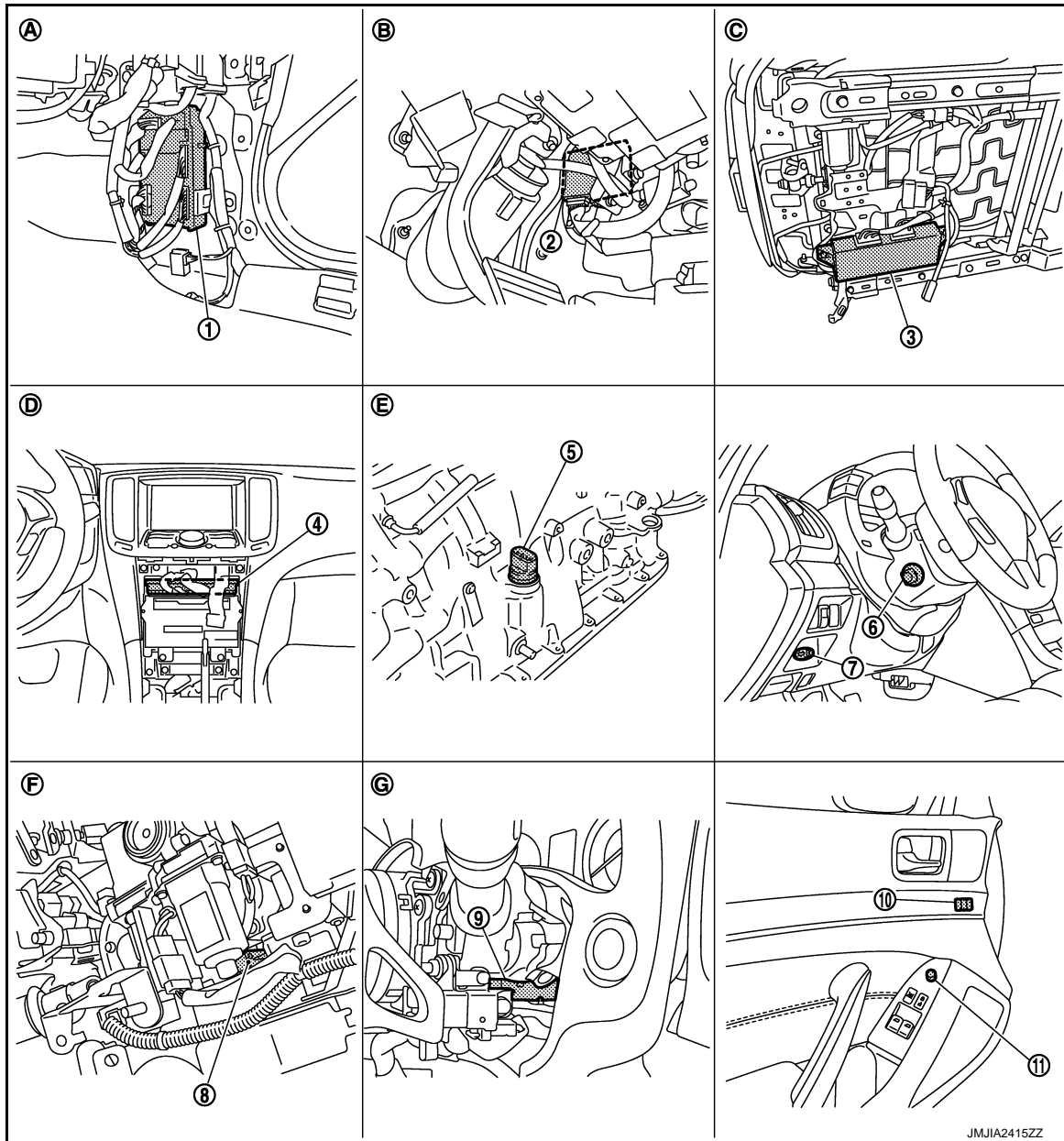

- | | | |
|--|--|--|
| 1. BCM | 2. Automatic drive positioner control unit | 3. Driver seat control unit |
| 4. Unified meter and A/C amp. | 5. A/T assembly | 6. Tilt & telescopic switch |
| 7. Key slot | 8. Tilt sensor | 9. Telescopic sensor |
| 10. Seat memory switch | 11. Door mirror remote control switch | |
| A. Dash side lower (passenger side) | B. View with instrument driver lower panel removed | C. Backside of seat cushion (driver side) |
| D. Behind cluster lid C | E. A/T assembly (TCM is built in A/T assembly) | F. View with instrument driver lower panel removed |
| G. View with steering column cover lower and upper removed | | |

A
B
C
D
E
F
G
H
I
ADP
K
L
M
N
O
P

AUTOMATIC DRIVE POSITIONER SYSTEM

< SYSTEM DESCRIPTION >

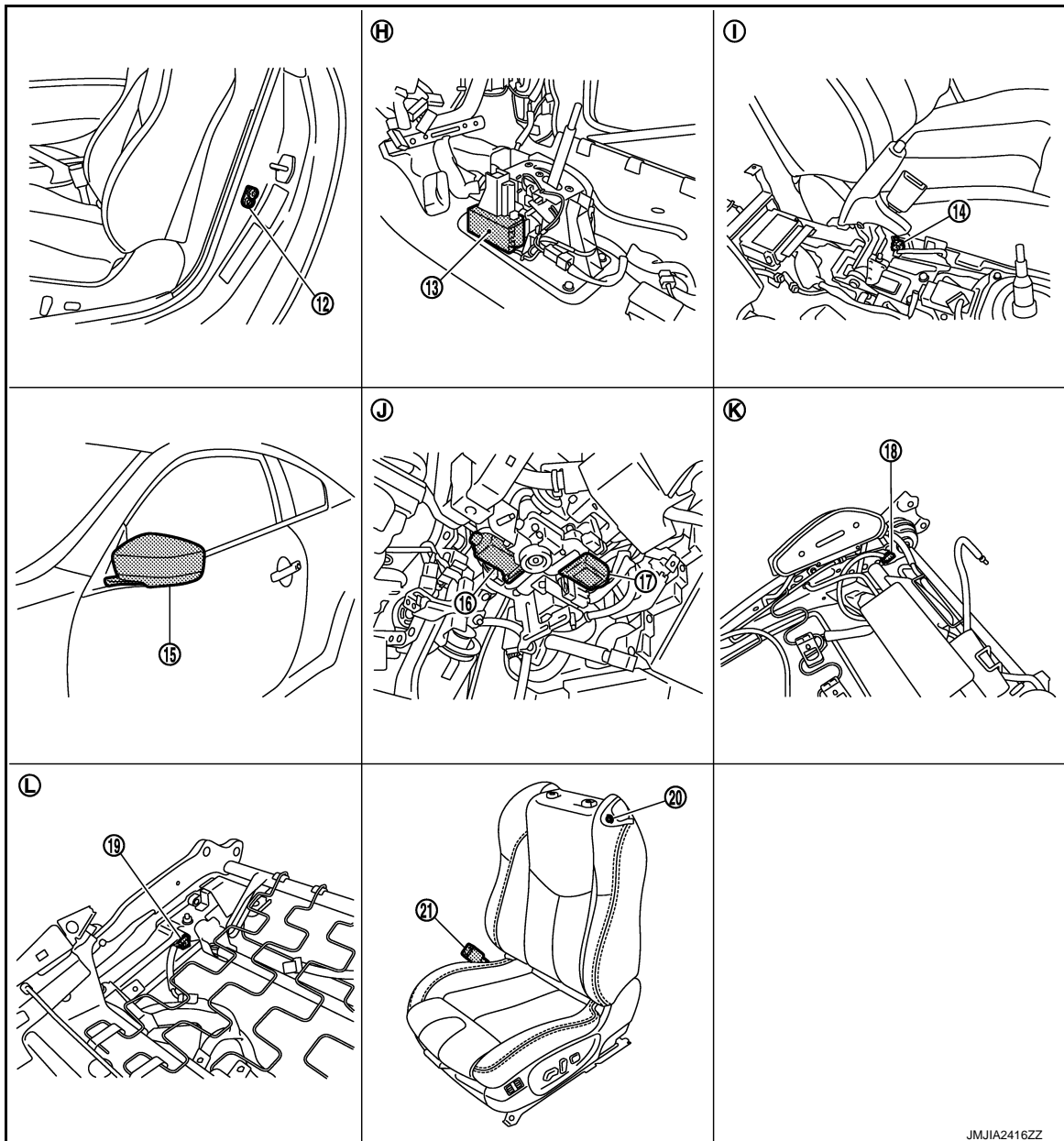

JMJIA2416ZZ

- | | | |
|--|--|--|
| 12. Driver side door switch | 13. A/T shift selector (detention switch) | 14. Parking brake switch |
| 15. Door mirror (driver side) | 16. Telescopic motor | 17. Tilt motor |
| 18. Forward switch | 19. Sliding limit switch | 20. Power walk-in switch |
| 21. Seat belt buckle switch (driver side) | | |
| H. View with center console assembly is removed. | I. View with center console assembly is removed. | J. View with instrument driver lower panel is removed. |
| K. View with seat back pad is removed. | L. View with seat cushion pad is removed. | |

AUTOMATIC DRIVE POSITIONER SYSTEM

< SYSTEM DESCRIPTION >

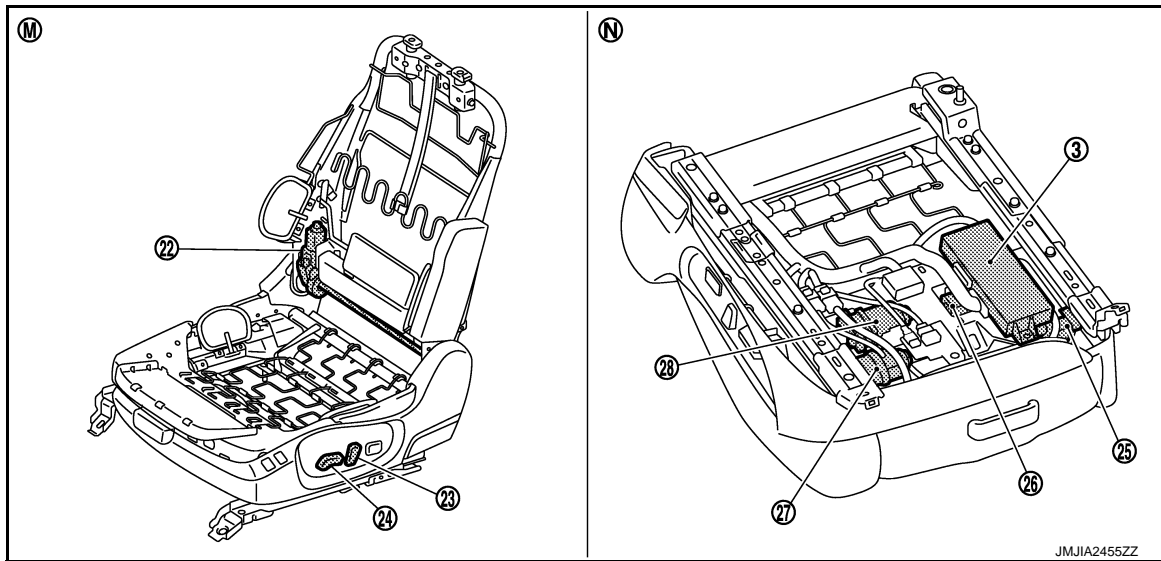

- 22. Reclining motor
 - 23. Reclining switch (Power seat switch)
 - 24. Sliding, lifting switch (Power seat switch)
 - 25. Sliding sensor
 - 26. Lifting motor (front)
 - 27. Sliding motor
 - 28. Lifting motor (rear)
- M. View with seat cushion pad and seat-back pad are removed. N. Backside of seat cushion

MEMORY FUNCTION : Component Description

INFOID:000000006471472

CONTROL UNITS

Item	Function
Driver seat control unit	<ul style="list-style-type: none"> • The address of each part is recorded. • Operates each motor of seat to the registered position. • Requests the operations of steering column and door mirror to automatic drive positioner control unit
Automatic drive positioner control unit	Operates the steering column and door mirror with the signal from the driver seat control.

INPUT PARTS

Switches

Item	Function
Memory switch 1/2	The registration and memory function can be performed with its operation.
Forward switch	Detect folded down or folded up of the seat back.

Sensors

Item	Function
Door mirror sensor (driver side/passenger side)	Detect the upward/downward and leftward/rightward position of outside mirror face.
Tilt & telescopic sensor	Detect the upward/downward and forward/backward position of steering column.
Lifting sensor (front)	Detect the upward/downward position of seat lifting (front).
Lifting sensor (rear)	Detect the upward/downward position of seat lifting (rear).
Reclining sensor	Detect the tilt of seatback.
Sliding sensor	Detect the forward/backward position of seat.

OUTPUT PARTS

A
B
C
D
E
F
G
H
I

ADP

K
L
M
N
O
P

AUTOMATIC DRIVE POSITIONER SYSTEM

< SYSTEM DESCRIPTION >

Item	Function
Door mirror motor (driver side/passenger side)	Move the outside mirror face upward/downward and leftward/rightward.
Tilt & telescopic motor	Move the steering column upward/downward and forward/backward.
Lifting motor (front)	Move the seat lifter (front) upward/downward.
Lifting motor (rear)	Move the seat lifter (rear) upward/downward.
Reclining motor	Tilt and raise up the seatback.
Sliding motor	Slide the seat forward/backward.
Memory indicator	Illuminates or blinks according to the registration/operation status.

INTELLIGENT KEY INTERLOCK FUNCTION

INTELLIGENT KEY INTERLOCK FUNCTION : System Diagram

INFOID:000000006471473

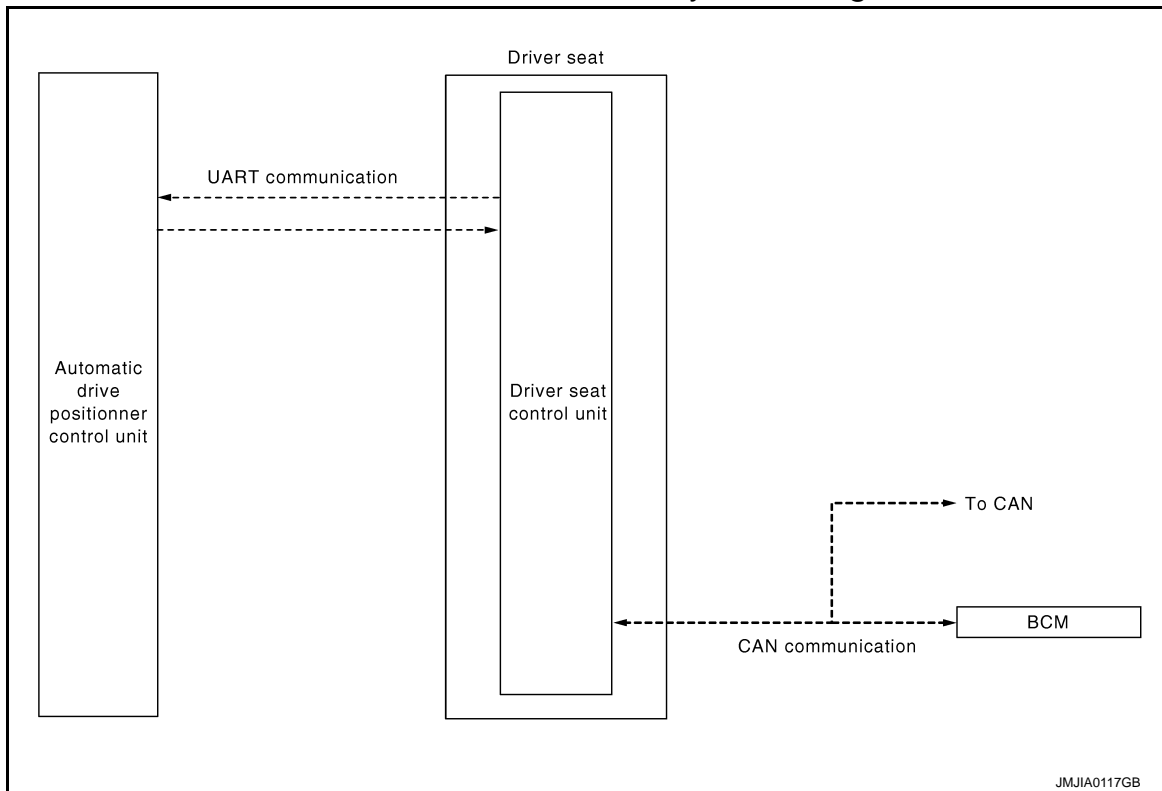

INTELLIGENT KEY INTERLOCK FUNCTION : System Description

INFOID:000000006471474

OUTLINE

When unlocking doors by using Intelligent Key or driver side door request switch, the system performs memory operation.

OPERATION PROCEDURE

1. Unlock doors by using Intelligent Key or driver side door request switch.
2. The system performs memory operation, and then performs exit assist operation.

NOTE:

If the seat position is in memorized position before unlocking doors, memory operation does not perform.

NOTE:

Further information for Intelligent Key interlock function. Refer to [ADP-10, "MEMORY STORING : Description"](#).

OPERATION CONDITION

Satisfy all of the following items. The Intelligent Key interlock function is performed if these items are satisfied.

AUTOMATIC DRIVE POSITIONER SYSTEM

< SYSTEM DESCRIPTION >

Item	Request status
Key switch	OFF (Key is removed.)
Ignition position	LOCK
Seat back	Folded up
A/T selector lever (A/T models)	P position
Parking break (M/T models)	Applied
Switch inputs <ul style="list-style-type: none"> • Power seat switch • Tilt & telescopic switch • Door mirror control switch • Set switch • Memory switch 	OFF (Not operated)

DETAIL FLOW

Order	Input	Output	Control unit condition
1	<ul style="list-style-type: none"> • Door unlock signal (CAN) • Key ID signal (CAN) 	—	Driver seat control unit receives the door unlock signal and the key ID signal from BCM when unlocking the door with Intelligent Key or driver side door request switch.
2	—	—	Driver seat control unit performs the memory function.

A
B
C
D
E
F
G
H
I
K
L
M
N
O
P

ADP

AUTOMATIC DRIVE POSITIONER SYSTEM

< SYSTEM DESCRIPTION >

INTELLIGENT KEY INTERLOCK FUNCTION : Component Parts Location INFOID:000000006471475

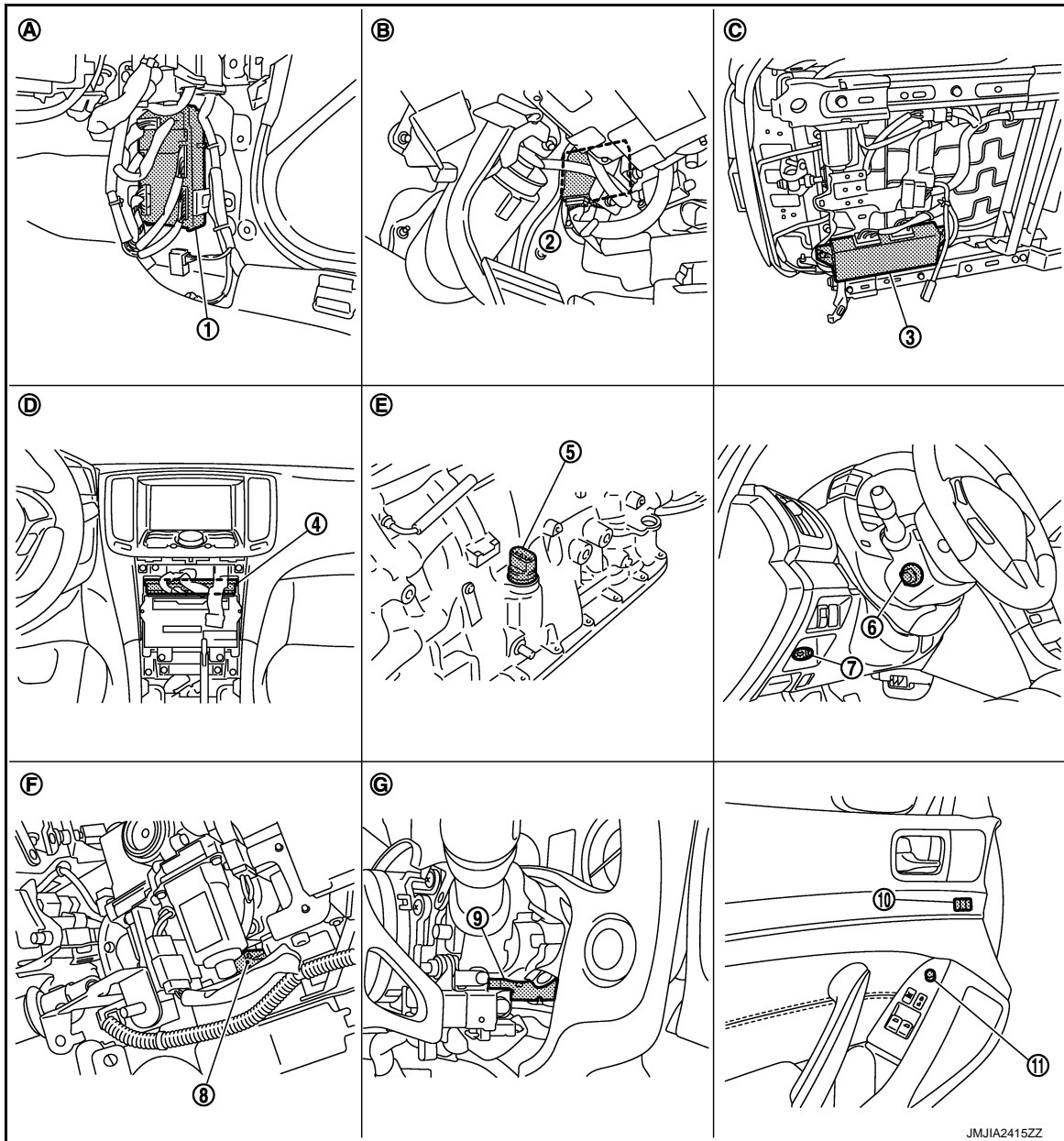

JMJIA2415ZZ

- | | | |
|--|--|--|
| 1. BCM | 2. Automatic drive positioner control unit | 3. Driver seat control unit |
| 4. Unified meter and A/C amp. | 5. A/T assembly | 6. Tilt & telescopic switch |
| 7. Key slot | 8. Tilt sensor | 9. Telescopic sensor |
| 10. Seat memory switch | 11. Door mirror remote control switch | |
| A. Dash side lower (passenger side) | B. View with instrument driver lower panel removed | C. Backside of seat cushion (driver side) |
| D. Behind cluster lid C | E. A/T assembly (TCM is built in A/T assembly) | F. View with instrument driver lower panel removed |
| G. View with steering column cover lower and upper removed | | |

AUTOMATIC DRIVE POSITIONER SYSTEM

< SYSTEM DESCRIPTION >

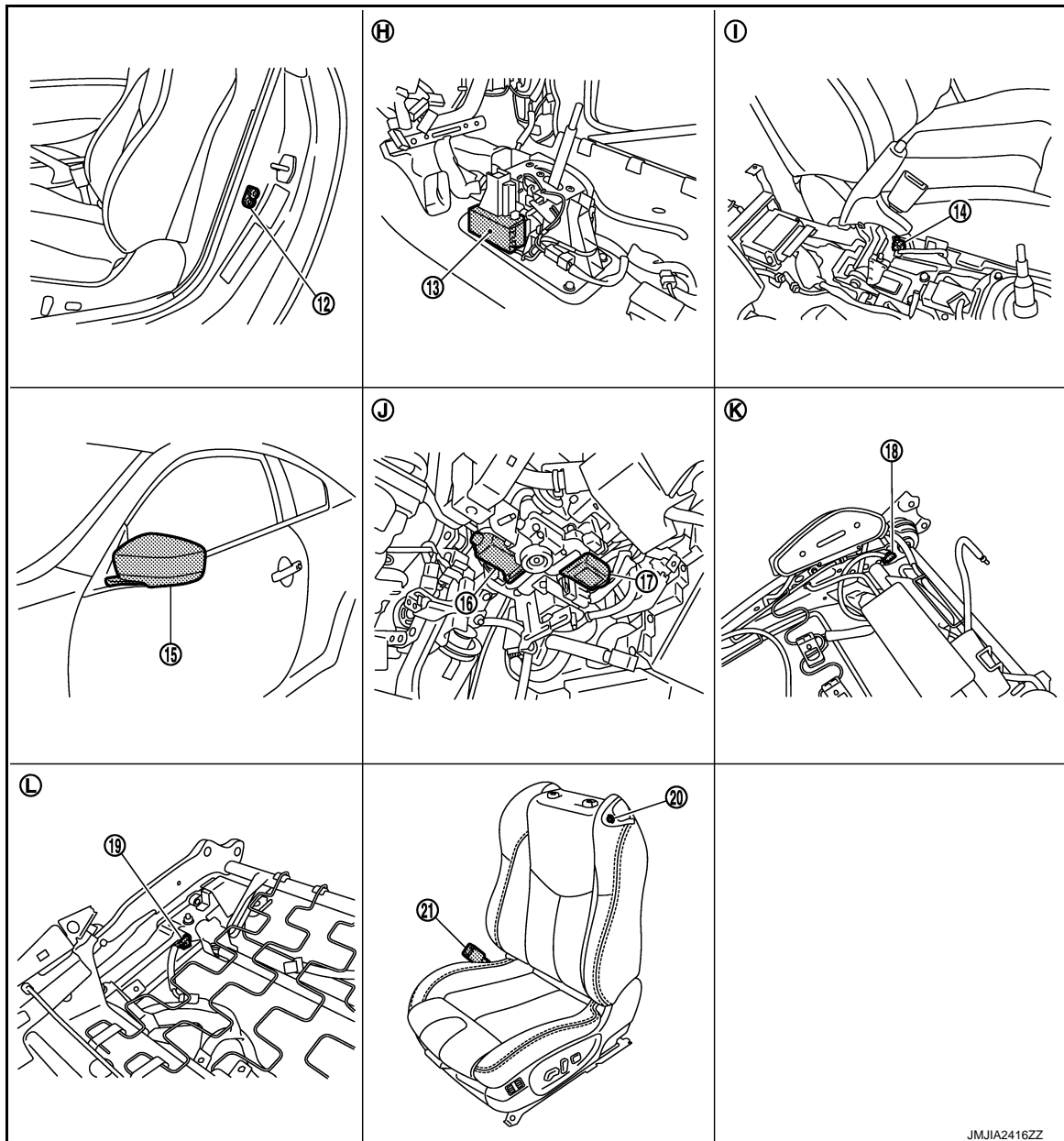

- | | | |
|--|--|--|
| 12. Driver side door switch | 13. A/T shift selector (detention switch) | 14. Parking brake switch |
| 15. Door mirror (driver side) | 16. Telescopic motor | 17. Tilt motor |
| 18. Forward switch | 19. Sliding limit switch | 20. Power walk-in switch |
| 21. Seat belt buckle switch (driver side) | | |
| H. View with center console assembly is removed. | I. View with center console assembly is removed. | J. View with instrument driver lower panel is removed. |
| K. View with seat back pad is removed. | L. View with seat cushion pad is removed. | |

JMJIA2416ZZ

A
B
C
D
E
F
G
H
I
ADP
K
L
M
N
O
P

AUTOMATIC DRIVE POSITIONER SYSTEM

< SYSTEM DESCRIPTION >

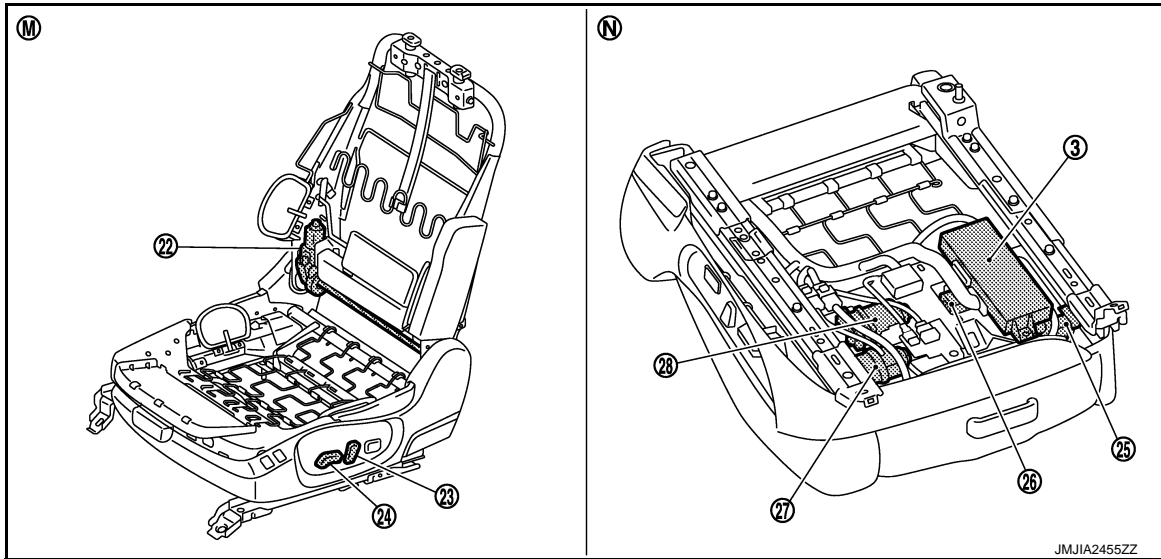

- | | | |
|--------------------------|---|--|
| 22. Reclining motor | 23. Reclining switch
(Power seat switch) | 24. Sliding, lifting switch
(Power seat switch) |
| 25. Sliding sensor | 26. Lifting motor (front) | 27. Sliding motor |
| 28. Lifting motor (rear) | | |
- M. View with seat cushion pad and seat-back pad are removed. N. Backside of seat cushion

INTELLIGENT KEY INTERLOCK FUNCTION : Component Description

INFOID:000000006471476

CONTROL UNITS

Item	Function
Driver seat control unit	It performs memory function after receiving the door unlock signal from BCM.
Automatic drive positioner control unit	Operates the steering column and door mirror with the instructions from the driver seat control unit.
BCM	Recognizes the following status and transmits it to the driver seat control unit via CAN communication. <ul style="list-style-type: none"> • Door lock: UNLOCK (with Intelligent Key or driver side door request switch)

POWER WALK-IN FUNCTION

AUTOMATIC DRIVE POSITIONER SYSTEM

< SYSTEM DESCRIPTION >

POWER WALK-IN FUNCTION : System Diagram

INFOID:000000006471477

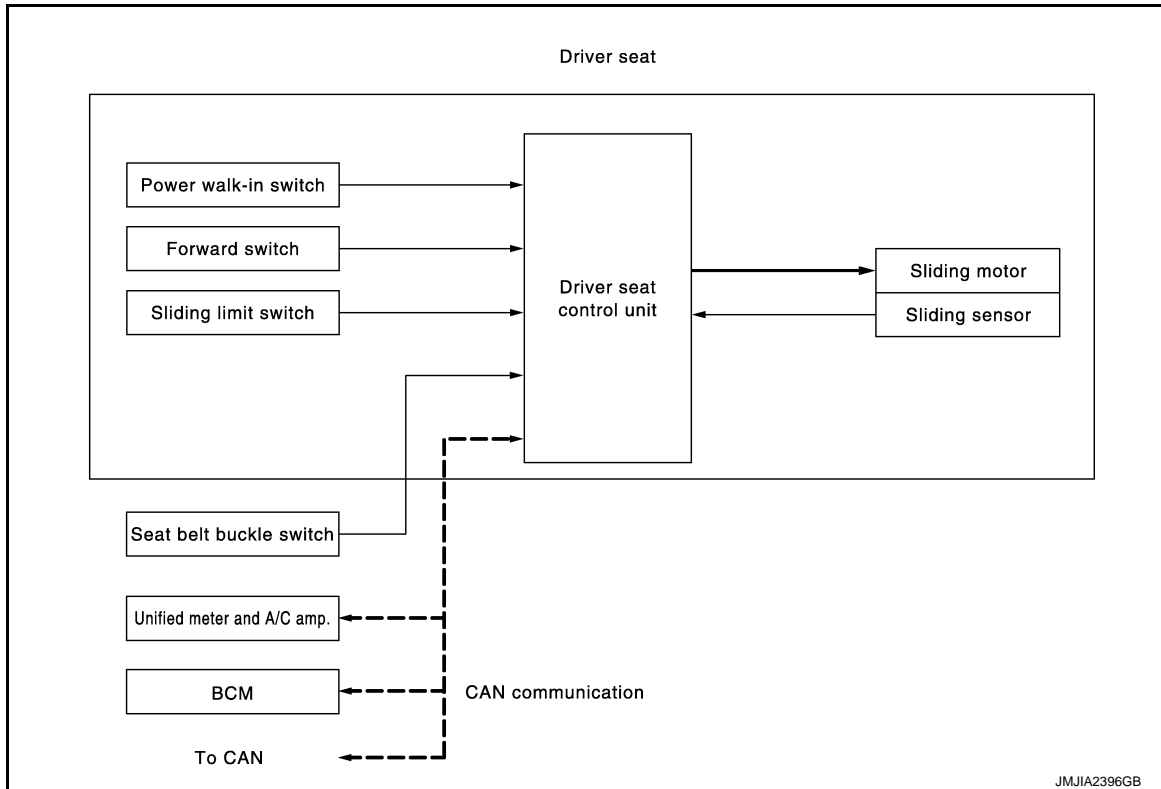

POWER WALK-IN FUNCTION : System Description

INFOID:000000006471478

OUTLINE

Slide the driver seat automatically with the power walk-in switch operation so as to easily facilitate the entry to the rear seat.

Forward Operation

Slide (forward) the driver seat to the front end position (sliding limit switch: ON) by operating the power walk-in switch when the seatback is folded down.

The forward operation is stopped by folding the seatback (forward switch: OFF) during the forward operation.

Backward Operation

The seat back is folded up after performing the forward operation of power walk-in function. Slide (backward) it to the position before performing the forward operation by operating the power walk-in switch.

If the manual operation, memory operation, and Intelligent Key interlock operation are performed after performing the forward operation, do not perform the backward operation.

OPERATION PROCEDURE

Forward Operation

1. Open driver door.
2. Pull the walk-in lever on the upper part of seatback, and then the seatback is folded down.
3. Press the power walk-in switch.
4. Slide the seat to the front end position.

Backward Operation

1. Open driver door.
2. Fold up the seatback after performing the forward operation.
3. Press the power walk-in switch.
4. Slide the seat to the previous position before the forward operation was performed.

OPERATION CONDITION

Perform the power walk-in function when the following conditions are satisfied.

A
B
C
D
E
F
G
H

I

ADP

K

L

M

N

O

P

AUTOMATIC DRIVE POSITIONER SYSTEM

< SYSTEM DESCRIPTION >

Forward Operation

Item	Request status
Driver side door	Open
Driver side seat belt	Not fastened
Power seat switch (sliding)	Not operated
Vehicle speed	0 km/h
Seat position (sliding)	Other than front end
Seat back	Folded down

Backward Operation

Item	Request status
Initialize	Done
Driver side seat belt	Not fastened
Switch inputs <ul style="list-style-type: none"> • Power seat switch (sliding) • Set switch • Memory switch 	Not operated
Vehicle speed	0 km/h
Seat position (sliding)	The seat sliding position will not move after performing the forward operation.
Seat back	Folded up

DETAIL FLOW

Forward Operation

Order	Inputs	Outputs	Control unit condition
1	Forward switch	—	Driver seat control unit detects that the seatback is folded down by the signal from the forward switch.
2	Power walk-in switch	—	The operation signal is inputted to the driver seat control unit when the power walk-in switch is operated.
3	—	Sliding motor (forward)	Driver seat control unit operates the seat sliding motor forward when it detects that the power walk-in switch is operated.
4	Sliding limit switch	—	Driver seat control unit stops the seat sliding motor when it detects that the seat sliding reaches the front end position by the sliding limit switch.

Backward Operation

Order	Inputs	Outputs	Control unit condition
1	Forward switch	—	Driver seat control unit detects that the seatback is folded up by the signal from the forward switch.
2	Power walk-in switch	—	The operation signal is inputted to the driver seat control unit when the power walk-in switch is operated.
3	—	Sliding motor (backward)	Driver seat control unit operates the sliding motor backward when it detects that the power walk-in switch is operated.
4	Sliding sensor	—	Driver seat control unit stops the seat sliding motor when the seat sliding position reaches the position before performing the forward operation by the signal from sliding sensor.

AUTOMATIC DRIVE POSITIONER SYSTEM

< SYSTEM DESCRIPTION >

POWER WALK-IN FUNCTION : Component Parts Location

INFOID:000000006471479

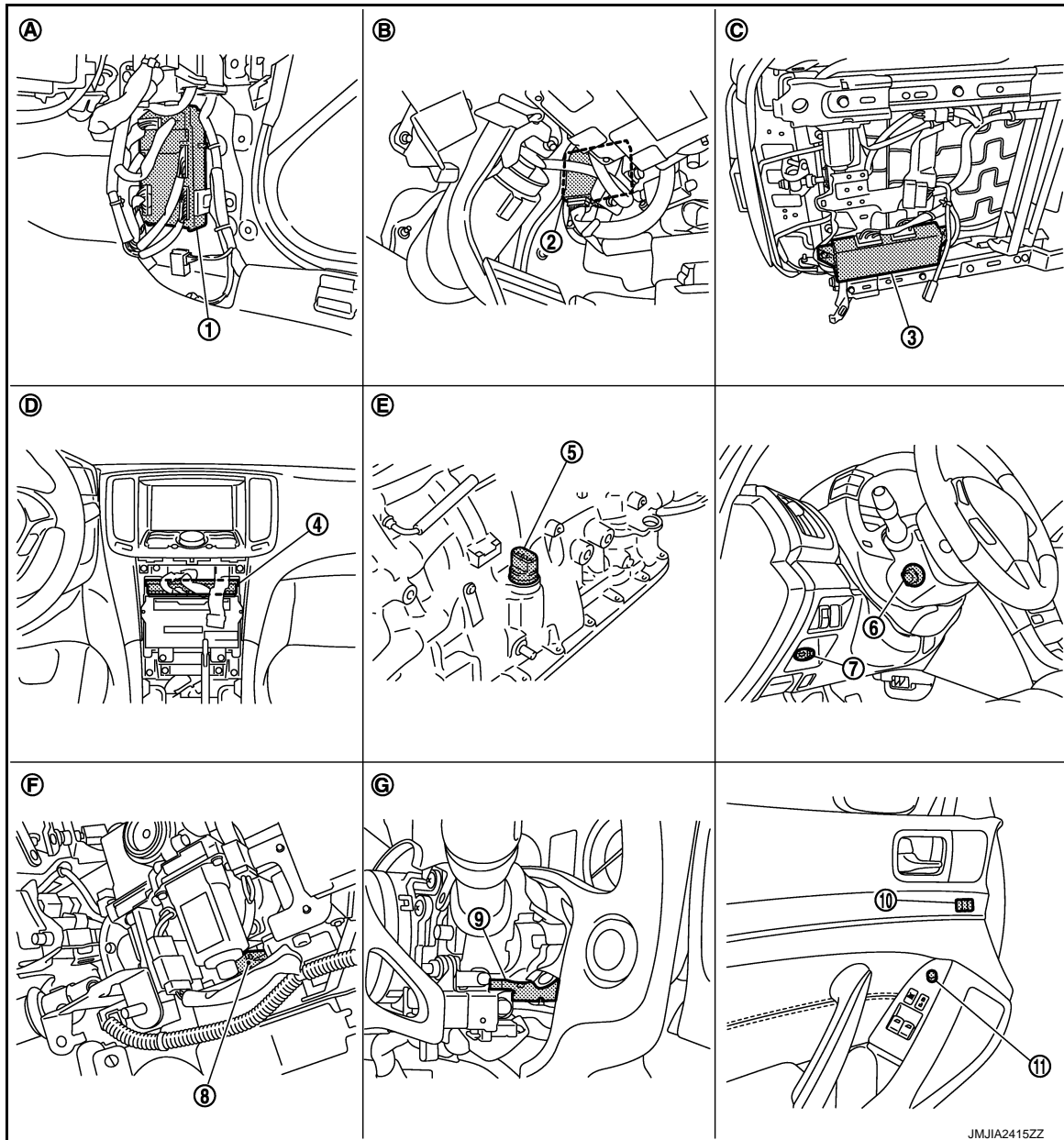

- | | | |
|--|--|--|
| 1. BCM | 2. Automatic drive positioner control unit | 3. Driver seat control unit |
| 4. Unified meter and A/C amp. | 5. A/T assembly | 6. Tilt & telescopic switch |
| 7. Key slot | 8. Tilt sensor | 9. Telescopic sensor |
| 10. Seat memory switch | 11. Door mirror remote control switch | |
| A. Dash side lower (passenger side) | B. View with instrument driver lower panel removed (Remove 4WAS front control unit with 4WAS models) | C. Backside of seat cushion (driver side) |
| D. Behind cluster lid C | E. A/T assembly (TCM is built in A/T assembly) | F. View with instrument driver lower panel removed |
| G. View with steering column cover lower and upper removed | | |

A
B
C
D
E
F
G
H
I
ADP
K
L
M
N
O
P

AUTOMATIC DRIVE POSITIONER SYSTEM

< SYSTEM DESCRIPTION >

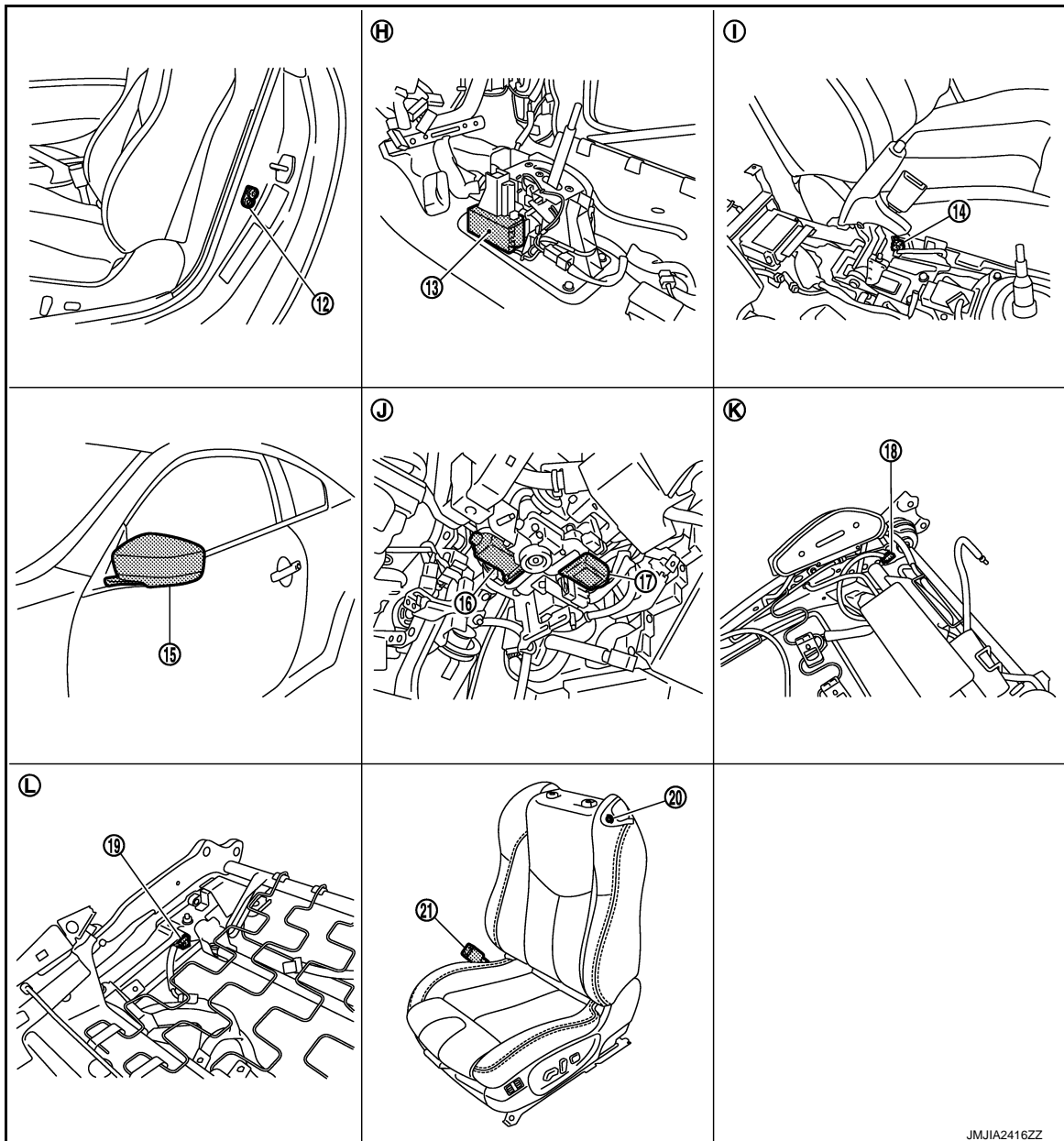

JMJIA2416ZZ

12. Driver side door switch

15. Door mirror (driver side)

18. Forward switch

21. Seat belt buckle switch (driver side)

H. View with center console assembly is removed.

K. View with seat back pad is removed.

13. A/T shift selector (detention switch)

16. Telescopic motor

19. Sliding limit switch

I. View with center console assembly is removed.

L. View with seat cushion pad is removed.

14. Parking brake switch

17. Tilt motor

20. Power walk-in switch

J. View with instrument driver lower panel is removed.

AUTOMATIC DRIVE POSITIONER SYSTEM

< SYSTEM DESCRIPTION >

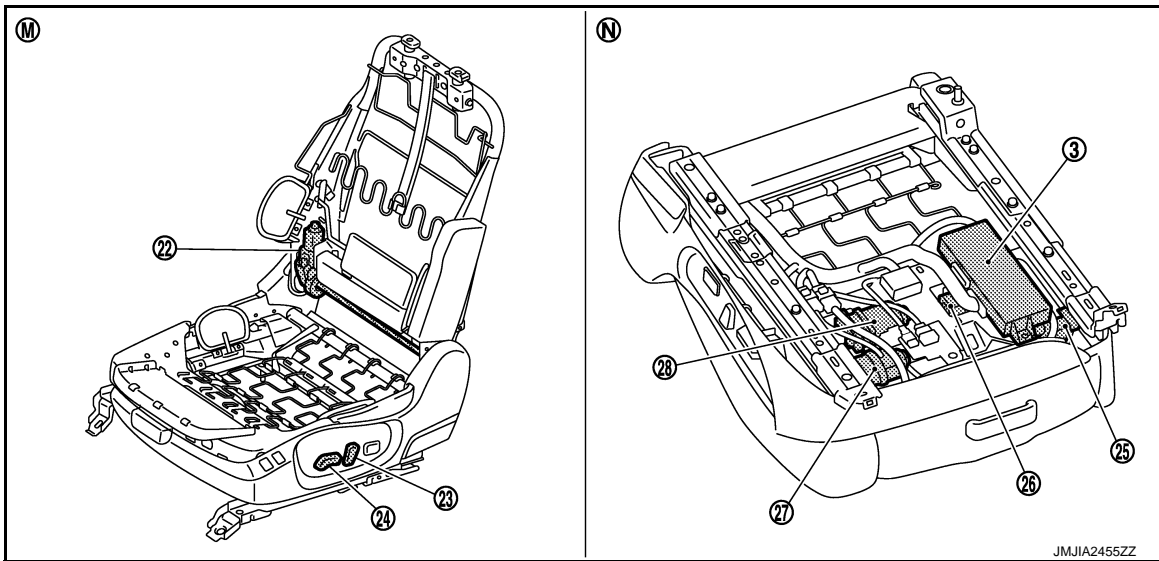

- | | | |
|--------------------------|---|--|
| 22. Reclining motor | 23. Reclining switch
(Power seat switch) | 24. Sliding, lifting switch
(Power seat switch) |
| 25. Sliding sensor | 26. Lifting motor (front) | 27. Sliding motor |
| 28. Lifting motor (rear) | | |
- M. View with seat cushion pad and seat-back pad are removed. N. Backside of seat cushion

POWER WALK-IN FUNCTION : Component Description

INFOID:000000006471480

CONTROL UNITS

Item	Function
Driver seat control unit	<ul style="list-style-type: none"> Main units of automatic drive positioner system It is connected to the CAN. It communicates with the automatic drive positioner control unit via UART communication.
BCM	Transmit the following status to the driver seat control unit via CAN communication. <ul style="list-style-type: none"> Driver door: OPEN/CLOSE Starter: CRANKING/OTHER
Unified meter and A/C amp.	Transmit the vehicle speed signal to the driver seat control unit via CAN communication.

INPUT PARTS

Switches

Item	Function
Front door switch (driver side)	Detect front door (driver side) open/close status.
Power walk-in switch	Perform the power walk-in operation by operating the power walk-in switch.
Sliding limit switch	Detect the front end position of seat sliding during the power walk-in function forward operation.
Seat belt buckle switch	Detect the seat belt fastening/releasing condition.
Forward switch	Detect the folded up/folded down condition of seatback that is the operation condition of power walk-in function.

Sensors

Item	Function
Sliding sensor	Detect the forward/backward position of seat.

A
B
C
D
E
F
G
H
I
K
L
M
N
O
P

ADP

AUTOMATIC DRIVE POSITIONER SYSTEM

< SYSTEM DESCRIPTION >

OUTPUT PARTS

Item	Function
Sliding motor	Slide the seat forward/backward.

DIAGNOSIS SYSTEM (DRIVER SEAT C/U)

< SYSTEM DESCRIPTION >

DIAGNOSIS SYSTEM (DRIVER SEAT C/U)

Diagnosis Description

INFOID:000000006471481

The automatic drive positioner system can be checked and diagnosed for component operation using CONSULT-III.

DIAGNOSTIC MODE

Diagnostic mode	Description
SELF-DIAG RESULTS	Performs self-diagnosis for the auto drive positioner system and displays the results.
DATA MONITOR	Displays input signals transmitted from various switches and sensors to driver seat control unit in real time.
CAN DIAG SUPPORT MNTR	The result of transmit/receive diagnosis of CAN communication can be read.
ACTIVE TEST	Drives each output device.
ECU PART NUMBER	Displays part numbers of driver seat control unit.

CONSULT-III Function

INFOID:000000006471482

SELF DIAGNOSTIC RESULTS

Refer to [ADP-165, "DTC Index"](#).

DATA MONITOR

Monitor Item	Unit	Main Signals	Selection From Menu	Contents
SET SW	"ON/OFF"	×	×	ON/OFF status judged from the setting switch signal.
MEMORY SW 1	"ON/OFF"	×	×	ON/OFF status judged from the seat memory switch 1 signal.
MEMORY SW 2	"ON/OFF"	×	×	ON/OFF status judged from the seat memory switch 2 signal.
SLIDE SW-FR*3	"ON/OFF"	×	×	ON/OFF status judged from the sliding switch (forward) signal.
SLIDE SW-RR*3	"ON/OFF"	×	×	ON/OFF status judged from the sliding switch (backward) signal.
RECLN SW-FR*3	"ON/OFF"	×	×	ON/OFF status judged from the reclining switch (forward) signal.
RECLN SW-RR*3	"ON/OFF"	×	×	ON/OFF status judged from the reclining switch (backward) signal.
LIFT FR SW-UP*3	"ON/OFF"	×	×	ON/OFF status judged from the lifting switch front (upward) signal.
LIFT FR SW-DN*3	"ON/OFF"	×	×	ON/OFF status judged from the lifting switch front (downward) signal.
LIFT RR SW-UP*3	"ON/OFF"	×	×	ON/OFF status judged from the lifting switch rear (upward) signal.
LIFT RR SW-DN*3	"ON/OFF"	×	×	ON/OFF status judged from the lifting switch rear (downward) signal.
MIR CON SW-UP	"ON/OFF"	×	×	ON/OFF status judged from the mirror switch (upward) signal.
MIR CON SW-DN	"ON/OFF"	×	×	ON/OFF status judged from the mirror switch (downward) signal.
MIR CON SW-RH	"ON/OFF"	×	×	ON/OFF status judged from the door mirror remote control switch (passenger side) signal.
MIR CON SW-LH	"ON/OFF"	×	×	ON/OFF status judged from the door mirror remote control switch (driver side) signal.
MIR CHNG SW-R	"ON/OFF"	×	×	ON/OFF status judged from the door mirror remote control switch (switching to right) signal.
MIR CHNG SW-L	"ON/OFF"	×	×	ON/OFF status judged from the door mirror remote control switch (switching to left) signal.

DIAGNOSIS SYSTEM (DRIVER SEAT C/U)

< SYSTEM DESCRIPTION >

Monitor Item	Unit	Main Signals	Selection From Menu	Contents
TILT SW-UP	"ON/OFF"	×	×	ON/OFF status judged from the tilt switch (upward) signal.
TILT SW-DOWN	"ON/OFF"	×	×	ON/OFF status judged from the tilt switch (downward) signal.
TELESCO SW-FR	"ON/OFF"	×	×	ON/OFF status judged from the telescoping switch (forward) signal.
TELESCO SW-RR	"ON/OFF"	×	×	ON/OFF status judged from the telescoping switch (backward) signal.
FORWARD SW*3	"ON/OFF"	×	×	ON/OFF status judged from the forward switch signal.
WALK-IN SW*3	"ON/OFF"	×	×	ON/OFF status judged from the power walk-in switch signal.
FWD LIMIT SW*3	"ON/OFF"	×	×	ON/OFF status judged from the sliding limit switch signal.
SEAT BELT SW*3	"ON/OFF"	×	×	ON/OFF status judged from the seat belt buckle switch signal.
DETENT SW*1	"ON/OFF"	×	×	The selector lever position "OFF (P position) / ON (other than the P position)" judged from the detention switch signal.
PARK BRAKE SW*2	"ON/OFF"	×	×	The parking brake condition "ON (applied) / OFF (release)" judged from the parking brake switch signal.
STARTER SW	"ON/OFF"	×	×	Ignition key switch ON (START, ON) /OFF (ACC, OFF) status judged from the ignition switch signal.
SLIDE PULSE*3	—	—	×	Value (32768) when battery connections are standard. If it moves backward, the value increases. If it moves forward, the value decreases.
RECLN PULS*4	—	—	×	Value (32768) when battery connections are standard. If it moves backward, the value increases. If it moves forward, the value decreases.
LIFT FR PULSE*4	—	—	×	Value (32768) when battery connections are standard. If it moves DOWN, the value increases. If it moves UP, the value decreases.
LIFT RR PULSE*4	—	—	×	Value (32768) when battery connections are standard. If it moves DOWN, the value increases. If it moves UP, the value decreases.
MIR/SEN RH U-D	"V"	—	×	Voltage input from door mirror sensor (passenger side) upward/downward is displayed.
MIR/SEN RH R-L	"V"	—	×	Voltage input from door mirror sensor (passenger side) leftward/rightward is displayed.
MIR/SEN LH U-D	"V"	—	×	Voltage input from door mirror sensor (driver side) upward/downward is displayed.
MIR/SEN LH R-L	"V"	—	×	Voltage input from door mirror sensor (driver side) leftward/rightward is displayed.
TILT SEN	"V"	—	×	Voltage input from tilt sensor upward/downward is displayed.
TELESCO SEN	"V"	—	×	Voltage input from telescopic sensor forward/backward is displayed.

*1: M/T models display all item except this item.

*2: A/T models display all item except this item.

*3: Only this item is displayed for driver seat without automatic drive positioner system.

*4: It is displayed but is not operated for models with driver seat without automatic driver positioner system.

ACTIVE TEST

CAUTION:

When driving vehicle, never perform active test.

Test item	Description
SEAT SLIDE	Activates/deactivates the sliding motor.
SEAT RECLINING	Activates/deactivates the reclining motor.

DIAGNOSIS SYSTEM (DRIVER SEAT C/U)

< SYSTEM DESCRIPTION >

Test item	Description
SEAT LIFTER FR	Activates/deactivates the lifting motor (front).
SEAT LIFTER RR	Activates/deactivates the lifting motor (rear).
TILT MOTOR*	Activates/deactivates the tilt motor.
TELESCO MOTOR*	Activates/deactivates the telescopic motor.
MIRROR MOTOR RH*	Activates/deactivates the mirror motor (passenger side).
MIRROR MOTOR LH*	Activates/deactivates the mirror motor (driver side).
MEMORY SW INDCTR*	Turns ON/OFF the memory indicator.

*: Does not display without automatic driver position system.

A
B
C
D
E
F
G
H
I
K
L
M
N
O
P

ADP

U1000 CAN COMM CIRCUIT

< DTC/CIRCUIT DIAGNOSIS >

DTC/CIRCUIT DIAGNOSIS

U1000 CAN COMM CIRCUIT

Description

INFOID:000000006471483

CAN (Controller Area Network) is a serial communication line for real time applications. It is an on-vehicle multiplex communication line with high data communication speed and excellent error detection ability. Modern vehicle is equipped with many electronic control unit, and each control unit shares information and links with other control units during operation (not independent). In CAN communication, control units are connected with 2 communication lines (CAN H-line, CAN L-line) allowing a high rate of information transmission with less wiring. Each control unit transmits/receives data but selectively reads required data only.

DTC Logic

INFOID:000000006471484

DTC DETECTION LOGIC

DTC No.	Trouble diagnosis name	DTC detecting condition	Possible cause
U1000	CAN COMM CIRCUIT	<ul style="list-style-type: none">Driver seat control unit cannot communicate to other control units.Driver seat control unit cannot communicate for more than the specified time.	Harness or connectors (CAN communication line is open or shorted)

DTC CONFIRMATION PROCEDURE

1.STEP 1

1. Turn ignition switch ON and wait for 3 seconds or more.
2. Check "Self diagnostic result" using CONSULT-III.

Is the DTC detected?

- YES >> Perform diagnosis procedure. Refer to [ADP-48, "Diagnosis Procedure"](#).
NO >> INSPECTION END

Diagnosis Procedure

INFOID:000000006471485

Refer to [LAN-14, "Trouble Diagnosis Flow Chart"](#).

Special Repair Requirement

INFOID:000000006471486

Refer to [ADP-10, "SYSTEM INITIALIZATION : Description"](#).

B2112 SLIDING MOTOR

< DTC/CIRCUIT DIAGNOSIS >

B2112 SLIDING MOTOR

Description

INFOID:000000006471487

- The seat sliding motor is installed to the seat cushion frame.
- The seat sliding motor is installed with the driver seat control unit.
- Slides the seat forward/ rearward by changing the rotation direction of sliding motor.

DTC Logic

INFOID:000000006471488

DTC DETECTION LOGIC

NOTE:

First perform diagnosis for B2126 if B2126 is detected.

DTC No.	Trouble diagnosis name	DTC detecting condition	Possible cause
B2112	SEAT SLIDE	The driver seat control unit detects the output of sliding motor output terminal for 0.1 second or more even if the sliding switch is not input.	<ul style="list-style-type: none">• Driver seat control unit• Slide motor harness is power shorted

DTC CONFIRMATION PROCEDURE

1. PERFORM DTC CONFIRMATION PROCEDURE

1. Turn ignition switch ON.
2. Check "Self diagnostic result" using CONSULT-III.

Is the DTC detected?

- YES >> Perform diagnosis procedure. Refer to [ADP-49, "Diagnosis Procedure"](#).
NO >> INSPECTION END

Diagnosis Procedure

INFOID:000000006471489

1. CHECK SLIDING MOTOR CIRCUIT (POWER SHORT)

ADP

1. Turn ignition switch OFF.
2. Disconnect sliding motor and driver seat control unit connector.
3. Check voltage between sliding motor harness connector and ground.

(+)		(-)	Voltage (V) (Approx.)
Sliding motor			
Connector	Terminals	Ground	0
B525	35		
	42		

Is the inspection result normal?

- YES >> GO TO 2.
NO >> Repair or replace harness.

2. CHECK DRIVER SEAT CONTROL UNIT OUTPUT SIGNAL

1. Connect driver seat control unit connector.
2. Check voltage between driver seat control unit harness connector and ground.

(+)		(-)	Voltage (V) (Approx.)
Driver seat control unit			
Connector	Terminals	Ground	0
B525	35		
	42		

Is the inspection result normal?

B2112 SLIDING MOTOR

< DTC/CIRCUIT DIAGNOSIS >

YES >> GO TO 3.

NO >> Replace driver seat control unit. Refer to [ADP-236, "Removal and Installation"](#)

3.CHECK INTERMITTENT INCIDENT

Refer to [GI-43, "Intermittent Incident"](#).

>> INSPECTION END

B2113 RECLINING MOTOR

< DTC/CIRCUIT DIAGNOSIS >

B2113 RECLINING MOTOR

Description

INFOID:000000006471490

- The seat reclining motor is installed to the seatback frame.
- The seat reclining motor is activated with the driver seat control unit.
- Tilts the seatback frontward/rearward by changing the rotation direction of reclining motor.

DTC Logic

INFOID:000000006471491

DTC DETECTION LOGIC

NOTE:

First perform diagnosis for B2126 if B2126 is detected.

DTC No.	Trouble diagnosis name	DTC detecting condition	Possible cause
B2113	SEAT RECLINING	The driver seat control unit detects the output of reclining motor output terminal for 0.1 second or more even if the reclining switch is not input.	<ul style="list-style-type: none">• Driver seat control unit• Reclining motor harness is power shorted

DTC CONFIRMATION PROCEDURE

1. PERFORM DTC CONFIRMATION PROCEDURE

1. Turn ignition switch ON.
2. Check "Self diagnostic result" using CONSULT-III.

Is the DTC detected?

- YES >> Perform diagnosis procedure. Refer to [ADP-51, "Diagnosis Procedure"](#).
NO >> INSPECTION END

Diagnosis Procedure

INFOID:000000006471492

1. CHECK RECLINING MOTOR CIRCUIT (POWER SHORT)

1. Turn ignition switch OFF.
2. Disconnect reclining motor and driver seat control unit connector.
3. Check voltage between reclining motor harness connector and ground.

(+)		(-)	Voltage (V) (Approx.)
Reclining motor			
Connector	Terminals	Ground	0
B523	36		
	44		

Is the inspection result normal?

- YES >> GO TO 2.
NO >> Repair or replace harness.

2. CHECK DRIVER SEAT CONTROL UNIT OUTPUT SIGNAL

1. Connect driver seat control unit connector.
2. Check voltage between driver seat control unit harness connector and ground.

(+)		(-)	Voltage (V) (Approx.)
Driver seat control unit			
Connector	Terminals	Ground	0
B523	36		
	44		

Is the inspection result normal?

B2113 RECLINING MOTOR

< DTC/CIRCUIT DIAGNOSIS >

YES >> GO TO 3.

NO >> Replace driver seat control unit. Refer to [ADP-236, "Removal and Installation"](#).

3.CHECK INTERMITTENT INCIDENT

Refer to [GI-43, "Intermittent Incident"](#).

>> INSPECTION END

B2118 TILT SENSOR

< DTC/CIRCUIT DIAGNOSIS >

B2118 TILT SENSOR

Description

INFOID:000000006471493

- The tilt sensor is installed to the steering column assembly.
- The resistance of tilt sensor is changed according to the up/down position of steering column.
- The terminal voltage of automatic drive positioner control unit will be changed according to a change of tilt sensor resistance. Automatic drive positioner control unit calculates the tilt position from the voltage.

DTC Logic

INFOID:000000006471494

DTC DETECTION LOGIC

DTC No.	Trouble diagnosis name	DTC detecting condition	Possible cause
B2118	TILT SENSOR	The input voltage of tilt sensor is less than 0.1V or more than 4.9V.	<ul style="list-style-type: none"> • Harness and connectors (Tilt sensor circuit is opened/shorted, tilt sensor power supply circuit is opened/shorted.) • Tilt sensor

DTC CONFIRMATION PROCEDURE

1.PERFORM DTC CONFIRMATION PROCEDURE

1. Turn ignition switch ON.
2. Check "Self diagnostic result" using CONSULT-III.

Is the DTC detected?

- YES >> Perform diagnosis procedure. Refer to [ADP-53. "Diagnosis Procedure"](#).
 NO >> INSPECTION END

Diagnosis Procedure

INFOID:000000006471495

1.CHECK TILT SENSOR SIGNAL

1. Turn ignition switch ON.
2. Select "TILT SEN" in the "Data monitor" mode using CONSULT-III.
3. Check tilt sensor signal under the following condition.

Monitor item	Condition	Value
TILT SEN	Tilt position	Change between 1.1 V (close to top) 3.9 V (close to bottom)

Is the value normal?

- YES >> GO TO 6.
 NO >> GO TO 2.

2.CHECK TILT SENSOR CIRCUIT

1. Turn ignition switch OFF.
2. Disconnect automatic drive positioner control unit and tilt & telescopic sensor connector.
3. Check continuity between automatic drive positioner control unit harness connector and tilt & telescopic sensor harness connector.

Automatic drive positioner control unit		Tilt & telescopic sensor		Continuity
Connector	Terminal	Connector	Terminal	
M51	7	M48	3	Existed

4. Check continuity between automatic drive positioner control unit harness connector and ground.

A
B
C
D
E
F
G
H
I
K
L
M
N
O
P

ADP

B2118 TILT SENSOR

< DTC/CIRCUIT DIAGNOSIS >

Automatic drive positioner control unit		Ground	Continuity
Connector	Terminal		
M51	7		Not existed

Is the inspection result normal?

- YES >> GO TO 3.
NO >> Repair or replace harness.

3. CHECK TILT SENSOR POWER SUPPLY

1. Connect automatic drive positioner control unit connector.
2. Turn ignition switch ON.
3. Check voltage between tilt & telescopic sensor harness connector and ground.

(+)		(-)	Voltage (V) (Approx.)
Tilt & telescopic sensor			
Connector	Terminal		
M48	1	Ground	5

Is the inspection result normal?

- YES >> GO TO 5.
NO >> GO TO 4.

4. CHECK TILT SENSOR POWER SUPPLY CIRCUIT

1. Turn ignition switch OFF.
2. Disconnect automatic drive positioner control unit connector.
3. Check continuity between automatic drive positioner control unit harness connector and tilt & telescopic sensor harness connector.

Automatic drive positioner control unit		Tilt & telescopic sensor		Continuity
Connector	Terminal	Connector	Terminal	
M52	33	M48	1	Existed

4. Check continuity between automatic drive positioner control unit harness connector and ground.

Automatic drive positioner control unit		Ground	Continuity
Connector	Terminal		
M52	33		Not existed

Is the inspection result normal?

- YES >> Replace automatic drive positioner control unit. Refer to [ADP-237, "Removal and Installation"](#).
NO >> Repair or replace harness.

5. CHECK TILT SENSOR GROUND CIRCUIT

1. Turn ignition switch OFF.
2. Disconnect automatic drive positioner control unit connector.
3. Check continuity between automatic drive positioner control unit harness connector and tilt & telescopic sensor harness connector.

Automatic drive positioner control unit		Tilt & telescopic sensor		Continuity
Connector	Terminal	Connector	Terminal	
M52	41	M48	4	Existed

Is the inspection result normal?

- YES >> Replace tilt & telescopic sensor.
NO >> Repair or replace harness.

6. CHECK INTERMITTENT INCIDENT

Refer to [GI-43, "Intermittent Incident"](#).

B2118 TILT SENSOR

< DTC/CIRCUIT DIAGNOSIS >

>> INSPECTION END

A

B

C

D

E

F

G

H

I

ADP

K

L

M

N

O

P

B2119 TELESCOPIC SENSOR

< DTC/CIRCUIT DIAGNOSIS >

B2119 TELESCOPIC SENSOR

Description

INFOID:000000006471496

- The telescopic sensor is installed to the steering column assembly.
- The resistance of telescopic sensor is changed according to the forward/backward position of steering column.
- The terminal voltage of automatic drive positioner control unit will be changed according to a change of telescopic sensor resistance. Automatic drive positioner control unit calculates the telescopic position from the voltage.

DTC Logic

INFOID:000000006471497

DTC DETECTION LOGIC

DTC No.	Trouble diagnosis name	DTC detecting condition	Possible cause
B2119	TELESCOPIC SENSOR	The input voltage of telescopic sensor is less than 0.1V or more than 4.9V.	<ul style="list-style-type: none">• Harness and connectors (Telescopic sensor circuit is opened/shorted, telescopic sensor power supply circuit is opened/shorted.)• Telescopic sensor

DTC CONFIRMATION PROCEDURE

1. PERFORM DTC CONFIRMATION PROCEDURE

1. Turn ignition switch ON.
2. Check "Self diagnostic result" using CONSULT-III.

Is the DTC is detected?

- YES >> Perform diagnosis procedure. Refer to [ADP-56. "Diagnosis Procedure"](#).
NO >> INSPECTION END

Diagnosis Procedure

INFOID:000000006471498

1. CHECK TELESCOPIC SENSOR SIGNAL

1. Turn ignition switch ON.
2. Select "TELESCO SEN" in the "Data monitor" mode using CONSULT-III.
3. Check the tilt sensor signal under the following condition.

Monitor item	Condition	Value
TELESCO SEN	Telescopic position	Change between 0.5 V (close to top) 4.5 V (close to bottom)

Is the valve normal?

- YES >> GO TO 6.
NO >> GO TO 2.

2. CHECK TELESCOPIC SENSOR CIRCUIT

1. Turn ignition switch OFF.
2. Disconnect automatic drive positioner control unit and tilt & telescopic sensor connector.
3. Check continuity between automatic drive positioner control unit harness connector and tilt & telescopic sensor harness connector.

Automatic drive positioner control unit		Tilt & telescopic sensor		Continuity
Connector	Terminal	Connector	Terminal	
M51	23	M48	2	Existed

4. Check continuity between automatic drive positioner control unit harness connector and ground.

B2119 TELESCOPIC SENSOR

< DTC/CIRCUIT DIAGNOSIS >

Automatic drive positioner control unit		Ground	Continuity
Connector	Terminal		
M51	23		Not existed

Is the inspection result normal?

YES >> GO TO 3.

NO >> Repair or replace harness.

3.CHECK TELESCOPIC SENSOR POWER SUPPLY

1. Connect automatic drive positioner control unit connector.
2. Turn ignition switch ON.
3. Check voltage between tilt & telescopic sensor harness connector and ground.

(+)		(-)	Voltage (V) (Approx.)
Tilt & telescopic sensor			
Connector	Terminal		
M48	1	Ground	5

Is the inspection result normal?

YES >> GO TO 5.

NO >> GO TO 4.

4.CHECK TELESCOPIC SENSOR POWER SUPPLY CIRCUIT

1. Turn ignition switch OFF.
2. Disconnect automatic drive positioner control unit connector.
3. Check continuity between automatic drive positioner control unit harness connector and tilt & telescopic sensor harness connector.

Automatic drive positioner control unit		Tilt & telescopic sensor		Continuity
Connector	Terminal	Connector	Terminal	
M52	33	M48	1	Existed

4. Check continuity between automatic drive positioner control unit harness connector and ground.

Automatic drive positioner control unit		Ground	Continuity
Connector	Terminal		
M52	33		Not existed

Is the inspection result normal?

YES >> Replace automatic drive positioner control unit. Refer to [ADP-237, "Removal and Installation"](#).

NO >> Repair or replace harness.

5.CHECK TELESCOPIC SENSOR GROUND CIRCUIT

1. Turn ignition switch OFF.
2. Disconnect automatic drive positioner control unit connector.
3. Check continuity between automatic drive positioner control unit harness connector and tilt & telescopic sensor harness connector.

Automatic drive positioner control unit		Tilt & telescopic sensor		Continuity
Connector	Terminal	Connector	Terminal	
M52	41	M48	4	Existed

Is the inspection result normal?

YES >> Replace tilt & telescopic sensor.

NO >> Repair or replace harness.

6.CHECK INTERMITTENT INCIDENT

Refer to [GI-43, "Intermittent Incident"](#).

B2119 TELESCOPIC SENSOR

< DTC/CIRCUIT DIAGNOSIS >

>> INSPECTION END

B2126 DETENT SW

< DTC/CIRCUIT DIAGNOSIS >

B2126 DETENT SW

Description

INFOID:000000006471499

- Detention switch is installed on A/T shift selector. It is turned OFF when the A/T selector lever is in P position.
- The driver seat control unit judges that the A/T selector lever is in P position if continuity does not exist in this circuit.

DTC Logic

INFOID:000000006471500

DTC DETECTION LOGIC

DTC No.	Trouble diagnosis name	DTC detecting condition	Possible cause
B2126	DETENT SW	Selector lever is in P position and the vehicle speed of 7 ± 4 km/h is detected.	<ul style="list-style-type: none"> • Harness and connectors (Detention switch circuit is opened/shorted.) • Detention switch • Unified meter and A/C amp. (CAN communication)

DTC CONFIRMATION PROCEDURE

1. PERFORM DTC CONFIRMATION PROCEDURE

1. Drive the vehicle at 7 ± 4 km/h or more.
2. Check "Self diagnostic result" using CONSULT-III.

Is the DTC detected?

- YES >> Perform diagnosis procedure. Refer to [ADP-59, "Diagnosis Procedure"](#).
 NO >> INSPECTION END

Diagnosis Procedure

INFOID:000000006471501

ADP

1. CHECK DTC WITH "BCM"

Check "Self diagnostic result" for BCM using CONSULT-III.

Is the either DTC B2601, B2602, B2603, B2604 or B2605 detected?

- YES >> Check the DTC. Refer to [BCS-75, "DTC Index"](#).
 NO >> GO TO 2.

2. CHECK DTC WITH "METER/M&A"

Check "Self diagnostic result" for METER/M&A using CONSULT-III.

Is the DTC detected?

- YES >> Check the DTC. Refer to [MWI-103, "DTC Index"](#).
 NO >> GO TO 3.

3. CHECK DETENTION SWITCH SIGNAL

1. Turn ignition switch ON.
2. Select "DETENT SW" in the "Data Monitor" mode using CONSULT-III.
3. Check detention switch signal under the following condition.

Monitor item	Condition		Status
DETENT SW	selector lever	P position	OFF
		Other than above	ON

Is the status normal?

- YES >> GO TO 5.
 NO >> GO TO 4.

4. CHECK DETENTION SWITCH CIRCUIT

B2126 DETENT SW

< DTC/CIRCUIT DIAGNOSIS >

1. Turn ignition switch OFF.
2. Disconnect driver seat control unit connector and A/T shift selector connector.
3. Check continuity between driver seat control unit harness connector and A/T shift selector harness connector.

Driver seat control unit		A/T shift selector		Continuity
Connector	Terminal	Connector	Terminal	
B503	21	M137	11	Existed

4. Check continuity between driver seat control unit harness connector and ground.

Driver seat control unit		Ground	Continuity
Connector	Terminal		
B503	21		Not existed

Is the inspection result normal?

YES >> Replace driver seat control unit. Refer to [ADP-236, "Removal and Installation"](#).

NO >> Repair or replace harness.

5. CHECK INTERMITTENT INCIDENT

Refer to [GI-43, "Intermittent Incident"](#).

>> INSPECTION END

B2127 PARKING BRAKE SWITCH

< DTC/CIRCUIT DIAGNOSIS >

B2127 PARKING BRAKE SWITCH

Description

INFOID:000000006471502

- Parking brake switch is installed on parking brake lever. It is turned ON when the parking brake is applied.
- The driver seat control unit judges that the parking brake is engaged if continuity exists in this circuit.

DTC Logic

INFOID:000000006471503

DTC DETECTION LOGIC

DTC No.	Trouble diagnosis name	DTC detecting condition	Possible cause
B2127	PARKING BRAKE	Parking brake is engaged and the vehicle speed of 7 km/h (4MPH) or more is detected.	<ul style="list-style-type: none">• Harness and connectors (Parking brake switch circuit is opened/shorted.)• Parking brake switch• Combination meter (CAN communication)• Driver seat control unit

DTC CONFIRMATION PROCEDURE

1. STEP 1

1. Drive the vehicle at 7 km/h (4 MPH) or more.
2. Check "Self Diagnostic Result" using CONSULT-III.

Is the DTC detected?

- YES >> Perform diagnosis procedure. Refer to [ADP-61, "Diagnosis Procedure"](#).
NO >> INSPECTION END

Diagnosis Procedure

INFOID:000000006471504

1. CHECK PARKING BRAKE SWITCH SIGNAL

ADP

1. Turn ignition switch ON.
2. Select "PARK BRAKE SW" in the "Data Monitor" mode using CONSULT-III.
3. Check parking brake switch signal under the following condition.

Monitor item	Condition		Status
PARK BRAKE SW	Parking brake	Applied	ON
		Release	OFF

Is the status normal?

- YES >> GO TO 5.
NO >> GO TO 2.

2. CHECK PARKING BRAKE SWITCH INPUT SIGNAL

1. Turn ignition switch OFF.
2. Disconnect parking brake switch harness connector.
3. Turn ignition switch ON.
4. Check voltage between parking brake switch harness connector and ground.

(+)		(-)	Voltage (V) (Approx.)
Connector	Terminal		
B14	1	Ground	Battery voltage

Is the inspection result normal?

- YES >> GO TO 4.
NO >> GO TO 3.

B2127 PARKING BRAKE SWITCH

< DTC/CIRCUIT DIAGNOSIS >

3. CHECK PARKING BRAKE SWITCH HARNESS CONTINUITY

1. Turn ignition switch OFF.
2. Disconnect driver seat control unit connector and parking brake switch connector.
3. Check continuity between driver seat control unit harness connector and parking brake switch harness connector.

Driver seat control unit		Parking brake switch		Continuity
Connector	Terminal	Connector	Terminal	
B503	8	B14	1	Existed

4. Check continuity between driver seat control unit harness connector and ground.

Driver seat control unit		Ground	Continuity
Connector	Terminal		
B503	8		Not existed

Is the inspection result normal?

- YES >> Replace driver seat control unit. Refer to [ADP-236, "Removal and Installation"](#).
 NO >> Repair or replace harness.

4. CHECK PARKING BRAKE SWITCH

Refer to [ADP-62, "Component Inspection"](#).

Is the inspection result normal?

- YES >> GO TO 5.
 NO >> Adjust or replace parking brake switch.

5. CHECK INTERMITTENT INCIDENT

Refer to [GI-43, "Intermittent Incident"](#).

>> INSPECTION END

Component Inspection

INFOID:000000006471505

1. CHECK PARKING BRAKE SWITCH

1. Turn ignition switch OFF.
2. Disconnect parking brake switch connector.
3. Check continuity between parking brake switch terminal and ground part of parking brake switch.

Terminal		Condition	Continuity
Parking brake switch			
1	Ground part of parking brake switch	Parking brake	Applied Existed
			Other than above Not existed

Is the inspection result normal?

- YES >> INSPECTION END
 NO >> Adjust or replace parking brake switch.

B2128 UART COMMUNICATION LINE

< DTC/CIRCUIT DIAGNOSIS >

B2128 UART COMMUNICATION LINE

Description

INFOID:000000006471506

Driver seat control unit performs UART communication with the automatic drive positioner control unit using 2 communication lines, TX and RX line. Driver seat control unit receives the operation signals of tilt & telescopic switch, door mirror remote control switch, set switch and memory switch and the position signals of tilt & telescopic sensor and door mirror sensor from the automatic drive positioner control unit and transmits the operation request signal.

DTC Logic

INFOID:000000006471507

DTC DETECTION LOGIC

DTC No.	Trouble diagnosis name	DTC detecting condition	Possible cause
B2128	UART COMM	The communication between driver seat control unit and auto drive positioner control unit is interrupted for a period of time.	<ul style="list-style-type: none">• UART communication line (UART communication line is open or shorted)• Driver seat control unit• Automatic drive positioner control unit

DTC CONFIRMATION PROCEDURE

1.PERFORM DTC CONFIRMATION PROCEDURE

1. Turn ignition switch ON.
2. Operate tilt & telescopic switch for more than 2 seconds.
3. Check "Self diagnostic result" using CONSULT-III.

Is the DTC detected?

- YES >> Perform diagnosis procedure. Refer to [ADP-63, "Diagnosis Procedure"](#).
NO >> INSPECTION END

Diagnosis Procedure

INFOID:000000006471508

ADP

1.CHECK UART COMMUNICATION LINE CONTINUITY

1. Turn ignition switch OFF.
2. Disconnect driver seat control unit and automatic drive positioner control unit connector.
3. Check continuity between driver seat control unit harness connector and automatic drive positioner control unit harness connector.

Driver seat control unit		Automatic drive positioner control unit		Continuity
Connector	Terminal	Connector	Terminal	
B503	1	M51	10	Existed
	17		26	

4. Check continuity between driver seat control unit harness connector and ground.

Driver seat control unit		Ground	Continuity
Connector	Terminal		
B503	1		Not existed
	17		

Is the inspection result normal?

- YES >> Check intermittent incident. Refer to [GI-43, "Intermittent Incident"](#).
NO >> Repair or replace harness.

POWER SUPPLY AND GROUND CIRCUIT

< DTC/CIRCUIT DIAGNOSIS >

POWER SUPPLY AND GROUND CIRCUIT

BCM

BCM : Diagnosis Procedure

INFOID:000000006471509

1. CHECK FUSE AND FUSIBLE LINK

Check that the following fuse and fusible link are not blown.

Signal name	Fuse and fusible link No.
Battery power supply	K (40A)
	10 (10A)

Is the fuse fusing?

YES >> Replace the blown fuse or fusible link after repairing the affected circuit if a fuse or fusible link is blown.

NO >> GO TO 2.

2. CHECK POWER SUPPLY CIRCUIT

1. Turn ignition switch OFF.
2. Disconnect BCM connectors.
3. Check voltage between BCM harness connector and ground.

(+)		(-)	Voltage (Approx.)
BCM			
Connector	Terminal	Ground	Battery voltage
M118	1		
M119	11		

Is the measurement value normal?

YES >> GO TO 3.

NO >> Repair harness or connector.

3. CHECK GROUND CIRCUIT

Check continuity between BCM harness connector and ground.

BCM		Ground	Continuity
Connector	Terminal		
M119	13		Existed

Does continuity exist?

YES >> INSPECTION END

NO >> Repair harness or connector.

DRIVER SEAT CONTROL UNIT

DRIVER SEAT CONTROL UNIT : Diagnosis Procedure

INFOID:000000006471510

NOTE:

Do not disconnect the battery negative terminal and the driver seat control unit connector until DTC is confirmed using CONSULT-III.

1. CHECK POWER SUPPLY CIRCUIT

1. Turn ignition switch OFF.
2. Check voltage between driver seat control unit harness connector and ground.

POWER SUPPLY AND GROUND CIRCUIT

< DTC/CIRCUIT DIAGNOSIS >

(+)		(-)	Voltage (V) (Approx.)
Driver seat control unit			
Connector	Terminal	Ground	Battery voltage
B504	33		
	40		

Is the inspection result normal?

YES >> GO TO 2.

NO >> Check the following.

- Repair or replace harness between driver seat control unit and fuse block (J/B).
- Circuit breaker.

2.CHECK GROUND CIRCUIT

Check continuity between the driver seat control unit harness connector and ground.

Driver seat control unit		Ground	Continuity
Connector	Terminal		Existed
B503	32		
B504	48		

Is the inspection result normal?

YES >> INSPECTION END

NO >> Repair or replace harness.

DRIVER SEAT CONTROL UNIT : Special Repair Requirement

INFOID:000000006471511

1.PERFORM ADDITIONAL SERVICE

Perform additional service when removing battery negative terminal.

>> Refer to [ADP-64. "DRIVER SEAT CONTROL UNIT : Diagnosis Procedure"](#).

AUTOMATIC DRIVE POSITIONER CONTROL UNIT

AUTOMATIC DRIVE POSITIONER CONTROL UNIT : Diagnosis Procedure

INFOID:000000006471512

NOTE:

Do not disconnect the battery negative terminal and the driver seat control unit connector until DTC is confirmed using CONSULT-III.

1.CHECK POWER SUPPLY CIRCUIT

1. Turn ignition switch OFF.
2. Check voltage between automatic drive positioner control unit harness connector and ground.

(+)		(-)	Voltage (V) (Approx.)
Automatic drive positioner control unit			
Connector	Terminal	Ground	Battery voltage
M52	34		
	39		

Is the inspection result normal?

YES >> GO TO 2.

NO - 1 >> Repair or replace harness between automatic drive positioner control unit and fuse block (J/B).

NO - 2 >> Check circuit breaker.

2.CHECK GROUND CIRCUIT

Check continuity between the automatic drive positioner control unit harness connector and ground.

A
B
C
D
E
F
G
H
I
K
L
M
N
O
P

ADP

POWER SUPPLY AND GROUND CIRCUIT

< DTC/CIRCUIT DIAGNOSIS >

Automatic drive positioner control unit		Ground	Continuity
Connector	Terminal		
M52	40		Existed
	48		

Is the inspection result normal?

YES >> INSPECTION END

NO >> Repair or replace harness.

AUTOMATIC DRIVE POSITIONER CONTROL UNIT : Special Repair Requirement

INFOID:000000006471513

1.PERFORM ADDITIONAL SERVICE

Perform additional service when removing battery negative terminal.

>> Refer to [ADP-9, "ADDITIONAL SERVICE WHEN REMOVING BATTERY NEGATIVE TERMINAL : Description"](#).

SLIDING SWITCH

< DTC/CIRCUIT DIAGNOSIS >

SLIDING SWITCH

Description

INFOID:000000006471514

Sliding switch is equipped to the power seat switch on the seat cushion side surface. The operation signal is input to the driver seat control unit when the sliding switch is operated.

Component Function Check

INFOID:000000006471515

1. CHECK FUNCTION

1. Turn ignition switch ON.
2. Select "SLIDE SW-FR", "SLIDE SW-RR" in the "Data monitor" mode using CONSULT-III.
3. Check sliding switch signal under the following conditions.

Monitor item	Condition		Status
SLIDE SW-FR	Sliding switch (forward)	Operate	ON
		Release	OFF
SLIDE SW-RR	Sliding switch (backward)	Operate	ON
		Release	OFF

Is the indication normal?

YES >> INSPECTION END

NO >> Perform diagnosis procedure. Refer to [ADP-67. "Diagnosis Procedure"](#).

Diagnosis Procedure

INFOID:000000006471516

1. CHECK SLIDING SWITCH SIGNAL

1. Turn ignition switch OFF.
2. Disconnect power seat switch connector.
3. Check voltage between power seat switch harness connector and ground.

(+)		(-)	Voltage (V) (Approx.)
Power seat switch			
Connector	Terminal	Ground	Battery voltage
B510	11		
	26		

Is the inspection result normal?

YES >> GO TO 3.

NO >> GO TO 2.

2. CHECK SLIDING SWITCH CIRCUIT

1. Disconnect driver seat control unit connector.
2. Check continuity between driver seat control unit harness connector and power seat switch harness connector.

Driver seat control unit		Power seat switch		Continuity
Connector	Terminal	Connector	Terminal	
B503	11	B510	11	Existed
	26		26	

3. Check continuity between driver seat control unit harness connector and ground.

SLIDING SWITCH

< DTC/CIRCUIT DIAGNOSIS >

Driver seat control unit		Ground	Continuity
Connector	Terminal		
B503	11		
	26		

Is the inspection result normal?

YES >> Replace driver seat control unit. Refer to [ADP-236, "Removal and Installation"](#).

NO >> Repair or replace harness.

3.CHECK SLIDING SWITCH

Refer to [ADP-68, "Component Inspection"](#).

Is the inspection result normal?

YES >> GO TO 4.

NO >> Replace power seat switch. Refer to [ADP-239, "Removal and Installation"](#).

4.CHECK INTERMITTENT INCIDENT

Refer to [GI-43, "Intermittent Incident"](#).

>> INSPECTION END

Component Inspection

INFOID:000000006471517

1.CHECK SLIDING SWITCH

1. Turn ignition switch OFF.
2. Disconnect power seat switch connector.
3. Check continuity between power seat switch terminals.

Power seat switch		Condition	Continuity	
Terminal				
32	11	Sliding switch (backward)	Operate	Existed
			Release	Not existed
	26	Sliding switch (forward)	Operate	Existed
			Release	Not existed

Is the inspection result normal?

YES >> INSPECTION END

NO >> Replace power seat switch. Refer to [ADP-239, "Removal and Installation"](#).

RECLINING SWITCH

< DTC/CIRCUIT DIAGNOSIS >

RECLINING SWITCH

Description

INFOID:000000006471518

Reclining switch is equipped to the power seat switch on the seat cushion side surface. The operation signal is input to the driver seat control unit when the reclining switch is operated.

Component Function Check

INFOID:000000006471519

1. CHECK FUNCTION

1. Turn ignition switch ON.
2. Select "RECLN SW-FR", "RECLN SW-RR" in the "Data monitor" mode using CONSULT-III.
3. Check reclining switch signal under the following conditions.

Monitor item	Condition	Status	
RECLINE SW-FR	Reclining switch (forward)	Operate	ON
		Release	OFF
RECLINE SW-RR	Reclining switch (backward)	Operate	ON
		Release	OFF

Is the indication normal?

YES >> INSPECTION END

NO >> Perform diagnosis procedure. Refer to [ADP-69. "Diagnosis Procedure"](#).

Diagnosis Procedure

INFOID:000000006471520

1. CHECK RECLINING SWITCH SIGNAL

1. Turn ignition switch OFF.
2. Disconnect power seat switch connector.
3. Check voltage between power seat switch harness connector and ground.

(+)		(-)	Voltage (V) (Approx.)
Power seat switch			
Connector	Terminal	Ground	Battery voltage
B510	12		
	27		

Is the inspection result normal?

YES >> GO TO 3.

NO >> GO TO 2.

2. CHECK RECLINING SWITCH CIRCUIT

1. Disconnect driver seat control unit connector.
2. Check continuity between driver seat control unit harness connector and power seat switch harness connector.

Driver seat control unit		Power seat switch		Continuity
Connector	Terminal	Connector	Terminal	
B503	12	B510	12	Existed
	27		27	

3. Check continuity between driver seat control unit harness connector and ground.

RECLINING SWITCH

< DTC/CIRCUIT DIAGNOSIS >

Driver seat control unit		Ground	Continuity
Connector	Terminal		
B503	12		
	27		

Is the inspection result normal?

YES >> Replace driver seat control unit. Refer to [ADP-236, "Removal and Installation"](#).

NO >> Repair or replace harness.

3.CHECK RECLINING SWITCH

Refer to [ADP-70, "Component Inspection"](#).

Is the inspection result normal?

YES >> GO TO 4.

NO >> Replace power seat switch. Refer to [ADP-239, "Removal and Installation"](#).

4.CHECK INTERMITTENT INCIDENT

Refer to [GI-43, "Intermittent Incident"](#).

>> INSPECTION END

Component Inspection

INFOID:000000006471521

1.CHECK RECLINING SWITCH

1. Turn ignition switch OFF.
2. Disconnect power seat switch connector.
3. Check continuity between power seat switch terminals.

Power seat switch		Condition	Continuity	
Terminal				
32	12	Reclining switch (backward)	Operate	Existed
			Release	Not existed
	27	Reclining switch (forward)	Operate	Existed
			Release	Not existed

Is the inspection result normal?

YES >> INSPECTION END

NO >> Replace power seat switch. Refer to [ADP-239, "Removal and Installation"](#).

LIFTING SWITCH (FRONT)

< DTC/CIRCUIT DIAGNOSIS >

LIFTING SWITCH (FRONT)

Description

INFOID:000000006471522

Lifting switch (front) is equipped to the power seat switch on the seat cushion side surface. The operation signal is input to the driver seat control unit when the lifting switch (front) is operated.

Component Function Check

INFOID:000000006471523

1. CHECK FUNCTION

1. Turn ignition switch ON.
2. Select "LIFT FR SW-UP", "LIFT FR SW-DN" in the "Data monitor" mode using CONSULT-III.
3. Check lifting switch (front) signal under the following conditions.

Monitor item	Condition		Status
LIFT FR SW-UP	Lifting switch front (up)	Operate	ON
		Release	OFF
LIFT FR SW-DN	Lifting switch front (down)	Operate	ON
		Release	OFF

Is the indication normal?

YES >> INSPECTION END

NO >> Perform diagnosis procedure. Refer to [ADP-71, "Diagnosis Procedure"](#).

Diagnosis Procedure

INFOID:000000006471524

1. CHECK LIFTING SWITCH SIGNAL

1. Turn ignition switch OFF.
2. Disconnect power seat switch connector.
3. Check voltage between power seat switch harness connector and ground.

(+)		(-)	Voltage (V) (Approx.)
Power seat switch			
Connector	Terminal	Ground	Battery voltage
B510	13		
	28		

Is the inspection result normal?

YES >> GO TO 3.

NO >> GO TO 2.

2. CHECK LIFTING SWITCH (FRONT) CIRCUIT

1. Disconnect driver seat control unit connector.
2. Check continuity between driver seat control unit harness connector and power seat switch harness connector.

Driver seat control unit		Power seat switch		Continuity
Connector	Terminal	Connector	Terminal	
B503	13	B510	13	Existed
	28		28	

3. Check continuity between driver seat control unit harness connector and ground.

LIFTING SWITCH (FRONT)

< DTC/CIRCUIT DIAGNOSIS >

Driver seat control unit		Ground	Continuity
Connector	Terminal		
B503	13		
	28		

Is the inspection result normal?

YES >> Replace driver seat control unit. Refer to [ADP-236, "Removal and Installation"](#).

NO >> Repair or replace harness.

3.CHECK LIFTING SWITCH (FRONT)

Refer to [ADP-72, "Component Inspection"](#).

Is the inspection result normal?

YES >> GO TO 4.

NO >> Replace power seat switch. Refer to [ADP-239, "Removal and Installation"](#).

4.CHECK INTERMITTENT INCIDENT

Refer to [GI-43, "Intermittent Incident"](#).

>> INSPECTION END

Component Inspection

INFOID:000000006471525

1.CHECK LIFTING SWITCH (FRONT)

1. Turn ignition switch OFF.
2. Disconnect power seat switch connector.
3. Check continuity between power seat switch terminals.

Power seat switch		Condition	Continuity	
Terminal				
32	13	Lifting switch front (down)	Operate	Existed
			Release	Not existed
	28	Lifting switch front (up)	Operate	Existed
			Release	Not existed

Is the inspection result normal?

YES >> INSPECTION END

NO >> Replace power seat switch. Refer to [ADP-239, "Removal and Installation"](#).

LIFTING SWITCH (REAR)

< DTC/CIRCUIT DIAGNOSIS >

LIFTING SWITCH (REAR)

Description

INFOID:000000006471526

Lifting switch (rear) is equipped to the power seat switch on the seat cushion side surface. The operation signal is input to the driver seat control unit when the lifting switch (rear) is operated.

Component Function Check

INFOID:000000006471527

1. CHECK FUNCTION

1. Turn ignition switch ON.
2. Select "LIFT RR SW-UP", "LIFT RR SW-DN" in the "Data monitor" mode using CONSULT-III.
3. Check lifting switch (rear) signal under the following conditions.

Monitor item	Condition		Status
LIFT RR SW-UP	Lifting switch rear (up)	Operate	ON
		Release	OFF
LIFT RR SW-DN	Lifting switch rear (down)	Operate	ON
		Release	OFF

Is the indication normal?

YES >> INSPECTION END

NO >> Perform diagnosis procedure. Refer to [ADP-73. "Diagnosis Procedure"](#).

Diagnosis Procedure

INFOID:000000006471528

1. CHECK LIFTING SWITCH (REAR) SIGNAL

1. Turn ignition switch OFF.
2. Disconnect power seat switch connector.
3. Check voltage between power seat switch harness connector and ground.

(+)		(-)	Voltage (V) (Approx.)
Power seat switch			
Connector	Terminal	Ground	Battery voltage
B510	14		
	29		

Is the inspection result normal?

YES >> GO TO 3.

NO >> GO TO 2.

2. CHECK LIFTING SWITCH (REAR) CIRCUIT

1. Disconnect driver seat control unit connector.
2. Check continuity between driver seat control unit harness connector and power seat switch harness connector.

Driver seat control unit		Power seat switch		Continuity
Connector	Terminal	Connector	Terminal	
B503	14	B510	14	Existed
	29		29	

3. Check continuity between driver seat control unit harness connector and ground.

LIFTING SWITCH (REAR)

< DTC/CIRCUIT DIAGNOSIS >

Driver seat control unit		Ground	Continuity
Connector	Terminal		
B503	14		
	29		

Is the inspection result normal?

YES >> Replace driver seat control unit. Refer to [ADP-236, "Removal and Installation"](#).

NO >> Repair or replace harness.

3.CHECK LIFTING SWITCH (REAR)

Refer to [ADP-74, "Component Inspection"](#).

Is the inspection result normal?

YES >> GO TO 4.

NO >> Replace power seat switch. Refer to [ADP-239, "Removal and Installation"](#).

4.CHECK INTERMITTENT INCIDENT

Refer to [GI-43, "Intermittent Incident"](#).

>> INSPECTION END

Component Inspection

INFOID:000000006471529

1.CHECK LIFTING SWITCH (REAR)

1. Turn ignition switch OFF.
2. Disconnect power seat switch connector.
3. Check continuity between power seat switch terminals.

Power seat switch		Condition		Continuity
Terminal				
32	14	Lifting switch rear (down)	Operate	Existed
			Release	Not existed
	29	Lifting switch rear (up)	Operate	Existed
			Release	Not existed

Is the inspection result normal?

YES >> INSPECTION END

NO >> Replace power seat switch. Refer to [ADP-239, "Removal and Installation"](#).

FORWARD SWITCH

< DTC/CIRCUIT DIAGNOSIS >

FORWARD SWITCH

Description

INFOID:000000006471530

Forward switch is installed on the seat back frame. Forward switch detects condition of seat back.

Component Function Check

INFOID:000000006471531

1.CHECK FUNCTION

1. Turn ignition switch ON.
2. Select "FORWARD SW" in the "Data Monitor" mode using CONSULT-III.
3. Check the forward switch signal under the following condition.

Test item	Condition		Status
FORWARD SW	Driver side seat back	Folded up	ON
		Folded down	OFF

Is the indication normal?

YES >> INSPECTION END

NO >> Perform diagnosis procedure. Refer to [ADP-75, "Diagnosis Procedure"](#).

Diagnosis Procedure

INFOID:000000006471532

1.CHECK FORWARD SWITCH SIGNAL

1. Turn ignition switch OFF.
2. Disconnect forward switch harness connector.
3. Check voltage between forward switch harness connector and ground.

(+)		(-)	Voltage (V) (Approx.)
Forward switch			
Connector	Terminal	Ground	5
B512	41		

Is the inspection result normal?

YES >> GO TO 3.

NO >> GO TO 2.

2.CHECK FORWARD SWITCH CIRCUIT

1. Disconnect driver seat control unit connector.
2. Check continuity between driver seat control unit harness connector and forward switch harness connector.

Driver seat control unit		Forward switch		Continuity
Connector	Terminal	Connector	Terminal	
B504	41	B512	41	Existed

3. Check continuity between driver seat control unit harness connector and ground.

Driver seat control unit		Ground	Continuity
Connector	Terminal		
B504	41		Not existed

Is the inspection result normal?

YES >> Replace driver seat control unit. Refer to [ADP-236, "Removal and Installation"](#)

NO >> Repair or replace harness.

3.FORWARD SWITCH GROUND CIRCUIT

Check continuity between forward switch harness connector and ground.

FORWARD SWITCH

< DTC/CIRCUIT DIAGNOSIS >

Forward switch		Ground	Continuity
Connector	Terminal		
B512	32		Existed

Is the inspection result normal?

- YES >> GO TO 4.
 NO >> Repair or replace harness.

4.CHECK FORWARD SWITCH

Refer to [ADP-76. "Component Inspection"](#).

Is the inspection result normal?

- YES >> GO TO 5.
 NO >> Replace forward switch (Built in seat back frame). Refer to [SE-233. "Exploded View"](#).

5.CHECK INTERMITTENT INCIDENT

Refer to [GI-43. "Intermittent Incident"](#).

>> INSPECTION END

Component Inspection

INFOID:000000006471533

1.CHECK FORWARD SWITCH

1. Turn ignition switch OFF.
2. Disconnect forward switch connector.
3. Check continuity between forward switch terminals.

Forward switch		Condition	Continuity	
Connector	Terminal			
B512	41	32	Driver side seat back	
			Folded up	Not existed
			Folded down	Existed

Is the inspection result normal?

- YES >> INSPECTION END
 NO >> Replace forward switch (Built in seat back frame). Refer to [SE-233. "Exploded View"](#).

SEAT BELT BUCKLE SWITCH

< DTC/CIRCUIT DIAGNOSIS >

SEAT BELT BUCKLE SWITCH

Description

INFOID:000000006471534

Seat belt buckle switch is installed in seat belt buckle. Seat belt buckle switch detects condition of seat belt.

Component Function Check

INFOID:000000006471535

1.CHECK FUNCTION

1. Turn ignition switch ON.
2. Select "SEAT BELT SW" in the "Data Monitor" mode using CONSULT-III.
3. Check the seat belt buckle switch signal under the following condition.

Test item	Condition		Status
SEAT BELT SW	Driver side seat belt	Fastened	ON
		Released	OFF

Is the indication normal?

YES >> INSPECTION END

NO >> Perform diagnosis procedure. Refer to [ADP-77, "Diagnosis Procedure"](#).

Diagnosis Procedure

INFOID:000000006471536

1.CHECK SEAT BELT BUCKLE SWITCH SIGNAL

1. Turn ignition switch OFF.
2. Disconnect seat belt buckle switch harness connector.
3. Check voltage between seat belt buckle switch harness connector and ground.

(+)		(-)	Voltage (V) (Approx.)
Seat belt buckle switch			
Connector	Terminal		
B13	1	Ground	5

Is the inspection result normal?

YES >> GO TO 3.

NO >> GO TO 2.

2.CHECK SEAT BELT BUCKLE SWITCH CIRCUIT

1. Disconnect driver seat control unit connector.
2. Check continuity between driver seat control unit harness connector and seat belt buckle switch harness connector.

Driver seat control unit		Seat belt buckle switch		Continuity
Connector	Terminal	Connector	Terminal	
B503	5	B13	1	Existed

3. Check continuity between driver seat control unit harness connector and ground.

Driver seat control unit		Ground	Continuity
Connector	Terminal		
B503	5		Not existed

Is the inspection result normal?

YES >> Replace driver seat control unit. Refer to [ADP-236, "Removal and Installation"](#).

NO >> Repair or replace harness.

3.CHECK SEAT BELT BUCKLE SWITCH GROUND CIRCUIT

Check continuity between seat belt buckle switch harness connector and ground.

SEAT BELT BUCKLE SWITCH

< DTC/CIRCUIT DIAGNOSIS >

Seat belt buckle switch		Ground	Continuity
Connector	Terminal		
B13	2		Existed

Is the inspection result normal?

YES >> GO TO 4.

NO >> Repair or replace harness.

4.CHECK SEAT BELT BUCKLE SWITCH

Refer to [ADP-78, "Component Inspection"](#).

Is the inspection result normal?

YES >> GO TO 5.

NO >> Replace seat belt buckle switch (Built in seat belt buckle). Refer to [SE-233, "Exploded View"](#).

5.CHECK INTERMITTENT INCIDENT

Refer to [GI-43, "Intermittent Incident"](#).

>> INSPECTION END

Component Inspection

INFOID:000000006471537

1.CHECK SEAT BELT BUCKLE SWITCH

1. Turn ignition switch OFF.
2. Disconnect seat belt buckle switch connector.
3. Check continuity between seat belt buckle switch terminals.

Seat belt buckle switch		Condition		Continuity	
Connector	Terminal				
B13	1	2	Driver side seat belt	Fastened	Not existed
				Released	Existed

Is the inspection result normal?

YES >> INSPECTION END

NO >> Replace seat belt buckle switch (Built in seat belt buckle). Refer to [SE-233, "Exploded View"](#).

SLIDING LIMIT SWITCH

< DTC/CIRCUIT DIAGNOSIS >

SLIDING LIMIT SWITCH

Description

INFOID:000000006471538

Sliding limit switch is installed on seat cushion frame. Sliding limit switch detects condition of seat sliding.

Component Function Check

INFOID:000000006471539

1. CHECK FUNCTION

1. Select "FWD LIMIT SW" in the "Data Monitor" mode using CONSULT-III.
2. Check the sliding limit switch signal under the following condition.

Test item	Condition		Status
FWD LIMIT SW	Seat sliding	Front edge	ON
		Other than above	OFF

Is the indication normal?

YES >> INSPECTION END

NO >> Perform diagnosis procedure. Refer to [ADP-79, "Diagnosis Procedure"](#).

Diagnosis Procedure

INFOID:000000006471540

1. CHECK SLIDING LIMIT SWITCH SIGNAL

1. Turn ignition switch OFF.
2. Disconnect sliding limit switch harness connector.
3. Check voltage between sliding limit switch harness connector and ground.

(+)		(-)	Voltage (V) (Approx.)
Sliding limit switch			
Connector	Terminal	Ground	5
B514	4		

Is the inspection result normal?

YES >> GO TO 3.

NO >> GO TO 2.

2. CHECK SLIDING LIMIT SWITCH CIRCUIT

1. Disconnect driver seat control unit connector.
2. Check continuity between driver seat control unit harness connector and sliding limit switch harness connector.

Driver seat control unit		Sliding limit switch		Continuity
Connector	Terminal	Connector	Terminal	
B503	4	B514	4	Existed

3. Check continuity between driver seat control unit harness connector and ground.

Driver seat control unit		Ground	Continuity
Connector	Terminal		
B503	4		Not existed

Is the inspection result normal?

YES >> Replace driver seat control unit. Refer to [ADP-236, "Removal and Installation"](#)

NO >> Repair or replace harness.

3. CHECK SLIDING LIMIT SWITCH GROUND CIRCUIT

Check continuity between sliding limit switch harness connector and ground.

SLIDING LIMIT SWITCH

< DTC/CIRCUIT DIAGNOSIS >

Sliding limit switch		Ground	Continuity
Connector	Terminal		Existed
B514	32		

Is the inspection result normal?

- YES >> GO TO 4.
NO >> Repair or replace harness.

4.CHECK SLIDING LIMIT SWITCH

Refer to [ADP-80. "Component Inspection"](#).

Is the inspection result normal?

- YES >> GO TO 5.
NO >> Replace forward switch (Built in seat back frame). Refer to [SE-233. "Exploded View"](#).

5.CHECK INTERMITTENT INCIDENT

Refer to [GI-43. "Intermittent Incident"](#).

>> INSPECTION END

Component Inspection

INFOID:000000006471541

1.CHECK SLIDING LIMIT SWITCH

1. Turn ignition switch OFF.
2. Disconnect sliding limit switch connector.
3. Check continuity between sliding limit switch terminals.

Sliding limit switch			Condition	Continuity	
Connector	Terminal			Existed	
B514	4	32	Seat sliding	Front edge	Existed
			Other than above	Not existed	

Is the inspection result normal?

- YES >> INSPECTION END
NO >> Replace forward switch (Built in seat back frame). Refer to [SE-233. "Exploded View"](#).

POWER WALK-IN SWITCH

< DTC/CIRCUIT DIAGNOSIS >

POWER WALK-IN SWITCH

Description

INFOID:000000006471542

Power walk-in switch is installed on seat back. The operation signal is input to driver seat control unit when power walk-in switch is operated.

Component Function Check

INFOID:000000006471543

1.CHECK FUNCTION

1. Turn ignition switch ON.
2. Select "WALK-IN SW" in the "Data Monitor" mode using CONSULT-III.
3. Check the power walk-in switch signal under the following condition.

Test item	Condition		Status
WALK-IN SW	Power walk-in switch	Pressed	ON
		Released	OFF

Is the indication normal?

YES >> INSPECTION END

NO >> Perform diagnosis procedure. Refer to [ADP-81, "Diagnosis Procedure"](#).

Diagnosis Procedure

INFOID:000000006471544

1.CHECK POWER WALK-IN SWITCH SIGNAL

1. Turn ignition switch OFF.
2. Disconnect power walk-in switch harness connector.
3. Check voltage between power walk-in switch harness connector and ground.

(+)		(-)	Voltage (V) (Approx.)
Power walk-in switch			
Connector	Terminal		
B513	30	Ground	5

Is the inspection result normal?

YES >> GO TO 3.

NO >> GO TO 2.

2.CHECK POWER WALK-IN SWITCH CIRCUIT

1. Disconnect driver seat control unit connector and power walk-in switch connector.
2. Check continuity between driver seat control unit harness connector and power walk-in switch harness connector.

Driver seat control unit		Power walk-in switch		Continuity
Connector	Terminal	Connector	Terminal	
B503	30	B513	30	Existed

3. Check continuity between driver seat control unit harness connector and ground.

Driver seat control unit		Ground	Continuity
Connector	Terminal		
B503	30		Not existed

Is the inspection result normal?

YES >> Replace driver seat control unit. Refer to [ADP-236, "Removal and Installation"](#).

NO >> Repair or replace harness.

3.CHECK POWER WALK-IN SWITCH GROUND CIRCUIT

POWER WALK-IN SWITCH

< DTC/CIRCUIT DIAGNOSIS >

Check continuity between power walk-in switch harness connector and ground.

Power walk-in switch		Ground	Continuity
Connector	Terminal		
B513	32		Existed

Is the inspection result normal?

YES >> GO TO 4.

NO >> Repair or replace harness.

4.CHECK POWER WALK-IN SWITCH

Refer to [ADP-82, "Component Inspection"](#).

Is the inspection result normal?

YES >> GO TO 5.

NO >> Replace power walk-in switch (Built in walk-in lever). Refer to [SE-233, "Exploded View"](#).

5.CHECK INTERMITTENT INCIDENT

Refer to [GI-43, "Intermittent Incident"](#).

>> INSPECTION END

Component Inspection

INFOID:000000006471545

1.CHECK POWER WALK-IN SWITCH

1. Turn ignition switch OFF.
2. Disconnect power walk-in switch connector.
3. Check continuity between power walk-in switch terminals.

Power walk-in switch			Condition		Continuity
Connector	Terminal		Power walk-in switch		
B513	30	32		Pressed	Existed
			Released	Not existed	

Is the inspection result normal?

YES >> INSPECTION END

NO >> Replace power walk-in switch (Built in walk-in lever). Refer to [SE-233, "Exploded View"](#).

TILT SWITCH

< DTC/CIRCUIT DIAGNOSIS >

TILT SWITCH

Description

INFOID:000000006471546

Tilt switch is equipped to the steering column. The operation signal is input to the automatic drive positioner control unit when the tilt switch is operated.

Component Function Check

INFOID:000000006471547

1.CHECK FUNCTION

1. Turn ignition switch ON.
2. Select "TILT SW-UP", "TILT SW-DN" in the "Data monitor" mode using CONSULT-III.
3. Check tilt switch signal under the following conditions.

Monitor item	Condition	Status	
TILT SW-UP	Tilt switch (up)	Operate	ON
		Release	OFF
TILT SW-DN	Tilt switch (down)	Operate	ON
		Release	OFF

Is the indication normal?

YES >> INSPECTION END

NO >> Perform diagnosis procedure. Refer to [ADP-83. "Diagnosis Procedure"](#).

Diagnosis Procedure

INFOID:000000006471548

1.CHECK TILT SWITCH SIGNAL

1. Turn ignition switch OFF.
2. Disconnect tilt & telescopic switch connector.
3. Check voltage between tilt & telescopic switch harness connector and ground.

(+)		(-)	Voltage (V) (Approx.)
Tilt & telescopic switch			
Connector	Terminal	Ground	Battery voltage
M31	4		
	5		

Is the inspection result normal?

YES >> GO TO 3.

NO >> GO TO 2.

2.CHECK TILT SWITCH CIRCUIT

1. Disconnect automatic drive positioner control unit connector.
2. Check continuity between automatic drive positioner control unit harness connector and tilt & telescopic switch harness connector.

Automatic drive positioner control unit		Tilt & telescopic switch		Continuity
Connector	Terminal	Connector	Terminal	
M51	1	M31	4	Existed
	17		5	

3. Check continuity between automatic drive positioner control unit harness connector and ground.

TILT SWITCH

< DTC/CIRCUIT DIAGNOSIS >

Automatic drive positioner control unit		Ground	Continuity
Connector	Terminal		
M51	1		
	17		

Is the inspection result normal?

YES >> Replace automatic drive positioner control unit. Refer to [ADP-237, "Removal and Installation"](#).

NO >> Repair or replace harness.

3.CHECK TILT SWITCH

Refer to [ADP-84, "Component Inspection"](#).

Is the inspection result normal?

YES >> GO TO 4.

NO >> Replace tilt & telescopic switch. Refer to [ADP-241, "Removal and Installation"](#).

4.CHECK INTERMITTENT INCIDENT

Refer to [GI-43, "Intermittent Incident"](#).

>> INSPECTION END

Component Inspection

INFOID:000000006471549

1.CHECK TILT SWITCH

1. Turn ignition switch OFF.
2. Disconnect tilt & telescopic switch connector.
3. Check continuity between tilt & telescopic switch terminals.

Tilt & telescopic switch		Condition		Continuity
Terminal				
1	4	Tilt switch (up)	Operate	Existed
			Release	Not existed
	5	Tilt switch (down)	Operate	Existed
			Release	Not existed

Is the inspection result normal?

YES >> INSPECTION END

NO >> Replace tilt & telescopic switch. Refer to [ADP-241, "Removal and Installation"](#).

TELESCOPIC SWITCH

< DTC/CIRCUIT DIAGNOSIS >

TELESCOPIC SWITCH

Description

INFOID:000000006471550

Telescopic switch is equipped to the steering column. The operation signal is input to the automatic drive positioner control unit when the telescopic switch is operated.

Component Function Check

INFOID:000000006471551

1. CHECK FUNCTION

1. Turn ignition switch ON.
2. Select "TELESCO SW-FR", "TELESCO SW-RR" in the "Data monitor" mode using CONSULT-III.
3. Check telescopic switch signal under the following conditions.

Monitor item	Condition	Status	
TELESCO SW-FR	Telescopic switch (forward)	Operate	ON
		Release	OFF
TELESCO SW-RR	Telescopic switch (backward)	Operate	ON
		Release	OFF

Is the indication normal?

YES >> INSPECTION END

NO >> Perform diagnosis procedure. Refer to [ADP-85. "Diagnosis Procedure"](#).

Diagnosis Procedure

INFOID:000000006471552

1. CHECK TELESCOPIC SWITCH SIGNAL

1. Turn ignition switch OFF.
2. Disconnect tilt & telescopic switch connector.
3. Check voltage between tilt & telescopic switch harness connector and ground.

(+)		(-)	Voltage (V) (Approx.)
Tilt & telescopic switch			
Connector	Terminal	Ground	Battery voltage
M31	2		
	3		

Is the inspection result normal?

YES >> GO TO 3.

NO >> GO TO 2.

2. CHECK TELESCOPIC SWITCH CIRCUIT

1. Disconnect automatic drive positioner control unit connector.
2. Check continuity between automatic drive positioner control unit harness connector and tilt & telescopic switch harness connector.

Automatic drive positioner control unit		Tilt & telescopic switch		Continuity
Connector	Terminal	Connector	Terminal	
M51	11	M31	2	Existed
	27		3	

3. Check continuity between automatic drive positioner control unit harness connector and ground.

TELESCOPIC SWITCH

< DTC/CIRCUIT DIAGNOSIS >

Automatic drive positioner control unit		Ground	Continuity
Connector	Terminal		
M51	11		
	27		Not existed

Is the inspection result normal?

YES >> Replace automatic drive positioner control unit. Refer to [ADP-237, "Removal and Installation"](#).

NO >> Repair or replace harness.

3.CHECK TELESCOPIC SWITCH

Refer to [ADP-86, "Component Inspection"](#).

Is the inspection result normal?

YES >> GO TO 4.

NO >> Replace tilt & telescopic switch. Refer to [ADP-241, "Removal and Installation"](#).

4.CHECK INTERMITTENT INCIDENT

Refer to [GI-43, "Intermittent Incident"](#).

>> INSPECTION END

Component Inspection

INFOID:000000006471553

1.CHECK TELESCOPIC SWITCH

1. Turn ignition switch OFF.
2. Disconnect tilt & telescopic switch connector.
3. Check continuity between tilt & telescopic switch terminals.

Tilt & telescopic switch		Condition		Continuity
Terminal				
1	2	Telescopic switch (forward)	Operate	Existed
			Release	Not existed
	3	Telescopic switch (backward)	Operate	Existed
			Release	Not existed

Is the inspection result normal?

YES >> INSPECTION END

NO >> Replace tilt & telescopic switch. Refer to [ADP-241, "Removal and Installation"](#).

SEAT MEMORY SWITCH

< DTC/CIRCUIT DIAGNOSIS >

SEAT MEMORY SWITCH

Description

INFOID:000000006471554

Memory switch is equipped on the seat set switch and seat memory switch installed to the driver side door trim. The operation signal is input to the automatic drive positioner control unit when the set switch or memory switch is operated.

Component Function Check

INFOID:000000006471555

1.CHECK FUNCTION

1. Turn ignition switch ON.
2. Select "MEMORY SW 1", "MEMORY SW 2" "SET SW" in the "Data monitor" mode using CONSULT-III.
3. Check seat memory switch signal under the following conditions.

Monitor item	Condition	Status	
SET SW	SET SW	Press	ON
		Release	OFF
MEMORY SW 1	Memory switch 1	Press	ON
		Release	OFF
MEMORY SW 2	Memory switch 2	Press	ON
		Release	OFF

Is the indication normal?

YES >> INSPECTION END

NO >> Perform diagnosis procedure. Refer to [ADP-87, "Diagnosis Procedure"](#).

Diagnosis Procedure

INFOID:000000006471556

1.CHECK SEAT MEMORY SWITCH SIGNAL

1. Turn ignition switch OFF.
2. Disconnect seat memory switch connector.
3. Turn ignition switch ON.
4. Check voltage between seat memory switch harness connector and ground.

(+)		(-)	Voltage (V) (Approx.)
Seat memory switch			
Connector	Terminal	Ground	5
D5	1		
	2		
	3		

Is the inspection result normal?

YES >> GO TO 3.

NO >> GO TO 2.

2.CHECK MEMORY SWITCH CIRCUIT

1. Turn ignition switch OFF.
2. Disconnect automatic drive positioner control unit connector.
3. Check continuity between automatic drive positioner control unit harness connector and seat memory switch harness connector.

SEAT MEMORY SWITCH

< DTC/CIRCUIT DIAGNOSIS >

Automatic drive positioner control unit		Seat memory switch		Continuity
Connector	Terminal	Connector	Terminal	
M51	24	D5	3	Existed
	9		1	
	25		2	

4. Check continuity between automatic drive positioner control unit harness connector and ground.

Automatic drive positioner control unit		Ground	Continuity
Connector	Terminal		
M51	24	Ground	Not existed
	9		
	25		

Is the inspection result normal?

YES >> Replace automatic drive positioner control unit. Refer to [ADP-237, "Removal and Installation"](#).

NO >> Repair or replace harness.

3.CHECK MEMORY SWITCH GROUND CIRCUIT

- Turn ignition switch OFF.
- Check continuity between seat memory switch harness connector and ground.

Seat memory switch		Ground	Continuity
Connector	Terminal		
D5	4	Ground	Existed

Is the inspection result normal?

YES >> GO TO 4.

NO >> Repair or replace harness.

4.CHECK SEAT MEMORY SWITCH

Refer to [ADP-88, "Component Inspection"](#).

Is the inspection result normal?

YES >> GO TO 5.

NO >> Replace seat memory switch. Refer to [ADP-238, "Removal and Installation"](#).

5.CHECK INTERMITTENT INCIDENT

Refer to [GI-43, "Intermittent Incident"](#).

>> INSPECTION END

Component Inspection

INFOID:000000006471557

1.CHECK SEAT MEMORY SWITCH

- Turn ignition switch OFF.
- Disconnect seat memory switch connector.
- Check continuity between seat memory switch terminals.

SEAT MEMORY SWITCH

< DTC/CIRCUIT DIAGNOSIS >

Seat memory switch		Condition		Continuity
Terminal				
4	3	Set switch	Press	Existed
			Release	Not existed
	1	Memory switch 1	Press	Existed
			Release	Not existed
	2	Memory switch 2	Press	Existed
			Release	Not existed

Is the inspection result normal?

YES >> INSPECTION END

NO >> Replace seat memory switch. Refer to [ADP-238, "Removal and Installation"](#).

A
B
C
D
E
F
G
H
I
K
L
M
N
O
P

ADP

DOOR MIRROR REMOTE CONTROL SWITCH

< DTC/CIRCUIT DIAGNOSIS >

DOOR MIRROR REMOTE CONTROL SWITCH MIRROR SWITCH

MIRROR SWITCH : Description

INFOID:000000006471558

It operates angle of the door mirror face.

It transmits mirror face adjust operation to AUTOMATIC DRIVE POSITIONER CONTROL UNIT.

MIRROR SWITCH : Component Function Check

INFOID:000000006471559

1. CHECK MIRROR SWITCH FUNCTION

1. Turn ignition switch ON.
2. Select "MIR CON SW-UP/DN", "MIR CON SW-RH/LH" in the "DATA MONITOR" mode using CONSULT-III.
3. Check mirror switch signal under the following conditions.

Monitor item	Condition	Status
MIR CON SW-UP/DN	When operating the mirror switch up or down side.	ON
	Other than above.	OFF
MIR CON SW-RH/LH	When operating the mirror switch right or left side.	ON
	Other than above.	OFF

Is the inspection result normal?

YES >> Mirror switch function is OK.

NO >> Perform diagnosis procedure. Refer to [ADP-90. "MIRROR SWITCH : Diagnosis Procedure"](#).

MIRROR SWITCH : Diagnosis Procedure

INFOID:000000006471560

1. CHECK MIRROR SWITCH INPUT SIGNAL

1. Turn ignition switch OFF.
2. Disconnect door mirror remote control switch connector.
3. Turn ignition switch ON.
4. Check voltage between door mirror remote control switch harness connector and ground.

(+)		(-)	Voltage (V) (Approx.)
Door mirror remote control switch			
Connector	Terminal	Ground	5
D17	4		
	12		
	13		
	15		

Is the inspection result normal?

YES >> GO TO 3.

NO >> GO TO 2.

2. CHECK MIRROR SWITCH CIRCUIT

1. Turn ignition switch OFF.
2. Disconnect automatic drive positioner control unit connector.
3. Check continuity between automatic drive positioner control unit harness connector and door mirror remote control switch harness connector.

DOOR MIRROR REMOTE CONTROL SWITCH

< DTC/CIRCUIT DIAGNOSIS >

Automatic drive positioner control unit		Door mirror remote control switch		Continuity
Connector	Terminal	Connector	Terminal	
M51	3	D17	15	Existed
	4		13	
	19		12	
	20		4	

4. Check continuity between automatic drive positioner control unit harness connector and ground.

Automatic drive positioner control unit		Ground	Continuity
Connector	Terminal		
M51	3	Ground	Not existed
	4		
	19		
	20		

Is the inspection result normal?

YES >> Replace automatic drive positioner control unit. Refer to [ADP-237, "Removal and Installation"](#).

NO >> Repair or replace harness.

3.CHECK DOOR MIRROR REMOTE CONTROL SWITCH GROUND CIRCUIT

- Turn ignition switch OFF.
- Check continuity between door mirror remote control switch harness connector and ground.

Door mirror remote control switch		Ground	Continuity
Connector	Terminal		
D17	7	Ground	Existed

Is the inspection result normal?

YES >> GO TO 4.

NO >> Repair or replace harness.

4.CHECK MIRROR SWITCH

Check door mirror remote control switch (mirror switch).
Refer to [ADP-91, "MIRROR SWITCH : Component Inspection"](#).

Is the inspection result normal?

YES >> GO TO 5.

NO >> Replace door mirror remote control switch (mirror switch). Refer to [MIR-24, "Removal and Installation"](#).

5.CHECK INTERMITTENT INCIDENT

Check intermittent incident.
Refer to [GI-43, "Intermittent Incident"](#).

>> INSPECTION END

MIRROR SWITCH : Component Inspection

INFOID:000000006471561

1.CHECK MIRROR SWITCH

- Turn ignition switch OFF.
- Disconnect door mirror remote control switch connector.
- Check continuity between door mirror remote control switch terminals.

DOOR MIRROR REMOTE CONTROL SWITCH

< DTC/CIRCUIT DIAGNOSIS >

Door mirror remote control switch		Condition	Continuity
Connector	Terminal		
D17	4	RIGHT	Existed
		Other than above	Not existed
	13	LEFT	Existed
		Other than above	Not existed
	15	UP	Existed
		Other than above	Not existed
	12	DOWN	Existed
		Other than above	Not existed

Is the inspection result normal?

YES >> INSPECTION END

NO >> Replace door mirror remote control switch. Refer to [MIR-24. "Removal and Installation"](#).

CHANGEOVER SWITCH

CHANGEOVER SWITCH : Description

INFOID:000000006471562

Changeover switch is integrated into door mirror remote control switch.

Changeover switch has three positions (L, N and R).

It changes operating door mirror motor by transmitting control signal to automatic drive positioner control unit.

CHANGEOVER SWITCH : Component Function Check

INFOID:000000006471563

1. CHECK CHANGEOVER SWITCH FUNCTION

Check the operation on "MIR CHNG SW-R" or "MIR CHNG SW-L" in the "DATA MONITOR" mode using CONSULT-III.

Monitor item	Condition
MIR CHNG SW-R/L	When operating the changeover toward the right or left side. : ON
	Other than above. : OFF

Is the inspection result normal?

YES >> Changeover switch function is OK.

NO >> Refer to [ADP-92. "CHANGEOVER SWITCH : Diagnosis Procedure"](#).

CHANGEOVER SWITCH : Diagnosis Procedure

INFOID:000000006471564

1. CHECK CHANGEOVER SWITCH INPUT SIGNAL

1. Turn ignition switch OFF.
2. Disconnect door mirror remote control switch connector.
3. Turn ignition switch ON.
4. Check voltage between door mirror remote control switch harness connector and ground.

(+)		(-)	Voltage (V) (Approx.)
Door mirror remote control switch			
Connector	Terminal		
D17	10	Ground	5
	11		

Is the inspection result normal?

YES >> GO TO 3.

NO >> GO TO 2.

2. CHECK CHANGEOVER SWITCH CIRCUIT

DOOR MIRROR REMOTE CONTROL SWITCH

< DTC/CIRCUIT DIAGNOSIS >

1. Turn ignition switch OFF.
2. Disconnect automatic drive positioner control unit connector.
3. Check continuity between automatic drive positioner control unit harness connector and door mirror remote control switch harness connector.

Automatic drive positioner control unit		Door mirror remote control switch		Continuity
Connector	Terminal	Connector	Terminal	
M51	2	D17	11	Existed
	18		10	

4. Check continuity between automatic drive positioner control unit harness connector and ground.

Automatic drive positioner control unit		Ground	Continuity
Connector	Terminal		
M51	2		Not existed
	18		

Is the inspection result normal?

- YES >> Replace automatic drive positioner control unit. Refer to [ADP-237, "Removal and Installation"](#).
 NO >> Repair or replace harness.

3.CHECK DOOR MIRROR REMOTE CONTROL SWITCH GROUND CIRCUIT

1. Turn ignition switch OFF.
2. Check continuity between door mirror remote control switch harness connector and ground.

Door mirror remote control switch		Ground	Continuity
Connector	Terminal		
D17	7		Existed

Is the inspection result normal?

- YES >> GO TO 4.
 NO >> Repair or replace harness.

4.CHECK CHANGEOVER SWITCH

Check door mirror remote control switch (changeover switch).
 Refer to [ADP-93, "CHANGEOVER SWITCH : Component Inspection"](#).

Is the inspection result normal?

- YES >> GO TO 5.
 NO >> Replace door mirror remote control switch (changeover switch). Refer to [MIR-24, "Removal and Installation"](#).

5.CHECK INTERMITTENT INCIDENT

Check intermittent incident.
 Refer to [GI-43, "Intermittent Incident"](#).

>> INSPECTION END

CHANGEOVER SWITCH : Component Inspection

INFOID:000000006471565

1.CHECK CHANGEOVER SWITCH

1. Turn ignition switch OFF.
2. Disconnect door mirror remote control switch connector.
3. Check continuity between door mirror remote control switch terminals.

DOOR MIRROR REMOTE CONTROL SWITCH

< DTC/CIRCUIT DIAGNOSIS >

Door mirror remote control switch		Terminal	Condition	Continuity
Connector				
D17	10	7	LEFT	Existed
			Other than above	Not existed
	11		RIGHT	Existed
			Other than above	Not existed

Is the inspection result normal?

YES >> INSPECTION END

NO >> Replace door mirror remote control switch. Refer to [MIR-24. "Removal and Installation"](#).

POWER SEAT SWITCH GROUND CIRCUIT

< DTC/CIRCUIT DIAGNOSIS >

POWER SEAT SWITCH GROUND CIRCUIT

Diagnosis Procedure

INFOID:000000006471566

1. CHECK POWER SEAT SWITCH GROUND CIRCUIT

1. Turn ignition switch OFF.
2. Disconnect power seat switch connector.
3. Check continuity between power seat switch connector and ground.

Power seat switch		Ground	Continuity
Connector	Terminal		Existed
B510	32		

Is the inspection result normal?

- YES >> GO TO 2.
NO >> Repair or replace harness.

2. CHECK POWER SEAT SWITCH INTERNAL CIRCUIT

Check reclining switch.
Refer to [ADP-70, "Component Inspection"](#).

Is the inspection result normal?

- YES >> GO TO 3.
NO >> Replace power seat switch. Refer to [ADP-239, "Removal and Installation"](#).

3. CHECK INTERMITTENT INCIDENT

Refer to [GI-43, "Intermittent Incident"](#).

>> INSPECTION END

A
B
C
D
E
F
G
H
I
K
L
M
N
O
P

ADP

TILT & TELESCOPIC SWITCH GROUND CIRCUIT

< DTC/CIRCUIT DIAGNOSIS >

TILT & TELESCOPIC SWITCH GROUND CIRCUIT

Diagnosis Procedure

INFOID:000000006471567

1. CHECK POWER TILT & TELESCOPIC SWITCH GROUND CIRCUIT

1. Turn ignition switch OFF.
2. Disconnect power tilt & telescopic switch connector.
3. Check continuity between power seat switch connector and ground.

Tilt & telescopic switch		Ground	Continuity
Connector	Terminal		Existed
M31	1		

Is the inspection result normal?

- YES >> GO TO 2.
NO >> Repair or replace harness.

2. CHECK POWER TILT & TELESCOPIC SWITCH INTERNAL CIRCUIT

Check tilt switch.
Refer to [ADP-84, "Component Inspection"](#).

Is the inspection result normal?

- YES >> GO TO 3.
NO >> Replace tilt & telescopic switch. Refer to [ADP-241, "Removal and Installation"](#).

3. CHECK INTERMITTENT INCIDENT

Refer to [GI-43, "Intermittent Incident"](#).

>> INSPECTION END

SLIDING SENSOR

< DTC/CIRCUIT DIAGNOSIS >

SLIDING SENSOR

Description

INFOID:000000006471568

- The sliding sensor is installed to the seat slide cushion frame.
- The pulse signal is input to the driver seat control unit when sliding is performed.
- The driver seat control unit counts the pulse and calculates the sliding amount of the seat.

Component Function Check

INFOID:000000006471569

1. CHECK FUNCTION

1. Turn ignition switch ON.
2. Select "SLIDE PULSE" in the "Data monitor" mode using CONSULT-III.
3. Check sliding sensor signal under the following conditions.

Monitor item	Condition		Valve
SLIDE PULSE	Seat sliding	Operate (forward)	Change (increase)*1
		Operate (backward)	Change (decrease)*1
		Release	No change*1

*1: The value at the seat position attained when the battery is connected is considered to be 32768.

Is the indication normal?

- YES >> INSPECTION END
 NO >> Perform diagnosis procedure. Refer to [ADP-97. "Diagnosis Procedure"](#).

Diagnosis Procedure

INFOID:000000006471570

1. CHECK SLIDING SENSOR SIGNAL

1. Turn ignition switch ON.
2. Check voltage signal between driver seat control unit harness connector and ground using oscilloscope.

ADP

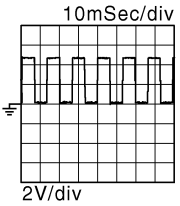
(+) Driver seat control unit		(-)	Condition	Voltage (V) (Approx.)
Connector	Terminal			
B503	24	Ground	Seat sliding	 <p>10mSec/div 2V/div JMJA0119ZZ</p>
			Other than above	

Is the inspection result normal?

- YES >> Replace driver seat control unit. Refer to [ADP-236. "Removal and Installation"](#).
 NO >> GO TO 2.

2. CHECK SLIDING SENSOR CIRCUIT

1. Turn ignition switch OFF.
2. Disconnect driver seat control unit connector and sliding sensor connector.
3. Check continuity between driver seat control unit harness connector and sliding sensor harness connector.

SLIDING SENSOR

< DTC/CIRCUIT DIAGNOSIS >

Driver seat control unit		Sliding sensor		Continuity
Connector	Terminal	Connector	Terminal	
B503	24	B526	24	Existed

4. Check continuity between driver seat control unit harness connector and ground.

Driver seat control unit		Ground	Continuity
Connector	Terminal		
B503	24		Not existed

Is the inspection result normal?

YES >> GO TO 3.

NO >> Repair or replace harness.

3.CHECK SLIDING SENSOR POWER SUPPLY

1. Connect driver seat control unit connector.
2. Turn ignition switch ON.
3. Check voltage between sliding sensor harness connector and ground.

(+)		(-)	Voltage (V) (Approx.)
Sliding sensor			
Connector	Terminal		
B526	16	Ground	Battery voltage

Is the inspection result normal?

YES >> GO TO 5.

NO >> GO TO 4.

4.CHECK SLIDING SENSOR POWER SUPPLY CIRCUIT

1. Turn ignition switch OFF.
2. Disconnect driver seat control unit connector.
3. Check continuity between driver seat control unit harness connector and sliding sensor harness connector.

Driver seat control unit		Sliding sensor		Continuity
Connector	Terminal	Connector	Terminal	
B503	16	B526	16	Existed

4. Check continuity between driver seat control unit harness connector and ground.

Driver seat control unit		Ground	Continuity
Connector	Terminal		
B503	16		Not existed

Is the inspection result normal?

YES >> Replace driver seat control unit. Refer to [ADP-236, "Removal and Installation"](#).

NO >> Repair or replace harness.

5.CHECK SLIDING SENSOR GROUND CIRCUIT 1

1. Turn ignition switch OFF.
2. Disconnect driver seat control unit connector.
3. Check continuity between driver seat control unit harness connector and sliding sensor harness connector.

Driver seat control unit		Sliding sensor		Continuity
Connector	Terminal	Connector	Terminal	
B503	31	B526	31	Existed

SLIDING SENSOR

< DTC/CIRCUIT DIAGNOSIS >

Is the inspection result normal?

YES >> GO TO 6.

NO >> Repair or replace harness.

6.CHECK SLIDING SENSOR GROUND CIRCUIT 2

1. Connect driver seat control unit connector.
2. Check continuity between driver seat control unit harness connector and ground.

Driver seat control unit		Ground	Continuity
Connector	Terminal		
B503	31		Existed

Is the inspection result normal?

YES >> Replace sliding sensor (Built in seat slide cushion frame). Refer to [ST-19, "WITH ELECTRIC MOTOR : Exploded View"](#).

NO >> Replace driver seat control unit. Refer to [ADP-236, "Removal and Installation"](#).

A
B
C
D
E
F
G
H
I
K
L
M
N
O
P

ADP

RECLINING SENSOR

< DTC/CIRCUIT DIAGNOSIS >

RECLINING SENSOR

Description

INFOID:000000006471571

- The reclining motor is installed to the seatback frame.
- The pulse signal is input to the driver seat control unit when the reclining is operated.
- The driver seat control unit counts the pulse and calculates the reclining amount of the seat.

Component Function Check

INFOID:000000006471572

1. CHECK FUNCTION

1. Turn ignition switch ON.
2. Select "RECLN PULSE" in the "Data monitor" mode using CONSULT-III.
3. Check reclining sensor signal under the following conditions.

Monitor item	Condition		Value
RECLN PULSE	Seat reclining	Operate (forward)	Change (increase) ^{*1}
		Operate (backward)	Change (decrease) ^{*1}
		Release	No change ^{*1}

*1: The value at the seat position attained when the battery is connected is considered to be 32768.

Is the indication normal?

YES >> INSPECTION END

NO >> Perform diagnosis procedure. Refer to [ADP-100, "Diagnosis Procedure"](#).

Diagnosis Procedure

INFOID:000000006471573

1. CHECK RECLINING SENSOR SIGNAL

1. Turn ignition switch ON.
2. Check voltage signal between driver seat control unit harness connector and ground using oscilloscope.

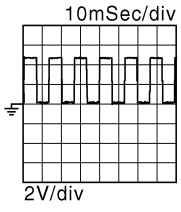
(+) Driver seat control unit		(-)	Condition	Voltage (V) (Approx.)
Connector	Terminal			
B503	9	Ground	Seat reclining	 <p>10mSec/div 2V/div JMJA0119ZZ</p>
			Other than above	0 or 5

Is the inspection result normal?

YES >> Replace driver seat control unit. Refer to [ADP-236, "Removal and Installation"](#).

NO >> GO TO 2.

2. CHECK RECLINING SENSOR CIRCUIT

1. Turn ignition switch OFF.
2. Disconnect driver seat control unit and reclining motor connector.
3. Check continuity between driver seat control unit harness connector and reclining motor harness connector.

RECLINING SENSOR

< DTC/CIRCUIT DIAGNOSIS >

Driver seat control unit		Reclining motor		Continuity
Connector	Terminal	Connector	Terminal	
B503	9	B523	9	Existed

4. Check continuity between driver seat control unit harness connector and ground.

Driver seat control unit		Ground	Continuity
Connector	Terminal		
B503	9		Not existed

Is the inspection result normal?

YES >> GO TO 3.

NO >> Repair or replace harness.

3. CHECK RECLINING SENSOR POWER SUPPLY

1. Connect driver seat control unit connector.
2. Turn ignition switch ON.
3. Check voltage between reclining motor harness connector and ground.

(+)		(-)	Voltage (V) (Approx.)
Reclining motor			
Connector	Terminal		
B523	16	Ground	Battery voltage

Is the inspection result normal?

YES >> GO TO 5.

NO >> GO TO 4.

4. CHECK RECLINING SENSOR POWER SUPPLY CIRCUIT

1. Turn ignition switch OFF.
2. Disconnect driver seat control unit connector.
3. Check continuity between driver seat control unit harness connector and reclining motor harness connector.

Driver seat control unit		Reclining motor		Continuity
Connector	Terminal	Connector	Terminal	
B503	16	B523	16	Existed

4. Check continuity between driver seat control unit harness connector and ground.

Driver seat control unit		Ground	Continuity
Connector	Terminal		
B503	16		Not existed

Is the inspection result normal?

YES >> Replace driver seat control unit. Refer to [ADP-236, "Removal and Installation"](#).

NO >> Repair or replace harness.

5. CHECK RECLINING SENSOR GROUND CIRCUIT 1

1. Turn ignition switch OFF.
2. Disconnect driver seat control unit connector.
3. Check continuity between driver seat control unit harness connector and reclining motor harness connector.

Driver seat control unit		Reclining motor		Continuity
Connector	Terminal	Connector	Terminal	
B503	31	B523	31	Existed

RECLINING SENSOR

< DTC/CIRCUIT DIAGNOSIS >

Is the inspection result normal?

YES >> GO TO 6.

NO >> Repair or replace harness.

6. CHECK RECLINING SENSOR GROUND CIRCUIT 2

1. Connect driver seat control unit connector.
2. Check continuity between reclining sensor harness connector and ground.

Driver seat control unit		Ground	Continuity
Connector	Terminal		
B503	31		Existed

Is the inspection result normal?

YES >> Replace reclining motor. Refer to [SE-233, "Exploded View"](#).

NO >> Replace driver seat control unit. Refer to [ADP-236, "Removal and Installation"](#).

LIFTING SENSOR (FRONT)

< DTC/CIRCUIT DIAGNOSIS >

LIFTING SENSOR (FRONT)

Description

INFOID:000000006471574

- The lifting sensor (front) is installed to the seat slide cushion frame.
- The pulse signal is input to the driver seat control unit when the lifting (front) is operated.
- The driver seat control unit counts the pulse and calculates the lifting (front) amount of the seat.

Component Function Check

INFOID:000000006471575

1. CHECK FUNCTION

1. Turn ignition switch ON.
2. Select "LIFT FR PULSE" in the "Data monitor" mode using CONSULT-III.
3. Check the lifting sensor (front) signal under the following conditions.

Monitor item	Condition		Value
LIFT FR PULSE	Seat lifting (front)	Operate (Up)	Change (increase) ^{*1}
		Operate (Down)	Change (decrease) ^{*1}
		Release	No change ^{*1}

*1: The value at the seat position attained when the battery is connected is considered to be 32768.

Is the indication normal?

YES >> INSPECTION END

NO >> Perform diagnosis procedure. Refer to [ADP-103. "Diagnosis Procedure"](#).

Diagnosis Procedure

INFOID:000000006471576

1. CHECK LIFTING SENSOR (FRONT) SIGNAL

1. Turn ignition switch ON.
2. Check the voltage signal driver seat control unit harness connector and ground with an oscilloscope.

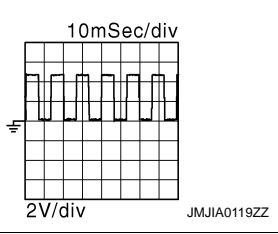
(+)		(-)	Condition	Voltage (V) (Approx.)
Driver seat control unit Connector	Terminal			
B503	25	Ground	Seat Lifting (front)	
			Operate	
			Other than above	0 or 5

Is the inspection result normal?

YES >> Replace driver seat control unit. Refer to [ADP-236. "Removal and Installation"](#).

NO >> GO TO 2.

2. CHECK LIFTING SENSOR (FRONT) CIRCUIT

1. Turn ignition switch OFF.
2. Disconnect driver seat control unit and lifting motor (front) connector.
3. Check continuity between driver seat control unit harness connector and lifting motor (front) harness connector.

LIFTING SENSOR (FRONT)

< DTC/CIRCUIT DIAGNOSIS >

Driver seat control unit		Lifting motor (front)		Continuity
Connector	Terminal	Connector	Terminal	
B503	25	B527	25	Existed

4. Check continuity between driver seat control unit harness connector and ground.

Driver seat control unit		Ground	Continuity
Connector	Terminal		
B503	25		Not existed

Is the inspection result normal?

YES >> GO TO 3.

NO >> Repair or replace harness.

3.CHECK LIFTING SENSOR (FRONT) POWER SUPPLY

1. Connect driver seat control unit connector.
2. Turn ignition switch ON.
3. Check voltage between lifting motor (front) harness connector and ground.

(+)		(-)	Voltage (V) (Approx.)
Lifting motor (front)			
Connector	Terminal		
B527	16	Ground	Battery voltage

Is the inspection result normal?

YES >> GO TO 5.

NO >> GO TO 4.

4.CHECK LIFTING SENSOR (FRONT) POWER SUPPLY CIRCUIT

1. Turn ignition switch OFF.
2. Disconnect driver seat control unit connector.
3. Check continuity between driver seat control unit harness connector and lifting motor (front) harness connector.

Driver seat control unit		Lifting motor (front)		Continuity
Connector	Terminal	Connector	Terminal	
B503	16	B527	16	Existed

4. Check continuity between driver seat control unit harness connector and ground.

Driver seat control unit		Ground	Continuity
Connector	Terminal		
B503	16		Not existed

Is the inspection result normal?

YES >> Replace driver seat control unit. Refer to [ADP-236, "Removal and Installation"](#).

NO >> Repair or replace harness.

5.CHECK LIFTING SENSOR (FRONT) GROUND CIRCUIT 1

1. Turn ignition switch OFF.
2. Disconnect driver seat control unit connector.
3. Check continuity between driver seat control unit harness connector and lifting motor (front) harness connector.

Driver seat control unit		Lifting motor (front)		Continuity
Connector	Terminal	Connector	Terminal	
B503	31	B527	31	Existed

LIFTING SENSOR (FRONT)

< DTC/CIRCUIT DIAGNOSIS >

Is the inspection result normal?

YES >> GO TO 6.

NO >> Repair or replace harness.

6. CHECK LIFTING SENSOR (FRONT) GROUND CIRCUIT 2

1. Connect driver seat control unit connector.
2. Check continuity between lifting motor (front) harness connector and ground.

Driver seat control unit		Ground	Continuity
Connector	Terminal		
B503	31		Existed

Is the inspection result normal?

YES >> Replace lifting motor (front). Refer to [SE-233. "Exploded View"](#).

NO >> Replace driver seat control unit. Refer to [ADP-236. "Removal and Installation"](#).

A
B
C
D
E
F
G
H
I
K
L
M
N
O
P

ADP

LIFTING SENSOR (REAR)

< DTC/CIRCUIT DIAGNOSIS >

LIFTING SENSOR (REAR)

Description

INFOID:000000006471577

- The lifting sensor (rear) is installed to the seat slide cushion frame.
- The pulse signal is input to the driver seat control unit when the lifting (rear) is operated.
- The driver seat control unit counts the pulse and calculates the lifting (rear) amount of the seat.

Component Function Check

INFOID:000000006471578

1. CHECK FUNCTION

1. Turn ignition switch ON.
2. Select "LIFT RR PULSE" in the "Data monitor" mode using CONSULT-III.
3. Check lifting sensor (rear) signal under the following conditions.

Monitor item	Condition		Value
LIFT RR PULSE	Seat lifting (rear)	Operate (Up)	Change (increase) ^{*1}
		Operate (Down)	Change (decrease) ^{*1}
		Release	No change ^{*1}

*1: The value at the seat position attained when the battery is connected is considered to be 32768.

Is the indication normal?

YES >> INSPECTION END

NO >> Perform diagnosis procedure. Refer to [ADP-106, "Diagnosis Procedure"](#).

Diagnosis Procedure

INFOID:000000006471579

1. CHECK LIFTING SENSOR (REAR) SIGNAL

1. Turn ignition switch ON.
2. Check voltage signal between driver seat control unit harness connector and ground with oscilloscope.

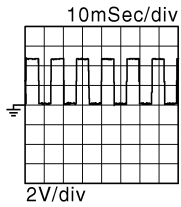
(+) Driver seat control unit		(-)	Condition	Voltage (V) (Approx.)
Connector	Terminal			
B503	10	Ground	Seat Lifting (rear)	 <p>10mSec/div 2V/div JMJA0119ZZ</p>
			Operate	
			Other than above	0 or 5

Is the inspection result normal?

YES >> Replace driver seat control unit. Refer to [ADP-236, "Removal and Installation"](#).

NO >> GO TO 2.

2. CHECK LIFTING SENSOR (REAR) CIRCUIT

1. Turn ignition switch OFF.
2. Disconnect driver seat control unit and lifting motor (rear) connector.
3. Check the continuity between driver seat control unit harness connector and lifting motor (rear) harness connector.

LIFTING SENSOR (REAR)

< DTC/CIRCUIT DIAGNOSIS >

Driver seat control unit		Lifting motor (rear)		Continuity
Connector	Terminal	Connector	Terminal	
B503	10	B529	10	Existed

4. Check the continuity between driver seat control unit harness connector and ground.

Driver seat control unit		Ground	Continuity
Connector	Terminal		
B503	10		Not Existed

Is the inspection result normal?

YES >> GO TO 3.

NO >> Repair or replace harness.

3.CHECK LIFTING SENSOR (REAR) POWER SUPPLY

1. Connect driver seat control unit connector.
2. Turn ignition switch ON.
3. Check the voltage between lifting motor (rear) harness connector and ground.

(+)		(-)	Voltage (V) (Approx.)
Lifting motor (rear)			
Connector	Terminal		
B529	16	Ground	Battery voltage

Is the inspection result normal?

YES >> GO TO 5.

NO >> GO TO 4.

4.CHECK LIFTING SENSOR (REAR) POWER SUPPLY CIRCUIT

1. Turn ignition switch OFF.
2. Disconnect driver seat control unit connector.
3. Check the continuity between driver seat control unit harness connector and lifting motor (rear) harness connector.

Driver seat control unit		Lifting motor (rear)		Continuity
Connector	Terminal	Connector	Terminal	
B503	16	B529	16	Existed

4. Check the continuity between driver seat control unit harness connector and ground.

Driver seat control unit		Ground	Continuity
Connector	Terminal		
B503	16		Not existed

Is the inspection result normal?

YES >> Replace driver seat control unit. Refer to [ADP-236, "Removal and Installation"](#).

NO >> Repair or replace harness.

5.CHECK LIFTING SENSOR (REAR) GROUND CIRCUIT 1

1. Turn ignition switch OFF.
2. Disconnect driver seat control unit connector.
3. Check the continuity between driver seat control unit harness connector and lifting motor (rear) harness connector.

Driver seat control unit		Lifting motor (rear)		Continuity
Connector	Terminal	Connector	Terminal	
B503	31	B529	31	Existed

LIFTING SENSOR (REAR)

< DTC/CIRCUIT DIAGNOSIS >

Is the inspection result normal?

YES >> GO TO 6.

NO >> Repair or replace harness.

6. CHECK LIFTING SENSOR (REAR) GROUND CIRCUIT 2

1. Connect driver seat control unit connector.
2. Check continuity between lifting motor (rear) harness connector and ground.

Driver seat control unit		Ground	Continuity
Connector	Terminal		
B503	31		Existed

Is the inspection result normal?

YES >> Replace lifting motor (rear). Refer to [SE-233, "Exploded View"](#).

NO >> Replace driver seat control unit. Refer to [ADP-236, "Removal and Installation"](#).

TILT SENSOR

< DTC/CIRCUIT DIAGNOSIS >

TILT SENSOR

Description

INFOID:000000006471581

- The tilt sensor is installed to the steering column assembly.
- The resistance of tilt sensor changes according to the up/down position of steering column.
- The terminal voltage of automatic drive positioner control unit changes according to a change of tilt sensor resistance. Automatic drive positioner control unit calculates the tilt position from the voltage.

Component Function Check

INFOID:000000006471581

1. CHECK FUNCTION

1. Turn ignition switch ON.
2. Select "TILT SEN" in the "Data monitor" mode using CONSULT-III.
3. Check the tilt sensor signal under the following condition.

Monitor item	Condition	Value
TILT SEN	Tilt position	Change between 1.1 V (Close to top) 3.9 V (Close to bottom)

Is the indication normal?

YES >> INSPECTION END

NO >> Perform diagnosis procedure. Refer to [ADP-109, "Diagnosis Procedure"](#).

Diagnosis Procedure

INFOID:000000006471582

1. CHECK TILT SENSOR SIGNAL

1. Turn ignition switch ON.
2. Check voltage automatic drive positioner control unit harness connector and ground.

(+)		(-)	Condition	Voltage (V) (Approx.)
Automatic drive positioner control unit Connector	Terminal			
M51	7	Ground	Tilt position	Change between 1.1 V (Close to top) 3.9 V (Close to bottom)

Is the inspection result normal?

YES >> Replace automatic drive positioner control unit. Refer to [ADP-237, "Removal and Installation"](#).

NO >> GO TO 2.

2. CHECK TILT SENSOR CIRCUIT

1. Turn ignition switch OFF.
2. Disconnect automatic drive positioner control unit and tilt & telescopic sensor connector.
3. Check continuity between automatic drive positioner control unit harness connector and tilt & telescopic sensor harness connector.

Automatic drive positioner control unit		Tilt & telescopic sensor		Continuity
Connector	Terminal	Connector	Terminal	
M51	7	M48	3	Existed

4. Check continuity between automatic drive positioner control unit harness connector and ground.

Automatic drive positioner control unit		Ground	Continuity
Connector	Terminal		
M51	7		Not existed

Is the inspection result normal?

TILT SENSOR

< DTC/CIRCUIT DIAGNOSIS >

- YES >> GO TO 3.
NO >> Repair or replace harness.

3.CHECK TILT SENSOR POWER SUPPLY

1. Connect automatic drive positioner control unit connector.
2. Turn ignition switch ON.
3. Check voltage between tilt & telescopic sensor harness connector and ground.

(+)		(-)	Voltage (V) (Approx.)
Tilt & telescopic sensor			
Connector	Terminal		
M48	1	Ground	5

Is the inspection result normal?

- YES >> GO TO 5.
NO >> GO TO 4.

4.CHECK TILT SENSOR POWER SUPPLY CIRCUIT

1. Turn ignition switch OFF.
2. Disconnect automatic drive positioner control unit connector, door mirror (driver side) connector and door mirror (passenger side) connector.
3. Check continuity between automatic drive positioner control unit harness connector and tilt & telescopic sensor harness connector.

Automatic drive positioner control unit		Tilt & telescopic sensor		Continuity
Connector	Terminal	Connector	Terminal	
M52	33	M48	1	Existed

4. Check continuity between automatic drive positioner control unit harness connector and ground.

Automatic drive positioner control unit		Ground	Continuity
Connector	Terminal		
M52	33		Not existed

Is the inspection result normal?

- YES >> Replace automatic drive positioner control unit. Refer to [ADP-237, "Removal and Installation"](#).
NO >> Repair or replace harness.

5.CHECK TILT SENSOR GROUND CIRCUIT 1

1. Turn ignition switch OFF.
2. Disconnect automatic drive positioner control unit connector.
3. Check continuity between automatic drive positioner control unit harness connector and tilt & telescopic sensor harness connector.

Automatic drive positioner control unit		Tilt & telescopic sensor		Continuity
Connector	Terminal	Connector	Terminal	
M52	41	M48	4	Existed

Is the inspection result normal?

- YES >> GO TO 6.
NO >> Repair or replace harness.

6.CHECK TILT SENSOR GROUND CIRCUIT 2

1. Connect automatic drive positioner control unit connector.
2. Check continuity between automatic drive positioner control unit harness connector and ground.

TILT SENSOR

< DTC/CIRCUIT DIAGNOSIS >

Automatic drive positioner control unit		Ground	Continuity
Connector	Terminal		Existed
M52	41		

Is the inspection result normal?

- YES >> Replace tilt & telescopic sensor (Built in steering column assembly). Refer to [ST-16, "WITHOUT ELECTRIC MOTOR : Exploded View"](#).
- NO >> Replace automatic drive positioner control unit. Refer to [ADP-237, "Removal and Installation"](#).

A
B
C
D
E
F
G
H
I
K
L
M
N
O
P

ADP

TELESCOPIC SENSOR

< DTC/CIRCUIT DIAGNOSIS >

TELESCOPIC SENSOR

Description

INFOID:000000006471583

- The telescopic sensor is installed to the steering column assembly.
- The resistance of telescopic sensor changes according to the forward/backward position of steering column.
- The terminal voltage of automatic drive positioner control unit changes according to a change of telescopic sensor resistance. Automatic drive positioner control unit calculates the telescopic position from the voltage.

Component Function Check

INFOID:000000006471584

1. CHECK FUNCTION

1. Turn ignition switch ON.
2. Select "TELESCO SEN" in the "Data monitor" mode using CONSULT-III.
3. Check the tilt sensor signal under the following conditions.

Monitor item	Condition	Value
TELESCO SEN	Telescopic position	Change between 0.5 [V] (close to top) 4.5 [V] (close to bottom)

Is the indication normal?

YES >> INSPECTION END.

NO >> Perform diagnosis procedure. Refer to [ADP-112, "Diagnosis Procedure"](#).

Diagnosis Procedure

INFOID:000000006471585

1. CHECK TELESCOPIC SENSOR SIGNAL

1. Turn ignition switch ON.
2. Check voltage automatic drive positioner control unit harness connector and ground.

(+)		(-)	Condition	Voltage (V) (Approx.)
Automatic drive positioner control unit	Connector			
Terminal	Terminal	Ground	Telescopic position	Change between 0.5 [V] (close to top) 4.5 [V] (close to bottom)
M51	23	Ground	Telescopic position	Change between 0.5 [V] (close to top) 4.5 [V] (close to bottom)

Is the inspection result normal?

YES >> Replace automatic drive positioner control unit. Refer to [ADP-237, "Removal and Installation"](#).

NO >> GO TO 2.

2. CHECK TELESCOPIC SENSOR CIRCUIT

1. Turn ignition switch OFF.
2. Disconnect automatic drive positioner control unit and tilt & telescopic sensor connector.
3. Check continuity between automatic drive positioner control unit harness connector and tilt & telescopic sensor harness connector.

Automatic drive positioner control unit		Tilt & telescopic sensor		Continuity
Connector	Terminal	Connector	Terminal	
M51	23	M48	2	Existed

4. Check continuity between automatic drive positioner control unit harness connector and ground.

Automatic drive positioner control unit		Ground	Continuity
Connector	Terminal		
M51	23		Not existed

Is the inspection result normal?

TELESCOPIC SENSOR

< DTC/CIRCUIT DIAGNOSIS >

- YES >> GO TO 3.
 NO >> Repair or replace harness.

3.CHECK TELESCOPIC SENSOR POWER SUPPLY

1. Connect automatic drive positioner control unit connector.
2. Turn ignition switch ON.
3. Check voltage between tilt & telescopic sensor harness connector and ground.

(+)		(-)	Voltage (V) (Approx.)
Tilt & telescopic sensor			
Connector	Terminal		
M48	1	Ground	5

Is the inspection result normal?

- YES >> GO TO 5.
 NO >> GO TO 4.

4.CHECK TELESCOPIC SENSOR POWER SUPPLY CIRCUIT

1. Turn ignition switch OFF.
2. Disconnect automatic drive positioner control unit connector, door mirror (driver side) connector and door mirror (passenger side) connector.
3. Check continuity between automatic drive positioner control unit harness connector and tilt & telescopic sensor harness connector.

Automatic drive positioner control unit		Tilt & telescopic sensor		Continuity
Connector	Terminal	Connector	Terminal	
M52	33	M48	1	Existed

4. Check continuity between automatic drive positioner control unit harness connector and ground.

Automatic drive positioner control unit		Ground	Continuity
Connector	Terminal		
M52	33		Not existed

Is the inspection result normal?

- YES >> Replace automatic drive positioner control unit. Refer to [ADP-237, "Removal and Installation"](#).
 NO >> Repair or replace harness.

5.CHECK TELESCOPIC SENSOR GROUND CIRCUIT 1

1. Turn ignition switch OFF.
2. Disconnect automatic drive positioner control unit connector.
3. Check continuity between automatic drive positioner control unit harness connector and tilt & telescopic sensor harness connector.

Automatic drive positioner control unit		Tilt & telescopic sensor		Continuity
Connector	Terminal	Connector	Terminal	
M52	41	M48	4	Existed

Is the inspection result normal?

- YES >> GO TO 6.
 NO >> Repair or replace harness.

6.CHECK TELESCOPIC SENSOR GROUND CIRCUIT 2

1. Connect automatic drive positioner control unit connector.
2. Check continuity between automatic drive control unit harness connector and ground.

TELESCOPIC SENSOR

< DTC/CIRCUIT DIAGNOSIS >

Automatic drive positioner control unit		Ground	Continuity
Connector	Terminal		Existed
M52	41		

Is the inspection result normal?

- YES >> Replace tilt & telescopic sensor (Built in steering column assembly). Refer to [ST-16, "WITHOUT ELECTRIC MOTOR : Exploded View"](#).
- NO >> Replace automatic drive positioner control unit. Refer to [ADP-237, "Removal and Installation"](#).

MIRROR SENSOR

< DTC/CIRCUIT DIAGNOSIS >

MIRROR SENSOR

DRIVER SIDE

DRIVER SIDE : Description

INFOID:000000006471586

- The mirror sensor (driver side) is installed to the door mirror (driver side).
- The resistance of 2 sensors (horizontal and vertical) is changed when the door mirror (driver side) is operated.
- Automatic drive positioner control unit calculates the door mirror position according to the change of the voltage of 2 sensor input terminals.

DRIVER SIDE : Component Function Check

INFOID:000000006471587

1.CHECK FUNCTION

1. Turn ignition switch ON.
2. Select "MIR/SEN LH U-D", "MIR/SEN LH R-L" in the "Data monitor" using CONSULT-III.
3. Check mirror sensor (driver side) signal under the following condition.

Monitor item	Condition	Value
MIR/SEN LH U-D	Door mirror (driver side)	Change between 3.4 [V] (close to peak) 0.6 [V] (close to valley)
MIR/SEN LH R-L		Change between 0.6 [V] (close to left edge) 3.4 [V] (close to right edge)

Is the indication normal?

YES >> INSPECTION END

NO >> Perform diagnosis procedure. Refer to [ADP-115. "DRIVER SIDE : Diagnosis Procedure"](#).

DRIVER SIDE : Diagnosis Procedure

INFOID:000000006471588

1.CHECK DOOR MIRROR SENSOR (DRIVER SIDE) SIGNAL

1. Turn ignition switch ON.
2. Check voltage automatic drive positioner control unit harness connector and ground.

(+)		(-)	Condition	Voltage (V) (Approx.)
Automatic drive positioner control unit				
Connector	Terminal			
M51	6	Ground	Door mirror (Driver side) position	Change between 3.4 [V] (close to peak) 0.6 [V] (close to valley)
	22			Change between 3.4 [V] (close to left edge) 0.6 [V] (close to right edge)

Is the inspection result normal?

YES >> Replace automatic drive positioner control unit. Refer to [ADP-237. "Removal and Installation"](#).

NO >> GO TO 2.

2.CHECK DOOR MIRROR (DRIVER SIDE) SENSOR CIRCUIT

1. Turn ignition OFF.
2. Disconnect automatic drive positioner control unit connector and door mirror (drive side) connector.
3. Check continuity between automatic drive positioner control unit harness connector and door mirror (driver side) harness connector.

MIRROR SENSOR

< DTC/CIRCUIT DIAGNOSIS >

Automatic drive positioner control unit		Door mirror (driver side)		Continuity
Connector	Terminal	Connector	Terminal	
M51	6	D3	9	Existed
	22		10	

4. Check continuity between automatic drive positioner control unit harness connector and ground.

Automatic drive positioner control unit		Ground	Continuity
Connector	Terminal		
M51	6		Not existed
	22		

Is the inspection result normal?

YES >> GO TO 3.

NO >> Repair or replace harness.

3. CHECK DOOR MIRROR (DRIVER SIDE) SENSOR POWER SUPPLY

1. Connect automatic drive positioner control unit connector.
2. Turn ignition switch ON.
3. Check voltage between door mirror (driver side) harness connector and ground.

(+)		(-)	Voltage (V) (Approx.)
Door mirror (driver side)			
Connector	Terminal		
D3	11	Ground	5

Is the inspection result normal?

YES >> GO TO 5.

NO >> GO TO 4.

4. CHECK DOOR MIRROR (DRIVER SIDE) SENSOR POWER SUPPLY CIRCUIT

1. Turn ignition switch OFF.
2. Disconnect automatic drive positioner control unit connector, tilt&telescopic switch connector and door mirror (passenger side) connector.
3. Check continuity between automatic drive positioner control unit harness connector and door mirror (driver side) harness connector.

Automatic drive positioner control unit		Door mirror (driver side)		Continuity
Connector	Terminal	Connector	Terminal	
M52	33	D3	11	Existed

4. Check continuity between automatic drive positioner control unit harness connector and ground.

Automatic drive positioner control unit		Ground	Continuity
Connector	Terminal		
M52	33		Not existed

Is the inspection result normal?

YES >> Replace automatic drive positioner control unit. Refer to [ADP-237, "Removal and Installation"](#).

NO >> Repair or replace harness.

5. CHECK DOOR MIRROR (DRIVER SIDE) SENSOR GROUND 1

1. Turn ignition switch OFF.
2. Disconnect automatic drive control unit connector.
3. Check continuity between automatic drive positioner control unit harness connector and door mirror (driver side) harness connector.

MIRROR SENSOR

< DTC/CIRCUIT DIAGNOSIS >

Automatic drive positioner control unit		Door mirror (driver side)		Continuity
Connector	Terminal	Connector	Terminal	
M52	41	D3	12	Existed

Is the inspection result normal?

- YES >> GO TO 6.
 NO >> Repair or replace harness.

6.CHECK DOOR MIRROR (DRIVER SIDE) SENSOR GROUND 2

1. Connect automatic drive positioner control unit connector.
2. Check continuity between automatic drive positioner control unit harness connector and ground.

Automatic drive positioner control unit		Ground	Continuity
Connector	Terminal		
M52	41		Existed

Is the inspection result normal?

- YES >> Replace automatic drive positioner control unit. Refer to [ADP-237, "Removal and Installation"](#).
 NO >> Replace door mirror sensor (Built in passenger side door mirror). Refer to [MIR-21, "DOOR MIRROR ASSEMBLY : Removal and Installation"](#).

PASSENGER SIDE

PASSENGER SIDE : Description

INFOID:000000006471589

- The mirror sensor (passenger side) is installed to the door mirror (passenger side).
- The resistance of 2 sensors (horizontal and vertical) is changed when the door mirror (passenger side) is operated.
- Automatic drive positioner control unit calculates the door mirror position according to the change of the voltage of 2 sensor input terminals.

PASSENGER SIDE : Component Function Check

INFOID:000000006471590

ADP

1.CHECK FUNCTION

1. Turn ignition switch ON.
2. Select "MIR/SEN RH U-D", "MIR/SEN RH R-L" in the "Data monitor" using CONSULT-III.
3. Check the mirror sensor (passenger side) signal under the following conditions.

Monitor item	Condition	Value
MIR/SEN RH U-D	Door mirror (passenger side)	Change between 3.4 [V] (close to peak) 0.6 [V] (close to valley)
MIR/SEN RH R-L		Change between 3.4 [V] (close to left edge) 0.6 [V] (close to right edge)

Is the indication normal?

- YES >> INSPECTION END
 NO >> Perform diagnosis procedure. Refer to [ADP-117, "PASSENGER SIDE : Diagnosis Procedure"](#).

PASSENGER SIDE : Diagnosis Procedure

INFOID:000000006471591

1.CHECK DOOR MIRROR SENSOR (PASSENGER SIDE) SIGNAL

1. Turn ignition switch ON.
2. Check voltage automatic drive positioner control unit harness connector and ground.

MIRROR SENSOR

< DTC/CIRCUIT DIAGNOSIS >

(+)		(-)	Condition	Voltage (V) (Approx.)
Automatic drive positioner control unit				
Connector	Terminal			
M51	5	Ground	Door mirror (Passenger side) position	Change between 3.4 [V] (close to peak) 0.6 [V] (close to valley)
	21			Change between 3.4 [V] (close to left edge) 0.6 [V] (close to right edge)

Is the inspection result normal?

- YES >> Replace automatic drive positioner control unit. Refer to [ADP-237. "Removal and Installation"](#).
 NO >> GO TO 2.

2.CHECK DOOR MIRROR (PASSENGER SIDE) SENSOR CIRCUIT

- Turn ignition switch OFF.
- Disconnect automatic drive positioner control unit connector and door mirror (passenger side) connector.
- Check continuity between automatic drive positioner control unit harness connector and door mirror (passenger side) harness connector.

Automatic drive positioner control unit		Door mirror (passenger side)		Continuity
Connector	Terminal	Connector	Terminal	
M51	5	D33	9	Existed
	21		10	

- Check continuity between automatic drive positioner control unit harness connector and ground.

Automatic drive positioner control unit		Ground	Continuity
Connector	Terminal		
M51	5		Not existed
	21		

Is the inspection result normal?

- YES >> GO TO 3.
 NO >> Repair or replace harness.

3.CHECK DOOR MIRROR SENSOR (PASSENGER SIDE) POWER SUPPLY

- Connect automatic drive positioner control unit connector.
- Turn ignition switch ON.
- Check voltage between door mirror (passenger side) harness connector and ground.

(+)		(-)	Voltage (V) (Approx.)
Door mirror (passenger side)			
Connector	Terminal		
D33	11	Ground	5

Is the inspection result normal?

- YES >> GO TO 5.
 NO >> GO TO 4.

4.CHECK DOOR MIRROR (PASSENGER SIDE) SENSOR POWER SUPPLY CIRCUIT

- Turn ignition switch OFF.
- Disconnect automatic drive positioner control unit connector, tilt&telescopic switch connector and door mirror (driver side) connector.
- Check continuity between automatic drive positioner control unit harness connector and door mirror (passenger side) harness connector.

MIRROR SENSOR

< DTC/CIRCUIT DIAGNOSIS >

Automatic drive positioner control unit		Door mirror (passenger side)		Continuity
Connector	Terminal	Connector	Terminal	
M52	33	D33	11	Existed

4. Check continuity between automatic drive positioner control unit harness connector and ground.

Automatic drive positioner control unit		Ground	Continuity
Connector	Terminal		
M52	33		Not existed

Is the inspection result normal?

- YES >> Replace automatic driver positioner control unit. Refer to [ADP-237, "Removal and Installation"](#).
 NO >> Repair or replace harness.

5.CHECK DOOR MIRROR (PASSENGER SIDE) SENSOR GROUND 1

- Turn ignition switch OFF.
- Disconnect automatic drive positioner control unit connector.
- Check continuity between automatic drive positioner control unit harness connector and door mirror (passenger side) connector.

Automatic drive positioner control unit		Door mirror (passenger side)		Continuity
Connector	Terminal	Connector	Terminal	
M52	41	D33	12	Existed

Is the inspection result normal?

- YES >> GO TO 6.
 NO >> Repair or replace harness.

6.CHECK DOOR MIRROR (PASSENGER SIDE) SENSOR GROUND 2

- Connect automatic drive positioner control unit connector.
- Check continuity between automatic drive positioner control unit harness connector and ground.

Automatic drive positioner control unit		Ground	Continuity
Connector	Terminal		
M52	41		Existed

Is the inspection result normal?

- YES >> Replace automatic drive positioner control unit. Refer to [ADP-237, "Removal and Installation"](#).
 NO >> Replace door mirror sensor (Built in passenger side door mirror). Refer to [MIR-21, "DOOR MIRROR ASSEMBLY : Removal and Installation"](#).

A
B
C
D
E
F
G
H
I
K
L
M
N
O
P

ADP

SLIDING MOTOR

< DTC/CIRCUIT DIAGNOSIS >

SLIDING MOTOR

Description

INFOID:000000006471592

- The seat sliding motor is installed to the seat cushion frame.
- The seat sliding motor is activated with the driver seat control unit.
- The seat is slid forward/rearward by changing the rotation direction of sliding motor.

Component Function Check

INFOID:000000006471593

1. CHECK FUNCTION

1. Turn ignition switch ON.
2. Select "SEAT SLIDE" in "Active test" mode using CONSULT-III.
3. Check the sliding motor operation.

Test item		Description	
SEAT SLIDE	OFF	Seat sliding	Stop
	FR		Forward
	RR		Backward

Is the operation of relevant parts normal?

YES >> INSPECTION END

NO >> Perform diagnosis procedure. Refer to [ADP-120, "Diagnosis Procedure"](#).

Diagnosis Procedure

INFOID:000000006471594

1. CHECK SLIDING MOTOR POWER SUPPLY

1. Turn ignition switch OFF.
2. Disconnect sliding motor connector.
3. Turn the ignition switch ON.
4. Perform "Active test" ("SEAT SLIDE") using CONSULT-III
5. Check voltage between sliding motor harness connector and ground.

(+)		(-)	Condition	Voltage (V) (Approx.)	
Sliding motor					
Connector	Terminal				
B525	35	Ground	SEAT SLIDE	OFF	0
				FR (forward)	Battery voltage
				RR (backward)	0
	42			OFF	0
				FR (forward)	0
				RR (backward)	Battery voltage

Is the inspection result normal?

YES >> Replace sliding motor. (Built in seat slide cushion frame.) Refer to [SE-233, "Exploded View"](#).

NO >> GO TO 2.

2. CHECK SLIDING MOTOR CIRCUIT

1. Turn ignition switch OFF.
2. Disconnect driver seat control unit connector.
3. Check continuity between driver seat control unit harness connector and sliding motor harness connector.

SLIDING MOTOR

< DTC/CIRCUIT DIAGNOSIS >

Driver seat control unit		Sliding motor		Continuity
Connector	Terminal	Connector	Terminal	
B504	35	B525	35	Existed
	42		42	

4. Check continuity between driver seat control unit harness connector and ground.

Driver seat control unit		Ground	Continuity
Connector	Terminal		
B504	35		Not existed
	42		

Is the inspection result normal?

- YES >> Replace driver seat control unit. Refer to [ADP-236. "Removal and Installation"](#).
- NO >> Repair or replace harness.

A
B
C
D
E
F
G
H
I
K
L
M
N
O
P

ADP

RECLINING MOTOR

< DTC/CIRCUIT DIAGNOSIS >

RECLINING MOTOR

Description

INFOID:000000006471595

- The seat reclining motor is installed to the seat back frame.
- The seat reclining motor is activated with the driver seat control unit.
- The seatback is reclined frontward/rearward by changing the rotation direction of reclining motor.

Component Function Check

INFOID:000000006471596

1. CHECK FUNCTION

1. Turn ignition switch ON.
2. Select "SEAT RECLINING" in "Active test" mode using CONSULT-III.
3. Check the reclining motor operation.

Test item		Description	
SEAT RECLINING	OFF	Seat reclining	Stop
	FR		Forward
	RR		Backward

Is the operation of relevant parts normal?

YES >> INSPECTION END

NO >> Perform diagnosis procedure. Refer to [ADP-122, "Diagnosis Procedure"](#).

Diagnosis Procedure

INFOID:000000006471597

1. CHECK RECLINING MOTOR POWER SUPPLY

1. Turn ignition switch OFF.
2. Disconnect reclining motor connector.
3. Turn the ignition switch ON.
4. Perform "Active test" ("SEAT RECLINING") using CONSULT-III
5. Check voltage between reclining motor harness connector and ground.

(+)		(-)	Condition	Voltage (V) (Approx.)	
Reclining motor					
Connector	Terminal				
B523	36	Ground	SEAT RECLINING	OFF	0
			FR (forward)	Battery voltage	
			RR (backward)	0	
	44		OFF	0	
			FR (forward)	0	
			RR (backward)	Battery voltage	

Is the inspection result normal?

YES >> Replace reclining motor. (Built in seat back frame.) Refer to [SE-233, "Exploded View"](#).

NO >> GO TO 2.

2. CHECK RECLINING MOTOR CIRCUIT

1. Turn ignition switch OFF.
2. Disconnect driver seat control unit connector.
3. Check continuity between driver seat control unit harness connector and reclining motor harness connector.

RECLINING MOTOR

< DTC/CIRCUIT DIAGNOSIS >

Driver seat control unit		Reclining motor		Continuity
Connector	Terminal	Connector	Terminal	
B504	36	B523	36	Existed
	44		44	

4. Check continuity between driver seat control unit harness connector and ground.

Driver seat control unit		Ground	Continuity
Connector	Terminal		
B504	36		Not existed
	44		

Is the inspection result normal?

YES >> Replace driver seat control unit. Refer to [ADP-236. "Removal and Installation"](#).

NO >> Repair or replace harness.

A
B
C
D
E
F
G
H
I
K
L
M
N
O
P

ADP

LIFTING MOTOR (FRONT)

< DTC/CIRCUIT DIAGNOSIS >

LIFTING MOTOR (FRONT)

Description

INFOID:000000006471598

- The lifting motor (front) is installed to the seat slide cushion frame.
- The lifting motor (front) is activated with the driver seat control unit.
- The lifter (front) is moved upward/downward by changing the rotation direction of lifting motor (front).

Component Function Check

INFOID:000000006471599

1. CHECK FUNCTION

1. Turn ignition switch ON.
2. Select "SEAT LIFTER FR" in "Active test" mode using CONSULT-III.
3. Check the lifting motor (front) operation.

Test item		Description	
SEAT LIFTER FR	OFF	Seat lifting (front)	Stop
	UP		Upward
	DWN		Downward

Is the operation of relevant parts normal?

YES >> INSPECTION END

NO >> Perform diagnosis procedure. Refer to [ADP-124, "Diagnosis Procedure"](#).

Diagnosis Procedure

INFOID:000000006471600

1. CHECK LIFTING MOTOR (FRONT) POWER SUPPLY

1. Turn ignition switch OFF.
2. Disconnect lifting motor (front) connector.
3. Turn the ignition switch ON.
4. Perform "Active test" ("SEAT LIFTER FR") using CONSULT-III.
5. Check voltage between lifting motor (front) harness connector and ground.

(+)		(-)	Condition	Voltage (V) (Approx.)	
Connector	Terminal				
B527	37	Ground	SEAT LIFTER FR	OFF	0
				UP	0
	DWN (down)			Battery voltage	
	OFF			0	
	UP			Battery voltage	
	DWN (down)			0	
45					

Is the inspection result normal?

YES >> Replace lifting motor (front). (Built in seat slide cushion frame.) Refer to [SE-233, "Exploded View"](#).

NO >> GO TO 2.

2. CHECK LIFTING MOTOR (FRONT) CIRCUIT

1. Turn ignition switch OFF.
2. Disconnect driver seat control unit connector.
3. Check continuity between driver seat control unit harness connector and lifting motor (front) harness connector.

LIFTING MOTOR (FRONT)

< DTC/CIRCUIT DIAGNOSIS >

Driver seat control unit		Lifting motor (front)		Continuity
Connector	Terminal	Connector	Terminal	
B504	37	B527	37	Existed
	45		45	

4. Check continuity between driver seat control unit harness connector and ground.

Driver seat control unit		Ground	Continuity
Connector	Terminal		
B504	37		Not existed
	45		

Is the inspection result normal?

YES >> Replace driver seat control unit. Refer to [ADP-236. "Removal and Installation"](#).

NO >> Repair or replace harness.

A
B
C
D
E
F
G
H
I
K
L
M
N
O
P

ADP

LIFTING MOTOR (REAR)

< DTC/CIRCUIT DIAGNOSIS >

LIFTING MOTOR (REAR)

Description

INFOID:000000006471601

- The lifting motor (rear) is installed to the seat slide cushion frame.
- The lifting motor (rear) is activated with the driver seat control unit.
- The seat lifter (rear) is moved upward/downward by changing the rotation direction of lifting motor (rear).

Component Function Check

INFOID:000000006471602

1. CHECK FUNCTION

1. Turn ignition switch ON.
2. Select "SEAT LIFTER RR" in "Active test" mode using CONSULT-III.
3. Check the lifting motor (rear) operation.

Test item		Description	
SEAT LIFTER RR	OFF	Seat lifting (rear)	Stop
	UP		Upward
	DWN		Downward

Is the operation of relevant parts normal?

YES >> INSPECTION END

NO >> Perform diagnosis procedure. Refer to [ADP-126, "Diagnosis Procedure"](#).

Diagnosis Procedure

INFOID:000000006471603

1. CHECK LIFTING MOTOR (REAR) POWER SUPPLY

1. Turn ignition switch OFF.
2. Disconnect lifting motor (rear) connector.
3. Turn the ignition switch ON.
4. Perform "Active test" ("SEAT LIFTER RR") using CONSULT-III
5. Check voltage between lifting motor (rear) harness connector and ground.

(+)		(-)	Condition	Voltage (V) (Approx.)	
Lifting motor (rear)					
Connector	Terminal				
B529	38	Ground	SEAT LIFTER RR	OFF	0
				UP	Battery voltage
	DWN (DOWN)			0	
	OFF			0	
	UP			0	
	DWN (DOWN)			Battery voltage	
39					

Is the inspection result normal?

YES >> Replace lifting motor (rear). (Built in seat slide cushion frame.) Refer to [SE-233, "Exploded View"](#).

NO >> GO TO 2.

2. CHECK LIFTING MOTOR (REAR) CIRCUIT

1. Turn ignition switch OFF.
2. Disconnect driver seat control unit connector and lifting motor (rear) connector.
3. Check continuity between driver seat control unit harness connector and lifting motor (rear) harness connector.

LIFTING MOTOR (REAR)

< DTC/CIRCUIT DIAGNOSIS >

Driver seat control unit		Lifting motor (rear)		Continuity
Connector	Terminal	Connector	Terminal	
B504	38	B529	38	Existed
	39		39	

4. Check continuity between driver seat control unit harness connector and ground.

Driver seat control unit		Ground	Continuity
Connector	Terminal		
B504	38		Not existed
	39		

Is the inspection result normal?

- YES >> Replace driver seat control unit. Refer to [ADP-236. "Removal and Installation"](#).
- NO >> Repair or replace harness.

A
B
C
D
E
F
G
H
I
K
L
M
N
O
P

ADP

TILT MOTOR

< DTC/CIRCUIT DIAGNOSIS >

TILT MOTOR

Description

INFOID:000000006471604

- The tilt motor is installed to the steering column assembly.
- The tilt motor is activated with the automatic drive positioner control unit.
- The steering column is tilted upward/downward by changing the rotation direction of tilt motor.

Component Function Check

INFOID:000000006471605

1. CHECK FUNCTION

1. Turn ignition switch ON.
2. Select "TILT MOTOR" in "Active test" mode using CONSULT-III.
3. Check the tilt motor operation.

Test item		Description	
TILT MOTOR	OFF	Steering tilt	Stop
	UP		Upward
	DWN		Downward

Is the operation of relevant parts normal?

YES >> INSPECTION END

NO >> Perform diagnosis procedure. Refer to [ADP-128, "Diagnosis Procedure"](#).

Diagnosis Procedure

INFOID:000000006471606

1. CHECK TILT MOTOR POWER SUPPLY

1. Turn ignition switch OFF.
2. Disconnect tilt & telescopic motor connector.
3. Turn ignition switch ON.
4. Perform "Active test" ("TILT MOTOR") using CONSULT-III.
5. Check voltage between tilt & telescopic motor harness connector and ground.

(+)		(-)	Condition	Voltage (V) (Approx.)	
Connector	Terminal				
M49	3	Ground	TILT MOTOR	OFF	0
			UP	0	
			DWN (down)	Battery voltage	
	4		OFF	0	
			UP	Battery voltage	
			DWN (down)	0	

Is the inspection result normal?

YES >> Replace tilt motor. (Built in steering column assembly.) Refer to [ST-19, "WITH ELECTRIC MOTOR : Exploded View"](#).

NO >> GO TO 2.

2. CHECK TILT MOTOR CIRCUIT

1. Turn ignition switch OFF.
2. Disconnect automatic drive positioner control unit connector.
3. Check continuity between automatic drive positioner control unit harness connector and tilt & telescopic motor harness connector.

TILT MOTOR

< DTC/CIRCUIT DIAGNOSIS >

Automatic drive positioner control unit		Tilt & telescopic motor		Continuity
Connector	Terminal	Connector	Terminal	
M52	35	M49	4	Existed
	42		3	

4. Check continuity between automatic drive positioner control unit harness connector and ground.

Automatic drive positioner control unit		Ground	Continuity
Connector	Terminal		
M52	35		Not existed
	42		

Is the inspection result normal?

- YES >> Replace automatic drive positioner control unit. Refer to [ADP-237, "Removal and Installation"](#).
 NO >> Repair or replace harness.

A
B
C
D
E
F
G
H
I
K
L
M
N
O
P

ADP

TELESCOPIC MOTOR

< DTC/CIRCUIT DIAGNOSIS >

TELESCOPIC MOTOR

Description

INFOID:000000006471607

- The telescopic motor is installed to the steering column assembly.
- The telescopic motor is activated with the automatic drive positioner control unit.
- Compresses the steering column by changing the rotation direction of telescopic motor.

Component Function Check

INFOID:000000006471608

1. CHECK FUNCTION

1. Turn ignition switch ON.
2. Select "TELESCO MOTOR" in "Active test" mode using CONSULT-III.
3. Check the telescopic motor operation.

Test item		Description	
TELESCO MOTOR	OFF	Steering telescopic	Stop
	FR		Forward
	RR		Backward

Is the operation of relevant parts normal?

YES >> INSPECTION END

NO >> Perform diagnosis procedure. Refer to [ADP-130, "Diagnosis Procedure"](#).

Diagnosis Procedure

INFOID:000000006471609

1. CHECK TELESCOPIC MOTOR POWER SUPPLY

1. Turn ignition switch OFF.
2. Disconnect tilt & telescopic motor connector.
3. Turn ignition switch ON.
4. Perform "Active test" ("TELESCO MOTOR") using CONSULT-III
5. Check voltage between tilt & telescopic motor harness connector and ground.

(+)		(-)	Condition	Voltage (V) (Approx.)	
Connector	Terminal				
M49	1	Ground	TELESCOPIC MOTOR	OFF	0
			FR (forward)	0	
			RR (backward)	Battery voltage	
	2		OFF	0	
			FR (forward)	Battery voltage	
			RR (backward)	0	

Is the inspection result normal?

YES >> Replace telescopic motor. (Built in steering column assembly.) Refer to [ST-19, "WITH ELECTRIC MOTOR : Exploded View"](#).

NO >> GO TO 2.

2. CHECK TELESCOPIC MOTOR CIRCUIT

1. Turn ignition switch OFF.
2. Disconnect automatic drive positioner control unit connector.
3. Check continuity between automatic drive positioner control unit harness connector and tilt & telescopic motor harness connector.

TELESCOPIC MOTOR

< DTC/CIRCUIT DIAGNOSIS >

Automatic drive positioner control unit		Tilt & telescopic motor		Continuity
Connector	Terminal	Connector	Terminal	
M52	36	M49	2	Existed
	44		1	

4. Check continuity between automatic drive positioner control unit harness connector and ground.

Automatic drive positioner control unit		Ground	Continuity
Connector	Terminal		
M52	36		Not existed
	44		

Is the inspection result normal?

YES >> Replace automatic drive positioner control unit. Refer to [ADP-237, "Removal and Installation"](#).

NO >> Repair or replace harness.

A
B
C
D
E
F
G
H
I
K
L
M
N
O
P

ADP

DOOR MIRROR MOTOR

< DTC/CIRCUIT DIAGNOSIS >

DOOR MIRROR MOTOR

Description

INFOID:000000006471610

It makes mirror face operate from side to side and up and down with the electric power that automatic drive positioner control unit supplies.

Component Function Check

INFOID:000000006471611

1. CHECK DOOR MIRROR MOTOR FUNCTION

1. Turn ignition switch ON.
2. Select "DOOR MIRROR MOTOR LH" and "DOOR MIRROR MOTOR RH" in "Active test" mode using CONSULT-III.
3. Check the door mirror motor operation.

Test item		Description	
DOOR MIRROR MOTOR LH	OFF	Door mirror face	Stop
	L		Outward
	R		Inward
	UP		Upward
	DWN		Downward

Test item		Description	
DOOR MIRROR MOTOR RH	OFF	Door mirror face	Stop
	L		Inward
	R		Outward
	UP		Upward
	DWN		Downward

Is the operation of relevant parts normal?

YES >> INSPECTION END

NO >> Perform diagnosis procedure. Refer to [ADP-132. "Diagnosis Procedure"](#).

Diagnosis Procedure

INFOID:000000006471612

1. CHECK DOOR MIRROR MOTOR INPUT SIGNAL

1. Turn ignition switch OFF.
2. Disconnect door mirror connector.
3. Turn ignition switch ON.
4. Check voltage between door mirror connector and ground.

(+)		(-)	Condition	Voltage (V) (Approx.)	
Door mirror					
Connector	Terminal				
D3 (Driver side) D33 (Passenger side)	5	Ground	Door mirror remote control switch	UP	Battery voltage
				Other than above	0
	6			LEFT	Battery voltage
				Other than above	0
	7			DOWN / RIGHT	Battery voltage
				Other than above	0

Is the inspection result normal?

YES >> Replace door mirror. Refer to [MIR-21. "DOOR MIRROR ASSEMBLY : Removal and Installation"](#).

NO >> GO TO 2.

DOOR MIRROR MOTOR

< DTC/CIRCUIT DIAGNOSIS >

2. CHECK HARNESS CONTINUITY

1. Turn ignition switch OFF.
2. Disconnect automatic drive positioner control unit connector.
3. Check continuity between automatic drive positioner control unit connector and door mirror connector.

[Door mirror driver side]

Automatic drive positioner control unit		Door mirror (driver side)		Continuity
Connector	Terminal	Connector	Terminal	
M51	16	D3	7	Existed
	31		5	
	32		6	

[Door mirror passenger side]

Automatic drive positioner control unit		Door mirror (passenger side)		Continuity
Connector	Terminal	Connector	Terminal	
M51	14	D33	5	Existed
	15		6	
	30		7	

4. Check continuity between automatic drive positioner control unit connector and ground.

[Door mirror driver side]

Automatic drive positioner control unit		Ground	Continuity
Connector	Terminal		
M51	16		Not existed
	31		
	32		

[Door mirror passenger side]

Automatic drive positioner control unit		Ground	Continuity
Connector	Terminal		
M51	14		Not existed
	15		
	30		

Is the inspection result normal?

- YES >> Replace automatic drive positioner control unit. Refer to [ADP-237, "Removal and Installation"](#).
 NO >> Repair or replace harness.

A
B
C
D
E
F
G
H
I
K
L
M
N
O
P

ADP

SEAT MEMORY INDICATOR

< DTC/CIRCUIT DIAGNOSIS >

SEAT MEMORY INDICATOR

Description

INFOID:000000006471613

- Memory indicator is equipped on the seat memory switch installed to the driver side door trim. The operation signal is inputted to the automatic drive positioner control unit when the memory switch is operated.
- The status of automatic drive positioner system can be checked according to the illuminating/flashing status.

Component Function Check

INFOID:000000006471614

1. CHECK FUNCTION

1. Turn ignition switch ON.
2. Select "MEMORY SW INDCTR" in "Active test" mode using CONSULT-III.
3. Check the memory indicator operation.

Test item		Description	
MEMORY SW INDCTR	OFF	Memory switch indicator	OFF
	ON-1		Indicator 1: ON
	ON-2		Indicator 2: ON

Is the operation of relevant parts normal?

YES >> INSPECTION END

NO >> Perform diagnosis procedure. Refer to [ADP-134, "Diagnosis Procedure"](#).

Diagnosis Procedure

INFOID:000000006471615

1. CHECK MEMORY INDICATOR POWER SUPPLY

Check voltage between seat memory switch harness connector and ground.

(+)		(-)	Voltage (V) (Approx.)
Seat memory switch			
Connector	Terminal	Ground	Battery voltage
D5	5		

Is the inspection result normal?

YES >> GO TO 2.

NO >> Check the following.

- 10A fuse [No.10 located in fuse block (J/B)].
- Harness for open or short between memory indicator and fuse.

2. CHECK MEMORY INDICATOR CIRCUIT

1. Turn ignition switch OFF.
2. Disconnect automatic drive positioner control unit and seat memory switch connector.
3. Check continuity between automatic drive positioner control unit harness connector and seat memory switch harness connector.

Automatic drive positioner control unit		Seat memory switch		Continuity
Connector	Terminal	Connector	Terminal	
M51	12	D5	6	Existed
	13		7	

4. Check continuity between automatic drive positioner control unit harness connector and ground.

Automatic drive positioner control unit		Ground	Continuity
Connector	Terminal		
M51	12		Not existed
	13		

SEAT MEMORY INDICATOR

< DTC/CIRCUIT DIAGNOSIS >

Is the inspection result normal?

YES >> Replace seat memory switch. Refer to [ADP-238, "Removal and Installation"](#).

NO >> Repair or replace harness.

A

B

C

D

E

F

G

H

I

ADP

K

L

M

N

O

P

DOOR MIRROR SYSTEM

< DTC/CIRCUIT DIAGNOSIS >

DOOR MIRROR SYSTEM

Wiring Diagram - DOOR MIRROR (WITH AUTOMATIC DRIVE POSITIONER) -

INFOID:000000006471616

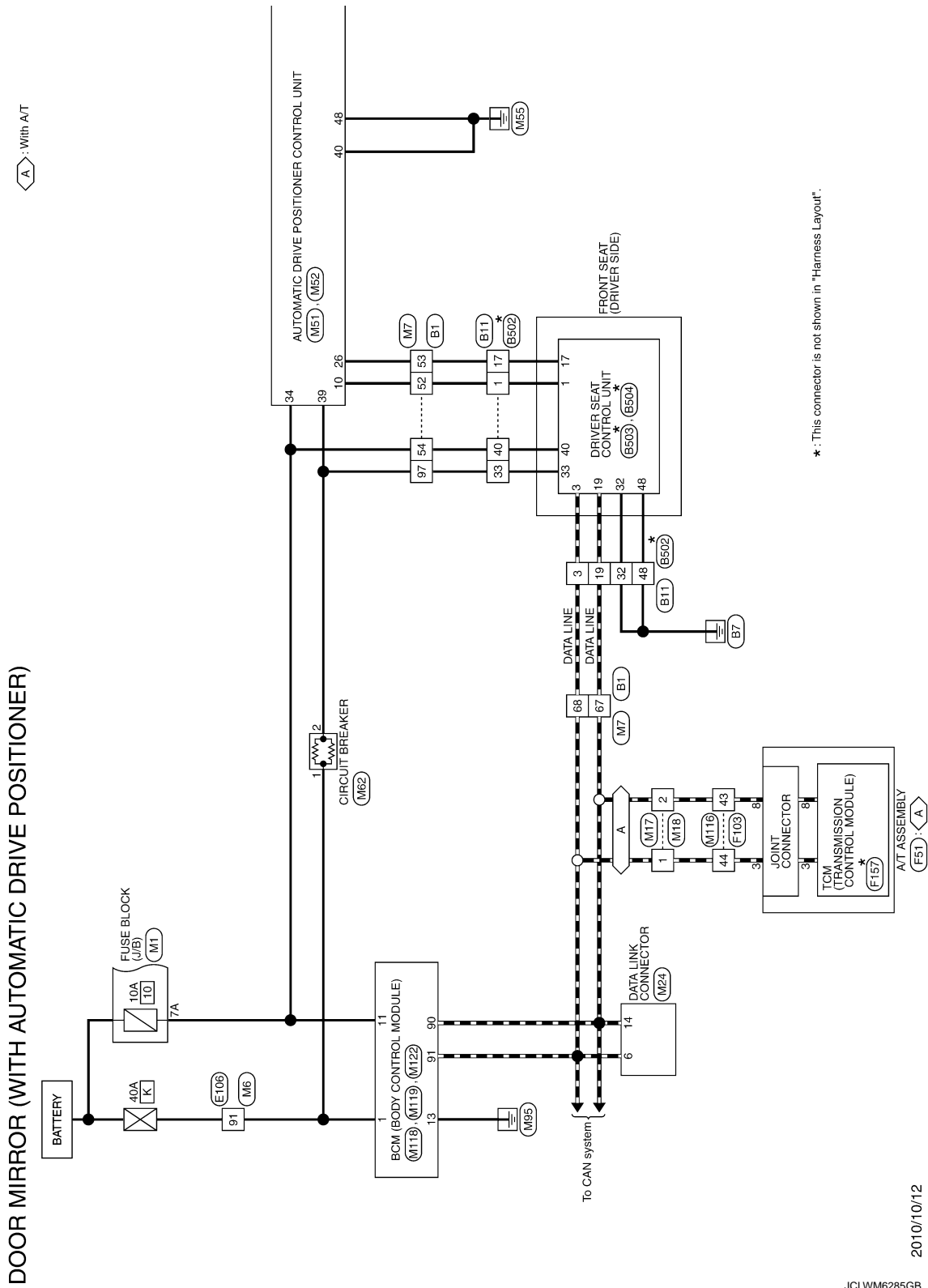

DOOR MIRROR SYSTEM

< DTC/CIRCUIT DIAGNOSIS >

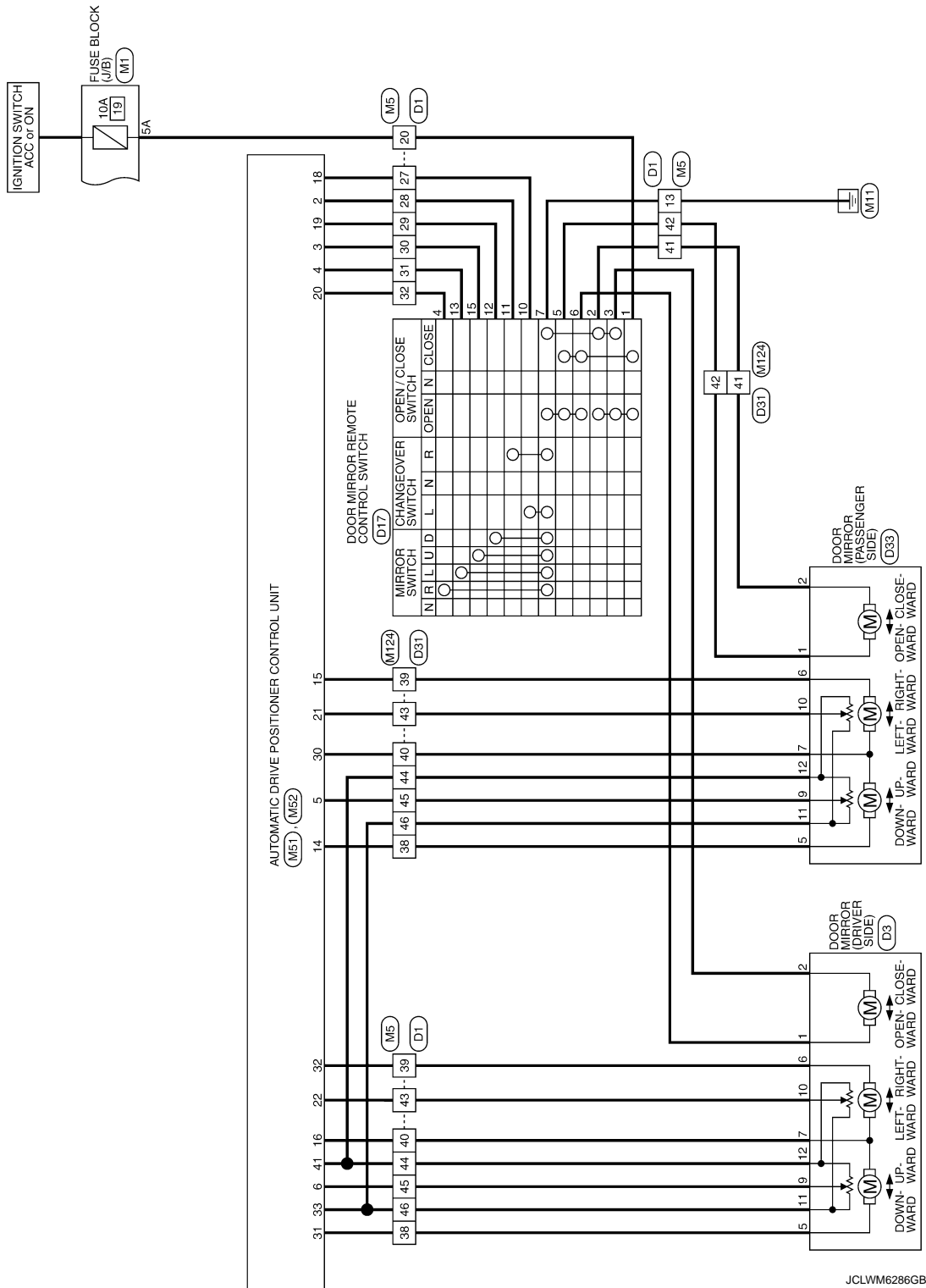

A
B
C
D
E
F
G
H
I
ADP
K
L
M
N
O
P

DOOR MIRROR SYSTEM

< DTC/CIRCUIT DIAGNOSIS >

DOOR MIRROR (WITH AUTOMATIC DRIVE POSITIONER)

Connector No.	B1
Connector Name	WIRE TO WIRE
Connector Type	TH807W-CS16-TM44



Terminal No.	Color of Wire	Signal Name [Specification]
1	W	-
2	L	-
3	R	-
4	V	-
5	W	-
6	B	-
7	G	-
8	BR	-
10	BR	-
12	SHIELD	-
13	Y	-
14	L	-
15	R	-
16	W	-
17	BR	-
20	G	-
21	SB	-
22	GR	-
23	W	-
24	SB	-
25	BR	-
26	LG	-
27	Y	-
28	R	-
29	V	-
31	SHIELD	-
32	G	-
33	R	-
34	BG	-
35	GR	-
36	BR	-
37	P	- [With climate controlled seat]
37	Y	- [Without climate controlled seat]
38	V	- [With climate controlled seat]
38	GR	- [Without climate controlled seat]
40	SHIELD	-
41	L	-
42	P	-
43	SHIELD	-

Connector No.	B11
Connector Name	WIRE TO WIRE
Connector Type	NS16FW-CS

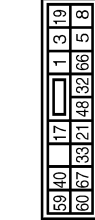

Terminal No.	Color of Wire	Signal Name [Specification]
1	G	-
3	L	-
5	V	-
17	LG	-
19	P	-
21	B	-
32	SB	-
33	SB	-
40	BR	-
48	B	-
60	BG	-
66	Y	-
67	GR	-

Connector No.	B502
Connector Name	WIRE TO WIRE
Connector Type	NS16MW-CS

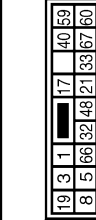

Terminal No.	Color of Wire	Signal Name [Specification]
1	L/W	-
3	R/Y	-
5	L	-
17	Y/R	-
19	V	-
21	L/Y	-
32	B/W	-
33	R	-
40	R/W	-

48	B	-
60	Y	-
66	B	-
67	W	-

Connector No.	B503
Connector Name	DRIVER SEAT CONTROL UNIT
Connector Type	TH32FW

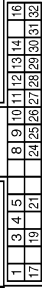

Terminal No.	Color of Wire	Signal Name [Specification]
1	L/W	RX
3	R/Y	CAN-H
4	O/B	SLIDING LIMIT SW
5	L	BUCKLE SW
8	L/Y	P RANGE SW
9	W/G	PULSE (REGLINING)
10	P/B	PULSE (RR LIFTING)
11	BR	SLIDING SW (BACKWARD)
12	SB	RECLINING SW (BACKWARD)
13	LG/R	FRONT LIFTING SW (DOWNWARD)
14	G/B	REAR LIFTING SW (DOWNWARD)
16	O	VCC
17	Y/R	TX
19	V	CAN-L
21	L/Y	P RANGE SW
24	R	PULSE (SLIDING)
25	V/B	PULSE (RR LIFTING)
26	V	SLIDING SW (FORWARD)
27	R/G	RECLINING SW (FORWARD)
28	W/B	FRONT LIFTING SW (UPWARD)
29	P/L	REAR LIFTING SW (UPWARD)
30	P	POWER WALK-IN SW
31	GR	SENSOR GND
32	B/W	GND (SIGNAL)

DOOR MIRROR SYSTEM

< DTC/CIRCUIT DIAGNOSIS >

DOOR MIRROR (WITH AUTOMATIC DRIVE POSITIONER)

Connector No.	B504
Connector Name	DRIVER SEAT CONTROL UNIT
Connector Type	HS16PW-CS



33	35	36	37	38	39
40	41	42	44	45	48

Terminal No.	Color of Wire	Signal Name [Specification]
33	R	BAT. (C/B)
35	W/R	SLIDING MOTOR (FORWARD)
36	G/Y	RECLINING MOTOR (FORWARD)
37	G/W	FRONT LIFTING MOTOR (DOWNWARD)
38	L/Y	REAR LIFTING MOTOR (UPWARD)
39	R/B	REAR LIFTING MOTOR (BACKWARD)
40	R/W	BAT. (PUSE)
41	Y/G	FORWARD SW
42	W	SLIDING MOTOR (BACKWARD)
44	P	RECLINING MOTOR (BACKWARD)
45	L/R	FRONT LIFTING MOTOR (UPWARD)
48	B	GND (POWER)

Connector No.	D1
Connector Name	WIRE TO WIRE
Connector Type	TH40PW-CS15



15	14	13	12	11	10	9	8	7	6	5	4	3	2	1
16	17	18	19	20	21	22	23	24	25	26	27	28	29	30

Terminal No.	Color of Wire	Signal Name [Specification]
4	BR	-
5	P	- [A/T models with automatic drive positioner]
6	B	- [Except for A/T models with automatic drive positioner]
7	R	-
8	G	-
9	P	-
10	LG	-
11	W	-
12	L	-

13	B	-
14	V	-
15	Y	-
16	Y/B	-
17	Y	-
20	SB	-
21	R	-
22	P	-
23	O	-
24	Y	-
25	SB	-
26	GR	-
27	GR	-
28	LG	-
29	G	-
30	Y	-
31	W	-
32	BR	-
33	L	-
34	R	-
35	V	-
37	B	-
38	O	-
39	GR	-
40	G	-
41	Y	-
42	LG	-
43	BR	-
44	V	-
45	P	-
46	W	-
47	V	-
48	P	-
49	W	-
50	SB	-
51	R	-
52	L	-

Connector No.	D3
Connector Name	DOOR MIRROR (DRIVER SIDE)
Connector Type	TH12MW-NH



5	6	7	2	1	4
12	11	10	9	8	

Terminal No.	Color of Wire	Signal Name [Specification]
1	SB	- [With automatic drive positioner]
1	P	- [Without automatic drive positioner]
2	O	- [With automatic drive positioner]
2	SB	- [Without automatic drive positioner]
4	L	-
5	O	- [With automatic drive positioner]
5	W	- [Without automatic drive positioner]
6	GR	- [With automatic drive positioner]
6	BR	- [Without automatic drive positioner]
7	G	- [With automatic drive positioner]
7	V	- [Without automatic drive positioner]
8	B	-
9	P	-
10	BR	-
11	W	-
12	V	-

Connector No.	D17
Connector Name	DOOR MIRROR REMOTE CONTROL SWITCH
Connector Type	TK16FBR



1	2	3	4	5	6	7
8	9	10	11	12	13	14
15	16					

Terminal No.	Color of Wire	Signal Name [Specification]
1	V	-
2	Y	-
3	O	-
4	BR	-
5	LG	-
6	SB	-
7	B	-
8	P	- [With A/T]
8	B	- [With M/T]
9	R	-
10	GR	-
11	LG	-
12	G	-
13	W	-
15	Y	-

Connector No.	D31
Connector Name	WIRE TO WIRE
Connector Type	TH40PW-CS15



15	14	13	12	11	10	9	8	7	6	5	4	3	2	1
16	17	18	19	20	21	22	23	24	25	26	27	28	29	30

Terminal No.	Color of Wire	Signal Name [Specification]
6	BR	-
7	R	-
8	G	-
9	P	-
10	LG	-
11	W	-
12	L	-
13	B	-
14	Y	-
15	W	-
34	Y	-
35	Y/B	-
38	O	-
39	GR	-
40	G	-
41	Y	-
42	LG	-
43	BR	-
44	V	-
45	P	-
46	W	-
47	V	-
48	P	-
49	W	-
50	SB	-
51	R	-
52	L	-
53	O	-
54	GR	-
55	G	-

JCLWM6288GB

A
B
C
D
E
F
G
H
I
K
L
M
N
O
P

ADP

DOOR MIRROR SYSTEM

< DTC/CIRCUIT DIAGNOSIS >

DOOR MIRROR (WITH AUTOMATIC DRIVE POSITIONER)

Connector No.	D33
Connector Name	DOOR MIRROR (PASSENGER SIDE)
Connector Type	TH2MW-NH

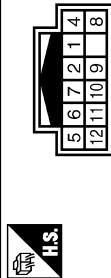

Terminal No.	Color of Wire	Signal Name [Specification]
1	LG	- [With automatic drive positioner]
1	Y	- [Without automatic drive positioner]
2	Y	- [With automatic drive positioner]
2	LG	- [Without automatic drive positioner]
4	L	-
5	O	- [With automatic drive positioner]
5	GR	- [Without automatic drive positioner]
6	GR	- [With automatic drive positioner]
6	G	- [Without automatic drive positioner]
7	G	- [With automatic drive positioner]
7	O	- [Without automatic drive positioner]
8	B	-
9	P	-
10	BR	-
11	W	-
12	V	-

Connector No.	E106
Connector Name	WIRE TO WIRE
Connector Type	TH80PW-CS16-TM4

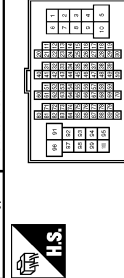

Terminal No.	Color of Wire	Signal Name [Specification]
1	GR	-
3	BG	-
4	B/W	-
5	G	-
6	BG	-
7	LG	-

8	G	-
9	R	-
10	W	-
11	V	-
12	R	-
13	L	-
14	GR	-
15	P	-
16	W	-
17	V	-
18	BG	-
19	GR	-
20	LG	-
30	R	-
31	L	-
32	BG	-
33	P	-
34	V	-
35	BR	-
36	W	-
37	Y	-
38	R	-
39	B	-
40	G	-
41	W	-
42	LG	-
43	SR	-
44	GR	-
45	BG	-
46	LG	-
47	V	-
48	P	-
49	L	-
59	B	-
66	LG	-
67	SR	-
68	R	-
69	W	-
70	G	-
80	W	-
81	P	-
82	G	-
83	V	-
84	L	-
85	BG	-
86	LG	-
87	Y	-
88	GR	-
89	W	-
90	W	-
91	G	-
91	G	-
92	B	-

93	GR	-
94	L	-
95	Y	-
97	BR	-
98	SHIELD	-
99	L	-
100	P	-

Connector No.	F51
Connector Name	A/T ASSEMBLY
Connector Type	RK10FG-DGY



Terminal No.	Color of Wire	Signal Name [Specification]
1	Y	-
2	R	-
3	L	-
4	V	-
5	B	-
6	Y	-
7	R	-
8	P	-
9	GR	-
10	B	-

Connector No.	F103
Connector Name	WIRE TO WIRE
Connector Type	TK36FW-MS10

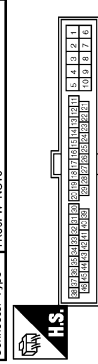

Terminal No.	Color of Wire	Signal Name [Specification]
2	G	-
3	W	-
4	R	-

5	B	-
9	Y	-
10	GR	-
19	O	-
20	Y	-
28	B	-
29	LG	-
30	R	-
31	R	-
41	O	-
42	BR	-
43	P	-
44	L	-
45	Y	-
46	V	-

Connector No.	F157
Connector Name	TOM (TRANSMISSION CONTROL MODULE)
Connector Type	SP10FG



Terminal No.	Color of Wire	Signal Name [Specification]
1	-	VIGN
2	-	BATT
3	-	CAN-H
4	-	CAN-H
5	-	K-LINE
6	-	GND
7	-	VIGN
8	-	REV LAMP RLY
9	-	CAN-L
10	-	STARTER RLY
10	-	GND

DOOR MIRROR SYSTEM

< DTC/CIRCUIT DIAGNOSIS >

DOOR MIRROR (WITH AUTOMATIC DRIVE POSITIONER)

Connector No.	M1
Connector Name	FUSE BLOCK (J/B)
Connector Type	NS38FW-M2



Terminal No.	Color of Wire	Signal Name [Specification]
1A	V	-
2A	G	-
3A	L	-
4A	P	-
5A	BR	-
6A	Y	-
7A	GR	-
8A	L	-

Connector No.	M5
Connector Name	WIRE TO WIRE
Connector Type	TH40MW-CS15

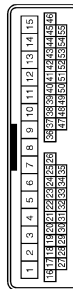

Terminal No.	Color of Wire	Signal Name [Specification]
4	R	-
5	B	-
6	BG	-
7	W	-
8	B	-
9	G	-
10	V	-
11	W	-
12	L	-
13	B	-
14	GR	-
15	Y/B	-
17	Y	-

20	BG	-
21	W	-
22	P	-
23	BG	-
24	V	-
25	BR	-
26	R	-
27	P	-
28	LG	-
29	SB	-
30	G	-
31	V	-
32	BR	-
33	GR	-
34	G	-
35	L	-
37	B	-
38	G	- [With automatic drive positioner]
38	L	- [Without automatic drive positioner]
39	BR	- [With automatic drive positioner]
39	L	- [Without automatic drive positioner]
40	Y	-
41	BR	- [With automatic drive positioner]
41	G	- [Without automatic drive positioner]
42	R	-
43	G	-
44	Y	-
45	GR	-
46	BR	-
47	V	-
48	LG	-
49	P	-
50	SB	-
51	GR	-
52	L	-

Connector No.	M6
Connector Name	WIRE TO WIRE
Connector Type	TH80MW-CS16-TM4

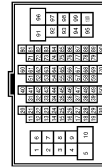

Terminal No.	Color of Wire	Signal Name [Specification]
1	BG	-

87	V	-
88	B	-
89	SB	-
90	G	-
91	W	-
92	B	-
93	G	-
94	L	-
95	BR	-
97	P	-
98	SHIELD	-
99	V	-
100	SB	-

3	R	-
4	G	-
5	G	-
6	BR	-
7	BR	-
8	Y	-
9	R	-
10	W	-
11	GR	-
12	R	-
13	L	-
14	G	-
15	P	-
16	W	-
17	BR	-
18	V	-
19	BG	-
20	L	-
30	R	-
31	L	-
32	Y	-
33	GR	-
34	P	-
35	BR	-
36	BR	-
37	Y	-
38	LG	-
39	SB	-
40	G	-
41	W	-
42	LG	-
43	P	-
44	GR	- [With A/T]
44	R	- [With M/T]
45	BG	-
46	G	-
47	P	-
48	P	-
49	L	-
59	B	-
67	Y	-
67	G	-
69	R	-
69	W	-
70	G	-
80	SB	-
81	R	-
82	V	-
83	W	-
84	L	-
85	BG	-
86	G	-

A
B
C
D
E
F
G
H
I
K
L
M
N
O
P

ADP

DOOR MIRROR SYSTEM

< DTC/CIRCUIT DIAGNOSIS >

DOOR MIRROR (WITH AUTOMATIC DRIVE POSITIONER)

Connector No.	M7
Connector Name	WIRE TO WIRE
Connector Type	TH80MW-CS16-TM4



Terminal No.	Color of Wire	Signal Name [Specification]
1	BG	-
2	LG	-
3	G	-
4	V	-
5	L	-
6	B	-
8	L	-
10	BR	-
12	SHIELD	-
13	V	-
14	BR	-
15	GR	-
16	LG	-
17	L	-
20	BR	-
21	G	-
22	R	-
23	SB	-
24	B	-
25	W	-
26	Y	-
27	V	-
28	P	-
29	V	-
31	SHIELD	-
32	G	-
33	R	-
34	BG	-
35	GR	-
36	BR	-
37	P	- [With climate controlled seat]
37	L	- [Without climate controlled seat]
38	V	- [With climate controlled seat]
38	GR	- [Without climate controlled seat]
40	SHIELD	-
41	L	-
42	P	-
43	SHIELD	-

Connector No.	M17
Connector Name	WIRE TO WIRE
Connector Type	TKG2FW



Terminal No.	Color of Wire	Signal Name [Specification]
1	L	-
2	P	-

Connector No.	M18
Connector Name	WIRE TO WIRE
Connector Type	TKG2MW



Terminal No.	Color of Wire	Signal Name [Specification]
1	L	-
2	P	-

Connector No.	M24
Connector Name	DATA LINK CONNECTOR
Connector Type	BD16FW

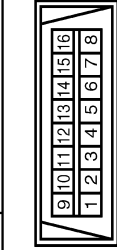

Terminal No.	Color of Wire	Signal Name [Specification]
3	LG	-
4	B	-

5	BR	-
6	L	-
7	V	-
8	G	-
11	SB	-
14	P	-
16	R	-

Connector No.	M51
Connector Name	AUTOMATIC DRIVE POSITIONER CONTROL UNIT
Connector Type	TH42FW-NH

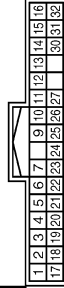

Terminal No.	Color of Wire	Signal Name [Specification]
1	Y	TILT SW (UPWARD)
2	LG	MIRROR SELECT SW (RH)
3	G	MIRROR SW (UPWARD)
4	V	MIRROR SW (LEFTWARD)
5	R	MIRROR SENSOR (RH VERTICAL)
6	GR	MIRROR SENSOR (LH VERTICAL)
7	BG	TILT SENSOR
9	BR	ADDRESS 1
10	V	TX (UART)
11	GR	TELESCOPIC SW (FRONTWARD)
12	BG	IND 1
13	P	IND 2
14	W	MIRROR MOTOR (RH VERTICAL)
15	BG	MIRROR MOTOR (RH HORIZONTAL)
16	L	MIRROR MOTOR (LH COMMON)
17	BR	TILT SW (DOWNWARD)
18	P	MIRROR SELECT SW (LH)
19	SB	MIRROR SW (DOWNWARD)
20	BR	MIRROR SW (RIGHTWARD)
21	L	MIRROR SENSOR (RH HORIZONTAL)
22	G	MIRROR SENSOR (LH HORIZONTAL)
23	P	TELESCOPIC SENSOR
24	R	SET SW
25	V	ADDRESS 2
26	P	RX (UART)
27	G	TELESCOPIC SW (BACKWARD)
30	SB	MIRROR MOTOR (RH COMMON)
31	G	MIRROR MOTOR (LH VERTICAL)
32	BR	MIRROR MOTOR (LH HORIZONTAL)

DOOR MIRROR SYSTEM

< DTC/CIRCUIT DIAGNOSIS >

DOOR MIRROR (WITH AUTOMATIC DRIVE POSITIONER)

Connector No.	M62
Connector Name	AUTOMATIC DRIVE POSITIONER CONTROL UNIT
Connector Type	MS16FW-CS



33	34	35	36	39
40	41	42	44	48

Terminal No.	Color of Wire	Signal Name [Specification]
33	BR	POWER SUPPLY (SENSOR)
34	R	BAT (FUSE)
35	L	TILT MOTOR (UPWARD)
36	GR	TELESCOPIC MOTOR (FORWARD)
38	BR	BAT (C/B)
40	B	GND (SIGNAL)
41	Y	GND (SENSOR)
42	BG	TILT MOTOR (DOWNWARD)
44	G	TELESCOPIC MOTOR (BACKWARD)
48	B	GND (POWER)

Connector No.	M62
Connector Name	CIRCUIT BREAKER
Connector Type	MD2FW-LC



1	2
---	---

Terminal No.	Color of Wire	Signal Name [Specification]
1	W	
2	SB	

Connector No.	M116
Connector Name	WIRE TO WIRE
Connector Type	TK38MP-MS10



1	2	3	4	5	6	7	8	9	10	11	12	13	14	15	16	17	18	19	20	21	22	23	24	25	26	27	28	29	30	31	32	33	34	35	36	37	38	39	40	41	42	43	44	45	46	47	48	49	50	51	52	53	54	55	56	57	58	59	60	61	62	63	64	65	66	67	68	69	70	71	72	73	74	75	76	77	78	79	80	81	82	83	84	85	86	87	88	89	90	91	92	93	94	95	96	97	98	99	100	101	102	103	104	105	106	107	108	109	110	111	112	113	114	115	116	117	118	119	120	121	122	123	124	125	126	127	128	129	130	131	132	133	134	135	136	137	138	139	140	141	142	143	144	145	146	147	148	149	150	151	152	153	154	155	156	157	158	159	160	161	162	163	164	165	166	167	168	169	170	171	172	173	174	175	176	177	178	179	180	181	182	183	184	185	186	187	188	189	190	191	192	193	194	195	196	197	198	199	200	201	202	203	204	205	206	207	208	209	210	211	212	213	214	215	216	217	218	219	220	221	222	223	224	225	226	227	228	229	230	231	232	233	234	235	236	237	238	239	240	241	242	243	244	245	246	247	248	249	250	251	252	253	254	255	256	257	258	259	260	261	262	263	264	265	266	267	268	269	270	271	272	273	274	275	276	277	278	279	280	281	282	283	284	285	286	287	288	289	290	291	292	293	294	295	296	297	298	299	300	301	302	303	304	305	306	307	308	309	310	311	312	313	314	315	316	317	318	319	320	321	322	323	324	325	326	327	328	329	330	331	332	333	334	335	336	337	338	339	340	341	342	343	344	345	346	347	348	349	350	351	352	353	354	355	356	357	358	359	360	361	362	363	364	365	366	367	368	369	370	371	372	373	374	375	376	377	378	379	380	381	382	383	384	385	386	387	388	389	390	391	392	393	394	395	396	397	398	399	400	401	402	403	404	405	406	407	408	409	410	411	412	413	414	415	416	417	418	419	420	421	422	423	424	425	426	427	428	429	430	431	432	433	434	435	436	437	438	439	440	441	442	443	444	445	446	447	448	449	450	451	452	453	454	455	456	457	458	459	460	461	462	463	464	465	466	467	468	469	470	471	472	473	474	475	476	477	478	479	480	481	482	483	484	485	486	487	488	489	490	491	492	493	494	495	496	497	498	499	500	501	502	503	504	505	506	507	508	509	510	511	512	513	514	515	516	517	518	519	520	521	522	523	524	525	526	527	528	529	530	531	532	533	534	535	536	537	538	539	540	541	542	543	544	545	546	547	548	549	550	551	552	553	554	555	556	557	558	559	560	561	562	563	564	565	566	567	568	569	570	571	572	573	574	575	576	577	578	579	580	581	582	583	584	585	586	587	588	589	590	591	592	593	594	595	596	597	598	599	600	601	602	603	604	605	606	607	608	609	610	611	612	613	614	615	616	617	618	619	620	621	622	623	624	625	626	627	628	629	630	631	632	633	634	635	636	637	638	639	640	641	642	643	644	645	646	647	648	649	650	651	652	653	654	655	656	657	658	659	660	661	662	663	664	665	666	667	668	669	670	671	672	673	674	675	676	677	678	679	680	681	682	683	684	685	686	687	688	689	690	691	692	693	694	695	696	697	698	699	700	701	702	703	704	705	706	707	708	709	710	711	712	713	714	715	716	717	718	719	720	721	722	723	724	725	726	727	728	729	730	731	732	733	734	735	736	737	738	739	740	741	742	743	744	745	746	747	748	749	750	751	752	753	754	755	756	757	758	759	760	761	762	763	764	765	766	767	768	769	770	771	772	773	774	775	776	777	778	779	780	781	782	783	784	785	786	787	788	789	790	791	792	793	794	795	796	797	798	799	800	801	802	803	804	805	806	807	808	809	810	811	812	813	814	815	816	817	818	819	820	821	822	823	824	825	826	827	828	829	830	831	832	833	834	835	836	837	838	839	840	841	842	843	844	845	846	847	848	849	850	851	852	853	854	855	856	857	858	859	860	861	862	863	864	865	866	867	868	869	870	871	872	873	874	875	876	877	878	879	880	881	882	883	884	885	886	887	888	889	890	891	892	893	894	895	896	897	898	899	900	901	902	903	904	905	906	907	908	909	910	911	912	913	914	915	916	917	918	919	920	921	922	923	924	925	926	927	928	929	930	931	932	933	934	935	936	937	938	939	940	941	942	943	944	945	946	947	948	949	950	951	952	953	954	955	956	957	958	959	960	961	962	963	964	965	966	967	968	969	970	971	972	973	974	975	976	977	978	979	980	981	982	983	984	985	986	987	988	989	990	991	992	993	994	995	996	997	998	999	1000
---	---	---	---	---	---	---	---	---	----	----	----	----	----	----	----	----	----	----	----	----	----	----	----	----	----	----	----	----	----	----	----	----	----	----	----	----	----	----	----	----	----	----	----	----	----	----	----	----	----	----	----	----	----	----	----	----	----	----	----	----	----	----	----	----	----	----	----	----	----	----	----	----	----	----	----	----	----	----	----	----	----	----	----	----	----	----	----	----	----	----	----	----	----	----	----	----	----	----	-----	-----	-----	-----	-----	-----	-----	-----	-----	-----	-----	-----	-----	-----	-----	-----	-----	-----	-----	-----	-----	-----	-----	-----	-----	-----	-----	-----	-----	-----	-----	-----	-----	-----	-----	-----	-----	-----	-----	-----	-----	-----	-----	-----	-----	-----	-----	-----	-----	-----	-----	-----	-----	-----	-----	-----	-----	-----	-----	-----	-----	-----	-----	-----	-----	-----	-----	-----	-----	-----	-----	-----	-----	-----	-----	-----	-----	-----	-----	-----	-----	-----	-----	-----	-----	-----	-----	-----	-----	-----	-----	-----	-----	-----	-----	-----	-----	-----	-----	-----	-----	-----	-----	-----	-----	-----	-----	-----	-----	-----	-----	-----	-----	-----	-----	-----	-----	-----	-----	-----	-----	-----	-----	-----	-----	-----	-----	-----	-----	-----	-----	-----	-----	-----	-----	-----	-----	-----	-----	-----	-----	-----	-----	-----	-----	-----	-----	-----	-----	-----	-----	-----	-----	-----	-----	-----	-----	-----	-----	-----	-----	-----	-----	-----	-----	-----	-----	-----	-----	-----	-----	-----	-----	-----	-----	-----	-----	-----	-----	-----	-----	-----	-----	-----	-----	-----	-----	-----	-----	-----	-----	-----	-----	-----	-----	-----	-----	-----	-----	-----	-----	-----	-----	-----	-----	-----	-----	-----	-----	-----	-----	-----	-----	-----	-----	-----	-----	-----	-----	-----	-----	-----	-----	-----	-----	-----	-----	-----	-----	-----	-----	-----	-----	-----	-----	-----	-----	-----	-----	-----	-----	-----	-----	-----	-----	-----	-----	-----	-----	-----	-----	-----	-----	-----	-----	-----	-----	-----	-----	-----	-----	-----	-----	-----	-----	-----	-----	-----	-----	-----	-----	-----	-----	-----	-----	-----	-----	-----	-----	-----	-----	-----	-----	-----	-----	-----	-----	-----	-----	-----	-----	-----	-----	-----	-----	-----	-----	-----	-----	-----	-----	-----	-----	-----	-----	-----	-----	-----	-----	-----	-----	-----	-----	-----	-----	-----	-----	-----	-----	-----	-----	-----	-----	-----	-----	-----	-----	-----	-----	-----	-----	-----	-----	-----	-----	-----	-----	-----	-----	-----	-----	-----	-----	-----	-----	-----	-----	-----	-----	-----	-----	-----	-----	-----	-----	-----	-----	-----	-----	-----	-----	-----	-----	-----	-----	-----	-----	-----	-----	-----	-----	-----	-----	-----	-----	-----	-----	-----	-----	-----	-----	-----	-----	-----	-----	-----	-----	-----	-----	-----	-----	-----	-----	-----	-----	-----	-----	-----	-----	-----	-----	-----	-----	-----	-----	-----	-----	-----	-----	-----	-----	-----	-----	-----	-----	-----	-----	-----	-----	-----	-----	-----	-----	-----	-----	-----	-----	-----	-----	-----	-----	-----	-----	-----	-----	-----	-----	-----	-----	-----	-----	-----	-----	-----	-----	-----	-----	-----	-----	-----	-----	-----	-----	-----	-----	-----	-----	-----	-----	-----	-----	-----	-----	-----	-----	-----	-----	-----	-----	-----	-----	-----	-----	-----	-----	-----	-----	-----	-----	-----	-----	-----	-----	-----	-----	-----	-----	-----	-----	-----	-----	-----	-----	-----	-----	-----	-----	-----	-----	-----	-----	-----	-----	-----	-----	-----	-----	-----	-----	-----	-----	-----	-----	-----	-----	-----	-----	-----	-----	-----	-----	-----	-----	-----	-----	-----	-----	-----	-----	-----	-----	-----	-----	-----	-----	-----	-----	-----	-----	-----	-----	-----	-----	-----	-----	-----	-----	-----	-----	-----	-----	-----	-----	-----	-----	-----	-----	-----	-----	-----	-----	-----	-----	-----	-----	-----	-----	-----	-----	-----	-----	-----	-----	-----	-----	-----	-----	-----	-----	-----	-----	-----	-----	-----	-----	-----	-----	-----	-----	-----	-----	-----	-----	-----	-----	-----	-----	-----	-----	-----	-----	-----	-----	-----	-----	-----	-----	-----	-----	-----	-----	-----	-----	-----	-----	-----	-----	-----	-----	-----	-----	-----	-----	-----	-----	-----	-----	-----	-----	-----	-----	-----	-----	-----	-----	-----	-----	-----	-----	-----	-----	-----	-----	-----	-----	-----	-----	-----	-----	-----	-----	-----	-----	-----	-----	-----	-----	-----	-----	-----	-----	-----	-----	-----	-----	-----	-----	-----	-----	-----	-----	-----	-----	-----	-----	-----	-----	-----	-----	-----	-----	-----	-----	-----	-----	-----	-----	-----	-----	-----	-----	-----	-----	-----	-----	-----	-----	-----	-----	-----	-----	-----	-----	-----	-----	-----	-----	-----	-----	-----	-----	-----	-----	-----	-----	-----	-----	-----	-----	-----	-----	-----	-----	-----	-----	-----	-----	-----	-----	-----	-----	-----	-----	-----	-----	-----	-----	-----	-----	-----	-----	-----	-----	-----	-----	-----	-----	-----	-----	-----	-----	-----	-----	-----	-----	-----	-----	-----	-----	-----	-----	-----	-----	-----	-----	-----	-----	-----	-----	-----	-----	-----	-----	-----	-----	-----	-----	-----	-----	-----	-----	-----	-----	-----	-----	-----	-----	-----	-----	-----	-----	-----	-----	-----	-----	-----	-----	-----	-----	-----	-----	-----	-----	-----	-----	-----	-----	-----	-----	-----	-----	-----	-----	-----	-----	-----	-----	-----	-----	-----	-----	-----	-----	-----	-----	-----	-----	-----	-----	-----	-----	-----	-----	-----	-----	-----	-----	-----	-----	-----	-----	-----	-----	-----	-----	-----	-----	-----	-----	-----	-----	-----	-----	-----	-----	-----	-----	-----	-----	-----	-----	-----	-----	-----	-----	-----	-----	-----	-----	-----	-----	-----	-----	-----	-----	-----	-----	-----	-----	-----	-----	-----	-----	-----	-----	-----	-----	-----	-----	-----	-----	-----	-----	-----	-----	-----	-----	-----	-----	-----	------

Terminal No.	Color of Wire	Signal Name [Specification]
2	W	
3	BG	
4	R	
5	B	
9	BR	
10	R	
19	BG	
20	Y	
28	GR	
29	LG	
30	LG	
31	W	
41	BG	
42	G	
43	P	
44	L	
45	G	
46	Y	

Connector No.	M118
Connector Name	BCM (BODY CONTROL MODULE)
Connector Type	MD8FB-LC



1	2	3
---	---	---

Terminal No.	Color of Wire	Signal Name [Specification]
1	W	BAT (F/L)
2	Y	POWER WINDOW POWER SUPPLY (BAT)
3	BG	POWER WINDOW POWER SUPPLY (RAP)

Connector No.	M119
Connector Name	BCM (BODY CONTROL MODULE)
Connector Type	MS16FW-CS



4	5	6	7	8	9	10		
11	12	13	14	15	16	17	18	19

Terminal No.	Color of Wire	Signal Name [Specification]
4	LG	INTERIOR ROOM LAMP POWER SUPPLY
5	P	PASSENGER DOOR UNLOCK OUTPUT
7	SB	SLEEP LAMP
8	V	ALL DOOR FUEL LID LOCK OUTPUT
9	G	DRIVER DOOR FUEL LID UNLOCK OUTPUT
11	GR	BAT (FUSE)
13	B	GND
14	W	PUSH-BUTTON IGNITION SW ILL GND
15	BG	ACC IND
17	BR	TURN SIGNAL RH (FRONT)
18	BG	TURN SIGNAL LH (FRONT)
19	V	ROOM LAMP TIMER CONTROL

Connector No.	M122
Connector Name	BCM (BODY CONTROL MODULE)
Connector Type	TH40FB-NH



61	62	63	64	65	66	67	68	69	70	71	72	73	74	75	76	77	78	79	80	81	82	83	84	85	86	87	88	89	90	91	92	93	94	95	96	97	98	99	100	101	102	103	104	105	106	107	108	109	110	111	112	113	114	115	116	117	118	119	120	121	122	123	124	125	126	127	128	129	130	131	132	133	134	135	136	137	138	139	140	141	142	143	144	145	146	147	148	149	150	151	152	153	154	155	156	157	158	159	160	161	162	163	164	165	166	167	168	169	170	171	172	173	174	175	176	177	178	179	180	181	182	183	184	185	186	187	188	189	190	191	192	193	194	195	196	197	198	199	200	201	202	203	204	205</
----	----	----	----	----	----	----	----	----	----	----	----	----	----	----	----	----	----	----	----	----	----	----	----	----	----	----	----	----	----	----	----	----	----	----	----	----	----	----	-----	-----	-----	-----	-----	-----	-----	-----	-----	-----	-----	-----	-----	-----	-----	-----	-----	-----	-----	-----	-----	-----	-----	-----	-----	-----	-----	-----	-----	-----	-----	-----	-----	-----	-----	-----	-----	-----	-----	-----	-----	-----	-----	-----	-----	-----	-----	-----	-----	-----	-----	-----	-----	-----	-----	-----	-----	-----	-----	-----	-----	-----	-----	-----	-----	-----	-----	-----	-----	-----	-----	-----	-----	-----	-----	-----	-----	-----	-----	-----	-----	-----	-----	-----	-----	-----	-----	-----	-----	-----	-----	-----	-----	-----	-----	-----	-----	-----	-----	-----	-----	-----	-----	-----	-----	-------

DOOR MIRROR SYSTEM

< DTC/CIRCUIT DIAGNOSIS >

DOOR MIRROR (WITH AUTOMATIC DRIVE POSITIONER)

Connector No.	M124
Connector Name	WIRE TO WIRE
Connector Type	THRMWV-CS15

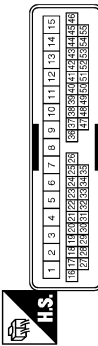

Terminal No.	Color of Wire	Signal Name [Specification]
6	BG	-
7	R	-
8	G	-
9	P	-
10	V	-
11	SB	- [With BOSE system]
11	GR	- [Without BOSE system]
12	BR	-
13	B	-
14	G	-
15	W	-
34	Y	-
35	Y/B	-
38	W	-
39	BG	-
40	SB	-
41	BR	- [With automatic drive positioner]
41	G	- [Without automatic drive positioner]
42	R	-
43	L	-
44	Y	-
45	R	-
46	W	-
47	SB	-
48	BR	-
49	Y	-
50	P	-
51	LG	-
52	BG	-
53	Y	-
54	L	-
55	L	-

JCLWM6293GB

DRIVER SEAT CONTROL UNIT (WITH AUTOMATIC DRIVE POSITIONER)

< ECU DIAGNOSIS INFORMATION >

ECU DIAGNOSIS INFORMATION

DRIVER SEAT CONTROL UNIT (WITH AUTOMATIC DRIVE POSITIONER)

Reference Value

INFOID:000000006471617

VALUES ON THE DIAGNOSIS TOOL

CONSULT-III MONITOR ITEM

Monitor Item	Condition	Value/Status	
SET SW	Set switch	Push	ON
		Release	OFF
MEMORY SW1	Memory switch 1	Push	ON
		Release	OFF
MEMORY SW2	Memory switch 2	Push	ON
		Release	OFF
SLIDE SW-FR	Sliding switch (front)	Operate	ON
		Release	OFF
SLIDE SW-RR	Sliding switch (rear)	Operate	ON
		Release	OFF
RECLN SW-FR	Reclining switch (front)	Operate	ON
		Release	OFF
RECLN SW-RR	Reclining switch (rear)	Operate	ON
		Release	OFF
LIFT FR SW-UP	Lifting switch front (up)	Operate	ON
		Release	OFF
LIFT FR SW-DN	Lifting switch front (down)	Operate	ON
		Release	OFF
LIFT RR SW-UP	Lifting switch rear (up)	Operate	ON
		Release	OFF
LIFT RR SW-DN	Lifting switch rear (down)	Operate	ON
		Release	OFF
MIR CON SW-UP	Mirror switch	Up	ON
		Other than above	OFF
MIR CON SW-DN	Mirror switch	Down	ON
		Other than above	OFF
MIR CON SW-RH	Mirror switch	Right	ON
		Other than above	OFF
MIR CON SW-LH	Mirror switch	Left	ON
		Other than above	OFF
MIR CHNG SW-R	Changeover switch	Right	ON
		Other than above	OFF
MIR CHNG SW-L	Changeover switch	Left	ON
		Other than above	OFF
TILT SW-UP	Tilt switch	Up	ON
		Other than above	OFF
TILT SW-DOWN	Tilt switch	Down	ON
		Other than above	OFF

A
B
C
D
E
F
G
H
I
K
L
M
N
O
P

ADP

DRIVER SEAT CONTROL UNIT (WITH AUTOMATIC DRIVE POSITIONER)

< ECU DIAGNOSIS INFORMATION >

Monitor Item	Condition		Value/Status
TELESCO SW-FR	Telescopic switch	Forward	ON
		Other than above	OFF
TELESCO SW-RR	Tilt switch	Backward	ON
		Other than above	OFF
FORWARD SW	Seat back	Folded down	ON
		Other than above	OFF
WALK-IN SW	Power walk-in switch	Pressed	ON
		Other than above	OFF
FWD LIMIT SW	Seat sliding	Front edge	ON
		Other than above	OFF
SEAT BELT SW	Seat belt	Fastened	ON
		Other than above	OFF
DETENT SW ^{*1}	A/T selector lever	P position	OFF
		Other than above	ON
PARK BRAKE SW ^{*2}	Parking brake	Applied	ON
		Release	OFF
STARTER SW	Ignition position	Cranking	ON
		Other than above	OFF
SLIDE PULSE	Seat sliding	Forward	The numeral value decreases ^{*3}
		Backward	The numeral value increases ^{*3}
		Other than above	No change to numeral value ^{*3}
RECLN PULSE	Seat reclining	Forward	The numeral value decreases ^{*3}
		Backward	The numeral value increases ^{*3}
		Other than above	No change to numeral value ^{*3}
LIFT FR PULSE	Seat lifter (front)	Up	The numeral value decreases ^{*3}
		Down	The numeral value increases ^{*3}
		Other than above	No change to numeral value ^{*3}
LIFT RR PULSE	Seat lifter (rear)	Up	The numeral value decreases ^{*3}
		Down	The numeral value increases ^{*3}
		Other than above	No change to numeral value ^{*3}
MIR/SEN RH U-D	Door mirror (passenger side)	Change between 3.4 (close to peak) 0.6 (close to valley)	
MIR/SEN RH R-L	Door mirror (passenger side)	Change between 3.4 (close to left edge) 0.6 (close to right edge)	
MIR/SEN LH U-D	Door mirror (driver side)	Change between 3.4 (close to peak) 0.6 (close to valley)	
MIR/SEN LH R-L	Door mirror (driver side)	Change between 0.6 (close to left edge) 3.4 (close to right edge)	
TILT SEN	Tilt position	Change between 1.2 (close to top) 3.4 (close to bottom)	
TELESCO SEN	Telescopic position	Change between 3.4 (close to top) 0.8 (close to bottom)	

*1: A/T model

*2: M/T model

*3: The value at the position attained when the battery is connected is regarded as 32768.

DRIVER SEAT CONTROL UNIT (WITH AUTOMATIC DRIVE POSITIONER)

< ECU DIAGNOSIS INFORMATION >

TERMINAL LAYOUT

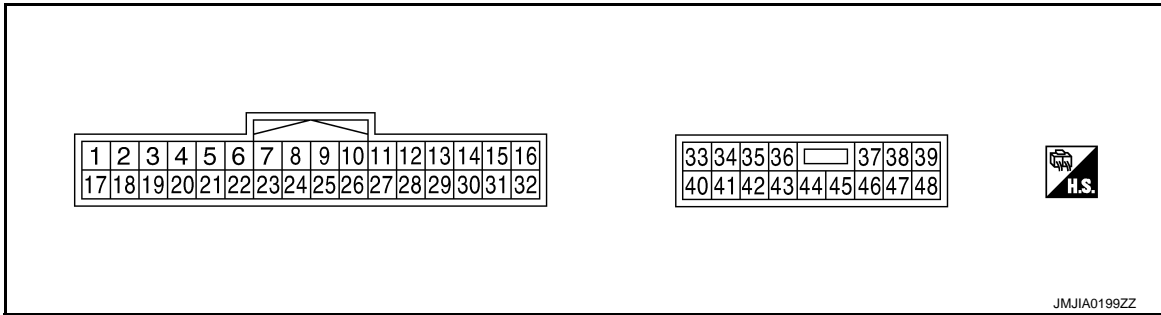

PHYSICAL VALUES

Terminal No. (Wire color)		Description		Condition	Voltage (V) (Approx)	
+	-	Signal name	Input/ Output			
1 L/W	Ground	UART communication (RX)	Input	Ignition switch ON	 JM/JIA0118ZZ	
3 R/Y	—	CAN-H	—	—	—	
4 O/B	Ground	Sliding limit switch signal	Input	Seat sliding front edge	0	
				Seat switch & power walk-in switch is pressed	5	
5 L	Ground	Seat belt buckle switch signal (driver side)	Input	Seat belt fastened & seat switch pressed	5	
				Other than above	0	
8 L/Y	Ground	Parking brake switch signal	Input	Parking brake	Applied	0
					Release	Battery voltage
9 W/G	Ground	Reclining sensor signal	Input	Seat reclining	Operate	 JM/JIA0119ZZ
					Stop	0 or 5
10 P/B	Ground	Lifting sensor (rear) signal	Input	Seat lifting (rear)	Operate	 JM/JIA0119ZZ
					Stop	0 or 5

A
B
C
D
E
F
G
H
I
K
L
M
N
O
P

ADP

DRIVER SEAT CONTROL UNIT (WITH AUTOMATIC DRIVE POSITIONER)

< ECU DIAGNOSIS INFORMATION >

Terminal No. (Wire color)		Description		Condition		Voltage (V) (Approx)
+	-	Signal name	Input/ Output			
11 (BR)	Ground	Sliding switch backward signal	Input	Sliding switch	Operate (backward)	0
					Release	Battery voltage
12 (SB)	Ground	Reclining switch backward signal	Input	Reclining switch	Operate (backward)	0
					Release	Battery voltage
13 (LG/R)	Ground	Lifting switch (front) downward signal	Input	Lifting switch (front)	Operate (downward)	0
					Release	Battery voltage
14 (GB)	Ground	Lifting switch (rear) downward signal	Input	Lifting switch (rear)	Operate (downward)	0
					Release	Battery voltage
16 (O)	Ground	Sensor power supply	Output	—		Battery voltage
17 (Y/R)	Ground	UART communication (TX)	Output	Ignition switch ON		
19 (V)	—	CAN-L	—	—		—
21 (L/Y)	Ground	Detention switch switch	Input	A/T selector lever	P position	0
					Except P position	
24 (R)	Ground	Sliding sensor signal	Input	Seat sliding	Operate	
					Stop	0 or 5
25 (Y/B)	Ground	Lifting sensor (front) signal	Input	Seat lifting (front)	Operate	
					Stop	0 or 5

DRIVER SEAT CONTROL UNIT (WITH AUTOMATIC DRIVE POSITIONER)

< ECU DIAGNOSIS INFORMATION >

Terminal No. (Wire color)		Description		Condition		Voltage (V) (Approx)
+	-	Signal name	Input/ Out- put			
26 (Y)	Ground	Sliding switch forward signal	Input	Sliding switch	Operate (forward)	0
					Release	Battery voltage
27 (R/G)	Ground	Reclining switch forward signal	Input	Reclining switch	Operate (forward)	0
					Release	Battery voltage
28 (W/B)	Ground	Lifting switch (front) upward signal	Input	Seat lifting switch (front)	Operate (upward)	0
					Release	Battery voltage
29 (P/L)	Ground	Lifting switch (rear) upward signal	Input	Seat lifting switch (rear)	Operate (upward)	0
					Release	Battery voltage
30 (P)	Ground	Power walk-in switch signal	Input	Power walk-in switch	Pressed	0
					Other than above	Battery voltage
31 (GR)	Ground	Sensor ground	—	—	—	0
32 (B/W)	Ground	Ground (signal)	—	—	—	0
33 (R)	Ground	Power source (C/B)	Input	—	—	Battery voltage
35 (W/R)	Ground	Sliding motor forward output	Output	Seat sliding	Operate (forward)	Battery voltage
					Release	0
36 (G/Y)	Ground	Reclining motor forward output signal	Output	Seat reclining	Operate (forward)	Battery voltage
					Release	0
37 (G/W)	Ground	Lifting motor (front) downward output	Output	Seat lifting (front)	Operate (downward)	Battery voltage
					Stop	0
38 (L/Y)	Ground	Lifting motor (rear) upward output	Output	Seat lifting (rear)	Operate (upward)	Battery voltage
					Stop	0
39 (R/B)	Ground	Lifting motor (rear) downward output	Output	Seat lifting (rear)	Operate (downward)	Battery voltage
					Stop	0
40 (R/W)	Ground	Power source (Fuse)	Input	—	—	Battery voltage
41 (Y/G)	Ground	Forward switch signal	Input	Seat back is folded down and power walk-in switch pressed		0
				Seat back is fold up and seat reclining is operation		battery voltage
				Seat back is fold up and power walk-in switch is pressed		5
42 (W)	Ground	Sliding motor backward output	Output	Seat sliding	Operate (backward)	Battery voltage
					Stop	0

A
B
C
D
E
F
G
H
I
K
L
M
N
O
P

ADP

DRIVER SEAT CONTROL UNIT (WITH AUTOMATIC DRIVE POSITIONER)

< ECU DIAGNOSIS INFORMATION >

Terminal No. (Wire color)		Description		Condition	Voltage (V) (Approx)	
+	-	Signal name	Input/ Output			
44 (P)	Ground	Reclining motor backward output	Out- put	Seat reclining	Operate (backward)	Battery voltage
					Stop	0
45 (L/R)	Ground	Lifting motor (front) upward output	Out- put	Seat lifting (front)	Operate (upward)	Battery voltage
					Stop	0
48 (B)	Ground	Ground (power)	—	—	0	

DRIVER SEAT CONTROL UNIT (WITH AUTOMATIC DRIVE POSITIONER)

< ECU DIAGNOSIS INFORMATION >

Wiring Diagram - AUTOMATIC DRIVE POSITIONER CONTROL SYSTEM -

INFOID:000000006471618

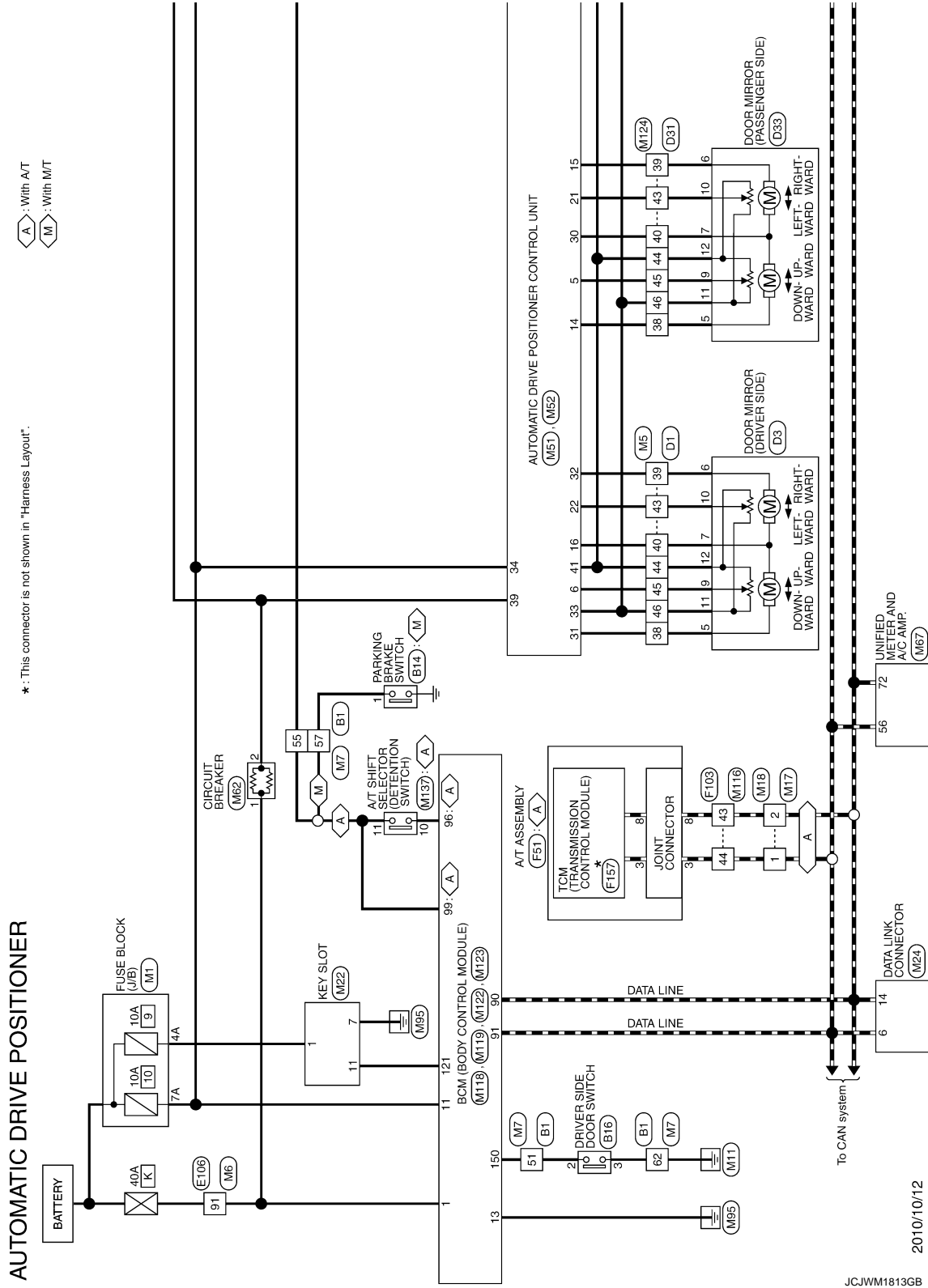

2010/10/12

JCJWM1813GB

A
B
C
D
E
F
G
H
I
ADP
K
L
M
N
O
P

DRIVER SEAT CONTROL UNIT (WITH AUTOMATIC DRIVE POSITIONER)

< ECU DIAGNOSIS INFORMATION >

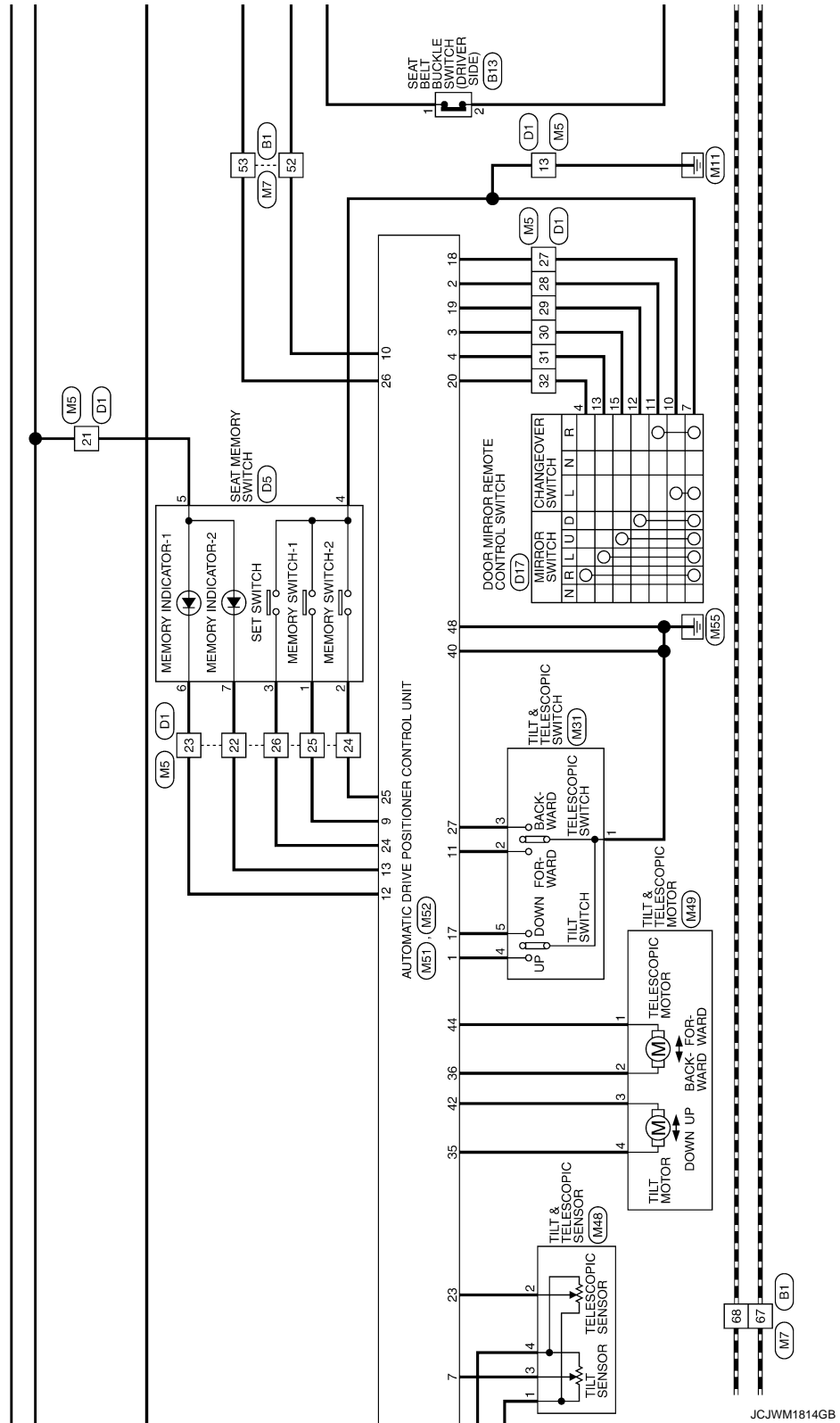

JCJWM1814GB

DRIVER SEAT CONTROL UNIT (WITH AUTOMATIC DRIVE POSITIONER)

< ECU DIAGNOSIS INFORMATION >

- A : With AT
- M : With M/T
- WS : With climate controlled seat
- OS : Without climate controlled seat

* : This connector is not shown in "Harness Layout".

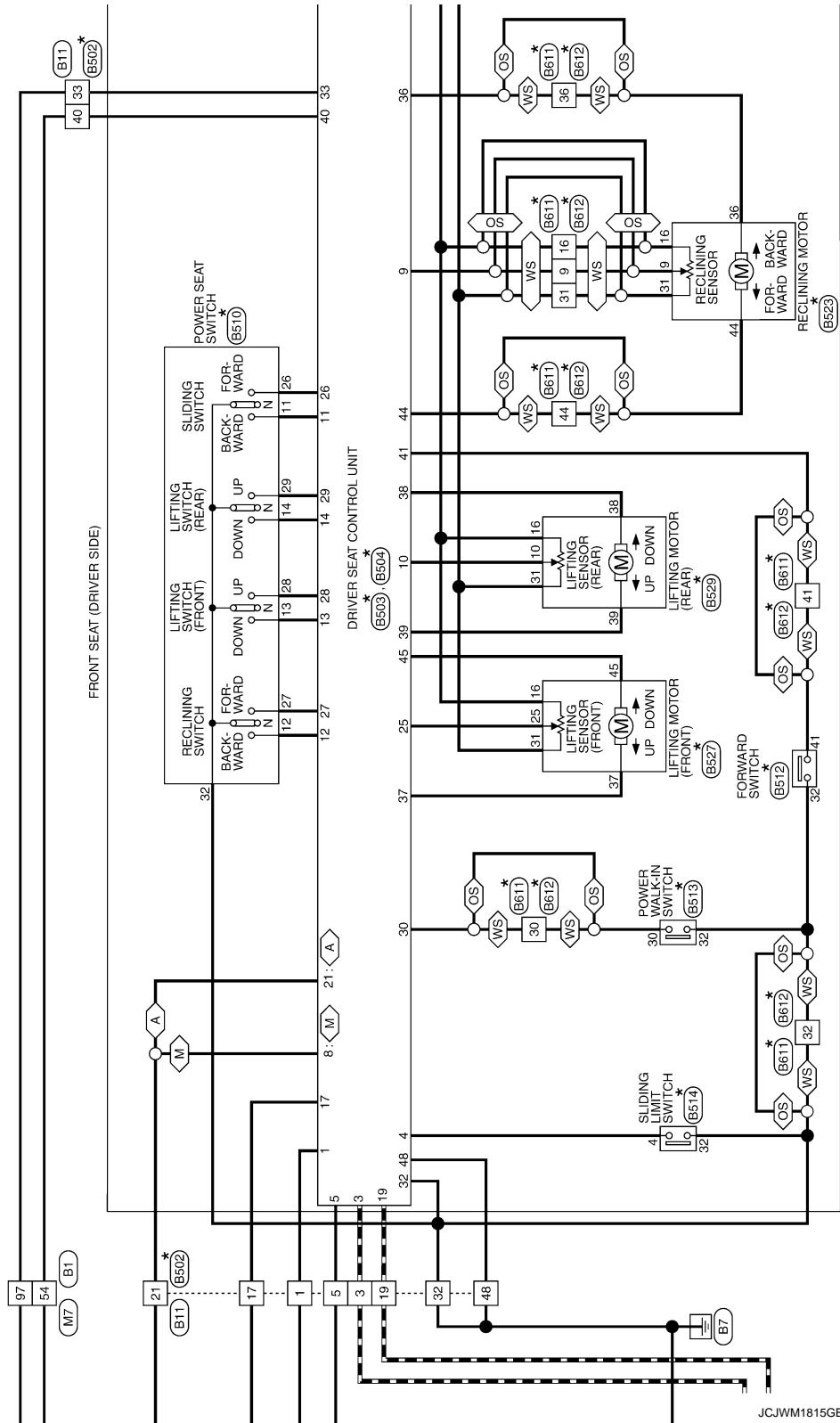

JCJWM1815GB

A
B
C
D
E
F
G
H
I
J
K
L
M
N
O
P

ADP

DRIVER SEAT CONTROL UNIT (WITH AUTOMATIC DRIVE POSITIONER)

< ECU DIAGNOSIS INFORMATION >

*: This connector is not shown in "Harness Layout".

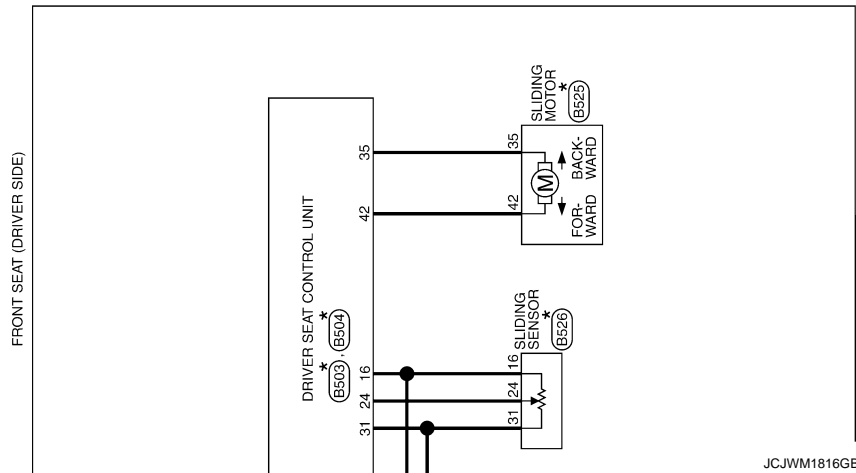

DRIVER SEAT CONTROL UNIT (WITH AUTOMATIC DRIVE POSITIONER)

< ECU DIAGNOSIS INFORMATION >

AUTOMATIC DRIVE POSITIONER

Connector No.	B1
Connector Name	WIRE TO WIRE
Connector Type	TH80PW-CS16-TM4



Terminal No.	Color of Wire	Signal Name [Specification]
1	W	
2	L	
3	R	
4	V	
5	W	
6	B	
7	G	
8	BR	
9	Y	
10	BR	
11	SHIELD	
12	SHIELD	
13	Y	
14	L	
15	R	
16	W	
17	BR	
20	G	
21	SB	
22	GR	
23	W	
24	SB	
25	BR	
26	LG	
27	Y	
28	R	
29	V	
31	SHIELD	
32	G	
33	R	
34	BG	
35	GR	
36	BR	
37	P	- [With climate controlled seat]
37	Y	- [Without climate controlled seat]
38	V	- [With climate controlled seat]
38	GR	- [Without climate controlled seat]
40	SHIELD	
41	L	
42	P	
43	SHIELD	

44	SB	-
45	V	-
46	W	-
47	SB	-
48	LG	-
49	LG	- [With BOSE system]
49	Y	- [Without BOSE system]
50	SB	- [With BOSE system]
50	LG	- [Without BOSE system]
51	SB	-
52	G	-
53	LG	-
54	BR	-
55	Y	-
56	W	-
57	V	-
58	R	-
60	R	-
61	BG	-
62	B	-
63	L	-
64	P	-
65	B	-
66	SB	-
67	P	-
68	L	-
69	P	-
70	L	-
80	G	-
81	V	-
82	R	-
83	BR	-
84	G	-
85	L	-
86	Y	-
87	GR	-
89	R	-
91	R	-
93	BG	-
94	P	-
95	GR	-
96	GR	-
97	SB	-
99	Y	-
100	Y/B	-

Connector No.	B11
Connector Name	WIRE TO WIRE
Connector Type	MS18PW-CS



Terminal No.	Color of Wire	Signal Name [Specification]
1	G	
3	L	
5	V	
17	LG	
19	P	
21	Y	
32	B	
33	SB	
40	BR	
48	B	
60	BG	
66	Y	
67	GR	

Connector No.	B13
Connector Name	SEAT BELT BUCKLE SWITCH (DRIVER SIDE)
Connector Type	A03FW

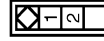

Terminal No.	Color of Wire	Signal Name [Specification]
1	W	
2	B	

Connector No.	B14
Connector Name	PARKING BRAKE SWITCH
Connector Type	PO1FB-A



Terminal No.	Color of Wire	Signal Name [Specification]
1	V	

Connector No.	B16
Connector Name	DRIVER SIDE DOOR SWITCH
Connector Type	A03FW

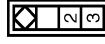

Terminal No.	Color of Wire	Signal Name [Specification]
2	SB	
3	B	

A
B
C
D
E
F
G
H
I
K
L
M
N
O
P

ADP

DRIVER SEAT CONTROL UNIT (WITH AUTOMATIC DRIVE POSITIONER)

< ECU DIAGNOSIS INFORMATION >

AUTOMATIC DRIVE POSITIONER

Connector No.	B523
Connector Name	RECLINING MOTOR (DRIVER SIDE)
Connector Type	NS06FY-CS

44	36
16	31
9	9



Terminal No.	Color of Wire	Signal Name [Specification]
9	W/G	-
16	O	-
31	GR	-
36	G/Y	-
44	P	-

Connector No.	B525
Connector Name	SLIDING MOTOR (DRIVER SIDE)
Connector Type	6098-0239



42	35
----	----

Terminal No.	Color of Wire	Signal Name [Specification]
25	W/R	-
42	W	-

Connector No.	B526
Connector Name	SLIDING SENSOR (DRIVER SIDE)
Connector Type	6098-0241



24	31	16
----	----	----

Terminal No.	Color of Wire	Signal Name [Specification]
16	O	-
24	R	-
31	GR	-

Connector No.	B527
Connector Name	LIFTING MOTOR (FRONT) (DRIVER SIDE)
Connector Type	NS06FY-CS



45	37
16	31
16	25

Terminal No.	Color of Wire	Signal Name [Specification]
16	O	-
25	Y/B	-
31	GR	-
37	G/W	-
45	L/R	-

Connector No.	B529
Connector Name	LIFTING MOTOR (REAR) (DRIVER SIDE)
Connector Type	NS06FER-CS



38	39
16	31
16	10

Terminal No.	Color of Wire	Signal Name [Specification]
10	P/B	-
16	O	-
31	GR	-
38	L/Y	-
39	R/B	-

Connector No.	B611
Connector Name	WIRE TO WIRE
Connector Type	NS12FER-CS



58	57	44	36
30	16	31	9
30	16	31	9

Terminal No.	Color of Wire	Signal Name [Specification]
9	W/G	-
16	O	-
30	P	-
31	GR	-
32	B/W	-
36	G/Y	-
41	Y/G	-
44	P	-
57	W	-
58	L	-

Connector No.	B612
Connector Name	WIRE TO WIRE
Connector Type	NS12FER-CS



36	44	57	58
41	32	9	31
41	32	9	31

Terminal No.	Color of Wire	Signal Name [Specification]
9	W/G	-
16	O	-
30	P	-
31	GR	-
32	B/W	-
36	G/Y	-
41	Y/G	-
44	P	-
57	W	-
58	L	-

A
B
C
D
E
F
G
H
I
ADP
K
L
M
N
O
P

DRIVER SEAT CONTROL UNIT (WITH AUTOMATIC DRIVE POSITIONER)

< ECU DIAGNOSIS INFORMATION >

AUTOMATIC DRIVE POSITIONER

Connector No.	D1
Connector Name	WIRE TO WIRE
Connector Type	TH40FW-CS15

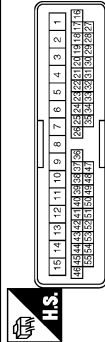

Terminal No.	Color of Wire	Signal Name [Specification]
4	BR	-
5	P	- [A/T models with automatic drive positioner]
6	B	- [Except for A/T models with automatic drive positioner]
7	SB	-
8	G	-
9	C	-
10	P	-
11	LG	-
12	L	-
13	B	-
14	V	-
15	Y	-
16	Y/B	-
17	Y	-
20	V	-
21	R	-
22	P	-
23	O	-
24	Y	-
25	SB	-
26	GR	-
27	GR	-
28	LG	-
29	G	-
30	Y	-
31	W	-
32	BR	-
33	L	-
34	R	-
35	V	-
37	B	-
38	O	-
39	GR	-
40	G	-
41	Y	-
42	LG	-
43	BR	-

44	V	-
45	P	-
46	W	-
47	V	-
48	P	-
49	W	-
50	SB	-
51	R	-
52	L	-

Connector No.	D3
Connector Name	DOOR MIRROR (DRIVER SIDE)
Connector Type	TH12MW-NH

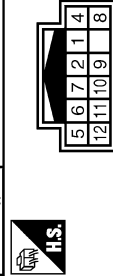

Terminal No.	Color of Wire	Signal Name [Specification]
1	SB	- [With automatic drive positioner]
1	P	- [Without automatic drive positioner]
2	O	- [With automatic drive positioner]
2	SB	- [Without automatic drive positioner]
4	L	-
5	O	- [With automatic drive positioner]
5	W	- [Without automatic drive positioner]
6	GR	- [With automatic drive positioner]
6	BR	- [Without automatic drive positioner]
7	G	- [With automatic drive positioner]
7	V	- [Without automatic drive positioner]
8	B	-
9	P	-
10	BR	-
11	W	-
12	V	-

Connector No.	D5
Connector Name	SEAT MEMORY SWITCH
Connector Type	A08FW

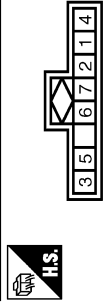

Terminal No.	Color of Wire	Signal Name [Specification]
1	SB	-
2	Y	-
3	GR	-
4	B	-
5	R	-
6	O	-
7	P	-

Connector No.	D17
Connector Name	DOOR MIRROR REMOTE CONTROL SWITCH
Connector Type	TK18FBR

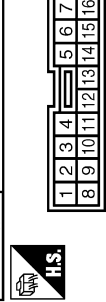

Terminal No.	Color of Wire	Signal Name [Specification]
1	V	-
2	Y	-
3	O	-
4	BR	-
5	LG	-
6	SB	-
7	B	-
8	P	- [With A/T]
8	R	- [With M/T]
9	B	-
10	GR	-
11	LG	-
12	G	-
13	W	-
15	Y	-

Connector No.	D31
Connector Name	WIRE TO WIRE
Connector Type	TH40FW-CS15

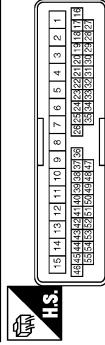

Terminal No.	Color of Wire	Signal Name [Specification]
6	BR	-
7	R	-
8	G	-
9	P	-
10	LG	-
11	W	-
12	L	-
13	B	-
14	Y	-
15	W	-
34	Y	-
35	Y/B	-
38	O	-
39	GR	-
40	G	-
41	Y	-
42	LG	-
43	BR	-
44	V	-
45	P	-
46	W	-
47	V	-
48	P	-
49	W	-
50	SB	-
51	R	-
52	L	-
53	O	-
54	GR	-
55	G	-

JCJWM1820GB

DRIVER SEAT CONTROL UNIT (WITH AUTOMATIC DRIVE POSITIONER)

< ECU DIAGNOSIS INFORMATION >

AUTOMATIC DRIVE POSITIONER

Connector No.	D03
Connector Name	DOOR MIRROR (PASSENGER SIDE)
Connector Type	TH12MW-NH

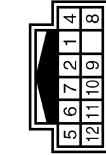

Terminal No.	Color of Wire	Signal Name [Specification]
1	LG	- [With automatic drive positioner]
1	Y	- [Without automatic drive positioner]
2	Y	- [With automatic drive positioner]
2	LG	- [Without automatic drive positioner]
4	L	- [With automatic drive positioner]
4	O	- [Without automatic drive positioner]
5	GR	- [With automatic drive positioner]
5	GR	- [Without automatic drive positioner]
6	GR	- [With automatic drive positioner]
6	G	- [Without automatic drive positioner]
7	G	- [With automatic drive positioner]
7	O	- [Without automatic drive positioner]
8	B	-
9	P	-
10	BR	-
11	W	-
12	V	-

Connector No.	E106
Connector Name	WIRE TO WIRE
Connector Type	TH80PV-CS16-TM4

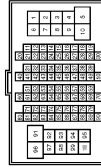

Terminal No.	Color of Wire	Signal Name [Specification]
1	GR	-
3	BG	-
4	B/W	-
5	G	-
6	BG	-
7	LG	-

8	G	-
9	R	-
10	W	-
11	V	-
12	R	-
13	L	-
14	GR	-
15	P	-
16	W	-
17	V	-
18	BG	-
19	GR	-
20	LG	-
30	R	-
31	L	-
32	BG	-
33	P	-
34	V	-
35	BR	-
36	W	-
37	Y	-
38	R	-
39	B	-
40	G	-
41	W	-
42	LG	-
43	SB	-
44	GR	-
45	BG	-
46	LG	-
47	V	-
48	P	-
49	L	-
59	B	-
66	LG	-
67	SB	-
68	R	-
69	W	-
70	G	-
80	W	-
81	P	-
82	G	-
83	V	-
84	L	-
85	BG	-
86	LG	-
87	Y	-
88	GR	-
89	W	-
90	W	-
91	G	-
91	G	-
92	B	-

93	GR	-
94	L	-
95	V	-
97	BR	-
98	SHIELD	-
99	L	-
100	P	-

Connector No.	F51
Connector Name	A/T ASSEMBLY
Connector Type	RK10FG-DGY

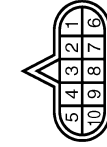

Terminal No.	Color of Wire	Signal Name [Specification]
1	Y	-
2	R	-
3	L	-
4	V	-
5	B	-
6	Y	-
7	R	-
8	P	-
9	GR	-
10	B	-

Connector No.	F103
Connector Name	WIRE TO WIRE
Connector Type	TK38FW-MS10

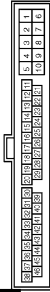

Terminal No.	Color of Wire	Signal Name [Specification]
2	G	-
3	W	-
4	R	-

5	B	-
9	Y	-
10	GR	-
19	O	-
20	Y	-
28	B	-
29	LG	-
30	R	-
31	R	-
41	O	-
42	BR	-
43	P	-
44	L	-
45	Y	-
46	V	-

Connector No.	F157
Connector Name	TOM (TRANSMISSION CONTROL MODULE)
Connector Type	SP10FG

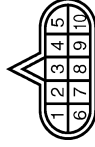

Terminal No.	Color of Wire	Signal Name [Specification]
1	-	VIGN
2	-	BATT
3	-	CAN-H
4	-	CAN-L
5	-	GND
6	-	VIGN
7	-	REV/LAMP RLY
8	-	CAN-L
9	-	STARTER RLY
10	-	GND

A
B
C
D
E
F
G
H
I
J
K
L
M
N
O
P

ADP

DRIVER SEAT CONTROL UNIT (WITH AUTOMATIC DRIVE POSITIONER)

< ECU DIAGNOSIS INFORMATION >

AUTOMATIC DRIVE POSITIONER

Connector No.	M1
Connector Name	FUSE BLOCK (J/B)
Connector Type	HS06FY-MZ

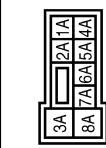

Terminal No.	Color of Wire	Signal Name [Specification]
1A	V	-
2A	G	-
3A	L	-
4A	P	-
5A	BR	-
6A	Y	-
7A	GR	-
8A	L	-

Connector No.	M5
Connector Name	WIRE TO WIPE
Connector Type	TH40MW-CS15

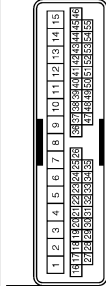

Terminal No.	Color of Wire	Signal Name [Specification]
4	R	-
5	B	-
6	BG	-
7	W	-
8	B	-
9	G	-
10	V	-
11	W	-
12	L	-
13	B	-
14	GR	-
15	Y	-
16	Y/B	-
17	Y	-

20	BG	-	-	-
21	W	-	-	-
22	P	-	-	-
23	BG	-	-	-
24	BR	-	-	-
25	BR	-	-	-
26	R	-	-	-
27	P	-	-	-
28	LG	-	-	-
29	SB	-	-	-
30	G	-	-	-
31	V	-	-	-
32	BR	-	-	-
33	GR	-	-	-
34	G	-	-	-
35	L	-	-	-
37	B	-	-	-
38	G	-	-	-
38	L	-	-	-
39	BR	-	-	-
39	Y	-	-	-
40	Y	-	-	-
41	BR	-	-	-
41	G	-	-	-
42	R	-	-	-
43	G	-	-	-
44	Y	-	-	-
45	GR	-	-	-
46	BR	-	-	-
47	V	-	-	-
48	LG	-	-	-
49	P	-	-	-
50	SB	-	-	-
51	GR	-	-	-
52	L	-	-	-

Connector No.	M6
Connector Name	WIRE TO WIPE
Connector Type	TH80MW-CS16-TM4

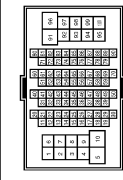

Terminal No.	Color of Wire	Signal Name [Specification]
1	BG	-

87	V	-	-	-
88	B	-	-	-
89	SB	-	-	-
90	G	-	-	-
91	W	-	-	-
92	B	-	-	-
93	G	-	-	-
94	L	-	-	-
95	BR	-	-	-
97	P	-	-	-
98	SHIELD	-	-	-
99	V	-	-	-
100	SB	-	-	-

3	R	-	-	-
4	G	-	-	-
5	G	-	-	-
8	BR	-	-	-
7	BR	-	-	-
8	Y	-	-	-
9	R	-	-	-
10	W	-	-	-
11	GR	-	-	-
12	R	-	-	-
13	L	-	-	-
14	G	-	-	-
15	P	-	-	-
16	W	-	-	-
17	BR	-	-	-
18	V	-	-	-
19	BG	-	-	-
20	L	-	-	-
30	R	-	-	-
31	L	-	-	-
32	Y	-	-	-
33	GR	-	-	-
34	P	-	-	-
35	BR	-	-	-
36	BR	-	-	-
37	Y	-	-	-
38	LG	-	-	-
39	SB	-	-	-
40	G	-	-	-
41	W	-	-	-
42	LG	-	-	-
43	P	-	-	-
44	GR	-	-	-
44	R	-	-	-
45	BG	-	-	-
46	G	-	-	-
47	P	-	-	-
48	P	-	-	-
49	L	-	-	-
59	B	-	-	-
68	Y	-	-	-
67	G	-	-	-
68	R	-	-	-
69	W	-	-	-
70	G	-	-	-
80	SB	-	-	-
81	R	-	-	-
92	V	-	-	-
93	W	-	-	-
84	L	-	-	-
85	BG	-	-	-
86	G	-	-	-

DRIVER SEAT CONTROL UNIT (WITH AUTOMATIC DRIVE POSITIONER)

< ECU DIAGNOSIS INFORMATION >

AUTOMATIC DRIVE POSITIONER

Connector No.	M7
Connector Name	WIRE TO WIRE
Connector Type	TH80MW-CS(E)-TM4

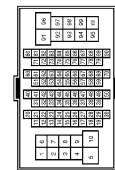

44	Y	-
45	BR	-
46	SB	-
47	SB	-
48	LG	-
49	LG	- [With BOSE system]
49	SB	- [Without BOSE system]
50	SB	- [With BOSE system]
50	LG	- [Without BOSE system]
51	R	-
52	V	-
53	P	-
54	BR	-
55	Y	- [With A/T]
55	BG	- [With M/T]
56	L	-
57	V	-
58	R	-
60	LG	-
61	BG	-
62	B	-
63	V	-
64	SB	-
65	BR	-
66	Y	-
67	P	-
68	L	-
69	P	-
70	L	-
80	G	-
81	LG	-
82	Y	-
83	BR	-
84	V	-
85	L	-
86	Y	-
87	GR	-
91	R	-
93	G	-
94	P	-
95	GR	-
96	Y	-
97	SB	-
99	Y	-
100	Y/B	-

Terminal No.	Color of Wire	Signal Name [Specification]
1	BG	-
2	LG	-
3	G	-
4	V	-
5	L	-
6	B	-
9	L	-
10	BR	-
12	SHIELD	-
13	V	-
14	BR	-
15	GR	-
16	LG	-
17	L	-
20	BR	-
21	G	-
22	R	-
23	SB	-
24	B	-
25	W	-
26	Y	-
27	V	-
28	P	-
29	V	-
31	SHIELD	-
32	G	-
33	R	-
34	BG	-
35	GR	-
36	BR	-
37	P	- [With climate controlled seat]
37	L	- [Without climate controlled seat]
38	V	- [With climate controlled seat]
38	GR	- [Without climate controlled seat]
40	SHIELD	-
41	L	-
42	P	-
43	SHIELD	-

Connector No.	M17
Connector Name	WIRE TO WIRE
Connector Type	TK22FW



Terminal No.	Color of Wire	Signal Name [Specification]
1	L	-
2	P	-

Connector No.	M18
Connector Name	WIRE TO WIRE
Connector Type	TK22MW



Terminal No.	Color of Wire	Signal Name [Specification]
1	L	-
2	P	-

Connector No.	M22
Connector Name	KEY SLOT
Connector Type	TH12FW-NH

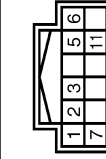

Terminal No.	Color of Wire	Signal Name [Specification]
1	V	BAT
2	GR	CLOCK

3	W	DATA
5	Y	ILL BAT
6	LG	ILL
7	B	GND
11	SB	KEY SWITCH SIGNAL

Connector No.	M24
Connector Name	DATA LINK CONNECTOR
Connector Type	BD16FW

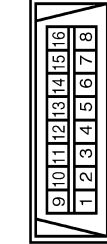

Terminal No.	Color of Wire	Signal Name [Specification]
3	LG	-
4	B	-
5	BR	-
6	L	-
7	V	-
8	G	-
11	SB	-
14	P	-
16	R	-

Connector No.	M31
Connector Name	TILT & TELESCOPIC SWITCH
Connector Type	TK20FGY

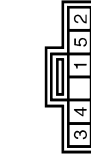

Terminal No.	Color of Wire	Signal Name [Specification]
1	B	-
2	GR	-
3	G	-
4	Y	-
5	BR	-

A
B
C
D
E
F
G
H
I
K
L
M
N
O
P

ADP

DRIVER SEAT CONTROL UNIT (WITH AUTOMATIC DRIVE POSITIONER)

< ECU DIAGNOSIS INFORMATION >

AUTOMATIC DRIVE POSITIONER

Connector No.	M48
Connector Name	TILT & TELESCOPIC SENSOR
Connector Type	TK04FW



Terminal No.	Color of Wire	Signal Name [Specification]
1	W	-
2	P	-
3	EG	-
4	Y	-

Connector No.	M49
Connector Name	TILT & TELESCOPIC MOTOR
Connector Type	NS04FW-CS



Terminal No.	Color of Wire	Signal Name [Specification]
1	G	-
2	GR	-
3	EG	-
4	L	-

Connector No.	M51
Connector Name	AUTOMATIC DRIVE POSITIONER CONTROL UNIT
Connector Type	TH82FW-NH

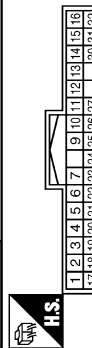

Terminal No.	Color of Wire	Signal Name [Specification]
1	Y	TILT SW (UPWARD)
2	LC	MIRROR SELECT SW (RH)
3	G	MIRROR SW (UPWARD)
4	V	MIRROR SW (LEFTWARD)
5	R	MIRROR SENSOR (RH VERTICAL)
6	GR	MIRROR SENSOR (LH VERTICAL)
7	EG	TILT SENSOR
9	BR	ADDRESS 1
10	V	TX (UART)
11	GR	TELESCOPIC SW (FRONTWARD)
12	BG	IND 1
13	P	IND 2
14	W	MIRROR MOTOR (RH VERTICAL)
15	BG	MIRROR MOTOR (RH HORIZONTAL)
16	Y	MIRROR MOTOR (LH COMMON)
17	BR	TILT SW (DOWNWARD)
18	P	MIRROR SELECT SW (LH)
19	SB	MIRROR SW (DOWNWARD)
20	BR	MIRROR SW (RIGHTWARD)
21	L	MIRROR SENSOR (RH HORIZONTAL)
22	G	MIRROR SENSOR (LH HORIZONTAL)
23	P	TELESCOPIC SENSOR
24	R	SET SW
25	V	ADDRESS 2
26	P	RX (UART)
27	G	TELESCOPIC SW (BACKWARD)
30	SB	MIRROR MOTOR (RH COMMON)
31	G	MIRROR MOTOR (LH VERTICAL)
32	BR	MIRROR MOTOR (LH HORIZONTAL)

Connector No.	M52
Connector Name	AUTOMATIC DRIVE POSITIONER CONTROL UNIT
Connector Type	NS10FW-CS

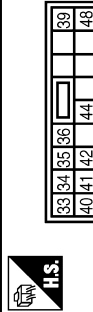

Terminal No.	Color of Wire	Signal Name [Specification]
33	BR	POWER SUPPLY (SENSOR)
34	R	BAT (FUSE)
35	L	TILT MOTOR (UPWARD)
36	GR	TELESCOPIC MOTOR (FORWARD)
38	BR	BAT (G/B)

40	B	GND (SIGNAL)
41	Y	GND (SENSOR)
42	BG	TILT MOTOR (DOWNWARD)
44	G	TELESCOPIC MOTOR (BACKWARD)
48	B	GND (POWER)

Connector No.	M62
Connector Name	CIRCUIT BREAKER
Connector Type	M02FW-LC



Terminal No.	Color of Wire	Signal Name [Specification]
1	W	-
2	SB	-

Connector No.	M67
Connector Name	UNIFIED METER AND A/C AMP.
Connector Type	TH82FW-NH



Terminal No.	Color of Wire	Signal Name [Specification]
41	BR	ACC POWER SUPPLY
42	BR	FUEL LEVEL SENSOR SIGNAL
43	R	INTAKE SENSOR SIGNAL
44	LG	IN-VEHICLE SENSOR SIGNAL
45	V	AMBIENT SENSOR SIGNAL
46	BG	SUNLOAD SENSOR SIGNAL
47	G	EXHAUST GAS / OUTSIDE OXYGEN DETECTING SENSOR SIGNAL
53	W	IGNITION POWER SUPPLY
54	BG	BATTERY POWER SUPPLY
55	B	GROUND
56	L	CAN-H
57	LG	BRAKE FLUID LEVEL SWITCH SIGNAL
58	Y	FUEL LEVEL SENSOR SIGNAL GROUND

59	GR	INTAKE SENSOR GROUND
60	L	IN-VEHICLE SENSOR GROUND
61	R	AMBIENT SENSOR GROUND
62	SB	SUNLOAD SENSOR GROUND
63	L	IGN CONTROL MODE OUTPUT SIGNAL
65	EG	ECV SIGNAL
69	L	A/C LAMP SIGNAL
70	R	EACH DOOR MOTOR POWER SUPPLY
71	GR	GROUND
72	P	CAN-L

Connector No.	M118
Connector Name	WIRE TO WIRE
Connector Type	TK38MW-NS10

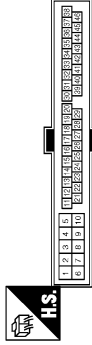

Terminal No.	Color of Wire	Signal Name [Specification]
2	W	-
3	BG	-
4	R	-
5	B	-
9	R	-
10	R	-
19	BG	-
20	Y	-
28	GR	-
29	LG	-
30	LG	-
31	W	-
41	BG	-
42	G	-
43	P	-
44	L	-
45	G	-
46	Y	-

DRIVER SEAT CONTROL UNIT (WITH AUTOMATIC DRIVE POSITIONER)

< ECU DIAGNOSIS INFORMATION >

AUTOMATIC DRIVE POSITIONER

Connector No.	M118
Connector Name	BCM (BODY CONTROL MODULE)
Connector Type	M32FB-LC



Terminal No.	Color of Wire	Signal Name [Specification]
1	W	BAT (F/L)
2	Y	POWER WINDOW POWER SUPPLY (BAT)
3	BG	POWER WINDOW POWER SUPPLY (RAP)

Connector No.	M119
Connector Name	BCM (BODY CONTROL MODULE)
Connector Type	NS16FW-CS



Terminal No.	Color of Wire	Signal Name [Specification]
4	LG	INTERIOR ROOM LAMP POWER SUPPLY
5	P	PASSENGER DOOR UNLOCK OUTPUT
7	SB	STEP LAMP
8	V	ALL DOOR FUEL LID LOCK OUTPUT
9	G	DRIVER DOOR FUEL LID UNLOCK OUTPUT
11	GR	BAT (FUSE)
13	B	GND
14	W	PUSH-BUTTON IGNITION SW ILL GND
15	BG	ACC IND
17	BR	TURN SIGNAL RH (FRONT)
18	BG	TURN SIGNAL LH (FRONT)
19	V	ROOM LAMP TIMER CONTROL

Connector No.	M122
Connector Name	BCM (BODY CONTROL MODULE)
Connector Type	TH4GFB-NH



Terminal No.	Color of Wire	Signal Name [Specification]
72	R	ROOM ANT 2-
73	G	ROOM ANT 2+
74	SR	PASSENGER DOOR ANT-
75	BR	PASSENGER DOOR ANT+
76	V	DRIVER DOOR ANT-
77	LG	DRIVER DOOR ANT+
78	L	ROOM ANT 1-
79	BR	ROOM ANT 1+
80	GR	NATS ANTENNA AMP
81	W	NATS ANTENNA AMP
82	R	IGN RELAY (F/B) CONT
83	Y	KEYLESS ENTRY RECEIVER COMM
87	Y	COMBI SW INPUT 5
88	BG	COMBI SW INPUT 3
89	BR	PUSH SW
90	P	CAN-L
91	L	CAN-H
92	LG	KEY SLOT ILL
93	V	ON IND
95	BG	ACC RELAY CONT
96	GR	A/T SHIFT SELECTOR POWER SUPPLY
97	L	S/L CONDITION 1
98	SB	S/L CONDITION 2
99	R	ASD CLUTCH SW (MTR.M/T)
99	R	SHIFT P (MTR.A/T)
100	Y	PASSENGER DOOR REQUEST SW
101	P	DRIVER DOOR REQUEST SW
102	BG	BLOWER FAN MOTOR RELAY CONT
103	LG	KEYLESS ENTRY RECEIVER POWER SUPPLY
106	W	S/L UNIT POWER SUPPLY
107	LG	COMBI SW INPUT 1
108	R	COMBI SW INPUT 4
109	W	COMBI SW INPUT 2
110	G	HAZARD SW
111	Y	S/L UNIT COMM

Connector No.	M123
Connector Name	BCM (BODY CONTROL MODULE)
Connector Type	TH4GFG-NH



Terminal No.	Color of Wire	Signal Name [Specification]
112	BR	RAIN SENSOR SERIAL LINK
113	G	OPTICAL SENSOR
114	R	CLUTCH INTERLOCK SW
116	SB	STOP LAMP SW 1
118	BR	STOP LAMP SW 2
119	GR	DR DOOR UNLOCK SENSOR
121	SB	KEY SLOT SW
123	W	IGN F/B
124	BG	PASSENGER DOOR SW
129	BG	TRUNK LID OPENER CANCEL SW
132	LG	P/W SW & RHT G/U COMM
133	Y	PUSH-BUTTON IGNITION SW ILL POWER
134	LG	LOCK IND
137	BG	RECEIVER / SENSOR GND
138	Y	RECEIVER / SENSOR POWER SUPPLY
139	L	TIRE PRESSURE RECEIVER COMM
140	GR	SHIFT N/P
141	R	SECURITY INDICATOR LAMP
142	BR	COMBI SW OUTPUT 5
143	V	COMBI SW OUTPUT 1
144	G	COMBI SW OUTPUT 2
145	L	COMBI SW OUTPUT 3
146	SB	COMBI SW OUTPUT 4
148	W	COMBI SW OUTPUT 4
150	R	DRIVER DOOR SW
151	G	REAR WINDOW DEFROGGER RELAY CONT

Connector No.	M124
Connector Name	WIRE TO WIRE
Connector Type	TH40MNF-CS15

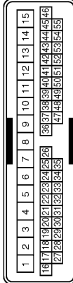

Terminal No.	Color of Wire	Signal Name [Specification]
6	BG	-
7	R	-
8	G	-
9	P	-
10	V	-
11	SB	- [With BOSE system]
11	GR	- [Without BOSE system]
12	BR	-
13	B	-
14	G	-
15	W	-
34	Y	-
35	Y/B	-
38	W	-
39	BG	-
40	SB	-
41	BR	- [With automatic drive positioner]
41	G	- [Without automatic drive positioner]
42	R	-
43	L	-
44	Y	-
45	R	-
46	W	-
47	SB	-
48	BR	-
49	Y	-
50	P	-
51	LG	-
52	BG	-
53	Y	-
54	L	-
55	L	-

A
B
C
D
E
F
G
H
I
ADP
K
L
M
N
O
P

DRIVER SEAT CONTROL UNIT (WITH AUTOMATIC DRIVE POSITIONER)

< ECU DIAGNOSIS INFORMATION >

AUTOMATIC DRIVE POSITIONER

Connector No.	M137
Connector Name	A/T SHIFT SELECTOR
Connector Type	TH12FV-NH

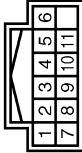

Terminal No.	Color of Wire	Signal Name [Specification]
1	W	-
2	V	-
3	L	-
4	BR	-
5	G	-
7	Y	-
8	SB	-
9	B	-
10	GR	-
11	R	-

JCJWM1826GB

INFOID:000000006471619

Fail Safe

The fail-safe mode may be activated if the following symptoms are observed.

DRIVER SEAT CONTROL UNIT (WITH AUTOMATIC DRIVE POSITIONER)

< ECU DIAGNOSIS INFORMATION >

Operating in fail-safe mode	Malfunction Item	Related DTC	Diagnosis
Only manual functions operate normally.	CAN communication*1	U1000	With ADP: ADP-48
			Without ADP: ADP-48
	Tilt sensor*1	B2118	With ADP: ADP-53
			Without ADP: ADP-53
	Telescopic sensor	B2119	ADP-56
	Detent switch	B2126	ADP-59
Parking brake switch	B2127	ADP-61	
Only manual functions, except door mirror, operate normally.	UART communication	B2128	ADP-63
Only manual functions, except seat sliding, operate normally.	Seat sliding output	B2112	ADP-49
Only manual functions, except seat reclining, operate normally.	Seat reclining output	B2113	ADP-51

*1: Driver seat without automatic driver positioner system display only "U1000 CAN COMM CIRCUIT" and "B2112 SEAT SLIDE".

DTC Index

INFOID:000000006471620

CONSULT-III display	Timing*1		Item	Reference page
	Current mal-function	Previous mal-function		
CAN COMM CIRCUIT*2 [U1000]	0	1-39	CAN communication	With ADP: ADP-48
				Without ADP: ADP-48
SEAT SLIDE*2 [B2112]	0	1-39	Seat slide motor output	With ADP: ADP-49
				Without ADP: ADP-49
SEAT RECLINING [B2113]	0	1-39	Seat reclining motor output	ADP-51
TILT SENSOR [B2118]	0	1-39	Tilt sensor input	ADP-53
TELESCO SENSOR [B2119]	0	1-39	Telescopic sensor input	ADP-56
DETENT SW*2 [B2126]	0	1-39	Detention switch condition	ADP-59
PARKING BRAKE [B2127]	0	1-39	Parking brake switch condition	ADP-61
UART COMM [B2128]	0	1-39	UART communication	ADP-63

*1:

- 0: Current malfunction is present
- 1-39: Displayed if any previous malfunction is present when current condition is normal. The numeral value increases by one at each IGN ON to OFF cycle from 1 to 39. The counter remains at 39 even if the number of cycles exceeds it. However, the counter is reset to 1 if any malfunction is detected again, the normal operation is resumed and the ignition switch is turned from OFF to ON.

*2: Driver seat without automatic driver positioner system display only "U1000 CAN COMM CIRCUIT" and "B2112 SEAT SLIDE".

AUTOMATIC DRIVE POSITIONER CONTROL UNIT

< ECU DIAGNOSIS INFORMATION >

AUTOMATIC DRIVE POSITIONER CONTROL UNIT

Reference Value

INFOID:000000006471621

TERMINAL LAYOUT

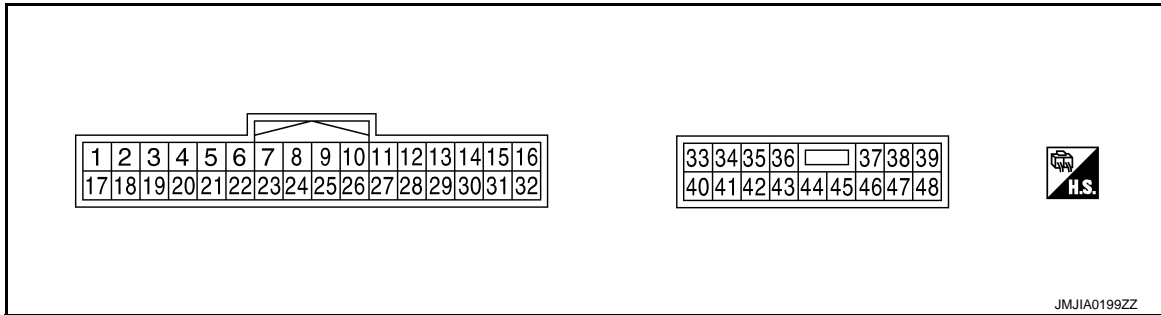

PHYSICAL VALUES

Terminal No. (Wire color)		Description		Condition		Voltage (V) (Approx.)
+	-	Signal name	Input/ Output			
1 (Y)	Ground	Tilt switch upward signal	Input	Tilt switch	Operate (upward)	0
					Other than above	5
2 (LG)	Ground	Changeover switch RH signal	Input	Changeover switch position	RH	0
					Neutral or LH	5
3 (G)	Ground	Mirror switch upward signal	Input	Mirror switch	Operated (upward)	0
					Other than above	5
4 (V)	Ground	Mirror switch leftward signal	Input	Mirror switch	Operated (leftward)	0
					Other than above	5
5 (R)	Ground	Door mirror sensor (RH) upward/downward signal	Input	Mirror face (door mirror RH)	Change between 3.4 (close to peak) 0.6 (close to valley)	
6 (GR)	Ground	Door mirror sensor (LH) upward/downward signal	Input	Mirror face (door mirror LH)	Change between 3.4 (close to peak) 0.6 (close to valley)	
7 (O)	Ground	Tilt sensor signal	Input	Tilt position	Change between 1.2 (close to top) 3.8 (close to bottom)	
9 (BR)	Ground	Memory switch 1 signal	Input	Memory switch 1	Press	0
					Other than above	5
10 (V)	Ground	UART communication (TX)	Output	Ignition switch ON		

AUTOMATIC DRIVE POSITIONER CONTROL UNIT

< ECU DIAGNOSIS INFORMATION >

Terminal No. (Wire color)		Description		Condition	Voltage (V) (Approx.)		
+	-	Signal name	Input/ Output				
11 (GR)	Ground	Telescopic switch forward signal	Input	Telescopic switch	Operate (forward)	0	A
					Other than above	5	B
12 (O)	Ground	Memory indicator 1 signal	Output	Memory indicator 1	Illuminate	1	C
					Other than above	Battery voltage	D
13 (P)	Ground	Memory indicator 2 signal	Output	Memory indicator 2	Illuminate	1	E
					Other than above	Battery voltage	F
14 (W)	Ground	Door mirror motor (RH) upward output	Output	Door mirror RH	Operate (upward)	Battery voltage	G
					Other than above	0	H
15 (O)	Ground	Door mirror motor (RH) leftward output	Output	Door mirror RH	Operate (leftward)	Battery voltage	I
					Other than above	0	J
16 (Y)	Ground	Door mirror motor (LH) downward output	Output	Door mirror (LH)	Operate (downward)	Battery voltage	K
					Other than above	0	L
		Door mirror motor (LH) rightward output			Operate (rightward)	Battery voltage	M
					Other than above	0	N
17 (BR)	Ground	Tilt switch downward signal	Input	Tilt switch	Operate (downward)	0	O
					Other than above	5	P
18 (P)	Ground	Changeover switch LH signal	Input	Changeover switch position	LH	0	
					Neutral or RH	5	
19 (SB)	Ground	Mirror switch downward signal	Input	Mirror switch	Operate (downward)	0	
					Other than above	5	
20 (BR)	Ground	Mirror switch rightward signal	Input	Mirror switch	Operate (rightward)	0	
					Other than above	5	
21 (L)	Ground	Door mirror sensor (RH) leftward/rightward signal	Input	Door mirror RH position	Change between 3.4 (close to left edge) 0.6 (close to right edge)		
22 (G)	Ground	Door mirror sensor (LH) leftward/rightward signal	Input	Door mirror LH position	Change between 0.6 (close to left edge) 3.4 (close to right edge)		
23 (P)	Ground	Telescopic sensor signal	Input	Telescopic position	Change between 0.8 (close to top) 4.4 (close to bottom)		

ADP

AUTOMATIC DRIVE POSITIONER CONTROL UNIT

< ECU DIAGNOSIS INFORMATION >

Terminal No. (Wire color)		Description		Condition	Voltage (V) (Approx.)	
+	-	Signal name	Input/ Output			
24 (R)	Ground	Set switch signal	Input	Set switch	Press	0
					Other than above	5
25 (LG)	Ground	Memory switch 2 signal	Input	Memory switch 2	Press	0
					Other than above	5
26 (P)	Ground	UART communication (RX)	Input	Ignition switch ON		
27 (G)	Ground	Telescopic switch backward signal	Input	Telescopic switch	Operate (backward)	0
					Other than above	5
30 (SB)	Ground	Door mirror motor (RH) downward output	Output	Door mirror (RH)	Operate (downward)	Battery voltage
					Other than above	0
		Door mirror motor (RH) rightward output			Operate (rightward)	Battery voltage
					Other than above	0
31 (G)	Ground	Door mirror motor (LH) upward output	Output	Door mirror (LH)	Operate (upward)	Battery voltage
					Other than above	0
32 (L)	Ground	Door mirror motor (LH) leftward output	Output	Door mirror (LH)	Operate (leftward)	Battery voltage
					Other than above	0
33 (W)	Ground	Sensor power supply	Input	—	5	
34 (V)	Ground	Power source (Fuse)	Input	—	Battery voltage	
35 (L)	Ground	Tilt motor upward output	Output	Steering tilt	Operate (upward)	Battery voltage
					Other than above	0
36 (GR)	Ground	Telescopic motor forward output signal	Output	Steering telescopic	Operate (forward)	Battery voltage
					Other than above	0
39 (W)	Ground	Power source (C/B)	Input	—	Battery voltage	
40 (B)	Ground	Ground	—	—	0	

AUTOMATIC DRIVE POSITIONER CONTROL UNIT

< ECU DIAGNOSIS INFORMATION >

Terminal No. (Wire color)		Description		Condition	Voltage (V) (Approx.)	A	
+	-	Signal name	Input/ Output			B	
41 (Y)	Ground	Sensor ground	—	—	0	C	
42 (O)	Ground	Tilt motor downward output	Output	Steering tilt	Operate (downward)	Battery voltage	D
					Other than above	0	E
44 (G)	Ground	Telescopic motor backward output	Output	Steering telescopic	Operate (backward)	Battery voltage	F
					Other than above	0	G
48 (B)	Ground	Ground	—	—	0	H	

ADP

AUTOMATIC DRIVE POSITIONER CONTROL UNIT

< ECU DIAGNOSIS INFORMATION >

Wiring Diagram - AUTOMATIC DRIVE POSITIONER CONTROL SYSTEM -

INFOID:000000006965317

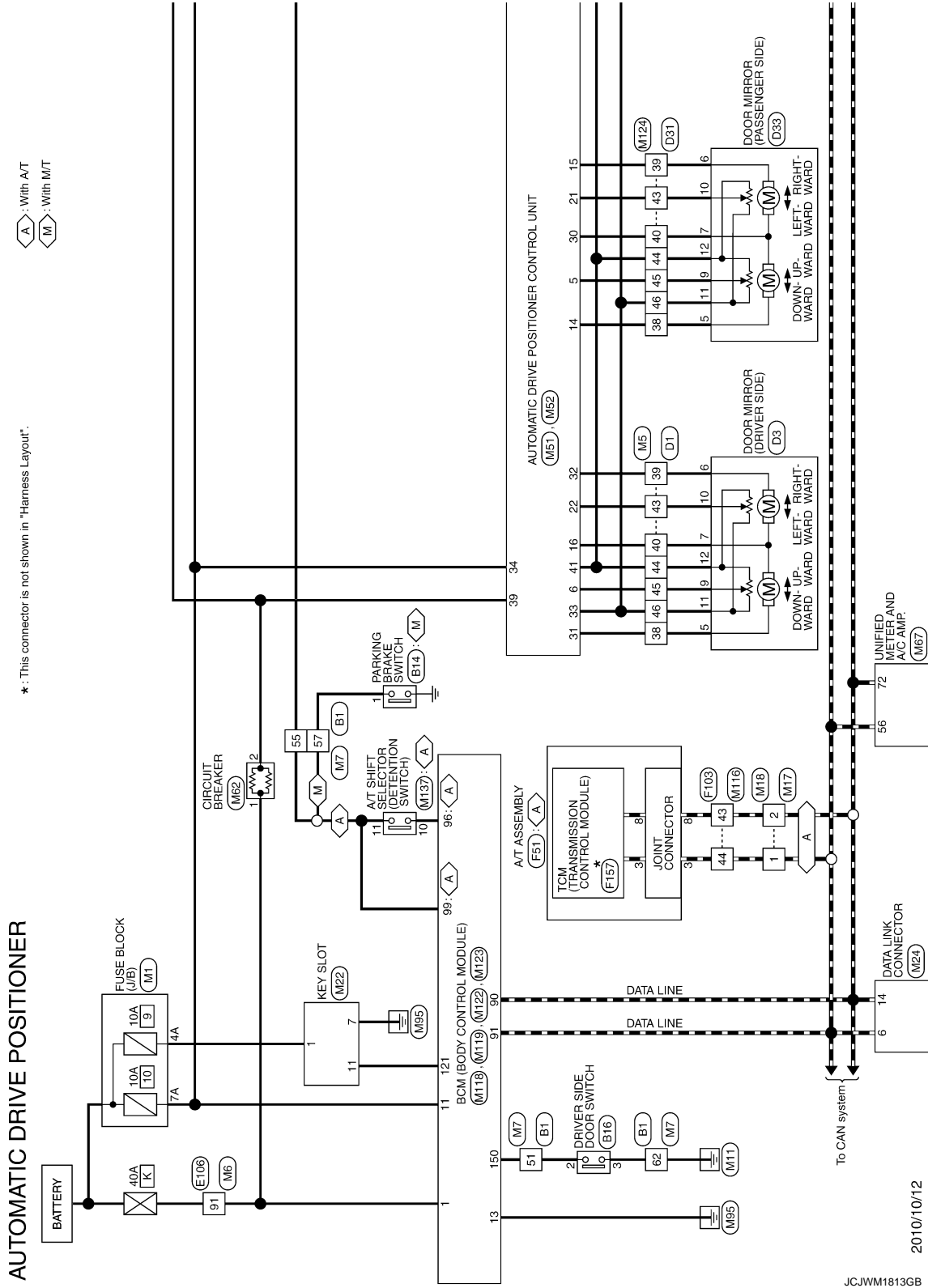

A : With A/T
M : With M/T

*: This connector is not shown in "Harness Layout".

AUTOMATIC DRIVE POSITIONER CONTROL UNIT

< ECU DIAGNOSIS INFORMATION >

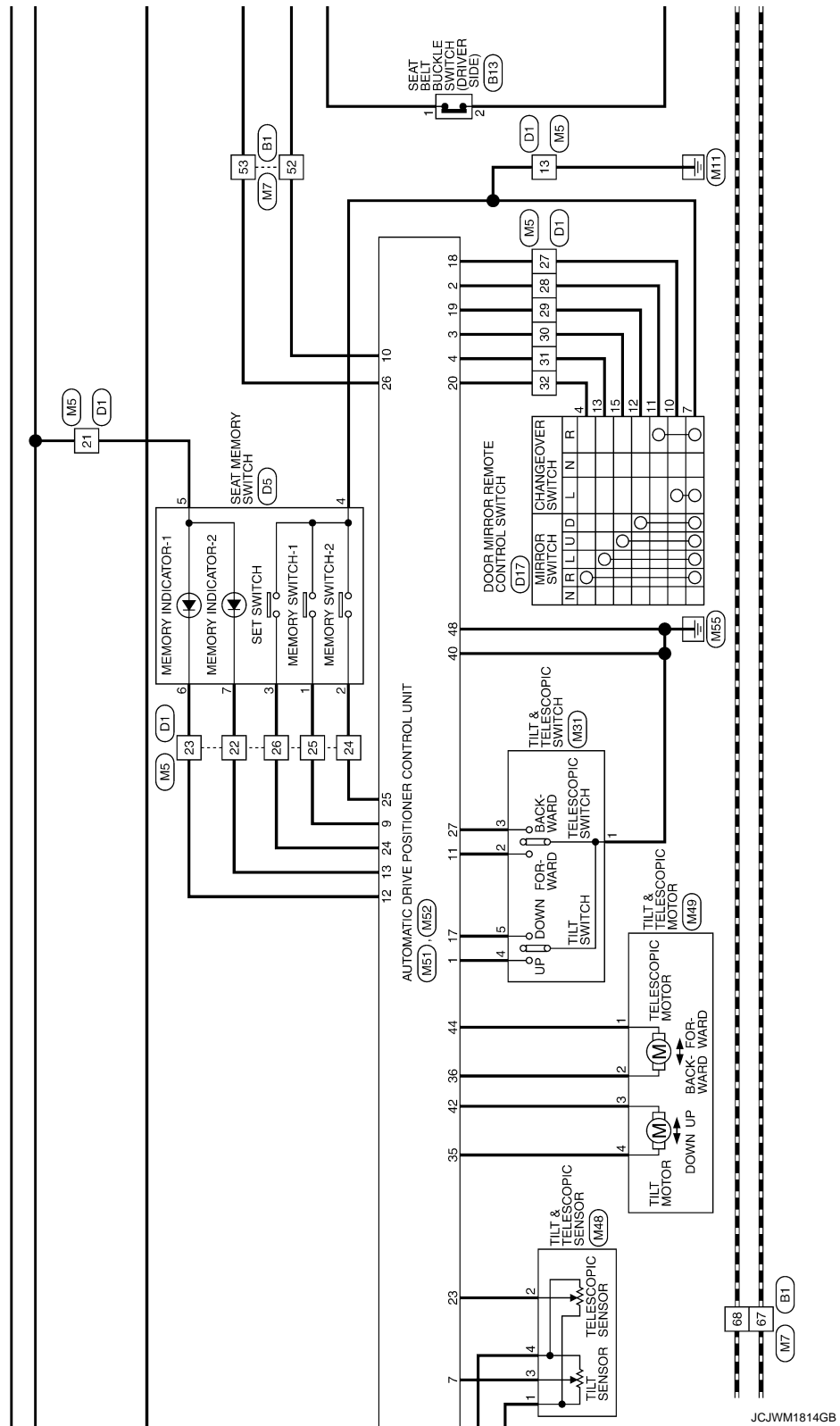

A
B
C
D
E
F
G
H
I
K
L
M
N
O
P

ADP

AUTOMATIC DRIVE POSITIONER CONTROL UNIT

< ECU DIAGNOSIS INFORMATION >

- : With AT
- : With M/T
- : With climate controlled seat
- : Without climate controlled seat

* : This connector is not shown in "Harness Layout".

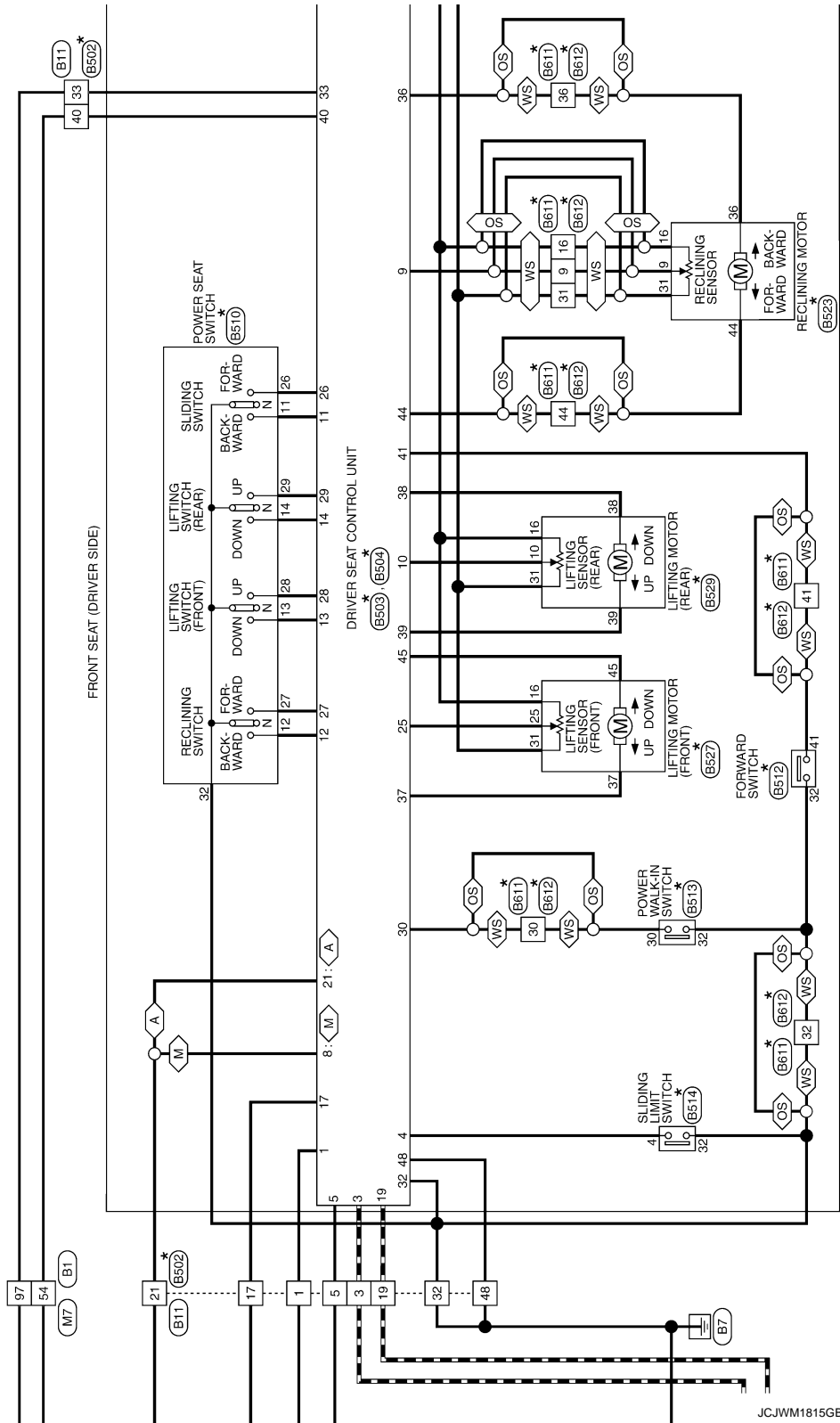

AUTOMATIC DRIVE POSITIONER CONTROL UNIT

< ECU DIAGNOSIS INFORMATION >

A
B
C
D
E
F
G
H
I

ADP

K
L
M
N
O
P

*: This connector is not shown in "Harness Layout".

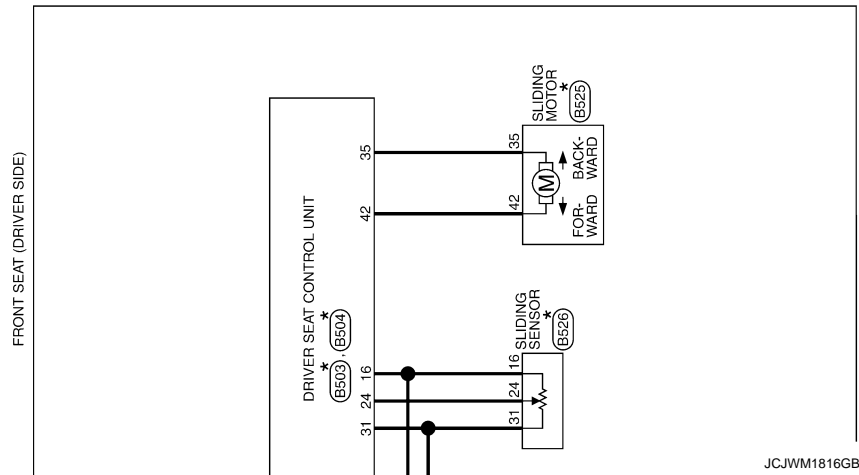

AUTOMATIC DRIVE POSITIONER CONTROL UNIT

< ECU DIAGNOSIS INFORMATION >

AUTOMATIC DRIVE POSITIONER

Connector No.	B1
Connector Name	WIRE TO WIRE
Connector Type	THB07V-CS16-TM4

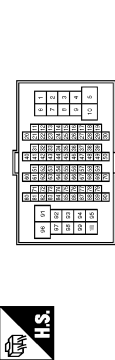

44	SB	-
45	V	-
46	W	-
47	SB	-
48	LG	-
49	LG	- [With BOSE system]
49	Y	- [Without BOSE system]
50	SB	- [With BOSE system]
50	LG	- [Without BOSE system]
51	SB	-
52	G	-
53	LG	-
54	BR	-
55	Y	-
56	W	-
57	V	-
58	R	-
60	R	-
61	BG	-
62	B	-
63	B	-
64	P	-
65	B	-
66	SB	-
67	P	-
68	L	-
69	P	-
70	L	-
80	G	-
81	V	-
82	R	-
83	BR	-
84	G	-
85	L	-
86	Y	-
87	GR	-
91	R	-
93	BG	-
94	P	-
95	GR	-
96	GR	-
97	SB	-
99	Y	-
100	Y/B	-

Connector No.	B14
Connector Name	PARKING BRAKE SWITCH
Connector Type	PO1FB-A



Terminal No.	1	V
--------------	---	---

Terminal No.	Color of Wire	Signal Name [Specification]
1	G	-
3	L	-
5	V	-
17	LG	-
19	P	-
21	Y	-
32	B	-
33	SB	-
40	BR	-
48	B	-
60	BG	-
68	Y	-
67	GR	-

Connector No.	B16
Connector Name	DRIVER SIDE DOOR SWITCH
Connector Type	A03FW

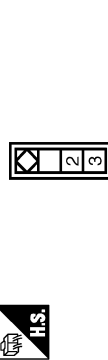

Terminal No.	Color of Wire	Signal Name [Specification]
2	SB	-
3	B	-

Connector No.	B13
Connector Name	SEAT BELT BUCKLE SWITCH (DRIVER SIDE)
Connector Type	A03FW

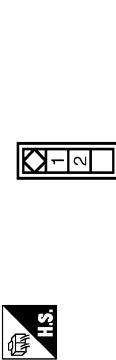

Terminal No.	Color of Wire	Signal Name [Specification]
1	W	-
2	B	-

Terminal No.	Color of Wire	Signal Name [Specification]
1	W	-
2	L	-
3	R	-
4	V	-
5	W	-
6	B	-
8	G	-
10	BR	-
12	SHIELD	-
13	Y	-
14	L	-
15	R	-
16	W	-
17	BR	-
20	G	-
21	SB	-
22	GR	-
23	W	-
24	SB	-
25	BR	-
26	LG	-
27	Y	-
28	R	-
29	V	-
31	SHIELD	-
32	G	-
33	R	-
34	BG	-
35	GR	-
36	BR	-
37	P	- [With climate controlled seat]
37	Y	- [Without climate controlled seat]
38	V	- [With climate controlled seat]
38	GR	- [Without climate controlled seat]
40	SHIELD	-
41	L	-
42	P	-
43	SHIELD	-

JCJWM1817GB

AUTOMATIC DRIVE POSITIONER CONTROL UNIT

< ECU DIAGNOSIS INFORMATION >

AUTOMATIC DRIVE POSITIONER

Connector No.	B523
Connector Name	RECLINING MOTOR (DRIVER SIDE)
Connector Type	NS06FY-CS



44	36
16	31
9	

Terminal No.	Color of Wire	Signal Name [Specification]
9	W/G	-
16	O	-
31	GR	-
36	G/Y	-
44	P	-

Connector No.	B525
Connector Name	SLIDING MOTOR (DRIVER SIDE)
Connector Type	6098-0239



42	35
----	----

Terminal No.	Color of Wire	Signal Name [Specification]
35	W/R	-
42	W	-

Connector No.	B526
Connector Name	SLIDING SENSOR (DRIVER SIDE)
Connector Type	6098-0241



24	31	16
----	----	----

Terminal No.	Color of Wire	Signal Name [Specification]
16	O	-
24	R	-
31	GR	-

Connector No.	B527
Connector Name	LIFTING MOTOR (FRONT) (DRIVER SIDE)
Connector Type	NS06FY-CS



45	37
16	31
25	

Terminal No.	Color of Wire	Signal Name [Specification]
16	O	-
25	Y/B	-
31	GR	-
37	G/W	-
45	L/R	-

Connector No.	B528
Connector Name	LIFTING MOTOR (REAR) (DRIVER SIDE)
Connector Type	NS06FBR-CS



38	39
16	31
10	

Terminal No.	Color of Wire	Signal Name [Specification]
10	P/B	-
16	O	-
31	GR	-
38	L/Y	-
39	R/B	-

Connector No.	B611
Connector Name	WIRE TO WIRE
Connector Type	NS12MFR-CS



58	57	44	36
30	16	31	9
32	41		

Terminal No.	Color of Wire	Signal Name [Specification]
9	W/G	-
16	O	-
30	P	-
31	GR	-
32	B/W	-
36	G/Y	-
41	Y/G	-
44	P	-
57	W	-
58	L	-

Connector No.	B612
Connector Name	WIRE TO WIRE
Connector Type	NS12FBR-CS



36	44	57	58
41	32	9	31
16	30		

Terminal No.	Color of Wire	Signal Name [Specification]
9	W/G	-
16	O	-
30	P	-
31	GR	-
32	B/W	-
36	G/Y	-
41	Y/G	-
44	P	-
57	W	-
58	L	-

AUTOMATIC DRIVE POSITIONER CONTROL UNIT

< ECU DIAGNOSIS INFORMATION >

AUTOMATIC DRIVE POSITIONER

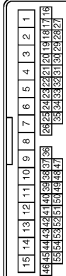

Connector No.	D1
Connector Name	WIRE TO WIRE
Connector Type	TH40PW-CS15

Terminal No.	Color of Wire	Signal Name [Specification]
4	BR	-
5	P	- [A/T models with automatic drive positioner]
5	B	- [Except for A/T models with automatic drive positioner]
6	SB	-
7	R	-
8	G	-
9	P	-
10	LG	-
11	W	-
12	L	-
13	B	-
14	V	-
15	Y	-
16	Y/B	-
17	Y	-
20	V	-
21	R	-
22	P	-
23	O	-
24	Y	-
25	SB	-
26	GR	-
27	GR	-
28	LG	-
29	G	-
30	Y	-
31	W	-
32	BR	-
33	L	-
34	R	-
35	V	-
37	B	-
38	O	-
39	GR	-
40	G	-
41	Y	-
42	LG	-
43	BR	-

44	V	-
45	P	-
46	W	-
47	V	-
48	P	-
49	W	-
50	SB	-
51	R	-
52	L	-

Connector No.	D3
Connector Name	DOOR MIRROR (DRIVER SIDE)
Connector Type	TH12MW-NH



Terminal No.	Color of Wire	Signal Name [Specification]
1	SB	- [With automatic drive positioner]
1	P	- [Without automatic drive positioner]
2	O	- [With automatic drive positioner]
2	SB	- [Without automatic drive positioner]
4	L	-
5	O	- [With automatic drive positioner]
5	W	- [Without automatic drive positioner]
6	GR	- [With automatic drive positioner]
6	BR	- [Without automatic drive positioner]
7	G	- [With automatic drive positioner]
7	V	- [Without automatic drive positioner]
8	B	-
9	P	-
10	BR	-
11	W	-
12	V	-

Connector No.	D5
Connector Name	SEAT MEMORY SWITCH
Connector Type	A08PW



Terminal No.	Color of Wire	Signal Name [Specification]
1	SB	-
2	Y	-
3	GR	-
4	B	-
5	R	-
6	O	-
7	P	-

Connector No.	D17
Connector Name	DOOR MIRROR REMOTE CONTROL SWITCH
Connector Type	TK18FBR

Terminal No.	Color of Wire	Signal Name [Specification]
1	V	-
2	Y	-
3	O	-
4	BR	-
5	LG	-
6	SB	-
7	B	-
8	P	- [With A/T]
8	B	- [With M/T]
9	R	-
10	GR	-
11	LG	-
12	G	-
13	W	-
15	Y	-

Connector No.	D31
Connector Name	WIRE TO WIRE
Connector Type	TH40PW-CS15



Terminal No.	Color of Wire	Signal Name [Specification]
6	BR	-
7	R	-
8	G	-
9	P	-
10	LG	-
11	W	-
12	L	-
13	B	-
14	Y	-
15	W	-
34	Y	-
35	Y/B	-
38	O	-
39	GR	-
40	G	-
41	Y	-
42	LG	-
43	BR	-
44	V	-
45	P	-
46	W	-
47	V	-
48	P	-
49	W	-
50	SB	-
51	R	-
52	L	-
53	O	-
54	GR	-
55	G	-

A
B
C
D
E
F
G
H
I
K
L
M
N
O
P

ADP

AUTOMATIC DRIVE POSITIONER CONTROL UNIT

< ECU DIAGNOSIS INFORMATION >

AUTOMATIC DRIVE POSITIONER

Connector No.	D33
Connector Name	DOOR MIRROR (PASSENGER SIDE)
Connector Type	TH2MW-NH

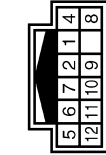

Terminal No.	Color of Wire	Signal Name [Specification]
1	LG	- [With automatic drive positioner]
1	Y	- [Without automatic drive positioner]
2	Y	- [With automatic drive positioner]
2	LG	- [Without automatic drive positioner]
4	L	- [With automatic drive positioner]
5	O	- [Without automatic drive positioner]
8	GR	- [With automatic drive positioner]
8	GR	- [Without automatic drive positioner]
6	G	- [With automatic drive positioner]
7	G	- [Without automatic drive positioner]
7	O	- [With automatic drive positioner]
7	O	- [Without automatic drive positioner]
8	B	-
9	P	-
10	BR	-
11	W	-
12	V	-

Connector No.	E106
Connector Name	WIRE TO WIRE
Connector Type	TH80PW-CS16-TM4



Terminal No.	Color of Wire	Signal Name [Specification]
1	GR	-
3	BG	-
4	B/W	-
5	G	-
6	BG	-
7	LG	-

8	G	-
9	R	-
10	W	-
11	V	-
12	R	-
13	L	-
14	GR	-
15	P	-
16	W	-
17	V	-
18	BG	-
19	GR	-
20	LG	-
30	R	-
31	L	-
32	BG	-
33	P	-
34	V	-
35	BR	-
36	W	-
37	Y	-
38	R	-
39	B	-
40	G	-
41	W	-
42	LG	-
43	SR	-
44	GR	-
45	BG	-
46	LG	-
47	V	-
48	P	-
49	L	-
59	B	-
66	LG	-
67	SR	-
68	R	-
69	W	-
70	G	-
80	W	-
81	P	-
82	G	-
83	V	-
84	L	-
85	BG	-
86	LG	-
87	Y	-
88	GR	-
89	W	-
90	W	-
91	G	-
91	G	-
92	B	-

93	GR	-
94	L	-
95	Y	-
97	BR	-
98	SHIELD	-
99	L	-
100	P	-

Connector No.	F51
Connector Name	A/T ASSEMBLY
Connector Type	RK10FG-DGY

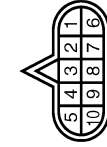

Terminal No.	Color of Wire	Signal Name [Specification]
1	Y	-
2	R	-
3	L	-
4	V	-
5	B	-
6	Y	-
7	R	-
8	P	-
9	GR	-
10	B	-

Connector No.	F103
Connector Name	WIRE TO WIRE
Connector Type	TK36FW-MS10



Terminal No.	Color of Wire	Signal Name [Specification]
2	G	-
3	W	-
4	R	-

5	B	-
9	Y	-
10	GR	-
19	O	-
20	Y	-
28	B	-
29	LG	-
30	R	-
31	R	-
41	O	-
42	BR	-
43	P	-
44	L	-
45	Y	-
46	V	-

Connector No.	F157
Connector Name	TOM (TRANSMISSION CONTROL MODULE)
Connector Type	SP10FG

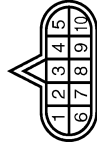

Terminal No.	Color of Wire	Signal Name [Specification]
1	-	VIGN
2	-	BATT
3	-	CAN-H
4	-	K-LINE
5	-	GND
6	-	VIGN
7	-	REV LAMP RLY
8	-	CAN-L
9	-	STARTER RLY
10	-	GND

AUTOMATIC DRIVE POSITIONER CONTROL UNIT

< ECU DIAGNOSIS INFORMATION >

AUTOMATIC DRIVE POSITIONER

Connector No.	M1
Connector Name	FUSE BLOCK (J/B)
Connector Type	NS36FW-M2

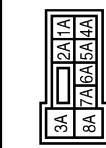

Terminal No.	Color of Wire	Signal Name [Specification]
1A	V	-
2A	G	-
3A	L	-
4A	P	-
5A	BR	-
6A	Y	-
7A	GR	-
8A	L	-

Connector No.	M5
Connector Name	WIRE TO WIRE
Connector Type	TH40MW-CS15

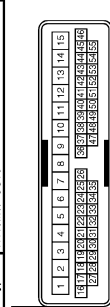

Terminal No.	Color of Wire	Signal Name [Specification]
4	R	-
5	B	-
6	BG	-
7	W	-
8	B	-
9	G	-
10	V	-
11	W	-
12	L	-
13	B	-
14	GR	-
15	Y	-
16	Y/B	-
17	Y	-

20	BG	-	-
21	W	-	-
22	P	-	-
23	BG	-	-
24	V	-	-
25	BR	-	-
26	R	-	-
27	P	-	-
28	LG	-	-
29	SB	-	-
30	G	-	-
31	V	-	-
32	BR	-	-
33	GR	-	-
34	G	-	-
35	L	-	-
37	B	-	-
38	G	-	-
39	L	-	-
39	BR	-	-
39	L	-	-
40	Y	-	-
41	BR	-	-
41	G	-	-
42	R	-	-
43	G	-	-
44	Y	-	-
45	GR	-	-
46	BR	-	-
47	V	-	-
48	LG	-	-
49	P	-	-
50	SB	-	-
51	GR	-	-
52	L	-	-

Connector No.	M6
Connector Name	WIRE TO WIRE
Connector Type	TH80MW-CS16-TM4

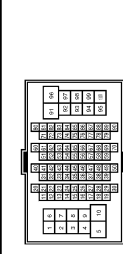

Terminal No.	Color of Wire	Signal Name [Specification]
1	BG	-

87	V	-	-
88	B	-	-
89	SB	-	-
90	G	-	-
91	W	-	-
92	B	-	-
93	G	-	-
94	L	-	-
95	BR	-	-
97	P	-	-
98	SHIELD	-	-
99	V	-	-
100	SB	-	-

3	R	-	-
4	G	-	-
5	G	-	-
6	BR	-	-
7	BR	-	-
8	Y	-	-
9	R	-	-
10	W	-	-
11	GR	-	-
12	R	-	-
13	L	-	-
14	G	-	-
15	P	-	-
16	W	-	-
17	BR	-	-
18	V	-	-
19	BG	-	-
20	L	-	-
30	R	-	-
31	L	-	-
32	Y	-	-
33	GR	-	-
34	P	-	-
35	BR	-	-
36	BR	-	-
37	Y	-	-
38	LG	-	-
39	SB	-	-
40	G	-	-
41	W	-	-
42	LG	-	-
43	P	-	-
44	GR	-	-
44	R	-	-
45	BG	-	-
46	G	-	-
47	P	-	-
48	P	-	-
49	L	-	-
49	L	-	-
59	B	-	-
69	Y	-	-
69	G	-	-
69	R	-	-
69	W	-	-
70	G	-	-
80	SB	-	-
81	R	-	-
82	V	-	-
83	W	-	-
84	L	-	-
85	BG	-	-
86	G	-	-

A
B
C
D
E
F
G
H
I
K
L
M
N
O
P

ADP

AUTOMATIC DRIVE POSITIONER CONTROL UNIT

< ECU DIAGNOSIS INFORMATION >

AUTOMATIC DRIVE POSITIONER

Connector No.	M7
Connector Name	WIRE TO WIRE
Connector Type	TH80MW-CS16-TIM4



44	Y	-	-
45	BR	-	-
46	SB	-	-
47	SB	-	-
48	LG	-	-
49	LG	-	- [With BOSE system]
49	SB	-	- [Without BOSE system]
50	SB	-	- [With BOSE system]
50	LG	-	- [Without BOSE system]
51	R	-	-
52	V	-	-
53	P	-	-
54	BR	-	-
55	Y	-	- [With A/T]
55	BG	-	- [With M/T]
56	L	-	-
57	V	-	-
58	R	-	-
60	LG	-	-
61	BG	-	-
62	B	-	-
63	V	-	-
64	SB	-	-
65	BR	-	-
66	Y	-	-
67	P	-	-
68	L	-	-
69	P	-	-
70	L	-	-
80	G	-	-
81	LG	-	-
82	Y	-	-
83	BR	-	-
84	V	-	-
85	L	-	-
86	Y	-	-
87	GR	-	-
81	R	-	-
83	G	-	-
84	P	-	-
95	GR	-	-
96	Y	-	-
97	SB	-	-
99	Y	-	-
100	Y/B	-	-

3	W	DATA
5	Y	ILL BAT
6	LG	ILL
7	B	CLD
11	SB	KEY SWITCH SIGNAL

Connector No.	M24
Connector Name	DATA LINK CONNECTOR
Connector Type	ED16FW

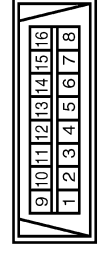

Terminal No.	Color of Wire	Signal Name [Specification]
3	LG	-
4	B	-
5	BR	-
6	L	-
7	V	-
8	G	-
11	SB	-
14	P	-
16	R	-

Connector No.	M31
Connector Name	TILT & TELESCOPIC SWITCH
Connector Type	TK08FGY



Terminal No.	Color of Wire	Signal Name [Specification]
1	B	-
2	GR	-
3	G	-
4	Y	-
5	BR	-

Connector No.	M17
Connector Name	WIRE TO WIRE
Connector Type	TKG2FW



Terminal No.	Color of Wire	Signal Name [Specification]
1	L	-
2	P	-

Connector No.	M18
Connector Name	WIRE TO WIRE
Connector Type	TKG2MW



Terminal No.	Color of Wire	Signal Name [Specification]
1	L	-
2	P	-

Connector No.	M22
Connector Name	KEY SLOT
Connector Type	TH12FW-NH

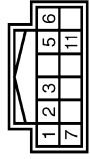

Terminal No.	Color of Wire	Signal Name [Specification]
1	V	BAT
2	GR	CLOCK

JCJWM1823GB

AUTOMATIC DRIVE POSITIONER CONTROL UNIT

< ECU DIAGNOSIS INFORMATION >

AUTOMATIC DRIVE POSITIONER

Connector No.	M48
Connector Name	TILT & TELESCOPIC SENSOR
Connector Type	TK04FW



Terminal No.	Color of Wire	Signal Name [Specification]
1	W	-
2	P	-
3	BG	-
4	Y	-

Connector No.	M49
Connector Name	TILT & TELESCOPIC MOTOR
Connector Type	NS04FW-CS

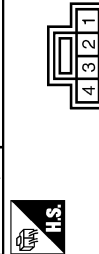

Terminal No.	Color of Wire	Signal Name [Specification]
1	G	-
2	GR	-
3	BG	-
4	L	-

Connector No.	M51
Connector Name	AUTOMATIC DRIVE POSITIONER CONTROL UNIT
Connector Type	TH82FW-NH

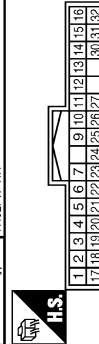

Terminal No.	Color of Wire	Signal Name [Specification]
1	Y	TILT SW (UPWARD)
2	LG	MIRROR SELECT SW (RH)
3	G	MIRROR SW (UPWARD)
4	V	MIRROR SW (LEFTWARD)
5	R	MIRROR SENSOR (RH VERTICAL)
6	GR	MIRROR SENSOR (LH VERTICAL)
7	BG	TILT SENSOR
9	BR	ADDRESS 1
10	V	TX (UART)
11	GR	TELESCOPIC SW (FRONTWARD)
12	BG	IND 1
13	P	IND 2
14	W	MIRROR MOTOR (RH VERTICAL)
15	BG	MIRROR MOTOR (RH HORIZONTAL)
16	Y	MIRROR MOTOR (LH COMMON)
17	BR	TILT SW (DOWNWARD)
18	P	MIRROR SELECT SW (LH)
19	SB	MIRROR SW (DOWNWARD)
20	BR	MIRROR SW (RIGHTWARD)
21	L	MIRROR SENSOR (RH HORIZONTAL)
22	G	MIRROR SENSOR (LH HORIZONTAL)
23	P	TELESCOPIC SENSOR
24	R	SET SW
25	V	ADDRESS 2
26	P	RX (UART)
27	G	TELESCOPIC SW (BACKWARD)
30	SB	MIRROR MOTOR (RH COMMON)
31	G	MIRROR MOTOR (LH VERTICAL)
32	BR	MIRROR MOTOR (LH HORIZONTAL)

Connector No.	M62
Connector Name	AUTOMATIC DRIVE POSITIONER CONTROL UNIT
Connector Type	NS16FF-CS

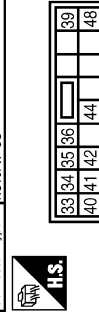

Terminal No.	Color of Wire	Signal Name [Specification]
33	BR	POWER SUPPLY (SENSOR)
34	R	BAT (FUSE)
35	L	TILT MOTOR (UPWARD)
36	GR	TELESCOPIC MOTOR (FORWARD)
38	BR	BAT (C/B)

40	B	GND (SIGNAL)
41	Y	GND (SENSOR)
42	BG	TILT MOTOR (DOWNWARD)
44	G	TELESCOPIC MOTOR (BACKWARD)
48	B	GND (POWER)

Connector No.	M62
Connector Name	CIRCUIT BREAKER
Connector Type	MD2FW-LC



Terminal No.	Color of Wire	Signal Name [Specification]
1	W	-
2	SB	-

Connector No.	M67
Connector Name	UNIFIED METER AND A/C AMP.
Connector Type	TH82FW-NH

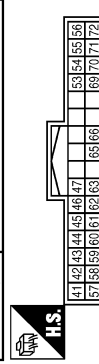

Terminal No.	Color of Wire	Signal Name [Specification]
41	BR	ACC POWER SUPPLY
42	BR	FUEL LEVEL SENSOR SIGNAL
43	R	INTAKE SENSOR SIGNAL
44	LG	IN-VEHICLE SENSOR SIGNAL
45	V	AMBIENT SENSOR SIGNAL
46	BG	SUNLOAD SENSOR SIGNAL
47	G	EXHAUST GAS / OUTSIDE OXIDE DETECTING SENSOR SIGNAL
53	W	IGNITION POWER SUPPLY
54	BG	BATTERY POWER SUPPLY
55	B	GROUND
56	L	CAN-H
57	LG	BRAKE FLUID LEVEL SWITCH SIGNAL
58	Y	FUEL LEVEL SENSOR SIGNAL GROUND

59	GR	INTAKE SENSOR GROUND
60	L	IN-VEHICLE SENSOR GROUND
61	R	AMBIENT SENSOR GROUND
62	SB	SUNLOAD SENSOR GROUND
63	L	ION CONTROL MODE OUTPUT SIGNAL
65	BG	EVY SIGNAL
69	L	A/C LAMP SIGNAL
70	R	EACH DOOR MOTOR POWER SUPPLY
71	GR	GROUND
72	P	CAN-L

Connector No.	M116
Connector Name	WIRE TO WIRE
Connector Type	TK36MW-NS10

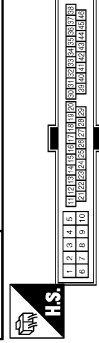

Terminal No.	Color of Wire	Signal Name [Specification]
2	W	-
3	BG	-
4	R	-
5	B	-
9	R	-
10	R	-
19	BG	-
20	Y	-
28	GR	-
29	LG	-
30	LG	-
31	W	-
41	BG	-
42	G	-
43	P	-
44	L	-
45	G	-
46	Y	-

A
B
C
D
E
F
G
H
I
K
L
M
N
O
P

ADP

JCJWM1824GB

AUTOMATIC DRIVE POSITIONER CONTROL UNIT

< ECU DIAGNOSIS INFORMATION >

AUTOMATIC DRIVE POSITIONER

Connector No.	M118
Connector Name	BCM (BODY CONTROL MODULE)
Connector Type	MD9FB-LC



Terminal No.	Color of Wire	Signal Name [Specification]
1	W	BAT (F/L)
2	Y	POWER WINDOW POWER SUPPLY (BAT)
3	EG	POWER WINDOW POWER SUPPLY (RAP)

Connector No.	M119
Connector Name	BCM (BODY CONTROL MODULE)
Connector Type	NS16FW-CS



Terminal No.	Color of Wire	Signal Name [Specification]
4	LG	INTERIOR ROOM LAMP POWER SUPPLY
5	P	PASSENGER DOOR UNLOCK OUTPUT
7	SB	STEP LAMP
8	V	ALL DOOR FUEL LID LOCK OUTPUT
9	G	DRIVER DOOR FUEL LID UNLOCK OUTPUT
11	GR	BAT (RUSE)
13	B	GND
14	W	PUSH-BUTTON IGNITION SW ILL GND
15	EG	ACC IND
17	BR	TURN SIGNAL RH (FRONT)
18	EG	TURN SIGNAL LH (FRONT)
19	V	ROOM LAMP TIMER CONTROL

Connector No.	M122
Connector Name	BCM (BODY CONTROL MODULE)
Connector Type	TH4GFB-NH



Terminal No.	Color of Wire	Signal Name [Specification]
72	R	ROOM ANT 2-
73	G	ROOM ANT 2+
74	SB	PASSENGER DOOR ANT-
75	BR	PASSENGER DOOR ANT+
76	V	DRIVER DOOR ANT-
77	LG	DRIVER DOOR ANT+
78	Y	ROOM ANT 1-
79	BR	ROOM ANT 1+
80	GR	NATS ANTENNA AMP
81	W	NATS ANTENNA AMP
82	R	IGN RELAY (F/B) CONT
83	Y	KEYLESS ENTRY RECEIVER COMM
87	Y	COMBI SW INPUT 5
88	EG	COMBI SW INPUT 3
89	BR	PUSH SW
90	P	CAN-L
91	L	CAN-H
92	LG	KEY SLOT ILL
93	V	ON IND
95	EG	ACC RELAY CONT
96	GR	A/T SHIFT SELECTOR POWER SUPPLY
97	L	S/L CONDITION 2
68	SB	ASCD CLUTCH SW [With W/T]
69	R	SHIFT P (MFC/A/T)
89	R	PASSENGER DOOR REQUEST SW
100	Y	DRIVER DOOR REQUEST SW
101	P	BLOWER FAN MOTOR RELAY CONT
102	EG	KEYLESS ENTRY RECEIVER POWER SUPPLY
103	LG	S/L UNIT POWER SUPPLY
106	W	COMBI SW INPUT 1
107	LG	COMBI SW INPUT 4
108	R	COMBI SW INPUT 2
109	W	HAZARD SW
110	G	S/L UNIT COMM
111	Y	S/L UNIT COMM

Connector No.	M123
Connector Name	BCM (BODY CONTROL MODULE)
Connector Type	TH4GFG-NH



Terminal No.	Color of Wire	Signal Name [Specification]
112	BR	RAIN SENSOR SERIAL LINK
113	G	OPTICAL SENSOR
114	R	CLUTCH INTERLOCK SW
116	SB	STOP LAMP SW 1
118	BR	STOP LAMP SW 2
119	GR	DR DOOR UNLOCK SENSOR
121	SB	KEY SLOT SW
123	W	IGN F/B
124	BG	PASSENGER DOOR SW
129	BG	TRUNK LID OPENER CANCEL SW
132	LG	P/W SW & RHT C/U COMM
133	Y	PUSH-BUTTON IGNITION SW ILL POWER
134	LG	LOCK IND
137	BG	RECEIVER / SENSOR GND
138	Y	RECEIVER / SENSOR POWER SUPPLY
139	L	TIRE PRESSURE RECEIVER COMM
140	GR	SHIFT N/P
141	R	SECURITY INDICATOR LAMP
142	BR	COMBI SW OUTPUT 5
143	V	COMBI SW OUTPUT 1
144	G	COMBI SW OUTPUT 2
145	L	COMBI SW OUTPUT 3
146	SB	COMBI SW OUTPUT 4
150	R	DRIVER DOOR SW
151	G	REAR WINDOW DEFROGGER RELAY CONT

Connector No.	M124
Connector Name	WIRE TO WIRE
Connector Type	TH40MM-CS15



Terminal No.	Color of Wire	Signal Name [Specification]
6	BG	-
7	R	-
8	G	-
9	P	-
10	V	-
11	SB	- [With BOSE system]
11	GR	- [Without BOSE system]
12	BR	-
13	B	-
14	G	-
15	W	-
34	Y	-
35	Y/B	-
38	W	-
39	BG	-
40	SB	-
41	BR	- [With automatic drive positioner]
41	G	- [Without automatic drive positioner]
42	R	-
43	L	-
44	Y	-
45	R	-
46	W	-
47	SB	-
48	BR	-
49	Y	-
50	P	-
51	LG	-
52	BG	-
53	Y	-
54	L	-
55	L	-

AUTOMATIC DRIVE POSITIONER CONTROL UNIT

< ECU DIAGNOSIS INFORMATION >

A
B
C
D
E
F
G
H
I
K
L
M
N
O
P

ADP

AUTOMATIC DRIVE POSITIONER

Connector No.	M137
Connector Name	A/T SHIFT SELECTOR
Connector Type	TH12FVN-NH

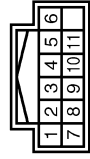

Terminal No.	Color of Wire	Signal Name [Specification]
1	W	-
2	V	-
3	L	-
4	BR	-
5	G	-
7	Y	-
8	SB	-
9	B	-
10	GR	-
11	R	-

JCJWM1826GB

BCM (BODY CONTROL MODULE)

< ECU DIAGNOSIS INFORMATION >

BCM (BODY CONTROL MODULE)

Reference Value

INFOID:000000006965054

VALUES ON THE DIAGNOSIS TOOL

CONSULT-III MONITOR ITEM

Monitor Item	Condition	Value/Status
FR WIPER HI	Other than front wiper switch HI	Off
	Front wiper switch HI	On
FR WIPER LOW	Other than front wiper switch LO	Off
	Front wiper switch LO	On
FR WASHER SW	Front washer switch OFF	Off
	Front washer switch ON	On
FR WIPER INT	Other than front wiper switch INT/AUTO	Off
	Front wiper switch INT/AUTO	On
FR WIPER STOP	Front wiper is not in STOP position	Off
	Front wiper is in STOP position	On
INT VOLUME	Wiper volume dial is in a dial position 1 - 7	Wiper volume dial position
TURN SIGNAL R	Other than turn signal switch RH	Off
	Turn signal switch RH	On
TURN SIGNAL L	Other than turn signal switch LH	Off
	Turn signal switch LH	On
TAIL LAMP SW	Other than lighting switch 1ST and 2ND	Off
	Lighting switch 1ST or 2ND	On
HI BEAM SW	Other than lighting switch HI	Off
	Lighting switch HI	On
HEAD LAMP SW 1	Other than lighting switch 2ND	Off
	Lighting switch 2ND	On
HEAD LAMP SW 2	Other than lighting switch 2ND	Off
	Lighting switch 2ND	On
PASSING SW	Other than lighting switch PASS	Off
	Lighting switch PASS	On
AUTO LIGHT SW	Other than lighting switch AUTO	Off
	Lighting switch AUTO	On
FR FOG SW	Front fog lamp switch OFF	Off
	Front fog lamp switch ON	On
RR FOG SW	NOTE: The item is indicated, but not monitored.	Off
DOOR SW-DR	Driver door closed	Off
	Driver door opened	On
DOOR SW-AS	Passenger door closed	Off
	Passenger door opened	On
DOOR SW-RR	NOTE: The item is indicated, but not monitored.	Off
DOOR SW-RL	NOTE: The item is indicated, but not monitored.	Off

BCM (BODY CONTROL MODULE)

< ECU DIAGNOSIS INFORMATION >

Monitor Item	Condition	Value/Status	
DOOR SW-BK	NOTE: The item is indicated, but not monitored.	Off	A
CDL LOCK SW	Other than power door lock switch LOCK	Off	B
	Power door lock switch LOCK	On	
CDL UNLOCK SW	Other than power door lock switch UNLOCK	Off	C
	Power door lock switch UNLOCK	On	
KEY CYL LK-SW	Other than driver door key cylinder LOCK position	Off	D
	Driver door key cylinder LOCK position	On	
KEY CYL UN-SW	Other than driver door key cylinder UNLOCK position	Off	D
	Driver door key cylinder UNLOCK position	On	
KEY CYL SW-TR	NOTE: The item is indicated, but not monitored.	Off	E
HAZARD SW	Hazard switch is OFF	Off	F
	Hazard switch is ON	On	
REAR DEF SW	NOTE: The item is indicated, but not monitored.	Off	
H/L WASH SW	NOTE: The item is indicated, but not monitored.	Off	G
TR CANCEL SW	Trunk lid opener cancel switch OFF	Off	H
	Trunk lid opener cancel switch ON	On	
TR/BD OPEN SW	Trunk lid opener switch OFF	Off	I
	While the trunk lid opener switch is turned ON	On	
TRNK/HAT MNTR	Trunk lid closed	Off	I
	Trunk lid opened	On	
RKE-LOCK	LOCK button of the Intelligent Key is not pressed	Off	ADP
	LOCK button of the Intelligent Key is pressed	On	
RKE-UNLOCK	UNLOCK button of the Intelligent Key is not pressed	Off	K
	UNLOCK button of the Intelligent Key is pressed	On	
RKE-TR/BD	TRUNK OPEN button of the Intelligent Key is not pressed	Off	L
	TRUNK OPEN button of the Intelligent Key is pressed	On	
RKE-PANIC	PANIC button of the Intelligent Key is not pressed	Off	M
	PANIC button of the Intelligent Key is pressed	On	
RKE-P/W OPEN	UNLOCK button of the Intelligent Key is not pressed	Off	N
	UNLOCK button of the Intelligent Key is pressed and held	On	
RKE-MODE CHG	LOCK/UNLOCK button of the Intelligent Key is not pressed and held simultaneously	Off	O
	LOCK/UNLOCK button of the Intelligent Key is pressed and held simultaneously	On	
OPTICAL SENSOR	Bright outside of the vehicle	Close to 5 V	O
	Dark outside of the vehicle	Close to 0 V	
REQ SW -DR	Driver door request switch is not pressed	Off	P
	Driver door request switch is pressed	On	
REQ SW -AS	Passenger door request switch is not pressed	Off	
	Passenger door request switch is pressed	On	
REQ SW -RR	NOTE: The item is indicated, but not monitored.	Off	
REQ SW -RL	NOTE: The item is indicated, but not monitored.	Off	

BCM (BODY CONTROL MODULE)

< ECU DIAGNOSIS INFORMATION >

Monitor Item	Condition	Value/Status
REQ SW -BD/TR	Trunk lid opener request switch is not pressed	Off
	Trunk lid opener request switch is pressed	On
PUSH SW	Push-button ignition switch (push switch) is not pressed	Off
	Push-button ignition switch (push switch) is pressed	On
IGN RLY2 -F/B	Ignition switch in OFF or ACC position	Off
	Ignition switch in ON position	On
ACC RLY -F/B	NOTE: The item is indicated, but not monitored.	Off
CLUCH SW	The clutch pedal is not depressed	Off
	The clutch pedal is depressed	On
BRAKE SW 1	The brake pedal is depressed when No. 7 fuse is blown	Off
	The brake pedal is not depressed when No. 7 fuse is blown, or No. 7 fuse is normal	On
BRAKE SW 2	The brake pedal is not depressed	Off
	The brake pedal is depressed	On
DETE/CANCL SW	<ul style="list-style-type: none"> • Selector lever in P position (Except M/T models) • The clutch pedal is depressed (M/T models) 	Off
	<ul style="list-style-type: none"> • Selector lever in any position other than P (Except M/T models) • The clutch pedal is not depressed (M/T models) 	On
SFT PN/N SW	Selector lever in any position other than P and N	Off
	Selector lever in P or N position	On
S/L -LOCK NOTE: For models without steering lock unit, this item is not monitored.	Steering is unlocked	Off
	Steering is locked	On
S/L -UNLOCK NOTE: For models without steering lock unit, this item is not monitored.	Steering is locked	Off
	Steering is unlocked	On
S/L RELAY-F/B NOTE: For models without steering lock unit, this item is not monitored.	Ignition switch in OFF or ACC position	Off
	Ignition switch in ON position	On
UNLK SEN -DR	Driver door is unlocked	Off
	Driver door is locked	On
PUSH SW -IPDM	Push-button ignition switch (push-switch) is not pressed	Off
	Push-button ignition switch (push-switch) is pressed	On
IGN RLY1 -F/B	Ignition switch in OFF or ACC position	Off
	Ignition switch in ON position	On
DETE SW -IPDM	Selector lever in any position other than P	Off
	Selector lever in P position	On
SFT PN -IPDM	<ul style="list-style-type: none"> • Selector lever in any position other than P and N (Except M/T models) • The clutch pedal is not depressed (M/T models) 	Off
	<ul style="list-style-type: none"> • Selector lever in P or N position • The clutch pedal is depressed 	On
SFT P -MET	Selector lever in any position other than P	Off
	Selector lever in P position	On

BCM (BODY CONTROL MODULE)

< ECU DIAGNOSIS INFORMATION >

Monitor Item	Condition	Value/Status	
SFT N -MET	Selector lever in any position other than N	Off	A
	Selector lever in N position	On	
ENGINE STATE	Engine stopped	Stop	B
	While the engine stalls	Stall	
	At engine cranking	Crank	C
	Engine running	Run	
S/L LOCK-IPDM NOTE: For models without steering lock unit, this item is not monitored.	Steering is unlocked	Off	
	Steering is locked	On	D
S/L UNLK-IPDM NOTE: For models without steering lock unit, this item is not monitored.	Steering is locked	Off	E
	Steering is unlocked	On	F
S/L RELAY-REQ NOTE: For models without steering lock unit, this item is not monitored.	Steering lock system is not the LOCK condition and the changing condition from LOCK to UNLOCK	Off	
	Steering lock system are not the LOCK condition or the changing condition from LOCK to UNLOCK	On	G
VEH SPEED 1	While driving	Equivalent to speedometer reading	H
VEH SPEED 2	While driving	Equivalent to speedometer reading	
DOOR STAT-DR	Driver door is locked	LOCK	I
	Wait with selective UNLOCK operation (60 seconds)	READY	
	Driver door is unlocked	UNLOCK	ADP
DOOR STAT-AS	Passenger door is locked	LOCK	
	Wait with selective UNLOCK operation (60 seconds)	READY	
	Passenger door is unlocked	UNLOCK	K
ID OK FLAG	Driver side door is open after ignition switch is turned OFF (Selector lever is in the P position except for M/T models)	Reset	
	Ignition switch ON	Set	L
PRMT ENG STRT	The engine start is prohibited	Reset	
	The engine start is permitted	Set	M
PRMT RKE STRT	NOTE: The item is indicated, but not monitored.	Reset	
KEY SW -SLOT	The Intelligent Key is not inserted into key slot	Off	N
	The Intelligent Key is inserted into key slot	On	
RKE OPE COUN1	During the operation of the Intelligent Key	Operation frequency of the Intelligent Key	O
RKE OPE COUN2	NOTE: The item is indicated, but not monitored.	—	
CONFRM ID ALL	The key ID that the key slot receives is not recognized by any key ID registered to BCM.	Yet	P
	The key ID that the key slot receives is recognized by any key ID registered to BCM.	Done	

BCM (BODY CONTROL MODULE)

< ECU DIAGNOSIS INFORMATION >

Monitor Item	Condition	Value/Status
CONFIRM ID4	The key ID that the key slot receives is not recognized by the fourth key ID registered to BCM.	Yet
	The key ID that the key slot receives is recognized by the fourth key ID registered to BCM.	Done
CONFIRM ID3	The key ID that the key slot receives is not recognized by the third key ID registered to BCM.	Yet
	The key ID that the key slot receives is recognized by the third key ID registered to BCM.	Done
CONFIRM ID2	The key ID that the key slot receives is not recognized by the second key ID registered to BCM.	Yet
	The key ID that the key slot receives is recognized by the second key ID registered to BCM.	Done
CONFIRM ID1	The key ID that the key slot receives is not recognized by the first key ID registered to BCM.	Yet
	The key ID that the key slot receives is recognized by the first key ID registered to BCM.	Done
TP 4	The ID of fourth Intelligent Key is not registered to BCM	Yet
	The ID of fourth Intelligent Key is registered to BCM	Done
TP 3	The ID of third Intelligent Key is not registered to BCM	Yet
	The ID of third Intelligent Key is registered to BCM	Done
TP 2	The ID of second Intelligent Key is not registered to BCM	Yet
	The ID of second Intelligent Key is registered to BCM	Done
TP 1	The ID of first Intelligent Key is not registered to BCM	Yet
	The ID of first Intelligent Key is registered to BCM	Done
AIR PRESS FL	Ignition switch ON (Only when the signal from the transmitter is received)	Air pressure of front LH tire
AIR PRESS FR	Ignition switch ON (Only when the signal from the transmitter is received)	Air pressure of front RH tire
AIR PRESS RR	Ignition switch ON (Only when the signal from the transmitter is received)	Air pressure of rear RH tire
AIR PRESS RL	Ignition switch ON (Only when the signal from the transmitter is received)	Air pressure of rear LH tire
ID REGST FL1	ID of front LH tire transmitter is registered	Done
	ID of front LH tire transmitter is not registered	Yet
ID REGST FR1	ID of front RH tire transmitter is registered	Done
	ID of front RH tire transmitter is not registered	Yet
ID REGST RR1	ID of rear RH tire transmitter is registered	Done
	ID of rear RH tire transmitter is not registered	Yet
ID REGST RL1	ID of rear LH tire transmitter is registered	Done
	ID of rear LH tire transmitter is not registered	Yet
WARNING LAMP	Tire pressure indicator OFF	Off
	Tire pressure indicator ON	On
BUZZER	Tire pressure warning alarm is not sounding	Off
	Tire pressure warning alarm is sounding	On

BCM (BODY CONTROL MODULE)

< ECU DIAGNOSIS INFORMATION >

TERMINAL LAYOUT

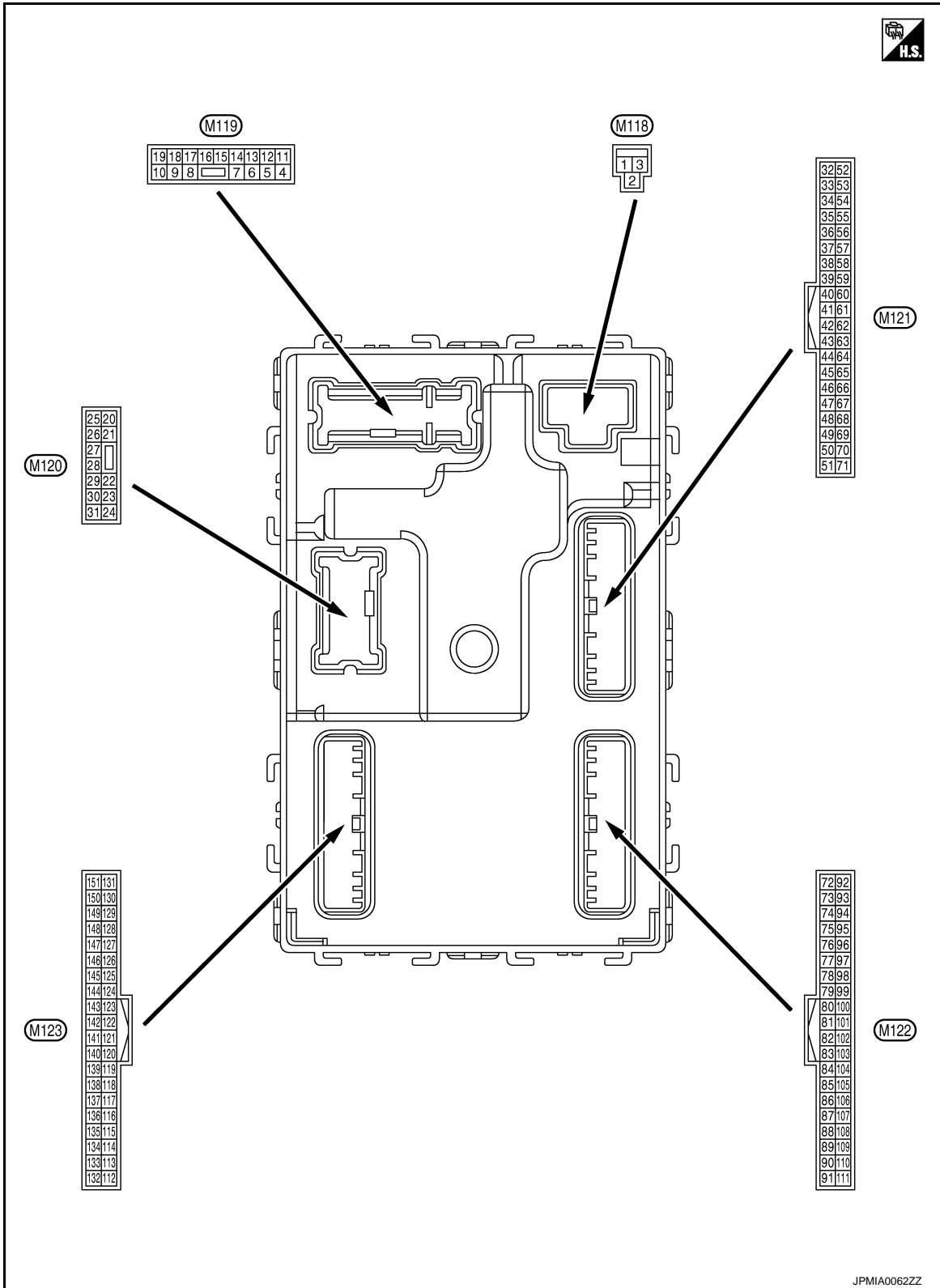

PHYSICAL VALUES

BCM (BODY CONTROL MODULE)

< ECU DIAGNOSIS INFORMATION >

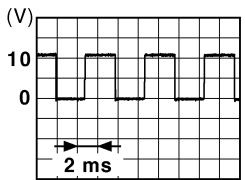
Terminal No. (Wire color)		Description		Condition		Value (Approx.)
		Signal name	Input/ Output			
+	-					
1 (W)	Ground	Battery power supply	Input	Ignition switch OFF		Battery voltage
2 (Y)	Ground	P/W power supply (BAT)	Output	Ignition switch OFF		12 V
3 (BG)	Ground	P/W power supply (RAP)	Output	Ignition switch ON		12 V
4 (LG)	Ground	Interior room lamp power supply	Output	Interior room lamp battery saver is activated. (Cuts the interior room lamp power supply)		0 V
				Interior room lamp battery saver is not activated. (Outputs the interior room lamp power supply)		12 V
5 (P)	Ground	Passenger door UN- LOCK	Output	Passenger door	UNLOCK (Actuator is activated)	12 V
					Other than UNLOCK (Actuator is not activated)	0 V
7 (SB)	Ground	Step lamp	Output	Step lamp	ON	0 V
					OFF	12 V
8 (V)	Ground	All doors, fuel lid LOCK	Output	All doors, fuel lid	LOCK (Actuator is activated)	12 V
					Other than LOCK (Actuator is not activated)	0 V
9 (G)	Ground	Driver door, fuel lid UNLOCK	Output	Driver door, fuel lid	UNLOCK (Actuator is activated)	12 V
					Other than UNLOCK (Actuator is not activated)	0 V
11 (GR)	Ground	Battery power supply	Input	Ignition switch OFF		Battery voltage
13 (B)	Ground	Ground	—	Ignition switch ON		0 V
14 (W)	Ground	Push-button ignition switch illumination ground	Output	Tail lamp	OFF	0 V
					ON	<p style="text-align: center;">NOTE: When the illumination brightening/dimming level is in the neutral position.</p>  <p style="text-align: right; font-size: small;">JSNIA0010GB</p>
15 (BG)	Ground	ACC indicator lamp	Output	Ignition switch	OFF (LOCK indicator is not illuminated)	Battery voltage
					ACC	0 V

BCM (BODY CONTROL MODULE)

< ECU DIAGNOSIS INFORMATION >

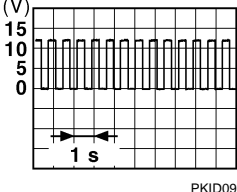
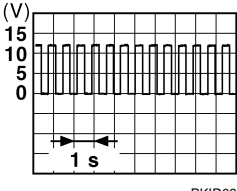
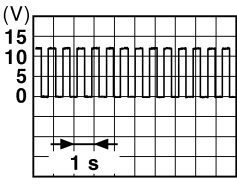
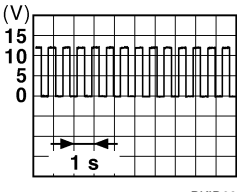
Terminal No. (Wire color)		Description		Condition	Value (Approx.)	
		Signal name	Input/ Output			
+	-					
17 (BR)	Ground	Turn signal RH (Front)	Output	Ignition switch ON	Turn signal switch OFF	0 V
					Turn signal switch RH	 6.5 V
18 (BG)	Ground	Turn signal LH (Front)	Output	Ignition switch ON	Turn signal switch OFF	0 V
					Turn signal switch LH	 6.5 V
19 (V)	Ground	Room lamp timer control	Output	Interior room lamp	OFF	12 V
					ON	0 V
20 (V)	Ground	Turn signal RH (Rear)	Output	Ignition switch ON	Turn signal switch OFF	0 V
					Turn signal switch RH	 6.5 V
23 (Y)	Ground	Trunk lid open	Output	Trunk lid	OPEN (Trunk lid opener actuator is activated)	12 V
					Other than OPEN (Trunk lid opener actuator is not activated)	0 V
25 (Y)	Ground	Turn signal LH (Rear)	Output	Ignition switch ON	Turn signal switch OFF	0 V
					Turn signal switch LH	 6.5 V
30 (P)	Ground	Trunk room lamp	Output	Trunk room lamp	ON	0 V
					OFF	12 V

A
B
C
D
E
F
G
H
I
K
L
M
N
O
P

ADP

BCM (BODY CONTROL MODULE)

< ECU DIAGNOSIS INFORMATION >

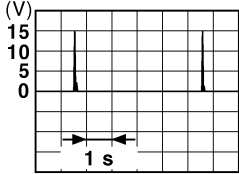
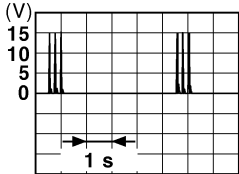
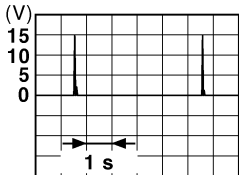
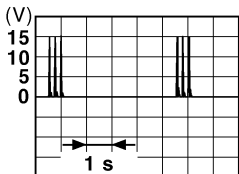
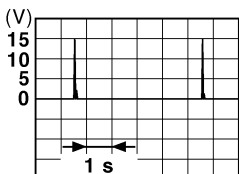
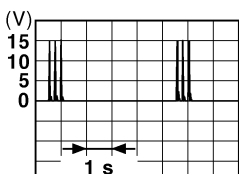
Terminal No. (Wire color)		Description		Condition	Value (Approx.)
+	-	Signal name	Input/ Output		
34 (SB)	Ground	Trunk room antenna (-)	Output	Ignition switch OFF	When Intelligent Key is in the passenger compart- ment  <small>JMKIA0062GB</small>
				Ignition switch OFF	When Intelligent Key is not in the passenger compart- ment  <small>JMKIA0063GB</small>
35 (V)	Ground	Trunk room antenna (+)	Output	Ignition switch OFF	When Intelligent Key is in the passenger compart- ment  <small>JMKIA0062GB</small>
				Ignition switch OFF	When Intelligent Key is not in the passenger compart- ment  <small>JMKIA0063GB</small>
38 (B)	Ground	Rear bumper anten- na (-)	Output	When the trunk lid opener re- quest switch is operated with ignition switch OFF	When Intelligent Key is in the antenna detection area  <small>JMKIA0062GB</small>
				When the trunk lid opener re- quest switch is operated with ignition switch OFF	When Intelligent Key is not in the antenna detection area  <small>JMKIA0063GB</small>

BCM (BODY CONTROL MODULE)

< ECU DIAGNOSIS INFORMATION >

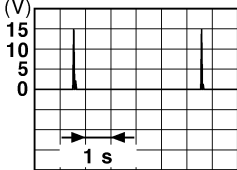
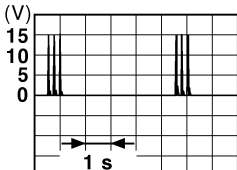
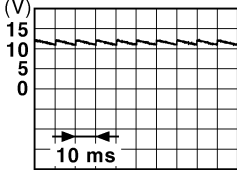
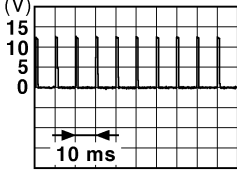
Terminal No. (Wire color)		Description		Condition	Value (Approx.)
+	-	Signal name	Input/ Output		
39 (W)	Ground	Rear bumper antenna (+)	Output	When Intelligent Key is in the antenna detection area	 JMKIA0062GB
				When the trunk lid opener request switch is operated with ignition switch OFF	 JMKIA0063GB
47 (Y)	Ground	Ignition relay (IPDM E/R) control	Output	Ignition switch	OFF or ACC: 12 V ON: 0 V
				Ignition switch	OFF (Trunk lid is closed): 11.8 V ON (Trunk lid is opened): 0 V
50 (G)	Ground	Trunk room lamp switch	Input	Trunk room lamp switch	 JPMA0011GB
				Trunk room lamp switch	OFF (Trunk lid is closed): 11.8 V ON (Trunk lid is opened): 0 V
52 (BR)	Ground	Starter relay control	Output	Ignition switch ON (A/T models)	When selector lever is in P or N position: 12 V When selector lever is not in P or N position: 0 V
				Ignition switch ON (M/T models)	When the clutch pedal is depressed: Battery voltage When the clutch pedal is not depressed: 0 V
			Input	Push-button ignition switch (push switch)	Pressed: 0 V Not pressed: Battery voltage
				Push-button ignition switch (push switch)	ON (Pressed): 0 V
61 (SB)	Ground	Trunk lid opener request switch	Input	Trunk lid opener request switch	 JPMA0016GB
				Trunk lid opener request switch	OFF (Not pressed): 1.0 V
64 (G)	Ground	Intelligent Key warning buzzer (Engine room)	Output	Intelligent Key warning buzzer (Engine room)	Sounding: 0 V Not sounding: 12 V
				Intelligent Key warning buzzer (Engine room)	Sounding: 0 V Not sounding: 12 V

A
B
C
D
E
F
G
H
I
K
L
M
N
O
P

ADP

BCM (BODY CONTROL MODULE)

< ECU DIAGNOSIS INFORMATION >

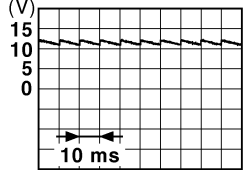
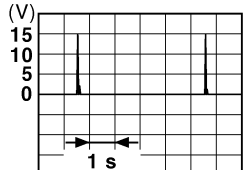
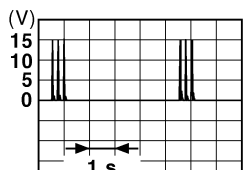
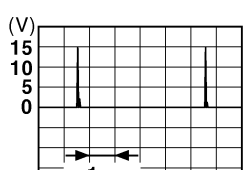
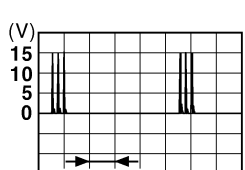
Terminal No. (Wire color)		Description		Condition	Value (Approx.)	
+	-	Signal name	Input/ Output			
67 (GR)	Ground	Trunk lid opener switch	Input	Trunk lid open- er switch	Pressed	0 V
					Not pressed	 <p style="text-align: right; font-size: small;">JPMIA0011GB</p>
72 (R)	Ground	Room antenna 2 (-) (Center console)	Output	Ignition switch OFF	When Intelligent Key is in the passenger compart- ment	 <p style="text-align: right; font-size: small;">JMKIA0062GB</p>
					When Intelligent Key is not in the passenger compart- ment	 <p style="text-align: right; font-size: small;">JMKIA0063GB</p>
73 (G)	Ground	Room antenna 2 (+) (Center console)	Output	Ignition switch OFF	When Intelligent Key is in the passenger compart- ment	 <p style="text-align: right; font-size: small;">JMKIA0062GB</p>
					When Intelligent Key is not in the passenger compart- ment	 <p style="text-align: right; font-size: small;">JMKIA0063GB</p>

BCM (BODY CONTROL MODULE)

< ECU DIAGNOSIS INFORMATION >

Terminal No. (Wire color)		Description		Condition	Value (Approx.)
		Signal name	Input/ Output		
+	-				
74 (SB)	Ground	Passenger door antenna (-)	Output	When Intelligent Key is in the antenna detection area	<p style="text-align: right; font-size: small;">JMkia0062GB</p>
				When the passenger door request switch is operated with ignition switch OFF	<p style="text-align: right; font-size: small;">JMkia0063GB</p>
75 (BR)	Ground	Passenger door antenna (+)	Output	When Intelligent Key is in the antenna detection area	<p style="text-align: right; font-size: small;">JMkia0062GB</p>
				When the passenger door request switch is operated with ignition switch OFF	<p style="text-align: right; font-size: small;">JMkia0063GB</p>
76 (V)	Ground	Driver door antenna (-)	Output	When Intelligent Key is in the antenna detection area	<p style="text-align: right; font-size: small;">JMkia0062GB</p>
				When the driver door request switch is operated with ignition switch OFF	<p style="text-align: right; font-size: small;">JMkia0063GB</p>

A
B
C
D
E
F
G
H
I
K
L
M
N
O
P

ADP

BCM (BODY CONTROL MODULE)

< ECU DIAGNOSIS INFORMATION >

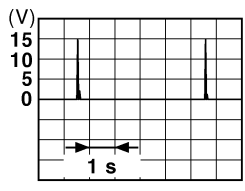
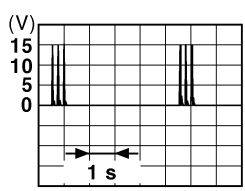
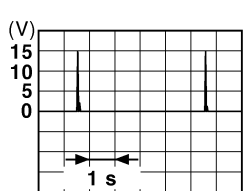
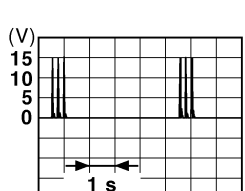
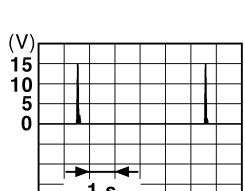
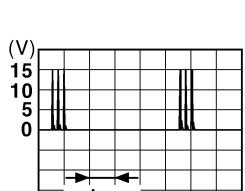
Terminal No. (Wire color)		Description		Condition	Value (Approx.)
+	-	Signal name	Input/ Output		
77 (LG)	Ground	Driver door antenna (+)	Output	When the driver door request switch is operated with ignition switch OFF	<p>When Intelligent Key is in the antenna detection area</p>  <p style="text-align: right; font-size: small;">JMKIA0062GB</p>
				When Intelligent Key is not in the antenna detection area	 <p style="text-align: right; font-size: small;">JMKIA0063GB</p>
78 (Y)	Ground	Room antenna 1 (-) (Instrument panel)	Output	Ignition switch OFF	<p>When Intelligent Key is in the passenger compartment</p>  <p style="text-align: right; font-size: small;">JMKIA0062GB</p>
				When Intelligent Key is not in the passenger compartment	 <p style="text-align: right; font-size: small;">JMKIA0063GB</p>
79 (BR)	Ground	Room antenna 1 (+) (Instrument panel)	Output	Ignition switch OFF	<p>When Intelligent Key is in the passenger compartment</p>  <p style="text-align: right; font-size: small;">JMKIA0062GB</p>
				When Intelligent Key is not in the passenger compartment	 <p style="text-align: right; font-size: small;">JMKIA0063GB</p>

BCM (BODY CONTROL MODULE)

< ECU DIAGNOSIS INFORMATION >

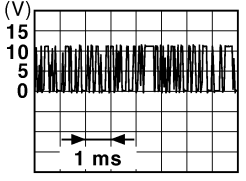
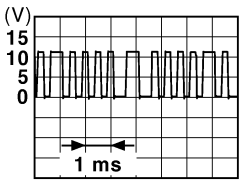
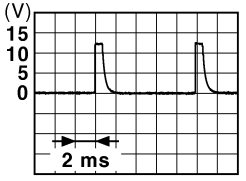
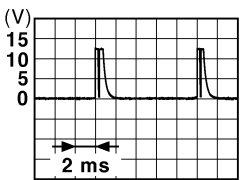
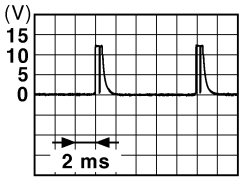
Terminal No. (Wire color)		Description		Condition		Value (Approx.)
+	-	Signal name	Input/ Output			
80 (GR)	Ground	NATS antenna amp.	Input/ Output	During waiting	Ignition switch is pressed while inserting the Intelligent Key into the key slot.	Just after pressing ignition switch. Pointer of tester should move.
81 (W)	Ground	NATS antenna amp.	Input/ Output	During waiting	Ignition switch is pressed while inserting the Intelligent Key into the key slot.	Just after pressing ignition switch. Pointer of tester should move.
82 (R)	Ground	Ignition relay [Fuse block (J/B)] control	Output	Ignition switch	OFF or ACC	0 V
					ON	12 V
83 (Y)	Ground	Remote keyless entry receiver communication	Input/ Output	During waiting		 <p style="text-align: right; font-size: small;">JMKIA0064GB</p>
				When operating either button on the Intelligent Key		 <p style="text-align: right; font-size: small;">JMKIA0065GB</p>
87 (Y)	Ground	Combination switch INPUT 5	Input	Combination switch	All switches OFF (Wiper volume dial 4)	 <p style="text-align: right; font-size: small;">JPMIA0041GB</p> <p style="text-align: center;">1.4 V</p>
					Front fog lamp switch ON (Wiper volume dial 4)	 <p style="text-align: right; font-size: small;">JPMIA0037GB</p> <p style="text-align: center;">1.3 V</p>
					Any of the conditions below with all switches OFF <ul style="list-style-type: none"> • Wiper volume dial 1 • Wiper volume dial 2 • Wiper volume dial 6 • Wiper volume dial 7 	 <p style="text-align: right; font-size: small;">JPMIA0040GB</p> <p style="text-align: center;">1.3 V</p>

A
B
C
D
E
F
G
H
I
K
L
M
N
O
P

ADP

BCM (BODY CONTROL MODULE)

< ECU DIAGNOSIS INFORMATION >

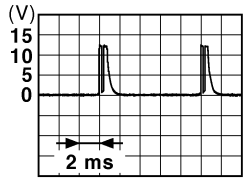
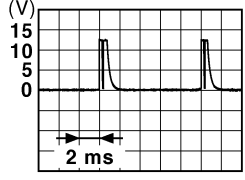
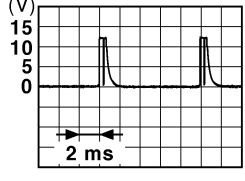
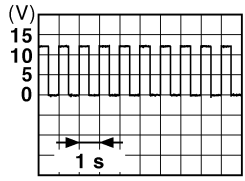
Terminal No. (Wire color)		Description		Condition	Value (Approx.)	
+	-	Signal name	Input/ Output			
88 (BG)	Ground	Combination switch INPUT 3	Input	Combination switch	All switches OFF (Wiper volume dial 4)	 <p style="text-align: right; font-size: small;">JPMAI0041GB</p> <p style="text-align: center;">1.4 V</p>
					Lighting switch HI (Wiper volume dial 4)	 <p style="text-align: right; font-size: small;">JPMAI0036GB</p> <p style="text-align: center;">1.3 V</p>
					Lighting switch 2ND (Wiper volume dial 4)	 <p style="text-align: right; font-size: small;">JPMAI0037GB</p> <p style="text-align: center;">1.3 V</p>
					Any of the conditions below with all switches OFF <ul style="list-style-type: none"> • Wiper volume dial 1 • Wiper volume dial 2 • Wiper volume dial 3 	 <p style="text-align: right; font-size: small;">JPMAI0040GB</p> <p style="text-align: center;">1.3 V</p>
89*2 (BR)	Ground	Push-button ignition switch (Push switch)	Input	Push-button ignition switch (push switch)	Pressed	0 V
					Not pressed	Battery voltage
90 (P)	Ground	CAN-L	Input/ Output	—	—	
91 (L)	Ground	CAN-H	Input/ Output	—	—	
92 (LG)	Ground	Key slot illumination	Output	Key slot illumina- tion	OFF	0 V
					Blinking	 <p style="text-align: right; font-size: small;">JPMAI0015GB</p> <p style="text-align: center;">6.5 V</p>
					ON	12 V

BCM (BODY CONTROL MODULE)

< ECU DIAGNOSIS INFORMATION >

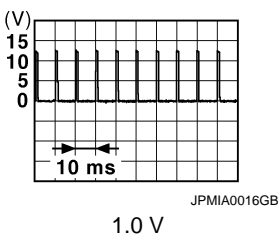
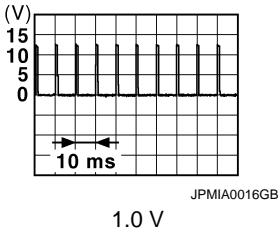
Terminal No. (Wire color)		Description		Condition		Value (Approx.)
		Signal name	Input/ Output			
+	-					
93 (V)	Ground	ON indicator lamp	Output	Ignition switch	OFF (LOCK indicator is not illuminated)	Battery voltage
					ON	0 V
95 (BG)	Ground	ACC relay control	Output	Ignition switch	OFF	0 V
					ACC or ON	12 V
96 (GR)	Ground	A/T shift selector (Detention switch) power supply	Output	—		12 V
97*2 (L)	Ground	Steering lock condition No. 1	Input	Steering lock	LOCK status	0 V
					UNLOCK status	12 V
98*2 (SB)	Ground	Steering lock condition No. 2	Input	Steering lock	LOCK status	12 V
					UNLOCK status	0 V
99 (R)	Ground	Selector lever P position switch	Input	Selector lever	P position	0 V
					Any position other than P	12 V
		ASCD clutch switch (M/T models without ICC)		ASCD clutch switch	OFF (Clutch pedal is depressed)	0 V
					ON (Clutch pedal is not depressed)	12 V
		ICC clutch switch (M/T models with ICC)		ICC clutch switch	OFF (Clutch pedal is depressed)	0 V
					ON (Clutch pedal is not depressed)	12 V
100 (Y)	Ground	Passenger door request switch	Input	Passenger door request switch	ON (Pressed)	0 V
					OFF (Not pressed)	
101 (P)	Ground	Driver door request switch	Input	Driver door request switch	ON (Pressed)	0 V
					OFF (Not pressed)	
102 (BG)	Ground	Blower fan motor relay control	Output	Ignition switch	OFF or ACC	0 V
					ON	12 V
103 (LG)	Ground	Remote keyless entry receiver power supply	Output	Ignition switch OFF		12 V
106*2 (W)	Ground	Steering lock unit power supply	Output	Ignition switch	OFF or ACC	12 V
					ON	0 V

A
B
C
D
E
F
G
H
I





ADP

K
L
M
N
O

P

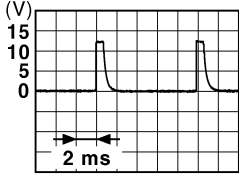

BCM (BODY CONTROL MODULE)

< ECU DIAGNOSIS INFORMATION >

Terminal No. (Wire color)		Description		Condition	Value (Approx.)
+	-	Signal name	Input/ Output		
107 (LG)	Ground	Combination switch INPUT 1	Input	Combination switch (Wiper volume dial 4)	All switches OFF <div style="text-align: right;">  <p style="text-align: right; margin-top: 0;">JPMIA0041GB 1.4 V</p> </div>
					Turn signal switch LH <div style="text-align: right;">  <p style="text-align: right; margin-top: 0;">JPMIA0037GB 1.3 V</p> </div>
					Turn signal switch RH <div style="text-align: right;">  <p style="text-align: right; margin-top: 0;">JPMIA0036GB 1.3 V</p> </div>
					Front wiper switch LO <div style="text-align: right;">  <p style="text-align: right; margin-top: 0;">JPMIA0038GB 1.3 V</p> </div>
					Front washer switch ON <div style="text-align: right;">  <p style="text-align: right; margin-top: 0;">JPMIA0039GB 1.3 V</p> </div>

BCM (BODY CONTROL MODULE)

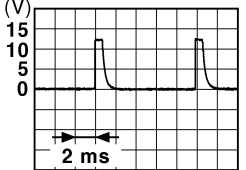

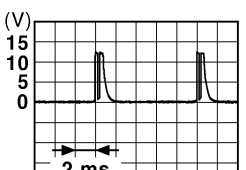
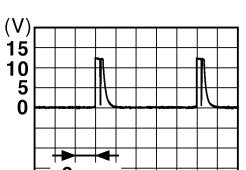

< ECU DIAGNOSIS INFORMATION >

Terminal No. (Wire color)		Description		Condition	Value (Approx.)
+	-	Signal name	Input/ Output		
108 (R)	Ground	Combination switch INPUT 4	Input	Combination switch	All switches OFF (Wiper volume dial 4)  <small>JPMIA0041GB</small> 1.4 V
					Lighting switch AUTO (Wiper volume dial 4)  <small>JPMIA0038GB</small> 1.3 V
					Lighting switch 1ST (Wiper volume dial 4)  <small>JPMIA0036GB</small> 1.3 V
					Any of the conditions below with all switches OFF <ul style="list-style-type: none"> • Wiper volume dial 1 • Wiper volume dial 5 • Wiper volume dial 6  <small>JPMIA0039GB</small> 1.3 V

A
B
C
D
E
F
G
H
I
ADP
K
L
M
N
O
P

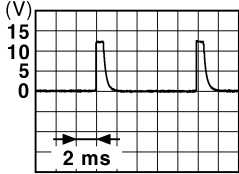
BCM (BODY CONTROL MODULE)

< ECU DIAGNOSIS INFORMATION >

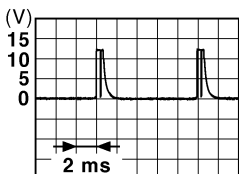
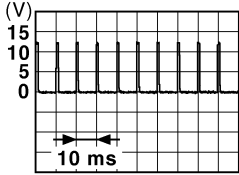
Terminal No. (Wire color)		Description		Condition	Value (Approx.)	
+	-	Signal name	Input/ Output			
109 (W)	Ground	Combination switch INPUT 2	Input	Combination switch (Wiper volume dial 4)	All switches OFF	 <p style="text-align: right;">1.4 V</p>
					Lighting switch PASS	 <p style="text-align: right;">1.3 V</p>
					Lighting switch 2ND	 <p style="text-align: right;">1.3 V</p>
					Front wiper switch INT/ AUTO	 <p style="text-align: right;">1.3 V</p>
					Front wiper switch HI	 <p style="text-align: right;">1.3 V</p>
					ON	0 V
110 (G)	Ground	Hazard switch	Input	Hazard switch	OFF	 <p style="text-align: right;">1.1 V</p>

BCM (BODY CONTROL MODULE)

< ECU DIAGNOSIS INFORMATION >

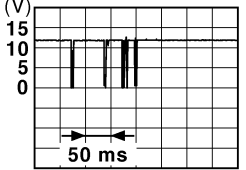
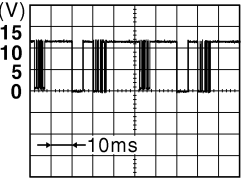
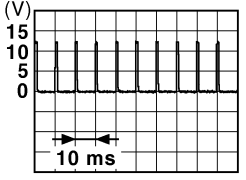
Terminal No. (Wire color)		Description		Condition	Value (Approx.)	
+	-	Signal name	Input/ Output			
111*2 (Y)	Ground	Steering lock unit communication	Input/ Output	Steering lock	LOCK status	12 V
					LOCK or UNLOCK	 <p style="text-align: right; font-size: small;">JMKIA0066GB</p>
					For 15 seconds after UN- LOCK	12 V
				15 seconds or later after UNLOCK	0 V	
112 (BR)	Ground	Rain sensor serial link	Input/ Output	Ignition switch ON	 <p style="text-align: right; font-size: small;">JPMIA0156GB</p>	
					8.7 V	
113 (G)	Ground	Optical sensor	Input	Ignition switch ON	When bright outside of the vehicle	Close to 5 V
					When dark outside of the vehicle	Close to 0 V
114 (R)	Ground	Clutch interlock switch	Input	Clutch interlock switch	OFF (Clutch pedal is not depressed)	0 V
					ON (Clutch pedal is de- pressed)	Battery voltage
116 (SB)	Ground	Stop lamp switch 1	Input	—	Battery voltage	
118 (BR)	Ground	Stop lamp switch 2 (Without ICC)	Input	Stop lamp switch	OFF (Brake pedal is not depressed)	0 V
					ON (Brake pedal is de- pressed)	Battery voltage
		Stop lamp switch 2 (With ICC)		Stop lamp switch OFF (Brake pedal is not depressed) and ICC brake hold relay OFF	0 V	
				Stop lamp switch ON (Brake pedal is de- pressed) or ICC brake hold relay ON	Battery voltage	
119 (GR)	Ground	Driver side door lock assembly (Unlock sensor)	Input	Driver door	LOCK status (Unlock sensor switch OFF)	 <p style="text-align: right; font-size: small;">JPMIA0012GB</p>
					UNLOCK status (Unlock switch sensor ON)	0 V

A
B
C
D
E
F
G
H
I
K
L
M
N
O
P

ADP

BCM (BODY CONTROL MODULE)

< ECU DIAGNOSIS INFORMATION >

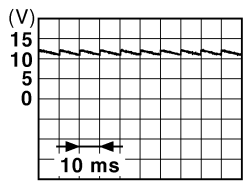
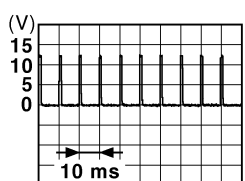
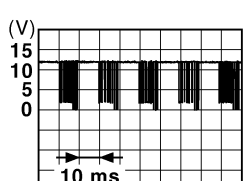
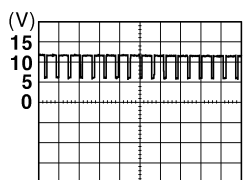
Terminal No. (Wire color)		Description		Condition	Value (Approx.)	
		Signal name	Input/ Output			
+	-					
121 (SB)	Ground	Key slot switch	Input	When the Intelligent Key is inserted into key slot	12 V	
				When the Intelligent Key is not inserted into key slot	0 V	
123 (W)	Ground	IGN feedback	Input	Ignition switch	OFF or ACC	0 V
					ON	Battery voltage
124 (BG)	Ground	Passenger door switch	Input	Passenger door switch	OFF (Door close)	 <small>JPMIA0011GB</small> 11.8 V
					ON (Door open)	0 V
129 (BG)	Ground	Trunk lid opener cancel switch	Input	Trunk lid opener cancel switch	CANCEL	 <small>JPMIA0012GB</small> 1.1 V
					ON	0 V
132 (LG)	Ground	Power window switch and R.H.T. control unit communication	Input/ Output	Ignition switch ON	 <small>JPMIA0013GB</small> 10.2 V	
				Ignition switch OFF or ACC	12 V	
133 (Y)	Ground	Push-button ignition switch illumination	Output	Push-button ignition switch illumination	ON (Tail lamps OFF)	9.5 V
					ON (Tail lamps ON)	<p style="text-align: center;">NOTE: The pulse width of this wave is varied by the illumination brightening/dimming level.</p>  <small>JPMIA0159GB</small>
					OFF	0 V
134 (LG)	Ground	LOCK indicator lamp	Output	LOCK indicator lamp	OFF	Battery voltage
					ON	0 V
137 (BG)	Ground	Receiver and sensor ground	Input	Ignition switch ON	0 V	

BCM (BODY CONTROL MODULE)

< ECU DIAGNOSIS INFORMATION >

Terminal No. (Wire color)		Description		Condition		Value (Approx.)
+	-	Signal name	Input/ Output			
138 (Y)	Ground	Receiver and sensor power supply	Output	Ignition switch	OFF	0 V
					ACC or ON	5.0 V
139 (L)	Ground	Tire pressure receiver communication	Input/ Output	Ignition switch ON	Standby state	
					When receiving the signal from the transmitter	
140 (GR)	Ground	Selector lever P/N position (A/T models)	Input	Selector lever	P or N position	12 V
					Except P and N positions	0 V
141 (R)	Ground	Security indicator lamp	Output	Security indicator lamp	ON	0 V
					Blinking	
142 (BR)	Ground	Combination switch OUTPUT 5	Output	Combination switch (Wiper volume dial 4)	All switches OFF	0 V
					Lighting switch 1ST	
Lighting switch HI	Turn signal switch RH					
Lighting switch 2ND		10.7 V				
143 (V)	Ground	Combination switch OUTPUT 1	Output	Combination switch	All switches OFF (Wiper volume dial 4)	0 V
					Front wiper switch HI (Wiper volume dial 4)	
				Any of the conditions below with all switches OFF	10.7 V	
				<ul style="list-style-type: none"> • Wiper volume dial 1 • Wiper volume dial 2 • Wiper volume dial 3 • Wiper volume dial 6 • Wiper volume dial 7 		

A
B
C
D
E
F
G
H
I
K
L
M
N
O
P

ADP

BCM (BODY CONTROL MODULE)

< ECU DIAGNOSIS INFORMATION >

Terminal No. (Wire color)		Description		Condition	Value (Approx.)	
+	-	Signal name	Input/ Output			
144 (G)	Ground	Combination switch OUTPUT 2	Output	Combination switch	All switches OFF (Wiper volume dial 4)	0 V
					Front washer switch ON (Wiper volume dial 4)	
					Any of the conditions below with all switches OFF <ul style="list-style-type: none"> • Wiper volume dial 1 • Wiper volume dial 5 • Wiper volume dial 6 	
					10.7 V	
145 (L)	Ground	Combination switch OUTPUT 3	Output	Combination switch (Wiper volume dial 4)	All switches OFF	0 V
					Front wiper switch INT/ AUTO	
					Front wiper switch LO	
					10.7 V	
146 (SB)	Ground	Combination switch OUTPUT 4	Output	Combination switch (Wiper volume dial 4)	All switches OFF	0 V
					Front fog lamp switch ON	
					Lighting switch 2ND	
					10.7 V	
150 (R)	Ground	Driver door switch	Input	Driver door switch	Lighting switch PASS	
					Turn signal switch LH	
					11.8 V	
151 (G)	Ground	Rear window defog- ger relay control	Output	Rear window defogger	OFF (Door close)	0 V
					ON (Door open)	Battery voltage

*1: Without steering lock unit

*2: With steering lock unit

BCM (BODY CONTROL MODULE)

< ECU DIAGNOSIS INFORMATION >

Wiring Diagram - BCM -

INFOID:000000006965055

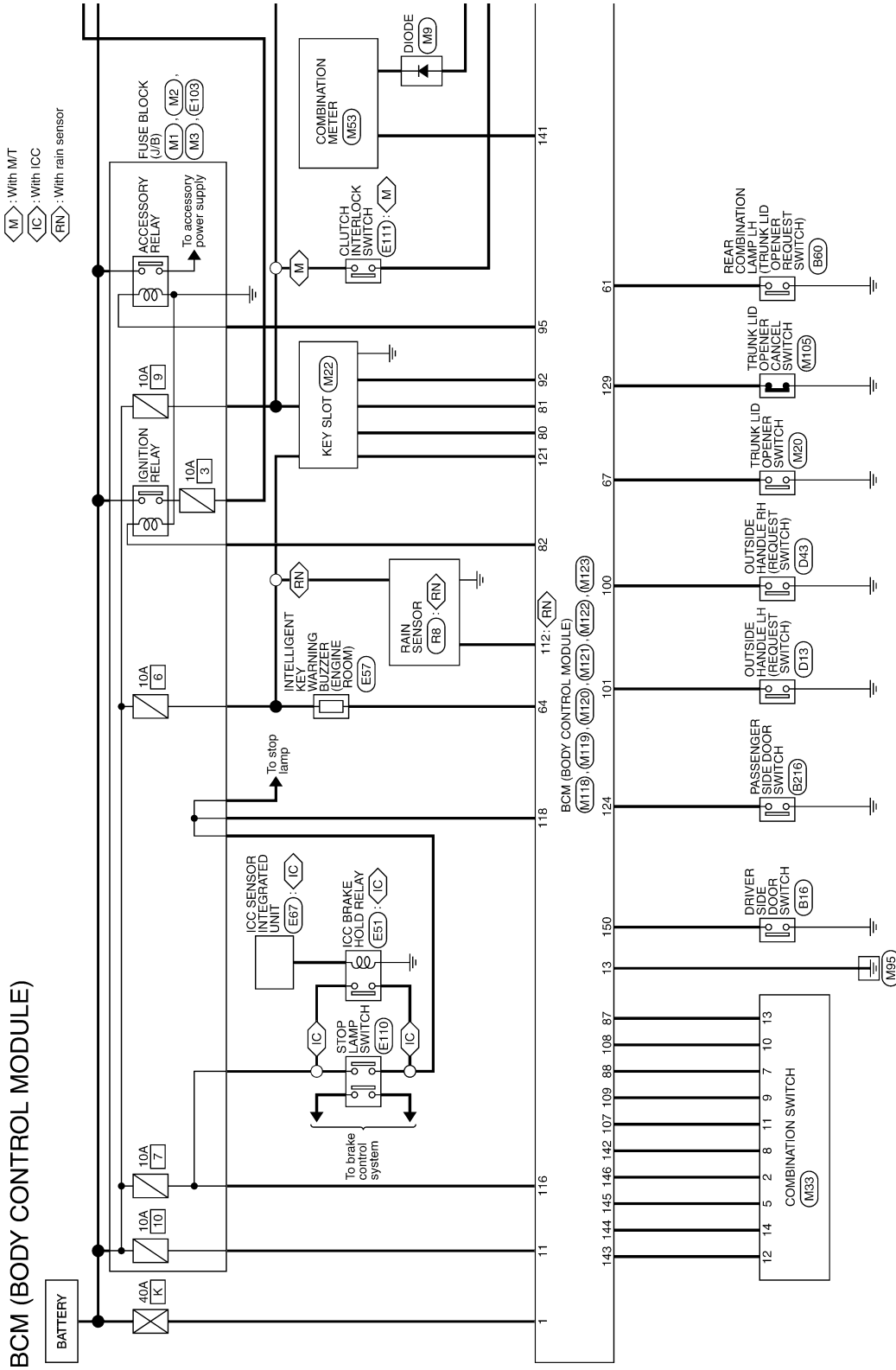

2010/10/12

JCMWN0248GB

A
B
C
D
E
F
G
H
I
ADP
K
L
M
N
O
P

BCM (BODY CONTROL MODULE)

< ECU DIAGNOSIS INFORMATION >

A : With A/T *1
M : With M/T
SL : With steering lock unit *1 89 : SL
XS : Without steering lock unit 60 : XS

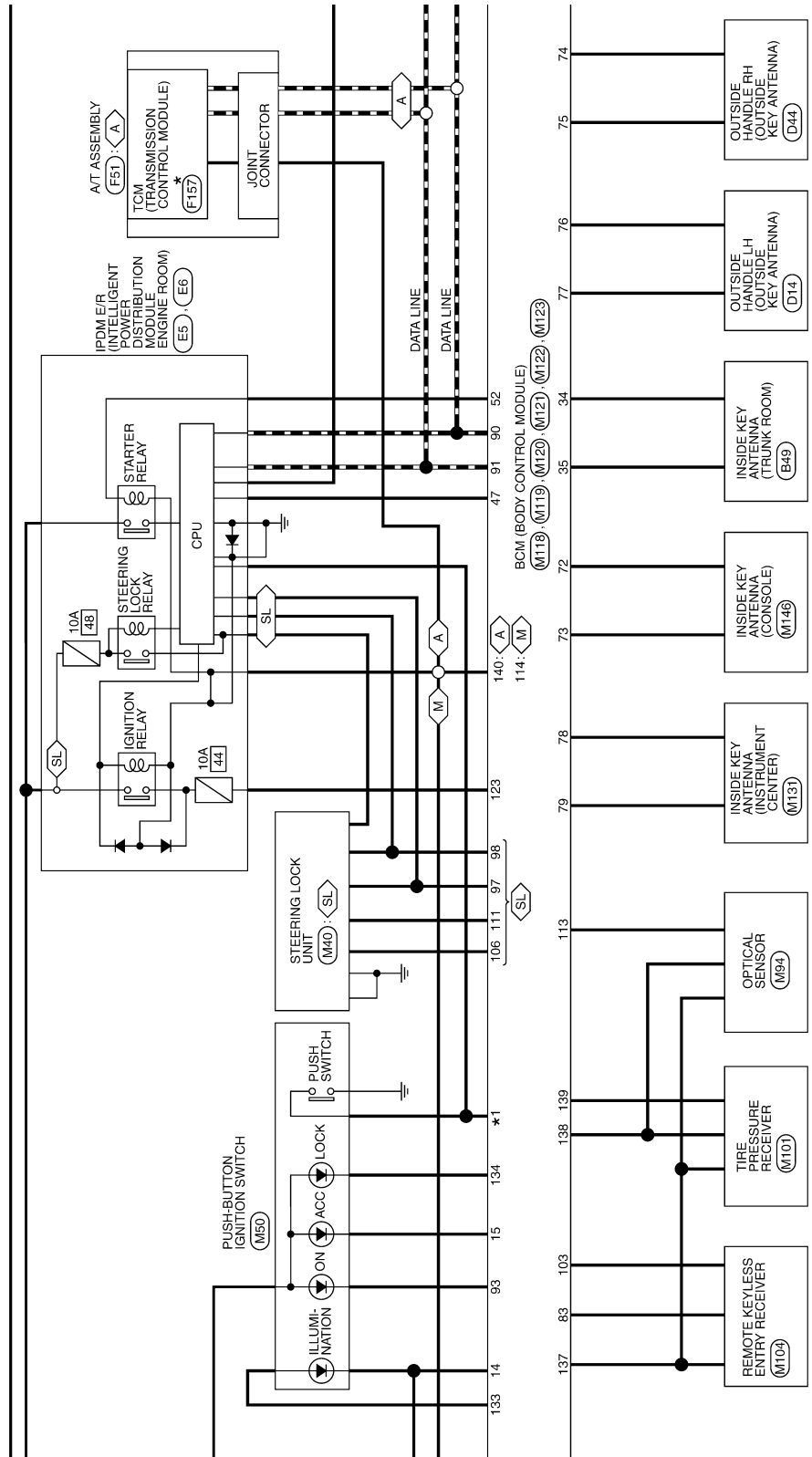

*: This connector is not shown in "Harness Layout".

JCMWN0249GB

BCM (BODY CONTROL MODULE)

< ECU DIAGNOSIS INFORMATION >

◊ A : With A/T
 ◊ M : With M/T

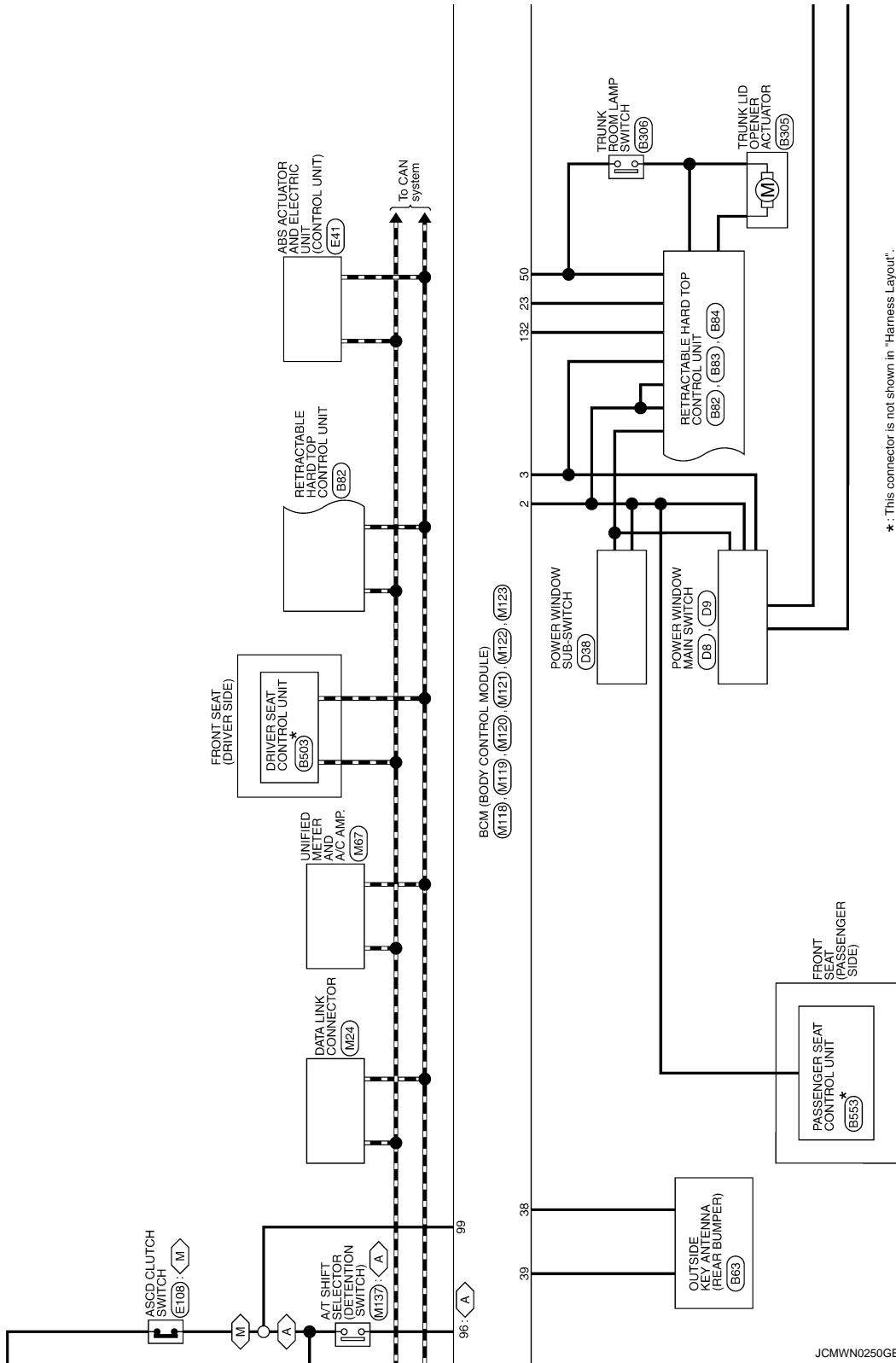

JCMWN0250GB

A
 B
 C
 D
 E
 F
 G
 H
 I
ADP
 K
 L
 M
 N
 O
 P

BCM (BODY CONTROL MODULE)

< ECU DIAGNOSIS INFORMATION >

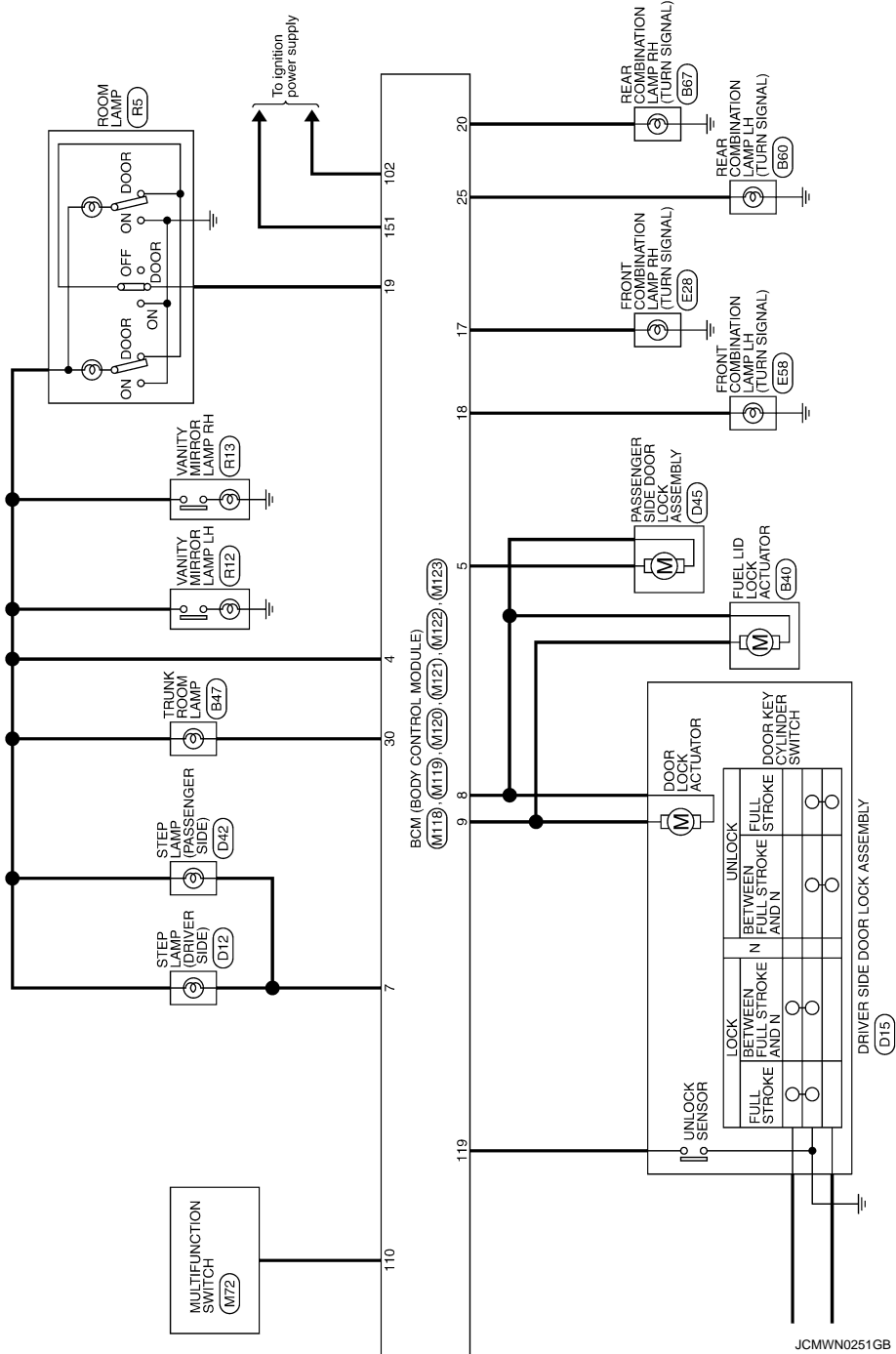

BCM (BODY CONTROL MODULE)

< ECU DIAGNOSIS INFORMATION >

BCM (BODY CONTROL MODULE)

Connector No.	M33
Connector Name	COMBINATION SWITCH
Connector Type	TH167V-NH

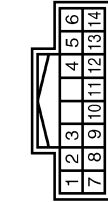

Terminal No.	Color of Wire	Signal Name [Specification]
1	P	FR WASHER (-)
2	SB	OUTPUT 4
3	L	OUTPUT 3
4	B	GND
5	EG	INPUT 3
6	BR	OUTPUT 5
7	W	INPUT 2
8	R	INPUT 4
9	LG	INPUT 1
10	V	OUTPUT 1
11	Y	INPUT 5
12	G	OUTPUT 2
13		
14		

Connector No.	M18
Connector Name	BCM (BODY CONTROL MODULE)
Connector Type	M03FB-LG



Terminal No.	Color of Wire	Signal Name [Specification]
1	W	BAT (F/L)
2	Y	POWER WINDOW POWER SUPPLY (BAT)
3	EG	POWER WINDOW POWER SUPPLY (RAP)

Connector No.	M119
Connector Name	BCM (BODY CONTROL MODULE)
Connector Type	NS16FF-CS

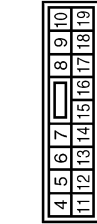

Terminal No.	Color of Wire	Signal Name [Specification]
4	LG	INTERIOR ROOM LAMP POWER SUPPLY
5	P	PASSENGER DOOR UNLOCK OUTPUT
6	SB	STEP LAMP
7	V	ALL DOOR FUEL LID LOCK OUTPUT
8	G	DRIVER DOOR FUEL LID UNLOCK OUTPUT
9	GR	BAT (FUSE)
10	B	GND
11	W	PUSH BUTTON IGNITION SW ILL GND
12	EG	ACC IND
13	BR	TURN SIGNAL RH (FRONT)
14	Y	TURN SIGNAL LH (FRONT)
15	LG	ROOM LAMP TIMER CONTROL
16	EG	
17	V	
18		
19		

Connector No.	M120
Connector Name	BCM (BODY CONTROL MODULE)
Connector Type	NS12FW-CS

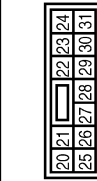

Terminal No.	Color of Wire	Signal Name [Specification]
20	V	TURN SIGNAL RH (REAR)
21	Y	TRUNK LID OPEN OUTPUT
22	Y	TURN SIGNAL LH (REAR)
23	P	TRUNK ROOM LAMP

Connector No.	M121
Connector Name	BCM (BODY CONTROL MODULE)
Connector Type	TH40FGY-NH

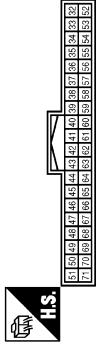

Terminal No.	Color of Wire	Signal Name [Specification]
34	SB	TRUNK ROOM ANT-
35	V	REAR BUMPER ANT-
36	B	REAR BUMPER ANT+
37	W	IGN RELAY (BDM F/R) CONT
38	Y	TRUNK ROOM LAMP SW
39	BR	STARTER RELAY CONT
40	EG	PUSH SW
41	SB	TRUNK LID OPENER REQUEST SW
42	G	I-KEY WARN BUZZER (ENG ROOM)
43	GR	TRUNK LID OPENER SW

Connector No.	M122
Connector Name	BCM (BODY CONTROL MODULE)
Connector Type	TH40FB-NH

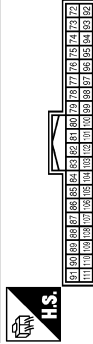

Terminal No.	Color of Wire	Signal Name [Specification]
72	R	ROOM ANT 2-
73	G	ROOM ANT 2+
74	SB	PASSENGER DOOR ANT-
75	BR	PASSENGER DOOR ANT+
76	V	DRIVER DOOR ANT-
77	LG	DRIVER DOOR ANT+
78	Y	ROOM ANT 1-
79	BR	ROOM ANT 1+
80	GR	NATS ANTENNA AMP
81	W	NATS ANTENNA AMP
82	R	IGN RELAY (F/B) CONT

83	Y	KEYLESS ENTRY RECEIVER COMM
87	Y	COMBI SW INPUT 5
88	EG	COMBI SW INPUT 3
89	BR	PUSH SW
90	P	CAN-L
91	L	CAN-H
92	LG	KEY SLOT ILL
93	V	ACC RELAY CONT
95	EG	ACC RELAY CONT
96	GR	A/T SHIFT SELECTOR POWER SUPPLY
97	L	S/L CONDITION 1
98	SB	S/L CONDITION 2
99	R	ASGD CLUTCH SW [With M/T]
99	R	SHIFT P [With A/T]
100	Y	PASSENGER DOOR REQUEST SW
101	P	DRIVER DOOR REQUEST SW
102	EG	BLOWER FAN MOTOR RELAY CONT
103	LG	KEYLESS ENTRY RECEIVER POWER SUPPLY
106	W	S/L UNIT POWER SUPPLY
107	LG	COMBI SW INPUT 1
108	R	COMBI SW INPUT 4
109	W	COMBI SW INPUT 2
110	G	HAZARD SW
111	Y	S/L UNIT COMM

A
B
C
D
E
F
G
H
I
ADP
K
L
M
N
O
P

BCM (BODY CONTROL MODULE)

< ECU DIAGNOSIS INFORMATION >

BCM (BODY CONTROL MODULE)	
Connector No.	M123
Connector Name	BCM (BODY CONTROL MODULE)
Connector Type	TH45FG-1N1

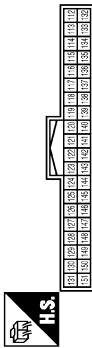

Terminal No.	Color of Wire	Signal Name [Specification]
112	BR	RAIN SENSOR SERIAL LINK
113	G	OPTICAL SENSOR
114	R	CLUTCH INTERLOCK SW
116	SB	STOP LAMP SW 1
118	BR	STOP LAMP SW 2
119	GR	DR DOOR UNLOCK SENSOR
121	SB	KEY SLOT SW
123	W	IGN P/B
124	BG	PASSENGER DOOR SW
129	BG	TRUNK LID OPENER CANCEL SW
132	LG	P/W SW & PRT C/U COMM
133	Y	PUSH-BUTTON IGNITION SW ILL POWER
134	LG	LOCK IND
137	BG	RECEIVER / SENSOR GND
138	Y	RECEIVER / SENSOR POWER SUPPLY
139	L	TIRE PRESSURE RECEIVER COMM
140	GR	SHIFT N/P
141	R	SECURITY INDICATOR LAMP
142	BR	COMBI SW OUTPUT 5
143	V	COMBI SW OUTPUT 1
144	G	COMBI SW OUTPUT 2
145	L	COMBI SW OUTPUT 3
146	SB	COMBI SW OUTPUT 4
150	R	DRIVER DOOR SW
151	G	REAR WINDOW DEFOGGER RELAY CONT

JCMWN0253GB

Fail-safe

INFOID:000000006965056

FAIL-SAFE CONTROL BY DTC

BCM performs fail-safe control when any DTC are detected.

BCM (BODY CONTROL MODULE)

< ECU DIAGNOSIS INFORMATION >

Display contents of CONSULT	Fail-safe	Cancellation	A
B2013: ID DISCORD BCM-S/L	Inhibit engine cranking	Erase DTC	A
B2014: CHAIN OF S/L-BCM	Inhibit engine cranking	Erase DTC	B
B2190: NATS ANTENNA AMP	Inhibit engine cranking	Erase DTC	B
B2191: DIFFERENCE OF KEY	Inhibit engine cranking	Erase DTC	C
B2192: ID DISCORD BCM-ECM	Inhibit engine cranking	Erase DTC	C
B2193: CHAIN OF BCM-ECM	Inhibit engine cranking	Erase DTC	D
B2195: ANTI-SCANNING	Inhibit engine cranking	Ignition switch ON → OFF	D
B2557: VEHICLE SPEED	Inhibit steering lock	When normal vehicle speed signals are received from ABS actuator and electric unit (control unit) for 500 ms	E
B2560: STARTER CONT RELAY	Inhibit engine cranking	500 ms after the following CAN signal communication status becomes consistent <ul style="list-style-type: none"> • Starter control relay signal • Starter relay status signal 	E
B2601: SHIFT POSITION	Inhibit steering lock	500 ms after the following signal reception status becomes consistent <ul style="list-style-type: none"> • Selector lever P position switch signal • P range signal (CAN) 	F
B2602: SHIFT POSITION	Inhibit steering lock	5 seconds after the following BCM recognition conditions are fulfilled <ul style="list-style-type: none"> • Ignition switch is in the ON position • Selector lever P position switch signal: Except P position (12 V) • Vehicle speed: 4 km/h (2.5 MPH) or more 	G
B2603: SHIFT POSI STATUS	Inhibit steering lock	500 ms after the following BCM recognition conditions are fulfilled <ul style="list-style-type: none"> • Ignition switch is in the ON position • Selector lever P position switch signal: Except P position (12 V) • Selector lever P/N position signal: Except P and N positions (0 V) 	H
B2604: PNP/CLUTCH SW	Inhibit steering lock	500 ms after any of the following BCM recognition conditions are fulfilled <ul style="list-style-type: none"> • Status 1 <ul style="list-style-type: none"> - Ignition switch is in the ON position - Selector lever P/N position signal: P and N position (12 V) - P range signal or N range signal (CAN): ON • Status 2 <ul style="list-style-type: none"> - Ignition switch is in the ON position - Selector lever P/N position signal: Except P and N positions (0 V) - P range signal and N range signal (CAN): OFF 	I
B2605: PNP/CLUTCH SW	Inhibit steering lock	500 ms after any of the following BCM recognition conditions are fulfilled <ul style="list-style-type: none"> • Status 1 <ul style="list-style-type: none"> - Ignition switch is in the ON position - Selector lever P/N position signal: Except P and N positions (0 V) - Interlock/PNP switch signal (CAN): OFF • Status 2 <ul style="list-style-type: none"> - Ignition switch is in the ON position - Selector lever P/N position signal: P or N position (12 V) - PNP switch signal (CAN): ON 	J
B2606: S/L RELAY	Inhibit engine cranking	500 ms after the following CAN signal communication status becomes consistent <ul style="list-style-type: none"> • Steering lock relay signal (Request signal) • Steering lock relay signal (Condition signal) 	K
B2607: S/L RELAY	Inhibit engine cranking	500 ms after the following CAN signal communication status has become consistent <ul style="list-style-type: none"> • Steering lock relay signal (Request signal) • Steering lock relay signal (Condition signal) 	L

ADP

BCM (BODY CONTROL MODULE)

< ECU DIAGNOSIS INFORMATION >

Display contents of CONSULT	Fail-safe	Cancellation
B2608: STARTER RELAY	Inhibit engine cranking	500 ms after the following signal communication status becomes consistent <ul style="list-style-type: none"> • Starter motor relay control signal • Starter relay status signal (CAN)
B2609: S/L STATUS	<ul style="list-style-type: none"> • Inhibit engine cranking • Inhibit steering lock 	When the following steering lock conditions agree <ul style="list-style-type: none"> • BCM steering lock control status • Steering lock condition No. 1 signal status • Steering lock condition No. 2 signal status
B260A: IGNITION RELAY	Inhibit engine cranking	500 ms after the following conditions are fulfilled <ul style="list-style-type: none"> • IGN relay (IPDM E/R) control signal: OFF (12 V) • Ignition ON signal (CAN to IPDM E/R): OFF (Request signal) • Ignition ON signal (CAN from IPDM E/R): OFF (Condition signal)
B260F: ENG STATE SIG LOST	Maintains the power supply position attained at the time of DTC detection	When any of the following conditions are fulfilled <ul style="list-style-type: none"> • Power position changes to ACC • Receives engine status signal (CAN)
B2612: S/L STATUS	<ul style="list-style-type: none"> • Inhibit engine cranking • Inhibit steering lock 	When any of the following conditions are fulfilled <ul style="list-style-type: none"> • Steering lock unit status signal (CAN) is received normally • The BCM steering lock control status matches the steering lock status recognized by the steering lock unit status signal (CAN from IPDM E/R)
B2617: BCM	Inhibit engine cranking	1 second after the starter motor relay control inside BCM becomes normal
B2618: BCM	Inhibit engine cranking	1 second after the ignition relay (IPDM E/R) control inside BCM becomes normal
B2619: BCM	Inhibit engine cranking	1 second after the steering lock unit power supply output control inside BCM becomes normal
B261E: VEHICLE TYPE	Inhibit engine cranking	BCM initialization
B26E8: CLUTCH SW	Inhibit engine cranking	When any of the following BCM recognition conditions are fulfilled <ul style="list-style-type: none"> • Status 1 <ul style="list-style-type: none"> - Clutch switch signal (CAN from ECM): ON - Clutch interlock switch signal: OFF (0 V) • Status 2 <ul style="list-style-type: none"> - Clutch switch signal (CAN from ECM): OFF - Clutch interlock switch signal: ON (Battery voltage)
B26E9: S/L STATUS	<ul style="list-style-type: none"> • Inhibit engine cranking • Inhibit steering lock 	When BCM transmits the LOCK request signal to steering lock unit, and receives LOCK response signal from steering lock unit, the following conditions are fulfilled <ul style="list-style-type: none"> • Steering condition No. 1 signal: LOCK (0 V) • Steering condition No. 2 signal: LOCK (12 V)

DTC Inspection Priority Chart

INFOID:000000006965057

If some DTCs are displayed at the same time, perform inspections one by one based on the following priority chart.

Priority	DTC
1	B2562: LOW VOLTAGE
2	<ul style="list-style-type: none"> • U1000: CAN COMM • U1010: CONTROL UNIT (CAN)
3	<ul style="list-style-type: none"> • B2190: NATS ANTENNA AMP • B2191: DIFFERENCE OF KEY • B2192: ID DISCORD BCM-ECM • B2193: CHAIN OF BCM-ECM • B2195: ANTI-SCANNING

BCM (BODY CONTROL MODULE)

< ECU DIAGNOSIS INFORMATION >

Priority	DTC	
4	• B2013: ID DISCORD BCM-S/L	A
	• B2014: CHAIN OF S/L-BCM	
	• B2553: IGNITION RELAY	B
	• B2555: STOP LAMP	
	• B2556: PUSH-BTN IGN SW	
	• B2557: VEHICLE SPEED	
	• B2560: STARTER CONT RELAY	
	• B2601: SHIFT POSITION	C
	• B2602: SHIFT POSITION	
	• B2603: SHIFT POSI STATUS	
	• B2604: PNP/CLUTCH SW	
	• B2605: PNP/CLUTCH SW	D
	• B2606: S/L RELAY	
	• B2607: S/L RELAY	
	• B2608: STARTER RELAY	
	• B2609: S/L STATUS	E
	• B260A: IGNITION RELAY	
	• B260B: STEERING LOCK UNIT	
	• B260C: STEERING LOCK UNIT	F
	• B260D: STEERING LOCK UNIT	
	• B260F: ENG STATE SIG LOST	
	• B2612: S/L STATUS	
	• B2614: BCM	G
	• B2615: BCM	
	• B2616: BCM	
	• B2617: BCMC	
	• B2618: BCM	H
• B2619: BCM		
• B261A: PUSH-BTN IGN SW		
• B261E: VEHICLE TYPE		
• B26E8: CLUTCH SW	I	
• B26E9: S/L STATUS		
• B26EA: KEY REGISTRATION		
• C1729: VHCL SPEED SIG ERR		
• U0415: VEHICLE SPEED	ADP	
5	• C1704: LOW PRESSURE FL	
	• C1705: LOW PRESSURE FR	K
	• C1706: LOW PRESSURE RR	
	• C1707: LOW PRESSURE RL	
	• C1708: [NO DATA] FL	
	• C1709: [NO DATA] FR	L
	• C1710: [NO DATA] RR	
	• C1711: [NO DATA] RL	
	• C1716: [PRESSDATA ERR] FL	
	• C1717: [PRESSDATA ERR] FR	M
	• C1718: [PRESSDATA ERR] RR	
	• C1719: [PRESSDATA ERR] RL	
• C1734: CONTROL UNIT		
6	• B2621: INSIDE ANTENNA	N
	• B2622: INSIDE ANTENNA	
	• B2623: INSIDE ANTENNA	

DTC Index

INFOID:000000006965058

NOTE:

The details of time display are as follows.

- CRNT: A malfunction is detected now.
- PAST: A malfunction was detected in the past.

IGN counter is displayed on Freeze Frame Data. For details of Freeze Frame Data, refer to [BCS-16. "COMMON ITEM : CONSULT-III Function \(BCM - COMMON ITEM\)".](#)

BCM (BODY CONTROL MODULE)

< ECU DIAGNOSIS INFORMATION >

CONSULT display	Fail-safe	Freeze Frame Data •Vehicle Speed •Odo/Trip Meter •Vehicle condition	Intelligent Key warning lamp ON	Tire pressure monitor warning lamp ON	Refer- ence page
No DTC is detected. further testing may be required.	—	—	—	—	—
U1000: CAN COMM	—	—	—	—	BCS-35
U1010: CONTROL UNIT (CAN)	—	—	—	—	BCS-36
U0415: VEHICLE SPEED	—	—	—	—	BCS-37
B2013: ID DISCORD BCM-S/L*	×	×	—	—	SEC-49
B2014: CHAIN OF S/L-BCM*	×	×	—	—	SEC-50
B2190: NATS ANTENNA AMP	×	—	—	—	SEC-41
B2191: DIFFERENCE OF KEY	×	—	—	—	SEC-44
B2192: ID DISCORD BCM-ECM	×	—	—	—	SEC-45
B2193: CHAIN OF BCM-ECM	×	—	—	—	SEC-47
B2195: ANTI-SCANNING	×	—	—	—	SEC-48
B2553: IGNITION RELAY	—	×	—	—	PCS-49
B2555: STOP LAMP	—	×	—	—	SEC-53
B2556: PUSH-BTN IGN SW	—	×	×	—	SEC-55
B2557: VEHICLE SPEED	×	×	×	—	SEC-57
B2560: STARTER CONT RELAY	×	×	×	—	SEC-58
B2562: LOW VOLTAGE	—	×	—	—	BCS-38
B2601: SHIFT POSITION	×	×	×	—	SEC-59
B2602: SHIFT POSITION	×	×	×	—	SEC-62
B2603: SHIFT POSI STATUS	×	×	×	—	SEC-64
B2604: PNP/CLUTCH SW	×	×	×	—	SEC-67
B2605: PNP/CLUTCH SW	×	×	×	—	SEC-69
B2606: S/L RELAY*	×	×	×	—	SEC-71
B2607: S/L RELAY*	×	×	×	—	SEC-72
B2608: STARTER RELAY	×	×	×	—	SEC-74
B2609: S/L STATUS*	×	×	×	—	SEC-76
B260A: IGNITION RELAY	×	×	×	—	PCS-51
B260B: STEERING LOCK UNIT*	—	×	×	—	SEC-80
B260C: STEERING LOCK UNIT*	—	×	×	—	SEC-81
B260D: STEERING LOCK UNIT*	—	×	×	—	SEC-82
B260F: ENG STATE SIG LOST	×	×	×	—	SEC-83
B2612: S/L STATUS*	×	×	×	—	SEC-88
B2614: BCM	—	×	×	—	PCS-53
B2615: BCM	—	×	×	—	PCS-56
B2616: BCM	—	×	×	—	PCS-59
B2617: BCM	×	×	×	—	SEC-92
B2618: BCM	×	×	×	—	PCS-62
B2619: BCM*	×	×	×	—	SEC-94
B261A: PUSH-BTN IGN SW	—	×	×	—	PCS-63
B261E: VEHICLE TYPE	×	×	× (Turn ON for 15 seconds)	—	SEC-95

BCM (BODY CONTROL MODULE)

< ECU DIAGNOSIS INFORMATION >

CONSULT display	Fail-safe	Freeze Frame Data •Vehicle Speed •Odo/Trip Meter •Vehicle condition	Intelligent Key warning lamp ON	Tire pressure monitor warning lamp ON	Refer- ence page
B2621: INSIDE ANTENNA	—	×	—	—	DLK-62
B2622: INSIDE ANTENNA	—	×	—	—	DLK-64
B2623: INSIDE ANTENNA	—	×	—	—	DLK-66
B26E8: CLUTCH SW	×	×	×	—	SEC-84
B26E9: S/L STATUS*	×	×	× (Turn ON for 15 seconds)	—	SEC-86
B26EA: KEY REGISTRATION	—	×	× (Turn ON for 15 seconds)	—	SEC-87
C1704: LOW PRESSURE FL	—	—	—	×	WT-24
C1705: LOW PRESSURE FR	—	—	—	×	
C1706: LOW PRESSURE RR	—	—	—	×	
C1707: LOW PRESSURE RL	—	—	—	×	
C1708: [NO DATA] FL	—	—	—	×	WT-26
C1709: [NO DATA] FR	—	—	—	×	
C1710: [NO DATA] RR	—	—	—	×	
C1711: [NO DATA] RL	—	—	—	×	
C1716: [PRESSDATA ERR] FL	—	—	—	×	WT-29
C1717: [PRESSDATA ERR] FR	—	—	—	×	
C1718: [PRESSDATA ERR] RR	—	—	—	×	
C1719: [PRESSDATA ERR] RL	—	—	—	×	
C1729: VHCL SPEED SIG ERR	—	—	—	×	WT-30
C1734: CONTROL UNIT	—	—	—	×	WT-31

*: For models without steering lock unit, this DTC is not applied.

A
B
C
D
E
F
G
H
I
ADP
K
L
M
N
O
P

MANUAL FUNCTION DOES NOT OPERATE

< SYMPTOM DIAGNOSIS >

SYMPTOM DIAGNOSIS

MANUAL FUNCTION DOES NOT OPERATE

ALL COMPONENT

ALL COMPONENT : Description

INFOID:000000006471628

All functions do not operate when manually operated.(power seat, tilt & telescopic, and door mirror.

ALL COMPONENT : Diagnosis Procedure

INFOID:000000006471629

1.CHECK DRIVER SEAT CONTROL UNIT POWER SUPPLY AND GROUND CIRCUIT

Check driver seat control unit power supply and ground circuit.

Refer to [ADP-64. "DRIVER SEAT CONTROL UNIT : Diagnosis Procedure"](#).

Is the inspection result normal?

YES >> GO TO 2.

NO >> Repair or replace the malfunctioning parts.

2.CHECK AUTOMATIC DRIVE POSITIONER CONTROL UNIT POWER SUPPLY AND GROUND CIRCUIT

Check automatic drive positioner control unit power supply and ground circuit.

Refer to [ADP-65. "AUTOMATIC DRIVE POSITIONER CONTROL UNIT : Diagnosis Procedure"](#).

Is the inspection result normal?

YES >> GO TO 3.

NO >> Repair or replace the malfunctioning parts.

3.CONFIRM THE OPERATION

Confirm the operation again.

Is the result normal?

YES >> Check intermittent incident. Refer to [GI-43. "Intermittent Incident"](#).

NO >> GO TO 1.

POWER SEAT

POWER SEAT : Description

INFOID:000000006471630

Power seat does not operate when manually operated.

POWER SEAT : Diagnosis Procedure

INFOID:000000006471631

1.CHECK POWER SEAT SWITCH GROUND CIRCUIT

Check power seat switch ground circuit.

Refer to [ADP-95. "Diagnosis Procedure"](#).

Is the inspection result normal?

YES >> GO TO 2.

NO >> Repair or replace harness or connector.

2.CONFIRM THE OPERATION

Confirm the operation again.

Is the result normal?

YES >> Check intermittent incident. Refer to [GI-43. "Intermittent Incident"](#).

NO >> GO TO 1.

STEERING POSITION FUNCTION DOES NOT OPERATE

STEERING POSITION FUNCTION DOES NOT OPERATE : Description

INFOID:000000006471632

Tilt & telescopic do not operate when manually operated.

MANUAL FUNCTION DOES NOT OPERATE

< SYMPTOM DIAGNOSIS >

STEERING POSITION FUNCTION DOES NOT OPERATE : Diagnosis Procedure

INFOID:000000006471633

1.CHECK TILT & TELESCOPIC SWITCH GROUND CIRCUIT

Check tilt & telescopic switch ground circuit.

Refer to [ADP-96. "Diagnosis Procedure"](#).

Is the inspection result normal?

YES >> GO TO 2.

NO >> Repair or replace harness or connector.

2.CONFIRM THE OPERATION

Confirm the operation again.

Is the result normal?

YES >> Check intermittent incident. Refer to [GI-43. "Intermittent Incident"](#).

NO >> GO TO 1.

SEAT SLIDING

SEAT SLIDING : Description

INFOID:000000006471634

Seat sliding alone does not operate when manually operated.

SEAT SLIDING : Diagnosis Procedure

INFOID:000000006471635

1.CHECK SLIDING MECHANISM

Check for the following.

- Mechanism deformation or pinched foreign materials.
- Interference with other parts because of poor installation.

Is the inspection result normal?

YES >> GO TO 2.

NO >> Repair or replace the malfunctioning parts.

2.CHECK SLIDING SWITCH

Check sliding switch.

Refer to [ADP-67. "Component Function Check"](#).

Is the inspection result normal?

YES >> GO TO 3.

NO >> Repair or replace the malfunctioning parts.

3.CHECK SLIDING MOTOR

Check sliding motor.

Refer to [ADP-120. "Component Function Check"](#).

Is the inspection result normal?

YES >> GO TO 4.

NO >> Repair or replace the malfunctioning parts.

4.CONFIRM THE OPERATION

Check the operation again.

Is the result normal?

YES >> Check intermittent incident. Refer to [GI-43. "Intermittent Incident"](#).

NO >> GO TO 1.

SEAT RECLINING

SEAT RECLINING : Description

INFOID:000000006471636

Seat reclining only does not operate when manually operated.

A
B
C
D
E
F
G
H
I
K
L
M
N
O
P

ADP

MANUAL FUNCTION DOES NOT OPERATE

< SYMPTOM DIAGNOSIS >

SEAT RECLINING : Diagnosis Procedure

INFOID:000000006471637

1.CHECK RECLINING MECHANISM

Check for the following.

- Mechanism deformation or pinched foreign materials.
- Interference with other parts because of poor installation.

Is the inspection result normal?

YES >> GO TO 2.

NO >> Repair or replace the malfunctioning parts.

2.CHECK RECLINING SWITCH

Check reclining switch.

Refer to [ADP-100. "Component Function Check"](#).

Is the inspection result normal?

YES >> GO TO 3.

NO >> Repair or replace the malfunctioning parts.

3.CHECK RECLINING MOTOR

Check reclining motor.

Refer to [ADP-122. "Component Function Check"](#).

Is the inspection result normal?

YES >> GO TO 4.

NO >> Repair or replace the malfunctioning parts.

4.CONFIRM THE OPERATION

Check the operation again.

Is the result normal?

YES >> Check intermittent incident. Refer to [GI-43. "Intermittent Incident"](#).

NO >> GO TO 1.

SEAT LIFTING (FRONT)

SEAT LIFTING (FRONT) : Description

INFOID:000000006471638

Seat lifting (front) only does not operate when manually operated.

SEAT LIFTING (FRONT) : Diagnosis Procedure

INFOID:000000006471639

1.CHECK LIFTING (FRONT) MECHANISM

Check for the following.

- Mechanism deformation or pinched foreign materials.
- Interference with other parts because of poor installation.

Is the inspection result normal?

YES >> GO TO 2.

NO >> Repair or replace the malfunctioning parts.

2.CHECK LIFTING SWITCH (FRONT)

Check lifting switch (front).

Refer to [ADP-71. "Component Function Check"](#).

Is the inspection result normal?

YES >> GO TO 3.

NO >> Repair or replace the malfunctioning parts.

3.CHECK LIFTING MOTOR (FRONT)

Check lifting motor (front).

Refer to [ADP-124. "Component Function Check"](#).

Is the inspection result normal?

MANUAL FUNCTION DOES NOT OPERATE

< SYMPTOM DIAGNOSIS >

- YES >> GO TO 4.
NO >> Repair or replace the malfunctioning parts.

4.CONFIRM THE OPERATION

Check the operation again.

Is the result normal?

- YES >> Check intermittent incident. Refer to [GI-43, "Intermittent Incident"](#).
NO >> GO TO 1.

SEAT LIFTING (REAR)

SEAT LIFTING (REAR) : Description

INFOID:000000006471640

Seat lifting (rear) only does not operate when manually operated.

SEAT LIFTING (REAR) : Diagnosis Procedure

INFOID:000000006471641

1.CHECK LIFTING (REAR) MECHANISM

Check for the following.

- Mechanism deformation or pinched foreign materials.
- Interference with other parts because of poor installation.

Is the inspection result normal?

- YES >> GO TO 2.
NO >> Repair or replace the malfunctioning parts.

2.CHECK LIFTING SWITCH (REAR)

Check lifting switch (rear).

Refer to [ADP-73, "Component Function Check"](#).

Is the inspection result normal?

- YES >> GO TO 3.
NO >> Repair or replace the malfunctioning parts.

3.CHECK LIFTING MOTOR (REAR)

Check lifting motor (rear).

Refer to [ADP-126, "Component Function Check"](#).

Is the inspection result normal?

- YES >> GO TO 4.
NO >> Repair or replace the malfunctioning parts.

4.CONFIRM THE OPERATION

Check the operation again.

Is the result normal?

- YES >> Check intermittent incident. Refer to [GI-43, "Intermittent Incident"](#).
NO >> GO TO 1.

STEERING TILT

STEERING TILT : Description

INFOID:000000006471642

Steering tilt only does not operate when manually operated.

STEERING TILT : Diagnosis Procedure

INFOID:000000006471643

1.CHECK STEERING TILT MECHANISM

Check for the following.

- Mechanism deformation or pinched foreign materials.
- Interference with other parts because of poor installation.

Is the inspection result normal?

- YES >> GO TO 2.

A
B
C
D
E
F
G
H
I
K
L
M
N
O
P

ADP

MANUAL FUNCTION DOES NOT OPERATE

< SYMPTOM DIAGNOSIS >

NO >> Repair or replace the malfunctioning parts.

2.CHECK TILT SWITCH

Check tilt switch.

Refer to [ADP-83, "Component Function Check"](#).

Is the inspection result normal?

YES >> GO TO 3.

NO >> Repair or replace the malfunctioning parts.

3.CHECK TILT MOTOR

Check tilt motor.

Refer to [ADP-128, "Component Function Check"](#).

Is the inspection result normal?

YES >> GO TO 4.

NO >> Repair or replace the malfunctioning parts.

4.CONFIRM THE OPERATION

Check the operation again.

Is the result normal?

YES >> Check intermittent incident. Refer to [GI-43, "Intermittent Incident"](#).

NO >> GO TO 1.

STEERING TELESCOPIC

STEERING TELESCOPIC : Description

INFOID:000000006471644

Steering telescopic only does not operate when manually operated.

STEERING TELESCOPIC : Diagnosis Procedure

INFOID:000000006471645

1.CHECK STEERING TELESCOPIC MECHANISM

Check for the following.

- Mechanism deformation or pinched foreign materials.
- Interference with other parts because of poor installation.

Is the inspection result normal?

YES >> GO TO 2.

NO >> Repair or replace the malfunctioning parts.

2.CHECK TELESCOPIC SWITCH

Check telescopic switch.

Refer to [ADP-85, "Component Function Check"](#).

Is the inspection result normal?

YES >> GO TO 3.

NO >> Repair or replace the malfunctioning parts.

3.CHECK TELESCOPIC MOTOR

Check telescopic motor.

Refer to [ADP-130, "Component Function Check"](#).

Is the inspection result normal?

YES >> GO TO 4.

NO >> Repair or replace the malfunctioning parts.

4.CONFIRM THE OPERATION

Check the operation again.

Is the result normal?

YES >> Check intermittent incident. Refer to [GI-43, "Intermittent Incident"](#).

NO >> GO TO 1.

DOOR MIRROR

MANUAL FUNCTION DOES NOT OPERATE

< SYMPTOM DIAGNOSIS >

DOOR MIRROR : Description

INFOID:000000006471646

Door mirror does not operate when manually operated.

DOOR MIRROR : Diagnosis Procedure

INFOID:000000006471647

1.CHECK DOOR MIRROR MECHANISM

Check for the following.

- Mechanism deformation or pinched foreign materials.
- Interference with other parts because of poor installation.

Is the inspection result normal?

YES >> GO TO 2.

NO >> Repair or replace the malfunctioning parts.

2.CHECK MIRROR SWITCH

Check mirror switch.

Refer to [ADP-90. "MIRROR SWITCH : Component Function Check"](#).

Is the inspection result normal?

YES >> GO TO 3.

NO >> Repair or replace the malfunctioning parts.

3.CHECK MIRROR MOTOR

Check mirror motor.

Refer to [ADP-132. "Component Function Check"](#).

Is the inspection result normal?

YES >> GO TO 4.

NO >> Repair or replace the malfunctioning parts.

4.CONFIRM THE OPERATION

Check the operation again.

Is the result normal?

YES >> Check intermittent incident. Refer to [GI-43. "Intermittent Incident"](#).

NO >> GO TO 1.

A
B
C
D
E
F
G
H
I
K
L
M
N
O
P

ADP

MEMORY FUNCTION DOES NOT OPERATE

< SYMPTOM DIAGNOSIS >

MEMORY FUNCTION DOES NOT OPERATE

ALL COMPONENT

ALL COMPONENT : Description

INFOID:000000006471648

All functions do not operate when memory operated. (power seat, tilt & telescopic, and door mirror)

ALL COMPONENT : Diagnosis Procedure

INFOID:000000006471649

1.CHECK MANUAL OPERATION

Check manual operation.

Is the inspection result normal?

YES >> GO TO 2.

NO >> Refer to [ADP-218. "ALL COMPONENT : Diagnosis Procedure"](#)

2.PERFORM MEMORY STORING PROCEDURE

Perform memory storing procedure.

Refer to [ADP-10. "MEMORY STORING : Special Repair Requirement"](#).

Is the inspection result normal?

YES >> Memory function is normal.

NO >> GO TO 3.

3.CHECK SEAT MEMORY SWITCH

Check seat memory switch.

Refer to [ADP-87. "Component Function Check"](#).

Is the inspection result normal?

YES >> GO TO 4.

NO >> Replace seat memory switch.

4.CONFIRM THE OPERATION

Confirm the operation again.

Is the result normal?

YES >> Check intermittent incident. Refer to [GI-43. "Intermittent Incident"](#).

NO >> GO TO 1.

SEAT SLIDING

SEAT SLIDING : Description

INFOID:000000006471650

Seat sliding only does not operate when memory operated.

SEAT SLIDING : Diagnosis Procedure

INFOID:000000006471651

1.CHECK MANUAL OPERATION

Check manual operation.

Is the inspection result normal?

YES >> GO TO 2.

NO >> Refer to [ADP-219. "SEAT SLIDING : Diagnosis Procedure"](#)

2.CHECK SLIDING SENSOR

Check sliding sensor.

Refer to [ADP-97. "Component Function Check"](#).

Is the inspection result normal?

YES >> GO TO 3.

NO >> Repair or replace the malfunctioning parts.

3.CONFIRM THE OPERATION

Check the operation again.

MEMORY FUNCTION DOES NOT OPERATE

< SYMPTOM DIAGNOSIS >

Is the result normal?

- YES >> Check intermittent incident. Refer to [GI-43, "Intermittent Incident"](#).
NO >> GO TO 1.

SEAT RECLINING

SEAT RECLINING : Description

INFOID:000000006471652

Seat reclining only does not operate when memory operated.

SEAT RECLINING : Diagnosis Procedure

INFOID:000000006471653

1.CHECK MANUAL OPERATION

Check manual operation.

Is the inspection result normal?

- YES >> GO TO 2.
NO >> Refer to [ADP-220, "SEAT RECLINING : Diagnosis Procedure"](#)

2.CHECK RECLINING SENSOR

Check reclining sensor.

Refer to [ADP-100, "Component Function Check"](#).

Is the inspection result normal?

- YES >> GO TO 3.
NO >> Repair or replace the malfunctioning parts.

3.CONFIRM THE OPERATION

Check the operation again.

Is the result normal?

- YES >> Check intermittent incident. Refer to [GI-43, "Intermittent Incident"](#).
NO >> GO TO 1.

SEAT LIFTING (FRONT)

SEAT LIFTING (FRONT) : Description

INFOID:000000006471654

Seat lifting (front) only does not operate when memory operated.

SEAT LIFTING (FRONT) : Diagnosis Procedure

INFOID:000000006471655

1.CHECK MANUAL OPERATION

Check manual operation.

Is the inspection result normal?

- YES >> GO TO 2.
NO >> Refer to [ADP-220, "SEAT LIFTING \(FRONT\) : Diagnosis Procedure"](#)

2.CHECK LIFTING SENSOR (FRONT)

Check lifting sensor (front).

Refer to [ADP-103, "Component Function Check"](#).

Is the inspection result normal?

- YES >> GO TO 3.
NO >> Repair or replace the malfunctioning parts.

3.CONFIRM THE OPERATION

Check the operation again.

Is the result normal?

- YES >> Check intermittent incident. Refer to [GI-43, "Intermittent Incident"](#).
NO >> GO TO 1.

SEAT LIFTING (REAR)

A

B

C

D

E

F

G

H

I

ADP

K

L

M

N

O

P

MEMORY FUNCTION DOES NOT OPERATE

< SYMPTOM DIAGNOSIS >

SEAT LIFTING (REAR) : Description

INFOID:000000006471656

Seat lifting (rear) only does not operate when memory operated.

SEAT LIFTING (REAR) : Diagnosis Procedure

INFOID:000000006471657

1.CHECK MANUAL OPERATION

Check manual operation.

Is the inspection result normal?

YES >> GO TO 2.

NO >> Refer to [ADP-221, "SEAT LIFTING \(REAR\) : Diagnosis Procedure"](#)

2.CHECK LIFTING SENSOR (REAR)

Check lifting sensor (rear).

Refer to [ADP-106, "Component Function Check"](#).

Is the inspection result normal?

YES >> GO TO 3.

NO >> Repair or replace the malfunctioning parts.

3.CONFIRM THE OPERATION

Check the operation again.

Is the result normal?

YES >> Check intermittent incident. Refer to [GI-43, "Intermittent Incident"](#).

NO >> GO TO 1.

STEERING TELESCOPIC

STEERING TELESCOPIC : Description

INFOID:000000006471658

Steering telescopic only does not operate when memory operated.

STEERING TELESCOPIC : Diagnosis Procedure

INFOID:000000006471659

1.CHECK MANUAL OPERATION

Check manual operation.

Is the inspection result normal?

YES >> GO TO 2.

NO >> Refer to [ADP-222, "STEERING TELESCOPIC : Diagnosis Procedure"](#)

2.CHECK TELESCOPIC SENSOR

Check steering telescopic sensor.

Refer to [ADP-112, "Component Function Check"](#).

Is the inspection result normal?

YES >> GO TO 3.

NO >> Repair or replace the malfunctioning parts.

3.CONFIRM THE OPERATION

Check the operation again.

Is the result normal?

YES >> Check intermittent incident. Refer to [GI-43, "Intermittent Incident"](#).

NO >> GO TO 1.

STEERING TILT

STEERING TILT : Description

INFOID:000000006471660

Steering tilt only does not operate when memory operated.

MEMORY FUNCTION DOES NOT OPERATE

< SYMPTOM DIAGNOSIS >

STEERING TILT : Diagnosis Procedure

INFOID:000000006471661

1.CHECK MANUAL OPERATION

Check manual operation.

Is the inspection result normal?

YES >> GO TO 2.

NO >> Refer to [ADP-221, "STEERING TILT : Diagnosis Procedure"](#)

2.CHECK TILT SENSOR

Check steering tilt sensor.

Refer to [ADP-109, "Component Function Check"](#).

Is the inspection result normal?

YES >> GO TO 3.

NO >> Repair or replace the malfunctioning parts.

3.CONFIRM THE OPERATION

Check the operation again.

Is the result normal?

YES >> Check intermittent incident. Refer to [GI-43, "Intermittent Incident"](#).

NO >> GO TO 1.

DOOR MIRROR

DOOR MIRROR : Description

INFOID:000000006471662

Door mirror does not operate when memory operated.

DOOR MIRROR : Diagnosis Procedure

INFOID:000000006471663

1.CHECK MANUAL OPERATION

Check manual operation.

Is the inspection result normal?

YES >> GO TO 2.

NO >> Refer to [ADP-223, "DOOR MIRROR : Diagnosis Procedure"](#)

2.CHECK MIRROR SENSOR

Check mirror sensor.

• Refer to [ADP-115, "DRIVER SIDE : Component Function Check"](#). (Driver side)

• Refer to [ADP-117, "PASSENGER SIDE : Component Function Check"](#). (Passenger side)

Is the inspection result normal?

YES >> GO TO 3.

NO >> Repair or replace the malfunctioning parts.

3.CONFIRM THE OPERATION

Check the operation again.

Is the result normal?

YES >> Check intermittent incident. Refer to [GI-43, "Intermittent Incident"](#).

NO >> GO TO 1.

A
B
C
D
E
F
G
H
I
K
L
M
N
O
P

ADP

MEMORY INDICATE DOES NOT ILLUMINATE

< SYMPTOM DIAGNOSIS >

MEMORY INDICATE DOES NOT ILLUMINATE

Diagnosis Procedure

INFOID:000000006471664

1. CHECK MEMORY INDICATOR

Check memory indicator.

Refer to [ADP-134, "Component Function Check"](#).

Is the inspection result normal?

YES >> GO TO 2.

NO >> Repair or replace the malfunctioning parts.

2. CONFIRM THE OPERATION

Confirm the operation again.

Is the result normal?

YES >> Check intermittent incident. Refer to [GI-43, "Intermittent Incident"](#).

NO >> GO TO 1.

SEAT SYNCHRONIZATION FUNCTION DOES NOT OPERATE

< SYMPTOM DIAGNOSIS >

SEAT SYNCHRONIZATION FUNCTION DOES NOT OPERATE

Diagnosis Procedure

INFOID:000000006471665

1.CHECK SYSTEM SETTING

Check system setting.

Refer to [ADP-11, "SYSTEM SETTING : Special Repair Requirement"](#).

Is the inspection result normal?

YES >> Synchronization function is normal.

NO >> GO TO 2.

2.CHECK ALL FUNCTIONS MAMUAL OPERATION

Check all functions manual operation.

Is the inspection result normal?

YES >> GO TO 3.

NO >> Refer to [ADP-218, "ALL COMPONENT : Diagnosis Procedure"](#).

3.CONFIRM THE OPERATION

Check the operation again.

Is the result normal?

YES >> Check intermittent incident. Refer to [GI-43, "Intermittent Incident"](#).

NO >> GO TO 1.

A
B
C
D
E
F
G
H
I
K
L
M
N
O
P

ADP

POWER WALK-IN FUNCTION DOES NOT OPERATE

< SYMPTOM DIAGNOSIS >

POWER WALK-IN FUNCTION DOES NOT OPERATE

Diagnosis Procedure

INFOID:000000006471666

1. CHECK POWER WALK-IN FUNCTION

Check power walk-in function.

Refer to [ADP-39, "POWER WALK-IN FUNCTION : System Description"](#).

Is the inspection result normal?

YES >> Power walk-in function is OK.

NO >> GO TO 2.

2. PERFORM INITIALIZATION PROCEDURE

1. Perform initialization procedure.

Refer to [ADP-10, "SYSTEM INITIALIZATION : Special Repair Requirement"](#).

2. Check power walk-in function.

Refer to [ADP-39, "POWER WALK-IN FUNCTION : System Description"](#).

Is the inspection result normal?

YES >> Power walk-in function is normal.

NO >> GO TO 3.

3. CHECK POWER WALK-IN SWITCH

Check power walk-in switch.

Refer to [ADP-81, "Component Function Check"](#).

Is the inspection result normal?

YES >> GO TO 4.

NO >> Repair or replace the malfunctioning parts.

4. CHECK SEAT BELT BUCKLE SWITCH

Check seat belt buckle switch.

Refer to [ADP-77, "Component Function Check"](#).

Is the inspection result normal?

YES >> GO TO 5.

NO >> Repair or replace the malfunctioning parts.

5. CHECK FORWARD SWITCH

Check forward switch.

Refer to [ADP-75, "Component Function Check"](#).

Is the inspection result normal?

YES >> GO TO 6.

NO >> Repair or replace the malfunctioning parts.

6. CHECK SLIDING LIMIT SWITCH

Check sliding limit switch.

Refer to [ADP-79, "Component Function Check"](#).

Is the inspection result normal?

YES >> GO TO 7.

NO >> Repair or replace the malfunctioning parts.

7. CHECK DRIVER SIDE DOOR SWITCH

Check driver side door switch.

Refer to [DLK-71, "Component Function Check"](#).

Is the inspection result normal?

YES >> GO TO 8.

NO >> Repair or replace the malfunctioning parts.

8. CONFIRM THE OPERATION

Check the operation again.

POWER WALK-IN FUNCTION DOES NOT OPERATE

< SYMPTOM DIAGNOSIS >

Refer to [ADP-39. "POWER WALK-IN FUNCTION : System Description"](#).

Is the result normal?

- YES >> Check intermittent incident. Refer to [GI-43. "Intermittent Incident"](#).
- NO >> GO TO 1.

A
B
C
D
E
F
G
H
I
K
L
M
N
O
P

ADP

INTELLIGENT KEY INTERLOCK FUNCTION DOES NOT OPERATE

< SYMPTOM DIAGNOSIS >

INTELLIGENT KEY INTERLOCK FUNCTION DOES NOT OPERATE

Diagnosis Procedure

INFOID:000000006471667

1. CHECK DOOR LOCK FUNCTION

Check door lock function.

Refer to [DLK-7, "Work Flow"](#).

Is the inspection result normal?

YES >> GO TO 2.

NO >> Repair or replace the malfunctioning parts.

2. PERFORM MEMORY STORING PROCEDURE

1. Perform memory storing procedure.

Refer to [ADP-10, "MEMORY STORING : Special Repair Requirement"](#).

2. Check Intelligent Key interlock function.

Refer to [ADP-34, "INTELLIGENT KEY INTERLOCK FUNCTION : System Description"](#).

Is the inspection result normal?

YES >> Intelligent Key inter lock function is normal.

NO >> GO TO 1.

NORMAL OPERATING CONDITION

< SYMPTOM DIAGNOSIS >

NORMAL OPERATING CONDITION

Description

INFOID:000000006471668

The following symptoms are normal operations, and they do not indicate a malfunction.

Symptom	Cause	Action to take	Reference page
Seat synchronization function does not operate.	The synchronization function will not operate if the steering (tilt, telescopic) or the door mirror moves to the operating end while the seat synchronization function is operating.	Perform the memory function or drive the vehicle at more than 7km/h (4 MPH).	ADP-24
	Seat adjustment value has exceed any of the values below. <ul style="list-style-type: none"> • Seat sliding: 76 mm • Seat reclining: 9.1 degrees • Seat lifting (rear): 20 mm 	—	—
Side support or lumbar support does not perform memory operation.	The side support and the lumbar support are controlled independently with no link to the automatic drive positioner system.	—	Side support: SE-24
			Lumbar support: SE-27
Memory function, power walk-in function, seat synchronization function, or Intelligent Key interlock function does not operate.	The operating conditions are not fulfilled.	Fulfill the operation conditions.	Memory function: ADP-29
			Power walk-in function: ADP-39
			Seat synchronization function: ADP-24
			Intelligent Key interlock function: ADP-34

A
B
C
D
E
F
G
H
I
K
L
M
N
O
P

ADP

PRECAUTIONS

< PRECAUTION >

PRECAUTION

PRECAUTIONS

Precaution for Supplemental Restraint System (SRS) "AIR BAG" and "SEAT BELT PRE-TENSIONER"

INFOID:000000006471669

The Supplemental Restraint System such as "AIR BAG" and "SEAT BELT PRE-TENSIONER", used along with a front seat belt, helps to reduce the risk or severity of injury to the driver and front passenger for certain types of collision. This system includes seat belt switch inputs and dual stage front air bag modules. The SRS system uses the seat belt switches to determine the front air bag deployment, and may only deploy one front air bag, depending on the severity of a collision and whether the front occupants are belted or unbelted. Information necessary to service the system safely is included in the "SRS AIR BAG" and "SEAT BELT" of this Service Manual.

WARNING:

Always observe the following items for preventing accidental activation.

- To avoid rendering the SRS inoperative, which could increase the risk of personal injury or death in the event of a collision that would result in air bag inflation, all maintenance must be performed by an authorized NISSAN/INFINITI dealer.
- Improper maintenance, including incorrect removal and installation of the SRS, can lead to personal injury caused by unintentional activation of the system. For removal of Spiral Cable and Air Bag Module, see "SRS AIR BAG".
- Never use electrical test equipment on any circuit related to the SRS unless instructed to in this Service Manual. SRS wiring harnesses can be identified by yellow and/or orange harnesses or harness connectors.

PRECAUTIONS WHEN USING POWER TOOLS (AIR OR ELECTRIC) AND HAMMERS

WARNING:

Always observe the following items for preventing accidental activation.

- When working near the Air Bag Diagnosis Sensor Unit or other Air Bag System sensors with the ignition ON or engine running, never use air or electric power tools or strike near the sensor(s) with a hammer. Heavy vibration could activate the sensor(s) and deploy the air bag(s), possibly causing serious injury.
- When using air or electric power tools or hammers, always switch the ignition OFF, disconnect the battery, and wait at least 3 minutes before performing any service.

Service Procedure Precautions for Models with a Pop-up Roll Bar

INFOID:000000006471670

WARNING:

Always observe the following items for preventing accidental activation.

- Risk of passenger injury or death may increase if the pop-up roll bar does not deploy during a roll over collision. In order to reduce the chance of an incident where the pop-up roll bar is inoperative, all maintenance must be performed by a NISSAN or INFINITI dealer.
- Before removing and installing the pop-up roll bar component parts and harness, always turn the ignition switch OFF, disconnect the battery negative terminal, and wait for 3 minutes or more. (The purpose of this operation is to discharge electricity that is accumulated in the auxiliary power supply circuit in the air bag diagnosis sensor unit.)
- When repairing, removing, and installing a pop-up roll bar, always refer to SRS AIR BAG and SRS AIR BAG CONTROL warnings in the Service Manual.

Precaution for Battery Service

INFOID:000000006471671

Before disconnecting the battery, lower both the driver and passenger windows. This will prevent any interference between the window edge and the vehicle when the door is opened/closed. During normal operation, the window slightly raises and lowers automatically to prevent any window to vehicle interference. The automatic window function will not work with the battery disconnected.

Service

INFOID:000000006471672

- When removing or installing various parts, place a cloth or padding onto the vehicle body to prevent scratches.

PRECAUTIONS

< PRECAUTION >

- Handle trim, molding, instruments, grille, etc. carefully during removing or installing. Be careful not to oil or damage them. A
- Apply sealing compound where necessary when installing parts.
- When applying sealing compound, be careful that the sealing compound does not protrude from parts.
- When replacing any metal parts (for example body outer panel, members, etc.), be sure to take rust prevention measures. B

Work

INFOID:000000006471673

- When removing or disassembling each component, be careful not to damage or deform it. If a component may be subject to interference, be sure to protect it with a shop cloth. C
- When removing (disengaging) components with a screwdriver or similar tool, be sure to wrap the component with a shop cloth or vinyl tape to protect it. D
- Protect the removed parts with a shop cloth and keep them.
- Replace a deformed or damaged clip.
- If a part is specified as a non-reusable part, always replace it with new one. E
- Be sure to tighten bolts and nuts securely to the specified torque.
- After re-installation is completed, be sure to check that each part works normally.
- Follow the steps below to clean components. F
- Water soluble foul: Dip a soft cloth into lukewarm water, and wring the water out of the cloth to wipe the fouled area.
Then rub with a soft and dry cloth.
- Oily foul: Dip a soft cloth into lukewarm water with mild detergent (concentration: within 2 to 3%), and wipe the fouled area. G
Then dip a cloth into fresh water, and wring the water out of the cloth to wipe the detergent off. Then rub with a soft and dry cloth.
- Do not use organic solvent such as thinner, benzene, alcohol, and gasoline. H
- For genuine leather seats, use a genuine leather seat cleaner. I

ADP

K

L

M

N

O

P

DRIVER SEAT CONTROL UNIT

< REMOVAL AND INSTALLATION >

REMOVAL AND INSTALLATION

DRIVER SEAT CONTROL UNIT

Exploded View

INFOID:000000006471674

Refer to [SE-233, "Exploded View"](#).

Removal and Installation

INFOID:000000006471675

REMOVAL

CAUTION:

When removing and installing, use shop cloths to protect parts from damage.

1. Remove driver seat (1). Refer to [SE-244, "Removal and Installation"](#).
2. Remove mounting bolts (A).
3. Remove driver seat control unit (2).

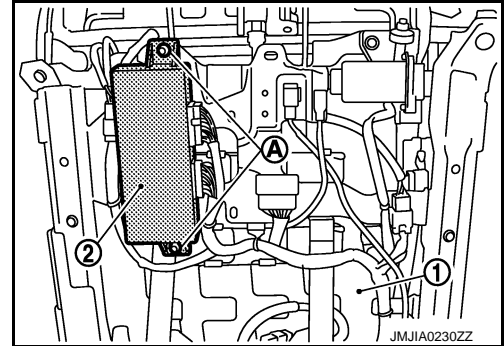

INSTALLATION

Install in reverse order of removal.

CAUTION:

Be sure to clump the harness to the right place.

NOTE:

After installing driver seat, perform additional service when replacing control unit. Refer to [ADP-9, "ADDITIONAL SERVICE WHEN REPLACING CONTROL UNIT : Special Repair Requirement"](#).

AUTOMATIC DRIVE POSITIONER CONTROL UNIT

< REMOVAL AND INSTALLATION >

AUTOMATIC DRIVE POSITIONER CONTROL UNIT

Exploded View

INFOID:000000006471676

Refer to [IP-12. "A/T MODELS : Exploded View"](#) (A/T models) or [IP-23. "M/T MODELS : Exploded View"](#) (M/T models).

Removal and Installation

INFOID:000000006471677

REMOVAL

CAUTION:

When removing and installing, use shop cloths to protect parts from damage.

1. Remove instrument driver lower panel. Refer to [IP-13. "A/T MODELS : Removal and Installation"](#) (A/T models) or [IP-24. "M/T MODELS : Removal and Installation"](#) (M/T models).
2. Remove screws (A).
3. Remove automatic drive positioner control unit (1).

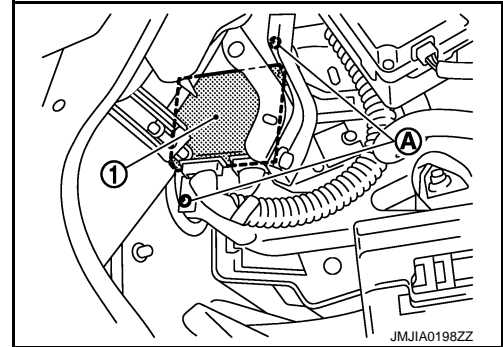

INSTALLATION

Install in reverse order of removal.

CAUTION:

Be sure to clump the harness to the right place.

A
B
C
D
E
F
G
H
I
K
L
M
N
O
P

ADP

SEAT MEMORY SWITCH

< REMOVAL AND INSTALLATION >

SEAT MEMORY SWITCH

Exploded View

INFOID:000000006471678

Refer to [INT-12. "Exploded View"](#)

Removal and Installation

INFOID:000000006471679

REMOVAL

CAUTION:

When removing and installing, use shop cloths to protect parts from damage.

1. Remove front door finisher (1). Refer to [INT-12. "Removal and Installation"](#).
2. Press pawls and remove seat memory switch (2) from front door finisher (1).

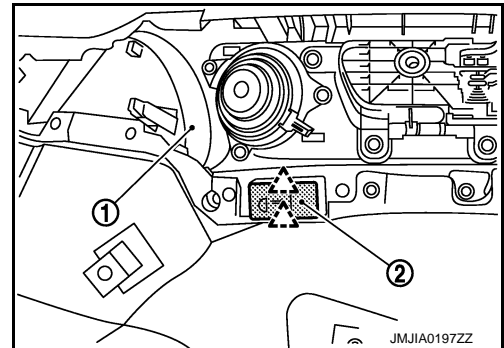

INSTALLATION

Install in reverse order of removal.

CAUTION:

Be sure to clump the harness to the right place.

POWER SEAT SWITCH

< REMOVAL AND INSTALLATION >

POWER SEAT SWITCH

Exploded View

INFOID:000000006471680

Refer to [SE-233, "Exploded View"](#).

Removal and Installation

INFOID:000000006471681

REMOVAL

CAUTION:

When removing and installing, use shop cloths to protect parts from damage.

1. Remove seat cushion outer finisher (1). Refer to [SE-244, "Removal and Installation"](#).
2. Remove screws (A).
3. Remove power seat switch (2) from seat cushion outer finisher (1).

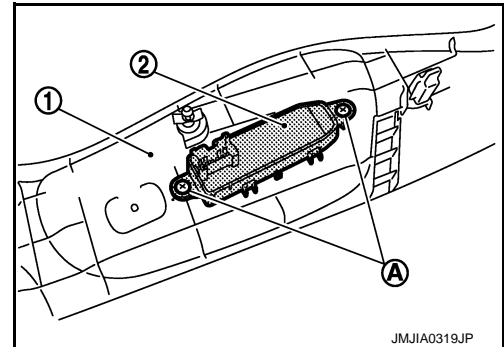

INSTALLATION

Install in reverse order of removal.

CAUTION:

Be sure to clump the harness to the right place.

A
B
C
D
E
F
G
H
I
K
L
M
N
O
P

ADP

SIDE SUPPORT SWITCH

< REMOVAL AND INSTALLATION >

SIDE SUPPORT SWITCH

Exploded View

INFOID:000000006471682

Refer to [SE-233. "Exploded View"](#)

Removal and Installation

INFOID:000000006471683

REMOVAL

CAUTION:

When removing and installing, use shop cloths to protect parts from damage.

1. Remove seat cushion outer finisher (1). Refer to [SE-244. "Removal and Installation"](#)
2. Remove screws (A).
3. Remove side support switch (2) from seat cushion outer finisher.

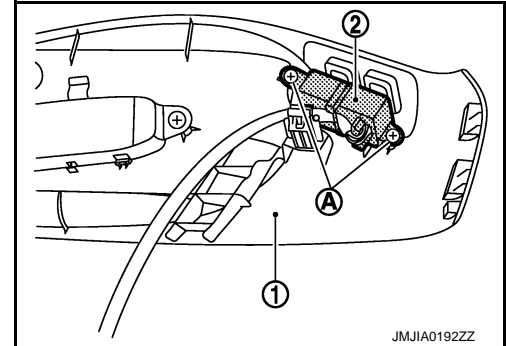

INSTALLATION

Install in reverse order of removal.

CAUTION:

Be sure to clump the harness to the right place.

TILT&TELESCOPIC SWITCH

< REMOVAL AND INSTALLATION >

TILT&TELESCOPIC SWITCH

Exploded View

INFOID:000000006471684

Refer to [IP-12, "A/T MODELS : Exploded View"](#) (A/T models) or [IP-23, "M/T MODELS : Exploded View"](#) (M/T models).

Removal and Installation

INFOID:000000006471685

REMOVAL

CAUTION:

When removing and installing, use shop cloths to protect parts from damage.

1. Remove steering column mask (1). Refer to [IP-13, "A/T MODELS : Removal and Installation"](#) (A/T models) or [IP-24, "M/T MODELS : Removal and Installation"](#) (M/T models).
2. Press pawls and remove tilt & telescopic switch (2) from steering column mask (1).

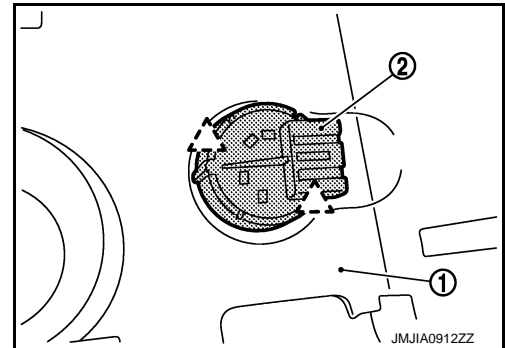

INSTALLATION

Install in reverse order of removal.

CAUTION:

Be sure to clump the harness to the right place.

A
B
C
D
E
F
G
H
I
K
L
M
N
O
P

ADP