

SECTION **DEF**  
**DEFOGGER**

A  
B  
C  
D  
E  
F  
G  
H  
I  
J  
K  
DEF  
M  
N  
O  
P

CONTENTS

<b>BASIC INSPECTION</b> .....	3	Diagnosis Procedure .....	14
<b>DIAGNOSIS AND REPAIR WORK FLOW</b> .....	3	Component Inspection .....	16
Work Flow .....	3	<b>DOOR MIRROR DEFOGGER</b> .....	17
<b>SYSTEM DESCRIPTION</b> .....	4	Description .....	17
<b>REAR WINDOW DEFOGGER SYSTEM</b> .....	4	Component Function Check .....	17
System Diagram .....	4	Diagnosis Procedure .....	17
System Description .....	4	<b>DRIVER SIDE DOOR MIRROR DEFOGGER</b> ...	19
Component Parts Location .....	5	Description .....	19
Component Description .....	5	Component Function Check .....	19
<b>DIAGNOSIS SYSTEM (BCM)</b> .....	7	Diagnosis Procedure .....	19
<b>COMMON ITEM</b> .....	7	<b>PASSENGER SIDE DOOR MIRROR DEFOGGER</b> .....	21
COMMON ITEM : CONSULT-III Function (BCM -		Description .....	21
COMMON ITEM) .....	7	Component Function Check .....	21
<b>REAR WINDOW DEFOGGER</b> .....	8	Diagnosis Procedure .....	21
REAR WINDOW DEFOGGER : CONSULT-III		<b>REAR WINDOW DEFOGGER SYSTEM</b> .....	23
Function (BCM - REAR DEFOGGER) .....	8	Wiring Diagram - DEFOGGER CONTROL SYS-	
<b>DTC/CIRCUIT DIAGNOSIS</b> .....	10	TEM - .....	23
<b>POWER SUPPLY AND GROUND CIRCUIT</b> ....	10	<b>ECU DIAGNOSIS INFORMATION</b> .....	28
Diagnosis Procedure .....	10	<b>BCM (BODY CONTROL MODULE)</b> .....	28
<b>REAR WINDOW DEFOGGER SWITCH</b> .....	11	Reference Value .....	28
Description .....	11	Wiring Diagram - BCM - .....	51
Component Function Check .....	11	Fail-safe .....	56
Diagnosis Procedure .....	11	DTC Inspection Priority Chart .....	58
<b>REAR WINDOW DEFOGGER RELAY</b> .....	12	DTC Index .....	60
Description .....	12	<b>SYMPTOM DIAGNOSIS</b> .....	63
Component Function Check .....	12	<b>REAR WINDOW DEFOGGER DOES NOT</b>	
Diagnosis Procedure .....	12	<b>OPERATE</b> .....	63
Component Inspection .....	13	Diagnosis Procedure .....	63
<b>REAR WINDOW DEFOGGER</b> .....	14	<b>REAR WINDOW DEFOGGER AND DOOR</b>	
Description .....	14	<b>MIRROR DEFOGGER DO NOT OPERATE.</b> ....	64
Component Function Check .....	14	Diagnosis Procedure .....	64

<b>REAR WINDOW DEFOGGER DOES NOT OPERATE BUT BOTH DOOR MIRROR DEFOGGERS OPERATE.</b> .....	<b>65</b>
Diagnosis Procedure .....	65
<b>DOOR MIRROR DEFOGGER DOES NOT OPERATE</b> .....	<b>66</b>
<b>BOTH SIDES</b> .....	<b>66</b>
BOTH SIDES : Diagnosis Procedure .....	66
<b>DRIVER SIDE</b> .....	<b>66</b>
DRIVER SIDE : Diagnosis Procedure .....	66
<b>PASSENGER SIDE</b> .....	<b>66</b>
PASSENGER SIDE : Diagnosis Procedure .....	66
<b>ON IS NOT DISPLAYED WHEN PRESSING REAR WINDOW DEFOGGER SWITCH BUT IT IS OPERATED</b> .....	<b>67</b>
Diagnosis Procedure .....	67

<b>REAR WINDOW DEFOGGER INDICATOR DOES NOT ILLUMINATE</b> .....	<b>68</b>
Diagnosis Procedure .....	68
<b>PRECAUTION</b> .....	<b>69</b>
<b>PRECAUTIONS</b> .....	<b>69</b>
Precaution for Supplemental Restraint System (SRS) "AIR BAG" and "SEAT BELT PRE-TENSIONER" .....	69
Precaution for Battery Service .....	69
<b>REMOVAL AND INSTALLATION</b> .....	<b>70</b>
<b>FILAMENT</b> .....	<b>70</b>
Inspection and Repair .....	70
<b>CONDENSER</b> .....	<b>72</b>
Exploded View .....	72
Removal and Installation .....	72

# DIAGNOSIS AND REPAIR WORK FLOW

< BASIC INSPECTION >

## BASIC INSPECTION

### DIAGNOSIS AND REPAIR WORK FLOW

#### Work Flow

INFOID:000000004249101

#### DETAILED FLOW

#### 1.OBTAIN INFORMATION ABOUT SYMPTOM

Interview the customer to obtain the malfunction information (conditions and environment when the malfunction occurred) as much as possible when the customer brings the vehicle in.

>> GO TO 2.

#### 2.CHECK DTC

Perform self diagnosis with CONSULT-III

Is any DTC detected?

YES >> Refer to [DEF-60. "DTC Index"](#)

NO >> GO TO 3.

#### 3.REPRODUCE THE MALFUNCTION INFORMATION

Check the malfunction on the vehicle that the customer describes.

Inspect the relation of the symptoms and the condition when the symptoms occur.

>> GO TO 4.

#### 4.IDENTIFY THE MALFUNCTIONING SYSTEM WITH "SYMPTOM DIAGNOSIS"

Use "Symptom diagnosis" from the symptom inspection result in step 3. Then identify where to start performing the diagnosis based on possible causes and symptoms.

>> GO TO 5.

#### 5.IDENTIFY MALFUNCTIONING PARTS WITH "COMPONENT DIAGNOSIS"

Perform the diagnosis with "Component diagnosis" of the applicable system.

>> GO TO 6.

#### 6.REPAIR OR REPLACE THE MALFUNCTIONING PARTS

Repair or replace the specified malfunctioning parts.

>> GO TO 7.

#### 7.FINAL CHECK

Check that malfunctions are not reproduced when obtaining the malfunction information from the customer, referring to the symptom inspection result in step 3.

Are all malfunctions corrected?

YES >> INSPECTION END

NO >> GO TO 4.

A  
B  
C  
D  
E  
F  
G  
H  
I  
J  
K  
DEF  
M  
N  
O  
P

# REAR WINDOW DEFOGGER SYSTEM

< SYSTEM DESCRIPTION >

## SYSTEM DESCRIPTION

### REAR WINDOW DEFOGGER SYSTEM

#### System Diagram

INFOID:000000004249102

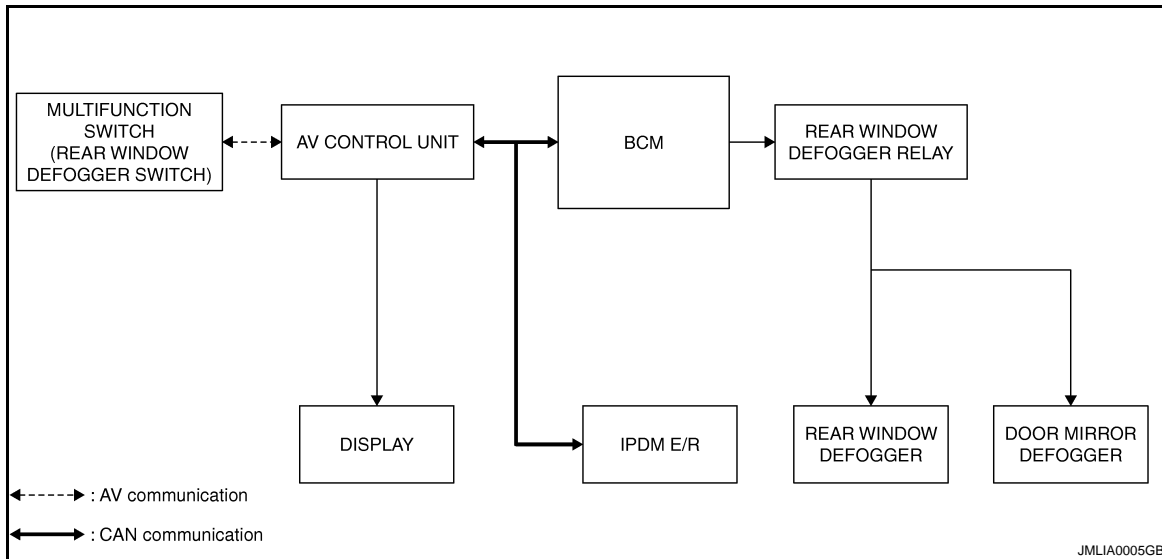

#### System Description

INFOID:000000004249103

#### Operation Description

- Turn rear window defogger switch ON when the ignition switch is turned ON. Then multifunction switch (rear window defogger switch) transmits rear window defogger switch signal to AV control unit via AV communication. AV control unit transmits rear window defogger switch signal to BCM via CAN communication.
- BCM turns rear window defogger relay ON and transmit rear window defogger ON signal to IPDM E/R via CAN communication when rear window defogger switch signal is received.
- Rear window defogger and door mirror defogger (with mirror defogger) are supplied with power and operate when rear window defogger relay turns ON.
- AV control unit transmit rear window defogger control signal to multifunction switch (rear window defogger switch) via AV communication.
- IPDM E/R transmits rear window defogger control signal to AV control unit via CAN communication.

#### Timer function

- BCM turns rear window defogger relay ON for approximately 15 minutes when rear window defogger switch is turned ON. It makes rear window defogger and door mirror defogger (with mirror defogger) operate.
- Timer is canceled after pressing rear window defogger switch again during timer operation. Then BCM turns rear window defogger relay OFF. The same reaction also occurs during timer operation, if the ignition switch is turned OFF.

# REAR WINDOW DEFOGGER SYSTEM

< SYSTEM DESCRIPTION >

## Component Parts Location

INFOID:000000004249104

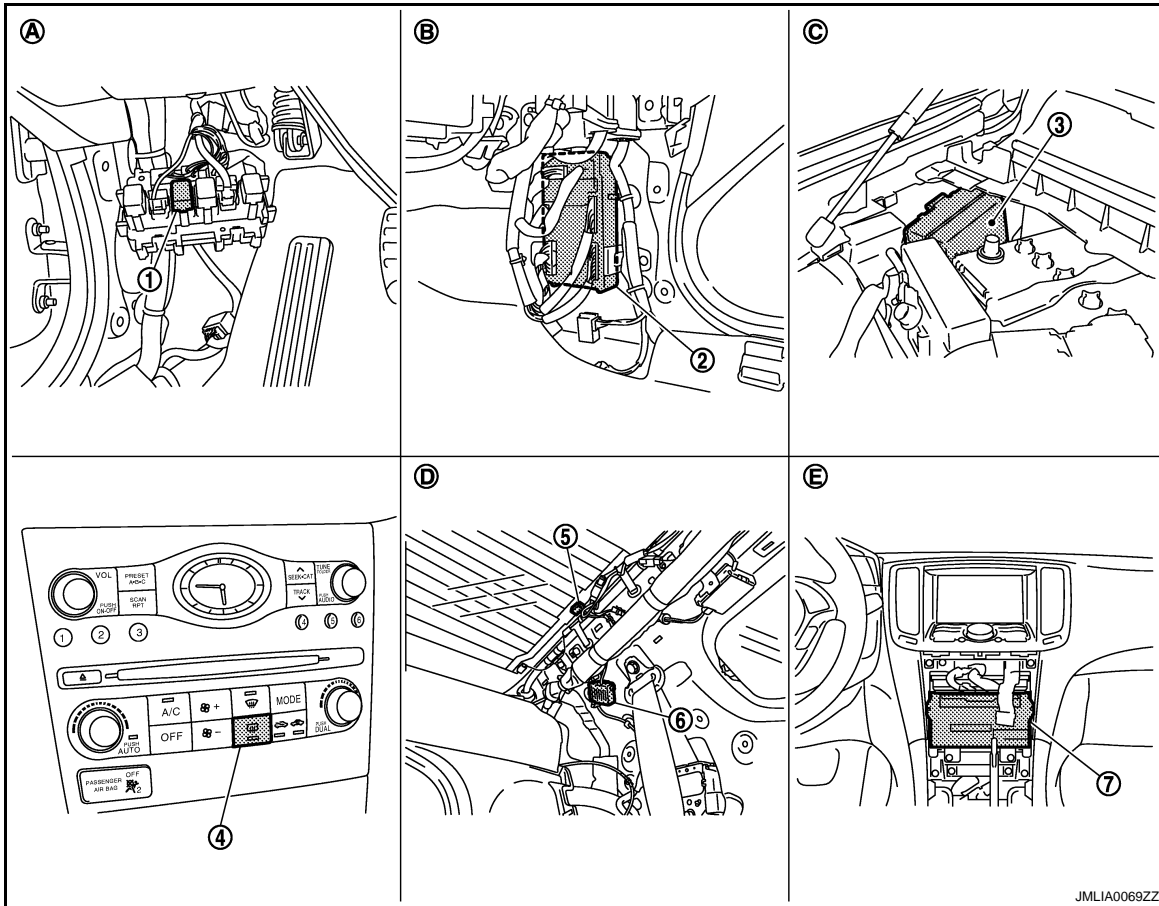

- |  |  |                                |
|--|--|--------------------------------|
| 1. Rear window defogger relay                                      | 2. BCM M118, M119, M122, M123                | 3. IPDM E/R E6                 |
| 4. Rear window defogger switch (built-in multifunction switch M72) | 5. Rear window defogger connector B401, B402 | 6. Condenser B26               |
| 7. AV control unit   |  |                                |
| • With NAVI: M87, M88  |  |                                |
| • Without NAVI: M83, M85   |  |                                |
| A. Dash side lower (driver side)                                   | B. Dash side lower (passenger side)          | C. Engine room dash panel (RH) |
| D. Behind rear pillar finisher (LH)                                | E. Behind cluster lid C                      |                                |

## Component Description

INFOID:000000004249105

BCM	<ul style="list-style-type: none"> <li>Operates the rear window defogger with the operation of rear window defogger switch</li> <li>Performs the timer control of rear window defogger</li> </ul>
Rear window defogger relay	Operates the rear window defogger and the door mirror defogger with the control signal from BCM
IPDM E/R	Transmit rear window defogger ON signal to AV control unit via CAN communication
Multifunction switch (Rear window defogger switch)	<ul style="list-style-type: none"> <li>The rear window defogger switch is installed</li> <li>Turns the indicator lamp ON when detecting the operation of rear window defogger</li> </ul>
AV control unit	Displays the rear window defogger ON to the display when detecting the operation of rear window defogger
Rear window defogger	Heats the heating wire with the power supply from the rear window defogger relay to prevent the rear window from fogging up
Door mirror defogger*	Heats the heating wire with the power supply from the rear window defogger relay to prevent the door mirror from fogging up

A  
B  
C  
D  
E  
F  
G  
H  
I  
J  
K  
L  
M  
N  
O  
P

DEF

# REAR WINDOW DEFOGGER SYSTEM

## < SYSTEM DESCRIPTION >

---

\*: With mirror defogger

# DIAGNOSIS SYSTEM (BCM)

< SYSTEM DESCRIPTION >

## DIAGNOSIS SYSTEM (BCM) COMMON ITEM

COMMON ITEM : CONSULT-III Function (BCM - COMMON ITEM)

INFOID:000000004610468

### APPLICATION ITEM

CONSULT-III performs the following functions via CAN communication with BCM.

Diagnosis mode	Function Description
Work Support	Changes the setting for each system function.
Self Diagnostic Result	Displays the diagnosis results judged by BCM.
CAN Diag Support Monitor	Monitors the reception status of CAN communication viewed from BCM. Refer to CONSULT-III operation manual.
Data Monitor	The BCM input/output signals are displayed.
Active Test	The signals used to activate each device are forcibly supplied from BCM.
Ecu Identification	The BCM part number is displayed.
Configuration	This function is not used even though it is displayed.

### SYSTEM APPLICATION

BCM can perform the following functions for each system.

#### NOTE:

It can perform the diagnosis modes except the following for all sub system selection items.

×: Applicable item

System	Sub system selection item	Diagnosis mode		
		Work Support	Data Monitor	Active Test
Door lock	DOOR LOCK	×	×	×
Rear window defogger	REAR DEFOGGER		×	×
Warning chime	BUZZER		×	×
Interior room lamp timer	INT LAMP	×	×	×
Exterior lamp	HEAD LAMP	×	×	×
Wiper and washer	WIPER	×	×	×
Turn signal and hazard warning lamps	FLASHER	×	×	×
—	AIR CONDITONER*			
• Intelligent Key system • Engine start system	INTELLIGENT KEY	×	×	×
Combination switch	COMB SW		×	
Body control system	BCM	×		
IVIS - NATS	IMMU		×	×
Interior room lamp battery saver	BATTERY SAVER	×	×	×
Trunk lid open	TRUNK		×	×
Vehicle security system	THEFT ALM	×	×	×
RAP system	RETAINED PWR*		×	
Signal buffer system	SIGNAL BUFFER		×	×
TPMS	TPMS (AIR PRESSURE MONITOR)	×	×	×

#### NOTE:

\*: This item is displayed, but is not used.

### FREEZE FRAME DATA (FFD)

The BCM records the following vehicle condition at the time a particular DTC is detected, and displays on CONSULT-III.

# DIAGNOSIS SYSTEM (BCM)

## < SYSTEM DESCRIPTION >

CONSULT screen item	Indication/Unit	Description	
Vehicle Speed	km/h	Vehicle speed of the moment a particular DTC is detected	
Odo/Trip Meter	km	Total mileage (Odometer value) of the moment a particular DTC is detected	
Vehicle Condition	SLEEP>LOCK	Power position status of the moment a particular DTC is detected	While turning BCM status from low power consumption mode to normal mode (Power supply position is "LOCK")
	SLEEP>OFF		While turning BCM status from low power consumption mode to normal mode (Power supply position is "OFF".)
	LOCK>ACC		While turning power supply position from "LOCK" to "ACC"
	ACC>ON		While turning power supply position from "ACC" to "IGN"
	RUN>ACC		While turning power supply position from "RUN" to "ACC" (Vehicle is stopping and selector lever is except P position.)
	CRANK>RUN		While turning power supply position from "CRANKING" to "RUN" (From cranking up the engine to run it)
	RUN>URGENT		While turning power supply position from "RUN" to "ACC" (Emergency stop operation)
	ACC>OFF		While turning power supply position from "ACC" to "OFF"
	OFF>LOCK		While turning power supply position from "OFF" to "LOCK"
	OFF>ACC		While turning power supply position from "OFF" to "ACC"
	ON>CRANK		While turning power supply position from "IGN" to "CRANKING"
	OFF>SLEEP		While turning BCM status from normal mode (Power supply position is "OFF".) to low power consumption mode
	LOCK>SLEEP		While turning BCM status from normal mode (Power supply position is "LOCK".) to low power consumption mode
	LOCK		Power supply position is "LOCK" (Ignition switch OFF with steering is locked.)
	OFF		Power supply position is "OFF" (Ignition switch OFF with steering is unlocked.)
	ACC		Power supply position is "ACC" (Ignition switch ACC)
	ON		Power supply position is "IGN" (Ignition switch ON with engine stopped)
	ENGINE RUN		Power supply position is "RUN" (Ignition switch ON with engine running)
CRANKING	Power supply position is "CRANKING" (At engine cranking)		
IGN Counter	0 - 39	<p>The number of times that ignition switch is turned ON after DTC is detected</p> <ul style="list-style-type: none"> <li>• The number is 0 when a malfunction is detected now.</li> <li>• The number increases like 1 → 2 → 3...38 → 39 after returning to the normal condition whenever ignition switch OFF → ON.</li> <li>• The number is fixed to 39 until the self-diagnosis results are erased if it is over 39.</li> </ul>	

## REAR WINDOW DEFOGGER

### REAR WINDOW DEFOGGER : CONSULT-III Function (BCM - REAR DEFOGGER)

INFOID:000000004249107

#### Data monitor

Monitor Item	Description
REAR DEF SW	This is displayed even when it is not equipped.
PUSH SW	Indicates [ON/OFF] condition of push switch.

#### ACTIVE TEST



# DIAGNOSIS SYSTEM (BCM)

## < SYSTEM DESCRIPTION >

Test Item	Description
REAR DEFOGGER	This test is able to check rear window defogger operation. Rear window defogger operates when "ON" on CONSULT-III screen is touched.

A

B

C

D

E

F

G

H

I

J

K

**DEF**

M

N

O

P

# POWER SUPPLY AND GROUND CIRCUIT

< DTC/CIRCUIT DIAGNOSIS >

## DTC/CIRCUIT DIAGNOSIS

### POWER SUPPLY AND GROUND CIRCUIT

#### Diagnosis Procedure

INFOID:000000004249108

#### 1. CHECK FUSE AND FUSIBLE LINK

Check that the following fuse and fusible link are not blown.

Terminal No.	Signal name	Fuse and fusible link No.
1	Battery power supply	K (40 A)
11		10 (10 A)

Is the inspection result normal?

YES >> GO TO 2.

NO >> Replace the blown fuse or fusible link after repairing the affected circuit if a fuse or fusible link is blown.

#### 2. CHECK POWER SUPPLY CIRCUIT

1. Turn ignition switch OFF.
2. Disconnect BCM connectors.
3. Check voltage between BCM harness connector and ground.

(+)		(-)	Voltage (Approx.)
BCM			
Connector	Terminal	Ground	Battery voltage
M118	1		
M119	11		

Is the inspection result normal?

YES >> GO TO 3.

NO >> Repair harness or connector.

#### 3. CHECK GROUND CIRCUIT

Check continuity between BCM harness connector and ground.

BCM		Ground	Continuity
Connector	Terminal		
M119	13		Existed

Is the inspection result normal?

YES >> INSPECTION END

NO >> Repair harness or connector.

# REAR WINDOW DEFOGGER SWITCH

< DTC/CIRCUIT DIAGNOSIS >

## REAR WINDOW DEFOGGER SWITCH

### Description

INFOID:000000004249109

- The rear window defogger is operated by turning the rear window defogger switch ON.
- The indicator lamp in the rear window defogger illuminates when the rear window defogger is operating.

### Component Function Check

INFOID:000000004249110

#### 1.CHECK REAR WINDOW DEFOGGER SWITCH FUNCTION

Check that the indicator lamp of rear window defogger illuminates when rear window defogger switch ON.

Is the inspection result normal?

- YES >> Rear window defogger switch function is OK.
- NO >> Refer to [DEF-11, "Diagnosis Procedure"](#)

### Diagnosis Procedure

INFOID:000000004249111

#### 1.CHECK MULTIFUNCTION SWITCH (REAR WINDOW DEFOGGER SWITCH)

Does multifunction switch operate normally?

- Base audio without navigation. Refer to [AV-19, "Diagnosis Description"](#)
- BOSE audio without navigation. Refer to [AV-138, "Diagnosis Description"](#)
- BOSE audio with navigation. Refer to [AV-393, "Diagnosis Description"](#)

Is the inspection result normal?

- YES >> INSPECTION END
- NO >> Replace multifunction switch (rear window defogger switch). Refer to [AV-119, "Removal and Installation"](#)

A  
B  
C  
D  
E  
F  
G  
H  
I  
J  
K  
DEF  
M  
N  
O  
P



# REAR WINDOW DEFOGGER RELAY

< DTC/CIRCUIT DIAGNOSIS >

## REAR WINDOW DEFOGGER RELAY

### Description

INFOID:000000004249112

Power is supplied to the rear window defogger with BCM control.

### Component Function Check

INFOID:000000004249113

#### 1.CHECK REAR WINDOW DEFOGGER RELAY POWER SUPPLY CIRCUIT

1. Perform Active Test ("REAR DEFOGGER") with CONSULT-III.
2. Touch "ON".
3. Check that the rear window heating wire is getting warmer.

Is the inspection result normal?

- YES >> Rear window defogger relay power supply circuit is OK.  
NO >> Refer to [DEF-12. "Diagnosis Procedure"](#)

### Diagnosis Procedure

INFOID:000000004249114

#### 1.CHECK FUSE

1. Turn ignition switch off.
2. Check the following.
  - 10A fuse [No.3, located in fuse block (J/B)]

Is the inspection result normal?

- YES >> GO TO 2.  
NO >> Replace the blown fuse after repairing the affected circuit if a fuse is blown.

#### 2.CHECK REAR WINDOW DEFOGGER CIRCUIT 1

1. Turn ignition switch ON.
2. Check voltage between BCM harness connector and ground.

(+)		(-)	Condition	Voltage (V) (Approx.)	
BCM					
Connector	Terminal				
M123	151	Ground	Rear window defogger switch	ON	0
				OFF	Battery voltage

Is the inspection result normal?

- YES >> GO TO 6.  
NO >> GO TO 3.

#### 3.CHECK REAR WINDOW DEFOGGER CIRCUIT 2

1. Turn ignition switch OFF.
2. Disconnect BCM connector and rear window defogger relay.
3. Check continuity between BCM harness connector and fuse block (J/B) harness connector.

BCM		Fuse block (J/B)		Continuity
Connector	Terminal	Connector	Terminal	
M123	151	M2	4B	Existed

Is the inspection result normal?

- YES >> GO TO 4.  
NO >> Repair or replace harness.

#### 4.CHECK REAR WINDOW DEFOGGER RELAY

Check rear window defogger relay.

Refer to [DEF-13. "Component Inspection"](#)

Is the inspection result normal?

# REAR WINDOW DEFOGGER RELAY

## < DTC/CIRCUIT DIAGNOSIS >

- YES >> GO TO 5.  
 NO >> Replace rear window defogger relay.

### 5.CHECK FUSE BLOCK (J/B)

1. Install the rear window defogger relay.
2. Turn ignition switch ON.
3. Check voltage between fuse block (J/B) (fuse block side) and ground.

(+)		(-)	Voltage (V) (Approx.)
Fuse block (J/B)			
Connector	Terminal		
M2	4B	Ground	Battery voltage

Is the inspection result normal?

- YES >> GO TO 6.  
 NO >> Repair or replace fuse block (J/B).

### 6.CHECK INTERMITTENT INCIDENT

Check intermittent incident.  
 Refer to [GI-41, "Intermittent Incident"](#)

>> INSPECTION END

## Component Inspection

INFOID:000000004249115

### 1.CHECK REAR WINDOW DEFOGGER RELAY

1. Turn ignition switch OFF.
2. Disconnect rear window defogger relay.
3. Check rear window defogger relay.

Terminal		Condition	Continuity
Rear window defogger relay			
3	5	12 V direct current supply between terminals 1 and 2.	Existed
		No current supply	Not existed

Is the inspection result normal?

- YES >> INSPECTION END  
 NO >> Replace rear window defogger relay.

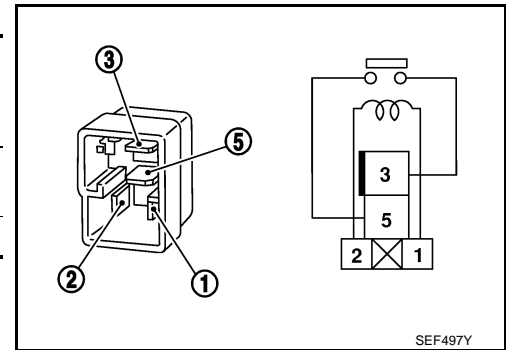

SEF497Y

A  
B  
C  
D  
E  
F  
G  
H  
I  
J  
K  
DEF  
M  
N  
O  
P

# REAR WINDOW DEFOGGER

< DTC/CIRCUIT DIAGNOSIS >

## REAR WINDOW DEFOGGER

### Description

INFOID:000000004249116

Heats the heating wire with the power supply from the rear window defogger relay to prevent the rear window from fogging up.

### Component Function Check

INFOID:000000004249117

### 1.CHECK REAR WINDOW DEFOGGER

1. Perform Active Test ("REAR DEFOGGER") with CONSULT-III.
2. Touch "ON".
3. Check that the rear window heating wire is getting warmer.

Is the inspection result normal?

- YES >> Rear window defogger is OK.  
NO >> Refer to [DEF-14, "Diagnosis Procedure"](#)

### Diagnosis Procedure

INFOID:000000004249118

### 1.CHECK FUSE

1. Turn ignition switch OFF.
2. Check the following.
  - 20A fuse [No.14, located in fuse block (J/B)]
  - 20A fuse [No.15, located in fuse block (J/B)]

Is the inspection result normal?

- YES >> GO TO 2.  
NO >> Replace the blown fuse after repairing the affected circuit if a fuse is blown.

### 2.CHECK POWER SUPPLY CIRCUIT

1. Turn ignition switch ON.
2. Check voltage between rear window defogger connector and ground.

(+)		(-)	Condition		Voltage (V) (Approx.)
Connector	Terminal				
B401	1	Ground	Rear window defogger switch	ON	Battery voltage
			OFF	0	

Is the inspection result normal?

- YES >> GO TO 3.  
NO >> GO TO 4.

### 3.CHECK GROUND CIRCUIT

1. Turn ignition switch OFF.
2. Disconnect rear window defogger connector.
3. Check continuity between rear window defogger harness connector and ground.

Rear window defogger		Ground	Continuity
Connector	Terminal		
B402	2		Existed

Is the inspection result normal?

- YES >> GO TO 7.  
NO >> Repair or replace harness.

### 4.CHECK REAR WINDOW DEFOGGER CIRCUIT 1

# REAR WINDOW DEFOGGER

## < DTC/CIRCUIT DIAGNOSIS >

1. Turn ignition switch OFF.
2. Disconnect condenser connector and rear window defogger connector.
3. Check continuity between condenser (condenser side) and rear window defogger harness connector.

Condenser		Rear window defogger		Continuity
Connector	Terminal	Connector	Terminal	
B26	1	B401	1	Existed

4. Check continuity between condenser (condenser side) connector and ground.

Condenser		Ground	Continuity
Connector	Terminal		
B26	1		Not existed

Is the inspection result normal?

YES >> GO TO 5.

NO >> Replace condenser. Refer to [DEF-72, "Removal and Installation"](#)

## 5. CHECK REAR WINDOW DEFOGGER CIRCUIT 2

1. Disconnect fuse block (J/B) connector.
2. Check continuity between fuse block (J/B) harness connector and condenser harness connector.

Fuse block (J/B)		Condenser		Continuity
Connector	Terminal	Connector	Terminal	
B6	10G	B26	1	Existed
	11G			

3. Check continuity between fuse block (J/B) harness connector and ground.

Fuse block (J/B)		Ground	Continuity
Connector	Terminal		
B6	10G		Not existed
	11G		

Is the inspection result normal?

YES >> GO TO 6.

NO >> Repair or replace harness.

## 6. CHECK FUSE BLOCK (J/B)

1. Turn ignition switch ON.
2. Check voltage between fuse block (J/B) (fuse block side) and ground.

(+)		(-)	Condition	Voltage (V) (Approx.)
Fuse block (J/B)				
Connector	Terminal			
B6	10G	Ground	Rear window defogger switch ON	Battery voltage
			Rear window defogger switch OFF	0
	11G		Rear window defogger switch ON	Battery voltage
			Rear window defogger switch OFF	0

Is the inspection result normal?

YES >> GO TO 8.

NO >> Repair or replace fuse block (J/B).

## 7. CHECK FILAMENT

Check filament.

Refer to [DEF-16, "Component Inspection"](#)

## REAR WINDOW DEFOGGER

< DTC/CIRCUIT DIAGNOSIS >

---

Is the inspection result normal?

YES >> GO TO 8.

NO >> Repair filament.

### 8.CHECK INTERMITTENT INCIDENT

---

Check intermittent incident.

Refer to [GI-41, "Intermittent Incident"](#)

>> INSPECTION END

### Component Inspection

INFOID:000000004249119

### 1.CHECK FILAMENT

---

Check the filament for damage or blown.

Refer to [DEF-70, "Inspection and Repair"](#)

Is the inspection result normal?

YES >> INSPECTION END

NO >> Repair filament.



# DOOR MIRROR DEFOGGER

< DTC/CIRCUIT DIAGNOSIS >

## DOOR MIRROR DEFOGGER

### Description

INFOID:000000004249120

Power is supplied to the door mirror defogger with BCM control.

### Component Function Check

INFOID:000000004249121

### 1.CHECK DOOR MIRROR DEFOGGER

1. Perform Active Test ("REAR DEFOGGER") with CONSULT-III.
2. Touch "ON".
3. Check that both side door mirror glass is getting warmer.

Is the inspection result normal?

- YES >> Door mirror defogger is OK.  
NO >> Refer to [DEF-17. "Diagnosis Procedure"](#)

### Diagnosis Procedure

INFOID:000000004612090

### 1.CHECK FUSE

1. Turn ignition switch OFF.
2. Check 10A fuse [No.13, located in fuse block (J/B)].

Is the inspection result normal?

- YES >> GO TO 2.  
NO >> Replace the blown fuse after repairing the affected circuit if a fuse is blown.

### 2.CHECK POWER SUPPLY CIRCUIT

1. Disconnect door mirror (driver side) connector.
2. Turn ignition switch ON.
3. Check voltage between door mirror (driver side) harness connector and ground.

(+)		(-)	Condition		Voltage (V) (Approx.)
Door mirror (driver side) Connector	Terminal				
D3	4	Ground	Rear window defogger switch	ON OFF	Battery voltage 0

Is the inspection result normal?

- YES >> GO TO 5.  
NO >> GO TO 3.

### 3.CHECK DRIVER SIDE DOOR MIRROR DEFOGGER CIRCUIT

1. Turn ignition switch OFF.
2. Disconnect fuse block (J/B) connector.
3. Check continuity between fuse block (J/B) harness connector and door mirror (driver side) harness connector.

Fuse block (J/B)		Door mirror (driver side)		Continuity
Connector	Terminal	Connector	Terminal	
M3	10C	D3	4	Existed

4. Check continuity between fuse block (J/B) harness connector and ground.

Fuse block (J/B)		Ground	Continuity
Connector	Terminal		
M3	10C		Not existed

Is the inspection result normal?

A  
B  
C  
D  
E  
F  
G  
H  
I  
J  
K  
DEF  
M  
N  
O  
P

# DOOR MIRROR DEFOGGER

## < DTC/CIRCUIT DIAGNOSIS >

---

- YES >> GO TO 4.  
NO >> Repair or replace harness.

### 4.CHECK FUSE BLOCK (J/B)

---

1. Turn ignition switch ON.
2. Check voltage between fuse block (J/B) (fuse block side) and ground.

(+)		(-)	Condition	Voltage (V) (Approx.)	
Fuse block (J/B)					
Connector	Terminal				
M3	10C	Ground	Rear window defogger	ON	Battery voltage
			switch	OFF	0

### Is the inspection result normal?

- YES >> GO TO 5.  
NO >> Repair or replace fuse block (J/B).

### 5.CHECK INTERMITTENT INCIDENT

---

Check intermittent incident.  
Refer to [GI-41, "Intermittent Incident"](#).

>> INSPECTION END

# DRIVER SIDE DOOR MIRROR DEFOGGER

< DTC/CIRCUIT DIAGNOSIS >

## DRIVER SIDE DOOR MIRROR DEFOGGER

### Description

INFOID:000000004249123

Heats the heating wire with the power supply from the rear window defogger relay to prevent the door mirror from fogging up.

### Component Function Check

INFOID:000000004249124

#### 1.CHECK DRIVER SIDE DOOR MIRROR DEFOGGER

1. Perform Active Test ("REAR DEFOGGER") with CONSULT-III.
2. Touch "ON".
3. Check that the driver side door mirror glass is getting warmer.

Is the inspection result normal?

- YES >> Driver side door mirror defogger is OK.  
NO >> Refer to [DEF-19, "Diagnosis Procedure"](#)

### Diagnosis Procedure

INFOID:000000004249125

#### 1.CHECK POWER SUPPLY CIRCUIT

1. Turn ignition switch OFF.
2. Disconnect door mirror (driver side) connector.
3. Turn ignition switch ON.
4. Check voltage between door mirror (driver side) harness connector and ground.

(+)		(-)	Condition		Voltage (V) (Approx.)
Door mirror (driver side) Connector	Terminal				
D3	4	Ground	Rear window defogger switch	ON	Battery voltage
				OFF	0

Is the inspection result normal?

- YES >> GO TO 3.  
NO >> GO TO 2.

#### 2.CHECK DRIVER SIDE DOOR MIRROR DEFOGGER CIRCUIT

1. Turn ignition switch OFF.
2. Check continuity between fuse block (J/B) harness connector and door mirror (driver side) harness connector.

Fuse block (J/B)		Door mirror (driver side)		Continuity
Connector	Terminal	Connector	Terminal	
M3	10C	D3	4	Existed

3. Check continuity between fuse block (J/B) harness connector and ground.

Fuse block (J/B)		Ground	Continuity
Connector	Terminal		
M3	10C		Not existed

Is the inspection result normal?

- YES >> GO TO 4.  
NO >> Repair or replace harness.

#### 3.CHECK GROUND CIRCUIT

1. Turn ignition switch OFF.
2. Check continuity between door mirror (driver side) harness connector and ground.

## DRIVER SIDE DOOR MIRROR DEFOGGER

< DTC/CIRCUIT DIAGNOSIS >

---

Door mirror (driver side)		Ground	Continuity
Connector	Terminal		Existed
D3	8		

---

Is the inspection result normal?

YES >> Replace door mirror glass (driver side). Refer to [MIR-19, "GLASS MIRROR : Disassembly and Assembly"](#)

NO >> Repair or replace harness.

### 4.CHECK INTERMITTENT INCIDENT

---

Check intermittent incident.

Refer to [GI-41, "Intermittent Incident"](#)

Is the inspection result normal?

>> INSPECTION END

# PASSENGER SIDE DOOR MIRROR DEFOGGER

< DTC/CIRCUIT DIAGNOSIS >

## PASSENGER SIDE DOOR MIRROR DEFOGGER

### Description

INFOID:000000004249127

Heats the heating wire with the power supply from the rear window defogger relay to prevent the door mirror from fogging up.

### Component Function Check

INFOID:000000004249128

#### 1.CHECK PASSENGER SIDE DOOR MIRROR DEFOGGER

1. Perform Active Test ("REAR DEFOGGER") with CONSULT-III.
2. Touch "ON".
3. Check that the passenger side door mirror glass is getting warmer.

Is the inspection result normal?

- YES >> Passenger side door mirror defogger is OK.  
NO >> Refer to [DEF-21, "Diagnosis Procedure"](#)

### Diagnosis Procedure

INFOID:000000004249129

#### 1.CHECK POWER SUPPLY CIRCUIT

1. Turn ignition switch OFF.
2. Disconnect door mirror (passenger side) connector.
3. Turn ignition switch ON.
4. Check voltage between door mirror (passenger side) harness connector and ground.

(+)		(-)	Condition		Voltage (V) (Approx.)
Door mirror (passenger side) Connector	Terminal				
D33	4	Ground	Rear window defogger switch	ON	Battery voltage
				OFF	0

Is the inspection result normal?

- YES >> GO TO 3.  
NO >> GO TO 2.

#### 2.CHECK PASSENGER SIDE DOOR MIRROR DEFOGGER CIRCUIT

1. Turn ignition switch OFF.
2. Check continuity between fuse block (J/B) harness connector and door mirror (passenger side) harness connector.

Fuse block (J/B)		Door mirror (passenger side)		Continuity
Connector	Terminal	Connector	Terminal	
M3	9C	D33	4	Existed

3. Check continuity between fuse block (J/B) harness connector and ground.

Fuse block (J/B)		Ground	Continuity
Connector	Terminal		
M3	9C		Not existed

Is the inspection result normal?

- YES >> GO TO 4.  
NO >> Repair or replace harness.

#### 3.CHECK GROUND CIRCUIT

1. Turn ignition switch OFF.
2. Check continuity between door mirror (passenger side) harness connector and ground.

A  
B  
C  
D  
E  
F  
G  
H  
I  
J  
K  
DEF  
M  
N  
O  
P

## PASSENGER SIDE DOOR MIRROR DEFOGGER

< DTC/CIRCUIT DIAGNOSIS >

---

Door mirror (passenger side)		Ground	Continuity
Connector	Terminal		Existed
D33	8		

---

Is the inspection result normal?

YES >> Replace door mirror glass (passenger side). Refer to [MIR-19, "GLASS MIRROR : Disassembly and Assembly"](#)

NO >> Repair or replace harness.

### 4. CHECK INTERMITTENT INCIDENT

---

Check intermittent incident.

Refer to [GI-41, "Intermittent Incident"](#)

>> INSPECTION END

# REAR WINDOW DEFOGGER SYSTEM

< DTC/CIRCUIT DIAGNOSIS >

## REAR WINDOW DEFOGGER SYSTEM

### Wiring Diagram - DEFOGGER CONTROL SYSTEM -



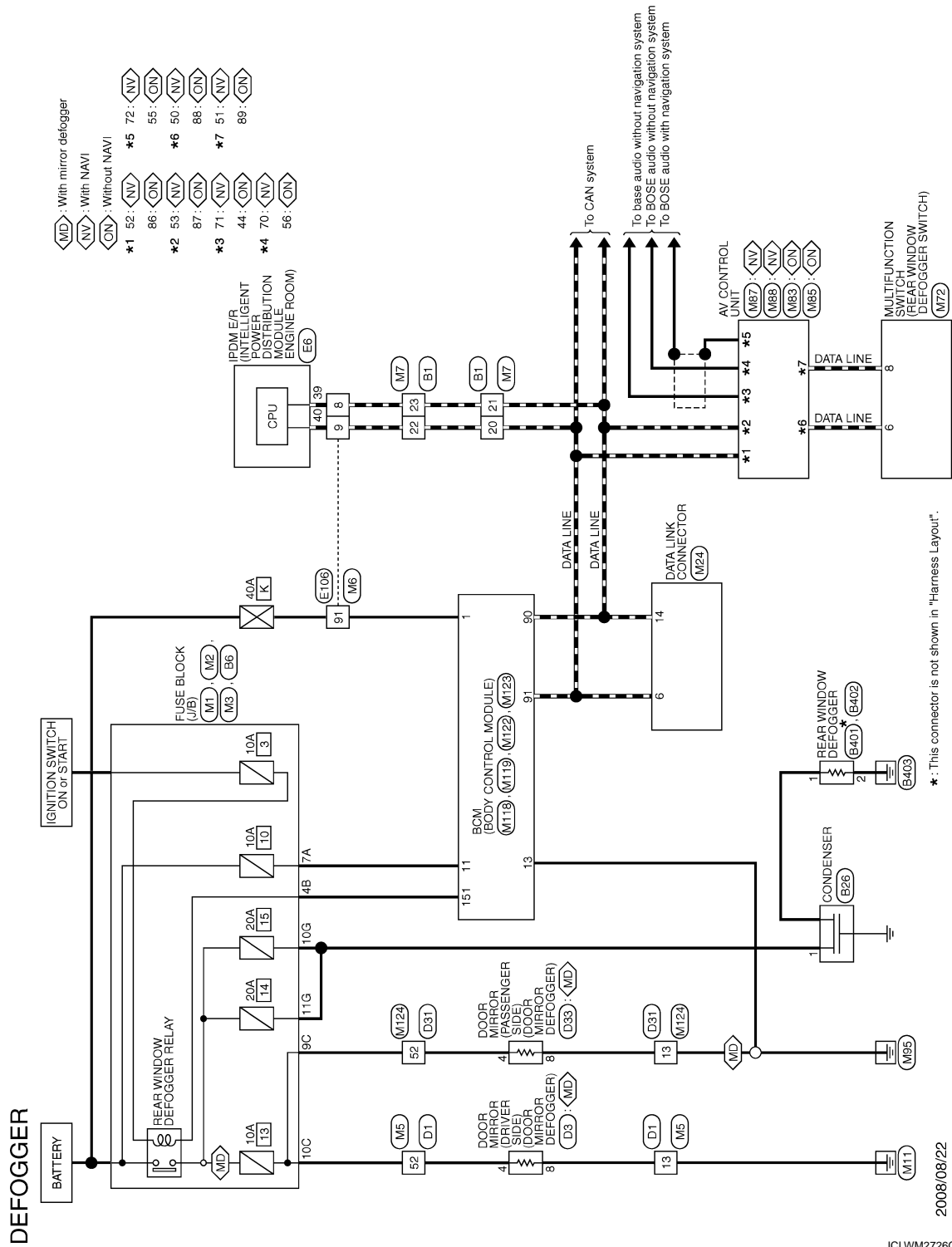

INFOID:000000004249132



# REAR WINDOW DEFOGGER SYSTEM

## < DTC/CIRCUIT DIAGNOSIS >

### DEFOGGER

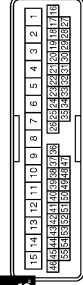
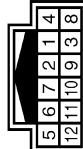
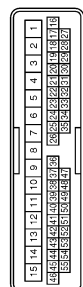
Connector No. B1	WIRE TO WIRE TH80FW-CS16-TM4		Terminal No.	Color of Wire	Signal Name [Specification]
Connector Name			20	L	-
Connector Type			21	P	-
			22	L	-
			23	P	-
Connector No. B401	REAR WINDOW DEFOGGER P01FB-A		Terminal No.	Color of Wire	Signal Name [Specification]
Connector Name			1	W	-
Connector Type					
Connector No. B26	CONDENSER M01FW-LC		Terminal No.	Color of Wire	Signal Name [Specification]
Connector Name			1	Y	-
Connector Type					
Connector No. B6	FUSE BLOCK (J/B) NS17FER-CS		Terminal No.	Color of Wire	Signal Name [Specification]
Connector Name			10G	W	-
Connector Type			11G	W	-
Connector No. B402	REAR WINDOW DEFOGGER P01FE-A		Terminal No.	Color of Wire	Signal Name [Specification]
Connector Name			2	-	-
Connector Type					
Connector No. D31	WIRE TO WIRE TH40FW-CS15		Terminal No.	Color of Wire	Signal Name [Specification]
Connector Name			13	B	-
Connector Type			52	L	-
Connector No. D3	DOOR MIRROR (DRIVER SIDE) TH12MW-NH		Terminal No.	Color of Wire	Signal Name [Specification]
Connector Name			4	L	-
Connector Type			8	B	-
Connector No. D1	WIRE TO WIRE TH40FW-CS15		Terminal No.	Color of Wire	Signal Name [Specification]
Connector Name			13	B	-
Connector Type			52	L	-











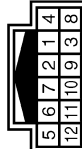





JCLWM2727GE

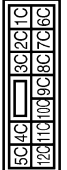

# REAR WINDOW DEFOGGER SYSTEM

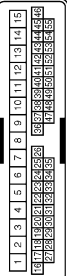
## < DTC/CIRCUIT DIAGNOSIS >

### DEFOGGER

Connector No. D33	DOOR MIRROR (PASSENGER SIDE)	TH2MW-NH		Terminal No.	Color of Wire	Signal Name [Specification]
Connector Name				4	L	-
Connector Type				8	B	-
						
Connector No. E106	WIRE TO WIRE	TH8DFW-CS16-TM4		Terminal No.	Color of Wire	Signal Name [Specification]
Connector Name				8	P	-
Connector Type				9	L	-
				91	G	-
						
Connector No. E6	IPDM E/R (INTELLIGENT POWER DISTRIBUTION MODULE ENGINE ROOM)	TR8DFW-NH		Terminal No.	Color of Wire	Signal Name [Specification]
Connector Name				39	P	-
Connector Type				40	L	-
						
Connector No. M2	FUSE BLOCK (J/B)	NS10FW-CS		Terminal No.	Color of Wire	Signal Name [Specification]
Connector Name				4	L	-
Connector Type				8	B	-
						
Connector No. M3	FUSE BLOCK (J/B)	NS12FW-CS		Terminal No.	Color of Wire	Signal Name [Specification]
Connector Name				9C	O	-
Connector Type				10C	L	-
						
Connector No. M4	FUSE BLOCK (J/B)	NS10FW-M2		Terminal No.	Color of Wire	Signal Name [Specification]
Connector Name				7A	R	-
Connector Type						
						
Connector No. M5	WIRE TO WIRE	TH4DMW-CS15		Terminal No.	Color of Wire	Signal Name [Specification]
Connector Name				13	B	-
Connector Type				52	L	-
						
Connector No. M6	WIRE TO WIRE	TH8DMW-CS16-TM4		Terminal No.	Color of Wire	Signal Name [Specification]
Connector Name				8	P	-
Connector Type				9	L	-
				91	W	-
						

JCLWM2728GE

A  
B  
C  
D  
E  
F  
G  
H  
I  
J  
K  
DEF  
M  
N  
O  
P

# REAR WINDOW DEFOGGER SYSTEM

## < DTC/CIRCUIT DIAGNOSIS >

### DEFOGGER

Connector No. M7	WIRE TO WIRE	TH80WV-CS16-TM4		<table border="1"> <tr><td>Terminal No.</td><td>Color of Wire</td><td>Signal Name [Specification]</td></tr> <tr><td>20</td><td>L</td><td>-</td></tr> <tr><td>21</td><td>P</td><td>-</td></tr> <tr><td>22</td><td>L</td><td>-</td></tr> <tr><td>23</td><td>P</td><td>-</td></tr> </table>	Terminal No.	Color of Wire	Signal Name [Specification]	20	L	-	21	P	-	22	L	-	23	P	-						
Terminal No.	Color of Wire	Signal Name [Specification]																							
20	L	-																							
21	P	-																							
22	L	-																							
23	P	-																							
Connector No. M3	AV CONTROL UNIT (WITHOUT NAVI)	TH24FW-NH		<table border="1"> <tr><td>Terminal No.</td><td>Color of Wire</td><td>Signal Name [Specification]</td></tr> <tr><td>44</td><td>BR</td><td>COMM (DISP-&gt;CONT)</td></tr> <tr><td>55</td><td>SHIELD</td><td>SHIELD</td></tr> <tr><td>56</td><td>Y</td><td>COMM (CONT-&gt;DISP)</td></tr> </table>	Terminal No.	Color of Wire	Signal Name [Specification]	44	BR	COMM (DISP->CONT)	55	SHIELD	SHIELD	56	Y	COMM (CONT->DISP)									
Terminal No.	Color of Wire	Signal Name [Specification]																							
44	BR	COMM (DISP->CONT)																							
55	SHIELD	SHIELD																							
56	Y	COMM (CONT->DISP)																							
Connector No. M72	MULTIFUNCTION SWITCH	TH16FW-NH		<table border="1"> <tr><td>Terminal No.</td><td>Color of Wire</td><td>Signal Name [Specification]</td></tr> <tr><td>6</td><td>SB</td><td>AV COMM (H)</td></tr> <tr><td>8</td><td>W</td><td>AV COMM (L)</td></tr> </table>	Terminal No.	Color of Wire	Signal Name [Specification]	6	SB	AV COMM (H)	8	W	AV COMM (L)												
Terminal No.	Color of Wire	Signal Name [Specification]																							
6	SB	AV COMM (H)																							
8	W	AV COMM (L)																							
Connector No. M24	DATA LINK CONNECTOR	BD16FW-P		<table border="1"> <tr><td>Terminal No.</td><td>Color of Wire</td><td>Signal Name [Specification]</td></tr> <tr><td>6</td><td>L</td><td>-</td></tr> <tr><td>14</td><td>P</td><td>-</td></tr> </table>	Terminal No.	Color of Wire	Signal Name [Specification]	6	L	-	14	P	-												
Terminal No.	Color of Wire	Signal Name [Specification]																							
6	L	-																							
14	P	-																							
Connector No. M85	AV CONTROL UNIT (WITHOUT NAVI)	TH22FW-NH		<table border="1"> <tr><td>Terminal No.</td><td>Color of Wire</td><td>Signal Name [Specification]</td></tr> <tr><td>86</td><td>L</td><td>CAN-H</td></tr> <tr><td>87</td><td>P</td><td>CAN-L</td></tr> <tr><td>88</td><td>V</td><td>AV COMM (H) [With BOSE system]</td></tr> <tr><td>88</td><td>SB</td><td>AV COMM (H) [Without BOSE system]</td></tr> <tr><td>89</td><td>LG</td><td>AV COMM (L) [With BOSE system]</td></tr> <tr><td>89</td><td>W</td><td>AV COMM (L) [Without BOSE system]</td></tr> </table>	Terminal No.	Color of Wire	Signal Name [Specification]	86	L	CAN-H	87	P	CAN-L	88	V	AV COMM (H) [With BOSE system]	88	SB	AV COMM (H) [Without BOSE system]	89	LG	AV COMM (L) [With BOSE system]	89	W	AV COMM (L) [Without BOSE system]
Terminal No.	Color of Wire	Signal Name [Specification]																							
86	L	CAN-H																							
87	P	CAN-L																							
88	V	AV COMM (H) [With BOSE system]																							
88	SB	AV COMM (H) [Without BOSE system]																							
89	LG	AV COMM (L) [With BOSE system]																							
89	W	AV COMM (L) [Without BOSE system]																							
Connector No. M87	AV CONTROL UNIT (WITH NAVI)	TH40FW-NH		<table border="1"> <tr><td>Terminal No.</td><td>Color of Wire</td><td>Signal Name [Specification]</td></tr> <tr><td>50</td><td>V</td><td>AV COMM (H)</td></tr> <tr><td>51</td><td>LG</td><td>AV COMM (L)</td></tr> <tr><td>52</td><td>L</td><td>CAN-H</td></tr> <tr><td>53</td><td>P</td><td>CAN-L</td></tr> </table>	Terminal No.	Color of Wire	Signal Name [Specification]	50	V	AV COMM (H)	51	LG	AV COMM (L)	52	L	CAN-H	53	P	CAN-L						
Terminal No.	Color of Wire	Signal Name [Specification]																							
50	V	AV COMM (H)																							
51	LG	AV COMM (L)																							
52	L	CAN-H																							
53	P	CAN-L																							
Connector No. M88	AV CONTROL UNIT (WITH NAVI)	TH12FW-NH		<table border="1"> <tr><td>Terminal No.</td><td>Color of Wire</td><td>Signal Name [Specification]</td></tr> <tr><td>70</td><td>BR</td><td>COMM (CONT-&gt;DISP)</td></tr> <tr><td>71</td><td>Y</td><td>COMM (DISP-&gt;CONT)</td></tr> <tr><td>72</td><td>SHIELD</td><td>SHIELD</td></tr> </table>	Terminal No.	Color of Wire	Signal Name [Specification]	70	BR	COMM (CONT->DISP)	71	Y	COMM (DISP->CONT)	72	SHIELD	SHIELD									
Terminal No.	Color of Wire	Signal Name [Specification]																							
70	BR	COMM (CONT->DISP)																							
71	Y	COMM (DISP->CONT)																							
72	SHIELD	SHIELD																							
Connector No. M18	BCM (BODY CONTROL MODULE)	MD3FB-LC		<table border="1"> <tr><td>Terminal No.</td><td>Color of Wire</td><td>Signal Name [Specification]</td></tr> <tr><td>1</td><td>W</td><td>BAT (F/L)</td></tr> </table>	Terminal No.	Color of Wire	Signal Name [Specification]	1	W	BAT (F/L)															
Terminal No.	Color of Wire	Signal Name [Specification]																							
1	W	BAT (F/L)																							

JCLWM2729GE

# REAR WINDOW DEFOGGER SYSTEM

## < DTC/CIRCUIT DIAGNOSIS >

DEFOGGER		
Connector No.	M119	
Connector Name	BCM (BODY CONTROL MODULE)	
Connector Type	TS16FW-CS	
Terminal No.	Color of Wire	Signal Name [Specification]
11	R	BAT (FUSE)
13	B	GND
Connector No.	M124	
Connector Name	WIRE TO WIRE	
Connector Type	TH40MP-CS15	
Terminal No.	Color of Wire	Signal Name [Specification]
13	B	
52	O	
Connector No.	M123	
Connector Name	BCM (BODY CONTROL MODULE)	
Connector Type	TH40FG-NH	
Terminal No.	Color of Wire	Signal Name [Specification]
151	G	REAR WINDOW DEFOGGER RELAY CONT
Connector No.	M122	
Connector Name	BCM (BODY CONTROL MODULE)	
Connector Type	TH40FP-NH	
Terminal No.	Color of Wire	Signal Name [Specification]
90	P	CAN-L
91	L	CAN-H

A  
B  
C  
D  
E  
F  
G  
H  
I  
J  
K  
DEF  
M  
N  
O  
P

JCLWM2730GE

## BCM (BODY CONTROL MODULE)

< ECU DIAGNOSIS INFORMATION >

# ECU DIAGNOSIS INFORMATION

## BCM (BODY CONTROL MODULE)

Reference Value

INFOID:000000004610460

### VALUES ON THE DIAGNOSIS TOOL

CONSULT-III MONITOR ITEM

Monitor Item	Condition	Value/Status
FR WIPER HI	Other than front wiper switch HI	Off
	Front wiper switch HI	On
FR WIPER LOW	Other than front wiper switch LO	Off
	Front wiper switch LO	On
FR WASHER SW	Front washer switch OFF	Off
	Front washer switch ON	On
FR WIPER INT	Other than front wiper switch INT	Off
	Front wiper switch INT	On
FR WIPER STOP	Front wiper is not in STOP position	Off
	Front wiper is in STOP position	On
INT VOLUME	Wiper intermittent dial is in a dial position 1 - 7	Wiper intermittent dial position
TURN SIGNAL R	Other than turn signal switch RH	Off
	Turn signal switch RH	On
TURN SIGNAL L	Other than turn signal switch LH	Off
	Turn signal switch LH	On
TAIL LAMP SW	Other than lighting switch 1ST and 2ND	Off
	Lighting switch 1ST or 2ND	On
HI BEAM SW	Other than lighting switch HI	Off
	Lighting switch HI	On
HEAD LAMP SW 1	Other than lighting switch 2ND	Off
	Lighting switch 2ND	On
HEAD LAMP SW 2	Other than lighting switch 2ND	Off
	Lighting switch 2ND	On
PASSING SW	Other than lighting switch PASS	Off
	Lighting switch PASS	On
AUTO LIGHT SW	Other than lighting switch AUTO	Off
	Lighting switch AUTO	On
FR FOG SW	Front fog lamp switch OFF	Off
	Front fog lamp switch ON	On
RR FOG SW	<b>NOTE:</b> The item is indicated, but not monitored.	Off
DOOR SW-DR	Driver door closed	Off
	Driver door opened	On
DOOR SW-AS	Passenger door closed	Off
	Passenger door opened	On
DOOR SW-RR	<b>NOTE:</b> The item is indicated, but not monitored.	Off

## BCM (BODY CONTROL MODULE)

### < ECU DIAGNOSIS INFORMATION >

Monitor Item	Condition	Value/Status	
DOOR SW-RL	<b>NOTE:</b> The item is indicated, but not monitored.	Off	A
DOOR SW-BK	<b>NOTE:</b> The item is indicated, but not monitored.	Off	B
CDL LOCK SW	Other than power door lock switch LOCK	Off	C
	Power door lock switch LOCK	On	
CDL UNLOCK SW	Other than power door lock switch UNLOCK	Off	D
	Power door lock switch UNLOCK	On	
KEY CYL LK-SW	Other than driver door key cylinder LOCK position	Off	E
	Driver door key cylinder LOCK position	On	
KEY CYL UN-SW	Other than driver door key cylinder UNLOCK position	Off	F
	Driver door key cylinder UNLOCK position	On	
KEY CYL SW-TR	<b>NOTE:</b> The item is indicated, but not monitored.	Off	G
HAZARD SW	Hazard switch is OFF	Off	H
	Hazard switch is ON	On	
REAR DEF SW	<b>NOTE:</b> The item is indicated, but not monitored.	Off	I
H/L WASH SW	<b>NOTE:</b> The item is indicated, but not monitored.	Off	J
TR CANCEL SW	Trunk lid opener cancel switch OFF	Off	K
	Trunk lid opener cancel switch ON	On	
TR/BD OPEN SW	Trunk lid opener switch OFF	Off	DEF
	While the trunk lid opener switch is turned ON	On	
TRNK/HAT MNTR	Trunk lid closed	Off	M
	Trunk lid opened	On	
RKE-LOCK	LOCK button of the Intelligent Key is not pressed	Off	N
	LOCK button of the Intelligent Key is pressed	On	
RKE-UNLOCK	UNLOCK button of the Intelligent Key is not pressed	Off	O
	UNLOCK button of the Intelligent Key is pressed	On	
RKE-TR/BD	TRUNK OPEN button of the Intelligent Key is not pressed	Off	P
	TRUNK OPEN button of the Intelligent Key is pressed	On	
RKE-PANIC	PANIC button of the Intelligent Key is not pressed	Off	
	PANIC button of the Intelligent Key is pressed	On	
RKE-P/W OPEN	UNLOCK button of the Intelligent Key is not pressed	Off	
	UNLOCK button of the Intelligent Key is pressed and held	On	
RKE-MODE CHG	LOCK/UNLOCK button of the Intelligent Key is not pressed and held simultaneously	Off	
	LOCK/UNLOCK button of the Intelligent Key is pressed and held simultaneously	On	
OPTICAL SENSOR	Bright outside of the vehicle	Close to 5 V	
	Dark outside of the vehicle	Close to 0 V	
REQ SW -DR	Driver door request switch is not pressed	Off	
	Driver door request switch is pressed	On	
REQ SW -AS	Passenger door request switch is not pressed	Off	
	Passenger door request switch is pressed	On	
REQ SW -RR	<b>NOTE:</b> The item is indicated, but not monitored.	Off	

## BCM (BODY CONTROL MODULE)

### < ECU DIAGNOSIS INFORMATION >

Monitor Item	Condition	Value/Status
REQ SW -RL	<b>NOTE:</b> The item is indicated, but not monitored.	Off
REQ SW -BD/TR	Trunk lid opener request switch is not pressed	Off
	Trunk lid opener request switch is pressed	On
PUSH SW	Push-button ignition switch (push switch) is not pressed	Off
	Push-button ignition switch (push switch) is pressed	On
IGN RLY2 -F/B	Ignition switch in OFF or ACC position	Off
	Ignition switch in ON position	On
ACC RLY -F/B	<b>NOTE:</b> The item is indicated, but not monitored.	Off
CLUCH SW	The clutch pedal is not depressed	Off
	The clutch pedal is depressed	On
BRAKE SW 1	The brake pedal is depressed when No. 7 fuse is blown	Off
	The brake pedal is not depressed when No. 7 fuse is blown, or No. 7 fuse is normal	On
BRAKE SW 2	The brake pedal is not depressed	Off
	The brake pedal is depressed	On
DETE/CANCL SW	<ul style="list-style-type: none"> <li>• Selector lever in P position (Except M/T models)</li> <li>• The clutch pedal is depressed (M/T models)</li> </ul>	Off
	<ul style="list-style-type: none"> <li>• Selector lever in any position other than P (Except M/T models)</li> <li>• The clutch pedal is not depressed (M/T models)</li> </ul>	On
SFT PN/N SW	Selector lever in any position other than P and N	Off
	Selector lever in P or N position	On
S/L -LOCK	Steering is unlocked	Off
	Steering is locked	On
S/L -UNLOCK	Steering is locked	Off
	Steering is unlocked	On
S/L RELAY-F/B	Ignition switch in OFF or ACC position	Off
	Ignition switch in ON position	On
UNLK SEN -DR	Driver door is unlocked	Off
	Driver door is locked	On
PUSH SW -IPDM	Push-button ignition switch (push-switch) is not pressed	Off
	Push-button ignition switch (push-switch) is pressed	On
IGN RLY1 -F/B	Ignition switch in OFF or ACC position	Off
	Ignition switch in ON position	On
DETE SW -IPDM	Selector lever in any position other than P	Off
	Selector lever in P position	On
SFT PN -IPDM	<ul style="list-style-type: none"> <li>• Selector lever in any position other than P and N (Except M/T models)</li> <li>• The clutch pedal is not depressed (M/T models)</li> </ul>	Off
	<ul style="list-style-type: none"> <li>• Selector lever in P or N position</li> <li>• The clutch pedal is depressed</li> </ul>	On
SFT P -MET	Selector lever in any position other than P	Off
	Selector lever in P position	On
SFT N -MET	Selector lever in any position other than N	Off
	Selector lever in N position	On

## BCM (BODY CONTROL MODULE)

### < ECU DIAGNOSIS INFORMATION >

Monitor Item	Condition	Value/Status	
ENGINE STATE	Engine stopped	Stop	A
	While the engine stalls	Stall	
	At engine cranking	Crank	B
	Engine running	Run	
S/L LOCK-IPDM	Steering is unlocked	Off	
	Steering is locked	On	C
S/L UNLK-IPDM	Steering is locked	Off	
	Steering is unlocked	On	D
S/L RELAY-REQ	Steering lock system is not the LOCK condition and the changing condition from LOCK to UNLOCK	Off	
	Steering lock system are not the LOCK condition or the changing condition from LOCK to UNLOCK	On	E
VEH SPEED 1	While driving	Equivalent to speedometer reading	F
VEH SPEED 2	While driving	Equivalent to speedometer reading	
DOOR STAT-DR	Driver door is locked	LOCK	G
	Wait with selective UNLOCK operation (60 seconds)	READY	
	Driver door is unlocked	UNLOCK	
DOOR STAT-AS	Passenger door is locked	LOCK	H
	Wait with selective UNLOCK operation (60 seconds)	READY	
	Passenger door is unlocked	UNLOCK	
ID OK FLAG	Steering is locked	Reset	I
	Steering is unlocked	Set	
PRMT ENG STRT	The engine start is prohibited	Reset	J
	The engine start is permitted	Set	
PRMT RKE STRT	<b>NOTE:</b> The item is indicated, but not monitored.	Reset	K
KEY SW -SLOT	The Intelligent Key is not inserted into key slot	Off	
	The Intelligent Key is inserted into key slot	On	DEF
RKE OPE COUN1	During the operation of the Intelligent Key	Operation frequency of the Intelligent Key	
RKE OPE COUN2	<b>NOTE:</b> The item is indicated, but not monitored.	—	M
CONFIRM ID ALL	The key ID that the key slot receives is not recognized by any key ID registered to BCM.	Yet	
	The key ID that the key slot receives is recognized by any key ID registered to BCM.	Done	N
CONFIRM ID4	The key ID that the key slot receives is not recognized by the fourth key ID registered to BCM.	Yet	O
	The key ID that the key slot receives is recognized by the fourth key ID registered to BCM.	Done	
CONFIRM ID3	The key ID that the key slot receives is not recognized by the third key ID registered to BCM.	Yet	P
	The key ID that the key slot receives is recognized by the third key ID registered to BCM.	Done	

## BCM (BODY CONTROL MODULE)

### < ECU DIAGNOSIS INFORMATION >

Monitor Item	Condition	Value/Status
CONFIRM ID2	The key ID that the key slot receives is not recognized by the second key ID registered to BCM.	Yet
	The key ID that the key slot receives is recognized by the second key ID registered to BCM.	Done
CONFIRM ID1	The key ID that the key slot receives is not recognized by the first key ID registered to BCM.	Yet
	The key ID that the key slot receives is recognized by the first key ID registered to BCM.	Done
TP 4	The ID of fourth Intelligent Key is not registered to BCM	Yet
	The ID of fourth Intelligent Key is registered to BCM	Done
TP 3	The ID of third Intelligent Key is not registered to BCM	Yet
	The ID of third Intelligent Key is registered to BCM	Done
TP 2	The ID of second Intelligent Key is not registered to BCM	Yet
	The ID of second Intelligent Key is registered to BCM	Done
TP 1	The ID of first Intelligent Key is not registered to BCM	Yet
	The ID of first Intelligent Key is registered to BCM	Done
AIR PRESS FL	Ignition switch ON (Only when the signal from the transmitter is received)	Air pressure of front LH tire
AIR PRESS FR	Ignition switch ON (Only when the signal from the transmitter is received)	Air pressure of front RH tire
AIR PRESS RR	Ignition switch ON (Only when the signal from the transmitter is received)	Air pressure of rear RH tire
AIR PRESS RL	Ignition switch ON (Only when the signal from the transmitter is received)	Air pressure of rear LH tire
ID REGST FL1	ID of front LH tire transmitter is registered	Done
	ID of front LH tire transmitter is not registered	Yet
ID REGST FR1	ID of front RH tire transmitter is registered	Done
	ID of front RH tire transmitter is not registered	Yet
ID REGST RR1	ID of rear RH tire transmitter is registered	Done
	ID of rear RH tire transmitter is not registered	Yet
ID REGST RL1	ID of rear LH tire transmitter is registered	Done
	ID of rear LH tire transmitter is not registered	Yet
WARNING LAMP	Tire pressure indicator OFF	Off
	Tire pressure indicator ON	On
BUZZER	Tire pressure warning alarm is not sounding	Off
	Tire pressure warning alarm is sounding	On



# BCM (BODY CONTROL MODULE)

< ECU DIAGNOSIS INFORMATION >

## TERMINAL LAYOUT

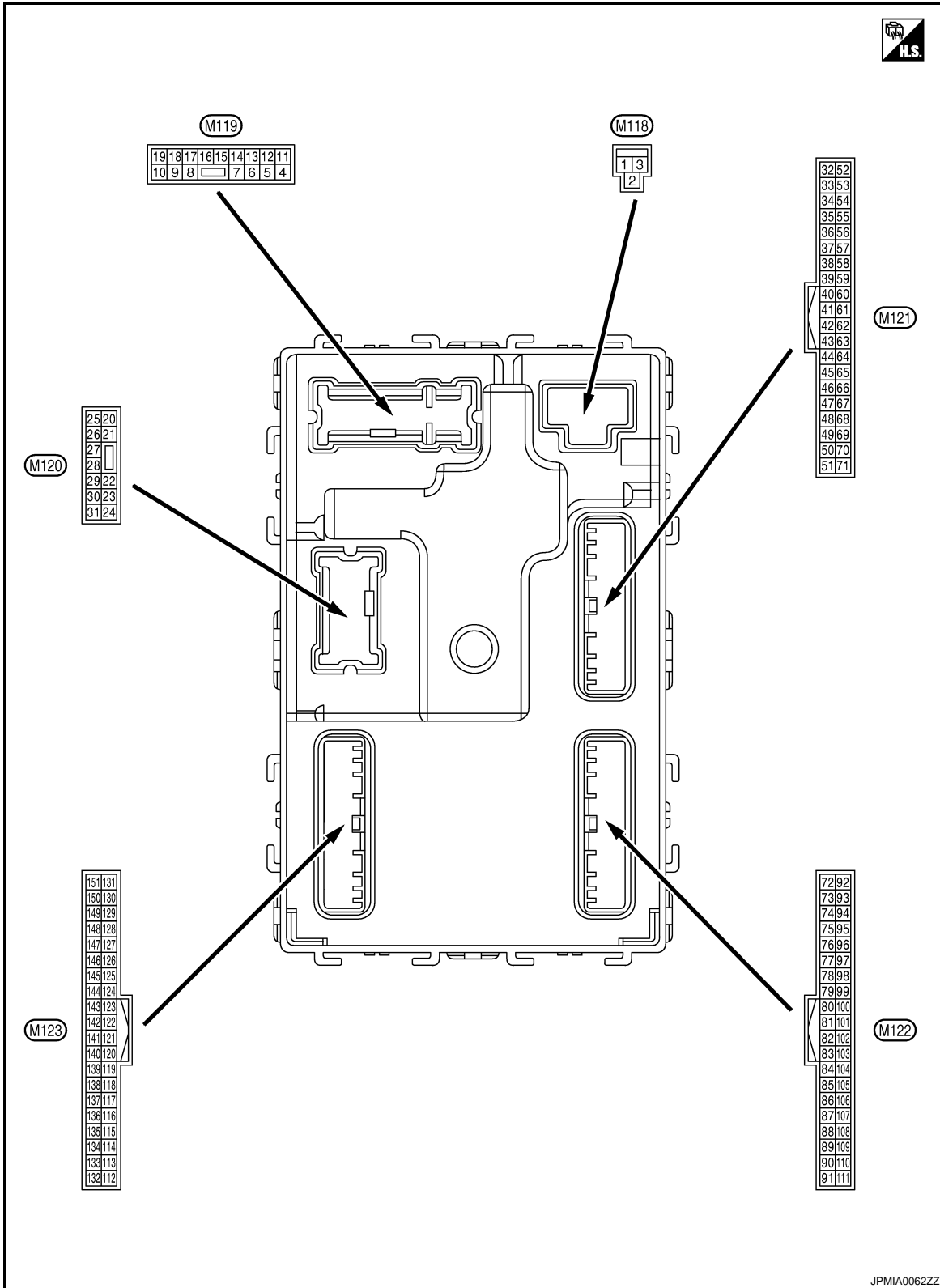

## PHYSICAL VALUES

A  
B  
C  
D  
E  
F  
G  
H  
I  
J  
K  
DEF  
M  
N  
O  
P

# BCM (BODY CONTROL MODULE)

## < ECU DIAGNOSIS INFORMATION >

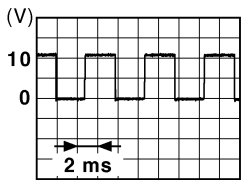
Terminal No. (Wire color)		Description		Condition		Value (Approx.)
		Signal name	Input/ Output			
+	-					
1 (W)	Ground	Battery power supply	Input	Ignition switch OFF		Battery voltage
2 (Y)	Ground	P/W power supply (BAT)	Output	Ignition switch OFF		12 V
3 (O)	Ground	P/W power supply (RAP)	Output	Ignition switch ON		12 V
4 (LG)	Ground	Interior room lamp power supply	Output	Interior room lamp battery saver is activated. (Cuts the interior room lamp power supply)		0 V
				Interior room lamp battery saver is not activated. (Outputs the interior room lamp power supply)		12 V
5 (P)	Ground	Passenger door UN- LOCK	Output	Passenger door	UNLOCK (Actuator is activated)	12 V
					Other than UNLOCK (Ac- tuator is not activated)	0 V
7 (SB)	Ground	Step lamp	Output	Step lamp	ON	0 V
					OFF	12 V
8 (V)	Ground	All doors, fuel lid LOCK	Output	All doors, fuel lid	LOCK (Actuator is activated)	12 V
					Other than LOCK (Actuator is not activated)	0 V
9 (G)	Ground	Driver door, fuel lid UNLOCK	Output	Driver door, fuel lid	UNLOCK (Actuator is activated)	12 V
					Other than UNLOCK (Actuator is not activated)	0 V
11 (R)	Ground	Battery power supply	Input	Ignition switch OFF		Battery voltage
13 (B)	Ground	Ground	—	Ignition switch ON		0 V
14 (W)	Ground	Push-button ignition switch illumination ground	Output	Tail lamp	OFF	0 V
					ON	<p style="text-align: center;"><b>NOTE:</b> When the illumination brighten- ing/dimming level is in the neutral position.</p>  <p style="text-align: right; font-size: small;">JSNIA0010GB</p>
15 (O)	Ground	ACC indicator lamp	Output	Ignition switch	OFF (LOCK indicator is not illuminated)	Battery voltage
					ACC	0 V

# BCM (BODY CONTROL MODULE)

## < ECU DIAGNOSIS INFORMATION >

Terminal No. (Wire color)		Description		Condition	Value (Approx.)
+	-	Signal name	Input/ Output		
17 (W)	Ground	Turn signal RH (Front)	Output	Ignition switch ON	0 V
				Turn signal switch OFF	6.5 V
18 (O)	Ground	Turn signal LH (Front)	Output	Ignition switch ON	0 V
				Turn signal switch OFF	6.5 V
19 (V)	Ground	Room lamp timer control	Output	Interior room lamp	OFF
				ON	12 V
20 (V)	Ground	Turn signal RH (Rear)	Output	Ignition switch ON	0 V
				Turn signal switch OFF	6.5 V
23 (L)	Ground	Trunk lid open	Output	Trunk lid	OPEN (Trunk lid opener actuator is activated)
				Other than OPEN (Trunk lid opener actuator is not activated)	12 V
					0 V
25 (Y)	Ground	Turn signal LH (Rear)	Output	Ignition switch ON	0 V
				Turn signal switch OFF	6.5 V
30 (P)	Ground	Trunk room lamp	Output	Trunk room lamp	ON
				OFF	12 V

A  
B  
C  
D  
E  
F  
G  
H  
I  
J  
K  
DEF  
M  
N  
O  
P

# BCM (BODY CONTROL MODULE)

## < ECU DIAGNOSIS INFORMATION >

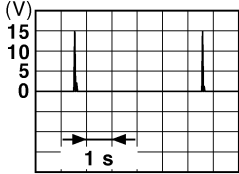
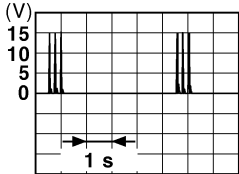
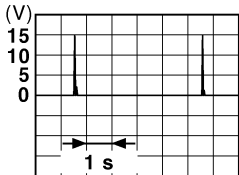
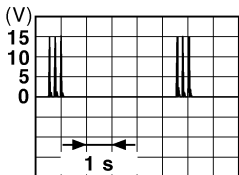
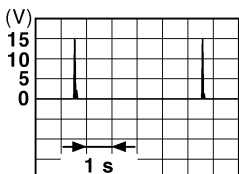
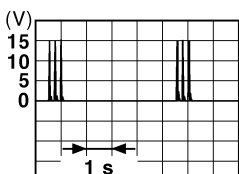
Terminal No. (Wire color)		Description		Condition	Value (Approx.)
+	-	Signal name	Input/ Output		
34 (SB)	Ground	Trunk room antenna (-)	Output	Ignition switch OFF	 <p style="text-align: right; font-size: small;">JMKIA0062GB</p>
				When Intelligent Key is not in the passenger compart- ment	 <p style="text-align: right; font-size: small;">JMKIA0063GB</p>
35 (V)	Ground	Trunk room antenna (+)	Output	Ignition switch OFF	 <p style="text-align: right; font-size: small;">JMKIA0062GB</p>
				When Intelligent Key is not in the passenger compart- ment	 <p style="text-align: right; font-size: small;">JMKIA0063GB</p>
38 (B)	Ground	Rear bumper anten- na (-)	Output	When the trunk lid opener re- quest switch is operated with ignition switch OFF	 <p style="text-align: right; font-size: small;">JMKIA0062GB</p>
				When Intelligent Key is not in the antenna detection area	 <p style="text-align: right; font-size: small;">JMKIA0063GB</p>

# BCM (BODY CONTROL MODULE)

## < ECU DIAGNOSIS INFORMATION >

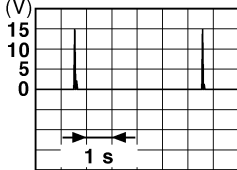
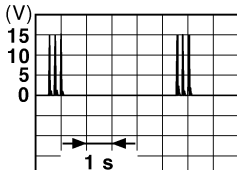
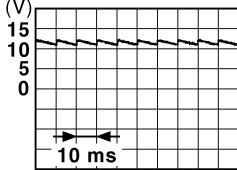
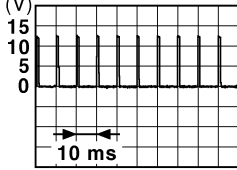
Terminal No. (Wire color)		Description		Condition	Value (Approx.)	
+	-	Signal name	Input/ Output			
39 (W)	Ground	Rear bumper antenna (+)	Output	When Intelligent Key is in the antenna detection area	 <p style="text-align: right; font-size: small;">JMKIA0062GB</p>	
				When the trunk lid opener request switch is operated with ignition switch OFF	 <p style="text-align: right; font-size: small;">JMKIA0063GB</p>	
47 (Y)	Ground	Ignition relay (IPDM E/R) control	Output	Ignition switch	OFF or ACC	
				ON	12 V	
50 (R)	Ground	Trunk room lamp switch	Input	Trunk room lamp switch	OFF (Trunk lid is closed)	
					ON (Trunk lid is opened)	 <p style="text-align: right; font-size: small;">JPMIA0011GB</p>
52 (SB)	Ground	Starter relay control	Output	Ignition switch ON (A/T models)	When selector lever is in P or N position	
					When selector lever is not in P or N position	12 V
				Ignition switch ON (M/T models)	When the clutch pedal is depressed	0 V
					When the clutch pedal is not depressed	Battery voltage
61 (SB)	Ground	Trunk lid opener request switch	Input	Trunk lid opener request switch	ON (Pressed)	
					OFF (Not pressed)	 <p style="text-align: right; font-size: small;">JPMIA0016GB</p>
64 (L)	Ground	Intelligent Key warning buzzer (Engine room)	Output	Intelligent Key warning buzzer (Engine room)	Sounding	
					Not sounding	0 V
					12 V	

A  
B  
C  
D  
E  
F  
G  
H  
I  
J  
K  
DEF  
M  
N  
O  
P

# BCM (BODY CONTROL MODULE)

## < ECU DIAGNOSIS INFORMATION >

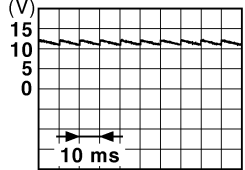
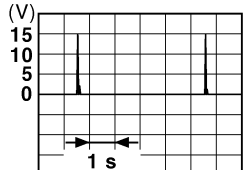
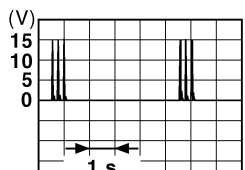
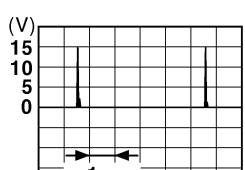
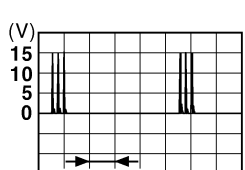
Terminal No. (Wire color)		Description		Condition	Value (Approx.)	
+	-	Signal name	Input/ Output			
67 (GR)	Ground	Trunk lid opener switch	Input	Trunk lid open- er switch	Pressed	0 V
					Not pressed	 <p style="text-align: right; font-size: small;">JPMIA0011GB</p>
72 (R)	Ground	Room antenna 2 (-) (Center console)	Output	Ignition switch OFF	When Intelligent Key is in the passenger compart- ment	 <p style="text-align: right; font-size: small;">JMKIA0062GB</p>
					When Intelligent Key is not in the passenger compart- ment	 <p style="text-align: right; font-size: small;">JMKIA0063GB</p>
73 (G)	Ground	Room antenna 2 (+) (Center console)	Output	Ignition switch OFF	When Intelligent Key is in the passenger compart- ment	 <p style="text-align: right; font-size: small;">JMKIA0062GB</p>
					When Intelligent Key is not in the passenger compart- ment	 <p style="text-align: right; font-size: small;">JMKIA0063GB</p>

# BCM (BODY CONTROL MODULE)

## < ECU DIAGNOSIS INFORMATION >

Terminal No. (Wire color)		Description		Condition	Value (Approx.)
+	-	Signal name	Input/ Output		
74 (SB)	Ground	Passenger door antenna (-)	Output	When Intelligent Key is in the antenna detection area	<p style="text-align: right; font-size: small;">JMKIA0062GB</p>
				When Intelligent Key is not in the antenna detection area	<p style="text-align: right; font-size: small;">JMKIA0063GB</p>
75 (BR)	Ground	Passenger door antenna (+)	Output	When Intelligent Key is in the antenna detection area	<p style="text-align: right; font-size: small;">JMKIA0062GB</p>
				When Intelligent Key is not in the antenna detection area	<p style="text-align: right; font-size: small;">JMKIA0063GB</p>
76 (V)	Ground	Driver door antenna (-)	Output	When Intelligent Key is in the antenna detection area	<p style="text-align: right; font-size: small;">JMKIA0062GB</p>
				When Intelligent Key is not in the antenna detection area	<p style="text-align: right; font-size: small;">JMKIA0063GB</p>

A  
B  
C  
D  
E  
F  
G  
H  
I  
J  
K  
DEF  
M  
N  
O  
P

# BCM (BODY CONTROL MODULE)



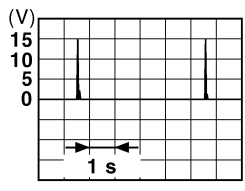
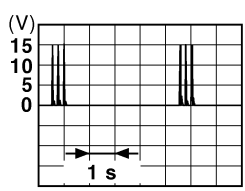
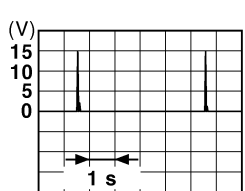
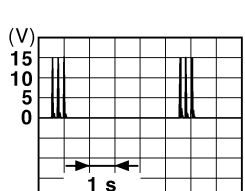
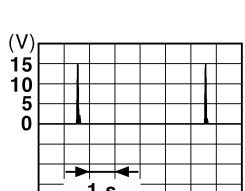
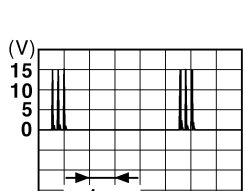

## < ECU DIAGNOSIS INFORMATION >

Terminal No. (Wire color)		Description		Condition	Value (Approx.)
		Signal name	Input/ Output		
+	-				
77 (LG)	Ground	Driver door antenna (+)	Output	When the driver door request switch is operated with ignition switch OFF	When Intelligent Key is in the antenna detection area   <small>JMKIA0062GB</small>
				When Intelligent Key is not in the antenna detection area   <small>JMKIA0063GB</small>	
78 (Y)	Ground	Room antenna 1 (-) (Instrument panel)	Output	Ignition switch OFF	When Intelligent Key is in the passenger compartment   <small>JMKIA0062GB</small>
				When Intelligent Key is not in the passenger compartment   <small>JMKIA0063GB</small>	
79 (BR)	Ground	Room antenna 1 (+) (Instrument panel)	Output	Ignition switch OFF	When Intelligent Key is in the passenger compartment   <small>JMKIA0062GB</small>
				When Intelligent Key is not in the passenger compartment   <small>JMKIA0063GB</small>	

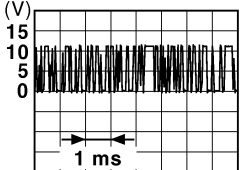
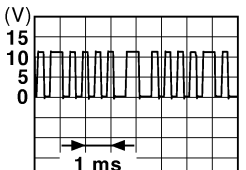

# BCM (BODY CONTROL MODULE)

## < ECU DIAGNOSIS INFORMATION >



Terminal No. (Wire color)		Description		Condition		Value (Approx.)
		Signal name	Input/ Output			
+	-					
80 (GR)	Ground	NATS antenna amp (Built in key slot)	Input/ Output	During waiting	Ignition switch is pressed while inserting the Intelligent Key into the key slot.	Just after pressing ignition switch. Pointer of tester should move.
81 (W)	Ground	NATS antenna amp (Built in key slot)	Input/ Output	During waiting	Ignition switch is pressed while inserting the Intelligent Key into the key slot.	Just after pressing ignition switch. Pointer of tester should move.
82 (R)	Ground	Ignition relay [Fuse block (J/B)] control	Output	Ignition switch	OFF or ACC	0 V
					ON	12 V
83 (Y)	Ground	Remote keyless entry receiver communication	Input/ Output	During waiting		 <p style="text-align: right; font-size: small;">JMKIA0064GB</p>
				When operating either button on the Intelligent Key		 <p style="text-align: right; font-size: small;">JMKIA0065GB</p>
87 (Y)	Ground	Combination switch INPUT 5	Input	Combination switch	All switches OFF (Wiper intermittent dial 4)	 <p style="text-align: right; font-size: small;">JPMIA0041GB</p> <p style="text-align: center;">1.4 V</p>
					Front fog lamp switch ON (Wiper intermittent dial 4)	 <p style="text-align: right; font-size: small;">JPMIA0037GB</p> <p style="text-align: center;">1.3 V</p>
					Any of the conditions below with all switches OFF <ul style="list-style-type: none"> <li>• Wiper intermittent dial 1</li> <li>• Wiper intermittent dial 2</li> <li>• Wiper intermittent dial 6</li> <li>• Wiper intermittent dial 7</li> </ul>	 <p style="text-align: right; font-size: small;">JPMIA0040GB</p> <p style="text-align: center;">1.3 V</p>

A  
B  
C  
D  
E  
F  
G  
H  
I  
J  
K  
DEF  
M  
N  
O  
P

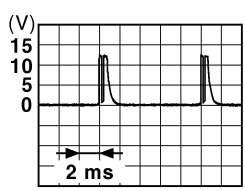

# BCM (BODY CONTROL MODULE)

## < ECU DIAGNOSIS INFORMATION >

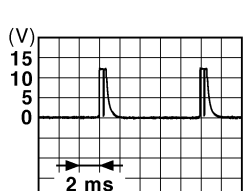
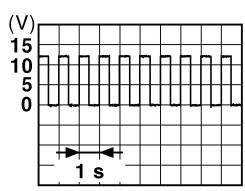
Terminal No. (Wire color)		Description		Condition	Value (Approx.)	
+	-	Signal name	Input/ Output			
88 (O)	Ground	Combination switch INPUT 3	Input	Combination switch	All switches OFF (Wiper intermittent dial 4)	 <p style="text-align: right; font-size: small;">JPMIA0041GB</p> <p style="text-align: center;">1.4 V</p>
					Lighting switch HI (Wiper intermittent dial 4)	 <p style="text-align: right; font-size: small;">JPMIA0036GB</p> <p style="text-align: center;">1.3 V</p>
					Lighting switch 2ND (Wiper intermittent dial 4)	 <p style="text-align: right; font-size: small;">JPMIA0037GB</p> <p style="text-align: center;">1.3 V</p>
					Any of the conditions below with all switches OFF <ul style="list-style-type: none"> <li>• Wiper intermittent dial 1</li> <li>• Wiper intermittent dial 2</li> <li>• Wiper intermittent dial 3</li> </ul>	 <p style="text-align: right; font-size: small;">JPMIA0040GB</p> <p style="text-align: center;">1.3 V</p>
89 (BR)	Ground	Push-button ignition switch (Push switch)	Input	Push-button ignition switch (push switch)	Pressed	0 V
					Not pressed	Battery voltage
90 (P)	Ground	CAN-L	Input/ Output	—	—	
91 (L)	Ground	CAN-H	Input/ Output	—	—	
92 (LG)	Ground	Key slot illumination	Output	Key slot illumination	OFF	0 V
					Blinking	 <p style="text-align: right; font-size: small;">JPMIA0015GB</p> <p style="text-align: center;">6.5 V</p>
					ON	12 V

# BCM (BODY CONTROL MODULE)

## < ECU DIAGNOSIS INFORMATION >

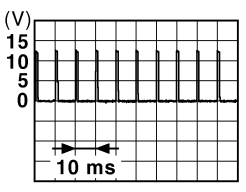
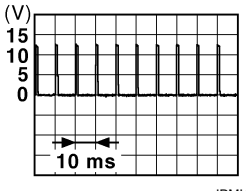
Terminal No. (Wire color)		Description		Condition		Value (Approx.)
		Signal name	Input/ Output			
+	-					
93 (Y)	Ground	ON indicator lamp	Output	Ignition switch	OFF (LOCK indicator is not illuminated)	Battery voltage
					ON	0 V
95 (O)	Ground	ACC relay control	Output	Ignition switch	OFF	0 V
					ACC or ON	12 V
96 (GR)	Ground	A/T shift selector (Detention switch) power supply	Output	—		12 V
97 (L)	Ground	Steering lock condition No. 1	Input	Steering lock	LOCK status	0 V
					UNLOCK status	12 V
98 (P)	Ground	Steering lock condition No. 2	Input	Steering lock	LOCK status	12 V
					UNLOCK status	0 V
99 (R)	Ground	Selector lever P position switch	Input	Selector lever	P position	0 V
					Any position other than P	12 V
		ASCD clutch switch (M/T models without ICC)		ASCD clutch switch	OFF (Clutch pedal is depressed)	0 V
					ON (Clutch pedal is not depressed)	12 V
		ICC clutch switch (M/T models with ICC)		ICC clutch switch	OFF (Clutch pedal is depressed)	0 V
					ON (Clutch pedal is not depressed)	12 V
100 (Y)	Ground	Passenger door request switch	Input	Passenger door request switch	ON (Pressed)	0 V
					OFF (Not pressed)	 <p style="text-align: right; margin-right: 50px;">1.0 V</p>
101 (P)	Ground	Driver door request switch	Input	Driver door request switch	ON (Pressed)	0 V
					OFF (Not pressed)	 <p style="text-align: right; margin-right: 50px;">1.0 V</p>
102 (O)	Ground	Blower fan motor relay control	Output	Ignition switch	OFF or ACC	0 V
					ON	12 V
103 (LG)	Ground	Remote keyless entry receiver power supply	Output	Ignition switch OFF		12 V
106 (W)	Ground	Steering lock unit power supply	Output	Ignition switch	OFF or ACC	12 V
					ON	0 V



A  
B  
C  
D  
E  
F  
G  
H  
I  
J  
K

DEF

M  
N  
O  
P

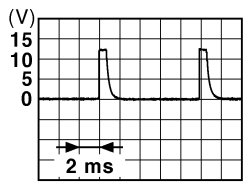
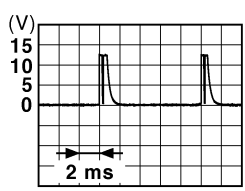

# BCM (BODY CONTROL MODULE)

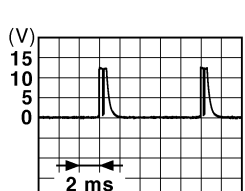
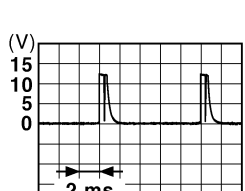
## < ECU DIAGNOSIS INFORMATION >

Terminal No. (Wire color)		Description		Condition	Value (Approx.)	
		Signal name	Input/ Output			
+	-					
107 (LG)	Ground	Combination switch INPUT 1	Input	Combination switch (Wiper intermittent dial 4)	All switches OFF	 <p style="text-align: right; font-size: small;">JPMIA0041GB</p> <p style="text-align: center;">1.4 V</p>
					Turn signal switch LH	 <p style="text-align: right; font-size: small;">JPMIA0037GB</p> <p style="text-align: center;">1.3 V</p>
					Turn signal switch RH	 <p style="text-align: right; font-size: small;">JPMIA0036GB</p> <p style="text-align: center;">1.3 V</p>
					Front wiper switch LO	 <p style="text-align: right; font-size: small;">JPMIA0038GB</p> <p style="text-align: center;">1.3 V</p>
					Front washer switch ON	 <p style="text-align: right; font-size: small;">JPMIA0039GB</p> <p style="text-align: center;">1.3 V</p>

# BCM (BODY CONTROL MODULE)

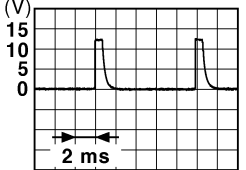
## < ECU DIAGNOSIS INFORMATION >

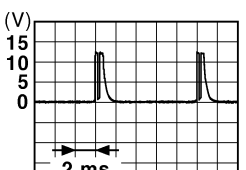
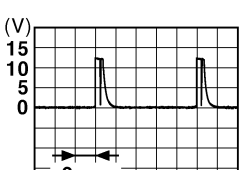



Terminal No. (Wire color)		Description		Condition	Value (Approx.)
		Signal name	Input/ Output		
+	-				
108 (R)	Ground	Combination switch INPUT 4	Input	Combination switch	All switches OFF (Wiper intermittent dial 4) <div style="text-align: right;">  <p>1.4 V</p> </div>
					Lighting switch AUTO (Wiper intermittent dial 4) <div style="text-align: right;">  <p>1.3 V</p> </div>
					Lighting switch 1ST (Wiper intermittent dial 4) <div style="text-align: right;">  <p>1.3 V</p> </div>
					Any of the conditions below with all switches OFF <ul style="list-style-type: none"> <li>• Wiper intermittent dial 1</li> <li>• Wiper intermittent dial 5</li> <li>• Wiper intermittent dial 6</li> </ul> <div style="text-align: right;">  <p>1.3 V</p> </div>

A  
B  
C  
D  
E  
F  
G  
H  
I  
J  
K  
DEF  
M  
N  
O  
P

DEF

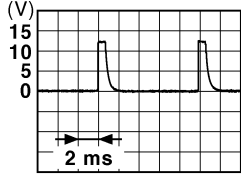
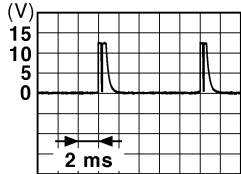
# BCM (BODY CONTROL MODULE)

## < ECU DIAGNOSIS INFORMATION >

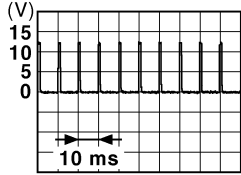
Terminal No. (Wire color)		Description		Condition	Value (Approx.)	
+	-	Signal name	Input/ Output			
109 (W)	Ground	Combination switch INPUT 2	Input	Combination switch (Wiper intermittent dial 4)	All switches OFF	 <p style="text-align: right;">JPMIA0041GB</p> <p style="text-align: center;">1.4 V</p>
					Lighting switch PASS	 <p style="text-align: right;">JPMIA0037GB</p> <p style="text-align: center;">1.3 V</p>
					Lighting switch 2ND	 <p style="text-align: right;">JPMIA0036GB</p> <p style="text-align: center;">1.3 V</p>
					Front wiper switch INT	 <p style="text-align: right;">JPMIA0038GB</p> <p style="text-align: center;">1.3 V</p>
					Front wiper switch HI	 <p style="text-align: right;">JPMIA0040GB</p> <p style="text-align: center;">1.3 V</p>
110 (G)	Ground	Hazard switch	Input	Hazard switch	ON	0 V
					OFF	 <p style="text-align: right;">JPMIA0012GB</p> <p style="text-align: center;">1.1 V</p>

# BCM (BODY CONTROL MODULE)

## < ECU DIAGNOSIS INFORMATION >

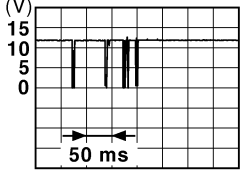
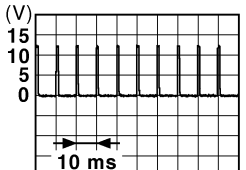
Terminal No. (Wire color)		Description		Condition	Value (Approx.)	
		Signal name	Input/ Output			
+	-					
111 (Y)	Ground	Steering lock unit communication	Input/ Output	Steering lock	LOCK status	12 V
					LOCK or UNLOCK	
					For 15 seconds after UNLOCK	12 V
					15 seconds or later after UNLOCK	0 V
113 (O)	Ground	Optical sensor	Input	Ignition switch ON	When bright outside of the vehicle	Close to 5 V
					When dark outside of the vehicle	Close to 0 V
114 (R)	Ground	Clutch interlock switch	Input	Clutch interlock switch	OFF (Clutch pedal is not depressed)	0 V
					ON (Clutch pedal is depressed)	Battery voltage
116 (SB)	Ground	Stop lamp switch 1	Input	—	Battery voltage	
118 (BR)	Ground	Stop lamp switch 2 (Without ICC)	Input	Stop lamp switch	OFF (Brake pedal is not depressed)	0 V
					ON (Brake pedal is depressed)	Battery voltage
		Stop lamp switch 2 (With ICC)		Stop lamp switch OFF (Brake pedal is not depressed) and ICC brake hold relay OFF	0 V	
				Stop lamp switch ON (Brake pedal is depressed) or ICC brake hold relay ON	Battery voltage	
119 (SB)	Ground	Driver side door lock assembly (Unlock sensor)	Input	Driver door	LOCK status (Unlock sensor switch OFF)	
					UNLOCK status (Unlock switch sensor ON)	0 V
121 (SB)	Ground	Key slot switch	Input	When the Intelligent Key is inserted into key slot	12 V	
				When the Intelligent Key is not inserted into key slot	0 V	
123 (W)	Ground	IGN feedback	Input	Ignition switch	OFF or ACC	0 V
					ON	Battery voltage

A  
B  
C  
D  
E  
F  
G  
H  
I  
J  
K  
DEF  
M  
N  
O  
P

# BCM (BODY CONTROL MODULE)

## < ECU DIAGNOSIS INFORMATION >

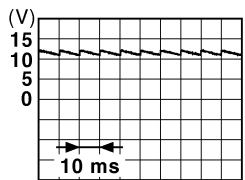
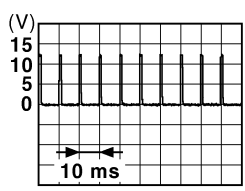
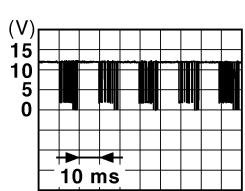
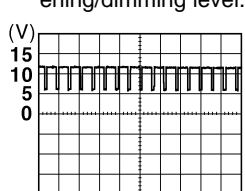
Terminal No. (Wire color)		Description		Condition	Value (Approx.)	
		Signal name	Input/ Output			
+	-					
124 (LG)	Ground	Passenger door switch	Input	Passenger door switch	OFF (Door close)	 11.8 V
					ON (Door open)	0 V
129 (O)	Ground	Trunk lid opener cancel switch	Input	Trunk lid open- er cancel switch	CANCEL	 1.1 V
					ON	0 V
132 (V)	Ground	Power window switch communication	Input/ Output	Ignition switch ON		 10.2 V
					Ignition switch OFF or ACC	12 V
133 (L)	Ground	Push-button ignition switch illumination	Output	Push-button ig- nition switch il- lumination	ON (Tail lamps OFF)	9.5 V
					ON (Tail lamps ON)	<p><b>NOTE:</b> The pulse width of this wave is varied by the illumination bright- ening/dimming level.</p>  
					OFF	0 V
134 (LG)	Ground	LOCK indicator lamp	Output	LOCK indicator lamp	OFF	Battery voltage
					ON	0 V
137 (O)	Ground	Receiver and sensor ground	Input	Ignition switch ON	0 V	
138 (V)	Ground	Receiver and sensor power supply	Output	Ignition switch	OFF	0 V
					ACC or ON	5.0 V



# BCM (BODY CONTROL MODULE)

## < ECU DIAGNOSIS INFORMATION >

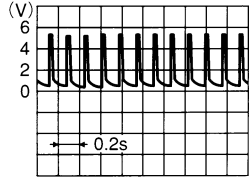
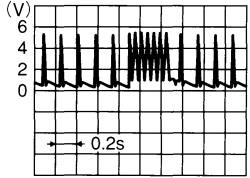
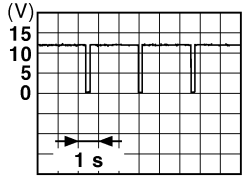
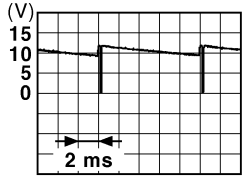
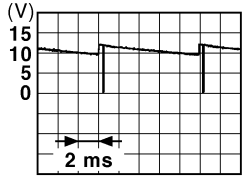
Terminal No. (Wire color)		Description		Condition	Value (Approx.)
+	-	Signal name	Input/ Output		
139 (L)	Ground	Tire pressure receiver communication	Input/ Output	Ignition switch ON	Standby state  OCC3881D
				When receiving the signal from the transmitter  OCC3880D	
140 (GR)	Ground	Selector lever P/N position (A/T models)	Input	Selector lever	P or N position 12 V Except P and N positions 0 V
				ON	0 V
141 (R)	Ground	Security indicator	Output	Security indicator	Blinking  11.3 V JPMIA0014GB
				OFF	12 V
142 (BR)	Ground	Combination switch OUTPUT 5	Output	Combination switch (Wiper intermittent dial 4)	All switches OFF 0 V Lighting switch 1ST Lighting switch HI Lighting switch 2ND  10.7 V JPMIA0031GB
				Turn signal switch RH	
143 (V)	Ground	Combination switch OUTPUT 1	Output	Combination switch	All switches OFF (Wiper intermittent dial 4) 0 V Front wiper switch HI (Wiper intermittent dial 4) Any of the conditions below with all switches OFF • Wiper intermittent dial 1 • Wiper intermittent dial 2 • Wiper intermittent dial 3 • Wiper intermittent dial 6 • Wiper intermittent dial 7  10.7 V JPMIA0032GB

A  
B  
C  
D  
E  
F  
G  
H  
I  
J  
K  
DEF  
M  
N  
O  
P

# BCM (BODY CONTROL MODULE)

## < ECU DIAGNOSIS INFORMATION >

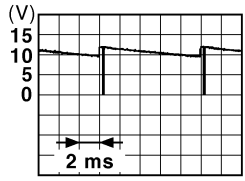
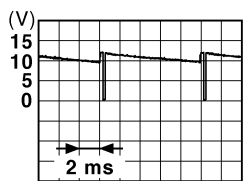
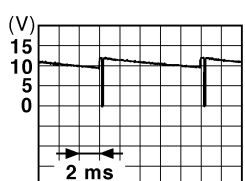
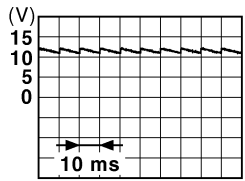
Terminal No. (Wire color)		Description		Condition	Value (Approx.)	
+	-	Signal name	Input/ Output			
144 (G)	Ground	Combination switch OUTPUT 2	Output	Combination switch	All switches OFF (Wiper intermittent dial 4)	0 V
					Front washer switch ON (Wiper intermittent dial 4)	 <p style="text-align: right; font-size: small;">JPMAI0033GB</p>
Any of the conditions below with all switches OFF					10.7 V	
<ul style="list-style-type: none"> <li>• Wiper intermittent dial 1</li> <li>• Wiper intermittent dial 5</li> <li>• Wiper intermittent dial 6</li> </ul>						
145 (L)	Ground	Combination switch OUTPUT 3	Output	Combination switch (Wiper intermit- tent dial 4)	All switches OFF	0 V
					Front wiper switch INT	 <p style="text-align: right; font-size: small;">JPMAI0034GB</p>
					Front wiper switch LO	
					Lighting switch AUTO	
					10.7 V	
146 (SB)	Ground	Combination switch OUTPUT 4	Output	Combination switch (Wiper intermit- tent dial 4)	All switches OFF	0 V
					Front fog lamp switch ON	 <p style="text-align: right; font-size: small;">JPMAI0035GB</p>
					Lighting switch 2ND	
					Lighting switch PASS	
					Turn signal switch LH	
					10.7 V	
149 (W)	Ground	Tire pressure warning check switch	Input	—	12 V	
150 (R)	Ground	Driver door switch	Input	Driver door switch	OFF (Door close)	 <p style="text-align: right; font-size: small;">JPMAI0011GB</p>
					ON (Door open)	
151 (G)	Ground	Rear window defog- ger relay control	Output	Rear window defogger	Active	0 V
					Not activated	Battery voltage

# BCM (BODY CONTROL MODULE)

< ECU DIAGNOSIS INFORMATION >

## Wiring Diagram - BCM -

INFOID:000000004610461

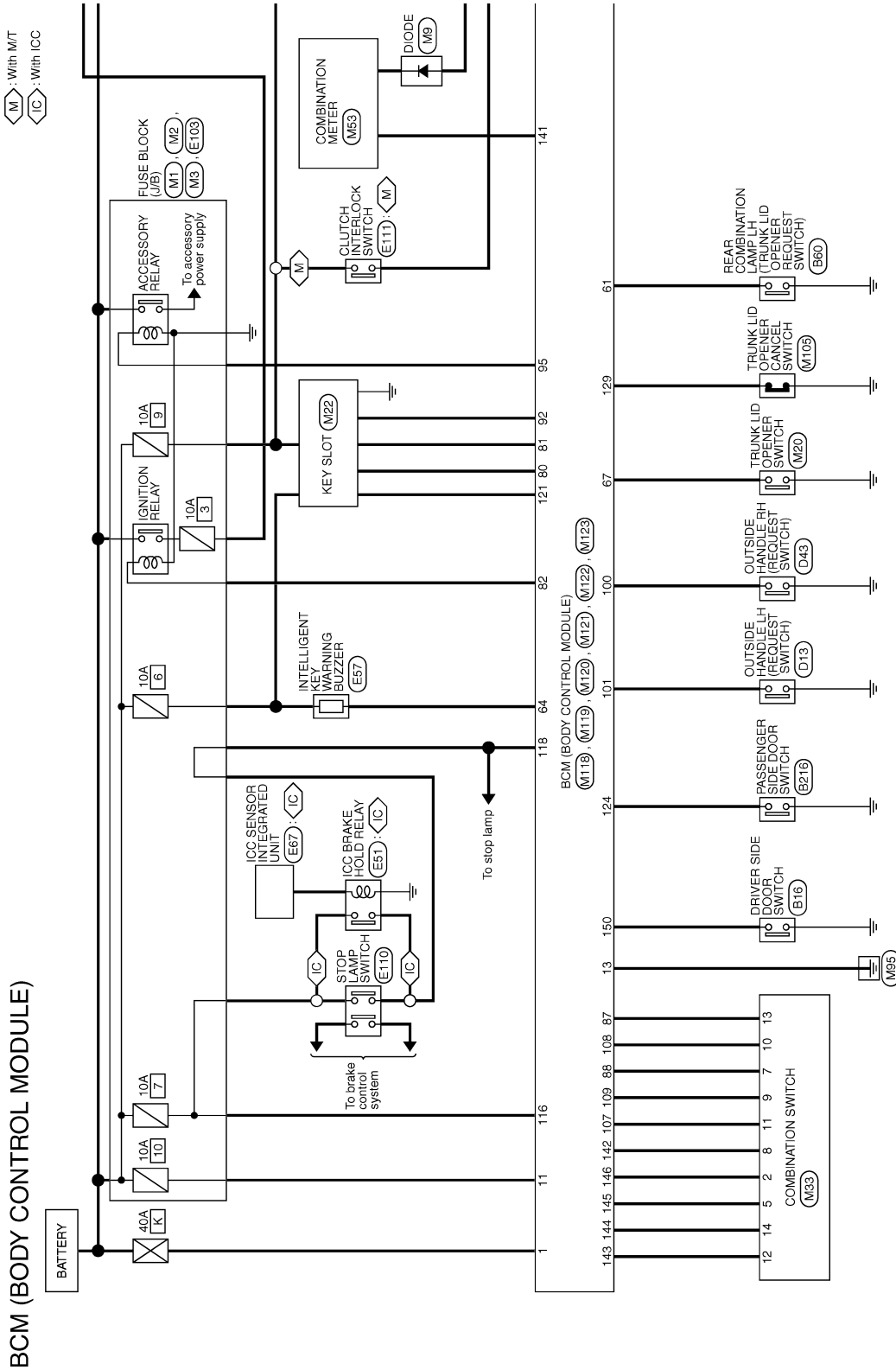

2008/08/22

JCMWM3046GI

A  
B  
C  
D  
E  
F  
G  
H  
I  
J  
K  
DEF  
M  
N  
O  
P

# BCM (BODY CONTROL MODULE)

< ECU DIAGNOSIS INFORMATION >

A : With A/T  
M : With M/T

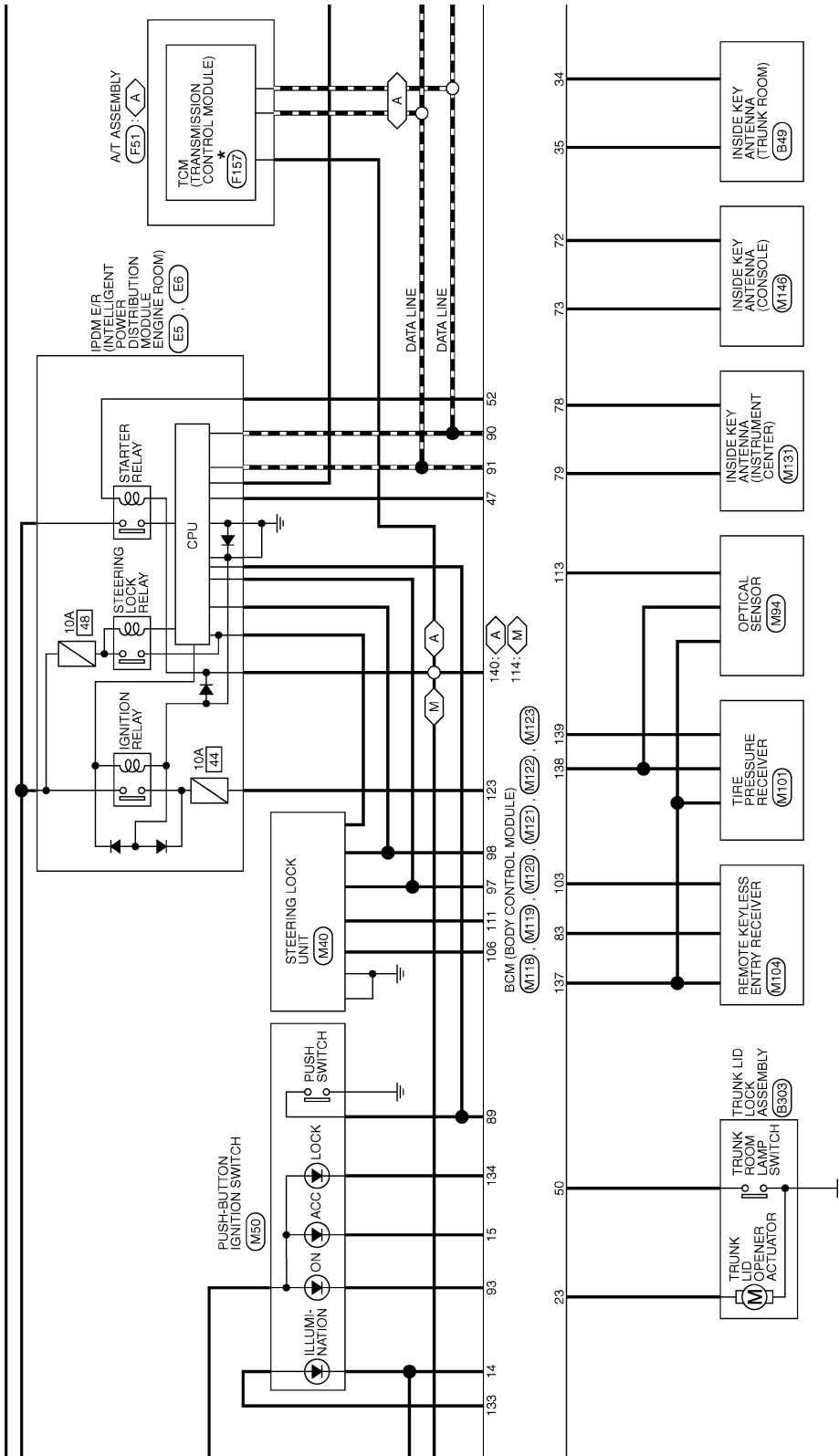

\*: This connector is not shown in "Harness Layout".

JCMWM3047G

# BCM (BODY CONTROL MODULE)

< ECU DIAGNOSIS INFORMATION >

- : With A/T
- : With M/T
- : With sunroof
- : With ICC
- : Without ICC

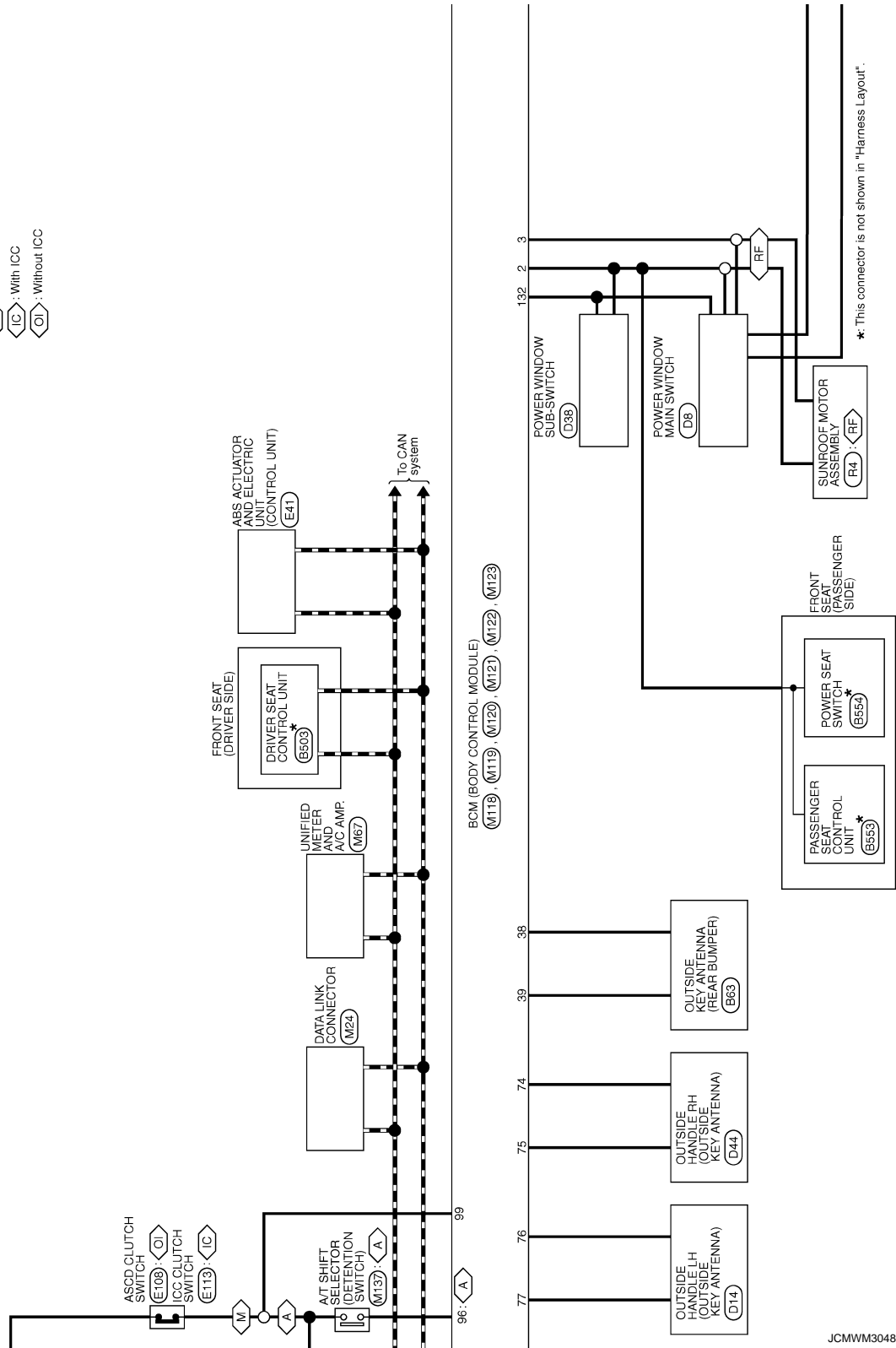

\*: This connector is not shown in "Harness Layout".

A  
B  
C  
D  
E  
F  
G  
H  
I  
J  
K  
DEF  
M  
N  
O  
P

# BCM (BODY CONTROL MODULE)

< ECU DIAGNOSIS INFORMATION >

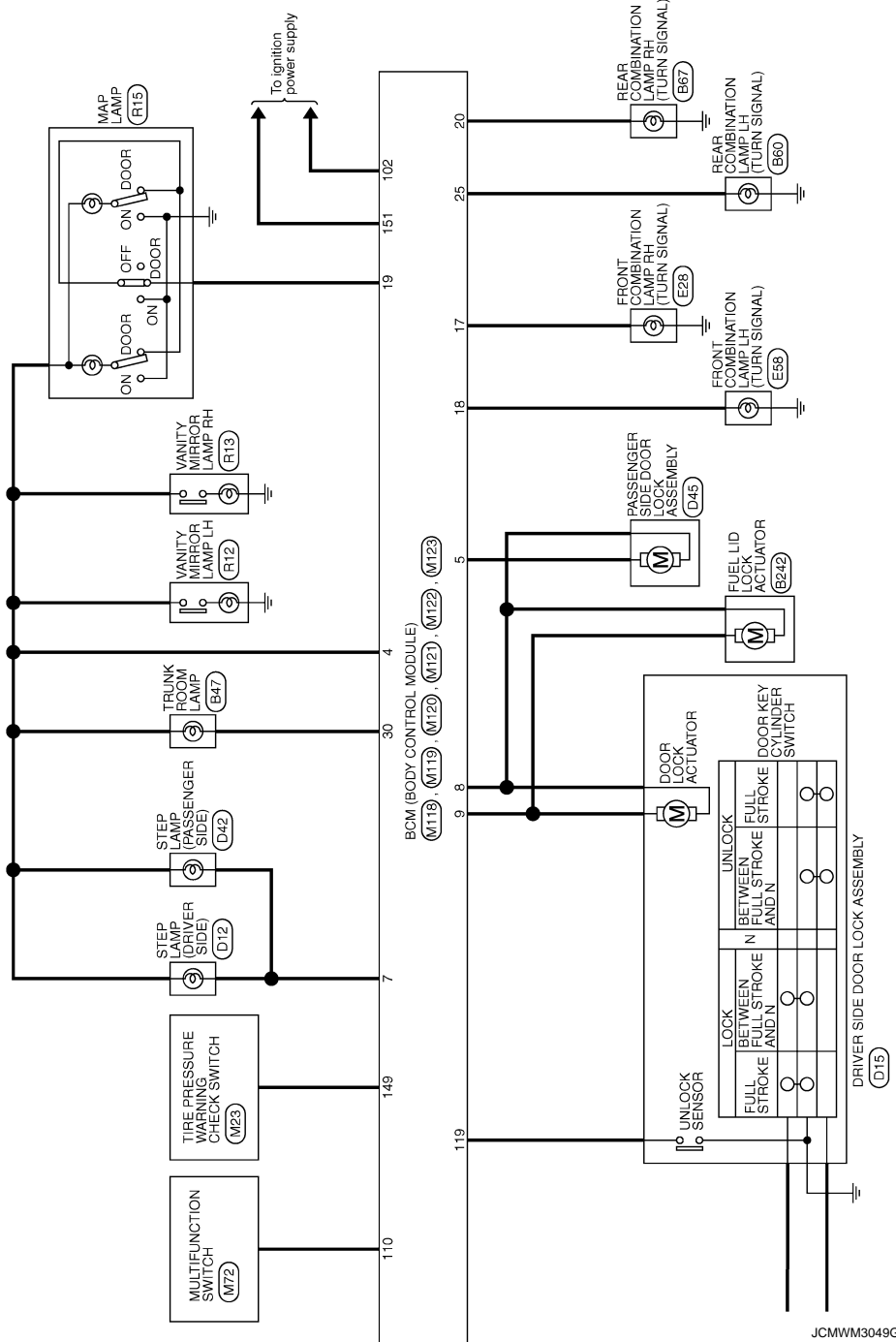

# BCM (BODY CONTROL MODULE)

< ECU DIAGNOSIS INFORMATION >

## BCM (BODY CONTROL MODULE)

Connector No.	M33
Connector Name	COMBINATION SWITCH
Connector Type	TH16FW-NH

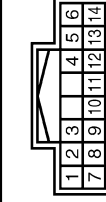

Terminal No.	Color of Wire	Signal Name [Specification]
2	SB	OUTPUT 4
5	L	OUTPUT 3
7	O	INPUT 3
8	BR	OUTPUT 5
9	W	INPUT 2
10	R	INPUT 4
11	LG	INPUT 1
12	V	OUTPUT 1
13	Y	INPUT 5
14	G	OUTPUT 2

Connector No.	M120
Connector Name	BCM (BODY CONTROL MODULE)
Connector Type	NS12FW-CS

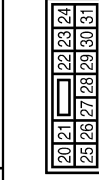

Terminal No.	Color of Wire	Signal Name [Specification]
20	V	TURN SIGNAL RH (REAR)
23	L	TRUNK LID OPEN OUTPUT
25	Y	TURN SIGNAL LH (REAR)
30	P	TRUNK ROOM LAMP

Connector No.	M118
Connector Name	BCM (BODY CONTROL MODULE)
Connector Type	M03FB-LC



Terminal No.	Color of Wire	Signal Name [Specification]
1	W	BAT (F/L)
2	Y	POWER WINDOW POWER SUPPLY (BAT)
3	O	POWER WINDOW POWER SUPPLY (BAP)

Connector No.	M121
Connector Name	BCM (BODY CONTROL MODULE)
Connector Type	TH40FGY-NH

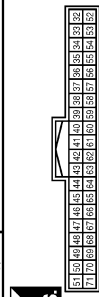

Terminal No.	Color of Wire	Signal Name [Specification]
34	SB	TRUNK ROOM ANT-
35	V	TRUNK ROOM ANT+
38	B	REAR BUMPER ANT-
39	W	REAR BUMPER ANT+
47	Y	IGN RELAY (PDM E/R) CONT
50	R	TRUNK ROOM LAMP SW
52	SB	STARTER RELAY CONT
61	SB	TRUNK LID OPENER REQUEST SW
64	L	I-KEY WARN BUZZER (ENG ROOM)
67	GR	TRUNK LID OPENER SW

Connector No.	M119
Connector Name	BCM (BODY CONTROL MODULE)
Connector Type	NS18FW-CS

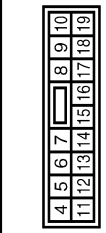

Terminal No.	Color of Wire	Signal Name [Specification]
4	LG	INTERIOR ROOM LAMP POWER SUPPLY
5	P	PASSENGER DOOR UNLOCK OUTPUT
7	SB	STEP LAMP OUTPUT
8	V	ALL DOOR FUEL LID LOCK OUTPUT
9	G	DRIVER DOOR FUEL LID UNLOCK OUTPUT
11	R	BAT (G/USE)
13	B	GND
14	W	PUSH-BUTTON IGNITION SW ILL GND
15	O	ACC IND
17	W	TURN SIGNAL RH (FRONT)
18	O	TURN SIGNAL LH (FRONT)

Connector No.	M122
Connector Name	BCM (BODY CONTROL MODULE)
Connector Type	TH40FB-NH

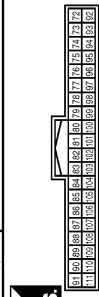

Terminal No.	Color of Wire	Signal Name [Specification]
72	R	ROOM ANT2-
73	G	ROOM ANT2+
74	SB	PASSENGER DOOR ANT-
75	BR	PASSENGER DOOR ANT+
76	V	DRIVER DOOR ANT-
77	LG	DRIVER DOOR ANT+
78	Y	ROOM ANT1-
79	BR	ROOM ANT1+
80	GR	IMMOBI ANTENNA CONTROL
81	W	IMMOBI ANTENNA SIGNAL
82	R	IGN RELAY (F/B) CONT

19	V	ROOM LAMP TIMER CONTROL
----	---	-------------------------

83	Y	KEYLESS ENTRY RECEIVER COMM
87	Y	COMBI SW INPUT 5
88	O	COMBI SW INPUT 3
89	BR	PUSH SW
90	P	CAN-L
91	L	CAN-H
92	LG	KEY SLOT ILL
93	Y	ON IND
95	O	ACC RELAY CONT
86	GR	A/T SHIFT SELECTOR POWER SUPPLY
97	L	S/L CONDITION 1
98	P	S/L CONDITION 2
99	R	ASPD CLUTCH SW (M/T models without ICC)
99	R	ICC CLUTCH SW (M/T models with ICC)
99	R	SHIFT P (A/T models)
100	Y	PASSENGER DOOR REQUEST SW
101	P	DRIVER DOOR REQUEST SW
102	O	BLOWER FAN MOTOR RELAY CONT
103	LG	KEYLESS ENTRY RECEIVER POWER SUPPLY
106	W	S/L UNIT POWER SUPPLY
107	LG	COMBI SW INPUT 4
108	R	ROOM SW INPUT 1
109	W	COMBI SW INPUT 2
110	G	HAZARD SW
111	Y	S/L UNIT COMM

A  
B  
C  
D  
E  
F  
G  
H  
I  
J  
K  
DEF  
M  
N  
O  
P

# BCM (BODY CONTROL MODULE)

< ECU DIAGNOSIS INFORMATION >

## BCM (BODY CONTROL MODULE)

Connector No.	M123
Connector Name	BCM BODY CONTROL MODULE
Connector Type	TH40FG-1M1



1	2	3	4	5	6	7	8	9	10	11	12	13	14	15	16	17	18	19	20	21	22	23	24	25	26	27	28	29	30	31	32	33	34	35	36	37	38	39	40	41	42	43	44	45	46	47	48	49	50	51	52	53	54	55	56	57	58	59	60	61	62	63	64	65	66	67	68	69	70	71	72	73	74	75	76	77	78	79	80	81	82	83	84	85	86	87	88	89	90	91	92	93	94	95	96	97	98	99	100
---	---	---	---	---	---	---	---	---	----	----	----	----	----	----	----	----	----	----	----	----	----	----	----	----	----	----	----	----	----	----	----	----	----	----	----	----	----	----	----	----	----	----	----	----	----	----	----	----	----	----	----	----	----	----	----	----	----	----	----	----	----	----	----	----	----	----	----	----	----	----	----	----	----	----	----	----	----	----	----	----	----	----	----	----	----	----	----	----	----	----	----	----	----	----	----	----	----	----	-----

Terminal No.	Color of Wire	Signal Name [Specification]
113	O	OPTICAL SENSOR
114	R	CLUTCH INTERLOCK SW
116	SB	STOP LAMP SW 1
118	BR	STOP LAMP SW 2
119	SB	DR DOOR UNLOCK SENSOR
121	SB	KEY SLOT SW
123	W	IGN F/B
124	LG	PASSENGER DOOR SW
129	O	TRUNK LID OPENER CANCEL SW
132	V	POWER WINDOW SW COMM
133	L	PUSH-BUTTON IGNITION SW FULL POWER

134	LG	LOCK IND
137	O	RECEIVER/SENSOR GND
138	V	RECEIVER/SENSOR POWER SUPPLY
139	L	TIRE PRESSURE RECEIVER COMM
140	GR	SHIFT N/P
141	R	SECURITY INDICATOR
142	BR	COMBI SW OUTPUT 3
143	V	COMBI SW OUTPUT 1
144	G	COMBI SW OUTPUT 2
145	L	COMBI SW OUTPUT 3
146	SB	COMBI SW OUTPUT 4
148	W	TIRE PRESSURE WARN CHECK SW
150	R	DRIVER DOOR SW
151	G	REAR WINDOW DEFROGGER RELAY CONT

JCMW3051G

## Fail-safe

INFOID:000000004610462

### FAIL-SAFE CONTROL BY DTC

BCM performs fail-safe control when any DTC are detected.



## BCM (BODY CONTROL MODULE)

### < ECU DIAGNOSIS INFORMATION >

Display contents of CONSULT	Fail-safe	Cancellation	A
B2013: ID DISCORD BCM-S/L	Inhibit engine cranking	Erase DTC	A
B2014: CHAIN OF S/L-BCM	Inhibit engine cranking	Erase DTC	B
B2190: NATS ANTENNA AMP	Inhibit engine cranking	Erase DTC	B
B2191: DIFFERENCE OF KEY	Inhibit engine cranking	Erase DTC	C
B2192: ID DISCORD BCM-ECM	Inhibit engine cranking	Erase DTC	C
B2193: CHAIN OF BCM-ECM	Inhibit engine cranking	Erase DTC	D
B2195: ANTI SCANNING	Inhibit engine cranking	Ignition switch ON → OFF	D
B2557: VEHICLE SPEED	Inhibit steering lock	When normal vehicle speed signals are received from ABS actuator and electric unit (control unit) for 500 ms	E
B2560: STARTER CONT RELAY	Inhibit engine cranking	500 ms after the following CAN signal communication status becomes consistent <ul style="list-style-type: none"> <li>• Starter control relay signal</li> <li>• Starter relay status signal</li> </ul>	E
B2601: SHIFT POSITION	Inhibit steering lock	500 ms after the following signal reception status becomes consistent <ul style="list-style-type: none"> <li>• Selector lever P position switch signal</li> <li>• P range signal (CAN)</li> </ul>	F
B2602: SHIFT POSITION	Inhibit steering lock	5 seconds after the following BCM recognition conditions are fulfilled <ul style="list-style-type: none"> <li>• Ignition switch is in the ON position</li> <li>• Selector lever P position switch signal: Except P position (battery voltage)</li> <li>• Vehicle speed: 4 km/h (2.5 MPH) or more</li> </ul>	G
B2603: SHIFT POSI STATUS	Inhibit steering lock	500 ms after the following BCM recognition conditions are fulfilled <ul style="list-style-type: none"> <li>• Ignition switch is in the ON position</li> <li>• Selector lever P position switch signal: Except P position (battery voltage)</li> <li>• Selector lever P/N position signal: Except P and N positions (0 V)</li> </ul>	H
B2604: PNP SW	Inhibit steering lock	500 ms after any of the following BCM recognition conditions are fulfilled <ul style="list-style-type: none"> <li>• Status 1 <ul style="list-style-type: none"> <li>- Ignition switch is in the ON position</li> <li>- Selector lever P/N position signal: P and N position (battery voltage)</li> <li>- P range signal or N range signal (CAN): ON</li> </ul> </li> <li>• Status 2 <ul style="list-style-type: none"> <li>- Ignition switch is in the ON position</li> <li>- Selector lever P/N position signal: Except P and N positions (0 V)</li> <li>- P range signal and N range signal (CAN): OFF</li> </ul> </li> </ul>	I
B2605: PNP SW	Inhibit steering lock	500 ms after any of the following BCM recognition conditions are fulfilled <ul style="list-style-type: none"> <li>• Status 1 <ul style="list-style-type: none"> <li>- Ignition switch is in the ON position</li> <li>- Selector lever P/N position signal: Except P and N positions (0 V)</li> <li>- Interlock/PNP switch signal (CAN): OFF</li> </ul> </li> <li>• Status 2 <ul style="list-style-type: none"> <li>- Ignition switch is in the ON position</li> <li>- Selector lever P/N position signal: P or N position (battery voltage)</li> <li>- PNP switch signal (CAN): ON</li> </ul> </li> </ul>	J
B2606: S/L RELAY	Inhibit engine cranking	500 ms after the following CAN signal communication status becomes consistent <ul style="list-style-type: none"> <li>• Steering lock relay signal (Request signal)</li> <li>• Steering lock relay signal (Condition signal)</li> </ul>	K

DEF

## BCM (BODY CONTROL MODULE)

### < ECU DIAGNOSIS INFORMATION >

Display contents of CONSULT	Fail-safe	Cancellation
B2607: S/L RELAY	Inhibit engine cranking	500 ms after the following CAN signal communication status has becomes consistent <ul style="list-style-type: none"> <li>• Steering lock relay signal (Request signal)</li> <li>• Steering lock relay signal (Condition signal)</li> </ul>
B2608: STARTER RELAY	Inhibit engine cranking	500 ms after the following signal communication status becomes consistent <ul style="list-style-type: none"> <li>• Starter motor relay control signal</li> <li>• Starter relay status signal (CAN)</li> </ul>
B2609: S/L STATUS	<ul style="list-style-type: none"> <li>• Inhibit engine cranking</li> <li>• Inhibit steering lock</li> </ul>	When the following steering lock conditions agree <ul style="list-style-type: none"> <li>• BCM steering lock control status</li> <li>• Steering lock condition No. 1 signal status</li> <li>• Steering lock condition No. 2 signal status</li> </ul>
B260A: IGNITION RELAY	Inhibit engine cranking	500 ms after the following conditions are fulfilled <ul style="list-style-type: none"> <li>• IGN relay (IPDM E/R) control signal: OFF (Battery voltage)</li> <li>• Ignition ON signal (CAN to IPDM E/R): OFF (Request signal)</li> <li>• Ignition ON signal (CAN from IPDM E/R): OFF (Condition signal)</li> </ul>
B260F: ENG STATE SIG LOST	Maintains the power supply position attained at the time of DTC detection	When any of the following conditions are fulfilled <ul style="list-style-type: none"> <li>• Power position changes to ACC</li> <li>• Receives engine status signal (CAN)</li> </ul>
B2612: S/L STATUS	<ul style="list-style-type: none"> <li>• Inhibit engine cranking</li> <li>• Inhibit steering lock</li> </ul>	When any of the following conditions are fulfilled <ul style="list-style-type: none"> <li>• Steering lock unit status signal (CAN) is received normally</li> <li>• The BCM steering lock control status matches the steering lock status recognized by the steering lock unit status signal (CAN from IPDM E/R)</li> </ul>
B2617: STARTER RELAY CIRC	Inhibit engine cranking	1 second after the starter motor relay control inside BCM becomes normal
B2618: BCM	Inhibit engine cranking	1 second after the ignition relay (IPDM E/R) control inside BCM becomes normal
B2619: BCM	Inhibit engine cranking	1 second after the steering lock unit power supply output control inside BCM becomes normal
B261E: VEHICLE TYPE	Inhibit engine cranking	BCM initialization
B26E8: CLUTCH SW	Inhibit engine cranking	When any of the following BCM recognition conditions are fulfilled <ul style="list-style-type: none"> <li>• Status 1               <ul style="list-style-type: none"> <li>- Clutch switch signal (CAN from ECM): ON</li> <li>- Clutch interlock switch signal: OFF (0 V)</li> </ul> </li> <li>• Status 2               <ul style="list-style-type: none"> <li>- Clutch switch signal (CAN from ECM): OFF</li> <li>- Clutch interlock switch signal: ON (Battery voltage)</li> </ul> </li> </ul>
B26E9: S/L STATUS	<ul style="list-style-type: none"> <li>• Inhibit engine cranking</li> <li>• Inhibit steering lock</li> </ul>	When BCM transmits the LOCK request signal to steering lock unit, and receives LOCK response signal from steering lock unit, the following conditions are fulfilled <ul style="list-style-type: none"> <li>• Steering condition No. 1 signal: LOCK (0 V)</li> <li>• Steering condition No. 2 signal: LOCK (Battery voltage)</li> </ul>

### HIGH FLASHER OPERATION

BCM detects the turn signal lamp circuit status by the current value.

BCM increases the turn signal lamp blinking speed if the bulb or harness open is detected with the turn signal lamp operating.

#### NOTE:

The blinking speed is normal while activating the hazard warning lamp.

### DTC Inspection Priority Chart

INFOID:000000004610463

If some DTCs are displayed at the same time, perform inspections one by one based on the following priority chart.

## BCM (BODY CONTROL MODULE)

### < ECU DIAGNOSIS INFORMATION >

Priority	DTC	A
1	B2562: LOW VOLTAGE	A
2	<ul style="list-style-type: none"> <li>• U1000: CAN COMM</li> <li>• U1010: CONTROL UNIT(CAN)</li> </ul>	B
3	<ul style="list-style-type: none"> <li>• B2190: NATS ANTENNA AMP</li> <li>• B2191: DIFFERENCE OF KEY</li> <li>• B2192: ID DISCORD BCM-ECM</li> <li>• B2193: CHAIN OF BCM-ECM</li> <li>• B2195: ANTI SCANNING</li> </ul>	C
4	<ul style="list-style-type: none"> <li>• B2013: ID DISCORD BCM-S/L</li> <li>• B2014: CHAIN OF S/L-BCM</li> <li>• B2553: IGNITION RELAY</li> <li>• B2555: STOP LAMP</li> <li>• B2556: PUSH-BTN IGN SW</li> <li>• B2557: VEHICLE SPEED</li> <li>• B2560: STARTER CONT RELAY</li> <li>• B2601: SHIFT POSITION</li> <li>• B2602: SHIFT POSITION</li> <li>• B2603: SHIFT POSI STATUS</li> <li>• B2604: PNP SW</li> <li>• B2605: PNP SW</li> <li>• B2606: S/L RELAY</li> <li>• B2607: S/L RELAY</li> <li>• B2608: STARTER RELAY</li> <li>• B2609: S/L STATUS</li> <li>• B260A: IGNITION RELAY</li> <li>• B260B: STEERING LOCK UNIT</li> <li>• B260C: STEERING LOCK UNIT</li> <li>• B260D: STEERING LOCK UNIT</li> <li>• B260F: ENG STATE SIG LOST</li> <li>• B2612: S/L STATUS</li> <li>• B2614: ACC RELAY CIRC</li> <li>• B2615: BLOWER RELAY CIRC</li> <li>• B2616: IGN RELAY CIRC</li> <li>• B2617: STARTER RELAY CIRC</li> <li>• B2618: BCM</li> <li>• B2619: BCM</li> <li>• B261A: PUSH-BTN IGN SW</li> <li>• B261E: VEHICLE TYPE</li> <li>• B26E8: CLUTCH SW</li> <li>• B26E9: S/L STATUS</li> <li>• B26EA: KEY REGISTRATION</li> <li>• C1729: VHCL SPEED SIG ERR</li> <li>• U0415: VEHICLE SPEED SIG</li> </ul>	D E F G H I J K
		DEF
		M
		N
		O
		P

# BCM (BODY CONTROL MODULE)

## < ECU DIAGNOSIS INFORMATION >

Priority	DTC
5	<ul style="list-style-type: none"> <li>• C1704: LOW PRESSURE FL</li> <li>• C1705: LOW PRESSURE FR</li> <li>• C1706: LOW PRESSURE RR</li> <li>• C1707: LOW PRESSURE RL</li> <li>• C1708: [NO DATA] FL</li> <li>• C1709: [NO DATA] FR</li> <li>• C1710: [NO DATA] RR</li> <li>• C1711: [NO DATA] RL</li> <li>• C1712: [CHECKSUM ERR] FL</li> <li>• C1713: [CHECKSUM ERR] FR</li> <li>• C1714: [CHECKSUM ERR] RR</li> <li>• C1715: [CHECKSUM ERR] RL</li> <li>• C1716: [PRESSDATA ERR] FL</li> <li>• C1717: [PRESSDATA ERR] FR</li> <li>• C1718: [PRESSDATA ERR] RR</li> <li>• C1719: [PRESSDATA ERR] RL</li> <li>• C1720: [CODE ERR] FL</li> <li>• C1721: [CODE ERR] FR</li> <li>• C1722: [CODE ERR] RR</li> <li>• C1723: [CODE ERR] RL</li> <li>• C1724: [BATT VOLT LOW] FL</li> <li>• C1725: [BATT VOLT LOW] FR</li> <li>• C1726: [BATT VOLT LOW] RR</li> <li>• C1727: [BATT VOLT LOW] RL</li> <li>• C1734: CONTROL UNIT</li> </ul>
6	<ul style="list-style-type: none"> <li>• B2621: INSIDE ANTENNA</li> <li>• B2622: INSIDE ANTENNA</li> <li>• B2623: INSIDE ANTENNA</li> </ul>

## DTC Index

INFOID:000000004610464

### NOTE:

The details of time display are as follows.

- CRNT: A malfunction is detected now.
- PAST: A malfunction was detected in the past.

IGN counter is displayed on Freeze Frame Data. For details of Freeze Frame Data, refer to [BCS-14, "COMMON ITEM : CONSULT-III Function \(BCM - COMMON ITEM\)"](#).

CONSULT display	Fail-safe	Freeze Frame Data •Vehicle Speed •Odo/Trip Meter •Vehicle condition	Intelligent Key warning lamp ON	Tire pressure monitor warning lamp ON	Refer- ence page
No DTC is detected. further testing may be required.	—	—	—	—	—
U1000: CAN COMM	—	—	—	—	<a href="#">BCS-35</a>
U1010: CONTROL UNIT(CAN)	—	—	—	—	<a href="#">BCS-36</a>
U0415: VEHICLE SPEED SIG	—	—	—	—	<a href="#">BCS-37</a>
B2013: ID DISCORD BCM-S/L	×	×	—	—	<a href="#">SEC-55</a>
B2014: CHAIN OF S/L-BCM	×	×	—	—	<a href="#">SEC-56</a>
B2190: NATS ANTENNA AMP	×	—	—	—	<a href="#">SEC-47</a>
B2191: DIFFERENCE OF KEY	×	—	—	—	<a href="#">SEC-50</a>
B2192: ID DISCORD BCM-ECM	×	—	—	—	<a href="#">SEC-51</a>
B2193: CHAIN OF BCM-ECM	×	—	—	—	<a href="#">SEC-53</a>
B2195: ANTI SCANNING	×	—	—	—	<a href="#">SEC-54</a>
B2553: IGNITION RELAY	—	×	—	—	<a href="#">PCS-48</a>
B2555: STOP LAMP	—	×	—	—	<a href="#">SEC-59</a>

## BCM (BODY CONTROL MODULE)

### < ECU DIAGNOSIS INFORMATION >

CONSULT display	Fail-safe	Freeze Frame Data •Vehicle Speed •Odo/Trip Meter •Vehicle condition	Intelligent Key warning lamp ON	Tire pressure monitor warning lamp ON	Refer- ence page
B2556: PUSH-BTN IGN SW	—	×	×	—	<a href="#">SEC-61</a>
B2557: VEHICLE SPEED	×	×	×	—	<a href="#">SEC-63</a>
B2560: STARTER CONT RELAY	×	×	×	—	<a href="#">SEC-64</a>
B2562: LOW VOLTAGE	—	×	—	—	<a href="#">BCS-38</a>
B2601: SHIFT POSITION	×	×	×	—	<a href="#">SEC-65</a>
B2602: SHIFT POSITION	×	×	×	—	<a href="#">SEC-68</a>
B2603: SHIFT POSI STATUS	×	×	×	—	<a href="#">SEC-70</a>
B2604: PNP SW	×	×	×	—	<a href="#">SEC-73</a>
B2605: PNP SW	×	×	×	—	<a href="#">SEC-75</a>
B2606: S/L RELAY	×	×	×	—	<a href="#">SEC-77</a>
B2607: S/L RELAY	×	×	×	—	<a href="#">SEC-78</a>
B2608: STARTER RELAY	×	×	×	—	<a href="#">SEC-80</a>
B2609: S/L STATUS	×	×	×	—	<a href="#">SEC-82</a>
B260A: IGNITION RELAY	×	×	×	—	<a href="#">PCS-50</a>
B260B: STEERING LOCK UNIT	—	×	×	—	<a href="#">SEC-86</a>
B260C: STEERING LOCK UNIT	—	×	×	—	<a href="#">SEC-87</a>
B260D: STEERING LOCK UNIT	—	×	×	—	<a href="#">SEC-88</a>
B260F: ENG STATE SIG LOST	×	×	×	—	<a href="#">SEC-89</a>
B2612: S/L STATUS	×	×	×	—	<a href="#">SEC-94</a>
B2614: ACC RELAY CIRC	—	×	×	—	<a href="#">PCS-52</a>
B2615: BLOWER RELAY CIRC	—	×	×	—	<a href="#">PCS-54</a>
B2616: IGN RELAY CIRC	—	×	×	—	<a href="#">PCS-56</a>
B2617: STARTER RELAY CIRC	×	×	×	—	<a href="#">SEC-98</a>
B2618: BCM	×	×	×	—	<a href="#">PCS-58</a>
B2619: BCM	×	×	×	—	<a href="#">SEC-100</a>
B261A: PUSH-BTN IGN SW	—	×	×	—	<a href="#">PCS-59</a>
B261E: VEHICLE TYPE	×	×	× (Turn ON for 15 seconds)	—	<a href="#">SEC-101</a>
B2621: INSIDE ANTENNA	—	×	—	—	<a href="#">DLK-55</a>
B2622: INSIDE ANTENNA	—	×	—	—	<a href="#">DLK-57</a>
B2623: INSIDE ANTENNA	—	×	—	—	<a href="#">DLK-59</a>
B26E8: CLUTCH SW	×	×	×	—	<a href="#">SEC-90</a>
B26E9: S/L STATUS	×	×	× (Turn ON for 15 seconds)	—	<a href="#">SEC-92</a>
B26EA: KEY REGISTRATION	—	×	× (Turn ON for 15 seconds)	—	<a href="#">SEC-93</a>
C1704: LOW PRESSURE FL	—	—	—	×	<a href="#">WT-17</a>
C1705: LOW PRESSURE FR	—	—	—	×	
C1706: LOW PRESSURE RR	—	—	—	×	
C1707: LOW PRESSURE RL	—	—	—	×	

A  
B  
C  
D  
E  
F  
G  
H  
I  
J  
K  
DEF  
M  
N  
O  
P

## BCM (BODY CONTROL MODULE)

### < ECU DIAGNOSIS INFORMATION >

CONSULT display	Fail-safe	Freeze Frame Data •Vehicle Speed •Odo/Trip Meter •Vehicle condition	Intelligent Key warning lamp ON	Tire pressure monitor warning lamp ON	Refer- ence page
C1708: [NO DATA] FL	—	—	—	×	<a href="#">WT-19</a>
C1709: [NO DATA] FR	—	—	—	×	
C1710: [NO DATA] RR	—	—	—	×	
C1711: [NO DATA] RL	—	—	—	×	
C1712: [CHECKSUM ERR] FL	—	—	—	×	<a href="#">WT-21</a>
C1713: [CHECKSUM ERR] FR	—	—	—	×	
C1714: [CHECKSUM ERR] RR	—	—	—	×	
C1715: [CHECKSUM ERR] RL	—	—	—	×	
C1716: [PRESSDATA ERR] FL	—	—	—	×	<a href="#">WT-24</a>
C1717: [PRESSDATA ERR] FR	—	—	—	×	
C1718: [PRESSDATA ERR] RR	—	—	—	×	
C1719: [PRESSDATA ERR] RL	—	—	—	×	
C1720: [CODE ERR] FL	—	—	—	×	<a href="#">WT-26</a>
C1721: [CODE ERR] FR	—	—	—	×	
C1722: [CODE ERR] RR	—	—	—	×	
C1723: [CODE ERR] RL	—	—	—	×	
C1724: [BATT VOLT LOW] FL	—	—	—	×	<a href="#">WT-29</a>
C1725: [BATT VOLT LOW] FR	—	—	—	×	
C1726: [BATT VOLT LOW] RR	—	—	—	×	
C1727: [BATT VOLT LOW] RL	—	—	—	×	
C1729: VHCL SPEED SIG ERR	—	—	—	×	<a href="#">WT-32</a>
C1734: CONTROL UNIT	—	—	—	×	<a href="#">WT-33</a>

# REAR WINDOW DEFOGGER DOES NOT OPERATE

< SYMPTOM DIAGNOSIS >

## SYMPTOM DIAGNOSIS

### REAR WINDOW DEFOGGER DOES NOT OPERATE

#### Diagnosis Procedure

INFOID:000000004249136

#### 1. CHECK POWER SUPPLY AND GROUND CIRCUIT

Check power supply and ground circuit.  
Refer to [DEF-10, "Diagnosis Procedure"](#).

Is the inspection result normal?

- YES >> GO TO 2.
- NO >> Repair or replace the malfunctioning parts.

#### 2. CHECK REAR WINDOW DEFOGGER SWITCH

Check rear window defogger switch.  
Refer to [DEF-11, "Component Function Check"](#).

Is the inspection result normal?

- YES >> GO TO 3.
- NO >> Repair or replace the malfunctioning parts.

#### 3. CHECK REAR WINDOW DEFOGGER RELAY

Check rear window defogger relay.  
Refer to [DEF-12, "Component Function Check"](#).

Is the inspection result normal?

- YES >> GO TO 4.
- NO >> Repair or replace the malfunctioning parts.

#### 4. CHECK REAR WINDOW DEFOGGER

Check rear window defogger.  
Refer to [DEF-14, "Component Function Check"](#).

Is the inspection result normal?

- YES >> GO TO 5.
- NO >> Repair or replace the malfunctioning parts.

#### 5. CONFIRM THE OPERATION

Confirm the operation again.

Is the inspection result normal?

- YES >> Check intermittent incident. Refer to [GI-41, "Intermittent Incident"](#).
- NO >> GO TO 1.

A  
B  
C  
D  
E  
F  
G  
H  
I  
J  
K  
DEF  
M  
N  
O  
P

# REAR WINDOW DEFOGGER AND DOOR MIRROR DEFOGGER DO NOT OPERATE.

< SYMPTOM DIAGNOSIS >

## REAR WINDOW DEFOGGER AND DOOR MIRROR DEFOGGER DO NOT OPERATE.

### Diagnosis Procedure

INFOID:000000004249137

#### 1. CHECK POWER SUPPLY AND GROUND CIRCUIT

---

Check power supply and ground circuit.

Refer to [DEF-10, "Diagnosis Procedure"](#).

Is the inspection result normal?

YES >> GO TO 2.

NO >> Repair or replace the malfunctioning parts.

#### 2. CHECK REAR WINDOW DEFOGGER SWITCH

---

Check rear window defogger switch.

Refer to [DEF-11, "Component Function Check"](#).

Is the inspection result normal?

YES >> GO TO 3.

NO >> Repair or replace the malfunctioning parts.

#### 3. CHECK REAR WINDOW DEFOGGER RELAY

---

Check rear window defogger relay.

Refer to [DEF-12, "Component Function Check"](#).

Is the inspection result normal?

YES >> GO TO 4.

NO >> Repair or replace the malfunctioning parts.

#### 4. CONFIRM THE OPERATION

---

Confirm the operation again.

Is the inspection result normal?

YES >> Check intermittent incident. Refer to [GI-41, "Intermittent Incident"](#).

NO >> GO TO 1.



# REAR WINDOW DEFOGGER DOES NOT OPERATE BUT BOTH DOOR MIRROR DEFOGGER OPERATE.

< SYMPTOM DIAGNOSIS >

REAR WINDOW DEFOGGER DOES NOT OPERATE BUT BOTH DOOR MIRROR DEFOGGER OPERATE.

## Diagnosis Procedure

INFOID:000000004249138

### 1. CHECK REAR WINDOW DEFOGGER

Check rear window defogger.

Refer to [DEF-14, "Component Function Check"](#).

Is the inspection result normal?

YES >> GO TO 2.

NO >> Repair or replace the malfunctioning parts.

### 2. CONFIRM THE OPERATION

Confirm the operation again

Is the inspection result normal?

YES >> Check intermittent incident. Refer to [GI-41, "Intermittent Incident"](#).

NO >> GO TO 1.

A  
B  
C  
D  
E  
F  
G  
H  
I  
J  
K  
DEF  
M  
N  
O  
P

# DOOR MIRROR DEFOGGER DOES NOT OPERATE

< SYMPTOM DIAGNOSIS >

---

## DOOR MIRROR DEFOGGER DOES NOT OPERATE BOTH SIDES

BOTH SIDES : Diagnosis Procedure

INFOID:000000004249139

### 1.CHECK DOOR MIRROR DEFOGGER

---

Check door mirror defogger.

Refer to [DEF-17, "Component Function Check"](#).

Is the inspection result normal?

YES >> GO TO 2.

NO >> Repair or replace the malfunctioning parts.

### 2.CONFIRM THE OPERATION

---

Confirm the operation again.

Is the inspection result normal?

YES >> Check intermittent incident. Refer to [GI-41, "Intermittent Incident"](#).

NO >> GO TO 1.

## DRIVER SIDE

DRIVER SIDE : Diagnosis Procedure

INFOID:000000004249140

### 1.CHECK DRIVER SIDE DOOR MIRROR DEFOGGER

---

Check driver side door mirror defogger.

Refer to [DEF-19, "Component Function Check"](#).

Is the inspection result normal?

YES >> GO TO 2.

NO >> Repair or replace the malfunctioning parts.

### 2.CONFIRM THE OPERATION

---

Confirm the operation again.

Is the inspection result normal?

YES >> Check intermittent incident. Refer to [GI-41, "Intermittent Incident"](#).

NO >> GO TO 1.

## PASSENGER SIDE

PASSENGER SIDE : Diagnosis Procedure

INFOID:000000004249141

### 1.CHECK PASSENGER SIDE DOOR MIRROR DEFOGGER.

---

Check passenger side door mirror defogger.

Refer to [DEF-21, "Component Function Check"](#).

Is the inspection result normal?

YES >> GO TO 2.

NO >> Repair or replace the malfunctioning parts.

### 2.CONFIRM THE OPERATION

---

Confirm the operation again.

Is the inspection result normal?

YES >> Check intermittent incident. Refer to [GI-41, "Intermittent Incident"](#).

NO >> GO TO 1.

# ON IS NOT DISPLAYED WHEN PRESSING REAR WINDOW DEFOGGER SWITCH BUT IT IS OPERATED

< SYMPTOM DIAGNOSIS >

## ON IS NOT DISPLAYED WHEN PRESSING REAR WINDOW DEFOGGER SWITCH BUT IT IS OPERATED

### Diagnosis Procedure

INFOID:000000004249142

#### 1.CHECK AV CONTROL UNIT FUNCTION

Check that the AV control unit is operating normally.

Base audio without navigation refer to [AV-10, "Work Flow"](#).

Bose audio without navigation refer to [AV-125, "Work Flow"](#).

Bose audio with navigation refer to [AV-372, "Work Flow"](#).

Is the inspection result normal?

YES >> GO TO 2.

NO >> Repair or replace the malfunctioning parts.

#### 2.CONFIRM THE OPERATION

Confirm the operation again.

Is the inspection result normal?

YES >> Check intermittent incident. Refer to [GI-41, "Intermittent Incident"](#).

NO >> GO TO 1.

A  
B  
C  
D  
E  
F  
G  
H  
I  
J  
K  
DEF  
M  
N  
O  
P

## REAR WINDOW DEFOGGER INDICATOR DOES NOT ILLUMINATE

< SYMPTOM DIAGNOSIS >

---

### REAR WINDOW DEFOGGER INDICATOR DOES NOT ILLUMINATE

#### Diagnosis Procedure

INFOID:000000004249143

#### 1. CHECK MULTIFUNCTION SWITCH (REAR WINDOW DEFOGGER SWITCH)

---

Check rear window defogger operate.

- YES >> Replace multifunction switch (rear window defogger switch). Refer to [AV-119. "Removal and Installation"](#)
- NO >> Check rear window defogger system. Refer to [DEF-3. "Work Flow"](#)

# PRECAUTIONS

< PRECAUTION >

## PRECAUTION

### PRECAUTIONS

#### Precaution for Supplemental Restraint System (SRS) "AIR BAG" and "SEAT BELT PRE-TENSIONER"

INFOID:000000004249144

The Supplemental Restraint System such as "AIR BAG" and "SEAT BELT PRE-TENSIONER", used along with a front seat belt, helps to reduce the risk or severity of injury to the driver and front passenger for certain types of collision. This system includes seat belt switch inputs and dual stage front air bag modules. The SRS system uses the seat belt switches to determine the front air bag deployment, and may only deploy one front air bag, depending on the severity of a collision and whether the front occupants are belted or unbelted. Information necessary to service the system safely is included in the "SRS AIR BAG" and "SEAT BELT" of this Service Manual.

#### **WARNING:**

- To avoid rendering the SRS inoperative, which could increase the risk of personal injury or death in the event of a collision which would result in air bag inflation, all maintenance must be performed by an authorized NISSAN/INFINITI dealer.
- Improper maintenance, including incorrect removal and installation of the SRS, can lead to personal injury caused by unintentional activation of the system. For removal of Spiral Cable and Air Bag Module, see the "SRS AIR BAG".
- Do not use electrical test equipment on any circuit related to the SRS unless instructed to in this Service Manual. SRS wiring harnesses can be identified by yellow and/or orange harnesses or harness connectors.

#### PRECAUTIONS WHEN USING POWER TOOLS (AIR OR ELECTRIC) AND HAMMERS

#### **WARNING:**

- When working near the Air Bag Diagnosis Sensor Unit or other Air Bag System sensors with the ignition ON or engine running, DO NOT use air or electric power tools or strike near the sensor(s) with a hammer. Heavy vibration could activate the sensor(s) and deploy the air bag(s), possibly causing serious injury.
- When using air or electric power tools or hammers, always switch the ignition OFF, disconnect the battery, and wait at least 3 minutes before performing any service.

#### Precaution for Battery Service

INFOID:000000004610466

Before disconnecting the battery, lower both the driver and passenger windows. This will prevent any interference between the window edge and the vehicle when the door is opened/closed. During normal operation, the window slightly raises and lowers automatically to prevent any window to vehicle interference. The automatic window function will not work with the battery disconnected.

A  
B  
C  
D  
E  
F  
G  
H  
I  
J  
K  
DEF  
M  
N  
O  
P

# FILAMENT

< REMOVAL AND INSTALLATION >

## REMOVAL AND INSTALLATION

### FILAMENT

#### Inspection and Repair

INFOID:000000004249145

#### INSPECTION

1. When measuring voltage, wrap tin foil around the top of the negative probe. Then press the foil against the wire with your finger.

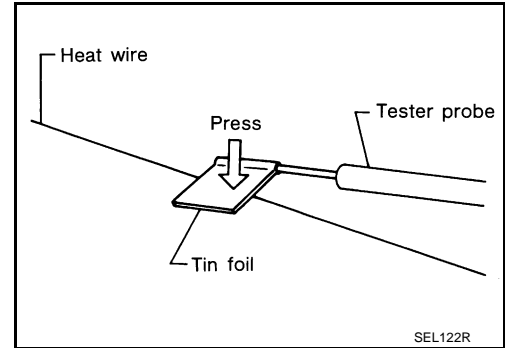

2. Attach probe circuit tester (in Volt range) to middle portion of each filament.

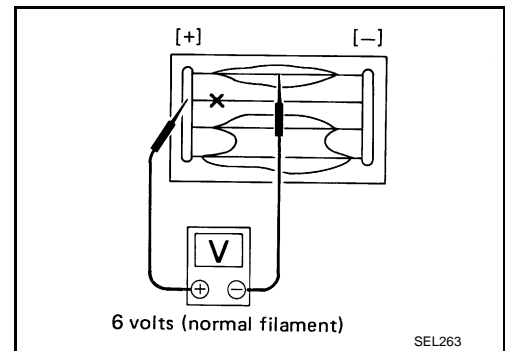

3. If a filament is burned out, circuit tester registers 0 or battery voltage.
4. To locate burned out point, move probe to left and right along filament. Test needle will swing abruptly when probe passes the point.

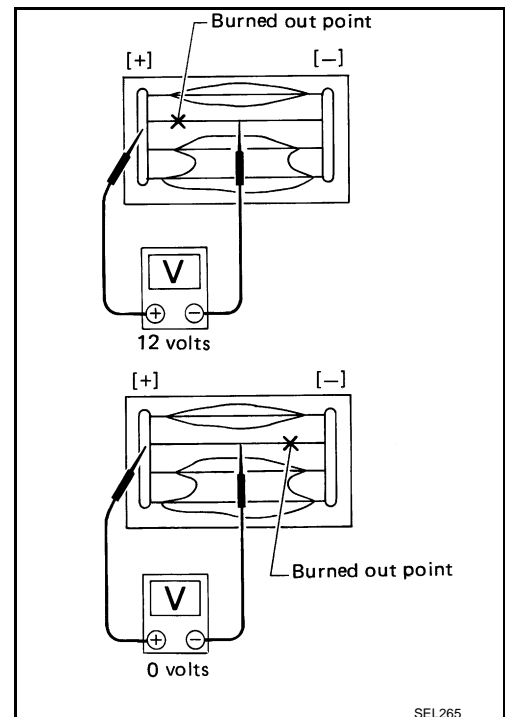

#### REPAIR

#### REPAIR EQUIPMENT

- Conductive silver composition (Dupont No. 4817 or equivalent)

# FILAMENT

## < REMOVAL AND INSTALLATION >

- Ruler 30 cm (11.8 in) long
- Drawing pen
- Heat gun
- Alcohol
- Cloth

### REPAIRING PROCEDURE

1. Wipe broken heat wire and its surrounding area clean with a cloth dampened in alcohol.
2. Apply a small amount of conductive silver composition to tip of drawing pen. Shake silver composition container before use.
3. Place ruler on glass along broken line. Deposit conductive silver composition on break with drawing pen. Slightly overlap existing heat wire on both sides [preferably 5 mm (0.20 in)] of the break.

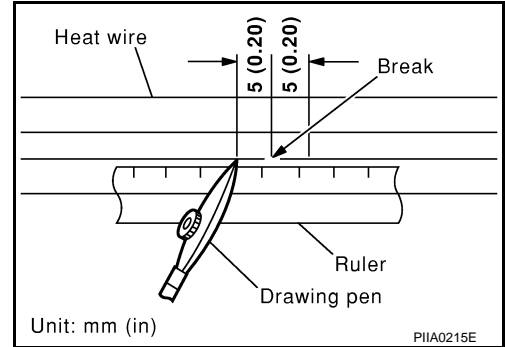

4. After repair has been completed, check repaired wire for continuity. This check should be conducted 10 minutes after silver composition is deposited. Do not touch repaired area while test is being conducted.

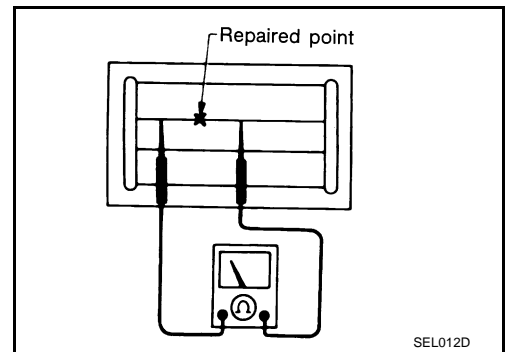

5. Apply a constant stream of hot air directly to the repaired area for approximately 20 minutes with a heat gun. A minimum distance of 3 cm (1.2 in) should be kept between repaired area and hot air outlet. If a heat gun is not available, let the repaired area dry for 24 hours.

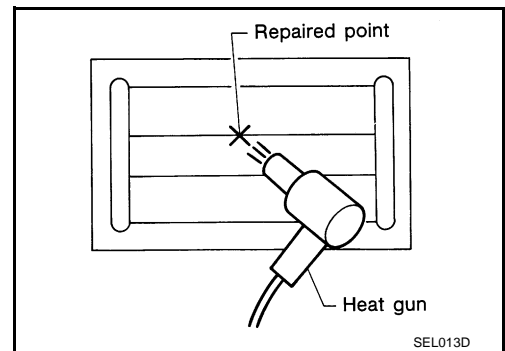

A  
B  
C  
D  
E  
F  
G  
H  
I  
J  
K  
DEF  
M  
N  
O  
P

# CONDENSER

< REMOVAL AND INSTALLATION >

## CONDENSER

### Exploded View

INFOID:000000004249146

Refer to [INT-14, "Exploded View"](#)

### Removal and Installation

INFOID:000000004249147

#### REMOVAL

1. Remove the rear seat cushion and the rear seatback.  
Refer to [SE-192, "Removal and Installation"](#)
2. Remove the rear kickplate, rear wheel well garnish and the rear pillar finisher.  
Refer to [INT-14, "Removal and Installation"](#)
3. Remove bolt (A), and then remove condenser (1) from the vehicle body.

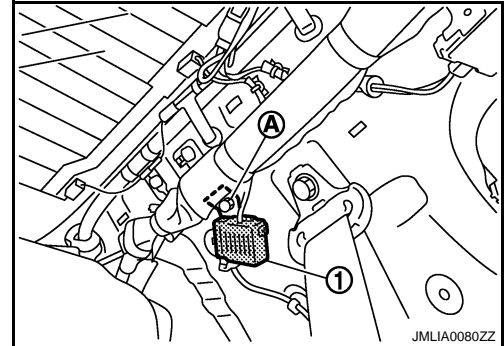

#### INSTALLATION

Install in the reverse order of removal.