

SECTION **SBC**

SEAT BELT CONTROL SYSTEM

A
B
C
D
E
F
G
SBC
I
J
K
L
M
N
O
P

CONTENTS

<p>BASIC INSPECTION 3</p> <p>DIAGNOSIS AND REPAIR WORK FLOW 3</p> <p style="padding-left: 20px;">Work Flow3</p> <p>SYSTEM DESCRIPTION 6</p> <p>PRE-CRASH SEAT BELT SYSTEM 6</p> <p style="padding-left: 20px;">System Diagram6</p> <p style="padding-left: 20px;">System Description6</p> <p style="padding-left: 20px;">Component Parts Location7</p> <p style="padding-left: 20px;">Component Description7</p> <p>DIAGNOSIS SYSTEM (PRE-CRASH SEAT BELT) 9</p> <p style="padding-left: 20px;">CONSULT-III Function9</p> <p>DTC/CIRCUIT DIAGNOSIS10</p> <p>U1000 CAN COMM CIRCUIT10</p> <p style="padding-left: 20px;">Description 10</p> <p style="padding-left: 20px;">DTC Logic 10</p> <p style="padding-left: 20px;">Diagnosis Procedure 10</p> <p>B2451 SB MOTOR RH CIRC11</p> <p style="padding-left: 20px;">Description 11</p> <p style="padding-left: 20px;">DTC Logic 11</p> <p style="padding-left: 20px;">Diagnosis Procedure 11</p> <p>B2452 SB MOTOR LH CIRC13</p> <p style="padding-left: 20px;">Description 13</p> <p style="padding-left: 20px;">DTC Logic 13</p> <p style="padding-left: 20px;">Diagnosis Procedure 13</p> <p>B2453 BR STROKE SEN CIRC15</p> <p style="padding-left: 20px;">Description 15</p> <p style="padding-left: 20px;">DTC Logic 15</p> <p style="padding-left: 20px;">Diagnosis Procedure 15</p> <p style="padding-left: 20px;">Component Inspection 16</p> <p>B2454 MOTOR PWR SUP CIRC18</p> <p style="padding-left: 20px;">Description 18</p>	<p style="padding-left: 20px;">DTC Logic18</p> <p style="padding-left: 20px;">Diagnosis Procedure18</p> <p>B2455 PSB C/U INT CIRCUIT19</p> <p style="padding-left: 20px;">Description19</p> <p style="padding-left: 20px;">DTC Logic19</p> <p style="padding-left: 20px;">Diagnosis Procedure19</p> <p>SEAT BELT BUCKLE SWITCH20</p> <p>DRIVER SIDE20</p> <p style="padding-left: 20px;">DRIVER SIDE : Description20</p> <p style="padding-left: 20px;">DRIVER SIDE : Component Function Check20</p> <p style="padding-left: 20px;">DRIVER SIDE : Diagnosis Procedure20</p> <p style="padding-left: 20px;">DRIVER SIDE : Component Inspection21</p> <p>PASSENGER SIDE21</p> <p style="padding-left: 20px;">PASSENGER SIDE : Description21</p> <p style="padding-left: 20px;">PASSENGER SIDE : Component Function Check21</p> <p style="padding-left: 20px;">PASSENGER SIDE : Diagnosis Procedure22</p> <p style="padding-left: 20px;">PASSENGER SIDE : Component Inspection23</p> <p>POWER SUPPLY AND GROUND CIRCUIT24</p> <p style="padding-left: 20px;">Diagnosis Procedure24</p> <p>ECU DIAGNOSIS INFORMATION25</p> <p>PRE-CRASH SEAT BELT CONTROL UNIT25</p> <p style="padding-left: 20px;">Reference Value25</p> <p style="padding-left: 20px;">Fail Safe26</p> <p style="padding-left: 20px;">DTC Index26</p> <p style="padding-left: 20px;">Wiring Diagram - SEAT BELT CONTROL SYSTEM -27</p> <p>SYMPTOM DIAGNOSIS31</p> <p>PRE-CRASH SEAT BELT DOES NOT OPERATE31</p> <p>BOTH SIDES31</p> <p style="padding-left: 20px;">BOTH SIDES : Diagnosis Procedure31</p>
--	---

DRIVER SIDE	31	PERIODIC MAINTENANCE	35
DRIVER SIDE : Diagnosis Procedure	31	PRE-INSPECTION FOR DIAGNOSTIC	35
PASSENGER SIDE	31	Description	35
PASSENGER SIDE : Diagnosis Procedure	31	BRAKE PEDAL STROKE SENSOR	36
PRECAUTION	33	Exploded View	36
PRECAUTIONS	33	Removal and Installation	36
Precaution for Supplemental Restraint System (SRS) "AIR BAG" and "SEAT BELT PRE-TEN- SIONER"	33	PRE-CRASH SEAT BELT CONTROL UNIT	37
Precaution for Seat Belt Service	33	Exploded View	37
Precaution for Battery Service	34	Removal and Installation	37

DIAGNOSIS AND REPAIR WORK FLOW

< BASIC INSPECTION >

BASIC INSPECTION

DIAGNOSIS AND REPAIR WORK FLOW

Work Flow

INFOID:000000004672943

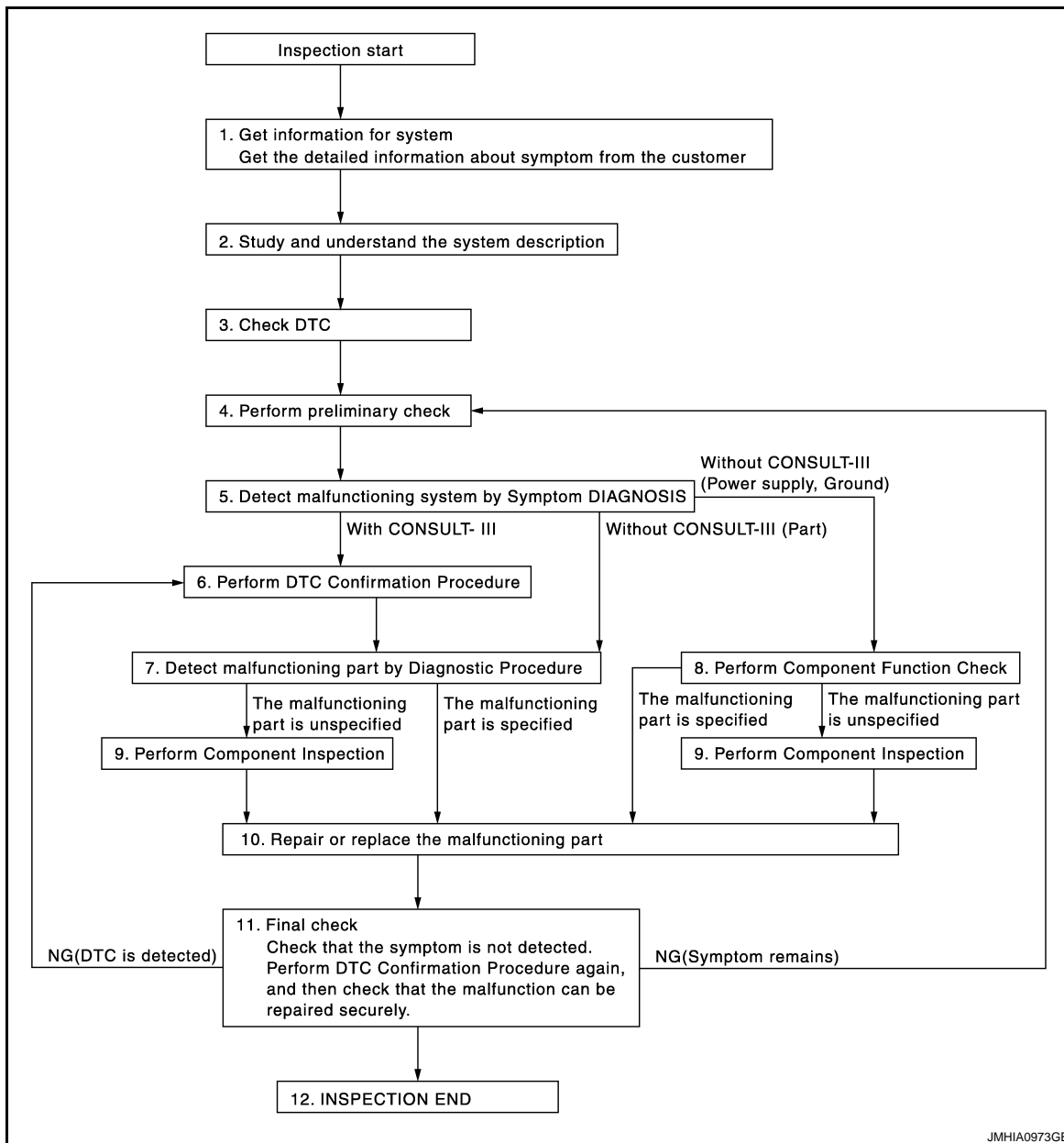

1. GET INFORMATION FOR SYSTEM

Interview the customer to obtain the malfunction information (conditions and environment when the malfunction occurred) as much as possible when the customer brings the vehicles in.

>> GO TO 2.

2. STUDY AND UNDERSTAND THE SYSTEM DESCRIPTION

Understand the operation condition or non-operation condition of pre-crash seat belt. Refer to [SBC-6. "System Description"](#).

>> GO TO 3.

DIAGNOSIS AND REPAIR WORK FLOW

< BASIC INSPECTION >

3.CHECK DTC

Perform "Self-diagnosis procedure" of appropriate DTC to check if DTC is detected again.
At this time, always connect CONSULT-III to the vehicle, and then check the diagnosis results in real time on "DATA MONITOR (AUTO RECORD)".

There is no priority for each DTC. Record them based on the following rules.

Current malfunction: Record all DTCs detected.

Past malfunction: Record up to 5 DTCs. When the 6th DTC is detected, it is overwritten to the last recorded DTC.

Is DTC detected?

YES >> GO TO 4.

NO >> Follow the diagnosis simulation test to check. Refer to [GI-41, "Intermittent Incident"](#).

4.PERFORM PRELIMINARY CHECK

Perform preliminary check. Refer to [SBC-31, "BOTH SIDES : Diagnosis Procedure"](#).

>> GO TO 5.

5.DETECT MALFUNCTIONING SYSTEM BY SYMPTOM DIAGNOSIS

Identify the malfunctioning system with "Malfunctioning system by symptom diagnosis". Refer to [SBC-31, "BOTH SIDES : Diagnosis Procedure"](#).

With CONSULT-III>>GO TO 6.

Without CONSULT-III>>GO TO 7 (Parts system).

Without CONSULT-III>>GO TO 8 (Power supply, ground system).

6.PERFORM DTC CONFIRMATION PROCEDURE"

Perform the inspection with "DTC CONFIRMATION PROCEDURE" of the applicable system.

>> GO TO 7.

7.DETECT MALFUNCTIONING PART BY DIAGNOSTIC PROCEDURE

Identify the malfunctioning part with "Diagnosis Procedure".

Are malfunctioning parts detected?

YES >> GO TO 10.

NO >> GO TO 9.

8.PERFORM COMPONENT FUNCTION CHECK

Identify the malfunctioning part with "Component Function Check".

Are malfunctioning parts detected?

YES >> GO TO 10.

NO >> GO TO 9.

9.PERFORM COMPONENT INSPECTION

Perform the inspection with "Component Inspection".

>> GO TO 10.

10.REPAIR OR REPLACE THE MALFUNCTIONING PART

Repair or replace the specified malfunctioning parts.

After repairing or replacing, reconnect parts or connector disconnected in "Diagnosis Procedure", and then erase DTC if necessary. Refer to [SBC-9, "CONSULT-III Function"](#).

>> GO TO 11.

11.FINAL CHECK

Perform "CONSULT-III function" again to check that the repair is performed correctly.

DIAGNOSIS AND REPAIR WORK FLOW

< BASIC INSPECTION >

Check that malfunctions are not reproduced when obtaining the malfunction information from the customer, referring to the symptom inspection result in step 4.

Are all malfunctions corrected?

YES >> • Before delivering the vehicle to the customer, check that that DTC is erased.
• INSPECTION END

NO >> DTC is reproduced: GO TO 6.

A

B

C

D

E

F

G

SBC

I

J

K

L

M

N

O

P

PRE-CRASH SEAT BELT SYSTEM

< SYSTEM DESCRIPTION >

SYSTEM DESCRIPTION

PRE-CRASH SEAT BELT SYSTEM

System Diagram

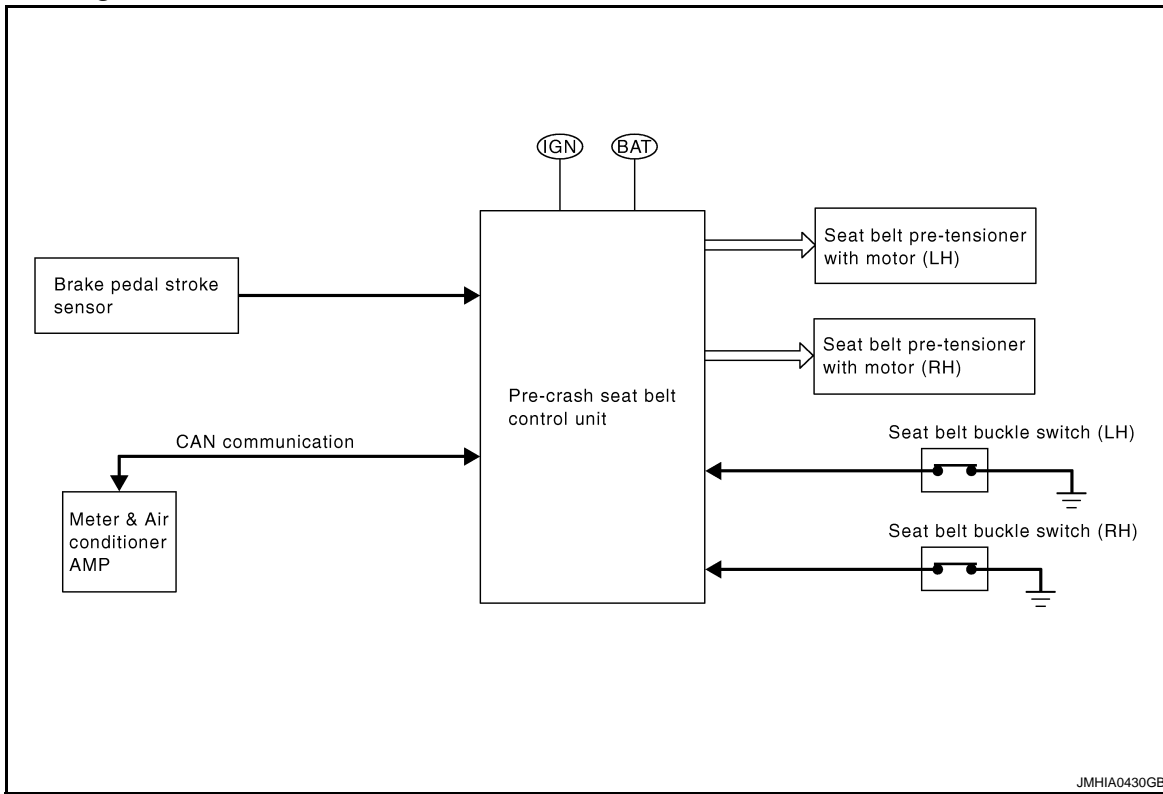

System Description

INFOID:000000004673712

- Pre-crash seat belt is adopted to RH/LH seat belts
- Pre-crash seat belt retracts shoulder webbing by a motor in pre-tensioner seat belt with control unit built in motor
- Facilitates an emergency operation by restraining change in occupant posture while emergency braking is being applied, intelligent brake is being activated
- Restrains occupant faster and firmly, maximizes the effect of other devices like air bag, and reduces possible damage if a collision is unavoidable
- Provides occupant a sense of ease by pulling occupants body to seat during braking that does not result a collision
- Retracts shoulder webbing and rewinds excessive seat belt slack when occupant is getting in or out of the vehicle, or fastening or unfastening seat belt

FUNCTION DESCRIPTION

Pre-crash seat belt is activated in the conditions as per the following.
Emergency braking is applied

OPERATION CONDITION

The activation and deactivation conditions of pre-crash seat belt are as per the following.

	Activating condition	Deactivating condition
When emergency braking is applied	<ul style="list-style-type: none"> • Judges that emergency braking is applied • Vehicle speed is 15 km/h (9 MPH) or more 	<ul style="list-style-type: none"> • When the vehicle accelerates • The vehicle stays stopped

OPERATION PROHIBITION CONDITION

- Seat belt is not fastened (Only the seat belt that is not fastened does not operate)
- At fail-safe condition

PRE-CRASH SEAT BELT SYSTEM

< SYSTEM DESCRIPTION >

Component Parts Location

INFOID:000000004672950

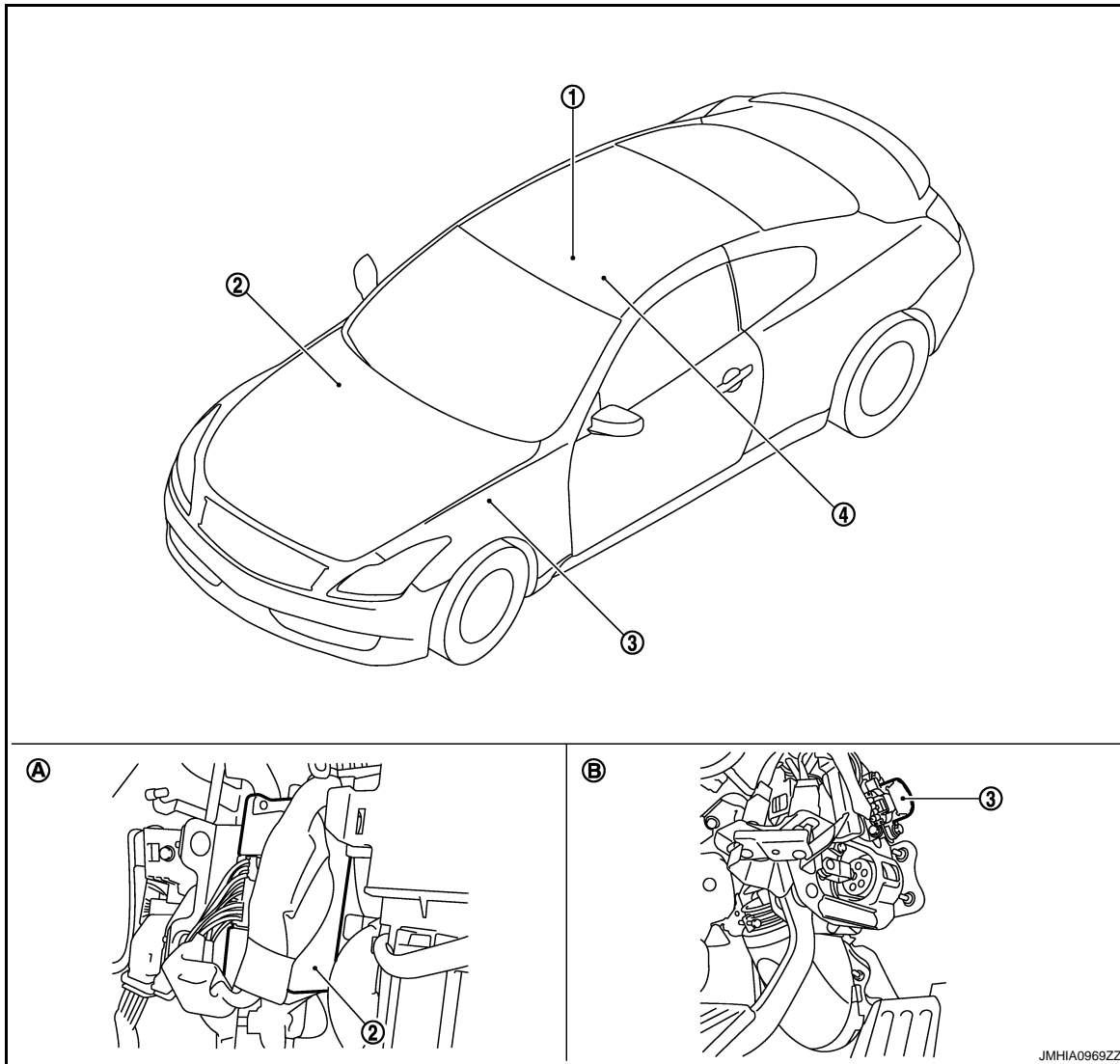

A

B

C

D

E

F

G

SBC

I

J

K

L

M

N

O

P

- | | | |
|--|---|-----------------------------------|
| 1. Seat belt buckle switch (passenger side) B213 | 2. Pre-crash seat belt control unit M110 | 3. Brake pedal stroke sensor E116 |
| 4. Seat belt buckle switch (driver side) B13 | | |
| A. Behind the glove box | B. Behind the driver instrument panel (lower) | |

Component Description

INFOID:000000004672951

Component	Function
Pre-crash seat belt control unit	It controls pre-crash seat belt motor according to input signal.
Pre-crash seat belt motor (Seat belt motor [RH/LH])	It is built into seat belt retractor, and it pulls, returns, and maintains according to the motor rotation.
Brake pedal stroke sensor	<ul style="list-style-type: none"> It changes voltage according to brake pedal depressed amount and sends the signal to pre-crash seat belt control unit. There are 2 signals (brake pedal stroke sensor 1 and 2) sent from the brake pedal stroke sensor. Pre-crash seat belt control unit will judge the stroke amount and the speed of the brake pedal according to the voltage of the signal sent by each side.

PRE-CRASH SEAT BELT SYSTEM

< SYSTEM DESCRIPTION >

Component	Function
Seat belt buckle switch	It is arranged in the seat belt buckle and judges whether the seat belt is fastened or not fastened.
Unified meter and A/C amp	It transmits the vehicle status to pre-crash seat belt control unit using the CAN communication system.

DIAGNOSIS SYSTEM (PRE-CRASH SEAT BELT)

< SYSTEM DESCRIPTION >

DIAGNOSIS SYSTEM (PRE-CRASH SEAT BELT)

CONSULT-III Function

INFOID:000000004672953

Diagnosis for pre-crash seat belt system can be performed using CONSULT-III.

APPLICATION ITEM

Part to be diagnosed	Diagnosis Mode	Function description
Pre-crash seat belt	Self-diagnosis Results	<ul style="list-style-type: none"> Displays data recorded when a malfunction is detected. Can print out the display. Erases DTC recorded in memory.
	Data Monitor	Displays input data for pre-crash seat belt control unit in real time.
	CAN DIAG SUPPORT MNTR	Monitors communication status of CAN communication.
	ECU PART NUMBER	Displays pre-crash seat belt control unit part number.

SELF-DIAGNOSIS RESULTS

CAUTION:

When malfunctions are detected in several systems, including the CAN communication [U1000], troubleshoot the CAN communication [U1000].

Diagnostic item	Malfunction judgement criteria	Refer to
CAN COMM CIRC [U1000]	CAN communication is malfunctioning.	SBC-10
Seat belt motor system RH [B2451]	Circuit of seat belt motor (RH) is open or shorted.	SBC-11
Seat belt motor system LH [B2452]	Circuit of seat belt motor (LH) is open or shorted.	SBC-13
B-pedal sensor system [B2453]	Circuit of brake pedal stroke sensor is open or shorted.	SBC-15
Motor power supply circuit system [B2454]	Circuit of motor power supply is open or shorted. CAUTION: Malfunction is judged when 30A (F/L-G) fusible link blows out even if motor power supply circuit is not malfunctioning.	SBC-18

NOTE:

Timing display judges the status of self-diagnosis results judged from each input signal.

- When malfunction is found in the past and it is normal now, "MEMORY" is displayed.
- When malfunction is found at present or found immediately after the self-diagnosis, "CURRENT" is displayed.
- When malfunction is not found in the past and it is normal now, nothing is displayed.

CAUTION:

Some malfunctions are displayed at low battery voltage (when keeping 7 to 8 V for 2 seconds) even if the system is not malfunctioning. Erase DTC memory and do not replace any parts after making sure that the system is normal especially if the malfunctions are displayed after replacing battery.

DATA MONITOR

Monitor item	[Operation or unit]	Display item
B PEDAL SIG1	[V]	Brake pedal stroke sensor 1 signal voltage is displayed.
B PEDAL SIG2	[V]	Brake pedal stroke sensor 2 signal voltage is displayed.
SB SW RH SIG	[ON/OFF]	ON/OFF status of RH seat belt switch signal is displayed.
SB SW LH SIG	[ON/OFF]	ON/OFF status of LH seat belt switch signal is displayed.
Vehicle speed sensor	[km/h]	Vehicle speed signal is displayed.

U1000 CAN COMM CIRCUIT

< DTC/CIRCUIT DIAGNOSIS >

DTC/CIRCUIT DIAGNOSIS

U1000 CAN COMM CIRCUIT

Description

INFOID:000000004679398

CAN (Controller Area Network) is a serial communication line for real time applications. It is an on-vehicle multiplex communication line with high data communication speed and excellent error detection ability. Modern vehicle is equipped with many electronic control unit, and each control unit shares information and links with other control units during operation (not independent). In CAN communication, control units are connected with 2 communication lines (CAN H-line, CAN L-line) allowing a high rate of information transmission with less wiring. Each control unit transmits/receives data but selectively reads required data only. CAN Communication Signal Chart. Refer to [LAN-27, "CAN Communication Signal Chart"](#).

DTC Logic

INFOID:000000004679399

DTC DETECTION LOGIC

DTC	CONSULT-III display description	DTC Detection Condition	Possible cause
U1000	CAN COMM CIRCUIT	When BCM cannot communicate CAN communication signal continuously for 2 seconds or more.	CAN communication system

Diagnosis Procedure

INFOID:000000004679400

1. PERFORM SELF DIAGNOSTIC

1. Turn ignition switch ON and wait for 2 seconds or more.
2. Check "Self Diagnostic Result".

Is DTC "U1000" displayed?

- YES >> Refer to [LAN-18, "Trouble Diagnosis Flow Chart"](#).
NO >> Refer to [GI-41, "Intermittent Incident"](#).

B2451 SB MOTOR RH CIRC

< DTC/CIRCUIT DIAGNOSIS >

B2451 SB MOTOR RH CIRC

Description

INFOID:000000004672956

- It pulls, returns, and maintains according to the motor rotation.
- It is built into the seat belt retractor.
- It is installed to back of RH center pillar garnish.

DTC Logic

INFOID:000000004672957

DTC DETECTION LOGIC

DTC No.	Self-diagnosis item	DTC Detection Condition	Possible causes
B2451	Seat belt motor system RH	Circuit of seat belt motor (RH) is open or shorted	<ul style="list-style-type: none"> • Open circuit, short circuit to battery, and short circuit to ground in seat belt motor (RH) harness • Pre-crash seat belt control unit

DTC CONFIRMATION PROCEDURE

1. SELF-DIAGNOSIS WITH PRE-CRASH SEAT BELT MOTOR RH CIRCUIT

1. Turn ignition switch ON.
2. Check "Self-diagnostic result" with CONSULT-III.

Is DTC detected?

- YES >> Refer to [SBC-11, "Diagnosis Procedure"](#).
- NO >> Pre-crash seat belt motor RH system is normal.

Diagnosis Procedure

INFOID:000000004673944

1. CHECK PRE-CRASH SEAT BELT MOTOR RH CIRCUIT

1. Turn ignition switch OFF.
2. Disconnect pre-crash seat belt control unit connector and pre-crash seat belt motor RH connector.
3. Check continuity between pre-crash seat belt control unit harness connector and pre-crash seat belt motor RH harness connector.

Pre-crash seat belt control unit		Pre-crash seat belt motor RH		Continuity
Connector	Terminal	Connector	Terminal	
M110	1	B228	1	Existed
	3		2	

4. Check continuity between pre-crash seat belt control unit harness connector and ground.

Pre-crash seat belt control unit		Ground	Continuity
Connector	Terminal		
M110	1		Not existed
	3		

Is the inspection result normal?

- YES >> GO TO 2.
- NO >> Repair or replace harness.

2. SELF-DIAGNOSIS WITH PRE-CRASH SEAT BELT MOTOR RH CIRCUIT

1. Replace pre-crash seat belt motor RH.
2. Connect pre-crash seat belt control unit connector and pre-crash seat belt motor RH connector.
3. Turn ignition switch ON.
4. Check "Self-diagnostic result" with CONSULT-III.

Is DTC detected?

- YES >> Replace pre-crash seat belt control unit.

A
B
C
D
E
F
G
I
J
K
L
M
N
O
P

SBC

B2451 SB MOTOR RH CIRC

< DTC/CIRCUIT DIAGNOSIS >

NO >> INSPECTION END

B2452 SB MOTOR LH CIRC

< DTC/CIRCUIT DIAGNOSIS >

B2452 SB MOTOR LH CIRC

Description

INFOID:000000004672960

- It pulls, returns, and maintains according to the motor rotation.
- It is built into the seat belt retractor.
- It is installed to the back of LH center pillar garnish.

DTC Logic

INFOID:000000004672961

DTC DETECTION LOGIC

DTC No.	Self-diagnosis item	DTC Detection Condition	Possible causes
B2452	Seat belt motor system LH	Circuit of seat belt motor (LH) is open or shorted	<ul style="list-style-type: none"> • Open circuit, short circuit to battery, and short circuit to ground in seat belt motor (LH) harness • Pre-crash seat belt control unit

DTC REPRODUCTION PROCEDURE

1. SELF-DIAGNOSIS WITH PRE-CRASH SEAT BELT MOTOR LH CIRCUIT

1. Turn ignition switch ON.
2. Check "Self-diagnostic result" with CONSULT-III.

Is DTC detected?

- YES >> Refer to [SBC-13. "Diagnosis Procedure"](#).
- NO >> Pre-crash seat belt motor LH system is normal.

Diagnosis Procedure

INFOID:000000004673945

1. CHECK PRE-CRASH SEAT BELT MOTOR LH CIRCUIT

1. Turn ignition switch OFF.
2. Disconnect pre-crash seat belt control unit connector and pre-crash seat belt motor LH connector.
3. Check continuity between pre-crash seat belt control unit harness connector and pre-crash seat belt motor LH harness connector.

Pre-crash seat belt control unit		Pre-crash seat belt motor LH		Continuity
Connector	Terminal	Connector	Terminal	
M110	4	B28	2	Existed
	6		1	

4. Check continuity between pre-crash seat belt control unit harness connector and ground.

Pre-crash seat belt control unit		Ground	Continuity
Connector	Terminal		
M110	4		Not existed
	6		

Is the inspection result normal?

- YES >> GO TO 2.
- NO >> Repair or replace harness.

2. SELF-DIAGNOSIS WITH PRE-CRASH SEAT BELT MOTOR LH CIRCUIT

1. Replace pre-crash seat belt motor LH.
2. Connect pre-crash seat belt control unit connector and pre-crash seat belt motor LH connector.
3. Turn ignition switch ON.
4. Check "Self-diagnostic result" with CONSULT-III.

Is DTC detected?

- YES >> Replace pre-crash seat belt control unit.

A
B
C
D
E
F
G
I
J
K
L
M
N
O
P

SBC

B2452 SB MOTOR LH CIRC

< DTC/CIRCUIT DIAGNOSIS >

NO >> INSPECTION END

B2453 BR STROKE SEN CIRC

< DTC/CIRCUIT DIAGNOSIS >

B2453 BR STROKE SEN CIRC

Description

INFOID:000000004673915

- It changes voltage according to brake pedal depressed amount and sends the signal to pre-crash seat belt control unit.
- There are 2 signals (brake pedal stroke sensor 1 and 2) sent from the brake pedal stroke sensor. Pre-crash seat belt control unit judges the stroke amount and the speed of the brake pedal according to the voltage of the signal sent by each side.
- It is installed to back of driver instrument panel (lower).

DTC Logic

INFOID:000000004673916

DTC DETECTION LOGIC

DTC No.	Self-diagnosis item	DTC Detection Condition	Possible causes
B2453	BR STROKE SEN CIRC	Circuit of brake pedal stroke sensor output is open or shorted	<ul style="list-style-type: none">• Open circuit, short circuit to battery, and short circuit to ground in brake pedal stroke sensor harness• Pre-crash seat belt control unit• Brake pedal stroke sensor

DTC CONFIRMATION PROCEDURE

1. SELF-DIAGNOSIS WITH PRE-CRASH SEAT BELT CONTROL UNIT

1. Turn ignition switch ON.
2. Check "Self-diagnostic result" with CONSULT-III.

Is DTC detected?

- YES >> Refer to [SBC-15. "Diagnosis Procedure"](#).
NO >> INSPECTION END

Diagnosis Procedure

INFOID:000000004673917

1. CHECK PRE-CRASH SEAT BELT CONTROL UNIT INPUT SIGNAL

1. Turn ignition switch ON.
2. Select "B PEDAL SIG1" and "B PEDAL SIG2" in "DATA MONITOR" mode with CONSULT-III.
3. Check "B PEDAL SIG1" and "B PEDAL SIG2" indication under the following conditions.

Monitor item	Condition	Voltage (V) (Approx.)
B PEDAL SIG1	Brake released → depressed	1 → 4
B PEDAL SIG2		4 → 1

Is the inspection result normal?

- YES >> GO TO 5.
NO >> GO TO 2.

2. CHECK BRAKE PEDAL STROKE SENSOR POWER SUPPLY

1. Turn ignition switch OFF.
2. Disconnect brake pedal stroke sensor connector.
3. Check voltage between brake pedal stroke sensor harness connector and ground.

Brake pedal stroke sensor		Ground	Voltage (V) (Approx.)
Connector	Terminal		
E116	2		5

Is the inspection result normal?

- YES >> GO TO 3.
NO >> GO TO 4.

B2453 BR STROKE SEN CIRC

< DTC/CIRCUIT DIAGNOSIS >

3. CHECK BRAKE PEDAL STROKE SENSOR CIRCUIT

1. Disconnect pre-crash seat belt control unit connector.
2. Check continuity between pre-crash seat belt control unit harness connector and brake pedal stroke sensor harness connector.

Pre-crash seat belt control unit		Brake pedal stroke sensor		Continuity
Connector	Terminal	Connector	Terminal	
M110	16	E116	1	Existed
	20		3	
	21		4	

3. Check continuity between pre-crash seat belt control unit harness connector and ground.

Pre-crash seat belt control unit		Ground	Continuity
Connector	Terminal		
M110	16	Ground	Not existed
	20		
	21		

Is the inspection result normal?

YES >> Refer to [SBC-16, "Component Inspection"](#).

NO >> Repair or replace harness between pre-crash seat belt control unit and brake pedal stroke sensor.

4. CHECK BRAKE PEDAL STROKE SENSOR POWER SUPPLY CIRCUIT

1. Disconnect pre-crash seat belt control unit connector.
2. Check continuity between pre-crash seat belt control unit harness connector and brake pedal stroke sensor harness connector.

Pre-crash seat belt control unit		Brake pedal stroke sensor		Continuity
Connector	Terminal	Connector	Terminal	
M110	18	E116	2	Existed

3. Check continuity between pre-crash seat belt control unit and ground.

Pre-crash seat belt control unit		Ground	Continuity
Connector	Terminal		
M110	18	Ground	Not existed

Is the inspection result normal?

YES >> Replace pre-crash seat belt control unit. Refer to [SBC-37, "Removal and Installation"](#).

NO >> Repair or replace harness between pre-crash seat belt control unit and brake pedal stroke sensor.

5. CHECK INTERMITTENT INCIDENT

Refer to [GI-41, "Intermittent Incident"](#).

>> INSPECTION END

Component Inspection

INFOID:000000004673918

1. CHECK BRAKE PEDAL STROKE SENSOR

1. Turn ignition switch OFF.
2. Disconnect brake pedal stroke sensor connector.
3. Check that continuity between brake pedal stroke sensor when performing the brake operation.

B2453 BR STROKE SEN CIRC

< DTC/CIRCUIT DIAGNOSIS >

Brake pedal stroke sensor		Condition	Resistance (K Ω) (Approx.)
Terminal			
2	1	Brake released → depressed	1.0 → 0.2
	3		0.2 → 1.0

Is the inspection result normal?

YES >> Brake pedal stroke sensor system is normal.

NO >> Replace brake pedal stroke sensor. Refer to [SBC-36, "Removal and Installation"](#).

A
B
C
D
E
F
G
I
J
K
L
M
N
O
P

SBC

B2454 MOTOR PWR SUP CIRC

< DTC/CIRCUIT DIAGNOSIS >

B2454 MOTOR PWR SUP CIRC

Description

INFOID:000000004673922

- When control unit activates pre-crash seat belt system, it retracts the shoulder belt with the electric motor and reduces seat belt slack.
- Power supply is supplied constantly from battery power supply.

DTC Logic

INFOID:000000004673923

DTC DETECTION LOGIC

DTC No.	Self-diagnosis item	DTC Detection Condition	Possible causes
B2454	SEAT BLT PWR DR CIRC	Motor power supply circuit is open or shorted	<ul style="list-style-type: none">• Open circuit and short circuit to ground in drive circuit power supply harness• Pre-crash seat belt control unit

DTC CONFIRMATION PROCEDURE

1. SELF-DIAGNOSIS WITH PRE-CRASH SEAT BELT CONTROL UNIT

1. Turn ignition switch ON.
2. Check "Self-diagnostic result" with CONSULT-III.

Is DTC detected?

- YES >> Refer to [SBC-18. "Diagnosis Procedure"](#).
NO >> INSPECTION END

Diagnosis Procedure

INFOID:000000004673924

1. CHECK FUSE AND FUSIBLE LINK

Check that the following fuse and fusible link are not blown.

Terminal No.	Signal name	Fuse and fusible link No.
2	Battery power supply	G

Is the inspection result normal?

- YES >> GO TO 2.
NO >> Replace the blown fuse or fusible link after repairing the affected circuit if a fuse or fusible link is blown.

2. CHECK PRE-CRASH SEAT BELT MOTOR POWER SUPPLY

1. Turn ignition switch OFF.
2. Disconnect pre-crash seat belt control unit connector.
3. Check voltage between pre-crash seat belt control unit harness connector and ground.

Pre-crash seat belt control unit		Ground	Voltage (V) (Approx.)
Connector	Terminal		Battery voltage
M110	2		

Is the inspection result normal?

- YES >> Replace pre-crash seat belt control unit. Refer to [SBC-37. "Removal and Installation"](#).
NO >> Repair or replace harness between pre-crash seat belt control unit and fusible link.

B2455 PSB C/U INT CIRCUIT

< DTC/CIRCUIT DIAGNOSIS >

B2455 PSB C/U INT CIRCUIT

Description

INFOID:000000004672971

- It controls pre-crash seat belt motor according to input signal.
- It consists of pre-crash seat belt control unit.

DTC Logic

INFOID:000000004673925

DTC DETECTION LOGIC

DTC No.	Self-diagnosis item	DTC Detection Condition	Possible causes
B2455	C/U internal circuit system	Pre-crash seat belt control unit internal circuit malfunction	Pre-crash seat belt control unit

DTC CONFIRMATION PROCEDURE

1.SELF-DIAGNOSIS WITH PRE-CRASH SEAT BELT CONTROL UNIT

1. Turn ignition switch ON.
2. Check "Self-diagnostic result" with CONSULT-III.

Is DTC detected?

- YES >> Refer to [SBC-19, "Diagnosis Procedure"](#).
NO >> INSPECTION END

Diagnosis Procedure

INFOID:000000004673926

1..INSPECTION START

1. Check "Self-diagnostic result" with CONSULT-III.
2. Touch "ERASE".
3. Perform DTC Confirmation Procedure.
See [SBC-19, "DTC Logic"](#).

Is DTC B2455 displayed again?

- YES >> Replace pre-crash seat belt control unit. Refer to [SBC-37, "Removal and Installation"](#).
NO >> GO TO 2.

2.CHECK INTERMITTENT INCIDENT

Refer to [GI-41, "Intermittent Incident"](#).

>> INSPECTION END

A
B
C
D
E
F
G
I
J
K
L
M
N
O
P

SBC

SEAT BELT BUCKLE SWITCH

< DTC/CIRCUIT DIAGNOSIS >

SEAT BELT BUCKLE SWITCH

DRIVER SIDE

DRIVER SIDE : Description

INFOID:000000004673927

- Performs the control of tension reducer according to the seat belt buckle switch ON/OFF.
- Detects whether or not the seat belt is fastened when the ignition switch turns ON. If the seat belt is not fastened, illuminates the seat belt warning lamp on the combination meter.
- The seat belt buckle switch is installed in the seat belt buckle.

DRIVER SIDE : Component Function Check

INFOID:000000004673928

1. CHECK PRE-CRASH SEAT BELT CONTROL UNIT INPUT SIGNAL

Ⓟ With CONSULT-III

When checking "SB SW LH SIG" on DATA MONITOR screen, check that ON/OFF display changes synchronized with the insertion operation to the seat belt buckle.

Monitor item	Condition
SB SW LH SIG	When driver side seat belt is not fastened: OFF
	When driver side seat belt is fastened: ON

Is the inspection result normal?

YES >> Seat belt buckle switch (driver side) circuit is normal.

NO >> Refer to [SBC-20, "DRIVER SIDE : Diagnosis Procedure"](#).

DRIVER SIDE : Diagnosis Procedure

INFOID:000000004673929

1. CHECK PRE-CRASH SEAT BELT CONTROL UNIT INPUT SIGNAL

Check that voltage between seat belt buckle switch (driver side) and ground.

(+)		(-)	Condition	Voltage (V) (Approx.)
Seat belt buckle switch (driver side)	Connector			
	Terminal	Ground	When driver side seat belt is not fastened	5
B13	1		When driver side seat belt is fastened	0

Is the inspection result normal?

YES >> Seat belt buckle switch (driver side) circuit is normal.

NO >> GO TO 2.

2. CHECK SEAT BELT BUCKLE SWITCH (DRIVER SIDE) CIRCUIT

1. Turn ignition switch OFF.
2. Disconnect pre-crash seat belt control unit connector and seat belt buckle switch (driver side) connector.
3. Check continuity between pre-crash seat belt control unit and seat belt buckle switch (driver side).

Pre-crash seat belt control unit		Seat belt buckle switch (driver side)		Continuity
Connector	Terminal	Connector	Terminal	
M110	10	B13	1	Existed

4. Check continuity between pre-crash seat belt control unit and ground.

Pre-crash seat belt control unit		Ground	Continuity
Connector	Terminal		
M110	10		Not existed

Is the inspection result normal?

SEAT BELT BUCKLE SWITCH

< DTC/CIRCUIT DIAGNOSIS >

YES >> GO TO 3.

NO >> Repair or replace harness between pre-crash seat belt control unit and seat belt buckle switch (driver side).

3.CHECK SEAT BELT BUCKLE SWITCH GROUND CIRCUIT

Check continuity between seat belt buckle switch (driver side) and ground.

Seat belt buckle switch (driver side)		Ground	Continuity
Connector	Terminal		Existed
B13	2		Existed

Is the inspection result normal?

YES >> GO TO 4.

NO >> Repair or replace harness between seat belt buckle switch and ground.

4.CHECK SEAT BELT BUCKLE SWITCH (DRIVER SIDE)

Check seat belt buckle switch (driver side). Refer to [SBC-21, "DRIVER SIDE : Component Inspection"](#).

Is the inspection result normal?

YES >> Replace pre-crash seat belt control unit. Refer to [SBC-37, "Removal and Installation"](#).

NO >> Replace seat belt buckle switch (driver side).

DRIVER SIDE : Component Inspection

INFOID:000000004673930

1.CHECK SEAT BELT BUCKLE SWITCH (DRIVER SIDE)

1. Turn ignition switch OFF.
2. Disconnect seat belt buckle switch connector.
3. Check continuity of seat belt buckle (driver side).

Seat belt buckle switch (driver side)		Condition	Continuity
Terminal			
1	2	When driver side seat belt is not fastened	Not existed
		When driver side seat belt is fastened	Existed

Is the inspection result normal?

YES >> INSPECTION END

NO >> Replace seat belt buckle switch (driver side).

PASSENGER SIDE

PASSENGER SIDE : Description

INFOID:000000004673931

- Performs the control of tension reducer according to the seat belt buckle switch ON/OFF.
- Detects whether or not the seat belt is fastened when the ignition switch turns ON. If the seat belt switch is not fastened, illuminates the seat belt warning lamp on the combination meter.
- The seat belt buckle switch is installed in the seat belt buckle.

PASSENGER SIDE : Component Function Check

INFOID:000000004673932

1.CHECK PRE-CRASH SEAT BELT CONTROL UNIT INPUT SIGNAL

Ⓜ With CONSULT-III

When checking "SB SW RH SIG" on DATA MONITOR screen, check that ON/OFF display changes are synchronized with the insertion operation to the seat belt buckle.

Monitor item	Condition
SB SW RH SIG	When driver side seat belt is not fastened: OFF
	When driver side seat belt is fastened: ON

Is the inspection result normal?

YES >> Seat belt buckle switch (passenger side) circuit is normal.

SEAT BELT BUCKLE SWITCH

< DTC/CIRCUIT DIAGNOSIS >

NO >> Refer to [SBC-22, "PASSENGER SIDE : Diagnosis Procedure"](#).

PASSENGER SIDE : Diagnosis Procedure

INFOID:000000004673933

1. CHECK PRE-CRASH SEAT BELT CONTROL UNIT INPUT SIGNAL

Check that voltage between seat belt buckle switch (passenger side) and ground.

(+)		(-)	Condition	Voltage (V) (Approx.)
Connector	Terminal			
B213	1	Ground	When driver side seat belt is not fastened	5
			When driver side seat belt is fastened	0

Is the inspection result normal?

YES >> Seat belt buckle switch (passenger side) circuit is normal.

NO >> GO TO 2.

2. CHECK SEAT BELT BUCKLE (PASSENGER SIDE) SWITCH CIRCUIT

- Turn ignition switch OFF.
- Disconnect pre-crash seat belt control unit connector and seat belt buckle switch (passenger side) connector.
- Check continuity between pre-crash seat belt control unit and seat belt buckle switch (passenger side).

Pre-crash seat belt control unit		Seat belt buckle switch (passenger side)		Continuity
Connector	Terminal	Connector	Terminal	
M110	8	B213	1	Existed

- Check continuity between pre-crash seat belt control unit and ground.

Pre-crash seat belt control unit		Ground	Continuity
Connector	Terminal		
M110	8		Not existed

Is the inspection result normal?

YES >> GO TO 3.

NO >> Repair or replace harness between pre-crash seat belt control unit and seat belt buckle switch (passenger side).

3. CHECK SEAT BELT BUCKLE SWITCH GROUND CIRCUIT

Check continuity between seat belt buckle switch (passenger side) and ground.

Seat belt buckle switch (passenger side)		Ground	Continuity
Connector	Terminal		
B213	2		Existed

Is the inspection result normal?

YES >> GO TO 4.

NO >> Repair or replace harness between seat belt buckle switch and ground.

4. CHECK SEAT BELT BUCKLE SWITCH (PASSENGER SIDE)

Check seat belt buckle switch (passenger side). Refer to [SBC-23, "PASSENGER SIDE : Component Inspection"](#).

Is the inspection result normal?

YES >> Replace pre-crash seat belt control unit. Refer to [SBC-37, "Removal and Installation"](#).

NO >> Replace seat belt buckle switch (passenger side).

SEAT BELT BUCKLE SWITCH

< DTC/CIRCUIT DIAGNOSIS >

PASSENGER SIDE : Component Inspection

INFOID:000000004673934

1. CHECK SEAT BELT BUCKLE SWITCH (PASSENGER SIDE)

1. Turn ignition switch OFF.
2. Disconnect seat belt buckle switch connector.
3. Check continuity of seat belt buckle (passenger side).

Seat belt buckle switch (passenger side)		Condition	Continuity
Terminal			
1	2	When driver side seat belt is not fastened	Not existed
		When driver side seat belt is fastened	Existed

Is the inspection result normal?

- YES >> INSPECTION END
NO >> Replace seat belt buckle switch (passenger side).

A
B
C
D
E
F
G
I
J
K
L
M
N
O
P

SBC

POWER SUPPLY AND GROUND CIRCUIT

< DTC/CIRCUIT DIAGNOSIS >

POWER SUPPLY AND GROUND CIRCUIT

Diagnosis Procedure

INFOID:000000004673939

1. CHECK FUSE AND FUSIBLE LINK

Check that the following fuse and fusible link are not blown.

Terminal No.	Signal name	Fuse and fusible link No.
13	Battery power supply	1

Is the fuse blown?

YES >> Replace the blown fuse or fusible link after repairing the affected circuit if a fuse or fusible link is blown.

NO >> GO TO 2.

2. CHECK POWER SUPPLY CIRCUIT

1. Turn ignition switch OFF.
2. Disconnect pre-crash seat belt control unit connectors.
3. Check voltage between harness pre-crash seat belt control unit connector and ground.

Pre-crash seat belt control unit		Ground	Voltage (V) (Approx.)
Connector	Terminal		Battery voltage
M110	13		

Is the measurement value normal?

YES >> GO TO 3.

NO >> Repair or replace harness.

3. CHECK GROUND CIRCUIT

Check continuity between pre-crash seat belt control unit harness connector and ground.

Pre-crash seat belt control unit		Ground	Continuity
Connector	Terminal		Existed
M110	5		
	26		

Does continuity exist?

YES >> INSPECTION END

NO >> Repair or replace harness.

PRE-CRASH SEAT BELT CONTROL UNIT

< ECU DIAGNOSIS INFORMATION >

ECU DIAGNOSIS INFORMATION

PRE-CRASH SEAT BELT CONTROL UNIT

Reference Value

INFOID:000000004673006

VALUES ON THE DIAGNOSIS TOOL
CONSULT-III MONITOR ITEM

Monitor item	Condition	Value/Status (Approx.)
B PEDAL SIG1 B PEDAL SIG2	Brake released Brake released	(1 V) (4 V)
B PEDAL SIG1 B PEDAL SIG2	Brake released → depressed Brake released → depressed	(1V→4 V) (4V→1 V)
SB SW RH SIG	RH seat belt is not fastened RH seat belt is fastened	OFF ON
SB SW LH SIG	LH seat belt is not fastened LH seat belt is fastened	OFF ON

TERMINAL LAYOUT

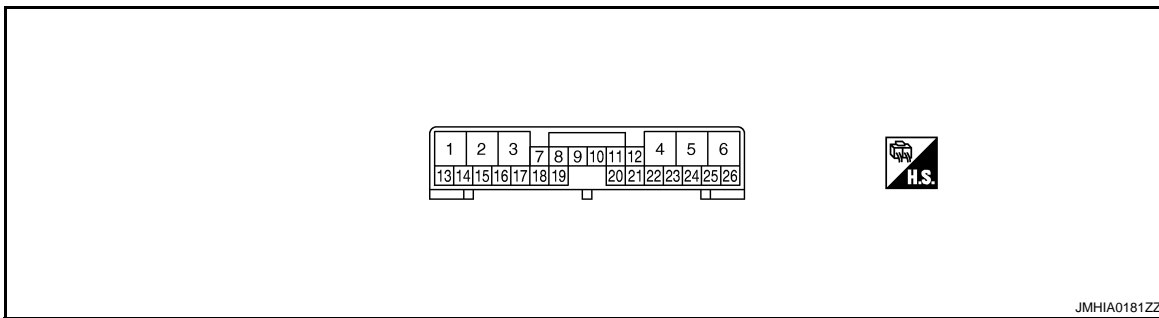

PHYSICAL VALUES

Terminal No. (Wire color)		Description		Condition	Value (*1) (Approx.)
+	-	Signal name	Input/Output		
1 (G/R)	Ground	RH seat belt motor release signal	Output	—	—
2 (W)	Ground	Drive circuit power supply (+BAT)	Input	Seat belt motor non-operational	Battery voltage
3 (G/Y)	Ground	RH seat belt motor forward (retract) signal	Output	—	—
4 (GR/W)	Ground	LH seat belt motor forward (retract) signal	Output	—	—
5 (W)	Ground	Drive circuit ground	—	—	0
6 (LY)	Ground	LH seat belt motor release signal	Output	—	—
7 (G)	Ground	Indicator (seat belt warning lamp)	Output	LH seat belt is not fastened	Ground
				LH seat belt is fastened	Battery voltage
				LH seat belt is fastened or malfunction of system	Battery voltage ↔ Ground
8 (LG)	Ground	RH seat belt buckle switch signal	Input	RH seat belt is fastened	Battery voltage
				RH seat belt is not fastened	Ground

PRE-CRASH SEAT BELT CONTROL UNIT

< ECU DIAGNOSIS INFORMATION >

Terminal No. (Wire color)		Description		Condition	Value (*1) (Approx.)
+	-	Signal name	Input/ Output		
10 (SB)	Ground	LH seat belt buckle switch signal	Input	LH seat belt is fastened	Battery voltage
				LH seat belt is not fastened	Ground
13 (W)	Ground	Control circuit power supply (IGN)	Input	IGN ON	Battery voltage
				IGN OFF	Ground
16 (W)	Ground	Brake pedal stroke sensor signal1	Input	Brake released → depressed	1 V → 4 V
				IGN OFF	1 V → 4 V
18 (R)	Ground	Brake pedal stroke sensor power circuit	Output	IGN ON	1 V → 4 V
				IGN OFF	1 V → 4 V
20 (G)	Ground	Brake pedal stroke sensor signal2	Input	Brake released → depressed	1 V → 4 V
				IGN OFF	0V
21 (B)	Ground	Brake pedal stroke sensor ground circuit	—	—	Ground
22 (P)	Ground	CAN communication signal (CAN L-line)	Input/ Output	—	—
24 (L)	Ground	CAN communication signal (CAN H-line)	Input/ Output	—	—
25	Ground	Shield ground	—	—	Ground
26 (B)	Ground	Control circuit ground	—	—	Ground

*1: Perform the measurement while connecting the control unit and the harness.

Fail Safe

INFOID:000000004673003

When a malfunction occurs in the following system, the pre-crash seat belt function is controlled according to the malfunctioning parts.

Display contents of CONSULT-III	Fail-safe	Cancellation
B2451: SB MOTOR RH CIRC	Deactivate the RH pre-crash seat belt function	Erase DTC
B2452: SB MOTOR LH CIRC	Deactivate the LH pre-crash seat belt function	Erase DTC
B2453: BR STROK SEN CIRC	Deactivate the interlock function during emergency brake operation	Erase DTC
B2454: MOTOR PWR SUP CIRC	Deactivate the pre-crash seat belt function	Erase DTC

DTC Index

INFOID:000000004673004

DTC	Trouble diagnosis name (CONSULT-III display)	DTC detection condition	Reference
—	—	No malfunction is detected	—
U1000	CAN COMM CIRCUIT	Pre-crash seat belt control unit cannot transmit and receive CAN communication signal for 2 seconds or more	SBC-10
B2451	SB MOTOR RH CIRC	RH seat belt motor circuit is shorted or open	SBC-11
B2452	SB MOTOR LH CIRC	LH seat belt motor circuit is shorted or open	SBC-13
B2453	BR STROK SEN CIRC	Brake pedal stroke sensor circuit is shorted or open	SBC-15
B2454	MOTOR PWR SUP CIRC	Motor power supply circuit is shorted or open	SBC-18
B2455	PSB C/U INT CIRCUIT	Internal breakdown in pre-crash seat belt control unit	SBC-19

PRE-CRASH SEAT BELT CONTROL UNIT

< ECU DIAGNOSIS INFORMATION >

Wiring Diagram - SEAT BELT CONTROL SYSTEM -

INFOID:000000004673005

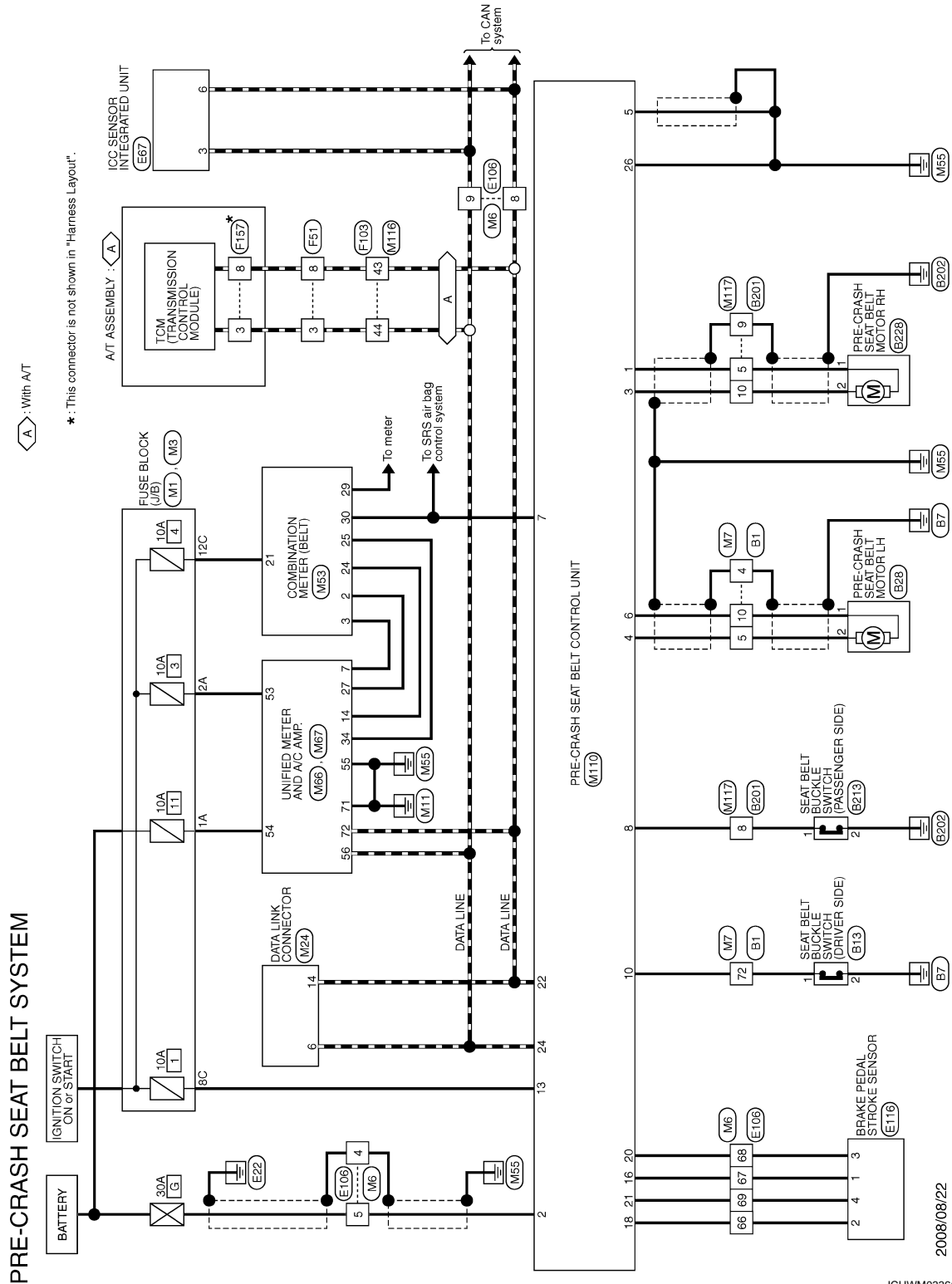

2008/08/22

JCHWM0336GI

A
B
C
D
E
F
G
H
I
J
K
L
M
N
O
P

SBC

PRE-CRASH SEAT BELT CONTROL UNIT

< ECU DIAGNOSIS INFORMATION >

PRE-CRASH SEAT BELT SYSTEM

Connector No.	B1
Connector Name	WIRE TO WIRE
Connector Type	TH80FW-CS16-TM4

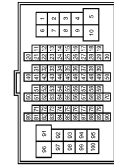

Terminal No.	Color of Wire	Signal Name [Specification]
4	SHIELD	-
5	G/R	-
10	G/Y	-
7Z	G	-

Connector No.	B13
Connector Name	SEAT BELT BUCKLE SWITCH (DRIVER SIDE)
Connector Type	A03FW



Terminal No.	Color of Wire	Signal Name [Specification]
1	G	-
2	B	-

Connector No.	B28
Connector Name	PRE-CRASH SEAT BELT MOTOR LH
Connector Type	TE02FW-2V



Terminal No.	Color of Wire	Signal Name [Specification]
1	G/Y	-
2	G/R	-

Connector No.	B201
Connector Name	WIRE TO WIRE
Connector Type	TH80FW-CS16-TM4

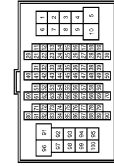

Terminal No.	Color of Wire	Signal Name [Specification]
5	G/R	-
8	LG	-
9	SHIELD	-
10	G/Y	-

Connector No.	B213
Connector Name	SEAT BELT BUCKLE SWITCH (PASSENGER SIDE)
Connector Type	A03FW

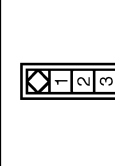

Terminal No.	Color of Wire	Signal Name [Specification]
1	LG	-
2	B	-

Connector No.	B228
Connector Name	PRE-CRASH SEAT BELT MOTOR RH
Connector Type	TE02FW-2V



Terminal No.	Color of Wire	Signal Name [Specification]
1	G/Y	-
2	G/Y	-

Connector No.	E67
Connector Name	ICC SENSOR INTEGRATED UNIT
Connector Type	RS08FB-PR



Terminal No.	Color of Wire	Signal Name [Specification]
3	L	CAN-H
6	P	CAN-L

Connector No.	E108
Connector Name	WIRE TO WIRE
Connector Type	TH80FW-CS16-TM4

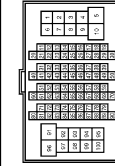

Terminal No.	Color of Wire	Signal Name [Specification]
4	SHIELD	-
5	W	-
8	P	-
9	L	-
6S	R	-
67	W	-
68	G	-
69	B	-

JCHWM0337GI

PRE-CRASH SEAT BELT CONTROL UNIT

< ECU DIAGNOSIS INFORMATION >

PRE-CRASH SEAT BELT SYSTEM

Connector No.	E116
Connector Name	BRAKE PEDAL STROKE SENSOR
Connector Type	HSAFB



Terminal No.	Color of Wire	Signal Name [Specification]
1	W	S1
2	R	VCC
3	G	SZ
4	B	GND

Connector No.	F51
Connector Name	A/T ASSEMBLY
Connector Type	BK10FG-DCY



Terminal No.	Color of Wire	Signal Name [Specification]
3	L	-
8	P	-

Connector No.	F103
Connector Name	WIRE TO WIRE
Connector Type	TK38FW-NS10

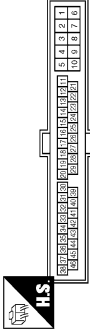

Terminal No.	Color of Wire	Signal Name [Specification]
43	P	-
44	L	-

Connector No.	F157
Connector Name	TCM (TRANSMISSION CONTROL MODULE)
Connector Type	SP10FG



Terminal No.	Color of Wire	Signal Name [Specification]
3	R	CAN-H
8	BR	CAN-L

Connector No.	M1
Connector Name	FUSE BLOCK (J/B)
Connector Type	NS06FW-MZ

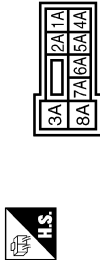

Terminal No.	Color of Wire	Signal Name [Specification]
1A	V	-
2A	G	-

Connector No.	M3
Connector Name	FUSE BLOCK (J/B)
Connector Type	NS12FW-CS

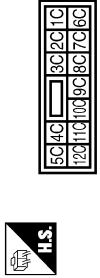

Terminal No.	Color of Wire	Signal Name [Specification]
8C	W	-
12C	R	-

Connector No.	M6
Connector Name	WIRE TO WIRE
Connector Type	TH80MW-CS16-TM4



Terminal No.	Color of Wire	Signal Name [Specification]
4	SHIELD	-
5	W	-
8	P	-
9	L	-
66	R	-
67	W	-
68	G	-
69	B	-

Connector No.	M7
Connector Name	WIRE TO WIRE
Connector Type	TH80MW-CS16-TM4



Terminal No.	Color of Wire	Signal Name [Specification]
4	SHIELD	-
5	G/R	-
10	G/Y	-
72	L/G	-

A
B
C
D
E
F
G
H
I
J
K
L
M
N
O
P

SBC

JCHWM0338G1

PRE-CRASH SEAT BELT CONTROL UNIT

< ECU DIAGNOSIS INFORMATION >

PRE-CRASH SEAT BELT SYSTEM

Connector No.	M24
Connector Name	DATA LINK CONNECTOR
Connector Type	BD16FW-P

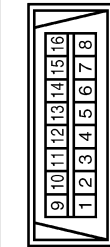

Terminal No.	Color of Wire	Signal Name [Specification]
6	L	-
14	P	-

Connector No.	M110
Connector Name	PRE-CRASH SEAT BELT CONTROL UNIT
Connector Type	TH20FW-TB6

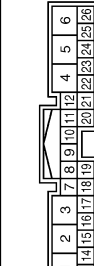

Terminal No.	Color of Wire	Signal Name [Specification]
1	G/R	MOTOR (RH) (RELEASE)
2	W	+B
3	G/Y	MOTOR (RH) (FASTEN)
4	G/R	MOTOR (LH) (FASTEN)
5	W	GND (DRIVE)
6	G/Y	MOTOR (LH) (RELEASE)
7	G	INDICATOR
8	LG	BUCKLE SW RH
10	SB	BUCKLE SW LH
13	W	IGN
16	W	SENS OUTPUT 1

Connector No.	M53
Connector Name	COMBINATION METER
Connector Type	SAB40FW

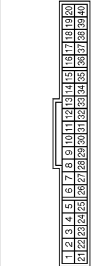

Terminal No.	Color of Wire	Signal Name [Specification]
2	LG	COMMUNICATION SIGNAL (METER>AMP)
3	GR	COMMUNICATION SIGNAL (AMP>METER)
21	R	IGNITION POWER SUPPLY
24	BR	COMMUNICATION SIGNAL (LCD>AMP)
25	Y	COMMUNICATION SIGNAL (AMP->LCD)
28	LG	SEAT BELT BUCKLE SW (DRIVER SIDE)
30	G	SEAT BELT

Connector No.	M18
Connector Name	SENS POWER
Connector Type	GND (CONT)



Terminal No.	Color of Wire	Signal Name [Specification]
18	R	SENS POWER
20	G	SENS OUTPUT 2
21	B	SENS GND
22	P	CAN-L
24	L	CAN-H
26	B	GND (CONT)

Connector No.	M86
Connector Name	UNIFIED METER AND A/C AMP
Connector Type	TH40FW-NH

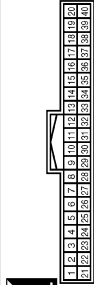

Terminal No.	Color of Wire	Signal Name [Specification]
7	GR	COMMUNICATION SIGNAL (AMP->METER)
14	BR	COMMUNICATION SIGNAL (LCD->AMP)
27	LG	COMMUNICATION SIGNAL (METER->AMP)
34	Y	COMMUNICATION SIGNAL (AMP->LCD)

Connector No.	M116
Connector Name	WIRE TO WIRE
Connector Type	TK3BMW-NS10

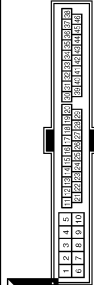

Terminal No.	Color of Wire	Signal Name [Specification]
43	P	-
44	L	-

Connector No.	M67
Connector Name	UNIFIED METER AND A/C AMP
Connector Type	TH32FW-NH

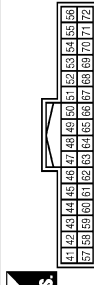

Terminal No.	Color of Wire	Signal Name [Specification]
53	G	IGNITION POWER SUPPLY
54	Y	BATTERY POWER SUPPLY
55	B	GROUND
56	L	CAN-H
71	GR	GROUND
72	P	CAN-L

Connector No.	M117
Connector Name	WIRE TO WIRE
Connector Type	TH8BMW-CS16-TM4

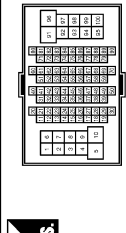

Terminal No.	Color of Wire	Signal Name [Specification]
5	G/R	-
8	LG	-
9	SHIELD	-
10	G/Y	-

PRE-CRASH SEAT BELT DOES NOT OPERATE

< SYMPTOM DIAGNOSIS >

SYMPTOM DIAGNOSIS

PRE-CRASH SEAT BELT DOES NOT OPERATE BOTH SIDES

BOTH SIDES : Diagnosis Procedure

INFOID:000000004673940

1.CHECK POWER SUPPLY AND GROUND CIRCUIT

Check power supply and ground circuit. Refer to [SBC-24, "Diagnosis Procedure"](#)

Is the inspection result normal?

YES >> GO TO 2.

NO >> Repair or replace the malfunctioning parts.

2.CONFIRM THE OPERATION

Confirm the operation again.

Is the inspection result normal?

YES >> Check intermittent incident. Refer to [GI-41, "Intermittent Incident"](#).

NO >> GO TO 1.

DRIVER SIDE

DRIVER SIDE : Diagnosis Procedure

INFOID:000000004673941

1.CHECK SEAT BELT BUCKLE SWITCH (DRIVER SIDE)

Check seat belt buckle switch (driver side). Refer to [SBC-20, "DRIVER SIDE : Component Function Check"](#)

Is the inspection result normal?

YES >> GO TO 2.

NO >> Repair or replace the malfunctioning parts.

2.CONFIRM THE OPERATION

Confirm the operation again.

Is the inspection result normal?

YES >> Check intermittent incident. Refer to [GI-41, "Intermittent Incident"](#).

NO >> GO TO 1.

PASSENGER SIDE

PASSENGER SIDE : Diagnosis Procedure

INFOID:000000004673942

1.CHECK POWER SUPPLY AND GROUND CIRCUIT

Check power supply and ground circuit. Refer to [SBC-24, "Diagnosis Procedure"](#)

Is the inspection result normal?

YES >> GO TO 2.

NO >> Repair or replace the malfunctioning parts.

2.CHECK SEAT BELT BUCKLE SWITCH (PASSENGER SIDE)

Check seat belt buckle switch (passenger side). Refer to [SBC-21, "PASSENGER SIDE : Component Function Check"](#)

Is the inspection result normal?

YES >> GO TO 3.

NO >> Repair or replace the malfunctioning parts.

3.CONFIRM THE OPERATION

Confirm the operation again.

Is the inspection result normal?

YES >> Check intermittent incident. Refer to [GI-41, "Intermittent Incident"](#).

A

B

C

D

E

F

G

SBC

I

J

K

L

M

N

O

P

PRE-CRASH SEAT BELT DOES NOT OPERATE

< SYMPTOM DIAGNOSIS >

NO >> GO TO 1.

PRECAUTIONS

< PRECAUTION >

PRECAUTION

PRECAUTIONS

Precaution for Supplemental Restraint System (SRS) "AIR BAG" and "SEAT BELT PRE-TENSIONER"

INFOID:000000004672989

The Supplemental Restraint System such as "AIR BAG" and "SEAT BELT PRE-TENSIONER", used along with a front seat belt, helps to reduce the risk or severity of injury to the driver and front passenger for certain types of collision. This system includes seat belt switch inputs and dual stage front air bag modules. The SRS system uses the seat belt switches to determine the front air bag deployment, and may only deploy one front air bag, depending on the severity of a collision and whether the front occupants are belted or unbelted. Information necessary to service the system safely is included in the "SRS AIR BAG" and "SEAT BELT" of this Service Manual.

WARNING:

- To avoid rendering the SRS inoperative, which could increase the risk of personal injury or death in the event of a collision which would result in air bag inflation, all maintenance must be performed by an authorized NISSAN/INFINITI dealer.
- Improper maintenance, including incorrect removal and installation of the SRS, can lead to personal injury caused by unintentional activation of the system. For removal of Spiral Cable and Air Bag Module, see the "SRS AIR BAG".
- Do not use electrical test equipment on any circuit related to the SRS unless instructed to in this Service Manual. SRS wiring harnesses can be identified by yellow and/or orange harnesses or harness connectors.

PRECAUTIONS WHEN USING POWER TOOLS (AIR OR ELECTRIC) AND HAMMERS

WARNING:

- When working near the Air Bag Diagnosis Sensor Unit or other Air Bag System sensors with the ignition ON or engine running, DO NOT use air or electric power tools or strike near the sensor(s) with a hammer. Heavy vibration could activate the sensor(s) and deploy the air bag(s), possibly causing serious injury.
- When using air or electric power tools or hammers, always switch the ignition OFF, disconnect the battery, and wait at least 3 minutes before performing any service.

Precaution for Seat Belt Service

INFOID:000000004672990

CAUTION:

- Before removing the seat belt pre-tensioner assembly, turn the ignition switch off, disconnect the both battery cables and wait at least 3 minutes.
- Do not use electrical test equipment for seat belt pre-tensioner connector.
- After replacing or reinstalling seat belt pre-tensioner assembly, or reconnecting front seat belt pre-tensioner connector, check the system function. Refer to [SRC-14, "Diagnosis Description"](#).
- Do not use disassemble buckle or seat belt assembly.
- Replace anchor bolts if they are deformed or worn out.
- Never oil tongue and buckle.
- If any component of seat belt assembly is questionable, do not repair. Replace the whole seat belt assembly.
- If webbing is cut, frayed, or damaged, replace seat belt assembly.
- When replacing seat belt assembly, use a genuine NISSAN seat belt assembly.

AFTER A COLLISION

WARNING:

Inspect all seat belt assemblies including retractors and attaching hardware after any collision. NISSAN recommends that all seat belt assemblies in use during a collision be replaced unless the collision was minor and the belts show no damage and continue to operate properly. Failure to do so could result in serious personal injury in an accident. Seat belt assemblies not in use during a collision should also be replaced if either damage or improper operation is noted. Seat belt pre-tensioner should be replaced even if the seat belts are not in use during a frontal collision in which the air bags are deployed.

Replace any seat belt assembly (including anchor bolts) if:

PRECAUTIONS

< PRECAUTION >

- The seat belt was in use at the time of a collision (except for minor collisions and the belts, retractors and buckles show no damage and continue to operate properly).
- The seat belt was damaged in an accident. (i.e. torn webbing, bent retractor or guide).
- The seat belt attaching point was damaged in an accident. Inspect the seat belt attaching area for damage or distortion and repair as necessary before installing a new seat belt assembly.
- Anchor bolts are deformed or worn out.
- The seat belt pre-tensioner should be replaced even if the seat belts are not in use during the collision in which the air bags are deployed.

Precaution for Battery Service

INFOID:000000004672991

Before disconnecting the battery, lower both the driver and passenger windows. This will prevent any interference between the window edge and the vehicle when the door is opened/closed. During normal operation, the window slightly raises and lowers automatically to prevent any window to vehicle interference. The automatic window function will not work with the battery disconnected.

PRE-INSPECTION FOR DIAGNOSTIC

< PERIODIC MAINTENANCE >

PERIODIC MAINTENANCE

PRE-INSPECTION FOR DIAGNOSTIC

Description

INFOID:000000004673943

WARNING:

- The following tests should be performed in a safe, open place that is free of traffic and obstacles.
- The tests should be performed on a dry, paved road. Never attempt to perform the tests on a wet or unpaved road, open road, or highway. (This may cause an accident or personal injury.)
- Driver and passenger should assume seat belt may operate and prepare themselves accordingly.

1. Fasten driver and passenger seat belts.
2. Drive at approximately 25 km/h (16 MPH).
3. Notify passenger of a sudden stop. Driver and passenger prepare themselves for the possibility of system not operating. Then, driver fully depresses the brake pedal to stop suddenly.
4. Check that the shoulder of the seat belt is pulled while braking.

A
B
C
D
E
F
G
I
J
K
L
M
N
O
P

SBC

BRAKE PEDAL STROKE SENSOR

< PERIODIC MAINTENANCE >

BRAKE PEDAL STROKE SENSOR

Exploded View

INFOID:000000004672992

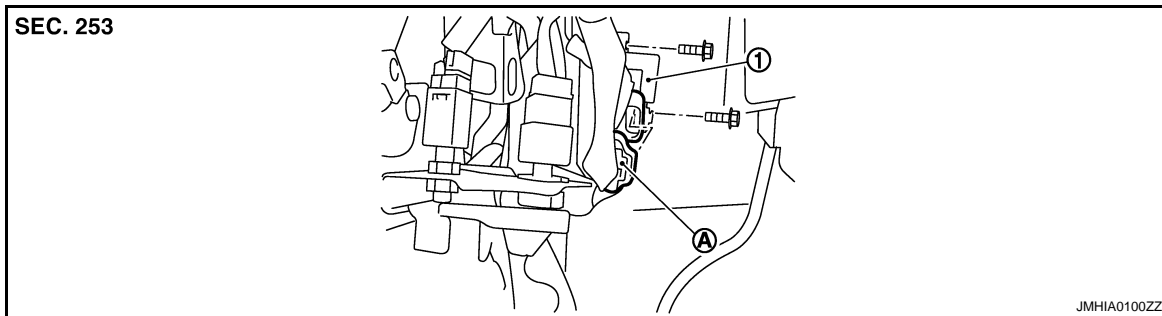

1. Brake pedal stroke sensor

A. Brake pedal stroke sensor connector

Removal and Installation

INFOID:000000004672993

REMOVAL

1. Remove the driver instrument panel (lower). Refer to [IP-12. "Removal and Installation"](#).
2. Disconnect the brake pedal stroke sensor connector (A).
3. Remove the screws.
4. Remove the brake pedal stroke sensor (1).

INSTALLATION

Install in the reverse order of removal.

PRE-CRASH SEAT BELT CONTROL UNIT

< PERIODIC MAINTENANCE >

PRE-CRASH SEAT BELT CONTROL UNIT

Exploded View

INFOID:000000004672994

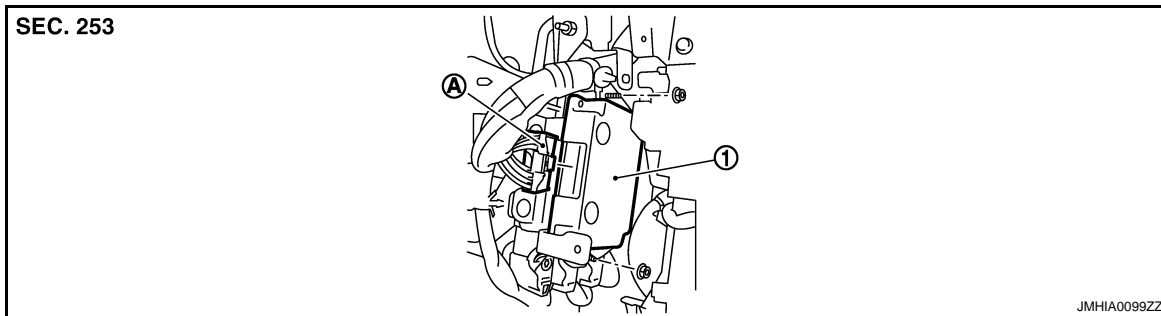

- 1. Pre-crash seat belt control unit
- A. Pre-crash seat belt control unit connector

Removal and Installation

INFOID:000000004672995

REMOVAL

1. Remove the glove box. Refer to [IP-12. "Removal and Installation"](#).
2. Disconnect the pre-crash seat belt control unit connector (A).
3. Remove the screws.
4. Remove the pre-crash seat belt control unit (1).

INSTALLATION

Install in the reverse order of removal.

A
B
C
D
E
F
G
I
J
K
L
M
N
O
P

SBC