

# SECTION **SEC**

## SECURITY CONTROL SYSTEM

A  
B  
C  
D  
E  
F  
G  
H  
I  
J  
K  
L  
M  
N  
O  
P

### CONTENTS

<p><b>BASIC INSPECTION</b> ..... 5</p> <p><b>DIAGNOSIS AND REPAIR WORK FLOW</b> ..... 5</p> <p style="padding-left: 20px;">Work Flow .....5</p> <p><b>INSPECTION AND ADJUSTMENT</b> ..... 8</p> <p><b>ECM RE-COMMUNICATING FUNCTION</b> .....8</p> <p style="padding-left: 20px;">ECM RE-COMMUNICATING FUNCTION : De- scription .....8</p> <p style="padding-left: 20px;">ECM RE-COMMUNICATING FUNCTION : Spe- cial Repair Requirement .....8</p> <p><b>SYSTEM DESCRIPTION</b> ..... 9</p> <p><b>INTELLIGENT KEY SYSTEM/ENGINE START FUNCTION</b> ..... 9</p> <p style="padding-left: 20px;">System Diagram .....9</p> <p style="padding-left: 20px;">System Description .....9</p> <p style="padding-left: 20px;">Component Parts Location ..... 13</p> <p style="padding-left: 20px;">Component Description ..... 16</p> <p><b>INFINITI VEHICLE IMMOBILIZER SYSTEM- NATS</b> .....17</p> <p style="padding-left: 20px;">System Diagram ..... 17</p> <p style="padding-left: 20px;">System Description ..... 17</p> <p style="padding-left: 20px;">Component Parts Location ..... 19</p> <p style="padding-left: 20px;">Component Description ..... 22</p> <p><b>VEHICLE SECURITY SYSTEM</b> .....23</p> <p style="padding-left: 20px;">System Diagram ..... 23</p> <p style="padding-left: 20px;">System Description ..... 23</p> <p style="padding-left: 20px;">Component Parts Location ..... 25</p> <p style="padding-left: 20px;">Component Description ..... 28</p> <p><b>DIAGNOSIS SYSTEM (BCM)</b> .....29</p> <p><b>COMMON ITEM</b> .....29</p> <p style="padding-left: 20px;">COMMON ITEM : CONSULT-III Function (BCM - COMMON ITEM) .....29</p> <p><b>INTELLIGENT KEY</b> ..... 30</p>	<p>INTELLIGENT KEY : CONSULT-III Function (BCM - INTELLIGENT KEY) .....30</p> <p><b>THEFT ALM</b> .....33</p> <p style="padding-left: 20px;">THEFT ALM : CONSULT-III Function (BCM - THEFT) ..... 33</p> <p><b>IMMU</b> .....34</p> <p style="padding-left: 20px;">IMMU : CONSULT-III Function (BCM - IMMU) .....34</p> <p><b>DTC/CIRCUIT DIAGNOSIS</b> .....36</p> <p><b>U1000 CAN COMM CIRCUIT</b> .....36</p> <p><b>BCM</b> .....36</p> <p style="padding-left: 20px;">BCM : Description .....36</p> <p style="padding-left: 20px;">BCM : DTC Logic .....36</p> <p style="padding-left: 20px;">BCM : Diagnosis Procedure .....36</p> <p><b>IPDM E/R (INTELLIGENT POWER DISTRIBU- TION MODULE ENGINE ROOM)</b> .....36</p> <p style="padding-left: 20px;">IPDM E/R (INTELLIGENT POWER DISTRIBU- TION MODULE ENGINE ROOM) : Description .....36</p> <p style="padding-left: 20px;">IPDM E/R (INTELLIGENT POWER DISTRIBU- TION MODULE ENGINE ROOM) : DTC Logic .....36</p> <p style="padding-left: 20px;">IPDM E/R (INTELLIGENT POWER DISTRIBU- TION MODULE ENGINE ROOM) : Diagnosis Pro- cedure ..... 37</p> <p><b>U1010 CONTROL UNIT (CAN)</b> .....38</p> <p><b>BCM</b> .....38</p> <p style="padding-left: 20px;">BCM : DTC Logic .....38</p> <p style="padding-left: 20px;">BCM : Diagnosis Procedure .....38</p> <p><b>P1610 LOCK MODE</b> .....39</p> <p style="padding-left: 20px;">Description .....39</p> <p style="padding-left: 20px;">DTC Logic .....39</p> <p style="padding-left: 20px;">Diagnosis Procedure .....39</p> <p><b>P1611 ID DISCORD, IMMU-ECM</b> .....40</p> <p style="padding-left: 20px;">Description .....40</p> <p style="padding-left: 20px;">DTC Logic .....40</p>
--	--

SEC

Diagnosis Procedure .....	40	Component Inspection .....	62
<b>P1612 CHAIN OF ECM-IMMU .....</b>	<b>42</b>	<b>B2557 VEHICLE SPEED .....</b>	<b>63</b>
Description .....	42	Description .....	63
DTC Logic .....	42	DTC Logic .....	63
Diagnosis Procedure .....	42	Diagnosis Procedure .....	63
<b>P1614 CHAIN OF IMM-KEY .....</b>	<b>43</b>	<b>B2560 STARTER CONTROL RELAY .....</b>	<b>64</b>
Description .....	43	Description .....	64
DTC Logic .....	43	DTC Logic .....	64
Diagnosis Procedure .....	43	Diagnosis Procedure .....	64
<b>P1615 DIFFERENCE OF KEY .....</b>	<b>46</b>	<b>B2601 SHIFT POSITION .....</b>	<b>65</b>
Description .....	46	Description .....	65
DTC Logic .....	46	DTC Logic .....	65
Diagnosis Procedure .....	46	Diagnosis Procedure .....	65
<b>B2190 NATS ANTENNA AMP. ....</b>	<b>47</b>	Component Inspection .....	67
Description .....	47	<b>B2602 SHIFT POSITION .....</b>	<b>68</b>
DTC Logic .....	47	Description .....	68
Diagnosis Procedure .....	47	DTC Logic .....	68
<b>B2191 DIFFERENCE OF KEY .....</b>	<b>50</b>	Diagnosis Procedure .....	68
Description .....	50	<b>B2603 SHIFT POSITION STATUS .....</b>	<b>70</b>
DTC Logic .....	50	Description .....	70
Diagnosis Procedure .....	50	DTC Logic .....	70
<b>B2192 ID DISCORD, IMM-ECM .....</b>	<b>51</b>	Diagnosis Procedure .....	70
Description .....	51	<b>B2604 PNP SWITCH .....</b>	<b>73</b>
DTC Logic .....	51	Description .....	73
Diagnosis Procedure .....	51	DTC Logic .....	73
<b>B2193 CHAIN OF ECM-IMMU .....</b>	<b>53</b>	Diagnosis Procedure .....	73
Description .....	53	<b>B2605 PNP SWITCH .....</b>	<b>75</b>
DTC Logic .....	53	Description .....	75
Diagnosis Procedure .....	53	DTC Logic .....	75
<b>B2195 ANTI-SCANNING .....</b>	<b>54</b>	Diagnosis Procedure .....	75
Description .....	54	<b>B2606 STEERING LOCK RELAY .....</b>	<b>77</b>
DTC Logic .....	54	Description .....	77
Diagnosis Procedure .....	54	DTC Logic .....	77
<b>B2013 ID DISCORD, IMM-STRG .....</b>	<b>55</b>	Diagnosis Procedure .....	77
Description .....	55	<b>B2607 STEERING LOCK RELAY .....</b>	<b>78</b>
DTC Logic .....	55	Description .....	78
Diagnosis Procedure .....	55	DTC Logic .....	78
<b>B2014 CHAIN OF STRG-IMMU .....</b>	<b>56</b>	Diagnosis Procedure .....	78
Description .....	56	<b>B2608 STARTER RELAY .....</b>	<b>80</b>
DTC Logic .....	56	Description .....	80
Diagnosis Procedure .....	56	DTC Logic .....	80
<b>B2555 STOP LAMP .....</b>	<b>59</b>	Diagnosis Procedure .....	80
Description .....	59	<b>B2609 STEERING STATUS .....</b>	<b>82</b>
DTC Logic .....	59	Description .....	82
Diagnosis Procedure .....	59	DTC Logic .....	82
Component Inspection .....	60	Diagnosis Procedure .....	82
<b>B2556 PUSH-BUTTON IGNITION SWITCH ....</b>	<b>61</b>	<b>B260B STEERING LOCK UNIT .....</b>	<b>86</b>
Description .....	61	Description .....	86
DTC Logic .....	61	DTC Logic .....	86
Diagnosis Procedure .....	61	Diagnosis Procedure .....	86

<b>B260C STEERING LOCK UNIT</b> .....	<b>87</b>	<b>B2109 STEERING LOCK RELAY</b> .....	<b>106</b>	
Description .....	87	Description .....	106	A
DTC Logic .....	87	DTC Logic .....	106	
Diagnosis Procedure .....	87	Diagnosis Procedure .....	106	
<b>B260D STEERING LOCK UNIT</b> .....	<b>88</b>	<b>B210A STEERING LOCK CONDITION SWITCH</b> .....	<b>107</b>	B
Description .....	88	Description .....	107	
DTC Logic .....	88	DTC Logic .....	107	C
Diagnosis Procedure .....	88	Diagnosis Procedure .....	107	
<b>B260F ENGINE STATUS</b> .....	<b>89</b>	<b>B210B STARTER CONTROL RELAY</b> .....	<b>111</b>	D
Description .....	89	Description .....	111	
DTC Logic .....	89	DTC Logic .....	111	
Diagnosis Procedure .....	89	Diagnosis Procedure .....	111	E
<b>B26E8 CLUTCH INTERLOCK SWITCH</b> .....	<b>90</b>	<b>B210C STARTER CONTROL RELAY</b> .....	<b>112</b>	F
Description .....	90	Description .....	112	
DTC Logic .....	90	DTC Logic .....	112	
Diagnosis Procedure .....	90	Diagnosis Procedure .....	112	
Component Inspection .....	91	<b>B210D STARTER RELAY</b> .....	<b>113</b>	G
<b>B26E9 STEERING STATUS</b> .....	<b>92</b>	Description .....	113	
Description .....	92	DTC Logic .....	113	
DTC Logic .....	92	Diagnosis Procedure .....	113	H
Diagnosis Procedure .....	92	<b>B210E STARTER RELAY</b> .....	<b>114</b>	I
<b>B26EA KEY REGISTRATION</b> .....	<b>93</b>	Description .....	114	
Description .....	93	DTC Logic .....	114	
DTC Logic .....	93	Diagnosis Procedure .....	114	J
Diagnosis Procedure .....	93	<b>B210F PNP/CLUTCH INTERLOCK SWITCH</b> ..	<b>116</b>	
<b>B2612 STEERING STATUS</b> .....	<b>94</b>	Description .....	116	
Description .....	94	DTC Logic .....	116	
DTC Logic .....	94	Diagnosis Procedure .....	116	
Diagnosis Procedure .....	94	<b>B2110 PNP/CLUTCH INTERLOCK SWITCH</b> ..	<b>118</b>	SEC
<b>B2617 STARTER RELAY CIRCUIT</b> .....	<b>98</b>	Description .....	118	
Description .....	98	DTC Logic .....	118	
DTC Logic .....	98	Diagnosis Procedure .....	118	L
Diagnosis Procedure .....	98	<b>POWER SUPPLY AND GROUND CIRCUIT</b> ..	<b>120</b>	
<b>B2619 BCM</b> .....	<b>100</b>	<b>BCM</b> .....	<b>120</b>	M
Description .....	100	BCM : Diagnosis Procedure .....	120	
DTC Logic .....	100	<b>IPDM E/R (INTELLIGENT POWER DISTRIBUTION MODULE ENGINE ROOM)</b> .....	<b>120</b>	N
Diagnosis Procedure .....	100	IPDM E/R (INTELLIGENT POWER DISTRIBUTION MODULE ENGINE ROOM) : Diagnosis Procedure .....	120	O
<b>B261E VEHICLE TYPE</b> .....	<b>101</b>	<b>KEY SLOT</b> .....	<b>122</b>	
Description .....	101	Description .....	122	
DTC Logic .....	101	Component Function Check .....	122	P
Diagnosis Procedure .....	101	Diagnosis Procedure .....	122	
<b>B261F ASCD CLUTCH SWITCH</b> .....	<b>102</b>	<b>KEY SLOT INDICATOR</b> .....	<b>123</b>	
Description .....	102	Description .....	123	
DTC Logic .....	102	Component Function Check .....	123	
Diagnosis Procedure .....	102	Diagnosis Procedure .....	123	
Component Inspection .....	103			
<b>B2108 STEERING LOCK RELAY</b> .....	<b>104</b>			
Description .....	104			
DTC Logic .....	104			
Diagnosis Procedure .....	104			

<b>HOOD SWITCH</b> .....	<b>125</b>	<b>STEERING DOES NOT LOCK</b> .....	<b>202</b>
Description .....	125	Description .....	202
Component Function Check .....	125	Diagnosis Procedure .....	202
Diagnosis Procedure .....	125		
Component Inspection .....	126	<b>SECURITY INDICATOR LAMP DOES NOT</b>	
<b>SECURITY INDICATOR LAMP</b> .....	<b>127</b>	<b>TURN ON OR FLASH</b> .....	<b>203</b>
Description .....	127	Description .....	203
Component Function Check .....	127	Diagnosis Procedure .....	203
Diagnosis Procedure .....	127		
<b>KEY WARNING LAMP</b> .....	<b>129</b>	<b>VEHICLE SECURITY SYSTEM CANNOT BE</b>	
Description .....	129	<b>SET</b> .....	<b>204</b>
Component Function Check .....	129		
Diagnosis Procedure .....	129	<b>INTELLIGENT KEY</b> .....	<b>204</b>
		INTELLIGENT KEY : Description .....	204
		INTELLIGENT KEY : Diagnosis Procedure .....	204
<b>INTELLIGENT KEY SYSTEM/ENGINE</b>		<b>DOOR REQUEST SWITCH</b> .....	<b>204</b>
<b>START FUNCTION</b> .....	<b>130</b>	DOOR REQUEST SWITCH : Description .....	204
Wiring Diagram - INTELLIGENT KEY SYSTEM/ ENGINE START FUNCTION - .....	130	DOOR REQUEST SWITCH : Diagnosis Proce- dure .....	204
<b>INFINITI VEHICLE IMMOBILIZER SYSTEM-</b>		<b>VEHICLE SECURITY ALARM DOES NOT</b>	
<b>NATS</b> .....	<b>139</b>	<b>ACTIVATE</b> .....	<b>206</b>
Wiring Diagram - IVIS - .....	139	Description .....	206
<b>VEHICLE SECURITY SYSTEM</b> .....	<b>147</b>	Diagnosis Procedure .....	206
Wiring Diagram - VEHICLE SECURITY SYSTEM - .....	147	<b>INTELLIGENT KEY INSERT INFORMATION</b>	
<b>ECU DIAGNOSIS INFORMATION</b> .....	<b>153</b>	<b>DOES NOT OPERATE</b> .....	<b>207</b>
<b>BCM (BODY CONTROL MODULE)</b> .....	<b>153</b>	Description .....	207
Reference Value .....	153	Diagnosis Procedure .....	207
Wiring Diagram - BCM - .....	176	<b>PRECAUTION</b> .....	<b>209</b>
Fail-safe .....	181	<b>PRECAUTIONS</b> .....	<b>209</b>
DTC Inspection Priority Chart .....	183	Precaution for Supplemental Restraint System (SRS) "AIR BAG" and "SEAT BELT PRE-TEN- SIONER" .....	209
DTC Index .....	185	Precaution Necessary for Steering Wheel Rota- tion after Battery Disconnect .....	209
<b>IPDM E/R (INTELLIGENT POWER DISTRI-</b>		Precautions For Xenon Headlamp Service .....	210
<b>BUTION MODULE ENGINE ROOM)</b> .....	<b>188</b>	Precaution for Procedure without Cowl Top Cover. 210	
Reference Value .....	188	<b>REMOVAL AND INSTALLATION</b> .....	<b>211</b>
Wiring Diagram - IPDM E/R - .....	195	<b>KEY SLOT</b> .....	<b>211</b>
Fail-safe .....	198	Exploded View .....	211
DTC Index .....	200	Removal and Installation .....	211
<b>SYMPTOM DIAGNOSIS</b> .....	<b>201</b>	<b>PUSH BUTTON IGNITION SWITCH</b> .....	<b>212</b>
<b>ENGINE DOES NOT START WHEN INTELLI-</b>		Exploded View .....	212
<b>GENENT KEY IS INSIDE OF VEHICLE</b> .....	<b>201</b>	Removal and Installation .....	212
Description .....	201		
Diagnosis Procedure .....	201		

# DIAGNOSIS AND REPAIR WORK FLOW

< BASIC INSPECTION >

## BASIC INSPECTION

### DIAGNOSIS AND REPAIR WORK FLOW

Work Flow

INFOID:000000004653108

OVERALL SEQUENCE

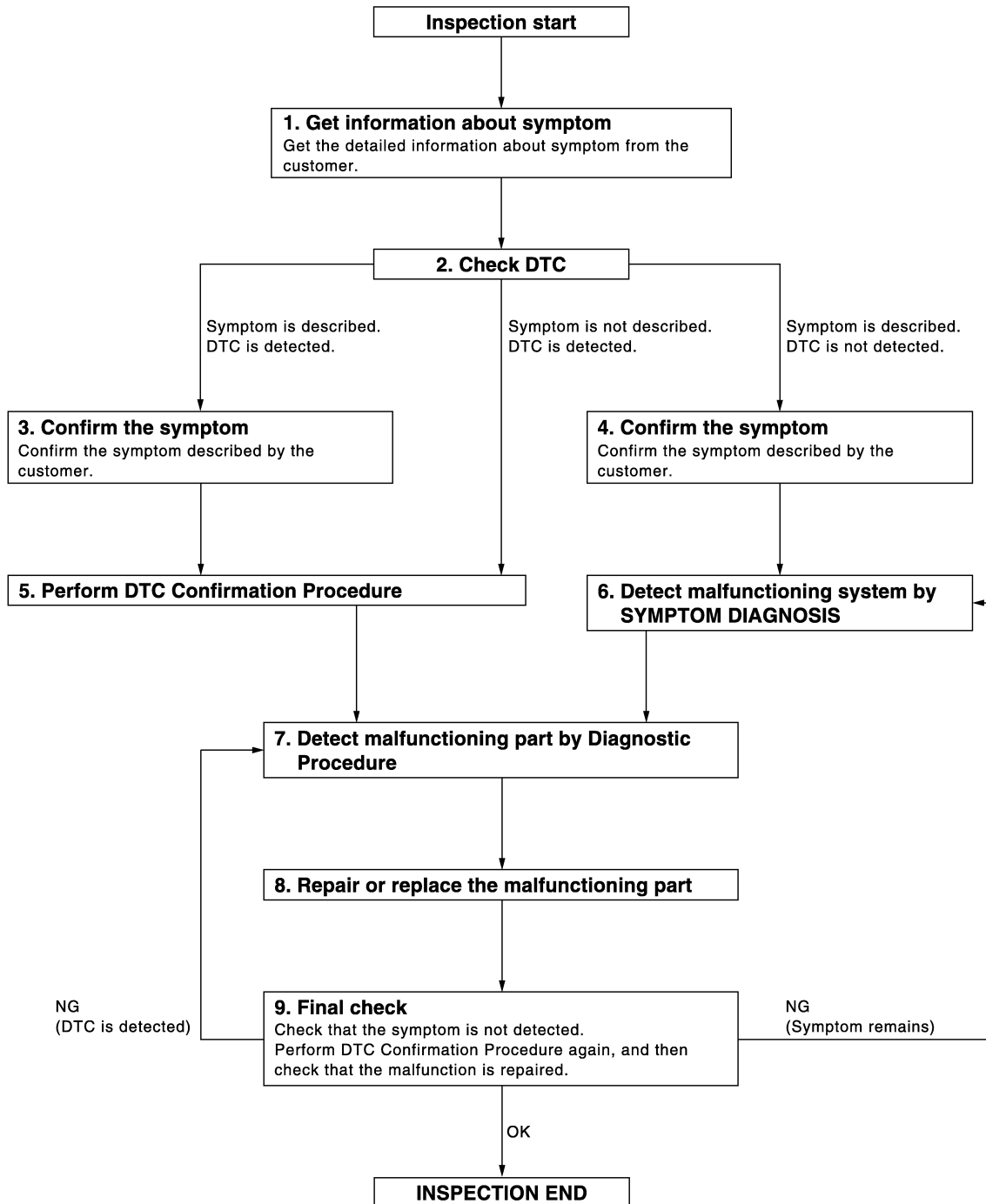

A  
B  
C  
D  
E  
F  
G  
H  
I  
J  
L  
M  
N  
O  
P

SEC

DETAILED FLOW

JMKIA3449GB

# DIAGNOSIS AND REPAIR WORK FLOW

< BASIC INSPECTION >

---

## 1. GET INFORMATION ABOUT SYMPTOM

---

Get detailed information from the customer about the symptom (the condition and the environment when the incident/malfunction occurs).

>> GO TO 2.

## 2. CHECK DTC

---

1. Check BCM and IPDM E/R for DTC.
2. Perform the following procedure if DTC is detected.
  - Record DTC and freeze frame data (Print them out using CONSULT-III.)
  - Erase DTC.
  - Study the relationship between the cause detected by DTC and the symptom described by the customer.
3. Check related service bulletins for information.

Are any symptoms described and any DTC detected?

Symptom is described, DTC is detected>>GO TO 3.

Symptom is described, DTC is not detected>>GO TO 4.

Symptom is not described, DTC is detected>>GO TO 5.

## 3. CONFIRM THE SYMPTOM

---

Confirm the symptom described by the customer.

Connect CONSULT-III to the vehicle in the "DATA MONITOR" mode and check real time diagnosis results.

Verify relation between the symptom and the condition when the symptom is detected.

>> GO TO 5.

## 4. CONFIRM THE SYMPTOM

---

Confirm the symptom described by the customer.

Connect CONSULT-III to the vehicle in the "DATA MONITOR" mode and check real time diagnosis results.

Verify relation between the symptom and the condition when the symptom is detected.

>> GO TO 6.

## 5. PERFORM DTC CONFIRMATION PROCEDURE

---

Perform DTC Confirmation Procedure for the detected DTC, and then check that DTC is detected again.

At this time, always connect CONSULT-III to the vehicle, and check diagnostic results in real time.

If two or more DTCs are detected, refer to [SEC-183, "DTC Inspection Priority Chart"](#) (BCM) or [SEC-200, "DTC Index"](#) (IPDM E/R), and determine trouble diagnosis order.

Is DTC detected?

YES >> GO TO 7.

NO >> Refer to [GI-41, "Intermittent Incident"](#).

## 6. DETECT MALFUNCTIONING SYSTEM BY SYMPTOM DIAGNOSIS

---

Detect malfunctioning system according to SYMPTOM DIAGNOSIS based on the confirmed symptom in step 4, and determine the trouble diagnosis order based on possible causes and symptom.

>> GO TO 7.

## 7. DETECT MALFUNCTIONING PART BY DIAGNOSTIC PROCEDURE

---

Inspect according to Diagnostic Procedure of the system.

**NOTE:**

The Diagnostic Procedure is described based on open and short circuit inspection.

Is malfunctioning part detected?

YES >> GO TO 8.

NO >> Check voltage of related BCM terminals using CONSULT-III.

## 8. REPAIR OR REPLACE THE MALFUNCTIONING PART

---

1. Repair or replace the malfunctioning part.

# DIAGNOSIS AND REPAIR WORK FLOW

## < BASIC INSPECTION >

---

2. Reconnect parts or connectors disconnected during Diagnostic Procedure again after repair and replacement.
3. Check DTC. If DTC is detected, erase it.

>> GO TO 9.

## 9. FINAL CHECK

---

When DTC is detected in step 2, perform DTC Confirmation Procedure or Component Function Check again, and then check that the malfunction is repaired securely.

When symptom is described by the customer, refer to confirmed symptom in step 3 or 4, and check that the symptom is not detected.

### Does the symptom reappear?

YES (DTC is detected)>>GO TO 7.

YES (Symptom remains)>>GO TO 6.

NO >> INSPECTION END

A  
B  
C  
D  
E  
F  
G  
H  
I  
J  
L  
M  
N  
O  
P

SEC

# INSPECTION AND ADJUSTMENT

< BASIC INSPECTION >

---

## INSPECTION AND ADJUSTMENT ECM RE-COMMUNICATING FUNCTION

### ECM RE-COMMUNICATING FUNCTION : Description

INFOID:000000004653109

Performing the following procedure can automatically activate recommunication of ECM and BCM, but only when the ECM is replaced with a new one\*.

\*: New one means a virgin ECM that is never energized on-board.

(In this step, initialization procedure by CONSULT-III is not necessary)

#### **NOTE:**

- When registering new Key IDs or replacing the ECM that is not brand new, refer to **CONSULT-III Operation Manual NATS-IVIS/NVIS**.
- If multiple keys are attached to the key holder, separate them before beginning work.
- Distinguish keys with unregistered key IDs from those with registered IDs.

### ECM RE-COMMUNICATING FUNCTION : Special Repair Requirement

INFOID:000000004653110

#### 1. PERFORM ECM RECOMMUNICATING FUNCTION

---

1. Install ECM.
2. Insert the registered Intelligent Key\* into key slot, turn ignition switch to "ON".  
\*: To perform this step, use the key that is used before performing ECM replacement.
3. Maintain ignition switch in the "ON" position for 5 seconds or more.
4. Turn ignition switch to "OFF".
5. Start engine.

#### Can engine be started?

YES >> Procedure is complete.

NO >> Initialize control unit. Refer to CONSULT-III Operation Manual NATS-IVIS/NVIS.



# INTELLIGENT KEY SYSTEM/ENGINE START FUNCTION

< SYSTEM DESCRIPTION >

## SYSTEM DESCRIPTION

### INTELLIGENT KEY SYSTEM/ENGINE START FUNCTION

#### System Diagram

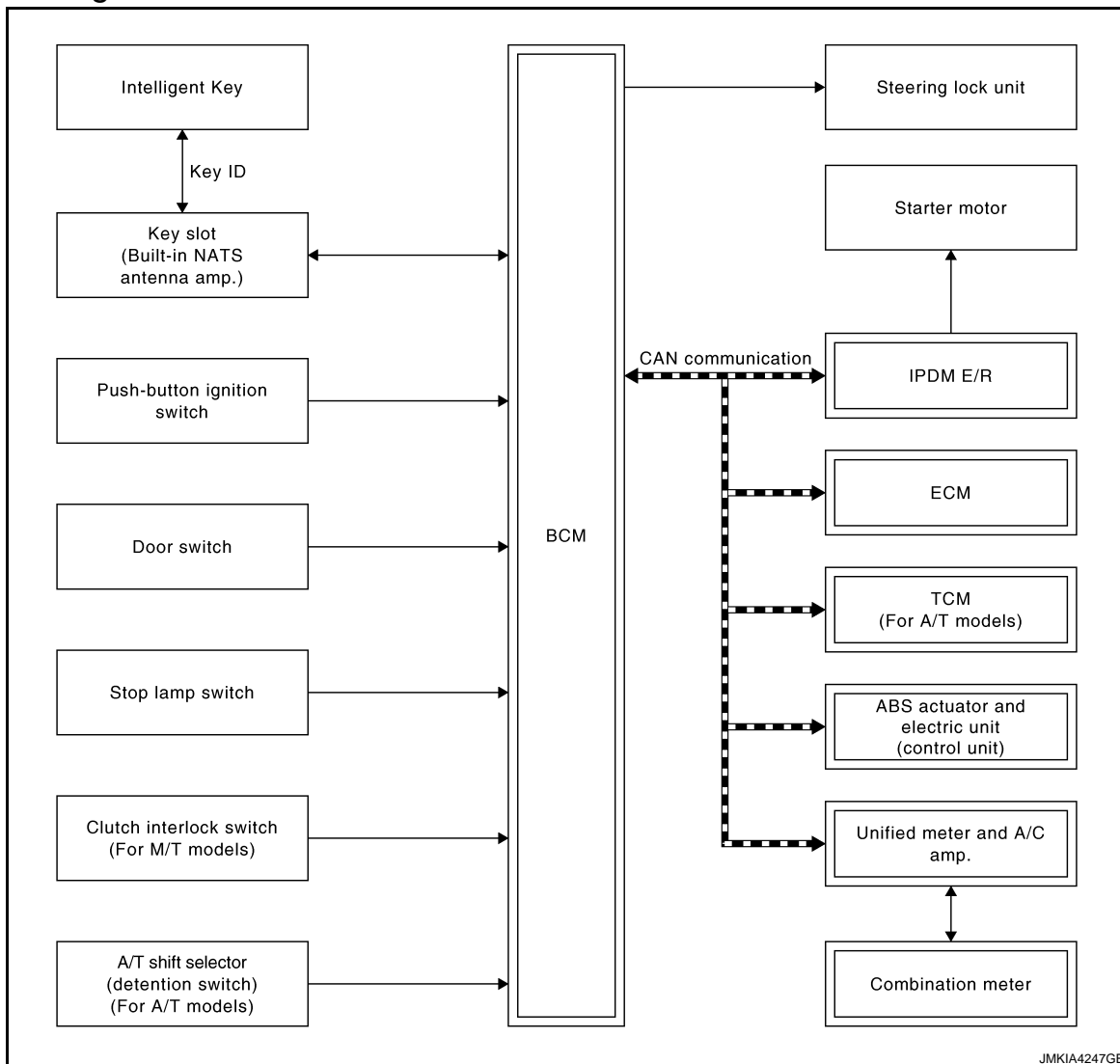

#### System Description

INFOID:0000000004662854

#### SYSTEM DESCRIPTION

- The engine start function of Intelligent Key system is a system that makes it possible to start and stop the engine without removing the key. It verifies an electronic ID using two-way communication when pressing the push-button ignition switch while carrying the Intelligent Key, which operates based on the results of electronic ID verification of Intelligent Key using two-way communication between the Intelligent Key and the vehicle.

#### NOTE:

- The driver should carry the Intelligent Key at all times.
- Intelligent Key has 2 IDs [Intelligent Key and IVIS (NATS)]. It can perform the door lock/unlock operation and the push-button ignition switch operation when the registered Intelligent Key is carried.
- When the Intelligent Key battery is discharged, it can be used as emergency back-up by inserting the Intelligent Key to the key slot. At that time, perform the IVIS (NATS) ID verification. If it is used when the Intelligent Key is carried, perform the Intelligent Key ID verification.
- If the ID is successfully verified, and when push-button ignition switch is pressed, steering lock is released and the engine can be started.

A  
B  
C  
D  
E  
F  
G  
H  
I  
J  
K  
L  
M  
N  
O  
P

SEC

# INTELLIGENT KEY SYSTEM/ENGINE START FUNCTION

## < SYSTEM DESCRIPTION >

- Up to 4 Intelligent Keys can be registered (Including the standard Intelligent Key) upon request from the customer.

### NOTE:

Refer to [DLK-15, "INTELLIGENT KEY SYSTEM : System Description"](#) for any functions other than engine start function of Intelligent Key system.

## PRECAUTIONS FOR INTELLIGENT KEY SYSTEM

**In the Intelligent Key system, the transponder [the chip for IVIS (NATS) ID verification] is integrated into the Intelligent Key. (For the conventional models, it is integrated into the mechanical key.) Therefore, the mechanical key cannot perform ID verification, and thus it cannot start the engine. Instead, IVIS (NATS) ID verification can be performed by inserting the Intelligent Key to the key slot, and then it can start the engine.**

## OPERATION WHEN INTELLIGENT KEY IS CARRIED

1. When the push-button ignition switch is pressed, the BCM activates the inside key antenna and transmits the request signal to the Intelligent Key.
2. The Intelligent Key receives the request signal and transmits the Intelligent Key ID signal to the BCM via the remote keyless entry receiver.
3. The Intelligent Key receives the Intelligent Key ID signal and verifies it with the registered ID.
4. BCM transmits the steering lock unlock signal to steering lock unit and IPDM E/R if the verification results are OK.
5. IPDM E/R turns the steering lock relay ON and supplies power supply to the steering lock unit.
6. The steering lock releases.
7. BCM transmits the power supply stop signal to IPDM E/R when detecting that the steering lock is in the unlock condition.
8. IPDM E/R turns the steering lock relay OFF and stops power supply to the steering lock unit.
9. BCM turns ACC relay ON and transmits the ignition power supply ON signal to IPDM E/R.
10. IPDM E/R turns the ignition relay ON and starts the ignition power supply.
11. BCM detects that the selector lever position and brake pedal operating condition (A/T models) or shift lever position and clutch pedal operation condition (M/T models).
12. BCM transmits the starter request signal via CAN communication to IPDM E/R and turns the starter relay in IPDM E/R ON if BCM judges that the engine start condition is satisfied.
13. IPDM E/R turns the starter control relay ON when receiving the starter request signal.
14. Power supply is supplied through the starter relay and the starter control relay to operate the starter motor and start cranking.
15. When BCM receives feedback signal from ECM indicating that the engine is started, the BCM transmits a stop signal to IPDM E/R and stops cranking by turning OFF the starter motor relay. (If engine start is unsuccessful, cranking stops automatically within 5 seconds.)

### CAUTION:

**If a malfunction is detected in the Intelligent Key system, the "KEY" warning lamp in the combination meter illuminates. At that time, the engine cannot be started.**

### CAUTION:

**When the Intelligent Key is carried outside of the vehicle (inside key antenna detection area) while the power supply is in the ACC or ON position, even if the engine start condition\* is satisfied, the engine cannot be started.**

\*: For the engine start condition, refer to "PUSH-BUTTON IGNITION SWITCH OPERATION PROCEDURE".

## OPERATION RANGE

Engine can be started when Intelligent Key is inside the vehicle. However, sometimes engine may not start when Intelligent Key is on instrument panel or in glove box.

## OPERATION WHEN KEY SLOT IS USED

When the Intelligent Key battery is discharged, it performs IVIS (NATS) ID verification between the integrated transponder and BCM by inserting the Intelligent Key into the key slot, and then the engine can be started. For details relating to starting the engine using key slot, refer to [SEC-17, "System Description"](#).

## BATTERY SAVER SYSTEM

When all the following conditions are met for 60 minutes, the battery saver system cuts off the power supply to prevent battery discharge.

# INTELLIGENT KEY SYSTEM/ENGINE START FUNCTION

## < SYSTEM DESCRIPTION >

- The ignition switch is in the ACC position
- All doors are closed
- Selector lever is in the P position

Reset Condition of Battery Saver System

### A/T models

In order to prevent the battery from discharging, the battery saver system cuts off the power supply when all doors are closed, the selector lever is in the P position, and the ignition switch is left in the ACC position for 60 minutes. If any of the following conditions are met the battery saver system is released and the steering changes automatically to the lock position from the OFF position.

- Opening any door
- Operating door lock using door request switch
- Operating door lock using Intelligent Key

Press push-button ignition switch and ignition switch changes to the ACC position from the OFF position.

### M/T models

If any of the above conditions are met, the battery saver system is released but the steering is not lock. In this case, the steering operation OFF to LOCK is prohibited.

## STEERING LOCK OPERATION

Steering is locked by steering lock unit when ignition switch is in the OFF position, selector lever is in the P position, and any of the following conditions are met.

- Opening door
- Closing door
- Door is locked using door request switch
- Door is locked using Intelligent Key

## POWER SUPPLY POSITION CHANGE TABLE BY PUSH-BUTTON IGNITION SWITCH OPERATION

The power supply position changing operation can be performed with the following operations.

### NOTE:

- When an Intelligent Key is within the detection area of inside key antenna and when it is inserted to the key slot, it is equivalent to the operations below.
- When starting the engine, the BCM monitors under the engine start conditions,

### A/T models

- Brake pedal operating condition
- A/T selector lever position
- Vehicle speed

### M/T models

- Clutch pedal operating condition
- Vehicle speed

Vehicle speed: less than 4 km/h (2.5 MPH)

Power supply position	Engine start/stop condition			Push-button ignition switch operation frequency
	A/T models		M/T models	
	Selector lever position	Brake pedal operation condition	Clutch pedal operation condition	
LOCK → ACC	—	Not depressed	Not depressed	1
LOCK → ACC → ON	—	Not depressed	Not depressed	2
LOCK → ACC → ON → OFF	—	Not depressed	Not depressed	3
LOCK → START ACC → START ON → START	P or N position	Depressed	Depressed	1
Engine is running → OFF	—	—	—	1

Vehicle speed: 4 km/h (2.5 MPH) or more

A  
B  
C  
D  
E  
F  
G  
H  
I  
J  
L  
M  
N  
O  
P

SEC

# INTELLIGENT KEY SYSTEM/ENGINE START FUNCTION

## < SYSTEM DESCRIPTION >

Power supply position	Engine start/stop condition			Push-button ignition switch operation frequency
	A/T models		M/T models	
	Selector lever position	Brake pedal operation condition	Clutch pedal operation condition	
Engine is running → ACC	—	—	—	Emergency stop operation
Engine stall return operation while driving	N position	Not depressed	Depressed	1

### Emergency stop operation

- Press and hold the push-button ignition switch for 2 seconds or more.
- Press the push-button ignition switch 3 times or more within 1.5 seconds.

# INTELLIGENT KEY SYSTEM/ENGINE START FUNCTION

< SYSTEM DESCRIPTION >

## Component Parts Location

INFOID:000000004658660

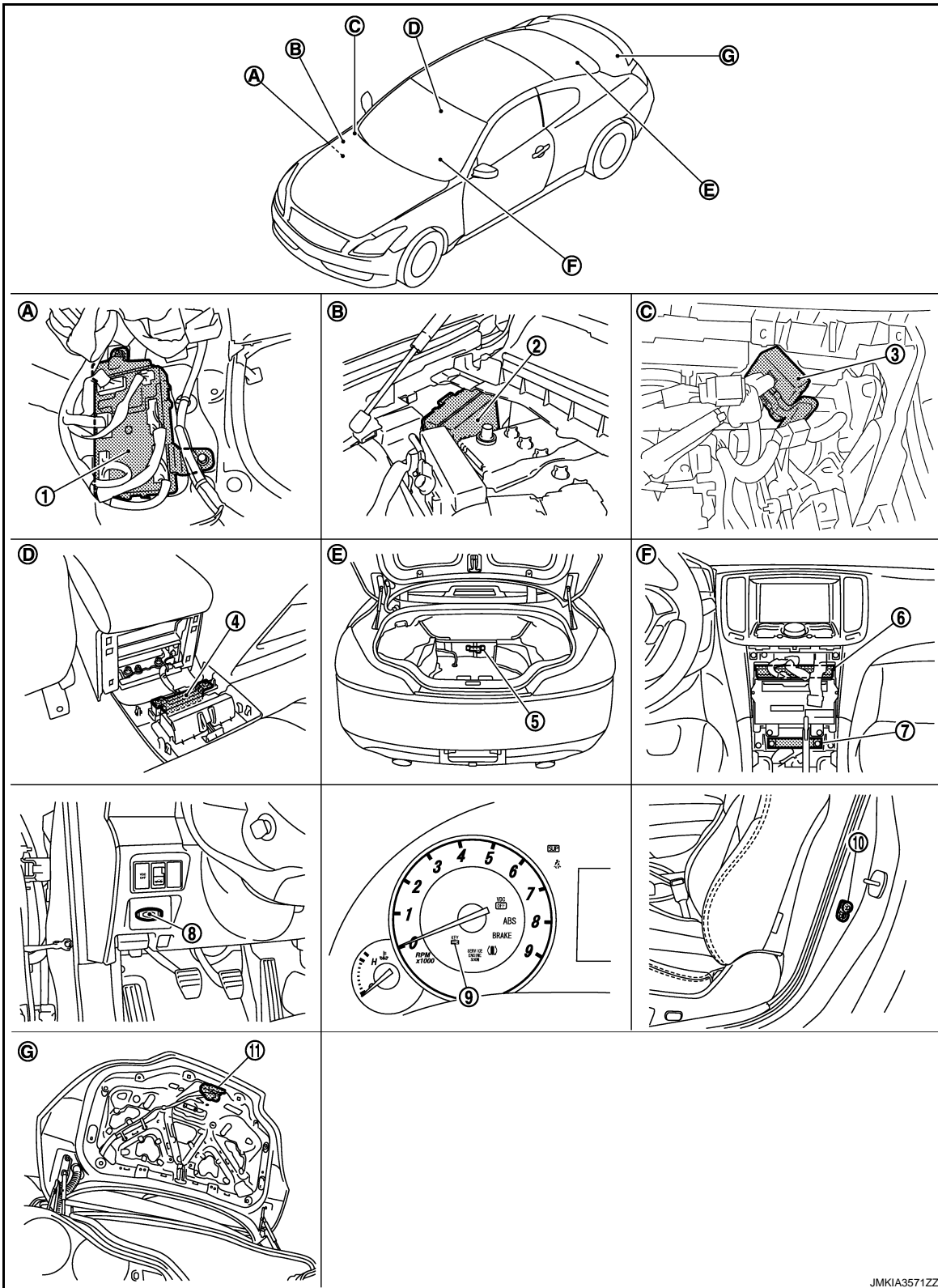

- |                                      |  |  |
|--------------------------------------|--|--|
| 1. BCM M118, M119, M121, M122, M123  | 2. IPDM E/R E5, E6, E7                 | 3. Remote keyless entry receiver M104  |
| 4. Inside key antenna (console) M146 | 5. Inside key antenna (trunk room) B49 | 6. Unified meter and A/C amp. M66, M67 |

A  
B  
C  
D  
E  
F  
G  
H  
I  
J  
K  
L  
M  
N  
O  
P

SEC

JMKIA3571ZZ

# INTELLIGENT KEY SYSTEM/ENGINE START FUNCTION

## < SYSTEM DESCRIPTION >

---

- |  |   |   |
|--|---|---|
| 7. Inside key antenna (instrument center) M131 | 8. Key slot M22   | 9. Combination meter (Key warning lamp) M53         |
| 10. Driver side door switch B16                | 11. Trunk lid lock assembly (trunk room lamp switch) B303 |   |
| A. Dash side lower (Passenger side).           | B. Engine room dash panel (RH).                           | C. View with instrument assist lower panel removed. |
| D. View with console rear finisher removed.    | E. View with trunk rear finisher (upper) removed.         | F. Behind cluster lid C.                            |
| G. View with trunk lid finisher removed.       |   |   |

# INTELLIGENT KEY SYSTEM/ENGINE START FUNCTION

## < SYSTEM DESCRIPTION >

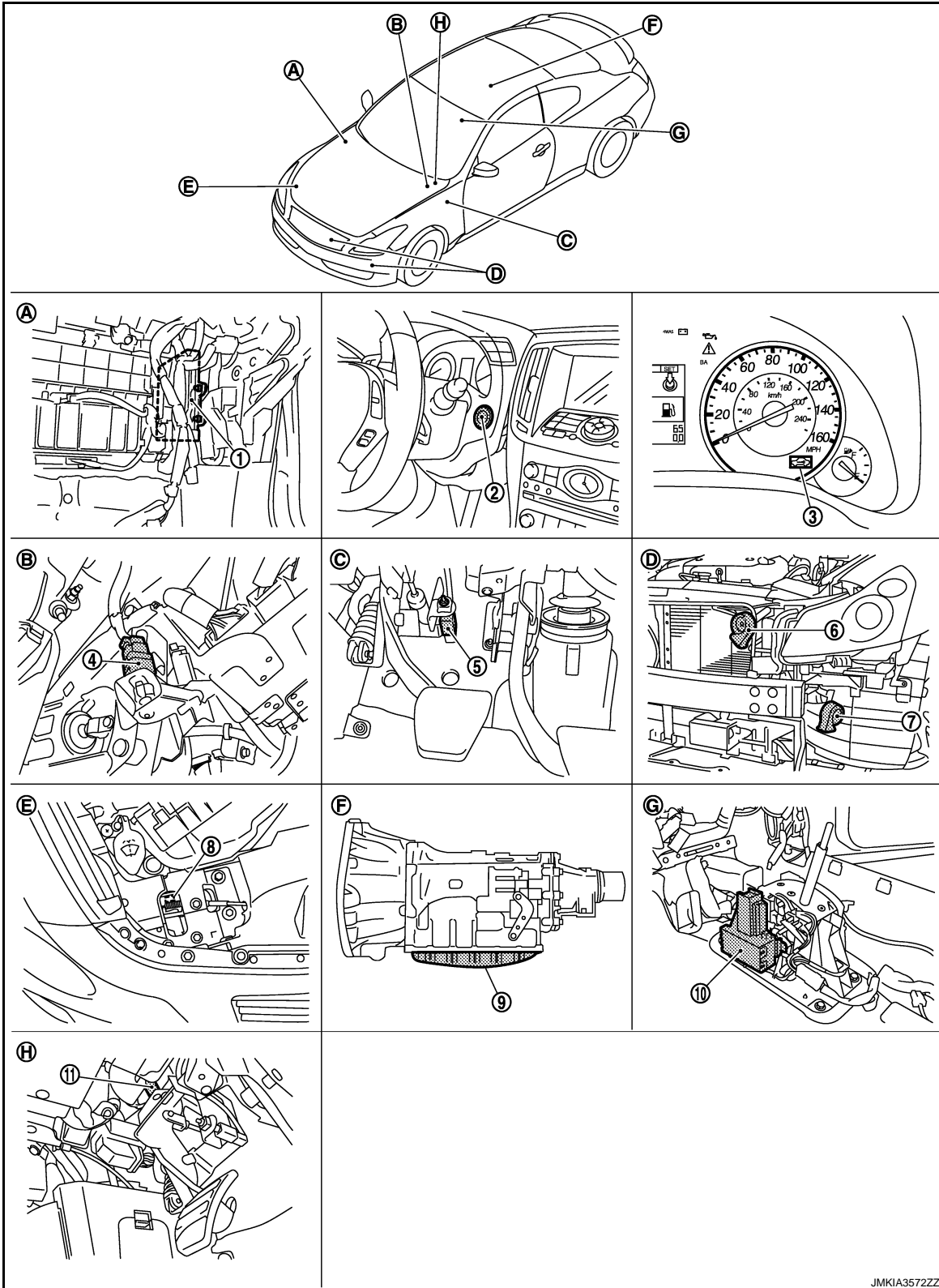

- |  |  |   |
|--|--|---|
| 1. ECM M107                                    | 2. Push-button ignition switch M50   | 3. Combination meter (Security indicator) M53 |
| 4. Stop lamp switch E110                       | 5. Clutch interlock switch E111  | 6. Horn (high) E61, E62                       |
| 7. Horn (low) E69, E70                         | 8. Hood switch E30   | 9. TCM F157                                   |
| 10. A/T shift selector (detention switch) M137 | 11. • ASCD clutch switch E108 (without ICC)<br>• ICC clutch switch E113 (with ICC) |   |

A  
B  
C  
D  
E  
F  
G  
H  
I  
J  
K  
L  
M  
N  
O  
P

SEC

JMKIA3572ZZ

# INTELLIGENT KEY SYSTEM/ENGINE START FUNCTION

## < SYSTEM DESCRIPTION >

- |   |  |  |
|---|--|--|
| A. View with instrument assist lower panel removed. | B. View with instrument driver lower cover removed.        | C. View with instrument driver lower cover removed.  |
| D. View with front bumper removed.                  | E. View with hood switch incorporated into hood lock (RH). | F. Inside of A/T assembly (built into A/T assembly). |
| G. View with center console assembly removed        | H. View with instrument driver lower cover removed.        |  |

## Component Description

INFOID:000000004653114

Component	Reference
BCM	<a href="#">SEC-100</a>
Steering lock unit	<a href="#">SEC-86</a>
Push-button ignition switch	<a href="#">SEC-61</a>
Door switch	<a href="#">DLK-62</a>
A/T shift selector (detention switch) (A/T models)	<a href="#">SEC-73</a>
Inside key antenna	<a href="#">DLK-55</a>
Remote keyless entry receiver	<a href="#">DLK-75</a>
Stop lamp switch	<a href="#">SEC-59</a>
TCM (A/T models)	<a href="#">SEC-65</a>
Clutch interlock switch (M/T models)	<a href="#">SEC-90</a>
Steering lock relay	<a href="#">SEC-77</a>
Starter relay	<a href="#">SEC-80</a>
Starter control relay	<a href="#">SEC-64</a>
Security indicator lamp	<a href="#">SEC-127</a>
Key warning lamp	<a href="#">SEC-129</a>



# INFINITI VEHICLE IMMOBILIZER SYSTEM-NATS

< SYSTEM DESCRIPTION >

## INFINITI VEHICLE IMMOBILIZER SYSTEM-NATS

### System Diagram

INFOID:000000004659202

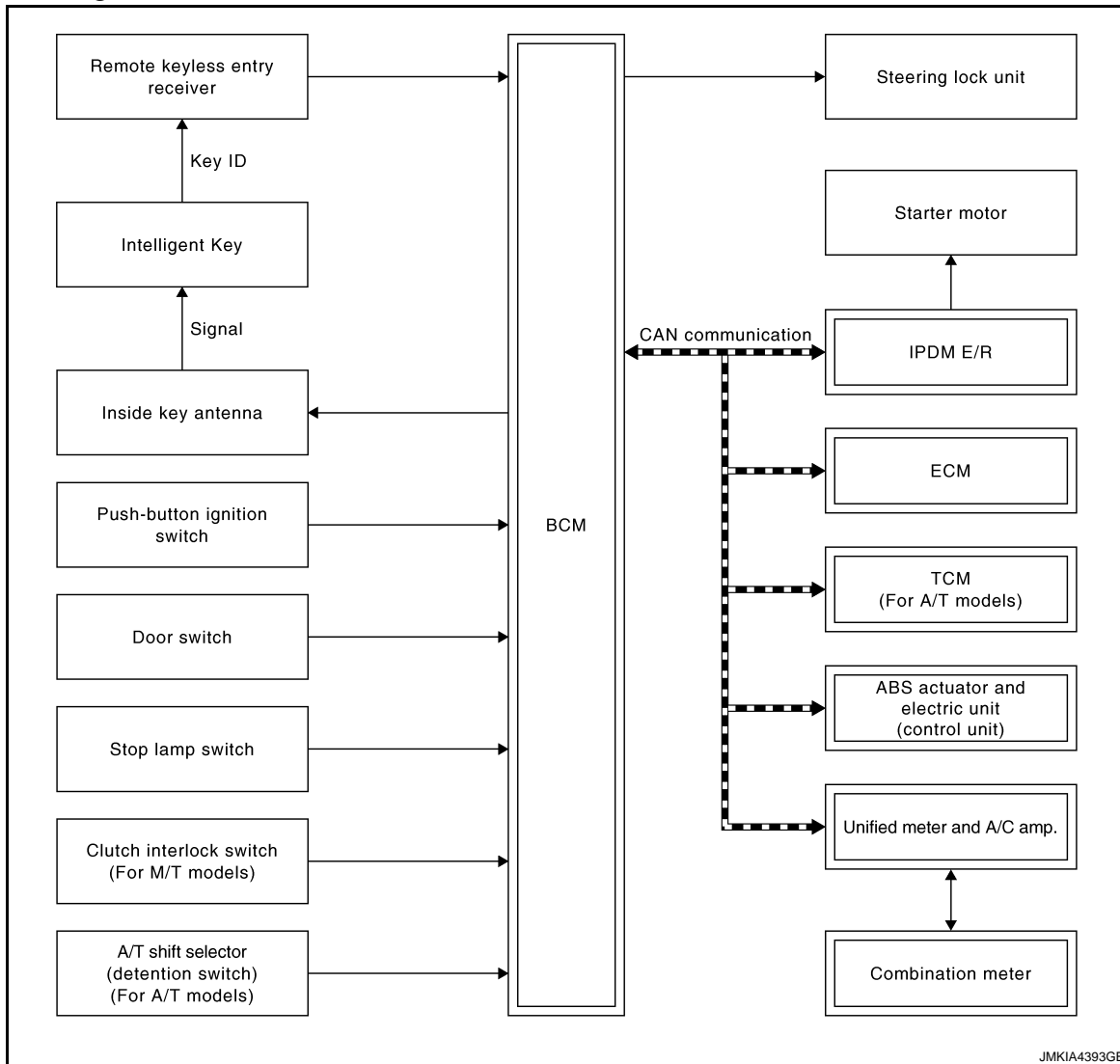

### System Description

INFOID:000000004662855

#### SYSTEM DESCRIPTION

- The IVIS (NATS) is an anti-theft system that registers an Intelligent Key ID to the vehicle and prevents the engine from being started by an unregistered Intelligent Key. It has higher protection against auto theft involving the duplication of mechanical keys.
- It performs ID verification when starting the engine in the same way as the Intelligent Key system. But, it performs the IVIS (NATS) ID verification when inserting the Intelligent Key and performs the Intelligent Key ID verification when carrying the Intelligent Key.
- The mechanical key integrated in the Intelligent Key cannot start the engine. When the Intelligent Key battery is discharged, the IVIS (NATS) ID verification memorized to the transponder integrated with Intelligent Key is performed by inserting the Intelligent Key into the key slot. If the verification results are OK, the engine start operation can be performed by the push-button ignition switch operation.
- Locate the security indicator lamp and apply the anti-theft system equipment sticker that warns that the IVIS (NATS) is onboard the model.
- Security indicator lamp always blinks when the power supply position is in the except ON position.
- Up to 4 Intelligent Keys can be registered (including the standard ignition key) upon request from the owner.
- Specified registration is required when replacing ECM, BCM, or Intelligent Key. For the registrations procedures for IVIS (NATS) and Intelligent Key when installing the BCM, refer to CONSULT-III Operation Manual NATS-IVIS/NVIS.

A  
B  
C  
D  
E  
F  
G  
H  
I  
J  
K  
L  
M  
N  
O  
P

SEC

# INFINITI VEHICLE IMMOBILIZER SYSTEM-NATS

## < SYSTEM DESCRIPTION >

---

- Possible symptom of IVIS (NATS) malfunction is “Engine cannot start”. The engine can be started with the Intelligent Key system and IVIS (NATS). Identify the possible causes according to “Work Flow”. Refer to [SEC-5, "Work Flow"](#).
- If ECM other than genuine part is installed, the engine cannot be started. For ECM replacement procedure, refer to [EC-16, "ADDITIONAL SERVICE WHEN REPLACING CONTROL UNIT \(ECM\) : Special Repair Requirement"](#).

## PRECAUTIONS FOR KEY REGISTRATION

- The key registration is a procedure that erases the current IVIS (NATS) ID once, and then reregisters a new ID operation. Therefore a registered Intelligent Key is necessary for this procedure. Before starting the registration operation collect all registered Intelligent Keys from the customer.
- When registering the Intelligent Key, perform only one procedure to simultaneously register both ID (IVIS “NATS” ID and Intelligent Key ID).  
The IVIS (NATS) ID registration is the procedure that registers the ID stored into the transponder (integrated in Intelligent Key) to BCM.  
The Intelligent key ID registration is the procedure that registers the ID to BCM.
- When performing the Intelligent Key system registration only, the engine cannot be started by inserting the key into the key slot. When performing the IVIS (NATS) registration only, the engine cannot be started by the operation when carrying the key. The registrations of both systems should be performed.

## SECURITY INDICATOR LAMP

- Warns that the vehicle is equipped with IVIS (NATS).
- Security indicator lamp always blinks when the ignition switch is in the except ON position.

### **NOTE:**

Because security indicator lamp is highly efficient, the battery is barely affected.

# INFINITI VEHICLE IMMOBILIZER SYSTEM-NATS

< SYSTEM DESCRIPTION >

## Component Parts Location

INFOID:000000004679405

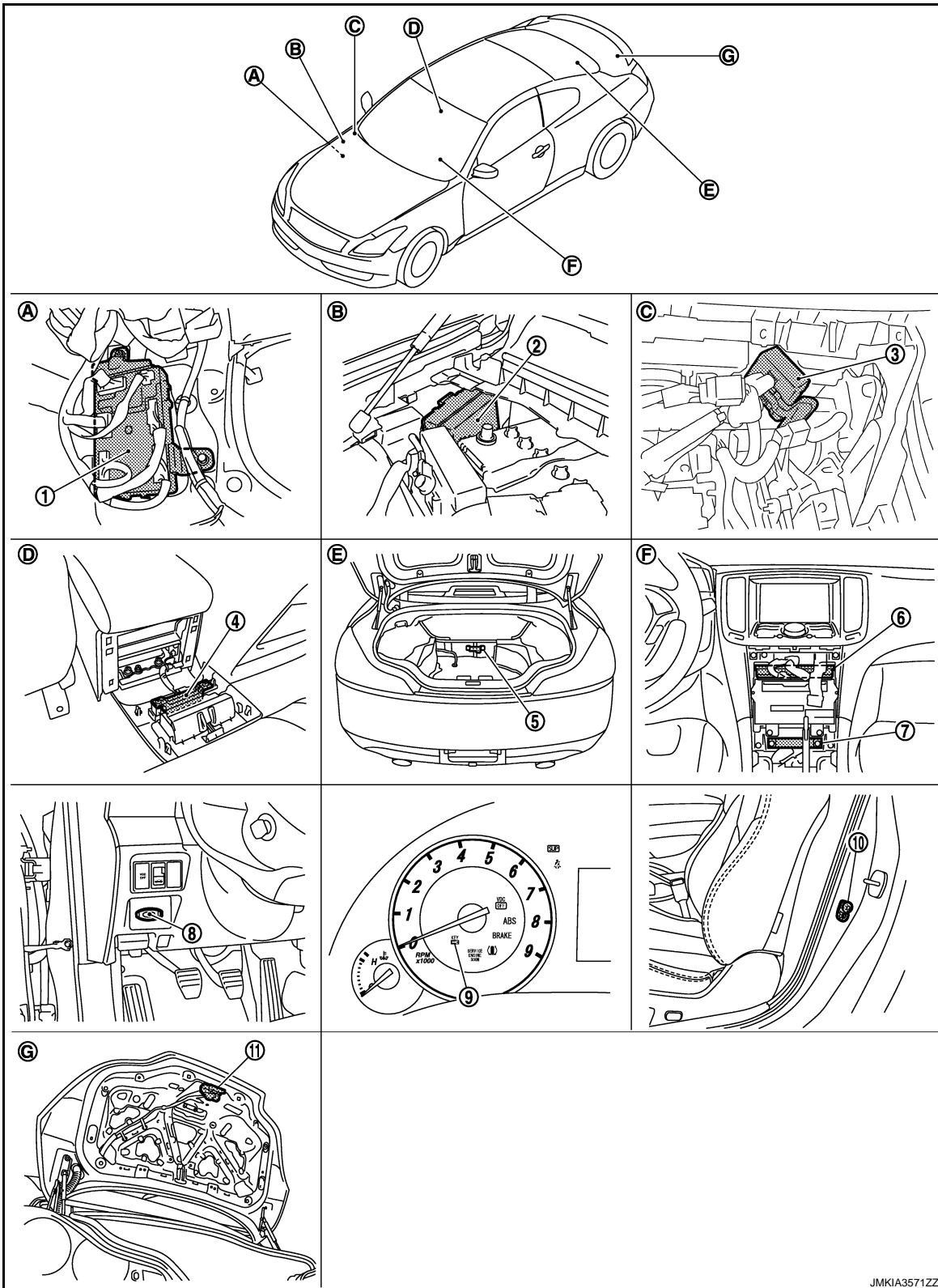

A  
B  
C  
D  
E  
F  
G  
H  
I  
J  
K  
L  
M  
N  
O  
P

SEC

- |                                      |  |  |
|--------------------------------------|--|--|
| 1. BCM M118, M119, M121, M122, M123  | 2. IPDM E/R E5, E6, E7                 | 3. Remote keyless entry receiver M104  |
| 4. Inside key antenna (console) M146 | 5. Inside key antenna (trunk room) B49 | 6. Unified meter and A/C amp. M66, M67 |

JMKIA3571ZZ

# INFINITI VEHICLE IMMOBILIZER SYSTEM-NATS

## < SYSTEM DESCRIPTION >

---

- |  |   |   |
|--|---|---|
| 7. Inside key antenna (instrument center) M131 | 8. Key slot M22   | 9. Combination meter (Key warning lamp) M53         |
| 10. Driver side door switch B16                | 11. Trunk lid lock assembly (trunk room lamp switch) B303 |   |
| A. Dash side lower (Passenger side).           | B. Engine room dash panel (RH).                           | C. View with instrument assist lower panel removed. |
| D. View with console rear finisher removed.    | E. View with trunk rear finisher (upper) removed.         | F. Behind cluster lid C.                            |
| G. View with trunk lid finisher removed.       |   |   |

# INFINITI VEHICLE IMMOBILIZER SYSTEM-NATS

< SYSTEM DESCRIPTION >

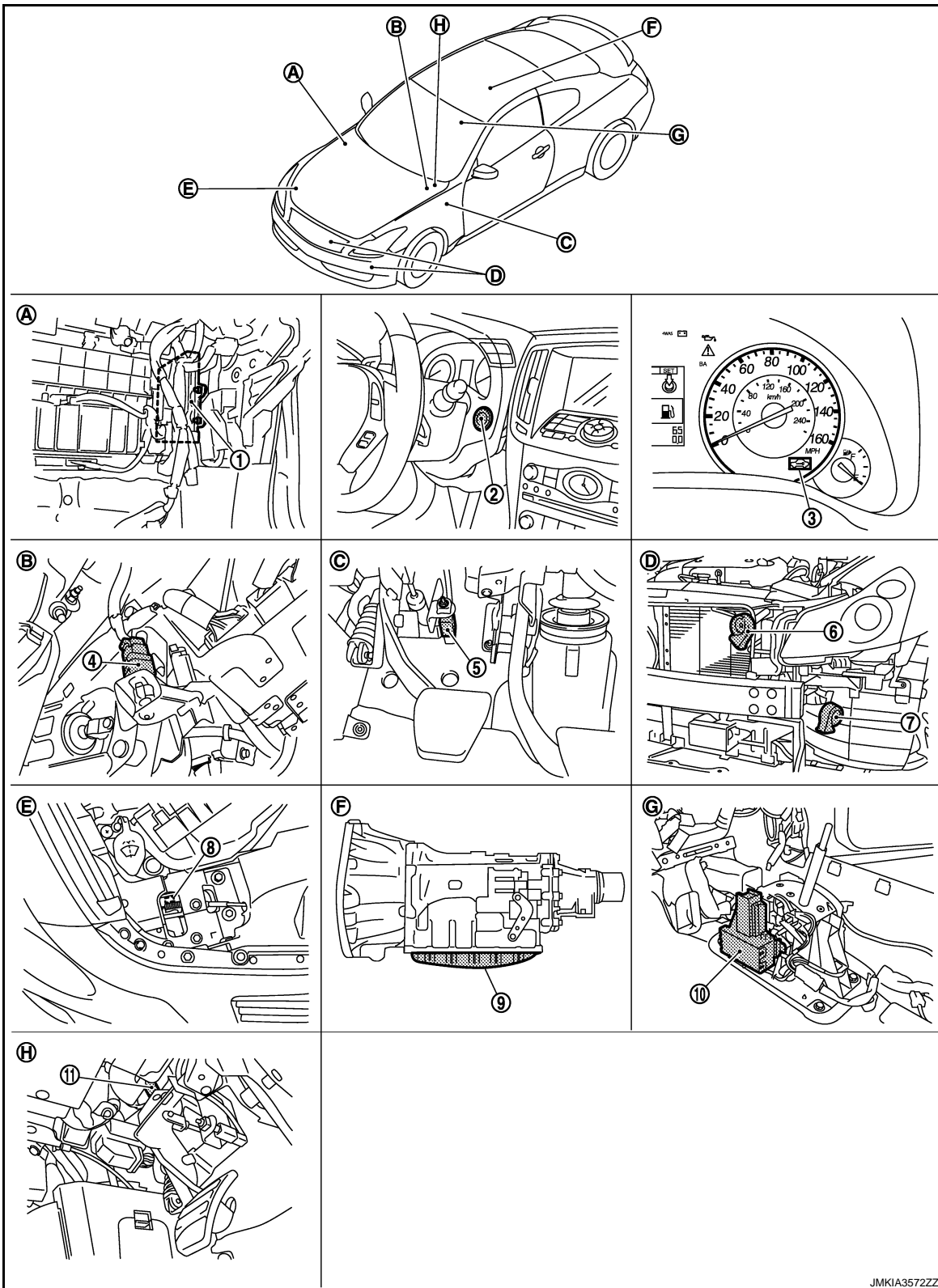

- |  |  |   |
|--|--|---|
| 1. ECM M107                                    | 2. Push-button ignition switch M50   | 3. Combination meter (Security indicator) M53 |
| 4. Stop lamp switch E110                       | 5. Clutch interlock switch E111  | 6. Horn (high) E61, E62                       |
| 7. Horn (low) E69, E70                         | 8. Hood switch E30   | 9. TCM F157                                   |
| 10. A/T shift selector (detention switch) M137 | 11. • ASCD clutch switch E108 (without ICC)<br>• ICC clutch switch E113 (with ICC) |   |

A  
B  
C  
D  
E  
F  
G  
H  
I  
J  
K  
L  
M  
N  
O  
P

SEC

JMKIA357ZZZ

# INFINITI VEHICLE IMMOBILIZER SYSTEM-NATS

## < SYSTEM DESCRIPTION >

- |   |  |  |
|---|--|--|
| A. View with instrument assist lower panel removed. | B. View with instrument driver lower cover removed.        | C. View with instrument driver lower cover removed.  |
| D. View with front bumper removed.                  | E. View with hood switch incorporated into hood lock (RH). | F. Inside of A/T assembly (built into A/T assembly). |
| G. View with center console assembly removed        | H. View with instrument driver lower cover removed.        |  |

## Component Description

INFOID:000000004653118

Component	Reference
BCM	<a href="#">SEC-100</a>
Steering lock unit	<a href="#">SEC-86</a>
Push-button ignition switch	<a href="#">SEC-61</a>
Door switch	<a href="#">DLK-62</a>
Key slot	<a href="#">SEC-122</a>
A/T shift selector (detention switch) (A/T models)	<a href="#">SEC-73</a>
Stop lamp switch	<a href="#">SEC-59</a>
TCM (A/T models)	<a href="#">SEC-65</a>
Clutch interlock switch (M/T models)	<a href="#">SEC-90</a>
Steering lock relay	<a href="#">SEC-77</a>
Starter relay	<a href="#">SEC-80</a>
Starter control relay	<a href="#">SEC-64</a>
Security indicator lamp	<a href="#">SEC-127</a>

# VEHICLE SECURITY SYSTEM

< SYSTEM DESCRIPTION >

## VEHICLE SECURITY SYSTEM

### System Diagram

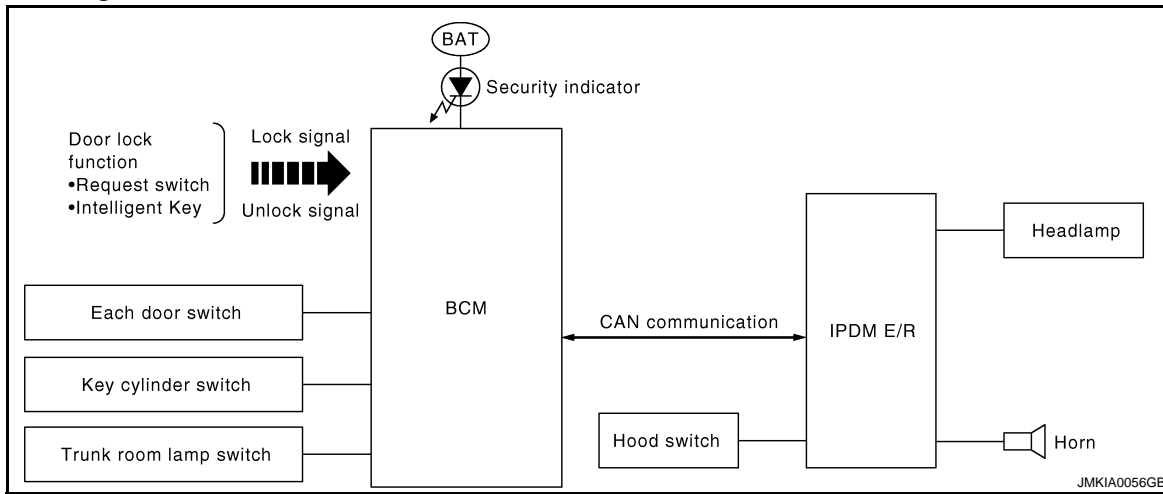

### System Description

INFOID:000000004662857

### OPERATION FLOW

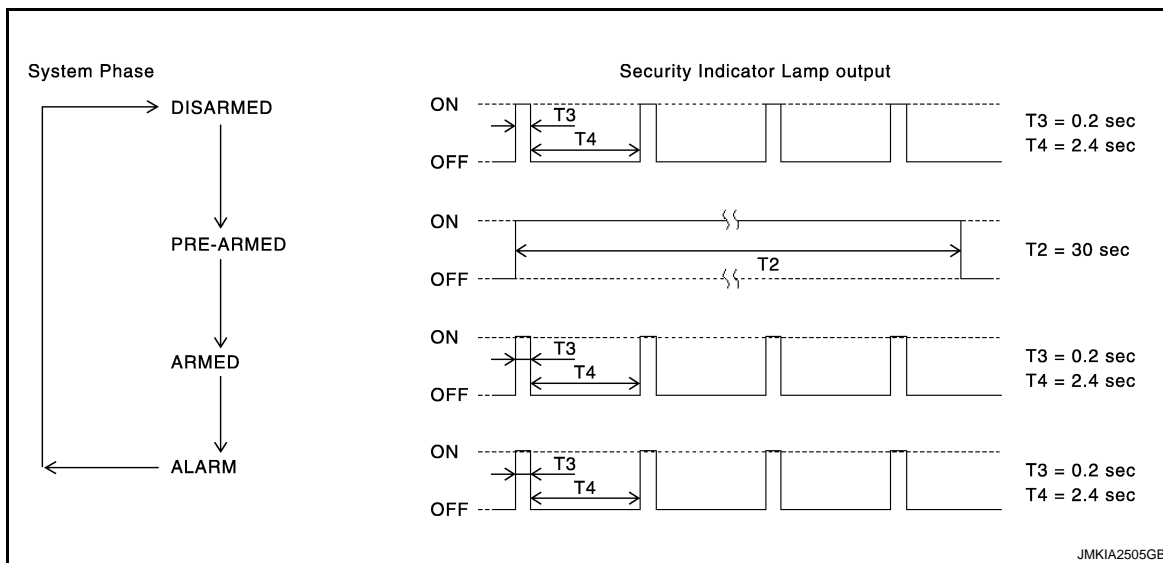

### SETTING THE VEHICLE SECURITY SYSTEM

Initial Condition

Ignition switch is in OFF position.

Disarmed Phase

- When any door or trunk lid is open, the vehicle security system is set in the disarmed phase on the assumption that the owner is inside or near the vehicle.
- When the vehicle security system is in the disarmed phase, the security indicator lamp blinks every 2.4 seconds.

Pre-armed Phase and Armed Phase

When the following operation is performed, the vehicle security system turns into the “pre-armed” phase. (The security indicator lamp illuminates.)

1. BCM receives LOCK signal from door request switch or Intelligent Key, after all doors are closed.
2. Security indicator lamp illuminates for 30 seconds. Then, the system automatically shifts into the “armed” phase.

### CANCELING THE SET VEHICLE SECURITY SYSTEM

A  
B  
C  
D  
E  
F  
G  
H  
I  
J  
L  
M  
N  
O  
P

SEC

# VEHICLE SECURITY SYSTEM

## < SYSTEM DESCRIPTION >

---

When one of the following operations is performed, the armed phase is canceled.

1. Unlock the all doors with the door request switch or Intelligent Key.
2. Turn ignition switch "ON" or "ACC" position.

### CANCELING THE ALARM OPERATION OF THE VEHICLE SECURITY SYSTEM

When unlocking the all doors with the door request switch or Intelligent Key the alarm operation is canceled.

### ACTIVATING THE ALARM OPERATION OF THE VEHICLE SECURITY SYSTEM

Check that the system is in the armed phase. (Security indicator lamp blinks every 2.4 seconds.)

When the following operation 1 or 2 is performed, the system sounds the horns and blinks the headlamps for about 50 seconds.

1. Trunk lid, any door or hood is opened during armed phase.
2. Disconnecting and connecting the battery connector before canceling armed phase.



# VEHICLE SECURITY SYSTEM

< SYSTEM DESCRIPTION >

## Component Parts Location

INFOID:000000004679406

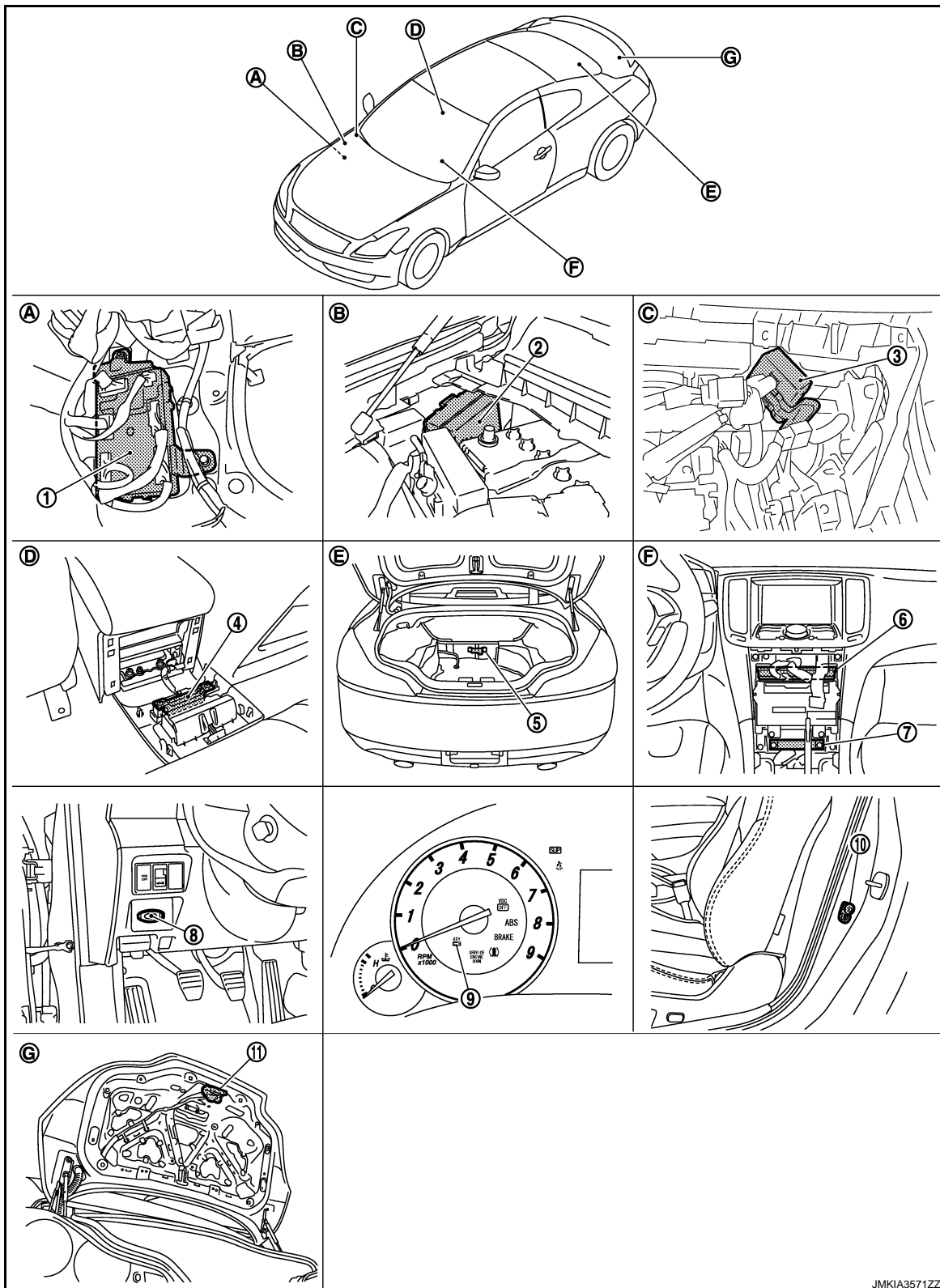

A  
B  
C  
D  
E  
F  
G  
H  
I  
J  
K  
L  
M  
N  
O  
P

SEC

- |                                      |  |  |
|--------------------------------------|--|--|
| 1. BCM M118, M119, M121, M122, M123  | 2. IPDM E/R E5, E6, E7                 | 3. Remote keyless entry receiver M104  |
| 4. Inside key antenna (console) M146 | 5. Inside key antenna (trunk room) B49 | 6. Unified meter and A/C amp. M66, M67 |

JMKIA3571ZZ

## VEHICLE SECURITY SYSTEM

### < SYSTEM DESCRIPTION >

---

- |  |   |   |
|--|---|---|
| 7. Inside key antenna (instrument center) M131 | 8. Key slot M22   | 9. Combination meter (Key warning lamp) M53         |
| 10. Driver side door switch B16                | 11. Trunk lid lock assembly (trunk room lamp switch) B303 |   |
| A. Dash side lower (Passenger side).           | B. Engine room dash panel (RH).                           | C. View with instrument assist lower panel removed. |
| D. View with console rear finisher removed.    | E. View with trunk rear finisher (upper) removed.         | F. Behind cluster lid C.                            |
| G. View with trunk lid finisher removed.       |   |   |

# VEHICLE SECURITY SYSTEM

## < SYSTEM DESCRIPTION >

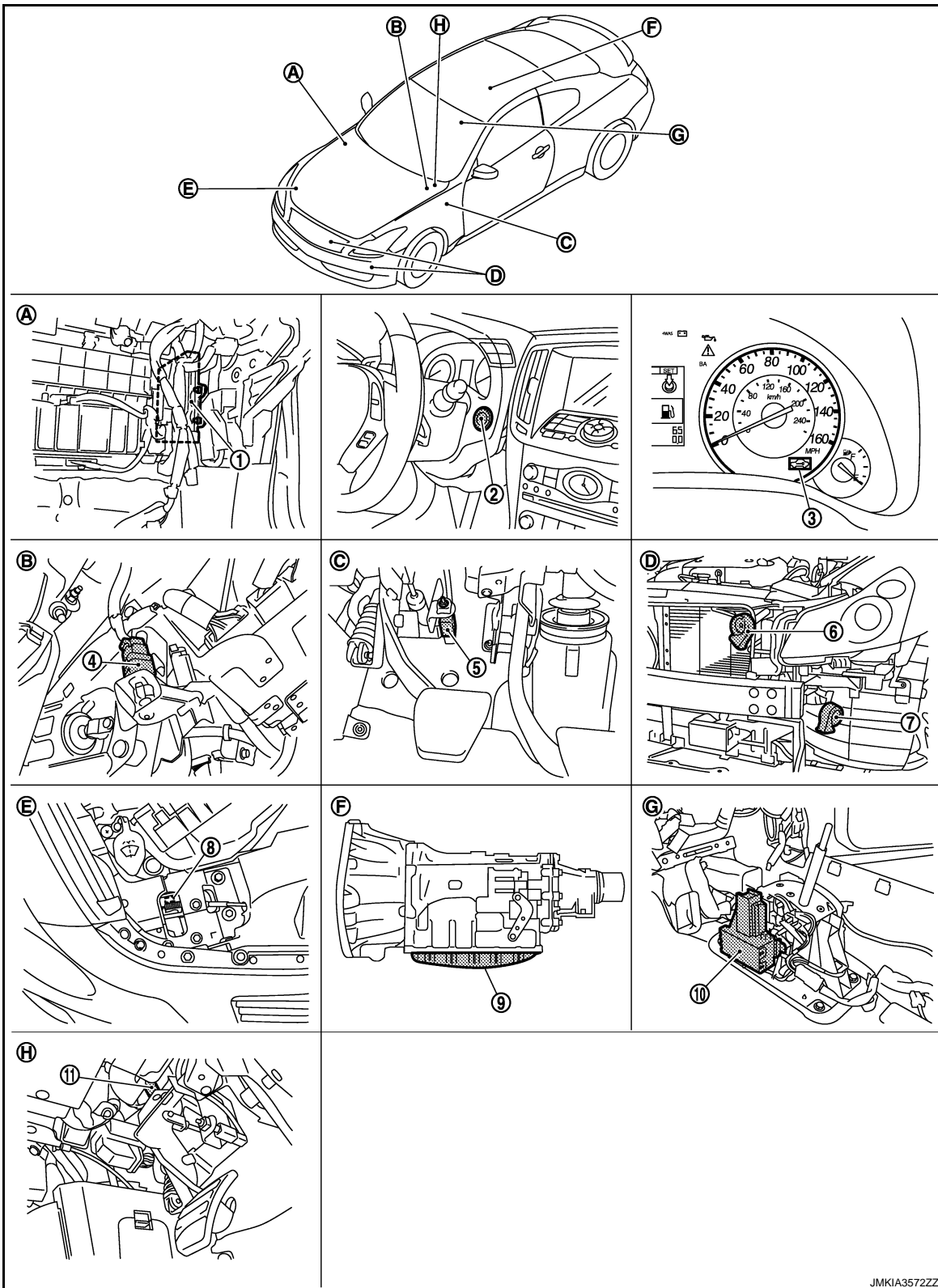

- |  |  |   |
|--|--|---|
| 1. ECM M107                                    | 2. Push-button ignition switch M50   | 3. Combination meter (Security indicator) M53 |
| 4. Stop lamp switch E110                       | 5. Clutch interlock switch E111  | 6. Horn (high) E61, E62                       |
| 7. Horn (low) E69, E70                         | 8. Hood switch E30   | 9. TCM F157                                   |
| 10. A/T shift selector (detention switch) M137 | 11. • ASCD clutch switch E108 (without ICC)<br>• ICC clutch switch E113 (with ICC) |   |

A  
B  
C  
D  
E  
F  
G  
H  
I  
J  
K  
L  
M  
N  
O  
P

**SEC**

JMKIA357ZZZ

# VEHICLE SECURITY SYSTEM

## < SYSTEM DESCRIPTION >

- |   |  |  |
|---|--|--|
| A. View with instrument assist lower panel removed. | B. View with instrument driver lower cover removed.        | C. View with instrument driver lower cover removed.  |
| D. View with front bumper removed.                  | E. View with hood switch incorporated into hood lock (RH). | F. Inside of A/T assembly (built into A/T assembly). |
| G. View with center console assembly removed        | H. View with instrument driver lower cover removed.        |  |

## Component Description

INFOID:000000004653122

Component	Reference
BCM	<a href="#">SEC-100</a>
Security indicator lamp	<a href="#">SEC-127</a>
Door switch	<a href="#">DLK-62</a>
Trunk room lamp switch	<a href="#">DLK-71</a>
Hood switch	<a href="#">SEC-125</a>

# DIAGNOSIS SYSTEM (BCM)

< SYSTEM DESCRIPTION >

## DIAGNOSIS SYSTEM (BCM)

### COMMON ITEM

#### COMMON ITEM : CONSULT-III Function (BCM - COMMON ITEM)

INFOID:000000004655575

#### APPLICATION ITEM

CONSULT-III performs the following functions via CAN communication with BCM.

Diagnosis mode	Function Description
Work Support	Changes the setting for each system function.
Self Diagnostic Result	Displays the diagnosis results judged by BCM.
CAN Diag Support Monitor	Monitors the reception status of CAN communication viewed from BCM. Refer to CONSULT-III operation manual.
Data Monitor	The BCM input/output signals are displayed.
Active Test	The signals used to activate each device are forcibly supplied from BCM.
Ecu Identification	The BCM part number is displayed.
Configuration	This function is not used even though it is displayed.

#### SYSTEM APPLICATION

BCM can perform the following functions for each system.

**NOTE:**

It can perform the diagnosis modes except the following for all sub system selection items.

x: Applicable item

System	Sub system selection item	Diagnosis mode		
		Work Support	Data Monitor	Active Test
Door lock	DOOR LOCK	x	x	x
Rear window defogger	REAR DEFOGGER		x	x
Warning chime	BUZZER		x	x
Interior room lamp timer	INT LAMP	x	x	x
Exterior lamp	HEAD LAMP	x	x	x
Wiper and washer	WIPER	x	x	x
Turn signal and hazard warning lamps	FLASHER	x	x	x
—	AIR CONDITONER*			
<ul style="list-style-type: none"> <li>• Intelligent Key system</li> <li>• Engine start system</li> </ul>	INTELLIGENT KEY	x	x	x
Combination switch	COMB SW		x	
Body control system	BCM	x		
IVIS - NATS	IMMU		x	x
Interior room lamp battery saver	BATTERY SAVER	x	x	x
Trunk lid open	TRUNK		x	x
Vehicle security system	THEFT ALM	x	x	x
RAP system	RETAINED PWR		x	
Signal buffer system	SIGNAL BUFFER		x	x
TPMS	TPMS (AIR PRESSURE MONITOR)	x	x	x

**NOTE:**

\*: This item is displayed, but is not used.

#### FREEZE FRAME DATA (FFD)

The BCM records the following vehicle condition at the time a particular DTC is detected, and displays on CONSULT-III.

# DIAGNOSIS SYSTEM (BCM)

## < SYSTEM DESCRIPTION >

CONSULT screen item	Indication/Unit	Description	
Vehicle Speed	km/h	Vehicle speed of the moment a particular DTC is detected	
Odo/Trip Meter	km	Total mileage (Odometer value) of the moment a particular DTC is detected	
Vehicle Condition	SLEEP>LOCK	Power position status of the moment a particular DTC is detected	While turning BCM status from low power consumption mode to normal mode (Power supply position is "LOCK")
	SLEEP>OFF		While turning BCM status from low power consumption mode to normal mode (Power supply position is "OFF".)
	LOCK>ACC		While turning power supply position from "LOCK" to "ACC"
	ACC>ON		While turning power supply position from "ACC" to "IGN"
	RUN>ACC		While turning power supply position from "RUN" to "ACC" (Vehicle is stopping and selector lever is except P position.)
	CRANK>RUN		While turning power supply position from "CRANKING" to "RUN" (From cranking up the engine to run it)
	RUN>URGENT		While turning power supply position from "RUN" to "ACC" (Emergency stop operation)
	ACC>OFF		While turning power supply position from "ACC" to "OFF"
	OFF>LOCK		While turning power supply position from "OFF" to "LOCK"
	OFF>ACC		While turning power supply position from "OFF" to "ACC"
	ON>CRANK		While turning power supply position from "IGN" to "CRANKING"
	OFF>SLEEP		While turning BCM status from normal mode (Power supply position is "OFF".) to low power consumption mode
	LOCK>SLEEP		While turning BCM status from normal mode (Power supply position is "LOCK".) to low power consumption mode
	LOCK		Power supply position is "LOCK" (Ignition switch OFF with steering is locked.)
	OFF		Power supply position is "OFF" (Ignition switch OFF with steering is unlocked.)
	ACC		Power supply position is "ACC" (Ignition switch ACC)
ON	Power supply position is "IGN" (Ignition switch ON with engine stopped)		
ENGINE RUN	Power supply position is "RUN" (Ignition switch ON with engine running)		
CRANKING	Power supply position is "CRANKING" (At engine cranking)		
IGN Counter	0 - 39	<p>The number of times that ignition switch is turned ON after DTC is detected</p> <ul style="list-style-type: none"> <li>• The number is 0 when a malfunction is detected now.</li> <li>• The number increases like 1 → 2 → 3...38 → 39 after returning to the normal condition whenever ignition switch OFF → ON.</li> <li>• The number is fixed to 39 until the self-diagnosis results are erased if it is over 39.</li> </ul>	

## INTELLIGENT KEY

### INTELLIGENT KEY : CONSULT-III Function (BCM - INTELLIGENT KEY)

INFOID:000000004655568

## WORK SUPPORT

Monitor item	Description
CONFIRM KEY FOB ID	It can be checked whether Intelligent Key ID code is registered or not in this mode.
AUTO LOCK SET	<p>Auto door lock time can be changed in this mode.</p> <ul style="list-style-type: none"> <li>• MODE 1: 1 minute</li> <li>• MODE 2: 5 minutes</li> <li>• MODE 3: 30 seconds</li> <li>• MODE 4: 2 minutes</li> </ul>

# DIAGNOSIS SYSTEM (BCM)

## < SYSTEM DESCRIPTION >

Monitor item	Description
LOCK/UNLOCK BY I-KEY	Door lock/unlock function by door request switch (driver side and passenger side) mode can be changed to operate (ON) or not operate (OFF) in this mode.
ENGINE START BY I-KEY	Engine start function mode can be changed to operate (ON) or not operate (OFF) with this mode.
TRUNK/GLASS HATCH OPEN	Buzzer reminder function mode by trunk opener request switch can be changed to operate (ON) or not operate (OFF) with this mode.
PANIC ALARM SET	Panic alarm button pressing time on Intelligent Key remote control button can be selected from the following with this mode. <ul style="list-style-type: none"> <li>• MODE 1: 0.5 sec.</li> <li>• MODE 2: Non-operation</li> <li>• MODE 3: 1.5 sec.</li> </ul>
PW DOWN SET	Unlock button pressing time on Intelligent Key button can be selected from the following with this mode. <ul style="list-style-type: none"> <li>• MODE 1: 3 sec.</li> <li>• MODE 2: Non-operation</li> <li>• MODE 3: 5 sec.</li> </ul>
TRUNK OPEN DELAY	Trunk button pressing on Intelligent Key button can be selected as per the following in this mode. <ul style="list-style-type: none"> <li>• MODE 1: Press and hold</li> <li>• MODE 2: Press twice</li> <li>• MODE 3: Press and hold, or press twice</li> </ul>
LO- BATT OF KEY FOB WARN	Intelligent Key low battery warning mode can be changed to operate (ON) or not operate (OFF) with this mode.
ANTI KEY LOCK IN FUNCTI	Key reminder function mode can be changed to operate (ON) or not operate (OFF) with this mode.
HAZARD ANSWER BACK	Hazard reminder function mode can be selected from the following with this mode. <ul style="list-style-type: none"> <li>• LOCK ONLY: Door lock operation only</li> <li>• UNLOCK ONLY: Door unlock operation only</li> <li>• LOCK/UNLOCK: Lock/unlock operation</li> <li>• OFF: Non-operation</li> </ul>
ANS BACK I-KEY LOCK	Buzzer reminder function (lock operation) mode by door request switch (driver side and passenger side) can be selected from the following with this mode. <ul style="list-style-type: none"> <li>• Horn chirp: Sound horn</li> <li>• Buzzer: Sound Intelligent Key warning buzzer</li> <li>• OFF: Non-operation</li> </ul>
ANS BACK I-KEY UNLOCK	Buzzer reminder function (unlock operation) mode by door request switch can be changed to operate (ON) or not operate (OFF) with this mode.
SHORT CRANKING OUTPUT	Starter motor can operate during the times below. <ul style="list-style-type: none"> <li>• 70 msec</li> <li>• 100 msec</li> <li>• 200 msec</li> </ul>
INSIDE ANT DIAGNOSIS	This function allows inside key antenna self-diagnosis.
HORN WITH KEYLESS LOCK	Horn reminder function mode by Intelligent Key button can be changed to operate (ON) or not operate (OFF) with this mode.

## SELF-DIAG RESULT

Refer to [SEC-185, "DTC Index"](#).

## DATA MONITOR

Monitor Item	Condition
REQ SW -DR	Indicates [ON/OFF] condition of door request switch (driver side).
REQ SW -AS	Indicates [ON/OFF] condition of door request switch (passenger side).
REQ SW -BD/TR	Indicates [ON/OFF] condition of trunk opener request switch.
PUSH SW	Indicates [ON/OFF] condition of push-button ignition switch.
IGN RLY2 -F/B	Indicates [ON/OFF] condition of ignition relay 2.

A  
B  
C  
D  
E  
F  
G  
H  
I  
J  
L  
M  
N  
O  
P

SEC

## DIAGNOSIS SYSTEM (BCM)

### < SYSTEM DESCRIPTION >

Monitor Item	Condition
ACC RLY-FB	<b>NOTE:</b> This item is displayed, but cannot be monitored.
CLUTCH SW*1	Indicates [ON/OFF] condition of clutch switch.
BRAKE SW 1	Indicates [ON/OFF]*2 condition of brake switch power supply.
BRAKE SW 2	Indicates [ON/OFF] condition of brake switch.
DETE/CANCL SW	Indicates [ON/OFF] condition of P position.
SFT PN/N SW	Indicates [ON/OFF] condition of P or N position.
S/L -LOCK	Indicates [ON/OFF] condition of steering lock unit (LOCK).
S/L -UNLOCK	Indicates [ON/OFF] condition of steering lock unit (UNLOCK).
S/L RELAY -F/B	Indicates [ON/OFF] condition of steering lock relay.
UNLK SEN -DR	Indicates [ON/OFF] condition of driver door UNLOCK status.
PUSH SW -IPDM	Indicates [ON/OFF] condition of push-button ignition switch.
IGN RLY1 -F/B	Indicates [ON/OFF] condition of ignition relay 1.
DETE SW -IPDM	Indicates [ON/OFF] condition of P position.
SFT PN -IPDM	Indicates [ON/OFF] condition of P or N position.
SFT P -MET	Indicates [ON/OFF] condition of P position.
SFT N -MET	Indicates [ON/OFF] condition of N position.
ENGINE STATE	Indicates [STOP/STALL/CRANK/RUN] condition of engine states.
S/L LOCK-IPDM	Indicates [ON/OFF] condition of steering lock unit (LOCK).
S/L UNLK-IPDM	Indicates [ON/OFF] condition of steering lock unit (UNLOCK).
S/L RELAY-REQ	Indicates [ON/OFF] condition of steering lock relay.
VEH SPEED 1	Display the vehicle speed signal received from combination meter by numerical value [Km/h].
VEH SPEED 2	Display the vehicle speed signal received from ABS or VDC or TCM by numerical value [Km/h].
DOOR STAT-DR	Indicates [LOCK/READY/UNLOCK] condition of driver side door status.
DOOR STAT-AS	Indicates [LOCK/READY/UNLOCK] condition of passenger side door status.
ID OK FLAG	Indicates [SET/RESET] condition of key ID.
PRMT ENG STRT	Indicates [SET/RESET] condition of engine start possibility.
PRMT RKE STRT	<b>NOTE:</b> This item is displayed, but cannot be monitored.
KEY SW -SLOT	Indicates [ON/OFF] condition of key slot.
TRNK/HAT MNTR	Indicates [ON/OFF] condition of trunk lid.
RKE-LOCK	Indicates [ON/OFF] condition of LOCK signal from Intelligent Key.
RKE-UNLOCK	Indicates [ON/OFF] condition of UNLOCK signal from Intelligent Key.
RKE-TR/BD	Indicates [ON/OFF] condition of TRUNK OPEN signal from Intelligent Key.
RKE-PANIC	Indicates [ON/OFF] condition of PANIC button of Intelligent Key.
RKE-P/W OPEN	Indicates [ON/OFF] condition of P/W DOWN signal from Intelligent Key.
RKE-MODE CHG	Indicates [ON/OFF] condition of MODE CHANGE signal from Intelligent Key.
RKE OPE COUN1	When remote keyless entry receiver receives the signal transmitted while operating on Intelligent Key, the numerical value start changing.
RKE OPE COUN2	<b>NOTE:</b> This item is displayed, but cannot be monitored.

\*1: It is displayed but does not operate on M/T models.

\*2: OFF is displayed when brake pedal is depressed while brake switch power supply is OFF.

### ACTIVE TEST



# DIAGNOSIS SYSTEM (BCM)

## < SYSTEM DESCRIPTION >

Test item	Description	
BATTERY SAVER	This test is able to check interior room lamp operation. The interior room lamp is activated after "ON" on CONSULT-III screen is touched.	A
PW REMOTO DOWN SET	This test is able to check power window down operation. The power window down is activated after "ON" on CONSULT-III screen is touched.	B
OUTSIDE BUZZER	This test is able to check Intelligent Key warning buzzer operation. The Intelligent Key warning buzzer is activated after "ON" on CONSULT-III screen is touched.	C
INSIDE BUZZER	This test is able to check warning chime in combination meter operation. <ul style="list-style-type: none"> <li>Take away warning chime sounds when "TAKE OUT" on CONSULT-III screen is touched.</li> <li>Key warning chime sounds when "KEY" on CONSULT-III screen is touched.</li> <li>OFF position warning chime sounds when "KNOB" on CONSULT-III screen is touched.</li> </ul>	D
INDICATOR	This test is able to check warning lamp operation. <ul style="list-style-type: none"> <li>"KEY" Warning lamp illuminates when "KEY ON" on CONSULT-III screen is touched.</li> <li>"KEY" Warning lamp blinks when "KEY IND" on CONSULT-III screen is touched.</li> </ul>	E
INT LAMP	This test is able to check interior room lamp operation. The interior room lamp is activated after "ON" on CONSULT-III screen is touched.	
LCD	This test is able to check meter display information <ul style="list-style-type: none"> <li>Engine start information displays when "BP N" on CONSULT-III screen is touched.</li> <li>Engine start information displays when "BP I" on CONSULT-III screen is touched.</li> <li>Key ID warning displays when "ID NG" on CONSULT-III screen is touched.</li> <li>Steering lock information displays when "ROTAT" on CONSULT-III screen is touched.</li> <li>P position warning displays when "SFT P" on CONSULT-III screen is touched.</li> <li>Intelligent Key insert information displays when "INSRT" on CONSULT-III screen is touched.</li> <li>Intelligent Key low battery warning displays when "BATT" on CONSULT-III screen is touched.</li> <li>Take away through window warning displays when "NO KY" on CONSULT-III screen is touched.</li> <li>Take away warning display when "OUTKEY" on CONSULT-III screen is touched.</li> <li>OFF position warning display when "LK WN" on CONSULT-III screen is touched.</li> </ul>	F
		G
		H
		I
TRUNK/GLASS HATCH	This test is able to check trunk lid opener actuator open operation. This actuator opens when "OPEN" on CONSULT-III screen is touched.	J
FLASHER	This test is able to check security hazard lamp operation. The hazard lamps are activated after "LH/RH/OFF" on CONSULT-III screen is touched.	
HORN	This test is able to check horn operation. The horn is activated after "ON" on CONSULT-III screen is touched.	
P RANGE	This test is able to check A/T shift selector power supply A/T shift selector power is supplied when "ON" on CONSULT-III screen is touched.	L
ENGINE SW ILLUMI	This test is able to check push-ignition switch illumination operation. Push-ignition switch illumination illuminates when "ON" on CONSULT-III screen is touched.	
LOCK INDICATOR	This test is able to check LOCK indicator in push-ignition switch operation. LOCK indicator in push-ignition switch illuminates when "ON" on CONSULT-III screen is touched.	M
ACC INDICATOR	This test is able to check ACC indicator in push-ignition switch operation. ACC indicator in push-ignition switch illuminates when "ON" on CONSULT-III screen is touched.	N
IGNITION ON IND	This test is able to check on indicator in push-ignition switch operation. ON indicator in push-ignition switch illuminates when "ON" on CONSULT-III screen is touched.	O
KEY SLOT ILLUMI	This test is able to check key slot illumination operation. Key slot illumination blinks when "ON" on CONSULT-III screen is touched.	
TRUNK/BACK DOOR	This test is able to check trunk lid opener actuator open operation. This actuator opens when "OPEN" on CONSULT-III screen is touched.	P

SEC

## THEFT ALM

### THEFT ALM : CONSULT-III Function (BCM - THEFT)

INFOID:000000004655579

## DATA MONITOR

# DIAGNOSIS SYSTEM (BCM)

## < SYSTEM DESCRIPTION >

Monitored Item	Description
REQ SW-DR	Indicates [ON/OFF] condition of door request switch (driver side).
REQ SW-AS	Indicates [ON/OFF] condition of door request switch (passenger side).
REQ SW-BD/TR	Indicates [ON/OFF] condition of trunk opener request switch.
PUSH SW	Indicates [ON/OFF] condition of push-button ignition switch
UNLK SEN-DR	Indicates [ON/OFF] condition of driver door UNLOCK status.
KEY SW -SLOT	Indicates [ON/OFF] condition of key slot.
DOOR SW-DR	Indicates [ON/OFF] condition of front door switch LH.
DOOR SW-AS	Indicates [ON/OFF] condition of front door switch RH.
DOOR SW-RR	Indicates [ON/OFF] condition of rear door switch RH.
DOOR SW-RL	Indicates [ON/OFF] condition of rear door switch LH.
DOOR SW-BK	This is displayed even when it is not equipped.
CDL LOCK SW	Indicates [ON/OFF] condition of lock signal from door lock/unlock switch LH and RH.
CDL UNLOCK SW	Indicates [ON/OFF] condition of unlock signal from door lock/unlock switch LH and RH.
KEY CYL LK-SW	Indicates [ON/OFF] condition of lock signal from front door key cylinder switch.
KEY CYL UN-SW	Indicates [ON/OFF] condition of unlock signal from front door key cylinder switch.
KEY CYL SW-TR	This is displayed even when it is not equipped.
TR/BD OPEN SW	Indicates [ON/OFF] condition of trunk lid opener switch.
TRNK/HAT MNTR	Indicates [ON/OFF] condition of trunk room lamp switch.
RKE-LOCK	Indicates [ON/OFF] condition of LOCK signal from Intelligent Key.
RKE-UNLOCK	Indicates [ON/OFF] condition of UNLOCK signal from Intelligent Key.
RKE-TR/BD	Indicates [ON/OFF] condition of TRUNK OPEN signal from Intelligent Key.

## WORK SUPPORT

Test Item	Description
SECURITY ALARM SET	This mode is able to confirm and change security alarm ON-OFF setting.
THEFT ALM TRG	The switch which triggered vehicle security alarm is recorded. This mode is able to confirm and erase the record of vehicle security alarm. The trigger data can be erased by touching "CLEAR" on CONSULT-III screen.

## ACTIVE TEST

Test Item	Description
THEFT IND	This test is able to check security indicator lamp operation. The lamp will be turned on when "ON" on CONSULT-III screen is touched.
VEHICLE SECURITY HORN	This test is able to check vehicle security horn operation. The horns will be activated for 0.5 seconds after "ON" on CONSULT-III screen is touched.
HEADLAMP(HI)	This test is able to check vehicle security lamp operation. The headlamps will be activated for 0.5 seconds after "ON" on CONSULT-III screen is touched.
FLASHER	This test is able to check vehicle security hazard lamp operation. The hazard lamps will be activated after "ON" on CONSULT-III screen is touched.

## IMMU

### IMMU : CONSULT-III Function (BCM - IMMU)

INFOID:000000004655580

## DATA MONITOR

# DIAGNOSIS SYSTEM (BCM)

## < SYSTEM DESCRIPTION >

Monitor item	Content	A
CONFIRM ID ALL	Indicates [YET] at all time. Switch to [DONE] when a registered Intelligent Key is inserted into the key slot.	B
CONFIRM ID4		
CONFIRM ID3		
CONFIRM ID2		
CONFIRM ID1		
TP 4	Indicates the number of ID which has been registered.	C
TP 3		
TP 2		
TP 1		
PUSH SW	Indicates [ON/OFF] condition of push-button ignition switch.	D
KEY SW -SLOT	Indicates [ON/OFF] condition of key slot.	

## ACTIVE TEST

Test item	Description	E
THEFT IND	This test is able to check security indicator lamp operation. The lamp will be turned on when "ON" on CONSULT-III screen touched.	F

G

H

I

J

L

M

N

O

P

# U1000 CAN COMM CIRCUIT

< DTC/CIRCUIT DIAGNOSIS >

## DTC/CIRCUIT DIAGNOSIS

### U1000 CAN COMM CIRCUIT

#### BCM

#### BCM : Description

INFOID:000000004662858

CAN (Controller Area Network) is a serial communication line for real time applications. It is an on-vehicle multiplex communication line with high data communication speed and excellent error detection ability. Modern vehicle is equipped with many electronic control unit, and each control unit shares information and links with other control units during operation (not independent). In CAN communication, control units are connected with 2 communication lines (CAN H-line, CAN L-line) allowing a high rate of information transmission with less wiring. Each control unit transmits/receives data but selectively reads required data only. CAN Communication Signal Chart. Refer to [LAN-27. "CAN Communication Signal Chart"](#).

#### BCM : DTC Logic

INFOID:000000004662859

#### DTC DETECTION LOGIC

DTC	CONSULT-III display description	DTC Detection Condition	Possible cause
U1000	CAN COMM	When BCM cannot communicate CAN communication signal continuously for 2 seconds or more.	CAN communication system

#### BCM : Diagnosis Procedure

INFOID:000000004662860

#### 1. PERFORM SELF DIAGNOSTIC

1. Turn ignition switch ON and wait for 2 seconds or more.
2. Check "Self Diagnostic Result".

#### Is DTC "U1000" displayed?

- YES >> Refer to [LAN-18. "Trouble Diagnosis Flow Chart"](#).  
NO >> Refer to [GI-41. "Intermittent Incident"](#).

### IPDM E/R (INTELLIGENT POWER DISTRIBUTION MODULE ENGINE ROOM)

#### IPDM E/R (INTELLIGENT POWER DISTRIBUTION MODULE ENGINE ROOM) : Description

INFOID:000000004662861

CAN (Controller Area Network) is a serial communication line for real time applications. It is an on-vehicle multiplex communication line with high data communication speed and excellent error detection ability. Modern vehicle is equipped with many electronic control unit, and each control unit shares information and links with other control units during operation (not independent). In CAN communication, control units are connected with 2 communication lines (CAN-H line, CAN-L line) allowing a high rate of information transmission with less wiring. Each control unit transmits/receives data but selectively reads required data only. CAN Communication Signal Chart. Refer to [LAN-27. "CAN Communication Signal Chart"](#).

#### IPDM E/R (INTELLIGENT POWER DISTRIBUTION MODULE ENGINE ROOM) : DTC Logic

INFOID:000000004662862

#### DTC DETECTION LOGIC

# U1000 CAN COMM CIRCUIT

## < DTC/CIRCUIT DIAGNOSIS >

DTC	CONSULT-III display description	DTC Detection Condition	Possible cause
U1000	CAN COMM CIRCUIT	When IPDM E/R cannot communicate CAN communication signal continuously for 2 seconds or more	In CAN communication system, any item (or items) of the following listed below is malfunctioning. <ul style="list-style-type: none"><li>• Transmission</li><li>• Receiving (ECM)</li><li>• Receiving (BCM)</li><li>• Receiving (Unified meter and A/C amp.)</li></ul>

### DTC CONFIRMATION PROCEDURE

## IPDM E/R (INTELLIGENT POWER DISTRIBUTION MODULE ENGINE ROOM) : Diagnosis Procedure

INFOID:000000004662863

### 1. PERFORM SELF DIAGNOSTIC

1. Turn the ignition switch ON and wait for 2 seconds or more.
2. Check "Self Diagnostic Result" of IPDM E/R.

#### Is DTC "U1000" displayed?

- YES >> Refer to [LAN-18, "Trouble Diagnosis Flow Chart"](#).  
NO >> Refer to [GI-41, "Intermittent Incident"](#).

A  
B  
C  
D  
E  
F  
G  
H  
I  
J  
L  
M  
N  
O  
P

SEC

## U1010 CONTROL UNIT (CAN)

< DTC/CIRCUIT DIAGNOSIS >

### U1010 CONTROL UNIT (CAN)

BCM

BCM : DTC Logic

INFOID:000000004662864

DTC DETECTION LOGIC

DTC	CONSULT-III display de- scription	DTC Detection Condition	Possible cause
U1010	CONTROL UNIT(CAN)	BCM detected internal CAN communication circuit malfunction.	BCM

BCM : Diagnosis Procedure

INFOID:000000004662865

#### 1.REPLACE BCM

When DTC "U1010" is detected, replace BCM.

>> Replace BCM. Refer to [BCS-81. "Exploded View"](#).

# P1610 LOCK MODE

< DTC/CIRCUIT DIAGNOSIS >

## P1610 LOCK MODE

### Description

INFOID:000000004662866

When the starting operation is carried more than five times consecutively under the following conditions, NATS shifts to the mode that prevents the engine from being started.

- Unregistered Intelligent Key is used.
- BCM or ECM is malfunctioning.

### DTC Logic

INFOID:000000004662867

### DTC DETECTION LOGIC

DTC No.	Trouble diagnosis name	DTC detecting condition	Possible cause
P1610	LOCK MODE	When the starting operation is carried out five or more times consecutively under the following conditions. <ul style="list-style-type: none"><li>• Unregistered Intelligent Key</li><li>• BCM or ECM is malfunctioning</li></ul>	—

### DTC CONFIRMATION PROCEDURE

#### 1.PERFORM DTC CONFIRMATION PROCEDURE

1. Turn ignition switch ON.
2. Check "Self-diagnostic result" using CONSULT-III.

Is DTC detected?

- YES >> Go to [SEC-39. "Diagnosis Procedure"](#).  
NO >> INSPECTION END

### Diagnosis Procedure

INFOID:000000004662868

#### 1.CHECK ENGINE START FUNCTION

1. Perform the check for DTC except DTC P1610.
2. Use CONSULT-III to erase DTC after fixing.
3. Turn ignition switch OFF.
4. Turn ignition switch ON when registered Intelligent Key is inserted into key slot and wait for 5 seconds.
5. Turn the ignition switch OFF and wait 5 seconds.
6. Repeat steps 4 and 5 twice (a total of 3 times).
7. Check that engine can start when registered Intelligent Key is inserted into key slot.

>> INSPECTION END

A  
B  
C  
D  
E  
F  
G  
H  
I  
J  
L  
M  
N  
O  
P

SEC

# P1611 ID DISCORD, IMMU-ECM

< DTC/CIRCUIT DIAGNOSIS >

## P1611 ID DISCORD, IMMU-ECM

### Description

INFOID:000000004662869

BCM performs the ID verification with ECM that allows the engine to start. Start the engine if the ID is successfully verified. ECM prevents the engine from starting if the ID is not registered. BCM starts the communication with ECM if ignition switch is turned ON.

### DTC Logic

INFOID:000000004662870

#### DTC DETECTION LOGIC

##### NOTE:

- If DTC P1611 is displayed with DTC U1000, first perform the trouble diagnosis for DTC U1000. Refer to [SEC-36, "BCM : DTC Logic"](#).
- If DTC P1611 is displayed with DTC U1010, first perform the trouble diagnosis for DTC U1010. Refer to [SEC-38, "BCM : DTC Logic"](#).

DTC No.	Trouble diagnosis name	DTC detecting condition	Possible cause
P1611	ID DISCORD, IMMU-ECM	The ID verification results between BCM and ECM are NG. Registration is necessary.	<ul style="list-style-type: none"><li>• BCM</li><li>• ECM</li></ul>

#### DTC CONFIRMATION PROCEDURE

### 1.PERFORM DTC CONFIRMATION PROCEDURE

1. Turn ignition switch ON under the following conditions.

##### A/T models

- Selector lever is in the P or N position
- Do not depress brake pedal

##### M/T models

- Do not depress clutch pedal
2. Check "Self-diagnostic result" using CONSULT-III.

##### Is DTC detected?

- YES >> Go to [SEC-40, "Diagnosis Procedure"](#).  
NO >> INSPECTION END

### Diagnosis Procedure

INFOID:000000004662871

### 1.PERFORM INITIALIZATION

Perform initialization using CONSULT-III. Reregister all Intelligent Keys.  
For initialization and registration of Intelligent Key, refer to "CONSULT-III Operation Manual NATS-IVIS/NVIS".

#### Can the system be initialized and can the engine be started with reregistered Intelligent Key?

- YES >> INSPECTION END  
NO >> GO TO 2.

### 2.REPLACE BCM

1. Replace BCM. Refer to [BCS-81, "Removal and Installation"](#).
2. Perform initialization using CONSULT-III.  
For initialization, refer to "CONSULT-III Operation Manual NATS-IVIS/NVIS".

#### Can the system be initialized and can the engine be started with reregistered Intelligent Key?

- YES >> INSPECTION END  
NO >> GO TO 3.

### 3.REPLACE ECM

1. Replace ECM. Refer to [EC-16, "ADDITIONAL SERVICE WHEN REPLACING CONTROL UNIT \(ECM\) : Description"](#).
2. Perform initialization using CONSULT-III.



## P1611 ID DISCORD, IMMUECM

### < DTC/CIRCUIT DIAGNOSIS >

---

For initialization, refer to "CONSULT-III Operation Manual NATS-IVIS/NVIS".

Can the system be initialized and can the engine be started with reregistered Intelligent Key?

YES >> INSPECTION END

NO >> GO TO 4.

### 4.CHECK INTERMITTENT INCIDENT

---

Refer to [G1-41, "Intermittent Incident"](#).

>> INSPECTION END

A

B

C

D

E

F

G

H

I

J

SEC

L

M

N

O

P

# P1612 CHAIN OF ECM-IMMU

< DTC/CIRCUIT DIAGNOSIS >

## P1612 CHAIN OF ECM-IMMU

### Description

INFOID:000000004662872

BCM performs ID verification with ECM that allows the engine to start. Start the engine if the ID is successfully verified. ECM prevents the engine from starting if the ID is not registered. BCM starts the communication with ECM if ignition switch is turned ON.

### DTC Logic

INFOID:000000004662873

#### DTC DETECTION LOGIC

##### NOTE:

- If DTC P1612 is displayed with DTC U1000, first perform the trouble diagnosis for DTC U1000. Refer to [SEC-36, "BCM : DTC Logic"](#).
- If DTC P1612 is displayed with DTC U1010, first perform the trouble diagnosis for DTC U1010. Refer to [SEC-38, "BCM : DTC Logic"](#).

DTC No.	Trouble diagnosis name	DTC detecting condition	Possible cause
P1612	CHAIN OF ECM-IMMU	Inactive communication between ECM and BCM	<ul style="list-style-type: none"><li>• Harness or connectors (The CAN communication line is open or shorted)</li><li>• BCM</li><li>• ECM</li></ul>

#### DTC CONFIRMATION PROCEDURE

##### 1. PERFORM DTC CONFIRMATION PROCEDURE

1. Turn ignition switch ON under the following conditions.

##### A/T models

- Selector lever is in the P or N position
- Do not depress brake pedal

##### M/T models

- Do not depress clutch pedal
2. Check "Self-diagnostic result" using CONSULT-III.

##### Is DTC detected?

- YES >> Go to [SEC-42, "Diagnosis Procedure"](#).  
NO >> INSPECTION END

### Diagnosis Procedure

INFOID:000000004662874

##### 1. REPLACE BCM

1. Replace BCM. Refer to [BCS-81, "Removal and Installation"](#).
2. Perform initialization using CONSULT-III.  
For initialization, refer to "CONSULT-III Operation Manual NATS-IVIS/NVIS".

##### Does the engine start?

- YES >> INSPECTION END  
NO >> GO TO 2.

##### 2. REPLACE ECM

Replace ECM. Refer to [EC-16, "ADDITIONAL SERVICE WHEN REPLACING CONTROL UNIT \(ECM\) : Description"](#).

>> INSPECTION END

# P1614 CHAIN OF IMMU-KEY

< DTC/CIRCUIT DIAGNOSIS >

## P1614 CHAIN OF IMMU-KEY

### Description

INFOID:000000004662875

Performs ID verification through BCM and Intelligent Key when push-button ignition switch is pressed. Prohibits the release of steering lock or start of engine when an unregistered ID of Intelligent Key is used.

### DTC Logic

INFOID:000000004662876

### DTC DETECTION LOGIC

DTC No.	Trouble diagnosis name	DTC detecting condition	Possible cause
P1614	CHAIN OF IMMU-KEY	Inactive communication between key slot and BCM.	<ul style="list-style-type: none"><li>• Harness or connectors (The key slot circuit is open or shorted)</li><li>• Key slot</li><li>• BCM</li></ul>

### DTC CONFIRMATION PROCEDURE

#### 1. PERFORM DTC CONFIRMATION PROCEDURE 1

1. Insert Intelligent Key into the key slot.
2. Check "Self-diagnostic result" using CONSULT-III.

#### Is DTC detected?

- YES >> Go to [SEC-43, "Diagnosis Procedure"](#).  
NO >> GO TO 2.

#### 2. PERFORM DTC CONFIRMATION PROCEDURE 2

1. Press the push-button ignition switch.
2. Check "Self-diagnostic result" using CONSULT-III.

#### Is DTC detected?

- YES >> Go to [SEC-43, "Diagnosis Procedure"](#).  
NO >> INSPECTION END

### Diagnosis Procedure

INFOID:000000004662877

SEC

#### 1. INSPECTION START

Perform inspection in accordance with procedure that confirms DTC.

#### Which procedure confirms DTC?

- DTC confirmation procedure 1 >> GO TO 2.  
DTC confirmation procedure 2 >> GO TO 4.

#### 2. CHECK KEY SLOT INPUT SIGNAL

1. Turn ignition switch OFF.
2. Disconnect key slot connector.
3. Check voltage between key slot harness connector and ground.

(+)		(-)	Voltage (V) (Approx.)
Key slot			
Connector	Terminal		
M22	2	Ground	Battery voltage

#### Is the inspection result normal?

- YES >> Replace key slot. Refer to [SEC-211, "Removal and Installation"](#).  
NO >> GO TO 3.

#### 3. CHECK KEY SLOT CIRCUIT

# P1614 CHAIN OF IMMU-KEY

## < DTC/CIRCUIT DIAGNOSIS >

1. Disconnect BCM connector.
2. Check continuity between key slot harness connector and BCM harness connector.

Key slot		BCM		Continuity
Connector	Terminal	Connector	Terminal	
M22	2	M122	80	Existed

3. Check continuity between key slot harness connector and ground.

Key slot		Ground	Continuity
Connector	Terminal		
M22	2		Not existed

Is the inspection result normal?

- YES >> Replace BCM. Refer to [BCS-81. "Removal and Installation"](#).  
 NO >> Repair or replace harness.

## 4.CHECK PUSH-BUTTON IGNITION SWITCH OPERATION

Press push-button ignition switch and check if it turns ON.

Does ignition switch turn to ON?

- YES >> GO TO 5.  
 NO >> GO TO 7.

## 5.CHECK KEY SLOT COMMUNICATION SIGNAL

1. Turn ignition switch OFF.
2. Disconnect key slot connector.
3. Check voltage between key slot harness connector and ground.

Key slot (+)		(-)	Voltage (V) (Approx.)
Connector	Terminal		
M22	3	Ground	Battery voltage

Is the inspection result normal?

- YES >> Replace key slot. Refer to [SEC-211. "Removal and Installation"](#).  
 NO >> GO TO 6.

## 6.CHECK KEY SLOT COMMUNICATION SIGNAL CIRCUIT

1. Disconnect BCM connector.
2. Check continuity between key slot harness connector and BCM harness connector.

Key slot		BCM		Continuity
Connector	Terminal	Connector	Terminal	
M22	3	M122	81	Existed

3. Check continuity between key slot harness connector and ground.

Key slot		Ground	Continuity
Connector	Terminal		
M22	3		Not existed

Is the inspection result normal?

- YES >> Replace BCM. Refer to [BCS-81. "Removal and Installation"](#).  
 NO >> Repair or replace harness.

## 7.CHECK KEY SLOT GROUND CIRCUIT

1. Turn ignition switch OFF.
2. Disconnect key slot connector.

# P1614 CHAIN OF IMMU-KEY

## < DTC/CIRCUIT DIAGNOSIS >

3. Check continuity between key slot harness connector and ground.

Key slot		Ground	Continuity
Connector	Terminal		
M22	7		Existed

Is the inspection result normal?

YES >> GO TO 8.

NO >> Repair or replace harness.

## 8. CHECK INTERMITTENT INCIDENT

Refer to [GI-41. "Intermittent Incident"](#).

>> INSPECTION END

A  
B  
C  
D  
E  
F  
G  
H  
I  
J  
L  
M  
N  
O  
P

SEC

# P1615 DIFFERENCE OF KEY

< DTC/CIRCUIT DIAGNOSIS >

## P1615 DIFFERENCE OF KEY

### Description

INFOID:000000004662878

Performs ID verification through BCM and Intelligent Key when push-button ignition switch is pressed. Prohibits the release of steering lock or start of engine when an unregistered ID of Intelligent Key is used.

### DTC Logic

INFOID:000000004662879

### DTC DETECTION LOGIC

DTC No.	Trouble diagnosis name	DTC detecting condition	Possible cause
P1615	DIFFERENCE OF KEY	The ID verification results between BCM and Intelligent Key are NG. Registration is necessary.	Intelligent Key

### DTC CONFIRMATION PROCEDURE

#### 1.PERFORM DTC CONFIRMATION PROCEDURE

1. Press the push-button ignition switch.
2. Check "Self-diagnostic result" using CONSULT-III.

#### Is DTC detected?

- YES >> Go to [SEC-46. "Diagnosis Procedure"](#).  
NO >> INSPECTION END

### Diagnosis Procedure

INFOID:000000004662880

#### 1.PERFORM INITIALIZATION

Perform initialization using CONSULT-III. Reregister all Intelligent Keys. For initialization and registration of Intelligent Key, refer to "CONSULT-III Operation Manual NATS-IVIS/NVIS".

#### Can the system be initialized and can the engine be started with reregistered Intelligent Key?

- YES >> INSPECTION END  
NO >> GO TO 2.

#### 2.REPLACE INTELLIGENT KEY

1. Replace Intelligent Key.
2. Perform initialization using CONSULT-III.  
For initialization and registration of Intelligent Key, refer to "CONSULT-III Operation Manual NATS-IVIS/NVIS".

#### Can the system be initialized and can the engine be started with reregistered Intelligent Key?

- YES >> INSPECTION END  
NO >> GO TO 3.

#### 3.CHECK INTERMITTENT INCIDENT

Refer to [GI-41. "Intermittent Incident"](#).

>> INSPECTION END

# B2190 NATS ANTENNA AMP.

< DTC/CIRCUIT DIAGNOSIS >

## B2190 NATS ANTENNA AMP.

### Description

INFOID:000000004662881

Performs ID verification through BCM and Intelligent Key when push-button ignition switch is pressed. Prohibits the release of steering lock or start of engine when an unregistered ID of Intelligent Key is used.

### DTC Logic

INFOID:000000004662882

### DTC DETECTION LOGIC

DTC No.	Trouble diagnosis name	DTC detecting condition	Possible cause
B2190	NATS ANTENNA AMP	Inactive communication between key slot and BCM.	<ul style="list-style-type: none"> <li>• Harness or connectors (The key slot circuit is open or shorted)</li> <li>• Key slot</li> <li>• BCM</li> </ul>

### DTC CONFIRMATION PROCEDURE

#### 1. PERFORM DTC CONFIRMATION PROCEDURE 1

1. Insert Intelligent Key into the key slot.
2. Check "Self-diagnostic result" using CONSULT-III.

#### Is DTC detected?

- YES >> Go to [SEC-47, "Diagnosis Procedure"](#).  
 NO >> GO TO 2.

#### 2. PERFORM DTC CONFIRMATION PROCEDURE 2

1. Press the push-button ignition switch.
2. Check "Self-diagnostic result" using CONSULT-III.

#### Is DTC detected?

- YES >> Go to [SEC-47, "Diagnosis Procedure"](#).  
 NO >> INSPECTION END

### Diagnosis Procedure

INFOID:000000004662883

SEC

#### 1. INSPECTION START

Perform inspection in accordance with the appropriate confirmation procedure DTC.

#### Which procedure confirms DTC?

- DTC confirmation procedure 1 >> GO TO 2.  
 DTC confirmation procedure 2 >> GO TO 4.

#### 2. CHECK KEY SLOT INPUT SIGNAL

1. Turn ignition switch OFF.
2. Disconnect key slot connector.
3. Check voltage between key slot harness connector and ground.

(+)		(-)	Voltage (V) (Approx.)
Key slot			
Connector	Terminal		
M22	2	Ground	Battery voltage

#### Is the inspection result normal?

- YES >> Replace key slot. Refer to [SEC-211, "Removal and Installation"](#).  
 NO >> GO TO 3.

#### 3. CHECK KEY SLOT CIRCUIT

## B2190 NATS ANTENNA AMP.

### < DTC/CIRCUIT DIAGNOSIS >

1. Disconnect BCM connector.
2. Check continuity between key slot harness connector and BCM harness connector.

Key slot		BCM		Continuity
Connector	Terminal	Connector	Terminal	
M22	2	M122	80	Existed

3. Check continuity between key slot harness connector and ground.

Key slot		Ground	Continuity
Connector	Terminal		
M22	2		Not existed

#### Is the inspection result normal?

- YES >> Replace BCM. Refer to [BCS-81. "Removal and Installation"](#).  
NO >> Repair or replace harness.

### 4.CHECK PUSH-BUTTON IGNITION SWITCH OPERATION

Press push-button ignition switch and check if it turns ON.

#### Does ignition switch turn to ON?

- YES >> GO TO 5.  
NO >> GO TO 7.

### 5.CHECK KEY SLOT COMMUNICATION SIGNAL

1. Turn ignition switch OFF.
2. Disconnect key slot connector.
3. Check voltage between key slot harness connector and ground.

(+)		(-)	Voltage (V) (Approx.)
Key slot			
Connector	Terminal		
M22	3	Ground	Battery voltage

#### Is the inspection result normal?

- YES >> Replace key slot. Refer to [SEC-211. "Removal and Installation"](#).  
NO >> GO TO 6.

### 6.CHECK KEY SLOT COMMUNICATION SIGNAL CIRCUIT

1. Disconnect BCM connector.
2. Check continuity between key slot harness connector and BCM harness connector.

Key slot		BCM		Continuity
Connector	Terminal	Connector	Terminal	
M22	3	M122	81	Existed

3. Check continuity between key slot harness connector and ground.

Key slot		Ground	Continuity
Connector	Terminal		
M22	3		Not existed

#### Is the inspection result normal?

- YES >> Replace BCM. Refer to [BCS-81. "Removal and Installation"](#).  
NO >> Repair or replace harness.

### 7.CHECK KEY SLOT GROUND CIRCUIT

1. Turn ignition switch OFF.
2. Disconnect key slot connector.



## B2190 NATS ANTENNA AMP.

### < DTC/CIRCUIT DIAGNOSIS >

3. Check continuity between key slot harness connector and ground.

Key slot		Ground	Continuity
Connector	Terminal		
M22	7		Existed

Is the inspection result normal?

YES >> GO TO 8.

NO >> Repair or replace harness.

### 8. CHECK INTERMITTENT INCIDENT

Refer to [GI-41. "Intermittent Incident"](#).

>> INSPECTION END

A  
B  
C  
D  
E  
F  
G  
H  
I  
J  
L  
M  
N  
O  
P

SEC

# B2191 DIFFERENCE OF KEY

< DTC/CIRCUIT DIAGNOSIS >

## B2191 DIFFERENCE OF KEY

### Description

INFOID:000000004662884

Performs ID verification through BCM and Intelligent Key when push-button ignition switch is pressed. Prohibits the release of steering lock or start of engine when an unregistered ID of Intelligent Key is used.

### DTC Logic

INFOID:000000004662885

### DTC DETECTION LOGIC

DTC No.	Trouble diagnosis name	DTC detecting condition	Possible cause
B2191	DIFFERENCE OF KEY	The ID verification results between BCM and Intelligent Key are NG. Registration is necessary.	Intelligent Key

### DTC CONFIRMATION PROCEDURE

#### 1.PERFORM DTC CONFIRMATION PROCEDURE

1. Press the push-button ignition switch.
2. Check "Self-diagnostic result" using CONSULT-III.

#### Is DTC detected?

- YES >> Go to [SEC-50. "Diagnosis Procedure"](#).  
NO >> INSPECTION END

### Diagnosis Procedure

INFOID:000000004662886

#### 1.PERFORM INITIALIZATION

Perform initialization using CONSULT-III. Reregister all Intelligent Keys. For initialization and registration of Intelligent Key, refer to "CONSULT-III Operation Manual NATS-IVIS/NVIS".

#### Can the system be initialized and can the engine be started with reregistered Intelligent Key?

- YES >> INSPECTION END  
NO >> GO TO 2.

#### 2.REPLACE INTELLIGENT KEY

1. Replace Intelligent Key.
2. Perform initialization using CONSULT-III.  
For initialization and registration of Intelligent Key, refer to "CONSULT-III Operation Manual NATS-IVIS/NVIS".

#### Can the system be initialized and can the engine be started with reregistered Intelligent Key?

- YES >> INSPECTION END  
NO >> GO TO 3.

#### 3.CHECK INTERMITTENT INCIDENT

Refer to [GI-41. "Intermittent Incident"](#).

>> INSPECTION END

# B2192 ID DISCORD, IMMUECM

< DTC/CIRCUIT DIAGNOSIS >

## B2192 ID DISCORD, IMMUECM

### Description

INFOID:000000004662887

BCM performs ID verification with ECM that allows the engine to start. Start the engine if the ID is successfully verified. ECM prevents the engine from starting if the ID is not registered. BCM starts the communication with ECM if ignition switch is turned ON.

### DTC Logic

INFOID:000000004662888

### DTC DETECTION LOGIC

#### NOTE:

- If DTC B2192 is displayed with DTC U1000, first perform the trouble diagnosis for DTC U1000. Refer to [SEC-36, "BCM : DTC Logic"](#).
- If DTC B2192 is displayed with DTC U1010, first perform the trouble diagnosis for DTC U1010. Refer to [SEC-38, "BCM : DTC Logic"](#).

DTC No.	Trouble diagnosis name	DTC detecting condition	Possible cause
B2192	ID DISCORD, IMMUECM	The ID verification results between BCM and ECM are NG. Registration is necessary.	<ul style="list-style-type: none"><li>• BCM</li><li>• ECM</li></ul>

### DTC CONFIRMATION PROCEDURE

#### 1. PERFORM DTC CONFIRMATION PROCEDURE

1. Turn ignition switch ON under the following conditions.

#### A/T models

- Selector lever is in the P or N position
- Do not depress brake pedal

#### M/T models

- Do not depress clutch pedal
2. Check "Self-diagnostic result" using CONSULT-III.

#### Is DTC detected?

- YES >> Go to [SEC-51, "Diagnosis Procedure"](#).
- NO >> INSPECTION END

### Diagnosis Procedure

INFOID:000000004662889

#### 1. PERFORM INITIALIZATION

Perform initialization using CONSULT-III. Reregister all Intelligent Keys.  
For initialization and registration of Intelligent Key, refer to "CONSULT-III Operation Manual NATS-IVIS/NVIS".

#### Can the system be initialized and can the engine be started with reregistered Intelligent Key?

- YES >> INSPECTION END
- NO >> GO TO 2.

#### 2. REPLACE BCM

1. Replace BCM. Refer to [BCS-81, "Removal and Installation"](#).
2. Perform initialization using CONSULT-III.  
For initialization, refer to "CONSULT-III Operation Manual NATS-IVIS/NVIS".

#### Can the system be initialized and can the engine be started with reregistered Intelligent Key?

- YES >> INSPECTION END
- NO >> GO TO 3.

#### 3. REPLACE ECM

1. Replace ECM. Refer to [EC-16, "ADDITIONAL SERVICE WHEN REPLACING CONTROL UNIT \(ECM\) : Description"](#).
2. Perform initialization using CONSULT-III.  
For initialization, refer to "CONSULT-III Operation Manual NATS-IVIS/NVIS".

A  
B  
C  
D  
E  
F  
G  
H  
I  
J  
L  
M  
N  
O  
P

SEC

## B2192 ID DISCORD, IMMU-ECM

< DTC/CIRCUIT DIAGNOSIS >

---

Can the system be initialized and can the engine be started with reregistered Intelligent Key?

YES >> INSPECTION END

NO >> GO TO 4.

**4.**CHECK INTERMITTENT INCIDENT

---

Refer to [GI-41, "Intermittent Incident"](#).

>> INSPECTION END

# B2193 CHAIN OF ECM-IMMU

< DTC/CIRCUIT DIAGNOSIS >

## B2193 CHAIN OF ECM-IMMU

### Description

INFOID:000000004662890

BCM performs the ID verification with ECM that allows the engine to start. Start the engine if the ID is successfully verified. ECM prevents the engine from starting if the ID is not registered. BCM starts the communication with ECM if ignition switch is turned ON.

### DTC Logic

INFOID:000000004662891

### DTC DETECTION LOGIC

#### NOTE:

- If DTC B2193 is displayed with DTC U1000, first perform the trouble diagnosis for DTC U1000. Refer to [SEC-36, "BCM : DTC Logic"](#).
- If DTC B2193 is displayed with DTC U1010, first perform the trouble diagnosis for DTC U1010. Refer to [SEC-38, "BCM : DTC Logic"](#).

DTC No.	Trouble diagnosis name	DTC detecting condition	Possible cause
B2193	CHAIN OF ECM-IMMU	Inactive communication between ECM and BCM	<ul style="list-style-type: none"><li>• Harness or connectors (The CAN communication line is open or shorted)</li><li>• BCM</li><li>• ECM</li></ul>

### DTC CONFIRMATION PROCEDURE

#### 1.PERFORM DTC CONFIRMATION PROCEDURE

1. Turn ignition switch ON under the following conditions.

#### A/T models

- Selector lever is in the P or N position
- Do not depress brake pedal

#### M/T models

- Do not depress clutch pedal
2. Check "Self-diagnostic result" using CONSULT-III.

#### Is DTC detected?

- YES >> Go to [SEC-53, "Diagnosis Procedure"](#).  
NO >> INSPECTION END

### Diagnosis Procedure

INFOID:000000004662892

#### 1.REPLACE BCM

1. Replace BCM. Refer to [BCS-81, "Removal and Installation"](#).
2. Perform initialization using CONSULT-III.  
For initialization, refer to "CONSULT-III Operation Manual NATS-IVIS/NVIS".

#### Does the engine start?

- YES >> INSPECTION END  
NO >> GO TO 2.

#### 2.REPLACE ECM

Replace ECM. Refer to [EC-16, "ADDITIONAL SERVICE WHEN REPLACING CONTROL UNIT \(ECM\) : Description"](#).

>> INSPECTION END

# B2195 ANTI-SCANNING

< DTC/CIRCUIT DIAGNOSIS >

## B2195 ANTI-SCANNING

### Description

INFOID:000000004662893

When ignition switch is turned ON, BCM performs ID verification with ECM. If ID verification that is out of the specified specification is detected, BCM prohibits further ID verification and engine cranking.

### DTC Logic

INFOID:000000004662894

### DTC DETECTION LOGIC

DTC No.	Trouble diagnosis name	DTC detecting condition	Possible cause
B2195	ANTI-SCANNING	ID verification between BCM and ECM that is out of the specified specification is detected	ID verification request out of the specified specification

### DTC CONFIRMATION PROCEDURE

#### 1. PERFORM DTC CONFIRMATION PROCEDURE

1. Turn ignition switch ON under the following conditions.

#### A/T models

- Selector lever is in the P or N position
- Do not depress brake pedal

#### M/T models

- Do not depress clutch pedal
2. Check "Self-diagnostic result" using CONSULT-III.

#### Is DTC detected?

- YES >> Refer to [SEC-54, "Diagnosis Procedure"](#).  
NO >> INSPECTION END.

### Diagnosis Procedure

INFOID:000000004662895

#### 1. CHECK SELF-DIAGNOSTIC RESULT-1

1. Perform "Self-diagnostic result" of BCM using CONSULT-III.
2. Erase DTC.
3. Perform DTC Confirmation Procedure. Refer to [SEC-54, "DTC Logic"](#).

#### Is DTC 2195 detected?

- YES >> GO TO 2.  
NO >> INSPECTION END

#### 2. CHECK EQUIPMENT OF THE VEHICLE

Check that unspecified accessory part related to engine start is not installed.

#### Is unspecified accessory part related to engine start installed?

- YES >> GO TO 3.  
NO >> Replace BCM. Refer to [BCS-81, "Removal and Installation"](#).

#### 3. CHECK SELF-DIAGNOSTIC RESULT-2

1. Obtain the customers approval to remove unspecified accessory part related to engine start, and then remove it.
2. Perform "Self-diagnostic result" of BCM using CONSULT-III.
3. Erase DTC.
4. Perform DTC Confirmation Procedure. Refer to [SEC-54, "DTC Logic"](#).

#### Is DTC 2195 detected?

- YES >> Replace BCM. Refer to [BCS-81, "Removal and Installation"](#).  
NO >> INSPECTION END

# B2013 ID DISCORD, IMMU-STRG

< DTC/CIRCUIT DIAGNOSIS >

## B2013 ID DISCORD, IMMU-STRG

### Description

INFOID:000000004662896

BCM performs the ID verification with the steering lock unit and releases the steering lock if both BCM and steering lock unit ID are same. BCM starts the communication with the steering lock unit when Intelligent Key is carried into the passenger compartment and the push-button ignition switch is pressed.

### DTC Logic

INFOID:000000004662897

### DTC DETECTION LOGIC

DTC No.	Trouble diagnosis name	DTC detecting condition	Possible cause
B2013	ID DISCORD, IMMU-STRG	The ID verification results between BCM and steering lock unit are NG. Registration is necessary.	Steering lock unit

### DTC CONFIRMATION PROCEDURE

#### 1.PERFORM DTC CONFIRMATION PROCEDURE

1. Lock steering.
2. Press the push-button ignition switch.
3. Check "Self-diagnostic result" using CONSULT-III.

#### Is DTC detected?

- YES >> Go to [SEC-55. "Diagnosis Procedure"](#).  
NO >> INSPECTION END

### Diagnosis Procedure

INFOID:000000004662898

#### 1.PERFORM INITIALIZATION

Perform initialization using CONSULT-III.  
For initialization, refer to "CONSULT-III Operation Manual NATS-IVIS/NVIS".

#### Does steering lock operate?

- YES >> INSPECTION END  
NO >> GO TO 2.

#### 2.REPLACE STEERING LOCK UNIT

1. Replace steering lock unit.
2. Perform initialization using CONSULT-III.  
For initialization, refer to "CONSULT-III Operation Manual NATS-IVIS/NVIS".

#### Does steering lock operate?

- YES >> INSPECTION END  
NO >> GO TO 3.

#### 3.CHECK INTERMITTENT INCIDENT

Refer to [GI-41. "Intermittent Incident"](#).

>> INSPECTION END

A  
B  
C  
D  
E  
F  
G  
H  
I  
J  
L  
M  
N  
O  
P

SEC

# B2014 CHAIN OF STRG-IMMU

< DTC/CIRCUIT DIAGNOSIS >

## B2014 CHAIN OF STRG-IMMU

### Description

INFOID:000000004662899

BCM performs the ID verification with the steering lock unit to release the steering. BCM starts the communication with the steering lock unit when Intelligent Key is carried into the passenger compartment and the push-button ignition switch is pressed.

### DTC Logic

INFOID:000000004662900

### DTC DETECTION LOGIC

DTC No.	Trouble diagnosis name	DTC detecting condition	Possible cause
B2014	CHAIN OF STRG-IMMU	Inactive communication between steering lock unit and BCM.	<ul style="list-style-type: none"><li>• Harness or connectors (Steering lock unit circuit is open or shorted)</li><li>• Steering lock unit</li><li>• BCM</li></ul>

### DTC CONFIRMATION PROCEDURE

#### 1.PERFORM DTC CONFIRMATION PROCEDURE

1. Lock steering.
2. Press the push-button ignition switch.
3. Check "Self-diagnostic result" using CONSULT-III.

#### Is DTC detected?

- YES >> Go to [SEC-56. "Diagnosis Procedure"](#).  
NO >> INSPECTION END

### Diagnosis Procedure

INFOID:000000004662901

#### 1.CHECK STEERING LOCK UNIT POWER SUPPLY

1. Turn ignition switch OFF.
2. Disconnect steering lock unit connector.
3. Check voltage between steering lock unit harness connector and ground.

(+)		(-)	Condition	Voltage (V) (Approx.)
Connector	Terminal			
M40	7	Ground	Ignition switch	OFF or ACC Battery voltage
				ON 0

#### Is the inspection result normal?

- YES >> GO TO 3.  
NO >> GO TO 2.

#### 2.CHECK STEERING LOCK UNIT POWER SUPPLY CIRCUIT

1. Disconnect BCM connector.
2. Check continuity between steering lock unit harness connector and BCM harness connector.

Steering lock unit		BCM		Continuity
Connector	Terminal	Connector	Terminal	
M40	7	M122	106	Existed

3. Check continuity between steering lock unit harness connector and ground.



# B2014 CHAIN OF STRG-IMMU

## < DTC/CIRCUIT DIAGNOSIS >

Steering lock unit		Ground	Continuity
Connector	Terminal		
M40	7		Not existed

Is the inspection result normal?

- YES >> Replace BCM. Refer to [BCS-81, "Removal and Installation"](#).  
 NO >> Repair or replace harness.

### 3.CHECK STEERING LOCK UNIT GROUND CIRCUIT

Check continuity between steering lock unit and ground.

Steering lock unit		Ground	Continuity
Connector	Terminal		
M40	5		Existed
	6		

Is the inspection result normal?

- YES >> GO TO 4.  
 NO >> Repair or replace harness.

### 4.CHECK STEERING LOCK UNIT COMMUNICATION SIGNAL

- Connect steering lock unit connector and BCM connector.
- Read voltage signal between steering lock unit harness connector and ground.

(+)		(-)	Condition	Voltage (V) (Approx.)	
Connector	Terminal				
M40	2	Ground	Steering lock unit	Lock status	
				Lock or unlock	Battery voltage
				For 15 seconds after unlock	Battery voltage
				15 seconds or later after unlock.	0

- Steering is locked** : Opening the door when ignition switch is ON to OFF.  
**Steering is unlocked** : Ignition switch is OFF to ACC.

Is the inspection result normal?

- YES >> Replace steering lock unit.  
 NO >> GO TO 5.

### 5.CHECK STEERING LOCK UNIT COMMUNICATION CIRCUIT

- Disconnect steering lock unit and BCM connector.
- Check continuity between steering lock unit harness connector and BCM harness connector.

Steering lock unit		BCM		Continuity
Connector	Terminal	Connector	Terminal	
M40	2	M122	111	Existed

## B2014 CHAIN OF STRG-IMMU

### < DTC/CIRCUIT DIAGNOSIS >

3. Check continuity between steering lock unit harness connector and ground.

Steering lock unit		Ground	Continuity
Connector	Terminal		
M40	2		Not existed

Is the inspection result normal?

YES >> Replace BCM. Refer to [BCS-81, "Removal and Installation"](#).

NO >> Repair or replace harness.

# B2555 STOP LAMP

< DTC/CIRCUIT DIAGNOSIS >

## B2555 STOP LAMP

### Description

INFOID:000000004662902

BCM detects the stop lamp status and confirms the stop lamp switch ON/OFF status. BCM confirms the engine start condition according to the stop lamp switch ON/OFF status.

### DTC Logic

INFOID:000000004662903

### DTC DETECTION LOGIC

DTC No.	Trouble diagnosis name	DTC detecting condition	Possible cause
B2555	STOP LAMP	BCM makes a comparison between the upper voltage and lower voltage of stop lamp switch. It judges from their values to detect the malfunctioning circuit.	<ul style="list-style-type: none"> <li>Harness or connectors (stop lamp switch circuit is open or shorted)</li> <li>Stop lamp switch</li> <li>Fuse</li> </ul>

### DTC CONFIRMATION PROCEDURE

#### 1. PERFORM DTC CONFIRMATION PROCEDURE

- Depress the brake pedal and wait 1 second or more.
- Check "Self-diagnostic result" using CONSULT-III.

Is DTC detected?

- YES >> Go to [SEC-59, "Diagnosis Procedure"](#).  
 NO >> INSPECTION END

### Diagnosis Procedure

INFOID:000000004662904

#### 1. CHECK STOP LAMP SWITCH INPUT SIGNAL

- Turn ignition switch OFF.
- Disconnect BCM connector.
- Check voltage between BCM harness connector and ground.

(+)		(-)	Voltage (V) (Approx.)
BCM			
Connector	Terminal		
M123	116	Ground	Battery voltage

Is the inspection normal?

- YES >> GO TO 2.  
 NO-1 >> Check 10 A fuse [No. 7, located in the fuse block (J/B)].  
 NO-2 >> Check harness for open or short between BCM and fuse.

#### 2. CHECK STOP LAMP SWITCH POWER SUPPLY CIRCUIT

- Disconnect stop lamp switch connector.
- Check voltage between stop lamp harness connector and ground.

(+)		(-)	Voltage (V) (Approx.)
Stop lamp switch			
Connector	Terminal		
E110	1	Ground	Battery voltage

Is the inspection result normal?

- YES >> GO TO 3.  
 NO >> Check harness for open or short to stop lamp switch.

#### 3. CHECK STOP LAMP SWITCH CIRCUIT

# B2555 STOP LAMP

## < DTC/CIRCUIT DIAGNOSIS >

1. Check continuity between stop lamp switch harness connector and BCM harness connector.

Stop lamp switch		BCM		Continuity
Connector	Terminal	Connector	Terminal	
E110	2	M123	118	Existed

2. Check continuity between stop lamp switch harness connector and ground.

Stop lamp switch		Ground	Continuity
Connector	Terminal		
E110	2		Not existed

Is the inspection result normal?

YES >> GO TO 4.

NO >> Repair or replace harness.

## 4.CHECK STOP LAMP SWITCH

Refer to [SEC-60, "Component Inspection"](#).

Is the inspection result normal?

YES >> GO TO 5.

NO >> Replace stop lamp switch. Refer to [BR-19, "Exploded View"](#).

## 5.CHECK INTERMITTENT INCIDENT

Refer to [GI-41, "Intermittent Incident"](#).

>> INSPECTION END

## Component Inspection

INFOID:000000004662905

## 1.CHECK STOP LAMP SWITCH

1. Turn ignition switch OFF.
2. Disconnect stop lamp switch connector.
3. Check continuity between stop lamp switch terminals.

Stop lamp switch		Condition	Continuity	
Terminal				
1	2	Brake pedal	Not depressed	Not existed
			Depressed	Existed

Is the inspection result normal?

YES >> INSPECTION END

NO >> Replace stop lamp switch. Refer to [BR-19, "Exploded View"](#).

# B2556 PUSH-BUTTON IGNITION SWITCH

< DTC/CIRCUIT DIAGNOSIS >

## B2556 PUSH-BUTTON IGNITION SWITCH

### Description

INFOID:000000004662906

The switch changes the power supply position. BCM maintains the power supply position status. BCM changes the power supply position with the operation of the push-button ignition switch.

### DTC Logic

INFOID:000000004662907

### DTC DETECTION LOGIC

DTC No.	Trouble diagnosis name	DTC detecting condition	Possible cause
B2556	PUSH-BUTTON IGNITION SWITCH	BCM detects the push-button ignition switch stuck at ON for 100 seconds or more.	<ul style="list-style-type: none"> <li>• Harness or connectors (Push-button ignition switch circuit is shorted.)</li> <li>• Push-button ignition switch</li> <li>• BCM</li> </ul>

### DTC CONFIRMATION PROCEDURE

#### 1. PERFORM DTC CONFIRMATION PROCEDURE

1. Start the engine and wait 100 seconds or more.
2. Check "Self-diagnostic result" using CONSULT-III.

Is DTC detected?

- YES >> Go to [SEC-61, "Diagnosis Procedure"](#).  
 NO >> INSPECTION END

### Diagnosis Procedure

INFOID:000000004662908

#### 1. CHECK PUSH-BUTTON IGNITION SWITCH INPUT SIGNAL

1. Turn ignition switch OFF.
2. Disconnect push-button ignition switch connector.
3. Check voltage between push-button ignition switch harness connector and ground.

(+)		(-)	Voltage (V) (Approx.)
Connector	Terminal		
M50	4	Ground	Battery voltage

Is the inspection result normal?

- YES >> GO TO 3.  
 NO >> GO TO 2.

#### 2. CHECK PUSH-BUTTON IGNITION SWITCH CIRCUIT

1. Disconnect BCM connector and IPDM E/R connector.
2. Check continuity between push-button ignition switch harness connector and BCM harness connector.

Push-button ignition switch		BCM		Continuity
Connector	Terminal	Connector	Terminal	
M50	4	M122	89	Existed

3. Check continuity between push-button ignition switch harness connector and ground.

Push-button ignition switch		Ground	Continuity
Connector	Terminal		
M50	4		Not existed

Is the inspection result normal?

# B2556 PUSH-BUTTON IGNITION SWITCH

## < DTC/CIRCUIT DIAGNOSIS >

- YES >> Replace BCM. Refer to [BCS-81, "Removal and Installation"](#).  
NO >> Repair or replace harness.

### 3.CHECK PUSH-BUTTON IGNITION SWITCH GROUND CIRCUIT

Check continuity between push-button ignition switch harness connector and ground.

Push-button ignition switch		Ground	Continuity
Connector	Terminal		
M50	1		Existed

Is the inspection result normal?

- YES >> GO TO 4.  
NO >> Repair or replace harness.

### 4.CHECK PUSH-BUTTON IGNITION SWITCH

Refer to [SEC-62, "Component Inspection"](#).

Is the inspection result normal?

- YES >> GO TO 5.  
NO >> Replace push-button ignition switch. Refer to [SEC-212, "Removal and Installation"](#).

### 5.CHECK INTERMITTENT INCIDENT

Refer to [GI-41, "Intermittent Incident"](#).

>> INSPECTION END

## Component Inspection

INFOID:000000004662909

### 1.CHECK PUSH-BUTTON IGNITION SWITCH

1. Turn ignition switch OFF.
2. Disconnect push-button ignition switch connector.
3. Check continuity between push-button ignition switch terminals.

Push-button ignition switch		Condition	Continuity
Terminal			
1	4	Push-button ignition switch	Pressed Existed
			Not pressed Not existed

Is the inspection result normal?

- YES >> INSPECTION END  
NO >> Replace push-button ignition switch. Refer to [SEC-212, "Removal and Installation"](#).

# B2557 VEHICLE SPEED

< DTC/CIRCUIT DIAGNOSIS >

## B2557 VEHICLE SPEED

### Description

INFOID:000000004662910

BCM receives 2 vehicle speed signals via CAN communication. 1 signal is transmitted by the “unified meter and A/C amp.”. Another signal is transmitted by “ABS actuator and electric unit (control unit.)”. BCM compares both signals to detect the vehicle speed.

### DTC Logic

INFOID:000000004662911

### DTC DETECTION LOGIC

#### NOTE:

- If DTC B2557 is displayed with DTC U1000, first perform the trouble diagnosis for DTC U1000. Refer to [SEC-36, "BCM : DTC Logic"](#).
- If DTC B2557 is displayed with DTC U1010, first perform the trouble diagnosis for DTC U1010. Refer to [SEC-38, "BCM : DTC Logic"](#).

DTC No.	Self-diagnosis name	DTC detecting condition	Possible causes
B2557	VEHICLE SPEED	BCM detects the following difference between the vehicle speed signal from “unified meter and A/C amp.” and the one from “ABS actuator and electric unit” for 10 seconds continuously. <ul style="list-style-type: none"> <li>• One is 10 km/h (6.2 MPH) or more and the other is 4 km/h (2.5 MPH) or less</li> </ul>	<ul style="list-style-type: none"> <li>• Wheel sensor</li> <li>• Unified meter and A/C amp.</li> <li>• ABS actuator and electric unit (control unit)</li> </ul>

### DTC CONFIRMATION PROCEDURE

#### 1. PERFORM DTC CONFIRMATION PROCEDURE

1. Drive the vehicle at the vehicle speed of 10 km/h (6.2 MPH) or more and wait 10 seconds or more.
2. Check “Self-diagnostic result” using CONSULT-III.

#### Is DTC detected?

- YES >> Go to [SEC-63, "Diagnosis Procedure"](#).  
 NO >> INSPECTION END

### Diagnosis Procedure

INFOID:000000004662912

#### 1. CHECK DTC WITH “ABS ACTUATOR AND ELECTRIC UNIT (CONTROL UNIT)”

Check “Self-diagnostic result” using CONSULT-III. Refer to [BRC-88, "DTC No. Index"](#).

#### Is the inspection result normal?

- YES >> GO TO 2.  
 NO >> Repair or replace the malfunctioning parts.

#### 2. CHECK DTC WITH “COMBINATION METER”

Check “Self-diagnostic result” using CONSULT-III. Refer to [MWI-99, "DTC Index"](#).

#### Is the inspection result normal?

- YES >> GO TO 3.  
 NO >> Repair or replace the malfunctioning parts.

#### 3. CHECK INTERMITTENT INCIDENT

Refer to [GI-41, "Intermittent Incident"](#).

>> INSPECTION END

A  
B  
C  
D  
E  
F  
G  
H  
I  
J  
L  
M  
N  
O  
P

SEC

# B2560 STARTER CONTROL RELAY

< DTC/CIRCUIT DIAGNOSIS >

## B2560 STARTER CONTROL RELAY

### Description

INFOID:000000004662913

Starter control relay, integrated in IPDM E/R, permits the starter relay operation when in the N or P position and the steering is locked or unlocked. It is installed parallel to the starter relay.

### DTC Logic

INFOID:000000004662914

### DTC DETECTION LOGIC

#### NOTE:

- If DTC B2560 is displayed with DTC U1000, first perform the trouble diagnosis for DTC U1000. Refer to [SEC-36, "BCM : DTC Logic"](#).
- If DTC B2560 is displayed with DTC U1010, first perform the trouble diagnosis for DTC U1010. Refer to [SEC-38, "BCM : DTC Logic"](#).

DTC No.	Self-diagnosis name	DTC detecting condition	Possible causes
B2560	STARTER CONTROL RELAY	BCM detects a discrepancy between the OFF request of starter control relay to IPDM E/R and the feedback. (The feedback is ON instead of OFF.)	IPDM E/R

### DTC CONFIRMATION PROCEDURE

#### 1. PERFORM DTC CONFIRMATION PROCEDURE

1. Turn ignition switch ON under the following conditions and wait 2 seconds or more.

#### A/T models

- Selector lever is in the P or N position
- Do not depress brake pedal

#### M/T models

- Do not depress clutch pedal
2. Check "Self-diagnostic result" using CONSULT-III.

#### Is DTC detected?

- YES >> Go to [SEC-64, "Diagnosis Procedure"](#).  
NO >> INSPECTION END

### Diagnosis Procedure

INFOID:000000004662915

#### 1. CHECK DTC WITH IPDM E/R

Check "Self-diagnostic result" using CONSULT-III. Refer to [SEC-200, "DTC Index"](#).

#### Is the inspection result normal?

- YES >> GO TO 2.  
NO >> Replace IPDM E/R. Refer to [PCS-32, "Removal and Installation"](#).

#### 2. CHECK INTERMITTENT INCIDENT

Refer to [GI-41, "Intermittent Incident"](#).

>> INSPECTION END



# B2601 SHIFT POSITION

< DTC/CIRCUIT DIAGNOSIS >

## B2601 SHIFT POSITION

### Description

INFOID:000000004679284

BCM confirms the shift position with the following 4 signals.

- Selector lever
- Transmission range switch
- P position signal from IPDM E/R (CAN)
- P position signal from TCM (CAN)

### DTC Logic

INFOID:000000004679285

### DTC DETECTION LOGIC

#### NOTE:

- If DTC B2601 is displayed with DTC U1000, first perform the trouble diagnosis for DTC U1000. Refer to [SEC-36. "BCM : DTC Logic"](#).
- If DTC B2601 is displayed with DTC U1010, first perform the trouble diagnosis for DTC U1010. Refer to [SEC-38. "BCM : DTC Logic"](#).

DTC No.	Trouble diagnosis name	DTC detecting condition	Possible cause
B2601	SHIFT POSITION	BCM detects when a difference between the shift P input signal and the shift position signal received from IPDM E/R via CAN communication continues for 2 seconds or more.	<ul style="list-style-type: none"> <li>• Harness or connectors (A/T shift selector circuit is open or shorted)</li> <li>• A/T shift selector (detention switch)</li> </ul>

### DTC CONFIRMATION PROCEDURE

#### 1. PERFORM DTC CONFIRMATION PROCEDURE

1. Turn ignition switch ON under the following conditions and wait 2 seconds or more.
  - Selector lever is in the P or N position
  - Do not depress brake pedal
2. Check "Self-diagnostic result" using CONSULT-III.

#### Is DTC detected?

- YES >> Go to [SEC-65. "Diagnosis Procedure"](#).  
 NO >> INSPECTION END

### Diagnosis Procedure

INFOID:000000004679286

#### 1. CHECK A/T SHIFT SELECTOR POWER SUPPLY

1. Turn ignition switch OFF.
2. Disconnect A/T shift selector (detention switch) connector.
3. Check voltage between A/T shift selector (detention switch) harness connector and ground.

(+)		(-)	Voltage (V) (Approx.)
Connector	Terminal		
A/T shift selector (detention switch)		Ground	Battery voltage
M137	10		

#### Is the inspection result normal?

- YES >> GO TO 3.  
 NO >> GO TO 2.

#### 2. CHECK A/T SHIFT SELECTOR POWER SUPPLY CIRCUIT

1. Disconnect BCM connector.
2. Check continuity between A/T shift selector (detention switch) harness connector and BCM harness connector.

A  
B  
C  
D  
E  
F  
G  
H  
I  
J  
L  
M  
N  
O  
P

SEC

## B2601 SHIFT POSITION

### < DTC/CIRCUIT DIAGNOSIS >

A/T shift selector (detention switch)		BCM		Continuity
Connector	Terminal	Connector	Terminal	
M137	10	M122	96	Existed

3. Check continuity between A/T shift selector (detention switch) harness connector and ground.

A/T shift selector (detention switch)		Ground	Continuity
Connector	Terminal		
M137	10		Not existed

Is the inspection result normal?

YES >> Replace BCM. Refer to [BCS-81, "Removal and Installation"](#).

NO >> Repair or replace harness.

### 3.CHECK A/T SHIFT SELECTOR CIRCUIT (BCM)

1. Disconnect BCM connector and IPDM E/R connector.
2. Check continuity between A/T shift selector (detention switch) harness connector and BCM harness connector.

A/T shift selector (detention switch)		BCM		Continuity
Connector	Terminal	Connector	Terminal	
M137	11	M122	99	Existed

3. Check continuity between A/T shift selector (detention switch) harness connector and ground.

A/T shift selector (detention switch)		Ground	Continuity
Connector	Terminal		
M137	11		Not existed

Is the inspection result normal?

YES >> GO TO 4.

NO >> Repair or replace harness.

### 4.CHECK A/T SHIFT SELECTOR CIRCUIT (IPDM E/R)

Check continuity between A/T shift selector (detention switch) harness connector and IPDM E/R harness connector.

A/T shift selector (detention switch)		IPDM E/R		Continuity
Connector	Terminal	Connector	Terminal	
M137	11	E6	43	Existed

Is the inspection result normal?

YES >> GO TO 5.

NO >> Repair or replace harness.

### 5.CHECK A/T SHIFT SELECTOR (DETENTION SWITCH)

Refer to [SEC-67, "Component Inspection"](#).

Is the inspection result normal?

YES >> GO TO 6.

NO >> Replace A/T shift selector. Refer to [TM-277, "2WD : Removal and Installation"](#) (2WD) or [TM-279, "AWD : Removal and Installation"](#) (AWD).

### 6.CHECK INTERMITTENT INCIDENT

Refer to [GI-41, "Intermittent Incident"](#).

>> INSPECTION END

# B2601 SHIFT POSITION

< DTC/CIRCUIT DIAGNOSIS >

## Component Inspection

INFOID:000000004679287

### 1. CHECK A/T SHIFT SELECTOR (DETENTION SWITCH)

1. Turn ignition switch OFF.
2. Disconnect A/T shift selector connector.
3. Check continuity between A/T shift selector (detention switch) terminals.

A/T shift selector (detention switch)		Condition		Continuity
Terminal				
10	11	Selector lever	P position	Not existed
			Other than above	Existed

Is the inspection result normal?

YES >> INSPECTION END

NO >> Replace A/T shift selector. Refer to [TM-277, "2WD : Removal and Installation"](#) (2WD) or [TM-279, "AWD : Removal and Installation"](#) (AWD).

A  
B  
C  
D  
E  
F  
G  
H  
I  
J  
L  
M  
N  
O  
P

SEC

# B2602 SHIFT POSITION

< DTC/CIRCUIT DIAGNOSIS >

## B2602 SHIFT POSITION

### Description

INFOID:000000004679288

BCM confirms the shift position with the following 4 signals.

- Selector lever
- Transmission range switch
- P position signal from IPDM E/R (CAN)
- P position signal from TCM (CAN)

### DTC Logic

INFOID:000000004679289

### DTC DETECTION LOGIC

#### NOTE:

- If DTC B2602 is displayed with DTC U1000, first perform the trouble diagnosis for DTC U1000. Refer to [SEC-36, "BCM : DTC Logic"](#).
- If DTC B2602 is displayed with DTC U1010, first perform the trouble diagnosis for DTC U1010. Refer to [SEC-38, "BCM : DTC Logic"](#).

DTC No.	Trouble diagnosis name	DTC detecting condition	Possible cause
B2602	SHIFT POSITION	BCM detects the following status for 10 seconds. <ul style="list-style-type: none"> <li>• Shift position is in the P position</li> <li>• Vehicle speed is 4 km/h (2.5 MPH) or more</li> <li>• Ignition switch is in the ON position</li> </ul>	<ul style="list-style-type: none"> <li>• Harness or connectors (A/T shift selector circuit is open or shorted)</li> <li>• A/T shift selector (detention switch)</li> <li>• ABS actuator and electric unit (control unit)</li> </ul>

### DTC CONFIRMATION PROCEDURE

#### 1. PERFORM DTC CONFIRMATION PROCEDURE

1. Start the engine under the following conditions and wait 10 seconds or more.
  - Selector lever is in the P or N position
  - Do not depress brake pedal
2. Check "Self-diagnostic result" using CONSULT-III.

Is DTC detected?

- YES >> Go to [SEC-68, "Diagnosis Procedure"](#).  
 NO >> INSPECTION END

### Diagnosis Procedure

INFOID:000000004679290

#### 1. CHECK DTC WITH "ABS ACTUATOR AND ELECTRIC UNIT"

Check "Self diagnostic result" using CONSULT-III. Refer to [BRC-88, "DTC No. Index"](#).

Is the inspection result normal?

- YES >> GO TO 2.  
 NO >> Repair or replace the malfunctioning parts.

#### 2. CHECK A/T SHIFT SELECTOR POWER SUPPLY

1. Turn ignition switch OFF.
2. Disconnect A/T shift selector (detention switch) connector.
3. Check voltage between A/T shift selector (detention switch) harness connector and ground.

(+)		(-)	Voltage (V) (Approx.)
Connector	Terminal		
A/T shift selector (detention switch)		Ground	Battery voltage
M137	10		

Is the inspection result normal?

# B2602 SHIFT POSITION

## < DTC/CIRCUIT DIAGNOSIS >

- YES >> GO TO 4.
- NO >> GO TO 3.

### 3.CHECK A/T SHIFT SELECTOR POWER SUPPLY CIRCUIT

1. Disconnect BCM connector.
2. Check continuity between A/T shift selector (detention switch) harness connector and BCM harness connector.

A/T shift selector (detention switch)		BCM		Continuity
Connector	Terminal	Connector	Terminal	
M137	10	M122	96	Existed

3. Check continuity between A/T shift selector (detention switch) harness connector and ground.

A/T shift selector (detention switch)		Ground	Continuity
Connector	Terminal		
M137	10		Not existed

Is the inspection result normal?

- YES >> Replace BCM. Refer to [BCS-81, "Removal and Installation"](#).
- NO >> Repair or replace harness.

### 4.CHECK A/T SHIFT SELECTOR CIRCUIT

1. Disconnect BCM connector and IPDM E/R connector.
2. Check continuity between A/T shift selector (detention switch) harness connector and BCM harness connector.

A/T shift selector (detention switch)		BCM		Continuity
Connector	Terminal	Connector	Terminal	
M137	11	M122	99	Existed

3. Check continuity between A/T shift selector (detention switch) harness connector and ground.

A/T shift selector (detention switch)		Ground	Continuity
Connector	Terminal		
M137	11		Not existed

Is the inspection result normal?

- YES >> GO TO 5.
- NO >> Repair or replace harness.

### 5.CHECK A/T SHIFT SELECTOR (DETENTION SWITCH)

Refer to [SEC-67, "Component Inspection"](#).

Is the inspection result normal?

- YES >> GO TO 6.
- NO >> Replace A/T shift selector. Refer to [TM-277, "2WD : Removal and Installation"](#) (2WD) or [TM-279, "AWD : Removal and Installation"](#) (AWD).

### 6.CHECK INTERMITTENT INCIDENT

Refer to [GI-41, "Intermittent Incident"](#).

>> INSPECTION END

# B2603 SHIFT POSITION STATUS

< DTC/CIRCUIT DIAGNOSIS >

## B2603 SHIFT POSITION STATUS

### Description

INFOID:000000004679291

BCM confirms the shift position with the following 4 signals.

- Selector lever
- Transmission range switch
- P position signal from IPDM E/R (CAN)
- P position signal from TCM (CAN)

### DTC Logic

INFOID:000000004679292

### DTC DETECTION LOGIC

#### NOTE:

- If DTC B2603 is displayed with DTC U1000, first perform the trouble diagnosis for DTC U1000. Refer to [SEC-36, "BCM : DTC Logic"](#).
- If DTC B2603 is displayed with DTC U1010, first perform the trouble diagnosis for DTC U1010. Refer to [SEC-38, "BCM : DTC Logic"](#).
- If DTC B2603 is displayed with DTC B2601, first perform the trouble diagnosis for DTC B2601. Refer to [SEC-65, "DTC Logic"](#).

DTC No.	Self-diagnosis name	DTC detecting condition	Possible causes
B2603	SHIFT POSITION STATUS	BCM detects the following status for 500 ms or more when shift is in the P position, and ignition switch is in the ON position. <ul style="list-style-type: none"><li>• Transmission range switch: approx. 0 V</li><li>• A/T shift selector (detention switch): approx. 0 V</li></ul>	<ul style="list-style-type: none"><li>• Harness or connector (A/T shift selector circuit is open or shorted)</li><li>• Harness or connectors (TCM circuit is open or shorted)</li><li>• A/T shift selector (detention switch)</li><li>• TCM</li></ul>

### DTC CONFIRMATION PROCEDURE

#### 1. PERFORM DTC CONFIRMATION PROCEDURE

1. Start the engine under the following conditions and wait 1 second or more.
  - Selector lever is in the P or N position
  - Do not depress brake pedal
2. Check "Self-diagnostic result" using CONSULT-III.

#### Is DTC detected?

- YES >> Go to [SEC-70, "Diagnosis Procedure"](#).  
NO >> INSPECTION END

### Diagnosis Procedure

INFOID:000000004679293

#### 1. CHECK DTC WITH TCM

Check "Self diagnostic result" with CONSULT-III.

#### Are any DTC detected?

- YES >> Refer to [TM-258, "DTC Index"](#).  
NO >> GO TO 2.

#### 2. CHECK TRANSMISSION RANGE SWITCH CIRCUIT 1

1. Turn ignition switch OFF.
2. Disconnect A/T assembly connector and BCM connector.
3. Check continuity between A/T assembly harness connector and BCM harness connector.

A/T assembly		BCM		Continuity
Connector	Terminal	Connector	Terminal	
F51	9	M123	140	Existed

4. Check continuity between A/T assembly harness connector and ground.

## B2603 SHIFT POSITION STATUS

### < DTC/CIRCUIT DIAGNOSIS >

A/T assembly		Ground	Continuity
Connector	Terminal		
F51	9		Not existed

Is the inspection result normal?

YES >> GO TO 3.

NO >> Repair or replace harness.

### 3. CHECK TRANSMISSION RANGE SWITCH CIRCUIT 2

1. Disconnect TCM connector.
2. Check continuity between TCM harness connector and A/T assembly harness connector.

TCM		A/T assembly		Continuity
Connector	Terminal	Connector	Terminal	
F157	9	F51	9	Existed

3. Check continuity between TCM harness connector and ground.

TCM		Ground	Continuity
Connector	Terminal		
F157	9		Not existed

Is the inspection result normal?

YES >> GO TO 4.

NO >> Repair or replace harness.

### 4. CHECK A/T SHIFT SELECTOR POWER SUPPLY

1. Disconnect A/T shift selector (detention switch) connector.
2. Check voltage between A/T shift selector (detention switch) harness connector and ground.

(+)		(-)	Voltage (V) (Approx.)
A/T shift selector (detention switch)			
Connector	Terminal		
M137	10	Ground	Battery voltage

Is the inspection result normal?

YES >> GO TO 6.

NO >> GO TO 5.

### 5. CHECK A/T SHIFT SELECTOR POWER SUPPLY CIRCUIT

1. Disconnect BCM connector.
2. Check continuity between A/T shift selector (detention switch) harness connector and BCM harness connector.

A/T shift selector (detention switch)		BCM		Continuity
Connector	Terminal	Connector	Terminal	
M137	10	M122	96	Existed

3. Check continuity between A/T shift selector (detention switch) harness connector and ground.

A/T shift selector (detention switch)		Ground	Continuity
Connector	Terminal		
M137	10		Not existed

Is the inspection result normal?

YES >> Replace BCM. Refer to [BCS-81, "Removal and Installation"](#).

NO >> Repair or replace harness.

SEC

## B2603 SHIFT POSITION STATUS

< DTC/CIRCUIT DIAGNOSIS >

### 6. CHECK A/T SHIFT SELECTOR CIRCUIT

1. Disconnect BCM connector and IPDM E/R connector.
2. Check continuity between A/T shift selector (detention switch) harness connector and BCM harness connector.

A/T shift selector (detention switch)		BCM		Continuity
Connector	Terminal	Connector	Terminal	
M137	11	M122	99	Existed

3. Check continuity between A/T shift selector (detention switch) harness connector and ground.

A/T shift selector (detention switch)		Ground	Continuity
Connector	Terminal		
M137	11		Not existed

Is the inspection result normal?

- YES >> GO TO 7.  
NO >> Repair or replace harness.

### 7. CHECK A/T SHIFT SELECTOR (DETENTION SWITCH)

Refer to [SEC-67. "Component Inspection"](#).

Is the inspection result normal?

- YES >> GO TO 8.  
NO >> Replace A/T shift selector. Refer to [TM-277. "2WD : Removal and Installation"](#) (2WD) or [TM-279. "AWD : Removal and Installation"](#) (AWD).

### 8. CHECK INTERMITTENT INCIDENT

Refer to [GI-41. "Intermittent Incident"](#).

>> INSPECTION END



# B2604 PNP SWITCH

< DTC/CIRCUIT DIAGNOSIS >

## B2604 PNP SWITCH

### Description

INFOID:000000004662926

BCM confirms the shift position with the following 4 signals.

- Selector lever
- Transmission range switch
- P position signal from IPDM E/R (CAN)
- P position signal from TCM (CAN)

### DTC Logic

INFOID:000000004662927

### DTC DETECTION LOGIC

#### NOTE:

- If DTC B2604 is displayed with DTC U1000, first perform the trouble diagnosis for DTC U1000. Refer to [SEC-36. "BCM : DTC Logic"](#).
- If DTC B2604 is displayed with DTC U1010, first perform the trouble diagnosis for DTC U1010. Refer to [SEC-38. "BCM : DTC Logic"](#).

DTC No.	Trouble diagnosis name	DTC detecting condition	Possible cause
B2604	PNP SWITCH	BCM detects the following status for 500 ms or more when the ignition switch is in the ON position. <ul style="list-style-type: none"><li>• N position input signal exists. Shift position signal from TCM does not exist.</li><li>• N position input signal does not exist. Shift position signal from TCM exists.</li></ul>	<ul style="list-style-type: none"><li>• Harness or connectors (TCM circuit is open or shorted)</li><li>• TCM</li></ul>

### DTC CONFIRMATION PROCEDURE

#### 1. PERFORM DTC CONFIRMATION PROCEDURE

1. Start the engine under the following conditions and wait 1 second or more.
  - Selector lever is in the P or N position
  - Do not depress brake pedal
2. Check "Self-diagnostic result" using CONSULT-III.

#### Is DTC detected?

- YES >> Go to [SEC-73. "Diagnosis Procedure"](#).  
NO >> INSPECTION END

### Diagnosis Procedure

INFOID:000000004662928

#### 1. CHECK DTC WITH TCM

Check "Self diagnostic result" using CONSULT-III.

#### Are any DTC detected?

- YES >> Refer to [TM-258. "DTC Index"](#).  
NO >> GO TO 2.

#### 2. CHECK TRANSMISSION RANGE SWITCH CIRCUIT 1

1. Turn ignition switch OFF.
2. Disconnect A/T assembly connector and BCM connector.
3. Check continuity between A/T assembly harness connector and BCM harness connector.

A/T assembly		BCM		Continuity
Connector	Terminal	Connector	Terminal	
F51	9	M123	140	Existed

4. Check continuity between A/T assembly harness connector and ground.

## B2604 PNP SWITCH

### < DTC/CIRCUIT DIAGNOSIS >

A/T assembly		Ground	Continuity
Connector	Terminal		
F51	9		Not existed

Is the inspection result normal?

YES >> GO TO 3.

NO >> Repair or replace harness.

### 3. CHECK TRANSMISSION RANGE SWITCH CIRCUIT 2

1. Disconnect TCM connector.
2. Check continuity between TCM harness connector and A/T assembly harness connector.

TCM		A/T assembly		Continuity
Connector	Terminal	Connector	Terminal	
F157	9	F51	9	Existed

3. Check continuity between TCM harness connector and ground.

TCM		Ground	Continuity
Connector	Terminal		
F157	9		Not existed

Is the inspection result normal?

YES >> GO TO 4.

NO >> Repair or replace harness.

### 4. CHECK INTERMITTENT INCIDENT

Refer to [GI-41, "Intermittent Incident"](#).

>> INSPECTION END

# B2605 PNP SWITCH

< DTC/CIRCUIT DIAGNOSIS >

## B2605 PNP SWITCH

### Description

INFOID:000000004662929

BCM confirms the shift position with the following 4 signals.

- Selector lever
- Transmission range switch
- P position signal from IPDM E/R (CAN)
- P position signal from TCM (CAN)

### DTC Logic

INFOID:000000004662930

### DTC DETECTION LOGIC

#### NOTE:

- If DTC B2605 is displayed with DTC U1000, first perform the trouble diagnosis for DTC U1000. Refer to [SEC-36. "BCM : DTC Logic"](#).
- If DTC B2605 is displayed with DTC U1010, first perform the trouble diagnosis for DTC U1010. Refer to [SEC-38. "BCM : DTC Logic"](#).

DTC No.	Trouble diagnosis name	DTC detecting condition	Possible cause
B2605	PNP SWITCH	BCM detects the following status for 500 ms or more when the ignition switch is in the ON position <ul style="list-style-type: none"><li>• N position input signal exists. Shift position signal from IPDM E/R does not exist.</li><li>• N position input signal does not exist. Shift position signal from IPDM E/R exists.</li></ul>	<ul style="list-style-type: none"><li>• Harness or connectors (TCM circuit is open or shorted)</li><li>• TCM</li><li>• IPDM E/R</li></ul>

### DTC CONFIRMATION PROCEDURE

#### 1. PERFORM DTC CONFIRMATION PROCEDURE

1. Turn ignition switch ON under the following conditions and wait 1 second or more.
  - Selector lever is in the P or N position
  - Do not depress brake pedal
2. Check "Self-diagnostic result" using CONSULT-III.

#### Is DTC detected?

- YES >> Go to [SEC-75. "Diagnosis Procedure"](#).  
NO >> INSPECTION END

### Diagnosis Procedure

INFOID:000000004662931

#### 1. CHECK DTC WITH IPDM E/R

Check "Self diagnostic result" using CONSULT-III. Refer to [SEC-200. "DTC Index"](#).

#### Is the inspection result normal?

- YES >> GO TO 2.  
NO >> Repair or replace the malfunctioning parts.

#### 2. CHECK TRANSMISSION RANGE SWITCH CIRCUIT 1

1. Turn ignition switch OFF.
2. Disconnect A/T assembly connector and BCM connector.
3. Check continuity between A/T assembly harness connector and BCM harness connector.

A/T assembly		BCM		Continuity
Connector	Terminal	Connector	Terminal	
F51	9	M123	140	Existed

4. Check continuity between A/T assembly harness connector and ground.

## B2605 PNP SWITCH

### < DTC/CIRCUIT DIAGNOSIS >

A/T assembly		Ground	Continuity
Connector	Terminal		
F51	9		Not existed

Is the inspection result normal?

YES >> GO TO 3.

NO >> Repair or replace harness.

### 3. CHECK TRANSMISSION RANGE SWITCH CIRCUIT 2

1. Disconnect TCM connector.
2. Check continuity between TCM harness connector and A/T assembly harness connector.

TCM		A/T assembly		Continuity
Connector	Terminal	Connector	Terminal	
F157	9	F51	9	Existed

3. Check continuity between TCM harness connector and ground.

TCM		Ground	Continuity
Connector	Terminal		
F157	9		Not existed

Is the inspection result normal?

YES >> GO TO 4.

NO >> Repair or replace harness.

### 4. CHECK INTERMITTENT INCIDENT

Refer to [GI-41, "Intermittent Incident"](#).

>> INSPECTION END

# B2606 STEERING LOCK RELAY

< DTC/CIRCUIT DIAGNOSIS >

## B2606 STEERING LOCK RELAY

### Description

INFOID:000000004662932

The steering lock relay ON signal is transmitted to IPDM E/R by BCM via CAN communication. IPDM E/R turns the steering lock relay ON and transmits the release of the steering to BCM.

### DTC Logic

INFOID:000000004662933

### DTC DETECTION LOGIC

#### NOTE:

- If DTC B2606 is displayed with DTC U1000, first perform the trouble diagnosis for DTC U1000. Refer to [SEC-36, "BCM : DTC Logic"](#).
- If DTC B2606 is displayed with DTC U1010, first perform the trouble diagnosis for DTC U1010. Refer to [SEC-38, "BCM : DTC Logic"](#).

DTC No.	Trouble diagnosis name	DTC detecting condition	Possible cause
B2606	STEERING LOCK RELAY	BCM detects that there is a discrepancy between the following statuses. <ul style="list-style-type: none"><li>• Steering lock unit ON signal transmitted by IPDM E/R</li><li>• The steering lock unit status feedback</li></ul>	Steering lock relay (In IPDM E/R)

### DTC CONFIRMATION PROCEDURE

#### 1. PERFORM DTC CONFIRMATION PROCEDURE

1. Turn ignition switch ON under the following conditions.

#### A/T models

- Selector lever is in the P or N position
- Do not depress brake pedal

#### M/T models

- Do not depress clutch pedal
2. Check "Self-diagnostic result" using CONSULT-III.

#### Is DTC detected?

- YES >> Go to [SEC-77, "Diagnosis Procedure"](#).  
NO >> INSPECTION END

### Diagnosis Procedure

INFOID:000000004662934

#### 1. CHECK DTC WITH IPDM E/R

Check "Self-diagnostic result" using CONSULT-III. Refer to [SEC-200, "DTC Index"](#).

#### Is the inspection result normal?

- YES >> GO TO 2.  
NO >> Replace IPDM E/R. Refer to [PCS-32, "Removal and Installation"](#).

#### 2. CHECK INTERMITTENT INCIDENT

Refer to [GI-41, "Intermittent Incident"](#).

>> INSPECTION END

# B2607 STEERING LOCK RELAY

< DTC/CIRCUIT DIAGNOSIS >

## B2607 STEERING LOCK RELAY

### Description

INFOID:000000004662935

BCM requests to IPDM E/R to supply power to steering lock unit. After receiving the power, the steering lock unit transmits an ON signal to BCM.

### DTC Logic

INFOID:000000004662936

### DTC DETECTION LOGIC

#### NOTE:

- If DTC B2607 is displayed with DTC U1000, first perform the trouble diagnosis for DTC U1000. Refer to [SEC-36, "BCM : DTC Logic"](#).
- If DTC B2607 is displayed with DTC U1010, first perform the trouble diagnosis for DTC U1010. Refer to [SEC-38, "BCM : DTC Logic"](#).

DTC No.	Trouble diagnosis name	DTC detecting condition	Possible cause
B2607	STEERING LOCK RELAY	BCM detects that there is a difference between the following statuses. <ul style="list-style-type: none"><li>• Steering lock unit ON signal transmitted by IPDM E/R</li><li>• The steering lock unit status feedback</li></ul>	<ul style="list-style-type: none"><li>• Harness or connectors (Steering lock unit power supply circuit is open or shorted)</li><li>• Steering lock relay (In IPDM E/R)</li></ul>

### DTC CONFIRMATION PROCEDURE

#### 1. PERFORM DTC CONFIRMATION PROCEDURE

1. Turn ignition switch ON under the following conditions.

#### A/T models

- Selector lever is in the P or N position
- Do not depress brake pedal

#### M/T models

- Do not depress clutch pedal
2. Check "Self-diagnostic result" using CONSULT-III.

#### Is DTC detected?

- YES >> Go to [SEC-78, "Diagnosis Procedure"](#).  
NO >> INSPECTION END

### Diagnosis Procedure

INFOID:000000004662937

#### 1. CHECK DTC WITH IPDM E/R

Check "Self-diagnostic result" using CONSULT-III. Refer to [SEC-200, "DTC Index"](#).

#### Is the inspection result normal?

- YES >> GO TO 2.  
NO >> Repair or replace the malfunctioning parts.

#### 2. CHECK STEERING LOCK UNIT POWER SUPPLY CIRCUIT

1. Turn ignition switch OFF.
2. Disconnect steering lock unit connector.
3. Check voltage between steering lock unit harness connector and ground.

(+)		(-)	Condition	Voltage (V) (Approx.)
Steering lock unit				
Connector	Terminal			
M40	1	Ground	Press push-button ignition switch when steering lock is in lock condition.	Battery voltage

#### Is the inspection result normal?

## B2607 STEERING LOCK RELAY

### < DTC/CIRCUIT DIAGNOSIS >

YES >> GO TO 4.

NO >> GO TO 3.

### 3. CHECK STEERING LOCK UNIT CIRCUIT

1. Disconnect IPDM E/R connector.
2. Check continuity between steering lock unit harness connector and IPDM E/R harness connector.

Steering lock unit		IPDM E/R		Continuity
Connector	Terminal	Connector	Terminal	
M40	1	E5	11	Existed

3. Check continuity between steering lock unit harness connector and ground.

Steering lock unit		Ground	Continuity
Connector	Terminal		
M40	1		Not existed

Is the inspection result normal?

YES >> Replace IPDM E/R. Refer to [PCS-32, "Removal and Installation"](#).

NO >> Repair or replace harness.

### 4. CHECK INTERMITTENT INCIDENT

Refer to [GI-41, "Intermittent Incident"](#).

>> INSPECTION END

A  
B  
C  
D  
E  
F  
G  
H  
I  
J  
L  
M  
N  
O  
P

SEC

# B2608 STARTER RELAY

< DTC/CIRCUIT DIAGNOSIS >

## B2608 STARTER RELAY

### Description

INFOID:000000004662938

Located in IPDM E/R, the starter relay runs the starter motor. The starter relay is turned ON by the BCM when the ignition switch is in the START position. IPDM E/R transmits the starter relay ON signal to BCM via CAN communication.

### DTC Logic

INFOID:000000004662939

#### DTC DETECTION LOGIC

##### NOTE:

- If DTC B2608 is displayed with DTC U1000, first perform the trouble diagnosis for DTC U1000. Refer to [SEC-36, "BCM : DTC Logic"](#).
- If DTC B2608 is displayed with DTC U1010, first perform the trouble diagnosis for DTC U1010. Refer to [SEC-38, "BCM : DTC Logic"](#).
- If DTC B2608 is displayed with DTC B210D for IPDM E/R, first perform the trouble diagnosis for DTC B210D. Refer to [SEC-113, "DTC Logic"](#).

DTC No.	Trouble diagnosis name	DTC detecting condition	Possible cause
B2608	STARTER RELAY	BCM receives starter relay ON signal (CAN) from IPDM E/R even if BCM turns the starter relay OFF.	<ul style="list-style-type: none"><li>• Harness or connectors (Starter relay circuit is open or shorted.)</li><li>• IPDM E/R</li></ul>

#### DTC CONFIRMATION PROCEDURE

##### 1. PERFORM DTC CONFIRMATION PROCEDURE

1. Turn ignition switch ON under the following conditions.

##### A/T models

- Selector lever is in the P or N position
- Do not depress brake pedal

##### M/T models

- Do not depress clutch pedal
2. Check "Self-diagnostic result" using CONSULT-III.

##### Is DTC detected?

- YES >> Go to [SEC-80, "Diagnosis Procedure"](#).  
NO >> INSPECTION END

### Diagnosis Procedure

INFOID:000000004662940

##### 1. CHECK BCM POWER SUPPLY CIRCUIT

1. Turn ignition switch ON.
2. Check voltage between BCM harness connector and ground.

(+)		(-)	Condition		Voltage (V) (Approx.)
BCM					
Connector	Terminal				
M121	52	Ground	Selector lever (A/T models)	N or P position	12
				Other than above	0
			Clutch pedal (M/T models)	Depressed	Battery voltage
				Not depressed	0

##### Is the measurement value within the specification?

- YES >> GO TO 3.  
NO >> GO TO 2.



# B2608 STARTER RELAY

< DTC/CIRCUIT DIAGNOSIS >

## 2. CHECK STARTER RELAY CIRCUIT

1. Turn ignition switch OFF.
2. Disconnect BCM connector and IPDM E/R connector.
3. Check continuity between IPDM E/R harness connector and BCM harness connector.

IPDM E/R		BCM		Continuity
Connector	Terminal	Connector	Terminal	
E6	46	M121	52	Existed

4. Check continuity between IPDM E/R harness connector and ground.

IPDM E/R		Ground	Continuity
Connector	Terminal		
E6	46		Not existed

Is the inspection result normal?

- YES >> Replace IPDM E/R. Refer to [PCS-32, "Removal and Installation"](#).  
NO >> Repair or replace harness.

## 3. CHECK INTERMITTENT INCIDENT

Refer to [GI-41, "Intermittent Incident"](#).

>> INSPECTION END

A  
B  
C  
D  
E  
F  
G  
H  
I  
J  
L  
M  
N  
O  
P

SEC

# B2609 STEERING STATUS

< DTC/CIRCUIT DIAGNOSIS >

## B2609 STEERING STATUS

### Description

INFOID:000000004662941

There are 2 switches in the steering lock unit (steering lock/unlock switch 1 and 2). BCM compares the 2 switch conditions to judge the present steering status.

### DTC Logic

INFOID:000000004662942

### DTC DETECTION LOGIC

#### NOTE:

- If DTC B2609 is displayed with DTC U1000, first perform the trouble diagnosis for DTC U1000. Refer to [SEC-36, "BCM : DTC Logic"](#).
- If DTC B2609 is displayed with DTC U1010, first perform the trouble diagnosis for DTC U1010. Refer to [SEC-38, "BCM : DTC Logic"](#).

DTC No.	Trouble diagnosis name	DTC detecting condition	Possible cause
B2609	STEERING STATUS	BCM detects the malfunction of steering lock unit switches for 1 second.	<ul style="list-style-type: none"><li>• Harness or connectors [Steering lock unit circuit (BCM side) is open or shorted]</li><li>• Harness or connectors [Steering lock unit circuit (IPDM E/R side) is open or shorted]</li><li>• Steering lock unit</li><li>• IPDM E/R</li></ul>

### DTC CONFIRMATION PROCEDURE

#### 1. PERFORM DTC CONFIRMATION PROCEDURE-1

1. Turn ignition switch ON under the following conditions.

#### A/T models

- Selector lever is in the P or N position
- Do not depress brake pedal

#### M/T models

- Do not depress clutch pedal
2. Check "Self-diagnostic result" using CONSULT-III.

#### Is DTC detected?

- YES >> Go to [SEC-82, "Diagnosis Procedure"](#).  
NO >> GO TO 2.

#### 2. PERFORM DTC CONFIRMATION PROCEDURE-2

1. Turn ignition switch ON.
2. Turn ignition switch OFF.
3. Press driver side door switch and wait 1second or more.
4. Check "Self-diagnostic result" using CONSULT-III.

#### Is DTC detected?

- YES >> Go to [SEC-82, "Diagnosis Procedure"](#).  
NO >> INSPECTION END

### Diagnosis Procedure

INFOID:000000004662943

#### 1. INSPECTION START

Perform inspection in accordance with procedure that confirms DTC.

#### Which procedure confirms DTC?

- DTC confirmation procedure 1>>GO TO 2.  
DTC confirmation procedure 2>>GO TO 6.

# B2609 STEERING STATUS

< DTC/CIRCUIT DIAGNOSIS >

## 2.CHECK BCM OUTPUT SIGNAL-1

1. Turn ignition switch OFF.
2. Disconnect steering lock unit connector and IPDM E/R connector.
3. Check voltage between steering lock unit harness connector and ground.

(+)		(-)	Voltage (V) (Approx.)
Steering lock unit			
Connector	Terminal	Ground	Battery voltage
M40	3		

Is the inspection result normal?

- YES >> GO TO 4.  
NO >> GO TO 3.

## 3.CHECK STEERING LOCK UNIT CIRCUIT-1

1. Disconnect BCM connector.
2. Check continuity between steering lock unit harness connector and BCM harness connector.

Steering lock unit		BCM		Continuity
Connector	Terminal	Connector	Terminal	
M40	3	M122	97	Existed

3. Check continuity between steering lock unit harness connector and ground.

Steering lock unit		Ground	Continuity
Connector	Terminal		
M40	3		Not existed

Is the inspection result normal?

- YES >> Replace BCM. Refer to [BCS-81, "Removal and Installation"](#).  
NO >> Repair or replace harness.

## 4.CHECK IPDM E/R OUTPUT SIGNAL-1

1. Connect IPDM E/R connector.
2. Disconnect BCM connector.
3. Check voltage between steering lock unit harness connector and ground.

(+)		(-)	Voltage (V) (Approx.)
Steering lock unit			
Connector	Terminal	Ground	Battery voltage
M40	3		

Is the inspection result normal?

- YES >> Replace steering lock unit.  
NO >> GO TO 5.

## 5.CHECK STEERING LOCK UNIT CIRCUIT-2

1. Disconnect IPDM E/R connector.
2. Check continuity between steering lock unit harness connector and IPDM E/R harness connector.

Steering lock unit		IPDM E/R		Continuity
Connector	Terminal	Connector	Terminal	
M40	3	E5	32	Existed

3. Check continuity between steering lock unit harness connector and ground.

A  
B  
C  
D  
E  
F  
G  
H  
I  
J  
L  
M  
N  
O  
P

SEC

## B2609 STEERING STATUS

### < DTC/CIRCUIT DIAGNOSIS >

Steering lock unit		Ground	Continuity
Connector	Terminal		
M40	3		Not existed

Is the inspection result normal?

YES >> Replace IPDM E/R. Refer to [PCS-32, "Removal and Installation"](#).

NO >> Repair or replace harness.

### 6.CHECK BCM OUTPUT SIGNAL-2

1. Turn ignition switch OFF.
2. Disconnect steering lock unit connector and IPDM E/R connector.
3. Check voltage between steering lock unit harness connector and ground.

(+)		(-)	Voltage (V) (Approx.)
Steering lock unit			
Connector	Terminal		
M40	8	Ground	Battery voltage

Is the inspection result normal?

YES >> GO TO 8.

NO >> GO TO 7.

### 7.CHECK STEERING LOCK UNIT CIRCUIT-3

1. Disconnect BCM connector.
2. Check continuity between steering lock unit harness connector and BCM harness connector.

Steering lock unit		BCM		Continuity
Connector	Terminal	Connector	Terminal	
M40	8	M122	98	Existed

3. Check continuity between steering lock unit harness connector and ground.

Steering lock unit		Ground	Continuity
Connector	Terminal		
M40	8		Not existed

Is the inspection result normal?

YES >> Replace BCM. Refer to [BCS-81, "Removal and Installation"](#).

NO >> Repair or replace harness.

### 8.CHECK IPDM E/R OUTPUT SIGNAL-2

1. Connect IPDM E/R connector.
2. Disconnect BCM connector.
3. Check voltage between steering lock unit harness connector and ground.

(+)		(-)	Voltage (V) (Approx.)
Steering lock unit			
Connector	Terminal		
M40	8	Ground	Battery voltage

Is the inspection result normal?

YES >> Replace steering lock unit.

NO >> GO TO 9.

### 9.CHECK STEERING LOCK UNIT CIRCUIT-4

1. Disconnect IPDM E/R connector.
2. Check continuity between steering lock unit harness connector and IPDM E/R harness connector.

## B2609 STEERING STATUS

### < DTC/CIRCUIT DIAGNOSIS >

Steering lock unit		IPDM E/R		Continuity
Connector	Terminal	Connector	Terminal	
M40	8	E5	33	Existed

3. Check continuity between steering lock unit harness connector and ground.

Steering lock unit		Ground	Continuity
Connector	Terminal		
M40	8		Not existed

Is the inspection result normal?

- YES >> Replace IPDM E/R. Refer to [PCS-32, "Removal and Installation"](#).  
 NO >> Repair or replace harness.

A  
B  
C  
D  
E  
F  
G  
H  
I  
J  
L  
M  
N  
O  
P

SEC

# B260B STEERING LOCK UNIT

< DTC/CIRCUIT DIAGNOSIS >

## B260B STEERING LOCK UNIT

### Description

INFOID:000000004662944

The steering lock unit performs the check by itself according to the steering status.

### DTC Logic

INFOID:000000004662945

### DTC DETECTION LOGIC

DTC No.	Trouble diagnosis name	DTC detecting condition	Possible cause
B260B	STEERING LOCK UNIT	BCM detects malfunctioning of steering lock unit before steering unlocking.	Steering lock unit

### DTC CONFIRMATION PROCEDURE

#### 1. PERFORM DTC CONFIRMATION PROCEDURE

1. Press the push-button ignition switch, when steering is locked.
2. Check "Self-diagnostic result" using CONSULT-III.

#### Is DTC detected?

- YES >> Go to [SEC-86. "Diagnosis Procedure"](#).  
NO >> INSPECTION END

### Diagnosis Procedure

INFOID:000000004662946

#### 1. INSPECTION START

1. Turn ignition switch ON.
2. Check "Self-diagnostic result" using CONSULT-III.
3. Touch "ERASE".
4. **Perform DTC Confirmation Procedure.**  
See [SEC-86. "DTC Logic"](#).

#### Is the DTC B260B displayed again?

- YES >> Replace steering lock unit.  
NO >> INSPECTION END

# B260C STEERING LOCK UNIT

< DTC/CIRCUIT DIAGNOSIS >

## B260C STEERING LOCK UNIT

### Description

INFOID:000000004662947

The steering lock unit performs the check by itself according to the steering status.

### DTC Logic

INFOID:000000004662948

### DTC DETECTION LOGIC

DTC No.	Trouble diagnosis name	DTC detecting condition	Possible cause
B260C	STEERING LOCK UNIT	BCM detects malfunctioning of steering lock unit before steering locking.	Steering lock unit

### DTC CONFIRMATION PROCEDURE

#### 1.PERFORM DTC CONFIRMATION PROCEDURE

1. Turn ignition switch ON.
2. Turn ignition switch OFF.
3. Press driver side door switch.
4. Check "Self-diagnostic result" using CONSULT-III.

#### Is DTC detected?

- YES >> Go to [SEC-87. "Diagnosis Procedure"](#).  
NO >> INSPECTION END

### Diagnosis Procedure

INFOID:000000004662949

#### 1.INSPECTION START

1. Turn ignition switch ON.
2. Check "Self-diagnostic result" using CONSULT-III.
3. Touch "ERASE".
4. **Perform DTC Confirmation Procedure.**  
See [SEC-87. "DTC Logic"](#).

#### Is the DTC B260C displayed again?

- YES >> Replace steering lock unit.  
NO >> INSPECTION END

A  
B  
C  
D  
E  
F  
G  
H  
I  
J  
L  
M  
N  
O  
P

SEC

# B260D STEERING LOCK UNIT

< DTC/CIRCUIT DIAGNOSIS >

## B260D STEERING LOCK UNIT

### Description

INFOID:000000004662950

The steering lock unit performs the check by itself according to the steering lock status (before lock, after lock and unlock).

### DTC Logic

INFOID:000000004662951

### DTC DETECTION LOGIC

DTC No.	Trouble diagnosis name	DTC detecting condition	Possible cause
B260D	STEERING LOCK UNIT	BCM detects malfunctioning of steering lock unit after steering locking.	Steering lock unit

### DTC CONFIRMATION PROCEDURE

#### 1. PERFORM DTC CONFIRMATION PROCEDURE

1. Turn ignition switch ON.
2. Turn ignition switch OFF.
3. Press driver side door switch.
4. Check "Self-diagnostic result" using CONSULT-III.

#### Is DTC detected?

- YES >> Go to [SEC-88, "Diagnosis Procedure"](#).  
NO >> INSPECTION END

### Diagnosis Procedure

INFOID:000000004662952

#### 1. INSPECTION START

1. Turn ignition switch ON.
2. Check "Self-diagnostic result" using CONSULT-III.
3. Touch "ERASE".
4. **Perform DTC Confirmation Procedure.**  
See [SEC-88, "DTC Logic"](#).

#### Is the DTC B260D displayed again?

- YES >> Replace steering lock unit.  
NO >> INSPECTION END



# B260F ENGINE STATUS

< DTC/CIRCUIT DIAGNOSIS >

## B260F ENGINE STATUS

### Description

INFOID:000000004662953

BCM receives the engine status signal from ECM via CAN communication.

### DTC Logic

INFOID:000000004662954

### DTC DETECTION LOGIC

#### NOTE:

- If DTC B260F is displayed with DTC U1000, first perform the trouble diagnosis for DTC U1000. Refer to [SEC-36, "BCM : DTC Logic"](#).
- If DTC B260F is displayed with DTC U1010, first perform the trouble diagnosis for DTC U1010. Refer to [SEC-38, "BCM : DTC Logic"](#).

DTC No.	Trouble diagnosis name	DTC detecting condition	Possible cause
B260F	INTERRUPTION OF ENGINE STATUS SIGNAL	BCM has not yet received the engine status signal from ECM when ignition switch is in the ON position.	ECM

### DTC CONFIRMATION PROCEDURE

#### 1. PERFORM DTC CONFIRMATION PROCEDURE

1. Turn ignition switch ON under the following conditions.

#### A/T models

- Selector lever is in the P or N position
- Do not depress brake pedal

#### M/T models

- Do not depress clutch pedal
2. Check "Self-diagnostic result" using CONSULT-III.

#### Is DTC detected?

- YES >> Go to [SEC-89, "Diagnosis Procedure"](#).
- NO >> INSPECTION END

### Diagnosis Procedure

INFOID:000000004662955

SEC

#### 1. INSPECTION START

1. Turn ignition switch ON.
2. Check "Self-diagnostic result" using CONSULT-III.
3. Touch "ERASE".
4. **Perform DTC Confirmation Procedure.**  
See [SEC-89, "DTC Logic"](#).

#### Is the DTC B260F displayed again?

- YES >> GO TO 2.
- NO >> GO TO 3.

#### 2. REPLACE ECM

Replace ECM. Refer to [EC-16, "ADDITIONAL SERVICE WHEN REPLACING CONTROL UNIT \(ECM\) : Description"](#).

>> INSPECTION END

#### 3. CHECK INTERMITTENT INCIDENT

Refer to [GI-41, "Intermittent Incident"](#).

>> INSPECTION END

# B26E8 CLUTCH INTERLOCK SWITCH

< DTC/CIRCUIT DIAGNOSIS >

## B26E8 CLUTCH INTERLOCK SWITCH

### Description

INFOID:000000004662956

When clutch interlock switch turns ON, BCM detects that clutch pedal is being depressed and permits to start the engine.

### DTC Logic

INFOID:000000004662957

#### NOTE:

If DTC B26E8 is displayed with DTC B210F, first perform the trouble diagnosis for DTC B210F. Refer to [SEC-116. "DTC Logic"](#).

### DTC DETECTION LOGIC

DTC No.	Trouble diagnosis name	DTC detection condition	Possible cause
B26E8	CLUTCH INTERLOCK SWITCH	Detects that ASCD cancel switch is in the ON position for 2 seconds or more while ignition switch and clutch interlock switch are ON.	<ul style="list-style-type: none"><li>Clutch interlock switch</li><li>Harness or connector (Clutch interlock switch circuit open or shorted)</li></ul>

### DTC CONFIRMATION PROCEDURE

#### 1. PERFORM DTC CONFIRMATION PROCEDURE

- Turn ignition switch ON under the following condition.
  - Shift lever is in the neutral position.
  - Depress clutch pedal.
- Check "Self-diagnostic result" using CONSULT-III.

#### Is DTC detected?

- YES >> Go to [SEC-90. "Diagnosis Procedure"](#).  
NO >> INSPECTION END

### Diagnosis Procedure

INFOID:000000004662958

#### 1. CHECK CLUTCH INTERLOCK SWITCH POWER SUPPLY

- Turn ignition switch OFF.
- Disconnect clutch interlock switch connector.
- Check voltage between clutch interlock switch harness connector and ground.

(+)		(-)	Voltage (V) (Approx.)
Clutch interlock switch			
Connector	Terminal		
E111	1	Ground	Battery voltage

#### Is the inspection result normal?

- YES >> GO TO 2.  
NO-1 >> Check 10 A fuse [No. 9, located in the fuse block (J/B)]  
NO-2 >> Check harness for open or short between clutch interlock switch and fuse.

#### 2. CHECK CLUTCH INTERLOCK SWITCH SIGNAL

- Connect clutch interlock switch connector.
- Disconnect BCM connector.
- Check voltage between BCM harness connector and ground.

# B26E8 CLUTCH INTERLOCK SWITCH

## < DTC/CIRCUIT DIAGNOSIS >

(+)		(-)	Condition	Voltage (V) (Approx.)	
BCM					
Connector	Terminal				
M123	114	Ground	Clutch pedal	Depressed	Battery voltage
				Not depressed	0

Is the inspection result normal?

YES >> Replace BCM. Refer to [BCS-81, "Removal and Installation"](#).

NO >> GO TO 3.

### 3.CHECK CLUTCH INTERLOCK SWITCH SIGNAL CIRCUIT

1. Disconnect clutch interlock switch connector.
2. Check continuity between clutch interlock switch harness connector and BCM harness connector.

Clutch interlock switch		BCM		Continuity
Connector	Terminal	Connector	Terminal	
E111	2	M123	114	Existed

3. Check continuity between clutch interlock switch harness connector and ground.

Clutch interlock switch		Ground	Continuity
Connector	Terminal		
E111	2		Not existed

Is the inspection result normal?

YES >> GO TO 4.

NO >> Repair or replace harness.

### 4.CHECK CLUTCH INTERLOCK SWITCH

Refer to [SEC-91, "Component Inspection"](#).

Is the inspection result normal?

YES >> GO TO 5.

NO >> Replace clutch interlock switch. Refer to [CL-7, "Exploded View"](#).

### 5.CHECK INTERMITTENT INCIDENT

Refer to [GI-41, "Intermittent Incident"](#).

>> INSPECTION END

## Component Inspection

INFOID:000000004662959

### 1.CHECK CLUTCH INTERLOCK SWITCH

1. Turn ignition switch OFF.
2. Disconnect clutch interlock switch connector.
3. Check continuity between clutch interlock switch terminals.

Clutch interlock switch		Condition	Continuity	
Terminal				
1	2	Clutch pedal	Depressed	Existed
			Not depressed	Not existed

Is the inspection result normal?

YES >> INSPECTION END

NO >> Replace clutch interlock switch. Refer to [CL-7, "Exploded View"](#).

# B26E9 STEERING STATUS

< DTC/CIRCUIT DIAGNOSIS >

## B26E9 STEERING STATUS

### Description

INFOID:000000004662960

There are 2 switches in the steering lock unit (steering lock/unlock switch 1 and 2). BCM compares the 2 switch conditions to judge the present steering status.

### DTC Logic

INFOID:000000004662961

### DTC DETECTION LOGIC

#### NOTE:

If DTC B26E9 is displayed with DTC B2609, first perform the trouble diagnosis for DTC B2609. Refer to [SEC-82, "DTC Logic"](#).

DTC No.	Trouble diagnosis name	DTC detecting condition	Possible cause
B26E9	S/L STATUS	BCM requests lock to steering lock unit, then steering lock unit transmits a recognition signal to BCM, but steering lock unit remains unlocked.	Steering lock unit

### DTC CONFIRMATION PROCEDURE

#### 1. PERFORM DTC CONFIRMATION PROCEDURE

1. Turn ignition switch ON.
2. Turn ignition switch OFF.
3. Press driver side door switch and wait 1 second or more.
4. Turn ignition switch ON.
5. Check "Self-diagnostic result" using CONSULT-III.

#### Is DTC detected?

- YES >> Refer to [SEC-92, "Diagnosis Procedure"](#).  
NO >> INSPECTION END

### Diagnosis Procedure

INFOID:000000004662962

#### 1. INSPECTION START

1. Turn ignition switch ON.
2. Check "Self-diagnostic result" using CONSULT-III.
3. Touch "ERASE".
4. Perform DTC Confirmation Procedure.  
Refer to [SEC-92, "DTC Logic"](#).

#### Is the DTC B26E9 displayed again?

- YES >> GO TO 2.  
NO >> GO TO 3.

#### 2. REPLACE STEERING LOCK UNIT

1. Replace steering lock unit.
2. Perform DTC confirmation procedure. Refer to [SEC-92, "DTC Logic"](#).

#### Is the DTC B26E9 displayed again?

- YES >> GO TO 3.  
NO >> INSPECTION END

#### 3. CHECK INTERMITTENT INCIDENT

Refer to [GI-41, "Intermittent Incident"](#).

>> INSPECTION END

# B26EA KEY REGISTRATION

< DTC/CIRCUIT DIAGNOSIS >

## B26EA KEY REGISTRATION

### Description

INFOID:000000004662963

When the registered Intelligent Key is carried, the door lock/unlock operation and the push-button ignition switch operation become possible.

### DTC Logic

INFOID:000000004662964

### DTC DETECTION LOGIC

DTC No.	Trouble diagnosis name	DTC detecting condition	Possible cause
B26EA	KEY REGISTRATION	Intelligent Key is not registered successfully.	<ul style="list-style-type: none"><li>• Improper registration operation</li><li>• Intelligent Key</li><li>• BCM</li></ul>

### DTC CONFIRMATION PROCEDURE

#### 1. PERFORM DTC CONFIRMATION PROCEDURE

1. Perform initialization using CONSULT-III. Reregister all Intelligent Keys.  
For initialization and registration of Intelligent Key, refer to "CONSULT-III Operation Manual NATS-IVIS/NVIS".
2. Check "Self-diagnostic result" using CONSULT-III.

#### Is DTC detected?

- YES >> Go to [SEC-93. "Diagnosis Procedure"](#)  
NO >> INSPECTION END

### Diagnosis Procedure

INFOID:000000004662965

#### 1. PERFORM INITIALIZATION

1. Perform initialization using CONSULT-III. Reregister all Intelligent Keys.  
For initialization and registration of Intelligent Key, refer to "CONSULT-III Operation Manual NATS-IVIS/NVIS".
2. Check "Self-diagnostic result" using CONSULT-III.

#### Is DTC detected?

- YES >> GO TO 2.  
NO >> INSPECTION END

#### 2. REPLACE INTELLIGENT KEY

1. Replace Intelligent Key. Reregister all Intelligent Keys
2. Perform initialization using CONSULT-III. For initialization, refer to "CONSULT-III Operation Manual NATS-IVIS/NVIS".
3. Check "Self-diagnostic result" using CONSULT-III.

#### Is DTC detected?

- YES >> Replace BCM. Refer to [BCS-81. "Removal and Installation"](#).  
NO >> INSPECTION END

# B2612 STEERING STATUS

< DTC/CIRCUIT DIAGNOSIS >

## B2612 STEERING STATUS

### Description

INFOID:000000004662966

There are 2 switches in the steering unit. IPDM E/R compares the 2 switch conditions to judge the present steering status and transmits the result to BCM via CAN communication.

### DTC Logic

INFOID:000000004662967

### DTC DETECTION LOGIC

#### NOTE:

- If DTC B2612 is displayed with DTC U1000, first perform the trouble diagnosis for DTC U1000. Refer to [SEC-36, "BCM : DTC Logic"](#).
- If DTC B2612 is displayed with DTC U1010, first perform the trouble diagnosis for DTC U1010. Refer to [SEC-38, "BCM : DTC Logic"](#).

DTC No.	Self-diagnosis name	DTC detecting condition	Possible causes
B2612	STEERING STATUS	BCM detects the difference between the following status for 1 second <ul style="list-style-type: none"><li>• Steering lock or unlock</li><li>• Feedback of steering lock status from IPDM E/R (CAN)</li></ul>	<ul style="list-style-type: none"><li>• Harness or connectors [Steering lock unit circuit (BCM side) is open or shorted]</li><li>• Harness or connectors [Steering lock unit circuit (IPDM E/R side) is open or shorted]</li><li>• Steering lock unit</li><li>• IPDM E/R</li></ul>

### DTC CONFIRMATION PROCEDURE

#### 1. PERFORM DTC CONFIRMATION PROCEDURE-1

1. Turn ignition switch ON under the following conditions.

#### A/T models

- Selector lever is in the P or N position
- Do not depress brake pedal

#### M/T models

- Do not depress clutch pedal
2. Check "Self-diagnostic result" using CONSULT-III.

#### Is DTC detected?

- YES >> Go to [SEC-94, "Diagnosis Procedure"](#).  
NO >> GO TO 2.

#### 2. PERFORM DTC CONFIRMATION PROCEDURE-2

1. Turn ignition switch ON.
2. Turn ignition switch OFF.
3. Press door switch.
4. Check "Self-diagnostic result" using CONSULT-III.

#### Is DTC detected?

- YES >> Go to [SEC-94, "Diagnosis Procedure"](#).  
NO >> INSPECTION END

### Diagnosis Procedure

INFOID:000000004662968

#### 1. INSPECTION START

Perform inspection in accordance with procedure that confirms DTC.

#### Which procedure confirms DTC?

- DTC confirmation procedure 1 >> GO TO 2.  
DTC confirmation procedure 2 >> GO TO 6.

#### 2. CHECK BCM OUTPUT SIGNAL-1

# B2612 STEERING STATUS

## < DTC/CIRCUIT DIAGNOSIS >

1. Turn ignition switch OFF.
2. Disconnect steering lock unit connector and IPDM E/R connector.
3. Check voltage between steering lock unit harness connector and ground.

(+)		(-)	Voltage (V) (Approx.)
Steering lock unit			
Connector	Terminal	Ground	Battery voltage
M40	3		

Is the inspection result normal?

- YES >> GO TO 4.  
NO >> GO TO 3.

### 3.CHECK STEERING LOCK UNIT CIRCUIT-1

1. Disconnect BCM connector.
2. Check continuity between steering lock unit harness connector and BCM harness connector.

Steering lock unit		BCM		Continuity
Connector	Terminal	Connector	Terminal	
M40	3	M122	97	Existed

3. Check continuity between steering lock unit harness connector and ground.

Steering lock unit		Ground	Continuity
Connector	Terminal		
M40	3		Not existed

Is the inspection result normal?

- YES >> Replace BCM. Refer to [BCS-81, "Removal and Installation"](#).  
NO >> Repair or replace harness.

### 4.CHECK IPDM E/R OUTPUT SIGNAL-1

1. Connect IPDM E/R connector.
2. Disconnect BCM connector.
3. Check voltage between steering lock unit harness connector and ground.

(+)		(-)	Voltage (V) (Approx.)
Steering lock unit			
Connector	Terminal	Ground	Battery voltage
M40	3		

Is the inspection result normal?

- YES >> Replace steering lock unit.  
NO >> GO TO 5.

### 5.CHECK STEERING LOCK UNIT CIRCUIT-2

1. Disconnect IPDM E/R connector.
2. Check continuity between steering lock unit harness connector and IPDM E/R harness connector.

Steering lock unit		IPDM E/R		Continuity
Connector	Terminal	Connector	Terminal	
M40	3	E5	32	Existed

3. Check continuity between steering lock unit harness connector and ground.

Steering lock unit		Ground	Continuity
Connector	Terminal		
M40	3		Not existed

A

B

C

D

E

F

G

H

I

J

SEC

L

M

N

O

P

## B2612 STEERING STATUS

### < DTC/CIRCUIT DIAGNOSIS >

#### Is the inspection result normal?

YES >> Replace IPDM E/R. Refer to [PCS-32, "Removal and Installation"](#).

NO >> Repair or replace harness.

#### 6. CHECK BCM OUTPUT SIGNAL-2

1. Turn ignition switch OFF.
2. Disconnect steering lock unit connector and IPDM E/R connector.
3. Check voltage between steering lock unit harness connector and ground.

(+)		(-)	Voltage (V) (Approx.)
Steering lock unit			
Connector	Terminal		
M40	8	Ground	Battery voltage

#### Is the inspection result normal?

YES >> GO TO 8.

NO >> GO TO 7.

#### 7. CHECK STEERING LOCK UNIT CIRCUIT-3

1. Disconnect BCM connector.
2. Check continuity between steering lock unit harness connector and BCM harness connector.

Steering lock unit		BCM		Continuity
Connector	Terminal	Connector	Terminal	
M40	8	M122	98	Existed

3. Check continuity between steering lock unit harness connector and ground.

Steering lock unit		Ground	Continuity
Connector	Terminal		
M40	8		Not existed

#### Is the inspection result normal?

YES >> Replace BCM. Refer to [BCS-81, "Removal and Installation"](#).

NO >> Repair or replace harness.

#### 8. CHECK IPDM E/R OUTPUT SIGNAL-2

1. Connect IPDM E/R connector.
2. Disconnect BCM connector.
3. Check voltage between steering lock unit harness connector and ground.

(+)		(-)	Voltage (V) (Approx.)
Steering lock unit			
Connector	Terminal		
M40	8	Ground	Battery voltage

#### Is the inspection result normal?

YES >> Replace steering lock unit.

NO >> GO TO 9.

#### 9. CHECK STEERING LOCK UNIT CIRCUIT-4

1. Disconnect IPDM E/R connector.
2. Check continuity between steering lock unit harness connector and IPDM E/R harness connector.

Steering lock unit		IPDM E/R		Continuity
Connector	Terminal	Connector	Terminal	
M40	8	E5	33	Existed



## B2612 STEERING STATUS

### < DTC/CIRCUIT DIAGNOSIS >

3. Check continuity between steering lock unit harness connector and ground.

Steering lock unit		Ground	Continuity
Connector	Terminal		
M40	8		Not existed

Is the inspection result normal?

YES >> Replace IPDM E/R. Refer to [PCS-32, "Removal and Installation"](#).

NO >> Repair or replace harness.

A

B

C

D

E

F

G

H

I

J

SEC

L

M

N

O

P

# B2617 STARTER RELAY CIRCUIT

< DTC/CIRCUIT DIAGNOSIS >

## B2617 STARTER RELAY CIRCUIT

### Description

INFOID:000000004662969

Located in IPDM E/R, the starter relay runs the starter motor. The starter relay is turned ON by the BCM when the ignition switch is in the START position. IPDM E/R transmits the starter relay ON signal to BCM via CAN communication.

### DTC Logic

INFOID:000000004662970

#### DTC DETECTION LOGIC

##### NOTE:

- If DTC B2617 is displayed with DTC U1000, first perform the trouble diagnosis for DTC U1000. Refer to [SEC-36, "BCM : DTC Logic"](#).
- If DTC B2617 is displayed with DTC U1010, first perform the trouble diagnosis for DTC U1010. Refer to [SEC-38, "BCM : DTC Logic"](#).
- If DTC B2617 is displayed with DTC B210E for IPDM E/R, first perform the trouble diagnosis for DTC B210E. Refer to [SEC-114, "DTC Logic"](#).

DTC No.	Trouble diagnosis name	DTC detecting condition	Possible cause
B2617	STARTER RELAY CIRCUIT	An immediate operation of starter relay is requested by BCM, but there is no response for more than 1 second.	<ul style="list-style-type: none"><li>• Harness or connectors (Starter relay circuit is open or shorted.)</li><li>• IPDM E/R</li></ul>

#### DTC CONFIRMATION PROCEDURE

##### 1. PERFORM DTC CONFIRMATION PROCEDURE

1. Turn ignition switch ON under the following conditions and wait 1 second or more.

##### A/T models

- Selector lever is in the P or N position
- Do not depress brake pedal

##### M/T models

- Do not depress clutch pedal
2. Check "Self-diagnostic result" using CONSULT-III.

##### Is DTC detected?

- YES >> Go to [SEC-98, "Diagnosis Procedure"](#).  
NO >> INSPECTION END

### Diagnosis Procedure

INFOID:000000004662971

##### 1. CHECK STARTER RELAY

1. Turn ignition switch ON.
2. Check voltage between BCM harness connector and ground.

(+)		(-)	Condition		Voltage (V) (Approx.)
BCM					
Connector	Terminal				
M121	52	Ground	Selector lever (A/T models)	N or P position	12
				Other than above	0
			Clutch pedal (M/T models)	Depressed	Battery voltage
				Not depressed	0

##### Is the measurement value within the specification.

- YES >> GO TO 3.  
NO >> GO TO 2.

# B2617 STARTER RELAY CIRCUIT

< DTC/CIRCUIT DIAGNOSIS >

## 2. CHECK STARTER RELAY CIRCUIT

1. Turn ignition switch OFF.
2. Disconnect BCM connector and IPDM E/R connector.
3. Check continuity between IPDM E/R harness connector and BCM harness connector.

IPDM E/R		BCM		Continuity
Connector	Terminal	Connector	Terminal	
E6	46	M121	52	Existed

4. Check continuity between IPDM E/R harness connector and ground.

IPDM E/R		Ground	Continuity
Connector	Terminal		
E6	46		Not existed

Is the inspection result normal?

- YES >> Replace IPDM E/R. Refer to [PCS-32, "Removal and Installation"](#).  
NO >> Repair or replace harness.

## 3. CHECK INTERMITTENT INCIDENT

Refer to [GI-41, "Intermittent Incident"](#).

>> INSPECTION END

A  
B  
C  
D  
E  
F  
G  
H  
I  
J  
L  
M  
N  
O  
P

SEC

# B2619 BCM

< DTC/CIRCUIT DIAGNOSIS >

## B2619 BCM

### Description

INFOID:000000004662972

BCM requests IPDM E/R to supply power to steering lock unit. After receiving the power, the steering lock unit transmits an ON signal to BCM.

### DTC Logic

INFOID:000000004662973

### DTC DETECTION LOGIC

DTC No.	Trouble diagnosis name	DTC detecting condition	Possible cause
B2619	BCM	BCM detects a discrepancy between the power supplied to the steering lock unit and the feedback for one second or more.	BCM

### DTC CONFIRMATION PROCEDURE

#### 1. PERFORM DTC CONFIRMATION PROCEDURE

1. Turn ignition switch ON under the following conditions and wait 1 second or more.

#### A/T models

- Selector lever is in the P or N position
- Do not depress brake pedal

#### M/T models

- Do not depress clutch pedal
2. Check "Self-diagnostic result" using CONSULT-III.

#### Is DTC detected?

- YES >> Go to [SEC-100. "Diagnosis Procedure"](#).  
NO >> INSPECTION END

### Diagnosis Procedure

INFOID:000000004662974

#### 1. INSPECTION START

1. Turn ignition switch ON.
2. Check "Self-diagnostic result" using CONSULT-III.
3. Touch "ERASE".
4. **Perform DTC Confirmation Procedure.**  
See [SEC-100. "DTC Logic"](#).

#### Is the DTC B2619 displayed again?

- YES >> Replace BCM. Refer to [BCS-81. "Removal and Installation"](#).  
NO >> INSPECTION END

# B261E VEHICLE TYPE

< DTC/CIRCUIT DIAGNOSIS >

## B261E VEHICLE TYPE

### Description

INFOID:000000004662975

There are two types of vehicles.

- HEV
- Conventional

### DTC Logic

INFOID:000000004662976

### DTC DETECTION LOGIC

#### NOTE:

- If DTC B261E is displayed with DTC U1000, first perform the trouble diagnosis for DTC U1000. Refer to [SEC-36, "BCM : DTC Logic"](#).
- If DTC B261E is displayed with DTC U1010, first perform the trouble diagnosis for DTC U1010. Refer to [SEC-38, "BCM : DTC Logic"](#).

DTC No.	Trouble diagnosis name	DTC detecting condition	Possible cause
B261E	VEHICLE TYPE	Difference of BCM configuration.	BCM

### DTC CONFIRMATION PROCEDURE

#### 1. PERFORM DTC CONFIRMATION PROCEDURE

1. Turn ignition switch ON under the following conditions.

#### A/T models

- Selector lever is in the P or N position
- Do not depress brake pedal

#### M/T models

- Do not depress clutch pedal
2. Check "Self-diagnostic result" using CONSULT-III.

#### Is DTC detected?

- YES >> Go to [SEC-101, "Diagnosis Procedure"](#).
- NO >> INSPECTION END

### Diagnosis Procedure

INFOID:000000004662977

#### 1. INSPECTION START

1. Turn ignition switch ON.
2. Check "Self-diagnostic result" using CONSULT-III.
3. Touch "ERASE".
4. **Perform DTC Confirmation Procedure.**  
See [SEC-101, "DTC Logic"](#).

#### Is the 1st trip DTC B261E displayed again?

- YES >> Replace BCM. Refer to [BCS-81, "Removal and Installation"](#).
- NO >> INSPECTION END

A  
B  
C  
D  
E  
F  
G  
H  
I  
J  
L  
M  
N  
O  
P

SEC

# B261F ASCD CLUTCH SWITCH

< DTC/CIRCUIT DIAGNOSIS >

## B261F ASCD CLUTCH SWITCH

### Description

INFOID:000000004662978

BCM judges that clutch pedal is operated by clutch interlock switch and clutch pedal position switch operation.

### DTC Logic

INFOID:000000004662979

### DTC DETECTION LOGIC

DTC No.	Trouble diagnosis name	DTC detection condition	Possible cause
B261F	ASCD CNCL/CLTH SW	When ignition switch is ON and vehicle speed is 40 km/h, BCM detects that clutch pedal position switch is ON for 10 seconds or more.	<ul style="list-style-type: none"> <li>Harness or connector (ASCD clutch switch circuit open or shorted)</li> <li>Clutch pedal position switch</li> <li>BCM</li> </ul>

### DTC CONFIRMATION PROCEDURE

#### 1. PERFORM DTC CONFIRMATION PROCEDURE

1. Drive the vehicle at the vehicle speed of 40 km/h (24.8 MPH) or more wait 10 seconds or more.
2. Check "Self-diagnostic result" using CONSULT-III.

#### Is DTC detected?

- YES >> Go to [SEC-102, "Diagnosis Procedure"](#).  
 NO >> INSPECTION END

### Diagnosis Procedure

INFOID:000000004662980

#### 1. CHECK ASCD CLUTCH SWITCH POWER SUPPLY

1. Turn ignition switch OFF.
2. Disconnect ASCD clutch switch connector.
3. Turn ignition switch ON.
4. Check voltage between ASCD clutch switch harness connector and ground.

(+)		(-)	Voltage (V) (Approx.)
ASCD clutch switch			
Connector	Terminal	Ground	Battery voltage
E108 (Without ICC)	1		
E113 (With ICC)			

#### Is the inspection result normal?

- YES >> GO TO 2.  
 NO-1 >> Check ASCD brake switch. Refer to [EC-484, "Component Function Check"](#).  
 NO-2 >> Check 10A fuse [No. 3, located in the fuse block (J/B)]  
 NO-3 >> Check harness for open or short between ASCD clutch switch and fuse.

#### 2. CHECK ASCD CLUTCH SWITCH SIGNAL

1. Turn ignition switch OFF.
2. Connect ASCD clutch switch connector.
3. Disconnect BCM connector.
4. Check voltage between BCM harness connector and ground.

(+)		(-)	Condition	Voltage (V) (Approx.)	
BCM					
Connector	Terminal	Ground	Clutch pedal	Depressed	
M122	99				Not depressed
					0

## B261F ASCD CLUTCH SWITCH

### < DTC/CIRCUIT DIAGNOSIS >

#### Is the inspection result normal?

- YES >> Replace BCM. Refer to [BCS-81, "Removal and Installation"](#).  
 NO >> GO TO 3.

### 3.CHECK ASCD CLUTCH SWITCH SIGNAL CIRCUIT

1. Disconnect ASCD clutch switch connector.
2. Check continuity between ASCD clutch switch harness connector and BCM harness connector.

ASCD clutch switch		BCM		Continuity
Connector	Terminal	Connector	Terminal	
E108 (Without ICC)	2	M122	99	Existed
E113 (With ICC)				

3. Check continuity between ASCD clutch switch harness connector and ground.

ASCD clutch switch		Ground	Continuity
Connector	Terminal		
E108 (Without ICC)	2		Not existed
E113 (With ICC)			

#### Is the inspection result normal?

- YES >> GO TO 4.  
 NO >> Repair or replace harness.

### 4.CHECK ASCD CLUTCH SWITCH

Refer to [SEC-103, "Component Inspection"](#).

#### Is the inspection result normal?

- YES >> GO TO 5.  
 NO >> Replace ASCD clutch switch. Refer to [CL-7, "Exploded View"](#).

### 5.CHECK INTERMITTENT INCIDENT

Refer to [GI-41, "Intermittent Incident"](#).

>> INSPECTION END

## Component Inspection

INFOID:000000004662981

### 1.CHECK ASCD CLUTCH SWITCH

1. Turn ignition switch OFF.
2. Disconnect ASCD clutch switch connector.
3. Check continuity between ASCD clutch switch terminals.

ASCD clutch switch		Condition	Continuity
Terminal			
1	2	Clutch pedal Depressed	Not existed
		Clutch pedal Not depressed	Existed

#### Is the inspection result normal?

- YES >> INSPECTION END  
 NO >> Replace ASCD clutch switch. Refer to [CL-7, "Exploded View"](#).

A  
B  
C  
D  
E  
F  
G  
H  
I  
J  
L  
M  
N  
O  
P

SEC

# B2108 STEERING LOCK RELAY

< DTC/CIRCUIT DIAGNOSIS >

## B2108 STEERING LOCK RELAY

### Description

INFOID:000000004662982

The steering lock relay ON signal is transmitted to IPDM E/R by BCM via CAN communication. IPDM E/R turns the steering lock relay ON and transmits the release of the steering to BCM.

### DTC Logic

INFOID:000000004662983

### DTC DETECTION LOGIC

#### NOTE:

If DTC B2108 is displayed with DTC U1000, first perform the trouble diagnosis for DTC U1000. Refer to [SEC-200, "DTC Index"](#).

DTC No.	Trouble diagnosis name	DTC detecting condition	Possible cause
B2108	STRG LCK RELAY ON	IPDM E/R detects that the relay is stuck in the ON position for about 1 second even if the IPDM E/R receives steering lock relay ON/OFF signal from BCM.	IPDM E/R

### DTC CONFIRMATION PROCEDURE

#### 1. PERFORM DTC CONFIRMATION PROCEDURE

1. Turn ignition switch ON under the following conditions and wait 1 second or more.

#### A/T models

- Selector lever is in the P or N position
- Do not depress brake pedal

#### M/T models

- Do not depress clutch pedal
2. Check "Self-diagnostic result" using CONSULT-III.

#### Is DTC detected?

- YES >> Go to [SEC-104, "Diagnosis Procedure"](#).  
NO >> INSPECTION END

### Diagnosis Procedure

INFOID:000000004662984

#### 1. CHECK STEERING LOCK RELAY

Check voltage between IPDM E/R harness connector and ground.

(+)		(-)	Condition		Voltage (V) (Approx.)
IPDM E/R					
Connector	Terminal				
E5	11	Ground	Ignition switch OFF	A few seconds after opening the driver door	Battery voltage
			Ignition switch LOCK	Press the push-button ignition switch	Battery voltage
			Ignition switch ACC or ON		0

#### Is the inspection normal?

- YES >> GO TO 2.  
NO >> Replace IPDM E/R. Refer to [PCS-32, "Removal and Installation"](#).

#### 2. CHECK STEERING LOCK RELAY CIRCUIT

1. Turn ignition switch OFF.
2. Disconnect IPDM E/R connector and steering lock unit connector.
3. Check continuity IPDM E/R harness connector and steering lock unit harness connector.



# B2108 STEERING LOCK RELAY

## < DTC/CIRCUIT DIAGNOSIS >

IPDM E/R		Steering lock unit		Continuity
Connector	Terminal	Connector	Terminal	
E5	11	M40	1	Existed

4. Check continuity IPDM E/R harness connector and ground.

IPDM E/R		Ground	Continuity
Connector	Terminal		
E5	11		Not existed

Is the inspection result normal?

YES >> GO TO 3.

NO >> Repair or replace harness.

### 3. CHECK INTERMITTENT INCIDENT

Refer to [GI-41, "Intermittent Incident"](#).

>> INSPECTION END

A  
B  
C  
D  
E  
F  
G  
H  
I  
J  
L  
M  
N  
O  
P

SEC

# B2109 STEERING LOCK RELAY

< DTC/CIRCUIT DIAGNOSIS >

## B2109 STEERING LOCK RELAY

### Description

INFOID:000000004662985

The steering lock relay ON signal is transmitted to IPDM E/R by BCM via CAN communication. IPDM E/R turns the steering lock relay ON and transmits the release of the steering to BCM.

### DTC Logic

INFOID:000000004662986

### DTC DETECTION LOGIC

#### NOTE:

- If DTC B2109 is displayed with DTC U1000, first perform the trouble diagnosis for DTC U1000. Refer to [SEC-36, "IPDM E/R \(INTELLIGENT POWER DISTRIBUTION MODULE ENGINE ROOM\) : DTC Logic"](#).
- When IPDM E/R power supply voltage is low (Approx. 7 - 8 V for about 1 second), the DTC B2109 may be detected.

DTC No.	Trouble diagnosis name	DTC detecting condition	Possible cause
B2109	STRG LCK RELAY OFF	IPDM E/R detects that the relay is stuck in the OFF position for about 1 second even if the IPDM E/R receives steering lock relay ON/OFF signal from BCM.	<ul style="list-style-type: none"><li>• Harness or connector (Power supply circuit)</li><li>• IPDM E/R</li><li>• Battery</li></ul>

### DTC CONFIRMATION PROCEDURE

#### 1.PERFORM DTC CONFIRMATION PROCEDURE

1. Turn ignition switch ON under the following conditions and wait 1 second or more.

#### A/T models

- Selector lever is in the P or N position
- Do not depress brake pedal

#### M/T models

- Do not depress clutch pedal
2. Check "Self-diagnostic result" using CONSULT-III.

#### Is DTC detected?

- YES >> Go to [SEC-106, "Diagnosis Procedure"](#).  
NO >> INSPECTION END

### Diagnosis Procedure

INFOID:000000004662987

#### 1.CHECK POWER SUPPLY CIRCUIT

Check IPDM E/R power supply circuit. Refer to [SEC-120, "IPDM E/R \(INTELLIGENT POWER DISTRIBUTION MODULE ENGINE ROOM\) : Diagnosis Procedure"](#).

#### Is the circuit normal?

- YES >> GO TO 2.  
NO >> Repair or replace the malfunctioning part.

#### 2.CHECK FUSE

1. Turn ignition switch OFF.
2. Check 10A fuse (No. 48, located in IPDM E/R).

#### Is the inspection normal?

- YES >> Replace IPDM E/R. Refer to [PCS-32, "Removal and Installation"](#).  
NO >> Replace the blown fuse after repairing the affected circuit if a fuse is blown.

# B210A STEERING LOCK CONDITION SWITCH

< DTC/CIRCUIT DIAGNOSIS >

## B210A STEERING LOCK CONDITION SWITCH

### Description

INFOID:000000004662988

There are 2 switches in the steering unit. IPDM E/R compares the 2 switch conditions to judge the present steering status and transmits the result to BCM via CAN communication.

### DTC Logic

INFOID:000000004662989

### DTC DETECTION LOGIC

#### NOTE:

If DTC B210A is displayed with DTC U1000, first perform the trouble diagnosis for DTC U1000. Refer to [SEC-36, "IPDM E/R \(INTELLIGENT POWER DISTRIBUTION MODULE ENGINE ROOM\) : DTC Logic"](#).

DTC No.	Trouble diagnosis name	DTC detecting condition	Possible cause
B210A	STRG LCK STATE SW	IPDM E/R detects the difference between steering condition switches 1 and 2 for 1 second.	<ul style="list-style-type: none"><li>• Harness or connectors [Steering lock unit circuit (BCM side) is open or shorted]</li><li>• Harness or connectors [Steering lock unit circuit (IPDM E/R side) is open or shorted]</li><li>• Steering lock unit</li><li>• IPDM E/R</li></ul>

### DTC CONFIRMATION PROCEDURE

#### 1.PERFORM DTC CONFIRMATION PROCEDURE-1

1. Turn ignition switch ON under the following conditions and wait 1 second or more.

#### A/T models

- Selector lever is in the P or N position
- Do not depress brake pedal

#### M/T models

- Do not depress clutch pedal
2. Check "Self-diagnostic result" using CONSULT-III.

#### Is DTC detected?

- YES >> Go to [SEC-107, "Diagnosis Procedure"](#).  
NO >> GO TO 2.

#### 2.PERFORM DTC CONFIRMATION PROCEDURE-2

1. Turn ignition switch ON.
2. Turn ignition switch OFF.
3. Press driver side door switch and wait 1 second or more.
4. Check "Self-diagnostic result" using CONSULT-III.

#### Is DTC detected?

- YES >> Go to [SEC-107, "Diagnosis Procedure"](#).  
NO >> INSPECTION END

### Diagnosis Procedure

INFOID:000000004662990

#### 1.INSPECTION START

Perform inspection in accordance with procedure that confirms DTC.

#### Which procedure confirms DTC?

- DTC confirmation procedure 1>>GO TO 2.  
DTC confirmation procedure 2>>GO TO 6.

#### 2.CHECK BCM OUTPUT SIGNAL-1

1. Turn ignition switch OFF.

## B210A STEERING LOCK CONDITION SWITCH

### < DTC/CIRCUIT DIAGNOSIS >

2. Disconnect steering lock unit connector and IPDM E/R connector.
3. Check voltage between steering lock unit harness connector and ground.

(+)		(-)	Voltage (V) (Approx.)
Steering lock unit			
Connector	Terminal		
M40	3	Ground	Battery voltage

Is the inspection result normal?

- YES >> GO TO 4.  
NO >> GO TO 3.

### 3.CHECK STEERING LOCK UNIT CIRCUIT-1

1. Disconnect BCM connector.
2. Check continuity between steering lock unit harness connector and BCM harness connector.

Steering lock unit		BCM		Continuity
Connector	Terminal	Connector	Terminal	
M40	3	M122	97	Existed

3. Check continuity between steering lock unit harness connector and ground.

Steering lock unit		Ground	Continuity
Connector	Terminal		
M40	3		Not existed

Is the inspection result normal?

- YES >> Replace BCM. Refer to [BCS-81, "Removal and Installation"](#).  
NO >> Repair or replace harness.

### 4.CHECK IPDM E/R OUTPUT SIGNAL-1

1. Connect IPDM E/R connector.
2. Disconnect BCM connector.
3. Check voltage between steering lock unit harness connector and ground.

(+)		(-)	Voltage (V) (Approx.)
Steering lock unit			
Connector	Terminal		
M40	3	Ground	Battery voltage

Is the inspection result normal?

- YES >> Replace steering lock unit.  
NO >> GO TO 5.

### 5.CHECK STEERING LOCK UNIT CIRCUIT-2

1. Disconnect IPDM E/R connector.
2. Check continuity between steering lock unit harness connector and IPDM E/R harness connector.

Steering lock unit		IPDM E/R		Continuity
Connector	Terminal	Connector	Terminal	
M40	3	E5	32	Existed

3. Check continuity between steering lock unit harness connector and ground.

Steering lock unit		Ground	Continuity
Connector	Terminal		
M40	3		Not existed

## B210A STEERING LOCK CONDITION SWITCH

### < DTC/CIRCUIT DIAGNOSIS >

#### Is the inspection result normal?

- YES >> Replace IPDM E/R. Refer to [PCS-32, "Removal and Installation"](#).  
 NO >> Repair or replace harness.

### 6. CHECK BCM OUTPUT SIGNAL-2

1. Turn ignition switch OFF.
2. Disconnect steering lock unit connector and IPDM E/R connector.
3. Check voltage between steering lock unit harness connector and ground.

(+)		(-)	Voltage (V) (Approx.)
Steering lock unit			
Connector	Terminal		
M40	8	Ground	Battery voltage

#### Is the inspection result normal?

- YES >> GO TO 8.  
 NO >> GO TO 7.

### 7. CHECK STEERING LOCK UNIT CIRCUIT-3

1. Disconnect BCM connector.
2. Check continuity between steering lock unit harness connector and BCM harness connector.

Steering lock unit		BCM		Continuity
Connector	Terminal	Connector	Terminal	
M40	8	M122	98	Existed

3. Check continuity between steering lock unit harness connector and ground.

Steering lock unit		Ground	Continuity
Connector	Terminal		
M40	8		Not existed

#### Is the inspection result normal?

- YES >> Replace BCM. Refer to [BCS-81, "Removal and Installation"](#).  
 NO >> Repair or replace harness.

### 8. CHECK IPDM E/R OUTPUT SIGNAL-2

1. Connect IPDM E/R connector.
2. Disconnect BCM connector.
3. Check voltage between steering lock unit harness connector and ground.

(+)		(-)	Voltage (V) (Approx.)
Steering lock unit			
Connector	Terminal		
M40	8	Ground	Battery voltage

#### Is the inspection result normal?

- YES >> Replace steering lock unit.  
 NO >> GO TO 9.

### 9. CHECK STEERING LOCK UNIT CIRCUIT-4

1. Disconnect IPDM E/R connector.
2. Check continuity between steering lock unit harness connector and IPDM E/R harness connector.

Steering lock unit		IPDM E/R		Continuity
Connector	Terminal	Connector	Terminal	
M40	8	E5	33	Existed

A  
B  
C  
D  
E  
F  
G  
H  
I  
J  
L  
M  
N  
O  
P

SEC

## B210A STEERING LOCK CONDITION SWITCH

### < DTC/CIRCUIT DIAGNOSIS >

3. Check continuity between steering lock unit harness connector and ground.

Steering lock unit		Ground	Continuity
Connector	Terminal		
M40	8		Not existed

Is the inspection result normal?

YES >> Replace IPDM E/R. Refer to [PCS-32, "Removal and Installation"](#).

NO >> Repair or replace harness.

# B210B STARTER CONTROL RELAY

< DTC/CIRCUIT DIAGNOSIS >

## B210B STARTER CONTROL RELAY

### Description

INFOID:000000004662991

Starter control relay, integrated in IPDM E/R, permits the starter relay operation when in the N or P position and the steering is locked or unlocked. It is installed parallel to the starter relay.

### DTC Logic

INFOID:000000004662992

### DTC DETECTION LOGIC

#### NOTE:

If DTC B210B is displayed with DTC U1000, first perform the trouble diagnosis for DTC U1000. Refer to [SEC-36, "IPDM E/R \(INTELLIGENT POWER DISTRIBUTION MODULE ENGINE ROOM\) : DTC Logic"](#).

DTC No.	Trouble diagnosis name	DTC detecting condition	Possible cause
B210B	START CONT RLY ON	IPDM E/R detects that the relay is stuck in the ON position even if the following conditions are met for about 1 second. <ul style="list-style-type: none"><li>• Starter control relay ON/OFF signal from BCM</li><li>• Transmission range switch input signal</li></ul>	IPDM E/R

### DTC CONFIRMATION PROCEDURE

#### 1. PERFORM DTC CONFIRMATION PROCEDURE

1. Turn the power supply position to start under the following conditions and wait 1 second or more.

#### A/T models

- Selector lever is in the P or N position
- Do not depress brake pedal

#### M/T models

- Do not depress clutch pedal
2. Check "Self-diagnostic result" using CONSULT-III.

#### Is DTC detected?

- YES >> Go to [SEC-111, "Diagnosis Procedure"](#).
- NO >> INSPECTION END

### Diagnosis Procedure

INFOID:000000004662993

#### 1. INSPECTION START

1. Turn ignition switch ON.
2. Check "Self-diagnostic result" for IPDM E/R using CONSULT-III.
3. Touch "ERASE".
4. **Perform DTC Confirmation Procedure.**  
See [SEC-111, "DTC Logic"](#).

#### Is the DTC B210B displayed again?

- YES >> Replace IPDM E/R. Refer [PCS-32, "Removal and Installation"](#).
- NO >> INSPECTION END

# B210C STARTER CONTROL RELAY

< DTC/CIRCUIT DIAGNOSIS >

## B210C STARTER CONTROL RELAY

### Description

INFOID:000000004662994

Starter control relay, integrated in IPDM E/R, permits the starter relay operation when in the N or P position and the steering is locked or unlocked. It is installed parallel to the starter relay.

### DTC Logic

INFOID:000000004662995

### DTC DETECTION LOGIC

#### NOTE:

- If DTC B210C is displayed with DTC U1000, first perform the trouble diagnosis for DTC U1000. Refer to [SEC-36, "IPDM E/R \(INTELLIGENT POWER DISTRIBUTION MODULE ENGINE ROOM\) : DTC Logic"](#).
- When IPDM E/R power supply voltage is low (Approx. 7 - 8 V for about 1 second), the DTC B210C may be detected.

DTC No.	Trouble diagnosis name	DTC detecting condition	Possible cause
B210C	START CONT RLY OFF	IPDM E/R detects that the relay is stuck in the OFF position even if the following conditions are met for about 1 second. <ul style="list-style-type: none"><li>• Starter control relay ON/OFF signal from BCM</li><li>• Transmission range switch input signal</li></ul>	<ul style="list-style-type: none"><li>• IPDM E/R</li><li>• Battery</li></ul>

### DTC CONFIRMATION PROCEDURE

#### 1. PERFORM DTC CONFIRMATION PROCEDURE

1. Turn the power supply position to start under the following conditions and wait 1 second or more.

#### A/T models

- Selector lever is in the P or N position
- Do not depress brake pedal

#### M/T models

- Do not depress clutch pedal
2. Check "Self-diagnostic result" using CONSULT-III.

#### Is DTC detected?

- YES >> Go to [SEC-112, "Diagnosis Procedure"](#).  
NO >> INSPECTION END

### Diagnosis Procedure

INFOID:000000004662996

#### 1. INSPECTION START

1. Turn ignition switch ON.
2. Check "Self-diagnostic result" for IPDM E/R using CONSULT-III.
3. Touch "ERASE".
4. **Perform DTC Confirmation Procedure.**  
See [SEC-112, "DTC Logic"](#).

#### Is the DTC B210C displayed again?

- YES >> Replace IPDM E/R. Refer to [PCS-32, "Removal and Installation"](#).  
NO >> INSPECTION END



# B210D STARTER RELAY

< DTC/CIRCUIT DIAGNOSIS >

## B210D STARTER RELAY

### Description

INFOID:000000004662997

Located in IPDM E/R, the starter relay runs the starter motor. The starter relay is turned ON by the BCM when the ignition switch is in the START position. IPDM E/R transmits the starter relay ON signal to BCM via CAN communication.

### DTC Logic

INFOID:000000004662998

#### DTC DETECTION LOGIC

##### NOTE:

- If DTC B210D is displayed with DTC U1000, first perform the trouble diagnosis for DTC U1000. Refer to [SEC-36, "IPDM E/R \(INTELLIGENT POWER DISTRIBUTION MODULE ENGINE ROOM\) : DTC Logic"](#).
- If DTC B210D is displayed with DTC B2617, first perform the trouble diagnosis for DTC B2617. Refer to [SEC-98, "DTC Logic"](#).

DTC No.	Trouble diagnosis name	DTC detecting condition	Possible cause
B210D	STARTER RELAY ON	IPDM E/R detects that the relay is stuck in the ON position even if the following conditions are met for about 1 second. <ul style="list-style-type: none"><li>• Starter control relay ON/OFF signal from BCM</li><li>• Transmission range switch input</li></ul>	IPDM E/R

#### DTC CONFIRMATION PROCEDURE

##### 1. PERFORM DTC CONFIRMATION PROCEDURE

1. Turn ignition switch ON under the following conditions and wait for 1 second or more.

##### A/T models

- Selector lever is in the P or N position
- Do not depress brake pedal

##### M/T models

- Do not depress clutch pedal
2. Check "Self-diagnostic result" using CONSULT-III.

##### Is DTC detected?

- YES >> Go to [SEC-113, "Diagnosis Procedure"](#).  
NO >> INSPECTION END

#### Diagnosis Procedure

INFOID:000000004662999

##### 1. INSPECTION START

1. Turn ignition switch ON.
2. Check "Self-diagnostic result" for IPDM E/R using CONSULT-III.
3. Touch "ERASE".
4. **Perform DTC Confirmation Procedure.**  
See [SEC-113, "DTC Logic"](#).

##### Is the DTC B210D displayed again?

- YES >> Replace IPDM E/R. Refer to [PCS-32, "Removal and Installation"](#).  
NO >> INSPECTION END

# B210E STARTER RELAY

< DTC/CIRCUIT DIAGNOSIS >

## B210E STARTER RELAY

### Description

INFOID:000000004663000

Located in IPDM E/R, the starter relay runs the starter motor. The starter relay is turned ON by the BCM when the ignition switch is in the START position. IPDM E/R transmits the starter relay ON signal to BCM via CAN communication.

### DTC Logic

INFOID:000000004663001

#### DTC DETECTION LOGIC

##### NOTE:

- If DTC B210E is displayed with DTC U1000, first perform the trouble diagnosis for DTC U1000. Refer to [SEC-36, "IPDM E/R \(INTELLIGENT POWER DISTRIBUTION MODULE ENGINE ROOM\) : DTC Logic"](#).
- If DTC B210E is displayed with DTC B2110 for IPDM E/R, first perform the trouble diagnosis for DTC B2110. Refer to [SEC-118, "DTC Logic"](#).
- When IPDM E/R power supply voltage is low (Approx. 7 - 8 V for about 1 second), the DTC B210F may be detected.

DTC No.	Trouble diagnosis name	DTC detecting condition	Possible cause
B210E	STARTER RELAY OFF	IPDM E/R detects that the relay is stuck in the OFF position even if the following conditions are met for about 1 second. <ul style="list-style-type: none"> <li>• Starter control relay ON/OFF signal from BCM</li> <li>• Transmission range switch input</li> </ul>	<ul style="list-style-type: none"> <li>• IPDM E/R</li> <li>• Battery</li> </ul>

#### DTC CONFIRMATION PROCEDURE

##### 1. PERFORM DTC CONFIRMATION PROCEDURE

1. Turn ignition switch ON under the following conditions and wait 1 second or more.

##### A/T models

- Selector lever is in the P or N position
- Do not depress brake pedal

##### M/T models

- Do not depress clutch pedal
2. Check "Self-diagnostic result" using CONSULT-III.

##### Is DTC detected?

- YES >> Go to [SEC-114, "Diagnosis Procedure"](#).  
NO >> INSPECTION END

### Diagnosis Procedure

INFOID:000000004663002

##### 1. CHECK STARTER RELAY OUTPUT SIGNAL

1. Turn ignition switch OFF.
2. Disconnect BCM connector.
3. Check voltage between BCM harness connector and ground.

(+)		(-)	Condition	Voltage (V) (Approx.)	
BCM					
Connector	Terminal				
M121	52	Ground	Selector lever (A/T models)	P or N position	12
				Other than above	0
			Clutch pedal (M/T models)	Depressed	Battery voltage
				Not depressed	0

##### Is the inspection result normal?

- YES >> GO TO 3.  
NO >> GO TO 2.

## B210E STARTER RELAY

< DTC/CIRCUIT DIAGNOSIS >

### 2. CHECK STARTER RELAY OUTPUT SIGNAL CIRCUIT

1. Disconnect IPDM E/R connector.
2. Check continuity between BCM harness connector and IPDM E/R harness connector.

BCM		IPDM E/R		Continuity
Connector	Terminal	Connector	Terminal	
M121	52	E6	46	Existed

3. Check continuity between BCM harness connector and ground.

BCM		Ground	Continuity
Connector	Terminal		
M121	52		Not existed

Is the inspection result normal?

YES >> Replace IPDM E/R. Refer to [PCS-32. "Removal and Installation"](#).

NO >> Repair or replace harness.

### 3. CHECK STARTER RELAY POWER SUPPLY CIRCUIT

1. Turn ignition switch OFF.
2. Disconnect IPDM E/R connector.
3. Check voltage between IPDM E/R harness connector and ground.

(+)		(-)	Voltage (V) (Approx.)
IPDM E/R			
Connector	Terminal		
E5	36	Ground	Battery voltage

Is the inspection result normal?

YES >> Replace IPDM E/R. Refer to [PCS-32. "Removal and Installation"](#).

NO >> Check harness for open or short between IPDM E/R and battery. Refer to [SEC-195. "Wiring Diagram - IPDM E/R -"](#).

A  
B  
C  
D  
E  
F  
G  
H  
I  
J  
L  
M  
N  
O  
P

SEC

# B210F PNP/CLUTCH INTERLOCK SWITCH

< DTC/CIRCUIT DIAGNOSIS >

## B210F PNP/CLUTCH INTERLOCK SWITCH

### Description

INFOID:000000004663003

IPDM E/R confirms the shift position with the following signals.

- Transmission range switch
- Shift position signal from BCM (CAN)

### DTC Logic

INFOID:000000004663004

### DTC DETECTION LOGIC

#### NOTE:

If DTC B210F is displayed with DTC U1000, first perform the trouble diagnosis for DTC U1000. Refer to [SEC-36. "IPDM E/R \(INTELLIGENT POWER DISTRIBUTION MODULE ENGINE ROOM\) : DTC Logic"](#)

DTC No.	Trouble diagnosis name	DTC detecting condition	Possible cause
B210F	INTER LOCK/PNP SW ON	IPDM E/R detects the difference between the signals below for 1 second or more. <ul style="list-style-type: none"> <li>• Transmission range switch input signal</li> <li>• Shift position signal from BCM (CAN)</li> </ul>	<ul style="list-style-type: none"> <li>• Harness or connectors (Transmission range switch circuit is open or shorted)</li> <li>• Transmission range switch</li> <li>• IPDM E/R</li> <li>• BCM</li> </ul>

### DTC CONFIRMATION PROCEDURE

#### 1. PERFORM DTC CONFIRMATION PROCEDURE

1. Turn ignition switch ON under the following conditions and wait 1 second or more.
  - Selector lever is in the P or N position
  - Do not depress brake pedal
2. Check "Self-diagnostic result" using CONSULT-III.

#### Is DTC detected?

- YES >> Go to [SEC-116. "Diagnosis Procedure"](#).  
NO >> INSPECTION END

### Diagnosis Procedure

INFOID:000000004663005

#### 1. CHECK DTC WITH BCM

Check "Self-diagnostic result" using CONSULT-III. Refer to [SEC-185. "DTC Index"](#).

#### Is the inspection result normal?

- YES >> GO TO 2.  
NO >> Repair or replace the malfunctioning parts.

#### 2. CHECK TRANSMISSION RANGE SWITCH SIGNAL

1. Turn ignition switch OFF.
2. Disconnect IPDM E/R connector.
3. Turn ignition switch ON.
4. Check voltage between IPDM E/R harness connector and ground.

(+)		(-)	Condition	Voltage (V) (Approx.)	
IPDM E/R					
Connector	Terminal				
E5	30	Ground	Selector lever (A/T models)	N or P position	Battery voltage
				Other than above	0
			Clutch pedal (M/T models)	Depressed	Battery voltage
				Not depressed	0

#### Is the inspection result normal?

- YES >> Replace IPDM E/R. Refer to [PCS-32. "Removal and Installation"](#).

## B210F PNP/CLUTCH INTERLOCK SWITCH

### < DTC/CIRCUIT DIAGNOSIS >

NO >> GO TO 3.

### 3. CHECK TRANSMISSION RANGE SWITCH SIGNAL CIRCUIT

1. Disconnect BCM connector.
2. Check continuity between IPDM E/R harness connector and BCM harness connector.

IPDM E/R		BCM		Continuity
Connector	Terminal	Connector	Terminal	
E5	30	M123	140	Existed

3. Check continuity between IPDM E/R harness connector and ground.

IPDM E/R		Ground	Continuity
Connector	Terminal		
E5	30		Not existed

Is the inspection result normal?

- YES >> Replace BCM. Refer to [BCS-81, "Removal and Installation"](#).  
NO >> Repair or replace harness.

A  
B  
C  
D  
E  
F  
G  
H  
I  
J  
L  
M  
N  
O  
P

SEC

# B2110 PNP/CLUTCH INTERLOCK SWITCH

< DTC/CIRCUIT DIAGNOSIS >

## B2110 PNP/CLUTCH INTERLOCK SWITCH

### Description

INFOID:000000004663006

IPDM E/R confirms the shift position with the following signals.

- Transmission range switch
- Shift position signal from BCM (CAN)

### DTC Logic

INFOID:000000004663007

### DTC DETECTION LOGIC

#### NOTE:

If DTC B2110 is displayed with DTC U1000, first perform the trouble diagnosis for DTC U1000. Refer to [SEC-36. "IPDM E/R \(INTELLIGENT POWER DISTRIBUTION MODULE ENGINE ROOM\) : DTC Logic"](#).

DTC No.	Trouble diagnosis name	DTC detecting condition	Possible cause
B2110	INTER LOCK/PNP SW	IPDM E/R detects the difference between the signals below for 1 second or more. <ul style="list-style-type: none"><li>• Transmission range switch input signal</li><li>• Shift position signal from BCM (CAN)</li></ul>	<ul style="list-style-type: none"><li>• Harness or connectors (Transmission range switch circuit is open or shorted)</li><li>• Transmission range switch</li><li>• IPDM E/R</li><li>• BCM</li></ul>

### DTC CONFIRMATION PROCEDURE

#### 1. PERFORM DTC CONFIRMATION PROCEDURE

1. Turn the ignition switch ON under the following conditions and wait 1 second or more.

#### A/T models

- Selector lever is in the P or N position
- Do not depress brake pedal

#### M/T models

- Do not depress clutch pedal
2. Check "Self-diagnostic result" using CONSULT-III.

#### Is DTC detected?

- YES >> Go to [SEC-118. "Diagnosis Procedure"](#).  
NO >> INSPECTION END

### Diagnosis Procedure

INFOID:000000004663008

#### 1. CHECK DTC WITH BCM

Check "Self-diagnostic result" using CONSULT-III. Refer to [SEC-185. "DTC Index"](#).

#### Is the inspection result normal?

- YES >> GO TO 2.  
NO >> Repair or replace the malfunctioning parts.

#### 2. CHECK TRANSMISSION RANGE SWITCH SIGNAL

1. Turn ignition switch OFF.
2. Disconnect IPDM E/R connector.
3. Turn ignition switch ON.
4. Check voltage between IPDM E/R harness connector and ground.

## B2110 PNP/CLUTCH INTERLOCK SWITCH

### < DTC/CIRCUIT DIAGNOSIS >

(+)		(-)	Condition		Voltage (V) (Approx.)
IPDM E/R					
Connector	Terminal				
E5	30	Ground	Selector lever (A/T models)	N or P position	Battery voltage
				Other than above	0
			Clutch pedal (M/T models)	Depressed	Battery voltage
				Not depressed	0

Is the inspection result normal?

YES >> Replace IPDM E/R. Refer to [PCS-32. "Removal and Installation"](#).

NO >> GO TO 3.

### 3. CHECK TRANSMISSION RANGE SWITCH SIGNAL CIRCUIT

1. Disconnect BCM connector.
2. Check continuity between IPDM E/R harness connector and BCM harness connector.

IPDM E/R		BCM		Continuity
Connector	Terminal	Connector	Terminal	
E5	30	M123	140	Existed

3. Check continuity between IPDM E/R harness connector and ground.

IPDM E/R		Ground	Continuity
Connector	Terminal		
E5	30		Not existed

Is the inspection result normal?

YES >> Replace BCM. Refer to [BCS-81. "Removal and Installation"](#).

NO >> Repair or replace harness.

A  
B  
C  
D  
E  
F  
G  
H  
I  
J  
L  
M  
N  
O  
P

SEC

# POWER SUPPLY AND GROUND CIRCUIT

< DTC/CIRCUIT DIAGNOSIS >

## POWER SUPPLY AND GROUND CIRCUIT

### BCM

#### BCM : Diagnosis Procedure

INFOID:000000004663009

#### 1. CHECK FUSE AND FUSIBLE LINK

Check that the following fuse and fusible link are not blown.

Signal name	Fuse and fusible link No.
Battery power supply	K
	10

#### Is the fuse fusing?

- YES >> Replace the blown fuse or fusible link after repairing the affected circuit if a fuse or fusible link is blown.  
NO >> GO TO 2.

#### 2. CHECK POWER SUPPLY CIRCUIT

1. Turn ignition switch OFF.
2. Disconnect BCM connectors.
3. Check voltage between BCM harness connector and ground.

Terminals		Voltage (Approx.)
(+)	(-)	
BCM		Ground Battery voltage
Connector	Terminal	
M118	1	
M119	11	

#### Is the measurement value normal?

- YES >> GO TO 3.  
NO >> Repair harness or connector.

#### 3. CHECK GROUND CIRCUIT

Check continuity between BCM harness connector and ground.

BCM		Ground	Continuity
Connector	Terminal		Existed
M119	13		Existed

#### Does continuity exist?

- YES >> INSPECTION END  
NO >> Repair harness or connector.

## IPDM E/R (INTELLIGENT POWER DISTRIBUTION MODULE ENGINE ROOM)

### IPDM E/R (INTELLIGENT POWER DISTRIBUTION MODULE ENGINE ROOM) : Diagnosis Procedure

INFOID:000000004663010

#### 1. CHECK FUSES AND FUSIBLE LINK

Check that the following IPDM E/R fuses or fusible links are not blown.



# POWER SUPPLY AND GROUND CIRCUIT

## < DTC/CIRCUIT DIAGNOSIS >

Signal name	Fuses and fusible link No.
Battery power supply	C
	50
	51

### Is the fuse fusing?

- YES >> Replace the blown fuse or fusible link after repairing the affected circuit if a fuse or fusible link is blown.
- NO >> GO TO 2.

## 2.CHECK POWER SUPPLY CIRCUIT

- Turn the ignition switch OFF.
- Disconnect IPDM E/R connector.
- Check voltage between IPDM E/R harness connector and the ground.

Terminals		Voltage (Approx.)
(+)	(-)	
IPDM E/R		Battery voltage
Connector	Terminal	
E4	1	
	2	

### Is the measurement value normal?

- YES >> GO TO 3.
- NO >> Repair the harness or connector.

## 3.CHECK GROUND CIRCUIT

Check continuity between IPDM E/R harness connectors and the ground.

IPDM E/R		Ground	Continuity
Connector	Terminal		
E5	12		Existed
E6	41		

### Does continuity exist?

- YES >> INSPECTION END
- NO >> Repair the harness or connector.

# KEY SLOT

< DTC/CIRCUIT DIAGNOSIS >

## KEY SLOT

### Description

INFOID:000000004663011

When the Intelligent Key battery is discharged, it performs the NVIS (NATS) ID verification between the integrated transponder and BCM by inserting the Intelligent Key into the key slot, and then the engine can be started.

### Component Function Check

INFOID:000000004663012

#### 1. CHECK FUNCTION

1. Remove Intelligent Key battery from Intelligent Key.
2. Change power supply position when Intelligent Key insert into key slot and then press push-button ignition switch.

Is the inspection result normal?

- YES >> Key slot function is normal.  
NO >> Go to [SEC-122, "Diagnosis Procedure"](#).

### Diagnosis Procedure

INFOID:000000004663013

#### 1. CHECK KEY SLOT POWER SUPPLY CIRCUIT

1. Turn ignition switch OFF.
2. Disconnect key slot connector.
3. Check voltage between key slot harness connector and ground.

(+)		(-)	Voltage (V) (Approx.)
Key slot			
Connector	Terminal	Ground	Battery voltage
M22	1		
	5		

Is the inspection result normal?

- YES >> GO TO 2.  
NO-1 >> Check 10 A fuse [No. 6 and 9 located in the fuse block (J/B)].  
NO-2 >> Check harness for open or short between key slot and fuse.

#### 2. CHECK KEY SLOT GROUND CIRCUIT

Check continuity between key slot harness connector and ground.

Key slot		Ground	Continuity
Connector	Terminal		
M22	7	Ground	Existed

Is the inspection result normal?

- YES >> Replace key slot. Refer to [SEC-211, "Removal and Installation"](#).  
NO >> Repair or replace harness.

# KEY SLOT INDICATOR

< DTC/CIRCUIT DIAGNOSIS >

## KEY SLOT INDICATOR

### Description

INFOID:000000004663014

Blinks when Intelligent Key insertion is required.

### Component Function Check

INFOID:000000004663015

### 1.CHECK FUNCTION

Check key slot illumination ("KEY SLOT ILLUMI") Active Test mode.

Is the inspection result normal?

YES >> Key slot function is normal.

NO >> Refer to [SEC-123. "Diagnosis Procedure"](#).

### Diagnosis Procedure

INFOID:000000004663016

### 1.CHECK KEY SLOT INDICATOR OUTPUT SIGNAL

Check voltage between key slot harness connector and ground.

Key slot (+)		(-)	Condition	Key slot illumination	Voltage (V) (Approx.)
Connector	Terminal				
M22	6	Ground	Insert Intelligent Key into key slot	OFF	Battery voltage
			Remove Intelligent Key from key slot	ON	0

Is the inspection result normal?

YES >> GO TO 5.

NO >> GO TO 2.

### 2.CHECK KEY SLOT POWER SUPPLY CIRCUIT

1. Turn ignition switch OFF.
2. Disconnect key slot connector.
3. Check voltage between key slot harness connector and ground.

Key slot (+)		(-)	Voltage (V) (Approx.)
Connector	Terminal		
M22	1	Ground	Battery voltage
	5		

Is the inspection result normal?

YES >> GO TO 3.

NO-1 >> Check 10 A fuse [No. 6 and 9 located in the fuse block (J/B)].

NO-2 >> Check harness for open or short between key slot and fuse.

### 3.CHECK KEY SLOT GROUND CIRCUIT

Check continuity between key slot harness connector and ground.

Key slot		Ground	Continuity
Connector	Terminal		
M22	7		Existed

Is the inspection result normal?

YES >> GO TO 4.

A  
B  
C  
D  
E  
F  
G  
H  
I  
J  
L  
M  
N  
O  
P

SEC

# KEY SLOT INDICATOR

< DTC/CIRCUIT DIAGNOSIS >

NO >> Repair or replace key slot ground circuit.

## 4.CHECK KEY SLOT CIRCUIT

1. Turn ignition switch OFF.
2. Disconnect BCM connector.
3. Check continuity between BCM harness connector and key slot harness connector.

BCM		Key slot		Continuity
Connector	Terminal	Connector	Terminal	
M122	92	M22	6	Existed

4. Check continuity between BCM harness connector and ground.

BCM		Ground	Continuity
Connector	Terminal		
M122	92		Not existed

Is the inspection result normal?

YES >> Replace key slot. Refer to [SEC-211, "Removal and Installation"](#).

NO >> Repair or replace harness.

## 5.CHECK INTERMITTENT INCIDENT

Refer to [GI-41, "Intermittent Incident"](#).

>> INSPECTION END

# HOOD SWITCH

< DTC/CIRCUIT DIAGNOSIS >

## HOOD SWITCH

### Description

INFOID:000000004663017

Hood switch is built into hood lock (RH) and connected to IPDM E/R which detects the open/close condition of hood.

### Component Function Check

INFOID:000000004663018

#### 1.CHECK FUNCTION

1. Select "HOOD SW" in the "Data Monitor" mode using CONSULT-III.
2. Check the hood switch signal under the following condition.

Test item	Condition		Status
HOOD SW	Hood	Open	ON
		Close	OFF

Is the indication normal?

- YES >> Hood switch is normal.  
NO >> Go to [SEC-125. "Diagnosis Procedure"](#).

### Diagnosis Procedure

INFOID:000000004663019

#### 1.CHECK HOOD SWITCH SIGNAL

1. Turn ignition switch OFF.
2. Disconnect hood switch connector.
3. Check voltage between hood switch harness connector and ground.

(+)		(-)	Voltage (V) (Approx.)
Hood switch			
Connector	Terminal	Ground	Battery voltage
E30	2		

Is the inspection result normal?

- YES >> GO TO 3.  
NO >> GO TO 2.

#### 2.CHECK HOOD SWITCH CIRCUIT

1. Disconnect IPDM E/R connector.
2. Check continuity between IPDM E/R harness connector and hood switch harness connector.

IPDM E/R		Hood switch		Continuity
Connector	Terminal	Connector	Terminal	
E9	104	E30	2	Existed

3. Check continuity between IPDM E/R harness connector and ground.

IPDM E/R		Ground	Continuity
Connector	Terminal		
E9	104		Not existed

Is the inspection result normal?

- YES >> Replace IPDM E/R. Refer to [PCS-32. "Removal and Installation"](#).  
NO >> Repair or replace harness.

#### 3.CHECK HOOD SWITCH GROUND CIRCUIT

Check continuity between hood switch harness connector and ground.

A  
B  
C  
D  
E  
F  
G  
H  
I  
J  
L  
M  
N  
O  
P

SEC

# HOOD SWITCH

## < DTC/CIRCUIT DIAGNOSIS >

Hood switch		Ground	Continuity
Connector	Terminal		
E30	1		Existed

Is the inspection result normal?

- YES >> GO TO 4.  
 NO >> Repair or replace harness.

### 4.CHECK HOOD SWITCH

Refer to [SEC-126. "Component Inspection"](#).

Is the inspection result normal?

- YES >> GO TO 5.  
 NO >> Replace hood lock (RH). Refer to [DLK-209. "HOOD LOCK CONTROL : Removal and Installation"](#).

### 5.CHECK INTERMITTENT INCIDENT

Refer to [GI-41. "Intermittent Incident"](#).

>> INSPECTION END

## Component Inspection

INFOID:000000004663020

### 1.CHECK HOOD SWITCH

1. Turn ignition switch OFF.
2. Disconnect hood switch connector.
3. Check continuity between hood switch terminals.

Hood switch		Condition	Continuity
Terminal			
1	2	Hood switch	Pressed
			Released
			Not existed
			Existed

Is the inspection result normal?

- YES >> INSPECTION END  
 NO >> Replace hood lock (RH). Refer to [DLK-209. "HOOD LOCK CONTROL : Removal and Installation"](#).

# SECURITY INDICATOR LAMP

< DTC/CIRCUIT DIAGNOSIS >

## SECURITY INDICATOR LAMP

### Description

INFOID:000000004663021

- Security indicator lamp is located on combination meter.
- IVIS (Nissan Vehicle Immobilizer System) and vehicle security system conditions are indicated by blink or illumination of security indicator lamp.

### Component Function Check

INFOID:000000004663022

#### 1. CHECK FUNCTION

1. Perform "THEFT IND" in the "ACTIVE TEST" mode with CONSULT-III.
2. Check security indicator lamp operation.

Test item		Description	
THEFT IND	ON	Security indicator lamp	Illuminates
	OFF		Does not illuminate

Is the inspection result normal?

- YES >> INSPECTION END  
NO >> Go to [SEC-127, "Diagnosis Procedure"](#).

### Diagnosis Procedure

INFOID:000000004663023

#### 1. CHECK SECURITY INDICATOR LAMP POWER SUPPLY CIRCUIT

1. Turn ignition switch OFF.
2. Disconnect combination meter connector.
3. Check voltage between combination meter harness connector and ground.

(+)		(-)	Voltage (V) (Approx.)
Combination meter			
Connector	Terminal	Ground	Battery voltage
M53	1		

Is the inspection result normal?

- YES >> GO TO 2.  
NO-1 >> 10A fuse [No. 11, located in the fuse block (J/B)].  
NO-2 >> Harness for open or short between combination meter and fuse.

#### 2. CHECK SECURITY INDICATOR LAMP SIGNAL

1. Connect combination meter connector.
2. Disconnect BCM connector.
3. Check voltage between BCM harness connector and ground.

(+)		(-)	Voltage (V) (Approx.)
BCM			
Connector	Terminal	Ground	Battery voltage
M123	141		

Is the inspection result normal?

- YES >> Replace BCM. Refer to [BCS-81, "Removal and Installation"](#).  
NO >> GO TO 3.

#### 3. CHECK COMBINATION METER CIRCUIT

1. Disconnect BCM connector.
2. Check continuity between combination meter harness connector and BCM harness connector.

# SECURITY INDICATOR LAMP

## < DTC/CIRCUIT DIAGNOSIS >

Combination meter		BCM		Continuity
Connector	Terminal	Connector	Terminal	
M53	10	M123	141	Existed

3. Check continuity between combination meter harness connector and ground.

Combination meter		Ground	Continuity
Connector	Terminal		
M53	10		Not existed

Is the inspection result normal?

- YES >> Replace combination meter. Refer to [MWI-125, "Removal and Installation"](#).  
NO >> Repair or replace harness.



# KEY WARNING LAMP

< DTC/CIRCUIT DIAGNOSIS >

## KEY WARNING LAMP

### Description

INFOID:000000004663024

Performs operation method guide and warning together with buzzer.

### Component Function Check

INFOID:000000004663025

#### 1.CHECK FUNCTION

Check the operation with "INDICATOR" in "Active Test" mode using CONSULT-III.

Test item	Condition	
INDICATOR	KEY ON	Key warning lamp illuminates
	KEY IND	Key warning lamp blinks

Is the inspection result normal?

YES >> Key warning lamp in combination meter is normal.

NO >> Refer to [SEC-129, "Diagnosis Procedure"](#).

### Diagnosis Procedure

INFOID:000000004663026

#### 1.CHECK KEY WARNING LAMP

Refer to [MWI-35, "Diagnosis Description"](#).

Is the inspection result normal?

YES >> GO TO 2.

NO >> Repair or replace harness.

#### 2.CHECK INTERMITTENT INCIDENT

Refer to [GI-41, "Intermittent Incident"](#).

>> INSPECTION END

A  
B  
C  
D  
E  
F  
G  
H  
I  
J  
L  
M  
N  
O  
P

SEC

# INTELLIGENT KEY SYSTEM/ENGINE START FUNCTION

< DTC/CIRCUIT DIAGNOSIS >

## INTELLIGENT KEY SYSTEM/ENGINE START FUNCTION

### Wiring Diagram - INTELLIGENT KEY SYSTEM/ENGINE START FUNCTION -

INFOID:000000004663027

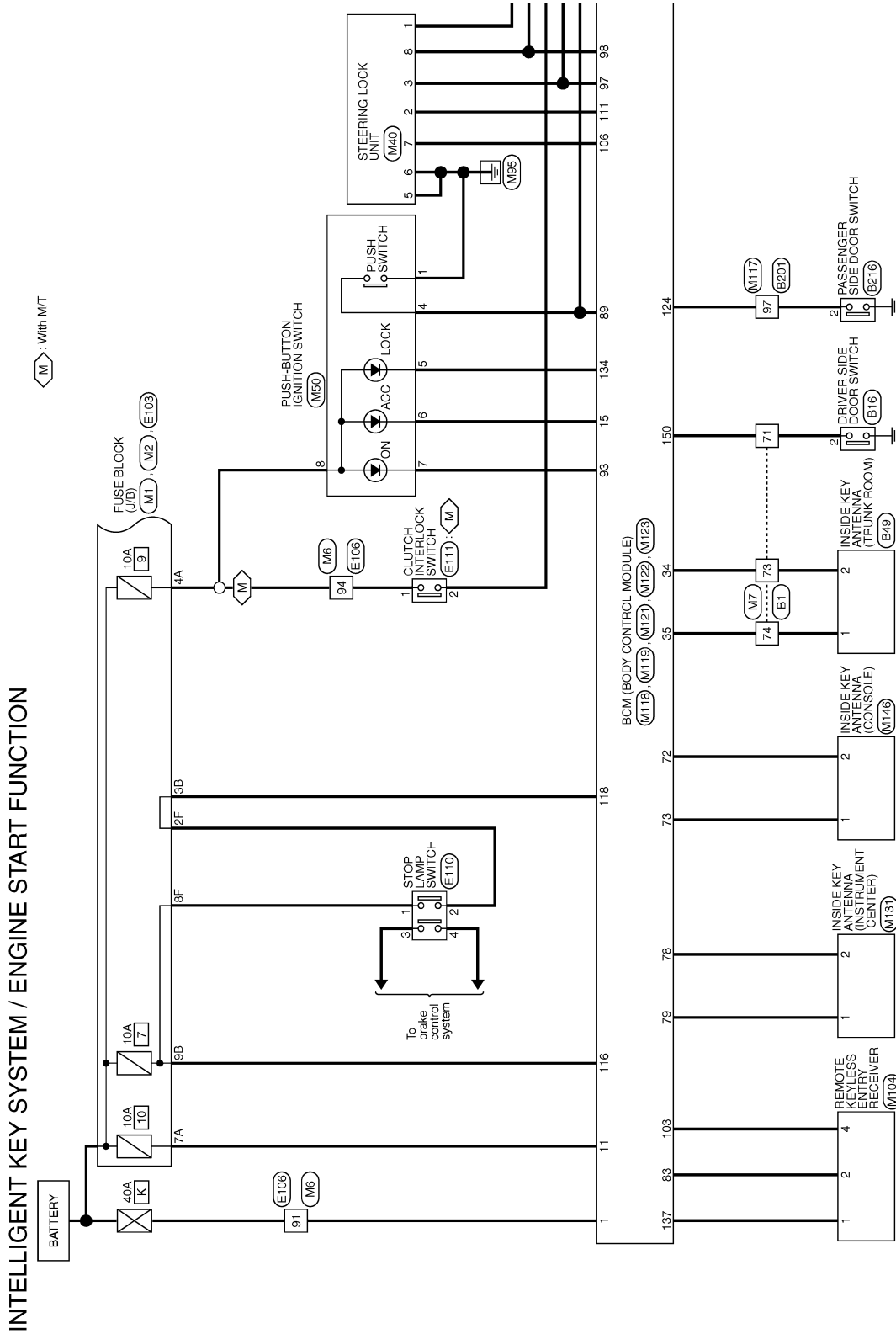

2008/08/22

JCKWM2122GI

# INTELLIGENT KEY SYSTEM/ENGINE START FUNCTION

< DTC/CIRCUIT DIAGNOSIS >

⬠: With AT  
⬠: With MT

\*: This connector is not shown in "Harness Layout".

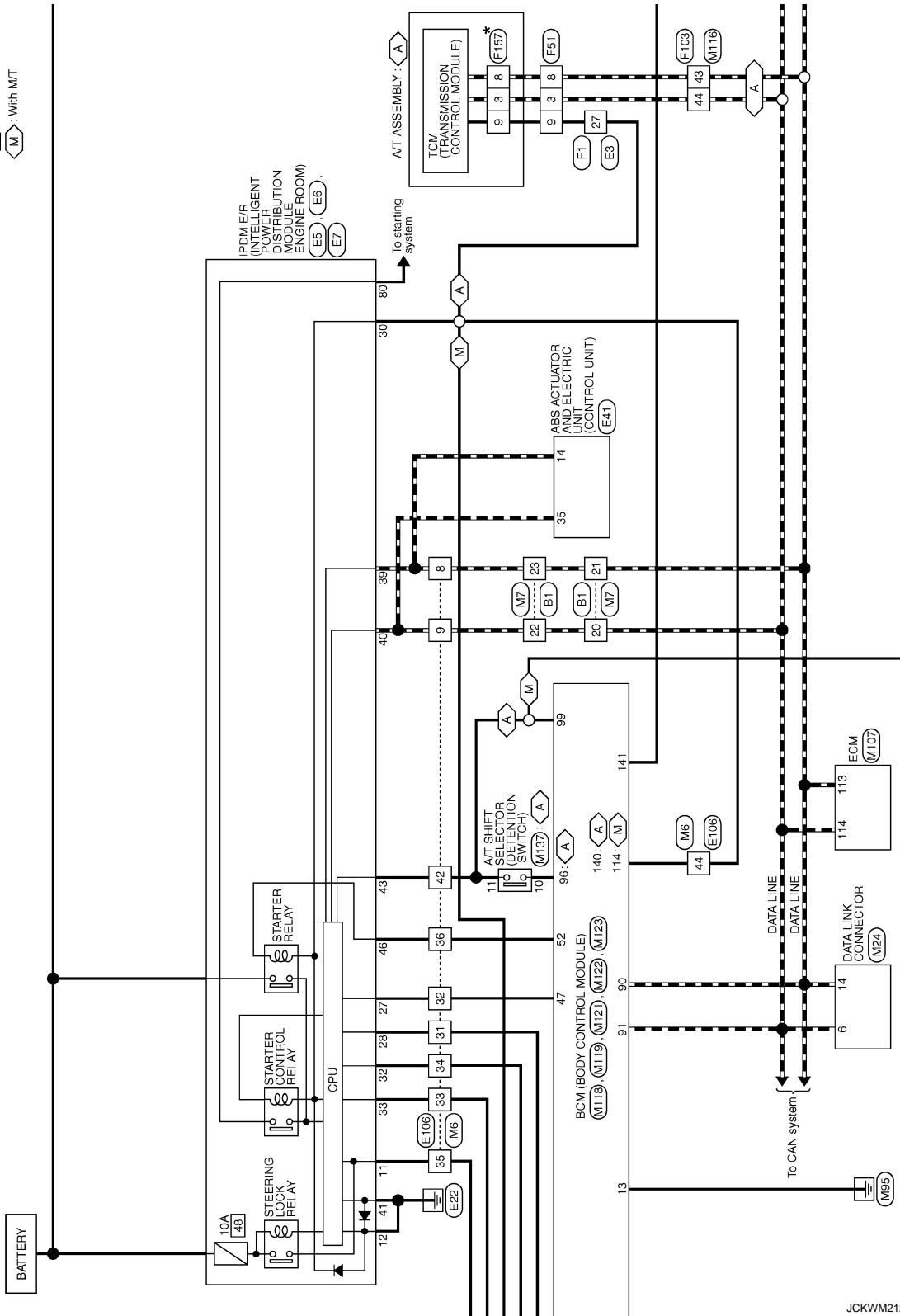

JCKWM2123GI

A  
B  
C  
D  
E  
F  
G  
H  
I  
J  
K  
L  
M  
N  
O  
P

SEC

# INTELLIGENT KEY SYSTEM/ENGINE START FUNCTION

## < DTC/CIRCUIT DIAGNOSIS >

A : With A/T  
M : With M/T

IC : With ICC  
OL : Without ICC

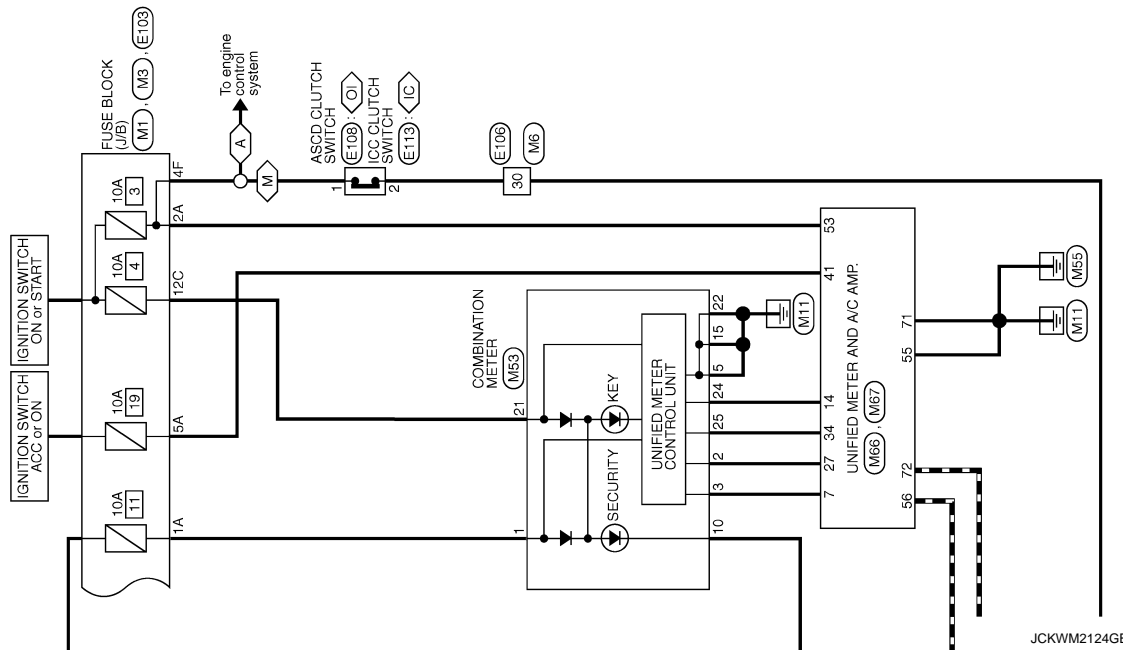





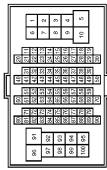
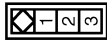

JCKWM2124Gf

# INTELLIGENT KEY SYSTEM/ENGINE START FUNCTION

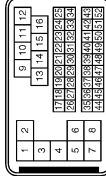
## < DTC/CIRCUIT DIAGNOSIS >

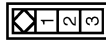
### INTELLIGENT KEY SYSTEM / ENGINE START FUNCTION

<table border="1"> <tr><td>Connector No.</td><td>B1</td></tr> <tr><td>Connector Name</td><td>WIRE TO WIRE</td></tr> <tr><td>Connector Type</td><td>TH08FW-CS16-TM4</td></tr> </table>  <table border="1"> <tr><td>Terminal No.</td><td>Color of Wire</td><td>Signal Name [Specification]</td></tr> <tr><td>20</td><td>L</td><td>-</td></tr> <tr><td>21</td><td>P</td><td>-</td></tr> <tr><td>22</td><td>L</td><td>-</td></tr> <tr><td>23</td><td>P</td><td>-</td></tr> <tr><td>24</td><td>V</td><td>-</td></tr> <tr><td>25</td><td>P</td><td>-</td></tr> <tr><td>26</td><td>L</td><td>-</td></tr> </table>	Connector No.	B1	Connector Name	WIRE TO WIRE	Connector Type	TH08FW-CS16-TM4	Terminal No.	Color of Wire	Signal Name [Specification]	20	L	-	21	P	-	22	L	-	23	P	-	24	V	-	25	P	-	26	L	-	<table border="1"> <tr><td>Connector No.</td><td>B16</td></tr> <tr><td>Connector Name</td><td>DRIVER SIDE DOOR SWITCH</td></tr> <tr><td>Connector Type</td><td>A03FW</td></tr> </table>  <table border="1"> <tr><td>Terminal No.</td><td>Color of Wire</td><td>Signal Name [Specification]</td></tr> <tr><td>2</td><td>V</td><td>-</td></tr> </table>	Connector No.	B16	Connector Name	DRIVER SIDE DOOR SWITCH	Connector Type	A03FW	Terminal No.	Color of Wire	Signal Name [Specification]	2	V	-	<table border="1"> <tr><td>Connector No.</td><td>B49</td></tr> <tr><td>Connector Name</td><td>INSIDE KEY ANTENNA (TRUNK ROOM)</td></tr> <tr><td>Connector Type</td><td>FKG2FGY</td></tr> </table>  <table border="1"> <tr><td>Terminal No.</td><td>Color of Wire</td><td>Signal Name [Specification]</td></tr> <tr><td>1</td><td>L</td><td>-</td></tr> <tr><td>2</td><td>P</td><td>-</td></tr> </table>	Connector No.	B49	Connector Name	INSIDE KEY ANTENNA (TRUNK ROOM)	Connector Type	FKG2FGY	Terminal No.	Color of Wire	Signal Name [Specification]	1	L	-	2	P	-	<table border="1"> <tr><td>Connector No.</td><td>E3</td></tr> <tr><td>Connector Name</td><td>WIRE TO WIRE</td></tr> <tr><td>Connector Type</td><td>SAA30MB-RS8-SH28</td></tr> </table>  <table border="1"> <tr><td>Terminal No.</td><td>Color of Wire</td><td>Signal Name [Specification]</td></tr> <tr><td>27</td><td>GR</td><td>-</td></tr> </table>	Connector No.	E3	Connector Name	WIRE TO WIRE	Connector Type	SAA30MB-RS8-SH28	Terminal No.	Color of Wire	Signal Name [Specification]	27	GR	-	<table border="1"> <tr><td>Connector No.</td><td>E6</td></tr> <tr><td>Connector Name</td><td>IPDM E/R (INTELLIGENT POWER DISTRIBUTION MODULE ENGINE ROOM)</td></tr> <tr><td>Connector Type</td><td>TH08FW-NH</td></tr> </table>  <table border="1"> <tr><td>Terminal No.</td><td>Color of Wire</td><td>Signal Name [Specification]</td></tr> <tr><td>39</td><td>P</td><td>-</td></tr> <tr><td>40</td><td>L</td><td>-</td></tr> <tr><td>41</td><td>B/W</td><td>-</td></tr> <tr><td>43</td><td>SB</td><td>- [W/RL A/T]</td></tr> <tr><td>46</td><td>P</td><td>- [W/RL M/T]</td></tr> </table>	Connector No.	E6	Connector Name	IPDM E/R (INTELLIGENT POWER DISTRIBUTION MODULE ENGINE ROOM)	Connector Type	TH08FW-NH	Terminal No.	Color of Wire	Signal Name [Specification]	39	P	-	40	L	-	41	B/W	-	43	SB	- [W/RL A/T]	46	P	- [W/RL M/T]
Connector No.	B1																																																																																																
Connector Name	WIRE TO WIRE																																																																																																
Connector Type	TH08FW-CS16-TM4																																																																																																
Terminal No.	Color of Wire	Signal Name [Specification]																																																																																															
20	L	-																																																																																															
21	P	-																																																																																															
22	L	-																																																																																															
23	P	-																																																																																															
24	V	-																																																																																															
25	P	-																																																																																															
26	L	-																																																																																															
Connector No.	B16																																																																																																
Connector Name	DRIVER SIDE DOOR SWITCH																																																																																																
Connector Type	A03FW																																																																																																
Terminal No.	Color of Wire	Signal Name [Specification]																																																																																															
2	V	-																																																																																															
Connector No.	B49																																																																																																
Connector Name	INSIDE KEY ANTENNA (TRUNK ROOM)																																																																																																
Connector Type	FKG2FGY																																																																																																
Terminal No.	Color of Wire	Signal Name [Specification]																																																																																															
1	L	-																																																																																															
2	P	-																																																																																															
Connector No.	E3																																																																																																
Connector Name	WIRE TO WIRE																																																																																																
Connector Type	SAA30MB-RS8-SH28																																																																																																
Terminal No.	Color of Wire	Signal Name [Specification]																																																																																															
27	GR	-																																																																																															
Connector No.	E6																																																																																																
Connector Name	IPDM E/R (INTELLIGENT POWER DISTRIBUTION MODULE ENGINE ROOM)																																																																																																
Connector Type	TH08FW-NH																																																																																																
Terminal No.	Color of Wire	Signal Name [Specification]																																																																																															
39	P	-																																																																																															
40	L	-																																																																																															
41	B/W	-																																																																																															
43	SB	- [W/RL A/T]																																																																																															
46	P	- [W/RL M/T]																																																																																															
<table border="1"> <tr><td>Connector No.</td><td>B218</td></tr> <tr><td>Connector Name</td><td>PASSENGER SIDE DOOR SWITCH</td></tr> <tr><td>Connector Type</td><td>A03FW</td></tr> </table>  <table border="1"> <tr><td>Terminal No.</td><td>Color of Wire</td><td>Signal Name [Specification]</td></tr> <tr><td>2</td><td>GR</td><td>-</td></tr> </table>	Connector No.	B218	Connector Name	PASSENGER SIDE DOOR SWITCH	Connector Type	A03FW	Terminal No.	Color of Wire	Signal Name [Specification]	2	GR	-	<table border="1"> <tr><td>Connector No.</td><td>E5</td></tr> <tr><td>Connector Name</td><td>IPDM E/R (INTELLIGENT POWER DISTRIBUTION MODULE ENGINE ROOM)</td></tr> <tr><td>Connector Type</td><td>TH02FW-CS12-MA-IV</td></tr> </table>  <table border="1"> <tr><td>Terminal No.</td><td>Color of Wire</td><td>Signal Name [Specification]</td></tr> <tr><td>11</td><td>BR</td><td>-</td></tr> <tr><td>12</td><td>B/W</td><td>-</td></tr> <tr><td>27</td><td>O</td><td>-</td></tr> <tr><td>28</td><td>L</td><td>-</td></tr> <tr><td>30</td><td>GR</td><td>-</td></tr> <tr><td>32</td><td>V</td><td>-</td></tr> <tr><td>33</td><td>P</td><td>-</td></tr> </table>	Connector No.	E5	Connector Name	IPDM E/R (INTELLIGENT POWER DISTRIBUTION MODULE ENGINE ROOM)	Connector Type	TH02FW-CS12-MA-IV	Terminal No.	Color of Wire	Signal Name [Specification]	11	BR	-	12	B/W	-	27	O	-	28	L	-	30	GR	-	32	V	-	33	P	-																																																						
Connector No.	B218																																																																																																
Connector Name	PASSENGER SIDE DOOR SWITCH																																																																																																
Connector Type	A03FW																																																																																																
Terminal No.	Color of Wire	Signal Name [Specification]																																																																																															
2	GR	-																																																																																															
Connector No.	E5																																																																																																
Connector Name	IPDM E/R (INTELLIGENT POWER DISTRIBUTION MODULE ENGINE ROOM)																																																																																																
Connector Type	TH02FW-CS12-MA-IV																																																																																																
Terminal No.	Color of Wire	Signal Name [Specification]																																																																																															
11	BR	-																																																																																															
12	B/W	-																																																																																															
27	O	-																																																																																															
28	L	-																																																																																															
30	GR	-																																																																																															
32	V	-																																																																																															
33	P	-																																																																																															

A  
B  
C  
D  
E  
F  
G  
H  
I  
J  
L  
M  
N  
O  
P

SEC

# INTELLIGENT KEY SYSTEM/ENGINE START FUNCTION

## < DTC/CIRCUIT DIAGNOSIS >

### INTELLIGENT KEY SYSTEM / ENGINE START FUNCTION

Connector No.	E7
Connector Name	IPDM E/R (INTELLIGENT POWER DISTRIBUTION MODULE ENGINE ROOM)
Connector Type	TH20FW-CS12-M4

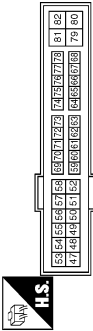

Terminal No.	Color of Wire	Signal Name [Specification]
80	W	-

Connector No.	E41
Connector Name	ABS ACTUATOR AND ELECTRIC UNIT (CONTROL UNIT)
Connector Type	EAA4ZFB-AE24-LH

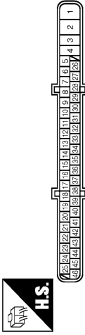

Terminal No.	Color of Wire	Signal Name [Specification]
14	P	CAN-L
35	L	CAN-H

Connector No.	E103
Connector Name	FUSE BLOCK (J/B)
Connector Type	NS16FW-CS

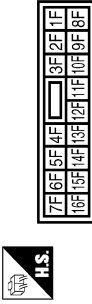

Terminal No.	Color of Wire	Signal Name [Specification]
2F	W	-
4F	G	-
8F	L	-

Connector No.	E106
Connector Name	WIRE TO WIRE
Connector Type	TH60FW-CS16-TM4

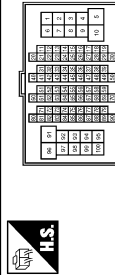

Terminal No.	Color of Wire	Signal Name [Specification]
44	GR	-
91	G	-
94	G	-

Connector No.	E108
Connector Name	ASCD CLUTCH SWITCH
Connector Type	S0ZFL



Connector No.	E110
Connector Name	STOP LAMP SWITCH
Connector Type	MM4FW-LC



Terminal No.	Color of Wire	Signal Name [Specification]
8	P	-
9	L	-
30	R	-
31	L	-
32	O	-
33	P	-
34	V	-
35	BR	-
36	W	- [With A/T]
36	P	- [With M/T]
42	SB	-

Terminal No.	Color of Wire	Signal Name [Specification]
1	G	-
2	R	-

Terminal No.	Color of Wire	Signal Name [Specification]
1	L	-
2	W	-
3	L	-
4	SB	-

JCKWM2126G

# INTELLIGENT KEY SYSTEM/ENGINE START FUNCTION

## < DTC/CIRCUIT DIAGNOSIS >

### INTELLIGENT KEY SYSTEM / ENGINE START FUNCTION

Connector No.	E111
Connector Name	CLUTCH INTERLOCK SWITCH
Connector Type	S0PFL



Terminal No.	Color of Wire	Signal Name [Specification]
1	G	-
2	GR	-

Connector No.	E113
Connector Name	IOC CLUTCH SWITCH
Connector Type	S0ZFL



Terminal No.	Color of Wire	Signal Name [Specification]
1	G	-
2	R	-

Connector No.	F1
Connector Name	WIRE TO WIRE
Connector Type	SAA3BFB-RS8-S1Z8

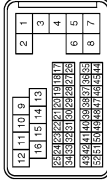

Terminal No.	Color of Wire	Signal Name [Specification]
27	GR	-

Connector No.	F51
Connector Name	A/T ASSEMBLY
Connector Type	RK10FG-DGY



Terminal No.	Color of Wire	Signal Name [Specification]
3	L	-
8	P	-
9	GR	-

Connector No.	F103
Connector Name	WIRE TO WIRE
Connector Type	TK3BFW-NS10



Terminal No.	Color of Wire	Signal Name [Specification]
43	P	-
44	L	-

Connector No.	F157
Connector Name	TGM (TRANSMISSION CONTROL MODULE)
Connector Type	SP10FG

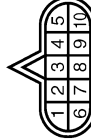

Terminal No.	Color of Wire	Signal Name [Specification]
3	R	CAN-H
8	BR	CAN-L
9	Y	STARTER RLY

Connector No.	M1
Connector Name	FUSE BLOCK (J/B)
Connector Type	NS06FW-M2



Terminal No.	Color of Wire	Signal Name [Specification]
1A	V	-
2A	G	-
4A	P	-
5A	L	-
7A	R	-

Connector No.	M2
Connector Name	FUSE BLOCK (J/B)
Connector Type	NS10FW-CS



Terminal No.	Color of Wire	Signal Name [Specification]
3B	P	-
9B	SB	-

A  
B  
C  
D  
E  
F  
G  
H  
I  
J  
K  
L  
M  
N  
O  
P

SEC

# INTELLIGENT KEY SYSTEM/ENGINE START FUNCTION

## < DTC/CIRCUIT DIAGNOSIS >

### INTELLIGENT KEY SYSTEM / ENGINE START FUNCTION

Connector No.	M3
Connector Name	FUSE BLOCK (J/B)
Connector Type	HS12FW-CS

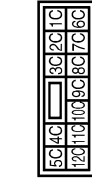

Terminal No.	Color of Wire	Signal Name [Specification]
12C	R	-

Connector No.	M6
Connector Name	WIRE TO WIRE
Connector Type	TH80MW-CS16-TM4

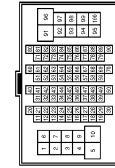

Terminal No.	Color of Wire	Signal Name [Specification]
8	P	-
9	L	-
30	R	-
31	V	-
32	Y	-
33	O	-
34	W	-
35	BR	-
36	SB	-
42	R	-
44	GR	- [With A/T]

44	R	- [With M/T]
91	W	-
94	P	-

Connector No.	M7
Connector Name	WIRE TO WIRE
Connector Type	TH80MW-CS16-TM4



Terminal No.	Color of Wire	Signal Name [Specification]
20	L	-
21	P	-
22	L	-
23	P	-
71	R	-
73	SB	-
74	V	-

Connector No.	M24
Connector Name	DATA LINK CONNECTOR
Connector Type	BD16FW-P

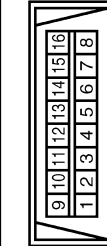

Connector No.	M40
Connector Name	STEERING LOCK UNIT
Connector Type	TH80FW-NH

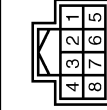

Connector No.	M50
Connector Name	PUSH-BUTTON IGNITION SWITCH
Connector Type	TK08FER

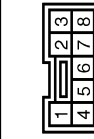

Connector No.	M53
Connector Name	COMBINATION METER
Connector Type	SAB40FW

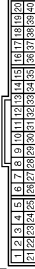

Terminal No.	Color of Wire	Signal Name [Specification]
6	L	-
14	P	-

Terminal No.	Color of Wire	Signal Name [Specification]
1	BR	S/L 12V (MECHANICAL)
2	Y	S/L (K LINE)
3	L	S/L COND1LON1
5	B	GND
6	B	GND
7	W	S/L 12V(GPU)
8	P	S/L COND1LON2

Terminal No.	Color of Wire	Signal Name [Specification]
1	GR	-
4	BR	-
5	LG	-
6	O	-
7	Y	-
8	P	-

Terminal No.	Color of Wire	Signal Name [Specification]
1	V	BATTERY
2	LG	COMMUNICATION SIGNAL (METER->AMP.)
3	GR	COMMUNICATION SIGNAL (AMP->METER)
5	B	GROUND
10	R	SECURITY
15	B	GROUND
21	R	IGNITION POWER SUPPLY
22	B	GROUND
24	BR	COMMUNICATION SIGNAL (LGD->AMP.)
25	Y	COMMUNICATION SIGNAL (AMP->LGD)



# INTELLIGENT KEY SYSTEM/ENGINE START FUNCTION

## < DTC/CIRCUIT DIAGNOSIS >

### INTELLIGENT KEY SYSTEM / ENGINE START FUNCTION

<table border="1"> <tr><td>Connector No.</td><td>M166</td></tr> <tr><td>Connector Name</td><td>UNIFIED METER AND A/C AMP.</td></tr> <tr><td>Connector Type</td><td>TH467V-NH</td></tr> </table> <table border="1"> <tr><th>Terminal No.</th><th>Color of Wire</th><th>Signal Name [Specification]</th></tr> <tr><td>7</td><td>GR</td><td>COMMUNICATION SIGNAL (AMP-&gt;METER)</td></tr> <tr><td>14</td><td>BR</td><td>COMMUNICATION SIGNAL (LCP-&gt;AMP.)</td></tr> <tr><td>27</td><td>LG</td><td>COMMUNICATION SIGNAL (METER-&gt;AMP.)</td></tr> <tr><td>34</td><td>Y</td><td>COMMUNICATION SIGNAL (AMP-&gt;LGD)</td></tr> </table>	Connector No.	M166	Connector Name	UNIFIED METER AND A/C AMP.	Connector Type	TH467V-NH	Terminal No.	Color of Wire	Signal Name [Specification]	7	GR	COMMUNICATION SIGNAL (AMP->METER)	14	BR	COMMUNICATION SIGNAL (LCP->AMP.)	27	LG	COMMUNICATION SIGNAL (METER->AMP.)	34	Y	COMMUNICATION SIGNAL (AMP->LGD)	<table border="1"> <tr><td>Connector No.</td><td>M167</td></tr> <tr><td>Connector Name</td><td>UNIFIED METER AND A/C AMP.</td></tr> <tr><td>Connector Type</td><td>TH432FV-NH</td></tr> </table> <table border="1"> <tr><th>Terminal No.</th><th>Color of Wire</th><th>Signal Name [Specification]</th></tr> <tr><td>41</td><td>L</td><td>ACC POWER SUPPLY</td></tr> <tr><td>53</td><td>G</td><td>IGNITION POWER SUPPLY</td></tr> <tr><td>55</td><td>B</td><td>GROUND</td></tr> <tr><td>56</td><td>L</td><td>CAN-H</td></tr> <tr><td>71</td><td>GR</td><td>GROUND</td></tr> <tr><td>72</td><td>P</td><td>CAN-L</td></tr> </table>	Connector No.	M167	Connector Name	UNIFIED METER AND A/C AMP.	Connector Type	TH432FV-NH	Terminal No.	Color of Wire	Signal Name [Specification]	41	L	ACC POWER SUPPLY	53	G	IGNITION POWER SUPPLY	55	B	GROUND	56	L	CAN-H	71	GR	GROUND	72	P	CAN-L	<table border="1"> <tr><td>Connector No.</td><td>M104</td></tr> <tr><td>Connector Name</td><td>REMOTE KEYLESS ENTRY RECEIVER</td></tr> <tr><td>Connector Type</td><td>JAB04FB</td></tr> </table> <table border="1"> <tr><th>Terminal No.</th><th>Color of Wire</th><th>Signal Name [Specification]</th></tr> <tr><td>1</td><td>O</td><td>GND</td></tr> <tr><td>2</td><td>Y</td><td>SIGNAL OUTPUT</td></tr> <tr><td>4</td><td>LG</td><td>BATTERY</td></tr> </table>	Connector No.	M104	Connector Name	REMOTE KEYLESS ENTRY RECEIVER	Connector Type	JAB04FB	Terminal No.	Color of Wire	Signal Name [Specification]	1	O	GND	2	Y	SIGNAL OUTPUT	4	LG	BATTERY	<table border="1"> <tr><td>Connector No.</td><td>M107</td></tr> <tr><td>Connector Name</td><td>ECM</td></tr> <tr><td>Connector Type</td><td>RH24FGY-RZP-R-LH-Z</td></tr> </table> <table border="1"> <tr><th>Terminal No.</th><th>Color of Wire</th><th>Signal Name [Specification]</th></tr> <tr><td>113</td><td>P</td><td>VEHICAN-LI</td></tr> <tr><td>114</td><td>L</td><td>VEHICAN-HI</td></tr> </table>	Connector No.	M107	Connector Name	ECM	Connector Type	RH24FGY-RZP-R-LH-Z	Terminal No.	Color of Wire	Signal Name [Specification]	113	P	VEHICAN-LI	114	L	VEHICAN-HI	<table border="1"> <tr><td>Connector No.</td><td>M116</td></tr> <tr><td>Connector Name</td><td>WIRE TO WIRE</td></tr> <tr><td>Connector Type</td><td>TK35MW-NS10</td></tr> </table> <table border="1"> <tr><th>Terminal No.</th><th>Color of Wire</th><th>Signal Name [Specification]</th></tr> <tr><td>43</td><td>P</td><td></td></tr> <tr><td>44</td><td>L</td><td></td></tr> </table>	Connector No.	M116	Connector Name	WIRE TO WIRE	Connector Type	TK35MW-NS10	Terminal No.	Color of Wire	Signal Name [Specification]	43	P		44	L		<table border="1"> <tr><td>Connector No.</td><td>M117</td></tr> <tr><td>Connector Name</td><td>WIRE TO WIRE</td></tr> <tr><td>Connector Type</td><td>TH80MW-CS16-TM4</td></tr> </table> <table border="1"> <tr><th>Terminal No.</th><th>Color of Wire</th><th>Signal Name [Specification]</th></tr> <tr><td>97</td><td>LG</td><td></td></tr> </table>	Connector No.	M117	Connector Name	WIRE TO WIRE	Connector Type	TH80MW-CS16-TM4	Terminal No.	Color of Wire	Signal Name [Specification]	97	LG		<table border="1"> <tr><td>Connector No.</td><td>M118</td></tr> <tr><td>Connector Name</td><td>ECM (BODY CONTROL MODULE)</td></tr> <tr><td>Connector Type</td><td>MD3FE-LC</td></tr> </table> <table border="1"> <tr><th>Terminal No.</th><th>Color of Wire</th><th>Signal Name [Specification]</th></tr> <tr><td>1</td><td>W</td><td>BAT (F/L)</td></tr> </table>	Connector No.	M118	Connector Name	ECM (BODY CONTROL MODULE)	Connector Type	MD3FE-LC	Terminal No.	Color of Wire	Signal Name [Specification]	1	W	BAT (F/L)	<table border="1"> <tr><td>Connector No.</td><td>M119</td></tr> <tr><td>Connector Name</td><td>ECM (BODY CONTROL MODULE)</td></tr> <tr><td>Connector Type</td><td>NS16FW-CS</td></tr> </table> <table border="1"> <tr><th>Terminal No.</th><th>Color of Wire</th><th>Signal Name [Specification]</th></tr> <tr><td>11</td><td>R</td><td>BAT (FUSE)</td></tr> <tr><td>13</td><td>B</td><td>GND</td></tr> <tr><td>15</td><td>O</td><td>ACC IND</td></tr> </table>	Connector No.	M119	Connector Name	ECM (BODY CONTROL MODULE)	Connector Type	NS16FW-CS	Terminal No.	Color of Wire	Signal Name [Specification]	11	R	BAT (FUSE)	13	B	GND	15	O	ACC IND
Connector No.	M166																																																																																																																																																
Connector Name	UNIFIED METER AND A/C AMP.																																																																																																																																																
Connector Type	TH467V-NH																																																																																																																																																
Terminal No.	Color of Wire	Signal Name [Specification]																																																																																																																																															
7	GR	COMMUNICATION SIGNAL (AMP->METER)																																																																																																																																															
14	BR	COMMUNICATION SIGNAL (LCP->AMP.)																																																																																																																																															
27	LG	COMMUNICATION SIGNAL (METER->AMP.)																																																																																																																																															
34	Y	COMMUNICATION SIGNAL (AMP->LGD)																																																																																																																																															
Connector No.	M167																																																																																																																																																
Connector Name	UNIFIED METER AND A/C AMP.																																																																																																																																																
Connector Type	TH432FV-NH																																																																																																																																																
Terminal No.	Color of Wire	Signal Name [Specification]																																																																																																																																															
41	L	ACC POWER SUPPLY																																																																																																																																															
53	G	IGNITION POWER SUPPLY																																																																																																																																															
55	B	GROUND																																																																																																																																															
56	L	CAN-H																																																																																																																																															
71	GR	GROUND																																																																																																																																															
72	P	CAN-L																																																																																																																																															
Connector No.	M104																																																																																																																																																
Connector Name	REMOTE KEYLESS ENTRY RECEIVER																																																																																																																																																
Connector Type	JAB04FB																																																																																																																																																
Terminal No.	Color of Wire	Signal Name [Specification]																																																																																																																																															
1	O	GND																																																																																																																																															
2	Y	SIGNAL OUTPUT																																																																																																																																															
4	LG	BATTERY																																																																																																																																															
Connector No.	M107																																																																																																																																																
Connector Name	ECM																																																																																																																																																
Connector Type	RH24FGY-RZP-R-LH-Z																																																																																																																																																
Terminal No.	Color of Wire	Signal Name [Specification]																																																																																																																																															
113	P	VEHICAN-LI																																																																																																																																															
114	L	VEHICAN-HI																																																																																																																																															
Connector No.	M116																																																																																																																																																
Connector Name	WIRE TO WIRE																																																																																																																																																
Connector Type	TK35MW-NS10																																																																																																																																																
Terminal No.	Color of Wire	Signal Name [Specification]																																																																																																																																															
43	P																																																																																																																																																
44	L																																																																																																																																																
Connector No.	M117																																																																																																																																																
Connector Name	WIRE TO WIRE																																																																																																																																																
Connector Type	TH80MW-CS16-TM4																																																																																																																																																
Terminal No.	Color of Wire	Signal Name [Specification]																																																																																																																																															
97	LG																																																																																																																																																
Connector No.	M118																																																																																																																																																
Connector Name	ECM (BODY CONTROL MODULE)																																																																																																																																																
Connector Type	MD3FE-LC																																																																																																																																																
Terminal No.	Color of Wire	Signal Name [Specification]																																																																																																																																															
1	W	BAT (F/L)																																																																																																																																															
Connector No.	M119																																																																																																																																																
Connector Name	ECM (BODY CONTROL MODULE)																																																																																																																																																
Connector Type	NS16FW-CS																																																																																																																																																
Terminal No.	Color of Wire	Signal Name [Specification]																																																																																																																																															
11	R	BAT (FUSE)																																																																																																																																															
13	B	GND																																																																																																																																															
15	O	ACC IND																																																																																																																																															

A  
B  
C  
D  
E  
F  
G  
H  
I  
J  
K  
L  
M  
N  
O  
P

SEC

# INTELLIGENT KEY SYSTEM/ENGINE START FUNCTION

## < DTC/CIRCUIT DIAGNOSIS >

### INTELLIGENT KEY SYSTEM / ENGINE START FUNCTION

Connector No.	M121
Connector Name	BCM (BODY CONTROL MODULE)
Connector Type	TH40FG-NH



1	2	3	4	5	6	7	8	9	10	11	12	13	14	15	16	17	18	19	20	21	22	23	24	25	26	27	28	29	30	31	32	33	34	35	36	37	38	39	40	41	42	43	44	45	46	47	48	49	50	51	52	53	54	55	56	57	58	59	60	61	62	63	64	65	66	67	68	69	70	71	72	73	74	75	76	77	78	79	80	81	82	83	84	85	86	87	88	89	90	91	92	93	94	95	96	97	98	99	100	101	102	103	104	105	106	107	108	109	110	111	112	113	114	115	116	117	118	119	120	121	122	123	124	125	126	127	128	129	130	131	132	133	134	135	136	137	138	139	140	141	142	143	144	145	146	147	148	149	150	151	152	153	154	155	156	157	158	159	160	161	162	163	164	165	166	167	168	169	170	171	172	173	174	175	176	177	178	179	180	181	182	183	184	185	186	187	188	189	190	191	192	193	194	195	196	197	198	199	200	201	202	203	204	205	206	207	208	209	210	211	212	213	214	215	216	217	218	219	220	221	222	223	224	225	226	227	228	229	230	231	232	233	234	235	236	237	238	239	240	241	242	243	244	245	246	247	248	249	250	251	252	253	254	255	256	257	258	259	260	261	262	263	264	265	266	267	268	269	270	271	272	273	274	275	276	277	278	279	280	281	282	283	284	285	286	287	288	289	290	291	292	293	294	295	296	297	298	299	300	301	302	303	304	305	306	307	308	309	310	311	312	313	314	315	316	317	318	319	320	321	322	323	324	325	326	327	328	329	330	331	332	333	334	335	336	337	338	339	340	341	342	343	344	345	346	347	348	349	350	351	352	353	354	355	356	357	358	359	360	361	362	363	364	365	366	367	368	369	370	371	372	373	374	375	376	377	378	379	380	381	382	383	384	385	386	387	388	389	390	391	392	393	394	395	396	397	398	399	400	401	402	403	404	405	406	407	408	409	410	411	412	413	414	415	416	417	418	419	420	421	422	423	424	425	426	427	428	429	430	431	432	433	434	435	436	437	438	439	440	441	442	443	444	445	446	447	448	449	450	451	452	453	454	455	456	457	458	459	460	461	462	463	464	465	466	467	468	469	470	471	472	473	474	475	476	477	478	479	480	481	482	483	484	485	486	487	488	489	490	491	492	493	494	495	496	497	498	499	500	501	502	503	504	505	506	507	508	509	510	511	512	513	514	515	516	517	518	519	520	521	522	523	524	525	526	527	528	529	530	531	532	533	534	535	536	537	538	539	540	541	542	543	544	545	546	547	548	549	550	551	552	553	554	555	556	557	558	559	560	561	562	563	564	565	566	567	568	569	570	571	572	573	574	575	576	577	578	579	580	581	582	583	584	585	586	587	588	589	590	591	592	593	594	595	596	597	598	599	600	601	602	603	604	605	606	607	608	609	610	611	612	613	614	615	616	617	618	619	620	621	622	623	624	625	626	627	628	629	630	631	632	633	634	635	636	637	638	639	640	641	642	643	644	645	646	647	648	649	650	651	652	653	654	655	656	657	658	659	660	661	662	663	664	665	666	667	668	669	670	671	672	673	674	675	676	677	678	679	680	681	682	683	684	685	686	687	688	689	690	691	692	693	694	695	696	697	698	699	700	701	702	703	704	705	706	707	708	709	710	711	712	713	714	715	716	717	718	719	720	721	722	723	724	725	726	727	728	729	730	731	732	733	734	735	736	737	738	739	740	741	742	743	744	745	746	747	748	749	750	751	752	753	754	755	756	757	758	759	760	761	762	763	764	765	766	767	768	769	770	771	772	773	774	775	776	777	778	779	780	781	782	783	784	785	786	787	788	789	790	791	792	793	794	795	796	797	798	799	800	801	802	803	804	805	806	807	808	809	810	811	812	813	814	815	816	817	818	819	820	821	822	823	824	825	826	827	828	829	830	831	832	833	834	835	836	837	838	839	840	841	842	843	844	845	846	847	848	849	850	851	852	853	854	855	856	857	858	859	860	861	862	863	864	865	866	867	868	869	870	871	872	873	874	875	876	877	878	879	880	881	882	883	884	885	886	887	888	889	890	891	892	893	894	895	896	897	898	899	900	901	902	903	904	905	906	907	908	909	910	911	912	913	914	915	916	917	918	919	920	921	922	923	924	925	926	927	928	929	930	931	932	933	934	935	936	937	938	939	940	941	942	943	944	945	946	947	948	949	950	951	952	953	954	955	956	957	958	959	960	961	962	963	964	965	966	967	968	969	970	971	972	973	974	975	976	977	978	979	980	981	982	983	984	985	986	987	988	989	990	991	992	993	994	995	996	997	998	999	1000
---	---	---	---	---	---	---	---	---	----	----	----	----	----	----	----	----	----	----	----	----	----	----	----	----	----	----	----	----	----	----	----	----	----	----	----	----	----	----	----	----	----	----	----	----	----	----	----	----	----	----	----	----	----	----	----	----	----	----	----	----	----	----	----	----	----	----	----	----	----	----	----	----	----	----	----	----	----	----	----	----	----	----	----	----	----	----	----	----	----	----	----	----	----	----	----	----	----	----	-----	-----	-----	-----	-----	-----	-----	-----	-----	-----	-----	-----	-----	-----	-----	-----	-----	-----	-----	-----	-----	-----	-----	-----	-----	-----	-----	-----	-----	-----	-----	-----	-----	-----	-----	-----	-----	-----	-----	-----	-----	-----	-----	-----	-----	-----	-----	-----	-----	-----	-----	-----	-----	-----	-----	-----	-----	-----	-----	-----	-----	-----	-----	-----	-----	-----	-----	-----	-----	-----	-----	-----	-----	-----	-----	-----	-----	-----	-----	-----	-----	-----	-----	-----	-----	-----	-----	-----	-----	-----	-----	-----	-----	-----	-----	-----	-----	-----	-----	-----	-----	-----	-----	-----	-----	-----	-----	-----	-----	-----	-----	-----	-----	-----	-----	-----	-----	-----	-----	-----	-----	-----	-----	-----	-----	-----	-----	-----	-----	-----	-----	-----	-----	-----	-----	-----	-----	-----	-----	-----	-----	-----	-----	-----	-----	-----	-----	-----	-----	-----	-----	-----	-----	-----	-----	-----	-----	-----	-----	-----	-----	-----	-----	-----	-----	-----	-----	-----	-----	-----	-----	-----	-----	-----	-----	-----	-----	-----	-----	-----	-----	-----	-----	-----	-----	-----	-----	-----	-----	-----	-----	-----	-----	-----	-----	-----	-----	-----	-----	-----	-----	-----	-----	-----	-----	-----	-----	-----	-----	-----	-----	-----	-----	-----	-----	-----	-----	-----	-----	-----	-----	-----	-----	-----	-----	-----	-----	-----	-----	-----	-----	-----	-----	-----	-----	-----	-----	-----	-----	-----	-----	-----	-----	-----	-----	-----	-----	-----	-----	-----	-----	-----	-----	-----	-----	-----	-----	-----	-----	-----	-----	-----	-----	-----	-----	-----	-----	-----	-----	-----	-----	-----	-----	-----	-----	-----	-----	-----	-----	-----	-----	-----	-----	-----	-----	-----	-----	-----	-----	-----	-----	-----	-----	-----	-----	-----	-----	-----	-----	-----	-----	-----	-----	-----	-----	-----	-----	-----	-----	-----	-----	-----	-----	-----	-----	-----	-----	-----	-----	-----	-----	-----	-----	-----	-----	-----	-----	-----	-----	-----	-----	-----	-----	-----	-----	-----	-----	-----	-----	-----	-----	-----	-----	-----	-----	-----	-----	-----	-----	-----	-----	-----	-----	-----	-----	-----	-----	-----	-----	-----	-----	-----	-----	-----	-----	-----	-----	-----	-----	-----	-----	-----	-----	-----	-----	-----	-----	-----	-----	-----	-----	-----	-----	-----	-----	-----	-----	-----	-----	-----	-----	-----	-----	-----	-----	-----	-----	-----	-----	-----	-----	-----	-----	-----	-----	-----	-----	-----	-----	-----	-----	-----	-----	-----	-----	-----	-----	-----	-----	-----	-----	-----	-----	-----	-----	-----	-----	-----	-----	-----	-----	-----	-----	-----	-----	-----	-----	-----	-----	-----	-----	-----	-----	-----	-----	-----	-----	-----	-----	-----	-----	-----	-----	-----	-----	-----	-----	-----	-----	-----	-----	-----	-----	-----	-----	-----	-----	-----	-----	-----	-----	-----	-----	-----	-----	-----	-----	-----	-----	-----	-----	-----	-----	-----	-----	-----	-----	-----	-----	-----	-----	-----	-----	-----	-----	-----	-----	-----	-----	-----	-----	-----	-----	-----	-----	-----	-----	-----	-----	-----	-----	-----	-----	-----	-----	-----	-----	-----	-----	-----	-----	-----	-----	-----	-----	-----	-----	-----	-----	-----	-----	-----	-----	-----	-----	-----	-----	-----	-----	-----	-----	-----	-----	-----	-----	-----	-----	-----	-----	-----	-----	-----	-----	-----	-----	-----	-----	-----	-----	-----	-----	-----	-----	-----	-----	-----	-----	-----	-----	-----	-----	-----	-----	-----	-----	-----	-----	-----	-----	-----	-----	-----	-----	-----	-----	-----	-----	-----	-----	-----	-----	-----	-----	-----	-----	-----	-----	-----	-----	-----	-----	-----	-----	-----	-----	-----	-----	-----	-----	-----	-----	-----	-----	-----	-----	-----	-----	-----	-----	-----	-----	-----	-----	-----	-----	-----	-----	-----	-----	-----	-----	-----	-----	-----	-----	-----	-----	-----	-----	-----	-----	-----	-----	-----	-----	-----	-----	-----	-----	-----	-----	-----	-----	-----	-----	-----	-----	-----	-----	-----	-----	-----	-----	-----	-----	-----	-----	-----	-----	-----	-----	-----	-----	-----	-----	-----	-----	-----	-----	-----	-----	-----	-----	-----	-----	-----	-----	-----	-----	-----	-----	-----	-----	-----	-----	-----	-----	-----	-----	-----	-----	-----	-----	-----	-----	-----	-----	-----	-----	-----	-----	-----	-----	-----	-----	-----	-----	-----	-----	-----	-----	-----	-----	-----	-----	-----	-----	-----	-----	-----	-----	-----	-----	-----	-----	-----	-----	-----	-----	-----	-----	-----	-----	-----	-----	-----	-----	-----	-----	-----	-----	-----	-----	-----	-----	-----	-----	-----	-----	-----	-----	-----	-----	-----	-----	-----	-----	-----	-----	-----	-----	-----	-----	-----	-----	-----	-----	-----	-----	-----	-----	-----	-----	-----	-----	-----	-----	-----	-----	-----	-----	-----	-----	-----	-----	-----	-----	-----	-----	-----	-----	-----	-----	-----	-----	-----	-----	-----	-----	-----	-----	-----	-----	-----	-----	-----	-----	-----	-----	-----	-----	-----	-----	-----	-----	-----	-----	-----	-----	-----	-----	-----	-----	-----	-----	-----	-----	-----	-----	-----	-----	-----	-----	-----	-----	-----	-----	-----	-----	-----	-----	-----	-----	-----	-----	-----	-----	-----	-----	-----	-----	-----	-----	-----	-----	-----	-----	-----	-----	-----	-----	-----	-----	-----	-----	-----	-----	-----	-----	-----	-----	-----	-----	-----	-----	-----	-----	-----	-----	-----	-----	-----	-----	-----	-----	-----	-----	-----	-----	-----	------

Terminal No.	Color of Wire	Signal Name [Specification]
34	SB	TRUNK ROOM ANT-
35	V	TRUNK ROOM ANT+
47	Y	IGN RELAY (PDM/E/R) CONT
52	SB	STARTER RELAY CONT

Connector No.	M131
Connector Name	INSIDE KEY ANTENNA (INSTRUMENT CENTER)
Connector Type	RK02FGY



Terminal No.	Color of Wire	Signal Name [Specification]
1	BR	-
2	Y	-

Connector No.	M122
Connector Name	BCM (BODY CONTROL MODULE)
Connector Type	TH40FB-NH



1	2	3	4	5	6	7	8	9	10	11	12	13	14	15	16	17	18	19	20	21	22	23	24	25	26	27	28	29	30	31	32	33	34	35	36	37	38	39	40	41	42	43	44	45	46	47	48	49	50	51	52	53	54	55	56	57	58	59	60	61	62	63	64	65	66	67	68	69	70	71	72	73	74	75	76	77	78	79	80	81	82	83	84	85	86	87	88	89	90	91	92	93	94	95	96	97	98	99	100	101	102	103	104	105	106	107	108	109	110	111	112	113	114	115	116	117	118	119	120	121	122	123	124	125	126	127	128	129	130	131	132	133	134	135	136	137	138	139	140	141	142	143	144	145	146	147	148	149	150	151	152	153	154	155	156	157	158	159	160	161	162	163	164	165	166	167	168	169	170	171	172	173	174	175	176	177	178	179	180	181	182	183	184	185	186	187	188	189	190	191	192	193	194	195	196	197	198	199	200	201	202	203	204	205	206	207	208	209	210	211	212	213	214	215	216	217	218	219	220	221	222	223	224	225	226	227	228	229	230	231	232	233	234	235	236	237	238	239	240	241	242	243	244	245	246	247	248	249	250	251	252	253	254	255	256	257	258	259	260	261	262	263	264	265	266	267	268	269	270	271	272	273	274	275	276	277	278	279	280	281	282	283	284	285	286	287	288	289	290	291	292	293	294	295	296	297	298	299	300	301	302	303	304	305	306	307	308	309	310	311	312	313	314	315	316	317	318	319	320	321	322	323	324	325	326	327	328	329	330	331	332	333	334	335	336	337	338	339	340	341	342	343	344	345	346	347	348	349	350	351	352	353	354	355	356	357	358	359	360	361	362	363	364	365	366	367	368	369	370	371	372	373	374	375	376	377	378	379	380	381	382	383	384	385	386	387	388	389	390	391	392	393	394	395	396	397	398	399	400	401	402	403	404	405	406	407	408	409	410	411	412	413	414	415	416	417	418	419	420	421	422	423	424	425	426	427	428	429	430	431	432	433	434	435	436	437	438	439</
---	---	---	---	---	---	---	---	---	----	----	----	----	----	----	----	----	----	----	----	----	----	----	----	----	----	----	----	----	----	----	----	----	----	----	----	----	----	----	----	----	----	----	----	----	----	----	----	----	----	----	----	----	----	----	----	----	----	----	----	----	----	----	----	----	----	----	----	----	----	----	----	----	----	----	----	----	----	----	----	----	----	----	----	----	----	----	----	----	----	----	----	----	----	----	----	----	----	----	-----	-----	-----	-----	-----	-----	-----	-----	-----	-----	-----	-----	-----	-----	-----	-----	-----	-----	-----	-----	-----	-----	-----	-----	-----	-----	-----	-----	-----	-----	-----	-----	-----	-----	-----	-----	-----	-----	-----	-----	-----	-----	-----	-----	-----	-----	-----	-----	-----	-----	-----	-----	-----	-----	-----	-----	-----	-----	-----	-----	-----	-----	-----	-----	-----	-----	-----	-----	-----	-----	-----	-----	-----	-----	-----	-----	-----	-----	-----	-----	-----	-----	-----	-----	-----	-----	-----	-----	-----	-----	-----	-----	-----	-----	-----	-----	-----	-----	-----	-----	-----	-----	-----	-----	-----	-----	-----	-----	-----	-----	-----	-----	-----	-----	-----	-----	-----	-----	-----	-----	-----	-----	-----	-----	-----	-----	-----	-----	-----	-----	-----	-----	-----	-----	-----	-----	-----	-----	-----	-----	-----	-----	-----	-----	-----	-----	-----	-----	-----	-----	-----	-----	-----	-----	-----	-----	-----	-----	-----	-----	-----	-----	-----	-----	-----	-----	-----	-----	-----	-----	-----	-----	-----	-----	-----	-----	-----	-----	-----	-----	-----	-----	-----	-----	-----	-----	-----	-----	-----	-----	-----	-----	-----	-----	-----	-----	-----	-----	-----	-----	-----	-----	-----	-----	-----	-----	-----	-----	-----	-----	-----	-----	-----	-----	-----	-----	-----	-----	-----	-----	-----	-----	-----	-----	-----	-----	-----	-----	-----	-----	-----	-----	-----	-----	-----	-----	-----	-----	-----	-----	-----	-----	-----	-----	-----	-----	-----	-----	-----	-----	-----	-----	-----	-----	-----	-----	-----	-----	-----	-----	-----	-----	-----	-----	-----	-----	-----	-----	-----	-----	-----	-----	-----	-----	-----	-----	-----	-----	-----	-----	-----	-----	-----	-----	-----	-----	-----	-----	-----	-----	-----	-----	-----	-----	-----	-----	-----	-----	-----	-----	-----	-----	-----	-----	-----	-----	-----	-----	-----	-----	-----	-----	-----	-----	-----	-----	-----	-----	-----	-----	-----	-----	-----	-----	-----	-----	-----	-----	-----	-----	-----	-----	-----	-----	-----	-----	-----	-----	-----	-------

# INFINITI VEHICLE IMMOBILIZER SYSTEM-NATS

< DTC/CIRCUIT DIAGNOSIS >

## INFINITI VEHICLE IMMOBILIZER SYSTEM-NATS

Wiring Diagram - IVIS -

INFOID:000000004663029

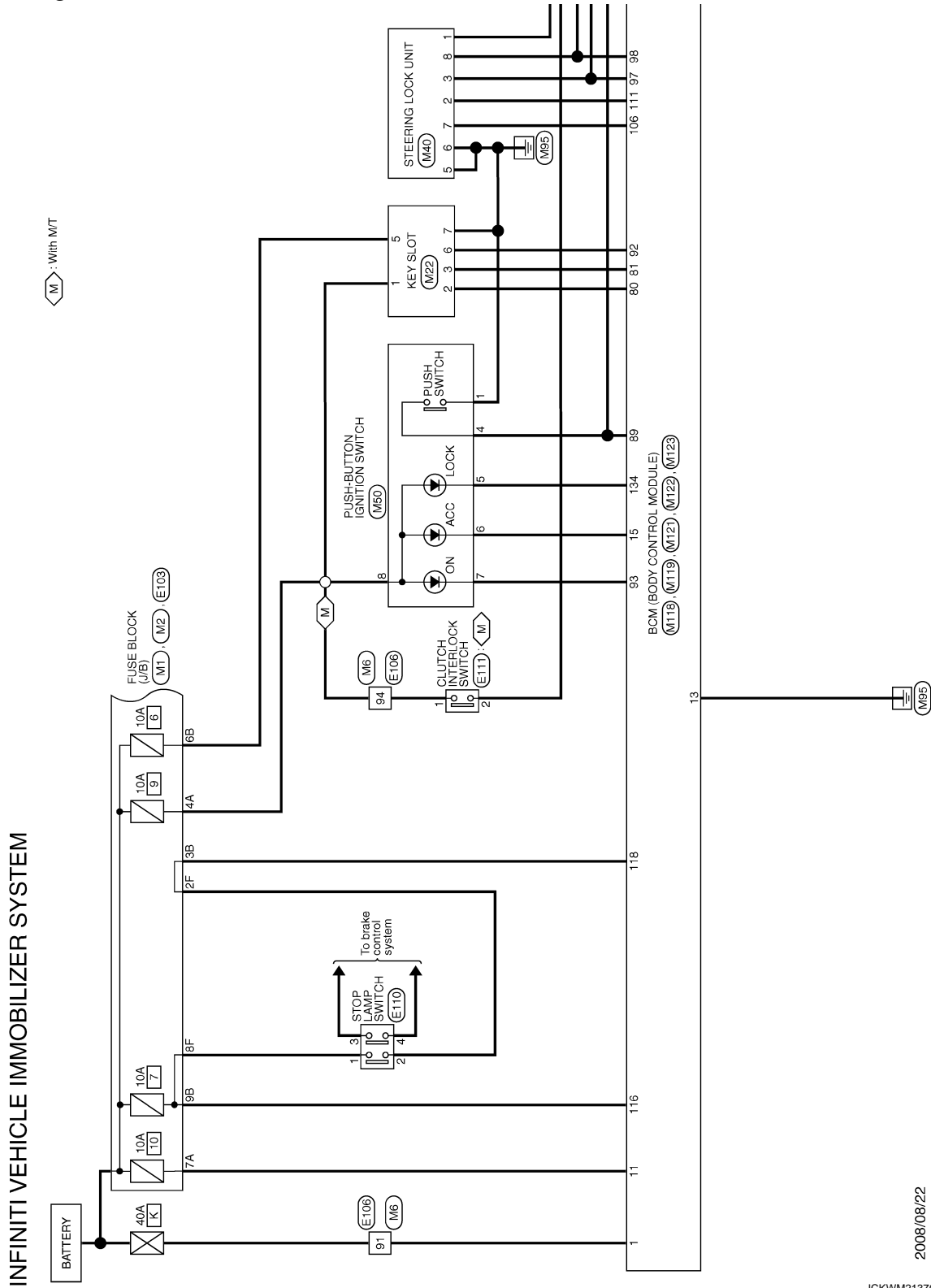

A  
B  
C  
D  
E  
F  
G  
H  
I  
J  
K  
L  
M  
N  
O  
P

SEC

2008/08/22

JCKWM2137GI

# INFINITI VEHICLE IMMOBILIZER SYSTEM-NATS

## < DTC/CIRCUIT DIAGNOSIS >

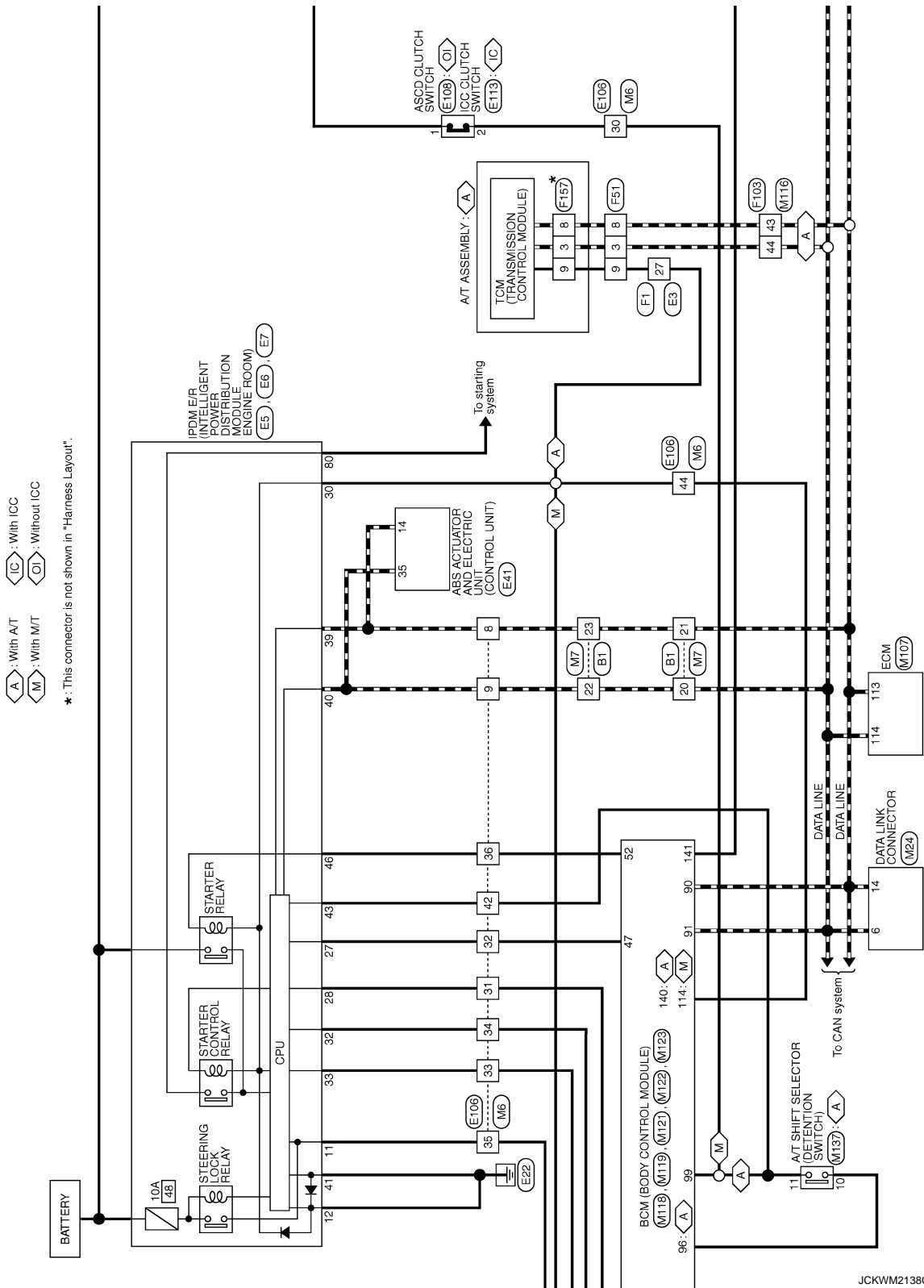



# INFINITI VEHICLE IMMOBILIZER SYSTEM-NATS

## < DTC/CIRCUIT DIAGNOSIS >

### INFINITI VEHICLE IMMOBILIZER SYSTEM

Connector No.	E6
Connector Name	IPDM E/R (INTELLIGENT POWER DISTRIBUTION MODULE ENGINE ROOM)
Connector Type	TH08FW-NH



Terminal No.	Color of Wire	Signal Name [Specification]
39	P	-
40	L	-
41	B/W	-
43	SS	-
46	W	- [With A/T]
46	P	- [With M/T]

Connector No.	E5
Connector Name	IPDM E/R (INTELLIGENT POWER DISTRIBUTION MODULE ENGINE ROOM)
Connector Type	TH20FW-CS12-M4-IV



Terminal No.	Color of Wire	Signal Name [Specification]
11	BR	-
12	B/W	-
27	O	-
30	GR	-
32	V	-
33	P	-

Connector No.	E103
Connector Name	FUSE BLOCK (U/B)
Connector Type	NS18FW-CS



Terminal No.	Color of Wire	Signal Name [Specification]
2F	W	-
4F	G	-
8F	L	-

Connector No.	E3
Connector Name	WIRE TO WIRE
Connector Type	SAA38MB-RS8-SH28

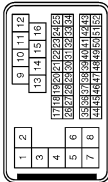

Terminal No.	Color of Wire	Signal Name [Specification]
27	GR	-

Connector No.	E41
Connector Name	ABS ACTUATOR AND ELECTRIC UNIT (CONTROL UNIT)
Connector Type	BAA42FB-AHZ4-LH



Terminal No.	Color of Wire	Signal Name [Specification]
14	P	CAN-L
35	L	CAN-H

Connector No.	B1
Connector Name	WIRE TO WIRE
Connector Type	TH80FW-CS16-TM4

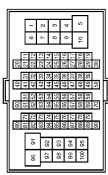

Terminal No.	Color of Wire	Signal Name [Specification]
20	L	-
21	P	-
22	L	-
23	P	-

Connector No.	E7
Connector Name	IPDM E/R (INTELLIGENT POWER DISTRIBUTION MODULE ENGINE ROOM)
Connector Type	TH20FW-CS12-M4

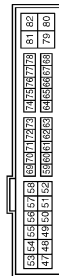

Terminal No.	Color of Wire	Signal Name [Specification]
80	W	-

JCKW2140G1



# INFINITI VEHICLE IMMOBILIZER SYSTEM-NATS

## < DTC/CIRCUIT DIAGNOSIS >

### INFINITI VEHICLE IMMOBILIZER SYSTEM

Connector No.	M2
Connector Name	FUSE BLOCK (J/B)
Connector Type	NS10FW-CS



Terminal No.	Color of Wire	Signal Name [Specification]
3B	P	-
6B	Y	-
9B	SB	-

Connector No.	M1
Connector Name	FUSE BLOCK (J/B)
Connector Type	NS68FW-M2



Terminal No.	Color of Wire	Signal Name [Specification]
1A	V	-
2A	G	-
4A	P	-
5A	L	-
7A	R	-

Connector No.	F157
Connector Name	TCM (TRANSMISSION CONTROL MODULE)
Connector Type	SP10FG

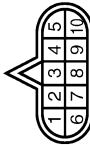

Terminal No.	Color of Wire	Signal Name [Specification]
3	R	CAN-H
8	BR	CAN-L
9	Y	STARTER RLY

Connector No.	F103
Connector Name	WIRE TO WIRE
Connector Type	TK68FW-NS10

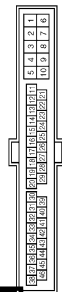

Terminal No.	Color of Wire	Signal Name [Specification]
43	P	-
44	L	-

Connector No.	M7
Connector Name	WIRE TO WIRE
Connector Type	TH80MW-CS16-TM4

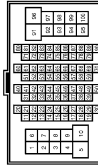

Terminal No.	Color of Wire	Signal Name [Specification]
44	R	- [With M/T]
91	W	-
94	P	-

Connector No.	M6
Connector Name	WIRE TO WIRE
Connector Type	TH80MW-CS16-TM4



Connector No.	M3
Connector Name	FUSE BLOCK (J/B)
Connector Type	NS12FW-CS

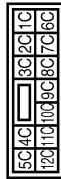

Terminal No.	Color of Wire	Signal Name [Specification]
20	L	-
21	P	-
22	L	-
23	P	-

Terminal No.	Color of Wire	Signal Name [Specification]
8	P	-
9	L	-
30	R	-
31	V	-
32	Y	-
33	O	-
34	W	-
35	BR	-
36	SB	-
42	R	-
44	GR	- [With A/T]

Terminal No.	Color of Wire	Signal Name [Specification]
12C	R	-

JCKWM2142GI



# INFINITI VEHICLE IMMOBILIZER SYSTEM-NATS

< DTC/CIRCUIT DIAGNOSIS >

## INFINITI VEHICLE IMMOBILIZER SYSTEM

Connector No.	M22
Connector Name	KEY SLOT
Connector Type	TH12FW-NH

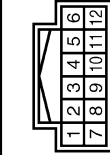

Terminal No.	Color of Wire	Signal Name [Specification]
1	R	BAT
2	GR	GLOCK
3	W	DATA
5	Y	ILL BATT
6	LG	ILL
7	B	GND

Connector No.	M24
Connector Name	DATA LINK CONNECTOR
Connector Type	BD16FW-P

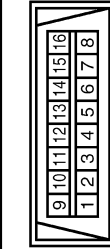

Terminal No.	Color of Wire	Signal Name [Specification]
6	L	-
14	P	-

Connector No.	M40
Connector Name	STEERING LOCK UNIT
Connector Type	TH40FW-NH

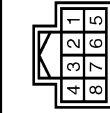

Terminal No.	Color of Wire	Signal Name [Specification]
1	BR	S/L 12V (MECHANICAL)
2	Y	S/L (LK LINE)
3	L	S/L COND.LT.LOW1
5	B	GND
6	B	GND
7	W	S/L 12V (CPU)
8	P	S/L COND.LT.LONZ

Connector No.	M60
Connector Name	PUSH-BUTTON IGNITION SWITCH
Connector Type	TK60FBR

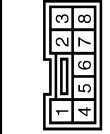

Terminal No.	Color of Wire	Signal Name [Specification]
1	GR	-
4	BR	-
5	LG	-
6	O	-
7	Y	-
8	P	-

Connector No.	M53
Connector Name	COMBINATION METER
Connector Type	SAB40FW

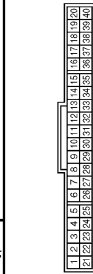

Terminal No.	Color of Wire	Signal Name [Specification]
1	V	BATTERY
2	LG	COMMUNICATION SIGNAL (METER->AMP)
3	GR	COMMUNICATION SIGNAL (AMP->METER)
5	B	GROUND
10	R	SECURITY
15	B	GROUND
21	R	IGNITION POWER SUPPLY
22	B	GROUND
24	BR	COMMUNICATION SIGNAL (LCD->AMP)
25	Y	COMMUNICATION SIGNAL (AMP->LCD)

Connector No.	M66
Connector Name	UNIFIED METER AND A/C AMP.
Connector Type	TH40FW-NH

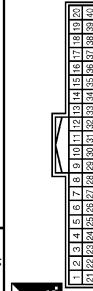

Terminal No.	Color of Wire	Signal Name [Specification]
7	GR	COMMUNICATION SIGNAL (AMP->METER)
14	BR	COMMUNICATION SIGNAL (LCD->AMP)
27	LG	COMMUNICATION SIGNAL (METER->AMP)
34	Y	COMMUNICATION SIGNAL (AMP->LCD)

Connector No.	M67
Connector Name	UNIFIED METER AND A/C AMP.
Connector Type	TH32FW-NH

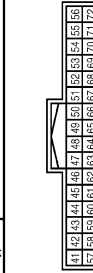

Terminal No.	Color of Wire	Signal Name [Specification]
41	L	ACC POWER SUPPLY
53	G	IGNITION POWER SUPPLY
55	B	GROUND
56	L	CAN-H
71	GR	GROUND
72	P	CAN-L

Connector No.	M107
Connector Name	ECM
Connector Type	RH24FGY-RZ8-FR-LH-Z

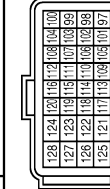

Terminal No.	Color of Wire	Signal Name [Specification]
113	P	VEHCAN-L1
114	L	VEHCAN-H1

JCKWM2143G1

A  
B  
C  
D  
E  
F  
G  
H  
I  
J  
K  
L  
M  
N  
O  
P

SEC

# INFINITI VEHICLE IMMOBILIZER SYSTEM-NATS

## < DTC/CIRCUIT DIAGNOSIS >

### INFINITI VEHICLE IMMOBILIZER SYSTEM

Connector No.	M116
Connector Name	WIRE TO WIRE
Connector Type	TK36NW-NS10

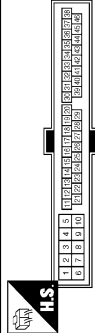

Terminal No.	Color of Wire	Signal Name [Specification]
43	P	-
44	L	-

Connector No.	M118
Connector Name	BCM (BODY CONTROL MODULE)
Connector Type	M03FB-LC



Terminal No.	Color of Wire	Signal Name [Specification]
1	W	BAT (F/L)

Connector No.	M119
Connector Name	BCM (BODY CONTROL MODULE)
Connector Type	NS18FW-CS

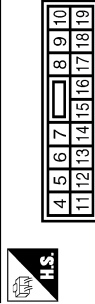

Terminal No.	Color of Wire	Signal Name [Specification]
11	R	BAT (FUSE)
13	B	GND
15	O	ACC IND

Connector No.	M121
Connector Name	BCM (BODY CONTROL MODULE)
Connector Type	TH40FG-NH

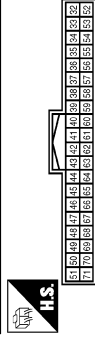

Terminal No.	Color of Wire	Signal Name [Specification]
47	Y	IGN RELAY (IPDM E/R) CONT
52	SB	STARTER RELAY CONT

Connector No.	M122
Connector Name	BCM (BODY CONTROL MODULE)
Connector Type	TH40FB-NH

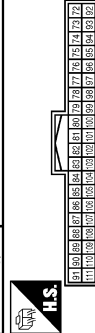

Terminal No.	Color of Wire	Signal Name [Specification]
80	GR	IMMOBI ANTENNA CONTROL
81	W	IMMOBI ANTENNA SIGNAL
88	BR	PUSH SW
90	P	CAN-L
91	L	CAN-H
92	LG	KEY SLOT ILL
93	Y	ON IND
96	GR	A/T SHIFT SELECTOR POWER SUPPLY
97	L	S/L CONDITION 1
98	P	S/L CONDITION 2
99	R	ASSED CLUTCH SW (M.T. models; without ECG)

99	R	ECU CLUTCH SW (M.T. models; with ECG)
99	R	SHIFT P (A/T models)
106	W	S/L UNIT POWER SUPPLY
111	Y	S/L UNIT COMM

Connector No.	M123
Connector Name	BCM (BODY CONTROL MODULE)
Connector Type	TH40FG-NH

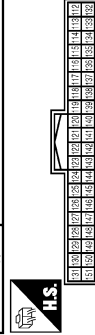

Terminal No.	Color of Wire	Signal Name [Specification]
114	R	CLUTCH INTERLOCK SW
116	SB	STOP LAMP SW 1
118	BR	STOP LAMP SW 2
134	LG	LOCK IND
140	GR	SHIFT N/P
141	R	SECURITY INDICATOR

Connector No.	M137
Connector Name	A/T SHIFT SELECTOR
Connector Type	TH12FW-NH

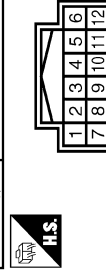

Terminal No.	Color of Wire	Signal Name [Specification]
10	GR	-
11	R	-

# VEHICLE SECURITY SYSTEM

< DTC/CIRCUIT DIAGNOSIS >

## VEHICLE SECURITY SYSTEM

### Wiring Diagram - VEHICLE SECURITY SYSTEM -

INFOID:000000004663031

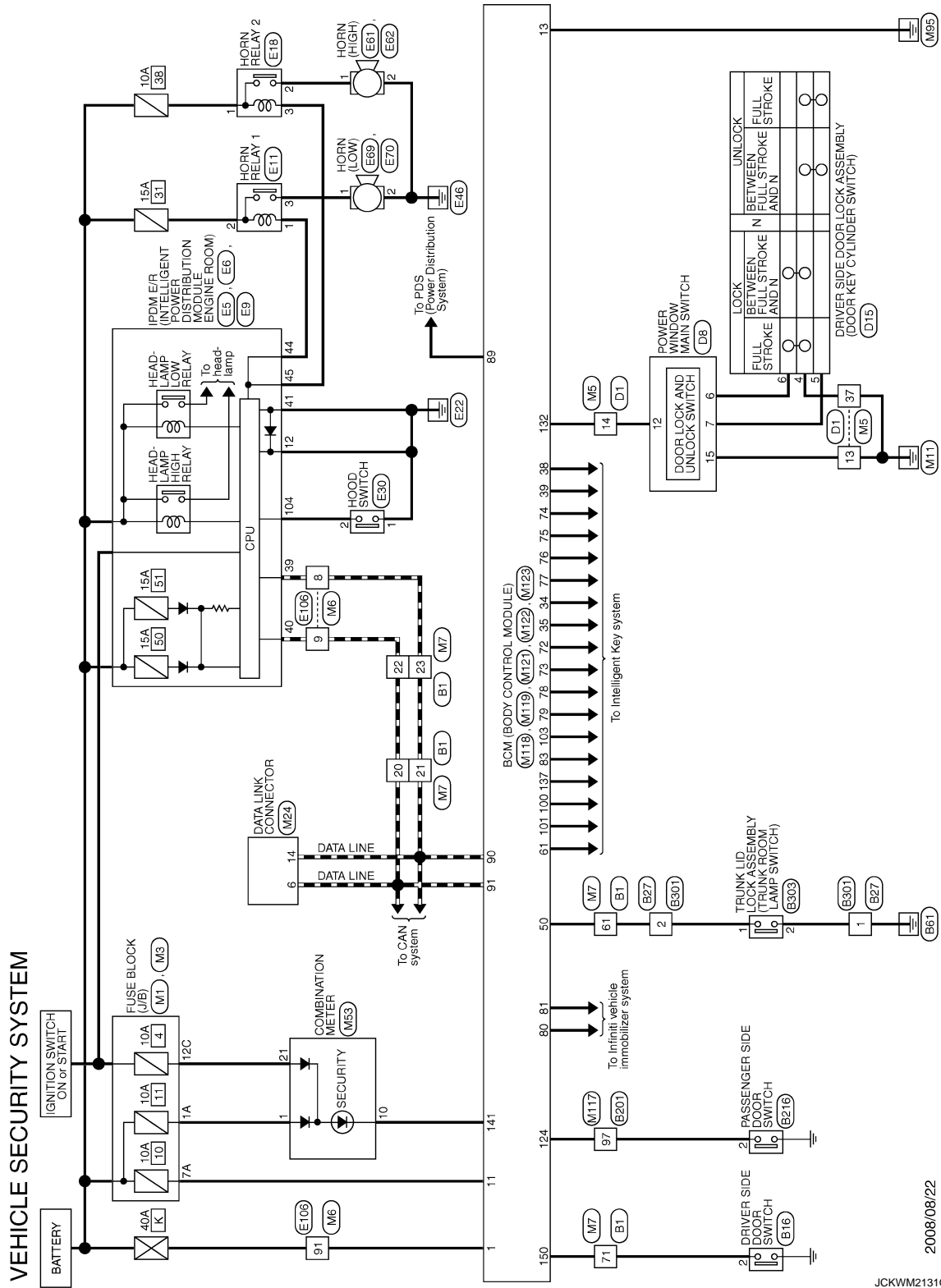

2008/08/22

JCKWM2131GI

A  
B  
C  
D  
E  
F  
G  
H  
I  
J  
K  
L  
M  
N  
O  
P

SEC



# VEHICLE SECURITY SYSTEM

< DTC/CIRCUIT DIAGNOSIS >

## VEHICLE SECURITY SYSTEM

Connector No.	D8
Connector Name	POWER WINDOW MAIN SWITCH
Connector Type	NS16FW-CS

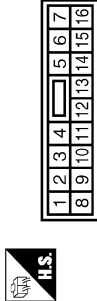

Terminal No.	Color of Wire	Signal Name [Specification]
6	GR	-
7	W	-
12	V	-
15	B	-

Connector No.	D15
Connector Name	DRIVER SIDE DOOR LOCK ASSEMBLY
Connector Type	ED8FGY-RS



Terminal No.	Color of Wire	Signal Name [Specification]
4	B	-
5	W	-
6	GR	-

Connector No.	E5
Connector Name	IPDM E/R (INTELLIGENT POWER DISTRIBUTION MODULE ENGINE ROOM)
Connector Type	THZDFW-CS12-M4-TV

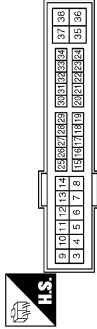

Terminal No.	Color of Wire	Signal Name [Specification]
12	B/W	-

Connector No.	E6
Connector Name	IPDM E/R (INTELLIGENT POWER DISTRIBUTION MODULE ENGINE ROOM)
Connector Type	TH83FW-NH



Terminal No.	Color of Wire	Signal Name [Specification]
39	P	-
40	L	-
41	B/W	-
44	W	-
45	G	-

Connector No.	E9
Connector Name	IPDM E/R (INTELLIGENT POWER DISTRIBUTION MODULE ENGINE ROOM)
Connector Type	TH16FW-NH

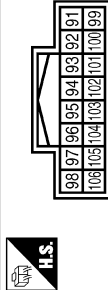

Terminal No.	Color of Wire	Signal Name [Specification]
104	LG	-

Connector No.	E11
Connector Name	HORN RELAY 1
Connector Type	24381 7890A



Terminal No.	Color of Wire	Signal Name [Specification]
1	LG	-
2	SB	-
3	Y	-

Connector No.	E18
Connector Name	HORN RELAY 2
Connector Type	M03FW-R-LC



Terminal No.	Color of Wire	Signal Name [Specification]
1	P	-
2	Y	-
3	G	-

Connector No.	E30
Connector Name	HOOD SWITCH
Connector Type	RH02FB



Terminal No.	Color of Wire	Signal Name [Specification]
1	B	-
2	LG	-

JCKWM2133Gf















A  
B  
C  
D  
E  
F  
G  
H  
I  
J  
K  
L  
M  
N  
O  
P

SEC

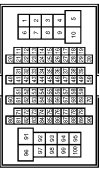
# VEHICLE SECURITY SYSTEM

## < DTC/CIRCUIT DIAGNOSIS >

### VEHICLE SECURITY SYSTEM

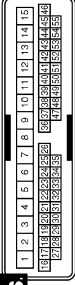
Connector No. E61	Connector Name HORN (HIGH)	Connector Type F01FB-A	 	Terminal No. 1	Color of Wire Y	Signal Name [Specification]	
Connector No. E62	Connector Name HORN (HIGH)	Connector Type F01FB-A	 	Terminal No. 2	Color of Wire B	Signal Name [Specification]	
Connector No. E69	Connector Name HORN (LOW)	Connector Type F01FB-A	 	Terminal No. 1	Color of Wire Y	Signal Name [Specification]	
Connector No. E70	Connector Name HORN (LOW)	Connector Type F01FB-A	 	Terminal No. 2	Color of Wire B	Signal Name [Specification]	
Connector No. E106	Connector Name WIRE TO WIRE	Connector Type TH60FW-CS16-TM4	 	Terminal No. 8	Color of Wire P	Signal Name [Specification]	
Connector No. M1	Connector Name FUSE BLOCK (J/B)	Connector Type NS06FW-M2	 	Terminal No. 1A 7A	Color of Wire V R	Signal Name [Specification]	
Connector No. M3	Connector Name FUSE BLOCK (J/B)	Connector Type NS12FW-CS	 	Terminal No. 12C	Color of Wire R	Signal Name [Specification]	
Connector No. M5	Connector Name WIRE TO WIRE	Connector Type TH40MW-CS15	 	Terminal No. 13 14 37	Color of Wire B V B	Signal Name [Specification]	

JCKWM2134G1

# VEHICLE SECURITY SYSTEM

< DTC/CIRCUIT DIAGNOSIS >

## VEHICLE SECURITY SYSTEM

Connector No.	M6
Connector Name	WIRE TO WIRE
Connector Type	TH80MW-CS1F-TM4

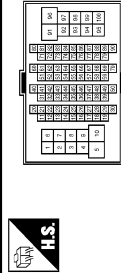

Terminal No.	Color of Wire	Signal Name [Specification]
8	P	-
9	L	-
91	W	-

Connector No.	M7
Connector Name	WIRE TO WIRE
Connector Type	TH80MW-CS1F-TM4

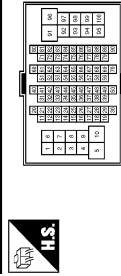

Terminal No.	Color of Wire	Signal Name [Specification]
20	L	-
21	P	-
22	L	-
23	P	-
61	R	-
71	R	-

Connector No.	M24
Connector Name	DATA LINK CONNECTOR
Connector Type	BD16FY-P

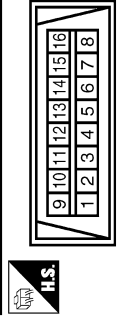

Terminal No.	Color of Wire	Signal Name [Specification]
6	L	-
14	P	-

Connector No.	M63
Connector Name	COMBINATION METER
Connector Type	SAB6FW

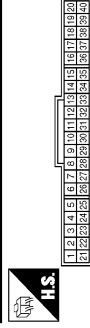

Terminal No.	Color of Wire	Signal Name [Specification]
1	V	BATTERY
10	R	SECURITY
21	R	IGNITION POWER SUPPLY

Connector No.	M17
Connector Name	WIRE TO WIRE
Connector Type	TH80MW-CS1F-TM4

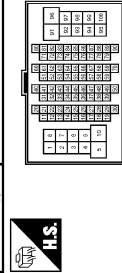

Terminal No.	Color of Wire	Signal Name [Specification]
97	LG	-

Connector No.	M118
Connector Name	BCM (BODY CONTROL MODULE)
Connector Type	M03FB-LC

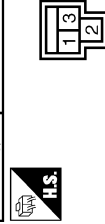

Terminal No.	Color of Wire	Signal Name [Specification]
1	W	BAT (F/L)

Connector No.	M119
Connector Name	BCM (BODY CONTROL MODULE)
Connector Type	NS18FW-CS

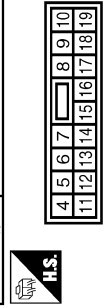

Terminal No.	Color of Wire	Signal Name [Specification]
11	R	BAT (FUSE)
13	B	GND

Connector No.	M121
Connector Name	BCM (BODY CONTROL MODULE)
Connector Type	TH40FGY-NH

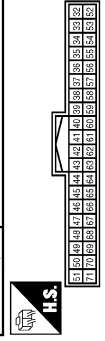

Terminal No.	Color of Wire	Signal Name [Specification]
34	SB	TRUNK ROOM ANT-
35	V	TRUNK ROOM ANT+
38	B	REAR BUMPER ANT-
39	W	REAR BUMPER ANT+
50	R	TRUNK ROOM LAMP SW
61	SB	TRUNK LID OPENER REQUEST SW

A  
B  
C  
D  
E  
F  
G  
H  
I  
J  
K  
L  
M  
N  
O  
P

SEC

JCKWM2135G1

# VEHICLE SECURITY SYSTEM

< DTC/CIRCUIT DIAGNOSIS >

## VEHICLE SECURITY SYSTEM

Connector No.	M123
Connector Name	BCM (BODY CONTROL MODULE)
Connector Type	TH40FB-NH

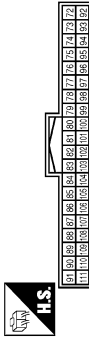

Terminal No.	Color of Wire	Signal Name [Specification]
72	R	ROOM ANT2-
73	G	ROOM ANT2+
74	SB	PASSENGER DOOR ANT-
75	BR	PASSENGER DOOR ANT+
76	V	DRIVER DOOR ANT-
77	LG	DRIVER DOOR ANT+
78	Y	ROOM ANT1-
79	BR	ROOM ANT1+
80	GR	IMMOBI ANTENNA CONTROL
81	W	IMMOBI ANTENNA SIGNAL
83	Y	KEYLESS ENTRY RECEIVER COMM

89	BR	PUSH SW
90	P	CAN-L
91	L	CAN-H
100	Y	PASSENGER DOOR REQUEST SW
101	P	DRIVER DOOR REQUEST SW
103	LG	KEYLESS ENTRY RECEIVER POWER SUPPLY

Connector No.	M123
Connector Name	BCM (BODY CONTROL MODULE)
Connector Type	TH40FB-NH



Terminal No.	Color of Wire	Signal Name [Specification]
124	LG	PASSENGER DOOR SW
132	V	POWER WINDOW SW COMM
137	O	RECEIVER SENSOR GND
141	R	SECURITY INDICATOR
150	R	DRIVER DOOR SW

JCKWM2136GI



## BCM (BODY CONTROL MODULE)

< ECU DIAGNOSIS INFORMATION >

# ECU DIAGNOSIS INFORMATION

## BCM (BODY CONTROL MODULE)

Reference Value

INFOID:000000004679491

### VALUES ON THE DIAGNOSIS TOOL

CONSULT-III MONITOR ITEM

Monitor Item	Condition	Value/Status
FR WIPER HI	Other than front wiper switch HI	Off
	Front wiper switch HI	On
FR WIPER LOW	Other than front wiper switch LO	Off
	Front wiper switch LO	On
FR WASHER SW	Front washer switch OFF	Off
	Front washer switch ON	On
FR WIPER INT	Other than front wiper switch INT	Off
	Front wiper switch INT	On
FR WIPER STOP	Front wiper is not in STOP position	Off
	Front wiper is in STOP position	On
INT VOLUME	Wiper intermittent dial is in a dial position 1 - 7	Wiper intermittent dial position
TURN SIGNAL R	Other than turn signal switch RH	Off
	Turn signal switch RH	On
TURN SIGNAL L	Other than turn signal switch LH	Off
	Turn signal switch LH	On
TAIL LAMP SW	Other than lighting switch 1ST and 2ND	Off
	Lighting switch 1ST or 2ND	On
HI BEAM SW	Other than lighting switch HI	Off
	Lighting switch HI	On
HEAD LAMP SW 1	Other than lighting switch 2ND	Off
	Lighting switch 2ND	On
HEAD LAMP SW 2	Other than lighting switch 2ND	Off
	Lighting switch 2ND	On
PASSING SW	Other than lighting switch PASS	Off
	Lighting switch PASS	On
AUTO LIGHT SW	Other than lighting switch AUTO	Off
	Lighting switch AUTO	On
FR FOG SW	Front fog lamp switch OFF	Off
	Front fog lamp switch ON	On
RR FOG SW	<b>NOTE:</b> The item is indicated, but not monitored.	Off
DOOR SW-DR	Driver door closed	Off
	Driver door opened	On
DOOR SW-AS	Passenger door closed	Off
	Passenger door opened	On
DOOR SW-RR	<b>NOTE:</b> The item is indicated, but not monitored.	Off

## BCM (BODY CONTROL MODULE)

### < ECU DIAGNOSIS INFORMATION >

Monitor Item	Condition	Value/Status
DOOR SW-RL	<b>NOTE:</b> The item is indicated, but not monitored.	Off
DOOR SW-BK	<b>NOTE:</b> The item is indicated, but not monitored.	Off
CDL LOCK SW	Other than power door lock switch LOCK	Off
	Power door lock switch LOCK	On
CDL UNLOCK SW	Other than power door lock switch UNLOCK	Off
	Power door lock switch UNLOCK	On
KEY CYL LK-SW	Other than driver door key cylinder LOCK position	Off
	Driver door key cylinder LOCK position	On
KEY CYL UN-SW	Other than driver door key cylinder UNLOCK position	Off
	Driver door key cylinder UNLOCK position	On
KEY CYL SW-TR	<b>NOTE:</b> The item is indicated, but not monitored.	Off
HAZARD SW	Hazard switch is OFF	Off
	Hazard switch is ON	On
REAR DEF SW	<b>NOTE:</b> The item is indicated, but not monitored.	Off
H/L WASH SW	<b>NOTE:</b> The item is indicated, but not monitored.	Off
TR CANCEL SW	Trunk lid opener cancel switch OFF	Off
	Trunk lid opener cancel switch ON	On
TR/BD OPEN SW	Trunk lid opener switch OFF	Off
	While the trunk lid opener switch is turned ON	On
TRNK/HAT MNTR	Trunk lid closed	Off
	Trunk lid opened	On
RKE-LOCK	LOCK button of the Intelligent Key is not pressed	Off
	LOCK button of the Intelligent Key is pressed	On
RKE-UNLOCK	UNLOCK button of the Intelligent Key is not pressed	Off
	UNLOCK button of the Intelligent Key is pressed	On
RKE-TR/BD	TRUNK OPEN button of the Intelligent Key is not pressed	Off
	TRUNK OPEN button of the Intelligent Key is pressed	On
RKE-PANIC	PANIC button of the Intelligent Key is not pressed	Off
	PANIC button of the Intelligent Key is pressed	On
RKE-P/W OPEN	UNLOCK button of the Intelligent Key is not pressed	Off
	UNLOCK button of the Intelligent Key is pressed and held	On
RKE-MODE CHG	LOCK/UNLOCK button of the Intelligent Key is not pressed and held simultaneously	Off
	LOCK/UNLOCK button of the Intelligent Key is pressed and held simultaneously	On
OPTICAL SENSOR	Bright outside of the vehicle	Close to 5 V
	Dark outside of the vehicle	Close to 0 V
REQ SW -DR	Driver door request switch is not pressed	Off
	Driver door request switch is pressed	On
REQ SW -AS	Passenger door request switch is not pressed	Off
	Passenger door request switch is pressed	On
REQ SW -RR	<b>NOTE:</b> The item is indicated, but not monitored.	Off

## BCM (BODY CONTROL MODULE)

### < ECU DIAGNOSIS INFORMATION >

Monitor Item	Condition	Value/Status	
REQ SW -RL	<b>NOTE:</b> The item is indicated, but not monitored.	Off	A
REQ SW -BD/TR	Trunk lid opener request switch is not pressed	Off	B
	Trunk lid opener request switch is pressed	On	
PUSH SW	Push-button ignition switch (push switch) is not pressed	Off	C
	Push-button ignition switch (push switch) is pressed	On	
IGN RLY2 -F/B	Ignition switch in OFF or ACC position	Off	D
	Ignition switch in ON position	On	
ACC RLY -F/B	<b>NOTE:</b> The item is indicated, but not monitored.	Off	E
CLUCH SW	The clutch pedal is not depressed	Off	E
	The clutch pedal is depressed	On	
BRAKE SW 1	The brake pedal is depressed when No. 7 fuse is blown	Off	F
	The brake pedal is not depressed when No. 7 fuse is blown, or No. 7 fuse is normal	On	
BRAKE SW 2	The brake pedal is not depressed	Off	G
	The brake pedal is depressed	On	
DETE/CANCL SW	<ul style="list-style-type: none"> <li>• Selector lever in P position (Except M/T models)</li> <li>• The clutch pedal is depressed (M/T models)</li> </ul>	Off	H
	<ul style="list-style-type: none"> <li>• Selector lever in any position other than P (Except M/T models)</li> <li>• The clutch pedal is not depressed (M/T models)</li> </ul>	On	
SFT PN/N SW	Selector lever in any position other than P and N	Off	I
	Selector lever in P or N position	On	
S/L -LOCK	Steering is unlocked	Off	J
	Steering is locked	On	
S/L -UNLOCK	Steering is locked	Off	J
	Steering is unlocked	On	
S/L RELAY-F/B	Ignition switch in OFF or ACC position	Off	SEC
	Ignition switch in ON position	On	
UNLK SEN -DR	Driver door is unlocked	Off	L
	Driver door is locked	On	
PUSH SW -IPDM	Push-button ignition switch (push-switch) is not pressed	Off	M
	Push-button ignition switch (push-switch) is pressed	On	
IGN RLY1 -F/B	Ignition switch in OFF or ACC position	Off	N
	Ignition switch in ON position	On	
DETE SW -IPDM	Selector lever in any position other than P	Off	O
	Selector lever in P position	On	
SFT PN -IPDM	<ul style="list-style-type: none"> <li>• Selector lever in any position other than P and N (Except M/T models)</li> <li>• The clutch pedal is not depressed (M/T models)</li> </ul>	Off	P
	<ul style="list-style-type: none"> <li>• Selector lever in P or N position</li> <li>• The clutch pedal is depressed</li> </ul>	On	
SFT P -MET	Selector lever in any position other than P	Off	P
	Selector lever in P position	On	
SFT N -MET	Selector lever in any position other than N	Off	P
	Selector lever in N position	On	

## BCM (BODY CONTROL MODULE)

### < ECU DIAGNOSIS INFORMATION >

Monitor Item	Condition	Value/Status
ENGINE STATE	Engine stopped	Stop
	While the engine stalls	Stall
	At engine cranking	Crank
	Engine running	Run
S/L LOCK-IPDM	Steering is unlocked	Off
	Steering is locked	On
S/L UNLK-IPDM	Steering is locked	Off
	Steering is unlocked	On
S/L RELAY-REQ	Steering lock system is not the LOCK condition and the changing condition from LOCK to UNLOCK	Off
	Steering lock system are not the LOCK condition or the changing condition from LOCK to UNLOCK	On
VEH SPEED 1	While driving	Equivalent to speedometer reading
VEH SPEED 2	While driving	Equivalent to speedometer reading
DOOR STAT-DR	Driver door is locked	LOCK
	Wait with selective UNLOCK operation (60 seconds)	READY
	Driver door is unlocked	UNLOCK
DOOR STAT-AS	Passenger door is locked	LOCK
	Wait with selective UNLOCK operation (60 seconds)	READY
	Passenger door is unlocked	UNLOCK
ID OK FLAG	Steering is locked	Reset
	Steering is unlocked	Set
PRMT ENG STRT	The engine start is prohibited	Reset
	The engine start is permitted	Set
PRMT RKE STRT	<b>NOTE:</b> The item is indicated, but not monitored.	Reset
KEY SW -SLOT	The Intelligent Key is not inserted into key slot	Off
	The Intelligent Key is inserted into key slot	On
RKE OPE COUN1	During the operation of the Intelligent Key	Operation frequency of the Intelligent Key
RKE OPE COUN2	<b>NOTE:</b> The item is indicated, but not monitored.	—
CONFIRM ID ALL	The key ID that the key slot receives is not recognized by any key ID registered to BCM.	Yet
	The key ID that the key slot receives is recognized by any key ID registered to BCM.	Done
CONFIRM ID4	The key ID that the key slot receives is not recognized by the fourth key ID registered to BCM.	Yet
	The key ID that the key slot receives is recognized by the fourth key ID registered to BCM.	Done
CONFIRM ID3	The key ID that the key slot receives is not recognized by the third key ID registered to BCM.	Yet
	The key ID that the key slot receives is recognized by the third key ID registered to BCM.	Done

## BCM (BODY CONTROL MODULE)

### < ECU DIAGNOSIS INFORMATION >

Monitor Item	Condition	Value/Status	
CONFIRM ID2	The key ID that the key slot receives is not recognized by the second key ID registered to BCM.	Yet	A
	The key ID that the key slot receives is recognized by the second key ID registered to BCM.	Done	B
CONFIRM ID1	The key ID that the key slot receives is not recognized by the first key ID registered to BCM.	Yet	C
	The key ID that the key slot receives is recognized by the first key ID registered to BCM.	Done	
TP 4	The ID of fourth Intelligent Key is not registered to BCM	Yet	D
	The ID of fourth Intelligent Key is registered to BCM	Done	
TP 3	The ID of third Intelligent Key is not registered to BCM	Yet	E
	The ID of third Intelligent Key is registered to BCM	Done	
TP 2	The ID of second Intelligent Key is not registered to BCM	Yet	F
	The ID of second Intelligent Key is registered to BCM	Done	
TP 1	The ID of first Intelligent Key is not registered to BCM	Yet	
	The ID of first Intelligent Key is registered to BCM	Done	
AIR PRESS FL	Ignition switch ON (Only when the signal from the transmitter is received)	Air pressure of front LH tire	G
AIR PRESS FR	Ignition switch ON (Only when the signal from the transmitter is received)	Air pressure of front RH tire	H
AIR PRESS RR	Ignition switch ON (Only when the signal from the transmitter is received)	Air pressure of rear RH tire	I
AIR PRESS RL	Ignition switch ON (Only when the signal from the transmitter is received)	Air pressure of rear LH tire	
ID REGST FL1	ID of front LH tire transmitter is registered	Done	J
	ID of front LH tire transmitter is not registered	Yet	
ID REGST FR1	ID of front RH tire transmitter is registered	Done	
	ID of front RH tire transmitter is not registered	Yet	
ID REGST RR1	ID of rear RH tire transmitter is registered	Done	
	ID of rear RH tire transmitter is not registered	Yet	
ID REGST RL1	ID of rear LH tire transmitter is registered	Done	L
	ID of rear LH tire transmitter is not registered	Yet	
WARNING LAMP	Tire pressure indicator OFF	Off	M
	Tire pressure indicator ON	On	
BUZZER	Tire pressure warning alarm is not sounding	Off	N
	Tire pressure warning alarm is sounding	On	

SEC

# BCM (BODY CONTROL MODULE)

< ECU DIAGNOSIS INFORMATION >

## TERMINAL LAYOUT

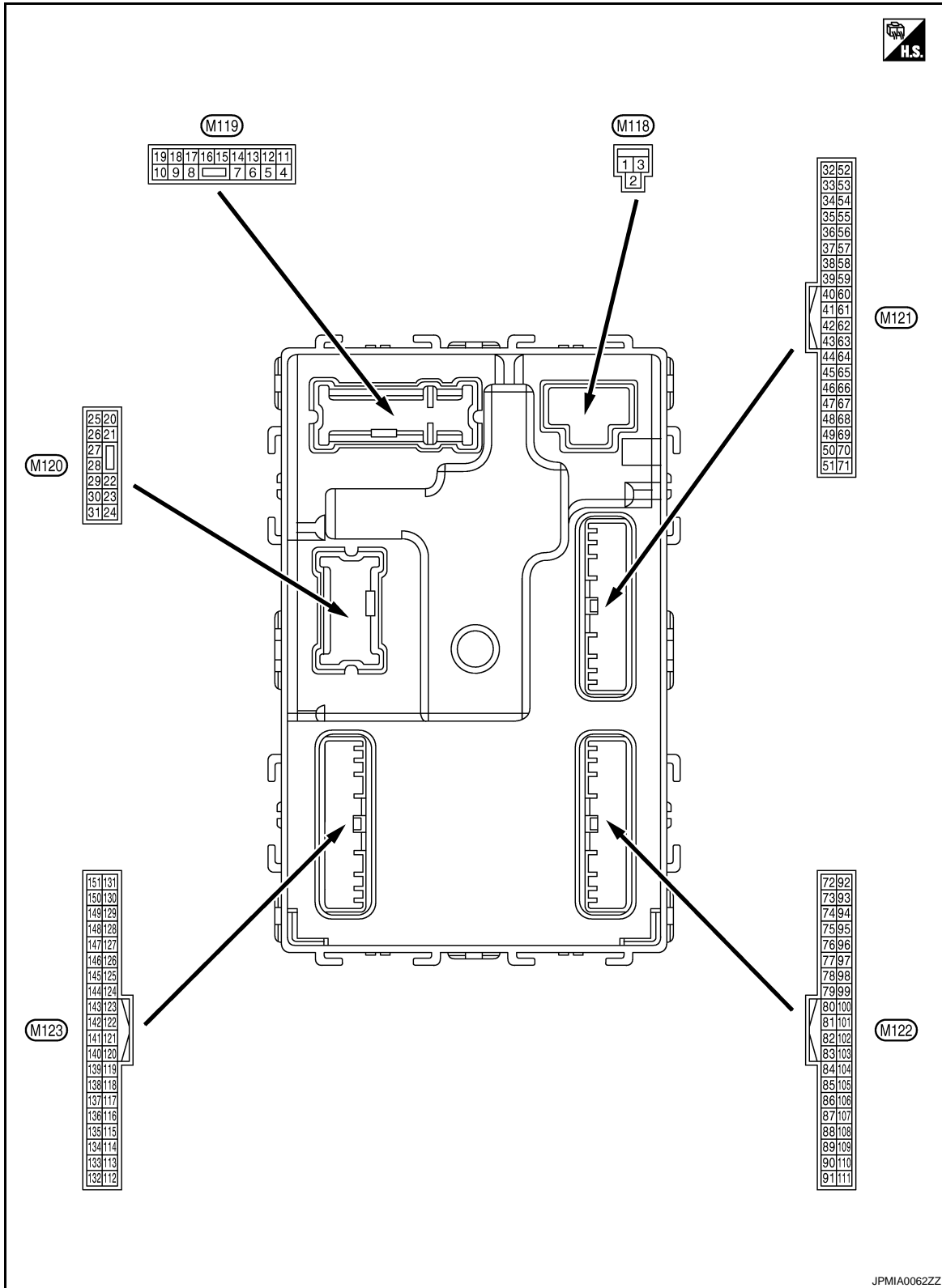

# BCM (BODY CONTROL MODULE)

## < ECU DIAGNOSIS INFORMATION >

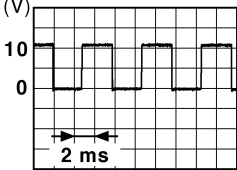
Terminal No. (Wire color)		Description		Condition		Value (Approx.)
		Signal name	Input/ Output			
+	-					
1 (W)	Ground	Battery power supply	Input	Ignition switch OFF		Battery voltage
2 (Y)	Ground	P/W power supply (BAT)	Output	Ignition switch OFF		12 V
3 (O)	Ground	P/W power supply (RAP)	Output	Ignition switch ON		12 V
4 (LG)	Ground	Interior room lamp power supply	Output	Interior room lamp battery saver is activated. (Cuts the interior room lamp power supply)		0 V
				Interior room lamp battery saver is not activated. (Outputs the interior room lamp power supply)		12 V
5 (P)	Ground	Passenger door UN- LOCK	Output	Passenger door	UNLOCK (Actuator is activated)	12 V
					Other than UNLOCK (Ac- tuator is not activated)	0 V
7 (SB)	Ground	Step lamp	Output	Step lamp	ON	0 V
					OFF	12 V
8 (V)	Ground	All doors, fuel lid LOCK	Output	All doors, fuel lid	LOCK (Actuator is activated)	12 V
					Other than LOCK (Actuator is not activated)	0 V
9 (G)	Ground	Driver door, fuel lid UNLOCK	Output	Driver door, fuel lid	UNLOCK (Actuator is activated)	12 V
					Other than UNLOCK (Actuator is not activated)	0 V
11 (R)	Ground	Battery power supply	Input	Ignition switch OFF		Battery voltage
13 (B)	Ground	Ground	—	Ignition switch ON		0 V
14 (W)	Ground	Push-button ignition switch illumination ground	Output	Tail lamp	OFF	0 V
					ON	<p style="text-align: center;"><b>NOTE:</b> When the illumination brighten- ing/dimming level is in the neutral position.</p>  <p style="text-align: right; font-size: small;">JSNIA0010GB</p>
15 (O)	Ground	ACC indicator lamp	Output	Ignition switch	OFF (LOCK indicator is not illuminated)	Battery voltage
					ACC	0 V

A  
B  
C  
D  
E  
F  
G  
H  
I  
J  
L  
M  
N  
O  
P

SEC

# BCM (BODY CONTROL MODULE)

## < ECU DIAGNOSIS INFORMATION >

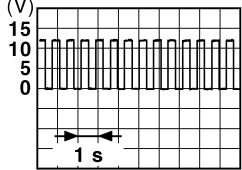
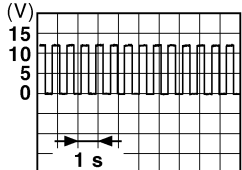
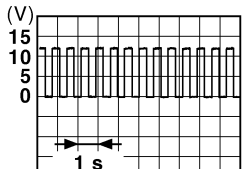
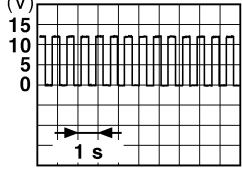
Terminal No. (Wire color)		Description		Condition	Value (Approx.)
+	-	Signal name	Input/ Output		
17 (W)	Ground	Turn signal RH (Front)	Output	Ignition switch ON	Turn signal switch OFF 0 V
				Turn signal switch RH	 6.5 V <small>PKID0926E</small>
18 (O)	Ground	Turn signal LH (Front)	Output	Ignition switch ON	Turn signal switch OFF 0 V
				Turn signal switch LH	 6.5 V <small>PKID0926E</small>
19 (V)	Ground	Room lamp timer control	Output	Interior room lamp	OFF 12 V
				ON	0 V
20 (V)	Ground	Turn signal RH (Rear)	Output	Ignition switch ON	Turn signal switch OFF 0 V
				Turn signal switch RH	 6.5 V <small>PKID0926E</small>
23 (L)	Ground	Trunk lid open	Output	Trunk lid	OPEN (Trunk lid opener actuator is activated) 12 V
				Other than OPEN (Trunk lid opener actuator is not activated)	0 V
25 (Y)	Ground	Turn signal LH (Rear)	Output	Ignition switch ON	Turn signal switch OFF 0 V
				Turn signal switch LH	 6.5 V <small>PKID0926E</small>
30 (P)	Ground	Trunk room lamp	Output	Trunk room lamp	ON 0 V
				OFF	12 V



# BCM (BODY CONTROL MODULE)

## < ECU DIAGNOSIS INFORMATION >

Terminal No. (Wire color)		Description		Condition	Value (Approx.)
+	-	Signal name	Input/ Output		
34 (SB)	Ground	Trunk room antenna (-)	Output	Ignition switch OFF	<p>JMKIA0062GB</p>
				When Intelligent Key is not in the passenger compart- ment	<p>JMKIA0063GB</p>
35 (V)	Ground	Trunk room antenna (+)	Output	Ignition switch OFF	<p>JMKIA0062GB</p>
				When Intelligent Key is not in the passenger compart- ment	<p>JMKIA0063GB</p>
38 (B)	Ground	Rear bumper anten- na (-)	Output	When the trunk lid opener re- quest switch is operated with ignition switch OFF	<p>JMKIA0062GB</p>
				When Intelligent Key is not in the antenna detection area	<p>JMKIA0063GB</p>

A  
B  
C  
D  
E  
F  
G  
H  
I  
J  
L  
M  
N  
O  
P

SEC

# BCM (BODY CONTROL MODULE)

## < ECU DIAGNOSIS INFORMATION >

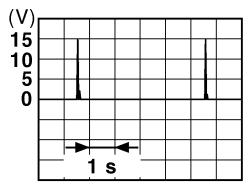
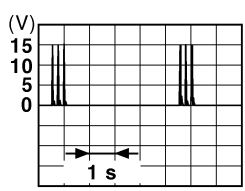
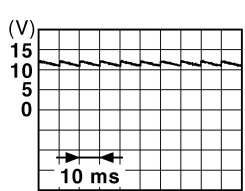
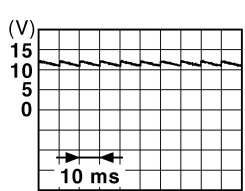
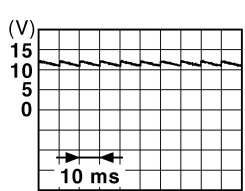
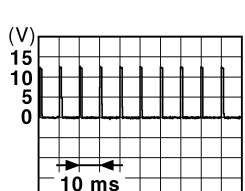
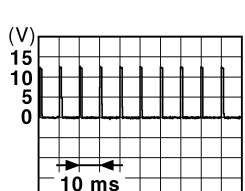
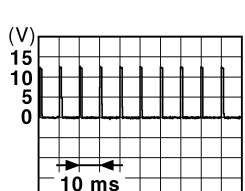
Terminal No. (Wire color)		Description		Condition	Value (Approx.)						
+	-	Signal name	Input/ Output								
39 (W)	Ground	Rear bumper antenna (+)	Output	When Intelligent Key is in the antenna detection area	 <p style="text-align: right; font-size: small;">JMKIA0062GB</p>						
				When the trunk lid opener request switch is operated with ignition switch OFF	 <p style="text-align: right; font-size: small;">JMKIA0063GB</p>						
47 (Y)	Ground	Ignition relay (IPDM E/R) control	Output	Ignition switch	<table border="1" style="width: 100%; border-collapse: collapse;"> <tr> <td>OFF or ACC</td> <td style="text-align: center;">12 V</td> </tr> <tr> <td>ON</td> <td style="text-align: center;">0 V</td> </tr> </table>	OFF or ACC	12 V	ON	0 V		
				OFF or ACC	12 V						
ON	0 V										
50 (R)	Ground	Trunk room lamp switch	Input	Trunk room lamp switch	<table border="1" style="width: 100%; border-collapse: collapse;"> <tr> <td>OFF (Trunk lid is closed)</td> <td>  <p style="text-align: right; font-size: small;">JPMIA0011GB</p> </td> </tr> <tr> <td>ON (Trunk lid is opened)</td> <td style="text-align: center;">0 V</td> </tr> </table>	OFF (Trunk lid is closed)	 <p style="text-align: right; font-size: small;">JPMIA0011GB</p>	ON (Trunk lid is opened)	0 V		
				OFF (Trunk lid is closed)	 <p style="text-align: right; font-size: small;">JPMIA0011GB</p>						
ON (Trunk lid is opened)	0 V										
52 (SB)	Ground	Starter relay control	Output	Ignition switch ON (A/T models)	When selector lever is in P or N position	12 V					
				Ignition switch ON (M/T models)	When the clutch pedal is depressed	Battery voltage					
				When selector lever is not in P or N position	0 V						
				When the clutch pedal is not depressed	0 V						
61 (SB)	Ground	Trunk lid opener request switch	Input	Trunk lid opener request switch	<table border="1" style="width: 100%; border-collapse: collapse;"> <tr> <td>ON (Pressed)</td> <td style="text-align: center;">0 V</td> </tr> <tr> <td>OFF (Not pressed)</td> <td>  <p style="text-align: right; font-size: small;">JPMIA0016GB</p> </td> </tr> <tr> <td colspan="2" style="text-align: center;">1.0 V</td> </tr> </table>	ON (Pressed)	0 V	OFF (Not pressed)	 <p style="text-align: right; font-size: small;">JPMIA0016GB</p>	1.0 V	
				ON (Pressed)	0 V						
OFF (Not pressed)	 <p style="text-align: right; font-size: small;">JPMIA0016GB</p>										
1.0 V											
64 (L)	Ground	Intelligent Key warning buzzer (Engine room)	Output	Intelligent Key warning buzzer (Engine room)	<table border="1" style="width: 100%; border-collapse: collapse;"> <tr> <td>Sounding</td> <td style="text-align: center;">0 V</td> </tr> <tr> <td>Not sounding</td> <td style="text-align: center;">12 V</td> </tr> </table>	Sounding	0 V	Not sounding	12 V		
				Sounding	0 V						
Not sounding	12 V										

# BCM (BODY CONTROL MODULE)

## < ECU DIAGNOSIS INFORMATION >

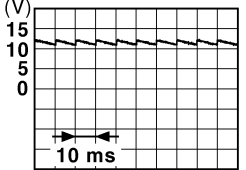
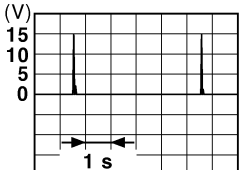
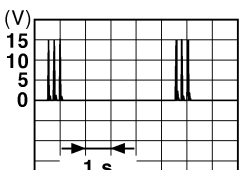
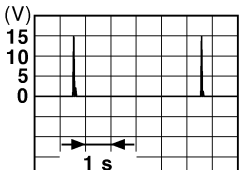
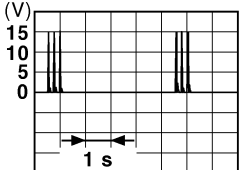
Terminal No. (Wire color)		Description		Condition	Value (Approx.)	
		Signal name	Input/ Output			
+	-					
67 (GR)	Ground	Trunk lid opener switch	Input	Trunk lid open- er switch	Pressed	0 V
					Not pressed	 <p style="text-align: right; font-size: small;">JPMIA0011GB</p>
72 (R)	Ground	Room antenna 2 (-) (Center console)	Output	Ignition switch OFF	When Intelligent Key is in the passenger compart- ment	 <p style="text-align: right; font-size: small;">JMKIA0062GB</p>
					When Intelligent Key is not in the passenger compart- ment	 <p style="text-align: right; font-size: small;">JMKIA0063GB</p>
73 (G)	Ground	Room antenna 2 (+) (Center console)	Output	Ignition switch OFF	When Intelligent Key is in the passenger compart- ment	 <p style="text-align: right; font-size: small;">JMKIA0062GB</p>
					When Intelligent Key is not in the passenger compart- ment	 <p style="text-align: right; font-size: small;">JMKIA0063GB</p>

A  
B  
C  
D  
E  
F  
G  
H  
I  
J  
L  
M  
N  
O  
P

SEC

# BCM (BODY CONTROL MODULE)

## < ECU DIAGNOSIS INFORMATION >

Terminal No. (Wire color)		Description		Condition	Value (Approx.)
+	-	Signal name	Input/ Output		
74 (SB)	Ground	Passenger door antenna (-)	Output	When Intelligent Key is in the antenna detection area	<p style="text-align: right; font-size: small;">JMKIA0062GB</p>
				When the passenger door request switch is operated with ignition switch OFF	<p style="text-align: right; font-size: small;">JMKIA0063GB</p>
75 (BR)	Ground	Passenger door antenna (+)	Output	When Intelligent Key is in the antenna detection area	<p style="text-align: right; font-size: small;">JMKIA0062GB</p>
				When the passenger door request switch is operated with ignition switch OFF	<p style="text-align: right; font-size: small;">JMKIA0063GB</p>
76 (V)	Ground	Driver door antenna (-)	Output	When Intelligent Key is in the antenna detection area	<p style="text-align: right; font-size: small;">JMKIA0062GB</p>
				When the driver door request switch is operated with ignition switch OFF	<p style="text-align: right; font-size: small;">JMKIA0063GB</p>

# BCM (BODY CONTROL MODULE)

## < ECU DIAGNOSIS INFORMATION >

Terminal No. (Wire color)		Description		Condition	Value (Approx.)
+	-	Signal name	Input/ Output		
77 (LG)	Ground	Driver door antenna (+)	Output	When the driver door request switch is operated with ignition switch OFF	<p style="text-align: right; font-size: small;">JMKIA0062GB</p>
				When Intelligent Key is not in the antenna detection area	<p style="text-align: right; font-size: small;">JMKIA0063GB</p>
78 (Y)	Ground	Room antenna 1 (-) (Instrument panel)	Output	Ignition switch OFF	<p style="text-align: right; font-size: small;">JMKIA0062GB</p>
				When Intelligent Key is not in the passenger compartment	<p style="text-align: right; font-size: small;">JMKIA0063GB</p>
79 (BR)	Ground	Room antenna 1 (+) (Instrument panel)	Output	Ignition switch OFF	<p style="text-align: right; font-size: small;">JMKIA0062GB</p>
				When Intelligent Key is not in the passenger compartment	<p style="text-align: right; font-size: small;">JMKIA0063GB</p>

A  
B  
C  
D  
E  
F  
G  
H  
I  
J  
L  
M  
N  
O  
P

SEC

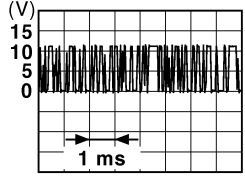
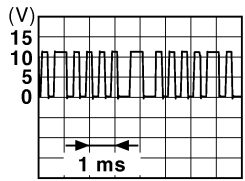
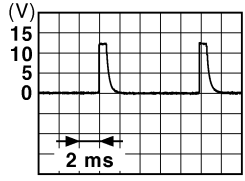
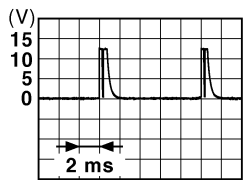
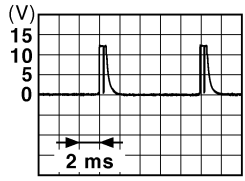

# BCM (BODY CONTROL MODULE)

## < ECU DIAGNOSIS INFORMATION >

Terminal No. (Wire color)		Description		Condition		Value (Approx.)
+	-	Signal name	Input/ Output			
80 (GR)	Ground	NATS antenna amp (Built in key slot)	Input/ Output	During waiting	Ignition switch is pressed while inserting the Intelli- gent Key into the key slot.	Just after pressing ignition switch. Pointer of tester should move.
81 (W)	Ground	NATS antenna amp (Built in key slot)	Input/ Output	During waiting	Ignition switch is pressed while inserting the Intelli- gent Key into the key slot.	Just after pressing ignition switch. Pointer of tester should move.
82 (R)	Ground	Ignition relay [Fuse block (J/B)] control	Output	Ignition switch	OFF or ACC	0 V
					ON	12 V
83 (Y)	Ground	Remote keyless entry receiver communica- tion	Input/ Output	During waiting		 <p style="text-align: right; font-size: small;">JMKIA0064GB</p>
				When operating either button on the Intelli- gent Key		 <p style="text-align: right; font-size: small;">JMKIA0065GB</p>
87 (Y)	Ground	Combination switch INPUT 5	Input	Combination switch	All switches OFF (Wiper intermittent dial 4)	 <p style="text-align: right; font-size: small;">JPMIA0041GB</p> <p style="text-align: center;">1.4 V</p>
					Front fog lamp switch ON (Wiper intermittent dial 4)	 <p style="text-align: right; font-size: small;">JPMIA0037GB</p> <p style="text-align: center;">1.3 V</p>
					Any of the conditions be- low with all switches OFF • Wiper intermittent dial 1 • Wiper intermittent dial 2 • Wiper intermittent dial 6 • Wiper intermittent dial 7	 <p style="text-align: right; font-size: small;">JPMIA0040GB</p> <p style="text-align: center;">1.3 V</p>

# BCM (BODY CONTROL MODULE)

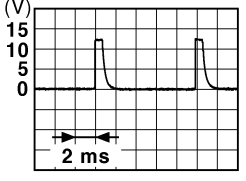
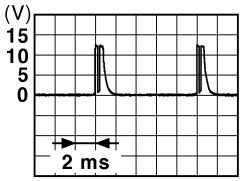
## < ECU DIAGNOSIS INFORMATION >

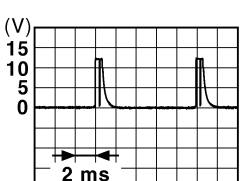
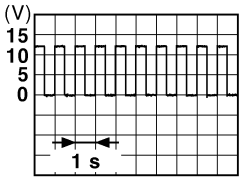
Terminal No. (Wire color)		Description		Condition	Value (Approx.)	
		Signal name	Input/ Output			
+	-					
88 (O)	Ground	Combination switch INPUT 3	Input	Combination switch	All switches OFF (Wiper intermittent dial 4)	 <small>JPMIA0041GB</small> 1.4 V
					Lighting switch HI (Wiper intermittent dial 4)	 <small>JPMIA0036GB</small> 1.3 V
					Lighting switch 2ND (Wiper intermittent dial 4)	 <small>JPMIA0037GB</small> 1.3 V
					Any of the conditions below with all switches OFF <ul style="list-style-type: none"> <li>• Wiper intermittent dial 1</li> <li>• Wiper intermittent dial 2</li> <li>• Wiper intermittent dial 3</li> </ul>	 <small>JPMIA0040GB</small> 1.3 V
89 (BR)	Ground	Push-button ignition switch (Push switch)	Input	Push-button ignition switch (push switch)	Pressed	0 V
					Not pressed	Battery voltage
90 (P)	Ground	CAN-L	Input/ Output	—	—	
91 (L)	Ground	CAN-H	Input/ Output	—	—	
92 (LG)	Ground	Key slot illumination	Output	Key slot illumina- tion	OFF	0 V
					Blinking	 <small>JPMIA0015GB</small> 6.5 V
					ON	12 V

A  
B  
C  
D  
E  
F  
G  
H  
I  
J  
L  
M  
N  
O  
P

SEC

# BCM (BODY CONTROL MODULE)

## < ECU DIAGNOSIS INFORMATION >

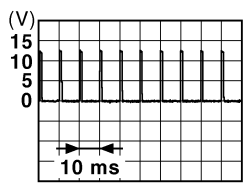
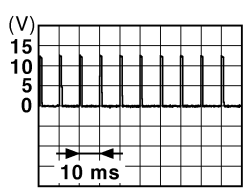
Terminal No. (Wire color)		Description		Condition		Value (Approx.)
		Signal name	Input/ Output			
+	-					
93 (Y)	Ground	ON indicator lamp	Output	Ignition switch	OFF (LOCK indicator is not illuminated)	Battery voltage
					ON	0 V
95 (O)	Ground	ACC relay control	Output	Ignition switch	OFF	0 V
					ACC or ON	12 V
96 (GR)	Ground	A/T shift selector (Detention switch) power supply	Output	—	—	12 V
97 (L)	Ground	Steering lock condition No. 1	Input	Steering lock	LOCK status	0 V
					UNLOCK status	12 V
98 (P)	Ground	Steering lock condition No. 2	Input	Steering lock	LOCK status	12 V
					UNLOCK status	0 V
99 (R)	Ground	Selector lever P position switch	Input	Selector lever	P position	0 V
					Any position other than P	12 V
		ASCD clutch switch (M/T models without ICC)		ASCD clutch switch	OFF (Clutch pedal is depressed)	0 V
					ON (Clutch pedal is not depressed)	12 V
		ICC clutch switch (M/T models with ICC)		ICC clutch switch	OFF (Clutch pedal is depressed)	0 V
					ON (Clutch pedal is not depressed)	12 V
100 (Y)	Ground	Passenger door request switch	Input	Passenger door request switch	ON (Pressed)	0 V
					OFF (Not pressed)	 <p style="text-align: right; margin-right: 50px;">1.0 V</p>
101 (P)	Ground	Driver door request switch	Input	Driver door request switch	ON (Pressed)	0 V
					OFF (Not pressed)	 <p style="text-align: right; margin-right: 50px;">1.0 V</p>
102 (O)	Ground	Blower fan motor relay control	Output	Ignition switch	OFF or ACC	0 V
					ON	12 V
103 (LG)	Ground	Remote keyless entry receiver power supply	Output	Ignition switch OFF	—	12 V
106 (W)	Ground	Steering lock unit power supply	Output	Ignition switch	OFF or ACC	12 V
					ON	0 V



# BCM (BODY CONTROL MODULE)

## < ECU DIAGNOSIS INFORMATION >

Terminal No. (Wire color)		Description		Condition	Value (Approx.)	
		Signal name	Input/ Output			
+	-					
107 (LG)	Ground	Combination switch INPUT 1	Input	Combination switch (Wiper intermit- tent dial 4)	All switches OFF	<p style="text-align: right;">1.4 V</p>
					Turn signal switch LH	<p style="text-align: right;">1.3 V</p>
					Turn signal switch RH	<p style="text-align: right;">1.3 V</p>
					Front wiper switch LO	<p style="text-align: right;">1.3 V</p>
					Front washer switch ON	<p style="text-align: right;">1.3 V</p>

A  
B  
C  
D  
E  
F  
G  
H  
I  
J  
L  
M  
N  
O  
P

SEC



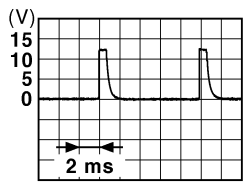
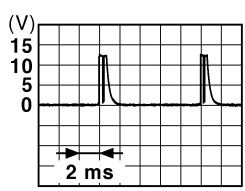
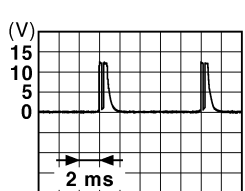
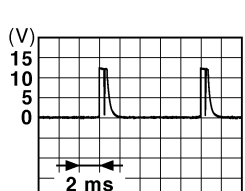

# BCM (BODY CONTROL MODULE)

## < ECU DIAGNOSIS INFORMATION >

Terminal No. (Wire color)		Description		Condition	Value (Approx.)	
		Signal name	Input/ Output			
+	-					
108 (R)	Ground	Combination switch INPUT 4	Input	Combination switch	All switches OFF (Wiper intermittent dial 4)	 <p style="text-align: right; font-size: small;">JPMIA0041GB</p> <p style="text-align: center;">1.4 V</p>
					Lighting switch AUTO (Wiper intermittent dial 4)	 <p style="text-align: right; font-size: small;">JPMIA0038GB</p> <p style="text-align: center;">1.3 V</p>
					Lighting switch 1ST (Wiper intermittent dial 4)	 <p style="text-align: right; font-size: small;">JPMIA0036GB</p> <p style="text-align: center;">1.3 V</p>
					Any of the conditions below with all switches OFF <ul style="list-style-type: none"> <li>• Wiper intermittent dial 1</li> <li>• Wiper intermittent dial 5</li> <li>• Wiper intermittent dial 6</li> </ul>	 <p style="text-align: right; font-size: small;">JPMIA0039GB</p> <p style="text-align: center;">1.3 V</p>

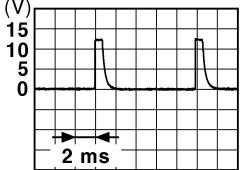
# BCM (BODY CONTROL MODULE)

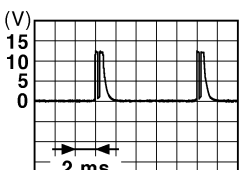
## < ECU DIAGNOSIS INFORMATION >

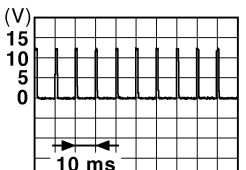
Terminal No. (Wire color)		Description		Condition	Value (Approx.)	
		Signal name	Input/ Output			
+	-					
109 (W)	Ground	Combination switch INPUT 2	Input	Combination switch (Wiper intermittent dial 4)	All switches OFF	 <small>JPMIA0041GB</small> 1.4 V
					Lighting switch PASS	 <small>JPMIA0037GB</small> 1.3 V
					Lighting switch 2ND	 <small>JPMIA0036GB</small> 1.3 V
					Front wiper switch INT	 <small>JPMIA0038GB</small> 1.3 V
					Front wiper switch HI	 <small>JPMIA0040GB</small> 1.3 V
					ON	0 V
110 (G)	Ground	Hazard switch	Input	Hazard switch	OFF	 <small>JPMIA0012GB</small> 1.1 V

A  
B  
C  
D  
E  
F  
G  
H  
I  
J  
L  
M  
N  
O  
P

SEC

# BCM (BODY CONTROL MODULE)

## < ECU DIAGNOSIS INFORMATION >

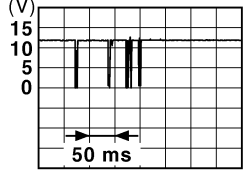
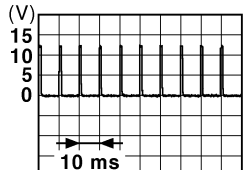
Terminal No. (Wire color)		Description		Condition	Value (Approx.)	
		Signal name	Input/ Output			
+	-					
111 (Y)	Ground	Steering lock unit communication	Input/ Output	Steering lock	LOCK status	12 V
					LOCK or UNLOCK	 <p style="text-align: right; font-size: small;">JMKIA0066GB</p>
					For 15 seconds after UNLOCK	12 V
					15 seconds or later after UNLOCK	0 V
113 (O)	Ground	Optical sensor	Input	Ignition switch ON	When bright outside of the vehicle	Close to 5 V
				When dark outside of the vehicle	Close to 0 V	
114 (R)	Ground	Clutch interlock switch	Input	Clutch interlock switch	OFF (Clutch pedal is not depressed)	0 V
				ON (Clutch pedal is depressed)	Battery voltage	
116 (SB)	Ground	Stop lamp switch 1	Input	—	Battery voltage	
118 (BR)	Ground	Stop lamp switch 2 (Without ICC)	Input	Stop lamp switch	OFF (Brake pedal is not depressed)	0 V
					ON (Brake pedal is depressed)	Battery voltage
		Stop lamp switch 2 (With ICC)		Stop lamp switch OFF (Brake pedal is not depressed) and ICC brake hold relay OFF	0 V	
				Stop lamp switch ON (Brake pedal is depressed) or ICC brake hold relay ON	Battery voltage	
119 (SB)	Ground	Driver side door lock assembly (Unlock sensor)	Input	Driver door	LOCK status (Unlock sensor switch OFF)	 <p style="text-align: right; font-size: small;">JPMIA0012GB</p>
				UNLOCK status (Unlock switch sensor ON)	0 V	
121 (SB)	Ground	Key slot switch	Input	When the Intelligent Key is inserted into key slot	12 V	
				When the Intelligent Key is not inserted into key slot	0 V	
123 (W)	Ground	IGN feedback	Input	Ignition switch	OFF or ACC	0 V
				ON	Battery voltage	

# BCM (BODY CONTROL MODULE)

## < ECU DIAGNOSIS INFORMATION >



Terminal No. (Wire color)		Description		Condition		Value (Approx.)
+	-	Signal name	Input/ Output			
124 (LG)	Ground	Passenger door switch	Input	Passenger door switch	OFF (Door close)	<p style="text-align: right; font-size: small;">JPMIA0011GB</p> <p style="text-align: center;">11.8 V</p>
					ON (Door open)	0 V
129 (O)	Ground	Trunk lid opener cancel switch	Input	Trunk lid opener cancel switch	CANCEL	<p style="text-align: right; font-size: small;">JPMIA0012GB</p> <p style="text-align: center;">1.1 V</p>
					ON	0 V
132 (V)	Ground	Power window switch communication	Input/ Output	Ignition switch ON	<p style="text-align: right; font-size: small;">JPMIA0013GB</p> <p style="text-align: center;">10.2 V</p>	
				Ignition switch OFF or ACC	12 V	
133 (L)	Ground	Push-button ignition switch illumination	Output	Push-button ignition switch illumination	<p style="text-align: center;"><b>NOTE:</b> The pulse width of this wave is varied by the illumination brightening/dimming level.</p> <p style="text-align: right; font-size: small;">JPMIA0159GB</p>	
				ON (Tail lamps OFF)	9.5 V	
				ON (Tail lamps ON)		
134 (LG)	Ground	LOCK indicator lamp	Output	LOCK indicator lamp	OFF	Battery voltage
				ON	0 V	
137 (O)	Ground	Receiver and sensor ground	Input	Ignition switch ON	0 V	
138 (V)	Ground	Receiver and sensor power supply	Output	Ignition switch	OFF	0 V
				ACC or ON	5.0 V	

A  
B  
C  
D  
E  
F  
G  
H  
I  
J  
L  
M  
N  
O  
P

SEC

# BCM (BODY CONTROL MODULE)

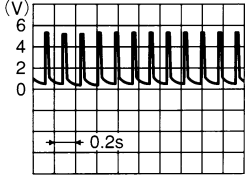
## < ECU DIAGNOSIS INFORMATION >

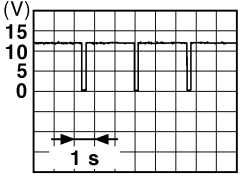
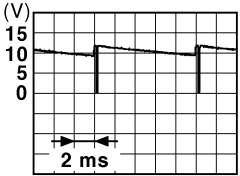
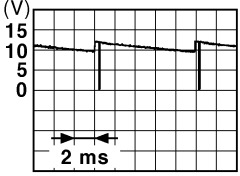
Terminal No. (Wire color)		Description		Condition	Value (Approx.)
+	-	Signal name	Input/ Output		
139 (L)	Ground	Tire pressure receiver communication	Input/ Output	Ignition switch ON	Standby state  OCC3881D
				When receiving the signal from the transmitter  OCC3880D	
140 (GR)	Ground	Selector lever P/N position (A/T models)	Input	Selector lever	P or N position 12 V Except P and N positions 0 V
					ON 0 V
141 (R)	Ground	Security indicator	Output	Security indicator	Blinking  JPMIA0014GB 11.3 V
					OFF 12 V
142 (BR)	Ground	Combination switch OUTPUT 5	Output	Combination switch (Wiper intermittent dial 4)	All switches OFF 0 V
					Lighting switch 1ST
					Lighting switch HI
					Lighting switch 2ND
		Turn signal switch RH  JPMIA0031GB 10.7 V			
143 (V)	Ground	Combination switch OUTPUT 1	Output	Combination switch	All switches OFF (Wiper intermittent dial 4) 0 V
					Front wiper switch HI (Wiper intermittent dial 4) Any of the conditions below with all switches OFF • Wiper intermittent dial 1 • Wiper intermittent dial 2 • Wiper intermittent dial 3 • Wiper intermittent dial 6 • Wiper intermittent dial 7  JPMIA0032GB 10.7 V

# BCM (BODY CONTROL MODULE)

## < ECU DIAGNOSIS INFORMATION >

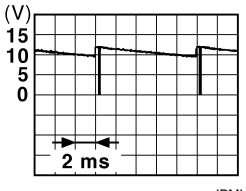
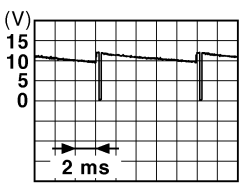
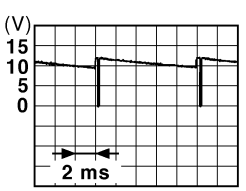
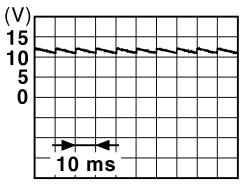
Terminal No. (Wire color)		Description		Condition	Value (Approx.)	
+	-	Signal name	Input/ Output			
144 (G)	Ground	Combination switch OUTPUT 2	Output	Combination switch	All switches OFF (Wiper intermittent dial 4)	0 V
					Front washer switch ON (Wiper intermittent dial 4)	
Any of the conditions below with all switches OFF					10.7 V	
<ul style="list-style-type: none"> <li>• Wiper intermittent dial 1</li> <li>• Wiper intermittent dial 5</li> <li>• Wiper intermittent dial 6</li> </ul>						
145 (L)	Ground	Combination switch OUTPUT 3	Output	Combination switch (Wiper intermit- tent dial 4)	All switches OFF	0 V
					Front wiper switch INT	
					Front wiper switch LO	
					Lighting switch AUTO	
					10.7 V	
146 (SB)	Ground	Combination switch OUTPUT 4	Output	Combination switch (Wiper intermit- tent dial 4)	All switches OFF	0 V
					Front fog lamp switch ON	
					Lighting switch 2ND	
					Lighting switch PASS	
					Turn signal switch LH	
					10.7 V	
149 (W)	Ground	Tire pressure warning check switch	Input	—	12 V	
150 (R)	Ground	Driver door switch	Input	Driver door switch	OFF (Door close)	
					ON (Door open)	
151 (G)	Ground	Rear window defog- ger relay control	Output	Rear window defogger	Active	0 V
				Not activated	Battery voltage	

A  
B  
C  
D  
E  
F  
G  
H  
I  
J  
L  
M  
N  
O  
P

SEC

# BCM (BODY CONTROL MODULE)

< ECU DIAGNOSIS INFORMATION >

## Wiring Diagram - BCM -

INFOID:000000004679492

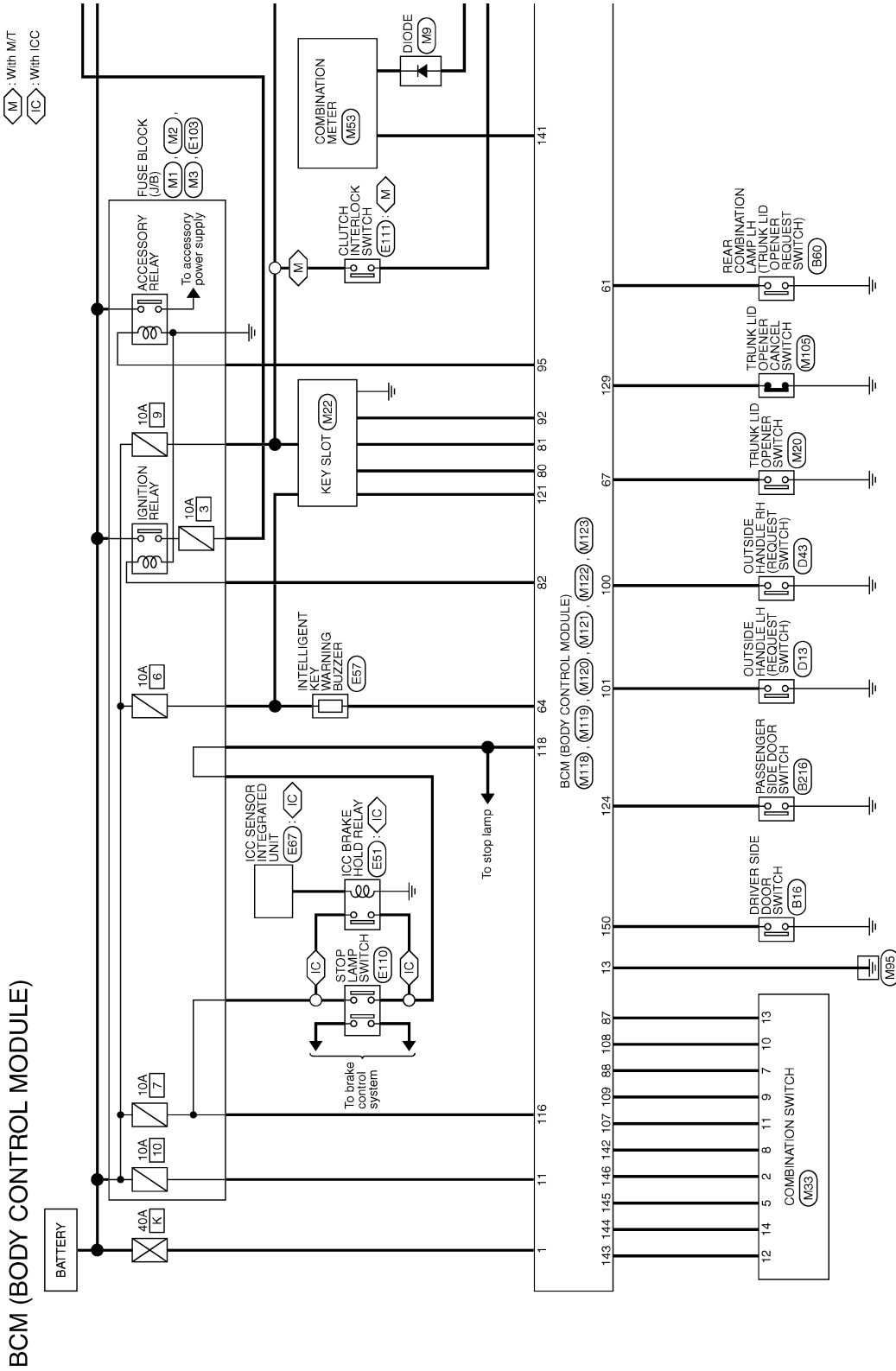

2008/08/22

JCMWM3046G



# BCM (BODY CONTROL MODULE)

< ECU DIAGNOSIS INFORMATION >

◁ : With A/T  
 ▷ : With M/T

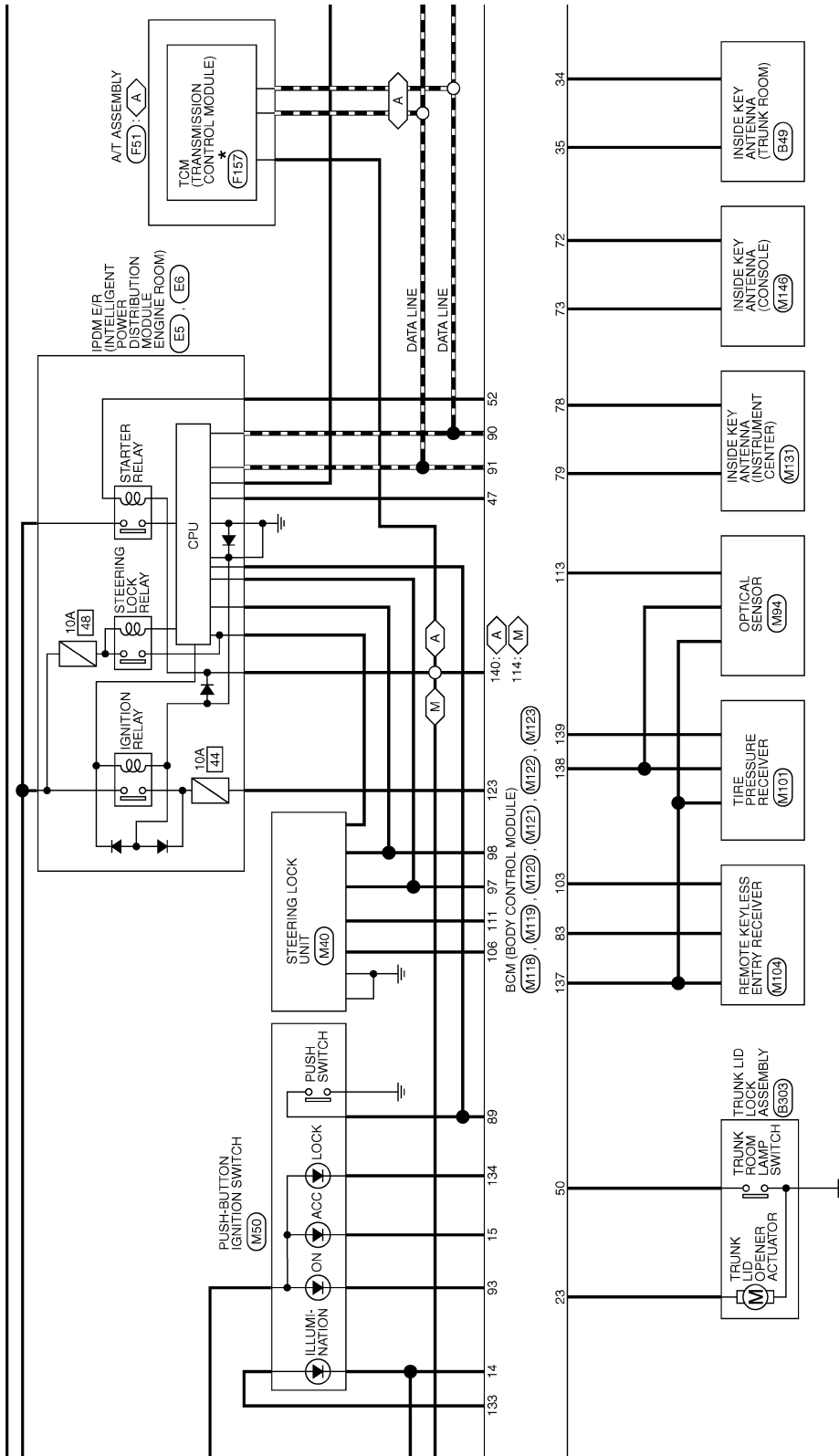

\*: This connector is not shown in "Harness Layout".

JCMWM3047G1

A  
 B  
 C  
 D  
 E  
 F  
 G  
 H  
 I  
 J  
 L  
 M  
 N  
 O  
 P

SEC

# BCM (BODY CONTROL MODULE)

< ECU DIAGNOSIS INFORMATION >

- : With A/T
- : With M/T
- : With sunroof
- : With ICC
- : Without ICC

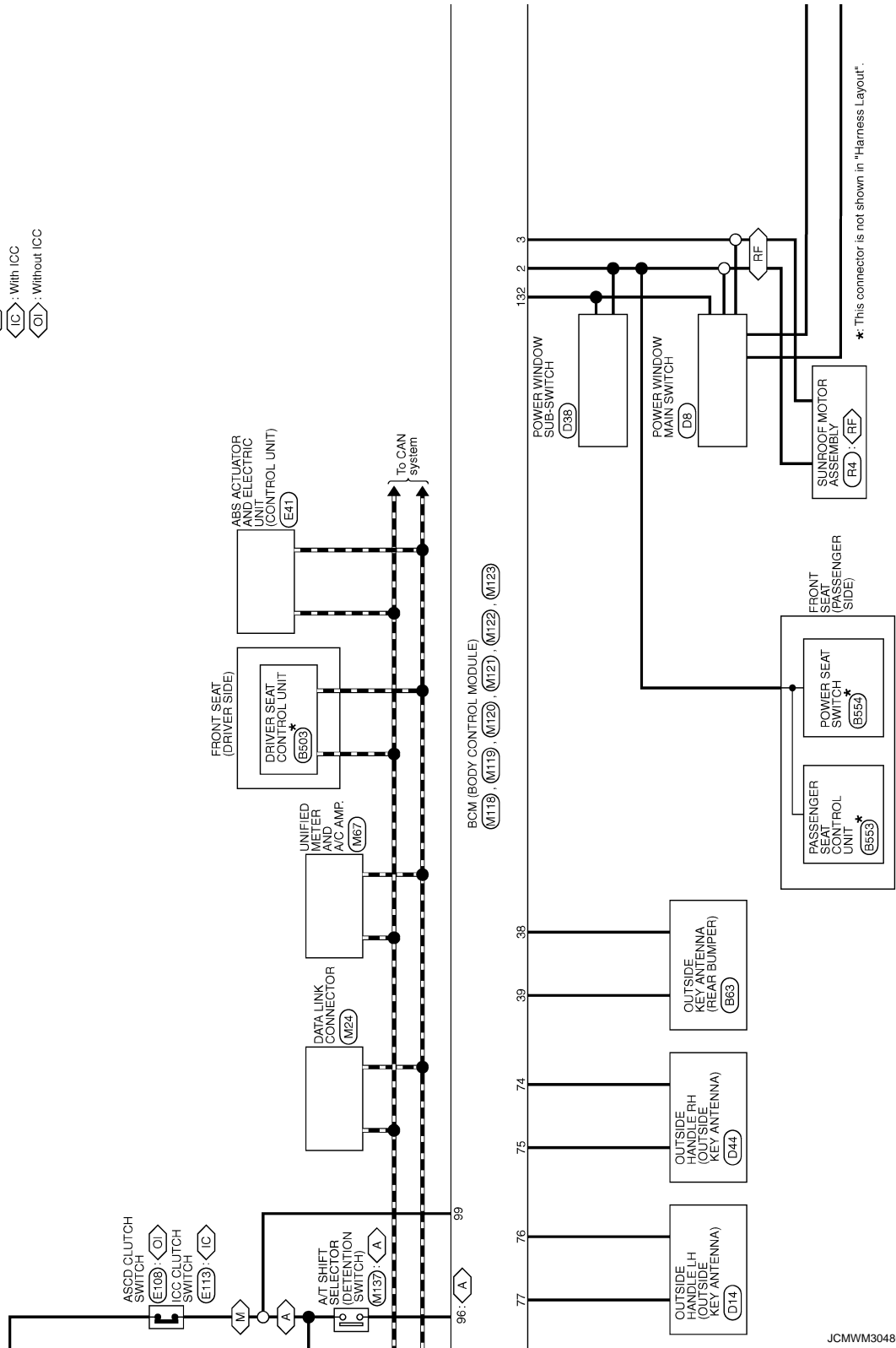

JCMWM3048G

# BCM (BODY CONTROL MODULE)

< ECU DIAGNOSIS INFORMATION >

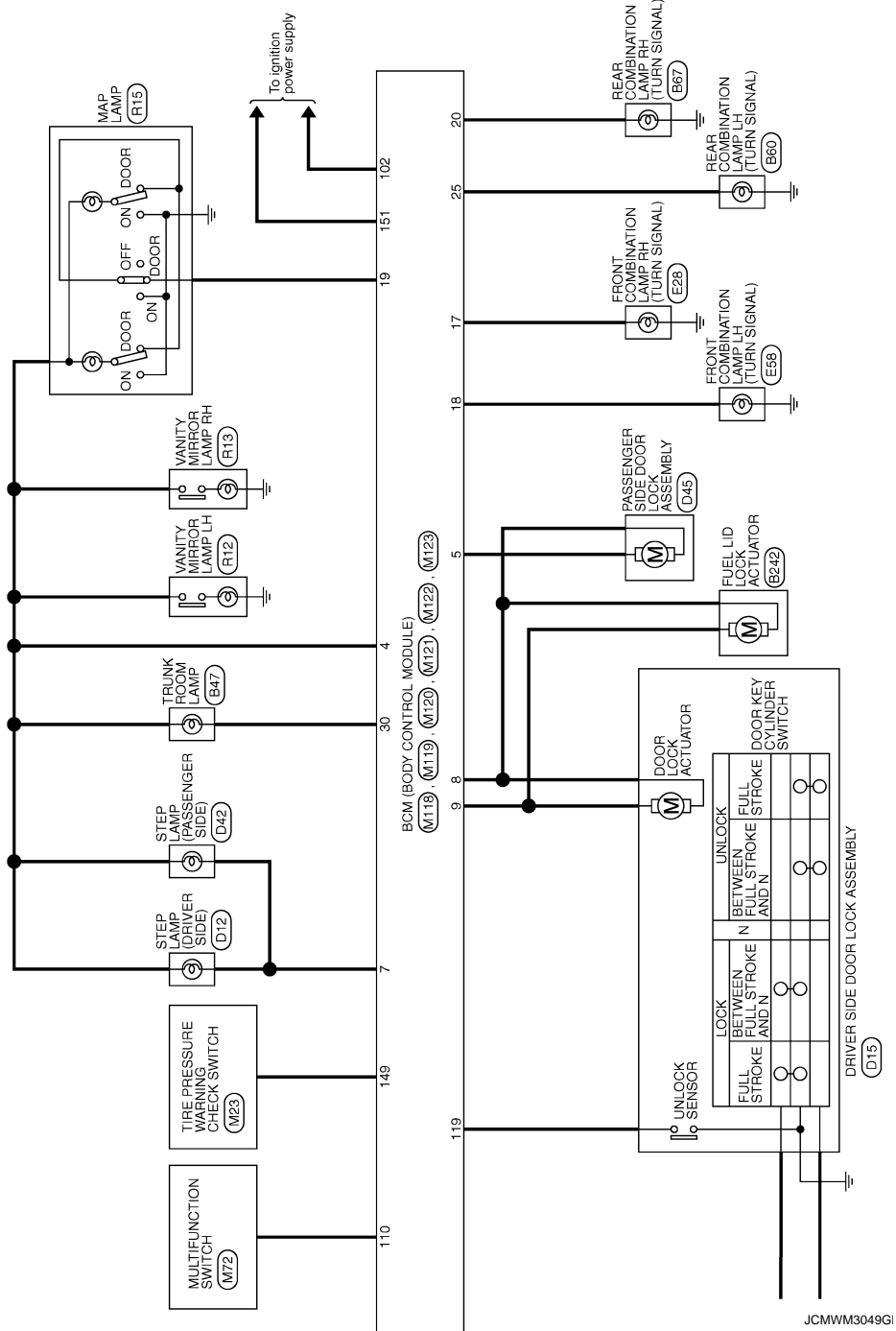

A  
B  
C  
D  
E  
F  
G  
H  
I  
J  
K  
L  
M  
N  
O  
P

SEC

# BCM (BODY CONTROL MODULE)

< ECU DIAGNOSIS INFORMATION >

**BCM (BODY CONTROL MODULE)**

Connector No.	M33
Connector Name	COMBINATION SWITCH
Connector Type	TH16FW-NH

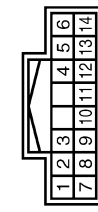

Terminal No.	Color of Wire	Signal Name [Specification]
2	SB	OUTPUT 4
5	L	OUTPUT 3
7	O	INPUT 3
8	BR	OUTPUT 5
9	W	INPUT 2
10	R	INPUT 4
11	LG	INPUT 1
12	V	OUTPUT 1
13	Y	INPUT 5
14	G	OUTPUT 2

Connector No.	M120
Connector Name	BCM (BODY CONTROL MODULE)
Connector Type	NS12FW-CS

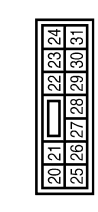

Terminal No.	Color of Wire	Signal Name [Specification]
20	V	TURN SIGNAL RH (REAR)
23	L	TRUNK LID OPEN OUTPUT
25	Y	TURN SIGNAL LH (REAR)
30	P	TRUNK ROOM LAMP

Connector No.	M118
Connector Name	BCM (BODY CONTROL MODULE)
Connector Type	M03FB-LC



Terminal No.	Color of Wire	Signal Name [Specification]
1	W	BAT (F/L)
2	Y	POWER WINDOW POWER SUPPLY (BAT)
3	O	POWER WINDOW POWER SUPPLY (RAIP)

Connector No.	M121
Connector Name	BCM (BODY CONTROL MODULE)
Connector Type	TH40FGY-NH

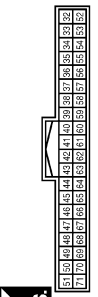

Terminal No.	Color of Wire	Signal Name [Specification]
34	SB	TRUNK ROOM ANT-
35	V	TRUNK ROOM ANT+
38	B	REAR BUMPER ANT-
39	W	REAR BUMPER ANT+
47	Y	IGN RELAY (IPDM E/R) CONT
50	R	TRUNK ROOM LAMP SW
52	SB	STARTER RELAY CONT
61	SB	TRUNK LID OPENER REQUEST SW
64	L	I-KEY WARN BUZZER (ENG ROOM)
67	GR	TRUNK LID OPENER SW

Connector No.	M119
Connector Name	BCM (BODY CONTROL MODULE)
Connector Type	NS18FW-CS

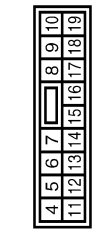

Terminal No.	Color of Wire	Signal Name [Specification]
4	LG	INTERIOR ROOM LAMP POWER SUPPLY
5	P	PASSENGER DOOR UNLOCK OUTPUT
7	SB	STEP LAMP OUTPUT
8	V	ALL DOOR FUEL LID LOCK OUTPUT
9	G	DRIVER DOOR FUEL LID UNLOCK OUTPUT
11	R	BAT (F/USE)
13	B	GND
14	W	PUSH-BUTTON IGNITION SW (LL GND ACC IND)
15	O	ACC IND
17	W	TURN SIGNAL RH (FRONT)
18	O	TURN SIGNAL LH (FRONT)

Connector No.	M122
Connector Name	BCM (BODY CONTROL MODULE)
Connector Type	TH40FB-NH

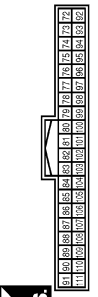

Terminal No.	Color of Wire	Signal Name [Specification]
72	R	ROOM ANT2-
73	G	ROOM ANT2+
74	SB	PASSENGER DOOR ANT-
75	BR	PASSENGER DOOR ANT+
76	V	DRIVER DOOR ANT-
77	LG	DRIVER DOOR ANT+
78	Y	ROOM ANT1-
79	BR	ROOM ANT1+
80	GR	IMMOBI ANTENNA CONTROL
81	W	IMMOBI ANTENNA SIGNAL
82	R	IGN RELAY (F/B) CONT

19	V	ROOM LAMP TIMER CONTROL
----	---	-------------------------

83	Y	KEYLESS ENTRY RECEIVER COMM
87	Y	COMBI SW INPUT 5
88	O	COMBI SW INPUT 3
89	BR	PUSH SW
90	P	CAN-L
91	L	CAN-H
92	LG	KEY SLOT ILL ON IND
93	Y	KEY SLOT ILL ON IND
95	O	ACC RELAY CONT
96	GR	A/T SHIFT SELECTOR POWER SUPPLY
97	L	S/L CONDITION 1
98	P	S/L CONDITION 2
99	R	ASD CLUTCH SW (M/T models without ICC)
99	R	ICC CLUTCH SW (M/T models with ICC)
99	R	SHIFT P (A/T models)
100	Y	PASSENGER DOOR REQUEST SW
101	P	DRIVER DOOR REQUEST SW
102	O	BLOWER FAN MOTOR RELAY CONT
103	LG	KEYLESS ENTRY RECEIVER POWER SUPPLY
106	W	S/L UNIT POWER SUPPLY
107	LG	COMBI SW INPUT 1
108	R	ROOM ANT1+
109	W	COMBI SW INPUT 2
110	G	HAZARD SW
111	Y	S/L UNIT COMM

# BCM (BODY CONTROL MODULE)

< ECU DIAGNOSIS INFORMATION >

A  
B  
C  
D  
E  
F  
G  
H  
I  
J  
L  
M  
N  
O  
P

SEC

## BCM (BODY CONTROL MODULE)

Connector No.	M123
Connector Name	BCM BODY CONTROL MODULE
Connector Type	TH40FG-1M1

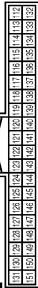

Terminal No.	Color of Wire	Signal Name [Specification]
113	O	OPTICAL SENSOR
114	R	CLUTCH INTERLOCK SW
116	SB	STOP LAMP SW 1
118	BR	STOP LAMP SW 2
119	SB	DR DOOR UNLOCK SENSOR
121	SB	KEY SLOT SW
123	W	IGN P/B
124	LG	PASSENGER DOOR SW
129	O	TRUNK LID OPENER CANCEL SW
132	V	POWER WINDOW SW COMM
133	L	PUSH-BUTTON IGNITION SW ILL POWER

134	LG	LOCK IND
137	O	RECEIVER SENSOR GND
138	V	RECEIVER SENSOR POWER SUPPLY
139	L	TIRE PRESSURE RECEIVER COMM
140	GR	SHIFT N/P
141	R	SECURITY INDICATOR
142	BR	COMBI SW OUTPUT 5
143	V	COMBI SW OUTPUT 1
144	G	COMBI SW OUTPUT 2
145	L	COMBI SW OUTPUT 3
146	SB	COMBI SW OUTPUT 4
148	W	TIRE PRESSURE WARN CHECK SW
150	R	DRIVER DOOR SW
151	G	REAR WINDOW DEFROGGER RELAY CONT

## Fail-safe

### FAIL-SAFE CONTROL BY DTC

BCM performs fail-safe control when any DTC are detected.

JCMWM3051G1

INFOID:000000004679493

## BCM (BODY CONTROL MODULE)

### < ECU DIAGNOSIS INFORMATION >

Display contents of CONSULT	Fail-safe	Cancellation
B2013: ID DISCORD BCM-S/L	Inhibit engine cranking	Erase DTC
B2014: CHAIN OF S/L-BCM	Inhibit engine cranking	Erase DTC
B2190: NATS ANTENNA AMP	Inhibit engine cranking	Erase DTC
B2191: DIFFERENCE OF KEY	Inhibit engine cranking	Erase DTC
B2192: ID DISCORD BCM-ECM	Inhibit engine cranking	Erase DTC
B2193: CHAIN OF BCM-ECM	Inhibit engine cranking	Erase DTC
B2195: ANTI SCANNING	Inhibit engine cranking	Ignition switch ON → OFF
B2557: VEHICLE SPEED	Inhibit steering lock	When normal vehicle speed signals are received from ABS actuator and electric unit (control unit) for 500 ms
B2560: STARTER CONT RELAY	Inhibit engine cranking	500 ms after the following CAN signal communication status becomes consistent <ul style="list-style-type: none"> <li>• Starter control relay signal</li> <li>• Starter relay status signal</li> </ul>
B2601: SHIFT POSITION	Inhibit steering lock	500 ms after the following signal reception status becomes consistent <ul style="list-style-type: none"> <li>• Selector lever P position switch signal</li> <li>• P range signal (CAN)</li> </ul>
B2602: SHIFT POSITION	Inhibit steering lock	5 seconds after the following BCM recognition conditions are fulfilled <ul style="list-style-type: none"> <li>• Ignition switch is in the ON position</li> <li>• Selector lever P position switch signal: Except P position (battery voltage)</li> <li>• Vehicle speed: 4 km/h (2.5 MPH) or more</li> </ul>
B2603: SHIFT POSI STATUS	Inhibit steering lock	500 ms after the following BCM recognition conditions are fulfilled <ul style="list-style-type: none"> <li>• Ignition switch is in the ON position</li> <li>• Selector lever P position switch signal: Except P position (battery voltage)</li> <li>• Selector lever P/N position signal: Except P and N positions (0 V)</li> </ul>
B2604: PNP SW	Inhibit steering lock	500 ms after any of the following BCM recognition conditions are fulfilled <ul style="list-style-type: none"> <li>• Status 1 <ul style="list-style-type: none"> <li>- Ignition switch is in the ON position</li> <li>- Selector lever P/N position signal: P and N position (battery voltage)</li> <li>- P range signal or N range signal (CAN): ON</li> </ul> </li> <li>• Status 2 <ul style="list-style-type: none"> <li>- Ignition switch is in the ON position</li> <li>- Selector lever P/N position signal: Except P and N positions (0 V)</li> <li>- P range signal and N range signal (CAN): OFF</li> </ul> </li> </ul>
B2605: PNP SW	Inhibit steering lock	500 ms after any of the following BCM recognition conditions are fulfilled <ul style="list-style-type: none"> <li>• Status 1 <ul style="list-style-type: none"> <li>- Ignition switch is in the ON position</li> <li>- Selector lever P/N position signal: Except P and N positions (0 V)</li> <li>- Interlock/PNP switch signal (CAN): OFF</li> </ul> </li> <li>• Status 2 <ul style="list-style-type: none"> <li>- Ignition switch is in the ON position</li> <li>- Selector lever P/N position signal: P or N position (battery voltage)</li> <li>- PNP switch signal (CAN): ON</li> </ul> </li> </ul>
B2606: S/L RELAY	Inhibit engine cranking	500 ms after the following CAN signal communication status becomes consistent <ul style="list-style-type: none"> <li>• Steering lock relay signal (Request signal)</li> <li>• Steering lock relay signal (Condition signal)</li> </ul>

## BCM (BODY CONTROL MODULE)

### < ECU DIAGNOSIS INFORMATION >

Display contents of CONSULT	Fail-safe	Cancellation
B2607: S/L RELAY	Inhibit engine cranking	500 ms after the following CAN signal communication status has becomes consistent <ul style="list-style-type: none"> <li>• Steering lock relay signal (Request signal)</li> <li>• Steering lock relay signal (Condition signal)</li> </ul>
B2608: STARTER RELAY	Inhibit engine cranking	500 ms after the following signal communication status becomes consistent <ul style="list-style-type: none"> <li>• Starter motor relay control signal</li> <li>• Starter relay status signal (CAN)</li> </ul>
B2609: S/L STATUS	<ul style="list-style-type: none"> <li>• Inhibit engine cranking</li> <li>• Inhibit steering lock</li> </ul>	When the following steering lock conditions agree <ul style="list-style-type: none"> <li>• BCM steering lock control status</li> <li>• Steering lock condition No. 1 signal status</li> <li>• Steering lock condition No. 2 signal status</li> </ul>
B260A: IGNITION RELAY	Inhibit engine cranking	500 ms after the following conditions are fulfilled <ul style="list-style-type: none"> <li>• IGN relay (IPDM E/R) control signal: OFF (Battery voltage)</li> <li>• Ignition ON signal (CAN to IPDM E/R): OFF (Request signal)</li> <li>• Ignition ON signal (CAN from IPDM E/R): OFF (Condition signal)</li> </ul>
B260F: ENG STATE SIG LOST	Maintains the power supply position attained at the time of DTC detection	When any of the following conditions are fulfilled <ul style="list-style-type: none"> <li>• Power position changes to ACC</li> <li>• Receives engine status signal (CAN)</li> </ul>
B2612: S/L STATUS	<ul style="list-style-type: none"> <li>• Inhibit engine cranking</li> <li>• Inhibit steering lock</li> </ul>	When any of the following conditions are fulfilled <ul style="list-style-type: none"> <li>• Steering lock unit status signal (CAN) is received normally</li> <li>• The BCM steering lock control status matches the steering lock status recognized by the steering lock unit status signal (CAN from IPDM E/R)</li> </ul>
B2617: STARTER RELAY CIRC	Inhibit engine cranking	1 second after the starter motor relay control inside BCM becomes normal
B2618: BCM	Inhibit engine cranking	1 second after the ignition relay (IPDM E/R) control inside BCM becomes normal
B2619: BCM	Inhibit engine cranking	1 second after the steering lock unit power supply output control inside BCM becomes normal
B261E: VEHICLE TYPE	Inhibit engine cranking	BCM initialization
B26E8: CLUTCH SW	Inhibit engine cranking	When any of the following BCM recognition conditions are fulfilled <ul style="list-style-type: none"> <li>• Status 1                             <ul style="list-style-type: none"> <li>- Clutch switch signal (CAN from ECM): ON</li> <li>- Clutch interlock switch signal: OFF (0 V)</li> </ul> </li> <li>• Status 2                             <ul style="list-style-type: none"> <li>- Clutch switch signal (CAN from ECM): OFF</li> <li>- Clutch interlock switch signal: ON (Battery voltage)</li> </ul> </li> </ul>
B26E9: S/L STATUS	<ul style="list-style-type: none"> <li>• Inhibit engine cranking</li> <li>• Inhibit steering lock</li> </ul>	When BCM transmits the LOCK request signal to steering lock unit, and receives LOCK response signal from steering lock unit, the following conditions are fulfilled <ul style="list-style-type: none"> <li>• Steering condition No. 1 signal: LOCK (0 V)</li> <li>• Steering condition No. 2 signal: LOCK (Battery voltage)</li> </ul>

### HIGH FLASHER OPERATION

BCM detects the turn signal lamp circuit status by the current value.

BCM increases the turn signal lamp blinking speed if the bulb or harness open is detected with the turn signal lamp operating.

#### NOTE:

The blinking speed is normal while activating the hazard warning lamp.

### DTC Inspection Priority Chart

INFOID:000000004679494

If some DTCs are displayed at the same time, perform inspections one by one based on the following priority chart.

## BCM (BODY CONTROL MODULE)

### < ECU DIAGNOSIS INFORMATION >

Priority	DTC
1	B2562: LOW VOLTAGE
2	<ul style="list-style-type: none"> <li>• U1000: CAN COMM</li> <li>• U1010: CONTROL UNIT(CAN)</li> </ul>
3	<ul style="list-style-type: none"> <li>• B2190: NATS ANTENNA AMP</li> <li>• B2191: DIFFERENCE OF KEY</li> <li>• B2192: ID DISCORD BCM-ECM</li> <li>• B2193: CHAIN OF BCM-ECM</li> <li>• B2195: ANTI SCANNING</li> </ul>
4	<ul style="list-style-type: none"> <li>• B2013: ID DISCORD BCM-S/L</li> <li>• B2014: CHAIN OF S/L-BCM</li> <li>• B2553: IGNITION RELAY</li> <li>• B2555: STOP LAMP</li> <li>• B2556: PUSH-BTN IGN SW</li> <li>• B2557: VEHICLE SPEED</li> <li>• B2560: STARTER CONT RELAY</li> <li>• B2601: SHIFT POSITION</li> <li>• B2602: SHIFT POSITION</li> <li>• B2603: SHIFT POSI STATUS</li> <li>• B2604: PNP SW</li> <li>• B2605: PNP SW</li> <li>• B2606: S/L RELAY</li> <li>• B2607: S/L RELAY</li> <li>• B2608: STARTER RELAY</li> <li>• B2609: S/L STATUS</li> <li>• B260A: IGNITION RELAY</li> <li>• B260B: STEERING LOCK UNIT</li> <li>• B260C: STEERING LOCK UNIT</li> <li>• B260D: STEERING LOCK UNIT</li> <li>• B260F: ENG STATE SIG LOST</li> <li>• B2612: S/L STATUS</li> <li>• B2614: ACC RELAY CIRC</li> <li>• B2615: BLOWER RELAY CIRC</li> <li>• B2616: IGN RELAY CIRC</li> <li>• B2617: STARTER RELAY CIRC</li> <li>• B2618: BCM</li> <li>• B2619: BCM</li> <li>• B261A: PUSH-BTN IGN SW</li> <li>• B261E: VEHICLE TYPE</li> <li>• B26E8: CLUTCH SW</li> <li>• B26E9: S/L STATUS</li> <li>• B26EA: KEY REGISTRATION</li> <li>• C1729: VHCL SPEED SIG ERR</li> <li>• U0415: VEHICLE SPEED SIG</li> </ul>



# BCM (BODY CONTROL MODULE)

## < ECU DIAGNOSIS INFORMATION >

Priority	DTC	
5	<ul style="list-style-type: none"> <li>• C1704: LOW PRESSURE FL</li> <li>• C1705: LOW PRESSURE FR</li> <li>• C1706: LOW PRESSURE RR</li> <li>• C1707: LOW PRESSURE RL</li> <li>• C1708: [NO DATA] FL</li> <li>• C1709: [NO DATA] FR</li> <li>• C1710: [NO DATA] RR</li> <li>• C1711: [NO DATA] RL</li> <li>• C1712: [CHECKSUM ERR] FL</li> <li>• C1713: [CHECKSUM ERR] FR</li> <li>• C1714: [CHECKSUM ERR] RR</li> <li>• C1715: [CHECKSUM ERR] RL</li> <li>• C1716: [PRESSDATA ERR] FL</li> <li>• C1717: [PRESSDATA ERR] FR</li> <li>• C1718: [PRESSDATA ERR] RR</li> <li>• C1719: [PRESSDATA ERR] RL</li> <li>• C1720: [CODE ERR] FL</li> <li>• C1721: [CODE ERR] FR</li> <li>• C1722: [CODE ERR] RR</li> <li>• C1723: [CODE ERR] RL</li> <li>• C1724: [BATT VOLT LOW] FL</li> <li>• C1725: [BATT VOLT LOW] FR</li> <li>• C1726: [BATT VOLT LOW] RR</li> <li>• C1727: [BATT VOLT LOW] RL</li> <li>• C1734: CONTROL UNIT</li> </ul>	A B C D E F G
6	<ul style="list-style-type: none"> <li>• B2621: INSIDE ANTENNA</li> <li>• B2622: INSIDE ANTENNA</li> <li>• B2623: INSIDE ANTENNA</li> </ul>	H

## DTC Index

INFOID:000000004679495

### NOTE:

The details of time display are as follows.

- CRNT: A malfunction is detected now.
- PAST: A malfunction was detected in the past.

IGN counter is displayed on Freeze Frame Data. For details of Freeze Frame Data, refer to [BCS-14. "COMMON ITEM : CONSULT-III Function \(BCM - COMMON ITEM\)"](#).

SEC

CONSULT display	Fail-safe	Freeze Frame Data •Vehicle Speed •Odo/Trip Meter •Vehicle condition	Intelligent Key warning lamp ON	Tire pressure monitor warning lamp ON	Refer- ence page
No DTC is detected. further testing may be required.	—	—	—	—	—
U1000: CAN COMM	—	—	—	—	<a href="#">BCS-35</a>
U1010: CONTROL UNIT(CAN)	—	—	—	—	<a href="#">BCS-36</a>
U0415: VEHICLE SPEED SIG	—	—	—	—	<a href="#">BCS-37</a>
B2013: ID DISCORD BCM-S/L	×	×	—	—	<a href="#">SEC-55</a>
B2014: CHAIN OF S/L-BCM	×	×	—	—	<a href="#">SEC-56</a>
B2190: NATS ANTENNA AMP	×	—	—	—	<a href="#">SEC-47</a>
B2191: DIFFERENCE OF KEY	×	—	—	—	<a href="#">SEC-50</a>
B2192: ID DISCORD BCM-ECM	×	—	—	—	<a href="#">SEC-51</a>
B2193: CHAIN OF BCM-ECM	×	—	—	—	<a href="#">SEC-53</a>
B2195: ANTI SCANNING	×	—	—	—	<a href="#">SEC-54</a>
B2553: IGNITION RELAY	—	×	—	—	<a href="#">PCS-48</a>
B2555: STOP LAMP	—	×	—	—	<a href="#">SEC-59</a>

L

M

N

O

P

## BCM (BODY CONTROL MODULE)

< ECU DIAGNOSIS INFORMATION >

CONSULT display	Fail-safe	Freeze Frame Data •Vehicle Speed •Odo/Trip Meter •Vehicle condition	Intelligent Key warning lamp ON	Tire pressure monitor warning lamp ON	Refer- ence page
B2556: PUSH-BTN IGN SW	—	×	×	—	<a href="#">SEC-61</a>
B2557: VEHICLE SPEED	×	×	×	—	<a href="#">SEC-63</a>
B2560: STARTER CONT RELAY	×	×	×	—	<a href="#">SEC-64</a>
B2562: LOW VOLTAGE	—	×	—	—	<a href="#">BCS-38</a>
B2601: SHIFT POSITION	×	×	×	—	<a href="#">SEC-65</a>
B2602: SHIFT POSITION	×	×	×	—	<a href="#">SEC-68</a>
B2603: SHIFT POSI STATUS	×	×	×	—	<a href="#">SEC-70</a>
B2604: PNP SW	×	×	×	—	<a href="#">SEC-73</a>
B2605: PNP SW	×	×	×	—	<a href="#">SEC-75</a>
B2606: S/L RELAY	×	×	×	—	<a href="#">SEC-77</a>
B2607: S/L RELAY	×	×	×	—	<a href="#">SEC-78</a>
B2608: STARTER RELAY	×	×	×	—	<a href="#">SEC-80</a>
B2609: S/L STATUS	×	×	×	—	<a href="#">SEC-82</a>
B260A: IGNITION RELAY	×	×	×	—	<a href="#">PCS-50</a>
B260B: STEERING LOCK UNIT	—	×	×	—	<a href="#">SEC-86</a>
B260C: STEERING LOCK UNIT	—	×	×	—	<a href="#">SEC-87</a>
B260D: STEERING LOCK UNIT	—	×	×	—	<a href="#">SEC-88</a>
B260F: ENG STATE SIG LOST	×	×	×	—	<a href="#">SEC-89</a>
B2612: S/L STATUS	×	×	×	—	<a href="#">SEC-94</a>
B2614: ACC RELAY CIRC	—	×	×	—	<a href="#">PCS-52</a>
B2615: BLOWER RELAY CIRC	—	×	×	—	<a href="#">PCS-54</a>
B2616: IGN RELAY CIRC	—	×	×	—	<a href="#">PCS-56</a>
B2617: STARTER RELAY CIRC	×	×	×	—	<a href="#">SEC-98</a>
B2618: BCM	×	×	×	—	<a href="#">PCS-58</a>
B2619: BCM	×	×	×	—	<a href="#">SEC-100</a>
B261A: PUSH-BTN IGN SW	—	×	×	—	<a href="#">PCS-59</a>
B261E: VEHICLE TYPE	×	×	× (Turn ON for 15 seconds)	—	<a href="#">SEC-101</a>
B2621: INSIDE ANTENNA	—	×	—	—	<a href="#">DLK-55</a>
B2622: INSIDE ANTENNA	—	×	—	—	<a href="#">DLK-57</a>
B2623: INSIDE ANTENNA	—	×	—	—	<a href="#">DLK-59</a>
B26E8: CLUTCH SW	×	×	×	—	<a href="#">SEC-90</a>
B26E9: S/L STATUS	×	×	× (Turn ON for 15 seconds)	—	<a href="#">SEC-92</a>
B26EA: KEY REGISTRATION	—	×	× (Turn ON for 15 seconds)	—	<a href="#">SEC-93</a>
C1704: LOW PRESSURE FL	—	—	—	×	<a href="#">WT-17</a>
C1705: LOW PRESSURE FR	—	—	—	×	
C1706: LOW PRESSURE RR	—	—	—	×	
C1707: LOW PRESSURE RL	—	—	—	×	

## BCM (BODY CONTROL MODULE)

### < ECU DIAGNOSIS INFORMATION >

CONSULT display	Fail-safe	Freeze Frame Data •Vehicle Speed •Odo/Trip Meter •Vehicle condition	Intelligent Key warning lamp ON	Tire pressure monitor warning lamp ON	Refer- ence page
C1708: [NO DATA] FL	—	—	—	×	<a href="#">WT-19</a>
C1709: [NO DATA] FR	—	—	—	×	
C1710: [NO DATA] RR	—	—	—	×	
C1711: [NO DATA] RL	—	—	—	×	<a href="#">WT-21</a>
C1712: [CHECKSUM ERR] FL	—	—	—	×	
C1713: [CHECKSUM ERR] FR	—	—	—	×	
C1714: [CHECKSUM ERR] RR	—	—	—	×	
C1715: [CHECKSUM ERR] RL	—	—	—	×	<a href="#">WT-24</a>
C1716: [PRESSDATA ERR] FL	—	—	—	×	
C1717: [PRESSDATA ERR] FR	—	—	—	×	
C1718: [PRESSDATA ERR] RR	—	—	—	×	
C1719: [PRESSDATA ERR] RL	—	—	—	×	<a href="#">WT-26</a>
C1720: [CODE ERR] FL	—	—	—	×	
C1721: [CODE ERR] FR	—	—	—	×	
C1722: [CODE ERR] RR	—	—	—	×	
C1723: [CODE ERR] RL	—	—	—	×	<a href="#">WT-29</a>
C1724: [BATT VOLT LOW] FL	—	—	—	×	
C1725: [BATT VOLT LOW] FR	—	—	—	×	
C1726: [BATT VOLT LOW] RR	—	—	—	×	
C1727: [BATT VOLT LOW] RL	—	—	—	×	<a href="#">WT-32</a>
C1729: VHCL SPEED SIG ERR	—	—	—	×	
C1734: CONTROL UNIT	—	—	—	×	<a href="#">WT-33</a>

A  
B  
C  
D  
E  
F  
G  
H  
I  
J  
L  
M  
N  
O  
P

SEC

# IPDM E/R (INTELLIGENT POWER DISTRIBUTION MODULE ENGINE ROOM)

< ECU DIAGNOSIS INFORMATION >

## IPDM E/R (INTELLIGENT POWER DISTRIBUTION MODULE ENGINE ROOM)

Reference Value

INFOID:000000004679497

VALUES ON THE DIAGNOSIS TOOL

Monitor Item	Condition		Value/Status
RAD FAN REQ	Engine idle speed	Changes depending on engine coolant temperature, air conditioner operation status, vehicle speed, etc.	0 - 100 %
AC COMP REQ	Engine running	A/C switch OFF	Off
		A/C switch ON (Compressor is operating)	On
TAIL&CLR REQ	Lighting switch OFF		Off
	Lighting switch 1ST, 2ND, HI or AUTO (Light is illuminated)		On
HL LO REQ	Lighting switch OFF		Off
	Lighting switch 2ND HI or AUTO (Light is illuminated)		On
HL HI REQ	Lighting switch OFF		Off
	Lighting switch HI		On
FR FOG REQ	Lighting switch 2ND or AUTO (Light is illuminated)	Front fog lamp switch OFF	Off
		<ul style="list-style-type: none"> <li>• Front fog lamp switch ON</li> <li>• Daytime running light activated (Only for Canada)</li> </ul>	On
FR WIP REQ	Ignition switch ON	Front wiper switch OFF	Stop
		Front wiper switch INT	1LOW
		Front wiper switch LO	Low
		Front wiper switch HI	Hi
WIP AUTO STOP	Ignition switch ON	Front wiper stop position	STOP P
		Any position other than front wiper stop position	ACT P
WIP PROT	Ignition switch ON	Front wiper operates normally	Off
		Front wiper stops at fail-safe operation	BLOCK
IGN RLY1 -REQ	Ignition switch OFF or ACC		Off
	Ignition switch ON		On
IGN RLY	Ignition switch OFF or ACC		Off
	Ignition switch ON		On
PUSH SW	Release the push-button ignition switch		Off
	Press the push-button ignition switch		On
INTER/NP SW	Ignition switch ON	Selector lever in any position other than P or N (A/T models)	Off
		Release clutch pedal (M/T models)	
	Ignition switch ON	Selector lever in P or N position (A/T models)	On
		Depress clutch pedal (M/T models)	
ST RLY CONT	Ignition switch ON		Off
	At engine cranking		On

# IPDM E/R (INTELLIGENT POWER DISTRIBUTION MODULE ENGINE ROOM)

## < ECU DIAGNOSIS INFORMATION >

Monitor Item	Condition	Value/Status	
IHBT RLY -REQ	Ignition switch ON	Off	A
	At engine cranking	On	
ST/INHI RLY	Ignition switch ON	Off	B
	At engine cranking	INHI ON → ST ON	
	The status of starter relay or starter control relay cannot be recognized by the battery voltage malfunction, etc. when the starter relay is ON and the starter control relay is OFF	UNKWN	C
DETENT SW	Ignition switch ON	Off	D
	Release the selector button with selector lever in P position <b>NOTE:</b> Fixed On for M/T models	On	E
S/L RLY -REQ	None of the conditions below are present	Off	F
	<ul style="list-style-type: none"> <li>Open the driver door after the ignition switch is turned OFF (for a few seconds)</li> <li>Press the push-button ignition switch when the steering lock is activated</li> <li>Depress the clutch pedal when the steering lock is activated</li> </ul>	On	G
S/L STATE	Steering lock is activated	LOCK	H
	Steering lock is deactivated	UNLOCK	
	[DTC: B210A] is detected	UNKWN	
DTRL REQ	<b>NOTE:</b> The item is indicated, but not monitored.	Off	I
OIL P SW	Ignition switch OFF, ACC or engine running	Open	J
	Ignition switch ON	Close	
HOOD SW	Close the hood	Off	
	Open the hood	On	
HL WASHER REQ	<b>NOTE:</b> The item is indicated, but not monitored.	Off	SEC
THFT HRN REQ	Not operation	Off	L
	<ul style="list-style-type: none"> <li>Panic alarm is activated</li> <li>Horn is activated with VEHICLE SECURITY (THEFT WARNING) SYSTEM</li> </ul>	On	
HORN CHIRP	Not operating	Off	M
	Door locking with Intelligent Key (horn chirp mode)	On	
CRNRNG LMP REQ	<b>NOTE:</b> The item is indicated, but not monitored.	Off	N

A  
B  
C  
D  
E  
F  
G  
H  
I  
J  
L  
M  
N  
O  
P

# IPDM E/R (INTELLIGENT POWER DISTRIBUTION MODULE ENGINE ROOM)

< ECU DIAGNOSIS INFORMATION >

## TERMINAL LAYOUT

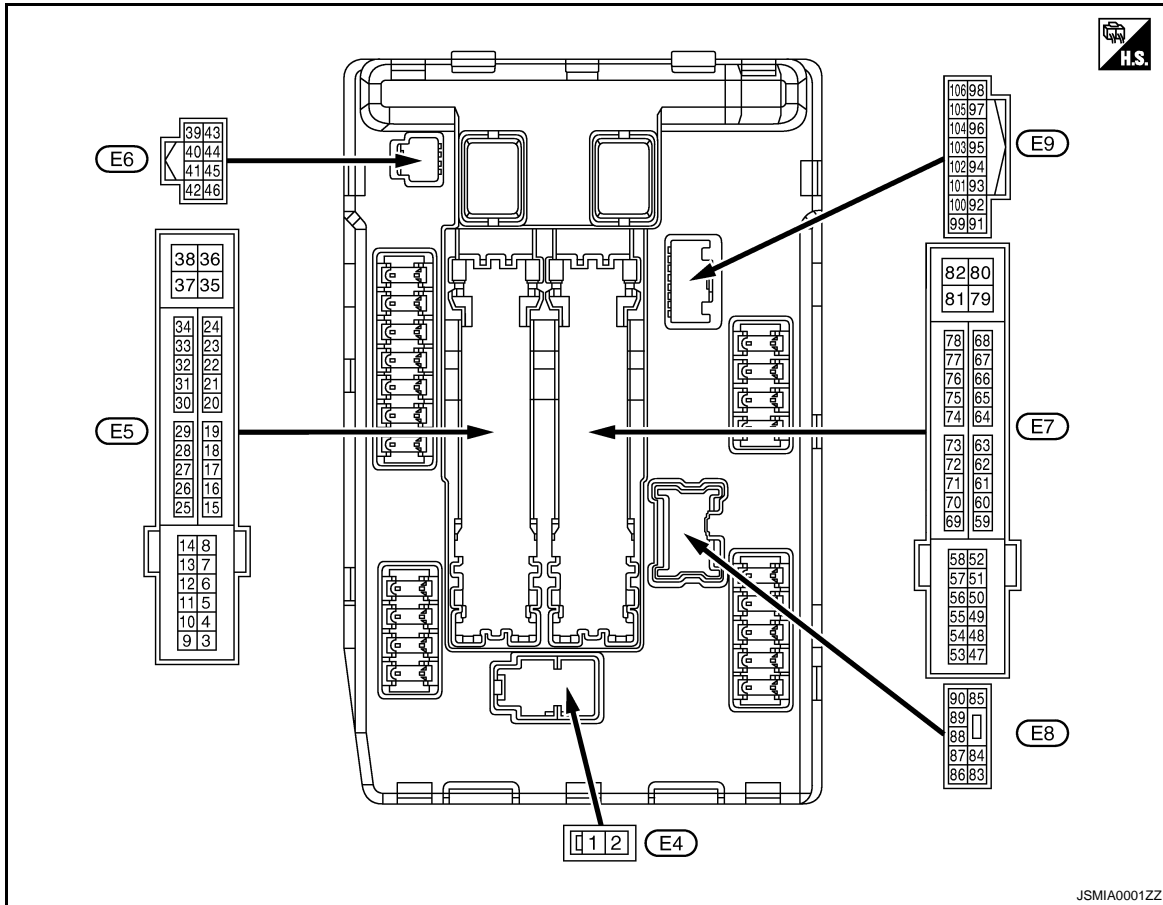

## PHYSICAL VALUES

Terminal No. (Wire color)		Description		Condition		Value (Approx.)
+	-	Signal name	Input/ Output			
1 (W)	Ground	Battery power supply	Input	Ignition switch OFF		Battery voltage
2 (L)	Ground	Battery power supply	Input	Ignition switch OFF		Battery voltage
4 (V)	Ground	Front wiper LO	Output	Ignition switch OFF	Front wiper switch OFF	0 V
				Ignition switch ON	Front wiper switch LO	Battery voltage
5 (L)	Ground	Front wiper HI	Output	Ignition switch OFF	Front wiper switch OFF	0 V
				Ignition switch ON	Front wiper switch HI	Battery voltage
7 (R)	Ground	Tail, license plate lamps & illuminations	Output	Ignition switch OFF	Lighting switch OFF	0 V
				Ignition switch ON	Lighting switch 1ST	Battery voltage
11 (BR)	Ground	Steering lock unit power supply	Output	Ignition switch OFF	A few seconds after opening the driver door	Battery voltage
				Ignition switch LOCK	Press the push-button ignition switch	Battery voltage
				Ignition switch ACC or ON		0 V
12 (B/W)	Ground	Ground	—	Ignition switch ON		0 V

# IPDM E/R (INTELLIGENT POWER DISTRIBUTION MODULE ENGINE ROOM)

## < ECU DIAGNOSIS INFORMATION >

Terminal No. (Wire color)		Description		Condition	Value (Approx.)	
+	-	Signal name	Input/ Output			
13 (Y)	Ground	Fuel pump power supply	Output	Approximately 1 second or more after turning the ignition switch ON	0 V	
				<ul style="list-style-type: none"> <li>Approximately 1 second after turning the ignition switch ON</li> <li>Engine running</li> </ul>	Battery voltage	
16 (LG)	Ground	Front wiper auto stop	Input	Ignition switch ON	0 V	
				Front wiper stop position	Battery voltage	
19 (W)	Ground	Ignition relay power supply	Output	Ignition switch OFF	0 V	
				Ignition switch ON	Battery voltage	
25 (G)	Ground	Ignition relay power supply	Output	Ignition switch OFF	0 V	
				Ignition switch ON	Battery voltage	
26*1 (R)	Ground	Ignition relay power supply	Output	Ignition switch OFF	0 V	
				Ignition switch ON	Battery voltage	
27 (O)	Ground	Ignition relay monitor	Input	Ignition switch OFF or ACC	Battery voltage	
				Ignition switch ON	0 V	
28 (L)	Ground	Push-button ignition switch	Input	Press the push-button ignition switch	0 V	
				Release the push-button ignition switch	Battery voltage	
30 (GR)	Ground	Starter relay control	Input	A/T models	Selector lever in any position other than P or N (Ignition switch ON)	0 V
					Selector lever P or N (Ignition switch ON)	Battery voltage
				M/T models	Release the clutch pedal	0 V
					Depress the clutch pedal	Battery voltage
32 (V)	Ground	Steering lock unit condition-1	Input	Steering lock is activated	0 V	
				Steering lock is deactivated	Battery voltage	
33 (P)	Ground	Steering lock unit condition-2	Input	Steering lock is activated	Battery voltage	
				Steering lock is deactivated	0 V	
36 (G)	Ground	Battery power supply	Input	Ignition switch OFF	Battery voltage	
39 (P)	—	CAN-L	Input/ Output	—	—	
40 (L)	—	CAN-H	Input/ Output	—	—	
41 (B/W)	Ground	Ground	—	Ignition switch ON	0 V	
42 (Y)	Ground	Cooling fan relay control	Input	Ignition switch OFF or ACC	0 V	
				Ignition switch ON	0.7 V	
43*2 (SB)	Ground	A/T shift selector (Detention switch)	Input	Ignition switch ON	Press the selector button (selector lever P)	Battery voltage
					<ul style="list-style-type: none"> <li>Selector lever in any position other than P</li> <li>Release the selector button (selector lever P)</li> </ul>	0 V
44 (W)	Ground	Horn relay control	Input	The horn is deactivated	Battery voltage	
				The horn is activated	0 V	

A  
B  
C  
D  
E  
F  
G  
H  
I  
J  
L  
M  
N  
O  
P

SEC

# IPDM E/R (INTELLIGENT POWER DISTRIBUTION MODULE ENGINE ROOM)

## < ECU DIAGNOSIS INFORMATION >

Terminal No. (Wire color)		Description		Condition		Value (Approx.)
+	-	Signal name	Input/ Output			
45 (G)	Ground	Anti theft horn relay control	Input	The horn is deactivated		Battery voltage
				The horn is activated		0 V
46 (W) <sup>*2</sup> (P) <sup>*3</sup>	Ground	Starter relay control	Input	A/T models	Selector lever in any position other than P or N (Ignition switch ON)	0 V
					Selector lever P or N (Ignition switch ON)	Battery voltage
				M/T models	Release the clutch pedal	0 V
					Depress the clutch pedal	Battery voltage
48 (BR)	Ground	A/C relay power supply	Output	Engine running	A/C switch OFF	0 V
					A/C switch ON (A/C compressor is operating)	Battery voltage
49 (O)	Ground	ECM relay power supply	Output	Ignition switch OFF (More than a few seconds after turning ignition switch OFF)		0 V
				<ul style="list-style-type: none"> <li>Ignition switch ON</li> <li>Ignition switch OFF (For a few seconds after turning ignition switch OFF)</li> </ul>		Battery voltage
51 (Y)	Ground	Ignition relay power supply	Output	Ignition switch OFF		0 V
				Ignition switch ON		Battery voltage
53 (W)	Ground	ECM relay power supply	Output	Ignition switch OFF (More than a few seconds after turning ignition switch OFF)		0 V
				<ul style="list-style-type: none"> <li>Ignition switch ON</li> <li>Ignition switch OFF (For a few seconds after turning ignition switch OFF)</li> </ul>		Battery voltage
54 (P)	Ground	Throttle control motor relay power supply	Output	Ignition switch OFF (More than a few seconds after turning ignition switch OFF)		0 V
				<ul style="list-style-type: none"> <li>Ignition switch ON</li> <li>Ignition switch OFF (For a few seconds after turning ignition switch OFF)</li> </ul>		Battery voltage
55 (SB)	Ground	ECM power supply	Output	Ignition switch OFF		Battery voltage
56 (LG)	Ground	Ignition relay power supply	Output	Ignition switch OFF		0 V
				Ignition switch ON		Battery voltage
57 (G)	Ground	Ignition relay power supply	Output	Ignition switch OFF		0 V
				Ignition switch ON		Battery voltage
58 <sup>*2</sup> (L)	Ground	Ignition relay power supply	Output	Ignition switch OFF		0 V
				Ignition switch ON		Battery voltage
69 (BR)	Ground	ECM relay control	Output	Ignition switch OFF (More than a few seconds after turning ignition switch OFF)		Battery voltage
				<ul style="list-style-type: none"> <li>Ignition switch ON</li> <li>Ignition switch OFF (For a few seconds after turning ignition switch OFF)</li> </ul>		0 - 1.5 V



# IPDM E/R (INTELLIGENT POWER DISTRIBUTION MODULE ENGINE ROOM)

## < ECU DIAGNOSIS INFORMATION >

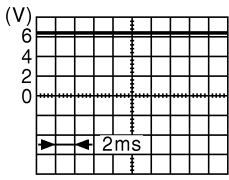
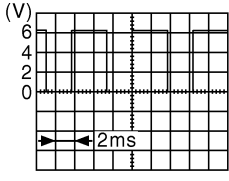
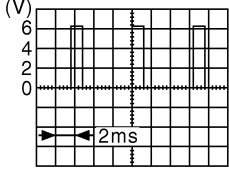
Terminal No. (Wire color)		Description		Condition		Value (Approx.)
+	-	Signal name	Input/ Output			
70 (O)	Ground	Throttle control motor re- lay control	Output	Ignition switch ON → OFF	0 - 1.0 V ↓ Battery voltage ↓ 0 V	
				Ignition switch ON	0 - 1.0 V	
73*3 (P)	Ground	Ignition relay power supply	Output	Ignition switch OFF	0 V	
				Ignition switch ON	Battery voltage	
74 (G)	Ground	Ignition relay power supply	Output	Ignition switch OFF	0 V	
				Ignition switch ON	Battery voltage	
75 (SB)	Ground	Oil pressure switch	Input	Ignition switch ON	Engine stopped 0 V Engine running Battery voltage	
76 (Y)	Ground	Power generation com- mand signal	Output	Ignition switch ON	 <p style="text-align: right;">JPMIA0001GB</p> <p style="text-align: center;">6.3 V</p>	
				40% is set on "ACTIVE TEST", "AL- TERNATOR DUTY" of "ENGINE"	 <p style="text-align: right;">JPMIA0002GB</p> <p style="text-align: center;">3.8 V</p>	
				80% is set on "ACTIVE TEST", "AL- TERNATOR DUTY" of "ENGINE"	 <p style="text-align: right;">JPMIA0003GB</p> <p style="text-align: center;">1.4 V</p>	
77 (R)	Ground	Fuel pump relay control	Output	<ul style="list-style-type: none"> <li>• Approximately 1 second after turning the ignition switch ON</li> <li>• Engine running</li> </ul>	0 - 1.0 V	
				Approximately 1 second or more after turning the ignition switch ON	Battery voltage	
80 (W)	Ground	Starter motor	Output	At engine cranking	Battery voltage	
83 (R)	Ground	Headlamp LO (RH)	Output	Ignition switch ON	Lighting switch OFF 0 V Lighting switch 2ND Battery voltage	
84 (P)	Ground	Headlamp LO (LH)	Output	Ignition switch ON	Lighting switch OFF 0 V Lighting switch 2ND Battery voltage	

A

B

C

D

E

F

G

H

I

J

SEC

L

M

N

O

P

# IPDM E/R (INTELLIGENT POWER DISTRIBUTION MODULE ENGINE ROOM)

## < ECU DIAGNOSIS INFORMATION >

Terminal No. (Wire color)		Description		Condition		Value (Approx.)
+	-	Signal name	Input/ Output			
86 (W)	Ground	Front fog lamp (RH)	Output	Lighting switch 2ND	Front fog lamp switch OFF	0 V
					<ul style="list-style-type: none"> <li>• Front fog lamp switch ON</li> <li>• Daytime running light activated (Only for Canada)</li> </ul>	Battery voltage
87 (L)	Ground	Front fog lamp (LH)	Output	Lighting switch 2ND	Front fog lamp switch OFF	0 V
					<ul style="list-style-type: none"> <li>• Front fog lamp switch ON</li> <li>• Daytime running light activated (Only for Canada)</li> </ul>	Battery voltage
88 (G)	Ground	Washer pump power supply	Output	Ignition switch ON		Battery voltage
89 (BR)	Ground	Headlamp HI (RH)	Output	Ignition switch ON	Lighting switch OFF	0 V
					<ul style="list-style-type: none"> <li>• Lighting switch HI</li> <li>• Lighting switch PASS</li> </ul>	Battery voltage
90 (LG)	Ground	Headlamp HI (LH)	Output	Ignition switch ON	Lighting switch OFF	0 V
					<ul style="list-style-type: none"> <li>• Lighting switch HI</li> <li>• Lighting switch PASS</li> </ul>	Battery voltage
91 (P)	Ground	Parking lamp (RH)	Output	Ignition switch ON	Lighting switch OFF	0 V
					Lighting switch 1ST	Battery voltage
92 (O)	Ground	Parking lamp (LH)	Output	Ignition switch ON	Lighting switch OFF	0 V
					Lighting switch 1ST	Battery voltage
97 (V)	Ground	Cooling fan control	Output	Engine idling		0 - 5 V
104 (LG)	Ground	Hood switch	Input	Close the hood		Battery voltage
				Open the hood		0 V

\*1: Only for the models with ICC system

\*2: A/T models only

\*3: M/T models only

# IPDM E/R (INTELLIGENT POWER DISTRIBUTION MODULE ENGINE ROOM)

< ECU DIAGNOSIS INFORMATION >

## Wiring Diagram - IPDM E/R -

INFOID:000000004679498

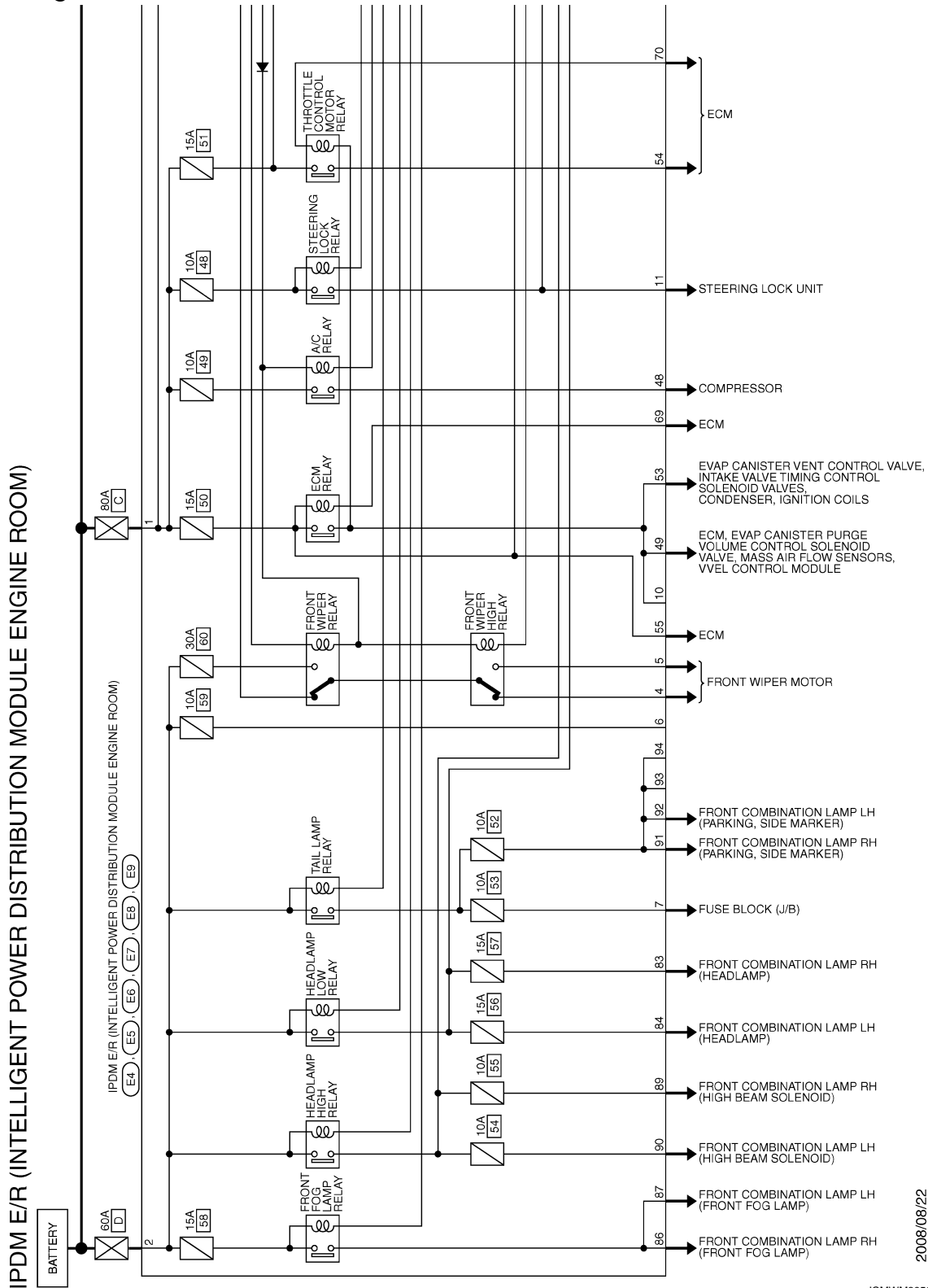

A  
B  
C  
D  
E  
F  
G  
H  
I  
J  
L  
M  
N  
O  
P

SEC

2008/08/22

JCMWM3058G1

# IPDM E/R (INTELLIGENT POWER DISTRIBUTION MODULE ENGINE ROOM)

< ECU DIAGNOSIS INFORMATION >

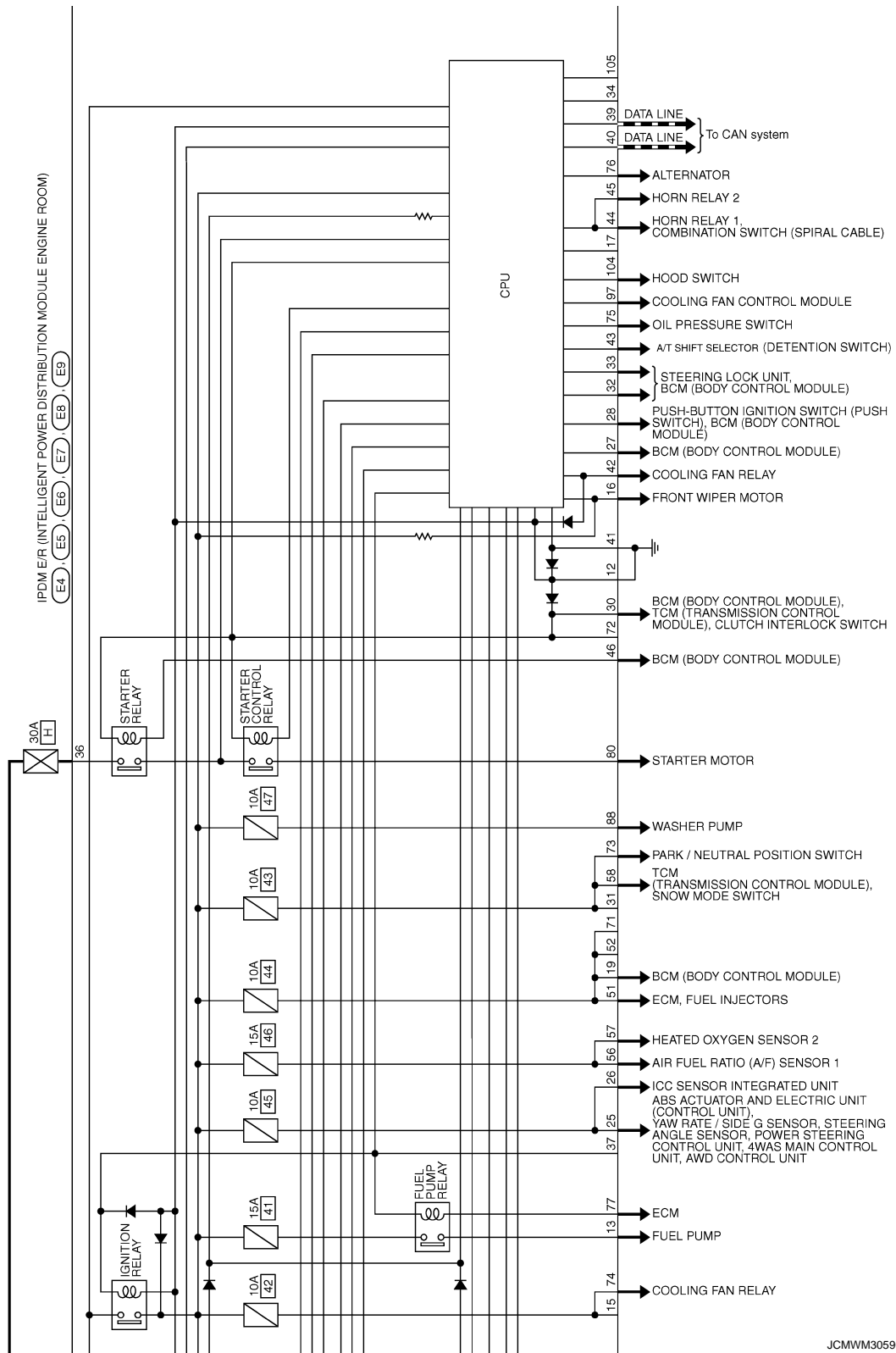

JCMWM3059G

# IPDM E/R (INTELLIGENT POWER DISTRIBUTION MODULE ENGINE ROOM)

< ECU DIAGNOSIS INFORMATION >

---

A  
B  
C  
D  
E  
F  
G  
H  
I  
J  
L  
M  
N  
O  
P

IPDM E/R  
(INTELLIGENT POWER  
DISTRIBUTION MODULE  
ENGINE ROOM)  
E4 E5 E6  
E7 E8 E9

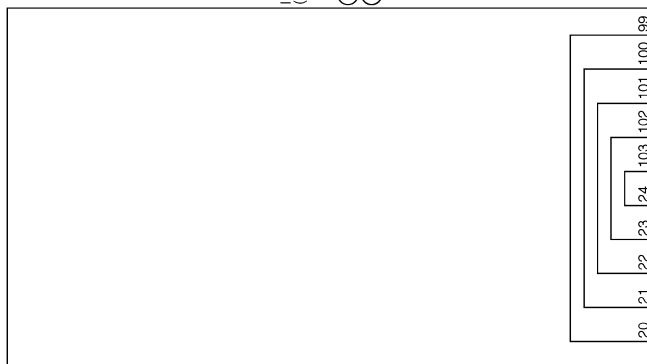

SEC

JCMWM3060GI

# IPDM E/R (INTELLIGENT POWER DISTRIBUTION MODULE ENGINE ROOM)

## < ECU DIAGNOSIS INFORMATION >

Connector No.	E6
Connector Name	IPDM E/R (INTELLIGENT POWER DISTRIBUTION MODULE ENGINE ROOM)
Connector Type	TH18FW-NH



42	41	40	39
46	45	44	43

Terminal No.	Color of Wire	Signal Name [Specification]
39	P	-
40	L	-
41	B/W	-
42	Y	-
43	SB	-
44	W	-
45	G	-
46	W	- [With A/T]
46	P	- [With M/T]

Connector No.	E9
Connector Name	IPDM E/R (INTELLIGENT POWER DISTRIBUTION MODULE ENGINE ROOM)
Connector Type	TH18FW-NH



98	97	96	95	94	93	92	91
108	103	104	103	102	101	100	99

Terminal No.	Color of Wire	Signal Name [Specification]
91	P	-
92	O	-
97	V	-
104	LG	-

28	L	-
30	GR	-
32	V	-
33	P	-
30	G	-



85	84	83
90	89	88
87	86	

Connector No.	E8
Connector Name	IPDM E/R (INTELLIGENT POWER DISTRIBUTION MODULE ENGINE ROOM)
Connector Type	NS08FW-CS



Terminal No.	Color of Wire	Signal Name [Specification]
83	R	-
84	P	-
86	W	-
87	L	-
88	G	-
89	BR	-
90	LG	-

Connector No.	E5
Connector Name	IPDM E/R (INTELLIGENT POWER DISTRIBUTION MODULE ENGINE ROOM)
Connector Type	TH20FW-CS12-M4-1V



9	10	11	12	13	14	25	26	27	28	29	30	31	32	33	34	37	38
3	4	5	6	7	8	15	16	17	18	19	20	21	22	23	24	35	36

Terminal No.	Color of Wire	Signal Name [Specification]
4	V	-
5	L	-
7	R	-
11	BR	-
12	B/W	-
13	Y	-
16	LG	-
19	W	-
25	G	-
26	R	-
27	O	-

Connector No.	E7
Connector Name	IPDM E/R (INTELLIGENT POWER DISTRIBUTION MODULE ENGINE ROOM)
Connector Type	TH20FW-CS12-M4



55	54	53	52	51	50	49	48
65	64	63	62	61	60	59	58
75	74	73	72	71	70	69	68

Connector No.	E4
Connector Name	IPDM E/R (INTELLIGENT POWER DISTRIBUTION MODULE ENGINE ROOM)
Connector Type	LO2FB-MC



1	2
---	---

Terminal No.	Color of Wire	Signal Name [Specification]
1	W	-
2	L	-

Connector No.	E7
Connector Name	IPDM E/R (INTELLIGENT POWER DISTRIBUTION MODULE ENGINE ROOM)
Connector Type	TH20FW-CS12-M4



Terminal No.	Color of Wire	Signal Name [Specification]
48	BR	-
49	O	-
51	Y	-
53	W	-
54	P	-
55	SB	-
56	LG	-
57	G	-
58	L	-
68	BR	-
70	O	-

### Fail-safe

### CAN COMMUNICATION CONTROL

When CAN communication with ECM and BCM is impossible, IPDM E/R performs fail-safe control. After CAN communication recovers normally, it also returns to normal control.

If No CAN Communication Is Available With ECM

JCMW3061G

INFOID:000000004679499

# IPDM E/R (INTELLIGENT POWER DISTRIBUTION MODULE ENGINE ROOM)

## < ECU DIAGNOSIS INFORMATION >

Control part	Fail-safe operation
Cooling fan	<ul style="list-style-type: none"> <li>Outputs the pulse duty signal (PWM signal) 100% when the ignition switch is turned ON</li> <li>Outputs the pulse duty signal (PWM signal) 0% when the ignition switch is turned OFF</li> </ul>
A/C compressor	A/C relay OFF
Alternator	Outputs the power generation command signal (PWM signal) 0%

### If No CAN Communication Is Available With BCM

Control part	Fail-safe operation
Headlamp	<ul style="list-style-type: none"> <li>Turns ON the headlamp low relay when the ignition switch is turned ON</li> <li>Turns OFF the headlamp low relay when the ignition switch is turned OFF</li> <li>Headlamp high relay OFF</li> </ul>
<ul style="list-style-type: none"> <li>Parking lamps</li> <li>Side maker lamp</li> <li>License plate lamps</li> <li>Illuminations</li> <li>Tail lamps</li> </ul>	<ul style="list-style-type: none"> <li>Turns ON the tail lamp relay when the ignition switch is turned ON</li> <li>Turns OFF the tail lamp relay when the ignition switch is turned OFF</li> </ul>
Front wiper	<ul style="list-style-type: none"> <li>The status just before activation of fail-safe control is maintained until the ignition switch is turned OFF while the front wiper is operating at LO or HI speed.</li> <li>The wiper is operated at LO speed until the ignition switch is turned OFF if the fail-safe control is activated while the front wiper is set in the INT mode and the front wiper motor is operating.</li> </ul>
Horn	Horn relay OFF
Ignition relay	The status just before activation of fail-safe is maintained.
Starter motor	Starter control relay OFF
Steering lock unit	Steering lock relay OFF

### IGNITION RELAY MALFUNCTION DETECTION FUNCTION

- IPDM E/R monitors the voltage at the contact circuit and excitation coil circuit of the ignition relay inside it.
- IPDM E/R judges the ignition relay error if the voltage differs between the contact circuit and the excitation coil circuit.
- If the ignition relay cannot turn OFF due to contact seizure, it activates the tail lamp relay for 10 minutes to alert the user to the ignition relay malfunction when the ignition switch is turned OFF.

SEC

Voltage judgment		IPDM E/R judgment	Operation
Ignition relay contact side	Ignition relay excitation coil side		
ON	ON	Ignition relay ON normal	—
OFF	OFF	Ignition relay OFF normal	—
ON	OFF	Ignition relay ON stuck	<ul style="list-style-type: none"> <li>Detects DTC "B2098: IGN RELAY ON"</li> <li>Turns ON the tail lamp relay for 10 minutes</li> </ul>
OFF	ON	Ignition relay OFF stuck	Detects DTC "B2099: IGN RELAY OFF"

### FRONT WIPER CONTROL

IPDM E/R detects front wiper stop position by a front wiper stop position signal. When a front wiper stop position signal is in the conditions listed below, IPDM E/R stops power supply to wiper after repeating a front wiper 10 seconds activation and 20 seconds stop five times.

Ignition switch	Front wiper switch	Front wiper stop position signal
ON	OFF	The front wiper stop position signal (stop position) cannot be input for 10 seconds.
	ON	The front wiper stop position signal does not change for 10 seconds.

# IPDM E/R (INTELLIGENT POWER DISTRIBUTION MODULE ENGINE ROOM)

## < ECU DIAGNOSIS INFORMATION >

### NOTE:

This operation status can be confirmed on the IPDM E/R “Data Monitor” that displays “BLOCK” for the item “WIP PROT” while the wiper is stopped.

### STARTER MOTOR PROTECTION FUNCTION

IPDM E/R turns OFF the starter control relay to protect the starter motor when the starter control relay remains active for 90 seconds.

### DTC Index

INFOID:000000004679500

### NOTE:

- The details of time display are as follows.
  - CRNT: A malfunction is detected now.
  - PAST: A malfunction was detected in the past.
- IGN counter is displayed on FFD (Freeze Frame data).
  - The number is 0 when is detected now.
  - The number increases like 1 → 2 ... 38 → 39 after returning to the normal condition whenever IGN OFF → ON.
  - The number is fixed to 39 until the self-diagnosis results are erased if it is over 39.

×: Applicable

CONSULT display	Fail-safe	Refer to
No DTC is detected. further testing may be required.	—	—
U1000: CAN COMM CIRCUIT	×	<a href="#">PCS-14</a>
B2098: IGN RELAY ON	×	<a href="#">PCS-15</a>
B2099: IGN RELAY OFF	—	<a href="#">PCS-16</a>
B2108: STRG LCK RELAY ON	—	<a href="#">SEC-104</a>
B2109: STRG LCK RELAY OFF	—	<a href="#">SEC-106</a>
B210A: STRG LCK STATE SW	—	<a href="#">SEC-107</a>
B210B: START CONT RLY ON	—	<a href="#">SEC-111</a>
B210C: START CONT RLY OFF	—	<a href="#">SEC-112</a>
B210D: STARTER RELAY ON	—	<a href="#">SEC-113</a>
B210E: STARTER RELAY OFF	—	<a href="#">SEC-114</a>
B210F: INTRLCK/PNP SW ON	—	<a href="#">SEC-116</a>
B2110: INTRLCK/PNP SW OFF	—	<a href="#">SEC-118</a>



# ENGINE DOES NOT START WHEN INTELLIGENT KEY IS INSIDE OF VEHICLE

< SYMPTOM DIAGNOSIS >

## SYMPTOM DIAGNOSIS

### ENGINE DOES NOT START WHEN INTELLIGENT KEY IS INSIDE OF VEHICLE

#### Description

INFOID:000000004663353

Engine does not start when push-button ignition switch is pressed while carrying Intelligent Key.

#### NOTE:

- Check that vehicle is under the condition shown in “Conditions of vehicle” before starting diagnosis, and check each symptom.
- The engine start function, door lock function, power distribution system, and NATS-IVIS/NVIS in the Intelligent Key system are closely related to each other regarding control. The vehicle security function can operate only when the door lock and power distribution system are operating normally.

#### Conditions of Vehicle (Operating Conditions)

- “ENGINE START BY I-KEY” in “WORK SUPPORT” is ON when setting on CONSULT-III.
- Intelligent Key is not inserted in key slot.
- One or more of Intelligent Keys with registered Intelligent Key ID is in the vehicle.

#### Diagnosis Procedure

INFOID:000000004663354

#### 1. CHECK INTELLIGENT KEY SYSTEM (DOOR LOCK FUNCTION)

Lock/unlock door with door request switch.

Refer to [DLK-19, "DOOR LOCK FUNCTION : System Description"](#).

Is the operation normal?

YES >> GO TO 2.

NO >> Check Intelligent Key system (door lock function). Refer to [DLK-167, "ALL DOOR : Diagnosis Procedure"](#).

#### 2. PERFORM WORK SUPPORT

Perform “INSIDE ANT DIAGNOSIS” on Work Support in “INTELLIGENT KEY”.

Refer to [SEC-30, "INTELLIGENT KEY : CONSULT-III Function \(BCM - INTELLIGENT KEY\)"](#).

>> GO TO 3.

#### 3. PERFORM SELF DIAGNOSTIC RESULT

Perform Self Diagnostic Result in “BCM”, and check whether or not DTC of inside key antenna is detected.

Is DTC detected?

YES >> Refer to [DLK-55, "DTC Logic"](#) (instrument center), [DLK-57, "DTC Logic"](#) (console) or [DLK-59, "DTC Logic"](#) (trunk room).

NO >> GO TO 4.

#### 4. CHECK PUSH-BUTTON IGNITION SWITCH

Check push-button ignition switch.

Refer to [PCS-62, "Component Function Check"](#).

Is the operation normal?

YES >> GO TO 5.

NO >> Repair or replace malfunctioning parts.

#### 5. CONFIRM THE OPERATION

Confirm the operation again.

Is the inspection normal?

YES >> Check intermittent incident. Refer to [GI-41, "Intermittent Incident"](#).

NO >> GO TO 1.

# STEERING DOES NOT LOCK

< SYMPTOM DIAGNOSIS >

---

## STEERING DOES NOT LOCK

### Description

INFOID:000000004663355

Steering does not lock when door is open while ignition switch is OFF.

**NOTE:**

Before performing the diagnosis, check "Work Flow". Refer to [SEC-5, "Work Flow"](#).

### Diagnosis Procedure

INFOID:000000004663356

#### 1. CHECK DOOR SWITCH

---

Check door switch.

Refer to [DLK-62, "Component Function Check"](#).

Is the inspection normal?

YES >> GO TO 2.

NO >> Repair or replace malfunctioning parts.

#### 2. CONFIRM THE OPERATION

---

Confirm the operation again.

Is the inspection normal?

YES >> Check intermittent incident. Refer to [GI-41, "Intermittent Incident"](#).

NO >> GO TO 1.

# SECURITY INDICATOR LAMP DOES NOT TURN ON OR FLASH

< SYMPTOM DIAGNOSIS >

## SECURITY INDICATOR LAMP DOES NOT TURN ON OR FLASH

### Description

INFOID:000000004663357

Security indicator lamp does not blink when ignition switch is in a position other than ON

#### NOTE:

- Before performing the diagnosis, check "Work Flow". Refer to [SEC-5, "Work Flow"](#).
- Check that vehicle is under the condition shown in "Conditions of vehicle" before starting diagnosis, and check each symptom.

### Conditions of Vehicle (Operating Conditions)

- Intelligent Key is not inserted in key slot.
- Ignition switch is not in the ON position.

### Diagnosis Procedure

INFOID:000000004663358

#### 1. CHECK SECURITY INDICATOR LAMP

Check security indicator lamp.

Refer to [SEC-127, "Component Function Check"](#).

Is the inspection result normal?

YES >> GO TO 2.

NO >> Repair or replace the malfunctioning parts.

#### 2. CONFIRM THE OPERATION

Confirm the operation again.

Is the result normal?

YES >> Check intermittent incident. Refer to [GI-41, "Intermittent Incident"](#).

NO >> GO TO 1.

A  
B  
C  
D  
E  
F  
G  
H  
I  
J  
L  
M  
N  
O  
P

SEC

# VEHICLE SECURITY SYSTEM CANNOT BE SET

< SYMPTOM DIAGNOSIS >

---

## VEHICLE SECURITY SYSTEM CANNOT BE SET INTELLIGENT KEY

### INTELLIGENT KEY : Description

INFOID:000000004663359

Armed phase is not activated when door is locked using Intelligent Key.

**NOTE:**

Check that vehicle is under the condition shown in "Conditions of vehicle" before starting diagnosis, and check each symptom.

#### CONDITION OF VEHICLE (OPERATING CONDITION)

Confirm the setting of "SECURITY ALARM SET" in "WORK SUPPORT" in "THEFT ALM" using CONSULT-III.

### INTELLIGENT KEY : Diagnosis Procedure

INFOID:000000004663360

#### 1.CHECK INTELLIGENT KEY SYSTEM (REMOTE KEYLESS ENTRY FUNCTION)

---

Lock/unlock door with Intelligent Key.

Refer to [DLK-28. "REMOTE KEYLESS ENTRY FUNCTION : System Description"](#).

Is the inspection result normal?

YES >> GO TO 2.

NO >> Check Intelligent Key system (remote keyless entry function). Refer to [DLK-169. "Diagnosis Procedure"](#).

#### 2.CHECK HOOD SWITCH

---

Check hood switch.

Refer to [SEC-125. "Component Function Check"](#).

Is the inspection result normal?

YES >> GO TO 3.

NO >> Repair or replace the malfunctioning parts.

#### 3.CONFIRM THE OPERATION

---

Confirm the operation again.

Is the result normal?

YES >> Check intermittent incident. Refer to [GI-41. "Intermittent Incident"](#).

NO >> GO TO 1.

## DOOR REQUEST SWITCH

### DOOR REQUEST SWITCH : Description

INFOID:000000004663361

Armed phase is not activated when door is locked using door request switch.

**NOTE:**

Check that vehicle is under the condition shown in "Conditions of vehicle" before starting diagnosis, and check each symptom.

#### CONDITION OF VEHICLE (OPERATING CONDITION)

Confirm the setting of "SECURITY ALARM SET" in "WORK SUPPORT" in "THEFT ALM" using CONSULT-III.

### DOOR REQUEST SWITCH : Diagnosis Procedure

INFOID:000000004663362

#### 1.CHECK INTELLIGENT KEY SYSTEM (DOOR LOCK FUNCTION)

---

Lock/unlock door with door request switch.

Refer to [DLK-19. "DOOR LOCK FUNCTION : System Description"](#).

Is the inspection result normal?

YES >> GO TO 2.

NO >> Check Intelligent Key system (door lock function). Refer to [DLK-167. "ALL DOOR : Diagnosis Procedure"](#).

#### 2.CHECK HOOD SWITCH

# VEHICLE SECURITY SYSTEM CANNOT BE SET

## < SYMPTOM DIAGNOSIS >

---

Check hood switch.

Refer to [SEC-125, "Component Function Check"](#).

Is the inspection result normal?

YES >> GO TO 3.

NO >> Repair or replace the malfunctioning parts.

## 3.CONFIRM THE OPERATION

---

Confirm the operation again.

Is the result normal?

YES >> Check intermittent incident. Refer to [GI-41, "Intermittent Incident"](#).

NO >> GO TO 1.

A  
B  
C  
D  
E  
F  
G  
H  
I  
J  
L  
M  
N  
O  
P

SEC

# VEHICLE SECURITY ALARM DOES NOT ACTIVATE

< SYMPTOM DIAGNOSIS >

---

## VEHICLE SECURITY ALARM DOES NOT ACTIVATE

### Description

INFOID:000000004663363

Alarm does not operate when alarm operating condition is satisfied.

**NOTE:**

Check that vehicle is under the condition shown in "Conditions of vehicle" before starting diagnosis, and check each symptom.

### CONDITIONS OF VEHICLE (OPERATING CONDITIONS)

"SECURITY ALARM SET" in "WORK SUPPORT" of "THEFT ALM" is ON when setting on CONSULT-III.

### Diagnosis Procedure

INFOID:000000004663364

---

#### 1.CHECK DOOR SWITCH

Check door switch.

Refer to [DLK-62, "Component Function Check"](#).

Is the inspection result normal?

YES >> GO TO 2.

NO >> Replace the malfunctioning door switch

---

#### 2.CHECK HOOD SWITCH

Check hood switch.

Refer to [SEC-125, "Component Function Check"](#).

Is the inspection result normal?

YES >> GO TO 3.

NO >> Repair or replace the malfunctioning parts.

---

#### 3.CHECK HEADLAMP

Check headlamp.

Refer to [EXL-65, "Component Function Check"](#).

Is the inspection result normal?

YES >> GO TO 4.

NO >> Repair or replace the malfunctioning parts.

---

#### 4.CHECK HORN

Check horn.

Refer to [HRN-2, "Wiring Diagram - HORN -"](#).

Is the inspection result normal?

YES >> GO TO 5.

NO >> Repair or replace the malfunctioning parts.

---

#### 5.CONFIRM THE OPERATION

Confirm the operation again.

Is the result normal?

YES >> Check intermittent incident. Refer to [GI-41, "Intermittent Incident"](#).

NO >> GO TO 1.

# INTELLIGENT KEY INSERT INFORMATION DOES NOT OPERATE

< SYMPTOM DIAGNOSIS >

## INTELLIGENT KEY INSERT INFORMATION DOES NOT OPERATE

### Description

INFOID:000000004663365

Intelligent Key insert information does not operate when push-button ignition switch is operated while Intelligent Key is not inside vehicle.

#### NOTE:

Warning functions operating condition is extremely complicated. During operation confirmation reconfirm the list above twice in order to ensure proper operation. Refer to [DLK-36, "WARNING FUNCTION : System Description"](#).

### Diagnosis Procedure

INFOID:000000004663366

#### 1.CHECK POWER POSITION

Check if ignition switch position is changing or not.

Does ignition switch position change?

YES >> GO TO 3.

NO >> GO TO 2.

#### 2.CHECK PUSH-BUTTON IGNITION SWITCH

Check push-button ignition switch.

Refer to [DLK-102, "Component Function Check"](#).

Is the inspection result normal?

YES >> Check BCM for DTC. Refer to [SEC-185, "DTC Index"](#).

NO >> Repair or replace the malfunctioning parts.

#### 3.CHECK DOOR SWITCH

Check door switch.

Refer to [DLK-62, "Component Function Check"](#).

Is the inspection result normal?

YES >> GO TO 4.

NO >> Repair or replace the malfunctioning parts.

#### 4.CHECK KEY SLOT

Check key slot.

Refer to [SEC-122, "Component Function Check"](#).

Is the inspection result normal?

YES >> GO TO 5.

NO >> Repair or replace the malfunctioning parts.

#### 5.CHECK COMBINATION METER DISPLAY

Check combination meter display.

Refer to [DLK-101, "Component Function Check"](#).

Is the inspection result normal?

YES >> GO TO 6.

NO >> Repair or replace the malfunctioning parts.

#### 6.CHECK KEY SLOT INDICATOR

Check key slot indicator.

Refer to [SEC-123, "Component Function Check"](#).

Is the inspection result normal?

YES >> GO TO 7.

NO >> Repair or replace the malfunctioning parts.

#### 7.CONFIRM THE OPERATION

Confirm the operation again.

Is the result normal?

A

B

C

D

E

F

G

H

I

J

SEC

L

M

N

O

P

## INTELLIGENT KEY INSERT INFORMATION DOES NOT OPERATE

### < SYMPTOM DIAGNOSIS >

---

- YES >> Check intermittent incident. Refer to [GI-41, "Intermittent Incident"](#).
- NO >> GO TO 1.



# PRECAUTIONS

< PRECAUTION >

## PRECAUTION

### PRECAUTIONS

#### Precaution for Supplemental Restraint System (SRS) "AIR BAG" and "SEAT BELT PRE-TENSIONER"

INFOID:000000004684701

The Supplemental Restraint System such as "AIR BAG" and "SEAT BELT PRE-TENSIONER", used along with a front seat belt, helps to reduce the risk or severity of injury to the driver and front passenger for certain types of collision. This system includes seat belt switch inputs and dual stage front air bag modules. The SRS system uses the seat belt switches to determine the front air bag deployment, and may only deploy one front air bag, depending on the severity of a collision and whether the front occupants are belted or unbelted. Information necessary to service the system safely is included in the "SRS AIR BAG" and "SEAT BELT" of this Service Manual.

#### **WARNING:**

- To avoid rendering the SRS inoperative, which could increase the risk of personal injury or death in the event of a collision which would result in air bag inflation, all maintenance must be performed by an authorized NISSAN/INFINITI dealer.
- Improper maintenance, including incorrect removal and installation of the SRS, can lead to personal injury caused by unintentional activation of the system. For removal of Spiral Cable and Air Bag Module, see the "SRS AIR BAG".
- Do not use electrical test equipment on any circuit related to the SRS unless instructed to in this Service Manual. SRS wiring harnesses can be identified by yellow and/or orange harnesses or harness connectors.

#### PRECAUTIONS WHEN USING POWER TOOLS (AIR OR ELECTRIC) AND HAMMERS

#### **WARNING:**

- When working near the Air Bag Diagnosis Sensor Unit or other Air Bag System sensors with the ignition ON or engine running, DO NOT use air or electric power tools or strike near the sensor(s) with a hammer. Heavy vibration could activate the sensor(s) and deploy the air bag(s), possibly causing serious injury.
- When using air or electric power tools or hammers, always switch the ignition OFF, disconnect the battery, and wait at least 3 minutes before performing any service.

#### Precaution Necessary for Steering Wheel Rotation after Battery Disconnect

INFOID:000000004684702

#### **NOTE:**

- Before removing and installing any control units, first turn the push-button ignition switch to the LOCK position, then disconnect both battery cables.
- After finishing work, confirm that all control unit connectors are connected properly, then re-connect both battery cables.
- Always use CONSULT-III to perform self-diagnosis as a part of each function inspection after finishing work. If a DTC is detected, perform trouble diagnosis according to self-diagnosis results.

For vehicle with steering lock unit, if the battery is disconnected or discharged, the steering wheel will lock and cannot be turned.

If turning the steering wheel is required with the battery disconnected or discharged, follow the operation procedure below before starting the repair operation.

#### OPERATION PROCEDURE

1. Connect both battery cables.

#### **NOTE:**

Supply power using jumper cables if battery is discharged.

2. Turn the push-button ignition switch to ACC position.  
(At this time, the steering lock will be released.)
3. Disconnect both battery cables. The steering lock will remain released with both battery cables disconnected and the steering wheel can be turned.
4. Perform the necessary repair operation.

A

B

C

D

E

F

G

H

I

J

SEC

L

M

N

O

P

# PRECAUTIONS

## < PRECAUTION >

5. When the repair work is completed, re-connect both battery cables. With the brake pedal released, turn the push-button ignition switch from ACC position to ON position, then to LOCK position. (The steering wheel will lock when the push-button ignition switch is turned to LOCK position.)
6. Perform self-diagnosis check of all control units using CONSULT-III.

## Precautions For Xenon Headlamp Service

INFOID:000000004684705

### **WARNING:**

Comply with the following warnings to prevent any serious accident.

- Disconnect the battery cable (negative terminal) or the power supply fuse before installing, removing, or touching the xenon headlamp (bulb included). The xenon headlamp contains high-voltage generated parts.
- Never work with wet hands.
- Check the xenon headlamp ON-OFF status after assembling it to the vehicle. Never turn the xenon headlamp ON in other conditions. Connect the power supply to the vehicle-side connector. (Turning it ON outside the lamp case may cause fire or visual impairments.)
- Never touch the bulb glass immediately after turning it OFF. It is extremely hot.

### **CAUTION:**

Comply with the following cautions to prevent any error and malfunction.

- Install the xenon bulb securely. (Insufficient bulb socket installation may melt the bulb, the connector, the housing, etc. by high-voltage leakage or corona discharge.)
- Never perform HID circuit inspection with a tester.
- Never touch the xenon bulb glass with hands. Never put oil and grease on it.
- Dispose of the used xenon bulb after packing it in thick vinyl without breaking it.
- Never wipe out dirt and contamination with organic solvent (thinner, gasoline, etc.).

## Precaution for Procedure without Cowl Top Cover

INFOID:000000004684704

When performing the procedure after removing cowl top cover, cover the lower end of windshield with urethane, etc.

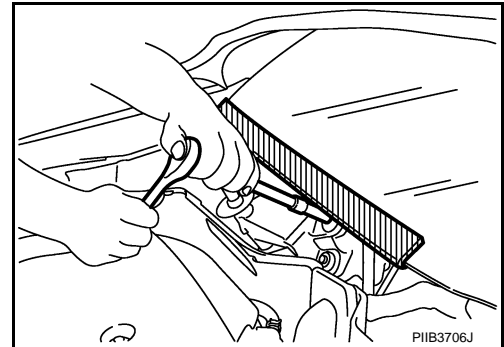

# KEY SLOT

< REMOVAL AND INSTALLATION >

## REMOVAL AND INSTALLATION

### KEY SLOT

#### Exploded View

INFOID:000000004249703

Refer to [IP-11, "Exploded View"](#).

#### Removal and Installation

INFOID:000000004249704

#### REMOVAL

1. Remove the instrument driver lower panel (2). Refer to [IP-12, "Removal and Installation"](#).
2. Disconnect key slot connector.
3. Remove the key slot mounting screw (A), and then remove key slot (1) from instrument driver lower panel (2).

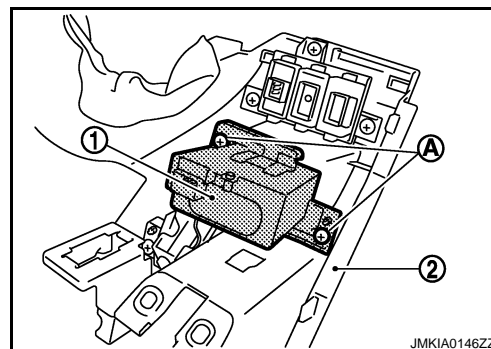

#### INSTALLATION

Install in the reverse order of removal.

A  
B  
C  
D  
E  
F  
G  
H  
I  
J  
L  
M  
N  
O  
P

SEC

# PUSH BUTTON IGNITION SWITCH

< REMOVAL AND INSTALLATION >

## PUSH BUTTON IGNITION SWITCH

### Exploded View

INFOID:000000004249705

Refer to [IP-11, "Exploded View"](#).

### Removal and Installation

INFOID:000000004249706

#### REMOVAL

1. Remove the cluster lid A assembly. Refer to [IP-12, "Removal and Installation"](#).
2. Remove the push-button ignition switch (1) from cluster lid A assembly, and then remove pawl (A). Press push-button ignition switch (1) back to disengage from cluster lid A assembly.

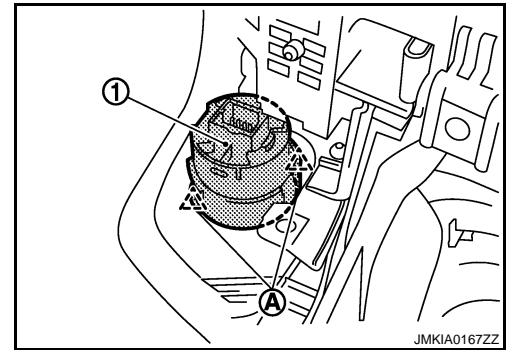

#### INSTALLATION

Install in the reverse order of removal.