

SECTION **LAN**  
LAN SYSTEM

A  
B  
C

CONTENTS

<b>CAN FUNDAMENTAL</b>		<b>PRECAUTIONS</b> .....24	F
<b>PRECAUTION</b> .....	7	Precaution for Supplemental Restraint System (SRS) "AIR BAG" and "SEAT BELT PRE-TENSIONER" .....	G
<b>PRECAUTIONS</b> .....	7	Precaution for Battery Service .....	H
Precautions for Trouble Diagnosis .....	7	Precautions for Trouble Diagnosis .....	
Precautions for Harness Repair .....	7	Precautions for Harness Repair .....	25
<b>SYSTEM DESCRIPTION</b> .....	8	<b>BASIC INSPECTION</b> .....	26
<b>CAN COMMUNICATION SYSTEM</b> .....	8	<b>DIAGNOSIS AND REPAIR WORKFLOW</b> .....	26
System Description .....	8	Interview Sheet .....	26
System Diagram .....	8	<b>SYSTEM DESCRIPTION</b> .....	27
CAN Communication Control Circuit .....	9	<b>CAN COMMUNICATION SYSTEM</b> .....	27
<b>DIAG ON CAN</b> .....	10	CAN System Specification Chart .....	27
Description .....	10	CAN Communication Signal Chart .....	27
System Diagram .....	10	<b>DTC/CIRCUIT DIAGNOSIS</b> .....	32
<b>TROUBLE DIAGNOSIS</b> .....	11	<b>CAN COMMUNICATION SYSTEM</b> .....	32
Condition of Error Detection .....	11	Component Parts Location .....	32
Symptom When Error Occurs in CAN Communication System .....	11	Wiring Diagram - CAN SYSTEM - .....	33
CAN Diagnosis with CONSULT-III .....	14	<b>MALFUNCTION AREA CHART</b> .....	41
Self-Diagnosis .....	15	Main Line .....	41
CAN Diagnostic Support Monitor .....	15	Branch Line .....	41
How to Use CAN Communication Signal Chart .....	17	Short Circuit .....	41
<b>BASIC INSPECTION</b> .....	18	<b>MAIN LINE BETWEEN DLC AND AV CIRCUIT</b> .....	42
<b>DIAGNOSIS AND REPAIR WORKFLOW</b> .....	18	Diagnosis Procedure .....	42
Trouble Diagnosis Flow Chart .....	18	<b>MAIN LINE BETWEEN AV AND ADP CIRCUIT</b> .....	43
Trouble Diagnosis Procedure .....	18	Diagnosis Procedure .....	43
<b>CAN</b>		<b>MAIN LINE BETWEEN ADP AND ABS CIRCUIT</b> .....	44
<b>HOW TO USE THIS MANUAL</b> .....	23	Diagnosis Procedure .....	44
<b>HOW TO USE THIS SECTION</b> .....	23		
Caution .....	23		
Abbreviation List .....	23		
<b>PRECAUTION</b> .....	24		

LAN

D  
E  
F  
G  
H  
I  
J  
K  
L  
N  
O  
P

<b>MAIN LINE BETWEEN ADP AND RAS CIRCUIT</b> .....	<b>46</b>	<b>MAIN LINE BETWEEN AV AND ADP CIRCUIT</b> .....	<b>67</b>
Diagnosis Procedure .....	46	Diagnosis Procedure .....	67
<b>MAIN LINE BETWEEN RAS AND ABS CIRCUIT</b> .....	<b>47</b>	<b>MAIN LINE BETWEEN ADP AND ABS CIRCUIT</b> .....	<b>68</b>
Diagnosis Procedure .....	47	Diagnosis Procedure .....	68
<b>ECM BRANCH LINE CIRCUIT</b> .....	<b>49</b>	<b>ECM BRANCH LINE CIRCUIT</b> .....	<b>70</b>
Diagnosis Procedure .....	49	Diagnosis Procedure .....	70
<b>A-BAG BRANCH LINE CIRCUIT</b> .....	<b>50</b>	<b>A-BAG BRANCH LINE CIRCUIT</b> .....	<b>71</b>
Diagnosis Procedure .....	50	Diagnosis Procedure .....	71
<b>BCM BRANCH LINE CIRCUIT</b> .....	<b>51</b>	<b>BCM BRANCH LINE CIRCUIT</b> .....	<b>72</b>
Diagnosis Procedure .....	51	Diagnosis Procedure .....	72
<b>DLC BRANCH LINE CIRCUIT</b> .....	<b>52</b>	<b>DLC BRANCH LINE CIRCUIT</b> .....	<b>73</b>
Diagnosis Procedure .....	52	Diagnosis Procedure .....	73
<b>M&amp;A BRANCH LINE CIRCUIT</b> .....	<b>53</b>	<b>M&amp;A BRANCH LINE CIRCUIT</b> .....	<b>74</b>
Diagnosis Procedure .....	53	Diagnosis Procedure .....	74
<b>STRG BRANCH LINE CIRCUIT</b> .....	<b>54</b>	<b>STRG BRANCH LINE CIRCUIT</b> .....	<b>75</b>
Diagnosis Procedure .....	54	Diagnosis Procedure .....	75
<b>4WD BRANCH LINE CIRCUIT</b> .....	<b>55</b>	<b>AV BRANCH LINE CIRCUIT</b> .....	<b>76</b>
Diagnosis Procedure .....	55	Diagnosis Procedure .....	76
<b>AV BRANCH LINE CIRCUIT</b> .....	<b>56</b>	<b>ADP BRANCH LINE CIRCUIT</b> .....	<b>77</b>
Diagnosis Procedure .....	56	Diagnosis Procedure .....	77
<b>PSB BRANCH LINE CIRCUIT</b> .....	<b>57</b>	<b>ABS BRANCH LINE CIRCUIT</b> .....	<b>78</b>
Diagnosis Procedure .....	57	Diagnosis Procedure .....	78
<b>TCM BRANCH LINE CIRCUIT</b> .....	<b>58</b>	<b>IPDM-E BRANCH LINE CIRCUIT</b> .....	<b>79</b>
Diagnosis Procedure .....	58	Diagnosis Procedure .....	79
<b>ADP BRANCH LINE CIRCUIT</b> .....	<b>59</b>	<b>CAN COMMUNICATION CIRCUIT</b> .....	<b>80</b>
Diagnosis Procedure .....	59	Diagnosis Procedure .....	80
<b>RAS BRANCH LINE CIRCUIT</b> .....	<b>60</b>	<b>CAN SYSTEM (TYPE 2)</b>	
Diagnosis Procedure .....	60	<b>DTC/CIRCUIT DIAGNOSIS</b> .....	<b>82</b>
<b>ABS BRANCH LINE CIRCUIT</b> .....	<b>61</b>	<b>MAIN LINE BETWEEN DLC AND AV CIRCUIT</b> .....	<b>82</b>
Diagnosis Procedure .....	61	Diagnosis Procedure .....	82
<b>ICC BRANCH LINE CIRCUIT</b> .....	<b>62</b>	<b>MAIN LINE BETWEEN AV AND ADP CIRCUIT</b> .....	<b>83</b>
Diagnosis Procedure .....	62	Diagnosis Procedure .....	83
<b>IPDM-E BRANCH LINE CIRCUIT</b> .....	<b>63</b>	<b>MAIN LINE BETWEEN ADP AND RAS CIRCUIT</b> .....	<b>84</b>
Diagnosis Procedure .....	63	Diagnosis Procedure .....	84
<b>CAN COMMUNICATION CIRCUIT</b> .....	<b>64</b>	<b>MAIN LINE BETWEEN RAS AND ABS CIRCUIT</b> .....	<b>85</b>
Diagnosis Procedure .....	64	Diagnosis Procedure .....	85
<b>CAN SYSTEM (TYPE 1)</b>		<b>ECM BRANCH LINE CIRCUIT</b> .....	<b>87</b>
<b>DTC/CIRCUIT DIAGNOSIS</b> .....	<b>66</b>	Diagnosis Procedure .....	87
<b>MAIN LINE BETWEEN DLC AND AV CIRCUIT</b> .....	<b>66</b>		
Diagnosis Procedure .....	66		

<b>A-BAG BRANCH LINE CIRCUIT</b> .....	<b>88</b>	<b>STRG BRANCH LINE CIRCUIT</b> .....	<b>109</b>	
Diagnosis Procedure .....	88	Diagnosis Procedure .....	109	A
<b>BCM BRANCH LINE CIRCUIT</b> .....	<b>89</b>	<b>AV BRANCH LINE CIRCUIT</b> .....	<b>110</b>	
Diagnosis Procedure .....	89	Diagnosis Procedure .....	110	B
<b>DLC BRANCH LINE CIRCUIT</b> .....	<b>90</b>	<b>PSB BRANCH LINE CIRCUIT</b> .....	<b>111</b>	
Diagnosis Procedure .....	90	Diagnosis Procedure .....	111	C
<b>M&amp;A BRANCH LINE CIRCUIT</b> .....	<b>91</b>	<b>ADP BRANCH LINE CIRCUIT</b> .....	<b>112</b>	
Diagnosis Procedure .....	91	Diagnosis Procedure .....	112	D
<b>STRG BRANCH LINE CIRCUIT</b> .....	<b>92</b>	<b>ABS BRANCH LINE CIRCUIT</b> .....	<b>113</b>	
Diagnosis Procedure .....	92	Diagnosis Procedure .....	113	E
<b>AV BRANCH LINE CIRCUIT</b> .....	<b>93</b>	<b>ICC BRANCH LINE CIRCUIT</b> .....	<b>114</b>	
Diagnosis Procedure .....	93	Diagnosis Procedure .....	114	F
<b>ADP BRANCH LINE CIRCUIT</b> .....	<b>94</b>	<b>IPDM-E BRANCH LINE CIRCUIT</b> .....	<b>115</b>	
Diagnosis Procedure .....	94	Diagnosis Procedure .....	115	G
<b>RAS BRANCH LINE CIRCUIT</b> .....	<b>95</b>	<b>CAN COMMUNICATION CIRCUIT</b> .....	<b>116</b>	
Diagnosis Procedure .....	95	Diagnosis Procedure .....	116	H
<b>ABS BRANCH LINE CIRCUIT</b> .....	<b>96</b>	<b>CAN SYSTEM (TYPE 4)</b>		
Diagnosis Procedure .....	96	<b>DTC/CIRCUIT DIAGNOSIS</b> .....	<b>118</b>	I
<b>IPDM-E BRANCH LINE CIRCUIT</b> .....	<b>97</b>	<b>MAIN LINE BETWEEN DLC AND AV CIR-</b>		J
Diagnosis Procedure .....	97	<b>CUIT</b> .....	<b>118</b>	
<b>CAN COMMUNICATION CIRCUIT</b> .....	<b>98</b>	Diagnosis Procedure .....	118	K
Diagnosis Procedure .....	98	<b>MAIN LINE BETWEEN AV AND ADP CIR-</b>		L
<b>CAN SYSTEM (TYPE 3)</b>		<b>CUIT</b> .....	<b>119</b>	
<b>DTC/CIRCUIT DIAGNOSIS</b> .....	<b>100</b>	Diagnosis Procedure .....	119	
<b>MAIN LINE BETWEEN DLC AND AV CIR-</b>		<b>MAIN LINE BETWEEN ADP AND RAS CIR-</b>		
<b>CUIT</b> .....	<b>100</b>	<b>CUIT</b> .....	<b>120</b>	
Diagnosis Procedure .....	100	Diagnosis Procedure .....	120	
<b>MAIN LINE BETWEEN AV AND ADP CIR-</b>		<b>MAIN LINE BETWEEN RAS AND ABS CIR-</b>		
<b>CUIT</b> .....	<b>101</b>	<b>CUIT</b> .....	<b>121</b>	
Diagnosis Procedure .....	101	Diagnosis Procedure .....	121	
<b>MAIN LINE BETWEEN ADP AND ABS CIR-</b>		<b>ECM BRANCH LINE CIRCUIT</b> .....	<b>123</b>	LAN
<b>CUIT</b> .....	<b>102</b>	Diagnosis Procedure .....	123	
Diagnosis Procedure .....	102	<b>A-BAG BRANCH LINE CIRCUIT</b> .....	<b>124</b>	N
<b>ECM BRANCH LINE CIRCUIT</b> .....	<b>104</b>	Diagnosis Procedure .....	124	
Diagnosis Procedure .....	104	<b>BCM BRANCH LINE CIRCUIT</b> .....	<b>125</b>	O
<b>A-BAG BRANCH LINE CIRCUIT</b> .....	<b>105</b>	Diagnosis Procedure .....	125	
Diagnosis Procedure .....	105	<b>DLC BRANCH LINE CIRCUIT</b> .....	<b>126</b>	P
<b>BCM BRANCH LINE CIRCUIT</b> .....	<b>106</b>	Diagnosis Procedure .....	126	
Diagnosis Procedure .....	106	<b>M&amp;A BRANCH LINE CIRCUIT</b> .....	<b>127</b>	
<b>DLC BRANCH LINE CIRCUIT</b> .....	<b>107</b>	Diagnosis Procedure .....	127	
Diagnosis Procedure .....	107	<b>STRG BRANCH LINE CIRCUIT</b> .....	<b>128</b>	
<b>M&amp;A BRANCH LINE CIRCUIT</b> .....	<b>108</b>	Diagnosis Procedure .....	128	
Diagnosis Procedure .....	108	<b>AV BRANCH LINE CIRCUIT</b> .....	<b>129</b>	
		Diagnosis Procedure .....	129	

<b>PSB BRANCH LINE CIRCUIT</b> .....	130	<b>ABS BRANCH LINE CIRCUIT</b> .....	151
Diagnosis Procedure .....	130	Diagnosis Procedure .....	151
<b>ADP BRANCH LINE CIRCUIT</b> .....	131	<b>IPDM-E BRANCH LINE CIRCUIT</b> .....	152
Diagnosis Procedure .....	131	Diagnosis Procedure .....	152
<b>RAS BRANCH LINE CIRCUIT</b> .....	132	<b>CAN COMMUNICATION CIRCUIT</b> .....	153
Diagnosis Procedure .....	132	Diagnosis Procedure .....	153
<b>ABS BRANCH LINE CIRCUIT</b> .....	133	<b>CAN SYSTEM (TYPE 6)</b>	
Diagnosis Procedure .....	133	<b>DTC/CIRCUIT DIAGNOSIS</b> .....	155
<b>ICC BRANCH LINE CIRCUIT</b> .....	134	<b>MAIN LINE BETWEEN DLC AND AV CIR-</b>	
Diagnosis Procedure .....	134	<b>CUIT</b> .....	155
<b>IPDM-E BRANCH LINE CIRCUIT</b> .....	135	Diagnosis Procedure .....	155
Diagnosis Procedure .....	135	<b>MAIN LINE BETWEEN AV AND ADP CIR-</b>	
<b>CAN COMMUNICATION CIRCUIT</b> .....	136	<b>CUIT</b> .....	156
Diagnosis Procedure .....	136	Diagnosis Procedure .....	156
<b>CAN SYSTEM (TYPE 5)</b>		<b>MAIN LINE BETWEEN ADP AND RAS CIR-</b>	
<b>DTC/CIRCUIT DIAGNOSIS</b> .....	138	<b>CUIT</b> .....	157
<b>MAIN LINE BETWEEN DLC AND AV CIR-</b>		Diagnosis Procedure .....	157
<b>CUIT</b> .....	138	<b>MAIN LINE BETWEEN RAS AND ABS CIR-</b>	
Diagnosis Procedure .....	138	<b>CUIT</b> .....	158
<b>MAIN LINE BETWEEN AV AND ADP CIR-</b>		Diagnosis Procedure .....	158
<b>CUIT</b> .....	139	<b>ECM BRANCH LINE CIRCUIT</b> .....	160
Diagnosis Procedure .....	139	Diagnosis Procedure .....	160
<b>MAIN LINE BETWEEN ADP AND ABS CIR-</b>		<b>A-BAG BRANCH LINE CIRCUIT</b> .....	161
<b>CUIT</b> .....	140	Diagnosis Procedure .....	161
Diagnosis Procedure .....	140	<b>BCM BRANCH LINE CIRCUIT</b> .....	162
<b>ECM BRANCH LINE CIRCUIT</b> .....	142	Diagnosis Procedure .....	162
Diagnosis Procedure .....	142	<b>DLC BRANCH LINE CIRCUIT</b> .....	163
<b>A-BAG BRANCH LINE CIRCUIT</b> .....	143	Diagnosis Procedure .....	163
Diagnosis Procedure .....	143	<b>M&amp;A BRANCH LINE CIRCUIT</b> .....	164
<b>BCM BRANCH LINE CIRCUIT</b> .....	144	Diagnosis Procedure .....	164
Diagnosis Procedure .....	144	<b>STRG BRANCH LINE CIRCUIT</b> .....	165
<b>DLC BRANCH LINE CIRCUIT</b> .....	145	Diagnosis Procedure .....	165
Diagnosis Procedure .....	145	<b>AV BRANCH LINE CIRCUIT</b> .....	166
<b>M&amp;A BRANCH LINE CIRCUIT</b> .....	146	Diagnosis Procedure .....	166
Diagnosis Procedure .....	146	<b>TCM BRANCH LINE CIRCUIT</b> .....	167
<b>STRG BRANCH LINE CIRCUIT</b> .....	147	Diagnosis Procedure .....	167
Diagnosis Procedure .....	147	<b>ADP BRANCH LINE CIRCUIT</b> .....	168
<b>AV BRANCH LINE CIRCUIT</b> .....	148	Diagnosis Procedure .....	168
Diagnosis Procedure .....	148	<b>RAS BRANCH LINE CIRCUIT</b> .....	169
<b>TCM BRANCH LINE CIRCUIT</b> .....	149	Diagnosis Procedure .....	169
Diagnosis Procedure .....	149	<b>ABS BRANCH LINE CIRCUIT</b> .....	170
<b>ADP BRANCH LINE CIRCUIT</b> .....	150	Diagnosis Procedure .....	170
Diagnosis Procedure .....	150	<b>IPDM-E BRANCH LINE CIRCUIT</b> .....	171
		Diagnosis Procedure .....	171

<b>CAN COMMUNICATION CIRCUIT</b> .....	172	<b>MAIN LINE BETWEEN DLC AND AV CIR-</b>	
Diagnosis Procedure .....	172	<b>CUIT</b> .....	193
<b>CAN SYSTEM (TYPE 7)</b>		Diagnosis Procedure .....	193
<b>DTC/CIRCUIT DIAGNOSIS</b> .....	174	<b>MAIN LINE BETWEEN AV AND ADP CIR-</b>	
<b>MAIN LINE BETWEEN DLC AND AV CIR-</b>		<b>CUIT</b> .....	194
<b>CUIT</b> .....	174	Diagnosis Procedure .....	194
Diagnosis Procedure .....	174	<b>MAIN LINE BETWEEN ADP AND RAS CIR-</b>	
<b>MAIN LINE BETWEEN AV AND ADP CIR-</b>		<b>CUIT</b> .....	195
<b>CUIT</b> .....	175	Diagnosis Procedure .....	195
Diagnosis Procedure .....	175	<b>MAIN LINE BETWEEN RAS AND ABS CIR-</b>	
<b>MAIN LINE BETWEEN ADP AND ABS CIR-</b>		<b>CUIT</b> .....	196
<b>CUIT</b> .....	176	Diagnosis Procedure .....	196
Diagnosis Procedure .....	176	<b>ECM BRANCH LINE CIRCUIT</b> .....	198
<b>ECM BRANCH LINE CIRCUIT</b> .....	178	Diagnosis Procedure .....	198
Diagnosis Procedure .....	178	<b>A-BAG BRANCH LINE CIRCUIT</b> .....	199
<b>A-BAG BRANCH LINE CIRCUIT</b> .....	179	Diagnosis Procedure .....	199
Diagnosis Procedure .....	179	<b>BCM BRANCH LINE CIRCUIT</b> .....	200
<b>BCM BRANCH LINE CIRCUIT</b> .....	180	Diagnosis Procedure .....	200
Diagnosis Procedure .....	180	<b>DLC BRANCH LINE CIRCUIT</b> .....	201
<b>DLC BRANCH LINE CIRCUIT</b> .....	181	Diagnosis Procedure .....	201
Diagnosis Procedure .....	181	<b>M&amp;A BRANCH LINE CIRCUIT</b> .....	202
<b>M&amp;A BRANCH LINE CIRCUIT</b> .....	182	Diagnosis Procedure .....	202
Diagnosis Procedure .....	182	<b>STRG BRANCH LINE CIRCUIT</b> .....	203
<b>STRG BRANCH LINE CIRCUIT</b> .....	183	Diagnosis Procedure .....	203
Diagnosis Procedure .....	183	<b>AV BRANCH LINE CIRCUIT</b> .....	204
<b>AV BRANCH LINE CIRCUIT</b> .....	184	Diagnosis Procedure .....	204
Diagnosis Procedure .....	184	<b>PSB BRANCH LINE CIRCUIT</b> .....	205
<b>PSB BRANCH LINE CIRCUIT</b> .....	185	Diagnosis Procedure .....	205
Diagnosis Procedure .....	185	<b>TCM BRANCH LINE CIRCUIT</b> .....	206
<b>TCM BRANCH LINE CIRCUIT</b> .....	186	Diagnosis Procedure .....	206
Diagnosis Procedure .....	186	<b>ADP BRANCH LINE CIRCUIT</b> .....	207
<b>ADP BRANCH LINE CIRCUIT</b> .....	187	Diagnosis Procedure .....	207
Diagnosis Procedure .....	187	<b>RAS BRANCH LINE CIRCUIT</b> .....	208
<b>ABS BRANCH LINE CIRCUIT</b> .....	188	Diagnosis Procedure .....	208
Diagnosis Procedure .....	188	<b>ABS BRANCH LINE CIRCUIT</b> .....	209
<b>ICC BRANCH LINE CIRCUIT</b> .....	189	Diagnosis Procedure .....	209
Diagnosis Procedure .....	189	<b>ICC BRANCH LINE CIRCUIT</b> .....	210
<b>IPDM-E BRANCH LINE CIRCUIT</b> .....	190	Diagnosis Procedure .....	210
Diagnosis Procedure .....	190	<b>IPDM-E BRANCH LINE CIRCUIT</b> .....	211
<b>CAN COMMUNICATION CIRCUIT</b> .....	191	Diagnosis Procedure .....	211
Diagnosis Procedure .....	191	<b>CAN COMMUNICATION CIRCUIT</b> .....	212
<b>CAN SYSTEM (TYPE 8)</b>		Diagnosis Procedure .....	212
<b>DTC/CIRCUIT DIAGNOSIS</b> .....	193	<b>CAN SYSTEM (TYPE 9)</b>	
<b>MAIN LINE BETWEEN DLC AND AV CIR-</b>		<b>CUIT</b> .....	212
<b>CUIT</b> .....	193	<b>CAN SYSTEM (TYPE 9)</b>	
Diagnosis Procedure .....	193	<b>DTC/CIRCUIT DIAGNOSIS</b> .....	214
<b>MAIN LINE BETWEEN AV AND ADP CIR-</b>			
<b>CUIT</b> .....	194		
Diagnosis Procedure .....	194		
<b>MAIN LINE BETWEEN ADP AND RAS CIR-</b>			
<b>CUIT</b> .....	195		
Diagnosis Procedure .....	195		
<b>MAIN LINE BETWEEN RAS AND ABS CIR-</b>			
<b>CUIT</b> .....	196		
Diagnosis Procedure .....	196		
<b>ECM BRANCH LINE CIRCUIT</b> .....	198		
Diagnosis Procedure .....	198		
<b>A-BAG BRANCH LINE CIRCUIT</b> .....	199		
Diagnosis Procedure .....	199		
<b>BCM BRANCH LINE CIRCUIT</b> .....	200		
Diagnosis Procedure .....	200		
<b>DLC BRANCH LINE CIRCUIT</b> .....	201		
Diagnosis Procedure .....	201		
<b>M&amp;A BRANCH LINE CIRCUIT</b> .....	202		
Diagnosis Procedure .....	202		
<b>STRG BRANCH LINE CIRCUIT</b> .....	203		
Diagnosis Procedure .....	203		
<b>AV BRANCH LINE CIRCUIT</b> .....	204		
Diagnosis Procedure .....	204		
<b>PSB BRANCH LINE CIRCUIT</b> .....	205		
Diagnosis Procedure .....	205		
<b>TCM BRANCH LINE CIRCUIT</b> .....	206		
Diagnosis Procedure .....	206		
<b>ADP BRANCH LINE CIRCUIT</b> .....	207		
Diagnosis Procedure .....	207		
<b>RAS BRANCH LINE CIRCUIT</b> .....	208		
Diagnosis Procedure .....	208		
<b>ABS BRANCH LINE CIRCUIT</b> .....	209		
Diagnosis Procedure .....	209		
<b>ICC BRANCH LINE CIRCUIT</b> .....	210		
Diagnosis Procedure .....	210		
<b>IPDM-E BRANCH LINE CIRCUIT</b> .....	211		
Diagnosis Procedure .....	211		
<b>CAN COMMUNICATION CIRCUIT</b> .....	212		
Diagnosis Procedure .....	212		
<b>CAN SYSTEM (TYPE 9)</b>			
<b>DTC/CIRCUIT DIAGNOSIS</b> .....	214		

A  
B  
C  
D  
E  
F  
G  
H  
I  
J  
K  
L  
LAN  
N  
O  
P

<b>MAIN LINE BETWEEN DLC AND AV CIR- CUIT</b> .....	<b>214</b>
Diagnosis Procedure .....	214
<b>MAIN LINE BETWEEN AV AND ADP CIR- CUIT</b> .....	<b>215</b>
Diagnosis Procedure .....	215
<b>MAIN LINE BETWEEN ADP AND ABS CIR- CUIT</b> .....	<b>216</b>
Diagnosis Procedure .....	216
<b>ECM BRANCH LINE CIRCUIT</b> .....	<b>218</b>
Diagnosis Procedure .....	218
<b>A-BAG BRANCH LINE CIRCUIT</b> .....	<b>219</b>
Diagnosis Procedure .....	219
<b>BCM BRANCH LINE CIRCUIT</b> .....	<b>220</b>
Diagnosis Procedure .....	220
<b>DLC BRANCH LINE CIRCUIT</b> .....	<b>221</b>
Diagnosis Procedure .....	221
<b>M&amp;A BRANCH LINE CIRCUIT</b> .....	<b>222</b>
Diagnosis Procedure .....	222
<b>STRG BRANCH LINE CIRCUIT</b> .....	<b>223</b>
Diagnosis Procedure .....	223
<b>4WD BRANCH LINE CIRCUIT</b> .....	<b>224</b>
Diagnosis Procedure .....	224
<b>AV BRANCH LINE CIRCUIT</b> .....	<b>225</b>
Diagnosis Procedure .....	225
<b>TCM BRANCH LINE CIRCUIT</b> .....	<b>226</b>
Diagnosis Procedure .....	226
<b>ADP BRANCH LINE CIRCUIT</b> .....	<b>227</b>
Diagnosis Procedure .....	227
<b>ABS BRANCH LINE CIRCUIT</b> .....	<b>228</b>
Diagnosis Procedure .....	228
<b>IPDM-E BRANCH LINE CIRCUIT</b> .....	<b>229</b>
Diagnosis Procedure .....	229
<b>CAN COMMUNICATION CIRCUIT</b> .....	<b>230</b>
Diagnosis Procedure .....	230
<b>CAN SYSTEM (TYPE 10)</b>	
<b>DTC/CIRCUIT DIAGNOSIS</b> .....	<b>232</b>

<b>MAIN LINE BETWEEN DLC AND AV CIR- CUIT</b> .....	<b>232</b>
Diagnosis Procedure .....	232
<b>MAIN LINE BETWEEN AV AND ADP CIR- CUIT</b> .....	<b>233</b>
Diagnosis Procedure .....	233
<b>MAIN LINE BETWEEN ADP AND ABS CIR- CUIT</b> .....	<b>234</b>
Diagnosis Procedure .....	234
<b>ECM BRANCH LINE CIRCUIT</b> .....	<b>236</b>
Diagnosis Procedure .....	236
<b>A-BAG BRANCH LINE CIRCUIT</b> .....	<b>237</b>
Diagnosis Procedure .....	237
<b>BCM BRANCH LINE CIRCUIT</b> .....	<b>238</b>
Diagnosis Procedure .....	238
<b>DLC BRANCH LINE CIRCUIT</b> .....	<b>239</b>
Diagnosis Procedure .....	239
<b>M&amp;A BRANCH LINE CIRCUIT</b> .....	<b>240</b>
Diagnosis Procedure .....	240
<b>STRG BRANCH LINE CIRCUIT</b> .....	<b>241</b>
Diagnosis Procedure .....	241
<b>4WD BRANCH LINE CIRCUIT</b> .....	<b>242</b>
Diagnosis Procedure .....	242
<b>AV BRANCH LINE CIRCUIT</b> .....	<b>243</b>
Diagnosis Procedure .....	243
<b>PSB BRANCH LINE CIRCUIT</b> .....	<b>244</b>
Diagnosis Procedure .....	244
<b>TCM BRANCH LINE CIRCUIT</b> .....	<b>245</b>
Diagnosis Procedure .....	245
<b>ADP BRANCH LINE CIRCUIT</b> .....	<b>246</b>
Diagnosis Procedure .....	246
<b>ABS BRANCH LINE CIRCUIT</b> .....	<b>247</b>
Diagnosis Procedure .....	247
<b>ICC BRANCH LINE CIRCUIT</b> .....	<b>248</b>
Diagnosis Procedure .....	248
<b>IPDM-E BRANCH LINE CIRCUIT</b> .....	<b>249</b>
Diagnosis Procedure .....	249
<b>CAN COMMUNICATION CIRCUIT</b> .....	<b>250</b>
Diagnosis Procedure .....	250

PRECAUTION

PRECAUTIONS

Precautions for Trouble Diagnosis

INFOID:000000005655370

**CAUTION:**

- Never apply 7.0 V or more to the measurement terminal.
- Use a tester with open terminal voltage of 7.0 V or less.
- Turn the ignition switch OFF and disconnect the battery cable from the negative terminal when checking the harness.

Precautions for Harness Repair

INFOID:000000005655371

- Solder the repaired area and wrap tape around the soldered area.

**NOTE:**

A fray of twisted lines must be within 110 mm (4.33 in).

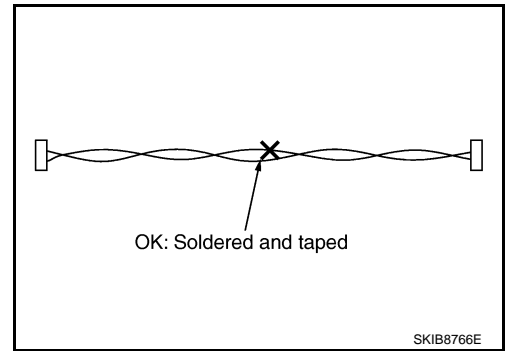

- Bypass connection is never allowed at the repaired area.

**NOTE:**

Bypass connection may cause CAN communication error. The spliced wire becomes separated and the characteristics of twisted line are lost.

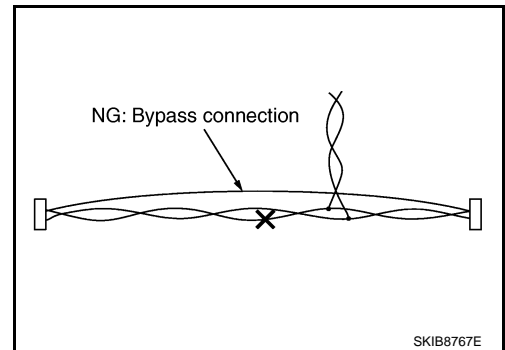

- Replace the applicable harness as an assembly if error is detected on the shield lines of CAN communication line.

A  
B  
C  
D  
E  
F  
G  
H  
I  
J  
K  
L

LAN

## SYSTEM DESCRIPTION

### CAN COMMUNICATION SYSTEM

#### System Description

INFOID:000000005655372

- CAN communication is a multiplex communication system. This enables the system to transmit and receive large quantities of data at high speed by connecting control units with two communication lines (CAN-H and CAN-L).
- Control units on the CAN network transmit signals using the CAN communication control circuit. They receive only necessary signals from other control units to operate various functions.
- CAN communication lines adopt twisted-pair line style (two lines twisted) for noise immunity.

#### System Diagram

INFOID:000000005655373

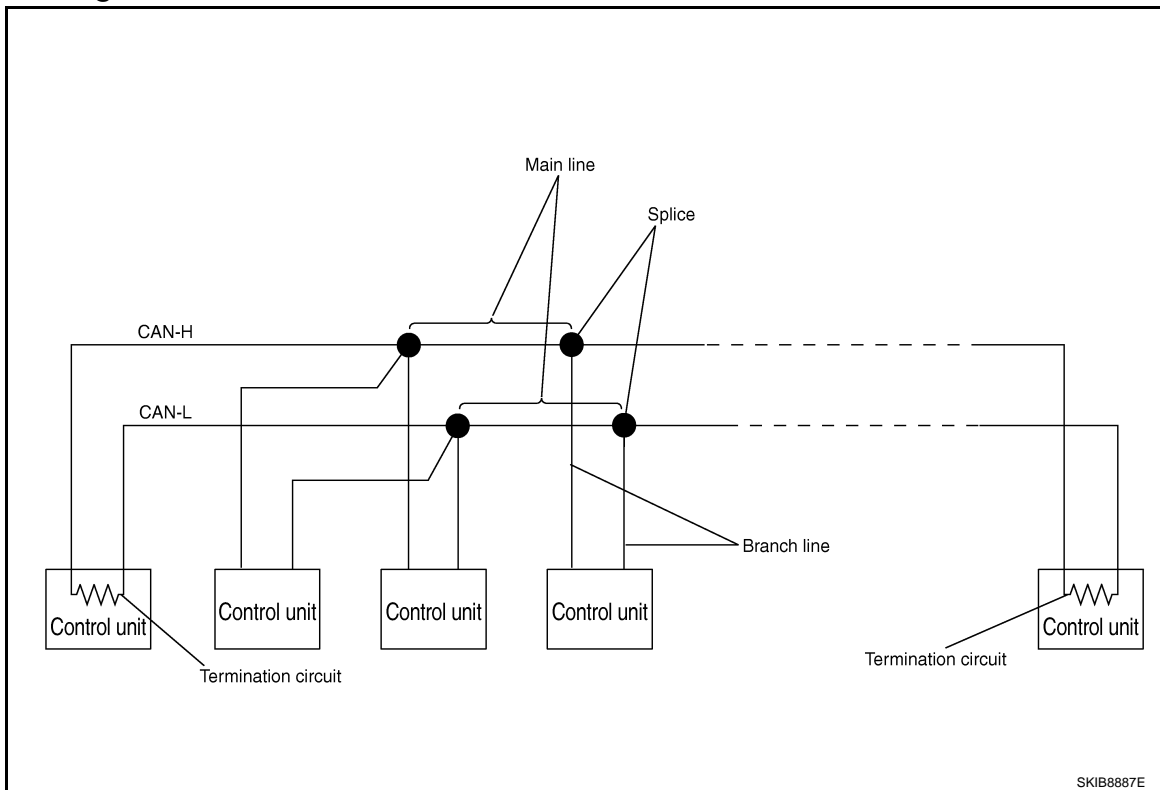

Each control unit passes an electric current to the termination circuits when transmitting CAN communication signal. The termination circuits produce an electrical potential difference between CAN-H and CAN-L. CAN communication system transmits and receives CAN communication signals by the potential difference.

Component	Description
Main line	CAN communication line between splices
Branch line	CAN communication line between splice and a control unit
Splice	A point connecting a branch line with a main line
Termination circuit	Refer to <a href="#">LAN-9, "CAN Communication Control Circuit"</a> .



# CAN COMMUNICATION SYSTEM

< SYSTEM DESCRIPTION >

[CAN FUNDAMENTAL]

## CAN Communication Control Circuit

INFOID:000000005655374

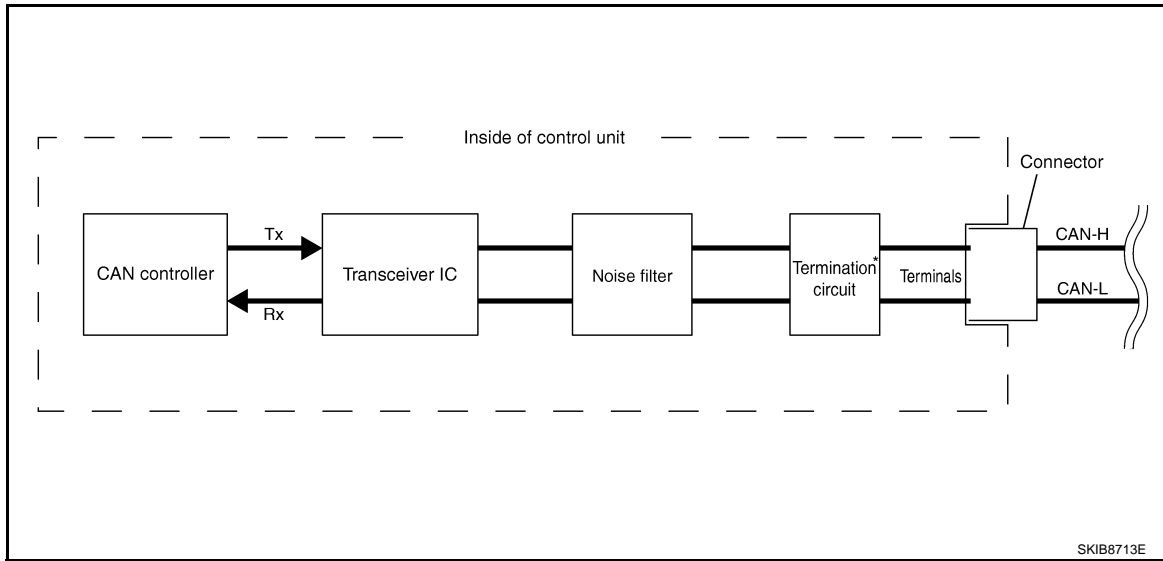

Component	System description
CAN controller	It controls CAN communication signal transmission and reception, error detection, etc.
Transceiver IC	It converts digital signal into CAN communication signal, and CAN communication signal into digital signal.
Noise filter	It eliminates noise of CAN communication signal.
Termination circuit* (Resistance of approx. 120 Ω)	It produces potential difference.

\*: These are the only control units wired with both ends of CAN communication system.

A  
B  
C  
D  
E  
F  
G  
H  
I  
J  
K  
L

LAN

N  
O  
P

## DIAG ON CAN

### Description

INFOID:000000005655375

“Diag on CAN” is a diagnosis using CAN communication instead of previous DDL1 and DDL2 communication lines, between control units and diagnosis unit.

### System Diagram

INFOID:000000005655376

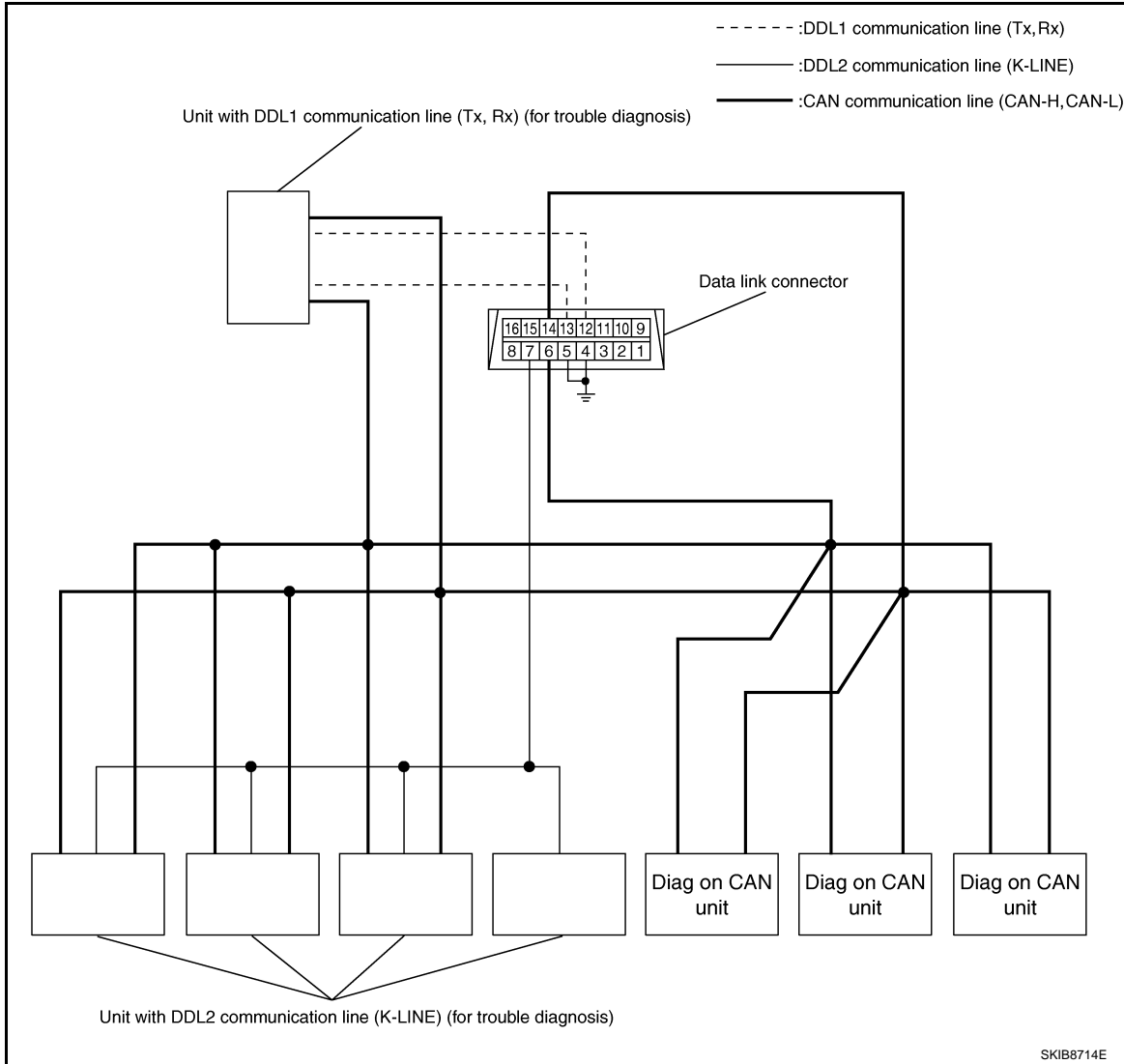

Name	Harness	Description
DDL1	Tx Rx	It is used for trouble diagnosis. (CAN-H and CAN-L are used for controlling)
DDL2	K-LINE	It is used for trouble diagnosis. (CAN-H and CAN-L are used for controlling)
Diag on CAN	CAN-H CAN-L	It is used for trouble diagnosis and control.

## TROUBLE DIAGNOSIS

## Condition of Error Detection

INFOID:000000005779350

DTC of CAN communication is indicated on SELF-DIAG RESULTS on CONSULT-III if a CAN communication signal is not transmitted or received between units for 2 seconds or more.

**NOTE:**

DTCs of CAN communication are as follows:

- U0101
- U0140
- U0164
- U1000
- U1001

## CAN COMMUNICATION SYSTEM ERROR

- CAN communication line open (CAN-H, CAN-L, or both)
- CAN communication line short (ground, between CAN communication lines, other harnesses)
- Error of CAN communication control circuit of the unit connected to CAN communication line

## WHEN DTC OF CAN COMMUNICATION IS INDICATED EVEN THOUGH CAN COMMUNICATION SYSTEM IS NORMAL

- Removal/installation of parts: Error may be detected when removing and installing CAN communication unit and related parts while turning the ignition switch ON. (A DTC except for CAN communication may be detected.)
- Fuse blown out (removed): CAN communication of the unit may cease.
- Voltage drop: Error may be detected if voltage drops due to discharged battery when turning the ignition switch ON (Depending on the control unit which carries out CAN communication).
- Error may be detected if the power supply circuit of the control unit, which carries out CAN communication, malfunctions (Depending on the control unit which carries out CAN communication).
- Error may be detected if reprogramming is not completed normally.

**CAUTION:**

**CAN communication system is normal if DTC of CAN communication is indicated on SELF-DIAG RESULTS of CONSULT-III under the above conditions. Erase the memory of the self-diagnosis of each unit.**

## Symptom When Error Occurs in CAN Communication System

INFOID:000000005655378

In CAN communication system, multiple units mutually transmit and receive signals. Each unit cannot transmit and receive signals if any error occurs on CAN communication line. Under this condition, multiple control units related to the root cause malfunction or go into fail-safe mode.

## ERROR EXAMPLE

**NOTE:**

- Each vehicle differs in symptom of each unit under fail-safe mode and CAN communication line wiring.
- Refer to [LAN-23, "Abbreviation List"](#) for the unit abbreviation.

A

B

C

D

E

F

G

H

I

J

K

L

LAN

N

O

P

# TROUBLE DIAGNOSIS

< SYSTEM DESCRIPTION >

[CAN FUNDAMENTAL]

Example: TCM branch line open circuit

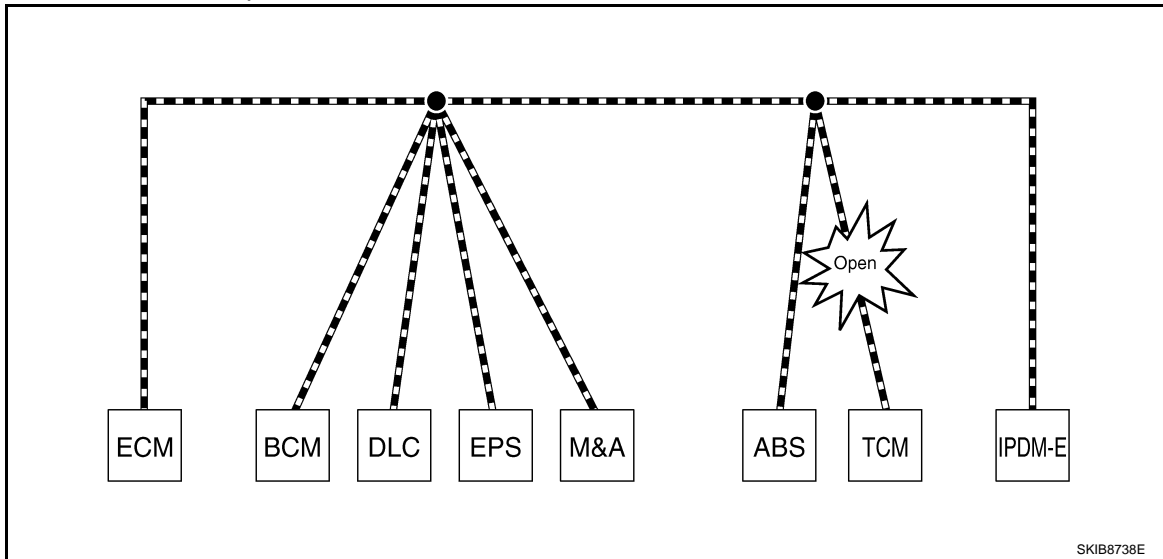

Unit name	Symptom
ECM	Engine torque limiting is affected, and shift harshness increases.
BCM	Reverse warning chime does not sound.
EPS control unit	Normal operation.
Combination meter	<ul style="list-style-type: none"> <li>• Shift position indicator and OD OFF indicator turn OFF.</li> <li>• Warning lamps turn ON.</li> </ul>
ABS actuator and electric unit (control unit)	Normal operation.
TCM	No impact on operation.
IPDM E/R	Normal operation.

Example: Data link connector branch line open circuit

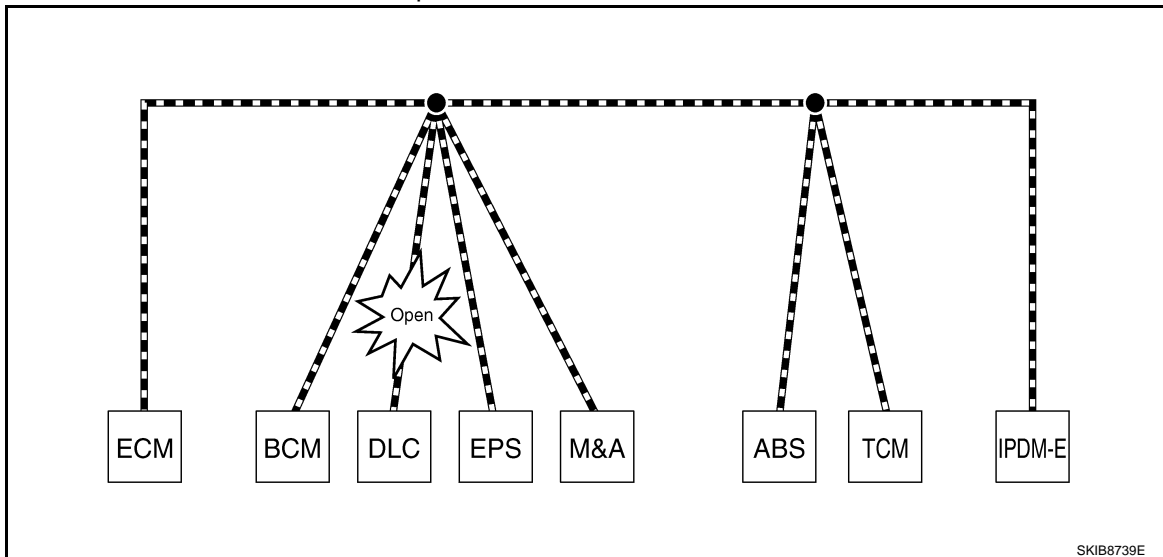

# TROUBLE DIAGNOSIS

< SYSTEM DESCRIPTION >

[CAN FUNDAMENTAL]

Unit name	Symptom
ECM	Normal operation.
BCM	
EPS control unit	
Combination meter	
ABS actuator and electric unit (control unit)	
TCM	
IPDM E/R	

**NOTE:**

- When data link connector branch line is open, transmission and reception of CAN communication signals are not affected. Therefore, no symptoms occur. However, be sure to repair malfunctioning circuit.
- The model (all units on CAN communication system are Diag on CAN) cannot perform CAN diagnosis with CONSULT-III if the following error occurs. The error is judged by the symptom.

Error	Difference of symptom
Data link connector branch line open circuit	Normal operation.
CAN-H, CAN-L harness short-circuit	Most of the units which are connected to the CAN communication system enter fail-safe mode or are deactivated.

Example: Main Line Between Data Link Connector and ABS Actuator and Electric Unit (Control Unit) Open Circuit

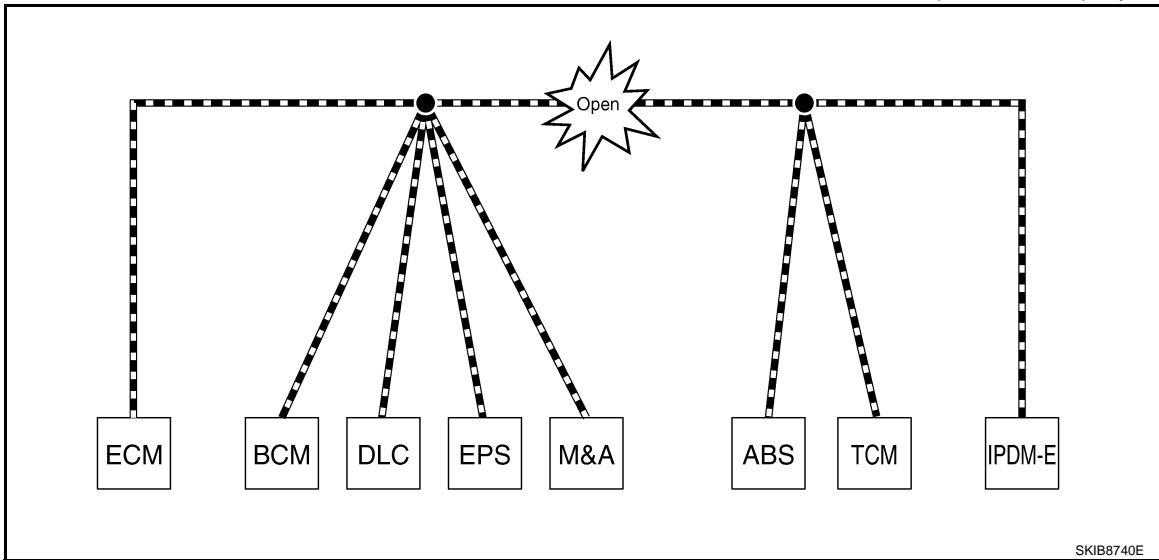

Unit name	Symptom
ECM	Engine torque limiting is affected, and shift harshness increases.
BCM	<ul style="list-style-type: none"> <li>• Reverse warning chime does not sound.</li> <li>• The front wiper moves under continuous operation mode even though the front wiper switch being in the intermittent position.</li> </ul>
EPS control unit	The steering effort increases.
Combination meter	<ul style="list-style-type: none"> <li>• The shift position indicator and OD OFF indicator turn OFF.</li> <li>• The speedometer is inoperative.</li> <li>• The odo/trip meter stops.</li> </ul>
ABS actuator and electric unit (control unit)	Normal operation.
TCM	No impact on operation.
IPDM E/R	When the ignition switch is ON, <ul style="list-style-type: none"> <li>• The headlamps (Lo) turn ON.</li> <li>• The cooling fan continues to rotate.</li> </ul>

A  
B  
C  
D  
E  
F  
G  
H  
I  
J  
K  
L  
N  
O  
P

LAN

# TROUBLE DIAGNOSIS

< SYSTEM DESCRIPTION >

[CAN FUNDAMENTAL]

Example: CAN-H, CAN-L Harness Short Circuit

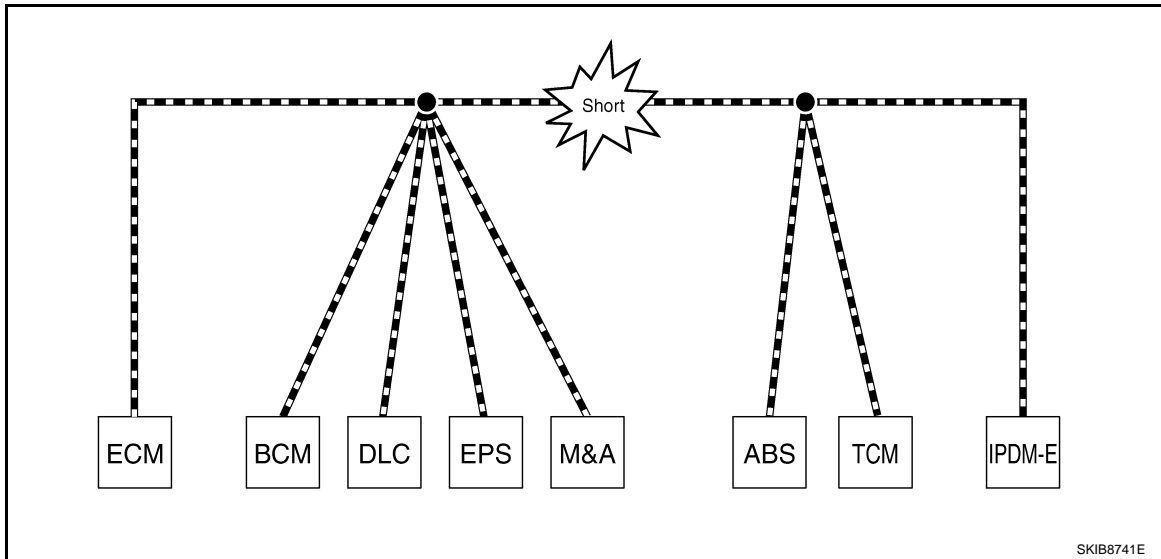

Unit name	Symptom
ECM	<ul style="list-style-type: none"> <li>• Engine torque limiting is affected, and shift harshness increases.</li> <li>• Engine speed drops.</li> </ul>
BCM	<ul style="list-style-type: none"> <li>• Reverse warning chime does not sound.</li> <li>• The front wiper moves under continuous operation mode even though the front wiper switch being in the intermittent position.</li> <li>• The room lamp does not turn ON.</li> <li>• The engine does not start (if an error or malfunction occurs while turning the ignition switch OFF.)</li> <li>• The steering lock does not release (if an error or malfunction occurs while turning the ignition switch OFF.)</li> </ul>
EPS control unit	The steering effort increases.
Combination meter	<ul style="list-style-type: none"> <li>• The tachometer and the speedometer do not move.</li> <li>• Warning lamps turn ON.</li> <li>• Indicator lamps do not turn ON.</li> </ul>
ABS actuator and electric unit (control unit)	Normal operation.
TCM	No impact on operation.
IPDM E/R	When the ignition switch is ON, <ul style="list-style-type: none"> <li>• The headlamps (Lo) turn ON.</li> <li>• The cooling fan continues to rotate.</li> </ul>

## CAN Diagnosis with CONSULT-III

INFOID:000000005655379

CAN diagnosis on CONSULT-III extracts the root cause by receiving the following information.

- Response to the system call
- Control unit diagnosis information
- Self-diagnosis
- CAN diagnostic support monitor

# TROUBLE DIAGNOSIS

< SYSTEM DESCRIPTION >

[CAN FUNDAMENTAL]

## Self-Diagnosis

INFOID:000000005881839

DTC	Self-diagnosis item (CONSULT-III indication)	DTC detection condition	Inspection/Action	
U0101	LOST COMM (TCM)	When ECM is not transmitting or receiving CAN communication signal of OBD (emission-related diagnosis) from TCM for 2 seconds or more.	Start the inspection. Refer to the applicable section of the indicated control unit.	
U0140	LOST COMM (BCM)	When ECM is not transmitting or receiving CAN communication signal of OBD (emission-related diagnosis) from BCM for 2 seconds or more.		
U0164	LOST COMM (HVAC)	When ECM is not transmitting or receiving CAN communication signal of OBD (emission-related diagnosis) from A/C auto amp. or unified meter and A/C amp. for 2 seconds or more.		
U1000	CAN COMM CIRCUIT	ECM		When ECM is not transmitting or receiving CAN communication signal of OBD (emission-related diagnosis) for 2 seconds or more.
		Except for ECM		When a control unit (except for ECM) is not transmitting or receiving CAN communication signal for 2 seconds or more.
U1001	CAN COMM CIRCUIT	When ECM is not transmitting or receiving CAN communication signal other than OBD (emission-related diagnosis) for 2 seconds or more.		
U1002	SYSTEM COMM	When a control unit is not transmitting or receiving CAN communication signal for 2 seconds or less.		
U1010	CONTROL UNIT(CAN)	When an error is detected during the initial diagnosis for CAN controller of each control unit.	Replace the control unit indicating "U1010" or "P0607".	
P0607	ECM			

## CAN Diagnostic Support Monitor

INFOID:000000005655381

### MONITOR ITEM (CONSULT-III)

Example: CAN DIAG SUPPORT MNTR indication

Without PAST				With PAST			
ECM				ECM			
	PRSENT	PAST		PRSENT	PAST		
INITIAL DIAG	OK		TRANSMIT DIAG	OK	OK		
TRANSMIT DIAG	OK		VDC/TCS/ABS	-	-		
TCM	OK		METER/M&A	OK	OK		
VDC/TCS/ABS	UNKWN		BCM/SEC	OK	OK		
METER/M&A	OK		ICC	-	-		
ICC	UNKWN		HVAC	-	-		
BCM/SEC	OK		TCM	OK	OK		
IPDM E/R	OK		EPS	-	-		
			IPDM E/R	OK	OK		
			e4WD	-	-		
			AWD/4WD	OK	OK		

JSMIA0015GB

Without PAST

Item	PRSENT	Description
Initial diagnosis	OK	Normal at present
	NG	Control unit error (Except for some control units)

# TROUBLE DIAGNOSIS

< SYSTEM DESCRIPTION >

[CAN FUNDAMENTAL]

Item	PRSNT	Description
Transmission diagnosis	OK	Normal at present
	UNKWN	Unable to transmit signals for 2 seconds or more. Diagnosis not performed
Control unit name (Reception diagnosis)	OK	Normal at present
	UNKWN	Unable to receive signals for 2 seconds or more. Diagnosis not performed
		No control unit for receiving signals. (No applicable optional parts)

With PAST

Item	PRSNT	PAST	Description
Transmission diagnosis	OK	OK	Normal at present and in the past
		1 – 39	Normal at present, but unable to transmit signals for 2 seconds or more in the past. (The number indicates the number of ignition switch cycles from OFF to ON.)
	UNKWN	0	Unable to transmit signals for 2 seconds or more at present.
Control unit name (Reception diagnosis)	OK	OK	Normal at present and in the past
		1 – 39	Normal at present, but unable to receive signals for 2 seconds or more in the past. (The number indicates the number of ignition switch cycles from OFF to ON.)
	UNKWN	0	Unable to receive signals for 2 seconds or more at present.
	–	–	Diagnosis not performed. No control unit for receiving signals. (No applicable optional parts)

## MONITOR ITEM (ON-BOARD DIAGNOSIS)

**NOTE:**

For some models, CAN communication diagnosis result is received from the vehicle monitor.

Example: Vehicle Display

Item	Result indicated	Error counter	Description
CAN_COMM (Initial diagnosis)	OK	0	Normal at present
	NG	1 – 50	Control unit error (The number indicates how many times diagnosis has been run.)
CAN_CIRC_1 (Transmission diagnosis)	OK	0	Normal at present
	UNKWN	1 – 50	Unable to transmit for 2 seconds or more at present. (The number indicates how many times diagnosis has been run.)
CAN_CIRC_2 – 9 (Reception diagnosis of each unit)	OK	0	Normal at present
	UNKWN	1 – 50	Unable to transmit for 2 seconds or more at present. (The number indicates how many times diagnosis has been run.)
			Diagnosis not performed. No control unit for receiving signals. (No applicable optional parts)



# TROUBLE DIAGNOSIS

< SYSTEM DESCRIPTION >

[CAN FUNDAMENTAL]

## How to Use CAN Communication Signal Chart

INFOID:000000005655382

The CAN communication signal chart lists the signals needed for trouble diagnosis. It is useful for detecting the root cause by finding a signal related to the symptom, and by checking transmission and reception unit.

Example: Tachometer does not move even though the engine rotates.

T: Transmit R: Receive

Signal name/Connecting unit	ECM	BCM	M&A	STRG	ABS	IPDM-E
A/C compressor feedback signal	T		R			
A/C compressor request signal	T					R
Accelerator pedal position signal	T				R	
Cooling fan motor operation signal	T					R
Engine coolant temperature signal	T		R			
Engine speed signal	T		R		R	
Fuel consumption monitor signal	T		R			
Malfunction indicator lamp signal	T		R			
A/C switch signal	R	T				
Ignition switch signal		T				R
Sleep/wake up signal		T	R			R

↓

It indicates that an error occurs between ECM and M&A (Shaded area).

SKIB8715E

A  
B  
C  
D  
E  
F  
G  
H  
I  
J  
K  
L  
N  
O  
P

LAN

## BASIC INSPECTION

### DIAGNOSIS AND REPAIR WORKFLOW

#### Trouble Diagnosis Flow Chart

INFOID:000000005655383

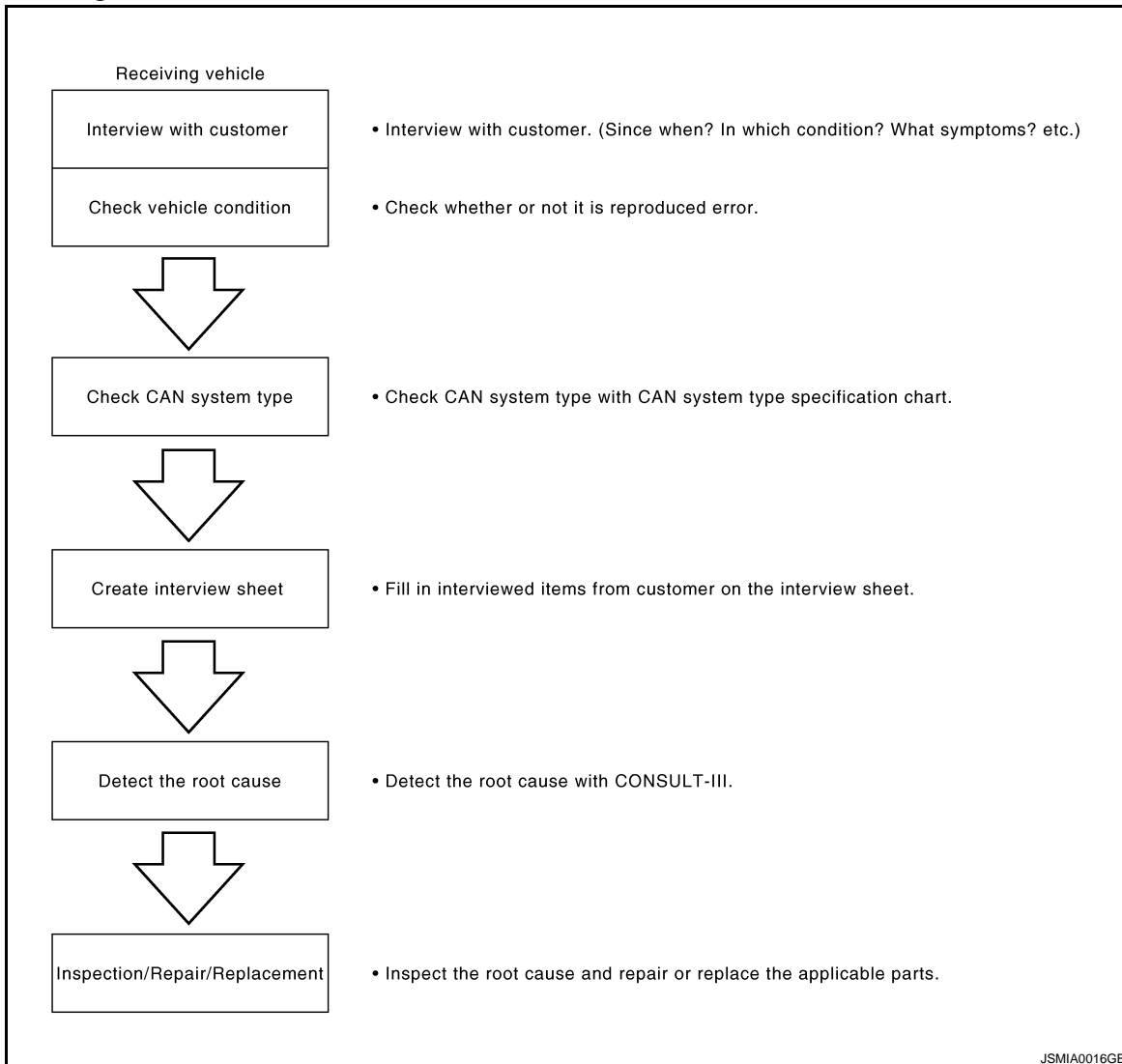

#### Trouble Diagnosis Procedure

INFOID:000000005655384

##### INTERVIEW WITH CUSTOMER

Interview with the customer is important to detect the root cause of CAN communication system errors and to understand vehicle condition and symptoms for proper trouble diagnosis.

###### Points in interview

- What: Parts name, system name
- When: Date, Frequency
- Where: Road condition, Place
- In what condition: Driving condition/environment
- Result: Symptom

###### NOTE:

- Check normal units as well as error symptoms.
- Example: Circuit between ECM and the combination meter is judged normal if the customer indicates tachometer functions normally.
- When a CAN communication system error is present, multiple control units may malfunction or go into fail-safe mode.

# DIAGNOSIS AND REPAIR WORKFLOW

< BASIC INSPECTION >

[CAN FUNDAMENTAL]

- Indication of the combination meter is important to detect the root cause because it is the most obvious to the customer, and it performs CAN communication with many units.

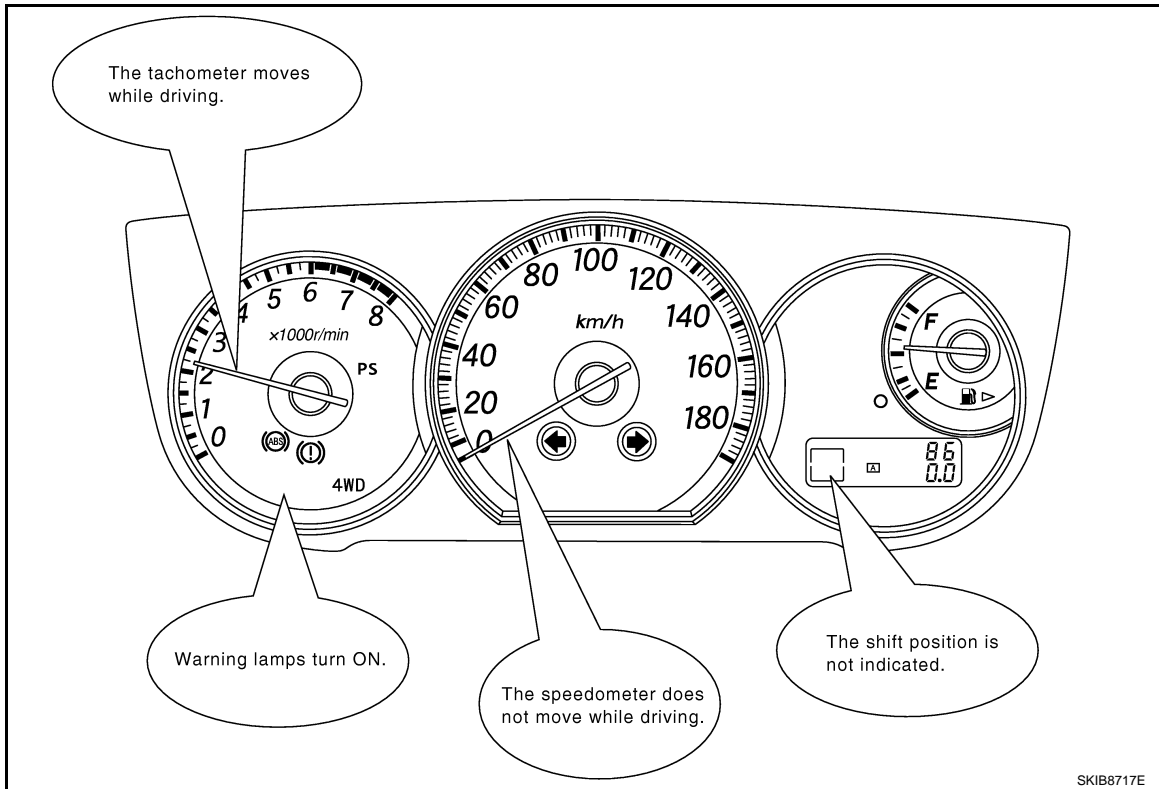

## INSPECTION OF VEHICLE CONDITION

Check whether the symptom is reproduced or not.

### NOTE:

Do not turn the ignition switch OFF or disconnect the battery cable while reproducing the error. The error may temporarily correct itself, making it difficult to determine the root cause.

## CHECK OF CAN SYSTEM TYPE (HOW TO USE CAN SYSTEM TYPE SPECIFICATION CHART)

Determine CAN system type based on vehicle equipment.

### NOTE:

- This chart is used if CONSULT-III does not automatically recognize CAN system type.
- There are two styles for CAN system type specification charts. Depending on the number of available system types, either style A or style B may be used.

CAN System Type Specification Chart (Style A)

### NOTE:

A  
B  
C  
D  
E  
F  
G  
H  
I  
J  
K  
L

LAN

# DIAGNOSIS AND REPAIR WORKFLOW

< BASIC INSPECTION >

[CAN FUNDAMENTAL]

CAN system type is easily checked with the vehicle equipment identification information shown in the chart.

Example:  
Vehicle is equipped as follows: Wagon, AWD, VQ35DE, CVT, VDC, and Intelligent Key system. (○ shows an example of CAN system type.)

**CAN System Specification Chart**  
Determine CAN system type from the following specification chart.

Body type	Wagon					
Axle	2WD			AWD		
Engine	QR25DE		VQ35DE			
Transmission	A/T		CVT			
Brake control	ABS			VDC		
Intelligent Key system		X		X		X
CAN system type	1	2	3	4	5	6
CAN communication signal chart	XX-XX. "TYPE 1/TYP E 2"		XX-XX. "TYPE 3/TYP E 4"		XX-XX. "TYPE 5/TYP E 6"	

X : Applicable

**VEHICLE EQUIPMENT IDENTIFICATION INFORMATION**  
**NOTE:**  
Check CAN system type from the vehicle shape and equipment.

With VDC

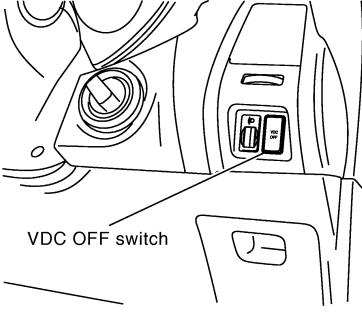

VDC OFF switch

With Intelligent Key system

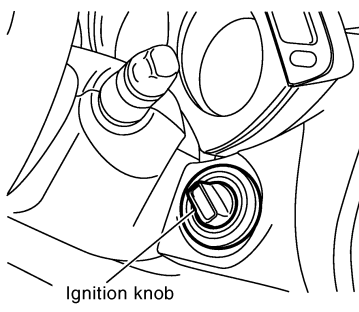

Ignition knob

In the above example,  
 • Checking VDC OFF switch leads to judge whether or not VDC is equipped.  
 • Checking the ignition knob leads to judge whether or not Intelligent Key system is equipped.

[ For the above case, CAN system type is "6". ]

JSMIA0017GB

CAN System Type Specification Chart (Style B)

**NOTE:**

# DIAGNOSIS AND REPAIR WORKFLOW

< BASIC INSPECTION >

[CAN FUNDAMENTAL]

CAN system type is easily checked with the vehicle equipment identification information shown in the chart.

Example:  
Vehicle is equipped as follows: Sedan, 2WD, MR20DE, CVT, ABS, Active AFS, Intelligent Key system, Navigation system and Automatic drive positioner. (○ shows an example of CAN system type.)

**CAN System Specification Chart**  
Refer to the specification as shown in the chart.

Body type	Sedan		
Axle	2WD		AWD
Engine	HR15DE	MR20DE	HR15DE
Transmission	A/T	CVT	A/T
Brake control		ABS	
Specification chart	XXX SPECIFICATION CHART A	YYY SPECIFICATION CHART B	ZZZ SPECIFICATION CHART C

x: Applicable

Check the vehicle equipment with the vehicle identification number plate.  
Check the vehicle equipment.  
Select the applicable vehicle equipment. Refer to the specification chart.

**SPECIFICATION CHART B**  
Determine CAN system type from the following specification chart.

Body type	Sedan											
Axle	2WD											
Engine	MR20DE											
Transmission	CVT											
Brake control	ABS											
Active AFS		x			x	x		x	x		x	
Intelligent Key system			x		x		x	x	x	x	x	
Navigation system				x		x	x		x		x	
Automatic drive positioner							x		x	x	x	
CAN system type	9	10	11	12	13	14	15	16	17	18	19	20
CAN communication signal chart	XXX TYPE MINPA 12V/16V/18V/20V/24V/28V/30V/32V/36V/40V/42V/44V/46V/48V/50V/52V/54V/56V/58V/60V/62V/64V/66V/68V/70V/72V/74V/76V/78V/80V/82V/84V/86V/88V/90V/92V/94V/96V/98V/100V/102V/104V/106V/108V/110V/112V/114V/116V/118V/120V/122V/124V/126V/128V/130V/132V/134V/136V/138V/140V/142V/144V/146V/148V/150V/152V/154V/156V/158V/160V/162V/164V/166V/168V/170V/172V/174V/176V/178V/180V/182V/184V/186V/188V/190V/192V/194V/196V/198V/200V											

x: Applicable

Check the vehicle equipment.  
The number indicates the CAN system type of the vehicle.

**VEHICLE EQUIPMENT IDENTIFICATION INFORMATION**  
**NOTE:**  
Check CAN system type from the vehicle shape and equipment.

<p>With active AFS</p> <p>Bending lamp Xenon bulb</p>	<p>With Intelligent Key system</p> <p>Ignition knob</p>
<p>With navigation system</p> <p>Display Multifunction switch</p>	<p>With automatic drive positioner</p> <p>Seat memory switch</p>

In the above example,  
 • Checking Xenon bulb and bending lamp lead to judge whether or not Active AFS is equipped.  
 • Checking the ignition knob leads to judge whether or not Intelligent Key system is equipped.  
 • Checking display and multifunction switch lead to judge whether or not Navigation system is equipped.  
 • Checking seat memory switch leads to judge whether or not Automatic drive positioner is equipped.

[ For the above case, CAN system type is "20". ]

JSMIA0018GB

## CREATE INTERVIEW SHEET

Fill out the symptom described by the customer, vehicle condition, and CAN system type on the interview sheet.

# DIAGNOSIS AND REPAIR WORKFLOW

< BASIC INSPECTION >

[CAN FUNDAMENTAL]

Interview Sheet (Example)

CAN Communication System Diagnosis Interview Sheet	
Date received:	3, Feb. 2006
Type: DBA-KG11	VIN No.: KG11-005040
Model: BDRARGZ397EDA-E-J-	
First registration: 10, Jan. 2001	Mileage: 62,140
CAN system type: Type 19	
Symptom (Results from interview with customer)	
<ul style="list-style-type: none"><li>•Headlamps suddenly turn ON while driving the vehicle.</li><li>•The engine does not restart after stopping the vehicle and turning the ignition switch OFF.</li><li>•The cooling fan continues rotating while turning the ignition switch ON.</li></ul>	
Condition at inspection	
Error Symptom: Present / Past	
<p>The engine does not start. While turning the ignition switch ON,</p> <ul style="list-style-type: none"><li>•The headlamps (Lo) turn ON, and the cooling fan continues rotating.</li><li>•The interior lamp does not turn ON.</li></ul>	

JSMIA0019GB

## DETECT THE ROOT CAUSE

CAN diagnosis function of CONSULT-III detects the root cause.

## HOW TO USE THIS SECTION

< HOW TO USE THIS MANUAL >

[CAN]

# HOW TO USE THIS MANUAL

## HOW TO USE THIS SECTION

### Caution

INFOID:000000005655385

- This section describes information peculiar to a vehicle and inspection procedures.
- For trouble diagnosis procedure, refer to [LAN-18, "Trouble Diagnosis Procedure"](#).

### Abbreviation List

INFOID:000000005655386

Unit name abbreviations in CONSULT-III CAN diagnosis and in this section are as per the following list.

Abbreviation	Unit name
4WD	AWD control unit
A-BAG	Air bag diagnosis sensor unit
ABS	ABS actuator and electric unit (control unit)
ADP	Driver seat control unit
AV	AV control unit
BCM	BCM
DLC	Data link connector
ECM	ECM
ICC	ICC sensor integrated unit
IPDM-E	IPDM E/R
M&A	Unified meter and A/C amp.
PSB	Pre-crash seat belt control unit
RAS	4WAS main control unit
STRG	Steering angle sensor
TCM	TCM

A

B

C

D

E

F

G

H

I

J

K

L

LAN

N

O

P

## PRECAUTION

### PRECAUTIONS

#### Precaution for Supplemental Restraint System (SRS) "AIR BAG" and "SEAT BELT PRE-TENSIONER"

INFOID:000000005655387

The Supplemental Restraint System such as "AIR BAG" and "SEAT BELT PRE-TENSIONER", used along with a front seat belt, helps to reduce the risk or severity of injury to the driver and front passenger for certain types of collision. This system includes seat belt switch inputs and dual stage front air bag modules. The SRS system uses the seat belt switches to determine the front air bag deployment, and may only deploy one front air bag, depending on the severity of a collision and whether the front occupants are belted or unbelted. Information necessary to service the system safely is included in the "SRS AIR BAG" and "SEAT BELT" of this Service Manual.

**WARNING:**

- To avoid rendering the SRS inoperative, which could increase the risk of personal injury or death in the event of a collision which would result in air bag inflation, all maintenance must be performed by an authorized NISSAN/INFINITI dealer.
- Improper maintenance, including incorrect removal and installation of the SRS, can lead to personal injury caused by unintentional activation of the system. For removal of Spiral Cable and Air Bag Module, see the "SRS AIR BAG".
- Do not use electrical test equipment on any circuit related to the SRS unless instructed to in this Service Manual. SRS wiring harnesses can be identified by yellow and/or orange harnesses or harness connectors.

#### PRECAUTIONS WHEN USING POWER TOOLS (AIR OR ELECTRIC) AND HAMMERS

**WARNING:**

- When working near the Air Bag Diagnosis Sensor Unit or other Air Bag System sensors with the ignition ON or engine running, DO NOT use air or electric power tools or strike near the sensor(s) with a hammer. Heavy vibration could activate the sensor(s) and deploy the air bag(s), possibly causing serious injury.
- When using air or electric power tools or hammers, always switch the ignition OFF, disconnect the battery, and wait at least 3 minutes before performing any service.

#### Precaution for Battery Service

INFOID:000000005655388

Before disconnecting the battery, lower both the driver and passenger windows. This will prevent any interference between the window edge and the vehicle when the door is opened/closed. During normal operation, the window slightly raises and lowers automatically to prevent any window to vehicle interference. The automatic window function will not work with the battery disconnected.

#### Precautions for Trouble Diagnosis

INFOID:000000005655389

**CAUTION:**

- Never apply 7.0 V or more to the measurement terminal.
- Use a tester with open terminal voltage of 7.0 V or less.
- Turn the ignition switch OFF and disconnect the battery cable from the negative terminal when checking the harness.



# PRECAUTIONS

[CAN]

< PRECAUTION >

## Precautions for Harness Repair

INFOID:000000005655390

- Solder the repaired area and wrap tape around the soldered area.  
**NOTE:**  
A fray of twisted lines must be within 110 mm (4.33 in).

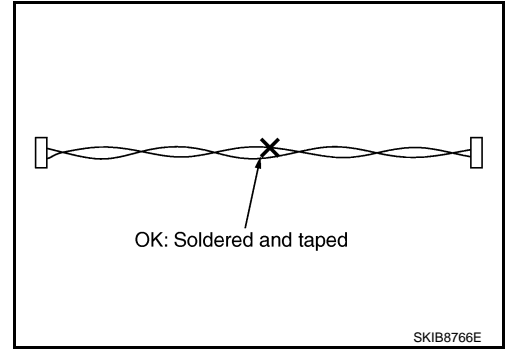

- Bypass connection is never allowed at the repaired area.  
**NOTE:**  
Bypass connection may cause CAN communication error. The spliced wire becomes separated and the characteristics of twisted line are lost.

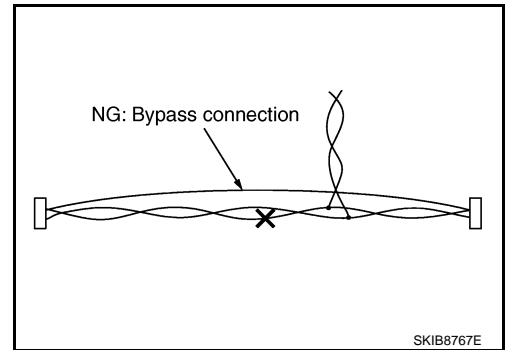

- Replace the applicable harness as an assembly if error is detected on the shield lines of CAN communication line.

A  
B  
C  
D  
E  
F  
G  
H  
I  
J  
K  
L

LAN

N  
O  
P

# BASIC INSPECTION

## DIAGNOSIS AND REPAIR WORKFLOW

### Interview Sheet

INFOID:000000005655391

#### CAN Communication System Diagnosis Interview Sheet

Date received:

Type:

VIN No.:

Model:

First registration:

Mileage:

CAN system type:

Symptom (Results from interview with customer)

Condition at inspection

Error symptom : Present / Past

SKIB8898E

# CAN COMMUNICATION SYSTEM

[CAN]

< SYSTEM DESCRIPTION >

## SYSTEM DESCRIPTION

### CAN COMMUNICATION SYSTEM

#### CAN System Specification Chart

INFOID:000000005655392

Determine CAN system type from the following specification chart.

**NOTE:**

Refer to [LAN-18. "Trouble Diagnosis Procedure"](#) for how to use CAN system specification chart.

Body type	Coupe									
Axle	2WD							AWD		
Engine	VQ37VHR									
Transmission	M/T					A/T				
Brake control	VDC									
4WAS		×		×		×		×		
ICC system			×	×			×	×		×
CAN system type	1	2	3	4	5	6	7	8	9	10

×: Applicable

#### VEHICLE EQUIPMENT IDENTIFICATION INFORMATION

**NOTE:**

Check CAN system type from the vehicle shape and equipment.

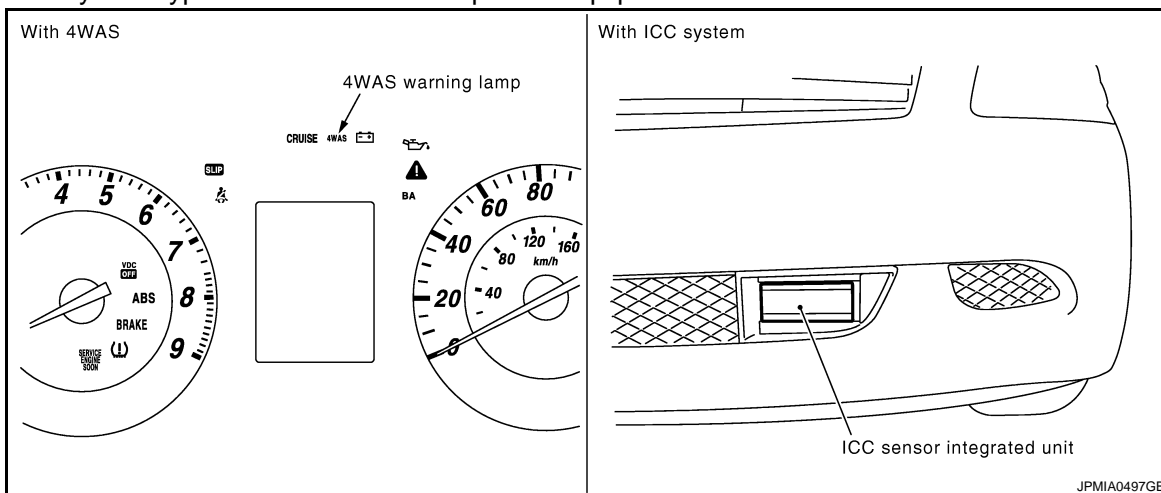

#### CAN Communication Signal Chart

INFOID:000000005655393

Refer to [LAN-17. "How to Use CAN Communication Signal Chart"](#) for how to use CAN communication signal chart.

**NOTE:**

Refer to [LAN-23. "Abbreviation List"](#) for the abbreviations of the connecting units.

T: Transmit R: Receive

Signal name/Connecting unit	ECM	BCM	M&A	STRG	4WD	AV	PSB	TCM	ADP	RAS	ABS	ICC	IPDM-E
A/C compressor request signal	T												R
Accelerator pedal position signal	T				R			R			R	R	
ASCD OD cancel request signal	T							R					
ASCD operation signal	T							R					
ASCD status signal	T		R										
ASCD SET indicator signal	T		R										

# CAN COMMUNICATION SYSTEM

< SYSTEM DESCRIPTION >

[CAN]

Signal name/Connecting unit	ECM	BCM	M&A	STRG	4WD	AV	PSB	TCM	ADP	RAS	ABS	ICC	IPDM-E
Closed throttle position signal	T							R				R	
Cooling fan speed request signal	T												R
Engine and A/T integrated control signal	T							R					
	R							T					
Engine coolant temperature signal	T		R										
Engine speed signal	T		R		R			R		R	R	R	
Engine status signal	T	R				R							
Fuel consumption monitor signal	T		R			R							
ICC brake switch signal	T											R	
ICC prohibition signal	T											R	
ICC steering switch signal	T											R	
Malfunctioning indicator lamp signal	T		R										
Park/neutral position switch signal*1	T											R	
Power generation command value signal	T												R
Snow mode switch signal	T										R	R	
	R		T										
Stop lamp switch signal	T											R	
					R						T	R	
		T						R					
Wide open throttle position signal	T							R					
Buzzer output signal		T	R										
			R									T	
Door switch signal		T	R						R				R
Door unlock signal		T							R				
Front fog light request signal		T	R										R
Front wiper request signal		T										R	R
High beam request signal		T	R										R
Horn reminder signal		T											R
Ignition switch ON signal		T											R
		R											T
Ignition switch signal		T							R				
Interlock/PNP switch signal		T											R
		R											T
Key ID signal		T							R				
Key switch signal		T							R				
Key warning lamp signal		T	R										
Low beam request signal		T											R
Low tire pressure warning lamp signal		T	R										
Meter display signal		T	R										
			R									T	
Oil pressure switch signal		T	R										
		R											T
Position light request signal		T	R										R

# CAN COMMUNICATION SYSTEM

< SYSTEM DESCRIPTION >

[CAN]

Signal name/Connecting unit	ECM	BCM	M&A	STRG	4WD	AV	PSB	TCM	ADP	RAS	ABS	ICC	IPDM-E	A
Rear window defogger control signal		T											R	A
	R	R				R							T	B
Sleep wake up signal		T	R						R				R	C
Starter control relay signal		T											R	D
Starter relay status signal		R											T	E
		T											R	F
Starting mode signal		T							R					G
Steering lock relay signal		R											T	H
		T											R	I
System setting signal		R				T								J
		T				R								K
Theft warning horn request signal		T											R	L
Trunk switch signal		T	R											LAN
Turn indicator signal		T	R											N
A/C evaporator temperature signal	R		T											O
A/C switch signal	R		T											P
A/C switch/indicator signal			R			T								
			T			R								
Blower fan motor switch signal	R		T											
Distance to empty signal			T			R								
Fuel level low warning signal			T			R								
Fuel level sensor signal	R		T											
Manual mode shift down signal			T					R						
Manual mode shift up signal			T					R						
Manual mode signal			T					R						
Non-manual mode signal			T					R						
Odometer signal		R	T											
Paddle shifter shift down signal <sup>*2</sup>			T					R						
Paddle shifter shift up signal <sup>*2</sup>			T					R						
Parking brake switch signal		R	T		R									
Seat belt buckle switch signal		R	T											
Sleep-ready signal		R	T											
		R											T	
Target A/C evaporator temperature signal	R		T											
Vehicle speed signal	R	R	T			R	R	R	R				R	
		R	R		R					R	T	R		
Wake up signal		R	T											
Steering angle sensor signal				T		R				R	R			
AWD signal					T						R			
AWD warning lamp signal			R		T									
A/C switch operation signal			R			T								
Rear window defogger switch signal		R				T								

# CAN COMMUNICATION SYSTEM

< SYSTEM DESCRIPTION >

[CAN]

Signal name/Connecting unit	ECM	BCM	M&A	STRG	4WD	AV	PSB	TCM	ADP	RAS	ABS	ICC	IPDM-E
Voice recognition signal*3			R			T							
A/T CHECK indicator lamp signal			R					T					
A/T self-diagnosis signal	R							T					
Current gear position signal								T			R	R	
Input speed signal	R							T				R	
Manual mode indicator signal			R					T					
N range signal		R						T					
Output shaft revolution signal	R							T				R	
P range signal		R						T			R		
Shift position signal			R				R*4	T	R		R	R	
4WAS signal										T	R		
4WAS warning lamp signal			R							T			
A/T shift schedule change demand signal								R			T		
ABS malfunction signal											T	R	
ABS operation signal								R			T	R	
ABS warning lamp signal			R								T		
Brake pressure control signal											T	R	
Brake warning lamp signal			R								T		
Side G sensor signal								R			T		
SLIP indicator lamp signal			R								T		
TCS gear keep request signal								R			T		
TCS malfunction signal											T	R	
TCS operation signal											T	R	
VDC malfunction signal								R			T	R	
VDC OFF indicator lamp signal			R								T		
VDC OFF switch signal											T	R	
VDC operation signal											T	R	
Deceleration degree commandment value signal											R	T	
ICC operation signal	R											T	
ICC warning lamp signal			R									T	
A/C compressor feedback signal	R		R										T
Detention switch signal		R							R				T
Front wiper stop position signal		R											T
High beam status signal	R												T
Hood switch signal		R											T
Low beam status signal	R												T
Push-button ignition switch status signal		R											T
Steering lock unit status signal		R											T

\*1: M/T models only

\*2: Models with paddle shifter

\*3: Models with navigation system

\*4: Receive reverse position signal only

**NOTE:**

# CAN COMMUNICATION SYSTEM

< SYSTEM DESCRIPTION >

[CAN]

CAN data of the air bag diagnosis sensor unit is not used by usual service work, thus it is omitted.

A

B

C

D

E

F

G

H

I

J

K

L

**LAN**

N

O

P

## DTC/CIRCUIT DIAGNOSIS

### CAN COMMUNICATION SYSTEM

#### Component Parts Location

INFOID:000000005655394

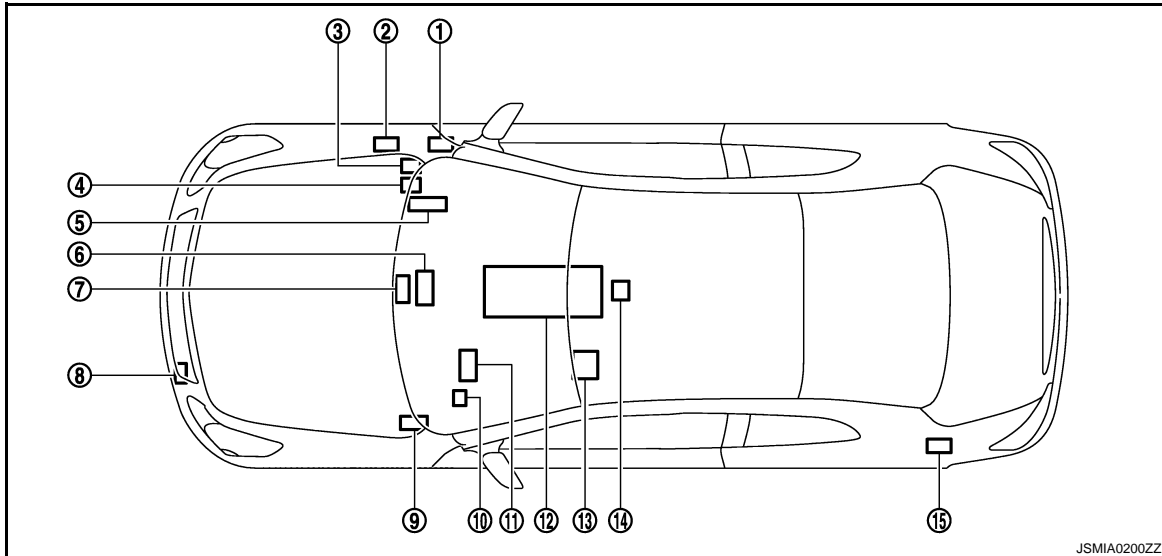

JSMIA0200ZZ

- |                                   |  |  |
|-----------------------------------|--|--|
| 1. BCM M122                       | 2. IPDM E/R E6                         | 3. Pre-crash seat belt control unit M110   |
| 4. AWD control unit F108          | 5. ECM M107                            | 6. AV control unit<br>M85: Without navigation system<br>(Without rear view monitor)<br>M204: Without navigation system<br>(With rear view monitor)<br>M210: With navigation system |
| 7. Unified meter and A/C amp. M67 | 8. ICC sensor integrated unit E67      | 9. ABS actuator and electric unit (control unit) E41   |
| 10. Data link connector M24       | 11. Steering angle sensor M37          | 12. A/T assembly F51   |
| 13. Driver seat control unit B503 | 14. Air bag diagnosis sensor unit M147 | 15. 4WAS main control unit B54   |







# CAN COMMUNICATION SYSTEM

< DTC/CIRCUIT DIAGNOSIS >

[CAN]

## CAN SYSTEM

Connector No.	B1
Connector Name	WIRE TO WIRE
Connector Type	TH80FW-CS16-TM4

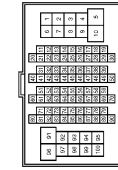

Terminal No.	Color of Wire	Signal Name [Specification]
1	BG	-
2	G	-
3	W	-
5	Y	-
6	SB	-
7	G	-
8	Y	-
9	GR	-
10	R	-
14	V	-
15	BR	-
16	LG	-
17	W	-
20	L	-
21	P	-
22	L	-
23	P	-
31	L	-
32	P	-
33	LG	-
34	Y	-
36	V	-
38	SB	-
37	SHIELD	-
38	W	-
40	BR	-
41	Y	-
42	SHIELD	-
43	P	-
44	L	-
45	SHIELD	-
46	R	-
47	G	-
48	SHIELD	-
48	SB	-
51	P	-
52	G	-
53	GR	-

Connector No.	B11
Connector Name	WIRE TO WIRE
Connector Type	NS18FW-CS

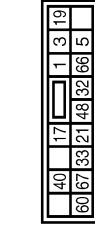

Terminal No.	Color of Wire	Signal Name [Specification]
1	W	-
3	L	-
5	V	-
17	LG	-
19	P	-
21	V	-
32	B	-
33	SB	-
40	BR	-
48	B	-
60	G	-
66	Y	-
67	GR	-

Connector No.	B54
Connector Name	4WS MAIN CONTROL UNIT
Connector Type	A38FW-M4



Terminal No.	Color of Wire	Signal Name [Specification]
1	L	CAN-H
4	BR	R-ANG GND
5	W	R-ANG VCC
7	R	R-ANG SUB SIG
8	P	CAN-L
15	G	R-ANG MAIN SIG
22	GR	STOP LAMP
25	SB	R-MTR RLY
27	V	IGN

31	BR	CAN-H
32	Y	CAN-L
34	B	GND
36	LG	P/S SOL
37	P	R-MTR PMR SUPPLY
38	Y	R-MTR (RH)
39	G	R-MTR (LH)
40	B	R-MTR GND

Connector No.	B501
Connector Name	WIRE TO WIRE
Connector Type	NS12MMF-CS

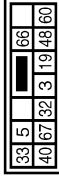

Terminal No.	Color of Wire	Signal Name [Specification]
3	R/Y	-
5	L	-
19	V	-
32	B/W	-
33	R	-
40	R/W	-
48	B	-
60	Y	-
66	B	-
67	W	-

A  
B  
C  
D  
E  
F  
G  
H  
I  
J  
K  
L  
N  
O  
P

LAN

# CAN COMMUNICATION SYSTEM

< DTC/CIRCUIT DIAGNOSIS >

[CAN]

## CAN SYSTEM

Connector No.	B502
Connector Name	WIRE TO WIRE
Connector Type	HS16MW-CS



19	3	1	17	40
5	66	32	48	21
33	67	60		

Terminal No.	Color of Wire	Signal Name [Specification]
1	L/W	-
3	R/Y	-
5	L	-
17	Y/R	-
19	V	-
21	L/Y	-
32	B/W	-
33	R	-
40	R/W	-
48	B	-
60	Y	-
66	B	-
67	W	-

Connector No.	B503
Connector Name	DRIVER SEAT CONTROL UNIT
Connector Type	THR2FW



1	3	4	5	8	9	10	11	12	13	14	16
17	18	21	24	25	26	27	28	29	30	31	32

Terminal No.	Color of Wire	Signal Name [Specification]
1	L/W	RX
3	R/Y	CAN-H
4	O/B	SLIDING LIMIT SW
5	L	BUCKLE SW
8	L/Y	P RANGE SW
9	W/G	PULSE (RECLINING)
10	P/B	PULSE (RR LIFTING)
11	BR	SLIDING SW (BACKWARD)
12	SB	RECLINING SW (BACKWARD)

13	L/G/R	FRONT LIFTING SW (DOWNWARD)
14	G/B	REAR LIFTING SW (DOWNWARD)
16	O	VCC
17	Y/R	TX
19	L/Y	CAN-L
21	L/Y	P RANGE SW
24	R	PULSE (SLIDING)
25	Y/B	PULSE (FR LIFTING)
26	Y	SLIDING SW (FORWARD)
27	R/G	RECLINING SW (FORWARD)
28	W/B	FRONT LIFTING SW (UPWARD)
29	P/L	REAR LIFTING SW (UPWARD)
30	P	POWER WALK-IN SW
31	GR	SENSOR GND
32	B/W	GND (SIGNAL)

Connector No.	E6
Connector Name	ENGINE INTELLIGENT POWER DISTRIBUTION MODULE (ENGINE ROOM)
Connector Type	THR6FW-NH



42	41	40	39
46	45	44	43

Terminal No.	Color of Wire	Signal Name [Specification]
39	P	-
40	L	-
41	B/W	-
42	Y	-
43	SB	-
44	LG	-
45	G	-
46	W	-

Connector No.	E41
Connector Name	ABS ACTUATOR AND ELECTRIC UNIT (CONTROL UNIT)
Connector Type	EAM4FB-A1Z4-LH



1	2	3	4	5	6	7	8	9	10	11	12	13	14	15	16	17	18	19	20	21	22	23	24	25	26	27	28	29	30	31	32	33	34	35	36	37	38	39	40	41	42	43	44	45	46	47	48	49	50	51	52	53	54	55	56	57	58	59	60	61	62	63	64	65	66	67	68	69	70	71	72	73	74	75	76	77	78	79	80	81	82	83	84	85	86	87	88	89	90	91	92	93	94	95	96	97	98	99	100
---	---	---	---	---	---	---	---	---	----	----	----	----	----	----	----	----	----	----	----	----	----	----	----	----	----	----	----	----	----	----	----	----	----	----	----	----	----	----	----	----	----	----	----	----	----	----	----	----	----	----	----	----	----	----	----	----	----	----	----	----	----	----	----	----	----	----	----	----	----	----	----	----	----	----	----	----	----	----	----	----	----	----	----	----	----	----	----	----	----	----	----	----	----	----	----	----	----	----	-----

Terminal No.	Color of Wire	Signal Name [Specification]
1	B	GND
2	L	UBMR
3	R	UBVR
4	B	GND
5	Y	DS FL
6	BG	DP RL
7	BR	DP RR
9	B	DP FR
10	W	DS FR
11	V	DIAG-K
14	P	CAN-L
25	Y	BUS-L
26	LG	DP FL
27	GR	DS RL
28	G	LZ
29	P	DS RR
30	SB	BLS
31	R	ESP OFF SWITCH
35	L	CAN-H
45	B	BUS-H

Connector No.	E67
Connector Name	ICC SENSOR INTEGRATED UNIT
Connector Type	RS08FB-PR



1	2	3
4	5	6

Terminal No.	Color of Wire	Signal Name [Specification]
1	R	IGNITION
2	V	BRAKE HOLD RELAY DRIVE SIGNAL

# CAN COMMUNICATION SYSTEM

< DTC/CIRCUIT DIAGNOSIS >

[CAN]

## CAN SYSTEM

Connector No.	E106
Connector Name	WIRE TO WIRE
Connector Type	TH80FW-CS16-TM4

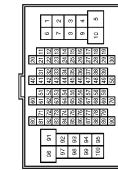

Terminal No.	Color of Wire	Signal Name [Specification]
1	GR	-
2	GR	-
3	EG	-
4	EG	-
5	G	-
6	EG	-
7	LG	-
8	BR	-
9	BR	-
10	W	-
11	V	-
12	R	-
13	L	-
14	GR	-
15	P	-
16	W	-
17	V	-
18	EG	-
19	GR	-
20	LG	-
21	R	-
22	R	-
23	P	-
24	V	-
25	RR	-
26	RR	-
27	W	-
28	Y	-
29	R	-
30	B	-
31	G	-
32	G	-
33	SB	-
34	GR	-
35	EG	-
36	EG	-
37	Y	-
38	R	-
39	B	-
40	G	-
41	W	-
42	LG	-
43	SB	-
44	GR	-
45	EG	-
46	LG	-
47	V	-
48	P	-
49	L	-
50	B	-
51	R	-
52	LG	-
53	LG	-
54	LG	-
55	B	-
56	R	-
57	Y	-
58	R	-
59	B	-
60	LG	-

67	SR	-
68	R	-
69	W	-
70	G	-
71	W	-
72	W	-
73	P	-
74	G	-
75	V	-
76	L	-
77	EG	-
78	EG	-
79	Y	-
80	GR	-
81	GR	-
82	W	-
83	GR	-
84	G	-
85	Y	-
86	EG	-
87	EG	-
88	GR	-
89	W	-
90	G	-
91	G	-
92	GR	-
93	GR	-
94	Y	-
95	Y	-
96	Y	-
97	BR	-
98	BR	-
99	SHIELD	-
100	P	-

Connector No.	FS1
Connector Name	A/T ASSEMBLY
Connector Type	RK1DFG-DGY

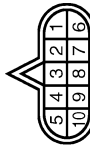

Terminal No.	Color of Wire	Signal Name [Specification]
1	Y	-
2	R	-
3	L	-
4	V	-
5	B	-
6	G	-
7	R	-
8	P	-
9	GR	-
10	B	-

Connector No.	F103
Connector Name	WIRE TO WIRE
Connector Type	TK38FW-NS10



Terminal No.	Color of Wire	Signal Name [Specification]
2	G	-
3	W	-
4	R	-
5	B	-
6	Y	-
7	Y	-
8	Y	-
9	Y	-
10	GR	-
11	O	-
12	Y	-
13	B	-
14	B	-
15	LG	-
16	R	-
17	R	-
18	B	-
19	B	-
20	L	-
21	L	-
22	L	-
23	L	-
24	L	-
25	L	-
26	L	-
27	L	-
28	L	-
29	L	-
30	R	-
31	R	-
32	R	-
33	B	-
34	B	-
35	L	-
36	P	-
37	Y	-
38	G	-
39	O	-
40	BR	-
41	BR	-
42	BR	-
43	P	-
44	L	-
45	G	-
46	V	-

Connector No.	F108
Connector Name	AWD CONTROL UNIT
Connector Type	TH18FW-AH

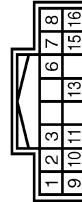

Terminal No.	Color of Wire	Signal Name [Specification]
1	BR	AWD SOL (+)
2	Y	AWD SOL (-)
3	W	OIL TEMP (+)
4	G	IGN
5	L	CAN-H
6	O	AWD SOL BAT
7	B	GND
8	B	GND
9	B	GND
10	B	GND
11	B	GND
12	B	GND
13	LG	OIL TEMP (+)
14	Y	VB
15	Y	VB
16	P	CAN-L

Connector No.	F157
Connector Name	TOM (TRANSMISSION CONTROL MODULE)
Connector Type	SP10FG

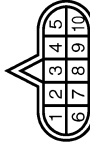

Terminal No.	Color of Wire	Signal Name [Specification]
1	W	VIGN
2	B	BATT
3	R	CAN-H
4	O	K-LINE
5	G	GND
6	GR	VIGN
7	L	REV LAMP RLY
8	BR	CAN-L
9	Y	STARTERLY
10	W/B	GND

A  
B  
C  
D  
E  
F  
G  
H  
I  
J  
K  
L  
LAN  
N  
O  
P

# CAN COMMUNICATION SYSTEM

< DTC/CIRCUIT DIAGNOSIS >

[CAN]

## CAN SYSTEM

Connector No.	M5
Connector Name	WIRE TO WIRE
Connector Type	TH80MW-CS16-TM4



Terminal No.	Color of Wire	Signal Name [Specification]
1	BG	-
3	R	-
5	G	-
6	L	-
7	W	-
10	W	-
11	V	-
12	R	-
13	L	-
14	GR	-
15	P	-
16	W	-
17	BR	-
18	BG	-
19	L	-
20	L	-
30	R	-
31	SB	-
32	Y	-
33	BG	-
34	R	-
35	BR	-
36	SB	-
37	Y	-
38	LG	-
39	SB	-
40	P	-
41	W	-
42	LG	-
43	R	-
44	Y	- [With A/T]
44	P	- [With M/T]
45	BG	-
46	G	-
47	V	-
48	P	-
48	L	-
58	B	-

66	GR	-
67	P	-
68	L	-
68	W	-
70	BR	-
80	L	-
81	R	-
82	V	-
83	W	-
84	L	-
85	BG	-
86	W	-
87	G	-
88	B	-
89	SB	-
91	L	-
93	Y	-
95	Y	-
96	R	-
97	P	-
98	SHIELD	-
99	V	-
100	SB	-

Connector No. M7

Connector Name WIRE TO WIRE

Connector Type TH80MW-CS16-TM4

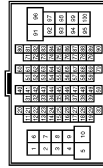

Terminal No.	Color of Wire	Signal Name [Specification]
1	BG	-
2	LG	-
3	BG	-
5	Y	-
6	P	-
7	G	-
8	L	-
9	V	-
10	R	-
14	R	-
15	BR	-
16	P	-
17	V	-

20	L	-
21	P	-
22	L	-
22	P	-
31	L	-
32	P	-
33	LG	-
34	SB	-
35	V	-
38	LG	-
37	SHIELD	-
38	GR	-
40	BR	-
41	Y	-
42	SHIELD	-
43	O	-
44	W	-
45	B	-
46	L	-
47	R	-
47	G	-
48	SHIELD	-
48	SB	-
51	W	-
52	B	-
53	SB	-
54	V	-
55	Y	-
56	L	-
57	W	-
58	BG	-
60	L	-
61	G	-
62	B	-
63	G	-
64	R	-
65	W	-
66	W	-
68	Y	-
87	SHIELD	-
71	R	-
72	LG	-
73	SB	-
74	V	-
75	LG	-
76	P	-
80	P	-
81	W	-
82	BR	-
95	BG	-

Connector No.	M24
Connector Name	DATA LINK CONNECTOR
Connector Type	BD16FW-P

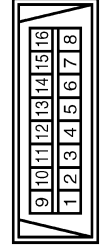

Terminal No.	Color of Wire	Signal Name [Specification]
3	LG	-
4	B	-
5	B	-
6	L	-
7	V	-
8	LG	-
11	SB	-
14	P	-
16	Y	-

Connector No. M27

Connector Name STEERING ANGLE SENSOR

Connector Type TH80RFW-NH

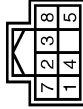

Terminal No.	Color of Wire	Signal Name [Specification]
1	L	CAN-H
2	P	CAN-L
7	B	GND
8	G	IGN

# CAN COMMUNICATION SYSTEM

< DTC/CIRCUIT DIAGNOSIS >

[CAN]

## CAN SYSTEM

Connector No.	M87
Connector Name	UNIFIED METER AND A/C AMP.
Connector Type	TH22FV-NH

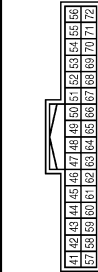

Terminal No.	Color of Wire	Signal Name [Specification]
41	L	ACC POWER SUPPLY
42	BR	FUEL LEVEL SENSOR SIGNAL
43	V	INTAKE SENSOR SIGNAL
44	LG	IN-VEHICLE SENSOR SIGNAL
45	V	AMBIENT SENSOR SIGNAL
46	GR	SUNLOAD SENSOR SIGNAL
47	W	GAS SENSOR SIGNAL
53	G	IGNITION POWER SUPPLY
54	Y	BATTERY POWER SUPPLY
55	B	GROUND
56	L	CAN-H
57	LG	BRAKE FLUID LEVEL SWITCH
58	P	FUEL LEVEL SENSOR GROUND
59	Y	INTAKE SENSOR GROUND
60	W	IN-VEHICLE SENSOR GROUND
61	R	AMBIENT SENSOR GROUND
62	SB	SUNLOAD SENSOR GROUND
63	L	ION CONTROL MODE OUTPUT SIGNAL
65	BG	ECV SIGNAL
68	P	A/C LAN SIGNAL
70	R	EACH DOOR MOTOR POWER SUPPLY
71	GR	GROUND
72	P	CAN-L

Connector No.	M85
Connector Name	AV CONTROL UNIT
Connector Type	TH22FV-NH

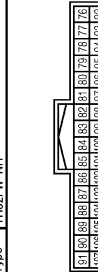

Terminal No.	Color of Wire	Signal Name [Specification]
85	B	GND
86	L	CAN-H
87	P	AV COMM (H)
88	SB	AV COMM (L)
89	LG	AV COMM (H)
90	SB	AV COMM (L)
91	LG	AV COMM (L)
95	R	AUX SOUND SIGNAL RH (+)
96	W	AUX SOUND SIGNAL LH (+)
97	B	AUX SOUND SIGNAL GND
101	BR	SW GND
103	LG	EJECT SIGNAL
104	R	IGNITION
105	BG	REVERSE
106	SB	PARKING BRAKE
107	GR	VEHICLE SPEED (6-PUL SE)

Connector No.	M107
Connector Name	ECM
Connector Type	RH24FY-RZ6-R-LH-Z

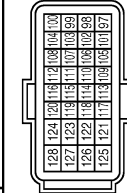

Terminal No.	Color of Wire	Signal Name [Specification]
97	R	APS 1
98	P	APS 2
99	L	AVCC 1-APS 1
100	W	GND-APS 1
101	SB	ASCSW
102	W	FTPRS
103	GR	AVCC 2-APS 2
104	V	GND-APS 2
105	L	PDPRESS
106	W	TF
107	BG	AVCC-PDPRES
108	Y	GND ASCDSW
109	G	NEUT-H
110	R	TACHO
112	L	GND-PDPRES
113	P	VEH-CAN-L1
114	L	VEH-CAN-H1
117	V	KLINE

Terminal No.	Color of Wire	Signal Name [Specification]
121	LG	QDGV
122	P	BRAKE
123	B	GND
124	B	GND
125	R	NER
126	BR	ENCSW
127	B	GND
128	B	GND

Connector No.	M110
Connector Name	PRE-CRASH SEAT BELT CONTROL UNIT
Connector Type	TH20FW-TB6

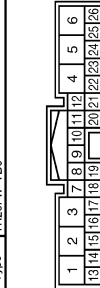

Terminal No.	Color of Wire	Signal Name [Specification]
1	Y	MOTOR (RH) (RELEASE)
2	W	+B
3	R	MOTOR (RH) (FASTEN)
4	Y	MOTOR (LH) (FASTEN)
5	W	GND (DRIVE)
6	R	MOTOR (LH) (RELEASE)
7	Y	INDICATOR
8	LG	BUCKLE SW RH
10	SB	BUCKLE SW LH
13	W	IGN
16	W	SENS OUTPUT 1
18	L	SENS POWER
20	BR	SENS OUTPUT 2
21	B	SENS GND
22	P	CAN-L
24	L	CAN-H
28	B	GND (CONT)

Connector No.	M116
Connector Name	WIRE TO WIRE
Connector Type	TK36MF-NS10

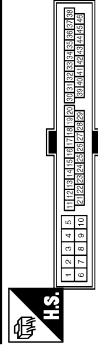

Terminal No.	Color of Wire	Signal Name [Specification]
2	W	-
3	BG	-
4	P	-
5	B	-
9	R	-
10	R	-
19	BG	-
20	Y	-
28	B	-
29	LG	-
30	BR	-
31	W	-
33	B	-
34	B	-
35	L	-
36	P	-
37	V	-
38	SB	-
41	BG	-
42	G	-
43	P	-
44	L	-
45	Y	-
46	V	-

A  
B  
C  
D  
E  
F  
G  
H  
I  
J  
K  
L  
N  
O  
P



# CAN COMMUNICATION SYSTEM

< DTC/CIRCUIT DIAGNOSIS >

[CAN]

## CAN SYSTEM

Connector No.	M122
Connector Name	BCM (BODY CONTROL MODULE)
Connector Type	TH40FB-NH

20	21	22	23	24	25	26	27	28	29	30	31	32	33	34	35	36	37	38	39	40	41	42	43	44	45	46	47	48	49	50	51	52	53	54	55	56	57	58	59	60	61	62	63	64	65	66	67	68	69	70	71	72	73	74	75	76	77	78	79	80	81	82	83	84	85	86	87	88	89	90	91	92	93	94	95	96	97	98	99	100	101	102	103	104	105	106	107	108	109	110	111				
16	17	18	19	20	21	22	23	24	25	26	27	28	29	30	31	32	33	34	35	36	37	38	39	40	41	42	43	44	45	46	47	48	49	50	51	52	53	54	55	56	57	58	59	60	61	62	63	64	65	66	67	68	69	70	71	72	73	74	75	76	77	78	79	80	81	82	83	84	85	86	87	88	89	90	91	92	93	94	95	96	97	98	99	100	101	102	103	104	105	106	107	108	109	110	111

Terminal No.	Color of Wire	Signal Name [Specification]
72	R	ROOM ANT 2-
73	G	ROOM ANT 2+
74	SB	PASSENGER DOOR ANT-
75	BR	PASSENGER DOOR ANT+
76	V	DRIVER DOOR ANT-
77	LG	DRIVER DOOR ANT+
78	Y	ROOM ANT 1-
79	BR	ROOM ANT 1+
80	GR	NATS ANT AMP
81	W	NATS ANT AMP
82	V	IGN RELAY (F/B) CONT
83	Y	KEYLESS ENTRY RECEIVER COMM
87	Y	COMBI SW INPUT 5
88	GR	COMBI SW INPUT 3
89	BR	PUSH SW
90	P	CAN-L
91	L	CAN-H
92	LG	KEY SLOT ILL
93	GR	ON IND
95	BG	ACC RELAY CONT
96	GR	A/T SHIFT SELECTOR POWER SUPPLY
97	L	S/L CONDITION 1
98	BG	S/L CONDITION 2
99	P	SHIFT P. [W/O A/T]
99	R	ICC CLUTCH SW [M/T models with ICC]
99	R	ASCD CLUTCH SW [M/T models without ICC]
100	Y	PASSENGER DOOR REQUEST SW
101	R	DRIVER DOOR REQUEST SW
102	BG	BLOWER FAN MOTOR RELAY CONT
103	LG	KEYLESS ENTRY RECEIVER POWER SUPPLY
106	W	S/L UNIT POWER SUPPLY
107	LG	COMBI SW INPUT 1
108	R	COMBI SW INPUT 4
109	W	COMBI SW INPUT 2
110	G	HAZARD SW
111	Y	S/L UNIT COMM

Connector No.	M147
Connector Name	AIR BAG DIAGNOSIS SENSOR UNIT
Connector Type	TH28FY-EX-SC

20	21	22	23	24	25	26	27	28	29	30	31	32	33	34	35	36	37	38	39	40	41	42	43	44	45	46	47	48	49	50	51	52	53	54	55	56	57	58	59	60	61	62	63	64	65	66	67	68	69	70	71	72	73	74	75	76	77	78	79	80	81	82	83	84	85	86	87	88	89	90	91	92	93	94	95	96	97	98	99	100	101	102	103	104	105	106	107	108	109	110	111				
16	17	18	19	20	21	22	23	24	25	26	27	28	29	30	31	32	33	34	35	36	37	38	39	40	41	42	43	44	45	46	47	48	49	50	51	52	53	54	55	56	57	58	59	60	61	62	63	64	65	66	67	68	69	70	71	72	73	74	75	76	77	78	79	80	81	82	83	84	85	86	87	88	89	90	91	92	93	94	95	96	97	98	99	100	101	102	103	104	105	106	107	108	109	110	111

Terminal No.	Color of Wire	Signal Name [Specification]
1	LG	IGN
2	B	GND
3	Y	DRL (-)
4	Y	DR 1 (-) DR 2 (-)
5	Y	AST (-)
6	Y	AST (+)
11	SB	EGZS (-)
12	V	EGZS (+)
15	LG	AIR BAG W/L
16	SHIELD	GND
18	R	GUT/OFF TELLTALE
21	L	CAN-H
24	G	SEAT BELT
45	Y	DR 2 (+)
46	P	CAN-L
47	Y	AS 2 (+)
48	Y	AS 2 (-)
49	L	ODS INPUT

Connector No.	M204
Connector Name	AV CONTROL UNIT
Connector Type	TH432FH-NH

76	77	78	79	80	81	82	83	84	85	86	87	88	89	90	91	92	93	94	95	96	97	98	99	100	101	102	103	104	105	106	107	108	109	110	111																																																												
16	17	18	19	20	21	22	23	24	25	26	27	28	29	30	31	32	33	34	35	36	37	38	39	40	41	42	43	44	45	46	47	48	49	50	51	52	53	54	55	56	57	58	59	60	61	62	63	64	65	66	67	68	69	70	71	72	73	74	75	76	77	78	79	80	81	82	83	84	85	86	87	88	89	90	91	92	93	94	95	96	97	98	99	100	101	102	103	104	105	106	107	108	109	110	111

Terminal No.	Color of Wire	Signal Name [Specification]
76	LG	AV COMM (L)
77	SB	AV COMM (H)
78	LG	AV COMM (L)
79	SB	AV COMM (H)

80	P	CAN-L
81	L	CAN-H
82	BR	SW GND
86	SHIELD	SHIELD
87	L	TEL VOICE SIGNAL (+)
88	P	TEL VOICE SIGNAL (-)
92	GR	VEHICLE SPEED (8-PULSE)
93	SB	PARKING BRAKE
94	BG	REVERSE
95	R	IGNITION
96	LG	DISK EJECT SIGNAL

Connector No.	M210
Connector Name	AV CONTROL UNIT
Connector Type	TH432FW-NH

61	62	63	64	65	66	67	68	69	70	71	72	73	74	75	76	77	78	79	80	81	82	83	84	85	86	87	88	89	90	91	92	93	94	95	96	97	98	99	100	101	102	103	104	105	106	107	108	109	110	111																																													
16	17	18	19	20	21	22	23	24	25	26	27	28	29	30	31	32	33	34	35	36	37	38	39	40	41	42	43	44	45	46	47	48	49	50	51	52	53	54	55	56	57	58	59	60	61	62	63	64	65	66	67	68	69	70	71	72	73	74	75	76	77	78	79	80	81	82	83	84	85	86	87	88	89	90	91	92	93	94	95	96	97	98	99	100	101	102	103	104	105	106	107	108	109	110	111

Terminal No.	Color of Wire	Signal Name [Specification]
65	SB	PARKING BRAKE
67	Y	COMPOSITE IMAGE SIGNAL GND
68	BR	COMPOSITE IMAGE SIGNAL
71	SHIELD	MICROPHONE GND
72	G	MICROPHONE VCC
73	LG	COMM (CONT->DISP)
74	P	CAN-L
75	LG	AV COMM (L)
76	LG	AV COMM (L)
78	L	ILLUMINATION
80	R	IGNITION
81	BG	REVERSE
82	GR	VEHICLE SPEED (8-PULSE)
83	SHIELD	SHIELD
87	R	MICROPHONE SIGNAL
88	B	SHIELD
89	L	COMM (DISP->CONT)
90	L	CAN-H
91	SB	AV COMM (H)
92	SB	AV COMM (H)



# MALFUNCTION AREA CHART

< DTC/CIRCUIT DIAGNOSIS >

[CAN]

## MALFUNCTION AREA CHART

### Main Line

INFOID:000000005655396

Malfunction area	Reference
Main line between data link connector and AV control unit	<a href="#">LAN-42, "Diagnosis Procedure"</a>
Main line between AV control unit and driver seat control unit	<a href="#">LAN-43, "Diagnosis Procedure"</a>
Main line between driver seat control unit and ABS actuator and electric unit (control unit)	<a href="#">LAN-44, "Diagnosis Procedure"</a>
Main line between driver seat control unit and 4WAS main control unit	<a href="#">LAN-46, "Diagnosis Procedure"</a>
Main line between 4WAS main control unit and ABS actuator and electric unit (control unit)	<a href="#">LAN-47, "Diagnosis Procedure"</a>

### Branch Line

INFOID:000000005655397

Malfunction area	Reference
ECM branch line circuit	<a href="#">LAN-49, "Diagnosis Procedure"</a>
Air bag diagnosis sensor unit branch line circuit	<a href="#">LAN-50, "Diagnosis Procedure"</a>
BCM branch line circuit	<a href="#">LAN-51, "Diagnosis Procedure"</a>
Data link connector branch line circuit	<a href="#">LAN-52, "Diagnosis Procedure"</a>
Unified meter and A/C amp. branch line circuit	<a href="#">LAN-53, "Diagnosis Procedure"</a>
Steering angle sensor branch line circuit	<a href="#">LAN-54, "Diagnosis Procedure"</a>
AWD control unit branch line circuit	<a href="#">LAN-55, "Diagnosis Procedure"</a>
AV control unit branch line circuit	<a href="#">LAN-56, "Diagnosis Procedure"</a>
Pre-crash seat belt control unit	<a href="#">LAN-57, "Diagnosis Procedure"</a>
TCM branch line circuit	<a href="#">LAN-58, "Diagnosis Procedure"</a>
Driver seat control unit branch line circuit	<a href="#">LAN-59, "Diagnosis Procedure"</a>
4WAS main control unit branch line circuit	<a href="#">LAN-60, "Diagnosis Procedure"</a>
ABS actuator and electric unit (control unit) branch line circuit	<a href="#">LAN-61, "Diagnosis Procedure"</a>
ICC sensor integrated unit branch line circuit	<a href="#">LAN-62, "Diagnosis Procedure"</a>
IPDM E/R branch line circuit	<a href="#">LAN-63, "Diagnosis Procedure"</a>

### Short Circuit

INFOID:000000005655398

Malfunction area	Reference
CAN communication circuit	<a href="#">LAN-64, "Diagnosis Procedure"</a>

A  
B  
C  
D  
E  
F  
G  
H  
I  
J  
K  
L  
LAN  
N  
O  
P

# MAIN LINE BETWEEN DLC AND AV CIRCUIT

< DTC/CIRCUIT DIAGNOSIS >

[CAN]

## MAIN LINE BETWEEN DLC AND AV CIRCUIT

### Diagnosis Procedure

INFOID:000000005655399

#### 1. CHECK HARNESS CONTINUITY (OPEN CIRCUIT)

1. Turn the ignition switch OFF.
2. Disconnect the battery cable from the negative terminal.
3. Disconnect the following harness connectors.
  - ECM
  - AV control unit
4. Check the continuity between the data link connector and the AV control unit harness connector.
  - Without navigation system (Without rear view monitor)

Data link connector		AV control unit harness connector		Continuity
Connector No.	Terminal No.	Connector No.	Terminal No.	
M24	6	M85	86	Existed
	14		87	Existed

- Without navigation system (With rear view monitor)

Data link connector		AV control unit harness connector		Continuity
Connector No.	Terminal No.	Connector No.	Terminal No.	
M24	6	M204	81	Existed
	14		80	Existed

- With navigation system

Data link connector		AV control unit harness connector		Continuity
Connector No.	Terminal No.	Connector No.	Terminal No.	
M24	6	M210	90	Existed
	14		74	Existed

#### Is the inspection result normal?

YES (Present error)>>Check CAN system type decision again.

YES (Past error)>>Error was detected in the main line between the data link connector and the AV control unit.

NO >> Repair the main line between the data link connector and the AV control unit.

# MAIN LINE BETWEEN AV AND ADP CIRCUIT

< DTC/CIRCUIT DIAGNOSIS >

[CAN]

## MAIN LINE BETWEEN AV AND ADP CIRCUIT

### Diagnosis Procedure

INFOID:000000005655401

#### 1. CHECK CONNECTOR

1. Turn the ignition switch OFF.
2. Disconnect the battery cable from the negative terminal.
3. Check the following terminals and connectors for damage, bend and loose connection (connector side and harness side).
  - Harness connector M7
  - Harness connector B1

Is the inspection result normal?

YES >> GO TO 2.

NO >> Repair the terminal and connector.

#### 2. CHECK HARNESS CONTINUITY (OPEN CIRCUIT)

1. Disconnect the following harness connectors.
  - AV control unit
  - Harness connectors M7 and B1
2. Check the continuity between the AV control unit harness connector and harness connector.
  - Without navigation system (Without rear view monitor)

AV control unit harness connector		Harness connector		Continuity
Connector No.	Terminal No.	Connector No.	Terminal No.	
M85	86	M7	20	Existed
	87		21	Existed

- Without navigation system (With rear view monitor)

AV control unit harness connector		Harness connector		Continuity
Connector No.	Terminal No.	Connector No.	Terminal No.	
M204	81	M7	20	Existed
	80		21	Existed

- With navigation system

AV control unit harness connector		Harness connector		Continuity
Connector No.	Terminal No.	Connector No.	Terminal No.	
M210	90	M7	20	Existed
	74		21	Existed

Is the inspection result normal?

YES >> GO TO 3.

NO >> Repair the main line between the AV control unit and the harness connector M7.

#### 3. CHECK HARNESS CONTINUITY (OPEN CIRCUIT)

Check the continuity between the harness connector terminals.

Connector No.	Terminal No.		Continuity
B1	20	22	Existed
	21	23	Existed

Is the inspection result normal?

YES (Present error)>>Check CAN system type decision again.

YES (Past error)>>Error was detected in the main line between the AV control unit and the driver seat control unit.

NO >> Repair the main line between the harness connectors B1 and the driver seat control unit.

# MAIN LINE BETWEEN ADP AND ABS CIRCUIT

< DTC/CIRCUIT DIAGNOSIS >

[CAN]

## MAIN LINE BETWEEN ADP AND ABS CIRCUIT

### Diagnosis Procedure

INFOID:000000005655400

#### 1. CHECK CONNECTOR

1. Turn the ignition switch OFF.
2. Disconnect the battery cable from the negative terminal.
3. Check the following terminals and connectors for damage, bend and loose connection (connector side and harness side).
  - Harness connector B1
  - Harness connector M7
  - Harness connector M6
  - Harness connector E106

Is the inspection result normal?

YES >> GO TO 2.

NO >> Repair the terminal and connector.

#### 2. CHECK HARNESS CONTINUITY (OPEN CIRCUIT)

1. Disconnect the harness connectors B1 and M7.
2. Check the continuity between the harness connector terminals.

Connector No.	Terminal No.		Continuity
B1	20	22	Existed
	21	23	Existed

Is the inspection result normal?

YES >> GO TO 3.

NO >> Repair the main line between the driver seat control unit and the harness connector B1.

#### 3. CHECK HARNESS CONTINUITY (OPEN CIRCUIT)

1. Disconnect the harness connectors M6 and E106.
2. Check the continuity between the harness connectors.

Harness connector		Harness connector		Continuity
Connector No.	Terminal No.	Connector No.	Terminal No.	
M7	22	M6	49	Existed
	23		48	Existed

Is the inspection result normal?

YES >> GO TO 4.

NO >> Repair the main line between the harness connectors M7 and M6.

#### 4. CHECK HARNESS CONTINUITY (OPEN CIRCUIT)

1. Disconnect the connector of ABS actuator and electric unit (control unit).
2. Check the continuity between the harness connector and the ABS actuator and electric unit (control unit) harness connector.

Harness connector		ABS actuator and electric unit (control unit) harness connector		Continuity
Connector No.	Terminal No.	Connector No.	Terminal No.	
E106	49	E41	35	Existed
	48		14	Existed

Is the inspection result normal?

YES (Present error)>>Check CAN system type decision again.

YES (Past error)>>Error was detected in the main line between the driver seat control unit and the ABS actuator and electric unit (control unit).

# MAIN LINE BETWEEN ADP AND ABS CIRCUIT

< DTC/CIRCUIT DIAGNOSIS >

[CAN]

NO >> Repair the main line between the harness connector E106 and the ABS actuator and electric unit (control unit).

A

B

C

D

E

F

G

H

I

J

K

L

LAN

N

O

P

# MAIN LINE BETWEEN ADP AND RAS CIRCUIT

< DTC/CIRCUIT DIAGNOSIS >

[CAN]

## MAIN LINE BETWEEN ADP AND RAS CIRCUIT

### Diagnosis Procedure

INFOID:000000005655402

#### 1. CHECK HARNESS CONTINUITY (OPEN CIRCUIT)

1. Turn the ignition switch OFF.
2. Disconnect the battery cable from the negative terminal.
3. Disconnect the harness connectors M7 and B1.
4. Check the continuity between the harness connector terminals.

Connector No.	Terminal No.		Continuity
B1	20	22	Existed
	21	23	Existed

#### Is the inspection result normal?

YES (Present error)>>Check CAN system type decision again.

YES (Past error)>>Error was detected in the main line between the driver seat control unit and the 4WAS main control unit.

NO >> Repair the main line between the driver seat control unit and the 4WAS main control unit.

# MAIN LINE BETWEEN RAS AND ABS CIRCUIT

< DTC/CIRCUIT DIAGNOSIS >

[CAN]

## MAIN LINE BETWEEN RAS AND ABS CIRCUIT

### Diagnosis Procedure

INFOID:000000005655403

#### 1. CHECK CONNECTOR

1. Turn the ignition switch OFF.
2. Disconnect the battery cable from the negative terminal.
3. Check the following terminals and connectors for damage, bend and loose connection (connector side and harness side).
  - Harness connector B1
  - Harness connector M7
  - Harness connector M6
  - Harness connector E106

Is the inspection result normal?

YES >> GO TO 2.

NO >> Repair the terminal and connector.

#### 2. CHECK HARNESS CONTINUITY (OPEN CIRCUIT)

1. Disconnect the harness connectors B1 and M7.
2. Check the continuity between the harness connector terminals.

Connector No.	Terminal No.		Continuity
B1	20	22	Existed
	21	23	Existed

Is the inspection result normal?

YES >> GO TO 3.

NO >> Repair the main line between the 4WAS main control unit and the harness connector B1.

#### 3. CHECK HARNESS CONTINUITY (OPEN CIRCUIT)

1. Disconnect the harness connectors M6 and E106.
2. Check the continuity between the harness connectors.

Harness connector		Harness connector		Continuity
Connector No.	Terminal No.	Connector No.	Terminal No.	
M7	22	M6	49	Existed
	23		48	Existed

Is the inspection result normal?

YES >> GO TO 4.

NO >> Repair the main line between the harness connectors M7 and M6.

#### 4. CHECK HARNESS CONTINUITY (OPEN CIRCUIT)

1. Disconnect the connector of ABS actuator and electric unit (control unit).
2. Check the continuity between the harness connector and the ABS actuator and electric unit (control unit) harness connector.

Harness connector		ABS actuator and electric unit (control unit) harness connector		Continuity
Connector No.	Terminal No.	Connector No.	Terminal No.	
E106	49	E41	35	Existed
	48		14	Existed

Is the inspection result normal?

YES (Present error)>>Check CAN system type decision again.

YES (Past error)>>Error was detected in the main line between the 4WAS main control unit and the ABS actuator and electric unit (control unit).

## MAIN LINE BETWEEN RAS AND ABS CIRCUIT

< DTC/CIRCUIT DIAGNOSIS >

[CAN]

---

NO >> Repair the main line between the harness connector E106 and the ABS actuator and electric unit (control unit).



# ECM BRANCH LINE CIRCUIT

< DTC/CIRCUIT DIAGNOSIS >

[CAN]

## ECM BRANCH LINE CIRCUIT

### Diagnosis Procedure

INFOID:000000005655404

#### 1. CHECK CONNECTOR

1. Turn the ignition switch OFF.
2. Disconnect the battery cable from the negative terminal.
3. Check the terminals and connectors of the ECM for damage, bend and loose connection (unit side and connector side).

Is the inspection result normal?

- YES >> GO TO 2.  
NO >> Repair the terminal and connector.

#### 2. CHECK HARNESS FOR OPEN CIRCUIT

1. Disconnect the connector of ECM.
2. Check the resistance between the ECM harness connector terminals.

ECM harness connector			Resistance ( $\Omega$ )
Connector No.	Terminal No.		
M107	114	113	Approx. 108 – 132

Is the measurement value within the specification?

- YES >> GO TO 3.  
NO >> Repair the ECM branch line.

#### 3. CHECK POWER SUPPLY AND GROUND CIRCUIT

Check the power supply and the ground circuit of the ECM. Refer to [EC-152, "Diagnosis Procedure"](#).

Is the inspection result normal?

- YES (Present error)>>Replace the ECM. Refer to [EC-17, "ADDITIONAL SERVICE WHEN REPLACING CONTROL UNIT \(ECM\) : Special Repair Requirement"](#).  
YES (Past error)>>Error was detected in the ECM branch line.  
NO >> Repair the power supply and the ground circuit.

A  
B  
C  
D  
E  
F  
G  
H  
I  
J  
K  
L

LAN

N  
O  
P

# A-BAG BRANCH LINE CIRCUIT

< DTC/CIRCUIT DIAGNOSIS >

[CAN]

## A-BAG BRANCH LINE CIRCUIT

### Diagnosis Procedure

INFOID:000000005884780

#### **WARNING:**

- Before servicing, turn ignition switch OFF, disconnect battery negative terminal, and wait 3 minutes or more. (To discharge backup capacitor.)
- Never use unspecified tester or other measuring device.

#### **1**.CHECK CONNECTOR

---

1. Turn the ignition switch OFF.
2. Disconnect the battery cable from the negative terminal.
3. Check the terminals and connectors of the air bag diagnosis sensor unit for damage, bend and loose connection (unit side and connector side).

Is the inspection result normal?

YES >> GO TO 2.

NO >> Replace the terminal and connector.

#### **2**.CHECK AIR BAG DIAGNOSIS SENSOR UNIT

---

Check the air bag diagnosis sensor unit. Refer to [SRC-5, "Work Flow"](#).

Is the inspection result normal?

YES >> Replace the main harness.

NO >> Replace parts whose air bag system has a malfunction.

# BCM BRANCH LINE CIRCUIT

< DTC/CIRCUIT DIAGNOSIS >

[CAN]

## BCM BRANCH LINE CIRCUIT

### Diagnosis Procedure

INFOID:000000005655408

#### 1. CHECK CONNECTOR

1. Turn the ignition switch OFF.
2. Disconnect the battery cable from the negative terminal.
3. Check the terminals and connectors of the BCM for damage, bend and loose connection (unit side and connector side).

Is the inspection result normal?

- YES >> GO TO 2.  
NO >> Repair the terminal and connector.

#### 2. CHECK HARNESS FOR OPEN CIRCUIT

1. Disconnect the connector of BCM.
2. Check the resistance between the BCM harness connector terminals.

BCM harness connector			Resistance (Ω)
Connector No.	Terminal No.		
M122	91	90	Approx. 54 – 66

Is the measurement value within the specification?

- YES >> GO TO 3.  
NO >> Repair the BCM branch line.

#### 3. CHECK POWER SUPPLY AND GROUND CIRCUIT

Check the power supply and the ground circuit of the BCM. Refer to [BCS-37, "Diagnosis Procedure"](#).

Is the inspection result normal?

- YES (Present error)>>Replace the BCM. Refer to [BCS-78, "Exploded View"](#).  
YES (Past error)>>Error was detected in the BCM branch line.  
NO >> Repair the power supply and the ground circuit.

A  
B  
C  
D  
E  
F  
G  
H  
I  
J  
K  
L

LAN

N  
O  
P

# DLC BRANCH LINE CIRCUIT

< DTC/CIRCUIT DIAGNOSIS >

[CAN]

## DLC BRANCH LINE CIRCUIT

### Diagnosis Procedure

INFOID:000000005655412

#### 1. CHECK CONNECTOR

1. Turn the ignition switch OFF.
2. Disconnect the battery cable from the negative terminal.
3. Check the terminals and connectors of the data link connector for damage, bend and loose connection (connector side and harness side).

Is the inspection result normal?

- YES >> GO TO 2.  
NO >> Repair the terminal and connector.

#### 2. CHECK HARNESS FOR OPEN CIRCUIT

Check the resistance between the data link connector terminals.

Data link connector			Resistance ( $\Omega$ )
Connector No.	Terminal No.		
M24	6	14	Approx. 54 – 66

Is the measurement value within the specification?

- YES (Present error)>>Check CAN system type decision again.  
YES (Past error)>>Error was detected in the data link connector branch line circuit.  
NO >> Repair the data link connector branch line.

# M&A BRANCH LINE CIRCUIT

< DTC/CIRCUIT DIAGNOSIS >

[CAN]

## M&A BRANCH LINE CIRCUIT

### Diagnosis Procedure

INFOID:000000005655413

#### 1. CHECK CONNECTOR

1. Turn the ignition switch OFF.
2. Disconnect the battery cable from the negative terminal.
3. Check the terminals and connectors of the unified meter and A/C amp. for damage, bend and loose connection (unit side and connector side).

Is the inspection result normal?

- YES >> GO TO 2.  
NO >> Repair the terminal and connector.

#### 2. CHECK HARNESS FOR OPEN CIRCUIT

1. Disconnect the connector of unified meter and A/C amp.
2. Check the resistance between the unified meter and A/C amp. harness connector terminals.

Unified meter and A/C amp. harness connector			Resistance (Ω)
Connector No.	Terminal No.		
M67	56	72	Approx. 54 – 66

Is the measurement value within the specification?

- YES >> GO TO 3.  
NO >> Repair the unified meter and A/C amp. branch line.

#### 3. CHECK POWER SUPPLY AND GROUND CIRCUIT

Check the power supply and the ground circuit of the unified meter and A/C amp. Refer to [MWI-50, "UNIFIED METER AND A/C AMP. : Diagnosis Procedure"](#).

Is the inspection result normal?

- YES (Present error)>>Replace the unified meter and A/C amp. Refer to [MWI-130, "Exploded View"](#).  
YES (Past error)>>Error was detected in the unified meter and A/C amp. branch line.  
NO >> Repair the power supply and the ground circuit.

A  
B  
C  
D  
E  
F  
G  
H  
I  
J  
K  
L

LAN

N  
O  
P

# STRG BRANCH LINE CIRCUIT

< DTC/CIRCUIT DIAGNOSIS >

[CAN]

## STRG BRANCH LINE CIRCUIT

### Diagnosis Procedure

INFOID:000000005655414

#### 1. CHECK CONNECTOR

1. Turn the ignition switch OFF.
2. Disconnect the battery cable from the negative terminal.
3. Check the terminals and connectors of the steering angle sensor for damage, bend and loose connection (unit side and connector side).

Is the inspection result normal?

- YES >> GO TO 2.  
NO >> Repair the terminal and connector.

#### 2. CHECK HARNESS FOR OPEN CIRCUIT

1. Disconnect the connector of steering angle sensor.
2. Check the resistance between the steering angle sensor harness connector terminals.

Steering angle sensor harness connector			Resistance (Ω)
Connector No.	Terminal No.		
M37	1	2	Approx. 54 – 66

Is the measurement value within the specification?

- YES >> GO TO 3.  
NO >> Repair the steering angle sensor branch line.

#### 3. CHECK POWER SUPPLY AND GROUND CIRCUIT

Check the power supply and the ground circuit of the steering angle sensor. Refer to [BRC-83, "Wiring Diagram - BRAKE CONTROL SYSTEM -"](#).

Is the inspection result normal?

- YES (Present error)>>Replace the steering angle sensor. Refer to [BRC-108, "Exploded View"](#).  
YES (Past error)>>Error was detected in the steering angle sensor branch line.  
NO >> Repair the power supply and the ground circuit.

# 4WD BRANCH LINE CIRCUIT

< DTC/CIRCUIT DIAGNOSIS >

[CAN]

## 4WD BRANCH LINE CIRCUIT

### Diagnosis Procedure

INFOID:000000005655405

#### 1. CHECK CONNECTOR

1. Turn the ignition switch OFF.
2. Disconnect the battery cable from the negative terminal.
3. Check the following terminals and connectors for damage, bend and loose connection (unit side and connector side).
  - AWD control unit connector
  - Harness connector F103
  - Harness connector M116

Is the inspection result normal?

YES >> GO TO 2.

NO >> Repair the terminal and connector.

#### 2. CHECK HARNESS FOR OPEN CIRCUIT

1. Disconnect the connector of AWD control unit.
2. Check the resistance between the AWD control unit harness connector terminals.

AWD control unit harness connector			Resistance (Ω)
Connector No.	Terminal No.		
F108	8	16	Approx. 54 – 66

Is the measurement value within the specification?

YES >> GO TO 3.

NO >> Repair the AWD control unit branch line.

#### 3. CHECK POWER SUPPLY AND GROUND CIRCUIT

Check the power supply and the ground circuit of the AWD control unit. Refer to [DLN-27, "Diagnosis Procedure"](#).

Is the inspection result normal?

YES (Present error)>>Replace the AWD control unit. Refer to [DLN-55, "Exploded View"](#).

YES (Past error)>>Error was detected in the AWD control unit branch line.

NO >> Repair the power supply and the ground circuit.

A  
B  
C  
D  
E  
F  
G  
H  
I  
J  
K  
L

LAN

N  
O  
P

## AV BRANCH LINE CIRCUIT

### Diagnosis Procedure

INFOID:000000005655407

#### 1. CHECK CONNECTOR

1. Turn the ignition switch OFF.
2. Disconnect the battery cable from the negative terminal.
3. Check the terminals and connectors of the AV control unit for damage, bend and loose connection (unit side and connector side).

Is the inspection result normal?

- YES >> GO TO 2.  
 NO >> Repair the terminal and connector.

#### 2. CHECK HARNESS FOR OPEN CIRCUIT

1. Disconnect the connector of AV control unit.
2. Check the resistance between the AV control unit harness connector terminals.
  - Without navigation system (Without rear view monitor)

AV control unit harness connector			Resistance (Ω)
Connector No.	Terminal No.		
M85	86	87	Approx. 54 – 66

- Without navigation system (With rear view monitor)

AV control unit harness connector			Resistance (Ω)
Connector No.	Terminal No.		
M204	81	80	Approx. 54 – 66

- With navigation system

AV control unit harness connector			Resistance (Ω)
Connector No.	Terminal No.		
M210	90	74	Approx. 54 – 66

Is the measurement value within the specification?

- YES >> GO TO 3.  
 NO >> Repair the AV control unit branch line.

#### 3. CHECK POWER SUPPLY AND GROUND CIRCUIT

Check the power supply and the ground circuit of the AV control unit. Refer to the following.

- Base audio without rear view camera: [AV-40, "AV CONTROL UNIT : Diagnosis Procedure"](#)
- Base audio with rear view camera: [AV-172, "AV CONTROL UNIT : Diagnosis Procedure"](#)
- BOSE audio without navigation: [AV-297, "AV CONTROL UNIT : Diagnosis Procedure"](#)
- BOSE audio with navigation: [AV-451, "AV CONTROL UNIT : Diagnosis Procedure"](#)

Is the inspection result normal?

- YES (Present error)>>Replace the AV control unit. Refer to the following.
- Base audio without rear view camera: [AV-89, "Exploded View"](#)
  - Base audio with rear view camera: [AV-201, "Exploded View"](#)
  - BOSE audio without navigation: [AV-328, "Exploded View"](#)
  - BOSE audio with navigation: [AV-477, "Exploded View"](#)

YES (Past error)>>Error was detected in the AV control unit branch line.

- NO >> Repair the power supply and the ground circuit.



# PSB BRANCH LINE CIRCUIT

< DTC/CIRCUIT DIAGNOSIS >

[CAN]

## PSB BRANCH LINE CIRCUIT

### Diagnosis Procedure

INFOID:000000005655409

#### 1. CHECK CONNECTOR

1. Turn the ignition switch OFF.
2. Disconnect the battery cable from the negative terminal.
3. Check the terminals and connectors of the pre-crash seat belt for damage, bend and loose connection (unit side and connector side).

Is the inspection result normal?

- YES >> GO TO 2.  
NO >> Repair the terminal and connector.

#### 2. CHECK HARNESS FOR OPEN CIRCUIT

1. Disconnect the connector of pre-crash seat belt control unit.
2. Check the resistance between the pre-crash seat belt control unit harness connector terminals.

Pre-crash seat belt control unit harness connector			Resistance (Ω)
Connector No.	Terminal No.		
M110	24	22	Approx. 54 – 66

Is the measurement value within the specification?

- YES >> GO TO 3.  
NO >> Repair the pre-crash seat belt control unit branch line.

#### 3. CHECK POWER SUPPLY AND GROUND CIRCUIT

Check the power supply and the ground circuit of the pre-crash seat belt control unit. Refer to [SBC-24, "Diagnosis Procedure"](#).

Is the inspection result normal?

- YES (Present error)>>Replace the pre-crash seat belt control unit. Refer to [SBC-39, "Exploded View"](#).  
YES (Past error)>>Error was detected in the pre-crash seat belt control unit branch line.  
NO >> Repair the power supply and the ground circuit.

A  
B  
C  
D  
E  
F  
G  
H  
I  
J  
K  
L

LAN

N  
O  
P

# TCM BRANCH LINE CIRCUIT

< DTC/CIRCUIT DIAGNOSIS >

[CAN]

## TCM BRANCH LINE CIRCUIT

### Diagnosis Procedure

INFOID:000000005655410

#### 1. CHECK CONNECTOR

1. Turn the ignition switch OFF.
2. Disconnect the battery cable from the negative terminal.
3. Check the following terminals and connectors for damage, bend and loose connection (unit side and connector side).
  - A/T assembly
  - Harness connector F103
  - Harness connector M116

Is the inspection result normal?

YES >> GO TO 2.

NO >> Repair the terminal and connector.

#### 2. CHECK HARNESS FOR OPEN CIRCUIT

1. Disconnect the connector of A/T assembly.
2. Check the resistance between the A/T assembly harness connector terminals.

A/T assembly harness connector		Resistance (Ω)
Connector No.	Terminal No.	
F51	3	Approx. 54 – 66
	8	

Is the measurement value within the specification?

YES >> GO TO 3.

NO >> Repair the TCM branch line.

#### 3. CHECK POWER SUPPLY AND GROUND CIRCUIT

Check the power supply and the ground circuit of the TCM. Refer to [TM-212, "Diagnosis Procedure"](#).

Is the inspection result normal?

YES (Present error)>>Replace the control valve with TCM. Refer to [TM-99, "Component Parts Location"](#).  
(Replace A/T assembly if control valve with TCM is not listed in the latest parts list.)

YES (Past error)>>Error was detected in the TCM branch line.

NO >> Repair the power supply and the ground circuit.

# ADP BRANCH LINE CIRCUIT

< DTC/CIRCUIT DIAGNOSIS >

[CAN]

## ADP BRANCH LINE CIRCUIT

### Diagnosis Procedure

INFOID:000000005655415

#### 1. CHECK CONNECTOR

1. Turn the ignition switch OFF.
2. Disconnect the battery cable from the negative terminal.
3. Check the following terminals and connectors for damage, bend and loose connection (unit side and connector side).
  - Models with automatic drive positioner
    - Driver seat control unit
    - Harness connector B502
    - Harness connector B11
  - Models without automatic drive positioner
    - Driver seat control unit
    - Harness connector B501
    - Harness connector B10

Is the inspection result normal?

YES >> GO TO 2.

NO >> Repair the terminal and connector.

#### 2. CHECK HARNESS FOR OPEN CIRCUIT

1. Disconnect the connector of driver seat control unit.
2. Check the resistance between the driver seat control unit harness connector terminals.

Driver seat control unit harness connector			Resistance (Ω)
Connector No.	Terminal No.		
B503	3	19	Approx. 54 – 66

Is the measurement value within the specification?

YES >> GO TO 3.

NO >> Repair the driver seat control unit branch line.

#### 3. CHECK POWER SUPPLY AND GROUND CIRCUIT

Check the power supply and the ground circuit of the driver seat control unit. Refer to [ADP-64. "DRIVER SEAT CONTROL UNIT : Diagnosis Procedure"](#).

Is the inspection result normal?

YES (Present error)>>Replace the driver seat control unit. Refer to [ADP-234. "Exploded View"](#).

YES (Past error)>>Error was detected in the driver seat control unit branch line.

NO >> Repair the power supply and the ground circuit.

A  
B  
C  
D  
E  
F  
G  
H  
I  
J  
K  
L  
N  
O  
P

LAN

# RAS BRANCH LINE CIRCUIT

< DTC/CIRCUIT DIAGNOSIS >

[CAN]

## RAS BRANCH LINE CIRCUIT

### Diagnosis Procedure

INFOID:000000005655416

#### 1. CHECK CONNECTOR

1. Turn the ignition switch OFF.
2. Disconnect the battery cable from the negative terminal.
3. Check the terminals and connectors of the 4WAS main control unit for damage, bend and loose connection (unit side and connector side).

Is the inspection result normal?

- YES >> GO TO 2.  
NO >> Repair the terminal and connector.

#### 2. CHECK HARNESS FOR OPEN CIRCUIT

1. Disconnect the connector of 4WAS main control unit.
2. Check the resistance between the 4WAS main control unit harness connector terminals.

4WAS main control unit harness connector			Resistance (Ω)
Connector No.	Terminal No.		
B54	1	8	Approx. 54 – 66

Is the measurement value within the specification?

- YES >> GO TO 3.  
NO >> Replace the body harness.

#### 3. CHECK POWER SUPPLY AND GROUND CIRCUIT

Check the power supply and the ground circuit of the 4WAS main control unit. Refer to [STC-136, "Diagnosis Procedure \(4WAS Main Control Unit\)"](#).

Is the inspection result normal?

- YES (Present error)>>Replace the 4WAS main control unit. Refer to [STC-181, "Exploded View"](#).  
YES (Past error)>>Error was detected in the 4WAS main control unit branch line.  
NO >> Repair the power supply and the ground circuit.

# ABS BRANCH LINE CIRCUIT

< DTC/CIRCUIT DIAGNOSIS >

[CAN]

## ABS BRANCH LINE CIRCUIT

### Diagnosis Procedure

INFOID:000000005655417

#### 1. CHECK CONNECTOR

1. Turn the ignition switch OFF.
2. Disconnect the battery cable from the negative terminal.
3. Check the terminals and connectors of the ABS actuator and electric unit (control unit) for damage, bend and loose connection (unit side and connector side).

Is the inspection result normal?

- YES >> GO TO 2.  
NO >> Repair the terminal and connector.

#### 2. CHECK HARNESS FOR OPEN CIRCUIT

1. Disconnect the connector of ABS actuator and electric unit (control unit).
2. Check the resistance between the ABS actuator and electric unit (control unit) harness connector terminals.

ABS actuator and electric unit (control unit) harness connector			Resistance (Ω)
Connector No.	Terminal No.		
E41	35	14	Approx. 54 – 66

Is the measurement value within the specification?

- YES >> GO TO 3.  
NO >> Repair the ABS actuator and electric unit (control unit) branch line.

#### 3. CHECK POWER SUPPLY AND GROUND CIRCUIT

Check the power supply and the ground circuit of the ABS actuator and electric unit (control unit). Refer to [BRC-69, "Diagnosis Procedure"](#).

Is the inspection result normal?

- YES (Present error)>>Replace the ABS actuator and electric unit (control unit). Refer to [BRC-105, "Exploded View"](#).  
YES (Past error)>>Error was detected in the ABS actuator and electric unit (control unit) branch line.  
NO >> Repair the power supply and the ground circuit.

A  
B  
C  
D  
E  
F  
G  
H  
I  
J  
K  
L

LAN

# ICC BRANCH LINE CIRCUIT

< DTC/CIRCUIT DIAGNOSIS >

[CAN]

## ICC BRANCH LINE CIRCUIT

### Diagnosis Procedure

INFOID:000000005655418

#### 1. CHECK CONNECTOR

1. Turn the ignition switch OFF.
2. Disconnect the battery cable from the negative terminal.
3. Check the terminals and connectors of the ICC sensor integrated unit for damage, bend and loose connection (unit side and connector side).

Is the inspection result normal?

- YES >> GO TO 2.  
NO >> Repair the terminal and connector.

#### 2. CHECK HARNESS FOR OPEN CIRCUIT

1. Disconnect the connector of ICC sensor integrated unit.
2. Check the resistance between the ICC sensor integrated unit harness connector terminals.

ICC sensor integrated unit harness connector			Resistance (Ω)
Connector No.	Terminal No.		
E67	3	6	Approx. 54 – 66

Is the measurement value within the specification?

- YES >> GO TO 3.  
NO >> Repair the ICC sensor integrated unit branch line.

#### 3. CHECK POWER SUPPLY AND GROUND CIRCUIT

Check the power supply and the ground circuit of the ICC sensor integrated unit. Refer to [CCS-102, "Diagnosis Procedure"](#).

Is the inspection result normal?

- YES (Present error)>>Replace the ICC sensor integrated unit. Refer to [CCS-133, "Exploded View"](#).  
YES (Past error)>>Error was detected in the ICC sensor integrated unit branch line.  
NO >> Repair the power supply and the ground circuit.

# IPDM-E BRANCH LINE CIRCUIT

< DTC/CIRCUIT DIAGNOSIS >

[CAN]

## IPDM-E BRANCH LINE CIRCUIT

### Diagnosis Procedure

INFOID:000000005655419

#### 1. CHECK CONNECTOR

1. Turn the ignition switch OFF.
2. Disconnect the battery cable from the negative terminal.
3. Check the terminals and connectors of the IPDM E/R for damage, bend and loose connection (unit side and connector side).

Is the inspection result normal?

- YES >> GO TO 2.  
NO >> Repair the terminal and connector.

#### 2. CHECK HARNESS FOR OPEN CIRCUIT

1. Disconnect the connector of IPDM E/R.
2. Check the resistance between the IPDM E/R harness connector terminals.

IPDM E/R harness connector			Resistance (Ω)
Connector No.	Terminal No.		
E6	40	39	Approx. 108 – 132

Is the measurement value within the specification?

- YES >> GO TO 3.  
NO >> Repair the IPDM E/R branch line.

#### 3. CHECK POWER SUPPLY AND GROUND CIRCUIT

Check the power supply and the ground circuit of the IPDM E/R. Refer to [PCS-17, "Diagnosis Procedure"](#).

Is the inspection result normal?

- YES (Present error)>>Replace the IPDM E/R. Refer to [PCS-32, "Exploded View"](#).  
YES (Past error)>>Error was detected in the IPDM E/R branch line.  
NO >> Repair the power supply and the ground circuit.

A  
B  
C  
D  
E  
F  
G  
H  
I  
J  
K  
L

LAN

N  
O  
P

# CAN COMMUNICATION CIRCUIT

[CAN]

< DTC/CIRCUIT DIAGNOSIS >

## CAN COMMUNICATION CIRCUIT

### Diagnosis Procedure

INFOID:000000005655420

#### 1. CONNECTOR INSPECTION

1. Turn the ignition switch OFF.
2. Disconnect the battery cable from the negative terminal.
3. Disconnect all the unit connectors on CAN communication system.
4. Check terminals and connectors for damage, bend and loose connection.

Is the inspection result normal?

- YES >> GO TO 2.  
NO >> Repair the terminal and connector.

#### 2. CHECK HARNESS CONTINUITY (SHORT CIRCUIT)

Check the continuity between the data link connector terminals.

Data link connector			Continuity
Connector No.	Terminal No.		
M24	6	14	Not existed

Is the inspection result normal?

- YES >> GO TO 3.  
NO >> Check the harness and repair the root cause.

#### 3. CHECK HARNESS CONTINUITY (SHORT CIRCUIT)

Check the continuity between the data link connector and the ground.

Data link connector		Ground	Continuity
Connector No.	Terminal No.		
M24	6		Not existed
	14		Not existed

Is the inspection result normal?

- YES >> GO TO 4.  
NO >> Check the harness and repair the root cause.

#### 4. CHECK ECM AND IPDM E/R TERMINATION CIRCUIT

1. Remove the ECM and the IPDM E/R.
2. Check the resistance between the ECM terminals.

ECM		Resistance ( $\Omega$ )
Terminal No.		
114	113	Approx. 108 – 132

3. Check the resistance between the IPDM E/R terminals.

IPDM E/R		Resistance ( $\Omega$ )
Terminal No.		
40	39	Approx. 108 – 132

Is the measurement value within the specification?

- YES >> GO TO 5.  
NO >> Replace the ECM and/or the IPDM E/R.

#### 5. CHECK SYMPTOM

Connect all the connectors. Check if the symptoms described in the "Symptom (Results from interview with customer)" are reproduced.

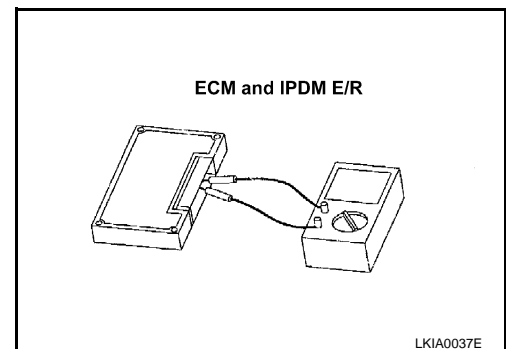



# CAN COMMUNICATION CIRCUIT

[CAN]

< DTC/CIRCUIT DIAGNOSIS >

## Inspection result

Reproduced>>GO TO 6.

Non-reproduced>>Start the diagnosis again. Follow the trouble diagnosis procedure when past error is detected.

## 6.CHECK UNIT REPRODUCTION

Perform the reproduction test as per the following procedure for each unit.

1. Turn the ignition switch OFF.
2. Disconnect the battery cable from the negative terminal.
3. Disconnect one of the unit connectors of CAN communication system.

### **NOTE:**

ECM and IPDM E/R have a termination circuit. Check other units first.

4. Connect the battery cable to the negative terminal. Check if the symptoms described in the "Symptom (Results from interview with customer)" are reproduced.

### **NOTE:**

Although unit-related error symptoms occur, do not confuse them with other symptoms.

## Inspection result

Reproduced>>Connect the connector. Check other units as per the above procedure.

Non-reproduced>>Replace the unit whose connector was disconnected.

A  
B  
C  
D  
E  
F  
G  
H  
I  
J  
K  
L  
N  
O  
P

LAN

# MAIN LINE BETWEEN DLC AND AV CIRCUIT

< DTC/CIRCUIT DIAGNOSIS >

[CAN SYSTEM (TYPE 1)]

## DTC/CIRCUIT DIAGNOSIS

### MAIN LINE BETWEEN DLC AND AV CIRCUIT

#### Diagnosis Procedure

INFOID:000000005779370

#### 1. CHECK HARNESS CONTINUITY (OPEN CIRCUIT)

1. Turn the ignition switch OFF.
2. Disconnect the battery cable from the negative terminal.
3. Disconnect the following harness connectors.
  - ECM
  - AV control unit
4. Check the continuity between the data link connector and the AV control unit harness connector.
  - Without navigation system (Without rear view monitor)

Data link connector		AV control unit harness connector		Continuity
Connector No.	Terminal No.	Connector No.	Terminal No.	
M24	6	M85	86	Existed
	14		87	Existed

- Without navigation system (With rear view monitor)

Data link connector		AV control unit harness connector		Continuity
Connector No.	Terminal No.	Connector No.	Terminal No.	
M24	6	M204	81	Existed
	14		80	Existed

- With navigation system

Data link connector		AV control unit harness connector		Continuity
Connector No.	Terminal No.	Connector No.	Terminal No.	
M24	6	M210	90	Existed
	14		74	Existed

#### Is the inspection result normal?

YES (Present error)>>Check CAN system type decision again.

YES (Past error)>>Error was detected in the main line between the data link connector and the AV control unit.

NO >> Repair the main line between the data link connector and the AV control unit.

# MAIN LINE BETWEEN AV AND ADP CIRCUIT

< DTC/CIRCUIT DIAGNOSIS >

[CAN SYSTEM (TYPE 1)]

## MAIN LINE BETWEEN AV AND ADP CIRCUIT

### Diagnosis Procedure

INFOID:000000005779371

#### 1.CHECK CONNECTOR

1. Turn the ignition switch OFF.
2. Disconnect the battery cable from the negative terminal.
3. Check the following terminals and connectors for damage, bend and loose connection (connector side and harness side).
  - Harness connector M7
  - Harness connector B1

Is the inspection result normal?

YES >> GO TO 2.

NO >> Repair the terminal and connector.

#### 2.CHECK HARNESS CONTINUITY (OPEN CIRCUIT)

1. Disconnect the following harness connectors.
  - AV control unit
  - Harness connectors M7 and B1
2. Check the continuity between the AV control unit harness connector and harness connector.
  - Without navigation system (Without rear view monitor)

AV control unit harness connector		Harness connector		Continuity
Connector No.	Terminal No.	Connector No.	Terminal No.	
M85	86	M7	20	Existed
	87		21	Existed

- Without navigation system (With rear view monitor)

AV control unit harness connector		Harness connector		Continuity
Connector No.	Terminal No.	Connector No.	Terminal No.	
M204	81	M7	20	Existed
	80		21	Existed

- With navigation system

AV control unit harness connector		Harness connector		Continuity
Connector No.	Terminal No.	Connector No.	Terminal No.	
M210	90	M7	20	Existed
	74		21	Existed

Is the inspection result normal?

YES >> GO TO 3.

NO >> Repair the main line between the AV control unit and the harness connector M7.

#### 3.CHECK HARNESS CONTINUITY (OPEN CIRCUIT)

Check the continuity between the harness connector terminals.

Connector No.	Terminal No.		Continuity
B1	20	22	Existed
	21	23	Existed

Is the inspection result normal?

YES (Present error)>>Check CAN system type decision again.

YES (Past error)>>Error was detected in the main line between the AV control unit and the driver seat control unit.

NO >> Repair the main line between the harness connectors B1 and the driver seat control unit.

# MAIN LINE BETWEEN ADP AND ABS CIRCUIT

< DTC/CIRCUIT DIAGNOSIS >

[CAN SYSTEM (TYPE 1)]

## MAIN LINE BETWEEN ADP AND ABS CIRCUIT

### Diagnosis Procedure

INFOID:000000005779372

#### 1. CHECK CONNECTOR

1. Turn the ignition switch OFF.
2. Disconnect the battery cable from the negative terminal.
3. Check the following terminals and connectors for damage, bend and loose connection (connector side and harness side).
  - Harness connector B1
  - Harness connector M7
  - Harness connector M6
  - Harness connector E106

Is the inspection result normal?

YES >> GO TO 2.

NO >> Repair the terminal and connector.

#### 2. CHECK HARNESS CONTINUITY (OPEN CIRCUIT)

1. Disconnect the harness connectors B1 and M7.
2. Check the continuity between the harness connector terminals.

Connector No.	Terminal No.		Continuity
B1	20	22	Existed
	21	23	Existed

Is the inspection result normal?

YES >> GO TO 3.

NO >> Repair the main line between the driver seat control unit and the harness connector B1.

#### 3. CHECK HARNESS CONTINUITY (OPEN CIRCUIT)

1. Disconnect the harness connectors M6 and E106.
2. Check the continuity between the harness connectors.

Harness connector		Harness connector		Continuity
Connector No.	Terminal No.	Connector No.	Terminal No.	
M7	22	M6	49	Existed
	23		48	Existed

Is the inspection result normal?

YES >> GO TO 4.

NO >> Repair the main line between the harness connectors M7 and M6.

#### 4. CHECK HARNESS CONTINUITY (OPEN CIRCUIT)

1. Disconnect the connector of ABS actuator and electric unit (control unit).
2. Check the continuity between the harness connector and the ABS actuator and electric unit (control unit) harness connector.

Harness connector		ABS actuator and electric unit (control unit) harness connector		Continuity
Connector No.	Terminal No.	Connector No.	Terminal No.	
E106	49	E41	35	Existed
	48		14	Existed

Is the inspection result normal?

YES (Present error)>>Check CAN system type decision again.

YES (Past error)>>Error was detected in the main line between the driver seat control unit and the ABS actuator and electric unit (control unit).

# MAIN LINE BETWEEN ADP AND ABS CIRCUIT

< DTC/CIRCUIT DIAGNOSIS >

[CAN SYSTEM (TYPE 1)]

NO >> Repair the main line between the harness connector E106 and the ABS actuator and electric unit (control unit).

A

B

C

D

E

F

G

H

I

J

K

L

LAN

N

O

P

# ECM BRANCH LINE CIRCUIT

< DTC/CIRCUIT DIAGNOSIS >

[CAN SYSTEM (TYPE 1)]

## ECM BRANCH LINE CIRCUIT

### Diagnosis Procedure

INFOID:000000005779374

#### 1.CHECK CONNECTOR

1. Turn the ignition switch OFF.
2. Disconnect the battery cable from the negative terminal.
3. Check the terminals and connectors of the ECM for damage, bend and loose connection (unit side and connector side).

Is the inspection result normal?

- YES >> GO TO 2.  
NO >> Repair the terminal and connector.

#### 2.CHECK HARNESS FOR OPEN CIRCUIT

1. Disconnect the connector of ECM.
2. Check the resistance between the ECM harness connector terminals.

ECM harness connector			Resistance (Ω)
Connector No.	Terminal No.		
M107	114	113	Approx. 108 – 132

Is the measurement value within the specification?

- YES >> GO TO 3.  
NO >> Repair the ECM branch line.

#### 3.CHECK POWER SUPPLY AND GROUND CIRCUIT

Check the power supply and the ground circuit of the ECM. Refer to [EC-152. "Diagnosis Procedure"](#).

Is the inspection result normal?

YES (Present error)>>Replace the ECM. Refer to [EC-17. "ADDITIONAL SERVICE WHEN REPLACING CONTROL UNIT \(ECM\) : Special Repair Requirement"](#).

YES (Past error)>>Error was detected in the ECM branch line.

NO >> Repair the power supply and the ground circuit.

# A-BAG BRANCH LINE CIRCUIT

< DTC/CIRCUIT DIAGNOSIS >

[CAN SYSTEM (TYPE 1)]

## A-BAG BRANCH LINE CIRCUIT

### Diagnosis Procedure

INFOID:000000005884784

#### **WARNING:**

- Before servicing, turn ignition switch OFF, disconnect battery negative terminal, and wait 3 minutes or more. (To discharge backup capacitor.)
- Never use unspecified tester or other measuring device.

#### 1. CHECK CONNECTOR

1. Turn the ignition switch OFF.
2. Disconnect the battery cable from the negative terminal.
3. Check the terminals and connectors of the air bag diagnosis sensor unit for damage, bend and loose connection (unit side and connector side).

Is the inspection result normal?

YES >> GO TO 2.

NO >> Replace the terminal and connector.

#### 2. CHECK AIR BAG DIAGNOSIS SENSOR UNIT

Check the air bag diagnosis sensor unit. Refer to [SRC-5, "Work Flow"](#).

Is the inspection result normal?

YES >> Replace the main harness.

NO >> Replace parts whose air bag system has a malfunction.

A  
B  
C  
D  
E  
F  
G  
H  
I  
J  
K  
L

LAN

N  
O  
P

# BCM BRANCH LINE CIRCUIT

< DTC/CIRCUIT DIAGNOSIS >

[CAN SYSTEM (TYPE 1)]

## BCM BRANCH LINE CIRCUIT

### Diagnosis Procedure

INFOID:000000005779376

#### 1. CHECK CONNECTOR

1. Turn the ignition switch OFF.
2. Disconnect the battery cable from the negative terminal.
3. Check the terminals and connectors of the BCM for damage, bend and loose connection (unit side and connector side).

Is the inspection result normal?

- YES >> GO TO 2.  
NO >> Repair the terminal and connector.

#### 2. CHECK HARNESS FOR OPEN CIRCUIT

1. Disconnect the connector of BCM.
2. Check the resistance between the BCM harness connector terminals.

BCM harness connector			Resistance (Ω)
Connector No.	Terminal No.		
M122	91	90	Approx. 54 – 66

Is the measurement value within the specification?

- YES >> GO TO 3.  
NO >> Repair the BCM branch line.

#### 3. CHECK POWER SUPPLY AND GROUND CIRCUIT

Check the power supply and the ground circuit of the BCM. Refer to [BCS-37, "Diagnosis Procedure"](#).

Is the inspection result normal?

- YES (Present error)>>Replace the BCM. Refer to [BCS-78, "Exploded View"](#).  
YES (Past error)>>Error was detected in the BCM branch line.  
NO >> Repair the power supply and the ground circuit.



# DLC BRANCH LINE CIRCUIT

< DTC/CIRCUIT DIAGNOSIS >

[CAN SYSTEM (TYPE 1)]

## DLC BRANCH LINE CIRCUIT

### Diagnosis Procedure

INFOID:000000005779377

#### 1. CHECK CONNECTOR

1. Turn the ignition switch OFF.
2. Disconnect the battery cable from the negative terminal.
3. Check the terminals and connectors of the data link connector for damage, bend and loose connection (connector side and harness side).

Is the inspection result normal?

- YES >> GO TO 2.  
NO >> Repair the terminal and connector.

#### 2. CHECK HARNESS FOR OPEN CIRCUIT

Check the resistance between the data link connector terminals.

Data link connector			Resistance (Ω)
Connector No.	Terminal No.		
M24	6	14	Approx. 54 – 66

Is the measurement value within the specification?

- YES (Present error)>>Check CAN system type decision again.  
YES (Past error)>>Error was detected in the data link connector branch line circuit.  
NO >> Repair the data link connector branch line.

A  
B  
C  
D  
E  
F  
G  
H  
I  
J  
K  
L

LAN

N  
O  
P

## M&A BRANCH LINE CIRCUIT

### Diagnosis Procedure

INFOID:000000005779378

#### 1. CHECK CONNECTOR

1. Turn the ignition switch OFF.
2. Disconnect the battery cable from the negative terminal.
3. Check the terminals and connectors of the unified meter and A/C amp. for damage, bend and loose connection (unit side and connector side).

Is the inspection result normal?

- YES >> GO TO 2.  
 NO >> Repair the terminal and connector.

#### 2. CHECK HARNESS FOR OPEN CIRCUIT

1. Disconnect the connector of unified meter and A/C amp.
2. Check the resistance between the unified meter and A/C amp. harness connector terminals.

Unified meter and A/C amp. harness connector			Resistance (Ω)
Connector No.	Terminal No.		
M67	56	72	Approx. 54 – 66

Is the measurement value within the specification?

- YES >> GO TO 3.  
 NO >> Repair the unified meter and A/C amp. branch line.

#### 3. CHECK POWER SUPPLY AND GROUND CIRCUIT

Check the power supply and the ground circuit of the unified meter and A/C amp. Refer to [MWI-50, "UNIFIED METER AND A/C AMP. : Diagnosis Procedure"](#).

Is the inspection result normal?

- YES (Present error)>>Replace the unified meter and A/C amp. Refer to [MWI-130, "Exploded View"](#).  
 YES (Past error)>>Error was detected in the unified meter and A/C amp. branch line.  
 NO >> Repair the power supply and the ground circuit.

# STRG BRANCH LINE CIRCUIT

< DTC/CIRCUIT DIAGNOSIS >

[CAN SYSTEM (TYPE 1)]

## STRG BRANCH LINE CIRCUIT

### Diagnosis Procedure

INFOID:000000005779379

#### 1. CHECK CONNECTOR

1. Turn the ignition switch OFF.
2. Disconnect the battery cable from the negative terminal.
3. Check the terminals and connectors of the steering angle sensor for damage, bend and loose connection (unit side and connector side).

Is the inspection result normal?

- YES >> GO TO 2.  
NO >> Repair the terminal and connector.

#### 2. CHECK HARNESS FOR OPEN CIRCUIT

1. Disconnect the connector of steering angle sensor.
2. Check the resistance between the steering angle sensor harness connector terminals.

Steering angle sensor harness connector			Resistance (Ω)
Connector No.	Terminal No.		
M37	1	2	Approx. 54 – 66

Is the measurement value within the specification?

- YES >> GO TO 3.  
NO >> Repair the steering angle sensor branch line.

#### 3. CHECK POWER SUPPLY AND GROUND CIRCUIT

Check the power supply and the ground circuit of the steering angle sensor. Refer to [BRC-83, "Wiring Diagram - BRAKE CONTROL SYSTEM -"](#).

Is the inspection result normal?

- YES (Present error)>>Replace the steering angle sensor. Refer to [BRC-108, "Exploded View"](#).  
YES (Past error)>>Error was detected in the steering angle sensor branch line.  
NO >> Repair the power supply and the ground circuit.

A  
B  
C  
D  
E  
F  
G  
H  
I  
J  
K  
L

LAN

N  
O  
P

## AV BRANCH LINE CIRCUIT

### Diagnosis Procedure

INFOID:000000005779380

#### 1. CHECK CONNECTOR

1. Turn the ignition switch OFF.
2. Disconnect the battery cable from the negative terminal.
3. Check the terminals and connectors of the AV control unit for damage, bend and loose connection (unit side and connector side).

Is the inspection result normal?

- YES >> GO TO 2.  
 NO >> Repair the terminal and connector.

#### 2. CHECK HARNESS FOR OPEN CIRCUIT

1. Disconnect the connector of AV control unit.
2. Check the resistance between the AV control unit harness connector terminals.
  - Without navigation system (Without rear view monitor)

AV control unit harness connector			Resistance (Ω)
Connector No.	Terminal No.		
M85	86	87	Approx. 54 – 66

- Without navigation system (With rear view monitor)

AV control unit harness connector			Resistance (Ω)
Connector No.	Terminal No.		
M204	81	80	Approx. 54 – 66

- With navigation system

AV control unit harness connector			Resistance (Ω)
Connector No.	Terminal No.		
M210	90	74	Approx. 54 – 66

Is the measurement value within the specification?

- YES >> GO TO 3.  
 NO >> Repair the AV control unit branch line.

#### 3. CHECK POWER SUPPLY AND GROUND CIRCUIT

Check the power supply and the ground circuit of the AV control unit. Refer to the following.

- Base audio without rear view camera: [AV-40, "AV CONTROL UNIT : Diagnosis Procedure"](#)
- Base audio with rear view camera: [AV-172, "AV CONTROL UNIT : Diagnosis Procedure"](#)
- BOSE audio without navigation: [AV-297, "AV CONTROL UNIT : Diagnosis Procedure"](#)
- BOSE audio with navigation: [AV-451, "AV CONTROL UNIT : Diagnosis Procedure"](#)

Is the inspection result normal?

- YES (Present error)>>Replace the AV control unit. Refer to the following.
- Base audio without rear view camera: [AV-89, "Exploded View"](#)
  - Base audio with rear view camera: [AV-201, "Exploded View"](#)
  - BOSE audio without navigation: [AV-328, "Exploded View"](#)
  - BOSE audio with navigation: [AV-477, "Exploded View"](#)

YES (Past error)>>Error was detected in the AV control unit branch line.

NO >> Repair the power supply and the ground circuit.

# ADP BRANCH LINE CIRCUIT

< DTC/CIRCUIT DIAGNOSIS >

[CAN SYSTEM (TYPE 1)]

## ADP BRANCH LINE CIRCUIT

### Diagnosis Procedure

INFOID:000000005779381

#### 1. CHECK CONNECTOR

1. Turn the ignition switch OFF.
2. Disconnect the battery cable from the negative terminal.
3. Check the following terminals and connectors for damage, bend and loose connection (unit side and connector side).
  - Models with automatic drive positioner
    - Driver seat control unit
    - Harness connector B502
    - Harness connector B11
  - Models without automatic drive positioner
    - Driver seat control unit
    - Harness connector B501
    - Harness connector B10

Is the inspection result normal?

YES >> GO TO 2.

NO >> Repair the terminal and connector.

#### 2. CHECK HARNESS FOR OPEN CIRCUIT

1. Disconnect the connector of driver seat control unit.
2. Check the resistance between the driver seat control unit harness connector terminals.

Driver seat control unit harness connector			Resistance (Ω)
Connector No.	Terminal No.		
B503	3	19	Approx. 54 – 66

Is the measurement value within the specification?

YES >> GO TO 3.

NO >> Repair the driver seat control unit branch line.

#### 3. CHECK POWER SUPPLY AND GROUND CIRCUIT

Check the power supply and the ground circuit of the driver seat control unit. Refer to [ADP-64. "DRIVER SEAT CONTROL UNIT : Diagnosis Procedure"](#).

Is the inspection result normal?

YES (Present error)>>Replace the driver seat control unit. Refer to [ADP-234. "Exploded View"](#).

YES (Past error)>>Error was detected in the driver seat control unit branch line.

NO >> Repair the power supply and the ground circuit.

A  
B  
C  
D  
E  
F  
G  
H  
I  
J  
K  
L  
N  
O  
P

LAN

# ABS BRANCH LINE CIRCUIT

< DTC/CIRCUIT DIAGNOSIS >

[CAN SYSTEM (TYPE 1)]

## ABS BRANCH LINE CIRCUIT

### Diagnosis Procedure

INFOID:000000005779382

#### 1. CHECK CONNECTOR

1. Turn the ignition switch OFF.
2. Disconnect the battery cable from the negative terminal.
3. Check the terminals and connectors of the ABS actuator and electric unit (control unit) for damage, bend and loose connection (unit side and connector side).

Is the inspection result normal?

- YES >> GO TO 2.  
NO >> Repair the terminal and connector.

#### 2. CHECK HARNESS FOR OPEN CIRCUIT

1. Disconnect the connector of ABS actuator and electric unit (control unit).
2. Check the resistance between the ABS actuator and electric unit (control unit) harness connector terminals.

ABS actuator and electric unit (control unit) harness connector			Resistance (Ω)
Connector No.	Terminal No.		
E41	35	14	Approx. 54 – 66

Is the measurement value within the specification?

- YES >> GO TO 3.  
NO >> Repair the ABS actuator and electric unit (control unit) branch line.

#### 3. CHECK POWER SUPPLY AND GROUND CIRCUIT

Check the power supply and the ground circuit of the ABS actuator and electric unit (control unit). Refer to [BRC-69. "Diagnosis Procedure"](#).

Is the inspection result normal?

- YES (Present error)>>Replace the ABS actuator and electric unit (control unit). Refer to [BRC-105. "Exploded View"](#).  
YES (Past error)>>Error was detected in the ABS actuator and electric unit (control unit) branch line.  
NO >> Repair the power supply and the ground circuit.

# IPDM-E BRANCH LINE CIRCUIT

< DTC/CIRCUIT DIAGNOSIS >

[CAN SYSTEM (TYPE 1)]

## IPDM-E BRANCH LINE CIRCUIT

### Diagnosis Procedure

INFOID:000000005779383

#### 1. CHECK CONNECTOR

1. Turn the ignition switch OFF.
2. Disconnect the battery cable from the negative terminal.
3. Check the terminals and connectors of the IPDM E/R for damage, bend and loose connection (unit side and connector side).

Is the inspection result normal?

- YES >> GO TO 2.  
NO >> Repair the terminal and connector.

#### 2. CHECK HARNESS FOR OPEN CIRCUIT

1. Disconnect the connector of IPDM E/R.
2. Check the resistance between the IPDM E/R harness connector terminals.

IPDM E/R harness connector			Resistance (Ω)
Connector No.	Terminal No.		
E6	40	39	Approx. 108 – 132

Is the measurement value within the specification?

- YES >> GO TO 3.  
NO >> Repair the IPDM E/R branch line.

#### 3. CHECK POWER SUPPLY AND GROUND CIRCUIT

Check the power supply and the ground circuit of the IPDM E/R. Refer to [PCS-17, "Diagnosis Procedure"](#).

Is the inspection result normal?

- YES (Present error)>>Replace the IPDM E/R. Refer to [PCS-32, "Exploded View"](#).  
YES (Past error)>>Error was detected in the IPDM E/R branch line.  
NO >> Repair the power supply and the ground circuit.

A  
B  
C  
D  
E  
F  
G  
H  
I  
J  
K  
L

LAN

N  
O  
P

# CAN COMMUNICATION CIRCUIT

< DTC/CIRCUIT DIAGNOSIS >

[CAN SYSTEM (TYPE 1)]

## CAN COMMUNICATION CIRCUIT

### Diagnosis Procedure

INFOID:000000005779384

#### 1. CONNECTOR INSPECTION

1. Turn the ignition switch OFF.
2. Disconnect the battery cable from the negative terminal.
3. Disconnect all the unit connectors on CAN communication system.
4. Check terminals and connectors for damage, bend and loose connection.

Is the inspection result normal?

- YES >> GO TO 2.  
NO >> Repair the terminal and connector.

#### 2. CHECK HARNESS CONTINUITY (SHORT CIRCUIT)

Check the continuity between the data link connector terminals.

Data link connector		Continuity
Connector No.	Terminal No.	
M24	6 14	Not existed

Is the inspection result normal?

- YES >> GO TO 3.  
NO >> Check the harness and repair the root cause.

#### 3. CHECK HARNESS CONTINUITY (SHORT CIRCUIT)

Check the continuity between the data link connector and the ground.

Data link connector		Ground	Continuity
Connector No.	Terminal No.		
M24	6		Not existed
	14		Not existed

Is the inspection result normal?

- YES >> GO TO 4.  
NO >> Check the harness and repair the root cause.

#### 4. CHECK ECM AND IPDM E/R TERMINATION CIRCUIT

1. Remove the ECM and the IPDM E/R.
2. Check the resistance between the ECM terminals.

ECM		Resistance ( $\Omega$ )
Terminal No.		
114	113	Approx. 108 – 132

3. Check the resistance between the IPDM E/R terminals.

IPDM E/R		Resistance ( $\Omega$ )
Terminal No.		
40	39	Approx. 108 – 132

Is the measurement value within the specification?

- YES >> GO TO 5.  
NO >> Replace the ECM and/or the IPDM E/R.

#### 5. CHECK SYMPTOM

Connect all the connectors. Check if the symptoms described in the "Symptom (Results from interview with customer)" are reproduced.

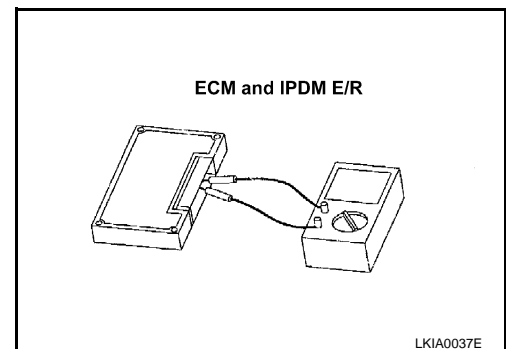



# CAN COMMUNICATION CIRCUIT

< DTC/CIRCUIT DIAGNOSIS >

[CAN SYSTEM (TYPE 1)]

## Inspection result

Reproduced>>GO TO 6.

Non-reproduced>>Start the diagnosis again. Follow the trouble diagnosis procedure when past error is detected.

## 6.CHECK UNIT REPRODUCTION

Perform the reproduction test as per the following procedure for each unit.

1. Turn the ignition switch OFF.
2. Disconnect the battery cable from the negative terminal.
3. Disconnect one of the unit connectors of CAN communication system.

### **NOTE:**

ECM and IPDM E/R have a termination circuit. Check other units first.

4. Connect the battery cable to the negative terminal. Check if the symptoms described in the "Symptom (Results from interview with customer)" are reproduced.

### **NOTE:**

Although unit-related error symptoms occur, do not confuse them with other symptoms.

## Inspection result

Reproduced>>Connect the connector. Check other units as per the above procedure.

Non-reproduced>>Replace the unit whose connector was disconnected.

A  
B  
C  
D  
E  
F  
G  
H  
I  
J  
K  
L

LAN

N  
O  
P

# MAIN LINE BETWEEN DLC AND AV CIRCUIT

< DTC/CIRCUIT DIAGNOSIS >

[CAN SYSTEM (TYPE 2)]

## DTC/CIRCUIT DIAGNOSIS

### MAIN LINE BETWEEN DLC AND AV CIRCUIT

#### Diagnosis Procedure

INFOID:000000005779386

#### 1. CHECK HARNESS CONTINUITY (OPEN CIRCUIT)

1. Turn the ignition switch OFF.
2. Disconnect the battery cable from the negative terminal.
3. Disconnect the following harness connectors.
  - ECM
  - AV control unit
4. Check the continuity between the data link connector and the AV control unit harness connector.
  - Without navigation system (Without rear view monitor)

Data link connector		AV control unit harness connector		Continuity
Connector No.	Terminal No.	Connector No.	Terminal No.	
M24	6	M85	86	Existed
	14		87	Existed

- Without navigation system (With rear view monitor)

Data link connector		AV control unit harness connector		Continuity
Connector No.	Terminal No.	Connector No.	Terminal No.	
M24	6	M204	81	Existed
	14		80	Existed

- With navigation system

Data link connector		AV control unit harness connector		Continuity
Connector No.	Terminal No.	Connector No.	Terminal No.	
M24	6	M210	90	Existed
	14		74	Existed

#### Is the inspection result normal?

YES (Present error)>>Check CAN system type decision again.

YES (Past error)>>Error was detected in the main line between the data link connector and the AV control unit.

NO >> Repair the main line between the data link connector and the AV control unit.

# MAIN LINE BETWEEN AV AND ADP CIRCUIT

< DTC/CIRCUIT DIAGNOSIS >

[CAN SYSTEM (TYPE 2)]

## MAIN LINE BETWEEN AV AND ADP CIRCUIT

### Diagnosis Procedure

INFOID:000000005779387

#### 1. CHECK CONNECTOR

1. Turn the ignition switch OFF.
2. Disconnect the battery cable from the negative terminal.
3. Check the following terminals and connectors for damage, bend and loose connection (connector side and harness side).
  - Harness connector M7
  - Harness connector B1

Is the inspection result normal?

YES >> GO TO 2.

NO >> Repair the terminal and connector.

#### 2. CHECK HARNESS CONTINUITY (OPEN CIRCUIT)

1. Disconnect the following harness connectors.
  - AV control unit
  - Harness connectors M7 and B1
2. Check the continuity between the AV control unit harness connector and harness connector.
  - Without navigation system (Without rear view monitor)

AV control unit harness connector		Harness connector		Continuity
Connector No.	Terminal No.	Connector No.	Terminal No.	
M85	86	M7	20	Existed
	87		21	Existed

- Without navigation system (With rear view monitor)

AV control unit harness connector		Harness connector		Continuity
Connector No.	Terminal No.	Connector No.	Terminal No.	
M204	81	M7	20	Existed
	80		21	Existed

- With navigation system

AV control unit harness connector		Harness connector		Continuity
Connector No.	Terminal No.	Connector No.	Terminal No.	
M210	90	M7	20	Existed
	74		21	Existed

Is the inspection result normal?

YES >> GO TO 3.

NO >> Repair the main line between the AV control unit and the harness connector M7.

#### 3. CHECK HARNESS CONTINUITY (OPEN CIRCUIT)

Check the continuity between the harness connector terminals.

Connector No.	Terminal No.		Continuity
B1	20	22	Existed
	21	23	Existed

Is the inspection result normal?

YES (Present error)>>Check CAN system type decision again.

YES (Past error)>>Error was detected in the main line between the AV control unit and the driver seat control unit.

NO >> Repair the main line between the harness connectors B1 and the driver seat control unit.

# MAIN LINE BETWEEN ADP AND RAS CIRCUIT

< DTC/CIRCUIT DIAGNOSIS >

[CAN SYSTEM (TYPE 2)]

## MAIN LINE BETWEEN ADP AND RAS CIRCUIT

### Diagnosis Procedure

INFOID:000000005779388

#### 1. CHECK HARNESS CONTINUITY (OPEN CIRCUIT)

1. Turn the ignition switch OFF.
2. Disconnect the battery cable from the negative terminal.
3. Disconnect the harness connectors M7 and B1.
4. Check the continuity between the harness connector terminals.

Connector No.	Terminal No.		Continuity
B1	20	22	Existed
	21	23	Existed

#### Is the inspection result normal?

YES (Present error)>>Check CAN system type decision again.

YES (Past error)>>Error was detected in the main line between the driver seat control unit and the 4WAS main control unit.

NO >> Repair the main line between the driver seat control unit and the 4WAS main control unit.

# MAIN LINE BETWEEN RAS AND ABS CIRCUIT

< DTC/CIRCUIT DIAGNOSIS >

[CAN SYSTEM (TYPE 2)]

## MAIN LINE BETWEEN RAS AND ABS CIRCUIT

### Diagnosis Procedure

INFOID:000000005779389

#### 1. CHECK CONNECTOR

1. Turn the ignition switch OFF.
2. Disconnect the battery cable from the negative terminal.
3. Check the following terminals and connectors for damage, bend and loose connection (connector side and harness side).
  - Harness connector B1
  - Harness connector M7
  - Harness connector M6
  - Harness connector E106

Is the inspection result normal?

YES >> GO TO 2.

NO >> Repair the terminal and connector.

#### 2. CHECK HARNESS CONTINUITY (OPEN CIRCUIT)

1. Disconnect the harness connectors B1 and M7.
2. Check the continuity between the harness connector terminals.

Connector No.	Terminal No.		Continuity
B1	20	22	Existed
	21	23	Existed

Is the inspection result normal?

YES >> GO TO 3.

NO >> Repair the main line between the 4WAS main control unit and the harness connector B1.

#### 3. CHECK HARNESS CONTINUITY (OPEN CIRCUIT)

1. Disconnect the harness connectors M6 and E106.
2. Check the continuity between the harness connectors.

Harness connector		Harness connector		Continuity
Connector No.	Terminal No.	Connector No.	Terminal No.	
M7	22	M6	49	Existed
	23		48	Existed

Is the inspection result normal?

YES >> GO TO 4.

NO >> Repair the main line between the harness connectors M7 and M6.

#### 4. CHECK HARNESS CONTINUITY (OPEN CIRCUIT)

1. Disconnect the connector of ABS actuator and electric unit (control unit).
2. Check the continuity between the harness connector and the ABS actuator and electric unit (control unit) harness connector.

Harness connector		ABS actuator and electric unit (control unit) harness connector		Continuity
Connector No.	Terminal No.	Connector No.	Terminal No.	
E106	49	E41	35	Existed
	48		14	Existed

Is the inspection result normal?

YES (Present error)>>Check CAN system type decision again.

YES (Past error)>>Error was detected in the main line between the 4WAS main control unit and the ABS actuator and electric unit (control unit).

A  
B  
C  
D  
E  
F  
G  
H  
I  
J  
K  
L  
N  
O  
P

LAN

## MAIN LINE BETWEEN RAS AND ABS CIRCUIT

< DTC/CIRCUIT DIAGNOSIS >

[CAN SYSTEM (TYPE 2)]

---

NO >> Repair the main line between the harness connector E106 and the ABS actuator and electric unit (control unit).

# ECM BRANCH LINE CIRCUIT

< DTC/CIRCUIT DIAGNOSIS >

[CAN SYSTEM (TYPE 2)]

## ECM BRANCH LINE CIRCUIT

### Diagnosis Procedure

INFOID:000000005779393

#### 1. CHECK CONNECTOR

1. Turn the ignition switch OFF.
2. Disconnect the battery cable from the negative terminal.
3. Check the terminals and connectors of the ECM for damage, bend and loose connection (unit side and connector side).

Is the inspection result normal?

- YES >> GO TO 2.  
NO >> Repair the terminal and connector.

#### 2. CHECK HARNESS FOR OPEN CIRCUIT

1. Disconnect the connector of ECM.
2. Check the resistance between the ECM harness connector terminals.

ECM harness connector			Resistance (Ω)
Connector No.	Terminal No.		
M107	114	113	Approx. 108 – 132

Is the measurement value within the specification?

- YES >> GO TO 3.  
NO >> Repair the ECM branch line.

#### 3. CHECK POWER SUPPLY AND GROUND CIRCUIT

Check the power supply and the ground circuit of the ECM. Refer to [EC-152, "Diagnosis Procedure"](#).

Is the inspection result normal?

YES (Present error)>>Replace the ECM. Refer to [EC-17, "ADDITIONAL SERVICE WHEN REPLACING CONTROL UNIT \(ECM\) : Special Repair Requirement"](#).

YES (Past error)>>Error was detected in the ECM branch line.

NO >> Repair the power supply and the ground circuit.

A  
B  
C  
D  
E  
F  
G  
H  
I  
J  
K  
L

LAN

N  
O  
P

# A-BAG BRANCH LINE CIRCUIT

< DTC/CIRCUIT DIAGNOSIS >

[CAN SYSTEM (TYPE 2)]

## A-BAG BRANCH LINE CIRCUIT

### Diagnosis Procedure

INFOID:000000005884785

#### **WARNING:**

- Before servicing, turn ignition switch OFF, disconnect battery negative terminal, and wait 3 minutes or more. (To discharge backup capacitor.)
- Never use unspecified tester or other measuring device.

#### **1.** CHECK CONNECTOR

---

1. Turn the ignition switch OFF.
2. Disconnect the battery cable from the negative terminal.
3. Check the terminals and connectors of the air bag diagnosis sensor unit for damage, bend and loose connection (unit side and connector side).

Is the inspection result normal?

YES >> GO TO 2.

NO >> Replace the terminal and connector.

#### **2.** CHECK AIR BAG DIAGNOSIS SENSOR UNIT

---

Check the air bag diagnosis sensor unit. Refer to [SRC-5, "Work Flow"](#).

Is the inspection result normal?

YES >> Replace the main harness.

NO >> Replace parts whose air bag system has a malfunction.



# BCM BRANCH LINE CIRCUIT

< DTC/CIRCUIT DIAGNOSIS >

[CAN SYSTEM (TYPE 2)]

## BCM BRANCH LINE CIRCUIT

### Diagnosis Procedure

INFOID:000000005779395

#### 1. CHECK CONNECTOR

1. Turn the ignition switch OFF.
2. Disconnect the battery cable from the negative terminal.
3. Check the terminals and connectors of the BCM for damage, bend and loose connection (unit side and connector side).

Is the inspection result normal?

- YES >> GO TO 2.  
NO >> Repair the terminal and connector.

#### 2. CHECK HARNESS FOR OPEN CIRCUIT

1. Disconnect the connector of BCM.
2. Check the resistance between the BCM harness connector terminals.

BCM harness connector			Resistance (Ω)
Connector No.	Terminal No.		
M122	91	90	Approx. 54 – 66

Is the measurement value within the specification?

- YES >> GO TO 3.  
NO >> Repair the BCM branch line.

#### 3. CHECK POWER SUPPLY AND GROUND CIRCUIT

Check the power supply and the ground circuit of the BCM. Refer to [BCS-37, "Diagnosis Procedure"](#).

Is the inspection result normal?

- YES (Present error)>>Replace the BCM. Refer to [BCS-78, "Exploded View"](#).  
YES (Past error)>>Error was detected in the BCM branch line.  
NO >> Repair the power supply and the ground circuit.

A  
B  
C  
D  
E  
F  
G  
H  
I  
J  
K  
L

LAN

N  
O  
P

# DLC BRANCH LINE CIRCUIT

< DTC/CIRCUIT DIAGNOSIS >

[CAN SYSTEM (TYPE 2)]

## DLC BRANCH LINE CIRCUIT

### Diagnosis Procedure

INFOID:000000005779396

#### 1. CHECK CONNECTOR

1. Turn the ignition switch OFF.
2. Disconnect the battery cable from the negative terminal.
3. Check the terminals and connectors of the data link connector for damage, bend and loose connection (connector side and harness side).

Is the inspection result normal?

- YES >> GO TO 2.  
NO >> Repair the terminal and connector.

#### 2. CHECK HARNESS FOR OPEN CIRCUIT

Check the resistance between the data link connector terminals.

Data link connector			Resistance ( $\Omega$ )
Connector No.	Terminal No.		
M24	6	14	Approx. 54 – 66

Is the measurement value within the specification?

- YES (Present error)>>Check CAN system type decision again.  
YES (Past error)>>Error was detected in the data link connector branch line circuit.  
NO >> Repair the data link connector branch line.

# M&A BRANCH LINE CIRCUIT

< DTC/CIRCUIT DIAGNOSIS >

[CAN SYSTEM (TYPE 2)]

## M&A BRANCH LINE CIRCUIT

### Diagnosis Procedure

INFOID:000000005779397

#### 1.CHECK CONNECTOR

1. Turn the ignition switch OFF.
2. Disconnect the battery cable from the negative terminal.
3. Check the terminals and connectors of the unified meter and A/C amp. for damage, bend and loose connection (unit side and connector side).

Is the inspection result normal?

- YES >> GO TO 2.  
NO >> Repair the terminal and connector.

#### 2.CHECK HARNESS FOR OPEN CIRCUIT

1. Disconnect the connector of unified meter and A/C amp.
2. Check the resistance between the unified meter and A/C amp. harness connector terminals.

Unified meter and A/C amp. harness connector			Resistance (Ω)
Connector No.	Terminal No.		
M67	56	72	Approx. 54 – 66

Is the measurement value within the specification?

- YES >> GO TO 3.  
NO >> Repair the unified meter and A/C amp. branch line.

#### 3.CHECK POWER SUPPLY AND GROUND CIRCUIT

Check the power supply and the ground circuit of the unified meter and A/C amp. Refer to [MWI-50, "UNIFIED METER AND A/C AMP. : Diagnosis Procedure"](#).

Is the inspection result normal?

- YES (Present error)>>Replace the unified meter and A/C amp. Refer to [MWI-130, "Exploded View"](#).  
YES (Past error)>>Error was detected in the unified meter and A/C amp. branch line.  
NO >> Repair the power supply and the ground circuit.

A  
B  
C  
D  
E  
F  
G  
H  
I  
J  
K  
L  
N  
O  
P

LAN

# STRG BRANCH LINE CIRCUIT

< DTC/CIRCUIT DIAGNOSIS >

[CAN SYSTEM (TYPE 2)]

## STRG BRANCH LINE CIRCUIT

### Diagnosis Procedure

INFOID:000000005779398

#### 1. CHECK CONNECTOR

1. Turn the ignition switch OFF.
2. Disconnect the battery cable from the negative terminal.
3. Check the terminals and connectors of the steering angle sensor for damage, bend and loose connection (unit side and connector side).

Is the inspection result normal?

- YES >> GO TO 2.  
NO >> Repair the terminal and connector.

#### 2. CHECK HARNESS FOR OPEN CIRCUIT

1. Disconnect the connector of steering angle sensor.
2. Check the resistance between the steering angle sensor harness connector terminals.

Steering angle sensor harness connector			Resistance (Ω)
Connector No.	Terminal No.		
M37	1	2	Approx. 54 – 66

Is the measurement value within the specification?

- YES >> GO TO 3.  
NO >> Repair the steering angle sensor branch line.

#### 3. CHECK POWER SUPPLY AND GROUND CIRCUIT

Check the power supply and the ground circuit of the steering angle sensor. Refer to [BRC-83, "Wiring Diagram - BRAKE CONTROL SYSTEM -"](#).

Is the inspection result normal?

- YES (Present error)>>Replace the steering angle sensor. Refer to [BRC-108, "Exploded View"](#).  
YES (Past error)>>Error was detected in the steering angle sensor branch line.  
NO >> Repair the power supply and the ground circuit.

## AV BRANCH LINE CIRCUIT

### Diagnosis Procedure

INFOID:000000005779400

#### 1. CHECK CONNECTOR

1. Turn the ignition switch OFF.
2. Disconnect the battery cable from the negative terminal.
3. Check the terminals and connectors of the AV control unit for damage, bend and loose connection (unit side and connector side).

Is the inspection result normal?

- YES >> GO TO 2.  
 NO >> Repair the terminal and connector.

#### 2. CHECK HARNESS FOR OPEN CIRCUIT

1. Disconnect the connector of AV control unit.
  2. Check the resistance between the AV control unit harness connector terminals.
- Without navigation system (Without rear view monitor)

AV control unit harness connector			Resistance (Ω)
Connector No.	Terminal No.		
M85	86	87	Approx. 54 – 66

- Without navigation system (With rear view monitor)

AV control unit harness connector			Resistance (Ω)
Connector No.	Terminal No.		
M204	81	80	Approx. 54 – 66

- With navigation system

AV control unit harness connector			Resistance (Ω)
Connector No.	Terminal No.		
M210	90	74	Approx. 54 – 66

Is the measurement value within the specification?

- YES >> GO TO 3.  
 NO >> Repair the AV control unit branch line.

#### 3. CHECK POWER SUPPLY AND GROUND CIRCUIT

Check the power supply and the ground circuit of the AV control unit. Refer to the following.

- Base audio without rear view camera: [AV-40, "AV CONTROL UNIT : Diagnosis Procedure"](#)
- Base audio with rear view camera: [AV-172, "AV CONTROL UNIT : Diagnosis Procedure"](#)
- BOSE audio without navigation: [AV-297, "AV CONTROL UNIT : Diagnosis Procedure"](#)
- BOSE audio with navigation: [AV-451, "AV CONTROL UNIT : Diagnosis Procedure"](#)

Is the inspection result normal?

- YES (Present error)>>Replace the AV control unit. Refer to the following.
- Base audio without rear view camera: [AV-89, "Exploded View"](#)
  - Base audio with rear view camera: [AV-201, "Exploded View"](#)
  - BOSE audio without navigation: [AV-328, "Exploded View"](#)
  - BOSE audio with navigation: [AV-477, "Exploded View"](#)

- YES (Past error)>>Error was detected in the AV control unit branch line.  
 NO >> Repair the power supply and the ground circuit.

A  
B  
C  
D  
E  
F  
G  
H  
I  
J  
K  
L

LAN

N  
O  
P

# ADP BRANCH LINE CIRCUIT

< DTC/CIRCUIT DIAGNOSIS >

[CAN SYSTEM (TYPE 2)]

## ADP BRANCH LINE CIRCUIT

### Diagnosis Procedure

INFOID:000000005779401

#### 1. CHECK CONNECTOR

1. Turn the ignition switch OFF.
2. Disconnect the battery cable from the negative terminal.
3. Check the following terminals and connectors for damage, bend and loose connection (unit side and connector side).
  - Models with automatic drive positioner
    - Driver seat control unit
    - Harness connector B502
    - Harness connector B11
  - Models without automatic drive positioner
    - Driver seat control unit
    - Harness connector B501
    - Harness connector B10

Is the inspection result normal?

YES >> GO TO 2.

NO >> Repair the terminal and connector.

#### 2. CHECK HARNESS FOR OPEN CIRCUIT

1. Disconnect the connector of driver seat control unit.
2. Check the resistance between the driver seat control unit harness connector terminals.

Driver seat control unit harness connector			Resistance (Ω)
Connector No.	Terminal No.		
B503	3	19	Approx. 54 – 66

Is the measurement value within the specification?

YES >> GO TO 3.

NO >> Repair the driver seat control unit branch line.

#### 3. CHECK POWER SUPPLY AND GROUND CIRCUIT

Check the power supply and the ground circuit of the driver seat control unit. Refer to [ADP-64. "DRIVER SEAT CONTROL UNIT : Diagnosis Procedure"](#).

Is the inspection result normal?

YES (Present error)>>Replace the driver seat control unit. Refer to [ADP-234. "Exploded View"](#).

YES (Past error)>>Error was detected in the driver seat control unit branch line.

NO >> Repair the power supply and the ground circuit.

# RAS BRANCH LINE CIRCUIT

< DTC/CIRCUIT DIAGNOSIS >

[CAN SYSTEM (TYPE 2)]

## RAS BRANCH LINE CIRCUIT

### Diagnosis Procedure

INFOID:000000005779402

#### 1. CHECK CONNECTOR

1. Turn the ignition switch OFF.
2. Disconnect the battery cable from the negative terminal.
3. Check the terminals and connectors of the 4WAS main control unit for damage, bend and loose connection (unit side and connector side).

Is the inspection result normal?

- YES >> GO TO 2.  
NO >> Repair the terminal and connector.

#### 2. CHECK HARNESS FOR OPEN CIRCUIT

1. Disconnect the connector of 4WAS main control unit.
2. Check the resistance between the 4WAS main control unit harness connector terminals.

4WAS main control unit harness connector			Resistance ( $\Omega$ )
Connector No.	Terminal No.		
B54	1	8	Approx. 54 – 66

Is the measurement value within the specification?

- YES >> GO TO 3.  
NO >> Replace the body harness.

#### 3. CHECK POWER SUPPLY AND GROUND CIRCUIT

Check the power supply and the ground circuit of the 4WAS main control unit. Refer to [STC-136, "Diagnosis Procedure \(4WAS Main Control Unit\)"](#).

Is the inspection result normal?

- YES (Present error)>>Replace the 4WAS main control unit. Refer to [STC-181, "Exploded View"](#).  
YES (Past error)>>Error was detected in the 4WAS main control unit branch line.  
NO >> Repair the power supply and the ground circuit.

A  
B  
C  
D  
E  
F  
G  
H  
I  
J  
K  
L

LAN

N  
O  
P

# ABS BRANCH LINE CIRCUIT

< DTC/CIRCUIT DIAGNOSIS >

[CAN SYSTEM (TYPE 2)]

## ABS BRANCH LINE CIRCUIT

### Diagnosis Procedure

INFOID:000000005779403

#### 1. CHECK CONNECTOR

1. Turn the ignition switch OFF.
2. Disconnect the battery cable from the negative terminal.
3. Check the terminals and connectors of the ABS actuator and electric unit (control unit) for damage, bend and loose connection (unit side and connector side).

Is the inspection result normal?

- YES >> GO TO 2.  
NO >> Repair the terminal and connector.

#### 2. CHECK HARNESS FOR OPEN CIRCUIT

1. Disconnect the connector of ABS actuator and electric unit (control unit).
2. Check the resistance between the ABS actuator and electric unit (control unit) harness connector terminals.

ABS actuator and electric unit (control unit) harness connector			Resistance (Ω)
Connector No.	Terminal No.		
E41	35	14	Approx. 54 – 66

Is the measurement value within the specification?

- YES >> GO TO 3.  
NO >> Repair the ABS actuator and electric unit (control unit) branch line.

#### 3. CHECK POWER SUPPLY AND GROUND CIRCUIT

Check the power supply and the ground circuit of the ABS actuator and electric unit (control unit). Refer to [BRC-69. "Diagnosis Procedure"](#).

Is the inspection result normal?

- YES (Present error)>>Replace the ABS actuator and electric unit (control unit). Refer to [BRC-105. "Exploded View"](#).  
YES (Past error)>>Error was detected in the ABS actuator and electric unit (control unit) branch line.  
NO >> Repair the power supply and the ground circuit.



# IPDM-E BRANCH LINE CIRCUIT

< DTC/CIRCUIT DIAGNOSIS >

[CAN SYSTEM (TYPE 2)]

## IPDM-E BRANCH LINE CIRCUIT

### Diagnosis Procedure

INFOID:000000005779405

#### 1. CHECK CONNECTOR

1. Turn the ignition switch OFF.
2. Disconnect the battery cable from the negative terminal.
3. Check the terminals and connectors of the IPDM E/R for damage, bend and loose connection (unit side and connector side).

Is the inspection result normal?

- YES >> GO TO 2.  
NO >> Repair the terminal and connector.

#### 2. CHECK HARNESS FOR OPEN CIRCUIT

1. Disconnect the connector of IPDM E/R.
2. Check the resistance between the IPDM E/R harness connector terminals.

IPDM E/R harness connector			Resistance (Ω)
Connector No.	Terminal No.		
E6	40	39	Approx. 108 – 132

Is the measurement value within the specification?

- YES >> GO TO 3.  
NO >> Repair the IPDM E/R branch line.

#### 3. CHECK POWER SUPPLY AND GROUND CIRCUIT

Check the power supply and the ground circuit of the IPDM E/R. Refer to [PCS-17, "Diagnosis Procedure"](#).

Is the inspection result normal?

- YES (Present error)>>Replace the IPDM E/R. Refer to [PCS-32, "Exploded View"](#).  
YES (Past error)>>Error was detected in the IPDM E/R branch line.  
NO >> Repair the power supply and the ground circuit.

A  
B  
C  
D  
E  
F  
G  
H  
I  
J  
K  
L

LAN

N  
O  
P

# CAN COMMUNICATION CIRCUIT

< DTC/CIRCUIT DIAGNOSIS >

[CAN SYSTEM (TYPE 2)]

## CAN COMMUNICATION CIRCUIT

### Diagnosis Procedure

INFOID:000000005779406

#### 1. CONNECTOR INSPECTION

1. Turn the ignition switch OFF.
2. Disconnect the battery cable from the negative terminal.
3. Disconnect all the unit connectors on CAN communication system.
4. Check terminals and connectors for damage, bend and loose connection.

Is the inspection result normal?

- YES >> GO TO 2.  
NO >> Repair the terminal and connector.

#### 2. CHECK HARNESS CONTINUITY (SHORT CIRCUIT)

Check the continuity between the data link connector terminals.

Data link connector		Continuity
Connector No.	Terminal No.	
M24	6 14	Not existed

Is the inspection result normal?

- YES >> GO TO 3.  
NO >> Check the harness and repair the root cause.

#### 3. CHECK HARNESS CONTINUITY (SHORT CIRCUIT)

Check the continuity between the data link connector and the ground.

Data link connector		Ground	Continuity
Connector No.	Terminal No.		
M24	6		Not existed
	14		Not existed

Is the inspection result normal?

- YES >> GO TO 4.  
NO >> Check the harness and repair the root cause.

#### 4. CHECK ECM AND IPDM E/R TERMINATION CIRCUIT

1. Remove the ECM and the IPDM E/R.
2. Check the resistance between the ECM terminals.

ECM		Resistance ( $\Omega$ )
Terminal No.		
114	113	Approx. 108 – 132

3. Check the resistance between the IPDM E/R terminals.

IPDM E/R		Resistance ( $\Omega$ )
Terminal No.		
40	39	Approx. 108 – 132

Is the measurement value within the specification?

- YES >> GO TO 5.  
NO >> Replace the ECM and/or the IPDM E/R.

#### 5. CHECK SYMPTOM

Connect all the connectors. Check if the symptoms described in the "Symptom (Results from interview with customer)" are reproduced.

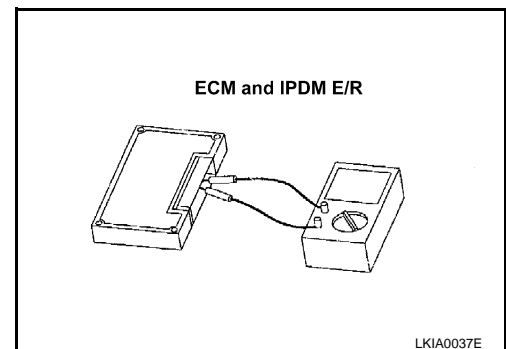

# CAN COMMUNICATION CIRCUIT

< DTC/CIRCUIT DIAGNOSIS >

[CAN SYSTEM (TYPE 2)]

## Inspection result

Reproduced>>GO TO 6.

Non-reproduced>>Start the diagnosis again. Follow the trouble diagnosis procedure when past error is detected.

## 6.CHECK UNIT REPRODUCTION

Perform the reproduction test as per the following procedure for each unit.

1. Turn the ignition switch OFF.
2. Disconnect the battery cable from the negative terminal.
3. Disconnect one of the unit connectors of CAN communication system.

### **NOTE:**

ECM and IPDM E/R have a termination circuit. Check other units first.

4. Connect the battery cable to the negative terminal. Check if the symptoms described in the "Symptom (Results from interview with customer)" are reproduced.

### **NOTE:**

Although unit-related error symptoms occur, do not confuse them with other symptoms.

## Inspection result

Reproduced>>Connect the connector. Check other units as per the above procedure.

Non-reproduced>>Replace the unit whose connector was disconnected.

A  
B  
C  
D  
E  
F  
G  
H  
I  
J  
K  
L

LAN

N  
O  
P

# MAIN LINE BETWEEN DLC AND AV CIRCUIT

< DTC/CIRCUIT DIAGNOSIS >

[CAN SYSTEM (TYPE 3)]

## DTC/CIRCUIT DIAGNOSIS

### MAIN LINE BETWEEN DLC AND AV CIRCUIT

#### Diagnosis Procedure

INFOID:000000005779407

#### 1. CHECK HARNESS CONTINUITY (OPEN CIRCUIT)

1. Turn the ignition switch OFF.
2. Disconnect the battery cable from the negative terminal.
3. Disconnect the following harness connectors.
  - ECM
  - AV control unit
4. Check the continuity between the data link connector and the AV control unit harness connector.
  - Without navigation system (Without rear view monitor)

Data link connector		AV control unit harness connector		Continuity
Connector No.	Terminal No.	Connector No.	Terminal No.	
M24	6	M85	86	Existed
	14		87	Existed

- Without navigation system (With rear view monitor)

Data link connector		AV control unit harness connector		Continuity
Connector No.	Terminal No.	Connector No.	Terminal No.	
M24	6	M204	81	Existed
	14		80	Existed

- With navigation system

Data link connector		AV control unit harness connector		Continuity
Connector No.	Terminal No.	Connector No.	Terminal No.	
M24	6	M210	90	Existed
	14		74	Existed

#### Is the inspection result normal?

YES (Present error)>>Check CAN system type decision again.

YES (Past error)>>Error was detected in the main line between the data link connector and the AV control unit.

NO >> Repair the main line between the data link connector and the AV control unit.

# MAIN LINE BETWEEN AV AND ADP CIRCUIT

< DTC/CIRCUIT DIAGNOSIS >

[CAN SYSTEM (TYPE 3)]

## MAIN LINE BETWEEN AV AND ADP CIRCUIT

### Diagnosis Procedure

INFOID:000000005779408

#### 1.CHECK CONNECTOR

1. Turn the ignition switch OFF.
2. Disconnect the battery cable from the negative terminal.
3. Check the following terminals and connectors for damage, bend and loose connection (connector side and harness side).
  - Harness connector M7
  - Harness connector B1

Is the inspection result normal?

YES >> GO TO 2.

NO >> Repair the terminal and connector.

#### 2.CHECK HARNESS CONTINUITY (OPEN CIRCUIT)

1. Disconnect the following harness connectors.
  - AV control unit
  - Harness connectors M7 and B1
2. Check the continuity between the AV control unit harness connector and harness connector.
  - Without navigation system (Without rear view monitor)

AV control unit harness connector		Harness connector		Continuity
Connector No.	Terminal No.	Connector No.	Terminal No.	
M85	86	M7	20	Existed
	87		21	Existed

- Without navigation system (With rear view monitor)

AV control unit harness connector		Harness connector		Continuity
Connector No.	Terminal No.	Connector No.	Terminal No.	
M204	81	M7	20	Existed
	80		21	Existed

- With navigation system

AV control unit harness connector		Harness connector		Continuity
Connector No.	Terminal No.	Connector No.	Terminal No.	
M210	90	M7	20	Existed
	74		21	Existed

Is the inspection result normal?

YES >> GO TO 3.

NO >> Repair the main line between the AV control unit and the harness connector M7.

#### 3.CHECK HARNESS CONTINUITY (OPEN CIRCUIT)

Check the continuity between the harness connector terminals.

Connector No.	Terminal No.		Continuity
B1	20	22	Existed
	21	23	Existed

Is the inspection result normal?

YES (Present error)>>Check CAN system type decision again.

YES (Past error)>>Error was detected in the main line between the AV control unit and the driver seat control unit.

NO >> Repair the main line between the harness connectors B1 and the driver seat control unit.

# MAIN LINE BETWEEN ADP AND ABS CIRCUIT

< DTC/CIRCUIT DIAGNOSIS >

[CAN SYSTEM (TYPE 3)]

## MAIN LINE BETWEEN ADP AND ABS CIRCUIT

### Diagnosis Procedure

INFOID:000000005779409

#### 1. CHECK CONNECTOR

1. Turn the ignition switch OFF.
2. Disconnect the battery cable from the negative terminal.
3. Check the following terminals and connectors for damage, bend and loose connection (connector side and harness side).
  - Harness connector B1
  - Harness connector M7
  - Harness connector M6
  - Harness connector E106

Is the inspection result normal?

YES >> GO TO 2.

NO >> Repair the terminal and connector.

#### 2. CHECK HARNESS CONTINUITY (OPEN CIRCUIT)

1. Disconnect the harness connectors B1 and M7.
2. Check the continuity between the harness connector terminals.

Connector No.	Terminal No.		Continuity
B1	20	22	Existed
	21	23	Existed

Is the inspection result normal?

YES >> GO TO 3.

NO >> Repair the main line between the driver seat control unit and the harness connector B1.

#### 3. CHECK HARNESS CONTINUITY (OPEN CIRCUIT)

1. Disconnect the harness connectors M6 and E106.
2. Check the continuity between the harness connectors.

Harness connector		Harness connector		Continuity
Connector No.	Terminal No.	Connector No.	Terminal No.	
M7	22	M6	49	Existed
	23		48	Existed

Is the inspection result normal?

YES >> GO TO 4.

NO >> Repair the main line between the harness connectors M7 and M6.

#### 4. CHECK HARNESS CONTINUITY (OPEN CIRCUIT)

1. Disconnect the connector of ABS actuator and electric unit (control unit).
2. Check the continuity between the harness connector and the ABS actuator and electric unit (control unit) harness connector.

Harness connector		ABS actuator and electric unit (control unit) harness connector		Continuity
Connector No.	Terminal No.	Connector No.	Terminal No.	
E106	49	E41	35	Existed
	48		14	Existed

Is the inspection result normal?

YES (Present error)>>Check CAN system type decision again.

YES (Past error)>>Error was detected in the main line between the driver seat control unit and the ABS actuator and electric unit (control unit).

# MAIN LINE BETWEEN ADP AND ABS CIRCUIT

< DTC/CIRCUIT DIAGNOSIS >

[CAN SYSTEM (TYPE 3)]

NO >> Repair the main line between the harness connector E106 and the ABS actuator and electric unit (control unit).

A

B

C

D

E

F

G

H

I

J

K

L

LAN

N

O

P

# ECM BRANCH LINE CIRCUIT

< DTC/CIRCUIT DIAGNOSIS >

[CAN SYSTEM (TYPE 3)]

## ECM BRANCH LINE CIRCUIT

### Diagnosis Procedure

INFOID:000000005779410

#### 1. CHECK CONNECTOR

1. Turn the ignition switch OFF.
2. Disconnect the battery cable from the negative terminal.
3. Check the terminals and connectors of the ECM for damage, bend and loose connection (unit side and connector side).

Is the inspection result normal?

- YES >> GO TO 2.  
NO >> Repair the terminal and connector.

#### 2. CHECK HARNESS FOR OPEN CIRCUIT

1. Disconnect the connector of ECM.
2. Check the resistance between the ECM harness connector terminals.

ECM harness connector			Resistance (Ω)
Connector No.	Terminal No.		
M107	114	113	Approx. 108 – 132

Is the measurement value within the specification?

- YES >> GO TO 3.  
NO >> Repair the ECM branch line.

#### 3. CHECK POWER SUPPLY AND GROUND CIRCUIT

Check the power supply and the ground circuit of the ECM. Refer to [EC-152. "Diagnosis Procedure"](#).

Is the inspection result normal?

- YES (Present error)>>Replace the ECM. Refer to [EC-17. "ADDITIONAL SERVICE WHEN REPLACING CONTROL UNIT \(ECM\) : Special Repair Requirement"](#).  
YES (Past error)>>Error was detected in the ECM branch line.  
NO >> Repair the power supply and the ground circuit.



# A-BAG BRANCH LINE CIRCUIT

< DTC/CIRCUIT DIAGNOSIS >

[CAN SYSTEM (TYPE 3)]

## A-BAG BRANCH LINE CIRCUIT

### Diagnosis Procedure

INFOID:000000005884788

#### **WARNING:**

- Before servicing, turn ignition switch OFF, disconnect battery negative terminal, and wait 3 minutes or more. (To discharge backup capacitor.)
- Never use unspecified tester or other measuring device.

#### **1**.CHECK CONNECTOR

1. Turn the ignition switch OFF.
2. Disconnect the battery cable from the negative terminal.
3. Check the terminals and connectors of the air bag diagnosis sensor unit for damage, bend and loose connection (unit side and connector side).

Is the inspection result normal?

- YES >> GO TO 2.  
NO >> Replace the terminal and connector.

#### **2**.CHECK AIR BAG DIAGNOSIS SENSOR UNIT

Check the air bag diagnosis sensor unit. Refer to [SRC-5, "Work Flow"](#).

Is the inspection result normal?

- YES >> Replace the main harness.  
NO >> Replace parts whose air bag system has a malfunction.

A  
B  
C  
D  
E  
F  
G  
H  
I  
J  
K  
L

LAN

N  
O  
P

# BCM BRANCH LINE CIRCUIT

< DTC/CIRCUIT DIAGNOSIS >

[CAN SYSTEM (TYPE 3)]

## BCM BRANCH LINE CIRCUIT

### Diagnosis Procedure

INFOID:000000005779412

#### 1. CHECK CONNECTOR

1. Turn the ignition switch OFF.
2. Disconnect the battery cable from the negative terminal.
3. Check the terminals and connectors of the BCM for damage, bend and loose connection (unit side and connector side).

Is the inspection result normal?

- YES >> GO TO 2.  
NO >> Repair the terminal and connector.

#### 2. CHECK HARNESS FOR OPEN CIRCUIT

1. Disconnect the connector of BCM.
2. Check the resistance between the BCM harness connector terminals.

BCM harness connector			Resistance (Ω)
Connector No.	Terminal No.		
M122	91	90	Approx. 54 – 66

Is the measurement value within the specification?

- YES >> GO TO 3.  
NO >> Repair the BCM branch line.

#### 3. CHECK POWER SUPPLY AND GROUND CIRCUIT

Check the power supply and the ground circuit of the BCM. Refer to [BCS-37, "Diagnosis Procedure"](#).

Is the inspection result normal?

- YES (Present error)>>Replace the BCM. Refer to [BCS-78, "Exploded View"](#).  
YES (Past error)>>Error was detected in the BCM branch line.  
NO >> Repair the power supply and the ground circuit.

# DLC BRANCH LINE CIRCUIT

< DTC/CIRCUIT DIAGNOSIS >

[CAN SYSTEM (TYPE 3)]

## DLC BRANCH LINE CIRCUIT

### Diagnosis Procedure

INFOID:000000005779413

#### 1. CHECK CONNECTOR

1. Turn the ignition switch OFF.
2. Disconnect the battery cable from the negative terminal.
3. Check the terminals and connectors of the data link connector for damage, bend and loose connection (connector side and harness side).

Is the inspection result normal?

- YES >> GO TO 2.  
NO >> Repair the terminal and connector.

#### 2. CHECK HARNESS FOR OPEN CIRCUIT

Check the resistance between the data link connector terminals.

Data link connector			Resistance (Ω)
Connector No.	Terminal No.		
M24	6	14	Approx. 54 – 66

Is the measurement value within the specification?

- YES (Present error)>>Check CAN system type decision again.  
YES (Past error)>>Error was detected in the data link connector branch line circuit.  
NO >> Repair the data link connector branch line.

A  
B  
C  
D  
E  
F  
G  
H  
I  
J  
K  
L  
N  
O  
P

LAN

## M&A BRANCH LINE CIRCUIT

### Diagnosis Procedure

INFOID:000000005779414

#### 1. CHECK CONNECTOR

1. Turn the ignition switch OFF.
2. Disconnect the battery cable from the negative terminal.
3. Check the terminals and connectors of the unified meter and A/C amp. for damage, bend and loose connection (unit side and connector side).

Is the inspection result normal?

- YES >> GO TO 2.  
 NO >> Repair the terminal and connector.

#### 2. CHECK HARNESS FOR OPEN CIRCUIT

1. Disconnect the connector of unified meter and A/C amp.
2. Check the resistance between the unified meter and A/C amp. harness connector terminals.

Unified meter and A/C amp. harness connector			Resistance (Ω)
Connector No.	Terminal No.		
M67	56	72	Approx. 54 – 66

Is the measurement value within the specification?

- YES >> GO TO 3.  
 NO >> Repair the unified meter and A/C amp. branch line.

#### 3. CHECK POWER SUPPLY AND GROUND CIRCUIT

Check the power supply and the ground circuit of the unified meter and A/C amp. Refer to [MWI-50, "UNIFIED METER AND A/C AMP. : Diagnosis Procedure"](#).

Is the inspection result normal?

- YES (Present error)>>Replace the unified meter and A/C amp. Refer to [MWI-130, "Exploded View"](#).  
 YES (Past error)>>Error was detected in the unified meter and A/C amp. branch line.  
 NO >> Repair the power supply and the ground circuit.

# STRG BRANCH LINE CIRCUIT

< DTC/CIRCUIT DIAGNOSIS >

[CAN SYSTEM (TYPE 3)]

## STRG BRANCH LINE CIRCUIT

### Diagnosis Procedure

INFOID:000000005779415

#### 1. CHECK CONNECTOR

1. Turn the ignition switch OFF.
2. Disconnect the battery cable from the negative terminal.
3. Check the terminals and connectors of the steering angle sensor for damage, bend and loose connection (unit side and connector side).

Is the inspection result normal?

- YES >> GO TO 2.  
NO >> Repair the terminal and connector.

#### 2. CHECK HARNESS FOR OPEN CIRCUIT

1. Disconnect the connector of steering angle sensor.
2. Check the resistance between the steering angle sensor harness connector terminals.

Steering angle sensor harness connector			Resistance (Ω)
Connector No.	Terminal No.		
M37	1	2	Approx. 54 – 66

Is the measurement value within the specification?

- YES >> GO TO 3.  
NO >> Repair the steering angle sensor branch line.

#### 3. CHECK POWER SUPPLY AND GROUND CIRCUIT

Check the power supply and the ground circuit of the steering angle sensor. Refer to [BRC-83, "Wiring Diagram - BRAKE CONTROL SYSTEM -"](#).

Is the inspection result normal?

- YES (Present error)>>Replace the steering angle sensor. Refer to [BRC-108, "Exploded View"](#).  
YES (Past error)>>Error was detected in the steering angle sensor branch line.  
NO >> Repair the power supply and the ground circuit.

A  
B  
C  
D  
E  
F  
G  
H  
I  
J  
K  
L

LAN

N  
O  
P

## AV BRANCH LINE CIRCUIT

### Diagnosis Procedure

INFOID:000000005779417

#### 1. CHECK CONNECTOR

1. Turn the ignition switch OFF.
2. Disconnect the battery cable from the negative terminal.
3. Check the terminals and connectors of the AV control unit for damage, bend and loose connection (unit side and connector side).

Is the inspection result normal?

- YES >> GO TO 2.  
 NO >> Repair the terminal and connector.

#### 2. CHECK HARNESS FOR OPEN CIRCUIT

1. Disconnect the connector of AV control unit.
2. Check the resistance between the AV control unit harness connector terminals.
  - Without navigation system (Without rear view monitor)

AV control unit harness connector			Resistance (Ω)
Connector No.	Terminal No.		
M85	86	87	Approx. 54 – 66

- Without navigation system (With rear view monitor)

AV control unit harness connector			Resistance (Ω)
Connector No.	Terminal No.		
M204	81	80	Approx. 54 – 66

- With navigation system

AV control unit harness connector			Resistance (Ω)
Connector No.	Terminal No.		
M210	90	74	Approx. 54 – 66

Is the measurement value within the specification?

- YES >> GO TO 3.  
 NO >> Repair the AV control unit branch line.

#### 3. CHECK POWER SUPPLY AND GROUND CIRCUIT

Check the power supply and the ground circuit of the AV control unit. Refer to the following.

- Base audio without rear view camera: [AV-40, "AV CONTROL UNIT : Diagnosis Procedure"](#)
- Base audio with rear view camera: [AV-172, "AV CONTROL UNIT : Diagnosis Procedure"](#)
- BOSE audio without navigation: [AV-297, "AV CONTROL UNIT : Diagnosis Procedure"](#)
- BOSE audio with navigation: [AV-451, "AV CONTROL UNIT : Diagnosis Procedure"](#)

Is the inspection result normal?

- YES (Present error)>>Replace the AV control unit. Refer to the following.
- Base audio without rear view camera: [AV-89, "Exploded View"](#)
  - Base audio with rear view camera: [AV-201, "Exploded View"](#)
  - BOSE audio without navigation: [AV-328, "Exploded View"](#)
  - BOSE audio with navigation: [AV-477, "Exploded View"](#)

YES (Past error)>>Error was detected in the AV control unit branch line.

- NO >> Repair the power supply and the ground circuit.

# PSB BRANCH LINE CIRCUIT

< DTC/CIRCUIT DIAGNOSIS >

[CAN SYSTEM (TYPE 3)]

## PSB BRANCH LINE CIRCUIT

### Diagnosis Procedure

INFOID:000000005779418

#### 1. CHECK CONNECTOR

1. Turn the ignition switch OFF.
2. Disconnect the battery cable from the negative terminal.
3. Check the terminals and connectors of the pre-crash seat belt for damage, bend and loose connection (unit side and connector side).

Is the inspection result normal?

- YES >> GO TO 2.  
NO >> Repair the terminal and connector.

#### 2. CHECK HARNESS FOR OPEN CIRCUIT

1. Disconnect the connector of pre-crash seat belt control unit.
2. Check the resistance between the pre-crash seat belt control unit harness connector terminals.

Pre-crash seat belt control unit harness connector			Resistance (Ω)
Connector No.	Terminal No.		
M110	24	22	Approx. 54 – 66

Is the measurement value within the specification?

- YES >> GO TO 3.  
NO >> Repair the pre-crash seat belt control unit branch line.

#### 3. CHECK POWER SUPPLY AND GROUND CIRCUIT

Check the power supply and the ground circuit of the pre-crash seat belt control unit. Refer to [SBC-24, "Diagnosis Procedure"](#).

Is the inspection result normal?

- YES (Present error)>>Replace the pre-crash seat belt control unit. Refer to [SBC-39, "Exploded View"](#).  
YES (Past error)>>Error was detected in the pre-crash seat belt control unit branch line.  
NO >> Repair the power supply and the ground circuit.

A  
B  
C  
D  
E  
F  
G  
H  
I  
J  
K  
L

LAN

N  
O  
P

# ADP BRANCH LINE CIRCUIT

< DTC/CIRCUIT DIAGNOSIS >

[CAN SYSTEM (TYPE 3)]

## ADP BRANCH LINE CIRCUIT

### Diagnosis Procedure

INFOID:000000005779419

#### 1. CHECK CONNECTOR

1. Turn the ignition switch OFF.
2. Disconnect the battery cable from the negative terminal.
3. Check the following terminals and connectors for damage, bend and loose connection (unit side and connector side).
  - Models with automatic drive positioner
    - Driver seat control unit
    - Harness connector B502
    - Harness connector B11
  - Models without automatic drive positioner
    - Driver seat control unit
    - Harness connector B501
    - Harness connector B10

Is the inspection result normal?

YES >> GO TO 2.

NO >> Repair the terminal and connector.

#### 2. CHECK HARNESS FOR OPEN CIRCUIT

1. Disconnect the connector of driver seat control unit.
2. Check the resistance between the driver seat control unit harness connector terminals.

Driver seat control unit harness connector			Resistance ( $\Omega$ )
Connector No.	Terminal No.		
B503	3	19	Approx. 54 – 66

Is the measurement value within the specification?

YES >> GO TO 3.

NO >> Repair the driver seat control unit branch line.

#### 3. CHECK POWER SUPPLY AND GROUND CIRCUIT

Check the power supply and the ground circuit of the driver seat control unit. Refer to [ADP-64. "DRIVER SEAT CONTROL UNIT : Diagnosis Procedure"](#).

Is the inspection result normal?

YES (Present error)>>Replace the driver seat control unit. Refer to [ADP-234. "Exploded View"](#).

YES (Past error)>>Error was detected in the driver seat control unit branch line.

NO >> Repair the power supply and the ground circuit.



# ABS BRANCH LINE CIRCUIT

< DTC/CIRCUIT DIAGNOSIS >

[CAN SYSTEM (TYPE 3)]

## ABS BRANCH LINE CIRCUIT

### Diagnosis Procedure

INFOID:000000005779420

#### 1. CHECK CONNECTOR

1. Turn the ignition switch OFF.
2. Disconnect the battery cable from the negative terminal.
3. Check the terminals and connectors of the ABS actuator and electric unit (control unit) for damage, bend and loose connection (unit side and connector side).

Is the inspection result normal?

- YES >> GO TO 2.  
NO >> Repair the terminal and connector.

#### 2. CHECK HARNESS FOR OPEN CIRCUIT

1. Disconnect the connector of ABS actuator and electric unit (control unit).
2. Check the resistance between the ABS actuator and electric unit (control unit) harness connector terminals.

ABS actuator and electric unit (control unit) harness connector			Resistance (Ω)
Connector No.	Terminal No.		
E41	35	14	Approx. 54 – 66

Is the measurement value within the specification?

- YES >> GO TO 3.  
NO >> Repair the ABS actuator and electric unit (control unit) branch line.

#### 3. CHECK POWER SUPPLY AND GROUND CIRCUIT

Check the power supply and the ground circuit of the ABS actuator and electric unit (control unit). Refer to [BRC-69, "Diagnosis Procedure"](#).

Is the inspection result normal?

- YES (Present error)>>Replace the ABS actuator and electric unit (control unit). Refer to [BRC-105, "Exploded View"](#).  
YES (Past error)>>Error was detected in the ABS actuator and electric unit (control unit) branch line.  
NO >> Repair the power supply and the ground circuit.

A  
B  
C  
D  
E  
F  
G  
H  
I  
J  
K  
L

LAN

## ICC BRANCH LINE CIRCUIT

### Diagnosis Procedure

INFOID:000000005779421

#### 1. CHECK CONNECTOR

1. Turn the ignition switch OFF.
2. Disconnect the battery cable from the negative terminal.
3. Check the terminals and connectors of the ICC sensor integrated unit for damage, bend and loose connection (unit side and connector side).

Is the inspection result normal?

- YES >> GO TO 2.  
 NO >> Repair the terminal and connector.

#### 2. CHECK HARNESS FOR OPEN CIRCUIT

1. Disconnect the connector of ICC sensor integrated unit.
2. Check the resistance between the ICC sensor integrated unit harness connector terminals.

ICC sensor integrated unit harness connector			Resistance (Ω)
Connector No.	Terminal No.		
E67	3	6	Approx. 54 – 66

Is the measurement value within the specification?

- YES >> GO TO 3.  
 NO >> Repair the ICC sensor integrated unit branch line.

#### 3. CHECK POWER SUPPLY AND GROUND CIRCUIT

Check the power supply and the ground circuit of the ICC sensor integrated unit. Refer to [CCS-102, "Diagnosis Procedure"](#).

Is the inspection result normal?

- YES (Present error)>>Replace the ICC sensor integrated unit. Refer to [CCS-133, "Exploded View"](#).  
 YES (Past error)>>Error was detected in the ICC sensor integrated unit branch line.  
 NO >> Repair the power supply and the ground circuit.

# IPDM-E BRANCH LINE CIRCUIT

< DTC/CIRCUIT DIAGNOSIS >

[CAN SYSTEM (TYPE 3)]

## IPDM-E BRANCH LINE CIRCUIT

### Diagnosis Procedure

INFOID:000000005779422

#### 1.CHECK CONNECTOR

1. Turn the ignition switch OFF.
2. Disconnect the battery cable from the negative terminal.
3. Check the terminals and connectors of the IPDM E/R for damage, bend and loose connection (unit side and connector side).

Is the inspection result normal?

- YES >> GO TO 2.  
NO >> Repair the terminal and connector.

#### 2.CHECK HARNESS FOR OPEN CIRCUIT

1. Disconnect the connector of IPDM E/R.
2. Check the resistance between the IPDM E/R harness connector terminals.

IPDM E/R harness connector			Resistance (Ω)
Connector No.	Terminal No.		
E6	40	39	Approx. 108 – 132

Is the measurement value within the specification?

- YES >> GO TO 3.  
NO >> Repair the IPDM E/R branch line.

#### 3.CHECK POWER SUPPLY AND GROUND CIRCUIT

Check the power supply and the ground circuit of the IPDM E/R. Refer to [PCS-17, "Diagnosis Procedure"](#).

Is the inspection result normal?

- YES (Present error)>>Replace the IPDM E/R. Refer to [PCS-32, "Exploded View"](#).  
YES (Past error)>>Error was detected in the IPDM E/R branch line.  
NO >> Repair the power supply and the ground circuit.

A  
B  
C  
D  
E  
F  
G  
H  
I  
J  
K  
L

LAN

N  
O  
P

# CAN COMMUNICATION CIRCUIT

< DTC/CIRCUIT DIAGNOSIS >

[CAN SYSTEM (TYPE 3)]

## CAN COMMUNICATION CIRCUIT

### Diagnosis Procedure

INFOID:000000005779423

#### 1. CONNECTOR INSPECTION

1. Turn the ignition switch OFF.
2. Disconnect the battery cable from the negative terminal.
3. Disconnect all the unit connectors on CAN communication system.
4. Check terminals and connectors for damage, bend and loose connection.

Is the inspection result normal?

- YES >> GO TO 2.  
NO >> Repair the terminal and connector.

#### 2. CHECK HARNESS CONTINUITY (SHORT CIRCUIT)

Check the continuity between the data link connector terminals.

Data link connector		Continuity
Connector No.	Terminal No.	
M24	6 14	Not existed

Is the inspection result normal?

- YES >> GO TO 3.  
NO >> Check the harness and repair the root cause.

#### 3. CHECK HARNESS CONTINUITY (SHORT CIRCUIT)

Check the continuity between the data link connector and the ground.

Data link connector		Ground	Continuity
Connector No.	Terminal No.		
M24	6		Not existed
	14		Not existed

Is the inspection result normal?

- YES >> GO TO 4.  
NO >> Check the harness and repair the root cause.

#### 4. CHECK ECM AND IPDM E/R TERMINATION CIRCUIT

1. Remove the ECM and the IPDM E/R.
2. Check the resistance between the ECM terminals.

ECM		Resistance ( $\Omega$ )
Terminal No.		
114	113	Approx. 108 – 132

3. Check the resistance between the IPDM E/R terminals.

IPDM E/R		Resistance ( $\Omega$ )
Terminal No.		
40	39	Approx. 108 – 132

Is the measurement value within the specification?

- YES >> GO TO 5.  
NO >> Replace the ECM and/or the IPDM E/R.

#### 5. CHECK SYMPTOM

Connect all the connectors. Check if the symptoms described in the "Symptom (Results from interview with customer)" are reproduced.

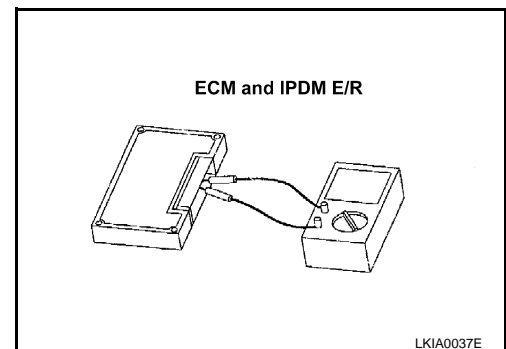

# CAN COMMUNICATION CIRCUIT

< DTC/CIRCUIT DIAGNOSIS >

[CAN SYSTEM (TYPE 3)]

## Inspection result

Reproduced>>GO TO 6.

Non-reproduced>>Start the diagnosis again. Follow the trouble diagnosis procedure when past error is detected.

## 6.CHECK UNIT REPRODUCTION

Perform the reproduction test as per the following procedure for each unit.

1. Turn the ignition switch OFF.
2. Disconnect the battery cable from the negative terminal.
3. Disconnect one of the unit connectors of CAN communication system.

### **NOTE:**

ECM and IPDM E/R have a termination circuit. Check other units first.

4. Connect the battery cable to the negative terminal. Check if the symptoms described in the "Symptom (Results from interview with customer)" are reproduced.

### **NOTE:**

Although unit-related error symptoms occur, do not confuse them with other symptoms.

## Inspection result

Reproduced>>Connect the connector. Check other units as per the above procedure.

Non-reproduced>>Replace the unit whose connector was disconnected.

A  
B  
C  
D  
E  
F  
G  
H  
I  
J  
K  
L

LAN

N  
O  
P

# MAIN LINE BETWEEN DLC AND AV CIRCUIT

< DTC/CIRCUIT DIAGNOSIS >

[CAN SYSTEM (TYPE 4)]

## DTC/CIRCUIT DIAGNOSIS

### MAIN LINE BETWEEN DLC AND AV CIRCUIT

#### Diagnosis Procedure

INFOID:000000005779430

#### 1. CHECK HARNESS CONTINUITY (OPEN CIRCUIT)

1. Turn the ignition switch OFF.
2. Disconnect the battery cable from the negative terminal.
3. Disconnect the following harness connectors.
  - ECM
  - AV control unit
4. Check the continuity between the data link connector and the AV control unit harness connector.
  - Without navigation system (Without rear view monitor)

Data link connector		AV control unit harness connector		Continuity
Connector No.	Terminal No.	Connector No.	Terminal No.	
M24	6	M85	86	Existed
	14		87	Existed

- Without navigation system (With rear view monitor)

Data link connector		AV control unit harness connector		Continuity
Connector No.	Terminal No.	Connector No.	Terminal No.	
M24	6	M204	81	Existed
	14		80	Existed

- With navigation system

Data link connector		AV control unit harness connector		Continuity
Connector No.	Terminal No.	Connector No.	Terminal No.	
M24	6	M210	90	Existed
	14		74	Existed

#### Is the inspection result normal?

YES (Present error)>>Check CAN system type decision again.

YES (Past error)>>Error was detected in the main line between the data link connector and the AV control unit.

NO >> Repair the main line between the data link connector and the AV control unit.

# MAIN LINE BETWEEN AV AND ADP CIRCUIT

< DTC/CIRCUIT DIAGNOSIS >

[CAN SYSTEM (TYPE 4)]

## MAIN LINE BETWEEN AV AND ADP CIRCUIT

### Diagnosis Procedure

INFOID:000000005779431

#### 1. CHECK CONNECTOR

1. Turn the ignition switch OFF.
2. Disconnect the battery cable from the negative terminal.
3. Check the following terminals and connectors for damage, bend and loose connection (connector side and harness side).
  - Harness connector M7
  - Harness connector B1

Is the inspection result normal?

YES >> GO TO 2.

NO >> Repair the terminal and connector.

#### 2. CHECK HARNESS CONTINUITY (OPEN CIRCUIT)

1. Disconnect the following harness connectors.
  - AV control unit
  - Harness connectors M7 and B1
2. Check the continuity between the AV control unit harness connector and harness connector.
  - Without navigation system (Without rear view monitor)

AV control unit harness connector		Harness connector		Continuity
Connector No.	Terminal No.	Connector No.	Terminal No.	
M85	86	M7	20	Existed
	87		21	Existed

- Without navigation system (With rear view monitor)

AV control unit harness connector		Harness connector		Continuity
Connector No.	Terminal No.	Connector No.	Terminal No.	
M204	81	M7	20	Existed
	80		21	Existed

- With navigation system

AV control unit harness connector		Harness connector		Continuity
Connector No.	Terminal No.	Connector No.	Terminal No.	
M210	90	M7	20	Existed
	74		21	Existed

Is the inspection result normal?

YES >> GO TO 3.

NO >> Repair the main line between the AV control unit and the harness connector M7.

#### 3. CHECK HARNESS CONTINUITY (OPEN CIRCUIT)

Check the continuity between the harness connector terminals.

Connector No.	Terminal No.		Continuity
B1	20	22	Existed
	21	23	Existed

Is the inspection result normal?

YES (Present error)>>Check CAN system type decision again.

YES (Past error)>>Error was detected in the main line between the AV control unit and the driver seat control unit.

NO >> Repair the main line between the harness connectors B1 and the driver seat control unit.

# MAIN LINE BETWEEN ADP AND RAS CIRCUIT

< DTC/CIRCUIT DIAGNOSIS >

[CAN SYSTEM (TYPE 4)]

## MAIN LINE BETWEEN ADP AND RAS CIRCUIT

### Diagnosis Procedure

INFOID:000000005779432

#### 1. CHECK HARNESS CONTINUITY (OPEN CIRCUIT)

1. Turn the ignition switch OFF.
2. Disconnect the battery cable from the negative terminal.
3. Disconnect the harness connectors M7 and B1.
4. Check the continuity between the harness connector terminals.

Connector No.	Terminal No.		Continuity
B1	20	22	Existed
	21	23	Existed

#### Is the inspection result normal?

YES (Present error)>>Check CAN system type decision again.

YES (Past error)>>Error was detected in the main line between the driver seat control unit and the 4WAS main control unit.

NO >> Repair the main line between the driver seat control unit and the 4WAS main control unit.



# MAIN LINE BETWEEN RAS AND ABS CIRCUIT

< DTC/CIRCUIT DIAGNOSIS >

[CAN SYSTEM (TYPE 4)]

## MAIN LINE BETWEEN RAS AND ABS CIRCUIT

### Diagnosis Procedure

INFOID:000000005779433

#### 1.CHECK CONNECTOR

1. Turn the ignition switch OFF.
2. Disconnect the battery cable from the negative terminal.
3. Check the following terminals and connectors for damage, bend and loose connection (connector side and harness side).
  - Harness connector B1
  - Harness connector M7
  - Harness connector M6
  - Harness connector E106

Is the inspection result normal?

YES >> GO TO 2.

NO >> Repair the terminal and connector.

#### 2.CHECK HARNESS CONTINUITY (OPEN CIRCUIT)

1. Disconnect the harness connectors B1 and M7.
2. Check the continuity between the harness connector terminals.

Connector No.	Terminal No.		Continuity
B1	20	22	Existed
	21	23	Existed

Is the inspection result normal?

YES >> GO TO 3.

NO >> Repair the main line between the 4WAS main control unit and the harness connector B1.

#### 3.CHECK HARNESS CONTINUITY (OPEN CIRCUIT)

1. Disconnect the harness connectors M6 and E106.
2. Check the continuity between the harness connectors.

Harness connector		Harness connector		Continuity
Connector No.	Terminal No.	Connector No.	Terminal No.	
M7	22	M6	49	Existed
	23		48	Existed

Is the inspection result normal?

YES >> GO TO 4.

NO >> Repair the main line between the harness connectors M7 and M6.

#### 4.CHECK HARNESS CONTINUITY (OPEN CIRCUIT)

1. Disconnect the connector of ABS actuator and electric unit (control unit).
2. Check the continuity between the harness connector and the ABS actuator and electric unit (control unit) harness connector.

Harness connector		ABS actuator and electric unit (control unit) harness connector		Continuity
Connector No.	Terminal No.	Connector No.	Terminal No.	
E106	49	E41	35	Existed
	48		14	Existed

Is the inspection result normal?

YES (Present error)>>Check CAN system type decision again.

YES (Past error)>>Error was detected in the main line between the 4WAS main control unit and the ABS actuator and electric unit (control unit).

A  
B  
C  
D  
E  
F  
G  
H  
I  
J  
K  
L  
N  
O  
P

LAN

## MAIN LINE BETWEEN RAS AND ABS CIRCUIT

< DTC/CIRCUIT DIAGNOSIS >

[CAN SYSTEM (TYPE 4)]

---

NO >> Repair the main line between the harness connector E106 and the ABS actuator and electric unit (control unit).

# ECM BRANCH LINE CIRCUIT

< DTC/CIRCUIT DIAGNOSIS >

[CAN SYSTEM (TYPE 4)]

## ECM BRANCH LINE CIRCUIT

### Diagnosis Procedure

INFOID:000000005779440

#### 1. CHECK CONNECTOR

1. Turn the ignition switch OFF.
2. Disconnect the battery cable from the negative terminal.
3. Check the terminals and connectors of the ECM for damage, bend and loose connection (unit side and connector side).

Is the inspection result normal?

- YES >> GO TO 2.  
NO >> Repair the terminal and connector.

#### 2. CHECK HARNESS FOR OPEN CIRCUIT

1. Disconnect the connector of ECM.
2. Check the resistance between the ECM harness connector terminals.

ECM harness connector			Resistance (Ω)
Connector No.	Terminal No.		
M107	114	113	Approx. 108 – 132

Is the measurement value within the specification?

- YES >> GO TO 3.  
NO >> Repair the ECM branch line.

#### 3. CHECK POWER SUPPLY AND GROUND CIRCUIT

Check the power supply and the ground circuit of the ECM. Refer to [EC-152, "Diagnosis Procedure"](#).

Is the inspection result normal?

YES (Present error)>>Replace the ECM. Refer to [EC-17, "ADDITIONAL SERVICE WHEN REPLACING CONTROL UNIT \(ECM\) : Special Repair Requirement"](#).

YES (Past error)>>Error was detected in the ECM branch line.

NO >> Repair the power supply and the ground circuit.

A  
B  
C  
D  
E  
F  
G  
H  
I  
J  
K  
L

LAN

# A-BAG BRANCH LINE CIRCUIT

< DTC/CIRCUIT DIAGNOSIS >

[CAN SYSTEM (TYPE 4)]

## A-BAG BRANCH LINE CIRCUIT

### Diagnosis Procedure

INFOID:000000005884794

#### **WARNING:**

- Before servicing, turn ignition switch OFF, disconnect battery negative terminal, and wait 3 minutes or more. (To discharge backup capacitor.)
- Never use unspecified tester or other measuring device.

#### **1**.CHECK CONNECTOR

---

1. Turn the ignition switch OFF.
2. Disconnect the battery cable from the negative terminal.
3. Check the terminals and connectors of the air bag diagnosis sensor unit for damage, bend and loose connection (unit side and connector side).

Is the inspection result normal?

YES >> GO TO 2.

NO >> Replace the terminal and connector.

#### **2**.CHECK AIR BAG DIAGNOSIS SENSOR UNIT

---

Check the air bag diagnosis sensor unit. Refer to [SRC-5, "Work Flow"](#).

Is the inspection result normal?

YES >> Replace the main harness.

NO >> Replace parts whose air bag system has a malfunction.

# BCM BRANCH LINE CIRCUIT

< DTC/CIRCUIT DIAGNOSIS >

[CAN SYSTEM (TYPE 4)]

## BCM BRANCH LINE CIRCUIT

### Diagnosis Procedure

INFOID:000000005779442

#### 1. CHECK CONNECTOR

1. Turn the ignition switch OFF.
2. Disconnect the battery cable from the negative terminal.
3. Check the terminals and connectors of the BCM for damage, bend and loose connection (unit side and connector side).

Is the inspection result normal?

- YES >> GO TO 2.  
NO >> Repair the terminal and connector.

#### 2. CHECK HARNESS FOR OPEN CIRCUIT

1. Disconnect the connector of BCM.
2. Check the resistance between the BCM harness connector terminals.

BCM harness connector			Resistance (Ω)
Connector No.	Terminal No.		
M122	91	90	Approx. 54 – 66

Is the measurement value within the specification?

- YES >> GO TO 3.  
NO >> Repair the BCM branch line.

#### 3. CHECK POWER SUPPLY AND GROUND CIRCUIT

Check the power supply and the ground circuit of the BCM. Refer to [BCS-37, "Diagnosis Procedure"](#).

Is the inspection result normal?

- YES (Present error)>>Replace the BCM. Refer to [BCS-78, "Exploded View"](#).  
YES (Past error)>>Error was detected in the BCM branch line.  
NO >> Repair the power supply and the ground circuit.

A  
B  
C  
D  
E  
F  
G  
H  
I  
J  
K  
L

LAN

N  
O  
P

# DLC BRANCH LINE CIRCUIT

< DTC/CIRCUIT DIAGNOSIS >

[CAN SYSTEM (TYPE 4)]

## DLC BRANCH LINE CIRCUIT

### Diagnosis Procedure

INFOID:000000005779443

#### 1. CHECK CONNECTOR

1. Turn the ignition switch OFF.
2. Disconnect the battery cable from the negative terminal.
3. Check the terminals and connectors of the data link connector for damage, bend and loose connection (connector side and harness side).

Is the inspection result normal?

- YES >> GO TO 2.  
NO >> Repair the terminal and connector.

#### 2. CHECK HARNESS FOR OPEN CIRCUIT

Check the resistance between the data link connector terminals.

Data link connector			Resistance ( $\Omega$ )
Connector No.	Terminal No.		
M24	6	14	Approx. 54 – 66

Is the measurement value within the specification?

- YES (Present error)>>Check CAN system type decision again.  
YES (Past error)>>Error was detected in the data link connector branch line circuit.  
NO >> Repair the data link connector branch line.

## M&A BRANCH LINE CIRCUIT

### Diagnosis Procedure

INFOID:000000005779444

#### 1. CHECK CONNECTOR

1. Turn the ignition switch OFF.
2. Disconnect the battery cable from the negative terminal.
3. Check the terminals and connectors of the unified meter and A/C amp. for damage, bend and loose connection (unit side and connector side).

Is the inspection result normal?

- YES >> GO TO 2.  
 NO >> Repair the terminal and connector.

#### 2. CHECK HARNESS FOR OPEN CIRCUIT

1. Disconnect the connector of unified meter and A/C amp.
2. Check the resistance between the unified meter and A/C amp. harness connector terminals.

Unified meter and A/C amp. harness connector			Resistance (Ω)
Connector No.	Terminal No.		
M67	56	72	Approx. 54 – 66

Is the measurement value within the specification?

- YES >> GO TO 3.  
 NO >> Repair the unified meter and A/C amp. branch line.

#### 3. CHECK POWER SUPPLY AND GROUND CIRCUIT

Check the power supply and the ground circuit of the unified meter and A/C amp. Refer to [MWI-50, "UNIFIED METER AND A/C AMP. : Diagnosis Procedure"](#).

Is the inspection result normal?

- YES (Present error)>>Replace the unified meter and A/C amp. Refer to [MWI-130, "Exploded View"](#).  
 YES (Past error)>>Error was detected in the unified meter and A/C amp. branch line.  
 NO >> Repair the power supply and the ground circuit.

A  
B  
C  
D  
E  
F  
G  
H  
I  
J  
K  
L

LAN

# STRG BRANCH LINE CIRCUIT

< DTC/CIRCUIT DIAGNOSIS >

[CAN SYSTEM (TYPE 4)]

## STRG BRANCH LINE CIRCUIT

### Diagnosis Procedure

INFOID:000000005779445

#### 1. CHECK CONNECTOR

1. Turn the ignition switch OFF.
2. Disconnect the battery cable from the negative terminal.
3. Check the terminals and connectors of the steering angle sensor for damage, bend and loose connection (unit side and connector side).

Is the inspection result normal?

- YES >> GO TO 2.  
NO >> Repair the terminal and connector.

#### 2. CHECK HARNESS FOR OPEN CIRCUIT

1. Disconnect the connector of steering angle sensor.
2. Check the resistance between the steering angle sensor harness connector terminals.

Steering angle sensor harness connector			Resistance (Ω)
Connector No.	Terminal No.		
M37	1	2	Approx. 54 – 66

Is the measurement value within the specification?

- YES >> GO TO 3.  
NO >> Repair the steering angle sensor branch line.

#### 3. CHECK POWER SUPPLY AND GROUND CIRCUIT

Check the power supply and the ground circuit of the steering angle sensor. Refer to [BRC-83, "Wiring Diagram - BRAKE CONTROL SYSTEM -"](#).

Is the inspection result normal?

- YES (Present error)>>Replace the steering angle sensor. Refer to [BRC-108, "Exploded View"](#).  
YES (Past error)>>Error was detected in the steering angle sensor branch line.  
NO >> Repair the power supply and the ground circuit.



## AV BRANCH LINE CIRCUIT

### Diagnosis Procedure

INFOID:000000005779446

#### 1. CHECK CONNECTOR

1. Turn the ignition switch OFF.
2. Disconnect the battery cable from the negative terminal.
3. Check the terminals and connectors of the AV control unit for damage, bend and loose connection (unit side and connector side).

Is the inspection result normal?

- YES >> GO TO 2.  
 NO >> Repair the terminal and connector.

#### 2. CHECK HARNESS FOR OPEN CIRCUIT

1. Disconnect the connector of AV control unit.
  2. Check the resistance between the AV control unit harness connector terminals.
- Without navigation system (Without rear view monitor)

AV control unit harness connector			Resistance (Ω)
Connector No.	Terminal No.		
M85	86	87	Approx. 54 – 66

- Without navigation system (With rear view monitor)

AV control unit harness connector			Resistance (Ω)
Connector No.	Terminal No.		
M204	81	80	Approx. 54 – 66

- With navigation system

AV control unit harness connector			Resistance (Ω)
Connector No.	Terminal No.		
M210	90	74	Approx. 54 – 66

Is the measurement value within the specification?

- YES >> GO TO 3.  
 NO >> Repair the AV control unit branch line.

#### 3. CHECK POWER SUPPLY AND GROUND CIRCUIT

Check the power supply and the ground circuit of the AV control unit. Refer to the following.

- Base audio without rear view camera: [AV-40, "AV CONTROL UNIT : Diagnosis Procedure"](#)
- Base audio with rear view camera: [AV-172, "AV CONTROL UNIT : Diagnosis Procedure"](#)
- BOSE audio without navigation: [AV-297, "AV CONTROL UNIT : Diagnosis Procedure"](#)
- BOSE audio with navigation: [AV-451, "AV CONTROL UNIT : Diagnosis Procedure"](#)

Is the inspection result normal?

- YES (Present error)>>Replace the AV control unit. Refer to the following.
- Base audio without rear view camera: [AV-89, "Exploded View"](#)
  - Base audio with rear view camera: [AV-201, "Exploded View"](#)
  - BOSE audio without navigation: [AV-328, "Exploded View"](#)
  - BOSE audio with navigation: [AV-477, "Exploded View"](#)

YES (Past error)>>Error was detected in the AV control unit branch line.

- NO >> Repair the power supply and the ground circuit.

A  
B  
C  
D  
E  
F  
G  
H  
I  
J  
K  
L

LAN

N  
O  
P

PSB BRANCH LINE CIRCUIT

Diagnosis Procedure

INFOID:000000005779447

1.CHECK CONNECTOR

1. Turn the ignition switch OFF.
2. Disconnect the battery cable from the negative terminal.
3. Check the terminals and connectors of the pre-crash seat belt for damage, bend and loose connection (unit side and connector side).

Is the inspection result normal?

- YES >> GO TO 2.  
 NO >> Repair the terminal and connector.

2.CHECK HARNESS FOR OPEN CIRCUIT

1. Disconnect the connector of pre-crash seat belt control unit.
2. Check the resistance between the pre-crash seat belt control unit harness connector terminals.

Pre-crash seat belt control unit harness connector		Resistance (Ω)
Connector No.	Terminal No.	
M110	24                      22	Approx. 54 – 66

Is the measurement value within the specification?

- YES >> GO TO 3.  
 NO >> Repair the pre-crash seat belt control unit branch line.

3.CHECK POWER SUPPLY AND GROUND CIRCUIT

Check the power supply and the ground circuit of the pre-crash seat belt control unit. Refer to [SBC-24, "Diagnosis Procedure"](#).

Is the inspection result normal?

- YES (Present error)>>Replace the pre-crash seat belt control unit. Refer to [SBC-39, "Exploded View"](#).  
 YES (Past error)>>Error was detected in the pre-crash seat belt control unit branch line.  
 NO >> Repair the power supply and the ground circuit.

# ADP BRANCH LINE CIRCUIT

< DTC/CIRCUIT DIAGNOSIS >

[CAN SYSTEM (TYPE 4)]

## ADP BRANCH LINE CIRCUIT

### Diagnosis Procedure

INFOID:000000005779448

#### 1. CHECK CONNECTOR

1. Turn the ignition switch OFF.
2. Disconnect the battery cable from the negative terminal.
3. Check the following terminals and connectors for damage, bend and loose connection (unit side and connector side).
  - Models with automatic drive positioner
    - Driver seat control unit
    - Harness connector B502
    - Harness connector B11
  - Models without automatic drive positioner
    - Driver seat control unit
    - Harness connector B501
    - Harness connector B10

Is the inspection result normal?

YES >> GO TO 2.

NO >> Repair the terminal and connector.

#### 2. CHECK HARNESS FOR OPEN CIRCUIT

1. Disconnect the connector of driver seat control unit.
2. Check the resistance between the driver seat control unit harness connector terminals.

Driver seat control unit harness connector			Resistance (Ω)
Connector No.	Terminal No.		
B503	3	19	Approx. 54 – 66

Is the measurement value within the specification?

YES >> GO TO 3.

NO >> Repair the driver seat control unit branch line.

#### 3. CHECK POWER SUPPLY AND GROUND CIRCUIT

Check the power supply and the ground circuit of the driver seat control unit. Refer to [ADP-64. "DRIVER SEAT CONTROL UNIT : Diagnosis Procedure"](#).

Is the inspection result normal?

YES (Present error)>>Replace the driver seat control unit. Refer to [ADP-234. "Exploded View"](#).

YES (Past error)>>Error was detected in the driver seat control unit branch line.

NO >> Repair the power supply and the ground circuit.

A  
B  
C  
D  
E  
F  
G  
H  
I  
J  
K  
L  
N  
O  
P

LAN

## RAS BRANCH LINE CIRCUIT

### Diagnosis Procedure

INFOID:000000005779449

#### 1. CHECK CONNECTOR

1. Turn the ignition switch OFF.
2. Disconnect the battery cable from the negative terminal.
3. Check the terminals and connectors of the 4WAS main control unit for damage, bend and loose connection (unit side and connector side).

Is the inspection result normal?

- YES >> GO TO 2.  
 NO >> Repair the terminal and connector.

#### 2. CHECK HARNESS FOR OPEN CIRCUIT

1. Disconnect the connector of 4WAS main control unit.
2. Check the resistance between the 4WAS main control unit harness connector terminals.

4WAS main control unit harness connector			Resistance (Ω)
Connector No.	Terminal No.		
B54	1	8	Approx. 54 – 66

Is the measurement value within the specification?

- YES >> GO TO 3.  
 NO >> Replace the body harness.

#### 3. CHECK POWER SUPPLY AND GROUND CIRCUIT

Check the power supply and the ground circuit of the 4WAS main control unit. Refer to [STC-136, "Diagnosis Procedure \(4WAS Main Control Unit\)"](#).

Is the inspection result normal?

- YES (Present error)>>Replace the 4WAS main control unit. Refer to [STC-181, "Exploded View"](#).  
 YES (Past error)>>Error was detected in the 4WAS main control unit branch line.  
 NO >> Repair the power supply and the ground circuit.

# ABS BRANCH LINE CIRCUIT

< DTC/CIRCUIT DIAGNOSIS >

[CAN SYSTEM (TYPE 4)]

## ABS BRANCH LINE CIRCUIT

### Diagnosis Procedure

INFOID:000000005779450

#### 1. CHECK CONNECTOR

1. Turn the ignition switch OFF.
2. Disconnect the battery cable from the negative terminal.
3. Check the terminals and connectors of the ABS actuator and electric unit (control unit) for damage, bend and loose connection (unit side and connector side).

Is the inspection result normal?

- YES >> GO TO 2.  
NO >> Repair the terminal and connector.

#### 2. CHECK HARNESS FOR OPEN CIRCUIT

1. Disconnect the connector of ABS actuator and electric unit (control unit).
2. Check the resistance between the ABS actuator and electric unit (control unit) harness connector terminals.

ABS actuator and electric unit (control unit) harness connector			Resistance (Ω)
Connector No.	Terminal No.		
E41	35	14	Approx. 54 – 66

Is the measurement value within the specification?

- YES >> GO TO 3.  
NO >> Repair the ABS actuator and electric unit (control unit) branch line.

#### 3. CHECK POWER SUPPLY AND GROUND CIRCUIT

Check the power supply and the ground circuit of the ABS actuator and electric unit (control unit). Refer to [BRC-69, "Diagnosis Procedure"](#).

Is the inspection result normal?

- YES (Present error)>>Replace the ABS actuator and electric unit (control unit). Refer to [BRC-105, "Exploded View"](#).  
YES (Past error)>>Error was detected in the ABS actuator and electric unit (control unit) branch line.  
NO >> Repair the power supply and the ground circuit.

A  
B  
C  
D  
E  
F  
G  
H  
I  
J  
K  
L

LAN

## ICC BRANCH LINE CIRCUIT

### Diagnosis Procedure

INFOID:000000005779451

#### 1. CHECK CONNECTOR

1. Turn the ignition switch OFF.
2. Disconnect the battery cable from the negative terminal.
3. Check the terminals and connectors of the ICC sensor integrated unit for damage, bend and loose connection (unit side and connector side).

Is the inspection result normal?

- YES >> GO TO 2.  
 NO >> Repair the terminal and connector.

#### 2. CHECK HARNESS FOR OPEN CIRCUIT

1. Disconnect the connector of ICC sensor integrated unit.
2. Check the resistance between the ICC sensor integrated unit harness connector terminals.

ICC sensor integrated unit harness connector			Resistance (Ω)
Connector No.	Terminal No.		
E67	3	6	Approx. 54 – 66

Is the measurement value within the specification?

- YES >> GO TO 3.  
 NO >> Repair the ICC sensor integrated unit branch line.

#### 3. CHECK POWER SUPPLY AND GROUND CIRCUIT

Check the power supply and the ground circuit of the ICC sensor integrated unit. Refer to [CCS-102, "Diagnosis Procedure"](#).

Is the inspection result normal?

- YES (Present error)>>Replace the ICC sensor integrated unit. Refer to [CCS-133, "Exploded View"](#).  
 YES (Past error)>>Error was detected in the ICC sensor integrated unit branch line.  
 NO >> Repair the power supply and the ground circuit.

# IPDM-E BRANCH LINE CIRCUIT

< DTC/CIRCUIT DIAGNOSIS >

[CAN SYSTEM (TYPE 4)]

## IPDM-E BRANCH LINE CIRCUIT

### Diagnosis Procedure

INFOID:000000005779452

#### 1. CHECK CONNECTOR

1. Turn the ignition switch OFF.
2. Disconnect the battery cable from the negative terminal.
3. Check the terminals and connectors of the IPDM E/R for damage, bend and loose connection (unit side and connector side).

Is the inspection result normal?

- YES >> GO TO 2.  
NO >> Repair the terminal and connector.

#### 2. CHECK HARNESS FOR OPEN CIRCUIT

1. Disconnect the connector of IPDM E/R.
2. Check the resistance between the IPDM E/R harness connector terminals.

IPDM E/R harness connector			Resistance (Ω)
Connector No.	Terminal No.		
E6	40	39	Approx. 108 – 132

Is the measurement value within the specification?

- YES >> GO TO 3.  
NO >> Repair the IPDM E/R branch line.

#### 3. CHECK POWER SUPPLY AND GROUND CIRCUIT

Check the power supply and the ground circuit of the IPDM E/R. Refer to [PCS-17, "Diagnosis Procedure"](#).

Is the inspection result normal?

- YES (Present error)>>Replace the IPDM E/R. Refer to [PCS-32, "Exploded View"](#).  
YES (Past error)>>Error was detected in the IPDM E/R branch line.  
NO >> Repair the power supply and the ground circuit.

A  
B  
C  
D  
E  
F  
G  
H  
I  
J  
K  
L

LAN

N  
O  
P

# CAN COMMUNICATION CIRCUIT

< DTC/CIRCUIT DIAGNOSIS >

[CAN SYSTEM (TYPE 4)]

## CAN COMMUNICATION CIRCUIT

### Diagnosis Procedure

INFOID:000000005779453

#### 1. CONNECTOR INSPECTION

1. Turn the ignition switch OFF.
2. Disconnect the battery cable from the negative terminal.
3. Disconnect all the unit connectors on CAN communication system.
4. Check terminals and connectors for damage, bend and loose connection.

Is the inspection result normal?

- YES >> GO TO 2.  
NO >> Repair the terminal and connector.

#### 2. CHECK HARNESS CONTINUITY (SHORT CIRCUIT)

Check the continuity between the data link connector terminals.

Data link connector		Continuity
Connector No.	Terminal No.	
M24	6 14	Not existed

Is the inspection result normal?

- YES >> GO TO 3.  
NO >> Check the harness and repair the root cause.

#### 3. CHECK HARNESS CONTINUITY (SHORT CIRCUIT)

Check the continuity between the data link connector and the ground.

Data link connector		Ground	Continuity
Connector No.	Terminal No.		
M24	6		Not existed
	14		Not existed

Is the inspection result normal?

- YES >> GO TO 4.  
NO >> Check the harness and repair the root cause.

#### 4. CHECK ECM AND IPDM E/R TERMINATION CIRCUIT

1. Remove the ECM and the IPDM E/R.
2. Check the resistance between the ECM terminals.

ECM		Resistance ( $\Omega$ )
Terminal No.		
114	113	Approx. 108 – 132

3. Check the resistance between the IPDM E/R terminals.

IPDM E/R		Resistance ( $\Omega$ )
Terminal No.		
40	39	Approx. 108 – 132

Is the measurement value within the specification?

- YES >> GO TO 5.  
NO >> Replace the ECM and/or the IPDM E/R.

#### 5. CHECK SYMPTOM

Connect all the connectors. Check if the symptoms described in the "Symptom (Results from interview with customer)" are reproduced.

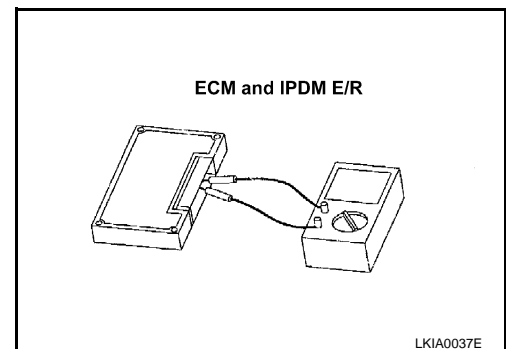



# CAN COMMUNICATION CIRCUIT

< DTC/CIRCUIT DIAGNOSIS >

[CAN SYSTEM (TYPE 4)]

## Inspection result

Reproduced>>GO TO 6.

Non-reproduced>>Start the diagnosis again. Follow the trouble diagnosis procedure when past error is detected.

## 6.CHECK UNIT REPRODUCTION

Perform the reproduction test as per the following procedure for each unit.

1. Turn the ignition switch OFF.
2. Disconnect the battery cable from the negative terminal.
3. Disconnect one of the unit connectors of CAN communication system.

### **NOTE:**

ECM and IPDM E/R have a termination circuit. Check other units first.

4. Connect the battery cable to the negative terminal. Check if the symptoms described in the "Symptom (Results from interview with customer)" are reproduced.

### **NOTE:**

Although unit-related error symptoms occur, do not confuse them with other symptoms.

## Inspection result

Reproduced>>Connect the connector. Check other units as per the above procedure.

Non-reproduced>>Replace the unit whose connector was disconnected.

A  
B  
C  
D  
E  
F  
G  
H  
I  
J  
K  
L  
N  
O  
P

LAN

# MAIN LINE BETWEEN DLC AND AV CIRCUIT

< DTC/CIRCUIT DIAGNOSIS >

[CAN SYSTEM (TYPE 5)]

## DTC/CIRCUIT DIAGNOSIS

### MAIN LINE BETWEEN DLC AND AV CIRCUIT

#### Diagnosis Procedure

INFOID:000000005779454

#### 1. CHECK HARNESS CONTINUITY (OPEN CIRCUIT)

1. Turn the ignition switch OFF.
2. Disconnect the battery cable from the negative terminal.
3. Disconnect the following harness connectors.
  - ECM
  - AV control unit
4. Check the continuity between the data link connector and the AV control unit harness connector.
  - Without navigation system (Without rear view monitor)

Data link connector		AV control unit harness connector		Continuity
Connector No.	Terminal No.	Connector No.	Terminal No.	
M24	6	M85	86	Existed
	14		87	Existed

- Without navigation system (With rear view monitor)

Data link connector		AV control unit harness connector		Continuity
Connector No.	Terminal No.	Connector No.	Terminal No.	
M24	6	M204	81	Existed
	14		80	Existed

- With navigation system

Data link connector		AV control unit harness connector		Continuity
Connector No.	Terminal No.	Connector No.	Terminal No.	
M24	6	M210	90	Existed
	14		74	Existed

#### Is the inspection result normal?

YES (Present error)>>Check CAN system type decision again.

YES (Past error)>>Error was detected in the main line between the data link connector and the AV control unit.

NO >> Repair the main line between the data link connector and the AV control unit.

# MAIN LINE BETWEEN AV AND ADP CIRCUIT

< DTC/CIRCUIT DIAGNOSIS >

[CAN SYSTEM (TYPE 5)]

## MAIN LINE BETWEEN AV AND ADP CIRCUIT

### Diagnosis Procedure

INFOID:000000005779455

#### 1.CHECK CONNECTOR

1. Turn the ignition switch OFF.
2. Disconnect the battery cable from the negative terminal.
3. Check the following terminals and connectors for damage, bend and loose connection (connector side and harness side).
  - Harness connector M7
  - Harness connector B1

Is the inspection result normal?

YES >> GO TO 2.

NO >> Repair the terminal and connector.

#### 2.CHECK HARNESS CONTINUITY (OPEN CIRCUIT)

1. Disconnect the following harness connectors.
  - AV control unit
  - Harness connectors M7 and B1
2. Check the continuity between the AV control unit harness connector and harness connector.
  - Without navigation system (Without rear view monitor)

AV control unit harness connector		Harness connector		Continuity
Connector No.	Terminal No.	Connector No.	Terminal No.	
M85	86	M7	20	Existed
	87		21	Existed

- Without navigation system (With rear view monitor)

AV control unit harness connector		Harness connector		Continuity
Connector No.	Terminal No.	Connector No.	Terminal No.	
M204	81	M7	20	Existed
	80		21	Existed

- With navigation system

AV control unit harness connector		Harness connector		Continuity
Connector No.	Terminal No.	Connector No.	Terminal No.	
M210	90	M7	20	Existed
	74		21	Existed

Is the inspection result normal?

YES >> GO TO 3.

NO >> Repair the main line between the AV control unit and the harness connector M7.

#### 3.CHECK HARNESS CONTINUITY (OPEN CIRCUIT)

Check the continuity between the harness connector terminals.

Connector No.	Terminal No.		Continuity
B1	20	22	Existed
	21	23	Existed

Is the inspection result normal?

YES (Present error)>>Check CAN system type decision again.

YES (Past error)>>Error was detected in the main line between the AV control unit and the driver seat control unit.

NO >> Repair the main line between the harness connectors B1 and the driver seat control unit.

# MAIN LINE BETWEEN ADP AND ABS CIRCUIT

< DTC/CIRCUIT DIAGNOSIS >

[CAN SYSTEM (TYPE 5)]

## MAIN LINE BETWEEN ADP AND ABS CIRCUIT

### Diagnosis Procedure

INFOID:000000005779456

#### 1. CHECK CONNECTOR

1. Turn the ignition switch OFF.
2. Disconnect the battery cable from the negative terminal.
3. Check the following terminals and connectors for damage, bend and loose connection (connector side and harness side).
  - Harness connector B1
  - Harness connector M7
  - Harness connector M6
  - Harness connector E106

Is the inspection result normal?

YES >> GO TO 2.

NO >> Repair the terminal and connector.

#### 2. CHECK HARNESS CONTINUITY (OPEN CIRCUIT)

1. Disconnect the harness connectors B1 and M7.
2. Check the continuity between the harness connector terminals.

Connector No.	Terminal No.		Continuity
B1	20	22	Existed
	21	23	Existed

Is the inspection result normal?

YES >> GO TO 3.

NO >> Repair the main line between the driver seat control unit and the harness connector B1.

#### 3. CHECK HARNESS CONTINUITY (OPEN CIRCUIT)

1. Disconnect the harness connectors M6 and E106.
2. Check the continuity between the harness connectors.

Harness connector		Harness connector		Continuity
Connector No.	Terminal No.	Connector No.	Terminal No.	
M7	22	M6	49	Existed
	23		48	Existed

Is the inspection result normal?

YES >> GO TO 4.

NO >> Repair the main line between the harness connectors M7 and M6.

#### 4. CHECK HARNESS CONTINUITY (OPEN CIRCUIT)

1. Disconnect the connector of ABS actuator and electric unit (control unit).
2. Check the continuity between the harness connector and the ABS actuator and electric unit (control unit) harness connector.

Harness connector		ABS actuator and electric unit (control unit) harness connector		Continuity
Connector No.	Terminal No.	Connector No.	Terminal No.	
E106	49	E41	35	Existed
	48		14	Existed

Is the inspection result normal?

YES (Present error)>>Check CAN system type decision again.

YES (Past error)>>Error was detected in the main line between the driver seat control unit and the ABS actuator and electric unit (control unit).

# MAIN LINE BETWEEN ADP AND ABS CIRCUIT

< DTC/CIRCUIT DIAGNOSIS >

[CAN SYSTEM (TYPE 5)]

NO >> Repair the main line between the harness connector E106 and the ABS actuator and electric unit (control unit).

A

B

C

D

E

F

G

H

I

J

K

L

LAN

N

O

P

# ECM BRANCH LINE CIRCUIT

< DTC/CIRCUIT DIAGNOSIS >

[CAN SYSTEM (TYPE 5)]

## ECM BRANCH LINE CIRCUIT

### Diagnosis Procedure

INFOID:000000005779457

#### 1. CHECK CONNECTOR

1. Turn the ignition switch OFF.
2. Disconnect the battery cable from the negative terminal.
3. Check the terminals and connectors of the ECM for damage, bend and loose connection (unit side and connector side).

Is the inspection result normal?

- YES >> GO TO 2.  
NO >> Repair the terminal and connector.

#### 2. CHECK HARNESS FOR OPEN CIRCUIT

1. Disconnect the connector of ECM.
2. Check the resistance between the ECM harness connector terminals.

ECM harness connector			Resistance (Ω)
Connector No.	Terminal No.		
M107	114	113	Approx. 108 – 132

Is the measurement value within the specification?

- YES >> GO TO 3.  
NO >> Repair the ECM branch line.

#### 3. CHECK POWER SUPPLY AND GROUND CIRCUIT

Check the power supply and the ground circuit of the ECM. Refer to [EC-152. "Diagnosis Procedure"](#).

Is the inspection result normal?

YES (Present error)>>Replace the ECM. Refer to [EC-17. "ADDITIONAL SERVICE WHEN REPLACING CONTROL UNIT \(ECM\) : Special Repair Requirement"](#).

YES (Past error)>>Error was detected in the ECM branch line.

NO >> Repair the power supply and the ground circuit.

# A-BAG BRANCH LINE CIRCUIT

< DTC/CIRCUIT DIAGNOSIS >

[CAN SYSTEM (TYPE 5)]

## A-BAG BRANCH LINE CIRCUIT

### Diagnosis Procedure

INFOID:000000005884796

#### **WARNING:**

- Before servicing, turn ignition switch OFF, disconnect battery negative terminal, and wait 3 minutes or more. (To discharge backup capacitor.)
- Never use unspecified tester or other measuring device.

#### **1**.CHECK CONNECTOR

1. Turn the ignition switch OFF.
2. Disconnect the battery cable from the negative terminal.
3. Check the terminals and connectors of the air bag diagnosis sensor unit for damage, bend and loose connection (unit side and connector side).

Is the inspection result normal?

- YES >> GO TO 2.  
NO >> Replace the terminal and connector.

#### **2**.CHECK AIR BAG DIAGNOSIS SENSOR UNIT

Check the air bag diagnosis sensor unit. Refer to [SRC-5, "Work Flow"](#).

Is the inspection result normal?

- YES >> Replace the main harness.  
NO >> Replace parts whose air bag system has a malfunction.

A  
B  
C  
D  
E  
F  
G  
H  
I  
J  
K  
L  
N  
O  
P

LAN

# BCM BRANCH LINE CIRCUIT

< DTC/CIRCUIT DIAGNOSIS >

[CAN SYSTEM (TYPE 5)]

## BCM BRANCH LINE CIRCUIT

### Diagnosis Procedure

INFOID:000000005779459

#### 1. CHECK CONNECTOR

1. Turn the ignition switch OFF.
2. Disconnect the battery cable from the negative terminal.
3. Check the terminals and connectors of the BCM for damage, bend and loose connection (unit side and connector side).

Is the inspection result normal?

- YES >> GO TO 2.  
NO >> Repair the terminal and connector.

#### 2. CHECK HARNESS FOR OPEN CIRCUIT

1. Disconnect the connector of BCM.
2. Check the resistance between the BCM harness connector terminals.

BCM harness connector			Resistance ( $\Omega$ )
Connector No.	Terminal No.		
M122	91	90	Approx. 54 – 66

Is the measurement value within the specification?

- YES >> GO TO 3.  
NO >> Repair the BCM branch line.

#### 3. CHECK POWER SUPPLY AND GROUND CIRCUIT

Check the power supply and the ground circuit of the BCM. Refer to [BCS-37, "Diagnosis Procedure"](#).

Is the inspection result normal?

- YES (Present error)>>Replace the BCM. Refer to [BCS-78, "Exploded View"](#).  
YES (Past error)>>Error was detected in the BCM branch line.  
NO >> Repair the power supply and the ground circuit.



# DLC BRANCH LINE CIRCUIT

< DTC/CIRCUIT DIAGNOSIS >

[CAN SYSTEM (TYPE 5)]

## DLC BRANCH LINE CIRCUIT

### Diagnosis Procedure

INFOID:000000005779460

#### 1. CHECK CONNECTOR

1. Turn the ignition switch OFF.
2. Disconnect the battery cable from the negative terminal.
3. Check the terminals and connectors of the data link connector for damage, bend and loose connection (connector side and harness side).

Is the inspection result normal?

- YES >> GO TO 2.  
NO >> Repair the terminal and connector.

#### 2. CHECK HARNESS FOR OPEN CIRCUIT

Check the resistance between the data link connector terminals.

Data link connector			Resistance (Ω)
Connector No.	Terminal No.		
M24	6	14	Approx. 54 – 66

Is the measurement value within the specification?

- YES (Present error)>>Check CAN system type decision again.  
YES (Past error)>>Error was detected in the data link connector branch line circuit.  
NO >> Repair the data link connector branch line.

A  
B  
C  
D  
E  
F  
G  
H  
I  
J  
K  
L

LAN

N  
O  
P

## M&A BRANCH LINE CIRCUIT

### Diagnosis Procedure

INFOID:000000005779461

#### 1. CHECK CONNECTOR

1. Turn the ignition switch OFF.
2. Disconnect the battery cable from the negative terminal.
3. Check the terminals and connectors of the unified meter and A/C amp. for damage, bend and loose connection (unit side and connector side).

Is the inspection result normal?

- YES >> GO TO 2.  
 NO >> Repair the terminal and connector.

#### 2. CHECK HARNESS FOR OPEN CIRCUIT

1. Disconnect the connector of unified meter and A/C amp.
2. Check the resistance between the unified meter and A/C amp. harness connector terminals.

Unified meter and A/C amp. harness connector			Resistance (Ω)
Connector No.	Terminal No.		
M67	56	72	Approx. 54 – 66

Is the measurement value within the specification?

- YES >> GO TO 3.  
 NO >> Repair the unified meter and A/C amp. branch line.

#### 3. CHECK POWER SUPPLY AND GROUND CIRCUIT

Check the power supply and the ground circuit of the unified meter and A/C amp. Refer to [MWI-50, "UNIFIED METER AND A/C AMP. : Diagnosis Procedure"](#).

Is the inspection result normal?

- YES (Present error)>>Replace the unified meter and A/C amp. Refer to [MWI-130, "Exploded View"](#).  
 YES (Past error)>>Error was detected in the unified meter and A/C amp. branch line.  
 NO >> Repair the power supply and the ground circuit.

# STRG BRANCH LINE CIRCUIT

< DTC/CIRCUIT DIAGNOSIS >

[CAN SYSTEM (TYPE 5)]

## STRG BRANCH LINE CIRCUIT

### Diagnosis Procedure

INFOID:000000005779462

#### 1. CHECK CONNECTOR

1. Turn the ignition switch OFF.
2. Disconnect the battery cable from the negative terminal.
3. Check the terminals and connectors of the steering angle sensor for damage, bend and loose connection (unit side and connector side).

Is the inspection result normal?

- YES >> GO TO 2.  
NO >> Repair the terminal and connector.

#### 2. CHECK HARNESS FOR OPEN CIRCUIT

1. Disconnect the connector of steering angle sensor.
2. Check the resistance between the steering angle sensor harness connector terminals.

Steering angle sensor harness connector			Resistance (Ω)
Connector No.	Terminal No.		
M37	1	2	Approx. 54 – 66

Is the measurement value within the specification?

- YES >> GO TO 3.  
NO >> Repair the steering angle sensor branch line.

#### 3. CHECK POWER SUPPLY AND GROUND CIRCUIT

Check the power supply and the ground circuit of the steering angle sensor. Refer to [BRC-83, "Wiring Diagram - BRAKE CONTROL SYSTEM -"](#).

Is the inspection result normal?

- YES (Present error)>>Replace the steering angle sensor. Refer to [BRC-108, "Exploded View"](#).  
YES (Past error)>>Error was detected in the steering angle sensor branch line.  
NO >> Repair the power supply and the ground circuit.

A  
B  
C  
D  
E  
F  
G  
H  
I  
J  
K  
L

LAN

N  
O  
P

## AV BRANCH LINE CIRCUIT

### Diagnosis Procedure

INFOID:000000005779463

#### 1. CHECK CONNECTOR

1. Turn the ignition switch OFF.
2. Disconnect the battery cable from the negative terminal.
3. Check the terminals and connectors of the AV control unit for damage, bend and loose connection (unit side and connector side).

Is the inspection result normal?

- YES >> GO TO 2.  
 NO >> Repair the terminal and connector.

#### 2. CHECK HARNESS FOR OPEN CIRCUIT

1. Disconnect the connector of AV control unit.
2. Check the resistance between the AV control unit harness connector terminals.
  - Without navigation system (Without rear view monitor)

AV control unit harness connector			Resistance (Ω)
Connector No.	Terminal No.		
M85	86	87	Approx. 54 – 66

- Without navigation system (With rear view monitor)

AV control unit harness connector			Resistance (Ω)
Connector No.	Terminal No.		
M204	81	80	Approx. 54 – 66

- With navigation system

AV control unit harness connector			Resistance (Ω)
Connector No.	Terminal No.		
M210	90	74	Approx. 54 – 66

Is the measurement value within the specification?

- YES >> GO TO 3.  
 NO >> Repair the AV control unit branch line.

#### 3. CHECK POWER SUPPLY AND GROUND CIRCUIT

Check the power supply and the ground circuit of the AV control unit. Refer to the following.

- Base audio without rear view camera: [AV-40, "AV CONTROL UNIT : Diagnosis Procedure"](#)
- Base audio with rear view camera: [AV-172, "AV CONTROL UNIT : Diagnosis Procedure"](#)
- BOSE audio without navigation: [AV-297, "AV CONTROL UNIT : Diagnosis Procedure"](#)
- BOSE audio with navigation: [AV-451, "AV CONTROL UNIT : Diagnosis Procedure"](#)

Is the inspection result normal?

- YES (Present error)>>Replace the AV control unit. Refer to the following.
- Base audio without rear view camera: [AV-89, "Exploded View"](#)
  - Base audio with rear view camera: [AV-201, "Exploded View"](#)
  - BOSE audio without navigation: [AV-328, "Exploded View"](#)
  - BOSE audio with navigation: [AV-477, "Exploded View"](#)

YES (Past error)>>Error was detected in the AV control unit branch line.

- NO >> Repair the power supply and the ground circuit.

# TCM BRANCH LINE CIRCUIT

< DTC/CIRCUIT DIAGNOSIS >

[CAN SYSTEM (TYPE 5)]

## TCM BRANCH LINE CIRCUIT

### Diagnosis Procedure

INFOID:000000005779464

#### 1.CHECK CONNECTOR

1. Turn the ignition switch OFF.
2. Disconnect the battery cable from the negative terminal.
3. Check the following terminals and connectors for damage, bend and loose connection (unit side and connector side).
  - A/T assembly
  - Harness connector F103
  - Harness connector M116

Is the inspection result normal?

- YES >> GO TO 2.  
NO >> Repair the terminal and connector.

#### 2.CHECK HARNESS FOR OPEN CIRCUIT

1. Disconnect the connector of A/T assembly.
2. Check the resistance between the A/T assembly harness connector terminals.

A/T assembly harness connector		Resistance (Ω)
Connector No.	Terminal No.	
F51	3	Approx. 54 – 66
	8	

Is the measurement value within the specification?

- YES >> GO TO 3.  
NO >> Repair the TCM branch line.

#### 3.CHECK POWER SUPPLY AND GROUND CIRCUIT

Check the power supply and the ground circuit of the TCM. Refer to [TM-212, "Diagnosis Procedure"](#).

Is the inspection result normal?

- YES (Present error)>>Replace the control valve with TCM. Refer to [TM-99, "Component Parts Location"](#).  
(Replace A/T assembly if control valve with TCM is not listed in the latest parts list.)  
YES (Past error)>>Error was detected in the TCM branch line.  
NO >> Repair the power supply and the ground circuit.

A  
B  
C  
D  
E  
F  
G  
H  
I  
J  
K  
L

LAN

## ADP BRANCH LINE CIRCUIT

### Diagnosis Procedure

INFOID:000000005779465

#### 1. CHECK CONNECTOR

1. Turn the ignition switch OFF.
2. Disconnect the battery cable from the negative terminal.
3. Check the following terminals and connectors for damage, bend and loose connection (unit side and connector side).
  - Models with automatic drive positioner
    - Driver seat control unit
    - Harness connector B502
    - Harness connector B11
  - Models without automatic drive positioner
    - Driver seat control unit
    - Harness connector B501
    - Harness connector B10

Is the inspection result normal?

YES >> GO TO 2.

NO >> Repair the terminal and connector.

#### 2. CHECK HARNESS FOR OPEN CIRCUIT

1. Disconnect the connector of driver seat control unit.
2. Check the resistance between the driver seat control unit harness connector terminals.

Driver seat control unit harness connector			Resistance (Ω)
Connector No.	Terminal No.		
B503	3	19	Approx. 54 – 66

Is the measurement value within the specification?

YES >> GO TO 3.

NO >> Repair the driver seat control unit branch line.

#### 3. CHECK POWER SUPPLY AND GROUND CIRCUIT

Check the power supply and the ground circuit of the driver seat control unit. Refer to [ADP-64. "DRIVER SEAT CONTROL UNIT : Diagnosis Procedure"](#).

Is the inspection result normal?

YES (Present error)>>Replace the driver seat control unit. Refer to [ADP-234. "Exploded View"](#).

YES (Past error)>>Error was detected in the driver seat control unit branch line.

NO >> Repair the power supply and the ground circuit.

# ABS BRANCH LINE CIRCUIT

< DTC/CIRCUIT DIAGNOSIS >

[CAN SYSTEM (TYPE 5)]

## ABS BRANCH LINE CIRCUIT

### Diagnosis Procedure

INFOID:000000005779466

#### 1. CHECK CONNECTOR

1. Turn the ignition switch OFF.
2. Disconnect the battery cable from the negative terminal.
3. Check the terminals and connectors of the ABS actuator and electric unit (control unit) for damage, bend and loose connection (unit side and connector side).

Is the inspection result normal?

- YES >> GO TO 2.  
NO >> Repair the terminal and connector.

#### 2. CHECK HARNESS FOR OPEN CIRCUIT

1. Disconnect the connector of ABS actuator and electric unit (control unit).
2. Check the resistance between the ABS actuator and electric unit (control unit) harness connector terminals.

ABS actuator and electric unit (control unit) harness connector			Resistance (Ω)
Connector No.	Terminal No.		
E41	35	14	Approx. 54 – 66

Is the measurement value within the specification?

- YES >> GO TO 3.  
NO >> Repair the ABS actuator and electric unit (control unit) branch line.

#### 3. CHECK POWER SUPPLY AND GROUND CIRCUIT

Check the power supply and the ground circuit of the ABS actuator and electric unit (control unit). Refer to [BRC-69, "Diagnosis Procedure"](#).

Is the inspection result normal?

- YES (Present error)>>Replace the ABS actuator and electric unit (control unit). Refer to [BRC-105, "Exploded View"](#).  
YES (Past error)>>Error was detected in the ABS actuator and electric unit (control unit) branch line.  
NO >> Repair the power supply and the ground circuit.

A  
B  
C  
D  
E  
F  
G  
H  
I  
J  
K  
L

LAN

# IPDM-E BRANCH LINE CIRCUIT

< DTC/CIRCUIT DIAGNOSIS >

[CAN SYSTEM (TYPE 5)]

## IPDM-E BRANCH LINE CIRCUIT

### Diagnosis Procedure

INFOID:000000005779467

#### 1. CHECK CONNECTOR

1. Turn the ignition switch OFF.
2. Disconnect the battery cable from the negative terminal.
3. Check the terminals and connectors of the IPDM E/R for damage, bend and loose connection (unit side and connector side).

Is the inspection result normal?

- YES >> GO TO 2.  
NO >> Repair the terminal and connector.

#### 2. CHECK HARNESS FOR OPEN CIRCUIT

1. Disconnect the connector of IPDM E/R.
2. Check the resistance between the IPDM E/R harness connector terminals.

IPDM E/R harness connector			Resistance (Ω)
Connector No.	Terminal No.		
E6	40	39	Approx. 108 – 132

Is the measurement value within the specification?

- YES >> GO TO 3.  
NO >> Repair the IPDM E/R branch line.

#### 3. CHECK POWER SUPPLY AND GROUND CIRCUIT

Check the power supply and the ground circuit of the IPDM E/R. Refer to [PCS-17, "Diagnosis Procedure"](#).

Is the inspection result normal?

- YES (Present error)>>Replace the IPDM E/R. Refer to [PCS-32, "Exploded View"](#).  
YES (Past error)>>Error was detected in the IPDM E/R branch line.  
NO >> Repair the power supply and the ground circuit.



# CAN COMMUNICATION CIRCUIT

< DTC/CIRCUIT DIAGNOSIS >

[CAN SYSTEM (TYPE 5)]

## CAN COMMUNICATION CIRCUIT

### Diagnosis Procedure

INFOID:000000005779468

#### 1. CONNECTOR INSPECTION

1. Turn the ignition switch OFF.
2. Disconnect the battery cable from the negative terminal.
3. Disconnect all the unit connectors on CAN communication system.
4. Check terminals and connectors for damage, bend and loose connection.

Is the inspection result normal?

- YES >> GO TO 2.  
NO >> Repair the terminal and connector.

#### 2. CHECK HARNESS CONTINUITY (SHORT CIRCUIT)

Check the continuity between the data link connector terminals.

Data link connector		Continuity
Connector No.	Terminal No.	
M24	6 14	Not existed

Is the inspection result normal?

- YES >> GO TO 3.  
NO >> Check the harness and repair the root cause.

#### 3. CHECK HARNESS CONTINUITY (SHORT CIRCUIT)

Check the continuity between the data link connector and the ground.

Data link connector		Ground	Continuity
Connector No.	Terminal No.		
M24	6		Not existed
	14		Not existed

Is the inspection result normal?

- YES >> GO TO 4.  
NO >> Check the harness and repair the root cause.

#### 4. CHECK ECM AND IPDM E/R TERMINATION CIRCUIT

1. Remove the ECM and the IPDM E/R.
2. Check the resistance between the ECM terminals.

ECM		Resistance ( $\Omega$ )
Terminal No.		
114	113	Approx. 108 – 132

3. Check the resistance between the IPDM E/R terminals.

IPDM E/R		Resistance ( $\Omega$ )
Terminal No.		
40	39	Approx. 108 – 132

Is the measurement value within the specification?

- YES >> GO TO 5.  
NO >> Replace the ECM and/or the IPDM E/R.

#### 5. CHECK SYMPTOM

Connect all the connectors. Check if the symptoms described in the "Symptom (Results from interview with customer)" are reproduced.

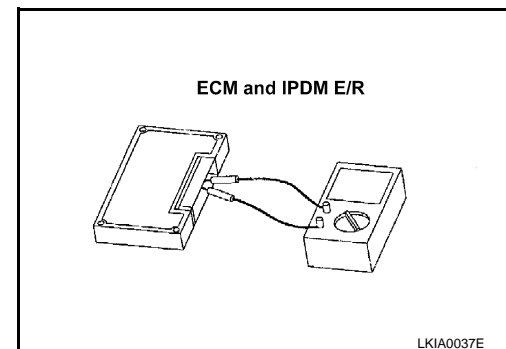

# CAN COMMUNICATION CIRCUIT

< DTC/CIRCUIT DIAGNOSIS >

[CAN SYSTEM (TYPE 5)]

---

## Inspection result

Reproduced>>GO TO 6.

Non-reproduced>>Start the diagnosis again. Follow the trouble diagnosis procedure when past error is detected.

## 6.CHECK UNIT REPRODUCTION

---

Perform the reproduction test as per the following procedure for each unit.

1. Turn the ignition switch OFF.
2. Disconnect the battery cable from the negative terminal.
3. Disconnect one of the unit connectors of CAN communication system.

### **NOTE:**

ECM and IPDM E/R have a termination circuit. Check other units first.

4. Connect the battery cable to the negative terminal. Check if the symptoms described in the "Symptom (Results from interview with customer)" are reproduced.

### **NOTE:**

Although unit-related error symptoms occur, do not confuse them with other symptoms.

## Inspection result

Reproduced>>Connect the connector. Check other units as per the above procedure.

Non-reproduced>>Replace the unit whose connector was disconnected.

# MAIN LINE BETWEEN DLC AND AV CIRCUIT

< DTC/CIRCUIT DIAGNOSIS >

[CAN SYSTEM (TYPE 6)]

## DTC/CIRCUIT DIAGNOSIS

### MAIN LINE BETWEEN DLC AND AV CIRCUIT

#### Diagnosis Procedure

INFOID:000000005779469

#### 1. CHECK HARNESS CONTINUITY (OPEN CIRCUIT)

1. Turn the ignition switch OFF.
2. Disconnect the battery cable from the negative terminal.
3. Disconnect the following harness connectors.
  - ECM
  - AV control unit
4. Check the continuity between the data link connector and the AV control unit harness connector.
  - Without navigation system (Without rear view monitor)

Data link connector		AV control unit harness connector		Continuity
Connector No.	Terminal No.	Connector No.	Terminal No.	
M24	6	M85	86	Existed
	14		87	Existed

- Without navigation system (With rear view monitor)

Data link connector		AV control unit harness connector		Continuity
Connector No.	Terminal No.	Connector No.	Terminal No.	
M24	6	M204	81	Existed
	14		80	Existed

- With navigation system

Data link connector		AV control unit harness connector		Continuity
Connector No.	Terminal No.	Connector No.	Terminal No.	
M24	6	M210	90	Existed
	14		74	Existed

#### Is the inspection result normal?

YES (Present error)>>Check CAN system type decision again.

YES (Past error)>>Error was detected in the main line between the data link connector and the AV control unit.

NO >> Repair the main line between the data link connector and the AV control unit.

LAN

# MAIN LINE BETWEEN AV AND ADP CIRCUIT

< DTC/CIRCUIT DIAGNOSIS >

[CAN SYSTEM (TYPE 6)]

## MAIN LINE BETWEEN AV AND ADP CIRCUIT

### Diagnosis Procedure

INFOID:000000005779470

#### 1.CHECK CONNECTOR

1. Turn the ignition switch OFF.
2. Disconnect the battery cable from the negative terminal.
3. Check the following terminals and connectors for damage, bend and loose connection (connector side and harness side).
  - Harness connector M7
  - Harness connector B1

Is the inspection result normal?

YES >> GO TO 2.

NO >> Repair the terminal and connector.

#### 2.CHECK HARNESS CONTINUITY (OPEN CIRCUIT)

1. Disconnect the following harness connectors.
  - AV control unit
  - Harness connectors M7 and B1
2. Check the continuity between the AV control unit harness connector and harness connector.
  - Without navigation system (Without rear view monitor)

AV control unit harness connector		Harness connector		Continuity
Connector No.	Terminal No.	Connector No.	Terminal No.	
M85	86	M7	20	Existed
	87		21	Existed

- Without navigation system (With rear view monitor)

AV control unit harness connector		Harness connector		Continuity
Connector No.	Terminal No.	Connector No.	Terminal No.	
M204	81	M7	20	Existed
	80		21	Existed

- With navigation system

AV control unit harness connector		Harness connector		Continuity
Connector No.	Terminal No.	Connector No.	Terminal No.	
M210	90	M7	20	Existed
	74		21	Existed

Is the inspection result normal?

YES >> GO TO 3.

NO >> Repair the main line between the AV control unit and the harness connector M7.

#### 3.CHECK HARNESS CONTINUITY (OPEN CIRCUIT)

Check the continuity between the harness connector terminals.

Connector No.	Terminal No.		Continuity
B1	20	22	Existed
	21	23	Existed

Is the inspection result normal?

YES (Present error)>>Check CAN system type decision again.

YES (Past error)>>Error was detected in the main line between the AV control unit and the driver seat control unit.

NO >> Repair the main line between the harness connectors B1 and the driver seat control unit.

# MAIN LINE BETWEEN ADP AND RAS CIRCUIT

< DTC/CIRCUIT DIAGNOSIS >

[CAN SYSTEM (TYPE 6)]

## MAIN LINE BETWEEN ADP AND RAS CIRCUIT

### Diagnosis Procedure

INFOID:000000005779471

#### 1. CHECK HARNESS CONTINUITY (OPEN CIRCUIT)

1. Turn the ignition switch OFF.
2. Disconnect the battery cable from the negative terminal.
3. Disconnect the harness connectors M7 and B1.
4. Check the continuity between the harness connector terminals.

Connector No.	Terminal No.		Continuity
B1	20	22	Existed
	21	23	Existed

#### Is the inspection result normal?

YES (Present error)>>Check CAN system type decision again.

YES (Past error)>>Error was detected in the main line between the driver seat control unit and the 4WAS main control unit.

NO >> Repair the main line between the driver seat control unit and the 4WAS main control unit.

A  
B  
C  
D  
E  
F  
G  
H  
I  
J  
K  
L  
N  
O  
P

LAN

# MAIN LINE BETWEEN RAS AND ABS CIRCUIT

< DTC/CIRCUIT DIAGNOSIS >

[CAN SYSTEM (TYPE 6)]

## MAIN LINE BETWEEN RAS AND ABS CIRCUIT

### Diagnosis Procedure

INFOID:000000005779472

#### 1. CHECK CONNECTOR

1. Turn the ignition switch OFF.
2. Disconnect the battery cable from the negative terminal.
3. Check the following terminals and connectors for damage, bend and loose connection (connector side and harness side).
  - Harness connector B1
  - Harness connector M7
  - Harness connector M6
  - Harness connector E106

Is the inspection result normal?

YES >> GO TO 2.

NO >> Repair the terminal and connector.

#### 2. CHECK HARNESS CONTINUITY (OPEN CIRCUIT)

1. Disconnect the harness connectors B1 and M7.
2. Check the continuity between the harness connector terminals.

Connector No.	Terminal No.		Continuity
B1	20	22	Existed
	21	23	Existed

Is the inspection result normal?

YES >> GO TO 3.

NO >> Repair the main line between the 4WAS main control unit and the harness connector B1.

#### 3. CHECK HARNESS CONTINUITY (OPEN CIRCUIT)

1. Disconnect the harness connectors M6 and E106.
2. Check the continuity between the harness connectors.

Harness connector		Harness connector		Continuity
Connector No.	Terminal No.	Connector No.	Terminal No.	
M7	22	M6	49	Existed
	23		48	Existed

Is the inspection result normal?

YES >> GO TO 4.

NO >> Repair the main line between the harness connectors M7 and M6.

#### 4. CHECK HARNESS CONTINUITY (OPEN CIRCUIT)

1. Disconnect the connector of ABS actuator and electric unit (control unit).
2. Check the continuity between the harness connector and the ABS actuator and electric unit (control unit) harness connector.

Harness connector		ABS actuator and electric unit (control unit) harness connector		Continuity
Connector No.	Terminal No.	Connector No.	Terminal No.	
E106	49	E41	35	Existed
	48		14	Existed

Is the inspection result normal?

YES (Present error)>>Check CAN system type decision again.

YES (Past error)>>Error was detected in the main line between the 4WAS main control unit and the ABS actuator and electric unit (control unit).

# MAIN LINE BETWEEN RAS AND ABS CIRCUIT

< DTC/CIRCUIT DIAGNOSIS >

[CAN SYSTEM (TYPE 6)]

NO >> Repair the main line between the harness connector E106 and the ABS actuator and electric unit (control unit).

A

B

C

D

E

F

G

H

I

J

K

L

LAN

N

O

P

# ECM BRANCH LINE CIRCUIT

< DTC/CIRCUIT DIAGNOSIS >

[CAN SYSTEM (TYPE 6)]

## ECM BRANCH LINE CIRCUIT

### Diagnosis Procedure

INFOID:000000005779473

#### 1. CHECK CONNECTOR

1. Turn the ignition switch OFF.
2. Disconnect the battery cable from the negative terminal.
3. Check the terminals and connectors of the ECM for damage, bend and loose connection (unit side and connector side).

Is the inspection result normal?

- YES >> GO TO 2.  
NO >> Repair the terminal and connector.

#### 2. CHECK HARNESS FOR OPEN CIRCUIT

1. Disconnect the connector of ECM.
2. Check the resistance between the ECM harness connector terminals.

ECM harness connector			Resistance (Ω)
Connector No.	Terminal No.		
M107	114	113	Approx. 108 – 132

Is the measurement value within the specification?

- YES >> GO TO 3.  
NO >> Repair the ECM branch line.

#### 3. CHECK POWER SUPPLY AND GROUND CIRCUIT

Check the power supply and the ground circuit of the ECM. Refer to [EC-152. "Diagnosis Procedure"](#).

Is the inspection result normal?

YES (Present error)>>Replace the ECM. Refer to [EC-17. "ADDITIONAL SERVICE WHEN REPLACING CONTROL UNIT \(ECM\) : Special Repair Requirement"](#).

YES (Past error)>>Error was detected in the ECM branch line.

NO >> Repair the power supply and the ground circuit.



# A-BAG BRANCH LINE CIRCUIT

< DTC/CIRCUIT DIAGNOSIS >

[CAN SYSTEM (TYPE 6)]

## A-BAG BRANCH LINE CIRCUIT

### Diagnosis Procedure

INFOID:000000005884798

#### **WARNING:**

- Before servicing, turn ignition switch OFF, disconnect battery negative terminal, and wait 3 minutes or more. (To discharge backup capacitor.)
- Never use unspecified tester or other measuring device.

#### **1**.CHECK CONNECTOR

1. Turn the ignition switch OFF.
2. Disconnect the battery cable from the negative terminal.
3. Check the terminals and connectors of the air bag diagnosis sensor unit for damage, bend and loose connection (unit side and connector side).

Is the inspection result normal?

- YES >> GO TO 2.  
NO >> Replace the terminal and connector.

#### **2**.CHECK AIR BAG DIAGNOSIS SENSOR UNIT

Check the air bag diagnosis sensor unit. Refer to [SRC-5, "Work Flow"](#).

Is the inspection result normal?

- YES >> Replace the main harness.  
NO >> Replace parts whose air bag system has a malfunction.

A  
B  
C  
D  
E  
F  
G  
H  
I  
J  
K  
L  
N  
O  
P

LAN

# BCM BRANCH LINE CIRCUIT

< DTC/CIRCUIT DIAGNOSIS >

[CAN SYSTEM (TYPE 6)]

## BCM BRANCH LINE CIRCUIT

### Diagnosis Procedure

INFOID:000000005779475

#### 1. CHECK CONNECTOR

1. Turn the ignition switch OFF.
2. Disconnect the battery cable from the negative terminal.
3. Check the terminals and connectors of the BCM for damage, bend and loose connection (unit side and connector side).

Is the inspection result normal?

- YES >> GO TO 2.  
NO >> Repair the terminal and connector.

#### 2. CHECK HARNESS FOR OPEN CIRCUIT

1. Disconnect the connector of BCM.
2. Check the resistance between the BCM harness connector terminals.

BCM harness connector			Resistance ( $\Omega$ )
Connector No.	Terminal No.		
M122	91	90	Approx. 54 – 66

Is the measurement value within the specification?

- YES >> GO TO 3.  
NO >> Repair the BCM branch line.

#### 3. CHECK POWER SUPPLY AND GROUND CIRCUIT

Check the power supply and the ground circuit of the BCM. Refer to [BCS-37, "Diagnosis Procedure"](#).

Is the inspection result normal?

- YES (Present error)>>Replace the BCM. Refer to [BCS-78, "Exploded View"](#).  
YES (Past error)>>Error was detected in the BCM branch line.  
NO >> Repair the power supply and the ground circuit.

# DLC BRANCH LINE CIRCUIT

< DTC/CIRCUIT DIAGNOSIS >

[CAN SYSTEM (TYPE 6)]

## DLC BRANCH LINE CIRCUIT

### Diagnosis Procedure

INFOID:000000005779476

#### 1. CHECK CONNECTOR

1. Turn the ignition switch OFF.
2. Disconnect the battery cable from the negative terminal.
3. Check the terminals and connectors of the data link connector for damage, bend and loose connection (connector side and harness side).

Is the inspection result normal?

- YES >> GO TO 2.  
NO >> Repair the terminal and connector.

#### 2. CHECK HARNESS FOR OPEN CIRCUIT

Check the resistance between the data link connector terminals.

Data link connector			Resistance (Ω)
Connector No.	Terminal No.		
M24	6	14	Approx. 54 – 66

Is the measurement value within the specification?

- YES (Present error)>>Check CAN system type decision again.  
YES (Past error)>>Error was detected in the data link connector branch line circuit.  
NO >> Repair the data link connector branch line.

A  
B  
C  
D  
E  
F  
G  
H  
I  
J  
K  
L

LAN

N  
O  
P

M&A BRANCH LINE CIRCUIT

Diagnosis Procedure

INFOID:000000005779477

1.CHECK CONNECTOR

1. Turn the ignition switch OFF.
2. Disconnect the battery cable from the negative terminal.
3. Check the terminals and connectors of the unified meter and A/C amp. for damage, bend and loose connection (unit side and connector side).

Is the inspection result normal?

- YES >> GO TO 2.  
 NO >> Repair the terminal and connector.

2.CHECK HARNESS FOR OPEN CIRCUIT

1. Disconnect the connector of unified meter and A/C amp.
2. Check the resistance between the unified meter and A/C amp. harness connector terminals.

Unified meter and A/C amp. harness connector			Resistance (Ω)
Connector No.	Terminal No.		
M67	56	72	Approx. 54 – 66

Is the measurement value within the specification?

- YES >> GO TO 3.  
 NO >> Repair the unified meter and A/C amp. branch line.

3.CHECK POWER SUPPLY AND GROUND CIRCUIT

Check the power supply and the ground circuit of the unified meter and A/C amp. Refer to [MWI-50, "UNIFIED METER AND A/C AMP. : Diagnosis Procedure"](#).

Is the inspection result normal?

- YES (Present error)>>Replace the unified meter and A/C amp. Refer to [MWI-130, "Exploded View"](#).  
 YES (Past error)>>Error was detected in the unified meter and A/C amp. branch line.  
 NO >> Repair the power supply and the ground circuit.

# STRG BRANCH LINE CIRCUIT

< DTC/CIRCUIT DIAGNOSIS >

[CAN SYSTEM (TYPE 6)]

## STRG BRANCH LINE CIRCUIT

### Diagnosis Procedure

INFOID:000000005779478

#### 1. CHECK CONNECTOR

1. Turn the ignition switch OFF.
2. Disconnect the battery cable from the negative terminal.
3. Check the terminals and connectors of the steering angle sensor for damage, bend and loose connection (unit side and connector side).

Is the inspection result normal?

- YES >> GO TO 2.  
NO >> Repair the terminal and connector.

#### 2. CHECK HARNESS FOR OPEN CIRCUIT

1. Disconnect the connector of steering angle sensor.
2. Check the resistance between the steering angle sensor harness connector terminals.

Steering angle sensor harness connector			Resistance (Ω)
Connector No.	Terminal No.		
M37	1	2	Approx. 54 – 66

Is the measurement value within the specification?

- YES >> GO TO 3.  
NO >> Repair the steering angle sensor branch line.

#### 3. CHECK POWER SUPPLY AND GROUND CIRCUIT

Check the power supply and the ground circuit of the steering angle sensor. Refer to [BRC-83, "Wiring Diagram - BRAKE CONTROL SYSTEM -"](#).

Is the inspection result normal?

- YES (Present error)>>Replace the steering angle sensor. Refer to [BRC-108, "Exploded View"](#).  
YES (Past error)>>Error was detected in the steering angle sensor branch line.  
NO >> Repair the power supply and the ground circuit.

A  
B  
C  
D  
E  
F  
G  
H  
I  
J  
K  
L

LAN

N  
O  
P

## AV BRANCH LINE CIRCUIT

### Diagnosis Procedure

INFOID:000000005779479

#### 1. CHECK CONNECTOR

1. Turn the ignition switch OFF.
2. Disconnect the battery cable from the negative terminal.
3. Check the terminals and connectors of the AV control unit for damage, bend and loose connection (unit side and connector side).

Is the inspection result normal?

- YES >> GO TO 2.  
 NO >> Repair the terminal and connector.

#### 2. CHECK HARNESS FOR OPEN CIRCUIT

1. Disconnect the connector of AV control unit.
2. Check the resistance between the AV control unit harness connector terminals.
  - Without navigation system (Without rear view monitor)

AV control unit harness connector			Resistance (Ω)
Connector No.	Terminal No.		
M85	86	87	Approx. 54 – 66

- Without navigation system (With rear view monitor)

AV control unit harness connector			Resistance (Ω)
Connector No.	Terminal No.		
M204	81	80	Approx. 54 – 66

- With navigation system

AV control unit harness connector			Resistance (Ω)
Connector No.	Terminal No.		
M210	90	74	Approx. 54 – 66

Is the measurement value within the specification?

- YES >> GO TO 3.  
 NO >> Repair the AV control unit branch line.

#### 3. CHECK POWER SUPPLY AND GROUND CIRCUIT

Check the power supply and the ground circuit of the AV control unit. Refer to the following.

- Base audio without rear view camera: [AV-40, "AV CONTROL UNIT : Diagnosis Procedure"](#)
- Base audio with rear view camera: [AV-172, "AV CONTROL UNIT : Diagnosis Procedure"](#)
- BOSE audio without navigation: [AV-297, "AV CONTROL UNIT : Diagnosis Procedure"](#)
- BOSE audio with navigation: [AV-451, "AV CONTROL UNIT : Diagnosis Procedure"](#)

Is the inspection result normal?

- YES (Present error)>>Replace the AV control unit. Refer to the following.
- Base audio without rear view camera: [AV-89, "Exploded View"](#)
  - Base audio with rear view camera: [AV-201, "Exploded View"](#)
  - BOSE audio without navigation: [AV-328, "Exploded View"](#)
  - BOSE audio with navigation: [AV-477, "Exploded View"](#)

YES (Past error)>>Error was detected in the AV control unit branch line.

- NO >> Repair the power supply and the ground circuit.

# TCM BRANCH LINE CIRCUIT

< DTC/CIRCUIT DIAGNOSIS >

[CAN SYSTEM (TYPE 6)]

## TCM BRANCH LINE CIRCUIT

### Diagnosis Procedure

INFOID:000000005779480

#### 1. CHECK CONNECTOR

1. Turn the ignition switch OFF.
2. Disconnect the battery cable from the negative terminal.
3. Check the following terminals and connectors for damage, bend and loose connection (unit side and connector side).
  - A/T assembly
  - Harness connector F103
  - Harness connector M116

Is the inspection result normal?

- YES >> GO TO 2.  
NO >> Repair the terminal and connector.

#### 2. CHECK HARNESS FOR OPEN CIRCUIT

1. Disconnect the connector of A/T assembly.
2. Check the resistance between the A/T assembly harness connector terminals.

A/T assembly harness connector		Resistance (Ω)
Connector No.	Terminal No.	
F51	3	Approx. 54 – 66
	8	

Is the measurement value within the specification?

- YES >> GO TO 3.  
NO >> Repair the TCM branch line.

#### 3. CHECK POWER SUPPLY AND GROUND CIRCUIT

Check the power supply and the ground circuit of the TCM. Refer to [TM-212, "Diagnosis Procedure"](#).

Is the inspection result normal?

- YES (Present error)>>Replace the control valve with TCM. Refer to [TM-99, "Component Parts Location"](#).  
(Replace A/T assembly if control valve with TCM is not listed in the latest parts list.)  
YES (Past error)>>Error was detected in the TCM branch line.  
NO >> Repair the power supply and the ground circuit.

A  
B  
C  
D  
E  
F  
G  
H  
I  
J  
K  
L

LAN

## ADP BRANCH LINE CIRCUIT

### Diagnosis Procedure

INFOID:000000005779481

#### 1. CHECK CONNECTOR

1. Turn the ignition switch OFF.
2. Disconnect the battery cable from the negative terminal.
3. Check the following terminals and connectors for damage, bend and loose connection (unit side and connector side).
  - Models with automatic drive positioner
    - Driver seat control unit
    - Harness connector B502
    - Harness connector B11
  - Models without automatic drive positioner
    - Driver seat control unit
    - Harness connector B501
    - Harness connector B10

Is the inspection result normal?

YES >> GO TO 2.

NO >> Repair the terminal and connector.

#### 2. CHECK HARNESS FOR OPEN CIRCUIT

1. Disconnect the connector of driver seat control unit.
2. Check the resistance between the driver seat control unit harness connector terminals.

Driver seat control unit harness connector			Resistance (Ω)
Connector No.	Terminal No.		
B503	3	19	Approx. 54 – 66

Is the measurement value within the specification?

YES >> GO TO 3.

NO >> Repair the driver seat control unit branch line.

#### 3. CHECK POWER SUPPLY AND GROUND CIRCUIT

Check the power supply and the ground circuit of the driver seat control unit. Refer to [ADP-64. "DRIVER SEAT CONTROL UNIT : Diagnosis Procedure"](#).

Is the inspection result normal?

YES (Present error)>>Replace the driver seat control unit. Refer to [ADP-234. "Exploded View"](#).

YES (Past error)>>Error was detected in the driver seat control unit branch line.

NO >> Repair the power supply and the ground circuit.



## RAS BRANCH LINE CIRCUIT

### Diagnosis Procedure

INFOID:000000005779482

#### 1. CHECK CONNECTOR

1. Turn the ignition switch OFF.
2. Disconnect the battery cable from the negative terminal.
3. Check the terminals and connectors of the 4WAS main control unit for damage, bend and loose connection (unit side and connector side).

Is the inspection result normal?

- YES >> GO TO 2.  
 NO >> Repair the terminal and connector.

#### 2. CHECK HARNESS FOR OPEN CIRCUIT

1. Disconnect the connector of 4WAS main control unit.
2. Check the resistance between the 4WAS main control unit harness connector terminals.

4WAS main control unit harness connector			Resistance (Ω)
Connector No.	Terminal No.		
B54	1	8	Approx. 54 – 66

Is the measurement value within the specification?

- YES >> GO TO 3.  
 NO >> Replace the body harness.

#### 3. CHECK POWER SUPPLY AND GROUND CIRCUIT

Check the power supply and the ground circuit of the 4WAS main control unit. Refer to [STC-136, "Diagnosis Procedure \(4WAS Main Control Unit\)"](#).

Is the inspection result normal?

- YES (Present error)>>Replace the 4WAS main control unit. Refer to [STC-181, "Exploded View"](#).  
 YES (Past error)>>Error was detected in the 4WAS main control unit branch line.  
 NO >> Repair the power supply and the ground circuit.

A  
B  
C  
D  
E  
F  
G  
H  
I  
J  
K  
L

LAN

N  
O  
P

# ABS BRANCH LINE CIRCUIT

< DTC/CIRCUIT DIAGNOSIS >

[CAN SYSTEM (TYPE 6)]

## ABS BRANCH LINE CIRCUIT

### Diagnosis Procedure

INFOID:000000005779483

#### 1. CHECK CONNECTOR

1. Turn the ignition switch OFF.
2. Disconnect the battery cable from the negative terminal.
3. Check the terminals and connectors of the ABS actuator and electric unit (control unit) for damage, bend and loose connection (unit side and connector side).

Is the inspection result normal?

- YES >> GO TO 2.  
NO >> Repair the terminal and connector.

#### 2. CHECK HARNESS FOR OPEN CIRCUIT

1. Disconnect the connector of ABS actuator and electric unit (control unit).
2. Check the resistance between the ABS actuator and electric unit (control unit) harness connector terminals.

ABS actuator and electric unit (control unit) harness connector			Resistance (Ω)
Connector No.	Terminal No.		
E41	35	14	Approx. 54 – 66

Is the measurement value within the specification?

- YES >> GO TO 3.  
NO >> Repair the ABS actuator and electric unit (control unit) branch line.

#### 3. CHECK POWER SUPPLY AND GROUND CIRCUIT

Check the power supply and the ground circuit of the ABS actuator and electric unit (control unit). Refer to [BRC-69. "Diagnosis Procedure"](#).

Is the inspection result normal?

- YES (Present error)>>Replace the ABS actuator and electric unit (control unit). Refer to [BRC-105. "Exploded View"](#).  
YES (Past error)>>Error was detected in the ABS actuator and electric unit (control unit) branch line.  
NO >> Repair the power supply and the ground circuit.

# IPDM-E BRANCH LINE CIRCUIT

< DTC/CIRCUIT DIAGNOSIS >

[CAN SYSTEM (TYPE 6)]

## IPDM-E BRANCH LINE CIRCUIT

### Diagnosis Procedure

INFOID:000000005779484

#### 1.CHECK CONNECTOR

1. Turn the ignition switch OFF.
2. Disconnect the battery cable from the negative terminal.
3. Check the terminals and connectors of the IPDM E/R for damage, bend and loose connection (unit side and connector side).

Is the inspection result normal?

- YES >> GO TO 2.  
NO >> Repair the terminal and connector.

#### 2.CHECK HARNESS FOR OPEN CIRCUIT

1. Disconnect the connector of IPDM E/R.
2. Check the resistance between the IPDM E/R harness connector terminals.

IPDM E/R harness connector			Resistance (Ω)
Connector No.	Terminal No.		
E6	40	39	Approx. 108 – 132

Is the measurement value within the specification?

- YES >> GO TO 3.  
NO >> Repair the IPDM E/R branch line.

#### 3.CHECK POWER SUPPLY AND GROUND CIRCUIT

Check the power supply and the ground circuit of the IPDM E/R. Refer to [PCS-17, "Diagnosis Procedure"](#).

Is the inspection result normal?

- YES (Present error)>>Replace the IPDM E/R. Refer to [PCS-32, "Exploded View"](#).  
YES (Past error)>>Error was detected in the IPDM E/R branch line.  
NO >> Repair the power supply and the ground circuit.

A  
B  
C  
D  
E  
F  
G  
H  
I  
J  
K  
L

LAN

N  
O  
P

# CAN COMMUNICATION CIRCUIT

< DTC/CIRCUIT DIAGNOSIS >

[CAN SYSTEM (TYPE 6)]

## CAN COMMUNICATION CIRCUIT

### Diagnosis Procedure

INFOID:000000005779485

#### 1. CONNECTOR INSPECTION

1. Turn the ignition switch OFF.
2. Disconnect the battery cable from the negative terminal.
3. Disconnect all the unit connectors on CAN communication system.
4. Check terminals and connectors for damage, bend and loose connection.

Is the inspection result normal?

- YES >> GO TO 2.  
NO >> Repair the terminal and connector.

#### 2. CHECK HARNESS CONTINUITY (SHORT CIRCUIT)

Check the continuity between the data link connector terminals.

Data link connector		Continuity
Connector No.	Terminal No.	
M24	6 14	Not existed

Is the inspection result normal?

- YES >> GO TO 3.  
NO >> Check the harness and repair the root cause.

#### 3. CHECK HARNESS CONTINUITY (SHORT CIRCUIT)

Check the continuity between the data link connector and the ground.

Data link connector		Ground	Continuity
Connector No.	Terminal No.		
M24	6		Not existed
	14		Not existed

Is the inspection result normal?

- YES >> GO TO 4.  
NO >> Check the harness and repair the root cause.

#### 4. CHECK ECM AND IPDM E/R TERMINATION CIRCUIT

1. Remove the ECM and the IPDM E/R.
2. Check the resistance between the ECM terminals.

ECM		Resistance ( $\Omega$ )
Terminal No.		
114	113	Approx. 108 – 132

3. Check the resistance between the IPDM E/R terminals.

IPDM E/R		Resistance ( $\Omega$ )
Terminal No.		
40	39	Approx. 108 – 132

Is the measurement value within the specification?

- YES >> GO TO 5.  
NO >> Replace the ECM and/or the IPDM E/R.

#### 5. CHECK SYMPTOM

Connect all the connectors. Check if the symptoms described in the "Symptom (Results from interview with customer)" are reproduced.

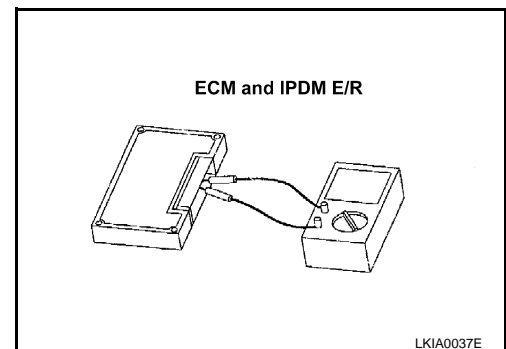

# CAN COMMUNICATION CIRCUIT

< DTC/CIRCUIT DIAGNOSIS >

[CAN SYSTEM (TYPE 6)]

## Inspection result

Reproduced>>GO TO 6.

Non-reproduced>>Start the diagnosis again. Follow the trouble diagnosis procedure when past error is detected.

## **6**.CHECK UNIT REPRODUCTION

Perform the reproduction test as per the following procedure for each unit.

1. Turn the ignition switch OFF.
2. Disconnect the battery cable from the negative terminal.
3. Disconnect one of the unit connectors of CAN communication system.

### **NOTE:**

ECM and IPDM E/R have a termination circuit. Check other units first.

4. Connect the battery cable to the negative terminal. Check if the symptoms described in the "Symptom (Results from interview with customer)" are reproduced.

### **NOTE:**

Although unit-related error symptoms occur, do not confuse them with other symptoms.

## Inspection result

Reproduced>>Connect the connector. Check other units as per the above procedure.

Non-reproduced>>Replace the unit whose connector was disconnected.

A  
B  
C  
D  
E  
F  
G  
H  
I  
J  
K  
L

LAN

N  
O  
P

# MAIN LINE BETWEEN DLC AND AV CIRCUIT

< DTC/CIRCUIT DIAGNOSIS >

[CAN SYSTEM (TYPE 7)]

## DTC/CIRCUIT DIAGNOSIS

### MAIN LINE BETWEEN DLC AND AV CIRCUIT

#### Diagnosis Procedure

INFOID:000000005779486

#### 1. CHECK HARNESS CONTINUITY (OPEN CIRCUIT)

1. Turn the ignition switch OFF.
2. Disconnect the battery cable from the negative terminal.
3. Disconnect the following harness connectors.
  - ECM
  - AV control unit
4. Check the continuity between the data link connector and the AV control unit harness connector.
  - Without navigation system (Without rear view monitor)

Data link connector		AV control unit harness connector		Continuity
Connector No.	Terminal No.	Connector No.	Terminal No.	
M24	6	M85	86	Existed
	14		87	Existed

- Without navigation system (With rear view monitor)

Data link connector		AV control unit harness connector		Continuity
Connector No.	Terminal No.	Connector No.	Terminal No.	
M24	6	M204	81	Existed
	14		80	Existed

- With navigation system

Data link connector		AV control unit harness connector		Continuity
Connector No.	Terminal No.	Connector No.	Terminal No.	
M24	6	M210	90	Existed
	14		74	Existed

#### Is the inspection result normal?

YES (Present error)>>Check CAN system type decision again.

YES (Past error)>>Error was detected in the main line between the data link connector and the AV control unit.

NO >> Repair the main line between the data link connector and the AV control unit.

# MAIN LINE BETWEEN AV AND ADP CIRCUIT

< DTC/CIRCUIT DIAGNOSIS >

[CAN SYSTEM (TYPE 7)]

## MAIN LINE BETWEEN AV AND ADP CIRCUIT

### Diagnosis Procedure

INFOID:000000005779487

#### 1. CHECK CONNECTOR

1. Turn the ignition switch OFF.
2. Disconnect the battery cable from the negative terminal.
3. Check the following terminals and connectors for damage, bend and loose connection (connector side and harness side).
  - Harness connector M7
  - Harness connector B1

Is the inspection result normal?

YES >> GO TO 2.

NO >> Repair the terminal and connector.

#### 2. CHECK HARNESS CONTINUITY (OPEN CIRCUIT)

1. Disconnect the following harness connectors.
  - AV control unit
  - Harness connectors M7 and B1
2. Check the continuity between the AV control unit harness connector and harness connector.
  - Without navigation system (Without rear view monitor)

AV control unit harness connector		Harness connector		Continuity
Connector No.	Terminal No.	Connector No.	Terminal No.	
M85	86	M7	20	Existed
	87		21	Existed

- Without navigation system (With rear view monitor)

AV control unit harness connector		Harness connector		Continuity
Connector No.	Terminal No.	Connector No.	Terminal No.	
M204	81	M7	20	Existed
	80		21	Existed

- With navigation system

AV control unit harness connector		Harness connector		Continuity
Connector No.	Terminal No.	Connector No.	Terminal No.	
M210	90	M7	20	Existed
	74		21	Existed

Is the inspection result normal?

YES >> GO TO 3.

NO >> Repair the main line between the AV control unit and the harness connector M7.

#### 3. CHECK HARNESS CONTINUITY (OPEN CIRCUIT)

Check the continuity between the harness connector terminals.

Connector No.	Terminal No.		Continuity
B1	20	22	Existed
	21	23	Existed

Is the inspection result normal?

YES (Present error)>>Check CAN system type decision again.

YES (Past error)>>Error was detected in the main line between the AV control unit and the driver seat control unit.

NO >> Repair the main line between the harness connectors B1 and the driver seat control unit.

# MAIN LINE BETWEEN ADP AND ABS CIRCUIT

< DTC/CIRCUIT DIAGNOSIS >

[CAN SYSTEM (TYPE 7)]

## MAIN LINE BETWEEN ADP AND ABS CIRCUIT

### Diagnosis Procedure

INFOID:000000005779488

#### 1. CHECK CONNECTOR

1. Turn the ignition switch OFF.
2. Disconnect the battery cable from the negative terminal.
3. Check the following terminals and connectors for damage, bend and loose connection (connector side and harness side).
  - Harness connector B1
  - Harness connector M7
  - Harness connector M6
  - Harness connector E106

Is the inspection result normal?

YES >> GO TO 2.

NO >> Repair the terminal and connector.

#### 2. CHECK HARNESS CONTINUITY (OPEN CIRCUIT)

1. Disconnect the harness connectors B1 and M7.
2. Check the continuity between the harness connector terminals.

Connector No.	Terminal No.		Continuity
B1	20	22	Existed
	21	23	Existed

Is the inspection result normal?

YES >> GO TO 3.

NO >> Repair the main line between the driver seat control unit and the harness connector B1.

#### 3. CHECK HARNESS CONTINUITY (OPEN CIRCUIT)

1. Disconnect the harness connectors M6 and E106.
2. Check the continuity between the harness connectors.

Harness connector		Harness connector		Continuity
Connector No.	Terminal No.	Connector No.	Terminal No.	
M7	22	M6	49	Existed
	23		48	Existed

Is the inspection result normal?

YES >> GO TO 4.

NO >> Repair the main line between the harness connectors M7 and M6.

#### 4. CHECK HARNESS CONTINUITY (OPEN CIRCUIT)

1. Disconnect the connector of ABS actuator and electric unit (control unit).
2. Check the continuity between the harness connector and the ABS actuator and electric unit (control unit) harness connector.

Harness connector		ABS actuator and electric unit (control unit) harness connector		Continuity
Connector No.	Terminal No.	Connector No.	Terminal No.	
E106	49	E41	35	Existed
	48		14	Existed

Is the inspection result normal?

YES (Present error)>>Check CAN system type decision again.

YES (Past error)>>Error was detected in the main line between the driver seat control unit and the ABS actuator and electric unit (control unit).



# MAIN LINE BETWEEN ADP AND ABS CIRCUIT

< DTC/CIRCUIT DIAGNOSIS >

[CAN SYSTEM (TYPE 7)]

NO >> Repair the main line between the harness connector E106 and the ABS actuator and electric unit (control unit).

A  
B  
C  
D  
E  
F  
G  
H  
I  
J  
K  
L  
N  
O  
P

LAN

# ECM BRANCH LINE CIRCUIT

< DTC/CIRCUIT DIAGNOSIS >

[CAN SYSTEM (TYPE 7)]

## ECM BRANCH LINE CIRCUIT

### Diagnosis Procedure

INFOID:000000005779489

#### 1. CHECK CONNECTOR

1. Turn the ignition switch OFF.
2. Disconnect the battery cable from the negative terminal.
3. Check the terminals and connectors of the ECM for damage, bend and loose connection (unit side and connector side).

Is the inspection result normal?

- YES >> GO TO 2.  
NO >> Repair the terminal and connector.

#### 2. CHECK HARNESS FOR OPEN CIRCUIT

1. Disconnect the connector of ECM.
2. Check the resistance between the ECM harness connector terminals.

ECM harness connector			Resistance (Ω)
Connector No.	Terminal No.		
M107	114	113	Approx. 108 – 132

Is the measurement value within the specification?

- YES >> GO TO 3.  
NO >> Repair the ECM branch line.

#### 3. CHECK POWER SUPPLY AND GROUND CIRCUIT

Check the power supply and the ground circuit of the ECM. Refer to [EC-152. "Diagnosis Procedure"](#).

Is the inspection result normal?

YES (Present error)>>Replace the ECM. Refer to [EC-17. "ADDITIONAL SERVICE WHEN REPLACING CONTROL UNIT \(ECM\) : Special Repair Requirement"](#).

YES (Past error)>>Error was detected in the ECM branch line.

NO >> Repair the power supply and the ground circuit.

# A-BAG BRANCH LINE CIRCUIT

< DTC/CIRCUIT DIAGNOSIS >

[CAN SYSTEM (TYPE 7)]

## A-BAG BRANCH LINE CIRCUIT

### Diagnosis Procedure

INFOID:000000005885027

#### **WARNING:**

- Before servicing, turn ignition switch OFF, disconnect battery negative terminal, and wait 3 minutes or more. (To discharge backup capacitor.)
- Never use unspecified tester or other measuring device.

#### 1. CHECK CONNECTOR

1. Turn the ignition switch OFF.
2. Disconnect the battery cable from the negative terminal.
3. Check the terminals and connectors of the air bag diagnosis sensor unit for damage, bend and loose connection (unit side and connector side).

Is the inspection result normal?

- YES >> GO TO 2.  
NO >> Replace the terminal and connector.

#### 2. CHECK AIR BAG DIAGNOSIS SENSOR UNIT

Check the air bag diagnosis sensor unit. Refer to [SRC-5, "Work Flow"](#).

Is the inspection result normal?

- YES >> Replace the main harness.  
NO >> Replace parts whose air bag system has a malfunction.

A  
B  
C  
D  
E  
F  
G  
H  
I  
J  
K  
L  
N  
O  
P

LAN

# BCM BRANCH LINE CIRCUIT

< DTC/CIRCUIT DIAGNOSIS >

[CAN SYSTEM (TYPE 7)]

## BCM BRANCH LINE CIRCUIT

### Diagnosis Procedure

INFOID:000000005779491

#### 1.CHECK CONNECTOR

1. Turn the ignition switch OFF.
2. Disconnect the battery cable from the negative terminal.
3. Check the terminals and connectors of the BCM for damage, bend and loose connection (unit side and connector side).

Is the inspection result normal?

- YES >> GO TO 2.  
NO >> Repair the terminal and connector.

#### 2.CHECK HARNESS FOR OPEN CIRCUIT

1. Disconnect the connector of BCM.
2. Check the resistance between the BCM harness connector terminals.

BCM harness connector			Resistance (Ω)
Connector No.	Terminal No.		
M122	91	90	Approx. 54 – 66

Is the measurement value within the specification?

- YES >> GO TO 3.  
NO >> Repair the BCM branch line.

#### 3.CHECK POWER SUPPLY AND GROUND CIRCUIT

Check the power supply and the ground circuit of the BCM. Refer to [BCS-37, "Diagnosis Procedure"](#).

Is the inspection result normal?

- YES (Present error)>>Replace the BCM. Refer to [BCS-78, "Exploded View"](#).  
YES (Past error)>>Error was detected in the BCM branch line.  
NO >> Repair the power supply and the ground circuit.

# DLC BRANCH LINE CIRCUIT

< DTC/CIRCUIT DIAGNOSIS >

[CAN SYSTEM (TYPE 7)]

## DLC BRANCH LINE CIRCUIT

### Diagnosis Procedure

INFOID:000000005779492

#### 1. CHECK CONNECTOR

1. Turn the ignition switch OFF.
2. Disconnect the battery cable from the negative terminal.
3. Check the terminals and connectors of the data link connector for damage, bend and loose connection (connector side and harness side).

Is the inspection result normal?

- YES >> GO TO 2.  
NO >> Repair the terminal and connector.

#### 2. CHECK HARNESS FOR OPEN CIRCUIT

Check the resistance between the data link connector terminals.

Data link connector			Resistance (Ω)
Connector No.	Terminal No.		
M24	6	14	Approx. 54 – 66

Is the measurement value within the specification?

- YES (Present error)>>Check CAN system type decision again.  
YES (Past error)>>Error was detected in the data link connector branch line circuit.  
NO >> Repair the data link connector branch line.

A  
B  
C  
D  
E  
F  
G  
H  
I  
J  
K  
L

LAN

N  
O  
P

## M&A BRANCH LINE CIRCUIT

### Diagnosis Procedure

INFOID:000000005779493

#### 1. CHECK CONNECTOR

1. Turn the ignition switch OFF.
2. Disconnect the battery cable from the negative terminal.
3. Check the terminals and connectors of the unified meter and A/C amp. for damage, bend and loose connection (unit side and connector side).

Is the inspection result normal?

- YES >> GO TO 2.  
 NO >> Repair the terminal and connector.

#### 2. CHECK HARNESS FOR OPEN CIRCUIT

1. Disconnect the connector of unified meter and A/C amp.
2. Check the resistance between the unified meter and A/C amp. harness connector terminals.

Unified meter and A/C amp. harness connector			Resistance (Ω)
Connector No.	Terminal No.		
M67	56	72	Approx. 54 – 66

Is the measurement value within the specification?

- YES >> GO TO 3.  
 NO >> Repair the unified meter and A/C amp. branch line.

#### 3. CHECK POWER SUPPLY AND GROUND CIRCUIT

Check the power supply and the ground circuit of the unified meter and A/C amp. Refer to [MWI-50, "UNIFIED METER AND A/C AMP. : Diagnosis Procedure"](#).

Is the inspection result normal?

- YES (Present error)>>Replace the unified meter and A/C amp. Refer to [MWI-130, "Exploded View"](#).  
 YES (Past error)>>Error was detected in the unified meter and A/C amp. branch line.  
 NO >> Repair the power supply and the ground circuit.

# STRG BRANCH LINE CIRCUIT

< DTC/CIRCUIT DIAGNOSIS >

[CAN SYSTEM (TYPE 7)]

## STRG BRANCH LINE CIRCUIT

### Diagnosis Procedure

INFOID:000000005779494

#### 1. CHECK CONNECTOR

1. Turn the ignition switch OFF.
2. Disconnect the battery cable from the negative terminal.
3. Check the terminals and connectors of the steering angle sensor for damage, bend and loose connection (unit side and connector side).

Is the inspection result normal?

- YES >> GO TO 2.  
NO >> Repair the terminal and connector.

#### 2. CHECK HARNESS FOR OPEN CIRCUIT

1. Disconnect the connector of steering angle sensor.
2. Check the resistance between the steering angle sensor harness connector terminals.

Steering angle sensor harness connector			Resistance (Ω)
Connector No.	Terminal No.		
M37	1	2	Approx. 54 – 66

Is the measurement value within the specification?

- YES >> GO TO 3.  
NO >> Repair the steering angle sensor branch line.

#### 3. CHECK POWER SUPPLY AND GROUND CIRCUIT

Check the power supply and the ground circuit of the steering angle sensor. Refer to [BRC-83, "Wiring Diagram - BRAKE CONTROL SYSTEM -"](#).

Is the inspection result normal?

- YES (Present error)>>Replace the steering angle sensor. Refer to [BRC-108, "Exploded View"](#).  
YES (Past error)>>Error was detected in the steering angle sensor branch line.  
NO >> Repair the power supply and the ground circuit.

A  
B  
C  
D  
E  
F  
G  
H  
I  
J  
K  
L

LAN

N  
O  
P

## AV BRANCH LINE CIRCUIT

### Diagnosis Procedure

INFOID:000000005779495

#### 1. CHECK CONNECTOR

1. Turn the ignition switch OFF.
2. Disconnect the battery cable from the negative terminal.
3. Check the terminals and connectors of the AV control unit for damage, bend and loose connection (unit side and connector side).

Is the inspection result normal?

- YES >> GO TO 2.  
 NO >> Repair the terminal and connector.

#### 2. CHECK HARNESS FOR OPEN CIRCUIT

1. Disconnect the connector of AV control unit.
2. Check the resistance between the AV control unit harness connector terminals.
  - Without navigation system (Without rear view monitor)

AV control unit harness connector			Resistance (Ω)
Connector No.	Terminal No.		
M85	86	87	Approx. 54 – 66

- Without navigation system (With rear view monitor)

AV control unit harness connector			Resistance (Ω)
Connector No.	Terminal No.		
M204	81	80	Approx. 54 – 66

- With navigation system

AV control unit harness connector			Resistance (Ω)
Connector No.	Terminal No.		
M210	90	74	Approx. 54 – 66

Is the measurement value within the specification?

- YES >> GO TO 3.  
 NO >> Repair the AV control unit branch line.

#### 3. CHECK POWER SUPPLY AND GROUND CIRCUIT

Check the power supply and the ground circuit of the AV control unit. Refer to the following.

- Base audio without rear view camera: [AV-40, "AV CONTROL UNIT : Diagnosis Procedure"](#)
- Base audio with rear view camera: [AV-172, "AV CONTROL UNIT : Diagnosis Procedure"](#)
- BOSE audio without navigation: [AV-297, "AV CONTROL UNIT : Diagnosis Procedure"](#)
- BOSE audio with navigation: [AV-451, "AV CONTROL UNIT : Diagnosis Procedure"](#)

Is the inspection result normal?

- YES (Present error)>>Replace the AV control unit. Refer to the following.
- Base audio without rear view camera: [AV-89, "Exploded View"](#)
  - Base audio with rear view camera: [AV-201, "Exploded View"](#)
  - BOSE audio without navigation: [AV-328, "Exploded View"](#)
  - BOSE audio with navigation: [AV-477, "Exploded View"](#)

YES (Past error)>>Error was detected in the AV control unit branch line.

- NO >> Repair the power supply and the ground circuit.



# PSB BRANCH LINE CIRCUIT

< DTC/CIRCUIT DIAGNOSIS >

[CAN SYSTEM (TYPE 7)]

## PSB BRANCH LINE CIRCUIT

### Diagnosis Procedure

INFOID:000000005779496

#### 1. CHECK CONNECTOR

1. Turn the ignition switch OFF.
2. Disconnect the battery cable from the negative terminal.
3. Check the terminals and connectors of the pre-crash seat belt for damage, bend and loose connection (unit side and connector side).

Is the inspection result normal?

- YES >> GO TO 2.  
NO >> Repair the terminal and connector.

#### 2. CHECK HARNESS FOR OPEN CIRCUIT

1. Disconnect the connector of pre-crash seat belt control unit.
2. Check the resistance between the pre-crash seat belt control unit harness connector terminals.

Pre-crash seat belt control unit harness connector			Resistance (Ω)
Connector No.	Terminal No.		
M110	24	22	Approx. 54 – 66

Is the measurement value within the specification?

- YES >> GO TO 3.  
NO >> Repair the pre-crash seat belt control unit branch line.

#### 3. CHECK POWER SUPPLY AND GROUND CIRCUIT

Check the power supply and the ground circuit of the pre-crash seat belt control unit. Refer to [SBC-24, "Diagnosis Procedure"](#).

Is the inspection result normal?

- YES (Present error)>>Replace the pre-crash seat belt control unit. Refer to [SBC-39, "Exploded View"](#).  
YES (Past error)>>Error was detected in the pre-crash seat belt control unit branch line.  
NO >> Repair the power supply and the ground circuit.

A  
B  
C  
D  
E  
F  
G  
H  
I  
J  
K  
L

LAN

N  
O  
P

# TCM BRANCH LINE CIRCUIT

< DTC/CIRCUIT DIAGNOSIS >

[CAN SYSTEM (TYPE 7)]

## TCM BRANCH LINE CIRCUIT

### Diagnosis Procedure

INFOID:000000005779497

#### 1. CHECK CONNECTOR

1. Turn the ignition switch OFF.
2. Disconnect the battery cable from the negative terminal.
3. Check the following terminals and connectors for damage, bend and loose connection (unit side and connector side).
  - A/T assembly
  - Harness connector F103
  - Harness connector M116

Is the inspection result normal?

YES >> GO TO 2.

NO >> Repair the terminal and connector.

#### 2. CHECK HARNESS FOR OPEN CIRCUIT

1. Disconnect the connector of A/T assembly.
2. Check the resistance between the A/T assembly harness connector terminals.

A/T assembly harness connector		Resistance (Ω)
Connector No.	Terminal No.	
F51	3                      8	Approx. 54 – 66

Is the measurement value within the specification?

YES >> GO TO 3.

NO >> Repair the TCM branch line.

#### 3. CHECK POWER SUPPLY AND GROUND CIRCUIT

Check the power supply and the ground circuit of the TCM. Refer to [TM-212, "Diagnosis Procedure"](#).

Is the inspection result normal?

YES (Present error)>>Replace the control valve with TCM. Refer to [TM-99, "Component Parts Location"](#).  
(Replace A/T assembly if control valve with TCM is not listed in the latest parts list.)

YES (Past error)>>Error was detected in the TCM branch line.

NO >> Repair the power supply and the ground circuit.

# ADP BRANCH LINE CIRCUIT

< DTC/CIRCUIT DIAGNOSIS >

[CAN SYSTEM (TYPE 7)]

## ADP BRANCH LINE CIRCUIT

### Diagnosis Procedure

INFOID:000000005779498

#### 1. CHECK CONNECTOR

1. Turn the ignition switch OFF.
2. Disconnect the battery cable from the negative terminal.
3. Check the following terminals and connectors for damage, bend and loose connection (unit side and connector side).
  - Models with automatic drive positioner
    - Driver seat control unit
    - Harness connector B502
    - Harness connector B11
  - Models without automatic drive positioner
    - Driver seat control unit
    - Harness connector B501
    - Harness connector B10

Is the inspection result normal?

YES >> GO TO 2.

NO >> Repair the terminal and connector.

#### 2. CHECK HARNESS FOR OPEN CIRCUIT

1. Disconnect the connector of driver seat control unit.
2. Check the resistance between the driver seat control unit harness connector terminals.

Driver seat control unit harness connector			Resistance (Ω)
Connector No.	Terminal No.		
B503	3	19	Approx. 54 – 66

Is the measurement value within the specification?

YES >> GO TO 3.

NO >> Repair the driver seat control unit branch line.

#### 3. CHECK POWER SUPPLY AND GROUND CIRCUIT

Check the power supply and the ground circuit of the driver seat control unit. Refer to [ADP-64. "DRIVER SEAT CONTROL UNIT : Diagnosis Procedure"](#).

Is the inspection result normal?

YES (Present error)>>Replace the driver seat control unit. Refer to [ADP-234. "Exploded View"](#).

YES (Past error)>>Error was detected in the driver seat control unit branch line.

NO >> Repair the power supply and the ground circuit.

A  
B  
C  
D  
E  
F  
G  
H  
I  
J  
K  
L  
N  
O  
P

LAN

# ABS BRANCH LINE CIRCUIT

< DTC/CIRCUIT DIAGNOSIS >

[CAN SYSTEM (TYPE 7)]

## ABS BRANCH LINE CIRCUIT

### Diagnosis Procedure

INFOID:000000005779499

#### 1. CHECK CONNECTOR

1. Turn the ignition switch OFF.
2. Disconnect the battery cable from the negative terminal.
3. Check the terminals and connectors of the ABS actuator and electric unit (control unit) for damage, bend and loose connection (unit side and connector side).

Is the inspection result normal?

- YES >> GO TO 2.  
NO >> Repair the terminal and connector.

#### 2. CHECK HARNESS FOR OPEN CIRCUIT

1. Disconnect the connector of ABS actuator and electric unit (control unit).
2. Check the resistance between the ABS actuator and electric unit (control unit) harness connector terminals.

ABS actuator and electric unit (control unit) harness connector			Resistance (Ω)
Connector No.	Terminal No.		
E41	35	14	Approx. 54 – 66

Is the measurement value within the specification?

- YES >> GO TO 3.  
NO >> Repair the ABS actuator and electric unit (control unit) branch line.

#### 3. CHECK POWER SUPPLY AND GROUND CIRCUIT

Check the power supply and the ground circuit of the ABS actuator and electric unit (control unit). Refer to [BRC-69. "Diagnosis Procedure"](#).

Is the inspection result normal?

- YES (Present error)>>Replace the ABS actuator and electric unit (control unit). Refer to [BRC-105. "Exploded View"](#).  
YES (Past error)>>Error was detected in the ABS actuator and electric unit (control unit) branch line.  
NO >> Repair the power supply and the ground circuit.

## ICC BRANCH LINE CIRCUIT

### Diagnosis Procedure

INFOID:000000005779500

#### 1. CHECK CONNECTOR

1. Turn the ignition switch OFF.
2. Disconnect the battery cable from the negative terminal.
3. Check the terminals and connectors of the ICC sensor integrated unit for damage, bend and loose connection (unit side and connector side).

Is the inspection result normal?

- YES >> GO TO 2.  
 NO >> Repair the terminal and connector.

#### 2. CHECK HARNESS FOR OPEN CIRCUIT

1. Disconnect the connector of ICC sensor integrated unit.
2. Check the resistance between the ICC sensor integrated unit harness connector terminals.

ICC sensor integrated unit harness connector			Resistance (Ω)
Connector No.	Terminal No.		
E67	3	6	Approx. 54 – 66

Is the measurement value within the specification?

- YES >> GO TO 3.  
 NO >> Repair the ICC sensor integrated unit branch line.

#### 3. CHECK POWER SUPPLY AND GROUND CIRCUIT

Check the power supply and the ground circuit of the ICC sensor integrated unit. Refer to [CCS-102, "Diagnosis Procedure"](#).

Is the inspection result normal?

- YES (Present error)>>Replace the ICC sensor integrated unit. Refer to [CCS-133, "Exploded View"](#).  
 YES (Past error)>>Error was detected in the ICC sensor integrated unit branch line.  
 NO >> Repair the power supply and the ground circuit.

A  
B  
C  
D  
E  
F  
G  
H  
I  
J  
K  
L

LAN

# IPDM-E BRANCH LINE CIRCUIT

< DTC/CIRCUIT DIAGNOSIS >

[CAN SYSTEM (TYPE 7)]

## IPDM-E BRANCH LINE CIRCUIT

### Diagnosis Procedure

INFOID:000000005779501

#### 1. CHECK CONNECTOR

1. Turn the ignition switch OFF.
2. Disconnect the battery cable from the negative terminal.
3. Check the terminals and connectors of the IPDM E/R for damage, bend and loose connection (unit side and connector side).

Is the inspection result normal?

- YES >> GO TO 2.  
NO >> Repair the terminal and connector.

#### 2. CHECK HARNESS FOR OPEN CIRCUIT

1. Disconnect the connector of IPDM E/R.
2. Check the resistance between the IPDM E/R harness connector terminals.

IPDM E/R harness connector			Resistance (Ω)
Connector No.	Terminal No.		
E6	40	39	Approx. 108 – 132

Is the measurement value within the specification?

- YES >> GO TO 3.  
NO >> Repair the IPDM E/R branch line.

#### 3. CHECK POWER SUPPLY AND GROUND CIRCUIT

Check the power supply and the ground circuit of the IPDM E/R. Refer to [PCS-17, "Diagnosis Procedure"](#).

Is the inspection result normal?

- YES (Present error)>>Replace the IPDM E/R. Refer to [PCS-32, "Exploded View"](#).  
YES (Past error)>>Error was detected in the IPDM E/R branch line.  
NO >> Repair the power supply and the ground circuit.

# CAN COMMUNICATION CIRCUIT

< DTC/CIRCUIT DIAGNOSIS >

[CAN SYSTEM (TYPE 7)]

## CAN COMMUNICATION CIRCUIT

### Diagnosis Procedure

INFOID:000000005779502

#### 1. CONNECTOR INSPECTION

1. Turn the ignition switch OFF.
2. Disconnect the battery cable from the negative terminal.
3. Disconnect all the unit connectors on CAN communication system.
4. Check terminals and connectors for damage, bend and loose connection.

Is the inspection result normal?

- YES >> GO TO 2.  
NO >> Repair the terminal and connector.

#### 2. CHECK HARNESS CONTINUITY (SHORT CIRCUIT)

Check the continuity between the data link connector terminals.

Data link connector		Continuity
Connector No.	Terminal No.	
M24	6 14	Not existed

Is the inspection result normal?

- YES >> GO TO 3.  
NO >> Check the harness and repair the root cause.

#### 3. CHECK HARNESS CONTINUITY (SHORT CIRCUIT)

Check the continuity between the data link connector and the ground.

Data link connector		Ground	Continuity
Connector No.	Terminal No.		
M24	6		Not existed
	14		Not existed

Is the inspection result normal?

- YES >> GO TO 4.  
NO >> Check the harness and repair the root cause.

#### 4. CHECK ECM AND IPDM E/R TERMINATION CIRCUIT

1. Remove the ECM and the IPDM E/R.
2. Check the resistance between the ECM terminals.

ECM		Resistance ( $\Omega$ )
Terminal No.		
114	113	Approx. 108 – 132

3. Check the resistance between the IPDM E/R terminals.

IPDM E/R		Resistance ( $\Omega$ )
Terminal No.		
40	39	Approx. 108 – 132

Is the measurement value within the specification?

- YES >> GO TO 5.  
NO >> Replace the ECM and/or the IPDM E/R.

#### 5. CHECK SYMPTOM

Connect all the connectors. Check if the symptoms described in the "Symptom (Results from interview with customer)" are reproduced.

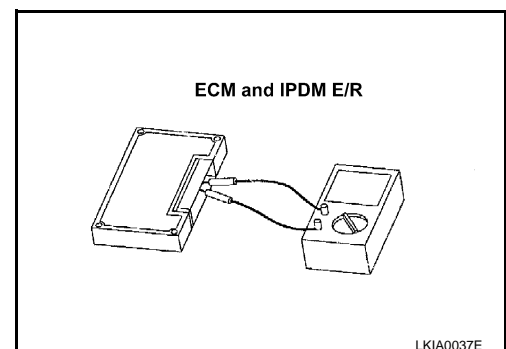

## CAN COMMUNICATION CIRCUIT

< DTC/CIRCUIT DIAGNOSIS >

[CAN SYSTEM (TYPE 7)]

---

### Inspection result

Reproduced>>GO TO 6.

Non-reproduced>>Start the diagnosis again. Follow the trouble diagnosis procedure when past error is detected.

## 6.CHECK UNIT REPRODUCTION

---

Perform the reproduction test as per the following procedure for each unit.

1. Turn the ignition switch OFF.
2. Disconnect the battery cable from the negative terminal.
3. Disconnect one of the unit connectors of CAN communication system.

### **NOTE:**

ECM and IPDM E/R have a termination circuit. Check other units first.

4. Connect the battery cable to the negative terminal. Check if the symptoms described in the "Symptom (Results from interview with customer)" are reproduced.

### **NOTE:**

Although unit-related error symptoms occur, do not confuse them with other symptoms.

### Inspection result

Reproduced>>Connect the connector. Check other units as per the above procedure.

Non-reproduced>>Replace the unit whose connector was disconnected.



# MAIN LINE BETWEEN DLC AND AV CIRCUIT

< DTC/CIRCUIT DIAGNOSIS >

[CAN SYSTEM (TYPE 8)]

## DTC/CIRCUIT DIAGNOSIS

### MAIN LINE BETWEEN DLC AND AV CIRCUIT

#### Diagnosis Procedure

INFOID:000000005779503

#### 1. CHECK HARNESS CONTINUITY (OPEN CIRCUIT)

1. Turn the ignition switch OFF.
2. Disconnect the battery cable from the negative terminal.
3. Disconnect the following harness connectors.
  - ECM
  - AV control unit
4. Check the continuity between the data link connector and the AV control unit harness connector.
  - Without navigation system (Without rear view monitor)

Data link connector		AV control unit harness connector		Continuity
Connector No.	Terminal No.	Connector No.	Terminal No.	
M24	6	M85	86	Existed
	14		87	Existed

- Without navigation system (With rear view monitor)

Data link connector		AV control unit harness connector		Continuity
Connector No.	Terminal No.	Connector No.	Terminal No.	
M24	6	M204	81	Existed
	14		80	Existed

- With navigation system

Data link connector		AV control unit harness connector		Continuity
Connector No.	Terminal No.	Connector No.	Terminal No.	
M24	6	M210	90	Existed
	14		74	Existed

#### Is the inspection result normal?

YES (Present error)>>Check CAN system type decision again.

YES (Past error)>>Error was detected in the main line between the data link connector and the AV control unit.

NO >> Repair the main line between the data link connector and the AV control unit.

LAN

# MAIN LINE BETWEEN AV AND ADP CIRCUIT

< DTC/CIRCUIT DIAGNOSIS >

[CAN SYSTEM (TYPE 8)]

## MAIN LINE BETWEEN AV AND ADP CIRCUIT

### Diagnosis Procedure

INFOID:000000005779504

#### 1. CHECK CONNECTOR

1. Turn the ignition switch OFF.
2. Disconnect the battery cable from the negative terminal.
3. Check the following terminals and connectors for damage, bend and loose connection (connector side and harness side).
  - Harness connector M7
  - Harness connector B1

Is the inspection result normal?

YES >> GO TO 2.

NO >> Repair the terminal and connector.

#### 2. CHECK HARNESS CONTINUITY (OPEN CIRCUIT)

1. Disconnect the following harness connectors.
  - AV control unit
  - Harness connectors M7 and B1
2. Check the continuity between the AV control unit harness connector and harness connector.
  - Without navigation system (Without rear view monitor)

AV control unit harness connector		Harness connector		Continuity
Connector No.	Terminal No.	Connector No.	Terminal No.	
M85	86	M7	20	Existed
	87		21	Existed

- Without navigation system (With rear view monitor)

AV control unit harness connector		Harness connector		Continuity
Connector No.	Terminal No.	Connector No.	Terminal No.	
M204	81	M7	20	Existed
	80		21	Existed

- With navigation system

AV control unit harness connector		Harness connector		Continuity
Connector No.	Terminal No.	Connector No.	Terminal No.	
M210	90	M7	20	Existed
	74		21	Existed

Is the inspection result normal?

YES >> GO TO 3.

NO >> Repair the main line between the AV control unit and the harness connector M7.

#### 3. CHECK HARNESS CONTINUITY (OPEN CIRCUIT)

Check the continuity between the harness connector terminals.

Connector No.	Terminal No.		Continuity
B1	20	22	Existed
	21	23	Existed

Is the inspection result normal?

YES (Present error)>>Check CAN system type decision again.

YES (Past error)>>Error was detected in the main line between the AV control unit and the driver seat control unit.

NO >> Repair the main line between the harness connectors B1 and the driver seat control unit.

# MAIN LINE BETWEEN ADP AND RAS CIRCUIT

< DTC/CIRCUIT DIAGNOSIS >

[CAN SYSTEM (TYPE 8)]

## MAIN LINE BETWEEN ADP AND RAS CIRCUIT

### Diagnosis Procedure

INFOID:000000005779505

#### 1. CHECK HARNESS CONTINUITY (OPEN CIRCUIT)

1. Turn the ignition switch OFF.
2. Disconnect the battery cable from the negative terminal.
3. Disconnect the harness connectors M7 and B1.
4. Check the continuity between the harness connector terminals.

Connector No.	Terminal No.		Continuity
B1	20	22	Existed
	21	23	Existed

#### Is the inspection result normal?

YES (Present error)>>Check CAN system type decision again.

YES (Past error)>>Error was detected in the main line between the driver seat control unit and the 4WAS main control unit.

NO >> Repair the main line between the driver seat control unit and the 4WAS main control unit.

A  
B  
C  
D  
E  
F  
G  
H  
I  
J  
K  
L

LAN

N  
O  
P

# MAIN LINE BETWEEN RAS AND ABS CIRCUIT

< DTC/CIRCUIT DIAGNOSIS >

[CAN SYSTEM (TYPE 8)]

## MAIN LINE BETWEEN RAS AND ABS CIRCUIT

### Diagnosis Procedure

INFOID:000000005779506

#### 1. CHECK CONNECTOR

1. Turn the ignition switch OFF.
2. Disconnect the battery cable from the negative terminal.
3. Check the following terminals and connectors for damage, bend and loose connection (connector side and harness side).
  - Harness connector B1
  - Harness connector M7
  - Harness connector M6
  - Harness connector E106

Is the inspection result normal?

YES >> GO TO 2.

NO >> Repair the terminal and connector.

#### 2. CHECK HARNESS CONTINUITY (OPEN CIRCUIT)

1. Disconnect the harness connectors B1 and M7.
2. Check the continuity between the harness connector terminals.

Connector No.	Terminal No.		Continuity
B1	20	22	Existed
	21	23	Existed

Is the inspection result normal?

YES >> GO TO 3.

NO >> Repair the main line between the 4WAS main control unit and the harness connector B1.

#### 3. CHECK HARNESS CONTINUITY (OPEN CIRCUIT)

1. Disconnect the harness connectors M6 and E106.
2. Check the continuity between the harness connectors.

Harness connector		Harness connector		Continuity
Connector No.	Terminal No.	Connector No.	Terminal No.	
M7	22	M6	49	Existed
	23		48	Existed

Is the inspection result normal?

YES >> GO TO 4.

NO >> Repair the main line between the harness connectors M7 and M6.

#### 4. CHECK HARNESS CONTINUITY (OPEN CIRCUIT)

1. Disconnect the connector of ABS actuator and electric unit (control unit).
2. Check the continuity between the harness connector and the ABS actuator and electric unit (control unit) harness connector.

Harness connector		ABS actuator and electric unit (control unit) harness connector		Continuity
Connector No.	Terminal No.	Connector No.	Terminal No.	
E106	49	E41	35	Existed
	48		14	Existed

Is the inspection result normal?

YES (Present error)>>Check CAN system type decision again.

YES (Past error)>>Error was detected in the main line between the 4WAS main control unit and the ABS actuator and electric unit (control unit).

# MAIN LINE BETWEEN RAS AND ABS CIRCUIT

< DTC/CIRCUIT DIAGNOSIS >

[CAN SYSTEM (TYPE 8)]

NO >> Repair the main line between the harness connector E106 and the ABS actuator and electric unit (control unit).

A  
B  
C  
D  
E  
F  
G  
H  
I  
J  
K  
L  
N  
O  
P

LAN

# ECM BRANCH LINE CIRCUIT

< DTC/CIRCUIT DIAGNOSIS >

[CAN SYSTEM (TYPE 8)]

## ECM BRANCH LINE CIRCUIT

### Diagnosis Procedure

INFOID:000000005779507

#### 1. CHECK CONNECTOR

1. Turn the ignition switch OFF.
2. Disconnect the battery cable from the negative terminal.
3. Check the terminals and connectors of the ECM for damage, bend and loose connection (unit side and connector side).

Is the inspection result normal?

- YES >> GO TO 2.  
NO >> Repair the terminal and connector.

#### 2. CHECK HARNESS FOR OPEN CIRCUIT

1. Disconnect the connector of ECM.
2. Check the resistance between the ECM harness connector terminals.

ECM harness connector			Resistance (Ω)
Connector No.	Terminal No.		
M107	114	113	Approx. 108 – 132

Is the measurement value within the specification?

- YES >> GO TO 3.  
NO >> Repair the ECM branch line.

#### 3. CHECK POWER SUPPLY AND GROUND CIRCUIT

Check the power supply and the ground circuit of the ECM. Refer to [EC-152. "Diagnosis Procedure"](#).

Is the inspection result normal?

- YES (Present error)>>Replace the ECM. Refer to [EC-17. "ADDITIONAL SERVICE WHEN REPLACING CONTROL UNIT \(ECM\) : Special Repair Requirement"](#).  
YES (Past error)>>Error was detected in the ECM branch line.  
NO >> Repair the power supply and the ground circuit.

# A-BAG BRANCH LINE CIRCUIT

< DTC/CIRCUIT DIAGNOSIS >

[CAN SYSTEM (TYPE 8)]

## A-BAG BRANCH LINE CIRCUIT

### Diagnosis Procedure

INFOID:000000005885028

#### **WARNING:**

- Before servicing, turn ignition switch OFF, disconnect battery negative terminal, and wait 3 minutes or more. (To discharge backup capacitor.)
- Never use unspecified tester or other measuring device.

#### **1**.CHECK CONNECTOR

1. Turn the ignition switch OFF.
2. Disconnect the battery cable from the negative terminal.
3. Check the terminals and connectors of the air bag diagnosis sensor unit for damage, bend and loose connection (unit side and connector side).

Is the inspection result normal?

YES >> GO TO 2.

NO >> Replace the terminal and connector.

#### **2**.CHECK AIR BAG DIAGNOSIS SENSOR UNIT

Check the air bag diagnosis sensor unit. Refer to [SRC-5, "Work Flow"](#).

Is the inspection result normal?

YES >> Replace the main harness.

NO >> Replace parts whose air bag system has a malfunction.

A  
B  
C  
D  
E  
F  
G  
H  
I  
J  
K  
L

LAN

N  
O  
P

# BCM BRANCH LINE CIRCUIT

< DTC/CIRCUIT DIAGNOSIS >

[CAN SYSTEM (TYPE 8)]

## BCM BRANCH LINE CIRCUIT

### Diagnosis Procedure

INFOID:000000005779509

#### 1. CHECK CONNECTOR

1. Turn the ignition switch OFF.
2. Disconnect the battery cable from the negative terminal.
3. Check the terminals and connectors of the BCM for damage, bend and loose connection (unit side and connector side).

Is the inspection result normal?

- YES >> GO TO 2.  
NO >> Repair the terminal and connector.

#### 2. CHECK HARNESS FOR OPEN CIRCUIT

1. Disconnect the connector of BCM.
2. Check the resistance between the BCM harness connector terminals.

BCM harness connector			Resistance (Ω)
Connector No.	Terminal No.		
M122	91	90	Approx. 54 – 66

Is the measurement value within the specification?

- YES >> GO TO 3.  
NO >> Repair the BCM branch line.

#### 3. CHECK POWER SUPPLY AND GROUND CIRCUIT

Check the power supply and the ground circuit of the BCM. Refer to [BCS-37, "Diagnosis Procedure"](#).

Is the inspection result normal?

- YES (Present error)>>Replace the BCM. Refer to [BCS-78, "Exploded View"](#).  
YES (Past error)>>Error was detected in the BCM branch line.  
NO >> Repair the power supply and the ground circuit.



# DLC BRANCH LINE CIRCUIT

< DTC/CIRCUIT DIAGNOSIS >

[CAN SYSTEM (TYPE 8)]

## DLC BRANCH LINE CIRCUIT

### Diagnosis Procedure

INFOID:000000005779510

#### 1. CHECK CONNECTOR

1. Turn the ignition switch OFF.
2. Disconnect the battery cable from the negative terminal.
3. Check the terminals and connectors of the data link connector for damage, bend and loose connection (connector side and harness side).

Is the inspection result normal?

- YES >> GO TO 2.  
NO >> Repair the terminal and connector.

#### 2. CHECK HARNESS FOR OPEN CIRCUIT

Check the resistance between the data link connector terminals.

Data link connector			Resistance (Ω)
Connector No.	Terminal No.		
M24	6	14	Approx. 54 – 66

Is the measurement value within the specification?

- YES (Present error)>>Check CAN system type decision again.  
YES (Past error)>>Error was detected in the data link connector branch line circuit.  
NO >> Repair the data link connector branch line.

A  
B  
C  
D  
E  
F  
G  
H  
I  
J  
K  
L

LAN

N  
O  
P

## M&A BRANCH LINE CIRCUIT

### Diagnosis Procedure

INFOID:000000005779511

#### 1. CHECK CONNECTOR

1. Turn the ignition switch OFF.
2. Disconnect the battery cable from the negative terminal.
3. Check the terminals and connectors of the unified meter and A/C amp. for damage, bend and loose connection (unit side and connector side).

Is the inspection result normal?

- YES >> GO TO 2.  
 NO >> Repair the terminal and connector.

#### 2. CHECK HARNESS FOR OPEN CIRCUIT

1. Disconnect the connector of unified meter and A/C amp.
2. Check the resistance between the unified meter and A/C amp. harness connector terminals.

Unified meter and A/C amp. harness connector			Resistance (Ω)
Connector No.	Terminal No.		
M67	56	72	Approx. 54 – 66

Is the measurement value within the specification?

- YES >> GO TO 3.  
 NO >> Repair the unified meter and A/C amp. branch line.

#### 3. CHECK POWER SUPPLY AND GROUND CIRCUIT

Check the power supply and the ground circuit of the unified meter and A/C amp. Refer to [MWI-50, "UNIFIED METER AND A/C AMP. : Diagnosis Procedure"](#).

Is the inspection result normal?

- YES (Present error)>>Replace the unified meter and A/C amp. Refer to [MWI-130, "Exploded View"](#).  
 YES (Past error)>>Error was detected in the unified meter and A/C amp. branch line.  
 NO >> Repair the power supply and the ground circuit.

# STRG BRANCH LINE CIRCUIT

< DTC/CIRCUIT DIAGNOSIS >

[CAN SYSTEM (TYPE 8)]

## STRG BRANCH LINE CIRCUIT

### Diagnosis Procedure

INFOID:000000005779512

#### 1.CHECK CONNECTOR

1. Turn the ignition switch OFF.
2. Disconnect the battery cable from the negative terminal.
3. Check the terminals and connectors of the steering angle sensor for damage, bend and loose connection (unit side and connector side).

Is the inspection result normal?

- YES >> GO TO 2.  
NO >> Repair the terminal and connector.

#### 2.CHECK HARNESS FOR OPEN CIRCUIT

1. Disconnect the connector of steering angle sensor.
2. Check the resistance between the steering angle sensor harness connector terminals.

Steering angle sensor harness connector			Resistance (Ω)
Connector No.	Terminal No.		
M37	1	2	Approx. 54 – 66

Is the measurement value within the specification?

- YES >> GO TO 3.  
NO >> Repair the steering angle sensor branch line.

#### 3.CHECK POWER SUPPLY AND GROUND CIRCUIT

Check the power supply and the ground circuit of the steering angle sensor. Refer to [BRC-83, "Wiring Diagram - BRAKE CONTROL SYSTEM -"](#).

Is the inspection result normal?

- YES (Present error)>>Replace the steering angle sensor. Refer to [BRC-108, "Exploded View"](#).  
YES (Past error)>>Error was detected in the steering angle sensor branch line.  
NO >> Repair the power supply and the ground circuit.

A  
B  
C  
D  
E  
F  
G  
H  
I  
J  
K  
L

LAN

N  
O  
P

## AV BRANCH LINE CIRCUIT

### Diagnosis Procedure

INFOID:000000005779513

#### 1. CHECK CONNECTOR

1. Turn the ignition switch OFF.
2. Disconnect the battery cable from the negative terminal.
3. Check the terminals and connectors of the AV control unit for damage, bend and loose connection (unit side and connector side).

Is the inspection result normal?

- YES >> GO TO 2.  
 NO >> Repair the terminal and connector.

#### 2. CHECK HARNESS FOR OPEN CIRCUIT

1. Disconnect the connector of AV control unit.
2. Check the resistance between the AV control unit harness connector terminals.
  - Without navigation system (Without rear view monitor)

AV control unit harness connector			Resistance (Ω)
Connector No.	Terminal No.		
M85	86	87	Approx. 54 – 66

- Without navigation system (With rear view monitor)

AV control unit harness connector			Resistance (Ω)
Connector No.	Terminal No.		
M204	81	80	Approx. 54 – 66

- With navigation system

AV control unit harness connector			Resistance (Ω)
Connector No.	Terminal No.		
M210	90	74	Approx. 54 – 66

Is the measurement value within the specification?

- YES >> GO TO 3.  
 NO >> Repair the AV control unit branch line.

#### 3. CHECK POWER SUPPLY AND GROUND CIRCUIT

Check the power supply and the ground circuit of the AV control unit. Refer to the following.

- Base audio without rear view camera: [AV-40, "AV CONTROL UNIT : Diagnosis Procedure"](#)
- Base audio with rear view camera: [AV-172, "AV CONTROL UNIT : Diagnosis Procedure"](#)
- BOSE audio without navigation: [AV-297, "AV CONTROL UNIT : Diagnosis Procedure"](#)
- BOSE audio with navigation: [AV-451, "AV CONTROL UNIT : Diagnosis Procedure"](#)

Is the inspection result normal?

- YES (Present error)>>Replace the AV control unit. Refer to the following.
- Base audio without rear view camera: [AV-89, "Exploded View"](#)
  - Base audio with rear view camera: [AV-201, "Exploded View"](#)
  - BOSE audio without navigation: [AV-328, "Exploded View"](#)
  - BOSE audio with navigation: [AV-477, "Exploded View"](#)

YES (Past error)>>Error was detected in the AV control unit branch line.

- NO >> Repair the power supply and the ground circuit.

# PSB BRANCH LINE CIRCUIT

< DTC/CIRCUIT DIAGNOSIS >

[CAN SYSTEM (TYPE 8)]

## PSB BRANCH LINE CIRCUIT

### Diagnosis Procedure

INFOID:000000005779514

#### 1. CHECK CONNECTOR

1. Turn the ignition switch OFF.
2. Disconnect the battery cable from the negative terminal.
3. Check the terminals and connectors of the pre-crash seat belt for damage, bend and loose connection (unit side and connector side).

Is the inspection result normal?

- YES >> GO TO 2.  
NO >> Repair the terminal and connector.

#### 2. CHECK HARNESS FOR OPEN CIRCUIT

1. Disconnect the connector of pre-crash seat belt control unit.
2. Check the resistance between the pre-crash seat belt control unit harness connector terminals.

Pre-crash seat belt control unit harness connector			Resistance (Ω)
Connector No.	Terminal No.		
M110	24	22	Approx. 54 – 66

Is the measurement value within the specification?

- YES >> GO TO 3.  
NO >> Repair the pre-crash seat belt control unit branch line.

#### 3. CHECK POWER SUPPLY AND GROUND CIRCUIT

Check the power supply and the ground circuit of the pre-crash seat belt control unit. Refer to [SBC-24, "Diagnosis Procedure"](#).

Is the inspection result normal?

- YES (Present error)>>Replace the pre-crash seat belt control unit. Refer to [SBC-39, "Exploded View"](#).  
YES (Past error)>>Error was detected in the pre-crash seat belt control unit branch line.  
NO >> Repair the power supply and the ground circuit.

A  
B  
C  
D  
E  
F  
G  
H  
I  
J  
K  
L

LAN

N  
O  
P

# TCM BRANCH LINE CIRCUIT

< DTC/CIRCUIT DIAGNOSIS >

[CAN SYSTEM (TYPE 8)]

## TCM BRANCH LINE CIRCUIT

### Diagnosis Procedure

INFOID:000000005779515

#### 1. CHECK CONNECTOR

1. Turn the ignition switch OFF.
2. Disconnect the battery cable from the negative terminal.
3. Check the following terminals and connectors for damage, bend and loose connection (unit side and connector side).
  - A/T assembly
  - Harness connector F103
  - Harness connector M116

Is the inspection result normal?

YES >> GO TO 2.

NO >> Repair the terminal and connector.

#### 2. CHECK HARNESS FOR OPEN CIRCUIT

1. Disconnect the connector of A/T assembly.
2. Check the resistance between the A/T assembly harness connector terminals.

A/T assembly harness connector		Resistance (Ω)
Connector No.	Terminal No.	
F51	3	Approx. 54 – 66
	8	

Is the measurement value within the specification?

YES >> GO TO 3.

NO >> Repair the TCM branch line.

#### 3. CHECK POWER SUPPLY AND GROUND CIRCUIT

Check the power supply and the ground circuit of the TCM. Refer to [TM-212, "Diagnosis Procedure"](#).

Is the inspection result normal?

YES (Present error)>>Replace the control valve with TCM. Refer to [TM-99, "Component Parts Location"](#).  
(Replace A/T assembly if control valve with TCM is not listed in the latest parts list.)

YES (Past error)>>Error was detected in the TCM branch line.

NO >> Repair the power supply and the ground circuit.

# ADP BRANCH LINE CIRCUIT

< DTC/CIRCUIT DIAGNOSIS >

[CAN SYSTEM (TYPE 8)]

## ADP BRANCH LINE CIRCUIT

### Diagnosis Procedure

INFOID:000000005779516

#### 1. CHECK CONNECTOR

1. Turn the ignition switch OFF.
2. Disconnect the battery cable from the negative terminal.
3. Check the following terminals and connectors for damage, bend and loose connection (unit side and connector side).
  - Models with automatic drive positioner
    - Driver seat control unit
    - Harness connector B502
    - Harness connector B11
  - Models without automatic drive positioner
    - Driver seat control unit
    - Harness connector B501
    - Harness connector B10

Is the inspection result normal?

YES >> GO TO 2.

NO >> Repair the terminal and connector.

#### 2. CHECK HARNESS FOR OPEN CIRCUIT

1. Disconnect the connector of driver seat control unit.
2. Check the resistance between the driver seat control unit harness connector terminals.

Driver seat control unit harness connector			Resistance (Ω)
Connector No.	Terminal No.		
B503	3	19	Approx. 54 – 66

Is the measurement value within the specification?

YES >> GO TO 3.

NO >> Repair the driver seat control unit branch line.

#### 3. CHECK POWER SUPPLY AND GROUND CIRCUIT

Check the power supply and the ground circuit of the driver seat control unit. Refer to [ADP-64. "DRIVER SEAT CONTROL UNIT : Diagnosis Procedure"](#).

Is the inspection result normal?

YES (Present error)>>Replace the driver seat control unit. Refer to [ADP-234. "Exploded View"](#).

YES (Past error)>>Error was detected in the driver seat control unit branch line.

NO >> Repair the power supply and the ground circuit.

A  
B  
C  
D  
E  
F  
G  
H  
I  
J  
K  
L  
N  
O  
P

LAN

## RAS BRANCH LINE CIRCUIT

### Diagnosis Procedure

INFOID:000000005779517

#### 1. CHECK CONNECTOR

1. Turn the ignition switch OFF.
2. Disconnect the battery cable from the negative terminal.
3. Check the terminals and connectors of the 4WAS main control unit for damage, bend and loose connection (unit side and connector side).

Is the inspection result normal?

- YES >> GO TO 2.  
 NO >> Repair the terminal and connector.

#### 2. CHECK HARNESS FOR OPEN CIRCUIT

1. Disconnect the connector of 4WAS main control unit.
2. Check the resistance between the 4WAS main control unit harness connector terminals.

4WAS main control unit harness connector			Resistance (Ω)
Connector No.	Terminal No.		
B54	1	8	Approx. 54 – 66

Is the measurement value within the specification?

- YES >> GO TO 3.  
 NO >> Replace the body harness.

#### 3. CHECK POWER SUPPLY AND GROUND CIRCUIT

Check the power supply and the ground circuit of the 4WAS main control unit. Refer to [STC-136, "Diagnosis Procedure \(4WAS Main Control Unit\)"](#).

Is the inspection result normal?

- YES (Present error)>>Replace the 4WAS main control unit. Refer to [STC-181, "Exploded View"](#).  
 YES (Past error)>>Error was detected in the 4WAS main control unit branch line.  
 NO >> Repair the power supply and the ground circuit.



# ABS BRANCH LINE CIRCUIT

< DTC/CIRCUIT DIAGNOSIS >

[CAN SYSTEM (TYPE 8)]

## ABS BRANCH LINE CIRCUIT

### Diagnosis Procedure

INFOID:000000005779518

#### 1. CHECK CONNECTOR

1. Turn the ignition switch OFF.
2. Disconnect the battery cable from the negative terminal.
3. Check the terminals and connectors of the ABS actuator and electric unit (control unit) for damage, bend and loose connection (unit side and connector side).

Is the inspection result normal?

- YES >> GO TO 2.  
NO >> Repair the terminal and connector.

#### 2. CHECK HARNESS FOR OPEN CIRCUIT

1. Disconnect the connector of ABS actuator and electric unit (control unit).
2. Check the resistance between the ABS actuator and electric unit (control unit) harness connector terminals.

ABS actuator and electric unit (control unit) harness connector			Resistance (Ω)
Connector No.	Terminal No.		
E41	35	14	Approx. 54 – 66

Is the measurement value within the specification?

- YES >> GO TO 3.  
NO >> Repair the ABS actuator and electric unit (control unit) branch line.

#### 3. CHECK POWER SUPPLY AND GROUND CIRCUIT

Check the power supply and the ground circuit of the ABS actuator and electric unit (control unit). Refer to [BRC-69, "Diagnosis Procedure"](#).

Is the inspection result normal?

- YES (Present error)>>Replace the ABS actuator and electric unit (control unit). Refer to [BRC-105, "Exploded View"](#).  
YES (Past error)>>Error was detected in the ABS actuator and electric unit (control unit) branch line.  
NO >> Repair the power supply and the ground circuit.

A  
B  
C  
D  
E  
F  
G  
H  
I  
J  
K  
L

LAN

## ICC BRANCH LINE CIRCUIT

### Diagnosis Procedure

INFOID:000000005779519

#### 1. CHECK CONNECTOR

1. Turn the ignition switch OFF.
2. Disconnect the battery cable from the negative terminal.
3. Check the terminals and connectors of the ICC sensor integrated unit for damage, bend and loose connection (unit side and connector side).

Is the inspection result normal?

- YES >> GO TO 2.  
 NO >> Repair the terminal and connector.

#### 2. CHECK HARNESS FOR OPEN CIRCUIT

1. Disconnect the connector of ICC sensor integrated unit.
2. Check the resistance between the ICC sensor integrated unit harness connector terminals.

ICC sensor integrated unit harness connector			Resistance (Ω)
Connector No.	Terminal No.		
E67	3	6	Approx. 54 – 66

Is the measurement value within the specification?

- YES >> GO TO 3.  
 NO >> Repair the ICC sensor integrated unit branch line.

#### 3. CHECK POWER SUPPLY AND GROUND CIRCUIT

Check the power supply and the ground circuit of the ICC sensor integrated unit. Refer to [CCS-102, "Diagnosis Procedure"](#).

Is the inspection result normal?

- YES (Present error)>>Replace the ICC sensor integrated unit. Refer to [CCS-133, "Exploded View"](#).  
 YES (Past error)>>Error was detected in the ICC sensor integrated unit branch line.  
 NO >> Repair the power supply and the ground circuit.

# IPDM-E BRANCH LINE CIRCUIT

< DTC/CIRCUIT DIAGNOSIS >

[CAN SYSTEM (TYPE 8)]

## IPDM-E BRANCH LINE CIRCUIT

### Diagnosis Procedure

INFOID:000000005779520

#### 1. CHECK CONNECTOR

1. Turn the ignition switch OFF.
2. Disconnect the battery cable from the negative terminal.
3. Check the terminals and connectors of the IPDM E/R for damage, bend and loose connection (unit side and connector side).

Is the inspection result normal?

- YES >> GO TO 2.  
NO >> Repair the terminal and connector.

#### 2. CHECK HARNESS FOR OPEN CIRCUIT

1. Disconnect the connector of IPDM E/R.
2. Check the resistance between the IPDM E/R harness connector terminals.

IPDM E/R harness connector			Resistance (Ω)
Connector No.	Terminal No.		
E6	40	39	Approx. 108 – 132

Is the measurement value within the specification?

- YES >> GO TO 3.  
NO >> Repair the IPDM E/R branch line.

#### 3. CHECK POWER SUPPLY AND GROUND CIRCUIT

Check the power supply and the ground circuit of the IPDM E/R. Refer to [PCS-17, "Diagnosis Procedure"](#).

Is the inspection result normal?

- YES (Present error)>>Replace the IPDM E/R. Refer to [PCS-32, "Exploded View"](#).  
YES (Past error)>>Error was detected in the IPDM E/R branch line.  
NO >> Repair the power supply and the ground circuit.

A  
B  
C  
D  
E  
F  
G  
H  
I  
J  
K  
L  
N  
O  
P

LAN

# CAN COMMUNICATION CIRCUIT

< DTC/CIRCUIT DIAGNOSIS >

[CAN SYSTEM (TYPE 8)]

## CAN COMMUNICATION CIRCUIT

### Diagnosis Procedure

INFOID:000000005779521

#### 1. CONNECTOR INSPECTION

1. Turn the ignition switch OFF.
2. Disconnect the battery cable from the negative terminal.
3. Disconnect all the unit connectors on CAN communication system.
4. Check terminals and connectors for damage, bend and loose connection.

Is the inspection result normal?

- YES >> GO TO 2.  
NO >> Repair the terminal and connector.

#### 2. CHECK HARNESS CONTINUITY (SHORT CIRCUIT)

Check the continuity between the data link connector terminals.

Data link connector		Continuity
Connector No.	Terminal No.	
M24	6 14	Not existed

Is the inspection result normal?

- YES >> GO TO 3.  
NO >> Check the harness and repair the root cause.

#### 3. CHECK HARNESS CONTINUITY (SHORT CIRCUIT)

Check the continuity between the data link connector and the ground.

Data link connector		Ground	Continuity
Connector No.	Terminal No.		
M24	6		Not existed
	14		Not existed

Is the inspection result normal?

- YES >> GO TO 4.  
NO >> Check the harness and repair the root cause.

#### 4. CHECK ECM AND IPDM E/R TERMINATION CIRCUIT

1. Remove the ECM and the IPDM E/R.
2. Check the resistance between the ECM terminals.

ECM		Resistance ( $\Omega$ )
Terminal No.		
114	113	Approx. 108 – 132

3. Check the resistance between the IPDM E/R terminals.

IPDM E/R		Resistance ( $\Omega$ )
Terminal No.		
40	39	Approx. 108 – 132

Is the measurement value within the specification?

- YES >> GO TO 5.  
NO >> Replace the ECM and/or the IPDM E/R.

#### 5. CHECK SYMPTOM

Connect all the connectors. Check if the symptoms described in the "Symptom (Results from interview with customer)" are reproduced.

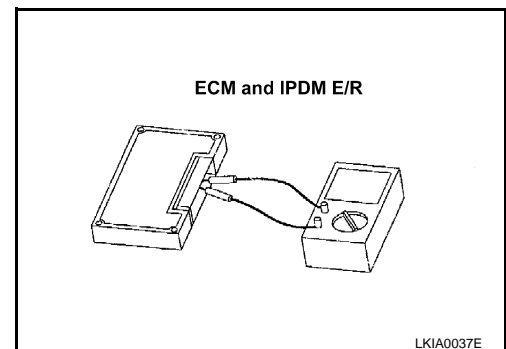

# CAN COMMUNICATION CIRCUIT

< DTC/CIRCUIT DIAGNOSIS >

[CAN SYSTEM (TYPE 8)]

## Inspection result

Reproduced>>GO TO 6.

Non-reproduced>>Start the diagnosis again. Follow the trouble diagnosis procedure when past error is detected.

## 6.CHECK UNIT REPRODUCTION

Perform the reproduction test as per the following procedure for each unit.

1. Turn the ignition switch OFF.
2. Disconnect the battery cable from the negative terminal.
3. Disconnect one of the unit connectors of CAN communication system.

### **NOTE:**

ECM and IPDM E/R have a termination circuit. Check other units first.

4. Connect the battery cable to the negative terminal. Check if the symptoms described in the "Symptom (Results from interview with customer)" are reproduced.

### **NOTE:**

Although unit-related error symptoms occur, do not confuse them with other symptoms.

## Inspection result

Reproduced>>Connect the connector. Check other units as per the above procedure.

Non-reproduced>>Replace the unit whose connector was disconnected.

A  
B  
C  
D  
E  
F  
G  
H  
I  
J  
K  
L

LAN

N  
O  
P

# MAIN LINE BETWEEN DLC AND AV CIRCUIT

< DTC/CIRCUIT DIAGNOSIS >

[CAN SYSTEM (TYPE 9)]

## DTC/CIRCUIT DIAGNOSIS

### MAIN LINE BETWEEN DLC AND AV CIRCUIT

#### Diagnosis Procedure

INFOID:000000005779522

#### 1. CHECK HARNESS CONTINUITY (OPEN CIRCUIT)

1. Turn the ignition switch OFF.
2. Disconnect the battery cable from the negative terminal.
3. Disconnect the following harness connectors.
  - ECM
  - AV control unit
4. Check the continuity between the data link connector and the AV control unit harness connector.
  - Without navigation system (Without rear view monitor)

Data link connector		AV control unit harness connector		Continuity
Connector No.	Terminal No.	Connector No.	Terminal No.	
M24	6	M85	86	Existed
	14		87	Existed

- Without navigation system (With rear view monitor)

Data link connector		AV control unit harness connector		Continuity
Connector No.	Terminal No.	Connector No.	Terminal No.	
M24	6	M204	81	Existed
	14		80	Existed

- With navigation system

Data link connector		AV control unit harness connector		Continuity
Connector No.	Terminal No.	Connector No.	Terminal No.	
M24	6	M210	90	Existed
	14		74	Existed

#### Is the inspection result normal?

YES (Present error)>>Check CAN system type decision again.

YES (Past error)>>Error was detected in the main line between the data link connector and the AV control unit.

NO >> Repair the main line between the data link connector and the AV control unit.

# MAIN LINE BETWEEN AV AND ADP CIRCUIT

< DTC/CIRCUIT DIAGNOSIS >

[CAN SYSTEM (TYPE 9)]

## MAIN LINE BETWEEN AV AND ADP CIRCUIT

### Diagnosis Procedure

INFOID:000000005779523

#### 1. CHECK CONNECTOR

1. Turn the ignition switch OFF.
2. Disconnect the battery cable from the negative terminal.
3. Check the following terminals and connectors for damage, bend and loose connection (connector side and harness side).
  - Harness connector M7
  - Harness connector B1

Is the inspection result normal?

YES >> GO TO 2.

NO >> Repair the terminal and connector.

#### 2. CHECK HARNESS CONTINUITY (OPEN CIRCUIT)

1. Disconnect the following harness connectors.
  - AV control unit
  - Harness connectors M7 and B1
2. Check the continuity between the AV control unit harness connector and harness connector.
  - Without navigation system (Without rear view monitor)

AV control unit harness connector		Harness connector		Continuity
Connector No.	Terminal No.	Connector No.	Terminal No.	
M85	86	M7	20	Existed
	87		21	Existed

- Without navigation system (With rear view monitor)

AV control unit harness connector		Harness connector		Continuity
Connector No.	Terminal No.	Connector No.	Terminal No.	
M204	81	M7	20	Existed
	80		21	Existed

- With navigation system

AV control unit harness connector		Harness connector		Continuity
Connector No.	Terminal No.	Connector No.	Terminal No.	
M210	90	M7	20	Existed
	74		21	Existed

Is the inspection result normal?

YES >> GO TO 3.

NO >> Repair the main line between the AV control unit and the harness connector M7.

#### 3. CHECK HARNESS CONTINUITY (OPEN CIRCUIT)

Check the continuity between the harness connector terminals.

Connector No.	Terminal No.		Continuity
B1	20	22	Existed
	21	23	Existed

Is the inspection result normal?

YES (Present error)>>Check CAN system type decision again.

YES (Past error)>>Error was detected in the main line between the AV control unit and the driver seat control unit.

NO >> Repair the main line between the harness connectors B1 and the driver seat control unit.

# MAIN LINE BETWEEN ADP AND ABS CIRCUIT

< DTC/CIRCUIT DIAGNOSIS >

[CAN SYSTEM (TYPE 9)]

## MAIN LINE BETWEEN ADP AND ABS CIRCUIT

### Diagnosis Procedure

INFOID:000000005779524

#### 1. CHECK CONNECTOR

1. Turn the ignition switch OFF.
2. Disconnect the battery cable from the negative terminal.
3. Check the following terminals and connectors for damage, bend and loose connection (connector side and harness side).
  - Harness connector B1
  - Harness connector M7
  - Harness connector M6
  - Harness connector E106

Is the inspection result normal?

YES >> GO TO 2.

NO >> Repair the terminal and connector.

#### 2. CHECK HARNESS CONTINUITY (OPEN CIRCUIT)

1. Disconnect the harness connectors B1 and M7.
2. Check the continuity between the harness connector terminals.

Connector No.	Terminal No.		Continuity
B1	20	22	Existed
	21	23	Existed

Is the inspection result normal?

YES >> GO TO 3.

NO >> Repair the main line between the driver seat control unit and the harness connector B1.

#### 3. CHECK HARNESS CONTINUITY (OPEN CIRCUIT)

1. Disconnect the harness connectors M6 and E106.
2. Check the continuity between the harness connectors.

Harness connector		Harness connector		Continuity
Connector No.	Terminal No.	Connector No.	Terminal No.	
M7	22	M6	49	Existed
	23		48	Existed

Is the inspection result normal?

YES >> GO TO 4.

NO >> Repair the main line between the harness connectors M7 and M6.

#### 4. CHECK HARNESS CONTINUITY (OPEN CIRCUIT)

1. Disconnect the connector of ABS actuator and electric unit (control unit).
2. Check the continuity between the harness connector and the ABS actuator and electric unit (control unit) harness connector.

Harness connector		ABS actuator and electric unit (control unit) harness connector		Continuity
Connector No.	Terminal No.	Connector No.	Terminal No.	
E106	49	E41	35	Existed
	48		14	Existed

Is the inspection result normal?

YES (Present error)>>Check CAN system type decision again.

YES (Past error)>>Error was detected in the main line between the driver seat control unit and the ABS actuator and electric unit (control unit).



# MAIN LINE BETWEEN ADP AND ABS CIRCUIT

< DTC/CIRCUIT DIAGNOSIS >

[CAN SYSTEM (TYPE 9)]

NO >> Repair the main line between the harness connector E106 and the ABS actuator and electric unit (control unit).

A

B

C

D

E

F

G

H

I

J

K

L

LAN

N

O

P

# ECM BRANCH LINE CIRCUIT

< DTC/CIRCUIT DIAGNOSIS >

[CAN SYSTEM (TYPE 9)]

## ECM BRANCH LINE CIRCUIT

### Diagnosis Procedure

INFOID:000000005779525

#### 1. CHECK CONNECTOR

1. Turn the ignition switch OFF.
2. Disconnect the battery cable from the negative terminal.
3. Check the terminals and connectors of the ECM for damage, bend and loose connection (unit side and connector side).

Is the inspection result normal?

- YES >> GO TO 2.  
NO >> Repair the terminal and connector.

#### 2. CHECK HARNESS FOR OPEN CIRCUIT

1. Disconnect the connector of ECM.
2. Check the resistance between the ECM harness connector terminals.

ECM harness connector			Resistance (Ω)
Connector No.	Terminal No.		
M107	114	113	Approx. 108 – 132

Is the measurement value within the specification?

- YES >> GO TO 3.  
NO >> Repair the ECM branch line.

#### 3. CHECK POWER SUPPLY AND GROUND CIRCUIT

Check the power supply and the ground circuit of the ECM. Refer to [EC-152. "Diagnosis Procedure"](#).

Is the inspection result normal?

YES (Present error)>>Replace the ECM. Refer to [EC-17. "ADDITIONAL SERVICE WHEN REPLACING CONTROL UNIT \(ECM\) : Special Repair Requirement"](#).

YES (Past error)>>Error was detected in the ECM branch line.

NO >> Repair the power supply and the ground circuit.

# A-BAG BRANCH LINE CIRCUIT

< DTC/CIRCUIT DIAGNOSIS >

[CAN SYSTEM (TYPE 9)]

## A-BAG BRANCH LINE CIRCUIT

### Diagnosis Procedure

INFOID:000000005885114

#### **WARNING:**

- Before servicing, turn ignition switch OFF, disconnect battery negative terminal, and wait 3 minutes or more. (To discharge backup capacitor.)
- Never use unspecified tester or other measuring device.

#### **1**.CHECK CONNECTOR

1. Turn the ignition switch OFF.
2. Disconnect the battery cable from the negative terminal.
3. Check the terminals and connectors of the air bag diagnosis sensor unit for damage, bend and loose connection (unit side and connector side).

Is the inspection result normal?

YES >> GO TO 2.

NO >> Replace the terminal and connector.

#### **2**.CHECK AIR BAG DIAGNOSIS SENSOR UNIT

Check the air bag diagnosis sensor unit. Refer to [SRC-5, "Work Flow"](#).

Is the inspection result normal?

YES >> Replace the main harness.

NO >> Replace parts whose air bag system has a malfunction.

A  
B  
C  
D  
E  
F  
G  
H  
I  
J  
K  
L  
N  
O  
P

LAN

# BCM BRANCH LINE CIRCUIT

< DTC/CIRCUIT DIAGNOSIS >

[CAN SYSTEM (TYPE 9)]

## BCM BRANCH LINE CIRCUIT

### Diagnosis Procedure

INFOID:000000005779527

#### 1. CHECK CONNECTOR

1. Turn the ignition switch OFF.
2. Disconnect the battery cable from the negative terminal.
3. Check the terminals and connectors of the BCM for damage, bend and loose connection (unit side and connector side).

Is the inspection result normal?

- YES >> GO TO 2.  
NO >> Repair the terminal and connector.

#### 2. CHECK HARNESS FOR OPEN CIRCUIT

1. Disconnect the connector of BCM.
2. Check the resistance between the BCM harness connector terminals.

BCM harness connector			Resistance (Ω)
Connector No.	Terminal No.		
M122	91	90	Approx. 54 – 66

Is the measurement value within the specification?

- YES >> GO TO 3.  
NO >> Repair the BCM branch line.

#### 3. CHECK POWER SUPPLY AND GROUND CIRCUIT

Check the power supply and the ground circuit of the BCM. Refer to [BCS-37, "Diagnosis Procedure"](#).

Is the inspection result normal?

- YES (Present error)>>Replace the BCM. Refer to [BCS-78, "Exploded View"](#).  
YES (Past error)>>Error was detected in the BCM branch line.  
NO >> Repair the power supply and the ground circuit.

# DLC BRANCH LINE CIRCUIT

< DTC/CIRCUIT DIAGNOSIS >

[CAN SYSTEM (TYPE 9)]

## DLC BRANCH LINE CIRCUIT

### Diagnosis Procedure

INFOID:000000005779528

#### 1. CHECK CONNECTOR

1. Turn the ignition switch OFF.
2. Disconnect the battery cable from the negative terminal.
3. Check the terminals and connectors of the data link connector for damage, bend and loose connection (connector side and harness side).

Is the inspection result normal?

- YES >> GO TO 2.  
NO >> Repair the terminal and connector.

#### 2. CHECK HARNESS FOR OPEN CIRCUIT

Check the resistance between the data link connector terminals.

Data link connector			Resistance (Ω)
Connector No.	Terminal No.		
M24	6	14	Approx. 54 – 66

Is the measurement value within the specification?

- YES (Present error)>>Check CAN system type decision again.  
YES (Past error)>>Error was detected in the data link connector branch line circuit.  
NO >> Repair the data link connector branch line.

A  
B  
C  
D  
E  
F  
G  
H  
I  
J  
K  
L  
N  
O  
P

LAN

# M&A BRANCH LINE CIRCUIT

< DTC/CIRCUIT DIAGNOSIS >

[CAN SYSTEM (TYPE 9)]

## M&A BRANCH LINE CIRCUIT

### Diagnosis Procedure

INFOID:000000005779529

#### 1. CHECK CONNECTOR

1. Turn the ignition switch OFF.
2. Disconnect the battery cable from the negative terminal.
3. Check the terminals and connectors of the unified meter and A/C amp. for damage, bend and loose connection (unit side and connector side).

Is the inspection result normal?

- YES >> GO TO 2.  
NO >> Repair the terminal and connector.

#### 2. CHECK HARNESS FOR OPEN CIRCUIT

1. Disconnect the connector of unified meter and A/C amp.
2. Check the resistance between the unified meter and A/C amp. harness connector terminals.

Unified meter and A/C amp. harness connector			Resistance (Ω)
Connector No.	Terminal No.		
M67	56	72	Approx. 54 – 66

Is the measurement value within the specification?

- YES >> GO TO 3.  
NO >> Repair the unified meter and A/C amp. branch line.

#### 3. CHECK POWER SUPPLY AND GROUND CIRCUIT

Check the power supply and the ground circuit of the unified meter and A/C amp. Refer to [MWI-50, "UNIFIED METER AND A/C AMP. : Diagnosis Procedure"](#).

Is the inspection result normal?

- YES (Present error)>>Replace the unified meter and A/C amp. Refer to [MWI-130, "Exploded View"](#).  
YES (Past error)>>Error was detected in the unified meter and A/C amp. branch line.  
NO >> Repair the power supply and the ground circuit.

# STRG BRANCH LINE CIRCUIT

< DTC/CIRCUIT DIAGNOSIS >

[CAN SYSTEM (TYPE 9)]

## STRG BRANCH LINE CIRCUIT

### Diagnosis Procedure

INFOID:000000005779530

#### 1. CHECK CONNECTOR

1. Turn the ignition switch OFF.
2. Disconnect the battery cable from the negative terminal.
3. Check the terminals and connectors of the steering angle sensor for damage, bend and loose connection (unit side and connector side).

Is the inspection result normal?

- YES >> GO TO 2.  
NO >> Repair the terminal and connector.

#### 2. CHECK HARNESS FOR OPEN CIRCUIT

1. Disconnect the connector of steering angle sensor.
2. Check the resistance between the steering angle sensor harness connector terminals.

Steering angle sensor harness connector			Resistance (Ω)
Connector No.	Terminal No.		
M37	1	2	Approx. 54 – 66

Is the measurement value within the specification?

- YES >> GO TO 3.  
NO >> Repair the steering angle sensor branch line.

#### 3. CHECK POWER SUPPLY AND GROUND CIRCUIT

Check the power supply and the ground circuit of the steering angle sensor. Refer to [BRC-83, "Wiring Diagram - BRAKE CONTROL SYSTEM -"](#).

Is the inspection result normal?

- YES (Present error)>>Replace the steering angle sensor. Refer to [BRC-108, "Exploded View"](#).  
YES (Past error)>>Error was detected in the steering angle sensor branch line.  
NO >> Repair the power supply and the ground circuit.

A  
B  
C  
D  
E  
F  
G  
H  
I  
J  
K  
L

LAN

N  
O  
P

# 4WD BRANCH LINE CIRCUIT

< DTC/CIRCUIT DIAGNOSIS >

[CAN SYSTEM (TYPE 9)]

## 4WD BRANCH LINE CIRCUIT

### Diagnosis Procedure

INFOID:000000005779531

#### 1. CHECK CONNECTOR

1. Turn the ignition switch OFF.
2. Disconnect the battery cable from the negative terminal.
3. Check the following terminals and connectors for damage, bend and loose connection (unit side and connector side).
  - AWD control unit connector
  - Harness connector F103
  - Harness connector M116

Is the inspection result normal?

YES >> GO TO 2.

NO >> Repair the terminal and connector.

#### 2. CHECK HARNESS FOR OPEN CIRCUIT

1. Disconnect the connector of AWD control unit.
2. Check the resistance between the AWD control unit harness connector terminals.

AWD control unit harness connector		Resistance (Ω)
Connector No.	Terminal No.	
F108	8                      16	Approx. 54 – 66

Is the measurement value within the specification?

YES >> GO TO 3.

NO >> Repair the AWD control unit branch line.

#### 3. CHECK POWER SUPPLY AND GROUND CIRCUIT

Check the power supply and the ground circuit of the AWD control unit. Refer to [DLN-27, "Diagnosis Procedure"](#).

Is the inspection result normal?

YES (Present error)>>Replace the AWD control unit. Refer to [DLN-55, "Exploded View"](#).

YES (Past error)>>Error was detected in the AWD control unit branch line.

NO >> Repair the power supply and the ground circuit.



## AV BRANCH LINE CIRCUIT

### Diagnosis Procedure

INFOID:000000005779532

#### 1. CHECK CONNECTOR

1. Turn the ignition switch OFF.
2. Disconnect the battery cable from the negative terminal.
3. Check the terminals and connectors of the AV control unit for damage, bend and loose connection (unit side and connector side).

Is the inspection result normal?

- YES >> GO TO 2.  
 NO >> Repair the terminal and connector.

#### 2. CHECK HARNESS FOR OPEN CIRCUIT

1. Disconnect the connector of AV control unit.
  2. Check the resistance between the AV control unit harness connector terminals.
- Without navigation system (Without rear view monitor)

AV control unit harness connector			Resistance (Ω)
Connector No.	Terminal No.		
M85	86	87	Approx. 54 – 66

- Without navigation system (With rear view monitor)

AV control unit harness connector			Resistance (Ω)
Connector No.	Terminal No.		
M204	81	80	Approx. 54 – 66

- With navigation system

AV control unit harness connector			Resistance (Ω)
Connector No.	Terminal No.		
M210	90	74	Approx. 54 – 66

Is the measurement value within the specification?

- YES >> GO TO 3.  
 NO >> Repair the AV control unit branch line.

#### 3. CHECK POWER SUPPLY AND GROUND CIRCUIT

Check the power supply and the ground circuit of the AV control unit. Refer to the following.

- Base audio without rear view camera: [AV-40, "AV CONTROL UNIT : Diagnosis Procedure"](#)
- Base audio with rear view camera: [AV-172, "AV CONTROL UNIT : Diagnosis Procedure"](#)
- BOSE audio without navigation: [AV-297, "AV CONTROL UNIT : Diagnosis Procedure"](#)
- BOSE audio with navigation: [AV-451, "AV CONTROL UNIT : Diagnosis Procedure"](#)

Is the inspection result normal?

- YES (Present error)>>Replace the AV control unit. Refer to the following.
- Base audio without rear view camera: [AV-89, "Exploded View"](#)
  - Base audio with rear view camera: [AV-201, "Exploded View"](#)
  - BOSE audio without navigation: [AV-328, "Exploded View"](#)
  - BOSE audio with navigation: [AV-477, "Exploded View"](#)

YES (Past error)>>Error was detected in the AV control unit branch line.

- NO >> Repair the power supply and the ground circuit.

# TCM BRANCH LINE CIRCUIT

< DTC/CIRCUIT DIAGNOSIS >

[CAN SYSTEM (TYPE 9)]

## TCM BRANCH LINE CIRCUIT

### Diagnosis Procedure

INFOID:000000005779533

#### 1. CHECK CONNECTOR

1. Turn the ignition switch OFF.
2. Disconnect the battery cable from the negative terminal.
3. Check the following terminals and connectors for damage, bend and loose connection (unit side and connector side).
  - A/T assembly
  - Harness connector F103
  - Harness connector M116

Is the inspection result normal?

YES >> GO TO 2.

NO >> Repair the terminal and connector.

#### 2. CHECK HARNESS FOR OPEN CIRCUIT

1. Disconnect the connector of A/T assembly.
2. Check the resistance between the A/T assembly harness connector terminals.

A/T assembly harness connector		Resistance (Ω)
Connector No.	Terminal No.	
F51	3                      8	Approx. 54 – 66

Is the measurement value within the specification?

YES >> GO TO 3.

NO >> Repair the TCM branch line.

#### 3. CHECK POWER SUPPLY AND GROUND CIRCUIT

Check the power supply and the ground circuit of the TCM. Refer to [TM-212, "Diagnosis Procedure"](#).

Is the inspection result normal?

YES (Present error)>>Replace the control valve with TCM. Refer to [TM-99, "Component Parts Location"](#).  
(Replace A/T assembly if control valve with TCM is not listed in the latest parts list.)

YES (Past error)>>Error was detected in the TCM branch line.

NO >> Repair the power supply and the ground circuit.

# ADP BRANCH LINE CIRCUIT

< DTC/CIRCUIT DIAGNOSIS >

[CAN SYSTEM (TYPE 9)]

## ADP BRANCH LINE CIRCUIT

### Diagnosis Procedure

INFOID:000000005779534

#### 1. CHECK CONNECTOR

1. Turn the ignition switch OFF.
2. Disconnect the battery cable from the negative terminal.
3. Check the following terminals and connectors for damage, bend and loose connection (unit side and connector side).
  - Models with automatic drive positioner
    - Driver seat control unit
    - Harness connector B502
    - Harness connector B11
  - Models without automatic drive positioner
    - Driver seat control unit
    - Harness connector B501
    - Harness connector B10

Is the inspection result normal?

YES >> GO TO 2.

NO >> Repair the terminal and connector.

#### 2. CHECK HARNESS FOR OPEN CIRCUIT

1. Disconnect the connector of driver seat control unit.
2. Check the resistance between the driver seat control unit harness connector terminals.

Driver seat control unit harness connector			Resistance (Ω)
Connector No.	Terminal No.		
B503	3	19	Approx. 54 – 66

Is the measurement value within the specification?

YES >> GO TO 3.

NO >> Repair the driver seat control unit branch line.

#### 3. CHECK POWER SUPPLY AND GROUND CIRCUIT

Check the power supply and the ground circuit of the driver seat control unit. Refer to [ADP-64. "DRIVER SEAT CONTROL UNIT : Diagnosis Procedure"](#).

Is the inspection result normal?

YES (Present error)>>Replace the driver seat control unit. Refer to [ADP-234. "Exploded View"](#).

YES (Past error)>>Error was detected in the driver seat control unit branch line.

NO >> Repair the power supply and the ground circuit.

A  
B  
C  
D  
E  
F  
G  
H  
I  
J  
K  
L  
N  
O  
P

LAN

# ABS BRANCH LINE CIRCUIT

< DTC/CIRCUIT DIAGNOSIS >

[CAN SYSTEM (TYPE 9)]

## ABS BRANCH LINE CIRCUIT

### Diagnosis Procedure

INFOID:000000005779535

#### 1. CHECK CONNECTOR

1. Turn the ignition switch OFF.
2. Disconnect the battery cable from the negative terminal.
3. Check the terminals and connectors of the ABS actuator and electric unit (control unit) for damage, bend and loose connection (unit side and connector side).

Is the inspection result normal?

- YES >> GO TO 2.  
NO >> Repair the terminal and connector.

#### 2. CHECK HARNESS FOR OPEN CIRCUIT

1. Disconnect the connector of ABS actuator and electric unit (control unit).
2. Check the resistance between the ABS actuator and electric unit (control unit) harness connector terminals.

ABS actuator and electric unit (control unit) harness connector			Resistance (Ω)
Connector No.	Terminal No.		
E41	35	14	Approx. 54 – 66

Is the measurement value within the specification?

- YES >> GO TO 3.  
NO >> Repair the ABS actuator and electric unit (control unit) branch line.

#### 3. CHECK POWER SUPPLY AND GROUND CIRCUIT

Check the power supply and the ground circuit of the ABS actuator and electric unit (control unit). Refer to [BRC-69. "Diagnosis Procedure"](#).

Is the inspection result normal?

- YES (Present error)>>Replace the ABS actuator and electric unit (control unit). Refer to [BRC-105. "Exploded View"](#).  
YES (Past error)>>Error was detected in the ABS actuator and electric unit (control unit) branch line.  
NO >> Repair the power supply and the ground circuit.

# IPDM-E BRANCH LINE CIRCUIT

< DTC/CIRCUIT DIAGNOSIS >

[CAN SYSTEM (TYPE 9)]

## IPDM-E BRANCH LINE CIRCUIT

### Diagnosis Procedure

INFOID:000000005779536

#### 1.CHECK CONNECTOR

1. Turn the ignition switch OFF.
2. Disconnect the battery cable from the negative terminal.
3. Check the terminals and connectors of the IPDM E/R for damage, bend and loose connection (unit side and connector side).

Is the inspection result normal?

- YES >> GO TO 2.  
NO >> Repair the terminal and connector.

#### 2.CHECK HARNESS FOR OPEN CIRCUIT

1. Disconnect the connector of IPDM E/R.
2. Check the resistance between the IPDM E/R harness connector terminals.

IPDM E/R harness connector			Resistance (Ω)
Connector No.	Terminal No.		
E6	40	39	Approx. 108 – 132

Is the measurement value within the specification?

- YES >> GO TO 3.  
NO >> Repair the IPDM E/R branch line.

#### 3.CHECK POWER SUPPLY AND GROUND CIRCUIT

Check the power supply and the ground circuit of the IPDM E/R. Refer to [PCS-17, "Diagnosis Procedure"](#).

Is the inspection result normal?

- YES (Present error)>>Replace the IPDM E/R. Refer to [PCS-32, "Exploded View"](#).  
YES (Past error)>>Error was detected in the IPDM E/R branch line.  
NO >> Repair the power supply and the ground circuit.

A  
B  
C  
D  
E  
F  
G  
H  
I  
J  
K  
L

LAN

N  
O  
P

# CAN COMMUNICATION CIRCUIT

< DTC/CIRCUIT DIAGNOSIS >

[CAN SYSTEM (TYPE 9)]

## CAN COMMUNICATION CIRCUIT

### Diagnosis Procedure

INFOID:000000005779537

#### 1. CONNECTOR INSPECTION

1. Turn the ignition switch OFF.
2. Disconnect the battery cable from the negative terminal.
3. Disconnect all the unit connectors on CAN communication system.
4. Check terminals and connectors for damage, bend and loose connection.

Is the inspection result normal?

- YES >> GO TO 2.  
NO >> Repair the terminal and connector.

#### 2. CHECK HARNESS CONTINUITY (SHORT CIRCUIT)

Check the continuity between the data link connector terminals.

Data link connector			Continuity
Connector No.	Terminal No.		
M24	6	14	Not existed

Is the inspection result normal?

- YES >> GO TO 3.  
NO >> Check the harness and repair the root cause.

#### 3. CHECK HARNESS CONTINUITY (SHORT CIRCUIT)

Check the continuity between the data link connector and the ground.

Data link connector		Ground	Continuity
Connector No.	Terminal No.		
M24	6		Not existed
	14		Not existed

Is the inspection result normal?

- YES >> GO TO 4.  
NO >> Check the harness and repair the root cause.

#### 4. CHECK ECM AND IPDM E/R TERMINATION CIRCUIT

1. Remove the ECM and the IPDM E/R.
2. Check the resistance between the ECM terminals.

ECM		Resistance ( $\Omega$ )
Terminal No.		
114	113	Approx. 108 – 132

3. Check the resistance between the IPDM E/R terminals.

IPDM E/R		Resistance ( $\Omega$ )
Terminal No.		
40	39	Approx. 108 – 132

Is the measurement value within the specification?

- YES >> GO TO 5.  
NO >> Replace the ECM and/or the IPDM E/R.

#### 5. CHECK SYMPTOM

Connect all the connectors. Check if the symptoms described in the "Symptom (Results from interview with customer)" are reproduced.

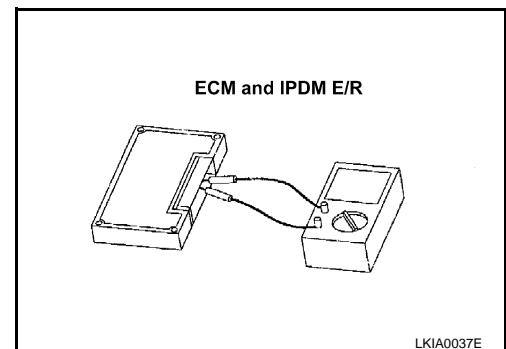

# CAN COMMUNICATION CIRCUIT

< DTC/CIRCUIT DIAGNOSIS >

[CAN SYSTEM (TYPE 9)]

## Inspection result

Reproduced>>GO TO 6.

Non-reproduced>>Start the diagnosis again. Follow the trouble diagnosis procedure when past error is detected.

## 6.CHECK UNIT REPRODUCTION

Perform the reproduction test as per the following procedure for each unit.

1. Turn the ignition switch OFF.
2. Disconnect the battery cable from the negative terminal.
3. Disconnect one of the unit connectors of CAN communication system.

### **NOTE:**

ECM and IPDM E/R have a termination circuit. Check other units first.

4. Connect the battery cable to the negative terminal. Check if the symptoms described in the "Symptom (Results from interview with customer)" are reproduced.

### **NOTE:**

Although unit-related error symptoms occur, do not confuse them with other symptoms.

## Inspection result

Reproduced>>Connect the connector. Check other units as per the above procedure.

Non-reproduced>>Replace the unit whose connector was disconnected.

A  
B  
C  
D  
E  
F  
G  
H  
I  
J  
K  
L

LAN

N  
O  
P

# MAIN LINE BETWEEN DLC AND AV CIRCUIT

< DTC/CIRCUIT DIAGNOSIS >

[CAN SYSTEM (TYPE 10)]

## DTC/CIRCUIT DIAGNOSIS

### MAIN LINE BETWEEN DLC AND AV CIRCUIT

#### Diagnosis Procedure

INFOID:000000005779538

#### 1. CHECK HARNESS CONTINUITY (OPEN CIRCUIT)

1. Turn the ignition switch OFF.
2. Disconnect the battery cable from the negative terminal.
3. Disconnect the following harness connectors.
  - ECM
  - AV control unit
4. Check the continuity between the data link connector and the AV control unit harness connector.
  - Without navigation system (Without rear view monitor)

Data link connector		AV control unit harness connector		Continuity
Connector No.	Terminal No.	Connector No.	Terminal No.	
M24	6	M85	86	Existed
	14		87	Existed

- Without navigation system (With rear view monitor)

Data link connector		AV control unit harness connector		Continuity
Connector No.	Terminal No.	Connector No.	Terminal No.	
M24	6	M204	81	Existed
	14		80	Existed

- With navigation system

Data link connector		AV control unit harness connector		Continuity
Connector No.	Terminal No.	Connector No.	Terminal No.	
M24	6	M210	90	Existed
	14		74	Existed

#### Is the inspection result normal?

YES (Present error)>>Check CAN system type decision again.

YES (Past error)>>Error was detected in the main line between the data link connector and the AV control unit.

NO >> Repair the main line between the data link connector and the AV control unit.



# MAIN LINE BETWEEN AV AND ADP CIRCUIT

< DTC/CIRCUIT DIAGNOSIS >

[CAN SYSTEM (TYPE 10)]

## MAIN LINE BETWEEN AV AND ADP CIRCUIT

### Diagnosis Procedure

INFOID:000000005779539

#### 1.CHECK CONNECTOR

1. Turn the ignition switch OFF.
2. Disconnect the battery cable from the negative terminal.
3. Check the following terminals and connectors for damage, bend and loose connection (connector side and harness side).
  - Harness connector M7
  - Harness connector B1

Is the inspection result normal?

YES >> GO TO 2.

NO >> Repair the terminal and connector.

#### 2.CHECK HARNESS CONTINUITY (OPEN CIRCUIT)

1. Disconnect the following harness connectors.
  - AV control unit
  - Harness connectors M7 and B1
2. Check the continuity between the AV control unit harness connector and harness connector.
  - Without navigation system (Without rear view monitor)

AV control unit harness connector		Harness connector		Continuity
Connector No.	Terminal No.	Connector No.	Terminal No.	
M85	86	M7	20	Existed
	87		21	Existed

- Without navigation system (With rear view monitor)

AV control unit harness connector		Harness connector		Continuity
Connector No.	Terminal No.	Connector No.	Terminal No.	
M204	81	M7	20	Existed
	80		21	Existed

- With navigation system

AV control unit harness connector		Harness connector		Continuity
Connector No.	Terminal No.	Connector No.	Terminal No.	
M210	90	M7	20	Existed
	74		21	Existed

Is the inspection result normal?

YES >> GO TO 3.

NO >> Repair the main line between the AV control unit and the harness connector M7.

#### 3.CHECK HARNESS CONTINUITY (OPEN CIRCUIT)

Check the continuity between the harness connector terminals.

Connector No.	Terminal No.		Continuity
B1	20	22	Existed
	21	23	Existed

Is the inspection result normal?

YES (Present error)>>Check CAN system type decision again.

YES (Past error)>>Error was detected in the main line between the AV control unit and the driver seat control unit.

NO >> Repair the main line between the harness connectors B1 and the driver seat control unit.

A  
B  
C  
D  
E  
F  
G  
H  
I  
J  
K  
L

LAN

N  
O  
P

# MAIN LINE BETWEEN ADP AND ABS CIRCUIT

< DTC/CIRCUIT DIAGNOSIS >

[CAN SYSTEM (TYPE 10)]

## MAIN LINE BETWEEN ADP AND ABS CIRCUIT

### Diagnosis Procedure

INFOID:000000005779540

#### 1. CHECK CONNECTOR

1. Turn the ignition switch OFF.
2. Disconnect the battery cable from the negative terminal.
3. Check the following terminals and connectors for damage, bend and loose connection (connector side and harness side).
  - Harness connector B1
  - Harness connector M7
  - Harness connector M6
  - Harness connector E106

Is the inspection result normal?

YES >> GO TO 2.

NO >> Repair the terminal and connector.

#### 2. CHECK HARNESS CONTINUITY (OPEN CIRCUIT)

1. Disconnect the harness connectors B1 and M7.
2. Check the continuity between the harness connector terminals.

Connector No.	Terminal No.		Continuity
B1	20	22	Existed
	21	23	Existed

Is the inspection result normal?

YES >> GO TO 3.

NO >> Repair the main line between the driver seat control unit and the harness connector B1.

#### 3. CHECK HARNESS CONTINUITY (OPEN CIRCUIT)

1. Disconnect the harness connectors M6 and E106.
2. Check the continuity between the harness connectors.

Harness connector		Harness connector		Continuity
Connector No.	Terminal No.	Connector No.	Terminal No.	
M7	22	M6	49	Existed
	23		48	Existed

Is the inspection result normal?

YES >> GO TO 4.

NO >> Repair the main line between the harness connectors M7 and M6.

#### 4. CHECK HARNESS CONTINUITY (OPEN CIRCUIT)

1. Disconnect the connector of ABS actuator and electric unit (control unit).
2. Check the continuity between the harness connector and the ABS actuator and electric unit (control unit) harness connector.

Harness connector		ABS actuator and electric unit (control unit) harness connector		Continuity
Connector No.	Terminal No.	Connector No.	Terminal No.	
E106	49	E41	35	Existed
	48		14	Existed

Is the inspection result normal?

YES (Present error)>>Check CAN system type decision again.

YES (Past error)>>Error was detected in the main line between the driver seat control unit and the ABS actuator and electric unit (control unit).

# MAIN LINE BETWEEN ADP AND ABS CIRCUIT

< DTC/CIRCUIT DIAGNOSIS >

[CAN SYSTEM (TYPE 10)]

NO >> Repair the main line between the harness connector E106 and the ABS actuator and electric unit (control unit).

A

B

C

D

E

F

G

H

I

J

K

L

LAN

N

O

P

# ECM BRANCH LINE CIRCUIT

< DTC/CIRCUIT DIAGNOSIS >

[CAN SYSTEM (TYPE 10)]

## ECM BRANCH LINE CIRCUIT

### Diagnosis Procedure

INFOID:000000005779541

#### 1. CHECK CONNECTOR

1. Turn the ignition switch OFF.
2. Disconnect the battery cable from the negative terminal.
3. Check the terminals and connectors of the ECM for damage, bend and loose connection (unit side and connector side).

Is the inspection result normal?

- YES >> GO TO 2.  
NO >> Repair the terminal and connector.

#### 2. CHECK HARNESS FOR OPEN CIRCUIT

1. Disconnect the connector of ECM.
2. Check the resistance between the ECM harness connector terminals.

ECM harness connector			Resistance (Ω)
Connector No.	Terminal No.		
M107	114	113	Approx. 108 – 132

Is the measurement value within the specification?

- YES >> GO TO 3.  
NO >> Repair the ECM branch line.

#### 3. CHECK POWER SUPPLY AND GROUND CIRCUIT

Check the power supply and the ground circuit of the ECM. Refer to [EC-152. "Diagnosis Procedure"](#).

Is the inspection result normal?

YES (Present error)>>Replace the ECM. Refer to [EC-17. "ADDITIONAL SERVICE WHEN REPLACING CONTROL UNIT \(ECM\) : Special Repair Requirement"](#).

YES (Past error)>>Error was detected in the ECM branch line.

NO >> Repair the power supply and the ground circuit.

# A-BAG BRANCH LINE CIRCUIT

< DTC/CIRCUIT DIAGNOSIS >

[CAN SYSTEM (TYPE 10)]

## A-BAG BRANCH LINE CIRCUIT

### Diagnosis Procedure

INFOID:000000005885115

#### **WARNING:**

- Before servicing, turn ignition switch OFF, disconnect battery negative terminal, and wait 3 minutes or more. (To discharge backup capacitor.)
- Never use unspecified tester or other measuring device.

#### **1**.CHECK CONNECTOR

1. Turn the ignition switch OFF.
2. Disconnect the battery cable from the negative terminal.
3. Check the terminals and connectors of the air bag diagnosis sensor unit for damage, bend and loose connection (unit side and connector side).

Is the inspection result normal?

YES >> GO TO 2.

NO >> Replace the terminal and connector.

#### **2**.CHECK AIR BAG DIAGNOSIS SENSOR UNIT

Check the air bag diagnosis sensor unit. Refer to [SRC-5, "Work Flow"](#).

Is the inspection result normal?

YES >> Replace the main harness.

NO >> Replace parts whose air bag system has a malfunction.

A  
B  
C  
D  
E  
F  
G  
H  
I  
J  
K  
L  
N  
O  
P

LAN

## BCM BRANCH LINE CIRCUIT

### Diagnosis Procedure

INFOID:000000005779543

#### 1. CHECK CONNECTOR

1. Turn the ignition switch OFF.
2. Disconnect the battery cable from the negative terminal.
3. Check the terminals and connectors of the BCM for damage, bend and loose connection (unit side and connector side).

Is the inspection result normal?

- YES >> GO TO 2.  
 NO >> Repair the terminal and connector.

#### 2. CHECK HARNESS FOR OPEN CIRCUIT

1. Disconnect the connector of BCM.
2. Check the resistance between the BCM harness connector terminals.

BCM harness connector			Resistance (Ω)
Connector No.	Terminal No.		
M122	91	90	Approx. 54 – 66

Is the measurement value within the specification?

- YES >> GO TO 3.  
 NO >> Repair the BCM branch line.

#### 3. CHECK POWER SUPPLY AND GROUND CIRCUIT

Check the power supply and the ground circuit of the BCM. Refer to [BCS-37, "Diagnosis Procedure"](#).

Is the inspection result normal?

- YES (Present error)>>Replace the BCM. Refer to [BCS-78, "Exploded View"](#).  
 YES (Past error)>>Error was detected in the BCM branch line.  
 NO >> Repair the power supply and the ground circuit.

# DLC BRANCH LINE CIRCUIT

< DTC/CIRCUIT DIAGNOSIS >

[CAN SYSTEM (TYPE 10)]

## DLC BRANCH LINE CIRCUIT

### Diagnosis Procedure

INFOID:000000005779544

#### 1. CHECK CONNECTOR

1. Turn the ignition switch OFF.
2. Disconnect the battery cable from the negative terminal.
3. Check the terminals and connectors of the data link connector for damage, bend and loose connection (connector side and harness side).

Is the inspection result normal?

- YES >> GO TO 2.  
NO >> Repair the terminal and connector.

#### 2. CHECK HARNESS FOR OPEN CIRCUIT

Check the resistance between the data link connector terminals.

Data link connector			Resistance ( $\Omega$ )
Connector No.	Terminal No.		
M24	6	14	Approx. 54 – 66

Is the measurement value within the specification?

- YES (Present error)>>Check CAN system type decision again.  
YES (Past error)>>Error was detected in the data link connector branch line circuit.  
NO >> Repair the data link connector branch line.

A  
B  
C  
D  
E  
F  
G  
H  
I  
J  
K  
L

LAN

N  
O  
P

## M&A BRANCH LINE CIRCUIT

### Diagnosis Procedure

INFOID:000000005779545

#### 1. CHECK CONNECTOR

1. Turn the ignition switch OFF.
2. Disconnect the battery cable from the negative terminal.
3. Check the terminals and connectors of the unified meter and A/C amp. for damage, bend and loose connection (unit side and connector side).

Is the inspection result normal?

- YES >> GO TO 2.  
 NO >> Repair the terminal and connector.

#### 2. CHECK HARNESS FOR OPEN CIRCUIT

1. Disconnect the connector of unified meter and A/C amp.
2. Check the resistance between the unified meter and A/C amp. harness connector terminals.

Unified meter and A/C amp. harness connector			Resistance (Ω)
Connector No.	Terminal No.		
M67	56	72	Approx. 54 – 66

Is the measurement value within the specification?

- YES >> GO TO 3.  
 NO >> Repair the unified meter and A/C amp. branch line.

#### 3. CHECK POWER SUPPLY AND GROUND CIRCUIT

Check the power supply and the ground circuit of the unified meter and A/C amp. Refer to [MWI-50, "UNIFIED METER AND A/C AMP. : Diagnosis Procedure"](#).

Is the inspection result normal?

- YES (Present error)>>Replace the unified meter and A/C amp. Refer to [MWI-130, "Exploded View"](#).  
 YES (Past error)>>Error was detected in the unified meter and A/C amp. branch line.  
 NO >> Repair the power supply and the ground circuit.



# STRG BRANCH LINE CIRCUIT

< DTC/CIRCUIT DIAGNOSIS >

[CAN SYSTEM (TYPE 10)]

## STRG BRANCH LINE CIRCUIT

### Diagnosis Procedure

INFOID:000000005779546

#### 1.CHECK CONNECTOR

1. Turn the ignition switch OFF.
2. Disconnect the battery cable from the negative terminal.
3. Check the terminals and connectors of the steering angle sensor for damage, bend and loose connection (unit side and connector side).

Is the inspection result normal?

- YES >> GO TO 2.  
NO >> Repair the terminal and connector.

#### 2.CHECK HARNESS FOR OPEN CIRCUIT

1. Disconnect the connector of steering angle sensor.
2. Check the resistance between the steering angle sensor harness connector terminals.

Steering angle sensor harness connector			Resistance (Ω)
Connector No.	Terminal No.		
M37	1	2	Approx. 54 – 66

Is the measurement value within the specification?

- YES >> GO TO 3.  
NO >> Repair the steering angle sensor branch line.

#### 3.CHECK POWER SUPPLY AND GROUND CIRCUIT

Check the power supply and the ground circuit of the steering angle sensor. Refer to [BRC-83, "Wiring Diagram - BRAKE CONTROL SYSTEM -"](#).

Is the inspection result normal?

- YES (Present error)>>Replace the steering angle sensor. Refer to [BRC-108, "Exploded View"](#).  
YES (Past error)>>Error was detected in the steering angle sensor branch line.  
NO >> Repair the power supply and the ground circuit.

A  
B  
C  
D  
E  
F  
G  
H  
I  
J  
K  
L

LAN

N  
O  
P

# 4WD BRANCH LINE CIRCUIT

< DTC/CIRCUIT DIAGNOSIS >

[CAN SYSTEM (TYPE 10)]

## 4WD BRANCH LINE CIRCUIT

### Diagnosis Procedure

INFOID:000000005779547

#### 1. CHECK CONNECTOR

1. Turn the ignition switch OFF.
2. Disconnect the battery cable from the negative terminal.
3. Check the following terminals and connectors for damage, bend and loose connection (unit side and connector side).
  - AWD control unit connector
  - Harness connector F103
  - Harness connector M116

Is the inspection result normal?

YES >> GO TO 2.

NO >> Repair the terminal and connector.

#### 2. CHECK HARNESS FOR OPEN CIRCUIT

1. Disconnect the connector of AWD control unit.
2. Check the resistance between the AWD control unit harness connector terminals.

AWD control unit harness connector		Resistance (Ω)
Connector No.	Terminal No.	
F108	8                      16	Approx. 54 – 66

Is the measurement value within the specification?

YES >> GO TO 3.

NO >> Repair the AWD control unit branch line.

#### 3. CHECK POWER SUPPLY AND GROUND CIRCUIT

Check the power supply and the ground circuit of the AWD control unit. Refer to [DLN-27, "Diagnosis Procedure"](#).

Is the inspection result normal?

YES (Present error)>>Replace the AWD control unit. Refer to [DLN-55, "Exploded View"](#).

YES (Past error)>>Error was detected in the AWD control unit branch line.

NO >> Repair the power supply and the ground circuit.

## AV BRANCH LINE CIRCUIT

### Diagnosis Procedure

INFOID:000000005779548

#### 1. CHECK CONNECTOR

1. Turn the ignition switch OFF.
2. Disconnect the battery cable from the negative terminal.
3. Check the terminals and connectors of the AV control unit for damage, bend and loose connection (unit side and connector side).

Is the inspection result normal?

- YES >> GO TO 2.  
 NO >> Repair the terminal and connector.

#### 2. CHECK HARNESS FOR OPEN CIRCUIT

1. Disconnect the connector of AV control unit.
  2. Check the resistance between the AV control unit harness connector terminals.
- Without navigation system (Without rear view monitor)

AV control unit harness connector			Resistance (Ω)
Connector No.	Terminal No.		
M85	86	87	Approx. 54 – 66

- Without navigation system (With rear view monitor)

AV control unit harness connector			Resistance (Ω)
Connector No.	Terminal No.		
M204	81	80	Approx. 54 – 66

- With navigation system

AV control unit harness connector			Resistance (Ω)
Connector No.	Terminal No.		
M210	90	74	Approx. 54 – 66

Is the measurement value within the specification?

- YES >> GO TO 3.  
 NO >> Repair the AV control unit branch line.

#### 3. CHECK POWER SUPPLY AND GROUND CIRCUIT

Check the power supply and the ground circuit of the AV control unit. Refer to the following.

- Base audio without rear view camera: [AV-40, "AV CONTROL UNIT : Diagnosis Procedure"](#)
- Base audio with rear view camera: [AV-172, "AV CONTROL UNIT : Diagnosis Procedure"](#)
- BOSE audio without navigation: [AV-297, "AV CONTROL UNIT : Diagnosis Procedure"](#)
- BOSE audio with navigation: [AV-451, "AV CONTROL UNIT : Diagnosis Procedure"](#)

Is the inspection result normal?

- YES (Present error)>>Replace the AV control unit. Refer to the following.
- Base audio without rear view camera: [AV-89, "Exploded View"](#)
  - Base audio with rear view camera: [AV-201, "Exploded View"](#)
  - BOSE audio without navigation: [AV-328, "Exploded View"](#)
  - BOSE audio with navigation: [AV-477, "Exploded View"](#)

YES (Past error)>>Error was detected in the AV control unit branch line.

- NO >> Repair the power supply and the ground circuit.

A  
B  
C  
D  
E  
F  
G  
H  
I  
J  
K  
L

LAN

N  
O  
P

PSB BRANCH LINE CIRCUIT

Diagnosis Procedure

INFOID:000000005779549

1.CHECK CONNECTOR

1. Turn the ignition switch OFF.
2. Disconnect the battery cable from the negative terminal.
3. Check the terminals and connectors of the pre-crash seat belt for damage, bend and loose connection (unit side and connector side).

Is the inspection result normal?

- YES >> GO TO 2.  
 NO >> Repair the terminal and connector.

2.CHECK HARNESS FOR OPEN CIRCUIT

1. Disconnect the connector of pre-crash seat belt control unit.
2. Check the resistance between the pre-crash seat belt control unit harness connector terminals.

Pre-crash seat belt control unit harness connector		Resistance (Ω)
Connector No.	Terminal No.	
M110	24                      22	Approx. 54 – 66

Is the measurement value within the specification?

- YES >> GO TO 3.  
 NO >> Repair the pre-crash seat belt control unit branch line.

3.CHECK POWER SUPPLY AND GROUND CIRCUIT

Check the power supply and the ground circuit of the pre-crash seat belt control unit. Refer to [SBC-24, "Diagnosis Procedure"](#).

Is the inspection result normal?

- YES (Present error)>>Replace the pre-crash seat belt control unit. Refer to [SBC-39, "Exploded View"](#).  
 YES (Past error)>>Error was detected in the pre-crash seat belt control unit branch line.  
 NO >> Repair the power supply and the ground circuit.

# TCM BRANCH LINE CIRCUIT

< DTC/CIRCUIT DIAGNOSIS >

[CAN SYSTEM (TYPE 10)]

## TCM BRANCH LINE CIRCUIT

### Diagnosis Procedure

INFOID:000000005779550

#### 1. CHECK CONNECTOR

1. Turn the ignition switch OFF.
2. Disconnect the battery cable from the negative terminal.
3. Check the following terminals and connectors for damage, bend and loose connection (unit side and connector side).
  - A/T assembly
  - Harness connector F103
  - Harness connector M116

Is the inspection result normal?

- YES >> GO TO 2.  
NO >> Repair the terminal and connector.

#### 2. CHECK HARNESS FOR OPEN CIRCUIT

1. Disconnect the connector of A/T assembly.
2. Check the resistance between the A/T assembly harness connector terminals.

A/T assembly harness connector		Resistance (Ω)
Connector No.	Terminal No.	
F51	3	Approx. 54 – 66
	8	

Is the measurement value within the specification?

- YES >> GO TO 3.  
NO >> Repair the TCM branch line.

#### 3. CHECK POWER SUPPLY AND GROUND CIRCUIT

Check the power supply and the ground circuit of the TCM. Refer to [TM-212, "Diagnosis Procedure"](#).

Is the inspection result normal?

- YES (Present error)>>Replace the control valve with TCM. Refer to [TM-99, "Component Parts Location"](#).  
(Replace A/T assembly if control valve with TCM is not listed in the latest parts list.)  
YES (Past error)>>Error was detected in the TCM branch line.  
NO >> Repair the power supply and the ground circuit.

A  
B  
C  
D  
E  
F  
G  
H  
I  
J  
K  
L

LAN

## ADP BRANCH LINE CIRCUIT

### Diagnosis Procedure

INFOID:000000005779551

#### 1. CHECK CONNECTOR

1. Turn the ignition switch OFF.
2. Disconnect the battery cable from the negative terminal.
3. Check the following terminals and connectors for damage, bend and loose connection (unit side and connector side).
  - Models with automatic drive positioner
    - Driver seat control unit
    - Harness connector B502
    - Harness connector B11
  - Models without automatic drive positioner
    - Driver seat control unit
    - Harness connector B501
    - Harness connector B10

Is the inspection result normal?

YES >> GO TO 2.

NO >> Repair the terminal and connector.

#### 2. CHECK HARNESS FOR OPEN CIRCUIT

1. Disconnect the connector of driver seat control unit.
2. Check the resistance between the driver seat control unit harness connector terminals.

Driver seat control unit harness connector			Resistance (Ω)
Connector No.	Terminal No.		
B503	3	19	Approx. 54 – 66

Is the measurement value within the specification?

YES >> GO TO 3.

NO >> Repair the driver seat control unit branch line.

#### 3. CHECK POWER SUPPLY AND GROUND CIRCUIT

Check the power supply and the ground circuit of the driver seat control unit. Refer to [ADP-64. "DRIVER SEAT CONTROL UNIT : Diagnosis Procedure"](#).

Is the inspection result normal?

YES (Present error)>>Replace the driver seat control unit. Refer to [ADP-234. "Exploded View"](#).

YES (Past error)>>Error was detected in the driver seat control unit branch line.

NO >> Repair the power supply and the ground circuit.

# ABS BRANCH LINE CIRCUIT

< DTC/CIRCUIT DIAGNOSIS >

[CAN SYSTEM (TYPE 10)]

## ABS BRANCH LINE CIRCUIT

### Diagnosis Procedure

INFOID:000000005779552

#### 1. CHECK CONNECTOR

1. Turn the ignition switch OFF.
2. Disconnect the battery cable from the negative terminal.
3. Check the terminals and connectors of the ABS actuator and electric unit (control unit) for damage, bend and loose connection (unit side and connector side).

Is the inspection result normal?

- YES >> GO TO 2.  
NO >> Repair the terminal and connector.

#### 2. CHECK HARNESS FOR OPEN CIRCUIT

1. Disconnect the connector of ABS actuator and electric unit (control unit).
2. Check the resistance between the ABS actuator and electric unit (control unit) harness connector terminals.

ABS actuator and electric unit (control unit) harness connector			Resistance (Ω)
Connector No.	Terminal No.		
E41	35	14	Approx. 54 – 66

Is the measurement value within the specification?

- YES >> GO TO 3.  
NO >> Repair the ABS actuator and electric unit (control unit) branch line.

#### 3. CHECK POWER SUPPLY AND GROUND CIRCUIT

Check the power supply and the ground circuit of the ABS actuator and electric unit (control unit). Refer to [BRC-69, "Diagnosis Procedure"](#).

Is the inspection result normal?

- YES (Present error)>>Replace the ABS actuator and electric unit (control unit). Refer to [BRC-105, "Exploded View"](#).  
YES (Past error)>>Error was detected in the ABS actuator and electric unit (control unit) branch line.  
NO >> Repair the power supply and the ground circuit.

A  
B  
C  
D  
E  
F  
G  
H  
I  
J  
K  
L

LAN

## ICC BRANCH LINE CIRCUIT

### Diagnosis Procedure

INFOID:000000005779553

#### 1. CHECK CONNECTOR

1. Turn the ignition switch OFF.
2. Disconnect the battery cable from the negative terminal.
3. Check the terminals and connectors of the ICC sensor integrated unit for damage, bend and loose connection (unit side and connector side).

Is the inspection result normal?

- YES >> GO TO 2.  
 NO >> Repair the terminal and connector.

#### 2. CHECK HARNESS FOR OPEN CIRCUIT

1. Disconnect the connector of ICC sensor integrated unit.
2. Check the resistance between the ICC sensor integrated unit harness connector terminals.

ICC sensor integrated unit harness connector			Resistance (Ω)
Connector No.	Terminal No.		
E67	3	6	Approx. 54 – 66

Is the measurement value within the specification?

- YES >> GO TO 3.  
 NO >> Repair the ICC sensor integrated unit branch line.

#### 3. CHECK POWER SUPPLY AND GROUND CIRCUIT

Check the power supply and the ground circuit of the ICC sensor integrated unit. Refer to [CCS-102, "Diagnosis Procedure"](#).

Is the inspection result normal?

- YES (Present error)>>Replace the ICC sensor integrated unit. Refer to [CCS-133, "Exploded View"](#).  
 YES (Past error)>>Error was detected in the ICC sensor integrated unit branch line.  
 NO >> Repair the power supply and the ground circuit.



# IPDM-E BRANCH LINE CIRCUIT

< DTC/CIRCUIT DIAGNOSIS >

[CAN SYSTEM (TYPE 10)]

## IPDM-E BRANCH LINE CIRCUIT

### Diagnosis Procedure

INFOID:000000005779554

#### 1. CHECK CONNECTOR

1. Turn the ignition switch OFF.
2. Disconnect the battery cable from the negative terminal.
3. Check the terminals and connectors of the IPDM E/R for damage, bend and loose connection (unit side and connector side).

Is the inspection result normal?

- YES >> GO TO 2.  
NO >> Repair the terminal and connector.

#### 2. CHECK HARNESS FOR OPEN CIRCUIT

1. Disconnect the connector of IPDM E/R.
2. Check the resistance between the IPDM E/R harness connector terminals.

IPDM E/R harness connector			Resistance (Ω)
Connector No.	Terminal No.		
E6	40	39	Approx. 108 – 132

Is the measurement value within the specification?

- YES >> GO TO 3.  
NO >> Repair the IPDM E/R branch line.

#### 3. CHECK POWER SUPPLY AND GROUND CIRCUIT

Check the power supply and the ground circuit of the IPDM E/R. Refer to [PCS-17, "Diagnosis Procedure"](#).

Is the inspection result normal?

- YES (Present error)>>Replace the IPDM E/R. Refer to [PCS-32, "Exploded View"](#).  
YES (Past error)>>Error was detected in the IPDM E/R branch line.  
NO >> Repair the power supply and the ground circuit.

A  
B  
C  
D  
E  
F  
G  
H  
I  
J  
K  
L

LAN

N  
O  
P

# CAN COMMUNICATION CIRCUIT

< DTC/CIRCUIT DIAGNOSIS >

[CAN SYSTEM (TYPE 10)]

## CAN COMMUNICATION CIRCUIT

### Diagnosis Procedure

INFOID:000000005779555

#### 1. CONNECTOR INSPECTION

1. Turn the ignition switch OFF.
2. Disconnect the battery cable from the negative terminal.
3. Disconnect all the unit connectors on CAN communication system.
4. Check terminals and connectors for damage, bend and loose connection.

Is the inspection result normal?

- YES >> GO TO 2.  
NO >> Repair the terminal and connector.

#### 2. CHECK HARNESS CONTINUITY (SHORT CIRCUIT)

Check the continuity between the data link connector terminals.

Data link connector		Continuity
Connector No.	Terminal No.	
M24	6 14	Not existed

Is the inspection result normal?

- YES >> GO TO 3.  
NO >> Check the harness and repair the root cause.

#### 3. CHECK HARNESS CONTINUITY (SHORT CIRCUIT)

Check the continuity between the data link connector and the ground.

Data link connector		Ground	Continuity
Connector No.	Terminal No.		
M24	6		Not existed
	14		Not existed

Is the inspection result normal?

- YES >> GO TO 4.  
NO >> Check the harness and repair the root cause.

#### 4. CHECK ECM AND IPDM E/R TERMINATION CIRCUIT

1. Remove the ECM and the IPDM E/R.
2. Check the resistance between the ECM terminals.

ECM		Resistance ( $\Omega$ )
Terminal No.		
114	113	Approx. 108 – 132

3. Check the resistance between the IPDM E/R terminals.

IPDM E/R		Resistance ( $\Omega$ )
Terminal No.		
40	39	Approx. 108 – 132

Is the measurement value within the specification?

- YES >> GO TO 5.  
NO >> Replace the ECM and/or the IPDM E/R.

#### 5. CHECK SYMPTOM

Connect all the connectors. Check if the symptoms described in the "Symptom (Results from interview with customer)" are reproduced.

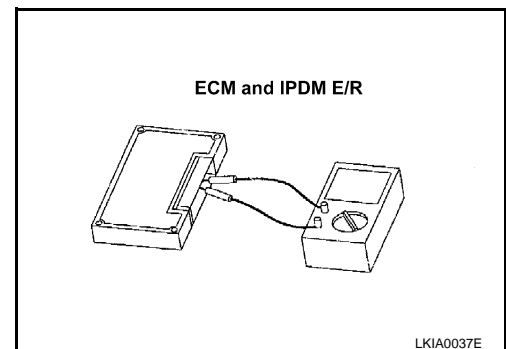

# CAN COMMUNICATION CIRCUIT

< DTC/CIRCUIT DIAGNOSIS >

[CAN SYSTEM (TYPE 10)]

## Inspection result

Reproduced>>GO TO 6.

Non-reproduced>>Start the diagnosis again. Follow the trouble diagnosis procedure when past error is detected.

## 6.CHECK UNIT REPRODUCTION

Perform the reproduction test as per the following procedure for each unit.

1. Turn the ignition switch OFF.
2. Disconnect the battery cable from the negative terminal.
3. Disconnect one of the unit connectors of CAN communication system.

### **NOTE:**

ECM and IPDM E/R have a termination circuit. Check other units first.

4. Connect the battery cable to the negative terminal. Check if the symptoms described in the "Symptom (Results from interview with customer)" are reproduced.

### **NOTE:**

Although unit-related error symptoms occur, do not confuse them with other symptoms.

## Inspection result

Reproduced>>Connect the connector. Check other units as per the above procedure.

Non-reproduced>>Replace the unit whose connector was disconnected.

A

B

C

D

E

F

G

H

I

J

K

L

LAN

N

O

P