

SECTION **DEF**  
**DEFOGGER**

A  
B  
C

CONTENTS

|   |    |   |    |     |
|---|----|---|----|-----|
| <b>BASIC INSPECTION</b> .....               | 3  | Description .....                           | 15 | F   |
| <b>DIAGNOSIS AND REPAIR WORK FLOW</b> ..... | 3  | Component Function Check .....              | 15 |     |
| Work Flow .....                             | 3  | Diagnosis Procedure .....                   | 15 |     |
| <b>SYSTEM DESCRIPTION</b> .....             | 4  | <b>DRIVER SIDE DOOR MIRROR DEFOGGER</b> ... | 17 | G   |
| <b>REAR WINDOW DEFOGGER SYSTEM</b> .....    | 4  | Description .....                           | 17 |     |
| System Diagram .....                        | 4  | Component Function Check .....              | 17 |     |
| System Description .....                    | 4  | Diagnosis Procedure .....                   | 17 | H   |
| Component Parts Location .....              | 5  | <b>PASSENGER SIDE DOOR MIRROR DEFOG-</b>    |    |     |
| Component Description .....                 | 5  | <b>GER</b> .....                            | 19 | I   |
| <b>DIAGNOSIS SYSTEM (BCM)</b> .....         | 6  | Description .....                           | 19 |     |
| <b>COMMON ITEM</b> .....                    | 6  | Component Function Check .....              | 19 |     |
| COMMON ITEM : CONSULT-III Function (BCM -   |    | Diagnosis Procedure .....                   | 19 | J   |
| COMMON ITEM) .....                          | 6  | <b>REAR WINDOW DEFOGGER SYSTEM</b> .....    | 21 |     |
| <b>REAR WINDOW DEFOGGER</b> .....           | 7  | Wiring Diagram - DEFOGGER CONTROL SYS-      |    |     |
| REAR WINDOW DEFOGGER : CONSULT-III          |    | TEM - .....                                 | 21 | K   |
| Function (BCM - REAR DEFOGGER) .....        | 7  | <b>ECU DIAGNOSIS INFORMATION</b> .....      | 29 |     |
| <b>DTC/CIRCUIT DIAGNOSIS</b> .....          | 9  | <b>BCM (BODY CONTROL MODULE)</b> .....      | 29 | DEF |
| <b>REAR WINDOW DEFOGGER SWITCH</b> .....    | 9  | Reference Value .....                       | 29 |     |
| Description .....                           | 9  | Wiring Diagram - BCM - .....                | 52 |     |
| Component Function Check .....              | 9  | Fail-safe .....                             | 57 | M   |
| Diagnosis Procedure .....                   | 9  | DTC Inspection Priority Chart .....         | 59 |     |
| <b>REAR WINDOW DEFOGGER RELAY</b> .....     | 10 | DTC Index .....                             | 60 |     |
| Description .....                           | 10 | <b>SYMPTOM DIAGNOSIS</b> .....              | 63 | N   |
| Component Function Check .....              | 10 | <b>REAR WINDOW DEFOGGER DOES NOT</b>        |    |     |
| Diagnosis Procedure .....                   | 10 | <b>OPERATE</b> .....                        | 63 | O   |
| Component Inspection .....                  | 11 | Diagnosis Procedure .....                   | 63 |     |
| <b>REAR WINDOW DEFOGGER</b> .....           | 12 | <b>REAR WINDOW DEFOGGER AND DOOR</b>        |    |     |
| Description .....                           | 12 | <b>MIRROR DEFOGGER DO NOT OPERATE.</b> .... | 64 | P   |
| Component Function Check .....              | 12 | Diagnosis Procedure .....                   | 64 |     |
| Diagnosis Procedure .....                   | 12 | <b>REAR WINDOW DEFOGGER DOES NOT</b>        |    |     |
| Component Inspection .....                  | 14 | <b>OPERATE BUT BOTH DOOR MIRROR DE-</b>     |    |     |
| <b>DOOR MIRROR DEFOGGER</b> .....           | 15 | <b>FOGGERS OPERATE.</b> .....               | 65 |     |
|   |    | Diagnosis Procedure .....                   | 65 |     |

D  
E

F  
G

H  
I

J  
K

L  
M

N  
O

P

|   |    |  |    |
|---|----|--|----|
| <b>DOOR MIRROR DEFOGGER DOES NOT OPERATE</b> .....  | 66 | Diagnosis Procedure .....  | 68 |
| <b>BOTH SIDES</b> .....   | 66 | <b>PRECAUTION</b> .....  | 69 |
| BOTH SIDES : Diagnosis Procedure .....  | 66 | <b>PRECAUTIONS</b> .....   | 69 |
| <b>DRIVER SIDE</b> .....  | 66 | Precaution for Supplemental Restraint System (SRS) "AIR BAG" and "SEAT BELT PRE-TENSIONER" ..... | 69 |
| DRIVER SIDE : Diagnosis Procedure .....   | 66 | Precaution for Battery Service .....   | 69 |
| <b>PASSENGER SIDE</b> .....   | 66 | <b>REMOVAL AND INSTALLATION</b> .....  | 70 |
| PASSENGER SIDE : Diagnosis Procedure .....  | 66 | <b>FILAMENT</b> .....  | 70 |
| <b>ON IS NOT DISPLAYED WHEN PRESSING REAR WINDOW DEFOGGER SWITCH BUT IT IS OPERATED</b> ..... | 67 | Inspection and Repair .....  | 70 |
| Diagnosis Procedure .....   | 67 | <b>CONDENSER</b> .....   | 72 |
| <b>REAR WINDOW DEFOGGER INDICATOR DOES NOT ILLUMINATE</b> .....                               | 68 | Exploded View .....  | 72 |
|   |    | Removal and Installation .....   | 72 |

# DIAGNOSIS AND REPAIR WORK FLOW

< BASIC INSPECTION >

## BASIC INSPECTION

### DIAGNOSIS AND REPAIR WORK FLOW

Work Flow

INFOID:000000006457010

DETAILED FLOW

#### 1.OBTAIN INFORMATION ABOUT SYMPTOM

Interview the customer to obtain the malfunction information (conditions and environment when the malfunction occurred) as much as possible when the customer brings the vehicle in.

>> GO TO 2.

#### 2.CHECK DTC

Perform self diagnosis with CONSULT-III

Is any DTC detected?

YES >> Refer to [BCS-74. "DTC Index"](#)

NO >> GO TO 3.

#### 3.REPRODUCE THE MALFUNCTION INFORMATION

Check the malfunction on the vehicle that the customer describes.

Inspect the relation of the symptoms and the condition when the symptoms occur.

>> GO TO 4.

#### 4.IDENTIFY THE MALFUNCTIONING SYSTEM WITH "SYMPTOM DIAGNOSIS"

Use "Symptom diagnosis" from the symptom inspection result in step 3. Then identify where to start performing the diagnosis based on possible causes and symptoms.

>> GO TO 5.

#### 5.IDENTIFY MALFUNCTIONING PARTS WITH "COMPONENT DIAGNOSIS"

Perform the diagnosis with "Component diagnosis" of the applicable system.

>> GO TO 6.

#### 6.REPAIR OR REPLACE THE MALFUNCTIONING PARTS

Repair or replace the specified malfunctioning parts.

>> GO TO 7.

#### 7.FINAL CHECK

Check that malfunctions are not reproduced when obtaining the malfunction information from the customer, referring to the symptom inspection result in step 3.

Are all malfunctions corrected?

YES >> INSPECTION END

NO >> GO TO 4.

A  
B  
C  
D  
E  
F  
G  
H  
I  
J  
K  
DEF  
M  
N  
O  
P

# REAR WINDOW DEFOGGER SYSTEM

< SYSTEM DESCRIPTION >

## SYSTEM DESCRIPTION

### REAR WINDOW DEFOGGER SYSTEM

#### System Diagram

INFOID:000000006457011

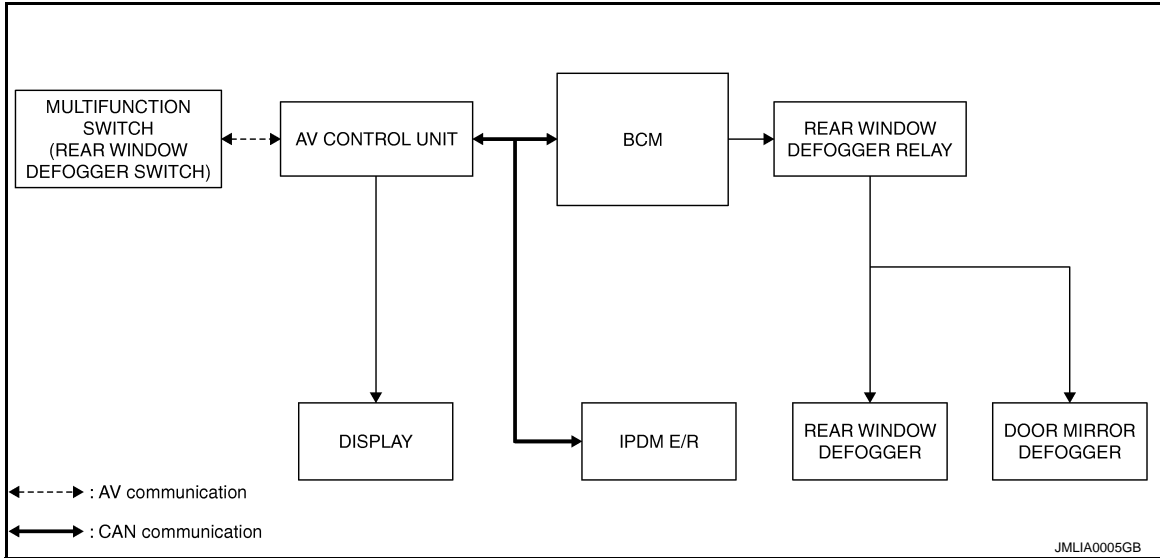

#### System Description

INFOID:000000006457012

#### Operation Description

- Turn rear window defogger switch ON when the ignition switch is turned ON. Then multifunction switch (rear window defogger switch) transmits rear window defogger switch signal to AV control unit via AV communication. AV control unit transmits rear window defogger switch signal to BCM via CAN communication.
- BCM turns rear window defogger relay ON and transmit rear window defogger ON signal to IPDM E/R via CAN communication when rear window defogger switch signal is received.
- Rear window defogger and door mirror defogger (with mirror defogger) are supplied with power and operate when rear window defogger relay turns ON.
- AV control unit transmit rear window defogger control signal to multifunction switch (rear window defogger switch) via AV communication.
- IPDM E/R transmits rear window defogger control signal to AV control unit via CAN communication.

#### Timer function

- BCM turns rear window defogger relay ON for approximately 15 minutes when rear window defogger switch is turned ON. It makes rear window defogger and door mirror defogger (with mirror defogger) operate.
- Timer is canceled after pressing rear window defogger switch again during timer operation. Then BCM turns rear window defogger relay OFF. The same reaction also occurs during timer operation, if the ignition switch is turned OFF.

# REAR WINDOW DEFOGGER SYSTEM

< SYSTEM DESCRIPTION >

## Component Parts Location

INFOID:000000006457013

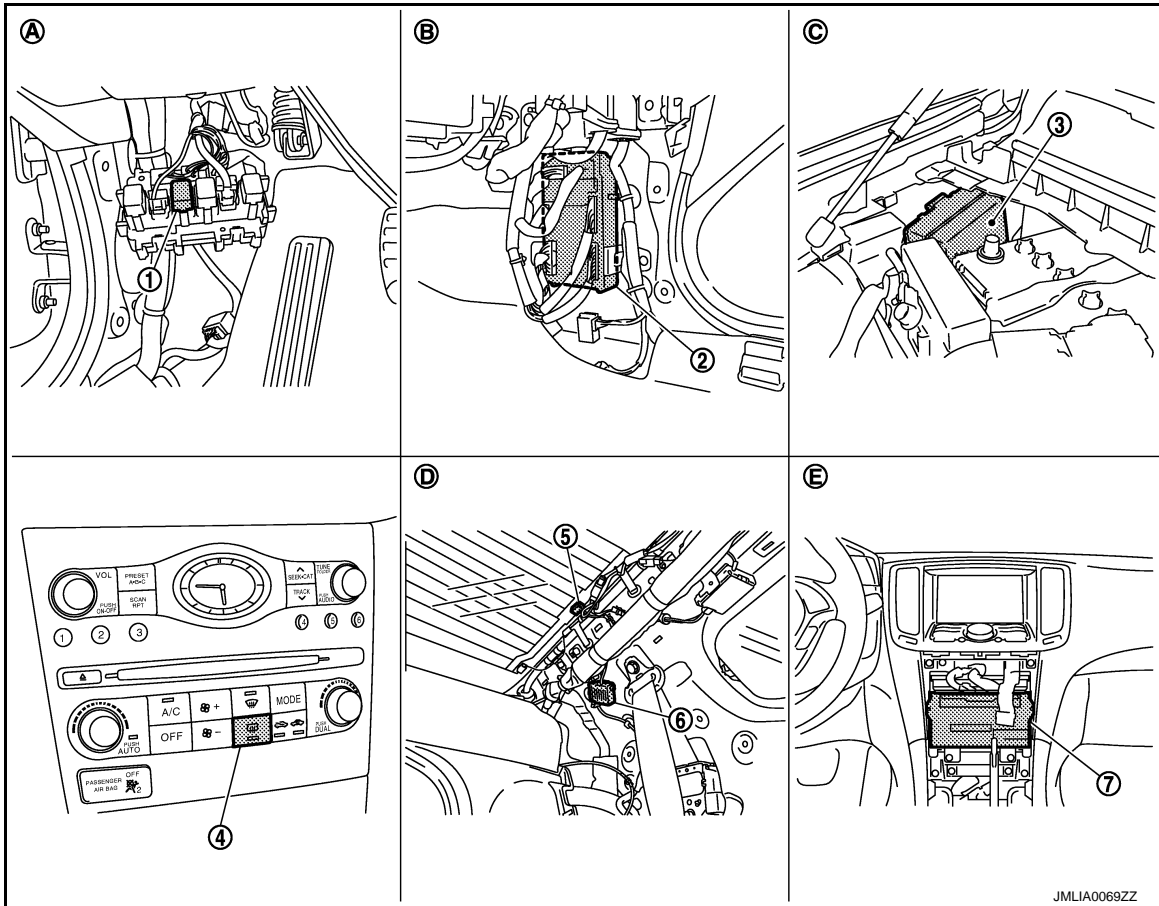

- |  |                                     |                                |
|--|-------------------------------------|--------------------------------|
| 1. Rear window defogger relay                                  | 2. BCM                              | 3. IPDM E/R                    |
| 4. Rear window defogger switch (built-in multifunction switch) | 5. Rear window defogger connector   | 6. Condenser                   |
| 7. AV control unit   |                                     |                                |
| A. Dash side lower (driver side)                               | B. Dash side lower (passenger side) | C. Engine room dash panel (RH) |
| D. Behind rear pillar finisher (LH)                            | E. Behind cluster lid C             |                                |

## Component Description

INFOID:000000006457014

|  |   |
|--|---|
| BCM  | <ul style="list-style-type: none"> <li>Operates the rear window defogger with the operation of rear window defogger switch</li> <li>Performs the timer control of rear window defogger</li> </ul> |
| Rear window defogger relay                         | Operates the rear window defogger and the door mirror defogger with the control signal from BCM   |
| IPDM E/R   | Transmit rear window defogger ON signal to AV control unit via CAN communication  |
| Multifunction switch (Rear window defogger switch) | <ul style="list-style-type: none"> <li>The rear window defogger switch is installed</li> <li>Turns the indicator lamp ON when detecting the operation of rear window defogger</li> </ul>          |
| AV control unit                                    | Displays the rear window defogger ON to the display when detecting the operation of rear window defogger  |
| Rear window defogger                               | Heats the heating wire with the power supply from the rear window defogger relay to prevent the rear window from fogging up   |
| Door mirror defogger*                              | Heats the heating wire with the power supply from the rear window defogger relay to prevent the door mirror from fogging up   |

\*: With mirror defogger

A  
B  
C  
D  
E  
F  
G  
H  
I  
J  
K  
DEF  
M  
N  
O  
P

# DIAGNOSIS SYSTEM (BCM)

< SYSTEM DESCRIPTION >

## DIAGNOSIS SYSTEM (BCM)

### COMMON ITEM

COMMON ITEM : CONSULT-III Function (BCM - COMMON ITEM)

INFOID:000000006933313

### APPLICATION ITEM

CONSULT-III performs the following functions via CAN communication with BCM.

| Diagnosis mode           | Function Description   |
|--------------------------|--|
| Work Support             | Changes the setting for each system function.  |
| Self Diagnostic Result   | Displays the diagnosis results judged by BCM.  |
| CAN Diag Support Monitor | Monitors the reception status of CAN communication viewed from BCM. Refer to CONSULT-III operation manual. |
| Data Monitor             | The BCM input/output signals are displayed.  |
| Active Test              | The signals used to activate each device are forcibly supplied from BCM.                                   |
| Ecu Identification       | The BCM part number is displayed.  |
| Configuration            | This function is not used even though it is displayed.   |

### SYSTEM APPLICATION

BCM can perform the following functions for each system.

#### NOTE:

It can perform the diagnosis modes except the following for all sub system selection items.

×: Applicable item

| System  | Sub system selection item | Diagnosis mode |              |             |
|---|---------------------------|----------------|--------------|-------------|
|   |                           | Work Support   | Data Monitor | Active Test |
| Door lock   | DOOR LOCK                 | ×              | ×            | ×           |
| Rear window defogger  | REAR DEFOGGER             |                | ×            | ×           |
| Warning chime   | BUZZER                    |                | ×            | ×           |
| Interior room lamp timer  | INT LAMP                  | ×              | ×            | ×           |
| Exterior lamp   | HEAD LAMP                 | ×              | ×            | ×           |
| Wiper and washer  | WIPER                     | ×              | ×            | ×           |
| Turn signal and hazard warning lamps  | FLASHER                   | ×              | ×            | ×           |
| —   | AIR CONDITONER*           |                |              |             |
| <ul style="list-style-type: none"> <li>• Intelligent Key system</li> <li>• Engine start system</li> </ul> | INTELLIGENT KEY           | ×              | ×            | ×           |
| Combination switch  | COMB SW                   |                | ×            |             |
| Body control system   | BCM                       | ×              |              |             |
| IVIS - NATS   | IMMU                      |                | ×            | ×           |
| Interior room lamp battery saver  | BATTERY SAVER             | ×              | ×            | ×           |
| Trunk lid open  | TRUNK                     |                | ×            | ×           |
| Vehicle security system   | THEFT ALM                 | ×              | ×            | ×           |
| RAP system  | RETAINED PWR              |                | ×            |             |
| Signal buffer system  | SIGNAL BUFFER             |                | ×            | ×           |
| TPMS  | AIR PRESSURE MONITOR      | ×              | ×            | ×           |

#### NOTE:

\*: This item is displayed, but is not used.

### FREEZE FRAME DATA (FFD)

The BCM records the following vehicle condition at the time a particular DTC is detected, and displays on CONSULT-III.

# DIAGNOSIS SYSTEM (BCM)

## < SYSTEM DESCRIPTION >

| CONSULT screen item | Indication/Unit   | Description  |  |   |
|---------------------|---|--|--|---|
| Vehicle Speed       | km/h  | Vehicle speed of the moment a particular DTC is detected   |  | A |
| Odo/Trip Meter      | km  | Total mileage (Odometer value) of the moment a particular DTC is detected  |  |   |
| Vehicle Condition   | SLEEP>LOCK  | Power supply position status of the moment a particular DTC is detected*   | While turning BCM status from low power consumption mode to normal mode (Power supply position is "LOCK"*)   | B |
|                     | SLEEP>OFF   |  | While turning BCM status from low power consumption mode to normal mode (Power supply position is "OFF".)    | C |
|                     | LOCK>ACC  |  | While turning power supply position from "LOCK"* to "ACC"  |   |
|                     | ACC>ON  |  | While turning power supply position from "ACC" to "IGN"  | D |
|                     | RUN>ACC   |  | While turning power supply position from "RUN" to "ACC" (Except emergency stop operation)                    |   |
|                     | CRANK>RUN   |  | While turning power supply position from "CRANKING" to "RUN" (From cranking up the engine to run it)         | E |
|                     | RUN>URGENT  |  | While turning power supply position from "RUN" to "ACC" (Emergency stop operation)                           |   |
|                     | ACC>OFF   |  | While turning power supply position from "ACC" to "OFF"  | F |
|                     | OFF>LOCK  |  | While turning power supply position from "OFF" to "LOCK"*  |   |
|                     | OFF>ACC   |  | While turning power supply position from "OFF" to "ACC"  | G |
|                     | ON>CRANK  |  | While turning power supply position from "IGN" to "CRANKING"   |   |
|                     | OFF>SLEEP   |  | While turning BCM status from normal mode (Power supply position is "OFF".) to low power consumption mode    | H |
|                     | LOCK>SLEEP  |  | While turning BCM status from normal mode (Power supply position is "LOCK"*. ) to low power consumption mode |   |
|                     | LOCK  |  | Power supply position is "LOCK" (Ignition switch OFF with steering is locked.)*                              | I |
|                     | OFF   |  | Power supply position is "OFF" (Ignition switch OFF with steering is unlocked.)                              | J |
|                     | ACC   |  | Power supply position is "ACC" (Ignition switch ACC)   |   |
| ON                  | Power supply position is "IGN" (Ignition switch ON with engine stopped) | K  |  |   |
| ENGINE RUN          | Power supply position is "RUN" (Ignition switch ON with engine running) |  |  |   |
| CRANKING            | Power supply position is "CRANKING" (At engine cranking)                | DEF  |  |   |
| IGN Counter         | 0 - 39  | The number of times that ignition switch is turned ON after DTC is detected <ul style="list-style-type: none"> <li>• The number is 0 when a malfunction is detected now.</li> <li>• The number increases like 1 → 2 → 3...38 → 39 after returning to the normal condition whenever ignition switch OFF → ON.</li> <li>• The number is fixed to 39 until the self-diagnosis results are erased if it is over 39.</li> </ul> |  | M |

### NOTE:

\*: For models without steering lock unit, power supply position changes from "OFF" to "LOCK" when steering lock conditions are satisfied.

## REAR WINDOW DEFOGGER

### REAR WINDOW DEFOGGER : CONSULT-III Function (BCM - REAR DEFOGGER)

INFOID:000000006457016

#### Data monitor

| Monitor Item | Description                                     |
|--------------|---|
| REAR DEF SW  | This is displayed even when it is not equipped. |
| PUSH SW      | Indicates [ON/OFF] condition of push switch.    |

## DIAGNOSIS SYSTEM (BCM)

< SYSTEM DESCRIPTION >

---

### ACTIVE TEST

| Test Item     | Description  |
|---------------|--|
| REAR DEFOGGER | This test is able to check rear window defogger operation. Rear window defogger operates when "ON" on CONSULT-III screen is touched. |



# REAR WINDOW DEFOGGER SWITCH

< DTC/CIRCUIT DIAGNOSIS >

## DTC/CIRCUIT DIAGNOSIS

### REAR WINDOW DEFOGGER SWITCH

#### Description

INFOID:000000006457017

- The rear window defogger is operated by turning the rear window defogger switch ON.
- The indicator lamp in the rear window defogger illuminates when the rear window defogger is operating.

#### Component Function Check

INFOID:000000006457018

#### 1. CHECK REAR WINDOW DEFOGGER SWITCH FUNCTION

Check that the indicator lamp of rear window defogger illuminates when rear window defogger switch ON.

Is the inspection result normal?

- YES >> Rear window defogger switch function is OK.
- NO >> Refer to [DEF-9, "Diagnosis Procedure"](#)

#### Diagnosis Procedure

INFOID:000000006457019

#### 1. CHECK MULTIFUNCTION SWITCH (REAR WINDOW DEFOGGER SWITCH)

Does multifunction switch operate normally?

- Base audio without rear view camera. Refer to [AV-20, "Diagnosis Description"](#)
- Base audio with rear view camera. Refer to [AV-112, "On Board Diagnosis Function"](#)
- BOSE audio without navigation. Refer to [AV-232, "On Board Diagnosis Function"](#)
- BOSE audio with navigation. Refer to [AV-369, "On Board Diagnosis Function"](#)

Is the inspection result normal?

- YES >> INSPECTION END
- NO >> Replace multifunction switch (rear window defogger switch). Refer to [AV-98, "Removal and Installation"](#)

A  
B  
C  
D  
E  
F  
G  
H  
I  
J  
K  
DEF  
M  
N  
O  
P

DEF

# REAR WINDOW DEFOGGER RELAY

< DTC/CIRCUIT DIAGNOSIS >

## REAR WINDOW DEFOGGER RELAY

### Description

INFOID:000000006457020

Power is supplied to the rear window defogger with BCM control.

### Component Function Check

INFOID:000000006457021

#### 1.CHECK REAR WINDOW DEFOGGER RELAY POWER SUPPLY CIRCUIT

1. Perform Active Test ("REAR DEFOGGER") with CONSULT-III.
2. Touch "ON".
3. Check that the rear window heating wire is getting warmer.

Is the inspection result normal?

- YES >> Rear window defogger relay power supply circuit is OK.  
NO >> Refer to [DEF-10, "Diagnosis Procedure"](#)

### Diagnosis Procedure

INFOID:000000006457022

#### 1.CHECK FUSE

1. Turn ignition switch off.
2. Check the following.
  - 10A fuse [No.3, located in fuse block (J/B)]

Is the inspection result normal?

- YES >> GO TO 2.  
NO >> Replace the blown fuse after repairing the affected circuit if a fuse is blown.

#### 2.CHECK REAR WINDOW DEFOGGER CIRCUIT 1

1. Turn ignition switch ON.
2. Check voltage between BCM harness connector and ground.

| (+)       |          | (-)    | Condition                   | Voltage (V)<br>(Approx.) |                 |
|-----------|----------|--------|-----------------------------|--------------------------|-----------------|
| BCM       |          |        |                             |                          |                 |
| Connector | Terminal |        |                             |                          |                 |
| M123      | 151      | Ground | Rear window defogger switch | ON                       | 0               |
|           |          |        |                             | OFF                      | Battery voltage |

Is the inspection result normal?

- YES >> GO TO 6.  
NO >> GO TO 3.

#### 3.CHECK REAR WINDOW DEFOGGER CIRCUIT 2

1. Turn ignition switch OFF.
2. Disconnect BCM connector and rear window defogger relay.
3. Check continuity between BCM harness connector and fuse block (J/B) harness connector.

| BCM       |          | Fuse block (J/B) |          | Continuity |
|-----------|----------|------------------|----------|------------|
| Connector | Terminal | Connector        | Terminal |            |
| M123      | 151      | M2               | 4B       | Existed    |

Is the inspection result normal?

- YES >> GO TO 4.  
NO >> Repair or replace harness.

#### 4.CHECK REAR WINDOW DEFOGGER RELAY

Check rear window defogger relay.

Refer to [DEF-11, "Component Inspection"](#)

Is the inspection result normal?

# REAR WINDOW DEFOGGER RELAY

## < DTC/CIRCUIT DIAGNOSIS >

- YES >> GO TO 5.  
 NO >> Replace rear window defogger relay.

### 5.CHECK FUSE BLOCK (J/B)

1. Install the rear window defogger relay.
2. Turn ignition switch ON.
3. Check voltage between fuse block (J/B) (fuse block side) and ground.

| (+)              |          | (-)    | Voltage (V)<br>(Approx.) |
|------------------|----------|--------|--------------------------|
| Fuse block (J/B) |          |        |                          |
| Connector        | Terminal |        |                          |
| M2               | 4B       | Ground | Battery voltage          |

Is the inspection result normal?

- YES >> GO TO 6.  
 NO >> Repair or replace fuse block (J/B).

### 6.CHECK INTERMITTENT INCIDENT

Check intermittent incident.  
 Refer to [GI-43. "Intermittent Incident"](#)

>> INSPECTION END

## Component Inspection

INFOID:000000006457023

### 1.CHECK REAR WINDOW DEFOGGER RELAY

1. Turn ignition switch OFF.
2. Disconnect rear window defogger relay.
3. Check rear window defogger relay.

| Terminal                   |   | Condition   | Continuity  |
|----------------------------|---|---|-------------|
| Rear window defogger relay |   |   |             |
| 3                          | 5 | 12 V direct current supply between terminals 1 and 2. | Existed     |
|                            |   | No current supply                                     | Not existed |

Is the inspection result normal?

- YES >> INSPECTION END  
 NO >> Replace rear window defogger relay.

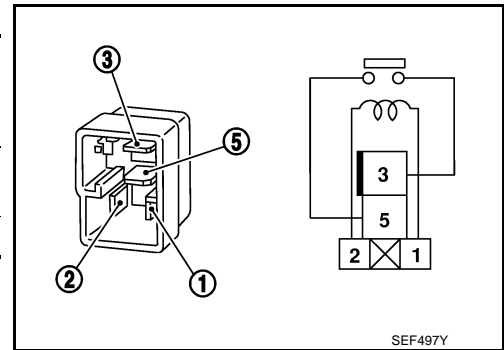

SEF497Y

A  
B  
C  
D  
E  
F  
G  
H  
I  
J  
K  
DEF  
M  
N  
O  
P

# REAR WINDOW DEFOGGER

< DTC/CIRCUIT DIAGNOSIS >

## REAR WINDOW DEFOGGER

### Description

INFOID:000000006457024

Heats the heating wire with the power supply from the rear window defogger relay to prevent the rear window from fogging up.

### Component Function Check

INFOID:000000006457025

### 1.CHECK REAR WINDOW DEFOGGER

1. Perform Active Test ("REAR DEFOGGER") with CONSULT-III.
2. Touch "ON".
3. Check that the rear window heating wire is getting warmer.

Is the inspection result normal?

- YES >> Rear window defogger is OK.  
NO >> Refer to [DEF-12. "Diagnosis Procedure"](#)

### Diagnosis Procedure

INFOID:000000006457026

### 1.CHECK FUSE

1. Turn ignition switch OFF.
2. Check the following.
  - 20A fuse [No.14, located in fuse block (J/B)]
  - 20A fuse [No.15, located in fuse block (J/B)]

Is the inspection result normal?

- YES >> GO TO 2.  
NO >> Replace the blown fuse after repairing the affected circuit if a fuse is blown.

### 2.CHECK POWER SUPPLY CIRCUIT

1. Turn ignition switch ON.
2. Check voltage between rear window defogger connector and ground.

| (+)       |          | (-)    | Condition                   |    | Voltage (V)<br>(Approx.) |
|-----------|----------|--------|-----------------------------|----|--------------------------|
| Connector | Terminal |        |                             |    |                          |
| B401      | 1        | Ground | Rear window defogger switch | ON | Battery voltage          |
|           |          |        | OFF                         | 0  |                          |

Is the inspection result normal?

- YES >> GO TO 3.  
NO >> GO TO 4.

### 3.CHECK GROUND CIRCUIT

1. Turn ignition switch OFF.
2. Disconnect rear window defogger connector.
3. Check continuity between rear window defogger harness connector and ground.

| Rear window defogger |          | Ground | Continuity |
|----------------------|----------|--------|------------|
| Connector            | Terminal |        |            |
| B402                 | 2        |        | Existed    |

Is the inspection result normal?

- YES >> GO TO 7.  
NO >> Repair or replace harness.

### 4.CHECK REAR WINDOW DEFOGGER CIRCUIT 1

# REAR WINDOW DEFOGGER

## < DTC/CIRCUIT DIAGNOSIS >

1. Turn ignition switch OFF.
2. Disconnect condenser connector and rear window defogger connector.
3. Check continuity between condenser (condenser side) and rear window defogger harness connector.

| Condenser |          | Rear window defogger |          | Continuity |
|-----------|----------|----------------------|----------|------------|
| Connector | Terminal | Connector            | Terminal |            |
| B26       | 1        | B401                 | 1        | Existed    |

4. Check continuity between condenser (condenser side) connector and ground.

| Condenser |          | Ground | Continuity  |
|-----------|----------|--------|-------------|
| Connector | Terminal |        |             |
| B26       | 1        |        | Not existed |

Is the inspection result normal?

YES >> GO TO 5.

NO >> Replace condenser. Refer to [DEF-72, "Removal and Installation"](#)

## 5.CHECK REAR WINDOW DEFOGGER CIRCUIT 2

1. Disconnect fuse block (J/B) connector.
2. Check continuity between fuse block (J/B) harness connector and condenser harness connector.

| Fuse block (J/B) |          | Condenser |          | Continuity |
|------------------|----------|-----------|----------|------------|
| Connector        | Terminal | Connector | Terminal |            |
| B6               | 10G      | B26       | 1        | Existed    |
|                  | 11G      |           |          |            |

3. Check continuity between fuse block (J/B) harness connector and ground.

| Fuse block (J/B) |          | Ground | Continuity  |
|------------------|----------|--------|-------------|
| Connector        | Terminal |        |             |
| B6               | 10G      |        | Not existed |
|                  | 11G      |        |             |

Is the inspection result normal?

YES >> GO TO 6.

NO >> Repair or replace harness.

## 6.CHECK FUSE BLOCK (J/B)

1. Turn ignition switch ON.
2. Check voltage between fuse block (J/B) (fuse block side) and ground.

| (+)              |          | (-)    | Condition                       | Voltage (V)<br>(Approx.) |
|------------------|----------|--------|---------------------------------|--------------------------|
| Fuse block (J/B) |          |        |                                 |                          |
| Connector        | Terminal |        |                                 |                          |
| B6               | 10G      | Ground | Rear window defogger switch ON  | Battery voltage          |
|                  |          |        | Rear window defogger switch OFF | 0                        |
|                  | 11G      |        | Rear window defogger switch ON  | Battery voltage          |
|                  |          |        | Rear window defogger switch OFF | 0                        |

Is the inspection result normal?

YES >> GO TO 8.

NO >> Repair or replace fuse block (J/B).

## 7.CHECK FILAMENT

Check filament.

Refer to [DEF-14, "Component Inspection"](#)

## REAR WINDOW DEFOGGER

< DTC/CIRCUIT DIAGNOSIS >

---

Is the inspection result normal?

YES >> GO TO 8.

NO >> Repair filament.

### 8.CHECK INTERMITTENT INCIDENT

---

Check intermittent incident.

Refer to [GI-43, "Intermittent Incident"](#)

>> INSPECTION END

### Component Inspection

INFOID:000000006457027

### 1.CHECK FILAMENT

---

Check the filament for damage or blown.

Refer to [DEF-70, "Inspection and Repair"](#)

Is the inspection result normal?

YES >> INSPECTION END

NO >> Repair filament.

# DOOR MIRROR DEFOGGER

< DTC/CIRCUIT DIAGNOSIS >

## DOOR MIRROR DEFOGGER

### Description

INFOID:000000006457028

Power is supplied to the door mirror defogger with BCM control.

### Component Function Check

INFOID:000000006457029

### 1.CHECK DOOR MIRROR DEFOGGER

1. Perform Active Test ("REAR DEFOGGER") with CONSULT-III.
2. Touch "ON".
3. Check that both side door mirror glass is getting warmer.

Is the inspection result normal?

- YES >> Door mirror defogger is OK.  
NO >> Refer to [DEF-15. "Diagnosis Procedure"](#)

### Diagnosis Procedure

INFOID:000000006457030

### 1.CHECK FUSE

1. Turn ignition switch OFF.
2. Check 10A fuse [No.13, located in fuse block (J/B)].

Is the inspection result normal?

- YES >> GO TO 2.  
NO >> Replace the blown fuse after repairing the affected circuit if a fuse is blown.

### 2.CHECK POWER SUPPLY CIRCUIT

1. Disconnect door mirror (driver side) connector.
2. Turn ignition switch ON.
3. Check voltage between door mirror (driver side) harness connector and ground.

| (+)                                    |          | (-)    | Condition                      |           | Voltage (V)<br>(Approx.) |
|--|----------|--------|--------------------------------|-----------|--------------------------|
| Door mirror (driver side)<br>Connector | Terminal |        |                                |           |                          |
| D3                                     | 4        | Ground | Rear window defogger<br>switch | ON<br>OFF | Battery voltage<br>0     |

Is the inspection result normal?

- YES >> GO TO 5.  
NO >> GO TO 3.

### 3.CHECK DRIVER SIDE DOOR MIRROR DEFOGGER CIRCUIT

1. Turn ignition switch OFF.
2. Disconnect fuse block (J/B) connector.
3. Check continuity between fuse block (J/B) harness connector and door mirror (driver side) harness connector.

| Fuse block (J/B) |          | Door mirror (driver side) |          | Continuity |
|------------------|----------|---------------------------|----------|------------|
| Connector        | Terminal | Connector                 | Terminal |            |
| M3               | 10C      | D3                        | 4        | Existed    |

4. Check continuity between fuse block (J/B) harness connector and ground.

| Fuse block (J/B) |          | Ground | Continuity  |
|------------------|----------|--------|-------------|
| Connector        | Terminal |        |             |
| M3               | 10C      |        | Not existed |

Is the inspection result normal?

A  
B  
C  
D  
E  
F  
G  
H  
I  
J  
K  
DEF  
M  
N  
O  
P

# DOOR MIRROR DEFOGGER

## < DTC/CIRCUIT DIAGNOSIS >

---

- YES >> GO TO 4.  
NO >> Repair or replace harness.

### 4. CHECK FUSE BLOCK (J/B)

---

1. Turn ignition switch ON.
2. Check voltage between fuse block (J/B) (fuse block side) and ground.

| (+)              |          | (-)    | Condition            | Voltage (V)<br>(Approx.) |                 |
|------------------|----------|--------|----------------------|--------------------------|-----------------|
| Fuse block (J/B) |          |        |                      |                          |                 |
| Connector        | Terminal |        |                      |                          |                 |
| M3               | 10C      | Ground | Rear window defogger | ON                       | Battery voltage |
|                  |          |        | switch               | OFF                      | 0               |

### Is the inspection result normal?

- YES >> GO TO 5.  
NO >> Repair or replace fuse block (J/B).

### 5. CHECK INTERMITTENT INCIDENT

---

Check intermittent incident.  
Refer to [GI-43, "Intermittent Incident"](#).

>> INSPECTION END



# DRIVER SIDE DOOR MIRROR DEFOGGER

< DTC/CIRCUIT DIAGNOSIS >

## DRIVER SIDE DOOR MIRROR DEFOGGER

### Description

INFOID:000000006457031

Heats the heating wire with the power supply from the rear window defogger relay to prevent the door mirror from fogging up.

### Component Function Check

INFOID:000000006457032

#### 1.CHECK DRIVER SIDE DOOR MIRROR DEFOGGER

1. Perform Active Test ("REAR DEFOGGER") with CONSULT-III.
2. Touch "ON".
3. Check that the driver side door mirror glass is getting warmer.

Is the inspection result normal?

- YES >> Driver side door mirror defogger is OK.  
NO >> Refer to [DEF-17, "Diagnosis Procedure"](#)

### Diagnosis Procedure

INFOID:000000006457033

#### 1.CHECK POWER SUPPLY CIRCUIT

1. Turn ignition switch OFF.
2. Disconnect door mirror (driver side) connector.
3. Turn ignition switch ON.
4. Check voltage between door mirror (driver side) harness connector and ground.

| (+)                                    |          | (-)    | Condition                      |     | Voltage (V)<br>(Approx.) |
|--|----------|--------|--------------------------------|-----|--------------------------|
| Door mirror (driver side)<br>Connector | Terminal |        |                                |     |                          |
| D3                                     | 4        | Ground | Rear window defogger<br>switch | ON  | Battery voltage          |
|  |          |        |                                | OFF | 0                        |

Is the inspection result normal?

- YES >> GO TO 3.  
NO >> GO TO 2.

#### 2.CHECK DRIVER SIDE DOOR MIRROR DEFOGGER CIRCUIT

1. Turn ignition switch OFF.
2. Check continuity between fuse block (J/B) harness connector and door mirror (driver side) harness connector.

| Fuse block (J/B) |          | Door mirror (driver side) |          | Continuity |
|------------------|----------|---------------------------|----------|------------|
| Connector        | Terminal | Connector                 | Terminal |            |
| M3               | 10C      | D3                        | 4        | Existed    |

3. Check continuity between fuse block (J/B) harness connector and ground.

| Fuse block (J/B) |          | Ground | Continuity  |
|------------------|----------|--------|-------------|
| Connector        | Terminal |        |             |
| M3               | 10C      |        | Not existed |

Is the inspection result normal?

- YES >> GO TO 4.  
NO >> Repair or replace harness.

#### 3.CHECK GROUND CIRCUIT

1. Turn ignition switch OFF.
2. Check continuity between door mirror (driver side) harness connector and ground.

## DRIVER SIDE DOOR MIRROR DEFOGGER

< DTC/CIRCUIT DIAGNOSIS >

---

| Door mirror (driver side) |          | Ground | Continuity |
|---------------------------|----------|--------|------------|
| Connector                 | Terminal |        | Existed    |
| D3                        | 8        |        |            |

---

Is the inspection result normal?

YES >> Replace door mirror glass (driver side). Refer to [MIR-20, "GLASS MIRROR : Disassembly and Assembly"](#)

NO >> Repair or replace harness.

### 4.CHECK INTERMITTENT INCIDENT

---

Check intermittent incident.

Refer to [GI-43, "Intermittent Incident"](#)

Is the inspection result normal?

>> INSPECTION END

# PASSENGER SIDE DOOR MIRROR DEFOGGER

< DTC/CIRCUIT DIAGNOSIS >

## PASSENGER SIDE DOOR MIRROR DEFOGGER

### Description

INFOID:000000006457034

Heats the heating wire with the power supply from the rear window defogger relay to prevent the door mirror from fogging up.

### Component Function Check

INFOID:000000006457035

#### 1.CHECK PASSENGER SIDE DOOR MIRROR DEFOGGER

1. Perform Active Test ("REAR DEFOGGER") with CONSULT-III.
2. Touch "ON".
3. Check that the passenger side door mirror glass is getting warmer.

Is the inspection result normal?

- YES >> Passenger side door mirror defogger is OK.  
NO >> Refer to [DEF-19, "Diagnosis Procedure"](#)

### Diagnosis Procedure

INFOID:000000006457036

#### 1.CHECK POWER SUPPLY CIRCUIT

1. Turn ignition switch OFF.
2. Disconnect door mirror (passenger side) connector.
3. Turn ignition switch ON.
4. Check voltage between door mirror (passenger side) harness connector and ground.

| (+)                                       |          | (-)    | Condition                      |     | Voltage (V)<br>(Approx.) |
|---|----------|--------|--------------------------------|-----|--------------------------|
| Door mirror (passenger side)<br>Connector | Terminal |        |                                |     |                          |
| D33                                       | 4        | Ground | Rear window defogger<br>switch | ON  | Battery voltage          |
|   |          |        |                                | OFF | 0                        |

Is the inspection result normal?

- YES >> GO TO 3.  
NO >> GO TO 2.

#### 2.CHECK PASSENGER SIDE DOOR MIRROR DEFOGGER CIRCUIT

1. Turn ignition switch OFF.
2. Check continuity between fuse block (J/B) harness connector and door mirror (passenger side) harness connector.

| Fuse block (J/B) |          | Door mirror (passenger side) |          | Continuity |
|------------------|----------|------------------------------|----------|------------|
| Connector        | Terminal | Connector                    | Terminal |            |
| M3               | 9C       | D33                          | 4        | Existed    |

3. Check continuity between fuse block (J/B) harness connector and ground.

| Fuse block (J/B) |          | Ground | Continuity  |
|------------------|----------|--------|-------------|
| Connector        | Terminal |        |             |
| M3               | 9C       |        | Not existed |

Is the inspection result normal?

- YES >> GO TO 4.  
NO >> Repair or replace harness.

#### 3.CHECK GROUND CIRCUIT

1. Turn ignition switch OFF.
2. Check continuity between door mirror (passenger side) harness connector and ground.

## PASSENGER SIDE DOOR MIRROR DEFOGGER

< DTC/CIRCUIT DIAGNOSIS >

---

| Door mirror (passenger side) |          | Ground | Continuity |
|------------------------------|----------|--------|------------|
| Connector                    | Terminal |        | Existed    |
| D33                          | 8        |        |            |

Is the inspection result normal?

YES >> Replace door mirror glass (passenger side). Refer to [MIR-20, "GLASS MIRROR : Disassembly and Assembly"](#)

NO >> Repair or replace harness.

### 4. CHECK INTERMITTENT INCIDENT

---

Check intermittent incident.

Refer to [GI-43, "Intermittent Incident"](#)

>> INSPECTION END

# REAR WINDOW DEFOGGER SYSTEM

< DTC/CIRCUIT DIAGNOSIS >

## REAR WINDOW DEFOGGER SYSTEM

### Wiring Diagram - DEFOGGER CONTROL SYSTEM -

INFOID:000000006457037

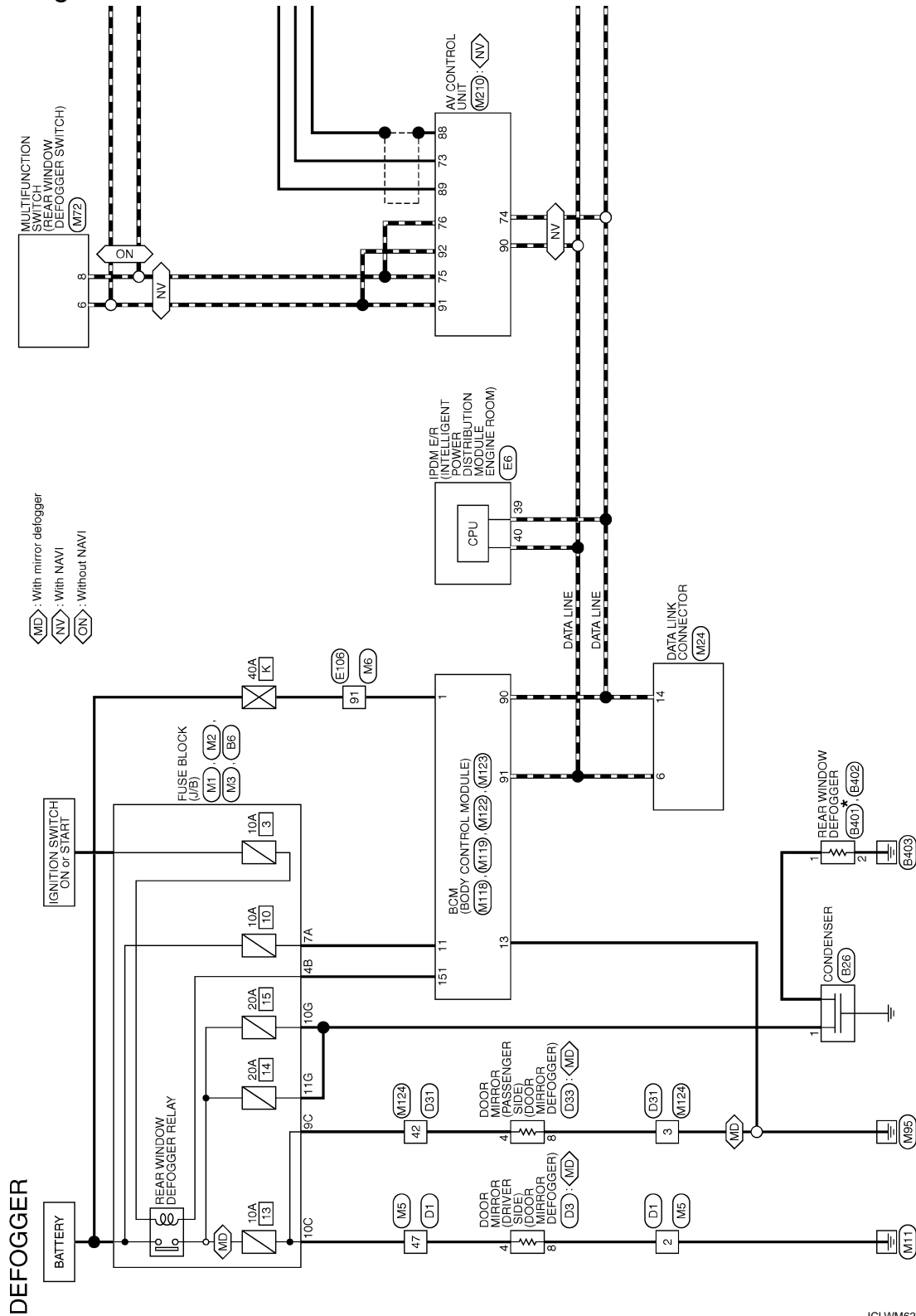

\*: This connector is not shown in "Harness Layout".

# REAR WINDOW DEFOGGER SYSTEM

## < DTC/CIRCUIT DIAGNOSIS >

- \*6 88: <OM>
  - 79: <RM>
  - \*7 89: <OM>
  - 78: <RM>
  - \*8 90: <OM>
  - 77: <RM>
  - \*9 91: <OM>
  - 76: <RM>
- 
- \*1 86: <OM>
  - 81: <RM>
  - \*2 87: <OM>
  - 80: <RM>
  - \*3 44: <OM>
  - 39: <RM>
  - \*4 56: <OM>
  - 51: <RM>
  - \*5 55: <OM>
  - 52: <RM>

<ON> : Without NAVI  
 <RM> : With rear view monitor  
 <OM> : Without rear view monitor

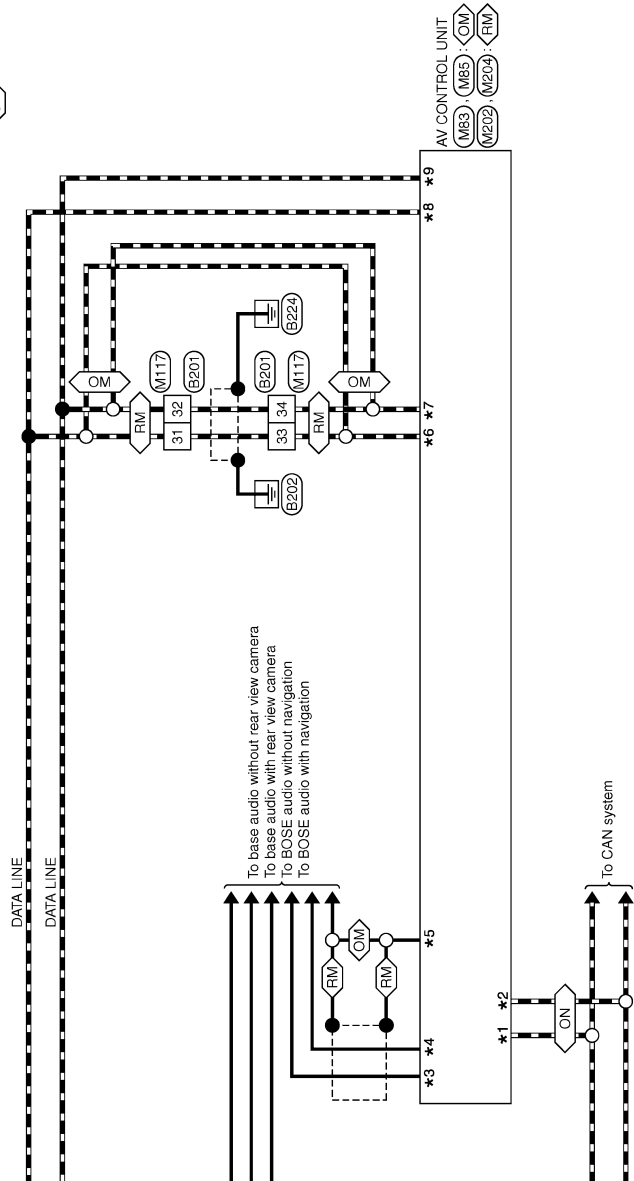

JCLWM6273GB

# REAR WINDOW DEFOGGER SYSTEM

## < DTC/CIRCUIT DIAGNOSIS >

### DEFOGGER

|                |                  |
|----------------|------------------|
| Connector No.  | B6               |
| Connector Name | FUSE BLOCK (J/B) |
| Connector Type | MS12FB-CS        |

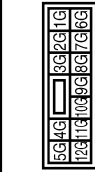

|              |               |                             |
|--------------|---------------|-----------------------------|
| Terminal No. | Color of Wire | Signal Name [Specification] |
| 5G           | LG            | -                           |
| 6G           | G             | -                           |
| 10G          | W             | -                           |
| 11G          | W             | -                           |
| 12G          | Y             | -                           |

|                |           |
|----------------|-----------|
| Connector No.  | B26       |
| Connector Name | CONDENSER |
| Connector Type | M01FW-LC  |



|              |               |                             |
|--------------|---------------|-----------------------------|
| Terminal No. | Color of Wire | Signal Name [Specification] |
| 1            | Y             | -                           |

|                |                 |
|----------------|-----------------|
| Connector No.  | B201            |
| Connector Name | WIRE TO WIRE    |
| Connector Type | TH80FW-CS16-TM4 |



|              |               |                             |
|--------------|---------------|-----------------------------|
| Terminal No. | Color of Wire | Signal Name [Specification] |
| 1            | Y             | -                           |
| 2            | B             | -                           |
| 3            | SB            | -                           |
| 4            | V             | -                           |

|    |        |   |
|----|--------|---|
| 1  | GR     | - |
| 5  | Y      | - |
| 8  | G      | - |
| 7  | BG     | - |
| 9  | LG     | - |
| 10 | R      | - |
| 30 | B      | - |
| 31 | L      | - |
| 32 | P      | - |
| 33 | SB     | - |
| 34 | V      | - |
| 40 | GR     | - |
| 41 | LG     | - |
| 42 | BG     | - |
| 43 | R      | - |
| 45 | G      | - |
| 46 | SHIELD | - |
| 47 | G      | - |
| 48 | Y      | - |
| 49 | SHIELD | - |
| 50 | P      | - |
| 59 | BG     | - |
| 71 | R      | - |
| 72 | V      | - |
| 80 | V      | - |
| 81 | SHIELD | - |
| 82 | Y      | - |
| 83 | BR     | - |
| 84 | O      | - |
| 85 | SHIELD | - |
| 86 | G      | - |
| 87 | R      | - |
| 88 | W      | - |
| 89 | B      | - |
| 90 | SB     | - |
| 91 | V      | - |
| 94 | W      | - |
| 95 | G      | - |
| 97 | BR     | - |

|                |                      |
|----------------|----------------------|
| Connector No.  | B401                 |
| Connector Name | REAR WINDOW DEFOGGER |
| Connector Type | P01FE-A              |



|              |               |                             |
|--------------|---------------|-----------------------------|
| Terminal No. | Color of Wire | Signal Name [Specification] |
| 1            | W             | -                           |

|                |                      |
|----------------|----------------------|
| Connector No.  | B402                 |
| Connector Name | REAR WINDOW DEFOGGER |
| Connector Type | P01FE-A              |



|              |               |                             |
|--------------|---------------|-----------------------------|
| Terminal No. | Color of Wire | Signal Name [Specification] |
| 2            | -             | -                           |

|                |              |
|----------------|--------------|
| Connector No.  | D1           |
| Connector Name | WIRE TO WIRE |
| Connector Type | TH80FW-CS15  |

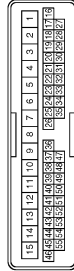

|              |               |                             |
|--------------|---------------|-----------------------------|
| Terminal No. | Color of Wire | Signal Name [Specification] |
| 1            | Y             | -                           |
| 2            | B             | -                           |
| 3            | SB            | -                           |
| 4            | V             | -                           |

|    |    |   |
|----|----|---|
| 8  | L  | - |
| 9  | P  | - |
| 10 | LG | - |
| 12 | GR | - |
| 13 | W  | - |
| 14 | G  | - |
| 15 | R  | - |
| 16 | GR | - |
| 17 | SB | - |
| 18 | BR | - |
| 19 | BG | - |
| 20 | P  | - |
| 21 | R  | - |
| 25 | V  | - |
| 26 | R  | - |
| 27 | BR | - |
| 28 | W  | - |
| 29 | Y  | - |
| 30 | G  | - |
| 31 | LG | - |
| 32 | GR | - |
| 33 | B  | - |
| 36 | W  | - |
| 37 | P  | - |
| 38 | V  | - |
| 39 | BR | - |
| 42 | G  | - |
| 43 | GR | - |
| 44 | BR | - |
| 44 | BG | - |
| 47 | L  | - |
| 48 | R  | - |
| 49 | SB | - |
| 50 | W  | - |
| 51 | P  | - |
| 52 | V  | - |

A  
B  
C  
D  
E  
F  
G  
H  
I  
J  
K  
DEF  
M  
N  
O  
P

# REAR WINDOW DEFOGGER SYSTEM

## < DTC/CIRCUIT DIAGNOSIS >

### DEFOGGER

|                |                           |
|----------------|---------------------------|
| Connector No.  | D33                       |
| Connector Name | DOOR MIRROR (DRIVER SIDE) |
| Connector Type | TH12MW-NH                 |



| Terminal No. | Color of Wire | Signal Name [Specification]            |
|--------------|---------------|--|
| 4            | L             | -                                      |
| 5            | BR            | - [With automatic drive positioner]    |
| 6            | EG            | - [Without automatic drive positioner] |
| 7            | GR            | -                                      |
| 8            | B             | -                                      |
| 9            | B             | -                                      |
| 10           | BR            | -                                      |
| 11           | W             | -                                      |
| 12           | V             | -                                      |

|                |              |
|----------------|--------------|
| Connector No.  | D31          |
| Connector Name | WIRE TO WIRE |
| Connector Type | TH40FW-CS15  |

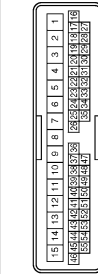

| Terminal No. | Color of Wire | Signal Name [Specification] |
|--------------|---------------|-----------------------------|
| 1            | W             | -                           |
| 2            | Y             | -                           |
| 3            | B             | -                           |
| 7            | LG            | -                           |
| 8            | P             | -                           |
| 10           | L             | -                           |
| 11           | W             | -                           |
| 12           | G             | -                           |
| 13           | R             | -                           |
| 36           | W             | -                           |
| 37           | P             | -                           |
| 38           | V             | -                           |

|    |    |   |
|----|----|---|
| 39 | BR | - |
| 42 | L  | - |
| 43 | GR | - |
| 44 | EG | - |
| 45 | G  | - |
| 47 | R  | - |
| 48 | SB | - |
| 49 | W  | - |
| 50 | P  | - |
| 51 | V  | - |
| 52 | GR | - |
| 53 | BG | - |
| 54 | G  | - |

|                |                              |
|----------------|------------------------------|
| Connector No.  | D33                          |
| Connector Name | DOOR MIRROR (PASSENGER SIDE) |
| Connector Type | TH12MW-NH                    |

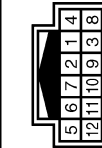

| Terminal No. | Color of Wire | Signal Name [Specification] |
|--------------|---------------|-----------------------------|
| 4            | L             | -                           |
| 5            | BG            | -                           |
| 6            | GR            | -                           |
| 7            | G             | -                           |
| 8            | B             | -                           |
| 9            | P             | -                           |
| 10           | BR            | -                           |
| 11           | W             | -                           |
| 12           | V             | -                           |

|                |  |
|----------------|--|
| Connector No.  | E6   |
| Connector Name | FRAME R INTELLIGENT POWER DISTRIBUTION MODULE (FRAME RIGI) |
| Connector Type | TH08FW-NH  |

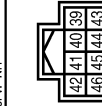

| Terminal No. | Color of Wire | Signal Name [Specification] |
|--------------|---------------|-----------------------------|
| 38           | P             | -                           |
| 40           | L             | -                           |
| 41           | B/W           | -                           |
| 42           | Y             | -                           |
| 43           | SB            | -                           |
| 44           | LG            | -                           |
| 45           | G             | -                           |
| 46           | W             | -                           |

|                |                 |
|----------------|-----------------|
| Connector No.  | E106            |
| Connector Name | WIRE TO WIRE    |
| Connector Type | TH08FW-CS16-TM4 |

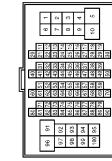

| Terminal No. | Color of Wire | Signal Name [Specification]       |
|--------------|---------------|-----------------------------------|
| 1            | GR            | -                                 |
| 3            | BG            | -                                 |
| 5            | G             | -                                 |
| 6            | BG            | -                                 |
| 7            | V             | - [With daytime running light]    |
| 9            | L             | - [Without daytime running light] |
| 10           | W             | - [With daytime running light]    |
| 11           | V             | - [Without daytime running light] |
| 12           | R             | -                                 |
| 13           | L             | -                                 |
| 14           | GR            | -                                 |
| 15           | P             | -                                 |
| 16           | W             | -                                 |
| 17           | V             | -                                 |
| 18           | BG            | -                                 |
| 19           | GR            | -                                 |
| 20           | LG            | -                                 |
| 30           | R             | -                                 |
| 31           | L             | -                                 |
| 32           | BG            | -                                 |
| 33           | P             | -                                 |
| 34           | V             | -                                 |
| 35           | BR            | -                                 |
| 36           | W             | -                                 |

|     |        |   |
|-----|--------|---|
| 37  | Y      | - |
| 38  | R      | - |
| 39  | B      | - |
| 40  | G      | - |
| 41  | W      | - |
| 42  | LG     | - |
| 43  | SB     | - |
| 44  | GR     | - |
| 45  | BG     | - |
| 46  | LG     | - |
| 47  | V      | - |
| 48  | P      | - |
| 49  | L      | - |
| 59  | B      | - |
| 66  | LG     | - |
| 67  | SB     | - |
| 68  | R      | - |
| 69  | W      | - |
| 70  | G      | - |
| 80  | W      | - |
| 81  | P      | - |
| 82  | G      | - |
| 83  | V      | - |
| 84  | L      | - |
| 85  | BG     | - |
| 86  | LG     | - |
| 87  | Y      | - |
| 88  | GR     | - |
| 89  | W      | - |
| 91  | G      | - |
| 93  | GR     | - |
| 95  | Y      | - |
| 96  | Y      | - |
| 97  | BR     | - |
| 98  | SHIELD | - |
| 99  | L      | - |
| 100 | P      | - |



# REAR WINDOW DEFOGGER SYSTEM

## < DTC/CIRCUIT DIAGNOSIS >

### DEFOGGER

|                |                  |
|----------------|------------------|
| Connector No.  | M1               |
| Connector Name | FUSE BLOCK (J/B) |
| Connector Type | NS38FW-M2        |



| Terminal No. | Color of Wire | Signal Name [Specification] |
|--------------|---------------|-----------------------------|
| 1A           | V             | -                           |
| 2A           | G             | -                           |
| 3A           | L             | -                           |
| 4A           | P             | -                           |
| 5A           | L             | -                           |
| 6A           | Y             | -                           |
| 7A           | R             | -                           |
| 8A           | L             | -                           |

|                |                  |
|----------------|------------------|
| Connector No.  | M2               |
| Connector Name | FUSE BLOCK (J/B) |
| Connector Type | NS10FW-CS        |



| Terminal No. | Color of Wire | Signal Name [Specification] |
|--------------|---------------|-----------------------------|
| 1B           | SB            | -                           |
| 2B           | P             | -                           |
| 3B           | G             | -                           |
| 4B           | P             | -                           |
| 5B           | BG            | -                           |
| 6B           | Y             | -                           |
| 7B           | P             | -                           |
| 8B           | R             | -                           |
| 9B           | SB            | -                           |

|                |                  |
|----------------|------------------|
| Connector No.  | M3               |
| Connector Name | FUSE BLOCK (J/B) |
| Connector Type | NS12FTV-CS       |

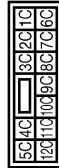

| Terminal No. | Color of Wire | Signal Name [Specification] |
|--------------|---------------|-----------------------------|
| 6C           | SB            | -                           |
| 7C           | B             | -                           |
| 8C           | W             | -                           |
| 9C           | BG            | -                           |
| 10C          | L             | -                           |
| 11C          | LG            | -                           |
| 12C          | G             | -                           |

|                |              |
|----------------|--------------|
| Connector No.  | M5           |
| Connector Name | WIRE TO WIRE |
| Connector Type | TH45MW-CS15  |

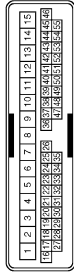

| Terminal No. | Color of Wire | Signal Name [Specification] |
|--------------|---------------|-----------------------------|
| 1            | Y             | -                           |
| 2            | B             | -                           |
| 3            | BG            | -                           |
| 4            | V             | -                           |
| 5            | SB            | -                           |
| 6            | G             | -                           |
| 7            | V             | -                           |
| 8            | L             | -                           |
| 9            | Y             | -                           |
| 10           | V             | -                           |
| 11           | L             | -                           |
| 12           | W             | -                           |
| 13           | W             | -                           |
| 14           | B             | -                           |
| 15           | W             | -                           |
| 16           | R             | -                           |
| 17           | BR            | -                           |
| 18           | V             | -                           |
| 19           | BG            | -                           |

|    |    |   |
|----|----|---|
| 20 | P  | - |
| 21 | W  | - |
| 22 | Y  | - |
| 23 | G  | - |
| 24 | L  | - |
| 25 | L  | - |
| 26 | Y  | - |
| 27 | G  | - |
| 28 | G  | - |
| 29 | SB | - |
| 30 | SB | - |
| 31 | LG | - |
| 32 | W  | - |
| 33 | B  | - |
| 34 | W  | - |
| 35 | BR | - |
| 36 | R  | - |
| 37 | GR | - |
| 38 | Y  | - |
| 39 | B  | - |
| 40 | Y  | - |
| 41 | G  | - |
| 42 | L  | - |
| 43 | L  | - |
| 44 | GR | - |
| 45 | SB | - |
| 46 | P  | - |
| 47 | LG | - |
| 48 | P  | - |
| 49 | L  | - |
| 50 | V  | - |

|                |                 |
|----------------|-----------------|
| Connector No.  | M6              |
| Connector Name | WIRE TO WIRE    |
| Connector Type | TH40MW-CS18-TM4 |



| Terminal No. | Color of Wire | Signal Name [Specification] |
|--------------|---------------|-----------------------------|
| 1            | BG            | -                           |
| 2            | R             | -                           |
| 3            | R             | -                           |
| 4            | G             | -                           |
| 5            | G             | -                           |
| 6            | LG            | -                           |
| 7            | W             | -                           |
| 8            | W             | -                           |
| 9            | W             | -                           |
| 10           | W             | -                           |
| 11           | V             | -                           |
| 12           | R             | -                           |
| 13           | L             | -                           |
| 14           | GR            | -                           |

|     |        |   |
|-----|--------|---|
| 15  | P      | - |
| 16  | W      | - |
| 17  | BR     | - |
| 18  | P      | - |
| 19  | L      | - |
| 20  | L      | - |
| 21  | L      | - |
| 22  | BR     | - |
| 23  | L      | - |
| 24  | L      | - |
| 25  | Y      | - |
| 26  | Y      | - |
| 27  | BG     | - |
| 28  | W      | - |
| 29  | BR     | - |
| 30  | R      | - |
| 31  | R      | - |
| 32  | Y      | - |
| 33  | BG     | - |
| 34  | W      | - |
| 35  | BR     | - |
| 36  | R      | - |
| 37  | Y      | - |
| 38  | R      | - |
| 39  | SB     | - |
| 40  | G      | - |
| 41  | V      | - |
| 42  | LG     | - |
| 43  | P      | - |
| 44  | B      | - |
| 45  | R      | - |
| 46  | BG     | - |
| 47  | L      | - |
| 48  | P      | - |
| 49  | L      | - |
| 50  | B      | - |
| 51  | G      | - |
| 52  | G      | - |
| 53  | W      | - |
| 54  | SB     | - |
| 55  | B      | - |
| 56  | V      | - |
| 57  | G      | - |
| 58  | R      | - |
| 59  | W      | - |
| 60  | W      | - |
| 61  | W      | - |
| 62  | W      | - |
| 63  | W      | - |
| 64  | W      | - |
| 65  | W      | - |
| 66  | W      | - |
| 67  | G      | - |
| 68  | R      | - |
| 69  | W      | - |
| 70  | G      | - |
| 71  | SB     | - |
| 72  | B      | - |
| 73  | V      | - |
| 74  | V      | - |
| 75  | W      | - |
| 76  | W      | - |
| 77  | W      | - |
| 78  | W      | - |
| 79  | W      | - |
| 80  | W      | - |
| 81  | W      | - |
| 82  | W      | - |
| 83  | W      | - |
| 84  | L      | - |
| 85  | GR     | - |
| 86  | G      | - |
| 87  | R      | - |
| 88  | B      | - |
| 89  | LG     | - |
| 90  | W      | - |
| 91  | W      | - |
| 92  | Y      | - |
| 93  | Y      | - |
| 94  | Y      | - |
| 95  | Y      | - |
| 96  | R      | - |
| 97  | GR     | - |
| 98  | SHIELD | - |
| 99  | V      | - |
| 100 | SB     | - |

A  
B  
C  
D  
E  
F  
G  
H  
I  
J  
K  
DEF  
M  
N  
O  
P

# REAR WINDOW DEFOGGER SYSTEM

## < DTC/CIRCUIT DIAGNOSIS >

### DEFOGGER

|                |                     |
|----------------|---------------------|
| Connector No.  | M24                 |
| Connector Name | DATA LINK CONNECTOR |
| Connector Type | BD16FV-P            |

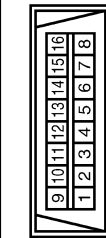

| Terminal No. | Color of Wire | Signal Name [Specification] |
|--------------|---------------|-----------------------------|
| 3            | LG            | -                           |
| 4            | B             | -                           |
| 5            | B             | -                           |
| 6            | L             | -                           |
| 7            | V             | -                           |
| 8            | G             | -                           |
| 11           | SB            | -                           |
| 14           | P             | -                           |
| 16           | R             | -                           |

|                |                      |
|----------------|----------------------|
| Connector No.  | M72                  |
| Connector Name | MULTIFUNCTION SWITCH |
| Connector Type | TH16FV-NH            |

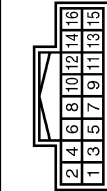

| Terminal No. | Color of Wire | Signal Name [Specification] |
|--------------|---------------|-----------------------------|
| 1            | B             | GND                         |
| 3            | P             | ACC                         |
| 4            | BG            | ILL                         |
| 5            | B             | ILL CONT                    |
| 6            | SB            | AV COMM (H)                 |
| 8            | LG            | AV COMM (L)                 |
| 9            | BR            | SW GND                      |
| 14           | V             | DISK EJECT SIGNAL           |
| 16           | G             | HAZARD ON                   |

|                |                 |
|----------------|-----------------|
| Connector No.  | M83             |
| Connector Name | AV CONTROL UNIT |
| Connector Type | TH24FV-NH       |

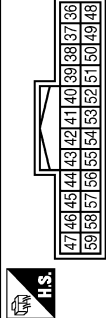

| Terminal No. | Color of Wire | Signal Name [Specification] |
|--------------|---------------|-----------------------------|
| 36           | BR            | COMPOSITE IMAGE SIGNAL      |
| 37           | Y             | COMPOSITE IMAGE GND         |
| 38           | P             | RGB (BLUE) SIGNAL           |
| 39           | L             | RGB (GREEN) SIGNAL          |
| 40           | G             | RGB (RED) SIGNAL            |
| 41           | W             | RGB SYNC                    |
| 42           | SHIELD        | SHIELD                      |
| 43           | B             | RGB AREA (V) SIGNAL         |
| 44           | L             | COMM (DISP->CONT)           |
| 45           | R             | HP                          |
| 46           | LG            | SIGNAL GND                  |
| 47           | BG            | SIGNAL VCC                  |
| 48           | BR            | COMP SYNC                   |
| 49           | Y             | SHIELD                      |
| 50           | SHIELD        | SHIELD                      |
| 55           | B             | SHIELD                      |
| 56           | LG            | COMM (CONT->DISP)           |
| 57           | G             | VP                          |
| 58           | BR            | INVERTER GND                |
| 59           | Y             | INVERTER VCC                |

|                |                 |
|----------------|-----------------|
| Connector No.  | M85             |
| Connector Name | AV CONTROL UNIT |
| Connector Type | TH24FV-NH       |

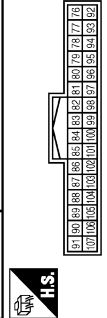

| Terminal No. | Color of Wire | Signal Name [Specification] |
|--------------|---------------|-----------------------------|
| 85           | B             | GND                         |
| 86           | L             | CAN-H                       |

|     |    |                         |
|-----|----|-------------------------|
| 87  | P  | CAN-L                   |
| 88  | SB | AV COMM (H)             |
| 89  | LG | AV COMM (L)             |
| 90  | SB | AV COMM (H)             |
| 91  | LG | AV COMM (L)             |
| 95  | R  | AUX SOUND SIGNAL RH (+) |
| 96  | W  | AUX SOUND SIGNAL LH (+) |
| 97  | B  | AUX SOUND SIGNAL GND    |
| 101 | BR | SW GND                  |
| 103 | V  | EJECT SIGNAL            |
| 104 | G  | IGNITION                |
| 105 | BG | REVERSE                 |
| 106 | SB | PARKING BRAKE           |
| 107 | R  | VEHICLE SPEED (8-PULSE) |

|                |                    |
|----------------|--------------------|
| Connector No.  | M117               |
| Connector Name | WIRE TO WIRE       |
| Connector Type | THE20W-C31 (8-TM4) |



| Terminal No. | Color of Wire | Signal Name [Specification] |
|--------------|---------------|-----------------------------|
| 1            | LG            | -                           |
| 5            | P             | -                           |
| 6            | G             | -                           |
| 7            | SB            | -                           |
| 9            | LG            | -                           |
| 10           | L             | -                           |
| 30           | B             | -                           |
| 31           | SB            | -                           |
| 32           | LG            | -                           |
| 33           | SB            | -                           |
| 34           | LG            | -                           |
| 40           | Y             | -                           |
| 41           | G             | -                           |
| 42           | LG            | -                           |
| 43           | R             | -                           |
| 45           | G             | -                           |
| 46           | SHIELD        | -                           |
| 47           | P             | -                           |
| 48           | L             | -                           |
| 49           | SHIELD        | -                           |
| 50           | V             | -                           |
| 59           | R             | -                           |

|    |        |   |
|----|--------|---|
| 71 | R      | - |
| 72 | L      | - |
| 80 | W      | - |
| 81 | SHIELD | - |
| 82 | P      | - |
| 83 | L      | - |
| 84 | G      | - |
| 85 | SHIELD | - |
| 86 | W      | - |
| 87 | B      | - |
| 88 | R      | - |
| 89 | G      | - |
| 90 | Y      | - |
| 91 | V      | - |
| 94 | Y      | - |
| 95 | G      | - |
| 97 | R      | - |

|                |                           |
|----------------|---------------------------|
| Connector No.  | M118                      |
| Connector Name | BCM (BODY CONTROL MODULE) |
| Connector Type | IM03FB-LC                 |



| Terminal No. | Color of Wire | Signal Name [Specification]     |
|--------------|---------------|---------------------------------|
| 1            | W             | BAT (F/L)                       |
| 2            | Y             | POWER WINDOW POWER SUPPLY (BAT) |
| 3            | BG            | POWER WINDOW POWER SUPPLY (R4P) |

# REAR WINDOW DEFOGGER SYSTEM

## < DTC/CIRCUIT DIAGNOSIS >

### DEFOGGER

|                |                           |
|----------------|---------------------------|
| Connector No.  | M119                      |
| Connector Name | BCM (BODY CONTROL MODULE) |
| Connector Type | MS16FW-CS                 |



|    |    |    |    |    |    |    |    |    |
|----|----|----|----|----|----|----|----|----|
| 4  | 5  | 6  | 7  | 8  | 9  | 10 |    |    |
| 11 | 12 | 13 | 14 | 15 | 16 | 17 | 18 | 19 |

| Terminal No. | Color of Wire | Signal Name [Specification]        |
|--------------|---------------|------------------------------------|
| 4            | LG            | INTERIOR ROOM LAMP POWER SUPPLY    |
| 5            | P             | PASSENGER DOOR UNLOCK OUTPUT       |
| 7            | SB            | STEP LAMP OUTPUT                   |
| 8            | V             | ALL DOOR FUEL LID LOCK OUTPUT      |
| 9            | G             | DRIVER DOOR FUEL LID UNLOCK OUTPUT |
| 11           | R             | BAT.(FUSE)                         |
| 13           | B             | GND                                |
| 14           | W             | PUSH-BUTTON IGNITION SW ILL GND    |
| 15           | EG            | ACC IND                            |
| 17           | W             | TURN SIGNAL RH (FRONT)             |
| 18           | EG            | TURN SIGNAL LH (FRONT)             |
| 19           | V             | INT ROOM LAMP CONT                 |

|                |                           |
|----------------|---------------------------|
| Connector No.  | M122                      |
| Connector Name | BCM (BODY CONTROL MODULE) |
| Connector Type | TH40FB-NH                 |



|    |    |    |    |    |    |    |    |    |    |
|----|----|----|----|----|----|----|----|----|----|
| 51 | 52 | 53 | 54 | 55 | 56 | 57 | 58 | 59 | 60 |
| 61 | 62 | 63 | 64 | 65 | 66 | 67 | 68 | 69 | 70 |
| 71 | 72 | 73 | 74 | 75 | 76 | 77 | 78 | 79 | 80 |
| 81 | 82 | 83 | 84 | 85 | 86 | 87 | 88 | 89 | 90 |

| Terminal No. | Color of Wire | Signal Name [Specification] |
|--------------|---------------|-----------------------------|
| 72           | R             | ROOM ANT 2-                 |
| 73           | G             | ROOM ANT 2+                 |
| 74           | SB            | PASSENGER DOOR ANT-         |
| 75           | BR            | PASSENGER DOOR ANT+         |
| 76           | V             | DRIVER DOOR ANT-            |
| 77           | LG            | DRIVER DOOR ANT+            |
| 78           | Y             | ROOM ANT 1-                 |
| 79           | BR            | ROOM ANT 1+                 |
| 80           | GR            | MATS ANT AMP                |
| 81           | W             | MATS ANT AMP                |

|     |    |                                     |
|-----|----|-------------------------------------|
| 82  | SB | IGN RELAY (F/B) CONT                |
| 83  | Y  | KEYLESS ENTRY RECEIVER COMM         |
| 87  | Y  | COMBI SW INPUT 5                    |
| 88  | EG | COMBI SW INPUT 3                    |
| 89  | BR | PUSH SW                             |
| 90  | P  | CAN-L                               |
| 91  | L  | CAN-H                               |
| 92  | LG | KEY SLOT ILL                        |
| 93  | GR | ON IND                              |
| 95  | EG | ACC RELAY CONT                      |
| 96  | GR | A/T SHIFT SELECTOR POWER SUPPLY     |
| 97  | L  | S/L CONDITION 1                     |
| 98  | P  | S/L CONDITION 2                     |
| 99  | R  | SHIFT P [With A/T]                  |
| 99  | BR | ASGD CLUTCH SW (With M/T)           |
| 100 | Y  | PASSENGER DOOR REQUEST SW           |
| 101 | P  | DRIVER DOOR REQUEST SW              |
| 102 | EG | BLOWER FAN MOTOR RELAY CONT         |
| 103 | P  | KEYLESS ENTRY RECEIVER POWER SUPPLY |
| 106 | SB | S/L UNIT POWER SUPPLY               |
| 107 | LG | COMBI SW INPUT 1                    |
| 108 | R  | COMBI SW INPUT 4                    |
| 109 | W  | COMBI SW INPUT 2                    |
| 110 | G  | HAZARD SW                           |
| 111 | Y  | S/L UNIT COMM                       |

|                |                           |
|----------------|---------------------------|
| Connector No.  | M123                      |
| Connector Name | BCM (BODY CONTROL MODULE) |
| Connector Type | TH40FG-NH                 |



|    |    |    |    |    |    |    |    |    |    |
|----|----|----|----|----|----|----|----|----|----|
| 10 | 11 | 12 | 13 | 14 | 15 | 16 | 17 | 18 | 19 |
| 20 | 21 | 22 | 23 | 24 | 25 | 26 | 27 | 28 | 29 |
| 30 | 31 | 32 | 33 | 34 | 35 | 36 | 37 | 38 | 39 |
| 40 | 41 | 42 | 43 | 44 | 45 | 46 | 47 | 48 | 49 |

| Terminal No. | Color of Wire | Signal Name [Specification] |
|--------------|---------------|-----------------------------|
| 112          | R             | RAIN SENSOR SERIAL LINK     |
| 113          | EG            | OPTICAL SENSOR              |
| 114          | R             | CLUTCH INTERLOCK SW         |
| 116          | SB            | STOP LAMP SW 1              |
| 118          | BR            | STOP LAMP SW 2              |
| 119          | SB            | DR DOOR UNLOCK SENSOR       |
| 121          | SB            | KEY SWITCH                  |
| 123          | V             | IGN F/B                     |
| 124          | R             | PASSENGER DOOR SW           |
| 129          | EG            | TRUNK CANCEL SW             |
| 132          | V             | POWER WINDOW SW COMM        |

|     |    |                                   |
|-----|----|-----------------------------------|
| 133 | L  | PUSH-BUTTON IGNITION SW ILL POWER |
| 134 | LG | LOCK IND                          |
| 137 | EG | RECEIVER SENSOR CMD               |
| 138 | V  | RECEIVER SENSOR POWER SUPPLY      |
| 139 | L  | TIRE PRESSURE RECEIVER COMM       |
| 140 | B  | SHIFT IN/P                        |
| 141 | W  | SECURITY INDICATOR LAMP           |
| 142 | BR | COMBI SW OUTPUT 5                 |
| 143 | P  | COMBI SW OUTPUT 1                 |
| 144 | G  | COMBI SW OUTPUT 2                 |
| 145 | L  | COMBI SW OUTPUT 3                 |
| 146 | SB | COMBI SW OUTPUT 4                 |
| 150 | GR | DRIVER DOOR SW                    |
| 151 | G  | REAR WINDOW DEFOGGER RELAY CONT   |

|                |              |
|----------------|--------------|
| Connector No.  | M124         |
| Connector Name | WIRE TO WIRE |
| Connector Type | TH40MW-CS15  |



|    |    |    |    |    |    |    |    |    |    |    |    |    |    |    |
|----|----|----|----|----|----|----|----|----|----|----|----|----|----|----|
| 1  | 2  | 3  | 4  | 5  | 6  | 7  | 8  | 9  | 10 | 11 | 12 | 13 | 14 | 15 |
| 16 | 17 | 18 | 19 | 20 | 21 | 22 | 23 | 24 | 25 | 26 | 27 | 28 | 29 | 30 |
| 31 | 32 | 33 | 34 | 35 | 36 | 37 | 38 | 39 | 40 | 41 | 42 | 43 | 44 | 45 |
| 46 | 47 | 48 | 49 | 50 | 51 | 52 | 53 | 54 | 55 | 56 | 57 | 58 | 59 | 60 |

| Terminal No. | Color of Wire | Signal Name [Specification] |
|--------------|---------------|-----------------------------|
| 1            | W             | -                           |
| 2            | GR            | -                           |
| 3            | B             | -                           |
| 7            | V             | -                           |
| 8            | P             | -                           |
| 10           | BR            | -                           |
| 11           | R             | -                           |
| 12           | G             | -                           |
| 13           | R             | -                           |
| 36           | G             | -                           |
| 37           | R             | -                           |
| 38           | GR            | -                           |
| 39           | L             | -                           |
| 42           | BG            | -                           |
| 43           | BG            | -                           |
| 44           | W             | -                           |
| 45           | SB            | -                           |
| 47           | LG            | -                           |
| 48           | P             | -                           |
| 49           | Y             | -                           |
| 50           | G             | -                           |
| 51           | P             | -                           |
| 52           | SHIELD        | COMM (CONT)-DISP            |
| 57           | SHIELD        | SHIELD                      |
| 58           | SHIELD        | SHIELD                      |

|    |   |   |
|----|---|---|
| 52 | L | - |
| 53 | L | - |
| 54 | Y | - |

|                |                 |
|----------------|-----------------|
| Connector No.  | M202            |
| Connector Name | AV CONTROL UNIT |
| Connector Type | TH24FW-NH       |



|    |    |    |    |    |    |    |    |    |    |    |    |
|----|----|----|----|----|----|----|----|----|----|----|----|
| 36 | 37 | 38 | 39 | 40 | 41 | 42 | 43 | 44 | 45 | 46 | 47 |
| 48 | 49 | 50 | 51 | 52 | 53 | 54 | 55 | 56 | 57 | 58 | 59 |

| Terminal No. | Color of Wire | Signal Name [Specification] |
|--------------|---------------|-----------------------------|
| 36           | EG            | SIGNAL VCC                  |
| 37           | LG            | SIGNAL GND                  |
| 38           | R             | HP                          |
| 39           | L             | COMM (DISP->CONT)           |
| 40           | B             | RGB AREA Y/SIGNAL           |
| 41           | SHIELD        | SHIELD                      |
| 42           | W             | RGB SYNC                    |
| 43           | G             | RGB (RRED) SIGNAL           |
| 44           | L             | RGB (GREEN) SIGNAL          |
| 45           | P             | RGB (BLUE) SIGNAL           |
| 46           | Y             | COMPOSITE IMAGE GND         |
| 47           | BR            | COMPOSITE IMAGE SIGNAL      |
| 48           | Y             | INVERTER VCC                |
| 49           | BR            | INVERTER GND                |
| 50           | G             | VP                          |
| 51           | P             | COMM (CONT)-DISP            |
| 52           | SHIELD        | SHIELD                      |
| 57           | SHIELD        | SHIELD                      |
| 58           | SHIELD        | SHIELD                      |

A B C D E F G H I J K DEF M N O P

# REAR WINDOW DEFOGGER SYSTEM

< DTC/CIRCUIT DIAGNOSIS >

## DEFOGGER

|                |                 |
|----------------|-----------------|
| Connector No.  | M204            |
| Connector Name | AV CONTROL UNIT |
| Connector Type | TH22FV-NH       |



|    |    |    |    |    |    |    |    |    |    |    |    |    |    |    |    |    |
|----|----|----|----|----|----|----|----|----|----|----|----|----|----|----|----|----|
| 76 | 77 | 78 | 79 | 80 | 81 | 82 | 83 | 84 | 85 | 86 | 87 | 88 | 89 | 90 | 91 | 92 |
|----|----|----|----|----|----|----|----|----|----|----|----|----|----|----|----|----|

| Terminal No. | Color of Wire | Signal Name [Specification] |
|--------------|---------------|-----------------------------|
| 76           | LG            | AV COMM (L)                 |
| 77           | SB            | AV COMM (H)                 |
| 78           | LG            | AV COMM (L)                 |
| 79           | SB            | AV COMM (H)                 |
| 80           | P             | CAN-L                       |
| 81           | L             | CAN-H                       |
| 82           | BR            | SW GND                      |
| 86           | SHIELD        | SHIELD                      |
| 87           | L             | TEL VOICE SIGNAL (+)        |
| 88           | P             | TEL VOICE SIGNAL (-)        |
| 92           | R             | VEHICLE SPEED (8-PULSE)     |
| 93           | SB            | PARKING BRAKE               |
| 94           | EG            | REVERSE                     |
| 95           | G             | IGNITION                    |
| 96           | V             | DISK EJECT SIGNAL           |

|                |                 |
|----------------|-----------------|
| Connector No.  | M210            |
| Connector Name | AV CONTROL UNIT |
| Connector Type | TH22FV-NH       |



|    |    |    |    |    |    |    |    |    |    |    |    |    |    |    |    |
|----|----|----|----|----|----|----|----|----|----|----|----|----|----|----|----|
| 61 | 62 | 63 | 64 | 65 | 66 | 67 | 68 | 69 | 70 | 71 | 72 | 73 | 74 | 75 | 76 |
|----|----|----|----|----|----|----|----|----|----|----|----|----|----|----|----|

| Terminal No. | Color of Wire | Signal Name [Specification] |
|--------------|---------------|-----------------------------|
| 65           | SB            | PARKING BRAKE               |
| 67           | P             | COMPOSITE IMAGE GND         |
| 68           | L             | COMPOSITE IMAGE SIGNAL      |
| 71           | SHIELD        | MICROPHONE GND              |
| 72           | G             | MICROPHONE VCC              |
| 73           | P             | COMM (CONT->DISP)           |
| 74           | P             | CAN-L                       |

|    |        |                         |
|----|--------|-------------------------|
| 75 | LG     | AV COMM (L)             |
| 76 | LG     | AV COMM (L)             |
| 79 | L      | ILLUMINATION            |
| 80 | G      | IGNITION                |
| 81 | EG     | REVERSE                 |
| 82 | R      | VEHICLE SPEED (8-PULSE) |
| 83 | SHIELD | SHIELD                  |
| 87 | R      | MICROPHONE SIGNAL       |
| 88 | SHIELD | SHIELD                  |
| 89 | L      | COMM (DISP->CONT)       |
| 90 | L      | CAN-H                   |
| 91 | SB     | AV COMM (H)             |
| 92 | SB     | AV COMM (H)             |

JCLWM6279GB

## BCM (BODY CONTROL MODULE)

< ECU DIAGNOSIS INFORMATION >

# ECU DIAGNOSIS INFORMATION

## BCM (BODY CONTROL MODULE)

Reference Value

INFOID:000000006933314

### VALUES ON THE DIAGNOSIS TOOL

CONSULT-III MONITOR ITEM

| Monitor Item   | Condition   | Value/Status               |
|----------------|---|----------------------------|
| FR WIPER HI    | Other than front wiper switch HI                          | Off                        |
|                | Front wiper switch HI                                     | On                         |
| FR WIPER LOW   | Other than front wiper switch LO                          | Off                        |
|                | Front wiper switch LO                                     | On                         |
| FR WASHER SW   | Front washer switch OFF                                   | Off                        |
|                | Front washer switch ON                                    | On                         |
| FR WIPER INT   | Other than front wiper switch INT/AUTO                    | Off                        |
|                | Front wiper switch INT/AUTO                               | On                         |
| FR WIPER STOP  | Front wiper is not in STOP position                       | Off                        |
|                | Front wiper is in STOP position                           | On                         |
| INT VOLUME     | Wiper volume dial is in a dial position 1 - 7             | Wiper volume dial position |
| TURN SIGNAL R  | Other than turn signal switch RH                          | Off                        |
|                | Turn signal switch RH                                     | On                         |
| TURN SIGNAL L  | Other than turn signal switch LH                          | Off                        |
|                | Turn signal switch LH                                     | On                         |
| TAIL LAMP SW   | Other than lighting switch 1ST and 2ND                    | Off                        |
|                | Lighting switch 1ST or 2ND                                | On                         |
| HI BEAM SW     | Other than lighting switch HI                             | Off                        |
|                | Lighting switch HI  | On                         |
| HEAD LAMP SW 1 | Other than lighting switch 2ND                            | Off                        |
|                | Lighting switch 2ND                                       | On                         |
| HEAD LAMP SW 2 | Other than lighting switch 2ND                            | Off                        |
|                | Lighting switch 2ND                                       | On                         |
| PASSING SW     | Other than lighting switch PASS                           | Off                        |
|                | Lighting switch PASS                                      | On                         |
| AUTO LIGHT SW  | Other than lighting switch AUTO                           | Off                        |
|                | Lighting switch AUTO                                      | On                         |
| FR FOG SW      | Front fog lamp switch OFF                                 | Off                        |
|                | Front fog lamp switch ON                                  | On                         |
| RR FOG SW      | <b>NOTE:</b><br>The item is indicated, but not monitored. | Off                        |
| DOOR SW-DR     | Driver door closed  | Off                        |
|                | Driver door opened  | On                         |
| DOOR SW-AS     | Passenger door closed                                     | Off                        |
|                | Passenger door opened                                     | On                         |
| DOOR SW-RR     | <b>NOTE:</b><br>The item is indicated, but not monitored. | Off                        |

## BCM (BODY CONTROL MODULE)

### < ECU DIAGNOSIS INFORMATION >

| Monitor Item   | Condition  | Value/Status |
|----------------|--|--------------|
| DOOR SW-RL     | <b>NOTE:</b><br>The item is indicated, but not monitored.                        | Off          |
| DOOR SW-BK     | <b>NOTE:</b><br>The item is indicated, but not monitored.                        | Off          |
| CDL LOCK SW    | Other than power door lock switch LOCK   | Off          |
|                | Power door lock switch LOCK  | On           |
| CDL UNLOCK SW  | Other than power door lock switch UNLOCK   | Off          |
|                | Power door lock switch UNLOCK  | On           |
| KEY CYL LK-SW  | Other than driver door key cylinder LOCK position                                | Off          |
|                | Driver door key cylinder LOCK position   | On           |
| KEY CYL UN-SW  | Other than driver door key cylinder UNLOCK position                              | Off          |
|                | Driver door key cylinder UNLOCK position   | On           |
| KEY CYL SW-TR  | <b>NOTE:</b><br>The item is indicated, but not monitored.                        | Off          |
| HAZARD SW      | Hazard switch is OFF   | Off          |
|                | Hazard switch is ON  | On           |
| REAR DEF SW    | <b>NOTE:</b><br>The item is indicated, but not monitored.                        | Off          |
| H/L WASH SW    | <b>NOTE:</b><br>The item is indicated, but not monitored.                        | Off          |
| TR CANCEL SW   | Trunk lid opener cancel switch OFF   | Off          |
|                | Trunk lid opener cancel switch ON  | On           |
| TR/BD OPEN SW  | Trunk lid opener switch OFF  | Off          |
|                | While the trunk lid opener switch is turned ON                                   | On           |
| TRNK/HAT MNTR  | Trunk lid closed   | Off          |
|                | Trunk lid opened   | On           |
| RKE-LOCK       | LOCK button of the Intelligent Key is not pressed                                | Off          |
|                | LOCK button of the Intelligent Key is pressed                                    | On           |
| RKE-UNLOCK     | UNLOCK button of the Intelligent Key is not pressed                              | Off          |
|                | UNLOCK button of the Intelligent Key is pressed                                  | On           |
| RKE-TR/BD      | TRUNK OPEN button of the Intelligent Key is not pressed                          | Off          |
|                | TRUNK OPEN button of the Intelligent Key is pressed                              | On           |
| RKE-PANIC      | PANIC button of the Intelligent Key is not pressed                               | Off          |
|                | PANIC button of the Intelligent Key is pressed                                   | On           |
| RKE-P/W OPEN   | UNLOCK button of the Intelligent Key is not pressed                              | Off          |
|                | UNLOCK button of the Intelligent Key is pressed and held                         | On           |
| RKE-MODE CHG   | LOCK/UNLOCK button of the Intelligent Key is not pressed and held simultaneously | Off          |
|                | LOCK/UNLOCK button of the Intelligent Key is pressed and held simultaneously     | On           |
| OPTICAL SENSOR | Bright outside of the vehicle  | Close to 5 V |
|                | Dark outside of the vehicle  | Close to 0 V |
| REQ SW -DR     | Driver door request switch is not pressed  | Off          |
|                | Driver door request switch is pressed  | On           |
| REQ SW -AS     | Passenger door request switch is not pressed                                     | Off          |
|                | Passenger door request switch is pressed   | On           |
| REQ SW -RR     | <b>NOTE:</b><br>The item is indicated, but not monitored.                        | Off          |

## BCM (BODY CONTROL MODULE)

### < ECU DIAGNOSIS INFORMATION >

| Monitor Item  | Condition   | Value/Status |   |
|---|---|--------------|---|
| REQ SW -RL  | <b>NOTE:</b><br>The item is indicated, but not monitored.   | Off          | A |
| REQ SW -BD/TR   | Trunk lid opener request switch is not pressed  | Off          | B |
|   | Trunk lid opener request switch is pressed  | On           |   |
| PUSH SW   | Push-button ignition switch (push switch) is not pressed  | Off          | C |
|   | Push-button ignition switch (push switch) is pressed  | On           |   |
| IGN RLY2 -F/B   | Ignition switch in OFF or ACC position  | Off          | D |
|   | Ignition switch in ON position  | On           |   |
| ACC RLY -F/B  | <b>NOTE:</b><br>The item is indicated, but not monitored.   | Off          | E |
| CLUCH SW  | The clutch pedal is not depressed   | Off          | E |
|   | The clutch pedal is depressed   | On           |   |
| BRAKE SW 1  | The brake pedal is depressed when No. 7 fuse is blown   | Off          | F |
|   | The brake pedal is not depressed when No. 7 fuse is blown, or No. 7 fuse is normal  | On           |   |
| BRAKE SW 2  | The brake pedal is not depressed  | Off          | G |
|   | The brake pedal is depressed  | On           |   |
| DETE/CANCL SW   | <ul style="list-style-type: none"> <li>• Selector lever in P position (Except M/T models)</li> <li>• The clutch pedal is depressed (M/T models)</li> </ul>                          | Off          | H |
|   | <ul style="list-style-type: none"> <li>• Selector lever in any position other than P (Except M/T models)</li> <li>• The clutch pedal is not depressed (M/T models)</li> </ul>       | On           |   |
| SFT PN/N SW   | Selector lever in any position other than P and N   | Off          | I |
|   | Selector lever in P or N position   | On           |   |
| S/L -LOCK<br><b>NOTE:</b><br>For models without steering lock unit, this item is not monitored.     | Steering is unlocked  | Off          | J |
|   | Steering is locked  | On           |   |
| S/L -UNLOCK<br><b>NOTE:</b><br>For models without steering lock unit, this item is not monitored.   | Steering is locked  | Off          | K |
|   | Steering is unlocked  | On           |   |
| S/L RELAY-F/B<br><b>NOTE:</b><br>For models without steering lock unit, this item is not monitored. | Ignition switch in OFF or ACC position  | Off          | M |
|   | Ignition switch in ON position  | On           |   |
| UNLK SEN -DR  | Driver door is unlocked   | Off          | N |
|   | Driver door is locked   | On           |   |
| PUSH SW -IPDM   | Push-button ignition switch (push-switch) is not pressed  | Off          | O |
|   | Push-button ignition switch (push-switch) is pressed  | On           |   |
| IGN RLY1 -F/B   | Ignition switch in OFF or ACC position  | Off          | P |
|   | Ignition switch in ON position  | On           |   |
| DETE SW -IPDM   | Selector lever in any position other than P   | Off          | P |
|   | Selector lever in P position  | On           |   |
| SFT PN -IPDM  | <ul style="list-style-type: none"> <li>• Selector lever in any position other than P and N (Except M/T models)</li> <li>• The clutch pedal is not depressed (M/T models)</li> </ul> | Off          | P |
|   | <ul style="list-style-type: none"> <li>• Selector lever in P or N position</li> <li>• The clutch pedal is depressed</li> </ul>  | On           |   |

DEF

## BCM (BODY CONTROL MODULE)

### < ECU DIAGNOSIS INFORMATION >

| Monitor Item  | Condition  | Value/Status                               |
|---|--|--|
| SFT P -MET  | Selector lever in any position other than P  | Off  |
|   | Selector lever in P position   | On   |
| SFT N -MET  | Selector lever in any position other than N  | Off  |
|   | Selector lever in N position   | On   |
| ENGINE STATE  | Engine stopped   | Stop                                       |
|   | While the engine stalls  | Stall                                      |
|   | At engine cranking   | Crank                                      |
|   | Engine running   | Run  |
| S/L LOCK-IPDM<br><b>NOTE:</b><br>For models without steering lock unit, this item is not monitored. | Steering is unlocked   | Off  |
|   | Steering is locked   | On   |
| S/L UNLK-IPDM<br><b>NOTE:</b><br>For models without steering lock unit, this item is not monitored. | Steering is locked   | Off  |
|   | Steering is unlocked   | On   |
| S/L RELAY-REQ<br><b>NOTE:</b><br>For models without steering lock unit, this item is not monitored. | Steering lock system is not the LOCK condition and the changing condition from LOCK to UNLOCK                            | Off  |
|   | Steering lock system are not the LOCK condition or the changing condition from LOCK to UNLOCK                            | On   |
| VEH SPEED 1   | While driving  | Equivalent to speedometer reading          |
| VEH SPEED 2   | While driving  | Equivalent to speedometer reading          |
| DOOR STAT-DR  | Driver door is locked  | LOCK                                       |
|   | Wait with selective UNLOCK operation (60 seconds)  | READY                                      |
|   | Driver door is unlocked  | UNLOCK                                     |
| DOOR STAT-AS  | Passenger door is locked   | LOCK                                       |
|   | Wait with selective UNLOCK operation (60 seconds)  | READY                                      |
|   | Passenger door is unlocked   | UNLOCK                                     |
| ID OK FLAG  | Driver side door is open after ignition switch is turned OFF (Selector lever is in the P position except for M/T models) | Reset                                      |
|   | Ignition switch is ON  | Set  |
| PRMT ENG STRT   | The engine start is prohibited   | Reset                                      |
|   | The engine start is permitted  | Set  |
| PRMT RKE STRT   | <b>NOTE:</b><br>The item is indicated, but not monitored.  | Reset                                      |
| KEY SW -SLOT  | The Intelligent Key is not inserted into key slot  | Off  |
|   | The Intelligent Key is inserted into key slot  | On   |
| RKE OPE COUN1   | During the operation of the Intelligent Key  | Operation frequency of the Intelligent Key |
| RKE OPE COUN2   | <b>NOTE:</b><br>The item is indicated, but not monitored.  | —  |
| CONFRM ID ALL   | The key ID that the key slot receives is not recognized by any key ID registered to BCM.                                 | Yet  |
|   | The key ID that the key slot receives is recognized by any key ID registered to BCM.                                     | Done                                       |



## BCM (BODY CONTROL MODULE)

### < ECU DIAGNOSIS INFORMATION >

| Monitor Item | Condition   | Value/Status                  |     |
|--------------|---|-------------------------------|-----|
| CONFIRM ID4  | The key ID that the key slot receives is not recognized by the fourth key ID registered to BCM. | Yet                           | A   |
|              | The key ID that the key slot receives is recognized by the fourth key ID registered to BCM.     | Done                          | B   |
| CONFIRM ID3  | The key ID that the key slot receives is not recognized by the third key ID registered to BCM.  | Yet                           | C   |
|              | The key ID that the key slot receives is recognized by the third key ID registered to BCM.      | Done                          |     |
| CONFIRM ID2  | The key ID that the key slot receives is not recognized by the second key ID registered to BCM. | Yet                           | D   |
|              | The key ID that the key slot receives is recognized by the second key ID registered to BCM.     | Done                          |     |
| CONFIRM ID1  | The key ID that the key slot receives is not recognized by the first key ID registered to BCM.  | Yet                           | E   |
|              | The key ID that the key slot receives is recognized by the first key ID registered to BCM.      | Done                          | F   |
| TP 4         | The ID of fourth Intelligent Key is not registered to BCM                                       | Yet                           |     |
|              | The ID of fourth Intelligent Key is registered to BCM   | Done                          | G   |
| TP 3         | The ID of third Intelligent Key is not registered to BCM  | Yet                           |     |
|              | The ID of third Intelligent Key is registered to BCM  | Done                          |     |
| TP 2         | The ID of second Intelligent Key is not registered to BCM                                       | Yet                           | H   |
|              | The ID of second Intelligent Key is registered to BCM   | Done                          |     |
| TP 1         | The ID of first Intelligent Key is not registered to BCM  | Yet                           | I   |
|              | The ID of first Intelligent Key is registered to BCM  | Done                          |     |
| AIR PRESS FL | Ignition switch ON (Only when the signal from the transmitter is received)                      | Air pressure of front LH tire |     |
| AIR PRESS FR | Ignition switch ON (Only when the signal from the transmitter is received)                      | Air pressure of front RH tire | J   |
| AIR PRESS RR | Ignition switch ON (Only when the signal from the transmitter is received)                      | Air pressure of rear RH tire  | K   |
| AIR PRESS RL | Ignition switch ON (Only when the signal from the transmitter is received)                      | Air pressure of rear LH tire  |     |
| ID REGST FL1 | ID of front LH tire transmitter is registered   | Done                          | DEF |
|              | ID of front LH tire transmitter is not registered   | Yet                           |     |
| ID REGST FR1 | ID of front RH tire transmitter is registered   | Done                          | M   |
|              | ID of front RH tire transmitter is not registered   | Yet                           |     |
| ID REGST RR1 | ID of rear RH tire transmitter is registered  | Done                          |     |
|              | ID of rear RH tire transmitter is not registered  | Yet                           | N   |
| ID REGST RL1 | ID of rear LH tire transmitter is registered  | Done                          |     |
|              | ID of rear LH tire transmitter is not registered  | Yet                           | O   |
| WARNING LAMP | Tire pressure indicator OFF   | Off                           |     |
|              | Tire pressure indicator ON  | On                            |     |
| BUZZER       | Tire pressure warning alarm is not sounding   | Off                           | P   |
|              | Tire pressure warning alarm is sounding   | On                            |     |

# BCM (BODY CONTROL MODULE)

< ECU DIAGNOSIS INFORMATION >

## TERMINAL LAYOUT

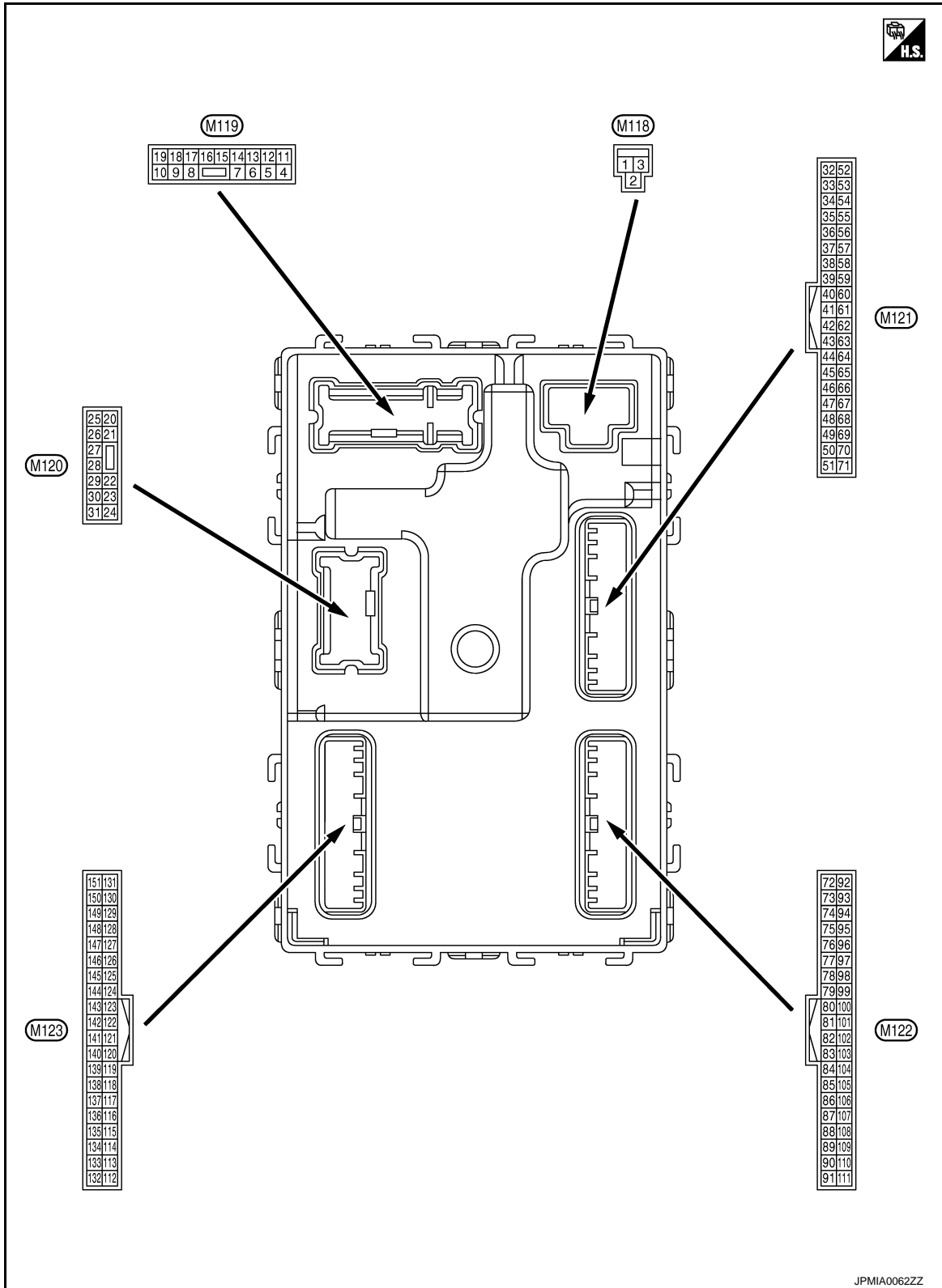

## PHYSICAL VALUES

# BCM (BODY CONTROL MODULE)

## < ECU DIAGNOSIS INFORMATION >

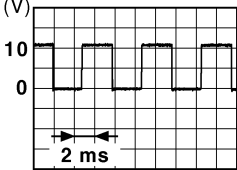
| Terminal No.<br>(Wire color) |        | Description   |                  | Condition   |  | Value<br>(Approx.)  |
|------------------------------|--------|---|------------------|---|--|---|
|                              |        | Signal name   | Input/<br>Output |   |  |   |
| +                            | -      |   |                  |   |  |   |
| 1<br>(W)                     | Ground | Battery power supply                                  | Input            | Ignition switch OFF   |  | Battery voltage   |
| 2<br>(Y)                     | Ground | P/W power supply<br>(BAT)                             | Output           | Ignition switch OFF   |  | 12 V  |
| 3<br>(BG)                    | Ground | P/W power supply<br>(RAP)                             | Output           | Ignition switch ON  |  | 12 V  |
| 4<br>(LG)                    | Ground | Interior room lamp<br>power supply                    | Output           | Interior room lamp battery saver is activated.<br>(Cuts the interior room lamp power supply)        |  | 0 V   |
|                              |        |   |                  | Interior room lamp battery saver is not activated.<br>(Outputs the interior room lamp power supply) |  | 12 V  |
| 5<br>(P)                     | Ground | Passenger door UN-<br>LOCK                            | Output           | Passenger<br>door   | UNLOCK (Actuator is activated)                     | 12 V  |
|                              |        |   |                  |   | Other than UNLOCK (Ac-<br>tuator is not activated) | 0 V   |
| 7<br>(SB)                    | Ground | Step lamp   | Output           | Step lamp   | ON   | 0 V   |
|                              |        |   |                  |   | OFF  | 12 V  |
| 8<br>(V)                     | Ground | All doors, fuel lid<br>LOCK                           | Output           | All doors, fuel<br>lid  | LOCK (Actuator is activated)                       | 12 V  |
|                              |        |   |                  |   | Other than LOCK<br>(Actuator is not activated)     | 0 V   |
| 9<br>(G)                     | Ground | Driver door, fuel lid<br>UNLOCK                       | Output           | Driver door,<br>fuel lid  | UNLOCK (Actuator is activated)                     | 12 V  |
|                              |        |   |                  |   | Other than UNLOCK<br>(Actuator is not activated)   | 0 V   |
| 11<br>(R)                    | Ground | Battery power supply                                  | Input            | Ignition switch OFF   |  | Battery voltage   |
| 13<br>(B)                    | Ground | Ground  | —                | Ignition switch ON  |  | 0 V   |
| 14<br>(W)                    | Ground | Push-button ignition<br>switch illumination<br>ground | Output           | Tail lamp   | OFF  | <p style="text-align: center;"><b>NOTE:</b><br/>When the illumination brighten-<br/>ing/dimming level is in the neutral<br/>position.</p>  <p style="text-align: right; font-size: small;">JSNIA0010GB</p> |
|                              |        |   |                  |   | ON   |   |
| 15<br>(BG)                   | Ground | ACC indicator lamp                                    | Output           | Ignition switch   | OFF (LOCK indicator is<br>not illuminated)         | Battery voltage   |
|                              |        |   |                  |   | ACC  | 0 V   |

# BCM (BODY CONTROL MODULE)

## < ECU DIAGNOSIS INFORMATION >

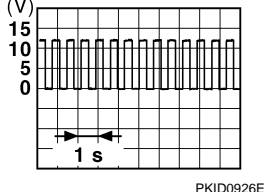
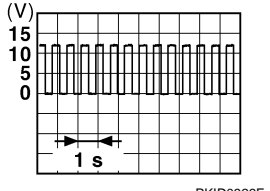
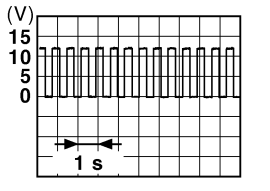
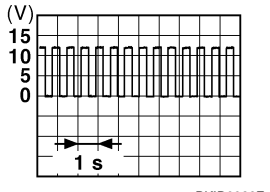
| Terminal No.<br>(Wire color) |        | Description                |                  | Condition  | Value<br>(Approx.)  |       |
|------------------------------|--------|----------------------------|------------------|--|---|-------|
|                              |        | Signal name                | Input/<br>Output |  |   |       |
| +                            | -      |                            |                  |  |   |       |
| 17<br>(W)                    | Ground | Turn signal RH<br>(Front)  | Output           | Ignition switch<br>ON  | Turn signal switch OFF  | 0 V   |
|                              |        |                            |                  | Turn signal switch RH  | <br><small>PKID0926E</small>   | 6.5 V |
| 18<br>(BG)                   | Ground | Turn signal LH (Front)     | Output           | Ignition switch<br>ON  | Turn signal switch OFF  | 0 V   |
|                              |        |                            |                  | Turn signal switch LH  | <br><small>PKID0926E</small>   | 6.5 V |
| 19<br>(V)                    | Ground | Room lamp timer<br>control | Output           | Interior room<br>lamp  | OFF   | 12 V  |
|                              |        |                            |                  | ON   | 0 V   |       |
| 20<br>(V)                    | Ground | Turn signal RH (Rear)      | Output           | Ignition switch<br>ON  | Turn signal switch OFF  | 0 V   |
|                              |        |                            |                  | Turn signal switch RH  | <br><small>PKID0926E</small> | 6.5 V |
| 23<br>(LG)                   | Ground | Trunk lid open             | Output           | Trunk lid  | OPEN<br>(Trunk lid opener actuator<br>is activated)   | 12 V  |
|                              |        |                            |                  | Other than OPEN<br>(Trunk lid opener actuator<br>is not activated) | 0 V   |       |
| 25<br>(Y)                    | Ground | Turn signal LH (Rear)      | Output           | Ignition switch<br>ON  | Turn signal switch OFF  | 0 V   |
|                              |        |                            |                  | Turn signal switch LH  | <br><small>PKID0926E</small> | 6.5 V |
| 30<br>(P)                    | Ground | Trunk room lamp            | Output           | Trunk room<br>lamp   | ON  | 0 V   |
|                              |        |                            |                  | OFF  | 12 V  |       |

# BCM (BODY CONTROL MODULE)

## < ECU DIAGNOSIS INFORMATION >

| Terminal No.<br>(Wire color) |        | Description                  |                  | Condition   | Value<br>(Approx.)  |
|------------------------------|--------|------------------------------|------------------|---|---|
| +                            | -      | Signal name                  | Input/<br>Output |   |   |
| 34<br>(SB)                   | Ground | Trunk room antenna<br>(-)    | Output           | Ignition switch<br>OFF  | <p style="text-align: right; font-size: small;">JMKIA0062GB</p> |
|                              |        |                              |                  | When Intelligent Key is not<br>in the passenger compart-<br>ment                            | <p style="text-align: right; font-size: small;">JMKIA0063GB</p> |
| 35<br>(V)                    | Ground | Trunk room antenna<br>(+)    | Output           | Ignition switch<br>OFF  | <p style="text-align: right; font-size: small;">JMKIA0062GB</p> |
|                              |        |                              |                  | When Intelligent Key is not<br>in the passenger compart-<br>ment                            | <p style="text-align: right; font-size: small;">JMKIA0063GB</p> |
| 38<br>(B)                    | Ground | Rear bumper anten-<br>na (-) | Output           | When the trunk lid opener re-<br>quest switch is<br>operated with<br>ignition switch<br>OFF | <p style="text-align: right; font-size: small;">JMKIA0062GB</p> |
|                              |        |                              |                  | When Intelligent Key is not<br>in the antenna detection<br>area                             | <p style="text-align: right; font-size: small;">JMKIA0063GB</p> |

A  
B  
C  
D  
E  
F  
G  
H  
I  
J  
K  
DEF  
M  
N  
O  
P



# BCM (BODY CONTROL MODULE)

## < ECU DIAGNOSIS INFORMATION >

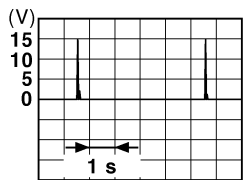
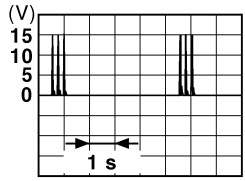
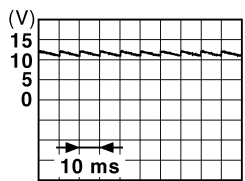
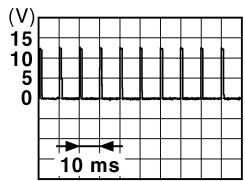
| Terminal No.<br>(Wire color) |        | Description                                  |                  | Condition   | Value<br>(Approx.)  |  |
|------------------------------|--------|--|------------------|---|---|--|
|                              |        | Signal name                                  | Input/<br>Output |   |   |  |
| +                            | -      |  |                  |   |   |  |
| 39<br>(W)                    | Ground | Rear bumper antenna (+)                      | Output           | When the trunk lid opener request switch is operated with ignition switch OFF | When Intelligent Key is in the antenna detection area   | <br><small>JMKIA0062GB</small>            |
|                              |        |  |                  | When Intelligent Key is not in the antenna detection area                     | <br><small>JMKIA0063GB</small> |  |
| 47<br>(Y)                    | Ground | Ignition relay (IPDM E/R) control            | Output           | Ignition switch   | OFF or ACC  | 12 V   |
|                              |        |  |                  |   | ON  | 0 V  |
| 50<br>(BG)                   | Ground | Trunk room lamp switch                       | Input            | Trunk room lamp switch  | OFF (Trunk lid is closed)   | <br><small>JPMIA0011GB</small><br>11.8 V |
|                              |        |  |                  |   | ON (Trunk lid is opened)  | 0 V  |
| 52<br>(R)                    | Ground | Starter relay control                        | Output           | Ignition switch ON (A/T models)   | When selector lever is in P or N position   | 12 V   |
|                              |        |  |                  |   | When selector lever is not in P or N position   | 0 V  |
|                              |        |  |                  | Ignition switch ON (M/T models)   | When the clutch pedal is depressed  | Battery voltage  |
|                              |        |  |                  |   | When the clutch pedal is not depressed  | 0 V  |
| 60*3<br>(BR)                 | Ground | Push-button ignition switch (Push switch)    | Input            | Push-button ignition switch (Push switch)                                     | Pressed   | 0 V  |
|                              |        |  |                  |   | Not pressed   | Battery voltage  |
| 61<br>(SB)                   | Ground | Trunk lid opener request switch              | Input            | Trunk lid opener request switch   | ON (Pressed)  | 0 V  |
|                              |        |  |                  |   | OFF (Not pressed)   | <br><small>JPMIA0016GB</small><br>1.0 V |
| 64<br>(G)                    | Ground | Intelligent Key warning buzzer (Engine room) | Output           | Intelligent Key warning buzzer (Engine room)                                  | Sounding  | 0 V  |
|                              |        |  |                  |   | Not sounding  | 12 V   |

# BCM (BODY CONTROL MODULE)

## < ECU DIAGNOSIS INFORMATION >

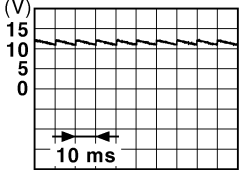
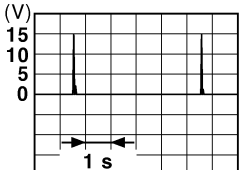
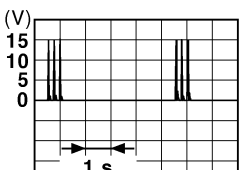
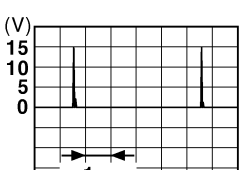
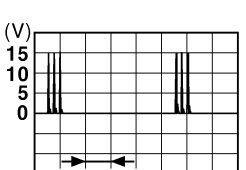
| Terminal No.<br>(Wire color) |        | Description                            |                  | Condition                    | Value<br>(Approx.)   |   |
|------------------------------|--------|--|------------------|------------------------------|--|---|
|                              |        | Signal name                            | Input/<br>Output |                              |  |   |
| +                            | -      |  |                  |                              |  |   |
| 67<br>(GR)                   | Ground | Trunk lid opener<br>switch             | Input            | Trunk lid open-<br>er switch | Pressed  | 0 V   |
|                              |        |  |                  |                              | Not pressed  |  <p style="text-align: right; font-size: small;">JPMIA0011GB</p>   |
| 72<br>(R)                    | Ground | Room antenna 2 (-)<br>(Center console) | Output           | Ignition switch<br>OFF       | When Intelligent Key is in<br>the passenger compart-<br>ment     |  <p style="text-align: right; font-size: small;">JMKIA0062GB</p>   |
|                              |        |  |                  |                              | When Intelligent Key is not<br>in the passenger compart-<br>ment |  <p style="text-align: right; font-size: small;">JMKIA0063GB</p>  |
| 73<br>(G)                    | Ground | Room antenna 2 (+)<br>(Center console) | Output           | Ignition switch<br>OFF       | When Intelligent Key is in<br>the passenger compart-<br>ment     |  <p style="text-align: right; font-size: small;">JMKIA0062GB</p> |
|                              |        |  |                  |                              | When Intelligent Key is not<br>in the passenger compart-<br>ment |  <p style="text-align: right; font-size: small;">JMKIA0063GB</p> |

A  
B  
C  
D  
E  
F  
G  
H  
I  
J  
K  
DEF  
M  
N  
O  
P

DEF

# BCM (BODY CONTROL MODULE)

## < ECU DIAGNOSIS INFORMATION >

| Terminal No.<br>(Wire color) |        | Description                |                  | Condition   | Value<br>(Approx.)  |
|------------------------------|--------|----------------------------|------------------|---|---|
| +                            | -      | Signal name                | Input/<br>Output |   |   |
| 74<br>(SB)                   | Ground | Passenger door antenna (-) | Output           | When Intelligent Key is in the antenna detection area                       | <p style="text-align: right; font-size: small;">JMKIA0062GB</p> |
|                              |        |                            |                  | When the passenger door request switch is operated with ignition switch OFF | <p style="text-align: right; font-size: small;">JMKIA0063GB</p> |
| 75<br>(BR)                   | Ground | Passenger door antenna (+) | Output           | When Intelligent Key is in the antenna detection area                       | <p style="text-align: right; font-size: small;">JMKIA0062GB</p> |
|                              |        |                            |                  | When the passenger door request switch is operated with ignition switch OFF | <p style="text-align: right; font-size: small;">JMKIA0063GB</p> |
| 76<br>(V)                    | Ground | Driver door antenna (-)    | Output           | When Intelligent Key is in the antenna detection area                       | <p style="text-align: right; font-size: small;">JMKIA0062GB</p> |
|                              |        |                            |                  | When the driver door request switch is operated with ignition switch OFF    | <p style="text-align: right; font-size: small;">JMKIA0063GB</p> |



# BCM (BODY CONTROL MODULE)

## < ECU DIAGNOSIS INFORMATION >



| Terminal No.<br>(Wire color) |        | Description                              |                  | Condition  | Value<br>(Approx.)  |
|------------------------------|--------|--|------------------|--|---|
| +                            | -      | Signal name                              | Input/<br>Output |  |   |
| 77<br>(LG)                   | Ground | Driver door antenna<br>(+)               | Output           | When the driver door request switch is operated with ignition switch OFF | <p style="text-align: right; font-size: small;">JMkia0062GB</p> |
|                              |        |  |                  | When Intelligent Key is not in the antenna detection area                | <p style="text-align: right; font-size: small;">JMkia0063GB</p> |
| 78<br>(Y)                    | Ground | Room antenna 1 (-)<br>(Instrument panel) | Output           | Ignition switch OFF  | <p style="text-align: right; font-size: small;">JMkia0062GB</p> |
|                              |        |  |                  | When Intelligent Key is not in the passenger compartment                 | <p style="text-align: right; font-size: small;">JMkia0063GB</p> |
| 79<br>(BR)                   | Ground | Room antenna 1 (+)<br>(Instrument panel) | Output           | Ignition switch OFF  | <p style="text-align: right; font-size: small;">JMkia0062GB</p> |
|                              |        |  |                  | When Intelligent Key is not in the passenger compartment                 | <p style="text-align: right; font-size: small;">JMkia0063GB</p> |

A  
B  
C  
D  
E  
F  
G  
H  
I  
J  
K  
DEF  
M  
N  
O  
P





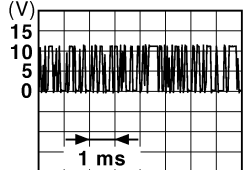
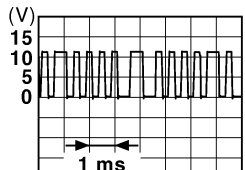

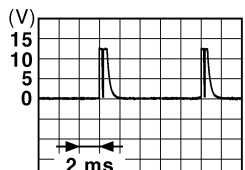
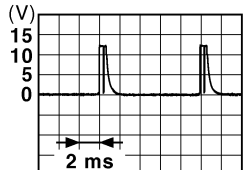
# BCM (BODY CONTROL MODULE)

## < ECU DIAGNOSIS INFORMATION >

| Terminal No.<br>(Wire color) |        | Description                                 |                  | Condition   |  | Value<br>(Approx.)   |
|------------------------------|--------|---|------------------|---|--|--|
| +                            | -      | Signal name                                 | Input/<br>Output |   |  |  |
| 80<br>(GR)                   | Ground | NATS antenna amp.                           | Input/<br>Output | During waiting                                      | Ignition switch is pressed while inserting the Intelligent Key into the key slot.  | Just after pressing ignition switch. Pointer of tester should move.  |
| 81<br>(W)                    | Ground | NATS antenna amp.                           | Input/<br>Output | During waiting                                      | Ignition switch is pressed while inserting the Intelligent Key into the key slot.  | Just after pressing ignition switch. Pointer of tester should move.  |
| 82<br>(SB)                   | Ground | Ignition relay [Fuse block (J/B)] control   | Output           | Ignition switch                                     | OFF or ACC   | 0 V  |
|                              |        |   |                  |   | ON   | 12 V   |
| 83<br>(Y)                    | Ground | Remote keyless entry receiver communication | Input/<br>Output | During waiting                                      |  |  <p style="text-align: right; font-size: small;">JMKIA0064GB</p>  |
|                              |        |   |                  | When operating either button on the Intelligent Key |  |  <p style="text-align: right; font-size: small;">JMKIA0065GB</p>   |
| 87<br>(Y)                    | Ground | Combination switch INPUT 5                  | Input            | Combination switch                                  | All switches OFF (Wiper volume dial 4)   |  <p style="text-align: right; font-size: small;">JPMIA0041GB</p> <p style="text-align: center;">1.4 V</p> |
|                              |        |   |                  |   | Front fog lamp switch ON (Wiper volume dial 4)   |  <p style="text-align: right; font-size: small;">JPMIA0037GB</p> <p style="text-align: center;">1.3 V</p> |
|                              |        |   |                  |   | Any of the conditions below with all switches OFF <ul style="list-style-type: none"> <li>• Wiper volume dial 1</li> <li>• Wiper volume dial 2</li> <li>• Wiper volume dial 6</li> <li>• Wiper volume dial 7</li> </ul> |  <p style="text-align: right; font-size: small;">JPMIA0040GB</p> <p style="text-align: center;">1.3 V</p> |

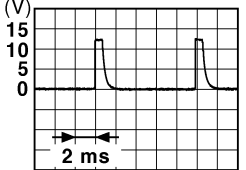
# BCM (BODY CONTROL MODULE)

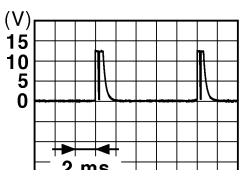
## < ECU DIAGNOSIS INFORMATION >

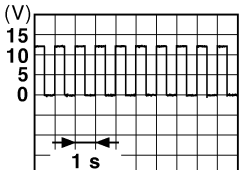
| Terminal No.<br>(Wire color) |        | Description                                  |                  | Condition                                       | Value<br>(Approx.)  |  |
|------------------------------|--------|--|------------------|---|---|--|
| +                            | -      | Signal name                                  | Input/<br>Output |   |   |  |
| 88<br>(BG)                   | Ground | Combination switch<br>INPUT 3                | Input            | Combination<br>switch                           | All switches OFF<br>(Wiper volume dial 4)   |  <p style="text-align: right; font-size: small;">JPMAI0041GB</p> <p style="text-align: center;">1.4 V</p>   |
|                              |        |  |                  |   | Lighting switch HI<br>(Wiper volume dial 4)   |  <p style="text-align: right; font-size: small;">JPMAI0036GB</p> <p style="text-align: center;">1.3 V</p>   |
|                              |        |  |                  |   | Lighting switch 2ND<br>(Wiper volume dial 4)  |  <p style="text-align: right; font-size: small;">JPMAI0037GB</p> <p style="text-align: center;">1.3 V</p>  |
|                              |        |  |                  |   | Any of the conditions below with all switches OFF <ul style="list-style-type: none"> <li>• Wiper volume dial 1</li> <li>• Wiper volume dial 2</li> <li>• Wiper volume dial 3</li> </ul> |  <p style="text-align: right; font-size: small;">JPMAI0040GB</p> <p style="text-align: center;">1.3 V</p> |
| 89*4<br>(BR)                 | Ground | Push-button ignition<br>switch (Push switch) | Input            | Push-button ignition<br>switch<br>(push switch) | Pressed   | 0 V  |
|                              |        |  |                  |   | Not pressed   | Battery voltage  |
| 90<br>(P)                    | Ground | CAN-L  | Input/<br>Output | —   | —   |  |
| 91<br>(L)                    | Ground | CAN-H  | Input/<br>Output | —   | —   |  |
| 92<br>(LG)                   | Ground | Key slot illumination                        | Output           | Key slot illumina-<br>tion                      | OFF   | 0 V  |
|                              |        |  |                  |   | Blinking  |  <p style="text-align: right; font-size: small;">JPMAI0015GB</p> <p style="text-align: center;">6.5 V</p> |
|                              |        |  |                  |   | ON  | 12 V   |

A  
B  
C  
D  
E  
F  
G  
H  
I  
J  
K

DEF

M  
N  
O  
P



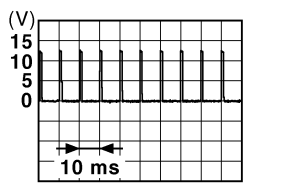
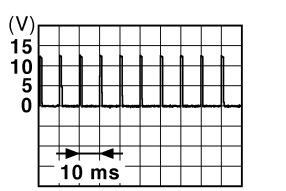

# BCM (BODY CONTROL MODULE)

## < ECU DIAGNOSIS INFORMATION >

| Terminal No.<br>(Wire color) |        | Description  |                  | Condition                     |   | Value<br>(Approx.)   |
|------------------------------|--------|--|------------------|-------------------------------|---|--|
|                              |        | Signal name  | Input/<br>Output |                               |   |  |
| +                            | -      |  |                  |                               |   |  |
| 93<br>(GR)                   | Ground | ON indicator lamp                                  | Output           | Ignition switch               | OFF (LOCK indicator is not illuminated) | Battery voltage  |
|                              |        |  |                  |                               | ON                                      | 0 V  |
| 95<br>(BG)                   | Ground | ACC relay control                                  | Output           | Ignition switch               | OFF                                     | 0 V  |
|                              |        |  |                  |                               | ACC or ON                               | 12 V   |
| 96<br>(GR)                   | Ground | A/T shift selector (Detention switch) power supply | Output           | —                             |   | 12 V   |
| 97*4<br>(L)                  | Ground | Steering lock condition No. 1                      | Input            | Steering lock                 | LOCK status                             | 0 V  |
|                              |        |  |                  |                               | UNLOCK status                           | 12 V   |
| 98*4<br>(P)                  | Ground | Steering lock condition No. 2                      | Input            | Steering lock                 | LOCK status                             | 12 V   |
|                              |        |  |                  |                               | UNLOCK status                           | 0 V  |
| 99<br>(R)*1<br>(BR)*2        | Ground | Selector lever P position switch                   | Input            | Selector lever                | P position                              | 0 V  |
|                              |        |  |                  |                               | Any position other than P               | 12 V   |
|                              |        | ASCD clutch switch (M/T models without ICC)        |                  | ASCD clutch switch            | OFF (Clutch pedal is depressed)         | 0 V  |
|                              |        |  |                  |                               | ON (Clutch pedal is not depressed)      | 12 V   |
|                              |        | ICC clutch switch (M/T models with ICC)            |                  | ICC clutch switch             | OFF (Clutch pedal is depressed)         | 0 V  |
|                              |        |  |                  |                               | ON (Clutch pedal is not depressed)      | 12 V   |
| 100<br>(Y)                   | Ground | Passenger door request switch                      | Input            | Passenger door request switch | ON (Pressed)                            | 0 V  |
|                              |        |  |                  |                               | OFF (Not pressed)                       | <br>1.0 V |
| 101<br>(P)                   | Ground | Driver door request switch                         | Input            | Driver door request switch    | ON (Pressed)                            | 0 V  |
|                              |        |  |                  |                               | OFF (Not pressed)                       | <br>1.0 V |
| 102<br>(BG)                  | Ground | Blower fan motor relay control                     | Output           | Ignition switch               | OFF or ACC                              | 0 V  |
|                              |        |  |                  |                               | ON                                      | 12 V   |
| 103<br>(P)                   | Ground | Remote keyless entry receiver power supply         | Output           | Ignition switch OFF           |   | 12 V   |
| 106*4<br>(SB)                | Ground | Steering lock unit power supply                    | Output           | Ignition switch               | OFF or ACC                              | 12 V   |
|                              |        |  |                  |                               | ON                                      | 0 V  |

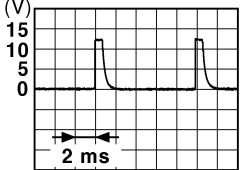
# BCM (BODY CONTROL MODULE)

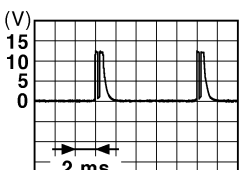
## < ECU DIAGNOSIS INFORMATION >

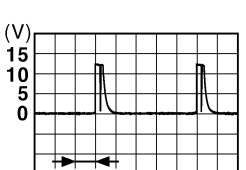
| Terminal No.<br>(Wire color) |        | Description                   |                  | Condition   | Value<br>(Approx.)     |  |
|------------------------------|--------|-------------------------------|------------------|---|------------------------|--|
|                              |        | Signal name                   | Input/<br>Output |   |                        |  |
| +                            | -      |                               |                  |   |                        |  |
| 107<br>(LG)                  | Ground | Combination switch<br>INPUT 1 | Input            | Combination<br>switch<br>(Wiper volume<br>dial 4) | All switches OFF       |  <p style="text-align: right; margin-right: 50px;">JPMAI0041GB</p> <p style="text-align: center;">1.4 V</p>   |
|                              |        |                               |                  |   | Turn signal switch LH  |  <p style="text-align: right; margin-right: 50px;">JPMAI0037GB</p> <p style="text-align: center;">1.3 V</p>   |
|                              |        |                               |                  |   | Turn signal switch RH  |  <p style="text-align: right; margin-right: 50px;">JPMAI0036GB</p> <p style="text-align: center;">1.3 V</p>  |
|                              |        |                               |                  |   | Front wiper switch LO  |  <p style="text-align: right; margin-right: 50px;">JPMAI0038GB</p> <p style="text-align: center;">1.3 V</p> |
|                              |        |                               |                  |   | Front washer switch ON |  <p style="text-align: right; margin-right: 50px;">JPMAI0039GB</p> <p style="text-align: center;">1.3 V</p> |

A  
B  
C  
D  
E  
F  
G  
H  
I  
J  
K  
DEF  
M  
N  
O  
P

DEF

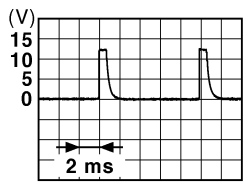
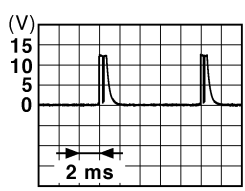
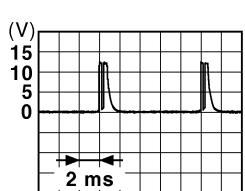
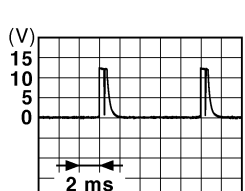

# BCM (BODY CONTROL MODULE)

## < ECU DIAGNOSIS INFORMATION >

| Terminal No.<br>(Wire color) |        | Description                   |                  | Condition             | Value<br>(Approx.)  |  |
|------------------------------|--------|-------------------------------|------------------|-----------------------|---|--|
|                              |        | Signal name                   | Input/<br>Output |                       |   |  |
| +                            | -      |                               |                  |                       |   |  |
| 108<br>(R)                   | Ground | Combination switch<br>INPUT 4 | Input            | Combination<br>switch | All switches OFF<br>(Wiper volume dial 4)   |  <p style="text-align: right; margin-right: 20px;">JPMIA0041GB</p> <p style="text-align: center;">1.4 V</p>   |
|                              |        |                               |                  |                       | Lighting switch AUTO<br>(Wiper volume dial 4)   |  <p style="text-align: right; margin-right: 20px;">JPMIA0038GB</p> <p style="text-align: center;">1.3 V</p>   |
|                              |        |                               |                  |                       | Lighting switch 1ST<br>(Wiper volume dial 4)  |  <p style="text-align: right; margin-right: 20px;">JPMIA0036GB</p> <p style="text-align: center;">1.3 V</p>  |
|                              |        |                               |                  |                       | Any of the conditions below with all switches OFF <ul style="list-style-type: none"> <li>• Wiper volume dial 1</li> <li>• Wiper volume dial 5</li> <li>• Wiper volume dial 6</li> </ul> |  <p style="text-align: right; margin-right: 20px;">JPMIA0039GB</p> <p style="text-align: center;">1.3 V</p> |

# BCM (BODY CONTROL MODULE)

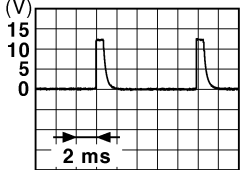
## < ECU DIAGNOSIS INFORMATION >

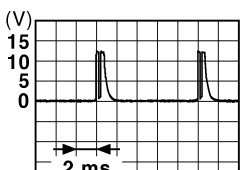
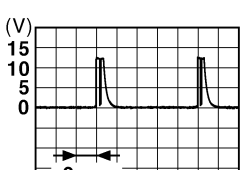
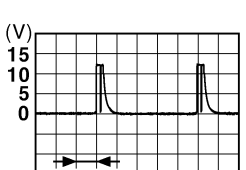
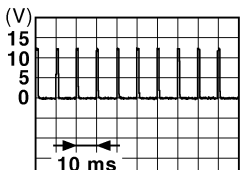
| Terminal No.<br>(Wire color) |        | Description                   |                  | Condition   | Value<br>(Approx.)  |   |
|------------------------------|--------|-------------------------------|------------------|---|---|---|
| +                            | -      | Signal name                   | Input/<br>Output |   |   |   |
| 109<br>(W)                   | Ground | Combination switch<br>INPUT 2 | Input            | Combination<br>switch<br>(Wiper volume<br>dial 4) | All switches OFF  |  <p style="text-align: right;">JPMA0041GB</p> <p style="text-align: center;">1.4 V</p>   |
|                              |        |                               |                  |   | Lighting switch PASS  |  <p style="text-align: right;">JPMA0037GB</p> <p style="text-align: center;">1.3 V</p>   |
|                              |        |                               |                  |   | Lighting switch 2ND   |  <p style="text-align: right;">JPMA0036GB</p> <p style="text-align: center;">1.3 V</p>  |
|                              |        |                               |                  |   | Front wiper switch INT/<br>AUTO   |  <p style="text-align: right;">JPMA0038GB</p> <p style="text-align: center;">1.3 V</p> |
|                              |        |                               |                  |   | Front wiper switch HI   |  <p style="text-align: right;">JPMA0040GB</p> <p style="text-align: center;">1.3 V</p> |
|                              |        |                               |                  |   | ON  | 0 V   |
| 110<br>(G)                   | Ground | Hazard switch                 | Input            | Hazard switch                                     |   |   |
|                              |        |                               |                  | OFF   |  <p style="text-align: right;">JPMA0012GB</p> <p style="text-align: center;">1.1 V</p> |   |

A  
B  
C  
D  
E  
F  
G  
H  
I  
J  
K  
DEF  
M  
N  
O  
P



# BCM (BODY CONTROL MODULE)

## < ECU DIAGNOSIS INFORMATION >

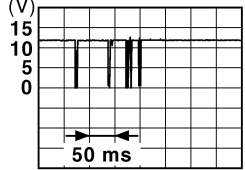
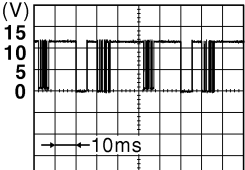
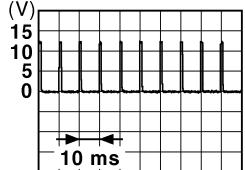
| Terminal No.<br>(Wire color) |        | Description  |                  | Condition   |   | Value<br>(Approx.)  |
|------------------------------|--------|--|------------------|---|---|---|
| +                            | -      | Signal name  | Input/<br>Output |   |   |   |
| 111*4<br>(Y)                 | Ground | Steering lock unit<br>communication                  | Input/<br>Output | Steering lock   | LOCK status                                   | 12 V  |
|                              |        |  |                  |   | LOCK or UNLOCK                                |    |
|                              |        |  |                  |   | For 15 seconds after UN-<br>LOCK              | 12 V  |
|                              |        |  |                  |   | 15 seconds or later after<br>UNLOCK           | 0 V   |
| 112<br>(R)                   | Ground | Rain sensor serial<br>link                           | Input/<br>Output | Ignition switch ON  |   |    |
|                              |        |  |                  |   |   | 8.7 V   |
| 113<br>(BG)                  | Ground | Optical sensor                                       | Input            | Ignition switch<br>ON   | When bright outside of the<br>vehicle         | Close to 5 V  |
|                              |        |  |                  |   | When dark outside of the<br>vehicle           | Close to 0 V  |
| 114<br>(R)                   | Ground | Clutch interlock<br>switch                           | Input            | Clutch interlock<br>switch  | OFF (Clutch pedal is not<br>depressed)        | 0 V   |
|                              |        |  |                  |   | ON (Clutch pedal is de-<br>pressed)           | Battery voltage   |
| 116<br>(SB)                  | Ground | Stop lamp switch 1                                   | Input            | —   |   | Battery voltage   |
| 118<br>(BR)                  | Ground | Stop lamp switch 2<br>(Without ICC)                  | Input            | Stop lamp<br>switch   | OFF (Brake pedal is not<br>depressed)         | 0 V   |
|                              |        |  |                  |   | ON (Brake pedal is de-<br>pressed)            | Battery voltage   |
|                              |        | Stop lamp switch 2<br>(With ICC)                     |                  | Stop lamp switch OFF (Brake pedal is not<br>depressed) and ICC brake hold relay OFF | 0 V   |   |
|                              |        |  |                  | Stop lamp switch ON (Brake pedal is de-<br>pressed) or ICC brake hold relay ON      | Battery voltage                               |   |
| 119<br>(SB)                  | Ground | Driver side door lock<br>assembly (Unlock<br>sensor) | Input            | Driver door   | LOCK status<br>(Unlock sensor switch<br>OFF)  |  |
|                              |        |  |                  |   | UNLOCK status<br>(Unlock switch sensor<br>ON) | 1.1 V   |
|                              |        |  |                  |   |   | 0 V   |



# BCM (BODY CONTROL MODULE)

## < ECU DIAGNOSIS INFORMATION >

| Terminal No.<br>(Wire color) |        | Description                              |                  | Condition  | Value<br>(Approx.)         |
|------------------------------|--------|--|------------------|--|----------------------------|
| +                            | -      | Signal name                              | Input/<br>Output |  |                            |
| 121<br>(SB)                  | Ground | Key slot switch                          | Input            | When the Intelligent Key is inserted into key slot     | 12 V                       |
|                              |        |  |                  | When the Intelligent Key is not inserted into key slot | 0 V                        |
| 123<br>(V)                   | Ground | IGN feedback                             | Input            | Ignition switch  | OFF or ACC                 |
|                              |        |  |                  |  | ON                         |
| 124<br>(R)                   | Ground | Passenger door switch                    | Input            | Passenger door switch                                  | OFF (Door close)           |
|                              |        |  |                  |  | ON (Door open)             |
| 129<br>(BG)                  | Ground | Trunk lid opener cancel switch           | Input            | Trunk lid opener cancel switch                         | CANCEL                     |
|                              |        |  |                  |  | ON                         |
| 132<br>(V)                   | Ground | Power window switch communication        | Input/<br>Output | Ignition switch ON                                     | 10.2 V                     |
|                              |        |  |                  |  | Ignition switch OFF or ACC |
| 133<br>(L)                   | Ground | Push-button ignition switch illumination | Output           | Push-button ignition switch illumination               | ON (Tail lamps ON)         |
|                              |        |  |                  |  | OFF                        |
| 134<br>(LG)                  | Ground | LOCK indicator lamp                      | Output           | LOCK indicator lamp                                    | OFF                        |
|                              |        |  |                  |  | ON                         |
| 137<br>(BG)                  | Ground | Receiver and sensor ground               | Input            | Ignition switch ON                                     | 0 V                        |

A  
B  
C  
D  
E  
F  
G  
H  
I  
J  
K  
M  
N  
O  
P

DEF

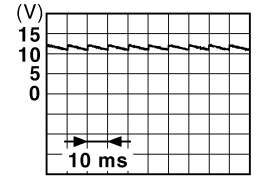

JPMIA0011GB

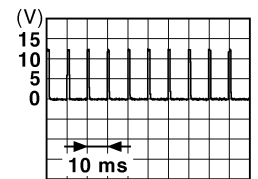

JPMIA0012GB

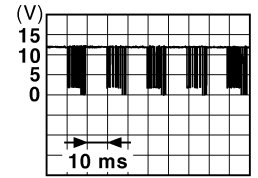

JPMIA0013GB

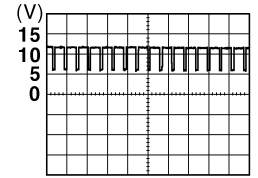



JPMIA0159GB

**NOTE:**  
The pulse width of this wave is varied by the illumination brightening/dimming level.

# BCM (BODY CONTROL MODULE)

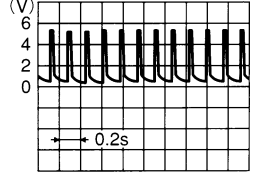
## < ECU DIAGNOSIS INFORMATION >

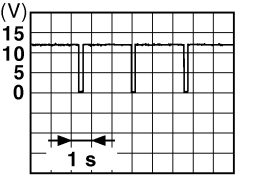
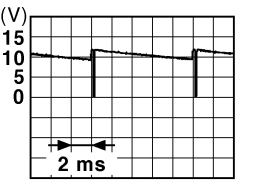
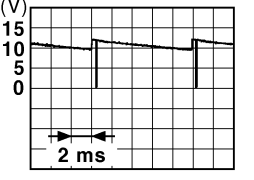
| Terminal No.<br>(Wire color) |        | Description                              |                  | Condition   |   | Value<br>(Approx.)   |
|------------------------------|--------|--|------------------|---|---|--|
|                              |        | Signal name                              | Input/<br>Output |   |   |  |
| +                            | -      |  |                  |   |   |  |
| 138<br>(V)                   | Ground | Receiver and sensor power supply         | Output           | Ignition switch                                   | OFF   | 0 V  |
|                              |        |  |                  |   | ACC or ON   | 5.0 V  |
| 139<br>(L)                   | Ground | Tire pressure receiver communication     | Input/<br>Output | Ignition switch ON                                | Standby state   | <br>OCC3881D      |
|                              |        |  |                  |   | When receiving the signal from the transmitter  | <br>OCC3880D      |
| 140<br>(B)                   | Ground | Selector lever P/N position (A/T models) | Input            | Selector lever                                    | P or N position   | 12 V   |
|                              |        |  |                  |   | Except P and N positions  | 0 V  |
| 141<br>(W)                   | Ground | Security indicator                       | Output           | Security indicator                                | ON  | 0 V  |
|                              |        |  |                  |   | Blinking  | <br>JPMIA0014GB |
| 142<br>(BR)                  | Ground | Combination switch OUTPUT 5              | Output           | Combination switch (Wiper volume dial 4)          | All switches OFF  | 0 V  |
|                              |        |  |                  |   | Lighting switch 1ST   | <br>JPMIA0031GB |
| Lighting switch HI           |        |  |                  |   |   |  |
| Lighting switch 2ND          |        |  |                  |   |   |  |
|                              |        |  |                  | Turn signal switch RH                             |   | 10.7 V   |
| 143<br>(P)                   | Ground | Combination switch OUTPUT 1              | Output           | Combination switch                                | All switches OFF (Wiper volume dial 4)  | 0 V  |
|                              |        |  |                  |   | Front wiper switch HI (Wiper volume dial 4)   | <br>JPMIA0032GB |
|                              |        |  |                  | Any of the conditions below with all switches OFF | <ul style="list-style-type: none"> <li>• Wiper volume dial 1</li> <li>• Wiper volume dial 2</li> <li>• Wiper volume dial 3</li> <li>• Wiper volume dial 6</li> <li>• Wiper volume dial 7</li> </ul> | 10.7 V   |

# BCM (BODY CONTROL MODULE)

## < ECU DIAGNOSIS INFORMATION >

| Terminal No.<br>(Wire color) |        | Description                             |                  | Condition   | Value<br>(Approx.)                                |     |   |
|------------------------------|--------|---|------------------|---|---|-----|---|
| +                            | -      | Signal name                             | Input/<br>Output |   |   |     |   |
| 144<br>(G)                   | Ground | Combination switch<br>OUTPUT 2          | Output           | Combination<br>switch                             | All switches OFF<br>(Wiper volume dial 4)         | 0 V |   |
|                              |        |   |                  |   | Front washer switch ON<br>(Wiper volume dial 4)   |     |   |
|                              |        |   |                  |   | Any of the conditions below with all switches OFF |     | <ul style="list-style-type: none"> <li>• Wiper volume dial 1</li> <li>• Wiper volume dial 5</li> <li>• Wiper volume dial 6</li> </ul> |
|                              |        |   |                  |   |   |     |   |
| 145<br>(L)                   | Ground | Combination switch<br>OUTPUT 3          | Output           | Combination<br>switch<br>(Wiper volume<br>dial 4) | All switches OFF                                  | 0 V |   |
|                              |        |   |                  |   | Front wiper switch INT/<br>AUTO                   |     |   |
|                              |        |   |                  |   | Front wiper switch LO                             |     |   |
|                              |        |   |                  |   | Lighting switch AUTO                              |     | 10.7 V  |
| 146<br>(SB)                  | Ground | Combination switch<br>OUTPUT 4          | Output           | Combination<br>switch<br>(Wiper volume<br>dial 4) | All switches OFF                                  | 0 V |   |
|                              |        |   |                  |   | Front fog lamp switch ON                          |     |   |
|                              |        |   |                  |   | Lighting switch 2ND                               |     |   |
|                              |        |   |                  |   | Lighting switch PASS                              |     |   |
|                              |        |   |                  |   | Turn signal switch LH                             |     | 10.7 V  |
| 150<br>(GR)                  | Ground | Driver door switch                      | Input            | Driver door<br>switch                             | OFF (Door close)                                  |     |   |
|                              |        |   |                  |   | 11.8 V  |     |   |
|                              |        |   |                  |   | ON (Door open)                                    | 0 V |   |
| 151<br>(G)                   | Ground | Rear window defog-<br>ger relay control | Output           | Rear window<br>defogger                           | Active  | 0 V |   |
|                              |        |   |                  | Not activated                                     | Battery voltage                                   |     |   |

- \*1: A/T models
- \*2: M/T models
- \*3: Without steering lock unit
- \*4: With steering lock unit

A  
B  
C  
D  
E  
F  
G  
H  
I  
J  
K  
DEF  
M  
N  
O  
P

# BCM (BODY CONTROL MODULE)

< ECU DIAGNOSIS INFORMATION >

## Wiring Diagram - BCM -

INFOID:000000006933315

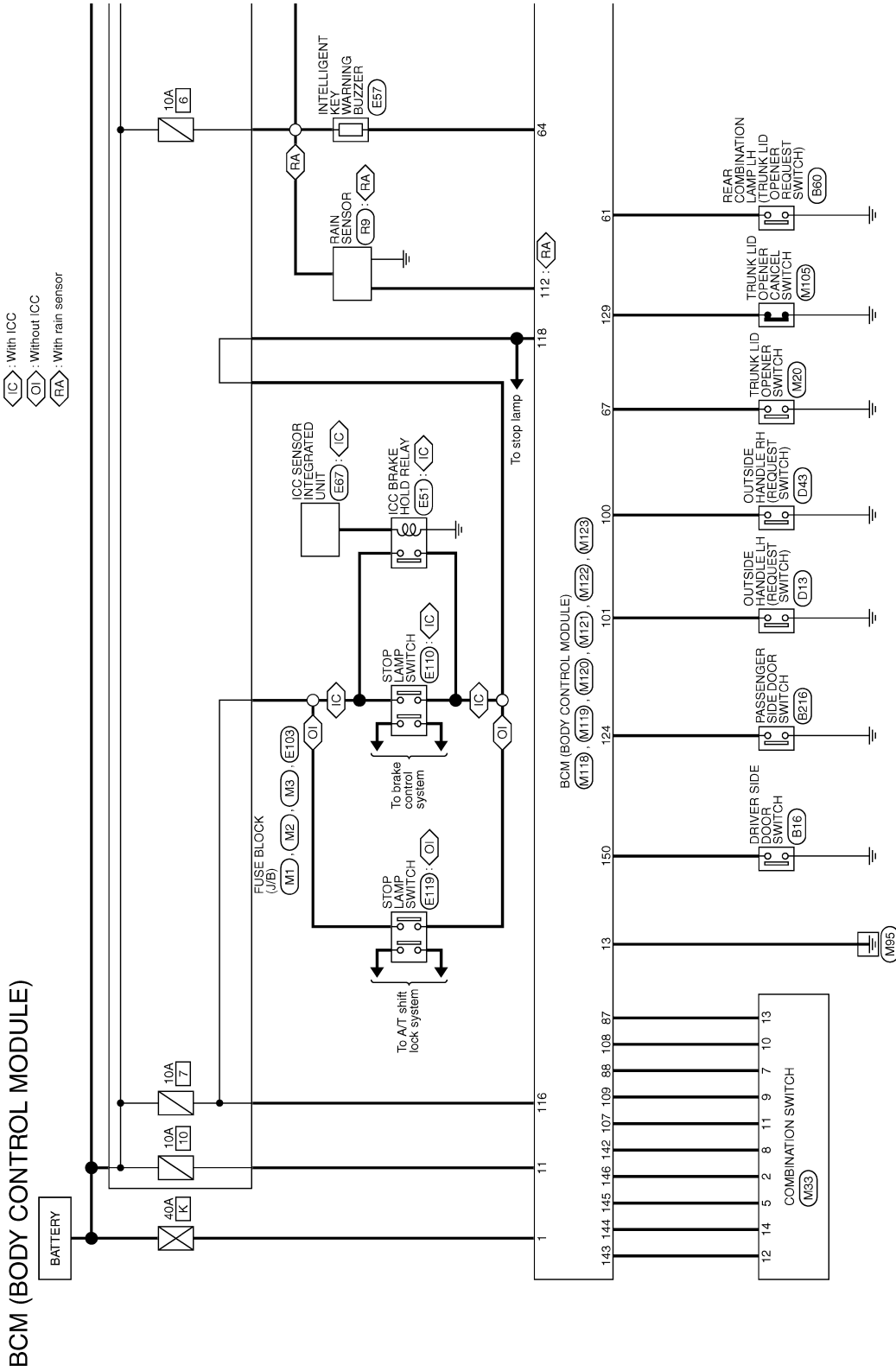

# BCM (BODY CONTROL MODULE)

< ECU DIAGNOSIS INFORMATION >

\*1 89: : Without steering lock unit

60: : With steering lock unit

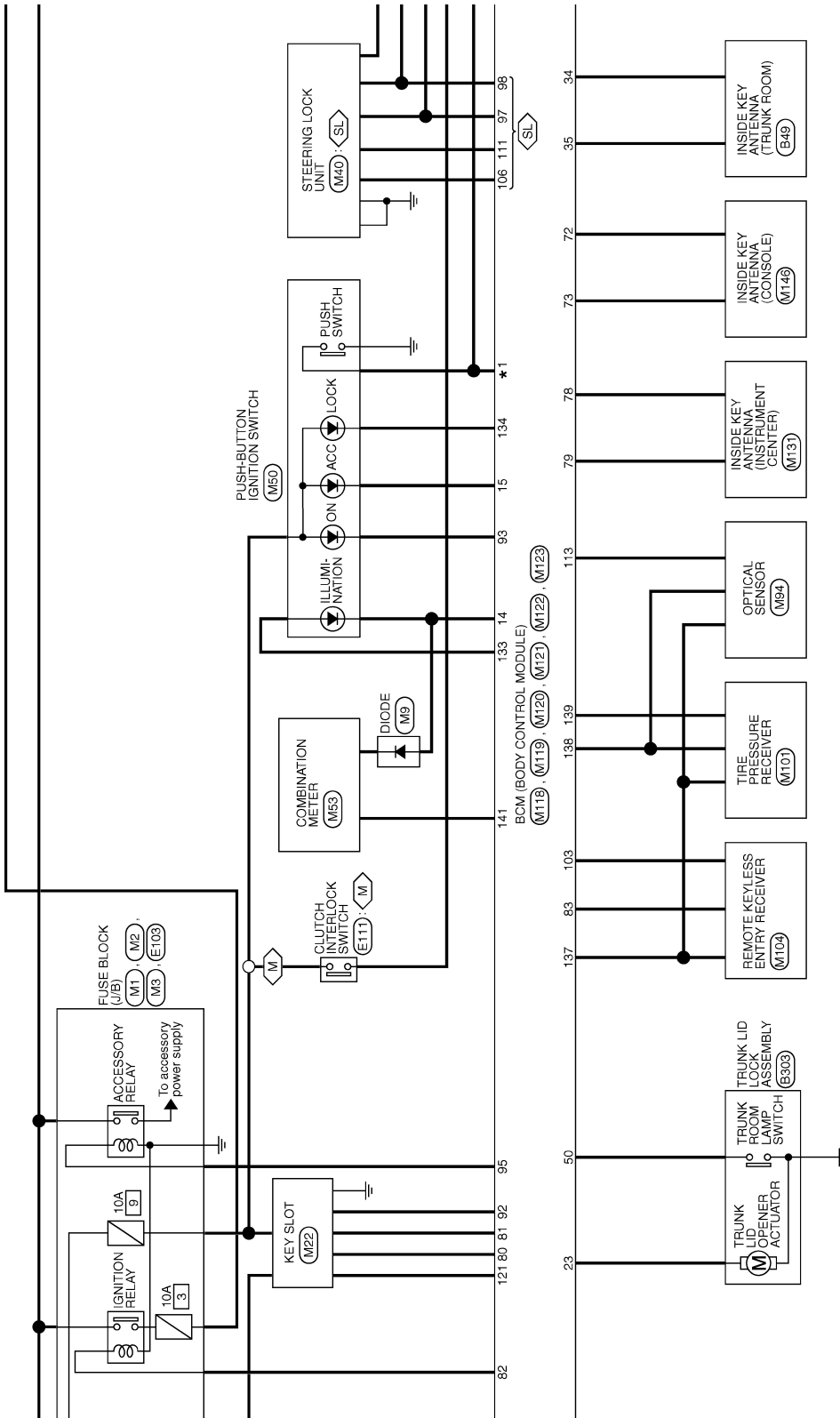

JCMWN0125GB

A  
B  
C  
D  
E  
F  
G  
H  
I  
J  
K  
DEF  
M  
N  
O  
P

# BCM (BODY CONTROL MODULE)

< ECU DIAGNOSIS INFORMATION >

- : With A/T
- : With M/T
- : With steering lock unit
- : With sunroof

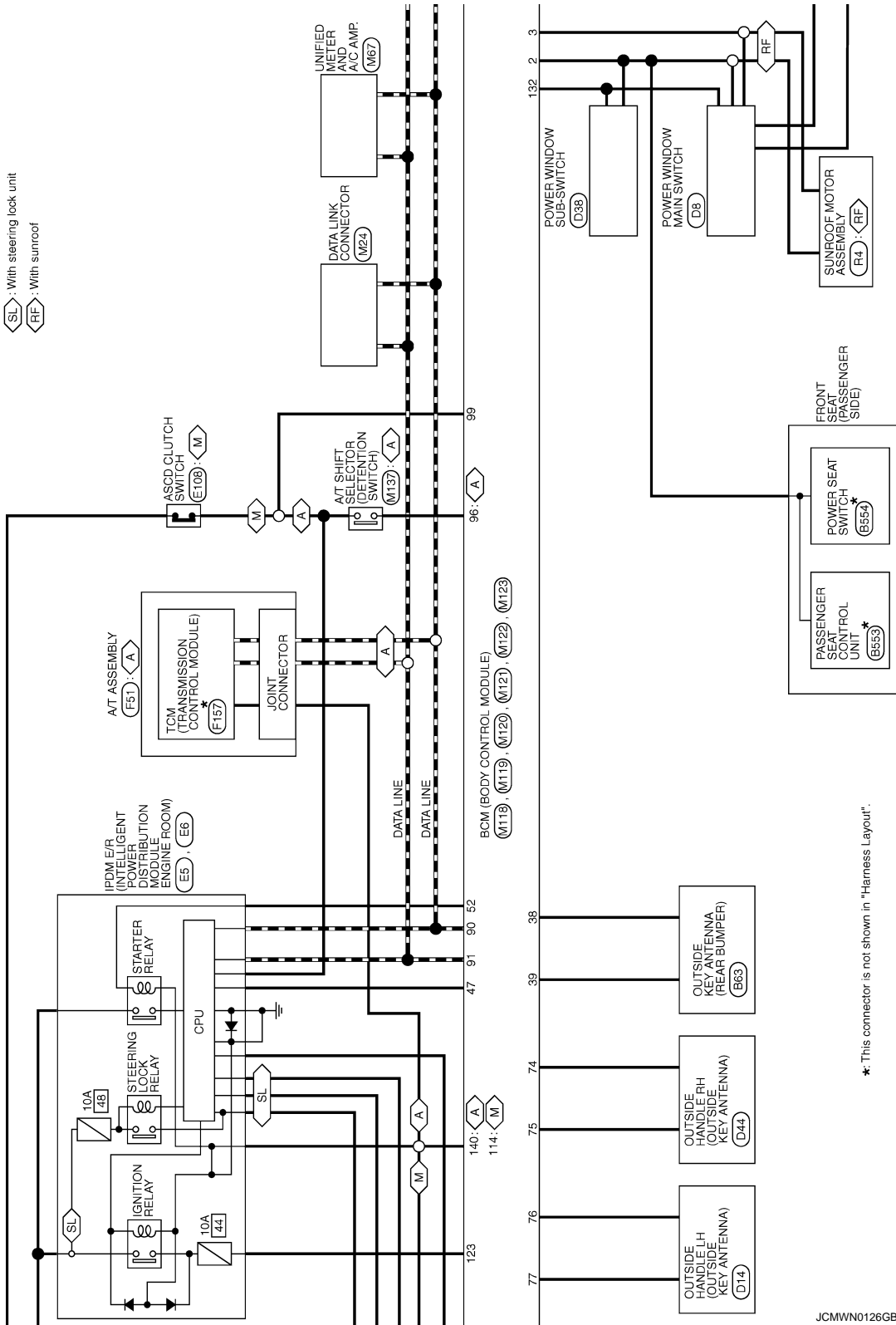

\*: This connector is not shown in "Harness Layout".

JCMWN0126GB

# BCM (BODY CONTROL MODULE)

< ECU DIAGNOSIS INFORMATION >

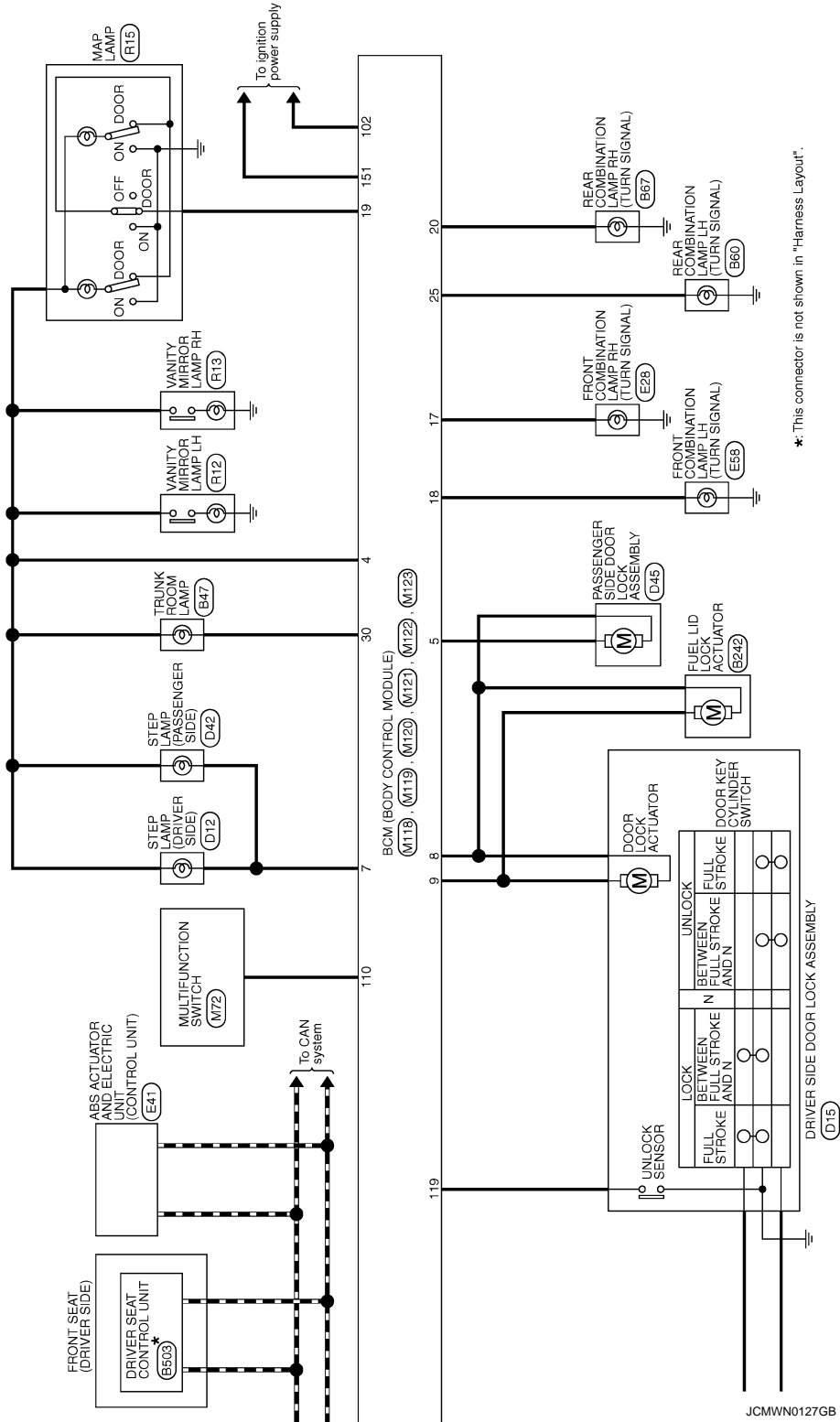

\*: This connector is not shown in "Harness Layout".

A  
B  
C  
D  
E  
F  
G  
H  
I  
J  
K  
L  
M  
N  
O  
P

DEF

# BCM (BODY CONTROL MODULE)

< ECU DIAGNOSIS INFORMATION >

## BCM (BODY CONTROL MODULE)

|                |                    |
|----------------|--------------------|
| Connector No.  | M33                |
| Connector Name | COMBINATION SWITCH |
| Connector Type | TH16FW-NH          |

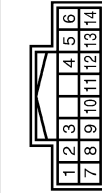

| Terminal No. | Color of Wire | Signal Name [Specification] |
|--------------|---------------|-----------------------------|
| 1            | GR            | FR WASHER (-)               |
| 2            | SB            | OUTPUT 4                    |
| 3            | L             | OUTPUT 3                    |
| 4            | B             | GND                         |
| 5            | EG            | INPUT 3                     |
| 6            | BR            | OUTPUT 5                    |
| 7            | W             | INPUT 2                     |
| 8            | R             | INPUT 4                     |
| 9            | LG            | INPUT 1                     |
| 10           | P             | OUTPUT 1                    |
| 11           | Y             | INPUT 5                     |
| 12           | G             | OUTPUT 2                    |

|                |                           |
|----------------|---------------------------|
| Connector No.  | M18                       |
| Connector Name | BCM (BODY CONTROL MODULE) |
| Connector Type | M03FB-LC                  |



| Terminal No. | Color of Wire | Signal Name [Specification]     |
|--------------|---------------|---------------------------------|
| 1            | W             | BAT (F/L)                       |
| 2            | Y             | POWER WINDOW POWER SUPPLY (BAT) |
| 3            | EG            | POWER WINDOW POWER SUPPLY (RAP) |

|                |                           |
|----------------|---------------------------|
| Connector No.  | M119                      |
| Connector Name | BCM (BODY CONTROL MODULE) |
| Connector Type | NS16FW-CS                 |



| Terminal No. | Color of Wire | Signal Name [Specification]        |
|--------------|---------------|------------------------------------|
| 4            | LG            | INTERIOR ROOM LAMP POWER SUPPLY    |
| 5            | P             | PASSENGER DOOR UNLOCK OUTPUT       |
| 6            | SB            | STEP LAMP OUTPUT                   |
| 7            | V             | ALL DOOR FUEL LID LOCK OUTPUT      |
| 8            | G             | DRIVER DOOR FUEL LID UNLOCK OUTPUT |
| 9            | R             | BAT (FUSE)                         |
| 10           | B             | GND                                |
| 11           | W             | PUSH BUTTON IGNITION SW ILL GND    |
| 12           | EG            | ACC IND                            |
| 13           | W             | TURN SIGNAL RH (FRONT)             |
| 14           | W             | TURN SIGNAL LH (FRONT)             |
| 15           | EG            | INT ROOM LAMP CONT                 |
| 16           | EG            |                                    |
| 17           | V             |                                    |
| 18           | V             |                                    |
| 19           | V             |                                    |

|                |                           |
|----------------|---------------------------|
| Connector No.  | M120                      |
| Connector Name | BCM (BODY CONTROL MODULE) |
| Connector Type | NS12FW-CS                 |

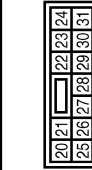

| Terminal No. | Color of Wire | Signal Name [Specification] |
|--------------|---------------|-----------------------------|
| 20           | V             | TURN SIGNAL RH (REAR)       |
| 21           | LG            | TRUNK LID OPEN OUTPUT       |
| 22           | Y             | TURN SIGNAL LH (REAR)       |
| 23           | P             | TRUNK ROOM LAMP             |

|                |                           |
|----------------|---------------------------|
| Connector No.  | M121                      |
| Connector Name | BCM (BODY CONTROL MODULE) |
| Connector Type | TH40FGY-NH                |

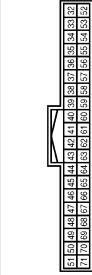

| Terminal No. | Color of Wire | Signal Name [Specification]  |
|--------------|---------------|------------------------------|
| 34           | SB            | TRUNK ROOM ANT-              |
| 35           | V             | REAR BUMPER ANT-             |
| 36           | B             | REAR BUMPER ANT+             |
| 37           | W             | REAR BUMPER ANT+             |
| 38           | W             | IGN RELAY (BDM E/P) CONT     |
| 39           | Y             | TRUNK ROOM LAMP SW           |
| 40           | EG            | STARTER RELAY CONT           |
| 41           | R             | PUSH SW                      |
| 42           | BR            | TRUNK LID OPENER REQUEST SW  |
| 43           | SB            | I-KEY WARN BUZZER (ENG ROOM) |
| 44           | G             | TRUNK LID OPENER SW          |
| 45           | GR            |                              |
| 46           | GR            |                              |
| 47           | GR            |                              |
| 48           | GR            |                              |
| 49           | GR            |                              |
| 50           | GR            |                              |
| 51           | GR            |                              |
| 52           | GR            |                              |
| 53           | GR            |                              |
| 54           | GR            |                              |
| 55           | GR            |                              |
| 56           | GR            |                              |
| 57           | GR            |                              |
| 58           | GR            |                              |
| 59           | GR            |                              |
| 60           | GR            |                              |
| 61           | GR            |                              |
| 62           | GR            |                              |
| 63           | GR            |                              |
| 64           | GR            |                              |
| 65           | GR            |                              |
| 66           | GR            |                              |
| 67           | GR            |                              |

|                |                           |
|----------------|---------------------------|
| Connector No.  | M122                      |
| Connector Name | BCM (BODY CONTROL MODULE) |
| Connector Type | TH40FB-NH                 |

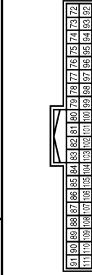

| Terminal No. | Color of Wire | Signal Name [Specification] |
|--------------|---------------|-----------------------------|
| 72           | R             | ROOM ANT 2-                 |
| 73           | G             | ROOM ANT 2+                 |
| 74           | SB            | PASSENGER DOOR ANT-         |
| 75           | BR            | PASSENGER DOOR ANT-         |
| 76           | V             | DRIVER DOOR ANT-            |
| 77           | LG            | DRIVER DOOR ANT+            |
| 78           | Y             | ROOM ANT 1-                 |
| 79           | BR            | ROOM ANT 1+                 |
| 80           | GR            | NATS ANT AMP                |
| 81           | W             | NATS ANT AMP                |
| 82           | SB            | IGN RELAY (E/B) CONT        |

|     |    |                                     |
|-----|----|-------------------------------------|
| 83  | Y  | KEYLESS ENTRY RECEIVER COMM         |
| 87  | Y  | COMBI SW INPUT 5                    |
| 88  | EG | COMBI SW INPUT 3                    |
| 89  | BR | PUSH SW                             |
| 90  | P  | CAN-L                               |
| 91  | L  | CAN-H                               |
| 92  | LG | KEY SLOT ILL                        |
| 93  | GR | ON IND                              |
| 95  | EG | ACC RELAY CONT                      |
| 96  | GR | A/T SHIFT SELECTOR POWER SUPPLY     |
| 97  | L  | S/L CONDITION 1                     |
| 98  | P  | S/L CONDITION 2                     |
| 99  | R  | SHIFT P [With A/T]                  |
| 99  | BR | ASGD CLUTCH SW [With M/T]           |
| 100 | Y  | PASSENGER DOOR REQUEST SW           |
| 101 | P  | DRIVER DOOR REQUEST SW              |
| 102 | EG | BLOWER FAN MOTOR RELAY CONT         |
| 103 | P  | KEYLESS ENTRY RECEIVER POWER SUPPLY |
| 106 | SB | S/L UNIT POWER SUPPLY               |
| 107 | LG | COMBI SW INPUT 1                    |
| 108 | R  | COMBI SW INPUT 4                    |
| 109 | W  | COMBI SW INPUT 2                    |
| 110 | G  | HAZARD SW                           |
| 111 | Y  | S/L UNIT COMM                       |



# BCM (BODY CONTROL MODULE)

< ECU DIAGNOSIS INFORMATION >

A  
B  
C  
D  
E  
F  
G  
H  
I  
J  
K  
DEF  
M  
N  
O  
P

**BCM (BODY CONTROL MODULE)**

|                |                           |
|----------------|---------------------------|
| Connector No.  | M123                      |
| Connector Name | BCM (BODY CONTROL MODULE) |
| Connector Type | THMFG-NH                  |

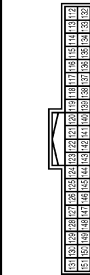

| Terminal No. | Color of Wire | Signal Name [Specification]       |
|--------------|---------------|-----------------------------------|
| 112          | R             | RAIN SENSOR SERIAL LINK           |
| 113          | BG            | OPTICAL SENSOR                    |
| 114          | R             | CLUTCH INTERLOCK SW               |
| 116          | SB            | STOP LAMP SW 1                    |
| 118          | BR            | STOP LAMP SW 2                    |
| 119          | SB            | DR DOOR UNLOCK SENSOR             |
| 121          | SB            | KEY SWITCH                        |
| 123          | V             | IGN P/B                           |
| 124          | R             | PASSENGER DOOR SW                 |
| 129          | BG            | TRUNK CANCEL SW                   |
| 132          | V             | POWER WINDOW SW COMM              |
| 133          | L             | PUSH-BUTTON IGNITION SW ILL POWER |
| 134          | LG            | LOCK IND                          |
| 137          | BG            | RECEIVER / SENSOR GND             |
| 138          | V             | RECEIVER / SENSOR POWER SUPPLY    |
| 139          | L             | TIRE PRESSURE RECEIVER COMM       |
| 140          | B             | SHIFT N/P                         |
| 141          | W             | SECURITY INDICATOR LAMP           |
| 142          | BR            | COMBI SW OUTPUT 5                 |
| 143          | P             | COMBI SW OUTPUT 1                 |
| 144          | G             | COMBI SW OUTPUT 2                 |
| 145          | L             | COMBI SW OUTPUT 3                 |
| 146          | SB            | COMBI SW OUTPUT 4                 |
| 150          | GR            | DRIVER DOOR SW                    |
| 151          | G             | REAR WINDOW DEFOGGER RELAY CONT   |

## Fail-safe

### FAIL-SAFE CONTROL BY DTC

BCM performs fail-safe control when any DTC are detected.

JCMWN0129GB

INFOID:000000006933316

## BCM (BODY CONTROL MODULE)

### < ECU DIAGNOSIS INFORMATION >

| Display contents of CONSULT | Fail-safe               | Cancellation   |
|-----------------------------|-------------------------|--|
| B2013: ID DISCORD BCM-S/L   | Inhibit engine cranking | Erase DTC  |
| B2014: CHAIN OF S/L-BCM     | Inhibit engine cranking | Erase DTC  |
| B2190: NATS ANTENNA AMP     | Inhibit engine cranking | Erase DTC  |
| B2191: DIFFERENCE OF KEY    | Inhibit engine cranking | Erase DTC  |
| B2192: ID DISCORD BCM-ECM   | Inhibit engine cranking | Erase DTC  |
| B2193: CHAIN OF BCM-ECM     | Inhibit engine cranking | Erase DTC  |
| B2195: ANTI-SCANNING        | Inhibit engine cranking | Ignition switch ON → OFF   |
| B2557: VEHICLE SPEED        | Inhibit steering lock   | When normal vehicle speed signals are received from ABS actuator and electric unit (control unit) for 500 ms   |
| B2560: STARTER CONT RELAY   | Inhibit engine cranking | 500 ms after the following CAN signal communication status becomes consistent <ul style="list-style-type: none"> <li>• Starter control relay signal</li> <li>• Starter relay status signal</li> </ul>  |
| B2601: SHIFT POSITION       | Inhibit steering lock   | 500 ms after the following signal reception status becomes consistent <ul style="list-style-type: none"> <li>• Selector lever P position switch signal</li> <li>• P range signal (CAN)</li> </ul>  |
| B2602: SHIFT POSITION       | Inhibit steering lock   | 5 seconds after the following BCM recognition conditions are fulfilled <ul style="list-style-type: none"> <li>• Ignition switch is in the ON position</li> <li>• Selector lever P position switch signal: Except P position (12 V)</li> <li>• Vehicle speed: 4 km/h (2.5 MPH) or more</li> </ul>   |
| B2603: SHIFT POSI STATUS    | Inhibit steering lock   | 500 ms after the following BCM recognition conditions are fulfilled <ul style="list-style-type: none"> <li>• Ignition switch is in the ON position</li> <li>• Selector lever P position switch signal: Except P position (12 V)</li> <li>• Selector lever P/N position signal: Except P and N positions (0 V)</li> </ul>   |
| B2604: PNP/CLUTCH SW        | Inhibit steering lock   | 500 ms after any of the following BCM recognition conditions are fulfilled <ul style="list-style-type: none"> <li>• Status 1 <ul style="list-style-type: none"> <li>- Ignition switch is in the ON position</li> <li>- Selector lever P/N position signal: P and N position (12 V)</li> <li>- P range signal or N range signal (CAN): ON</li> </ul> </li> <li>• Status 2 <ul style="list-style-type: none"> <li>- Ignition switch is in the ON position</li> <li>- Selector lever P/N position signal: Except P and N positions (0 V)</li> <li>- P range signal and N range signal (CAN): OFF</li> </ul> </li> </ul> |
| B2605: PNP/CLUTCH SW        | Inhibit steering lock   | 500 ms after any of the following BCM recognition conditions are fulfilled <ul style="list-style-type: none"> <li>• Status 1 <ul style="list-style-type: none"> <li>- Ignition switch is in the ON position</li> <li>- Selector lever P/N position signal: Except P and N positions (0 V)</li> <li>- Interlock/PNP switch signal (CAN): OFF</li> </ul> </li> <li>• Status 2 <ul style="list-style-type: none"> <li>- Ignition switch is in the ON position</li> <li>- Selector lever P/N position signal: P or N position (12 V)</li> <li>- PNP switch signal (CAN): ON</li> </ul> </li> </ul>                       |
| B2606: S/L RELAY            | Inhibit engine cranking | 500 ms after the following CAN signal communication status becomes consistent <ul style="list-style-type: none"> <li>• Steering lock relay signal (Request signal)</li> <li>• Steering lock relay signal (Condition signal)</li> </ul>   |
| B2607: S/L RELAY            | Inhibit engine cranking | 500 ms after the following CAN signal communication status has become consistent <ul style="list-style-type: none"> <li>• Steering lock relay signal (Request signal)</li> <li>• Steering lock relay signal (Condition signal)</li> </ul>  |

## BCM (BODY CONTROL MODULE)

### < ECU DIAGNOSIS INFORMATION >

| Display contents of CONSULT | Fail-safe  | Cancellation  |
|-----------------------------|--|---|
| B2608: STARTER RELAY        | Inhibit engine cranking  | 500 ms after the following signal communication status becomes consistent <ul style="list-style-type: none"> <li>• Starter motor relay control signal</li> <li>• Starter relay status signal (CAN)</li> </ul>   |
| B2609: S/L STATUS           | <ul style="list-style-type: none"> <li>• Inhibit engine cranking</li> <li>• Inhibit steering lock</li> </ul> | When the following steering lock conditions agree <ul style="list-style-type: none"> <li>• BCM steering lock control status</li> <li>• Steering lock condition No. 1 signal status</li> <li>• Steering lock condition No. 2 signal status</li> </ul>  |
| B260A: IGNITION RELAY       | Inhibit engine cranking  | 500 ms after the following conditions are fulfilled <ul style="list-style-type: none"> <li>• IGN relay (IPDM E/R) control signal: OFF (12 V)</li> <li>• Ignition ON signal (CAN to IPDM E/R): OFF (Request signal)</li> <li>• Ignition ON signal (CAN from IPDM E/R): OFF (Condition signal)</li> </ul>   |
| B260F: ENG STATE SIG LOST   | Maintains the power supply position attained at the time of DTC detection                                    | When any of the following conditions are fulfilled <ul style="list-style-type: none"> <li>• Power position changes to ACC</li> <li>• Receives engine status signal (CAN)</li> </ul>   |
| B2612: S/L STATUS           | <ul style="list-style-type: none"> <li>• Inhibit engine cranking</li> <li>• Inhibit steering lock</li> </ul> | When any of the following conditions are fulfilled <ul style="list-style-type: none"> <li>• Steering lock unit status signal (CAN) is received normally</li> <li>• The BCM steering lock control status matches the steering lock status recognized by the steering lock unit status signal (CAN from IPDM E/R)</li> </ul>  |
| B2617: BCM                  | Inhibit engine cranking  | 1 second after the starter motor relay control inside BCM becomes normal  |
| B2618: BCM                  | Inhibit engine cranking  | 1 second after the ignition relay (IPDM E/R) control inside BCM becomes normal  |
| B2619: BCM                  | Inhibit engine cranking  | 1 second after the steering lock unit power supply output control inside BCM becomes normal   |
| B261E: VEHICLE TYPE         | Inhibit engine cranking  | BCM initialization  |
| B26E8: CLUTCH SW            | Inhibit engine cranking  | When any of the following BCM recognition conditions are fulfilled <ul style="list-style-type: none"> <li>• Status 1                             <ul style="list-style-type: none"> <li>- Clutch switch signal (CAN from ECM): ON</li> <li>- Clutch interlock switch signal: OFF (0 V)</li> </ul> </li> <li>• Status 2                             <ul style="list-style-type: none"> <li>- Clutch switch signal (CAN from ECM): OFF</li> <li>- Clutch interlock switch signal: ON (Battery voltage)</li> </ul> </li> </ul> |
| B26E9: S/L STATUS           | <ul style="list-style-type: none"> <li>• Inhibit engine cranking</li> <li>• Inhibit steering lock</li> </ul> | When BCM transmits the LOCK request signal to steering lock unit, and receives LOCK response signal from steering lock unit, the following conditions are fulfilled <ul style="list-style-type: none"> <li>• Steering condition No. 1 signal: LOCK (0 V)</li> <li>• Steering condition No. 2 signal: LOCK (12 V)</li> </ul>   |

### DTC Inspection Priority Chart

INFOID:000000006933317

If some DTCs are displayed at the same time, perform inspections one by one based on the following priority chart.

| Priority | DTC   |
|----------|---|
| 1        | B2562: LOW VOLTAGE  |
| 2        | <ul style="list-style-type: none"> <li>• U1000: CAN COMM</li> <li>• U1010: CONTROL UNIT(CAN)</li> </ul>   |
| 3        | <ul style="list-style-type: none"> <li>• B2190: NATS ANTENNA AMP</li> <li>• B2191: DIFFERENCE OF KEY</li> <li>• B2192: ID DISCORD BCM-ECM</li> <li>• B2193: CHAIN OF BCM-ECM</li> <li>• B2195: ANTI-SCANNING</li> </ul> |

# BCM (BODY CONTROL MODULE)

## < ECU DIAGNOSIS INFORMATION >

| Priority | DTC   |
|----------|---|
| 4        | <ul style="list-style-type: none"> <li>• B2013: ID DISCORD BCM-S/L</li> <li>• B2014: CHAIN OF S/L-BCM</li> <li>• B2553: IGNITION RELAY</li> <li>• B2555: STOP LAMP</li> <li>• B2556: PUSH-BTN IGN SW</li> <li>• B2557: VEHICLE SPEED</li> <li>• B2560: STARTER CONT RELAY</li> <li>• B2601: SHIFT POSITION</li> <li>• B2602: SHIFT POSITION</li> <li>• B2603: SHIFT POSI STATUS</li> <li>• B2604: PNP/CLUTCH SW</li> <li>• B2605: PNP/CLUTCH SW</li> <li>• B2606: S/L RELAY</li> <li>• B2607: S/L RELAY</li> <li>• B2608: STARTER RELAY</li> <li>• B2609: S/L STATUS</li> <li>• B260A: IGNITION RELAY</li> <li>• B260B: STEERING LOCK UNIT</li> <li>• B260C: STEERING LOCK UNIT</li> <li>• B260D: STEERING LOCK UNIT</li> <li>• B260F: ENG STATE SIG LOST</li> <li>• B2612: S/L STATUS</li> <li>• B2614: BCM</li> <li>• B2615: BCM</li> <li>• B2616: BCM</li> <li>• B2617: BCM</li> <li>• B2618: BCM</li> <li>• B2619: BCM</li> <li>• B261A: PUSH-BTN IGN SW</li> <li>• B261E: VEHICLE TYPE</li> <li>• B26E8: CLUTCH SW</li> <li>• B26E9: S/L STATUS</li> <li>• B26EA: KEY REGISTRATION</li> <li>• C1729: VHCL SPEED SIG ERR</li> <li>• U0415: VEHICLE SPEED</li> </ul> |
| 5        | <ul style="list-style-type: none"> <li>• C1704: LOW PRESSURE FL</li> <li>• C1705: LOW PRESSURE FR</li> <li>• C1706: LOW PRESSURE RR</li> <li>• C1707: LOW PRESSURE RL</li> <li>• C1708: [NO DATA] FL</li> <li>• C1709: [NO DATA] FR</li> <li>• C1710: [NO DATA] RR</li> <li>• C1711: [NO DATA] RL</li> <li>• C1716: [PRESSDATA ERR] FL</li> <li>• C1717: [PRESSDATA ERR] FR</li> <li>• C1718: [PRESSDATA ERR] RR</li> <li>• C1719: [PRESSDATA ERR] RL</li> <li>• C1734: CONTROL UNIT</li> </ul>   |
| 6        | <ul style="list-style-type: none"> <li>• B2621: INSIDE ANTENNA</li> <li>• B2622: INSIDE ANTENNA</li> <li>• B2623: INSIDE ANTENNA</li> </ul>   |

### DTC Index

INFOID:000000006933318

#### NOTE:

The details of time display are as follows.

- CRNT: A malfunction is detected now.
- PAST: A malfunction was detected in the past.

IGN counter is displayed on Freeze Frame Data. For details of Freeze Frame Data, refer to [DEF-6. "COMMON ITEM : CONSULT-III Function \(BCM - COMMON ITEM\)".](#)

# BCM (BODY CONTROL MODULE)

## < ECU DIAGNOSIS INFORMATION >

| CONSULT display  | Fail-safe | Freeze Frame Data<br>•Vehicle Speed<br>•Odo/Trip Meter<br>•Vehicle condition | Intelligent Key<br>warning lamp ON | Tire pressure<br>monitor warning<br>lamp ON | Refer-<br>ence page     |
|--|-----------|--|------------------------------------|---|-------------------------|
| No DTC is detected.<br>further testing<br>may be required. | —         | —  | —                                  | —   | —                       |
| U1000: CAN COMM  | —         | —  | —                                  | —   | <a href="#">BCS-34</a>  |
| U1010: CONTROL UNIT(CAN)                                   | —         | —  | —                                  | —   | <a href="#">BCS-35</a>  |
| U0415: VEHICLE SPEED                                       | —         | —  | —                                  | —   | <a href="#">BCS-36</a>  |
| B2013: ID DISCORD BCM-S/L*                                 | ×         | ×  | —                                  | —   | <a href="#">SEC-57</a>  |
| B2014: CHAIN OF S/L-BCM*                                   | ×         | ×  | —                                  | —   | <a href="#">SEC-58</a>  |
| B2190: NATS ANTENNA AMP                                    | ×         | —  | —                                  | —   | <a href="#">SEC-49</a>  |
| B2191: DIFFERENCE OF KEY                                   | ×         | —  | —                                  | —   | <a href="#">SEC-52</a>  |
| B2192: ID DISCORD BCM-ECM                                  | ×         | —  | —                                  | —   | <a href="#">SEC-53</a>  |
| B2193: CHAIN OF BCM-ECM                                    | ×         | —  | —                                  | —   | <a href="#">SEC-55</a>  |
| B2195: ANTI-SCANNING                                       | ×         | —  | —                                  | —   | <a href="#">SEC-56</a>  |
| B2553: IGNITION RELAY                                      | —         | ×  | —                                  | —   | <a href="#">PCS-51</a>  |
| B2555: STOP LAMP   | —         | ×  | —                                  | —   | <a href="#">SEC-61</a>  |
| B2556: PUSH-BTN IGN SW                                     | —         | ×  | ×                                  | —   | <a href="#">SEC-63</a>  |
| B2557: VEHICLE SPEED                                       | ×         | ×  | ×                                  | —   | <a href="#">SEC-65</a>  |
| B2560: STARTER CONT RELAY                                  | ×         | ×  | ×                                  | —   | <a href="#">SEC-66</a>  |
| B2562: LOW VOLTAGE   | —         | ×  | —                                  | —   | <a href="#">BCS-37</a>  |
| B2601: SHIFT POSITION                                      | ×         | ×  | ×                                  | —   | <a href="#">SEC-67</a>  |
| B2602: SHIFT POSITION                                      | ×         | ×  | ×                                  | —   | <a href="#">SEC-70</a>  |
| B2603: SHIFT POSI STATUS                                   | ×         | ×  | ×                                  | —   | <a href="#">SEC-72</a>  |
| B2604: PNP/CLUTCH SW                                       | ×         | ×  | ×                                  | —   | <a href="#">SEC-75</a>  |
| B2605: PNP/CLUTCH SW                                       | ×         | ×  | ×                                  | —   | <a href="#">SEC-77</a>  |
| B2606: S/L RELAY*  | ×         | ×  | ×                                  | —   | <a href="#">SEC-79</a>  |
| B2607: S/L RELAY*  | ×         | ×  | ×                                  | —   | <a href="#">SEC-80</a>  |
| B2608: STARTER RELAY                                       | ×         | ×  | ×                                  | —   | <a href="#">SEC-82</a>  |
| B2609: S/L STATUS*   | ×         | ×  | ×                                  | —   | <a href="#">SEC-84</a>  |
| B260A: IGNITION RELAY                                      | ×         | ×  | ×                                  | —   | <a href="#">PCS-53</a>  |
| B260B: STEERING LOCK UNIT*                                 | —         | ×  | ×                                  | —   | <a href="#">SEC-88</a>  |
| B260C: STEERING LOCK UNIT*                                 | —         | ×  | ×                                  | —   | <a href="#">SEC-89</a>  |
| B260D: STEERING LOCK UNIT*                                 | —         | ×  | ×                                  | —   | <a href="#">SEC-90</a>  |
| B260F: ENG STATE SIG LOST                                  | ×         | ×  | ×                                  | —   | <a href="#">SEC-91</a>  |
| B2612: S/L STATUS*   | ×         | ×  | ×                                  | —   | <a href="#">SEC-96</a>  |
| B2614: BCM   | —         | ×  | ×                                  | —   | <a href="#">PCS-55</a>  |
| B2615: BCM   | —         | ×  | ×                                  | —   | <a href="#">PCS-57</a>  |
| B2616: BCM   | —         | ×  | ×                                  | —   | <a href="#">PCS-59</a>  |
| B2617: BCM   | ×         | ×  | ×                                  | —   | <a href="#">SEC-100</a> |
| B2618: BCM   | ×         | ×  | ×                                  | —   | <a href="#">PCS-61</a>  |
| B2619: BCM*  | ×         | ×  | ×                                  | —   | <a href="#">SEC-102</a> |
| B261A: PUSH-BTN IGN SW                                     | —         | ×  | ×                                  | —   | <a href="#">PCS-62</a>  |
| B261E: VEHICLE TYPE  | ×         | ×  | × (Turn ON for 15<br>seconds)      | —   | <a href="#">SEC-103</a> |

A

B

C

D

E

F

G

H

I

J

K

DEF

M

N

O

P

## BCM (BODY CONTROL MODULE)

### < ECU DIAGNOSIS INFORMATION >

| CONSULT display           | Fail-safe | Freeze Frame Data<br>•Vehicle Speed<br>•Odo/Trip Meter<br>•Vehicle condition | Intelligent Key<br>warning lamp ON | Tire pressure<br>monitor warning<br>lamp ON | Refer-<br>ence page    |
|---------------------------|-----------|--|------------------------------------|---|------------------------|
| B2621: INSIDE ANTENNA     | —         | ×  | —                                  | —   | <a href="#">DLK-56</a> |
| B2622: INSIDE ANTENNA     | —         | ×  | —                                  | —   | <a href="#">DLK-58</a> |
| B2623: INSIDE ANTENNA     | —         | ×  | —                                  | —   | <a href="#">DLK-60</a> |
| B26E8: CLUTCH SW          | ×         | ×  | ×                                  | —   | <a href="#">SEC-92</a> |
| B26E9: S/L STATUS*        | ×         | ×  | × (Turn ON for 15<br>seconds)      | —   | <a href="#">SEC-94</a> |
| B26EA: KEY REGISTRATION   | —         | ×  | × (Turn ON for 15<br>seconds)      | —   | <a href="#">SEC-95</a> |
| C1704: LOW PRESSURE FL    | —         | —  | —                                  | ×   | <a href="#">WT-24</a>  |
| C1705: LOW PRESSURE FR    | —         | —  | —                                  | ×   |                        |
| C1706: LOW PRESSURE RR    | —         | —  | —                                  | ×   |                        |
| C1707: LOW PRESSURE RL    | —         | —  | —                                  | ×   |                        |
| C1708: [NO DATA] FL       | —         | —  | —                                  | ×   | <a href="#">WT-26</a>  |
| C1709: [NO DATA] FR       | —         | —  | —                                  | ×   |                        |
| C1710: [NO DATA] RR       | —         | —  | —                                  | ×   |                        |
| C1711: [NO DATA] RL       | —         | —  | —                                  | ×   | <a href="#">WT-29</a>  |
| C1716: [PRESSDATA ERR] FL | —         | —  | —                                  | ×   |                        |
| C1717: [PRESSDATA ERR] FR | —         | —  | —                                  | ×   |                        |
| C1718: [PRESSDATA ERR] RR | —         | —  | —                                  | ×   |                        |
| C1719: [PRESSDATA ERR] RL | —         | —  | —                                  | ×   | <a href="#">WT-30</a>  |
| C1729: VHCL SPEED SIG ERR | —         | —  | —                                  | ×   |                        |
| C1734: CONTROL UNIT       | —         | —  | —                                  | ×   | <a href="#">WT-31</a>  |

\*: For models without steering lock unit, this DTC is not applied.

# REAR WINDOW DEFOGGER DOES NOT OPERATE

< SYMPTOM DIAGNOSIS >

## SYMPTOM DIAGNOSIS

### REAR WINDOW DEFOGGER DOES NOT OPERATE

#### Diagnosis Procedure

INFOID:000000006457043

#### 1. CHECK REAR WINDOW DEFOGGER SWITCH

Check rear window defogger switch.

Refer to [DEF-9. "Component Function Check"](#).

Is the inspection result normal?

YES >> GO TO 2.

NO >> Repair or replace the malfunctioning parts.

#### 2. CHECK REAR WINDOW DEFOGGER RELAY

Check rear window defogger relay.

Refer to [DEF-10. "Component Function Check"](#).

Is the inspection result normal?

YES >> GO TO 3.

NO >> Repair or replace the malfunctioning parts.

#### 3. CHECK REAR WINDOW DEFOGGER

Check rear window defogger.

Refer to [DEF-12. "Component Function Check"](#).

Is the inspection result normal?

YES >> GO TO 4.

NO >> Repair or replace the malfunctioning parts.

#### 4. CONFIRM THE OPERATION

Confirm the operation again.

Is the inspection result normal?

YES >> Check intermittent incident. Refer to [GI-43. "Intermittent Incident"](#).

NO >> GO TO 1.

A  
B  
C  
D  
E  
F  
G  
H  
I  
J  
K  
M  
N  
O  
P

DEF

# REAR WINDOW DEFOGGER AND DOOR MIRROR DEFOGGER DO NOT OPERATE.

< SYMPTOM DIAGNOSIS >

## REAR WINDOW DEFOGGER AND DOOR MIRROR DEFOGGER DO NOT OPERATE.

### Diagnosis Procedure

INFOID:000000006457044

#### 1. CHECK REAR WINDOW DEFOGGER SWITCH

---

Check rear window defogger switch.

Refer to [DEF-9, "Component Function Check"](#).

Is the inspection result normal?

YES >> GO TO 2.

NO >> Repair or replace the malfunctioning parts.

#### 2. CHECK REAR WINDOW DEFOGGER RELAY

---

Check rear window defogger relay.

Refer to [DEF-10, "Component Function Check"](#).

Is the inspection result normal?

YES >> GO TO 3.

NO >> Repair or replace the malfunctioning parts.

#### 3. CONFIRM THE OPERATION

---

Confirm the operation again.

Is the inspection result normal?

YES >> Check intermittent incident. Refer to [GI-43, "Intermittent Incident"](#).

NO >> GO TO 1.



# REAR WINDOW DEFOGGER DOES NOT OPERATE BUT BOTH DOOR MIRROR DEFOGGER OPERATE.

< SYMPTOM DIAGNOSIS >

REAR WINDOW DEFOGGER DOES NOT OPERATE BUT BOTH DOOR MIRROR DEFOGGER OPERATE.

## Diagnosis Procedure

INFOID:000000006457045

### 1. CHECK REAR WINDOW DEFOGGER

Check rear window defogger.

Refer to [DEF-12, "Component Function Check"](#).

Is the inspection result normal?

YES >> GO TO 2.

NO >> Repair or replace the malfunctioning parts.

### 2. CONFIRM THE OPERATION

Confirm the operation again

Is the inspection result normal?

YES >> Check intermittent incident. Refer to [GI-43, "Intermittent Incident"](#).

NO >> GO TO 1.

A  
B  
C  
D  
E  
F  
G  
H  
I  
J  
K  
DEF  
M  
N  
O  
P

# DOOR MIRROR DEFOGGER DOES NOT OPERATE

< SYMPTOM DIAGNOSIS >

---

## DOOR MIRROR DEFOGGER DOES NOT OPERATE BOTH SIDES

BOTH SIDES : Diagnosis Procedure

INFOID:000000006457046

### 1.CHECK DOOR MIRROR DEFOGGER

---

Check door mirror defogger.

Refer to [DEF-15, "Component Function Check"](#).

Is the inspection result normal?

YES >> GO TO 2.

NO >> Repair or replace the malfunctioning parts.

### 2.CONFIRM THE OPERATION

---

Confirm the operation again.

Is the inspection result normal?

YES >> Check intermittent incident. Refer to [GI-43, "Intermittent Incident"](#).

NO >> GO TO 1.

## DRIVER SIDE

DRIVER SIDE : Diagnosis Procedure

INFOID:000000006457047

### 1.CHECK DRIVER SIDE DOOR MIRROR DEFOGGER

---

Check driver side door mirror defogger.

Refer to [DEF-17, "Component Function Check"](#).

Is the inspection result normal?

YES >> GO TO 2.

NO >> Repair or replace the malfunctioning parts.

### 2.CONFIRM THE OPERATION

---

Confirm the operation again.

Is the inspection result normal?

YES >> Check intermittent incident. Refer to [GI-43, "Intermittent Incident"](#).

NO >> GO TO 1.

## PASSENGER SIDE

PASSENGER SIDE : Diagnosis Procedure

INFOID:000000006457048

### 1.CHECK PASSENGER SIDE DOOR MIRROR DEFOGGER.

---

Check passenger side door mirror defogger.

Refer to [DEF-19, "Component Function Check"](#).

Is the inspection result normal?

YES >> GO TO 2.

NO >> Repair or replace the malfunctioning parts.

### 2.CONFIRM THE OPERATION

---

Confirm the operation again.

Is the inspection result normal?

YES >> Check intermittent incident. Refer to [GI-43, "Intermittent Incident"](#).

NO >> GO TO 1.

# ON IS NOT DISPLAYED WHEN PRESSING REAR WINDOW DEFOGGER SWITCH BUT IT IS OPERATED

< SYMPTOM DIAGNOSIS >

## ON IS NOT DISPLAYED WHEN PRESSING REAR WINDOW DEFOGGER SWITCH BUT IT IS OPERATED

### Diagnosis Procedure

INFOID:000000006457049

#### 1.CHECK AV CONTROL UNIT FUNCTION

Check that the AV control unit is operating normally.

Base audio without rear view camera refer to [AV-11, "Work Flow"](#).

Base audio with rear view camera refer to [AV-157, "Work Flow"](#).

BOSE audio without navigation refer to [AV-283, "Work Flow"](#).

BOSE audio with navigation refer to [AV-415, "Work Flow"](#).

Is the inspection result normal?

YES >> GO TO 2.

NO >> Repair or replace the malfunctioning parts.

#### 2.CONFIRM THE OPERATION

Confirm the operation again.

Is the inspection result normal?

YES >> Check intermittent incident. Refer to [GI-43, "Intermittent Incident"](#).

NO >> GO TO 1.

A  
B  
C  
D  
E  
F  
G  
H  
I  
J  
K  
DEF  
M  
N  
O  
P

## REAR WINDOW DEFOGGER INDICATOR DOES NOT ILLUMINATE

< SYMPTOM DIAGNOSIS >

---

### REAR WINDOW DEFOGGER INDICATOR DOES NOT ILLUMINATE

#### Diagnosis Procedure

INFOID:000000006457050

#### 1. CHECK MULTIFUNCTION SWITCH (REAR WINDOW DEFOGGER SWITCH)

---

Check rear window defogger operate.

- YES >> Replace multifunction switch (rear window defogger switch). Refer to [AV-98. "Removal and Installation"](#)
- NO >> Check rear window defogger system. Refer to [DEF-3. "Work Flow"](#)

# PRECAUTIONS

< PRECAUTION >

## PRECAUTION

### PRECAUTIONS

#### Precaution for Supplemental Restraint System (SRS) "AIR BAG" and "SEAT BELT PRE-TENSIONER"

INFOID:000000006457051

The Supplemental Restraint System such as "AIR BAG" and "SEAT BELT PRE-TENSIONER", used along with a front seat belt, helps to reduce the risk or severity of injury to the driver and front passenger for certain types of collision. This system includes seat belt switch inputs and dual stage front air bag modules. The SRS system uses the seat belt switches to determine the front air bag deployment, and may only deploy one front air bag, depending on the severity of a collision and whether the front occupants are belted or unbelted. Information necessary to service the system safely is included in the "SRS AIR BAG" and "SEAT BELT" of this Service Manual.

#### **WARNING:**

Always observe the following items for preventing accidental activation.

- To avoid rendering the SRS inoperative, which could increase the risk of personal injury or death in the event of a collision that would result in air bag inflation, all maintenance must be performed by an authorized NISSAN/INFINITI dealer.
- Improper maintenance, including incorrect removal and installation of the SRS, can lead to personal injury caused by unintentional activation of the system. For removal of Spiral Cable and Air Bag Module, see "SRS AIR BAG".
- Never use electrical test equipment on any circuit related to the SRS unless instructed to in this Service Manual. SRS wiring harnesses can be identified by yellow and/or orange harnesses or harness connectors.

#### PRECAUTIONS WHEN USING POWER TOOLS (AIR OR ELECTRIC) AND HAMMERS

#### **WARNING:**

Always observe the following items for preventing accidental activation.

- When working near the Air Bag Diagnosis Sensor Unit or other Air Bag System sensors with the ignition ON or engine running, never use air or electric power tools or strike near the sensor(s) with a hammer. Heavy vibration could activate the sensor(s) and deploy the air bag(s), possibly causing serious injury.
- When using air or electric power tools or hammers, always switch the ignition OFF, disconnect the battery, and wait at least 3 minutes before performing any service.

#### Precaution for Battery Service

INFOID:000000006457052

Before disconnecting the battery, lower both the driver and passenger windows. This will prevent any interference between the window edge and the vehicle when the door is opened/closed. During normal operation, the window slightly raises and lowers automatically to prevent any window to vehicle interference. The automatic window function will not work with the battery disconnected.

A  
B  
C  
D  
E  
F  
G  
H  
I  
J  
K  
DEF  
M  
N  
O  
P

# FILAMENT

< REMOVAL AND INSTALLATION >

## REMOVAL AND INSTALLATION

### FILAMENT

#### Inspection and Repair

INFOID:000000006457053

#### INSPECTION

1. When measuring voltage, wrap tin foil around the top of the negative probe. Then press the foil against the wire with your finger.

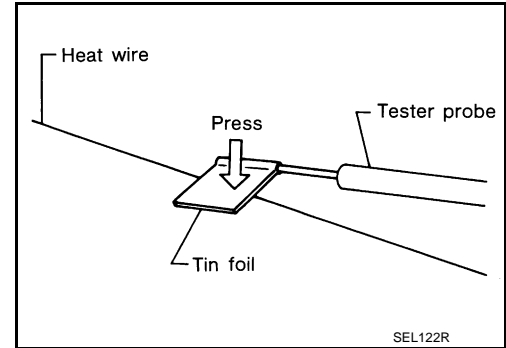

2. Attach probe circuit tester (in Volt range) to middle portion of each filament.

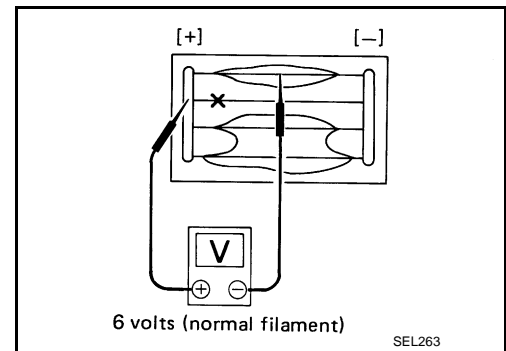

3. If a filament is burned out, circuit tester registers 0 or battery voltage.
4. To locate burned out point, move probe to left and right along filament. Test needle will swing abruptly when probe passes the point.

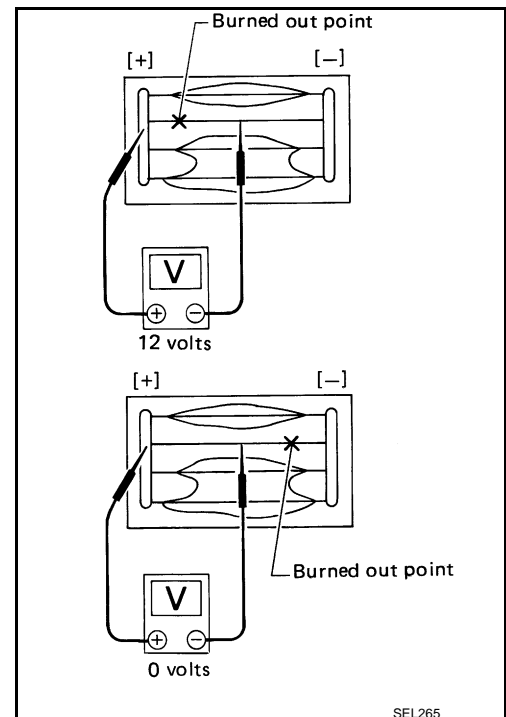

#### REPAIR

##### REPAIR EQUIPMENT

- Conductive silver composition (Dupont No. 4817 or equivalent)

# FILAMENT

## < REMOVAL AND INSTALLATION >

- Ruler 30 cm (11.8 in) long
- Drawing pen
- Heat gun
- Alcohol
- Cloth

### REPAIRING PROCEDURE

1. Wipe broken heat wire and its surrounding area clean with a cloth dampened in alcohol.
2. Apply a small amount of conductive silver composition to tip of drawing pen. Shake silver composition container before use.
3. Place ruler on glass along broken line. Deposit conductive silver composition on break with drawing pen. Slightly overlap existing heat wire on both sides [preferably 5 mm (0.20 in)] of the break.

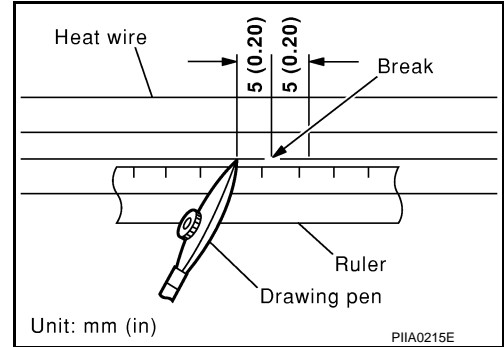

4. After repair has been completed, check repaired wire for continuity. This check should be conducted 10 minutes after silver composition is deposited. Do not touch repaired area while test is being conducted.

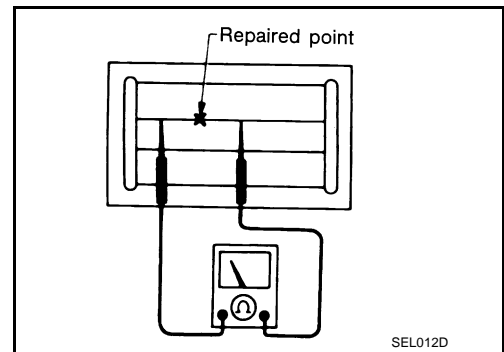

5. Apply a constant stream of hot air directly to the repaired area for approximately 20 minutes with a heat gun. A minimum distance of 3 cm (1.2 in) should be kept between repaired area and hot air outlet. If a heat gun is not available, let the repaired area dry for 24 hours.

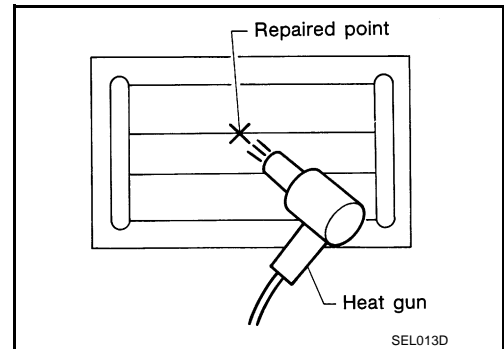

A  
B  
C  
D  
E  
F  
G  
H  
I  
J  
K  
DEF  
M  
N  
O  
P

# CONDENSER

< REMOVAL AND INSTALLATION >

## CONDENSER

### Exploded View

INFOID:000000006457054

Refer to [INT-15, "Exploded View"](#)

### Removal and Installation

INFOID:000000006457055

#### REMOVAL

1. Remove the rear seat cushion and the rear seatback.  
Refer to [SE-201, "Removal and Installation"](#)
2. Remove the rear kickplate, rear wheel well garnish and the rear pillar finisher.  
Refer to [INT-15, "Removal and Installation"](#)
3. Remove bolt (A), and then remove condenser (1) from the vehicle body.

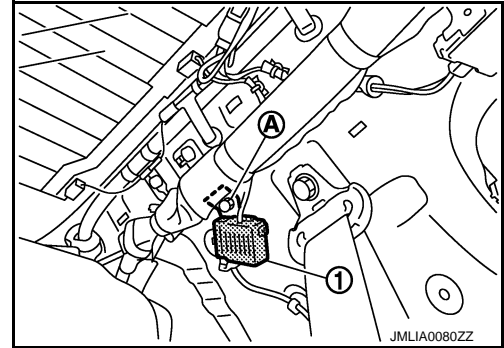

#### INSTALLATION

Install in the reverse order of removal.