

SECTION **EX**
EXHAUST SYSTEM

A
EX

CONTENTS

PRECAUTION	2	PERIODIC MAINTENANCE	4	F
PRECAUTIONS	2	EXHAUST SYSTEM	4	G
Removal and Installation	2	Inspection	4	
PREPARATION	3	REMOVAL AND INSTALLATION	5	
PREPARATION	3	EXHAUST SYSTEM	5	H
Special Service Tool	3	Exploded View	5	
Commercial Service Tool	3	Removal and Installation	6	
		Inspection	6	I

D
E
F
G
H
I
J
K
L
M
N
O
P

PRECAUTIONS

< PRECAUTION >

PRECAUTION

PRECAUTIONS

Removal and Installation

INFOID:000000006454791

CAUTION:

- Be sure to use genuine exhaust system parts or equivalents which are specially designed for heat resistance, corrosion resistance, and shape.
- Perform the operation with the exhaust system fully cooled down because the system will be hot just after engine stops.
- Be careful not to cut your hand on the heat insulator edge.

PREPARATION

< PREPARATION >

PREPARATION

PREPARATION

Special Service Tool

INFOID:000000006454792

A

EX

The actual shapes of Kent-Moore tools may differ from those of special service tools illustrated here.

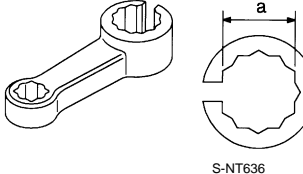
Tool number (Kent-Moore No.) Tool name	Description
KV10114400 (J-38365) Heated oxygen sensor wrench 	Loosening or tightening heated oxygen sensor 2 For 22 mm (0.87 in) (a) width hexagon nut

C

D

E

Commercial Service Tool

INFOID:000000006454793

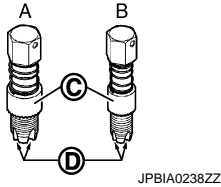
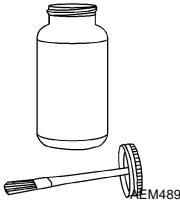
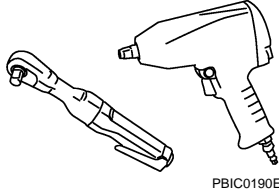
(Kent-Moore No.) Tool name	Description
A: (J-43897-18) B: (J-43897-12) Heated oxygen sensor thread cleaner 	Reconditioning the exhaust system threads before installing a new heated oxygen sensor (Use with anti-seize lubricant shown below.) A: J-43897-18 [18 mm (0.71 in) dia.] for zirconia heated oxygen sensor B: J-43897-12 [12 mm (0.47 in) dia.] for titania heated oxygen sensor C: Mating surface shave cylinder D: Flutes
(—) Anti-seize lubricant (Permatex 133AR or equivalent meeting MIL specification MIL-A-907) 	Lubricating heated oxygen sensor thread cleaner when reconditioning exhaust system threads
(—) Power tool 	Loosening bolts and nuts

F

G

H

I

J

K

L

M

N

O

P

EXHAUST SYSTEM

< PERIODIC MAINTENANCE >

PERIODIC MAINTENANCE

EXHAUST SYSTEM

Inspection

INFOID:000000006454794

Check exhaust pipes, muffler and mounting for improper attachment, leaks, cracks, damage or deterioration.

- If anything is found, repair or replace damaged parts.

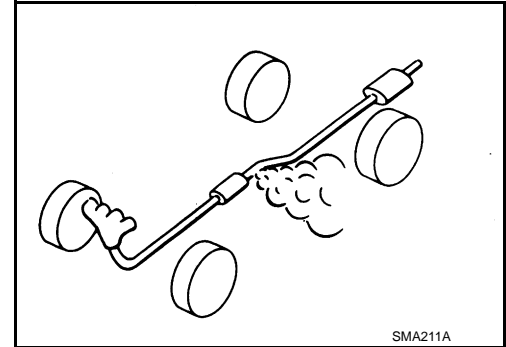

EXHAUST SYSTEM

< REMOVAL AND INSTALLATION >

REMOVAL AND INSTALLATION

EXHAUST SYSTEM

Exploded View

INFOID:000000006454795

A

EX

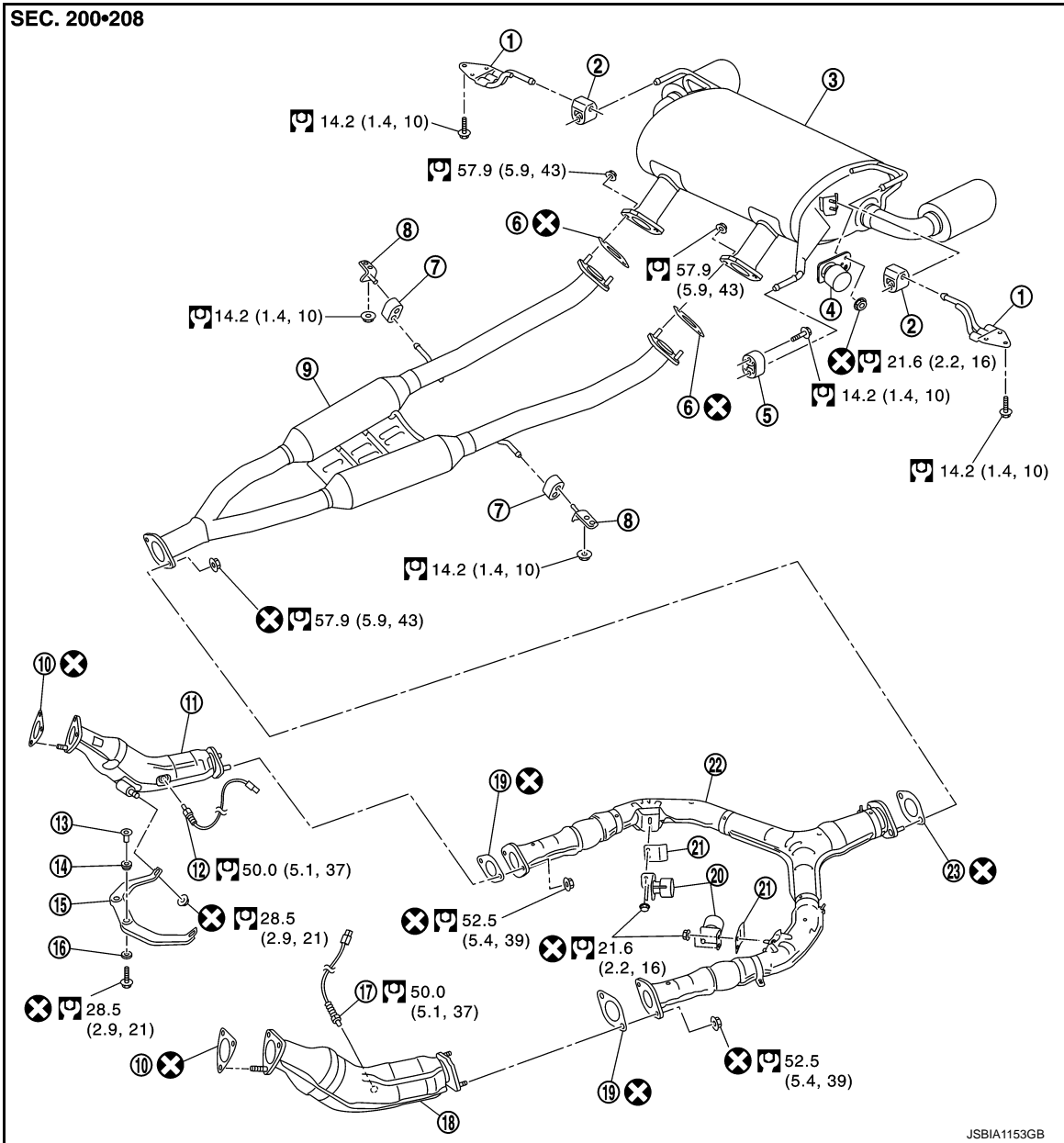

C

D

E

F

G

H

I

J

K

L

M

N

- | | | |
|------------------------|-------------------------------------|-------------------------------------|
| 1. Mounting bracket | 2. Mounting rubber | 3. Main muffler |
| 4. Dynamic damper | 5. Mounting rubber | 6. Gasket |
| 7. Mounting rubber | 8. Mounting bracket | 9. Center muffler |
| 10. Gasket | 11. Three way catalyst (bank 1) | 12. Heated oxygen sensor 2 (bank 1) |
| 13. Collar | 14. Grommet | 15. Exhaust mounting bracket |
| 16. Grommet | 17. Heated oxygen sensor 2 (bank 2) | 18. Three way catalyst (bank 2) |
| 19. Gasket | 20. Dynamic damper | 21. Insulator |
| 22. Exhaust front tube | 23. Gasket | |

Refer to [GI-4, "Components"](#) for symbols in the figure.

O

P

EXHAUST SYSTEM

< REMOVAL AND INSTALLATION >

Removal and Installation

INFOID:000000006454796

REMOVAL

- Disconnect each joint and mounting using power tool.
- Remove heated oxygen sensor 2 as follows:
 - Using heated oxygen sensor wrench [SST: KV10114400 (J-38365)] (C), removal heated oxygen sensor 2.

A : Bank 1

B : Bank 2

↔ : Vehicle front

CAUTION:

Be careful not to damage heated oxygen sensor 2.

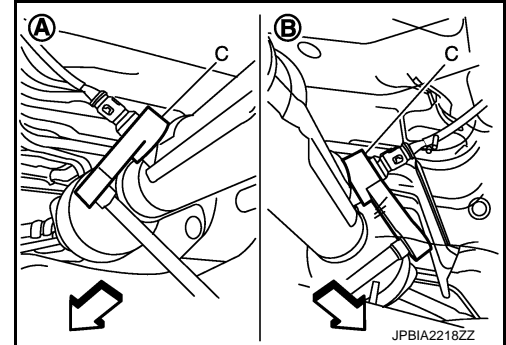

INSTALLATION

Note the following, and install in the reverse order of removal.

- Check for deformation of the grommets (14 and 16 of Components).
- Insert the collar (13 of Components) vertically.
- Temporarily tighten nuts and bolts when installing exhaust pipe assembly. Tighten them to the specified torque when connecting the vehicle rear to the vehicle front.

CAUTION:

- Always replace exhaust tube gaskets with new ones when reassembling.
- Discard any heated oxygen sensor 2 which has been dropped onto a hard surface such as a concrete floor. Use a new one.
- Before installing a new heated oxygen sensor 2, clean exhaust system threads using the heated oxygen sensor thread cleaner (commercial service tool: J-43897-18 or J-43897-12), and apply the anti-seize lubricant (commercial service tool).
- Never over torque heated oxygen sensor 2. Doing so may cause damage to heated oxygen sensor 2, resulting in the "MIL" coming on.
- Prevent rust preventives from adhering to the sensor body.
- If heat insulator is badly deformed, repair or replace it. If deposits such as mud pile up on the heat insulator, remove them.
- When installing heat insulator avoid large gaps or interference between heat insulator and each exhaust pipe.
- Remove deposits from the sealing surface of each connection. Connect them securely to avoid gases leakage.
- Temporarily tighten mounting nuts on the exhaust manifold side and mounting bolts on the vehicle side. Check each part for unusual interference, and then tighten them to the specified torque.
- When installing each mounting rubber, avoid twisting or unusual extension in up/down and right/left directions.

Inspection

INFOID:000000006454797

INSPECTION AFTER INSTALLATION

- Check clearance between tail tube and rear bumper is even.
- With engine running, check exhaust tube joints for gas leakage and unusual noises.
- Check to ensure that mounting brackets and mounting rubbers are installed properly and free from undue stress. Improper installation could result in excessive noise and vibration.