

A
B
C

SECTION INL

INTERIOR LIGHTING SYSTEM

CONTENTS

<p>BASIC INSPECTION 3</p> <p>DIAGNOSIS AND REPAIR WORKFLOW 3</p> <p style="padding-left: 20px;">Work Flow3</p> <p>SYSTEM DESCRIPTION 5</p> <p>INTERIOR ROOM LAMP CONTROL SYSTEM 5</p> <p style="padding-left: 20px;">System Diagram5</p> <p style="padding-left: 20px;">System Description5</p> <p style="padding-left: 20px;">Component Parts Location7</p> <p style="padding-left: 20px;">Component Description8</p> <p>INTERIOR ROOM LAMP BATTERY SAVER SYSTEM 9</p> <p style="padding-left: 20px;">System Diagram9</p> <p style="padding-left: 20px;">System Description9</p> <p style="padding-left: 20px;">Component Parts Location10</p> <p style="padding-left: 20px;">Component Description10</p> <p>ILLUMINATION CONTROL SYSTEM12</p> <p style="padding-left: 20px;">System Diagram12</p> <p style="padding-left: 20px;">System Description12</p> <p style="padding-left: 20px;">Component Parts Location13</p> <p style="padding-left: 20px;">Component Description13</p> <p>DIAGNOSIS SYSTEM (BCM)14</p> <p>COMMON ITEM14</p> <p style="padding-left: 20px;">COMMON ITEM : CONSULT-III Function (BCM - COMMON ITEM)14</p> <p>INT LAMP15</p> <p style="padding-left: 20px;">INT LAMP : CONSULT-III Function (BCM - INT LAMP)16</p> <p>BATTERY SAVER17</p> <p style="padding-left: 20px;">BATTERY SAVER : CONSULT-III Function (BCM - BATTERY SAVER)17</p> <p>DTC/CIRCUIT DIAGNOSIS19</p>	<p>POWER SUPPLY AND GROUND CIRCUIT19</p> <p>BCM19</p> <p style="padding-left: 20px;">BCM : Diagnosis Procedure19</p> <p>INTERIOR ROOM LAMP POWER SUPPLY CIRCUIT20</p> <p style="padding-left: 20px;">Description20</p> <p style="padding-left: 20px;">Component Function Check20</p> <p style="padding-left: 20px;">Diagnosis Procedure20</p> <p>INTERIOR ROOM LAMP CONTROL CIRCUIT22</p> <p style="padding-left: 20px;">Description22</p> <p style="padding-left: 20px;">Component Function Check22</p> <p style="padding-left: 20px;">Diagnosis Procedure22</p> <p>STEP LAMP CIRCUIT24</p> <p style="padding-left: 20px;">Description24</p> <p style="padding-left: 20px;">Component Function Check24</p> <p style="padding-left: 20px;">Diagnosis Procedure24</p> <p>TRUNK ROOM LAMP CIRCUIT26</p> <p style="padding-left: 20px;">Description26</p> <p style="padding-left: 20px;">Component Function Check26</p> <p style="padding-left: 20px;">Diagnosis Procedure26</p> <p>PUSH-BUTTON IGNITION SWITCH ILLUMINATION CIRCUIT28</p> <p style="padding-left: 20px;">Description28</p> <p style="padding-left: 20px;">Component Function Check28</p> <p style="padding-left: 20px;">Diagnosis Procedure28</p> <p>INTERIOR ROOM LAMP CONTROL SYSTEM30</p> <p style="padding-left: 20px;">Wiring Diagram - INTERIOR ROOM LAMP -30</p> <p>ILLUMINATION40</p> <p style="padding-left: 20px;">Wiring Diagram - ILLUMINATION -40</p> <p>ECU DIAGNOSIS INFORMATION55</p>
--	--

A
B
C
D
E
F
G
H
I
J
K
INL



M
N
O
P

BCM (BODY CONTROL MODULE)	55	Replacement	106
Reference Value	55	VANITY MIRROR LAMP	107
Wiring Diagram - BCM -	78	Exploded View	107
Fail-safe	83	Replacement	107
DTC Inspection Priority Chart	85	CIGARETTE LIGHTER ILLUMINATION	108
DTC Index	86	Exploded View	108
COMBINATION METER	89	Replacement	108
Reference Value	89	GLOVE BOX LAMP	109
Wiring Diagram - METER -	92	Exploded View	109
Fail-safe	102	Replacement	109
DTC Index	103	STEP LAMP	110
SYMPTOM DIAGNOSIS	104	Exploded View	110
INTERIOR LIGHTING SYSTEM SYMPTOMS.	104	Removal and Installation	110
Symptom Table	104	Replacement	110
PRECAUTION	105	TRUNK ROOM LAMP	111
PRECAUTIONS	105	Exploded View	111
Precaution for Supplemental Restraint System (SRS) "AIR BAG" and "SEAT BELT PRE-TEN- SIONER"	105	Removal and Installation	111
Precaution for Battery Service	105	Replacement	111
REMOVAL AND INSTALLATION	106	SERVICE DATA AND SPECIFICATIONS (SDS)	112
MAP LAMP	106	SERVICE DATA AND SPECIFICATIONS (SDS)	112
Exploded View	106	Bulb Specifications	112
Removal and Installation	106		

DIAGNOSIS AND REPAIR WORKFLOW

< BASIC INSPECTION >

BASIC INSPECTION

DIAGNOSIS AND REPAIR WORKFLOW

Work Flow

INFOID:000000006456929

OVERALL SEQUENCE

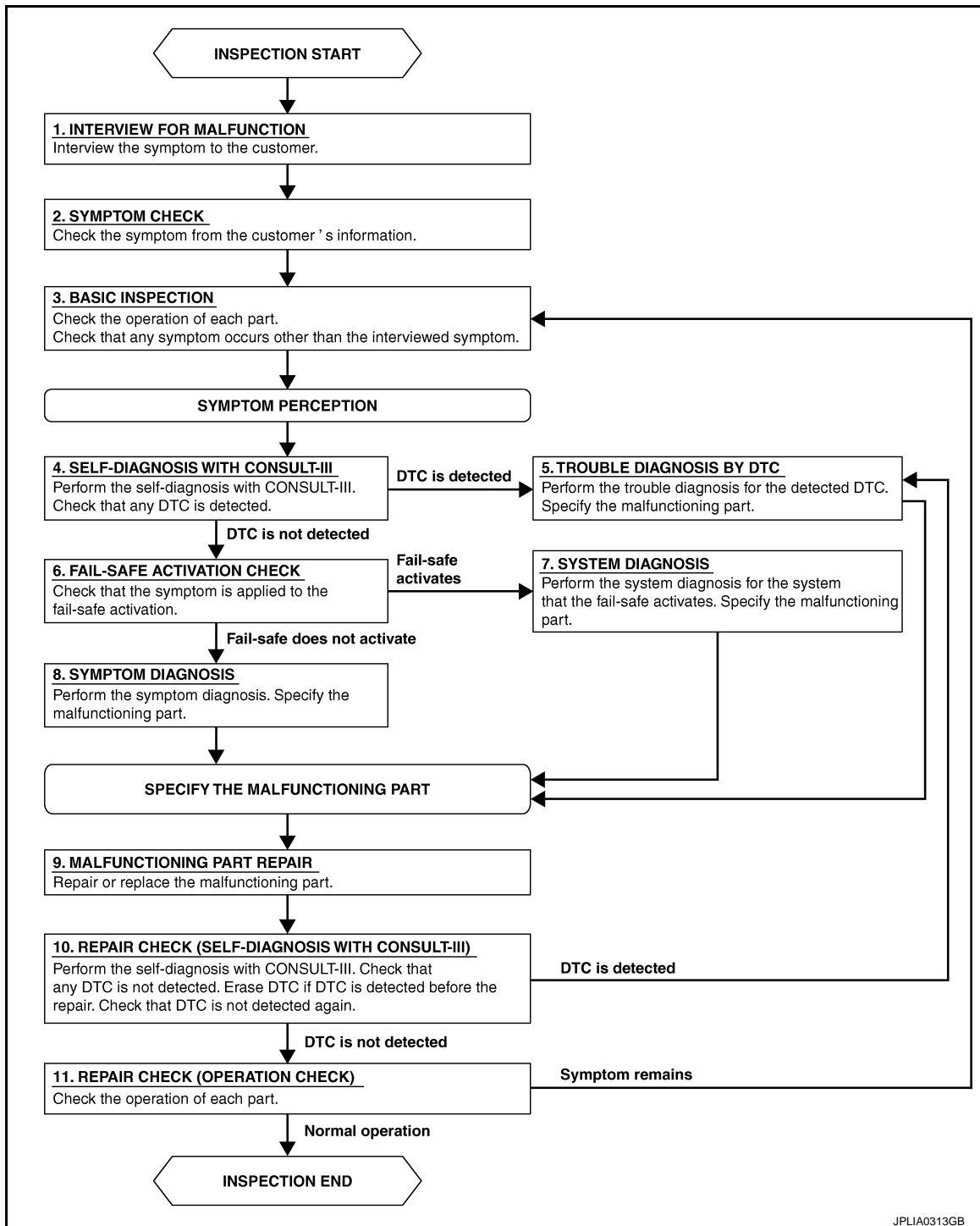

DETAILED FLOW

1. INTERVIEW FOR MALFUNCTION

Interview the symptom to the customer.

DIAGNOSIS AND REPAIR WORKFLOW

< BASIC INSPECTION >

>> GO TO 2.

2. SYMPTOM CHECK

Check the symptom from the customer's information.

>> GO TO 3.

3. BASIC INSPECTION

Check the operation of each part. Check that any symptom occurs other than the interviewed symptom.

>> GO TO 4.

4. SELF-DIAGNOSIS WITH CONSULT-III

Perform the self-diagnosis with CONSULT-III. Check that any DTC is detected.

Is any DTC detected?

YES >> GO TO 5.

NO >> GO TO 6.

5. TROUBLE DIAGNOSIS BY DTC

Perform the trouble diagnosis for the detected DTC. Specify the malfunctioning part.

>> GO TO 9.

6. FAIL-SAFE ACTIVATION CHECK

Check that the symptom is applied to the fail-safe activation.

Does the fail-safe activate?

YES >> GO TO 7.

NO >> GO TO 8.

7. SYSTEM DIAGNOSIS

Perform the system diagnosis for the system that the fail-safe activates. Specify the malfunctioning part.

>> GO TO 9.

8. SYMPTOM DIAGNOSIS

Perform the symptom diagnosis. Specify the malfunctioning part.

>> GO TO 9.

9. MALFUNCTION PART REPAIR

Repair or replace the malfunctioning part.

>> GO TO 10.

10. REPAIR CHECK (SELF-DIAGNOSIS WITH CONSULT-III)

Perform the self-diagnosis with CONSULT-III. Check that any DTC is not detected. Erase DTC if DTC is detected before the repair. Check that DTC is not detected again.

Is any DTC detected?

YES >> GO TO 5.

NO >> GO TO 11.

11. REPAIR CHECK (OPERATION CHECK)

Check the operation of each part.

Does it operate normally?

YES >> INSPECTION END

NO >> GO TO 3.

INTERIOR ROOM LAMP CONTROL SYSTEM

< SYSTEM DESCRIPTION >

SYSTEM DESCRIPTION

INTERIOR ROOM LAMP CONTROL SYSTEM

System Diagram

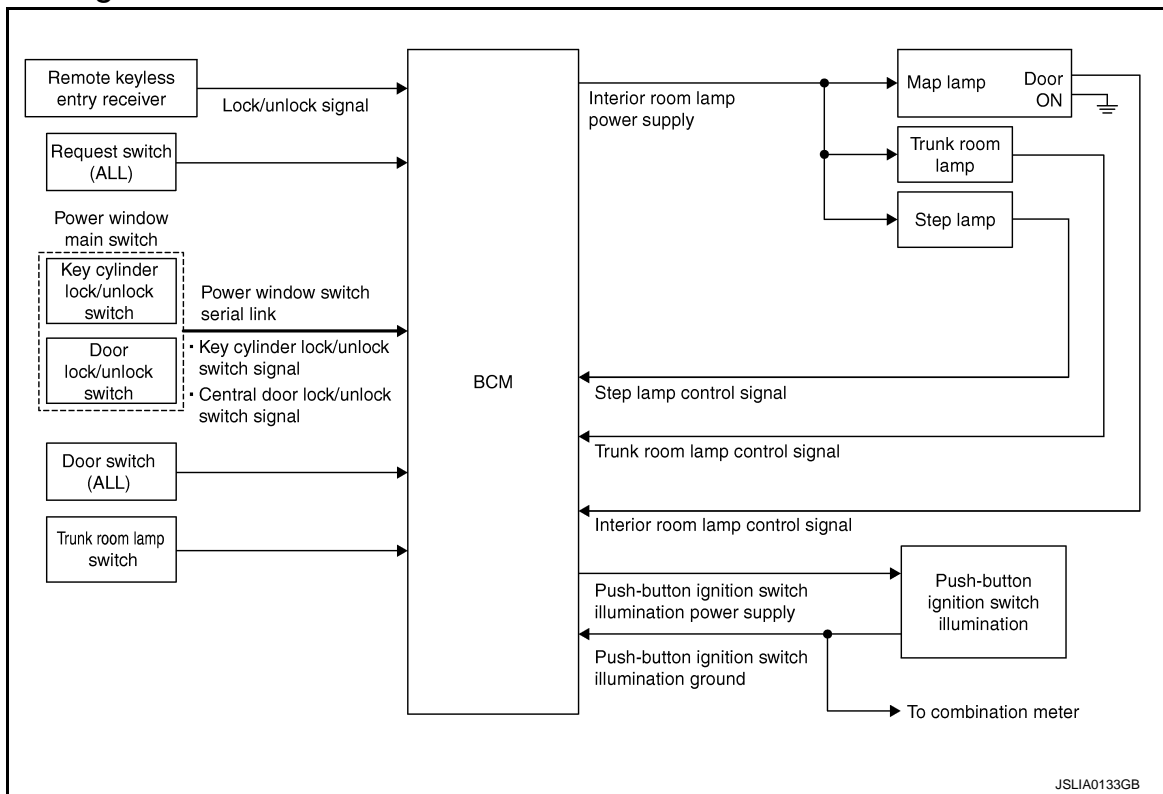

System Description

INFOID:000000006456931

OUTLINE

- Interior room lamps* are controlled by interior room lamp timer control function of BCM.
- *: Map lamp (when map lamp switch is in DOOR position).
- Trunk room lamp is controlled by trunk room lamp control function of BCM.
- Step lamp is controlled by step lamp control function of BCM.
- Push-button ignition switch illumination is controlled by the push-button ignition switch illumination control function of BCM.

INTERIOR ROOM LAMP TIMER CONTROL

Interior Room Lamp Timer Basic Operation

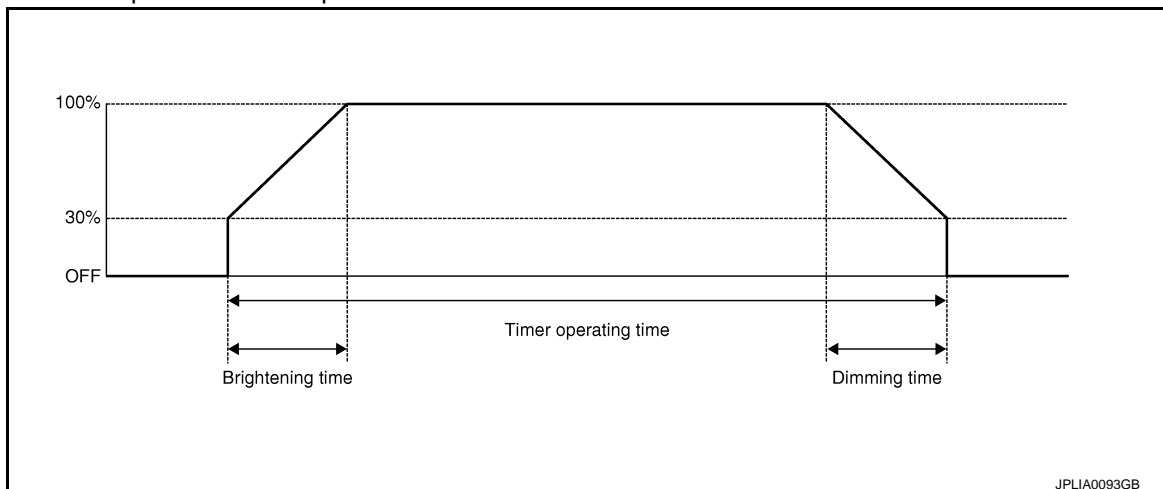

INTERIOR ROOM LAMP CONTROL SYSTEM

< SYSTEM DESCRIPTION >

- The interior room lamp turns ON and OFF (gradual brightening and dimming) by the interior room timer.
- BCM judges the vehicle condition with the following items. It activates the interior room timer.
 - Ignition switch status
 - Door switch signal (ALL)
 - Door lock/unlock signal (Remote keyless entry receiver, each request switch, key cylinder lock/unlock switch, central door lock/unlock switch)

NOTE:

Each function of interior room lamp timer can be set by CONSULT-III. Refer to [INL-16, "INT LAMP : CONSULT-III Function \(BCM - INT LAMP\)"](#).

Interior Room Lamp ON Operation

- BCM always turns the interior room lamp ON when any door opens.
- BCM activates the interior room lamp timer in any of the following conditions to turn the interior room lamp ON for a period of time.
 - Any door opens before all doors close.
 - Ignition switch is turned ON → OFF.
 - Any door unlock signal is detected when all doors close with ignition switch OFF.

NOTE:

Restart the timer if new condition is input during the timer operating time.

Interior Room Lamp OFF Operation

BCM stops the timer in any of the following conditions to turns the interior room lamp OFF.

- The timer operating time is expired.
- Ignition switch position is other than OFF with all doors close.
- Any door lock operation is detected with all doors close.

TRUNK ROOM LAMP CONTROL

BCM controls the trunk room lamp (ground-side) to turn ON with the trunk room lamp switch ON.

STEP LAMP CONTROL

BCM controls the step lamp (ground-side) to turn ON with any door switch ON.

PUSH-BUTTON IGNITION SWITCH ILLUMINATION CONTROL

Push-button Ignition Switch Illumination Basic Operation

- BCM provides the power supply and the ground to turn the push-button ignition switch illumination ON.
- BCM cuts the ground supply while the each illumination (tail lamp) ON. BCM switches to the ground control with the meter illumination control function.

Push-button Ignition Switch Illumination ON Operation

BCM turns the push-button ignition switch illumination ON in the following conditions.

- Ignition switch ON
- Each illumination (tail lamp) ON
- Any of the following conditions with ignition switch OFF
 - Engine start permission is entered.
 - Intelligent Key inserted into the key slot.
 - Driver door is LOCK → UNLOCK.
 - Driver door is open.

Push-button Ignition Switch Illumination OFF Operation

BCM turns the push-button ignition switch illumination OFF in any of the following conditions.

- The push-button ignition switch illumination ON conditions do not satisfy.
- All of the following conditions with ignition switch OFF
 - Each illumination (tail lamp) OFF
 - The push-button ignition switch illumination ON conditions do not change (15 seconds after the ignition switch OFF) or the driver door is UNLOCK → LOCK.

INTERIOR ROOM LAMP CONTROL SYSTEM

< SYSTEM DESCRIPTION >

Component Parts Location

INFOID:000000006456932

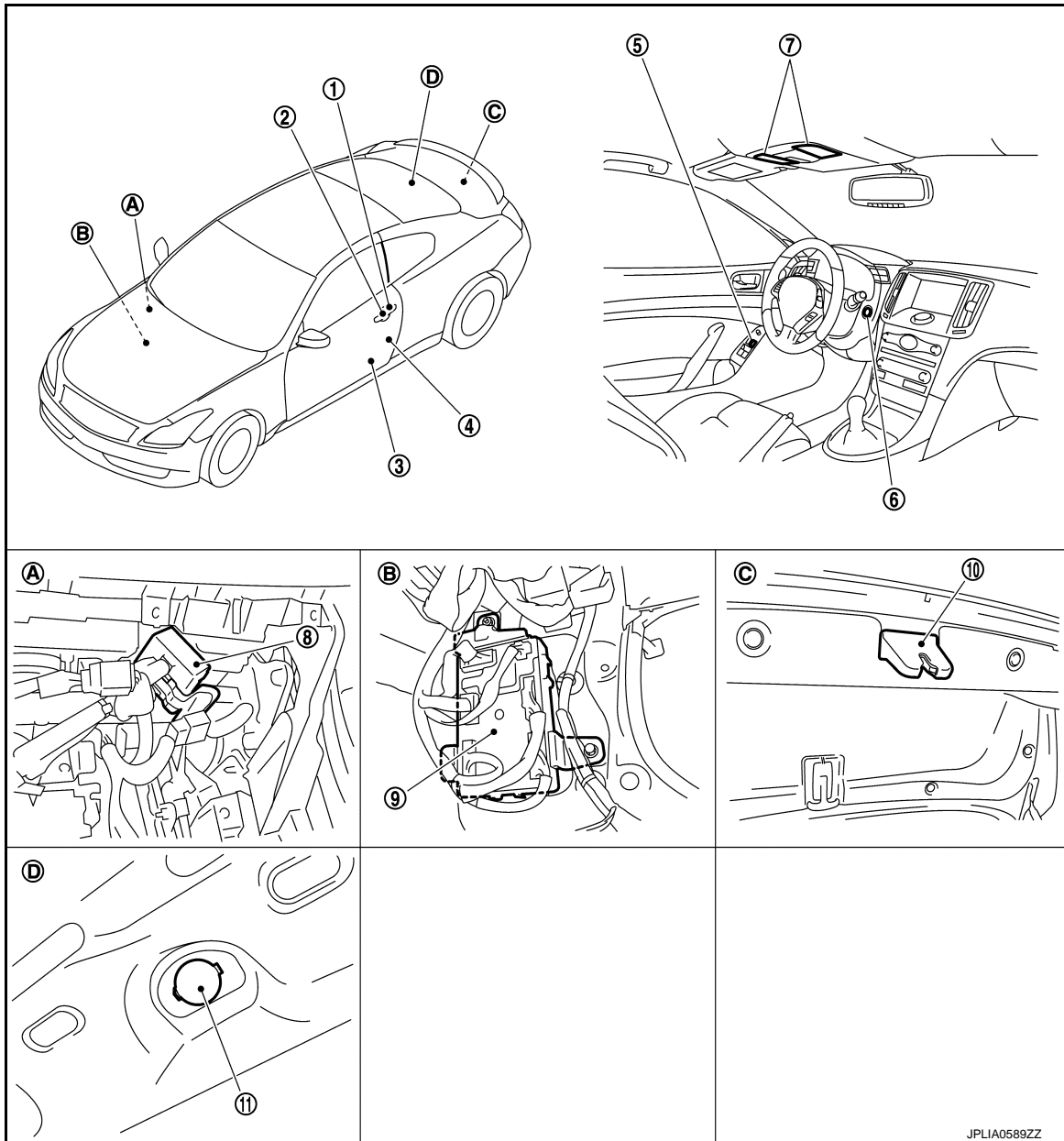

- | | | |
|----------------------------|-------------------------------------|--|
| 1. Key cylinder switch | 2. Request switch | 3. Step lamp |
| 4. Door switch | 5. Door lock and unlock switch | 6. Push-button ignition switch
(Push-button ignition switch illumination) |
| 7. Map lamp | 8. Remote keyless entry receiver | 9. BCM |
| 10. Trunk room lamp switch | 11. Trunk room lamp | |
| A. Behind the glove box | B. Dash side lower (passenger side) | C. Trunk lid lock assembly |
| D. Trunk room upward | | |

A
B
C
D
E
F
G
H
I
J
K
L
M
N
O
P

INL

JPLIA0589ZZ

INTERIOR ROOM LAMP CONTROL SYSTEM

< SYSTEM DESCRIPTION >

Component Description

INFOID:000000006456933

Part	Description
BCM	<ul style="list-style-type: none">• Activates the interior room lamp timer depending on the vehicle condition to turn the interior room lamp ON/OFF.• Turns the trunk room lamp ON /OFF according to the trunk room lamp switch status.• Turns the step lamp ON /OFF according to any door switch status.
Remote keyless entry receiver	Transmits the lock/unlock signal to BCM.
<ul style="list-style-type: none">• Door lock and unlock switch• Key cylinder switch	Transmits a switch signal by power window switch serial link.
<ul style="list-style-type: none">• Request switch• Door switch• Trunk room lamp switch	Inputs a switch signal to BCM.

INTERIOR ROOM LAMP BATTERY SAVER SYSTEM

< SYSTEM DESCRIPTION >

INTERIOR ROOM LAMP BATTERY SAVER SYSTEM

System Diagram

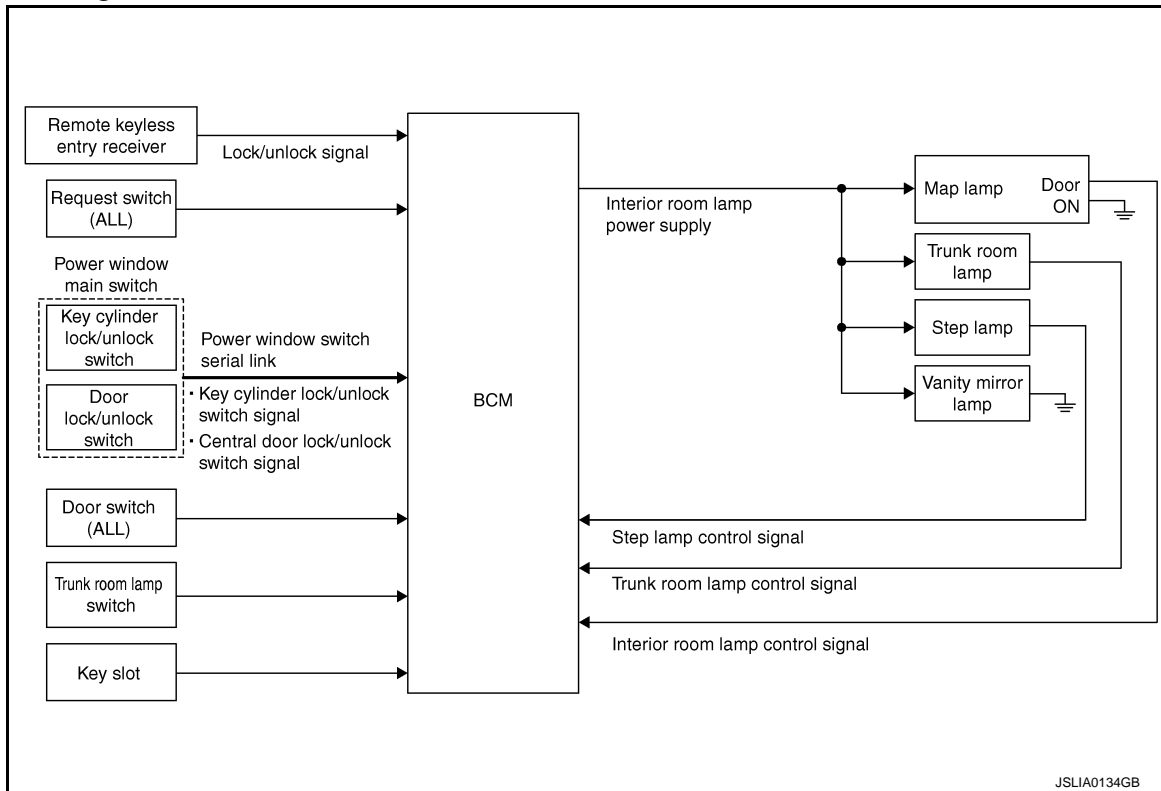

System Description

INFOID:000000006456935

OUTLINE

- Interior room lamp battery saver is controlled by BCM.
- BCM turns applicable lamps OFF depending on the vehicle condition. This function prevents the battery from over-discharging if the driver neglect turning OFF the any lamps.

Applicable lamps

- Map lamp
- Step lamp
- Trunk room lamp
- Vanity mirror lamp

INTERIOR ROOM LAMP BATTERY SAVER FUNCTION

- When the ignition switch is turned OFF, BCM operates the timer for a period of time to cut the interior room lamp power supply.
- BCM restart the timer when any of the following signals changes while operating the timer.
 - Ignition switch status
 - Door switch signal (ALL)
 - Door lock/unlock signal (Remote keyless entry receiver, each request switch, key cylinder lock/unlock switch, central door lock/unlock switch)
 - Trunk room lamp switch signal
 - Key switch signal (Key slot)
- BCM provides the interior room lamp power supply continuously when the ignition switch position is other than OFF.

NOTE:

Each function of interior room lamp battery saver can be set by CONSULT-III. Refer to [INL-17, "BATTERY SAVER : CONSULT-III Function \(BCM - BATTERY SAVER\)"](#).

INTERIOR ROOM LAMP BATTERY SAVER SYSTEM

< SYSTEM DESCRIPTION >

Component Parts Location

INFOID:000000006456936

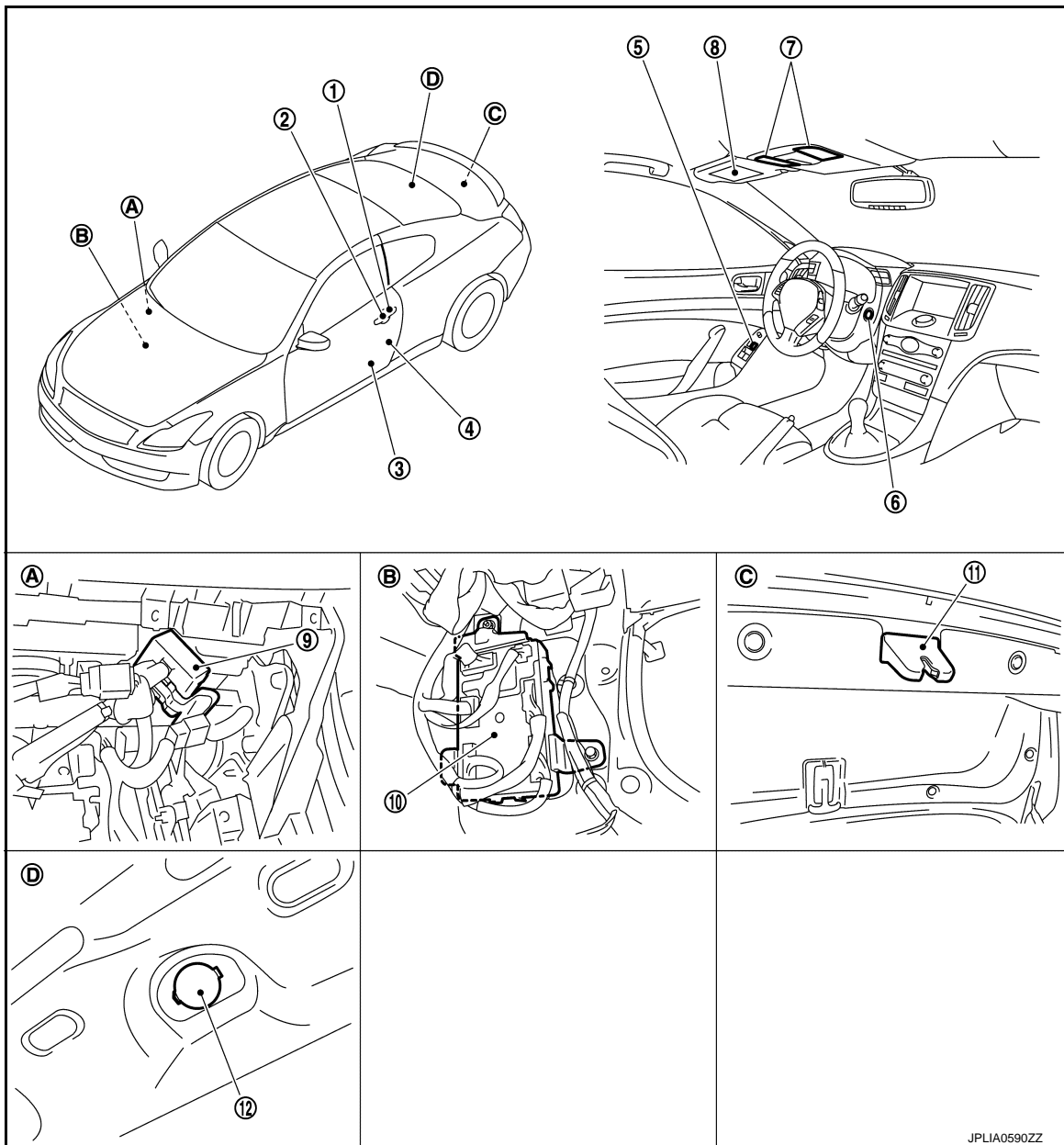

- | | | |
|-------------------------|-------------------------------------|----------------------------------|
| 1. Key cylinder switch | 2. Request switch | 3. Step lamp |
| 4. Door switch | 5. Door lock and unlock switch | 6. Push-button ignition switch |
| 7. Map lamp | 8. Vanity mirror lamp | 9. Remote keyless entry receiver |
| 10. BCM | 11. Trunk room lamp switch | 12. Trunk room lamp |
| A. Behind the glove box | B. Dash side lower (passenger side) | C. Trunk lid lock assembly |
| D. Trunk room upward | | |

Component Description

INFOID:000000006456937

Part	Description
BCM	Operates the interior room lamp battery saver depending on the vehicle condition to cut the interior room lamp power supply.
Remote keyless entry receiver	Transmits the lock/unlock signal to BCM.

INTERIOR ROOM LAMP BATTERY SAVER SYSTEM

< SYSTEM DESCRIPTION >

Part	Description
<ul style="list-style-type: none">• Door lock and unlock switch• Key cylinder switch	Transmits a switch signal by power window switch serial link.
<ul style="list-style-type: none">• Request switch• Door switch• Trunk room lamp switch	Inputs a switch signal to BCM.
Key slot	Inputs the key switch status to BCM.

A

B

C

D

E

F

G

H

I

J

K

INL

M

N

O

P

ILLUMINATION CONTROL SYSTEM

< SYSTEM DESCRIPTION >

ILLUMINATION CONTROL SYSTEM

System Diagram

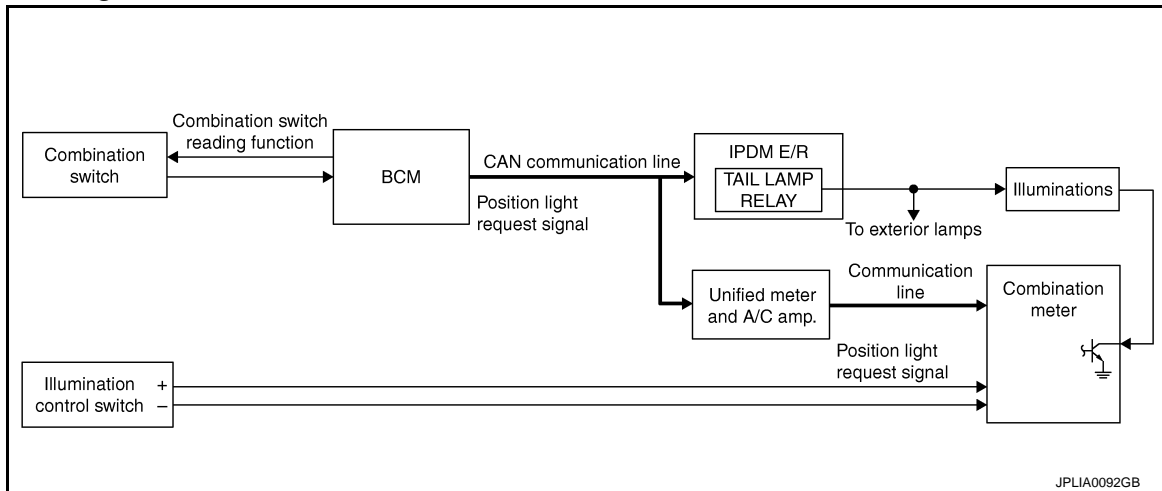

System Description

INFOID:000000006456939

OUTLINE

Each illumination lamp is controlled by each function of BCM, IPDM E/R and combination meter.

Control by BCM

- Combination switch reading function
- Headlamp control function

Control by IPDM E/R

- Relay control function

Control by combination meter

- Meter illumination control function (Refer to [MWI-25, "METER ILLUMINATION CONTROL : System Diagram."](#))

ILLUMINATION CONTROL

- BCM detects the combination switch condition by the combination switch reading function.
- BCM transmits position light request signal to IPDM E/R and combination meter (through the unified meter and A/C amp.) according to tail lamp ON condition.

Tail lamp ON condition

- Lighting switch 1ST
- Lighting switch 2ND
- Lighting switch AUTO, and the auto light function ON judgment (With auto light system)
- IPDM E/R turns the integrated tail lamp relay ON according to position light request signal. It provides the power supply to each illumination lamp.
- Combination meter enters in the nighttime mode according to position light request signal. Under the nighttime mode the combination meter controls the illuminance by controlling the each illumination lamp (ground side).

ILLUMINATION CONTROL SYSTEM

< SYSTEM DESCRIPTION >

Component Parts Location

INFOID:000000006456940

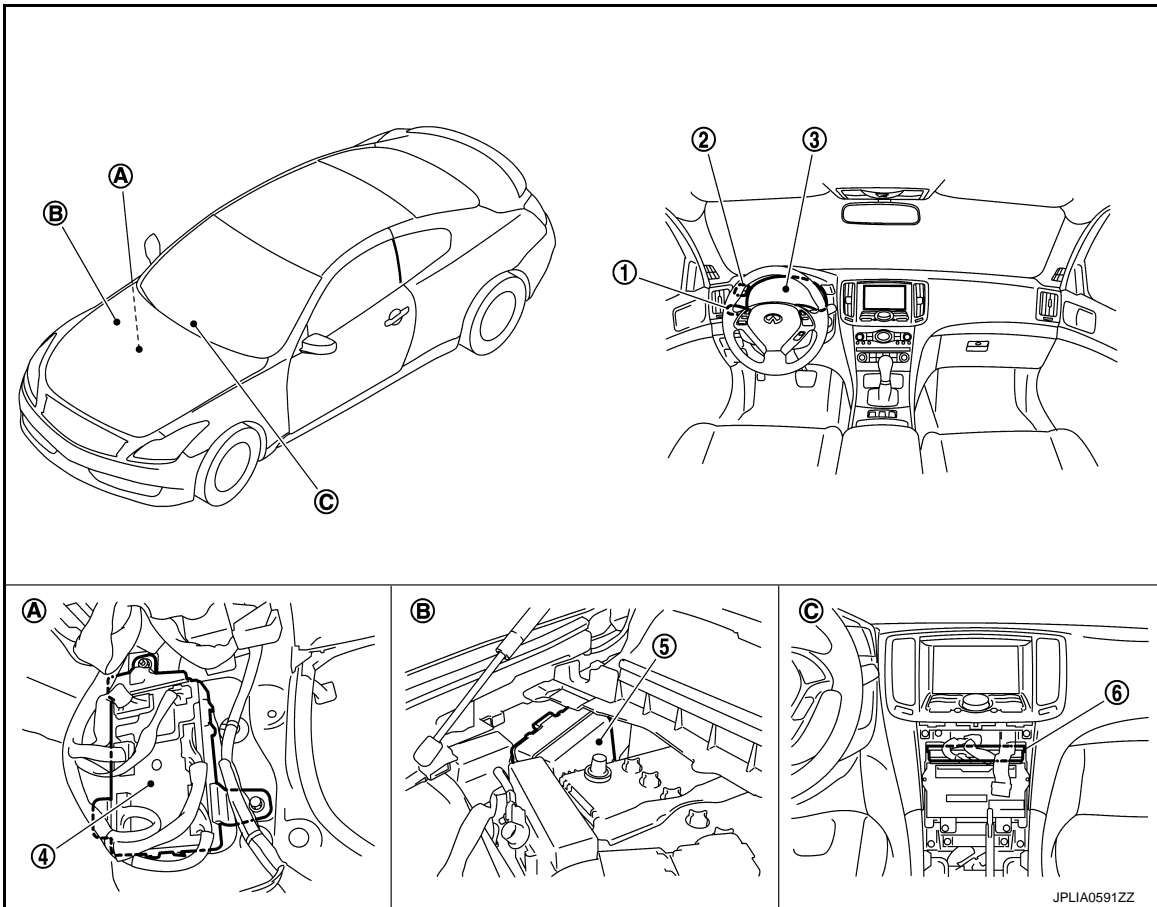

- | | | |
|------------------------------------|--------------------------------|-------------------------------|
| 1. Combination switch | 2. Illumination control switch | 3. Combination meter |
| 4. BCM | 5. IPDM E/R | 6. Unified meter and A/C amp. |
| A Dash side lower (passenger side) | B. Engine room dash panel (RH) | C. Behind the cluster lid C |

Component Description

INFOID:000000006456941

Part	Description
BCM	<ul style="list-style-type: none"> • Detects each switch condition by the combination switch reading function. • Judges the illumination lamp ON/OFF status depending on the vehicle condition. And then it transmits position light request signal to IPDM E/R and combination meter [with CAN communication (through the unified meter and A/C amp.)].
IPDM E/R	Controls the integrated relay according to the request from BCM (with CAN communication).
Combination meter	<ul style="list-style-type: none"> • Enters in nighttime mode according to the request from BCM (with CAN communication). • Controls the each illumination in the nighttime mode. Refer to MWI-25, "METER ILLUMINATION CONTROL : System Diagram" .
Combination switch (Lighting & turn signal switch)	Refer to BCS-7, "System Diagram" .

DIAGNOSIS SYSTEM (BCM)

< SYSTEM DESCRIPTION >

DIAGNOSIS SYSTEM (BCM)

COMMON ITEM

COMMON ITEM : CONSULT-III Function (BCM - COMMON ITEM)

INFOID:000000006456942

APPLICATION ITEM

CONSULT-III performs the following functions via CAN communication with BCM.

Diagnosis mode	Function Description
Work Support	Changes the setting for each system function.
Self Diagnostic Result	Displays the diagnosis results judged by BCM.
CAN Diag Support Monitor	Monitors the reception status of CAN communication viewed from BCM. Refer to CONSULT-III operation manual.
Data Monitor	The BCM input/output signals are displayed.
Active Test	The signals used to activate each device are forcibly supplied from BCM.
Ecu Identification	The BCM part number is displayed.
Configuration	This function is not used even though it is displayed.

SYSTEM APPLICATION

BCM can perform the following functions for each system.

NOTE:

It can perform the diagnosis modes except the following for all sub system selection items.

×: Applicable item

System	Sub system selection item	Diagnosis mode		
		Work Support	Data Monitor	Active Test
Door lock	DOOR LOCK	×	×	×
Rear window defogger	REAR DEFOGGER		×	×
Warning chime	BUZZER		×	×
Interior room lamp timer	INT LAMP	×	×	×
Exterior lamp	HEAD LAMP	×	×	×
Wiper and washer	WIPER	×	×	×
Turn signal and hazard warning lamps	FLASHER	×	×	×
—	AIR CONDITONER*			
<ul style="list-style-type: none"> • Intelligent Key system • Engine start system 	INTELLIGENT KEY	×	×	×
Combination switch	COMB SW		×	
Body control system	BCM	×		
IVIS - NATS	IMMU		×	×
Interior room lamp battery saver	BATTERY SAVER	×	×	×
Trunk lid open	TRUNK		×	×
Vehicle security system	THEFT ALM	×	×	×
RAP system	RETAINED PWR*		×	
Signal buffer system	SIGNAL BUFFER		×	×
TPMS	TPMS (AIR PRESSURE MONITOR)	×	×	×

NOTE:

*: This item is displayed, but is not used.

FREEZE FRAME DATA (FFD)

The BCM records the following vehicle condition at the time a particular DTC is detected, and displays on CONSULT-III.

DIAGNOSIS SYSTEM (BCM)

< SYSTEM DESCRIPTION >

CONSULT screen item	Indication/Unit	Description		
Vehicle Speed	km/h	Vehicle speed of the moment a particular DTC is detected		A
Odo/Trip Meter	km	Total mileage (Odometer value) of the moment a particular DTC is detected		
Vehicle Condition	SLEEP>LOCK	Power position status of the moment a particular DTC is detected	While turning BCM status from low power consumption mode to normal mode (Power supply position is "LOCK")	B
	SLEEP>OFF		While turning BCM status from low power consumption mode to normal mode (Power supply position is "OFF".)	C
	LOCK>ACC		While turning power supply position from "LOCK" to "ACC"	
	ACC>ON		While turning power supply position from "ACC" to "IGN"	D
	RUN>ACC		While turning power supply position from "RUN" to "ACC" (Vehicle is stopping and selector lever is except P position.)	
	CRANK>RUN		While turning power supply position from "CRANKING" to "RUN" (From cranking up the engine to run it)	E
	RUN>URGENT		While turning power supply position from "RUN" to "ACC" (Emergency stop operation)	
	ACC>OFF		While turning power supply position from "ACC" to "OFF"	F
	OFF>LOCK		While turning power supply position from "OFF" to "LOCK"	
	OFF>ACC		While turning power supply position from "OFF" to "ACC"	G
	ON>CRANK		While turning power supply position from "IGN" to "CRANKING"	
	OFF>SLEEP		While turning BCM status from normal mode (Power supply position is "OFF".) to low power consumption mode	H
	LOCK>SLEEP		While turning BCM status from normal mode (Power supply position is "LOCK".) to low power consumption mode	
	LOCK		Power supply position is "LOCK" (Ignition switch OFF with steering is locked.)	I
	OFF		Power supply position is "OFF" (Ignition switch OFF with steering is unlocked.)	J
	ACC		Power supply position is "ACC" (Ignition switch ACC)	
	ON		Power supply position is "IGN" (Ignition switch ON with engine stopped)	K
ENGINE RUN	Power supply position is "RUN" (Ignition switch ON with engine running)			
CRANKING	Power supply position is "CRANKING" (At engine cranking)	INL		
IGN Counter	0 - 39	The number of times that ignition switch is turned ON after DTC is detected <ul style="list-style-type: none"> • The number is 0 when a malfunction is detected now. • The number increases like 1 → 2 → 3...38 → 39 after returning to the normal condition whenever ignition switch OFF → ON. • The number is fixed to 39 until the self-diagnosis results are erased if it is over 39. 		M

INT LAMP

DIAGNOSIS SYSTEM (BCM)

< SYSTEM DESCRIPTION >

INT LAMP : CONSULT-III Function (BCM - INT LAMP)

INFOID:000000006456943

WORK SUPPORT

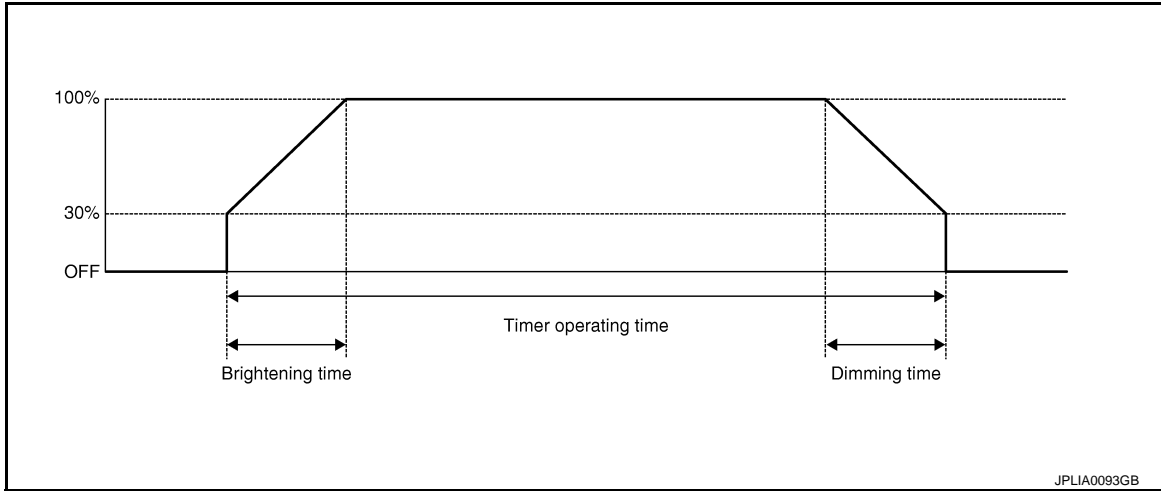

Service item	Setting item	Setting	
SET I/L D-UNLCK INTCON	ON*	With the interior room lamp timer function	
	OFF	Without the interior room lamp timer function	
ROOM LAMP TIMER SET	MODE 2	7.5 sec.	Sets the interior room lamp ON time. (Timer operating time)
	MODE 3*	15 sec.	
	MODE 4	30 sec.	
ROOM LAMP ON TIME SET	MODE 1	0.5 sec.	Sets the interior room lamp gradual brightening time.
	MODE 2*	1 sec.	
	MODE 3	2 sec.	
	MODE 4	3 sec.	
	MODE 5	0 sec.	
ROOM LAMP OFF TIME SET	MODE 1	0.5 sec.	Sets the interior room lamp gradual dimming time.
	MODE 2	1 sec.	
	MODE 3	2 sec.	
	MODE 4*	3 sec.	
R LAMP TIMER LOGIC SET	MODE 1*	Interior room lamp timer activates with synchronizing all doors.	
	MODE 2	Interior room lamp timer activates with synchronizing the driver door only.	

*: Factory setting

DATA MONITOR

Monitor item [Unit]	Description
REQ SW-DR [On/Off]	The switch status input from request switch (driver side)
REQ SW-AS [On/Off]	The switch status input from front request switch (passenger side)
PUSH SW [On/Off]	The switch status input from push-button ignition switch
ACC RLY-F/B [On/Off]	NOTE: The item is indicated, but not monitored.
KEY SW-SLOT [On/Off]	Key switch status input from key slot

DIAGNOSIS SYSTEM (BCM)

< SYSTEM DESCRIPTION >

Monitor item [Unit]	Description
DOOR SW-DR [On/Off]	The switch status input from driver side door switch
DOOR SW-AS [On/Off]	The switch status input from passenger side door switch
DOOR SW-RR [On/Off]	NOTE: The item is indicated, but not monitored.
DOOR SW- RL [On/Off]	
DOOR SW-BK [On/Off]	
CDL LOCK SW [On/Off]	Lock switch status received from the door lock and unlock switch by power window switch serial link
CDL UNLOCK SW [On/Off]	Unlock switch status received from the door lock and unlock switch by power window switch serial link
KEY CYL LK-SW [On/Off]	Lock switch status received from key cylinder switch by power window switch serial link
KEY CYL UN-SW [On/Off]	Unlock switch status received from key cylinder switch by power window switch serial link
TRNK/HAT MNTR [On/Off]	The switch status input from trunk room lamp switch
RKE-LOCK [On/Off]	Lock signal status received from remote keyless entry receiver
RKE-UNLOCK [On/Off]	Unlock signal status received from remote keyless entry receiver

ACTIVE TEST

Test item	Operation	Description
INT LAMP	On	Outputs the interior room lamp control signal to turn map lamp ON (Map lamp switch is in DOOR position).
	Off	Stops the interior room lamp control signal to turn map lamp OFF.
STEP LAMP TEST	On	Outputs the step lamp control signal to turn step lamp ON.
	Off	Stops the step lamp control signal to turn step lamp OFF.
LUGGAGE LAMP TEST	On	Outputs the trunk room lamp control signal to turn the trunk room lamp ON.
	Off	Stops the trunk room lamp control signal to turn the trunk room lamp OFF.

BATTERY SAVER

BATTERY SAVER : CONSULT-III Function (BCM - BATTERY SAVER)

INFOID:000000006456944

WORK SUPPORT

Service item	Setting item	Setting	
BATTERY SAVER SET	On*	With the exterior lamp battery saver function	
	Off	Without the exterior lamp battery saver function	
ROOM LAMP BAT SAV SET	On*	With the interior room lamp battery saver function	
	Off	Without the interior room lamp battery saver function	
ROOM LAMP TIMER SET	MODE 1	30 min.	Sets the interior room lamp battery saver timer operating time.
	MODE 2	60 min.	
	MODE 3*	15 min.	

*: Factory setting

DIAGNOSIS SYSTEM (BCM)

< SYSTEM DESCRIPTION >

DATA MONITOR

Monitor item [Unit]	Description
REQ SW-DR [On/Off]	The switch status input from request switch (driver side)
REQ SW-AS [On/Off]	The switch status input from front request switch (passenger side)
REQ SW-RR [On/Off]	NOTE: The item is indicated, but not monitored.
REQ SW-RL [On/Off]	
PUSH SW [On/Off]	The switch status input from push-button ignition switch
ACC RLY-F/B [On/Off]	NOTE: The item is indicated, but not monitored.
KEY SW-SLOT [On/Off]	Key switch status input from key slot
UNLK SEN-DR [On/Off]	Driver door unlock status input from unlock sensor
DOOR SW-DR [On/Off]	The switch status input driver side front door switch
DOOR SW-AS [On/Off]	The switch status input from passenger side door switch
DOOR SW-RR [On/Off]	NOTE: The item is indicated, but not monitored.
DOOR SW- RL [On/Off]	
DOOR SW-BK [On/Off]	
CDL LOCK SW [On/Off]	Lock switch status received from the door lock and unlock switch by power window switch serial link
CDL UNLOCK SW [On/Off]	Unlock switch status received from the door lock and unlock switch by power window switch serial link
KEY CYL LK-SW [On/Off]	Lock switch status received from key cylinder switch by power window switch serial link
KEY CYL UN-SW [On/Off]	Unlock switch status received from key cylinder switch by power window switch serial link
TRNK/HAT MNTR [On/Off]	The switch status input from trunk room lamp switch
RKE-LOCK [On/Off]	Lock signal status received from remote keyless entry receiver
RKE-UNLOCK [On/Off]	Unlock signal status received from remote keyless entry receiver

ACTIVE TEST

Test item	Operation	Description
BATTERY SAVER	Off	Cuts the interior room lamp power supply to turn interior room lamp OFF.
	On	Outputs the interior room lamp power supply to turn interior room lamp ON.*

*: Each lamp switch is in ON position.

POWER SUPPLY AND GROUND CIRCUIT

< DTC/CIRCUIT DIAGNOSIS >

DTC/CIRCUIT DIAGNOSIS

POWER SUPPLY AND GROUND CIRCUIT

BCM

BCM : Diagnosis Procedure

INFOID:000000006456945

1. CHECK FUSE AND FUSIBLE LINK

Check that the following fuse and fusible link are not blown.

Signal name	Fuse and fusible link No.
Battery power supply	K
	10

Is the fuse fusing?

YES >> Replace the blown fuse or fusible link after repairing the affected circuit if a fuse or fusible link is blown.

NO >> GO TO 2.

2. CHECK POWER SUPPLY CIRCUIT

1. Turn ignition switch OFF.
2. Disconnect BCM connectors.
3. Check voltage between BCM harness connector and ground.

Terminals		Voltage (Approx.)
(+)	(-)	
BCM		Battery voltage
Connector	Terminal	
M118	1	
M119	11	

Is the measurement value normal?

YES >> GO TO 3.

NO >> Repair harness or connector.

3. CHECK GROUND CIRCUIT

Check continuity between BCM harness connector and ground.

BCM		Ground	Continuity
Connector	Terminal		Existed
M119	13		Existed

Does continuity exist?

YES >> INSPECTION END

NO >> Repair harness or connector.

INTERIOR ROOM LAMP POWER SUPPLY CIRCUIT

< DTC/CIRCUIT DIAGNOSIS >

INTERIOR ROOM LAMP POWER SUPPLY CIRCUIT

Description

INFOID:000000006456946

Provides the interior room lamp power supply. Also cuts the power supply when the interior room lamp battery saver activating.

Component Function Check

INFOID:000000006456947

1.CHECK INTERIOR ROOM LAMP POWER SUPPLY FUNCTION

ⓅCONSULT-III ACTIVE TEST

1. Turn the ignition switch ON.
2. Turn each interior room lamp ON.
 - Map lamp
 - Step lamp
 - Vanity mirror lamp
 - Trunk room lamp
3. Select "BATTERY SAVER" of BCM (BATTERY SAVER) active test item.
4. With operating the test items, check that each interior room lamp turns ON/OFF.

Off : Interior room lamp OFF

On : Interior room lamp ON

Does the interior room lamp turn ON/OFF?

YES >> Interior room lamp power supply circuit is normal.

NO >> Refer to [INL-20, "Diagnosis Procedure"](#).

Diagnosis Procedure

INFOID:000000006456948

1.CHECK INTERIOR ROOM LAMP POWER SUPPLY OUTPUT

ⓅCONSULT-III ACTIVE TEST

1. Turn the ignition switch ON.
2. Select "BATTERY SAVER" of BCM (BATTERY SAVER) active test item.
3. With operating the test item, check voltage between BCM harness connector and the ground.

Terminals		Test item	Voltage (Approx.)
(+)	(-)		
BCM		BATTERY SAVER	0 V
Connector	Terminal		
M119	4	Off	0 V
		On	Battery voltage

Is the measurement value normal?

YES >> GO TO 2.

NO >> Replace BCM.

2.CHECK INTERIOR ROOM LAMP POWER SUPPLY OPEN CIRCUIT

1. Turn the ignition switch OFF.
2. Disconnect the following connectors.
 - Map lamp
 - Vanity mirror lamp (LH)
 - Vanity mirror lamp (RH)
 - Trunk room lamp
 - Step lamp (driver side)
 - Step lamp (passenger side)
3. Check continuity between BCM harness connector and each interior room lamp harness connector.

INTERIOR ROOM LAMP POWER SUPPLY CIRCUIT

< DTC/CIRCUIT DIAGNOSIS >

BCM		Each interior room lamp			Continuity
Connector	Terminal	Connector	Terminal		
M119	4	Map lamp	R15	1	Existed
		Vanity mirror lamp (LH)	R12	2	
		Vanity mirror lamp (RH)	R13	2	
		Trunk room lamp	B47	1	
		Step lamp (driver side)	D12	1	
		Step lamp (passenger side)	D42	1	

Does continuity exist?

YES >> GO TO 3.

NO >> Repair the harnesses or connectors.

3. CHECK INTERIOR ROOM LAMP POWER SUPPLY SHORT CIRCUIT

Check continuity between BCM harness connector and the ground.

BCM		Ground	Continuity
Connector	Terminal		
M119	4		Not existed

Does continuity exist?

YES >> Repair the harnesses or connectors.

NO >> Check that each interior room lamp has no internal short circuit.

A
B
C
D
E
F
G
H
I
J
K
L
M
N
O
P

INL

INTERIOR ROOM LAMP CONTROL CIRCUIT

< DTC/CIRCUIT DIAGNOSIS >

INTERIOR ROOM LAMP CONTROL CIRCUIT

Description

INFOID:000000006456949

Controls each interior room lamp (ground side) by PWM signal.

NOTE:

PWM signal control period is approximately 250 Hz (in the gradual brightening/dimming).

Component Function Check

INFOID:000000006456950

CAUTION:

Before performing the diagnosis, check that the following is normal.

- Interior room lamp power supply
- Map lamp bulb

1. CHECK INTERIOR ROOM LAMP CONTROL FUNCTION

CONSULT-III ACTIVE TEST

1. Switch the map lamp switch to DOOR.
2. Turn the ignition switch ON.
3. Select "INT LAMP" of BCM (INT LAMP) active test item.
4. With operating the test items, check that each interior room lamp turns ON/OFF (gradual brightening/dimming).

On : Interior room lamp gradual brightening

Off : Interior room lamp gradual dimming

Does the interior room lamp turns ON/OFF (gradual brightening/dimming)?

YES >> Interior room lamp control circuit is normal.

NO >> Refer to [INL-22. "Diagnosis Procedure"](#).

Diagnosis Procedure

INFOID:000000006456951

1. CHECK INTERIOR ROOM LAMP CONTROL OUTPUT

CONSULT-III ACTIVE TEST

1. Turn the ignition switch OFF.
2. Remove all the bulbs of map lamp.
3. Select "INT LAMP" of BCM (INT LAMP) active test item.
4. With operating the test item, check continuity between BCM harness connector and the ground.

BCM		Ground	Test item	Continuity
Connector	Terminal		INT LAMP	
M119	19		On	Existed
			Off	Not existed

Is the measurement value normal?

YES >> GO TO 2.

Fixed ON>>GO TO 3.

Fixed OFF>>Replace BCM.

2. CHECK INTERIOR ROOM LAMP CONTROL OPEN CIRCUIT

1. Turn the ignition switch OFF.
2. Disconnect BCM connector and map lamp connector.
3. Check continuity between BCM harness connector and map lamp harness connector.

BCM		Map lamp		Continuity
Connector	Terminal	Connector	Terminal	
M119	19	R15	2	Existed

Does continuity exist?

INTERIOR ROOM LAMP CONTROL CIRCUIT

< DTC/CIRCUIT DIAGNOSIS >

- YES >> Replace the map lamp.
NO >> Repair the harnesses or connectors.

3. CHECK INTERIOR ROOM LAMP CONTROL SHORT CIRCUIT

1. Turn the ignition switch OFF.
2. Disconnect BCM connector and map lamp connector.
3. Check continuity between BCM harness connector and the ground.

BCM		Ground	Continuity
Connector	Terminal		
M119	19		Not existed

Does continuity exist?

- YES >> Repair the harnesses or connectors.
NO >> Replace BCM.

A
B
C
D
E
F
G
H
I
J
K
M
N
O
P

INL

STEP LAMP CIRCUIT

< DTC/CIRCUIT DIAGNOSIS >

STEP LAMP CIRCUIT

Description

INFOID:000000006456952

Controls the step lamp (ground side) to turn the step lamp ON and OFF.

Component Function Check

INFOID:000000006456953

CAUTION:

Before performing the diagnosis, check that the following is normal.

- Interior room lamp power supply
- Step lamp bulb

1.CHECK STEP LAMP OPERATION

CONSULT-III ACTIVE TEST

1. Turn the ignition switch ON.
2. Select "STEP LAMP TEST" of BCM (INT LAMP) active test item.
3. With operating the test items, check that step lamp turns ON/OFF.

On : Step lamp ON
 Off : Step lamp OFF

Does the step lamp turn ON/OFF?

- YES >> Step lamp circuit is normal.
 NO >> Refer to [INL-24, "Diagnosis Procedure"](#).

Diagnosis Procedure

INFOID:000000006456954

1.CHECK STEP LAMP OUTPUT

CONSULT-III ACTIVE TEST

1. Turn the ignition switch OFF.
2. Remove the step lamp bulbs (driver side and passenger side).
3. Turn the ignition switch ON.
4. Select "STEP LAMP TEST" of BCM (INT LAMP) active test item.
5. With operating the test item, check continuity between BCM harness connector and the ground.

BCM		Ground	Test item	Continuity
Connector	Terminal		STEP LAMP TEST	
M119	7		On	Existed
			Off	Not existed

Is the measurement value normal?

- YES >> GO TO 2.
 Fixed ON>>GO TO 3.
 Fixed OFF>>Replace BCM.

2.CHECK STEP LAMP OPEN CIRCUIT

1. Turn the ignition switch OFF.
2. Disconnect BCM connector, and step lamp connector.
3. Check continuity between BCM harness connector and step lamp harness connector.

BCM		Step lamp			Continuity
Connector	Terminal	Connector	Terminal		
M119	7	Driver side	D12	2	Existed
		Passenger side	D42	2	

STEP LAMP CIRCUIT

< DTC/CIRCUIT DIAGNOSIS >

Does continuity exist?

- YES >> Replace the step lamp.
NO >> Repair the harnesses or connectors.

3.CHECK STEP LAMP SHORT CIRCUIT

1. Turn the ignition switch OFF.
2. Check continuity between BCM harness connector and the ground.

BCM		Ground	Continuity
Connector	Terminal		
M119	7		Not existed

Does continuity exist?

- YES >> Repair the harnesses or connectors.
NO >> Replace BCM.

A
B
C
D
E
F
G
H
I
J
K
M
N
O
P

INL

TRUNK ROOM LAMP CIRCUIT

< DTC/CIRCUIT DIAGNOSIS >

TRUNK ROOM LAMP CIRCUIT

Description

INFOID:000000006456955

Controls the trunk room lamp (ground side) to turn the trunk room lamp ON and OFF.

Component Function Check

INFOID:000000006456956

CAUTION:

Before performing the diagnosis, check that the following is normal.

- Interior room lamp power supply
- Trunk room lamp bulb

1.CHECK TRUNK ROOM LAMP OPERATION

CONSULT-III ACTIVE TEST

1. Turn the ignition switch ON.
2. Select "LUGGAGE LAMP TEST" of BCM (INT LAMP) active test item.
3. With operating the test items, check that trunk room lamp turns ON/OFF.

On : Trunk room lamp ON

Off : Trunk room lamp OFF

Does the trunk room lamp turn ON/OFF?

- YES >> Trunk room lamp circuit is normal.
NO >> Refer to [INL-24, "Diagnosis Procedure"](#).

Diagnosis Procedure

INFOID:000000006456957

1.CHECK TRUNK ROOM LAMP OUTPUT

CONSULT-III ACTIVE TEST

1. Turn the ignition switch OFF.
2. Remove trunk room lamp bulb.
3. Turn the ignition switch ON.
4. Select "LUGGAGE LAMP TEST" of BCM (INT LAMP) active test item.
5. With operating the test item, check continuity between BCM harness connector and the ground.

BCM		Ground	Test item	Continuity
Connector	Terminal		LUGGAGE LAMP TEST	
M120	30		On	Existed
			Off	Not existed

Is the measurement value normal?

- YES >> GO TO 2.
Fixed ON>>GO TO 3.
Fixed OFF>>Replace BCM.

2.CHECK TRUNK ROOM LAMP OPEN CIRCUIT

1. Turn the ignition switch OFF.
2. Disconnect BCM connector and trunk room lamp connector.
3. Check continuity between BCM harness connector and trunk room lamp harness connector.

BCM		Trunk room lamp		Continuity
Connector	Terminal	Connector	Terminal	
M120	30	B47	2	Existed

Does continuity exist?

- YES >> Replace the trunk room lamp.

TRUNK ROOM LAMP CIRCUIT

< DTC/CIRCUIT DIAGNOSIS >

NO >> Repair the harnesses or connectors.

3. CHECK TRUNK ROOM LAMP SHORT CIRCUIT

1. Turn the ignition switch OFF.
2. Disconnect BCM connector and trunk room lamp connector.
3. Check continuity between BCM harness connector and the ground.

BCM		Ground	Continuity
Connector	Terminal		
M120	30		Not existed

Does continuity exist?

YES >> Repair the harnesses or connectors.

NO >> Replace BCM.

A

B

C

D

E

F

G

H

I

J

K

INL

M

N

O

P

PUSH-BUTTON IGNITION SWITCH ILLUMINATION CIRCUIT

< DTC/CIRCUIT DIAGNOSIS >

PUSH-BUTTON IGNITION SWITCH ILLUMINATION CIRCUIT

Description

INFOID:000000006456958

Provides the power supply and the ground to control the push-button ignition switch illumination.

Component Function Check

INFOID:000000006456959

1.CHECK PUSH-BUTTON IGNITION SWITCH ILLUMINATION OPERATION

CONSULT-III ACTIVE TEST

1. Turn the ignition switch ON.
2. Select "ENGINE SW ILLUMI" of BCM (INTELLIGENT KEY) active test item.
3. With operating the test items, check that the push-button ignition switch illumination turns ON/OFF

On : Push-button ignition switch illumination ON

Off : Push-button ignition switch illumination OFF

Does the push-button ignition switch illumination turn ON/OFF?

- YES >> Push-button ignition switch illumination circuit is normal.
NO >> Refer to [INL-28, "Diagnosis Procedure"](#).

Diagnosis Procedure

INFOID:000000006456960

1.CHECK ILLUMINATION CONTROL SWITCHING OPERATION

1. Turn the ignition switch ON.
2. With operating the lighting switch, check that the push-button ignition switch illumination turns ON/OFF

Condition	Push-button ignition switch illumination
<ul style="list-style-type: none">• Ignition switch ON• Lighting switch 1ST	ON
<ul style="list-style-type: none">• Ignition switch OFF• Lighting switch OFF• Driver door LOCK	OFF

Does the push-button ignition switch illumination turn ON/OFF?

- YES >> GO TO 2.
NO >> GO TO 3.

2.CHECK PUSH-BUTTON IGNITION SWITCH ILLUMINATION GROUND CIRCUIT

1. Turn the ignition switch OFF.
2. Disconnect BCM connector and the push-button ignition switch connector.
3. Check continuity between BCM harness connector and the push-button ignition switch harness connector.

BCM		Push-button ignition switch		Continuity
Connector	Terminal	Connector	Terminal	
M119	14	M50	2	Existed

Does the continuity exist?

- YES >> Replace BCM.
NO >> Repair the harness or the connector.

3.CHECK PUSH-BUTTON IGNITION SWITCH ILLUMINATION POWER SUPPLY OUTPUT

CONSULT-III ACTIVE TEST

1. Turn the ignition switch ON.
2. Select "ENGINE SW ILLUMI" of BCM (INTELLIGENT KEY) active test item.
3. With operating the test item, check voltage between BCM harness connector and the ground.

PUSH-BUTTON IGNITION SWITCH ILLUMINATION CIRCUIT

< DTC/CIRCUIT DIAGNOSIS >

Terminals		Test item	Voltage (Approx.)
(+)	(-)		
BCM		ENGINE SW ILLUMI	5 V
Connector	Terminal		
M123	133	ON	5 V
		OFF	0 V

Is the measurement value normal?

- YES >> GO TO 4.
NO >> GO TO 5.

4. CHECK PUSH-BUTTON IGNITION SWITCH ILLUMINATION POWER SUPPLY OPEN CIRCUIT

- Turn the ignition switch OFF.
- Disconnect BCM connector and the push-button ignition switch connector.
- Check continuity between BCM harness connector and the push-button ignition switch harness connector.

BCM		Push-button ignition switch		Continuity
Connector	Terminal	Connector	Terminal	
M123	133	M50	3	Existed

Does the continuity exist?

- YES >> Replace the push-button ignition switch.
NO >> Repair the harness or the connector.

5. CHECK PUSH-BUTTON IGNITION SWITCH ILLUMINATION POWER SUPPLY SHORT CIRCUIT

- Turn the ignition switch OFF.
- Disconnect BCM connector and the push-button ignition switch connector.
- Check continuity between BCM harness connector and the ground.

BCM		Ground	Continuity
Connector	Terminal		
M123	133		Not existed

Does the continuity exist?

- YES >> Repair the harness or the connector.
NO >> Replace BCM.

A
B
C
D
E
F
G
H
I
J
K
M
N
O
P

INL

INTERIOR ROOM LAMP CONTROL SYSTEM

< DTC/CIRCUIT DIAGNOSIS >

INTERIOR ROOM LAMP CONTROL SYSTEM

Wiring Diagram - INTERIOR ROOM LAMP -

INFOID:000000006456961

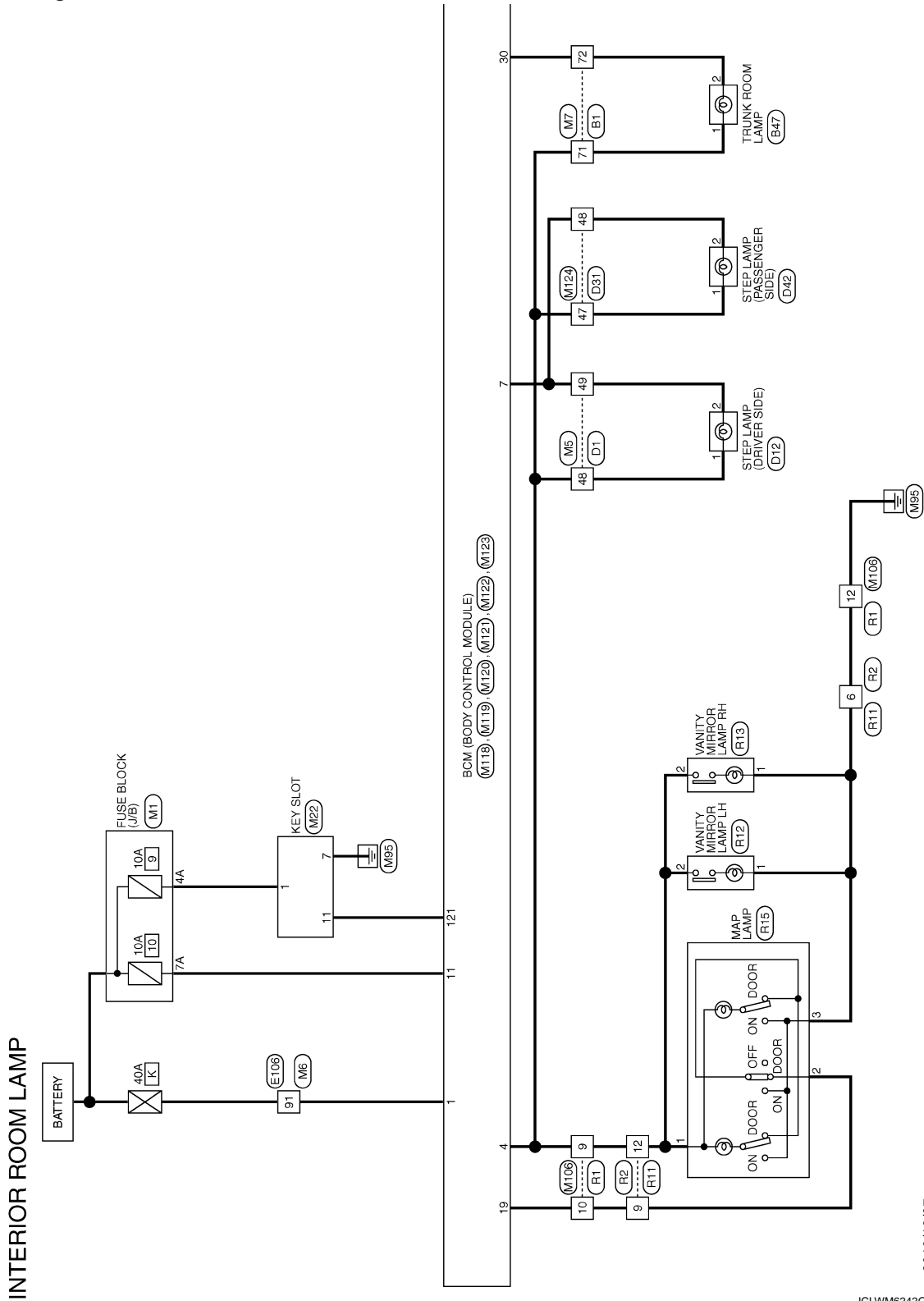

2010/10/07

JCLWM6242GB

INTERIOR ROOM LAMP CONTROL SYSTEM

< DTC/CIRCUIT DIAGNOSIS >

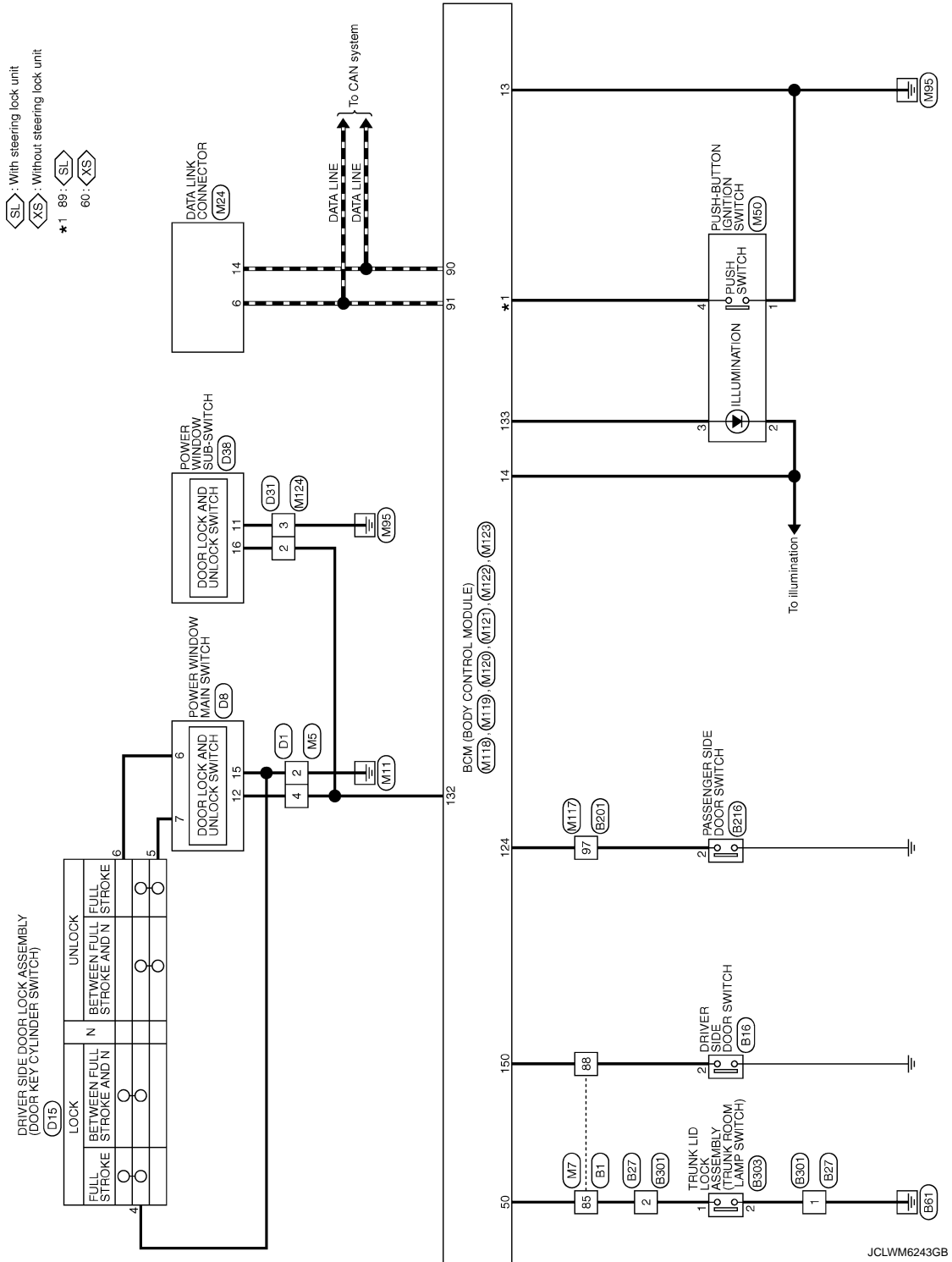

A
B
C
D
E
F
G
H
I
J
K
L
M
N
O
P

INL

INTERIOR ROOM LAMP CONTROL SYSTEM

< DTC/CIRCUIT DIAGNOSIS >

INTERIOR ROOM LAMP

Connector No.	B1
Connector Name	WIRE TO WIRE
Connector Type	THB07V-CS16-TM4

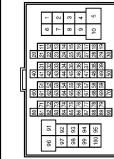

Terminal No.	Color of Wire	Signal Name [Specification]
1	GR	-
2	G	-
3	SB	-
4	Y	-
6	Y	-
15	V	-
16	BR	-
17	LG	-
18	W	-
20	L	-
21	P	-
22	L	-
23	P	-
24	GR	-
25	SB	-
26	G	-
27	W	-
28	G	-
31	V	-
32	SB	-
33	SHIELD	-
34	W	-
35	BR	-
36	Y	-
37	SHIELD	-
38	Y	-
38	LG	-
40	P	-
41	L	-
42	SHIELD	-
43	R	-
44	G	-
45	SHIELD	-
46	SB	-
49	L	-
50	P	-
55	P	-
56	G	-

58	V	-
59	LG	-
60	BR	-
61	W	-
62	R	-
63	L	-
64	Y	-
65	SHIELD	-
71	BR	-
72	SB	-
73	P	-
74	L	-
81	R	-
82	B	-
84	Y	-
85	L	-
86	GR	-
87	R	-
88	V	-
90	GR	-
91	Y	-
93	B/G	-
96	R	-
100	V	-

Connector No.	B16
Connector Name	DRIVER SIDE DOOR SWITCH
Connector Type	A03FW

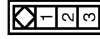

Terminal No.	Color of Wire	Signal Name [Specification]
2	V	-

Connector No.	B27
Connector Name	WIRE TO WIRE
Connector Type	NSGBMW-CS



Terminal No.	Color of Wire	Signal Name [Specification]
1	B	-
2	L	-
3	Y	-
4	LG	-
5	B	-
6	W	-
7	R	-
8	SHIELD	-

Connector No.	B47
Connector Name	TRUNK ROOM LAMP
Connector Type	S02FW



Terminal No.	Color of Wire	Signal Name [Specification]
1	BR	-
2	SB	-

JCLWM6244GB

INTERIOR ROOM LAMP CONTROL SYSTEM

< DTC/CIRCUIT DIAGNOSIS >

INTERIOR ROOM LAMP

Connector No.	B201
Connector Name	WIRE TO WIRE
Connector Type	TH80FW-CS16-TM4

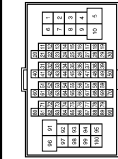

Terminal No.	Color of Wire	Signal Name [Specification]
1	GR	-
5	Y	-
6	G	-
7	BG	-
9	LG	-
10	R	-
30	B	-
31	L	-
32	P	-
33	SB	-
34	V	-
40	GR	-
41	LG	-
42	BG	-
43	R	-
45	G	-
46	SHIELD	-
47	G	-
48	Y	-
49	SHIELD	-
50	P	-
55	BG	-
71	R	-
72	V	-
80	V	-
81	SHIELD	-
82	Y	-
83	BR	-
84	O	-
85	SHIELD	-
86	G	-
87	R	-
88	W	-
89	B	-
90	SB	-
91	V	-
94	W	-
95	G	-

97	BR	-
----	----	---

Connector No.	B216
Connector Name	PASSENGER SIDE DOOR SWITCH
Connector Type	FA03FW



Terminal No.	Color of Wire	Signal Name [Specification]
2	BR	-

Connector No.	B301
Connector Name	WIRE TO WIRE
Connector Type	NS06FW-CS

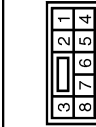

Terminal No.	Color of Wire	Signal Name [Specification]
1	B	-
2	L	-
3	G	-
4	LG	-
5	Y	-
6	W	-
7	R	-
8	SHIELD	-

Connector No.	B303
Connector Name	TRUNK LID LOCK ASSEMBLY
Connector Type	TB03FW



Terminal No.	Color of Wire	Signal Name [Specification]
1	L	-
2	B	-
3	G	-

Connector No.	D1
Connector Name	WIRE TO WIRE
Connector Type	TH10FW-CS15

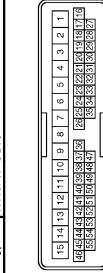

Terminal No.	Color of Wire	Signal Name [Specification]
1	Y	-
2	B	-
3	SB	-
4	V	-
8	L	-
9	P	-
10	LG	-
12	GR	-
13	W	-
14	G	-
15	R	-
16	GR	-
17	SB	-
18	BR	-
19	BG	-
20	P	-
21	R	-
25	V	-
26	R	-

27	BR	-
28	W	-
29	Y	-
30	G	-
31	LG	-
32	GR	-
33	B	-
36	W	-
37	P	-
38	V	-
39	BR	-
42	G	-
43	GR	-
44	BG	-
44	BG	- [With automatic drive positioner]
44	BG	- [Without automatic drive positioner]
47	L	-
48	R	-
49	SB	-
50	W	-
51	P	-
52	V	-

Connector No.	D8
Connector Name	POWER WINDOW MAIN SWITCH
Connector Type	NS16FW-CS



Terminal No.	Color of Wire	Signal Name [Specification]
1	Y	-
5	BG	-
6	GR	-
7	W	-
8	L	-
9	LG	-
10	SB	-
11	BR	-
12	V	-
13	R	-
14	G	-
15	B	-

JCLWM6245GB

A
B
C
D
E
F
G
H
I
J
K
L
M
N
O
P

INL

INTERIOR ROOM LAMP CONTROL SYSTEM

< DTC/CIRCUIT DIAGNOSIS >

INTERIOR ROOM LAMP

Connector No.	D12
Connector Name	STEP LAMP (DRIVER SIDE)
Connector Type	TH02FW



Terminal No.	Color of Wire	Signal Name [Specification]
1	R	-
2	SB	-

Connector No.	D15
Connector Name	DRIVER SIDE DOOR LOCK ASSEMBLY
Connector Type	ED0FCY-RS



Terminal No.	Color of Wire	Signal Name [Specification]
1	LG	-
2	P	-
3	L	-
4	B	-
5	W	-
6	GR	-

Connector No.	D31
Connector Name	WIRE TO WIRE
Connector Type	TH40FW-CS15



Terminal No.	Color of Wire	Signal Name [Specification]
1	W	-
2	Y	-
3	B	-
7	LG	-
8	P	-
10	L	-
11	W	-
12	G	-
13	R	-
36	W	-
37	P	-
38	V	-
39	BR	-
42	L	-
43	GR	-
44	BG	-
45	G	-
47	R	-
48	SB	-
49	W	-
50	P	-
51	V	-
52	GR	-
53	BG	-
54	G	-

Connector No.	D38
Connector Name	POWER WINDOW SUB-SWITCH
Connector Type	NS10FW-CS



Terminal No.	Color of Wire	Signal Name [Specification]
3	G	-
4	BG	-
8	L	-
9	BR	-
10	W	-
11	B	-
12	R	-
15	LG	-
16	Y	-

Connector No.	D42
Connector Name	STEP LAMP (PASSENGER SIDE)
Connector Type	TH02FW



Terminal No.	Color of Wire	Signal Name [Specification]
1	R	-
2	SB	-

Connector No.	E106
Connector Name	WIRE TO WIRE
Connector Type	TH03FW-CS16-TM4



Terminal No.	Color of Wire	Signal Name [Specification]
1	GR	-
3	BG	-
5	G	-
6	BG	-
7	V	- [With daytime running light]
7	LG	- [Without daytime running light]
8	L	- [With daytime running light]
9	R	- [Without daytime running light]
10	W	-
11	V	-
12	R	-
13	L	-
14	GR	-
15	P	-
16	W	-
17	V	-
18	BG	-
19	GR	-
20	LG	-
30	R	-

31	L	-
32	BG	-
33	P	-
34	V	-
35	BR	-
36	W	-
37	Y	-
38	R	-
39	B	-
40	G	-
41	W	-
42	LG	-
43	SB	-
44	GR	-
45	BG	-
46	LG	-
47	V	-
48	P	-
49	L	-
50	B	-
66	LG	-
67	SB	-
68	R	-
69	W	-
70	G	-
80	W	-
81	P	-
82	G	-
83	V	-
84	L	-
85	BG	-
86	LG	-
87	Y	-
88	GR	-
89	W	-
91	G	-
93	GR	-
95	Y	-
96	Y	-
97	BR	-
98	SHIELD	-
99	L	-
100	P	-

INTERIOR ROOM LAMP CONTROL SYSTEM

< DTC/CIRCUIT DIAGNOSIS >

INTERIOR ROOM LAMP

Connector No.	M1
Connector Name	FUSE BLOCK (J/B)
Connector Type	NS88FW-M2



Terminal No.	Color of Wire	Signal Name [Specification]
1A	V	
2A	G	
3A	L	
4A	P	
5A	L	
6A	Y	
7A	R	
8A	L	

Connector No.	M5
Connector Name	WIRE TO WIRE
Connector Type	TH40MW-CS15

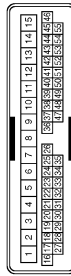

Terminal No.	Color of Wire	Signal Name [Specification]
1	Y	
2	B	
3	BG	
4	V	
8	SB	
9	G	
10	V	
12	L	
13	W	
14	B	
15	W	
16	R	
17	BR	
18	V	

19	BG	
20	P	
21	W	
23	Y	
26	G	
27	L	
28	Y	
29	G	
30	SB	
31	LG	
32	W	
33	B	
36	W	
37	GR	
38	Y	
39	B	
42	Y	
43	L	
44	G	
44	L	
47	GR	
48	SB	
49	SB	
50	P	
51	LG	
52	V	

Connector No.	M6
Connector Name	WIRE TO WIRE
Connector Type	TH80MW-CS16-TM4



Terminal No.	Color of Wire	Signal Name [Specification]
1	BG	
3	R	
5	G	
6	LG	
7	W	
9	G	
10	W	
11	V	
12	R	
13	L	

14	GR	
15	P	
16	W	
17	BR	
18	P	
19	L	
20	L	
30	BR	
31	L	
32	Y	
33	BG	
34	W	
35	BR	
36	R	
37	Y	
38	R	
39	SB	
40	G	
41	V	
42	LG	
43	P	
44	B	
44	R	
45	BG	
46	G	
47	L	
48	P	
49	L	
59	B	
66	Y	
67	G	
68	R	
69	W	
70	G	
80	SB	
81	B	
82	V	
83	W	
84	L	
85	GR	
86	G	
87	R	
88	B	
89	LG	
91	W	
93	Y	
95	Y	
96	R	
97	GR	
98	SHIELD	
99	V	
100	SB	

JCLWM6247GB

A
B
C
D
E
F
G
H
I
J
K
L
M
N
O
P

INL

INTERIOR ROOM LAMP CONTROL SYSTEM

< DTC/CIRCUIT DIAGNOSIS >

INTERIOR ROOM LAMP

Connector No.	M7
Connector Name	WIRE TO WIRE
Connector Type	TH80MW-CS1E-TM4



Terminal No.	Color of Wire	Signal Name [Specification]
1	GR	-
2	P	-
3	SB	- [With automatic drive positioner]
3	P	- [Without automatic drive positioner]
4	Y	-
6	L	-
15	R	-
16	BR	-
17	P	-
18	V	-
20	L	-
21	P	-
22	L	-
23	P	-
24	V	-
25	LG	-
26	BR	-
27	BG	-
28	LG	-
31	V	-
32	LG	-
33	SHIELD	-
34	GR	-
35	BR	-
36	Y	-
37	SHIELD	-
38	SB	-
39	LG	-
40	O	-
41	W	-
42	SHIELD	-
43	R	-
44	G	-
45	SHIELD	-
46	SB	-
48	L	-
50	P	-
55	W	-

56	B	-
58	V	-
59	Y	-
60	Y	-
61	W	-
62	R	-
63	G	-
64	B	-
65	SHIELD	-
71	V	-
72	P	-
73	SB	-
74	V	-
81	W	-
82	BR	-
84	LG	-
85	BG	-
86	SB	-
87	G	-
88	GR	-
90	P	-
91	BG	-
95	BG	-
96	Y	-
100	P	-

Connector No.	M22
Connector Name	KEY SLOT
Connector Type	TH12FW-NH

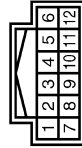

Terminal No.	Color of Wire	Signal Name [Specification]
1	R	BAT
2	GR	CLOCK
3	W	DATA
5	Y	ILL BAT
6	LG	ILL
7	B	GND
11	SB	KEY SWITCH SIGNAL

Connector No.	M24
Connector Name	DATA LINK CONNECTOR
Connector Type	ED16FW-P

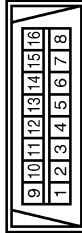

Terminal No.	Color of Wire	Signal Name [Specification]
3	LG	-
4	B	-
5	B	-
6	L	-
7	V	-
8	G	-
11	SB	-
14	P	-
16	R	-

Connector No.	M50
Connector Name	PUSH-BUTTON (IGNITION SWITCH)
Connector Type	TK08FRR



Terminal No.	Color of Wire	Signal Name [Specification]
1	B	-
2	R	-
3	L	-
4	BR	-
5	LG	-
6	BG	-
7	GR	-
8	P	-

Connector No.	M106
Connector Name	WIRE TO WIRE
Connector Type	NH10MP-CS10

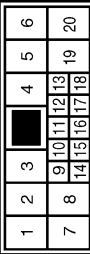

Terminal No.	Color of Wire	Signal Name [Specification]
2	L	-
3	SHIELD	-
4	G	-
5	BR	-
6	BG	-
7	V	-
8	P	-
9	LG	-
10	V	-
11	B	-
12	B	-
13	R	-
15	R	-
16	G	-
17	SHIELD	-
18	B	-
19	Y	-
20	R	-

JCLWM6248GB

INTERIOR ROOM LAMP CONTROL SYSTEM

< DTC/CIRCUIT DIAGNOSIS >

INTERIOR ROOM LAMP

Connector No.	M117
Connector Name	WIRE TO WIRE
Connector Type	TH80MW-CS (F-TM4)

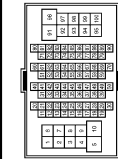

Terminal No.	Color of Wire	Signal Name [Specification]
1	LG	-
5	P	-
6	G	-
7	SB	-
9	LG	-
10	L	-
30	B	-
31	SB	-
32	LG	-
33	SB	-
34	LG	-
40	Y	-
41	G	-
42	LG	-
43	R	-
45	G	-
46	SHIELD	-
47	P	-
48	L	-
48	SHIELD	-
50	V	-
56	R	-
71	R	-
72	L	-
80	W	-
81	SHIELD	-
82	P	-
83	L	-
84	G	-
85	SHIELD	-
86	W	-
87	B	-
88	R	-
89	G	-
90	Y	-
91	V	-
94	Y	-
95	G	-

97	R	-
----	---	---

Connector No.	M118
Connector Name	BCM (BODY CONTROL MODULE)
Connector Type	M03FB-LC



Terminal No.	Color of Wire	Signal Name [Specification]
1	W	BAT (E/L)
2	Y	POWER WINDOW POWER SUPPLY (BAT)
3	BG	POWER WINDOW POWER SUPPLY (RAP)

Connector No.	M119
Connector Name	BCM (BODY CONTROL MODULE)
Connector Type	NS16FW-CS



Terminal No.	Color of Wire	Signal Name [Specification]
4	LG	INTERIOR ROOM LAMP POWER SUPPLY
5	P	PASSENGER DOOR UNLOCK OUTPUT
7	SB	STEP LAMP OUTPUT
8	V	ALL DOOR FUEL LID LOCK OUTPUT
9	G	DRIVER DOOR FUEL LID UNLOCK OUTPUT
11	R	BAT FUSE
13	B	GND
14	W	PUSH-BUTTON IGNITION SW ILL GND
15	BG	ACC IND
17	W	TURN SIGNAL RH (FRONT)
18	BG	TURN SIGNAL LH (FRONT)
19	V	INT ROOM LAMP CONT

Connector No.	M120
Connector Name	BCM (BODY CONTROL MODULE)
Connector Type	NS12FW-CS

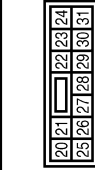

Terminal No.	Color of Wire	Signal Name [Specification]
20	V	TURN SIGNAL RH (REAR)
23	LG	TRUNK LID OPEN OUTPUT
25	Y	TURN SIGNAL LH (REAR)
30	P	TRUNK ROOM LAMP

Connector No.	M121
Connector Name	BCM (BODY CONTROL MODULE)
Connector Type	TH40FY-NH



Terminal No.	Color of Wire	Signal Name [Specification]
34	SB	TRUNK ROOM ANT-
35	V	TRUNK ROOM ANT+
38	B	REAR BUMPER ANT-
39	W	REAR BUMPER ANT+
47	Y	IGN RELAY (IPDM E/R) CONT
50	BG	TRUNK ROOM LAMP SW
52	R	STARTER RELAY CONT
60	BR	PUSH SW
61	SB	TRUNK LID OPENER REQUEST SW
64	G	I-KEY WARN BUZZER (ENG ROOM)
67	GR	TRUNK LID OPENER SW

Connector No.	M122
Connector Name	BCM (BODY CONTROL MODULE)
Connector Type	TH40FB-NH



Terminal No.	Color of Wire	Signal Name [Specification]
72	R	ROOM ANT Z-
73	G	ROOM ANT Z+
74	SB	PASSENGER DOOR ANT-
75	BR	PASSENGER DOOR ANT+
76	V	DRIVER DOOR ANT-
77	LG	DRIVER DOOR ANT+
78	Y	ROOM ANT 1-
79	BR	ROOM ANT 1+
80	GR	MATS ANT AMP
81	W	MATS ANT AMP
82	SB	IGN RELAY (F/B) CONT
83	Y	KEYLESS ENTRY RECEIVER COMM
87	Y	COMBI SW INPUT 5
88	BG	COMBI SW INPUT 3
89	BR	PUSH SW
90	P	CAN-L
91	L	CAN-H
92	LG	KEY SLOT ILL
93	GR	ON IND
95	BG	ACC RELAY CONT
96	GR	A/T SHIFT SELECTOR POWER SUPPLY
97	L	S/L CONDITION 2
98	P	S/L CONDITION 1
99	R	SHIFT P (WRN A/T)
99	BR	ASCD CLUTCH SW (WRN M/T)
100	Y	PASSENGER DOOR REQUEST SW
101	P	DRIVER DOOR REQUEST SW
102	BG	BLOWER FAN MOTOR RELAY CONT
103	P	KEYLESS ENTRY RECEIVER POWER SUPPLY
106	SB	S/L UNIT POWER SUPPLY
107	LG	COMBI SW INPUT 1
108	R	COMBI SW INPUT 4
109	W	COMBI SW INPUT 2
110	G	HAZARD SW
111	Y	S/L UNIT COMM

JCLWM6249GB

A B C D E F G H I J K M N O P

INL

INTERIOR ROOM LAMP CONTROL SYSTEM

< DTC/CIRCUIT DIAGNOSIS >

INTERIOR ROOM LAMP

Connector No.	M123
Connector Name	BCM BODY CONTROL MODULE
Connector Type	TH4DFG-IN1

1	2	3	4	5	6	7	8	9	10	11	12	13	14	15
16	17	18	19	20	21	22	23	24	25	26	27	28	29	30



Terminal No.	Color of Wire	Signal Name [Specification]
112	R	RAIN SENSOR SERIAL LINK
113	BG	OPTICAL SENSOR
114	R	CLUTCH INTERLOCK SW
116	SB	STOP LAMP SW 1
118	BR	STOP LAMP SW 2
119	SB	DR DOOR UNLOCK SENSOR
121	SB	KEY SWITCH
123	V	IGN P/B
124	R	PASSENGER DOOR SW
129	BG	TRUNK CANCEL SW
132	V	POWER WINDOW SW COMM
133	L	PUSH-BUTTON IGNITION SW ILL POWER
134	LG	LOCK IND
137	BG	RECEIVER / SENSOR GND
138	V	RECEIVER / SENSOR POWER SUPPLY
139	L	TIRE PRESSURE RECEIVER COMM
140	B	SHIFT N/P
141	W	SECURITY INDICATOR LAMP
142	BR	COMBI SW OUTPUT 5
143	P	COMBI SW OUTPUT 1
144	G	COMBI SW OUTPUT 2
145	L	COMBI SW OUTPUT 3
146	SB	COMBI SW OUTPUT 4
150	GR	DRIVER DOOR SW
151	G	REAR WINDOW DEFOGGER RELAY CONT

Connector No.	M124
Connector Name	WIRE TO WIRE
Connector Type	TH4GMW-CS15

1	2	3	4	5	6	7	8	9	10	11	12	13	14	15
16	17	18	19	20	21	22	23	24	25	26	27	28	29	30



Terminal No.	Color of Wire	Signal Name [Specification]
1	W	
2	GR	
3	B	
4	G	
5	BR	
6	Y	
7	G	
8	GR	
9	R	
10	BR	
11	R	
12	G	
13	R	
14	V	
15	B	
16	B	
17	Y	
18	R	
19	Y	
20	R	
21	O	
22	W	
23	BG	
24	BG	
25	W	
26	B	
27	SB	
28	LG	
29	P	
30	Y	
31	BR	
32	SB	
33	L	
34	Y	

Connector No.	R1
Connector Name	WIRE TO WIRE
Connector Type	NH10FW-CS10

6	5	4	3	2	1			
20	19	18	17	16	15	14	8	7



Terminal No.	Color of Wire	Signal Name [Specification]
2	GR	
3	SHIELD	
4	G	
5	BR	
6	Y	
7	G	
8	BR	
9	R	
10	V	
11	B	
12	B	
13	Y	
14	O	
15	O	
16	W	
17	SHIELD	
18	B	
19	Y	
20	R	

Connector No.	R2
Connector Name	WIRE TO WIRE
Connector Type	TH12FW-IN1

6	5	4	3	2	1
12	11	10	9	8	7



Terminal No.	Color of Wire	Signal Name [Specification]
1	B	
2	B	
3	SHIELD	
4	O	

5	W	-
6	B	-
7	P	-
8	GR	-
9	V	-
11	Y	-
12	R	-

Connector No.	R11
Connector Name	WIRE TO WIRE
Connector Type	TH12MW-IN1



1	2	3	4	5	6
7	8	9	10	11	12

Terminal No.	Color of Wire	Signal Name [Specification]
1	Y	
2	BR	
3	SHIELD	
4	W	
5	R	
6	B	
7	O	
8	G	
9	GR	
11	L	
12	P	

Connector No.	R12
Connector Name	VANITY MIRROR LAMP LH
Connector Type	IMCA02FW



1	2
---	---

Terminal No.	Color of Wire	Signal Name [Specification]
1	B	
2	P	

INTERIOR ROOM LAMP CONTROL SYSTEM

< DTC/CIRCUIT DIAGNOSIS >

A
B
C
D
E
F
G
H
I
J
K
INL
M
N
O
P

INTERIOR ROOM LAMP

Connector No.	RI5
Connector Name	VANITY MIRROR LAMP RH
Connector Type	MCAG2FW



Terminal No.	Color of Wire	Signal Name [Specification]
1	B	-
2	P	-

Connector No.	RI5
Connector Name	MAP LAMP
Connector Type	TK08FGY



Terminal No.	Color of Wire	Signal Name [Specification]
1	P	-
2	GR	-
3	B	-
4	Y	-
8	L	-

JCLWM6251GB

ILLUMINATION

< DTC/CIRCUIT DIAGNOSIS >

- *1 8: <OM>
 - 18: <RM>
 - 44: <OM>
 - *2 39: <RM>
 - 56: <OM>
 - 51: <RM>
 - *4 55: <OM>
 - 52: <RM>
- <CN>: Without NAVI
 - <AH>: With AVT and heated seat
 - <AV>: AWD models
 - <RM>: With automatic drive positioner
 - <OP>: Without automatic drive positioner
 - <SC>: With sonar system
 - <RM>: With rear view monitor
 - <OM>: Without rear view monitor

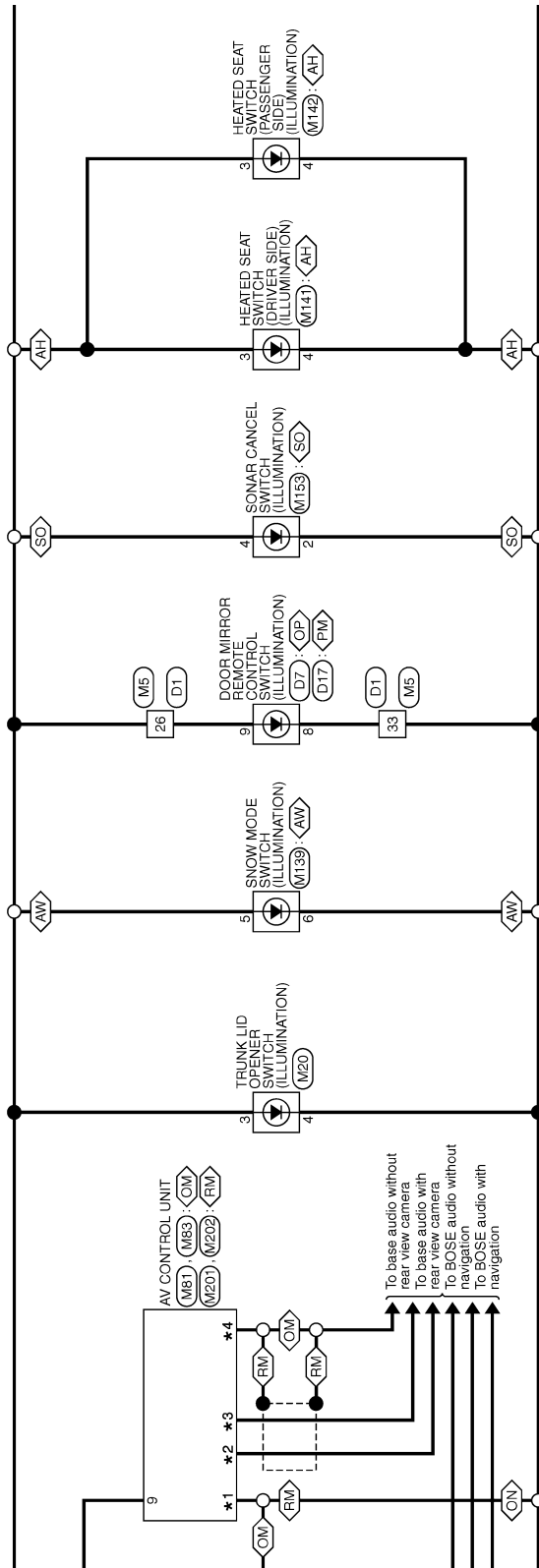

JCLWM6253GB

A
B
C
D
E
F
G
H
I
J
K
INL
M
N
O
P

ILLUMINATION

< DTC/CIRCUIT DIAGNOSIS >

A : With A/T
MH : With M/T and heated seat

*: This connector is not shown in "Harness Layout".

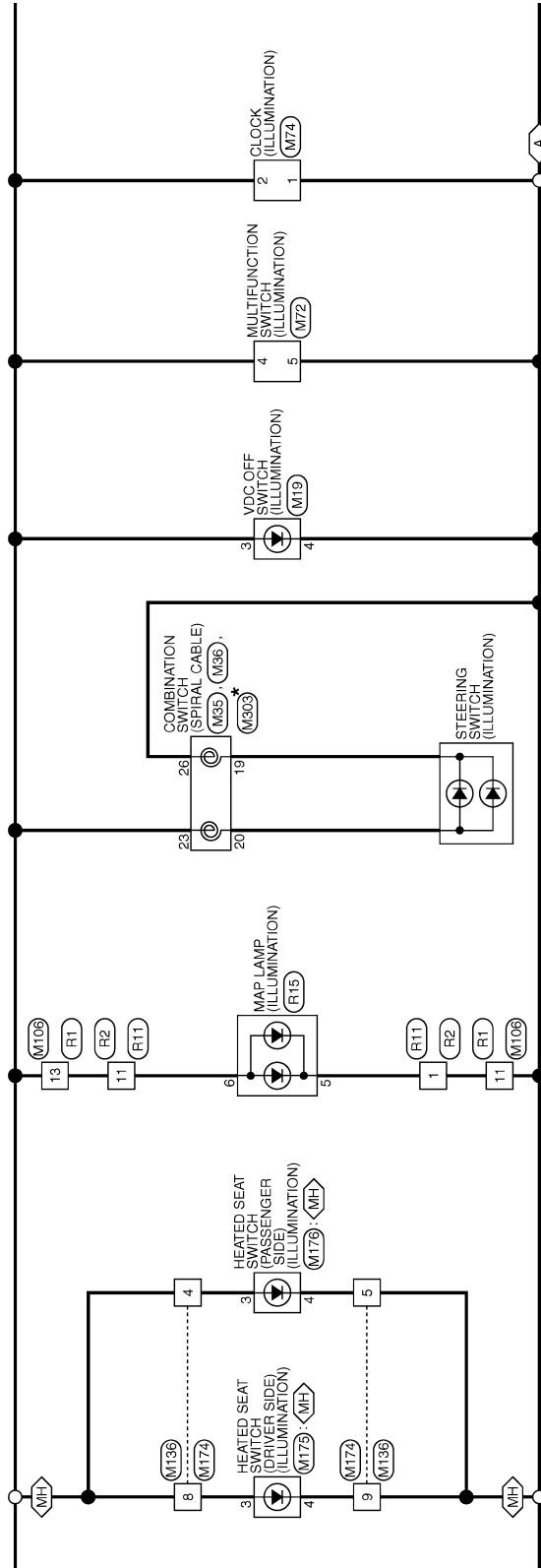

JCLWM6254GB

ILLUMINATION

< DTC/CIRCUIT DIAGNOSIS >

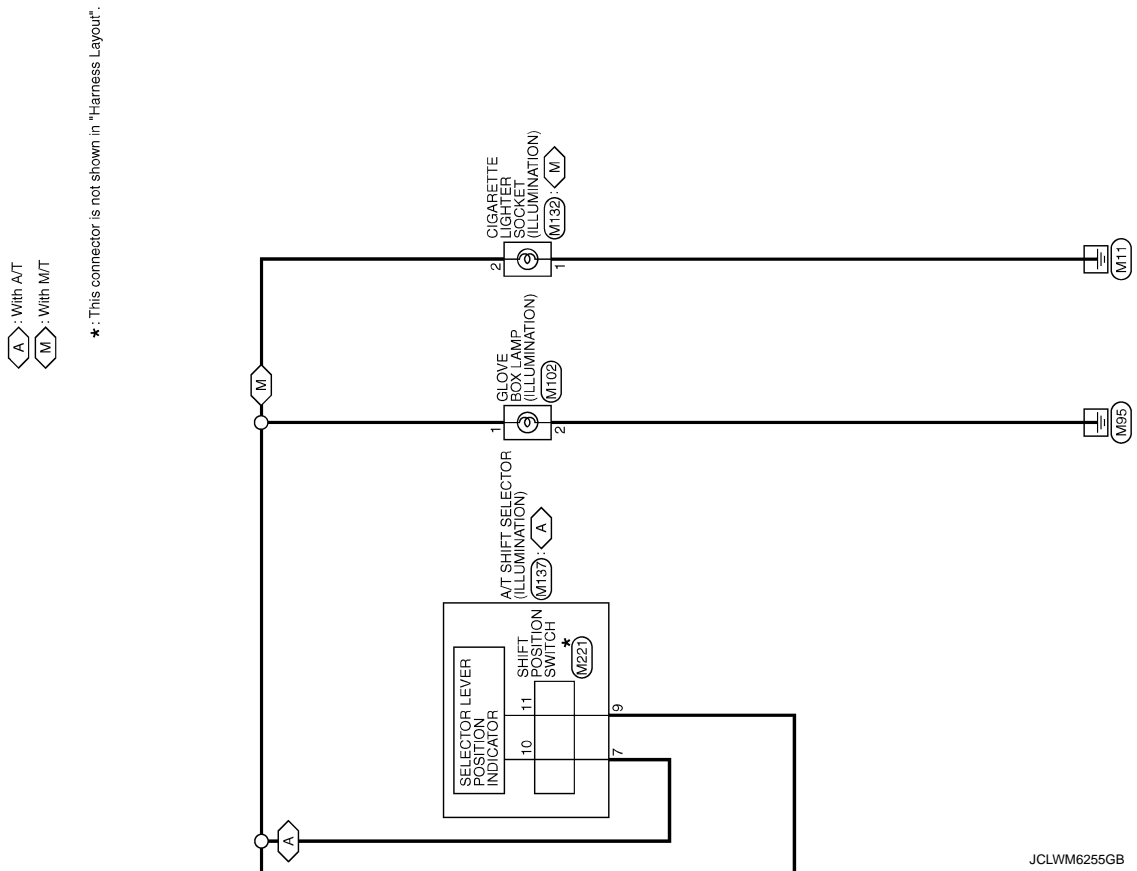

A
B
C
D
E
F
G
H
I
J
K
INL
M
N
O
P

ILLUMINATION

< DTC/CIRCUIT DIAGNOSIS >

ILLUMINATION

Connector No.	B1
Connector Name	WIRE TO WIRE
Connector Type	THB0FW-CS16-TM4

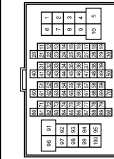

Terminal No.	Color of Wire	Signal Name [Specification]
1	GR	-
2	G	-
3	SB	-
4	Y	-
6	Y	-
15	V	-
16	BR	-
17	LG	-
18	W	-
20	L	-
21	P	-
22	L	-
23	P	-
24	GR	-
25	SB	-
26	G	-
27	W	-
28	G	-
31	V	-
32	SB	-
33	SHIELD	-
34	W	-
35	BR	-
36	Y	-
37	SHIELD	-
38	Y	-
38	LG	-
40	P	-
41	L	-
42	SHIELD	-
43	R	-
44	G	-
45	SHIELD	-
46	SB	-
49	L	-
50	P	-
55	P	-
56	G	-

58	V	-
59	LG	-
60	BR	-
61	W	-
62	R	-
63	L	-
64	Y	-
65	SHIELD	-
71	BR	-
72	SB	-
73	P	-
74	L	-
81	R	-
82	B	-
84	Y	-
85	L	-
86	GR	-
87	R	-
88	V	-
90	GR	-
91	Y	-
95	BG	-
96	R	-
100	V	-

Connector No.	B16
Connector Name	DRIVER SIDE DOOR SWITCH
Connector Type	A03FW

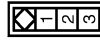

Terminal No.	Color of Wire	Signal Name [Specification]
2	V	-

Connector No.	B201
Connector Name	WIRE TO WIRE
Connector Type	THB0FW-CS16-TM4

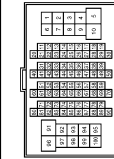

Terminal No.	Color of Wire	Signal Name [Specification]
1	GR	-
5	Y	-
6	G	-
7	BG	-
9	LG	-
10	R	-
30	B	-
31	L	-
32	P	-
33	SB	-
34	V	-
40	GR	-
41	LG	-
42	BG	-
43	R	-
45	G	-
46	SHIELD	-
47	G	-
48	Y	-
48	SHIELD	-
50	P	-
59	BG	-
61	R	-
71	R	-
72	V	-
80	V	-
81	SHIELD	-
82	Y	-
83	BR	-
84	O	-
85	SHIELD	-
86	G	-
87	R	-
88	W	-
89	B	-
90	SB	-
91	V	-
94	W	-
95	G	-

97	BR	-
----	----	---

ILLUMINATION

< DTC/CIRCUIT DIAGNOSIS >

ILLUMINATION

Connector No.	D1
Connector Name	WIRE TO WIRE
Connector Type	TH06FW-CS15



Terminal No.	Color of Wire	Signal Name [Specification]
1	Y	-
2	B	-
3	SB	-
4	Y	-
8	B	-
9	P	-
10	LG	-
12	GR	-
13	W	-
14	G	-
15	R	-
16	GR	-
17	SB	-
18	BR	-
19	BG	-
20	P	-
21	R	-
25	V	-
26	R	-
27	BR	-
28	W	-
29	Y	-
30	G	-
31	LG	-
32	GR	-
33	B	-
36	W	-
37	P	-
38	V	-
39	BR	-
42	G	-
43	GR	-
44	BR	- [With automatic drive positioner] - [Without automatic drive positioner]
44	BG	-
47	L	-
48	R	-
48	SB	-
48	SB	-
50	W	-

51	P	-
52	V	-

Connector No.	D7
Connector Name	DOOR MIRROR REMOTE CONTROL SWITCH
Connector Type	TK1BFW

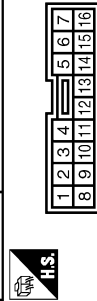

Terminal No.	Color of Wire	Signal Name [Specification]
1	B	-
7	V	-
8	B	-
9	R	-
10	G	-
12	G	-
13	R	-
14	GR	-
15	BG	-
16	BG	-

Connector No.	D17
Connector Name	DOOR MIRROR REMOTE CONTROL SWITCH
Connector Type	TK1BFBR

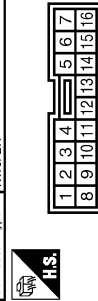

Terminal No.	Color of Wire	Signal Name [Specification]
4	BR	-
7	B	-
8	B	-
9	R	-
10	GR	-
11	LG	-
12	G	-
13	W	-

15	Y	-
----	---	---

Connector No.	E5
Connector Name	POLE 8 INTELLIGENT POWER DISTRIBUTION MODULE (PULSE-SENS)
Connector Type	TH06FW-CS12-MM-IV

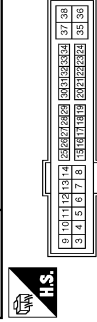

Terminal No.	Color of Wire	Signal Name [Specification]
4	V	-
5	L	-
8	SB	-
9	R	-
11	BR	-
12	B/W	-
13	Y	-
16	LG	-
18	W	-
19	W	-
25	G	-
26	R	-
27	BG	-
28	L	-
30	GR	-
32	V	-
33	P	-
38	G	-

Connector No.	E6
Connector Name	POLE 8 INTELLIGENT POWER DISTRIBUTION MODULE (PULSE-SENS)
Connector Type	TH06FW-NH

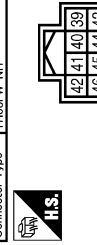

Terminal No.	Color of Wire	Signal Name [Specification]
38	P	-
40	L	-

41	B/W	-
42	Y	-
43	SB	-
44	LG	-
45	G	-
46	W	-

Connector No.	E103
Connector Name	FUSE BLOCK (J/B)
Connector Type	NS18FW-CS



Terminal No.	Color of Wire	Signal Name [Specification]
1F	SB	-
2F	V	-
4F	G	-
6F	BG	-
8F	L	-
9F	R	-

A
B
C
D
E
F
G
H
I
J
K
L
M
N
O
P

INL

ILLUMINATION

< DTC/CIRCUIT DIAGNOSIS >

ILLUMINATION

Connector No.	E106
Connector Name	WIRE TO WIRE
Connector Type	THB07W-CS16-TM4



Terminal No.	Color of Wire	Signal Name [Specification]
1	GR	-
3	BG	-
5	G	-
6	BG	-
7	V	- [With daytime running light]
7	LG	- [Without daytime running light]
8	L	- [With daytime running light]
9	R	- [Without daytime running light]
10	W	-
11	V	-
12	R	-
13	L	-
14	GR	-
15	P	-
16	W	-
17	V	-
18	BG	-
19	GR	-
20	LG	-
30	R	-
31	L	-
32	BG	-
33	P	-
34	V	-
35	BR	-
36	W	-
37	Y	-
38	R	-
39	B	-
40	G	-
41	W	-
42	LG	-
43	SB	-
44	GR	-
45	BG	-
46	LG	-
47	V	-
48	P	-

49	L	-
59	B	-
66	LG	-
67	SB	-
68	R	-
69	W	-
70	G	-
80	W	-
81	P	-
82	G	-
83	V	-
84	L	-
85	BG	-
86	LG	-
87	Y	-
88	GR	-
89	W	-
91	G	-
93	GR	-
95	Y	-
96	Y	-
97	BR	-
98	SHIELD	-
99	L	-
100	P	-

Connector No.	M1
Connector Name	FUSE BLOCK (J/B)
Connector Type	NS00FW-M2



Terminal No.	Color of Wire	Signal Name [Specification]
1A	V	-
2A	G	-
3A	L	-
4A	P	-
5A	L	-
6A	Y	-
7A	R	-
8A	L	-

Connector No.	M2
Connector Name	FUSE BLOCK (J/B)
Connector Type	NS10FW-CS



Terminal No.	Color of Wire	Signal Name [Specification]
1B	SB	-
3B	P	-
4B	G	-
5B	BG	-
6B	Y	-
7B	P	-
8B	R	-
9B	SB	-

Connector No.	M3
Connector Name	FUSE BLOCK (J/B)
Connector Type	NS12FW-CS

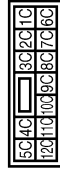

Terminal No.	Color of Wire	Signal Name [Specification]
9C	SB	-
7C	B	-
8C	W	-
9C	BG	-
10C	L	-
11C	LG	-
12C	G	-

JCLWM6258GB

ILLUMINATION

< DTC/CIRCUIT DIAGNOSIS >

ILLUMINATION

Connector No.	M5
Connector Name	WIRE TO WIRE
Connector Type	TH80MW-CS15



1	2	3	4	5	6	7	8	9	10	11	12	13	14	15	16	17	18	19	20	21	22	23	24	25	26	27	28	29	30	31	32	33	34	35	36	37	38	39	40	41	42	43	44	45	46	47	48	49	50
---	---	---	---	---	---	---	---	---	----	----	----	----	----	----	----	----	----	----	----	----	----	----	----	----	----	----	----	----	----	----	----	----	----	----	----	----	----	----	----	----	----	----	----	----	----	----	----	----	----

Terminal No.	Color of Wire	Signal Name [Specification]
1	Y	-
2	B	-
3	BG	-
4	V	-
8	SB	-
9	G	-
10	V	-
12	L	-
13	W	-
14	B	-
15	W	-
16	R	-
17	BR	-
18	V	-
19	BG	-
20	P	-
21	W	-
25	Y	-
26	G	-
27	L	-
28	Y	-
29	G	-
30	G	-
30	SB	-
31	LG	-
32	W	-
33	B	-
36	W	-
37	GR	-
38	Y	-
39	B	-
42	Y	-
43	L	-
44	G	-
44	L	- [With automatic drive positioner] - [Without automatic drive positioner]
47	L	-
48	GR	-
48	SB	-
50	P	-

51	LG
52	V

Connector No.	M6
Connector Name	WIRE TO WIRE
Connector Type	TH80MW-CS16-TM4



1	2	3	4	5	6	7	8	9	10	11	12	13	14	15	16	17	18	19	20	21	22	23	24	25	26	27	28	29	30	31	32	33	34	35	36	37	38	39	40	41	42	43	44	45	46	47	48	49	50
---	---	---	---	---	---	---	---	---	----	----	----	----	----	----	----	----	----	----	----	----	----	----	----	----	----	----	----	----	----	----	----	----	----	----	----	----	----	----	----	----	----	----	----	----	----	----	----	----	----

Terminal No.	Color of Wire	Signal Name [Specification]
1	BG	-
3	R	-
5	G	-
6	LG	-
7	W	-
9	G	-
10	W	-
11	V	-
12	R	-
13	L	-
14	GR	-
15	P	-
16	W	-
17	BR	-
18	P	-
19	L	-
20	L	-
20	BR	-
31	L	-
32	Y	-
33	BG	-
34	W	-
35	BR	-
36	R	-
37	Y	-
38	R	-
39	SB	-
40	G	-
41	V	-
42	LG	-
43	P	-
44	B	- [With A/T]
44	R	- [With M/T]
45	BG	-

46	G	-
47	L	-
48	P	-
48	L	-
49	B	-
60	Y	-
67	G	-
68	R	-
69	W	-
70	G	-
80	SB	-
81	B	-
82	V	-
83	W	-
84	L	-
85	GR	-
86	G	-
87	R	-
88	B	-
89	B	-
89	LG	-
91	W	-
93	Y	-
95	Y	-
96	R	-
97	GR	-
98	SHIELD	-
99	V	-
100	SB	-

JCLWM6259GB

A
B
C
D
E
F
G
H
I
J
K
INL
M
N
O
P

ILLUMINATION

< DTC/CIRCUIT DIAGNOSIS >

ILLUMINATION

Connector No.	M7
Connector Name	WIRE TO WIRE
Connector Type	TH80MW-CS16-TM4

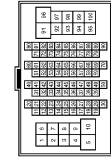

Terminal No.	Color of Wire	Signal Name [Specification]
1	GR	-
2	P	-
3	SB	- [With automatic drive positioner]
3	P	- [Without automatic drive positioner]
4	Y	-
6	L	-
15	R	-
16	BR	-
17	P	-
18	V	-
20	L	-
21	P	-
22	L	-
23	P	-
24	V	-
25	LG	-
26	BR	-
27	EG	-
28	LG	-
31	V	-
32	LG	-
33	SHIELD	-
34	GR	-
35	BR	-
36	Y	-
37	SHIELD	-
38	SB	-
39	LG	-
40	O	-
41	W	-
42	SHIELD	-
43	R	-
44	G	-
45	SHIELD	-
46	SB	-
48	L	-
50	P	-
55	W	-

56	B	-
58	V	-
59	Y	-
60	Y	-
61	W	-
62	R	-
63	G	-
64	B	-
65	SHIELD	-
71	V	-
72	P	-
73	SB	-
74	V	-
81	W	-
82	BR	-
84	LG	-
85	EG	-
86	SB	-
87	G	-
88	GR	-
89	P	-
91	EG	-
95	EG	-
96	Y	-
100	P	-

Connector No.	M9
Connector Name	DIODE
Connector Type	Z4335 C9500



Terminal No.	Color of Wire	Signal Name [Specification]
1	R	-
2	R	-

Connector No.	M19
Connector Name	VDC OFF SWITCH
Connector Type	TKG8FY



Terminal No.	Color of Wire	Signal Name [Specification]
1	R	-
2	B	-
3	SB	-
4	B	-

Connector No.	M20
Connector Name	TRUNK LID OPENER SWITCH
Connector Type	TKG4FW



Terminal No.	Color of Wire	Signal Name [Specification]
1	GR	-
2	B	-
3	LG	-
4	R	-

Connector No.	M21
Connector Name	DATA LINK CONNECTOR
Connector Type	BD16FW-P

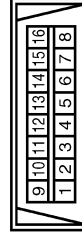

Terminal No.	Color of Wire	Signal Name [Specification]
3	LG	-
4	B	-
5	B	-
6	L	-
7	V	-
8	G	-
11	SB	-
14	P	-
16	R	-

Connector No.	M33
Connector Name	COMBINATION SWITCH
Connector Type	TH16FW-NH

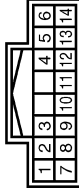

Terminal No.	Color of Wire	Signal Name [Specification]
1	GR	FR WASHER (-)
2	SB	OUTPUT 4
5	L	OUTPUT 3
6	B	GND
7	EG	INPUT 3
8	BR	OUTPUT 5
9	W	INPUT 2
10	R	INPUT 4
11	LG	INPUT 1
12	P	OUTPUT 1
13	Y	INPUT 5
14	G	OUTPUT 2

ILLUMINATION

< DTC/CIRCUIT DIAGNOSIS >

ILLUMINATION

Connector No.	M35
Connector Name	COMBINATION SWITCH (SPIRAL CABLE)
Connector Type	TK08FY-EX-1V



Terminal No.	Color of Wire	Signal Name [Specification]
23	R	-
28	Y	-
29	Y	-
30	Y	-

Connector No.	M36
Connector Name	COMBINATION SWITCH (SPIRAL CABLE)
Connector Type	TK08FY-1V

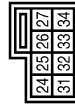

Terminal No.	Color of Wire	Signal Name [Specification]
24	P	-
26	SB	-
28	B	-
31	L	-
33	B	-
34	LG	-

Connector No.	M50
Connector Name	PUSH-BUTTON IGNITION SWITCH
Connector Type	TK08FER



Terminal No.	Color of Wire	Signal Name [Specification]
1	B	-
2	R	-
3	L	-
4	BR	-
5	LG	-
6	BG	-
7	GR	-
8	P	-

Connector No.	M53
Connector Name	COMBINATION METER
Connector Type	SAB40TV

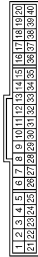

Terminal No.	Color of Wire	Signal Name [Specification]
1	V	BATTERY POWER SUPPLY
2	LG	COMMUNICATION SIGNAL (METER->AMP.)
3	GR	GROUND
5	B	GROUND
6	W	ALTERNATOR SIGNAL
7	LG	AIR BAG SIGNAL
10	W	SECURITY SIGNAL
15	B	GROUND
16	BR	METER CONTROL SWITCH GROUND
18	GR	ILL GND
19	B	ILL GND
20	R	ILL
21	G	IGNITION SIGNAL
22	B	GROUND

24	BR	COMMUNICATION SIGNAL (LCD->AMP.)
25	Y	COMMUNICATION SIGNAL (AMP->LCD)
26	R	VEHICLE SPEED SIGNAL (8-PULSE)
27	P	PARKING BRAKE SWITCH SIGNAL
28	SB	BRAKE FLUID LEVEL SWITCH
29	P	SEAT BELT BUCKLE SW SIGNAL (DRIVER SIDE)
30	G	SEAT BELT BUCKLE SWITCH SIGNAL (PASSENGER SIDE)
31	L	WASHER LEVEL SWITCH SIGNAL
33	R	ILLUMINATION CONTROL SIGNAL
36	LG	SELECT SWITCH SIGNAL
37	Y	ENTER SWITCH SIGNAL
38	G	TRIP A/B RESET SWITCH SIGNAL
39	P	ILLUMINATION CONTROL SWITCH SIGNAL (-)
40	BG	ILLUMINATION CONTROL SWITCH SIGNAL (+)

Connector No.	M54
Connector Name	METER CONTROL SWITCH
Connector Type	TH12FW-NH

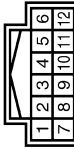

Terminal No.	Color of Wire	Signal Name [Specification]
1	Y	-
2	LG	-
3	B	-
4	R	-
5	G	-
7	BR	-
8	GR	-
9	BG	-
10	P	-

Connector No.	M65
Connector Name	UNIFIED METER AND A/C AMP.
Connector Type	TH40FW-NH



Terminal No.	Color of Wire	Signal Name [Specification]
4	G	STOP LAMP SWITCH SIGNAL
5	L	MANUAL MODE SHIFT UP SIGNAL
6	BG	PADDLE SHIFTER UP SIGNAL
7	GR	COMMUNICATION SIGNAL (AMP->METER)
8	L	VEHICLE SPEED SIGNAL (2-PULSE)
9	SB	SEAT BELT BUCKLE SWITCH SIGNAL (DRIVER SIDE)
10	W	MANUAL MODE SIGNAL
11	G	NON-MANUAL MODE SIGNAL
14	BR	COMMUNICATION SIGNAL (CD->AMP.)
20	BR	IGN ON / OFF SIGNAL
23	Y	AT SNOW SWITCH SIGNAL
25	V	MANUAL MODE SHIFT DOWN SIGNAL
26	G	PADDLE SHIFTER DOWN SIGNAL
27	LG	COMMUNICATION SIGNAL (METER->AMP.)
28	R	VEHICLE SPEED SIGNAL (8-PULSE)
30	V	PARKING BRAKE SWITCH SIGNAL
34	Y	COMMUNICATION SIGNAL (AMP->LCD)
38	P	BLOWER MOTOR CONTROL SIGNAL

JCLWM6261GB

A
B
C
D
E
F
G
H
I
J
K
L
M
N
O
P

INL

ILLUMINATION

< DTC/CIRCUIT DIAGNOSIS >

ILLUMINATION

Connector No.	M67
Connector Name	UNIFIED METER AND A/C AMP.
Connector Type	TH22FW-NH



1	2	3	4	5	6	7	8	9	10	11	12	13	14	15	16
---	---	---	---	---	---	---	---	---	----	----	----	----	----	----	----

Terminal No.	Color of Wire	Signal Name [Specification]
41	L	ACC POWER SUPPLY
42	BR	FUEL LEVEL SENSOR SIGNAL
43	BR	INTAKE SENSOR SIGNAL
44	LG	IN-VEHICLE SENSOR SIGNAL
45	V	AMBIENT SENSOR SIGNAL
46	Y	SUNLOAD SENSOR SIGNAL
47	G	EXHAUST GAS OXIDIZER SENSOR SIGNAL
53	W	IGNITION POWER SUPPLY
54	SB	BATTERY POWER SUPPLY
55	B	GROUND
56	L	CAN-H
57	LG	BRAKE FLUID LEVEL SWITCH
58	Y	FUEL LEVEL SENSOR GROUND
59	GR	INTAKE SENSOR GROUND
60	W	IN-VEHICLE SENSOR GROUND
61	B	AMBIENT SENSOR GROUND
62	SB	SUNLOAD SENSOR GROUND
63	L	ION CONTROL MODE OUTPUT SIGNAL
65	EG	ECV SIGNAL
68	P	A/C LAN SIGNAL
70	R	EACH DOOR MOTOR POWER SUPPLY
71	GR	GROUND
72	P	CAN-L

Connector No.	M72
Connector Name	MULTIFUNCTION SWITCH
Connector Type	TH16FW-NH



2	4	6	8	10	12	14	16
1	3	5	7	9	11	13	15

Terminal No.	Color of Wire	Signal Name [Specification]
1	B	ACC
3	P	GND
4	EG	ILL.
5	B	ILL CONT.
6	SB	AV COMM (RH)
8	LG	AV COMM (LL)
9	BR	SW GND
14	V	DISK EJECT SIGNAL
16	G	HAZARD ON

Connector No.	M74
Connector Name	CLOCK
Connector Type	TH10FW-NH



1	2	3	4
---	---	---	---

Terminal No.	Color of Wire	Signal Name [Specification]
1	B	ILLUMINATION (-)
2	L	ILLUMINATION (+)
3	B	GND
4	Y	BAT.

Connector No.	M81
Connector Name	AV CONTROL UNIT
Connector Type	TH18FW-CS2



19	10	11	12	13	14	15	16	17	18	20
----	----	----	----	----	----	----	----	----	----	----

Terminal No.	Color of Wire	Signal Name [Specification]
2	L	SOUND SIGNAL FRONT LH (+)
3	W	SOUND SIGNAL FRONT LH (-)
4	LG	SOUND SIGNAL REAR LH (+)
5	SB	SOUND SIGNAL REAR LH (-)
6	P	STRG SW A

Terminal No.	Color of Wire	Signal Name [Specification]
7	V	ACC
8	B	GND
9	L	ILLUMINATION
11	BR	SOUND SIGNAL FRONT RH (+)
12	R	SOUND SIGNAL FRONT RH (-)
13	L	SOUND SIGNAL REAR RH (+)
14	P	SOUND SIGNAL REAR RH (-)
15	B	STRG SW GND
16	L	STRG SW B
19	Y	BATTERY
20	B	GND

Connector No.	M83
Connector Name	AV CONTROL UNIT
Connector Type	TH24FW-NH



47	46	45	44	43	42	41	40	39	38	37	36
59	58	57	56	55	54	53	52	51	50	49	48

Terminal No.	Color of Wire	Signal Name [Specification]
36	BR	COMPOSITE IMAGE SIGNAL
37	Y	COMPOSITE IMAGE GND
38	P	RGB (B/BLUE) SIGNAL
39	L	RGB (G/GREEN) SIGNAL
40	G	RGB (R/RED) SIGNAL
41	W	RGB SYNC
42	SHIELD	SHIELD
43	B	RGB AREA(Y/S) SIGNAL
44	L	COMM (DISP->CONT)
45	R	HP
46	LG	SIGNAL GND
47	EG	SIGNAL VCC
48	BR	COMP SYNC
49	Y	SHIELD
50	SHIELD	SHIELD
55	B	SHIELD
56	LG	COMM (CONT->DISP)
57	G	VP
58	BR	INVERTER GND
59	Y	INVERTER VCC

Connector No.	M102
Connector Name	GLOVE BOX LAMP
Connector Type	AQ2FW



1	2
---	---

Terminal No.	Color of Wire	Signal Name [Specification]
1	R	
2	B	

Connector No.	M106
Connector Name	WIRE TO WIRE
Connector Type	NH10MP-CS10



1	2	3	4	5	6
7	8	9	10	11	12
			13	14	15
			16	17	18
			19	20	

Terminal No.	Color of Wire	Signal Name [Specification]
2	L	
3	SHIELD	
4	G	
5	BR	
6	EG	
7	Y	
8	P	
9	LG	
10	V	
11	B	
12	B	
13	R	
15	R	
16	G	
17	SHIELD	
18	B	
19	Y	
20	R	

ILLUMINATION

< DTC/CIRCUIT DIAGNOSIS >

ILLUMINATION

Connector No.	M117
Connector Name	WIRE TO WIRE
Connector Type	TH80MW-CS (F-TM4)



Terminal No.	Color of Wire	Signal Name [Specification]
1	LG	-
5	P	-
6	G	-
7	SB	-
9	LG	-
10	L	-
30	B	-
31	SB	-
32	LG	-
33	SB	-
34	LG	-
40	Y	-
41	G	-
42	LG	-
43	R	-
45	G	-
46	SHIELD	-
47	P	-
48	L	-
49	SHIELD	-
50	V	-
56	R	-
71	R	-
72	L	-
80	W	-
81	SHIELD	-
82	P	-
83	L	-
84	G	-
85	SHIELD	-
86	W	-
87	B	-
88	R	-
89	G	-
90	Y	-
91	V	-
94	Y	-
95	G	-

97	R	-
----	---	---

Connector No.	M118
Connector Name	BCM (BODY CONTROL MODULE)
Connector Type	M03FB-LC



Terminal No.	Color of Wire	Signal Name [Specification]
1	W	BAT (E/L)
2	Y	POWER WINDOW POWER SUPPLY (BAT)
3	BG	POWER WINDOW POWER SUPPLY (RAP)

Connector No.	M119
Connector Name	BCM (BODY CONTROL MODULE)
Connector Type	NS16FW-GS

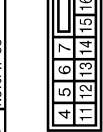

Terminal No.	Color of Wire	Signal Name [Specification]
4	LG	INTERIOR ROOM LAMP POWER SUPPLY
5	P	PASSENGER DOOR UNLOCK OUTPUT
7	SB	STEP LAMP OUTPUT
8	V	ALL DOOR FUEL LID LOCK OUTPUT
9	G	DRIVER DOOR FUEL LID UNLOCK OUTPUT
11	R	BAT FUSE
13	B	GND
14	W	PUSH-BUTTON IGNITION SW ILL GND
15	BG	ACC IND
17	W	TURN SIGNAL RH (FRONT)
18	BG	TURN SIGNAL LH (FRONT)
19	V	INT ROOM LAMP CONT

Connector No.	M122
Connector Name	BCM (BODY CONTROL MODULE)
Connector Type	TH40FB-NH

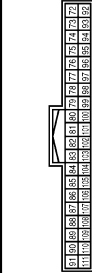

Terminal No.	Color of Wire	Signal Name [Specification]
72	R	ROOM ANT 2-
73	G	ROOM ANT 2+
74	SB	PASSENGER DOOR ANT-
75	BR	PASSENGER DOOR ANT+
76	V	DRIVER DOOR ANT-
77	LG	DRIVER DOOR ANT+
78	Y	ROOM ANT 1-
79	BR	ROOM ANT 1+
80	GR	NATS ANT AMP
81	W	NATS ANT AMP
82	SB	IGN RELAY (F/B) CONT
83	Y	KEYLESS ENTRY RECEIVER COMM
87	Y	COMBI SW INPUT 5
88	BG	COMBI SW INPUT 3
89	BR	PUSH SW
90	P	CAN-L
91	L	CAN-H
92	LG	KEY SLOT ILL
93	GR	ON IND
95	BG	ACC RELAY CONT
96	GR	A/T SHIFT SELECTOR POWER SUPPLY
97	L	S/L CONDITION 1
98	P	S/L CONDITION 2
99	R	SHIFT P (M/A/T)
99	BR	ASC D CLUTCH SW (M/A/T)
100	Y	PASSENGER DOOR REQUEST SW
101	P	DRIVER DOOR REQUEST SW
102	BG	BLOWER FAN MOTOR RELAY CONT
109	P	KEYLESS ENTRY RECEIVER POWER SUPPLY
106	SB	S/L UNIT POWER SUPPLY
107	LG	COMBI SW INPUT 1
108	R	COMBI SW INPUT 4
109	W	COMBI SW INPUT 2
110	G	HAZARD SW
111	Y	S/L UNIT COMM

Connector No.	M123
Connector Name	BCM (BODY CONTROL MODULE)
Connector Type	TH40FG-NH

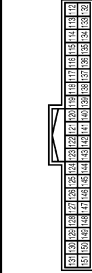

Terminal No.	Color of Wire	Signal Name [Specification]
112	R	RAIN SENSOR SERIAL LINK
113	BG	OPTICAL SENSOR
114	R	CLUTCH INTERLOCK SW
116	SB	STOP LAMP SW 2
118	BR	STOP LAMP SW 2
119	SB	DR DOOR UNLOCK SENSOR
121	SB	KEY SWITCH
123	V	IGN F/B
124	R	PASSENGER DOOR SW
129	BG	TRUNK CANCEL SW
132	V	POWER WINDOW SW COMM
133	L	PUSH-BUTTON IGNITION SW ILL POWER
134	LG	LOCK IND
137	BG	RECEIVER / SENSOR GND
138	V	RECEIVER / SENSOR POWER SUPPLY
139	L	TIRE PRESSURE RECEIVER COMM
140	B	SHIFT N/P
141	W	SECURITY INDICATOR LAMP
142	BR	COMBI SW OUTPUT 5
143	P	COMBI SW OUTPUT 1
144	G	COMBI SW OUTPUT 2
145	L	COMBI SW OUTPUT 3
146	SB	COMBI SW OUTPUT 4
150	GR	DRIVER DOOR SW
151	G	REAR WINDOW DEFROGGER RELAY CONT

JCLWM6263GB

A
B
C
D
E
F
G
H
I
J
K
L
M
N
O
P

INL

ILLUMINATION

< DTC/CIRCUIT DIAGNOSIS >

ILLUMINATION

Connector No.	M132
Connector Name	CIGARETTE LIGHTER SOCKET
Connector Type	NS03FW-CS



Terminal No.	Color of Wire	Signal Name [Specification]
1	B	-
2	BR	-
3	P	-

Connector No.	M136
Connector Name	WIRE TO WIRE
Connector Type	TH12FW-NH

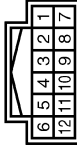

Terminal No.	Color of Wire	Signal Name [Specification]
1	L	-
2	GR	-
3	G	-
4	V	-
5	B	-
6	EG	-
7	B	-
8	R	-
9	B	-
10	LG	-
11	B	-
12	SB	-

Connector No.	M137
Connector Name	A/T SHIFT SELECTOR
Connector Type	TH12FW-NH

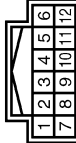

Terminal No.	Color of Wire	Signal Name [Specification]
1	W	-
2	V	-
3	L	-
4	B	-
5	G	-
7	Y	-
8	LG	-
9	B	-
10	GR	-
11	R	-

Connector No.	M139
Connector Name	SNOW MODE SWITCH
Connector Type	TK08FW



Terminal No.	Color of Wire	Signal Name [Specification]
1	R	-
2	GR	-
4	Y	-
5	P	-
6	B	-

Connector No.	M141
Connector Name	HEATED SEAT SWITCH (DRIVER SIDE)
Connector Type	TK08FW

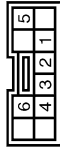

Terminal No.	Color of Wire	Signal Name [Specification]
1	L	-
2	GR	-
3	R	-
4	B	-
5	G	-
6	B	-

Connector No.	M142
Connector Name	HEATED SEAT SWITCH (PASSENGER SIDE)
Connector Type	TK08FBR



Terminal No.	Color of Wire	Signal Name [Specification]
1	LG	-
2	SB	-
3	V	-
4	B	-
5	BG	-
6	B	-

Connector No.	M153
Connector Name	SONAR CANCEL SWITCH
Connector Type	TK08FW



Terminal No.	Color of Wire	Signal Name [Specification]
1	SB	-
2	B	-
3	B	-
4	R	-
5	L	-
6	B	-

Connector No.	M174
Connector Name	WIRE TO WIRE
Connector Type	TH12MWF-NH

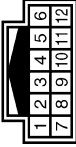

Terminal No.	Color of Wire	Signal Name [Specification]
1	L	-
2	GR	-
3	W	-
4	G	-
5	O	-
6	P	-
7	B	-
8	R	-
9	LG	-
10	Y	-
11	V	-
12	SB	-

ILLUMINATION

< DTC/CIRCUIT DIAGNOSIS >

ILLUMINATION

Connector No.	M175
Connector Name	HEATED SEAT SWITCH (DRIVER SIDE)
Connector Type	TK0DFW



Terminal No.	Color of Wire	Signal Name [Specification]
1	L	-
2	GR	-
3	R	-
4	LG	-
5	W	-
6	B	-

Connector No.	M176
Connector Name	HEATED SEAT SWITCH (PASSENGER SIDE)
Connector Type	TK08FB



Terminal No.	Color of Wire	Signal Name [Specification]
1	Y	-
2	SB	-
3	G	-
4	O	-
5	P	-
6	V	-

Connector No.	M201
Connector Name	AV CONTROL UNIT
Connector Type	TH18FT-C32



Terminal No.	Color of Wire	Signal Name [Specification]
2	L	SOUND SIGNAL FRONT LH (+)
3	W	SOUND SIGNAL FRONT LH (-)
4	LG	SOUND SIGNAL REAR LH (+)
5	SB	SOUND SIGNAL REAR LH (-)
6	P	STRG SW A
7	Y	ACC
9	L	ILLUMINATION
11	BR	SOUND SIGNAL FRONT RH (+)
12	R	SOUND SIGNAL FRONT RH (-)
13	L	SOUND SIGNAL REAR RH (+)
14	P	SOUND SIGNAL REAR RH (-)
15	B	STRG SW GND
16	L	STRG SW B
18	G	GND
19	Y	BATTERY
20	B	GND

Connector No.	M202
Connector Name	AV CONTROL UNIT
Connector Type	TH24FW-NH



Terminal No.	Color of Wire	Signal Name [Specification]
36	BG	SIGNAL YCC
37	LG	SIGNAL GND
38	R	HP
39	L	COMM (DISP->CONT)
40	B	RGB AREA (XS) SIGNAL
41	SHIELD	SHIELD

42	W	RGB SYNC
43	G	RGB (RED) SIGNAL
44	L	RGB (GREEN) SIGNAL
45	P	RGB (BLUE) SIGNAL
46	Y	COMPOSITE IMAGE GND
47	BR	COMPOSITE IMAGE SIGNAL
48	Y	INVERTER VCC
49	BR	INVERTER GND
50	G	VP
51	P	COMM (CONT->DISP)
52	SHIELD	SHIELD
57	SHIELD	SHIELD
58	SHIELD	SHIELD

Connector No.	M210
Connector Name	AV CONTROL UNIT
Connector Type	TH22FW-NH



Terminal No.	Color of Wire	Signal Name [Specification]
65	SB	PARKING BRAKE
67	P	COMPOSITE IMAGE GND
68	L	COMPOSITE IMAGE SIGNAL
71	SHIELD	MICROPHONE GND
72	G	MICROPHONE VCC
73	P	COMM (CONT->DISP)
74	P	CAN-L
75	LG	AV COMM (L)
76	LG	AV COMM (L)
79	L	ILLUMINATION
80	G	IGNITION
81	BG	REVERSE
82	R	VEHICLE SPEED (8-PULSE)
83	SHIELD	SHIELD
87	R	MICROPHONE SIGNAL
88	SHIELD	SHIELD
89	L	COMM (DISP->CONT)
90	L	CAN-H
91	SB	AV COMM (H)
92	SB	AV COMM (H)

Connector No.	M221
Connector Name	SHIFT POSITION SWITCH
Connector Type	TH12FW



Terminal No.	Color of Wire	Signal Name [Specification]
2	L	N
3	BR	D
4	G	R
5	P	P
6	V	M
7	O	AT
9	Y	MT
10	R	ILL
11	B	GND

Connector No.	M303
Connector Name	COMBINATION SWITCH (SERIAL CABLE)
Connector Type	TK08FGY



Terminal No.	Color of Wire	Signal Name [Specification]
13	R	-
14	W	-
15	L	-
16	B	-
17	BR	-
18	G	-
19	P	-
20	Y	-

A
B
C
D
E
F
G
H
I
J
K
L
M
N
O
P

INL

ILLUMINATION

< DTC/CIRCUIT DIAGNOSIS >

ILLUMINATION		R1	
Connector No.	W	5	W
Connector Name	B	6	B
Connector Type	IP	7	IP
	GR	8	GR
	Y	9	Y
	Y	11	Y
	R	12	R

ILLUMINATION		R11	
Connector No.	WIRE TO WIRE	Connector No.	R11
Connector Name	TH12MV-NH	Connector Name	WIRE TO WIRE
Connector Type		Connector Type	TH12MV-NH

ILLUMINATION		R2	
Connector No.	W	5	W
Connector Name	B	6	B
Connector Type	IP	7	IP
	GR	8	GR
	Y	9	Y
	Y	11	Y
	R	12	R

ILLUMINATION		R15	
Connector No.	WIRE TO WIRE	Connector No.	R15
Connector Name	TH12PV-NH	Connector Name	MAP LAMP
Connector Type		Connector Type	TK08FY

3	B	-
5	Y	-
6	L	-

5	W	-
6	B	-
7	IP	-
8	GR	-
9	Y	-
11	Y	-
12	R	-

Connector No.	R11
Connector Name	WIRE TO WIRE
Connector Type	TH12MV-NH



Terminal No.	Color of Wire	Signal Name [Specification]
1	Y	-
2	BR	-
3	SHIELD	-
4	W	-
5	R	-
6	B	-
7	O	-
8	G	-
9	GR	-
11	L	-
12	P	-

Connector No.	R15
Connector Name	MAP LAMP
Connector Type	TK08FY



Terminal No.	Color of Wire	Signal Name [Specification]
1	P	-
2	GR	-

Connector No.	R1
Connector Name	WIRE TO WIRE
Connector Type	NH10VY-CS10

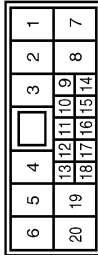

Terminal No.	Color of Wire	Signal Name [Specification]
2	GR	-
3	SHIELD	-
4	G	-
5	BR	-
6	Y	-
7	G	-
8	BR	-
9	R	-
10	V	-
11	B	-
12	B	-
13	Y	-
15	O	-
16	W	-
17	SHIELD	-
18	B	-
19	Y	-
20	R	-

Connector No.	R2
Connector Name	WIRE TO WIRE
Connector Type	TH12PV-NH

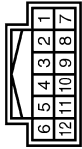

Terminal No.	Color of Wire	Signal Name [Specification]
1	B	-
2	B	-
3	SHIELD	-
4	O	-

JCLWM6266GB

BCM (BODY CONTROL MODULE)

< ECU DIAGNOSIS INFORMATION >

ECU DIAGNOSIS INFORMATION

BCM (BODY CONTROL MODULE)

Reference Value

INFOID:000000006956832

VALUES ON THE DIAGNOSIS TOOL

CONSULT-III MONITOR ITEM

Monitor Item	Condition	Value/Status
FR WIPER HI	Other than front wiper switch HI	Off
	Front wiper switch HI	On
FR WIPER LOW	Other than front wiper switch LO	Off
	Front wiper switch LO	On
FR WASHER SW	Front washer switch OFF	Off
	Front washer switch ON	On
FR WIPER INT	Other than front wiper switch INT/AUTO	Off
	Front wiper switch INT/AUTO	On
FR WIPER STOP	Front wiper is not in STOP position	Off
	Front wiper is in STOP position	On
INT VOLUME	Wiper volume dial is in a dial position 1 - 7	Wiper volume dial position
TURN SIGNAL R	Other than turn signal switch RH	Off
	Turn signal switch RH	On
TURN SIGNAL L	Other than turn signal switch LH	Off
	Turn signal switch LH	On
TAIL LAMP SW	Other than lighting switch 1ST and 2ND	Off
	Lighting switch 1ST or 2ND	On
HI BEAM SW	Other than lighting switch HI	Off
	Lighting switch HI	On
HEAD LAMP SW 1	Other than lighting switch 2ND	Off
	Lighting switch 2ND	On
HEAD LAMP SW 2	Other than lighting switch 2ND	Off
	Lighting switch 2ND	On
PASSING SW	Other than lighting switch PASS	Off
	Lighting switch PASS	On
AUTO LIGHT SW	Other than lighting switch AUTO	Off
	Lighting switch AUTO	On
FR FOG SW	Front fog lamp switch OFF	Off
	Front fog lamp switch ON	On
RR FOG SW	NOTE: The item is indicated, but not monitored.	Off
DOOR SW-DR	Driver door closed	Off
	Driver door opened	On
DOOR SW-AS	Passenger door closed	Off
	Passenger door opened	On
DOOR SW-RR	NOTE: The item is indicated, but not monitored.	Off

BCM (BODY CONTROL MODULE)

< ECU DIAGNOSIS INFORMATION >

Monitor Item	Condition	Value/Status
DOOR SW-RL	NOTE: The item is indicated, but not monitored.	Off
DOOR SW-BK	NOTE: The item is indicated, but not monitored.	Off
CDL LOCK SW	Other than power door lock switch LOCK	Off
	Power door lock switch LOCK	On
CDL UNLOCK SW	Other than power door lock switch UNLOCK	Off
	Power door lock switch UNLOCK	On
KEY CYL LK-SW	Other than driver door key cylinder LOCK position	Off
	Driver door key cylinder LOCK position	On
KEY CYL UN-SW	Other than driver door key cylinder UNLOCK position	Off
	Driver door key cylinder UNLOCK position	On
KEY CYL SW-TR	NOTE: The item is indicated, but not monitored.	Off
HAZARD SW	Hazard switch is OFF	Off
	Hazard switch is ON	On
REAR DEF SW	NOTE: The item is indicated, but not monitored.	Off
H/L WASH SW	NOTE: The item is indicated, but not monitored.	Off
TR CANCEL SW	Trunk lid opener cancel switch OFF	Off
	Trunk lid opener cancel switch ON	On
TR/BD OPEN SW	Trunk lid opener switch OFF	Off
	While the trunk lid opener switch is turned ON	On
TRNK/HAT MNTR	Trunk lid closed	Off
	Trunk lid opened	On
RKE-LOCK	LOCK button of the Intelligent Key is not pressed	Off
	LOCK button of the Intelligent Key is pressed	On
RKE-UNLOCK	UNLOCK button of the Intelligent Key is not pressed	Off
	UNLOCK button of the Intelligent Key is pressed	On
RKE-TR/BD	TRUNK OPEN button of the Intelligent Key is not pressed	Off
	TRUNK OPEN button of the Intelligent Key is pressed	On
RKE-PANIC	PANIC button of the Intelligent Key is not pressed	Off
	PANIC button of the Intelligent Key is pressed	On
RKE-P/W OPEN	UNLOCK button of the Intelligent Key is not pressed	Off
	UNLOCK button of the Intelligent Key is pressed and held	On
RKE-MODE CHG	LOCK/UNLOCK button of the Intelligent Key is not pressed and held simultaneously	Off
	LOCK/UNLOCK button of the Intelligent Key is pressed and held simultaneously	On
OPTICAL SENSOR	Bright outside of the vehicle	Close to 5 V
	Dark outside of the vehicle	Close to 0 V
REQ SW -DR	Driver door request switch is not pressed	Off
	Driver door request switch is pressed	On
REQ SW -AS	Passenger door request switch is not pressed	Off
	Passenger door request switch is pressed	On
REQ SW -RR	NOTE: The item is indicated, but not monitored.	Off

BCM (BODY CONTROL MODULE)

< ECU DIAGNOSIS INFORMATION >

Monitor Item	Condition	Value/Status	
REQ SW -RL	NOTE: The item is indicated, but not monitored.	Off	A
REQ SW -BD/TR	Trunk lid opener request switch is not pressed	Off	B
	Trunk lid opener request switch is pressed	On	
PUSH SW	Push-button ignition switch (push switch) is not pressed	Off	C
	Push-button ignition switch (push switch) is pressed	On	
IGN RLY2 -F/B	Ignition switch in OFF or ACC position	Off	D
	Ignition switch in ON position	On	
ACC RLY -F/B	NOTE: The item is indicated, but not monitored.	Off	E
CLUCH SW	The clutch pedal is not depressed	Off	E
	The clutch pedal is depressed	On	
BRAKE SW 1	The brake pedal is depressed when No. 7 fuse is blown	Off	F
	The brake pedal is not depressed when No. 7 fuse is blown, or No. 7 fuse is normal	On	
BRAKE SW 2	The brake pedal is not depressed	Off	G
	The brake pedal is depressed	On	
DETE/CANCL SW	<ul style="list-style-type: none"> • Selector lever in P position (Except M/T models) • The clutch pedal is depressed (M/T models) 	Off	H
	<ul style="list-style-type: none"> • Selector lever in any position other than P (Except M/T models) • The clutch pedal is not depressed (M/T models) 	On	
SFT PN/N SW	Selector lever in any position other than P and N	Off	I
	Selector lever in P or N position	On	
S/L -LOCK NOTE: For models without steering lock unit, this item is not monitored.	Steering is unlocked	Off	J
	Steering is locked	On	
S/L -UNLOCK NOTE: For models without steering lock unit, this item is not monitored.	Steering is locked	Off	K
	Steering is unlocked	On	
S/L RELAY-F/B NOTE: For models without steering lock unit, this item is not monitored.	Ignition switch in OFF or ACC position	Off	M
	Ignition switch in ON position	On	
UNLK SEN -DR	Driver door is unlocked	Off	N
	Driver door is locked	On	
PUSH SW -IPDM	Push-button ignition switch (push-switch) is not pressed	Off	O
	Push-button ignition switch (push-switch) is pressed	On	
IGN RLY1 -F/B	Ignition switch in OFF or ACC position	Off	P
	Ignition switch in ON position	On	
DETE SW -IPDM	Selector lever in any position other than P	Off	P
	Selector lever in P position	On	
SFT PN -IPDM	<ul style="list-style-type: none"> • Selector lever in any position other than P and N (Except M/T models) • The clutch pedal is not depressed (M/T models) 	Off	P
	<ul style="list-style-type: none"> • Selector lever in P or N position • The clutch pedal is depressed 	On	

INL

BCM (BODY CONTROL MODULE)

< ECU DIAGNOSIS INFORMATION >

Monitor Item	Condition	Value/Status
SFT P -MET	Selector lever in any position other than P	Off
	Selector lever in P position	On
SFT N -MET	Selector lever in any position other than N	Off
	Selector lever in N position	On
ENGINE STATE	Engine stopped	Stop
	While the engine stalls	Stall
	At engine cranking	Crank
	Engine running	Run
S/L LOCK-IPDM NOTE: For models without steering lock unit, this item is not monitored.	Steering is unlocked	Off
	Steering is locked	On
S/L UNLK-IPDM NOTE: For models without steering lock unit, this item is not monitored.	Steering is locked	Off
	Steering is unlocked	On
S/L RELAY-REQ NOTE: For models without steering lock unit, this item is not monitored.	Steering lock system is not the LOCK condition and the changing condition from LOCK to UNLOCK	Off
	Steering lock system are not the LOCK condition or the changing condition from LOCK to UNLOCK	On
VEH SPEED 1	While driving	Equivalent to speedometer reading
VEH SPEED 2	While driving	Equivalent to speedometer reading
DOOR STAT-DR	Driver door is locked	LOCK
	Wait with selective UNLOCK operation (60 seconds)	READY
	Driver door is unlocked	UNLOCK
DOOR STAT-AS	Passenger door is locked	LOCK
	Wait with selective UNLOCK operation (60 seconds)	READY
	Passenger door is unlocked	UNLOCK
ID OK FLAG	Driver side door is open after ignition switch is turned OFF (Selector lever is in the P position except for M/T models)	Reset
	Ignition switch is ON	Set
PRMT ENG STRT	The engine start is prohibited	Reset
	The engine start is permitted	Set
PRMT RKE STRT	NOTE: The item is indicated, but not monitored.	Reset
KEY SW -SLOT	The Intelligent Key is not inserted into key slot	Off
	The Intelligent Key is inserted into key slot	On
RKE OPE COUN1	During the operation of the Intelligent Key	Operation frequency of the Intelligent Key
RKE OPE COUN2	NOTE: The item is indicated, but not monitored.	—
CONFRM ID ALL	The key ID that the key slot receives is not recognized by any key ID registered to BCM.	Yet
	The key ID that the key slot receives is recognized by any key ID registered to BCM.	Done

BCM (BODY CONTROL MODULE)

< ECU DIAGNOSIS INFORMATION >

Monitor Item	Condition	Value/Status	
CONFIRM ID4	The key ID that the key slot receives is not recognized by the fourth key ID registered to BCM.	Yet	A
	The key ID that the key slot receives is recognized by the fourth key ID registered to BCM.	Done	B
CONFIRM ID3	The key ID that the key slot receives is not recognized by the third key ID registered to BCM.	Yet	C
	The key ID that the key slot receives is recognized by the third key ID registered to BCM.	Done	
CONFIRM ID2	The key ID that the key slot receives is not recognized by the second key ID registered to BCM.	Yet	D
	The key ID that the key slot receives is recognized by the second key ID registered to BCM.	Done	
CONFIRM ID1	The key ID that the key slot receives is not recognized by the first key ID registered to BCM.	Yet	E
	The key ID that the key slot receives is recognized by the first key ID registered to BCM.	Done	F
TP 4	The ID of fourth Intelligent Key is not registered to BCM	Yet	
	The ID of fourth Intelligent Key is registered to BCM	Done	G
TP 3	The ID of third Intelligent Key is not registered to BCM	Yet	
	The ID of third Intelligent Key is registered to BCM	Done	
TP 2	The ID of second Intelligent Key is not registered to BCM	Yet	H
	The ID of second Intelligent Key is registered to BCM	Done	
TP 1	The ID of first Intelligent Key is not registered to BCM	Yet	I
	The ID of first Intelligent Key is registered to BCM	Done	
AIR PRESS FL	Ignition switch ON (Only when the signal from the transmitter is received)	Air pressure of front LH tire	J
AIR PRESS FR	Ignition switch ON (Only when the signal from the transmitter is received)	Air pressure of front RH tire	
AIR PRESS RR	Ignition switch ON (Only when the signal from the transmitter is received)	Air pressure of rear RH tire	K
AIR PRESS RL	Ignition switch ON (Only when the signal from the transmitter is received)	Air pressure of rear LH tire	
ID REGST FL1	ID of front LH tire transmitter is registered	Done	INL
	ID of front LH tire transmitter is not registered	Yet	
ID REGST FR1	ID of front RH tire transmitter is registered	Done	M
	ID of front RH tire transmitter is not registered	Yet	
ID REGST RR1	ID of rear RH tire transmitter is registered	Done	N
	ID of rear RH tire transmitter is not registered	Yet	
ID REGST RL1	ID of rear LH tire transmitter is registered	Done	O
	ID of rear LH tire transmitter is not registered	Yet	
WARNING LAMP	Tire pressure indicator OFF	Off	
	Tire pressure indicator ON	On	
BUZZER	Tire pressure warning alarm is not sounding	Off	P
	Tire pressure warning alarm is sounding	On	

BCM (BODY CONTROL MODULE)

< ECU DIAGNOSIS INFORMATION >

TERMINAL LAYOUT

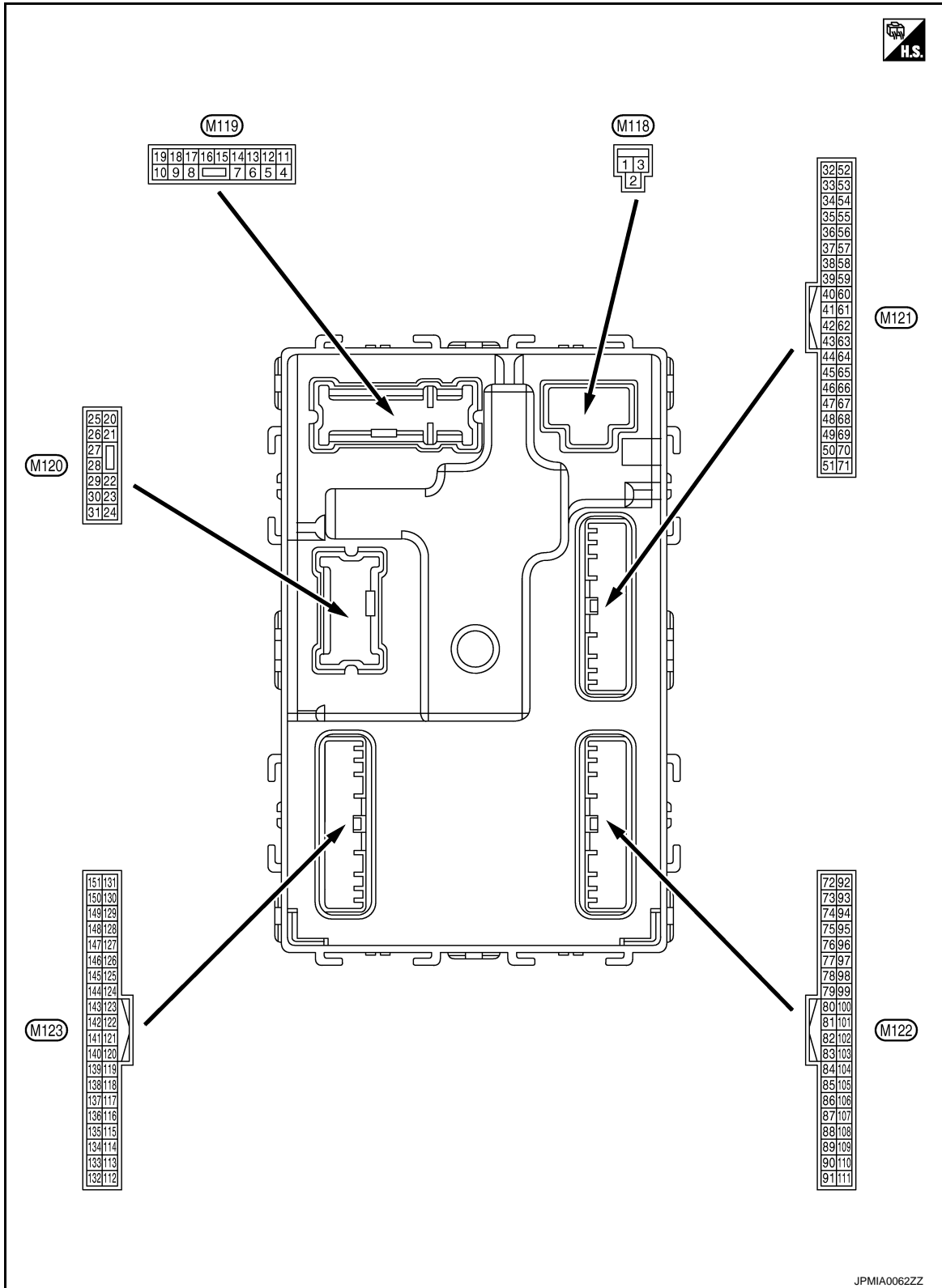

PHYSICAL VALUES

BCM (BODY CONTROL MODULE)

< ECU DIAGNOSIS INFORMATION >

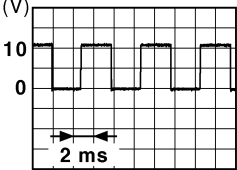
Terminal No. (Wire color)		Description		Condition		Value (Approx.)
		Signal name	Input/ Output			
+	-					
1 (W)	Ground	Battery power supply	Input	Ignition switch OFF		Battery voltage
2 (Y)	Ground	P/W power supply (BAT)	Output	Ignition switch OFF		12 V
3 (BG)	Ground	P/W power supply (RAP)	Output	Ignition switch ON		12 V
4 (LG)	Ground	Interior room lamp power supply	Output	Interior room lamp battery saver is activated. (Cuts the interior room lamp power supply)		0 V
				Interior room lamp battery saver is not activated. (Outputs the interior room lamp power supply)		12 V
5 (P)	Ground	Passenger door UN- LOCK	Output	Passenger door	UNLOCK (Actuator is activated)	12 V
					Other than UNLOCK (Ac- tuator is not activated)	0 V
7 (SB)	Ground	Step lamp	Output	Step lamp	ON	0 V
					OFF	12 V
8 (V)	Ground	All doors, fuel lid LOCK	Output	All doors, fuel lid	LOCK (Actuator is activated)	12 V
					Other than LOCK (Actuator is not activated)	0 V
9 (G)	Ground	Driver door, fuel lid UNLOCK	Output	Driver door, fuel lid	UNLOCK (Actuator is activated)	12 V
					Other than UNLOCK (Actuator is not activated)	0 V
11 (R)	Ground	Battery power supply	Input	Ignition switch OFF		Battery voltage
13 (B)	Ground	Ground	—	Ignition switch ON		0 V
14 (W)	Ground	Push-button ignition switch illumination ground	Output	Tail lamp	OFF	<p style="text-align: center;">NOTE: When the illumination brighten- ing/dimming level is in the neutral position.</p>  <p style="text-align: right; font-size: small;">JSNIA0010GB</p>
					ON	
15 (BG)	Ground	ACC indicator lamp	Output	Ignition switch	OFF (LOCK indicator is not illuminated)	Battery voltage
					ACC	0 V

A
B
C
D
E
F
G
H
I
J
K
INL
M
N
O
P

BCM (BODY CONTROL MODULE)

< ECU DIAGNOSIS INFORMATION >

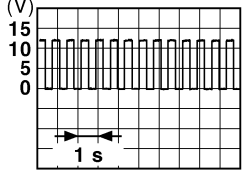
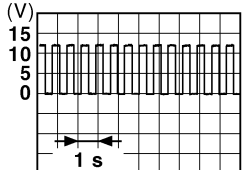
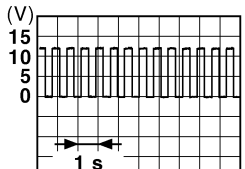
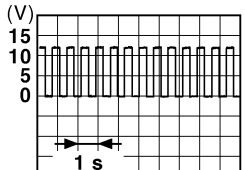
Terminal No. (Wire color)		Description		Condition	Value (Approx.)	
		Signal name	Input/ Output			
+	-					
17 (W)	Ground	Turn signal RH (Front)	Output	Ignition switch ON	Turn signal switch OFF	0 V
				Turn signal switch RH		6.5 V
18 (BG)	Ground	Turn signal LH (Front)	Output	Ignition switch ON	Turn signal switch OFF	0 V
				Turn signal switch LH		6.5 V
19 (V)	Ground	Room lamp timer control	Output	Interior room lamp	OFF	12 V
				ON	0 V	
20 (V)	Ground	Turn signal RH (Rear)	Output	Ignition switch ON	Turn signal switch OFF	0 V
				Turn signal switch RH		6.5 V
23 (LG)	Ground	Trunk lid open	Output	Trunk lid	OPEN (Trunk lid opener actuator is activated)	12 V
				Other than OPEN (Trunk lid opener actuator is not activated)	0 V	
25 (Y)	Ground	Turn signal LH (Rear)	Output	Ignition switch ON	Turn signal switch OFF	0 V
				Turn signal switch LH		6.5 V
30 (P)	Ground	Trunk room lamp	Output	Trunk room lamp	ON	0 V
				OFF	12 V	

BCM (BODY CONTROL MODULE)

< ECU DIAGNOSIS INFORMATION >

Terminal No. (Wire color)		Description		Condition	Value (Approx.)
+	-	Signal name	Input/ Output		
34 (SB)	Ground	Trunk room antenna (-)	Output	Ignition switch OFF	<p style="text-align: right; font-size: small;">JMKIA0062GB</p>
				When Intelligent Key is not in the passenger compart- ment	<p style="text-align: right; font-size: small;">JMKIA0063GB</p>
35 (V)	Ground	Trunk room antenna (+)	Output	Ignition switch OFF	<p style="text-align: right; font-size: small;">JMKIA0062GB</p>
				When Intelligent Key is not in the passenger compart- ment	<p style="text-align: right; font-size: small;">JMKIA0063GB</p>
38 (B)	Ground	Rear bumper anten- na (-)	Output	When the trunk lid opener re- quest switch is operated with ignition switch OFF	<p style="text-align: right; font-size: small;">JMKIA0062GB</p>
				When Intelligent Key is not in the antenna detection area	<p style="text-align: right; font-size: small;">JMKIA0063GB</p>

A
B
C
D
E
F
G
H
I
J
K
M
N
O
P

INL

BCM (BODY CONTROL MODULE)

< ECU DIAGNOSIS INFORMATION >

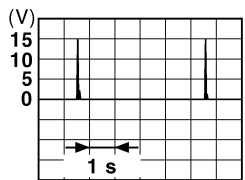
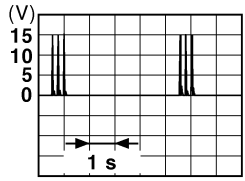
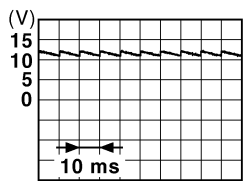
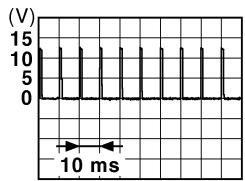
Terminal No. (Wire color)		Description		Condition	Value (Approx.)	
		Signal name	Input/ Output			
+	-					
39 (W)	Ground	Rear bumper antenna (+)	Output	When the trunk lid opener request switch is operated with ignition switch OFF	When Intelligent Key is in the antenna detection area	 <small>JMKIA0062GB</small>
				When Intelligent Key is not in the antenna detection area	 <small>JMKIA0063GB</small>	
47 (Y)	Ground	Ignition relay (IPDM E/R) control	Output	Ignition switch	OFF or ACC	12 V
					ON	0 V
50 (BG)	Ground	Trunk room lamp switch	Input	Trunk room lamp switch	OFF (Trunk lid is closed)	 <small>JPMIA0011GB</small> 11.8 V
					ON (Trunk lid is opened)	0 V
52 (R)	Ground	Starter relay control	Output	Ignition switch ON (A/T models)	When selector lever is in P or N position	12 V
					When selector lever is not in P or N position	0 V
				Ignition switch ON (M/T models)	When the clutch pedal is depressed	Battery voltage
					When the clutch pedal is not depressed	0 V
60*3 (BR)	Ground	Push-button ignition switch (Push switch)	Input	Push-button ignition switch (Push switch)	Pressed	0 V
					Not pressed	Battery voltage
61 (SB)	Ground	Trunk lid opener request switch	Input	Trunk lid opener request switch	ON (Pressed)	0 V
					OFF (Not pressed)	 <small>JPMIA0016GB</small> 1.0 V
64 (G)	Ground	Intelligent Key warning buzzer (Engine room)	Output	Intelligent Key warning buzzer (Engine room)	Sounding	0 V
					Not sounding	12 V

BCM (BODY CONTROL MODULE)

< ECU DIAGNOSIS INFORMATION >

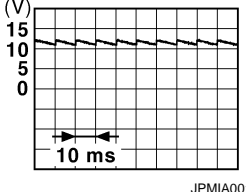
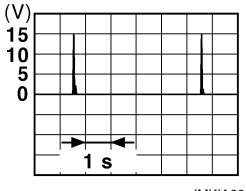
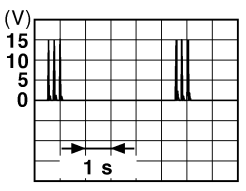
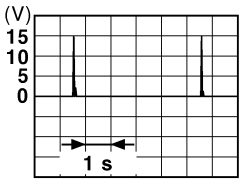
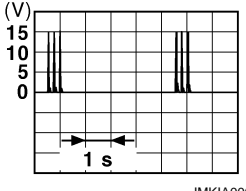
Terminal No. (Wire color)		Description		Condition	Value (Approx.)	
		Signal name	Input/ Output			
+	-					
67 (GR)	Ground	Trunk lid opener switch	Input	Trunk lid open- er switch	Pressed	0 V
					Not pressed	 <p style="text-align: right; font-size: small;">JPMIA0011GB</p>
72 (R)	Ground	Room antenna 2 (-) (Center console)	Output	Ignition switch OFF	When Intelligent Key is in the passenger compart- ment	 <p style="text-align: right; font-size: small;">JMKIA0062GB</p>
					When Intelligent Key is not in the passenger compart- ment	 <p style="text-align: right; font-size: small;">JMKIA0063GB</p>
73 (G)	Ground	Room antenna 2 (+) (Center console)	Output	Ignition switch OFF	When Intelligent Key is in the passenger compart- ment	 <p style="text-align: right; font-size: small;">JMKIA0062GB</p>
					When Intelligent Key is not in the passenger compart- ment	 <p style="text-align: right; font-size: small;">JMKIA0063GB</p>

A
B
C
D
E
F
G
H
I
J
K
L
M
N
O
P

INL

BCM (BODY CONTROL MODULE)

< ECU DIAGNOSIS INFORMATION >

Terminal No. (Wire color)		Description		Condition	Value (Approx.)
+	-	Signal name	Input/ Output		
74 (SB)	Ground	Passenger door antenna (-)	Output	When Intelligent Key is in the antenna detection area	<p style="text-align: right; font-size: small;">JMKIA0062GB</p>
				When the passenger door request switch is operated with ignition switch OFF	<p style="text-align: right; font-size: small;">JMKIA0063GB</p>
75 (BR)	Ground	Passenger door antenna (+)	Output	When Intelligent Key is in the antenna detection area	<p style="text-align: right; font-size: small;">JMKIA0062GB</p>
				When the passenger door request switch is operated with ignition switch OFF	<p style="text-align: right; font-size: small;">JMKIA0063GB</p>
76 (V)	Ground	Driver door antenna (-)	Output	When Intelligent Key is in the antenna detection area	<p style="text-align: right; font-size: small;">JMKIA0062GB</p>
				When the driver door request switch is operated with ignition switch OFF	<p style="text-align: right; font-size: small;">JMKIA0063GB</p>

BCM (BODY CONTROL MODULE)

< ECU DIAGNOSIS INFORMATION >



Terminal No. (Wire color)		Description		Condition	Value (Approx.)
+	-	Signal name	Input/ Output		
77 (LG)	Ground	Driver door antenna (+)	Output	When the driver door request switch is operated with ignition switch OFF	<p style="text-align: right; font-size: small;">JMkia0062GB</p>
				When Intelligent Key is not in the antenna detection area	<p style="text-align: right; font-size: small;">JMkia0063GB</p>
78 (Y)	Ground	Room antenna 1 (-) (Instrument panel)	Output	Ignition switch OFF	<p style="text-align: right; font-size: small;">JMkia0062GB</p>
				When Intelligent Key is not in the passenger compartment	<p style="text-align: right; font-size: small;">JMkia0063GB</p>
79 (BR)	Ground	Room antenna 1 (+) (Instrument panel)	Output	Ignition switch OFF	<p style="text-align: right; font-size: small;">JMkia0062GB</p>
				When Intelligent Key is not in the passenger compartment	<p style="text-align: right; font-size: small;">JMkia0063GB</p>

A
B
C
D
E
F
G
H
I
J
K
M
N
O
P

INL



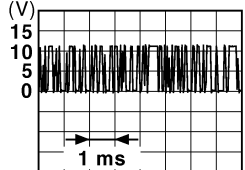
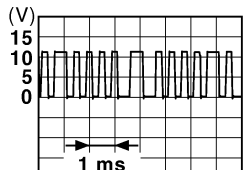

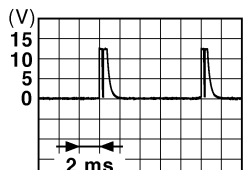
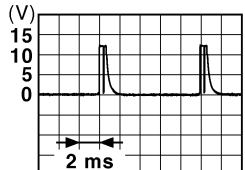
BCM (BODY CONTROL MODULE)

< ECU DIAGNOSIS INFORMATION >

Terminal No. (Wire color)		Description		Condition		Value (Approx.)
		Signal name	Input/ Output			
+	-					
80 (GR)	Ground	NATS antenna amp.	Input/ Output	During waiting	Ignition switch is pressed while inserting the Intelligent Key into the key slot.	Just after pressing ignition switch. Pointer of tester should move.
81 (W)	Ground	NATS antenna amp.	Input/ Output	During waiting	Ignition switch is pressed while inserting the Intelligent Key into the key slot.	Just after pressing ignition switch. Pointer of tester should move.
82 (SB)	Ground	Ignition relay [Fuse block (J/B)] control	Output	Ignition switch	OFF or ACC	0 V
					ON	12 V
83 (Y)	Ground	Remote keyless entry receiver communication	Input/ Output	During waiting		 <p style="text-align: right; font-size: small;">JMKIA0064GB</p>
				When operating either button on the Intelligent Key		 <p style="text-align: right; font-size: small;">JMKIA0065GB</p>
87 (Y)	Ground	Combination switch INPUT 5	Input	Combination switch	All switches OFF (Wiper volume dial 4)	 <p style="text-align: right; font-size: small;">JPMIA0041GB</p> <p style="text-align: center;">1.4 V</p>
					Front fog lamp switch ON (Wiper volume dial 4)	 <p style="text-align: right; font-size: small;">JPMIA0037GB</p> <p style="text-align: center;">1.3 V</p>
					Any of the conditions below with all switches OFF <ul style="list-style-type: none"> • Wiper volume dial 1 • Wiper volume dial 2 • Wiper volume dial 6 • Wiper volume dial 7 	 <p style="text-align: right; font-size: small;">JPMIA0040GB</p> <p style="text-align: center;">1.3 V</p>

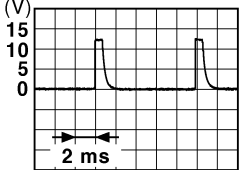
BCM (BODY CONTROL MODULE)

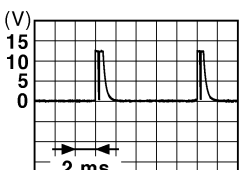
< ECU DIAGNOSIS INFORMATION >

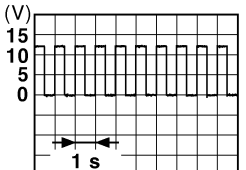
Terminal No. (Wire color)		Description		Condition	Value (Approx.)	
		Signal name	Input/ Output			
+	-					
88 (BG)	Ground	Combination switch INPUT 3	Input	Combination switch	All switches OFF (Wiper volume dial 4)	 1.4 V
					Lighting switch HI (Wiper volume dial 4)	 1.3 V
					Lighting switch 2ND (Wiper volume dial 4)	 1.3 V
					Any of the conditions below with all switches OFF <ul style="list-style-type: none"> • Wiper volume dial 1 • Wiper volume dial 2 • Wiper volume dial 3 	 1.3 V
89*4 (BR)	Ground	Push-button ignition switch (Push switch)	Input	Push-button ignition switch (push switch)	Pressed	0 V
					Not pressed	Battery voltage
90 (P)	Ground	CAN-L	Input/ Output	—	—	
91 (L)	Ground	CAN-H	Input/ Output	—	—	
92 (LG)	Ground	Key slot illumination	Output	Key slot illumina- tion	OFF	0 V
					Blinking	 6.5 V
					ON	12 V

A
B
C
D
E
F
G
H
I
J
K

INL

M
N
O
P



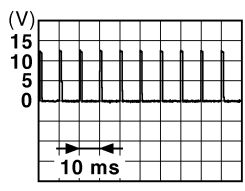
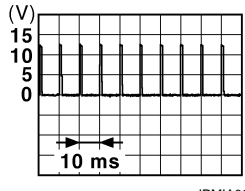

BCM (BODY CONTROL MODULE)

< ECU DIAGNOSIS INFORMATION >

Terminal No. (Wire color)		Description		Condition		Value (Approx.)
		Signal name	Input/ Output			
+	-					
93 (GR)	Ground	ON indicator lamp	Output	Ignition switch	OFF (LOCK indicator is not illuminated)	Battery voltage
					ON	0 V
95 (BG)	Ground	ACC relay control	Output	Ignition switch	OFF	0 V
					ACC or ON	12 V
96 (GR)	Ground	A/T shift selector (Detention switch) power supply	Output	—	—	12 V
97*4 (L)	Ground	Steering lock condition No. 1	Input	Steering lock	LOCK status	0 V
					UNLOCK status	12 V
98*4 (P)	Ground	Steering lock condition No. 2	Input	Steering lock	LOCK status	12 V
					UNLOCK status	0 V
99 (R)*1 (BR)*2	Ground	Selector lever P position switch	Input	Selector lever	P position	0 V
					Any position other than P	12 V
		ASCD clutch switch (M/T models without ICC)		ASCD clutch switch	OFF (Clutch pedal is depressed)	0 V
					ON (Clutch pedal is not depressed)	12 V
		ICC clutch switch (M/T models with ICC)		ICC clutch switch	OFF (Clutch pedal is depressed)	0 V
					ON (Clutch pedal is not depressed)	12 V
100 (Y)	Ground	Passenger door request switch	Input	Passenger door request switch	ON (Pressed)	0 V
					OFF (Not pressed)	 <p style="text-align: center;">1.0 V</p>
101 (P)	Ground	Driver door request switch	Input	Driver door request switch	ON (Pressed)	0 V
					OFF (Not pressed)	 <p style="text-align: center;">1.0 V</p>
102 (BG)	Ground	Blower fan motor relay control	Output	Ignition switch	OFF or ACC	0 V
					ON	12 V
103 (P)	Ground	Remote keyless entry receiver power supply	Output	Ignition switch OFF	—	12 V
106*4 (SB)	Ground	Steering lock unit power supply	Output	Ignition switch	OFF or ACC	12 V
					ON	0 V

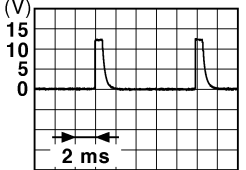
BCM (BODY CONTROL MODULE)

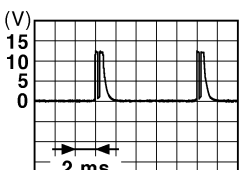

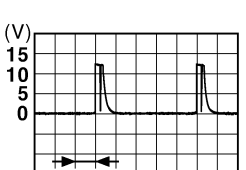
< ECU DIAGNOSIS INFORMATION >

Terminal No. (Wire color)		Description		Condition	Value (Approx.)	
		Signal name	Input/ Output			
+	-					
107 (LG)	Ground	Combination switch INPUT 1	Input	Combination switch (Wiper volume dial 4)	All switches OFF	 <p style="text-align: right;">JPMAI0041GB</p> <p style="text-align: center;">1.4 V</p>
					Turn signal switch LH	 <p style="text-align: right;">JPMAI0037GB</p> <p style="text-align: center;">1.3 V</p>
					Turn signal switch RH	 <p style="text-align: right;">JPMAI0036GB</p> <p style="text-align: center;">1.3 V</p>
					Front wiper switch LO	 <p style="text-align: right;">JPMAI0038GB</p> <p style="text-align: center;">1.3 V</p>
					Front washer switch ON	 <p style="text-align: right;">JPMAI0039GB</p> <p style="text-align: center;">1.3 V</p>

A
B
C
D
E
F
G
H
I
J
K
INL
M
N
O
P



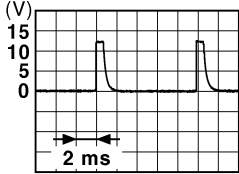

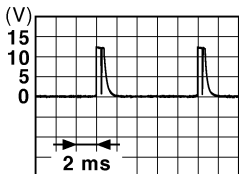
BCM (BODY CONTROL MODULE)

< ECU DIAGNOSIS INFORMATION >

Terminal No. (Wire color)		Description		Condition	Value (Approx.)	
		Signal name	Input/ Output			
+	-					
108 (R)	Ground	Combination switch INPUT 4	Input	Combination switch	All switches OFF (Wiper volume dial 4)	 <p style="text-align: right; font-size: small;">JPMIA0041GB</p> <p style="text-align: center;">1.4 V</p>
					Lighting switch AUTO (Wiper volume dial 4)	 <p style="text-align: right; font-size: small;">JPMIA0038GB</p> <p style="text-align: center;">1.3 V</p>
					Lighting switch 1ST (Wiper volume dial 4)	 <p style="text-align: right; font-size: small;">JPMIA0036GB</p> <p style="text-align: center;">1.3 V</p>
					Any of the conditions below with all switches OFF <ul style="list-style-type: none"> • Wiper volume dial 1 • Wiper volume dial 5 • Wiper volume dial 6 	 <p style="text-align: right; font-size: small;">JPMIA0039GB</p> <p style="text-align: center;">1.3 V</p>

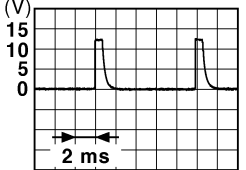
BCM (BODY CONTROL MODULE)

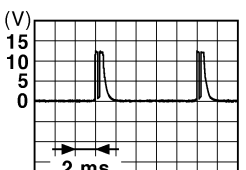
< ECU DIAGNOSIS INFORMATION >

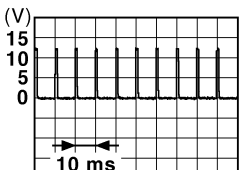
Terminal No. (Wire color)		Description		Condition	Value (Approx.)	
+	-	Signal name	Input/ Output			
109 (W)	Ground	Combination switch INPUT 2	Input	Combination switch (Wiper volume dial 4)	All switches OFF	 <p style="text-align: right;">JPMA0041GB</p> <p style="text-align: center;">1.4 V</p>
					Lighting switch PASS	 <p style="text-align: right;">JPMA0037GB</p> <p style="text-align: center;">1.3 V</p>
					Lighting switch 2ND	 <p style="text-align: right;">JPMA0036GB</p> <p style="text-align: center;">1.3 V</p>
					Front wiper switch INT/ AUTO	 <p style="text-align: right;">JPMA0038GB</p> <p style="text-align: center;">1.3 V</p>
					Front wiper switch HI	 <p style="text-align: right;">JPMA0040GB</p> <p style="text-align: center;">1.3 V</p>
					ON	0 V
110 (G)	Ground	Hazard switch	Input	Hazard switch	ON	
				Hazard switch	OFF	 <p style="text-align: right;">JPMA0012GB</p> <p style="text-align: center;">1.1 V</p>

A
B
C
D
E
F
G
H
I
J
K
L
M
N
O
P

INL

BCM (BODY CONTROL MODULE)

< ECU DIAGNOSIS INFORMATION >

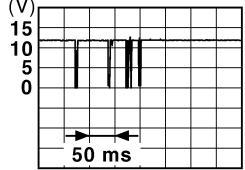
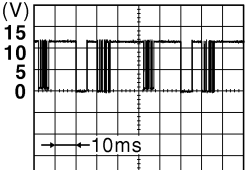
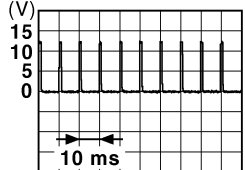
Terminal No. (Wire color)		Description		Condition	Value (Approx.)	
+	-	Signal name	Input/ Output			
111*4 (Y)	Ground	Steering lock unit communication	Input/ Output	Steering lock	LOCK status	12 V
					LOCK or UNLOCK	
					For 15 seconds after UN- LOCK	12 V
				15 seconds or later after UNLOCK	0 V	
112 (R)	Ground	Rain sensor serial link	Input/ Output	Ignition switch ON		
					8.7 V	
113 (BG)	Ground	Optical sensor	Input	Ignition switch ON	When bright outside of the vehicle	Close to 5 V
					When dark outside of the vehicle	Close to 0 V
114 (R)	Ground	Clutch interlock switch	Input	Clutch interlock switch	OFF (Clutch pedal is not depressed)	0 V
					ON (Clutch pedal is de- pressed)	Battery voltage
116 (SB)	Ground	Stop lamp switch 1	Input	—	Battery voltage	
118 (BR)	Ground	Stop lamp switch 2 (Without ICC)	Input	Stop lamp switch	OFF (Brake pedal is not depressed)	0 V
					ON (Brake pedal is de- pressed)	Battery voltage
		Stop lamp switch 2 (With ICC)		Stop lamp switch OFF (Brake pedal is not depressed) and ICC brake hold relay OFF	0 V	
				Stop lamp switch ON (Brake pedal is de- pressed) or ICC brake hold relay ON	Battery voltage	
119 (SB)	Ground	Driver side door lock assembly (Unlock sensor)	Input	Driver door	LOCK status (Unlock sensor switch OFF)	
					UNLOCK status (Unlock switch sensor ON)	1.1 V
					0 V	

BCM (BODY CONTROL MODULE)

< ECU DIAGNOSIS INFORMATION >

Terminal No. (Wire color)		Description		Condition	Value (Approx.)
		Signal name	Input/ Output		
+	-				
121 (SB)	Ground	Key slot switch	Input	When the Intelligent Key is inserted into key slot	12 V
				When the Intelligent Key is not inserted into key slot	0 V
123 (V)	Ground	IGN feedback	Input	Ignition switch	OFF or ACC
					ON
124 (R)	Ground	Passenger door switch	Input	Passenger door switch	OFF (Door close)
					ON (Door open)
129 (BG)	Ground	Trunk lid opener cancel switch	Input	Trunk lid opener cancel switch	CANCEL
					ON
132 (V)	Ground	Power window switch communication	Input/ Output	Ignition switch ON	10.2 V
				Ignition switch OFF or ACC	12 V
133 (L)	Ground	Push-button ignition switch illumination	Output	Push-button ignition switch illumination	9.5 V
				ON (Tail lamps ON)	0 V
134 (LG)	Ground	LOCK indicator lamp	Output	LOCK indicator lamp	Battery voltage
				ON	0 V
137 (BG)	Ground	Receiver and sensor ground	Input	Ignition switch ON	0 V

A
B
C
D
E
F
G
H
I
J
K
M
N
O
P

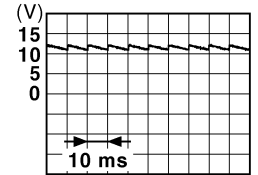

JPMIA0011GB

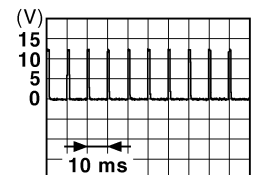

JPMIA0012GB



JPMIA0013GB

NOTE:
The pulse width of this wave is varied by the illumination brightening/dimming level.

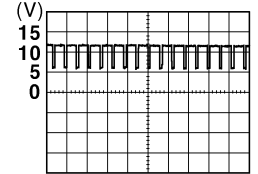

JPMIA0159GB

INL

BCM (BODY CONTROL MODULE)

< ECU DIAGNOSIS INFORMATION >

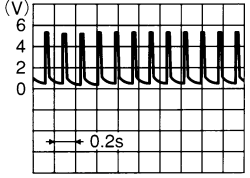
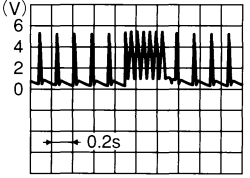
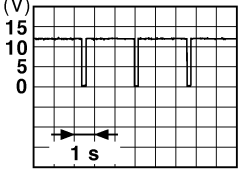
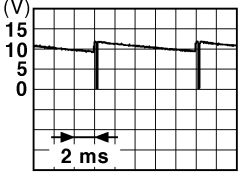
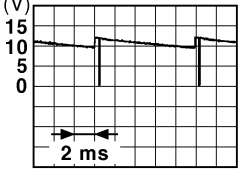
Terminal No. (Wire color)		Description		Condition		Value (Approx.)
		Signal name	Input/ Output			
+	-					
138 (V)	Ground	Receiver and sensor power supply	Output	Ignition switch	OFF	0 V
					ACC or ON	5.0 V
139 (L)	Ground	Tire pressure receiv- er communication	Input/ Output	Ignition switch ON	Standby state	 OCC3881D
					When receiving the signal from the transmitter	 OCC3880D
140 (B)	Ground	Selector lever P/N position (A/T models)	Input	Selector lever	P or N position	12 V
					Except P and N positions	0 V
141 (W)	Ground	Security indicator	Output	Security indica- tor	ON	0 V
					Blinking	 JPMIA0014GB 11.3 V
142 (BR)	Ground	Combination switch OUTPUT 5	Output	Combination switch (Wiper volume dial 4)	All switches OFF	0 V
					Lighting switch 1ST	 JPMIA0031GB 10.7 V
					Lighting switch HI	
					Lighting switch 2ND	
Turn signal switch RH						
143 (P)	Ground	Combination switch OUTPUT 1	Output	Combination switch	All switches OFF (Wiper volume dial 4)	0 V
					Front wiper switch HI (Wiper volume dial 4)	 JPMIA0032GB 10.7 V
					Any of the conditions be- low with all switches OFF	
					<ul style="list-style-type: none"> • Wiper volume dial 1 • Wiper volume dial 2 • Wiper volume dial 3 • Wiper volume dial 6 • Wiper volume dial 7 	

BCM (BODY CONTROL MODULE)

< ECU DIAGNOSIS INFORMATION >

Terminal No. (Wire color)		Description		Condition	Value (Approx.)		
+	-	Signal name	Input/ Output				
144 (G)	Ground	Combination switch OUTPUT 2	Output	Combination switch	All switches OFF (Wiper volume dial 4)	0 V	
					Front washer switch ON (Wiper volume dial 4)		
					Any of the conditions below with all switches OFF		10.7 V
145 (L)	Ground	Combination switch OUTPUT 3	Output	Combination switch (Wiper volume dial 4)	All switches OFF	0 V	
					Front wiper switch INT/ AUTO		
					Front wiper switch LO		10.7 V
					Lighting switch AUTO		
146 (SB)	Ground	Combination switch OUTPUT 4	Output	Combination switch (Wiper volume dial 4)	All switches OFF	0 V	
					Front fog lamp switch ON		
					Lighting switch 2ND		10.7 V
					Lighting switch PASS		
					Turn signal switch LH		
150 (GR)	Ground	Driver door switch	Input	Driver door switch	OFF (Door close)		
					ON (Door open)	0 V	
151 (G)	Ground	Rear window defogger relay control	Output	Rear window defogger	Active	0 V	
				Not activated	Battery voltage		

- *1: A/T models
- *2: M/T models
- *3: Without steering lock unit
- *4: With steering lock unit

A
B
C
D
E
F
G
H
I
J
K
INL
M
N
O
P

BCM (BODY CONTROL MODULE)

< ECU DIAGNOSIS INFORMATION >

Wiring Diagram - BCM -

INFOID:000000006956833

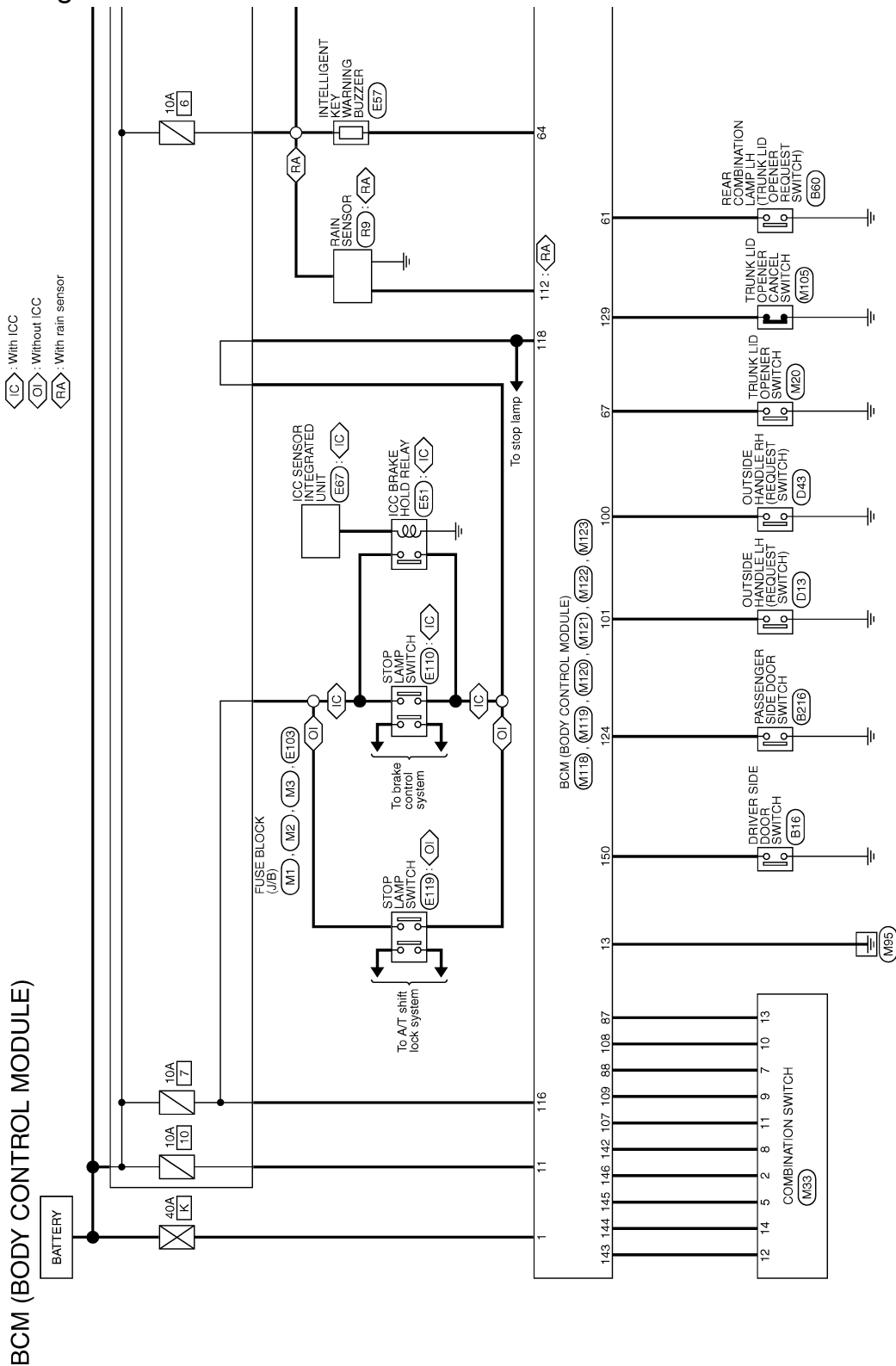

BCM (BODY CONTROL MODULE)

< ECU DIAGNOSIS INFORMATION >

*1 89: : Without steering lock unit

60: : With steering lock unit

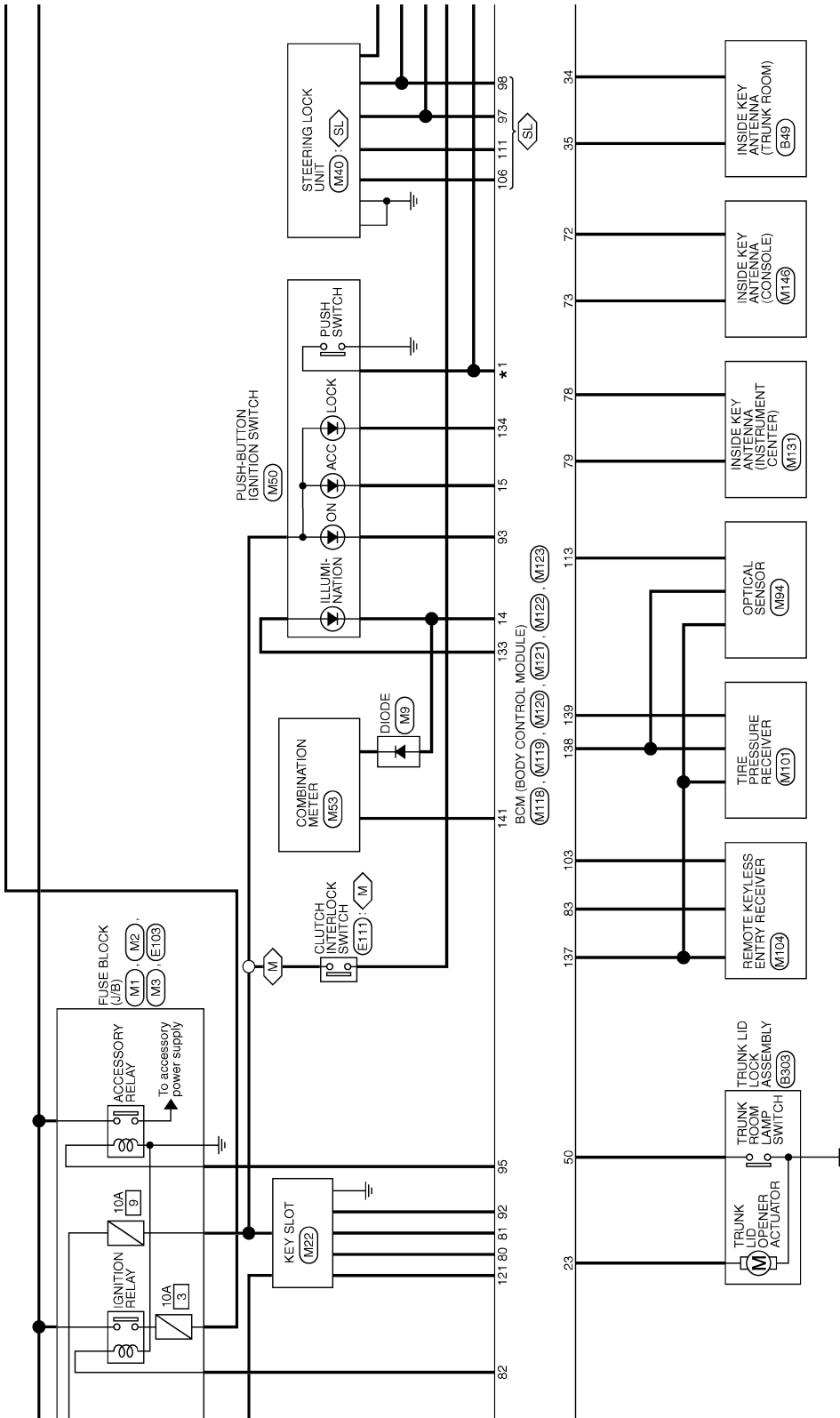

JCMWN0125GB

A
B
C
D
E
F
G
H
I
J
K
M
N
O
P

INL

BCM (BODY CONTROL MODULE)

< ECU DIAGNOSIS INFORMATION >

- : With A/T
- : With M/T
- : With steering lock unit
- : With sunroof

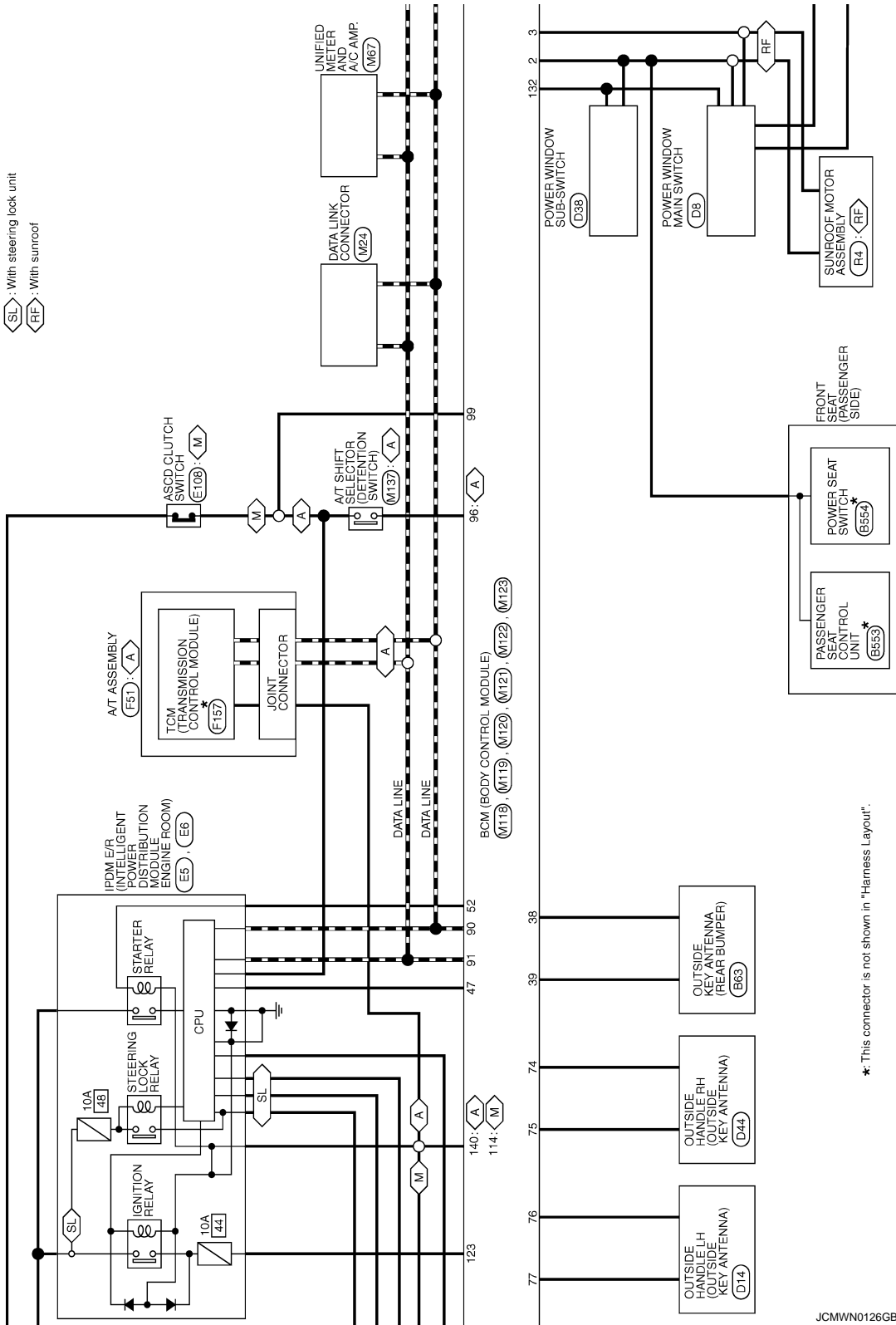

*: This connector is not shown in "Harness Layout".

JCMWN0126GB

BCM (BODY CONTROL MODULE)

< ECU DIAGNOSIS INFORMATION >

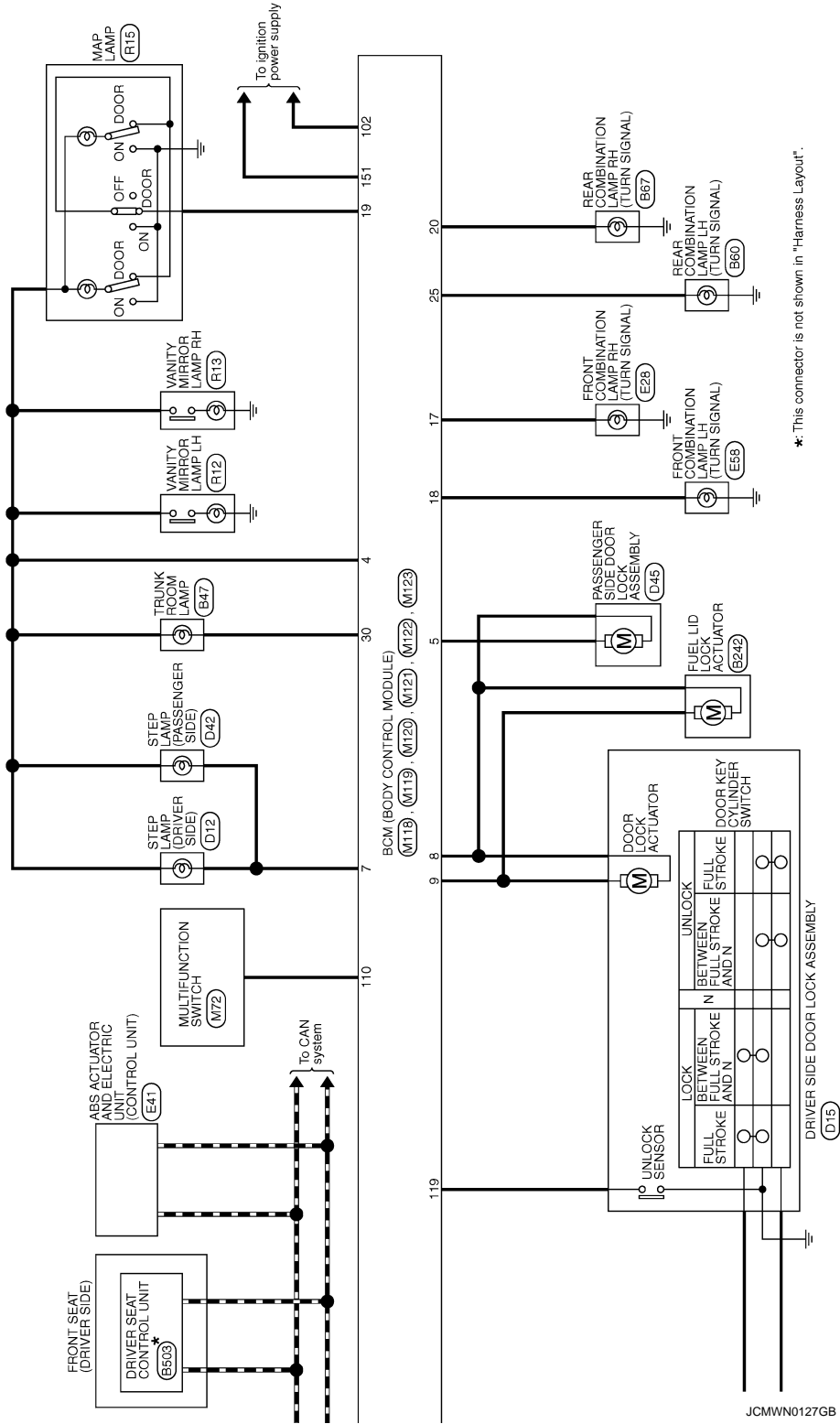

*: This connector is not shown in "Harness Layout".

A
B
C
D
E
F
G
H
I
J
K
L
M
N
O
P

INL

BCM (BODY CONTROL MODULE)

< ECU DIAGNOSIS INFORMATION >

BCM (BODY CONTROL MODULE)

Connector No.	M33
Connector Name	COMBINATION SWITCH
Connector Type	TH167V-NH

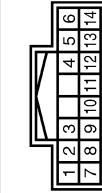

Terminal No.	Color of Wire	Signal Name [Specification]
1	GR	FR WASHER (-)
2	SB	OUTPUT 4
3	L	OUTPUT 3
4	B	GND
5	EG	INPUT 3
6	BR	OUTPUT 5
7	W	INPUT 2
8	R	INPUT 4
9	LG	INPUT 1
10	P	OUTPUT 1
11	Y	INPUT 5
12	G	OUTPUT 2

Connector No.	M18
Connector Name	BCM (BODY CONTROL MODULE)
Connector Type	M03FB-LC



Terminal No.	Color of Wire	Signal Name [Specification]
1	W	BAT (F/L)
2	Y	POWER WINDOW POWER SUPPLY (BAT)
3	EG	POWER WINDOW POWER SUPPLY (RAP)

Connector No.	M119
Connector Name	BCM (BODY CONTROL MODULE)
Connector Type	NS16FW-CS



Terminal No.	Color of Wire	Signal Name [Specification]
4	LG	INTERIOR ROOM LAMP POWER SUPPLY
5	P	PASSENGER DOOR UNLOCK OUTPUT
6	SB	STEP LAMP OUTPUT
7	V	ALL DOOR FUEL LID LOCK OUTPUT
8	G	DRIVER DOOR FUEL LID UNLOCK OUTPUT
9	R	BAT (FUSE)
10	B	GND
11	W	PUSH BUTTON IGNITION SW ILL GND
12	EG	ACC IND
13	W	TURN SIGNAL RH (FRONT)
14	EG	TURN SIGNAL LH (FRONT)
15	V	INT ROOM LAMP CONT

Connector No.	M120
Connector Name	BCM (BODY CONTROL MODULE)
Connector Type	NS12FW-CS

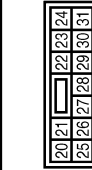

Terminal No.	Color of Wire	Signal Name [Specification]
20	V	TURN SIGNAL RH (REAR)
21	LG	TRUNK LID OPEN OUTPUT
22	Y	TURN SIGNAL LH (REAR)
23	P	TRUNK ROOM LAMP

Connector No.	M121
Connector Name	BCM (BODY CONTROL MODULE)
Connector Type	TH40FGY-NH

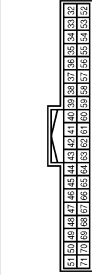

Terminal No.	Color of Wire	Signal Name [Specification]
34	SB	TRUNK ROOM ANT-
35	V	REAR BUMPER ANT-
36	W	REAR BUMPER ANT+
37	Y	IGN RELAY (BDM E/P) CONT
38	EG	TRUNK ROOM LAMP SW
39	R	STARTER RELAY CONT
40	BR	PUSH SW
41	SB	TRUNK LID OPENER REQUEST SW
42	G	I-KEY WARN BUZZER (ENG ROOM)
43	GR	TRUNK LID OPENER SW

Connector No.	M122
Connector Name	BCM (BODY CONTROL MODULE)
Connector Type	TH40FB-NH

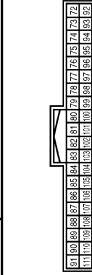

Terminal No.	Color of Wire	Signal Name [Specification]
72	R	ROOM ANT 2-
73	G	ROOM ANT 2+
74	SB	PASSENGER DOOR ANT-
75	BR	PASSENGER DOOR ANT+
76	V	DRIVER DOOR ANT-
77	LG	DRIVER DOOR ANT+
78	Y	ROOM ANT 1-
79	BR	ROOM ANT 1+
80	GR	NATS ANT AMP
81	W	NATS ANT AMP
82	SB	IGN RELAY (E/B) CONT

83	Y	KEYLESS ENTRY RECEIVER COMM
87	Y	COMBI SW INPUT 5
88	EG	COMBI SW INPUT 3
89	BR	PUSH SW
90	P	CAN-L
91	L	CAN-H
92	LG	KEY SLOT ILL
93	GR	ON IND
95	EG	ACC RELAY CONT
96	GR	A/T SHIFT SELECTOR POWER SUPPLY
97	L	S/L CONDITION 1
98	P	S/L CONDITION 2
99	R	SHIFT P [With A/T]
99	BR	ASGD CLUTCH SW [With M/T]
100	Y	PASSENGER DOOR REQUEST SW
101	P	DRIVER DOOR REQUEST SW
102	EG	BLOWER FAN MOTOR RELAY CONT
103	P	KEYLESS ENTRY RECEIVER POWER SUPPLY
106	SB	S/L UNIT POWER SUPPLY
107	LG	COMBI SW INPUT 1
108	R	COMBI SW INPUT 4
109	W	COMBI SW INPUT 2
110	G	HAZARD SW
111	Y	S/L UNIT COMM

BCM (BODY CONTROL MODULE)

< ECU DIAGNOSIS INFORMATION >

A
B
C
D
E
F
G
H
I
J
K
M
N
O
P

Terminal No.	Color of Wire	Signal Name [Specification]
112	R	RAIN SENSOR SERIAL LINK
113	BG	OPTICAL SENSOR
114	R	CLUTCH INTERLOCK SW
116	SB	STOP LAMP SW 1
118	BR	STOP LAMP SW 2
119	SB	DR DOOR UNLOCK SENSOR
121	SB	KEY SWITCH
123	V	IGN P/B
124	R	PASSENGER DOOR SW
129	BG	TRUNK CANCEL SW
132	V	POWER WINDOW SW COMM
133	L	PUSH-BUTTON IGNITION SW ILL POWER
134	LG	LOCK IND
137	BG	RECEIVER / SENSOR GND
138	V	RECEIVER / SENSOR POWER SUPPLY
139	L	TIRE PRESSURE RECEIVER COMM
140	B	SHIFT N/P
141	W	SECURITY INDICATOR LAMP
142	BR	COMBI SW OUTPUT 5
143	P	COMBI SW OUTPUT 1
144	G	COMBI SW OUTPUT 2
145	L	COMBI SW OUTPUT 3
146	SB	COMBI SW OUTPUT 4
150	GR	DRIVER DOOR SW
151	G	REAR WINDOW DEFOGGER RELAY CONT

Connector No.	BCM (BODY CONTROL MODULE)
M123	BCM (BODY CONTROL MODULE)
Connector Name	THMCFG-NH
Connector Type	

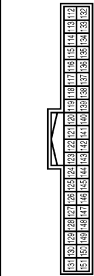

INL

Fail-safe

FAIL-SAFE CONTROL BY DTC

BCM performs fail-safe control when any DTC are detected.

JCMWN0129GB

INFOID:000000006956834

BCM (BODY CONTROL MODULE)

< ECU DIAGNOSIS INFORMATION >

Display contents of CONSULT	Fail-safe	Cancellation
B2013: ID DISCORD BCM-S/L	Inhibit engine cranking	Erase DTC
B2014: CHAIN OF S/L-BCM	Inhibit engine cranking	Erase DTC
B2190: NATS ANTENNA AMP	Inhibit engine cranking	Erase DTC
B2191: DIFFERENCE OF KEY	Inhibit engine cranking	Erase DTC
B2192: ID DISCORD BCM-ECM	Inhibit engine cranking	Erase DTC
B2193: CHAIN OF BCM-ECM	Inhibit engine cranking	Erase DTC
B2195: ANTI-SCANNING	Inhibit engine cranking	Ignition switch ON → OFF
B2557: VEHICLE SPEED	Inhibit steering lock	When normal vehicle speed signals are received from ABS actuator and electric unit (control unit) for 500 ms
B2560: STARTER CONT RELAY	Inhibit engine cranking	500 ms after the following CAN signal communication status becomes consistent <ul style="list-style-type: none"> • Starter control relay signal • Starter relay status signal
B2601: SHIFT POSITION	Inhibit steering lock	500 ms after the following signal reception status becomes consistent <ul style="list-style-type: none"> • Selector lever P position switch signal • P range signal (CAN)
B2602: SHIFT POSITION	Inhibit steering lock	5 seconds after the following BCM recognition conditions are fulfilled <ul style="list-style-type: none"> • Ignition switch is in the ON position • Selector lever P position switch signal: Except P position (12 V) • Vehicle speed: 4 km/h (2.5 MPH) or more
B2603: SHIFT POSI STATUS	Inhibit steering lock	500 ms after the following BCM recognition conditions are fulfilled <ul style="list-style-type: none"> • Ignition switch is in the ON position • Selector lever P position switch signal: Except P position (12 V) • Selector lever P/N position signal: Except P and N positions (0 V)
B2604: PNP/CLUTCH SW	Inhibit steering lock	500 ms after any of the following BCM recognition conditions are fulfilled <ul style="list-style-type: none"> • Status 1 <ul style="list-style-type: none"> - Ignition switch is in the ON position - Selector lever P/N position signal: P and N position (12 V) - P range signal or N range signal (CAN): ON • Status 2 <ul style="list-style-type: none"> - Ignition switch is in the ON position - Selector lever P/N position signal: Except P and N positions (0 V) - P range signal and N range signal (CAN): OFF
B2605: PNP/CLUTCH SW	Inhibit steering lock	500 ms after any of the following BCM recognition conditions are fulfilled <ul style="list-style-type: none"> • Status 1 <ul style="list-style-type: none"> - Ignition switch is in the ON position - Selector lever P/N position signal: Except P and N positions (0 V) - Interlock/PNP switch signal (CAN): OFF • Status 2 <ul style="list-style-type: none"> - Ignition switch is in the ON position - Selector lever P/N position signal: P or N position (12 V) - PNP switch signal (CAN): ON
B2606: S/L RELAY	Inhibit engine cranking	500 ms after the following CAN signal communication status becomes consistent <ul style="list-style-type: none"> • Steering lock relay signal (Request signal) • Steering lock relay signal (Condition signal)
B2607: S/L RELAY	Inhibit engine cranking	500 ms after the following CAN signal communication status has become consistent <ul style="list-style-type: none"> • Steering lock relay signal (Request signal) • Steering lock relay signal (Condition signal)

BCM (BODY CONTROL MODULE)

< ECU DIAGNOSIS INFORMATION >

Display contents of CONSULT	Fail-safe	Cancellation	
B2608: STARTER RELAY	Inhibit engine cranking	500 ms after the following signal communication status becomes consistent <ul style="list-style-type: none"> Starter motor relay control signal Starter relay status signal (CAN) 	A
B2609: S/L STATUS	<ul style="list-style-type: none"> Inhibit engine cranking Inhibit steering lock 	When the following steering lock conditions agree <ul style="list-style-type: none"> BCM steering lock control status Steering lock condition No. 1 signal status Steering lock condition No. 2 signal status 	B C
B260A: IGNITION RELAY	Inhibit engine cranking	500 ms after the following conditions are fulfilled <ul style="list-style-type: none"> IGN relay (IPDM E/R) control signal: OFF (12 V) Ignition ON signal (CAN to IPDM E/R): OFF (Request signal) Ignition ON signal (CAN from IPDM E/R): OFF (Condition signal) 	D
B260F: ENG STATE SIG LOST	Maintains the power supply position attained at the time of DTC detection	When any of the following conditions are fulfilled <ul style="list-style-type: none"> Power position changes to ACC Receives engine status signal (CAN) 	E
B2612: S/L STATUS	<ul style="list-style-type: none"> Inhibit engine cranking Inhibit steering lock 	When any of the following conditions are fulfilled <ul style="list-style-type: none"> Steering lock unit status signal (CAN) is received normally The BCM steering lock control status matches the steering lock status recognized by the steering lock unit status signal (CAN from IPDM E/R) 	F
B2617: BCM	Inhibit engine cranking	1 second after the starter motor relay control inside BCM becomes normal	G
B2618: BCM	Inhibit engine cranking	1 second after the ignition relay (IPDM E/R) control inside BCM becomes normal	H
B2619: BCM	Inhibit engine cranking	1 second after the steering lock unit power supply output control inside BCM becomes normal	I
B261E: VEHICLE TYPE	Inhibit engine cranking	BCM initialization	J
B26E8: CLUTCH SW	Inhibit engine cranking	When any of the following BCM recognition conditions are fulfilled <ul style="list-style-type: none"> Status 1 <ul style="list-style-type: none"> Clutch switch signal (CAN from ECM): ON Clutch interlock switch signal: OFF (0 V) Status 2 <ul style="list-style-type: none"> Clutch switch signal (CAN from ECM): OFF Clutch interlock switch signal: ON (Battery voltage) 	K
B26E9: S/L STATUS	<ul style="list-style-type: none"> Inhibit engine cranking Inhibit steering lock 	When BCM transmits the LOCK request signal to steering lock unit, and receives LOCK response signal from steering lock unit, the following conditions are fulfilled <ul style="list-style-type: none"> Steering condition No. 1 signal: LOCK (0 V) Steering condition No. 2 signal: LOCK (12 V) 	INL

DTC Inspection Priority Chart

INFOID:000000006956835

If some DTCs are displayed at the same time, perform inspections one by one based on the following priority chart.

Priority	DTC
1	B2562: LOW VOLTAGE
2	<ul style="list-style-type: none"> U1000: CAN COMM U1010: CONTROL UNIT(CAN)
3	<ul style="list-style-type: none"> B2190: NATS ANTENNA AMP B2191: DIFFERENCE OF KEY B2192: ID DISCORD BCM-ECM B2193: CHAIN OF BCM-ECM B2195: ANTI-SCANNING

BCM (BODY CONTROL MODULE)

< ECU DIAGNOSIS INFORMATION >

Priority	DTC
4	<ul style="list-style-type: none"> • B2013: ID DISCORD BCM-S/L • B2014: CHAIN OF S/L-BCM • B2553: IGNITION RELAY • B2555: STOP LAMP • B2556: PUSH-BTN IGN SW • B2557: VEHICLE SPEED • B2560: STARTER CONT RELAY • B2601: SHIFT POSITION • B2602: SHIFT POSITION • B2603: SHIFT POSI STATUS • B2604: PNP/CLUTCH SW • B2605: PNP/CLUTCH SW • B2606: S/L RELAY • B2607: S/L RELAY • B2608: STARTER RELAY • B2609: S/L STATUS • B260A: IGNITION RELAY • B260B: STEERING LOCK UNIT • B260C: STEERING LOCK UNIT • B260D: STEERING LOCK UNIT • B260F: ENG STATE SIG LOST • B2612: S/L STATUS • B2614: BCM • B2615: BCM • B2616: BCM • B2617: BCM • B2618: BCM • B2619: BCM • B261A: PUSH-BTN IGN SW • B261E: VEHICLE TYPE • B26E8: CLUTCH SW • B26E9: S/L STATUS • B26EA: KEY REGISTRATION • C1729: VHCL SPEED SIG ERR • U0415: VEHICLE SPEED
5	<ul style="list-style-type: none"> • C1704: LOW PRESSURE FL • C1705: LOW PRESSURE FR • C1706: LOW PRESSURE RR • C1707: LOW PRESSURE RL • C1708: [NO DATA] FL • C1709: [NO DATA] FR • C1710: [NO DATA] RR • C1711: [NO DATA] RL • C1716: [PRESSDATA ERR] FL • C1717: [PRESSDATA ERR] FR • C1718: [PRESSDATA ERR] RR • C1719: [PRESSDATA ERR] RL • C1734: CONTROL UNIT
6	<ul style="list-style-type: none"> • B2621: INSIDE ANTENNA • B2622: INSIDE ANTENNA • B2623: INSIDE ANTENNA

DTC Index

INFOID:000000006956836

NOTE:

The details of time display are as follows.

- CRNT: A malfunction is detected now.
- PAST: A malfunction was detected in the past.

IGN counter is displayed on Freeze Frame Data. For details of Freeze Frame Data, refer to [BCS-15. "COMMON ITEM : CONSULT-III Function \(BCM - COMMON ITEM\)".](#)

BCM (BODY CONTROL MODULE)

< ECU DIAGNOSIS INFORMATION >

CONSULT display	Fail-safe	Freeze Frame Data •Vehicle Speed •Odo/Trip Meter •Vehicle condition	Intelligent Key warning lamp ON	Tire pressure monitor warning lamp ON	Refer- ence page
No DTC is detected. further testing may be required.	—	—	—	—	—
U1000: CAN COMM	—	—	—	—	BCS-34
U1010: CONTROL UNIT(CAN)	—	—	—	—	BCS-35
U0415: VEHICLE SPEED	—	—	—	—	BCS-36
B2013: ID DISCORD BCM-S/L*	×	×	—	—	SEC-57
B2014: CHAIN OF S/L-BCM*	×	×	—	—	SEC-58
B2190: NATS ANTENNA AMP	×	—	—	—	SEC-49
B2191: DIFFERENCE OF KEY	×	—	—	—	SEC-52
B2192: ID DISCORD BCM-ECM	×	—	—	—	SEC-53
B2193: CHAIN OF BCM-ECM	×	—	—	—	SEC-55
B2195: ANTI-SCANNING	×	—	—	—	SEC-56
B2553: IGNITION RELAY	—	×	—	—	PCS-51
B2555: STOP LAMP	—	×	—	—	SEC-61
B2556: PUSH-BTN IGN SW	—	×	×	—	SEC-63
B2557: VEHICLE SPEED	×	×	×	—	SEC-65
B2560: STARTER CONT RELAY	×	×	×	—	SEC-66
B2562: LOW VOLTAGE	—	×	—	—	BCS-37
B2601: SHIFT POSITION	×	×	×	—	SEC-67
B2602: SHIFT POSITION	×	×	×	—	SEC-70
B2603: SHIFT POSI STATUS	×	×	×	—	SEC-72
B2604: PNP/CLUTCH SW	×	×	×	—	SEC-75
B2605: PNP/CLUTCH SW	×	×	×	—	SEC-77
B2606: S/L RELAY*	×	×	×	—	SEC-79
B2607: S/L RELAY*	×	×	×	—	SEC-80
B2608: STARTER RELAY	×	×	×	—	SEC-82
B2609: S/L STATUS*	×	×	×	—	SEC-84
B260A: IGNITION RELAY	×	×	×	—	PCS-53
B260B: STEERING LOCK UNIT*	—	×	×	—	SEC-88
B260C: STEERING LOCK UNIT*	—	×	×	—	SEC-89
B260D: STEERING LOCK UNIT*	—	×	×	—	SEC-90
B260F: ENG STATE SIG LOST	×	×	×	—	SEC-91
B2612: S/L STATUS*	×	×	×	—	SEC-96
B2614: BCM	—	×	×	—	PCS-55
B2615: BCM	—	×	×	—	PCS-57
B2616: BCM	—	×	×	—	PCS-59
B2617: BCM	×	×	×	—	SEC-100
B2618: BCM	×	×	×	—	PCS-61
B2619: BCM*	×	×	×	—	SEC-102
B261A: PUSH-BTN IGN SW	—	×	×	—	PCS-62
B261E: VEHICLE TYPE	×	×	× (Turn ON for 15 seconds)	—	SEC-103

A
B
C
D
E
F
G
H
I
J
K
INL
M
N
O
P

BCM (BODY CONTROL MODULE)

< ECU DIAGNOSIS INFORMATION >

CONSULT display	Fail-safe	Freeze Frame Data •Vehicle Speed •Odo/Trip Meter •Vehicle condition	Intelligent Key warning lamp ON	Tire pressure monitor warning lamp ON	Refer- ence page
B2621: INSIDE ANTENNA	—	×	—	—	DLK-56
B2622: INSIDE ANTENNA	—	×	—	—	DLK-58
B2623: INSIDE ANTENNA	—	×	—	—	DLK-60
B26E8: CLUTCH SW	×	×	×	—	SEC-92
B26E9: S/L STATUS*	×	×	× (Turn ON for 15 seconds)	—	SEC-94
B26EA: KEY REGISTRATION	—	×	× (Turn ON for 15 seconds)	—	SEC-95
C1704: LOW PRESSURE FL	—	—	—	×	WT-24
C1705: LOW PRESSURE FR	—	—	—	×	
C1706: LOW PRESSURE RR	—	—	—	×	
C1707: LOW PRESSURE RL	—	—	—	×	
C1708: [NO DATA] FL	—	—	—	×	WT-26
C1709: [NO DATA] FR	—	—	—	×	
C1710: [NO DATA] RR	—	—	—	×	
C1711: [NO DATA] RL	—	—	—	×	
C1716: [PRESSDATA ERR] FL	—	—	—	×	WT-29
C1717: [PRESSDATA ERR] FR	—	—	—	×	
C1718: [PRESSDATA ERR] RR	—	—	—	×	
C1719: [PRESSDATA ERR] RL	—	—	—	×	
C1729: VHCL SPEED SIG ERR	—	—	—	×	WT-30
C1734: CONTROL UNIT	—	—	—	×	WT-31

*: For models without steering lock unit, this DTC is not applied.

COMBINATION METER

< ECU DIAGNOSIS INFORMATION >

COMBINATION METER

Reference Value

INFOID:000000006956837

VALUES ON THE DIAGNOSIS TOOL

Refer to [MWI-84. "Reference Value"](#).

TERMINAL LAYOUT

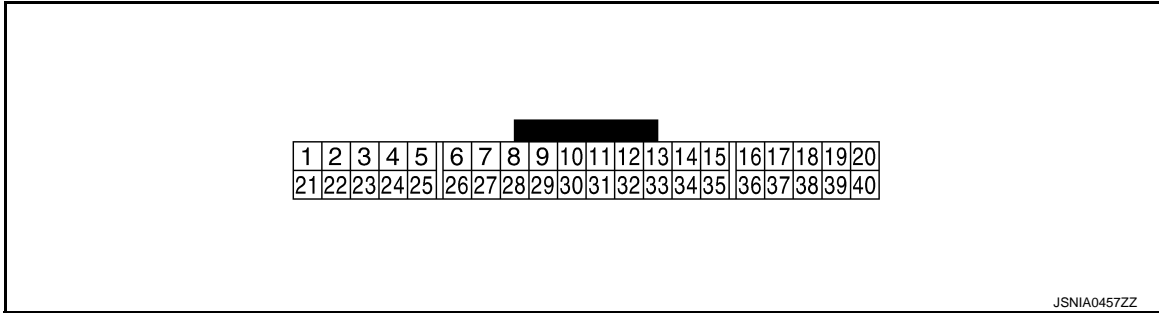

PHYSICAL VALUES

Terminal No. (Wire color)		Description		Condition		Value (Approx.)
+	-	Signal name	Input/ Output			
1 (V)	Ground	Battery power supply	Input	Ignition switch OFF	—	Battery voltage
2 (LG)	Ground	Communication signal (METER→ AMP.)	Output	Ignition switch ON	—	 JSNIA0027GB
3 (GR)	Ground	Communication signal (AMP.→ METER)	Input	Ignition switch ON	—	 JSNIA0027GB
5 (B)	Ground	Ground	—	Ignition switch ON	—	0 V
6 (W)	Ground	Alternator signal	Input	Ignition switch ON	Charge warning lamp ON	0 V
					Charge warning lamp OFF	12 V
7 (LG)	Ground	Air bag signal	Input	Ignition switch ON	Air bag warning lamp ON	4 V
					Air bag warning lamp OFF	0 V
10 (W)	Ground	Security signal	Input	Ignition switch OFF	Security warning lamp ON	0 V
					Security warning lamp OFF	12 V
15 (B)	Ground	Ground	—	Ignition switch ON	—	0 V

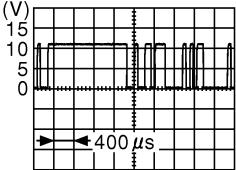
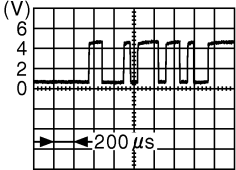
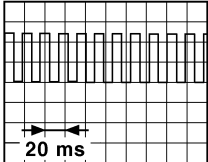
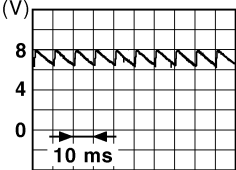
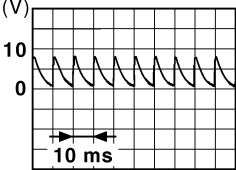

COMBINATION METER

< ECU DIAGNOSIS INFORMATION >

Terminal No. (Wire color)		Description		Condition		Value (Approx.)
+	-	Signal name	Input/ Output			
16 (BR)	Ground	Meter control switch ground	—	Ignition switch ON	—	0 V
21 (G)	Ground	Ignition signal	Input	Ignition switch ON	—	12 V
22 (B)	Ground	Ground	—	Ignition switch ON	—	0 V
24 (BR)	Ground	Communication signal (LCD→ AMP.)	Output	Ignition switch ON	—	 <small>JSNIA0028GB</small>
25 (Y)	Ground	Communication signal (AMP.→ LCD)	Input	Ignition switch ON	—	 <small>JSNIA0027GB</small>
26 (R)	Ground	Vehicle speed signal (8-pulse)	Input	Ignition switch ON	Speedometer operated [When vehicle speed is ap- prox. 40 km/h (25 MPH)]	<p>NOTE: The maximum voltage varies de- pending on the specification (destination unit).</p>  <small>JSNIA0012GB</small>
27 (P)	Ground	Parking brake switch signal	Input	Ignition switch ON	Parking brake applied	0 V
					Parking brake released	 <small>JSNIA0007GB</small>
28 (SB)	Ground	Brake fluid level switch sig- nal	Input	Ignition switch ON	Brake fluid level is normal.	 <small>JSNIA0008GB</small>
					The brake fluid level is low- er than the low level	0 V

COMBINATION METER

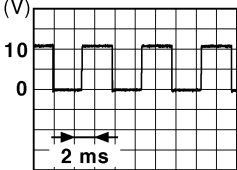
< ECU DIAGNOSIS INFORMATION >

Terminal No. (Wire color)		Description		Condition		Value (Approx.)
+	-	Signal name	Input/ Output			
29 (P)	Ground	Seat belt buckle switch signal (driver side)	Input	Ignition switch ON	When driver seat belt is fastened	12 V
					When driver seat belt is unfastened	0 V
30 (G)	Ground	Seat belt buckle switch signal (passenger side)	Input	Ignition switch ON	<ul style="list-style-type: none"> When getting in the passenger seat When passenger seat belt is fastened 	12 V
					<ul style="list-style-type: none"> When getting in the passenger seat When passenger seat belt is unfastened 	0 V
31 (L)	Ground	Washer level switch signal	Input	Ignition switch ON	Washer level switch ON	0 V
					Washer level switch OFF	5 V
33 (R)	Ground	Illumination control signal	Output	Ignition switch ON	Lighting switch ON, then operate the illumination control switch.	<p>NOTE: When brightness level is midway</p>  <p style="text-align: right; font-size: small;">JSNIA0010GB</p>
36 (LG)	16 (BR)	Select switch signal	Input	Ignition switch ON	When ● is pressed	0 V
					Other than the above	5 V
37 (Y)	16 (BR)	Enter switch signal	Input	Ignition switch ON	When □ is pressed	0 V
					Other than the above	5 V
38 (G)	16 (BR)	Trip A/B reset switch signal	Input	Ignition switch ON	When trip A/B reset switch is pressed	0 V
					Other than the above	5 V
39 (P)	16 (BR)	Illumination control switch signal (-)	Input	Ignition switch ON	When  switch is pressed	0 V
					Other than the above	5 V
40 (BG)	16 (BR)	Illumination control switch signal (+)	Input	Ignition switch ON	When  switch is pressed	0 V
					Other than the above	5 V

A
B
C
D
E
F
G
H
I
J
K
L
M
N
O
P

INL

COMBINATION METER

< ECU DIAGNOSIS INFORMATION >

Wiring Diagram - METER -

INFOID:000000006956838

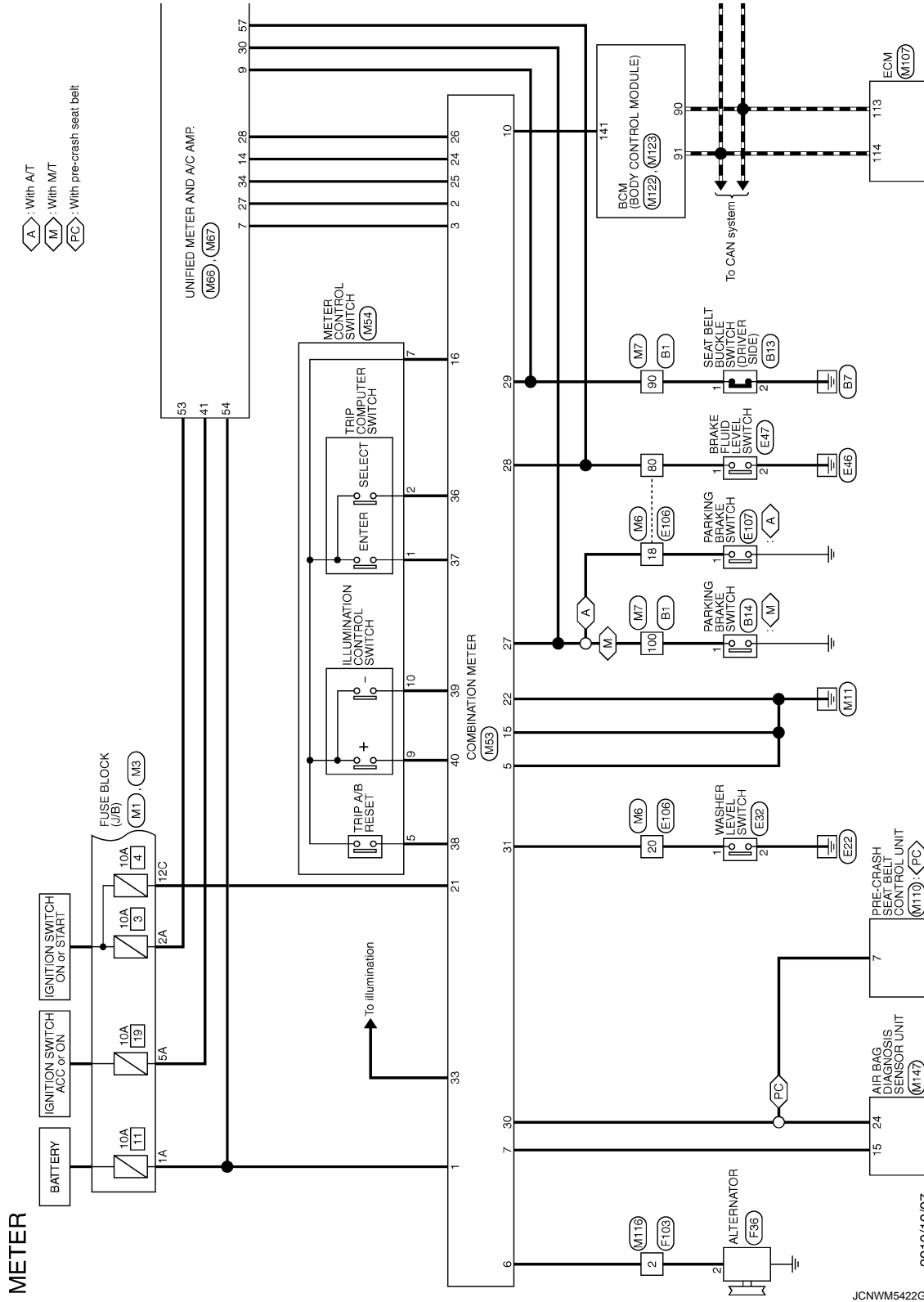

COMBINATION METER

< ECU DIAGNOSIS INFORMATION >

- : With 4MAS
- : With paddle shifter
- : With AT
- : AWD models
- : With ICC

* : This connector is not shown in "Harness Layout".

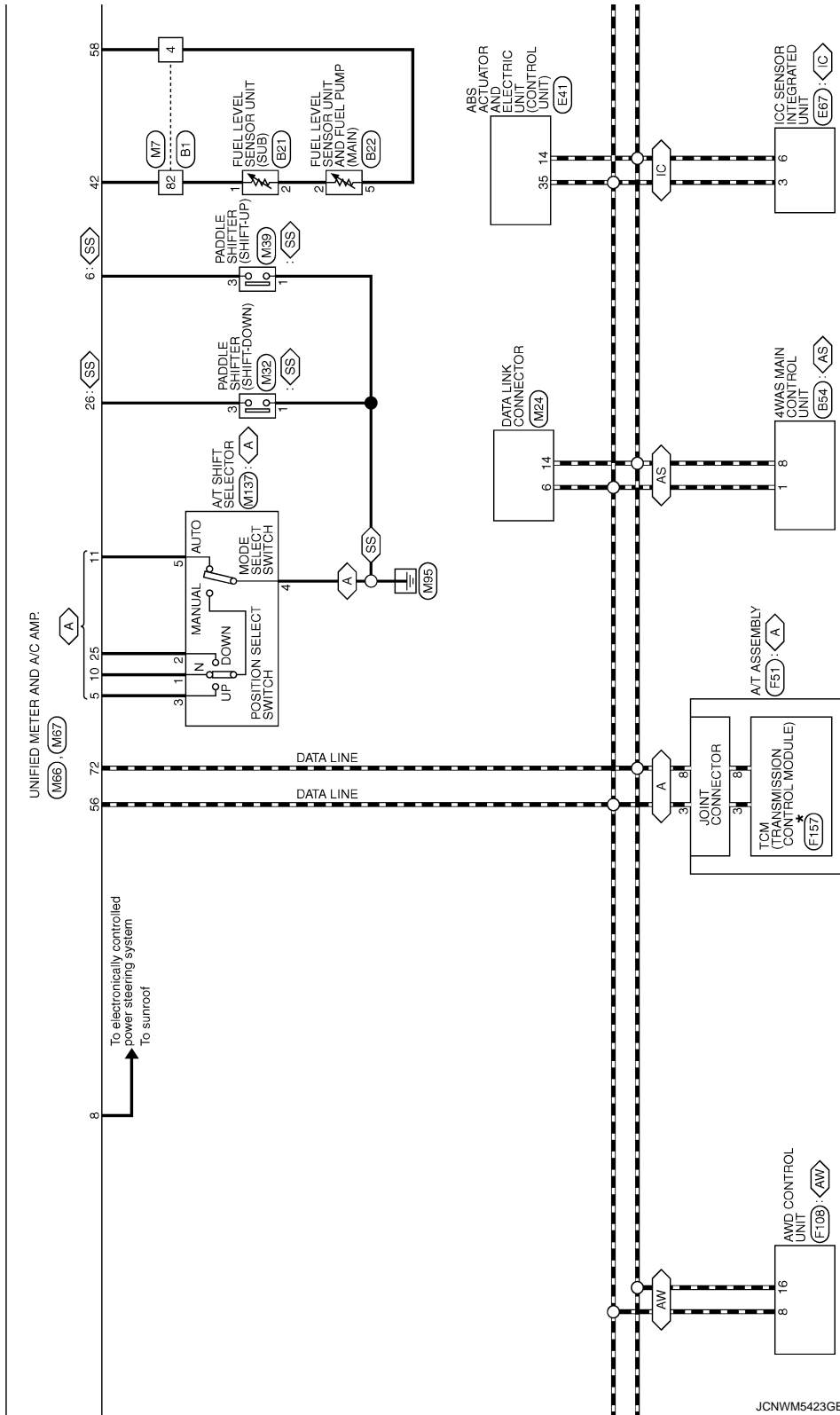

JCNWM5423GB

A
B
C
D
E
F
G
H
I
J
K
L
M
N
O
P

INL

COMBINATION METER

< ECU DIAGNOSIS INFORMATION >

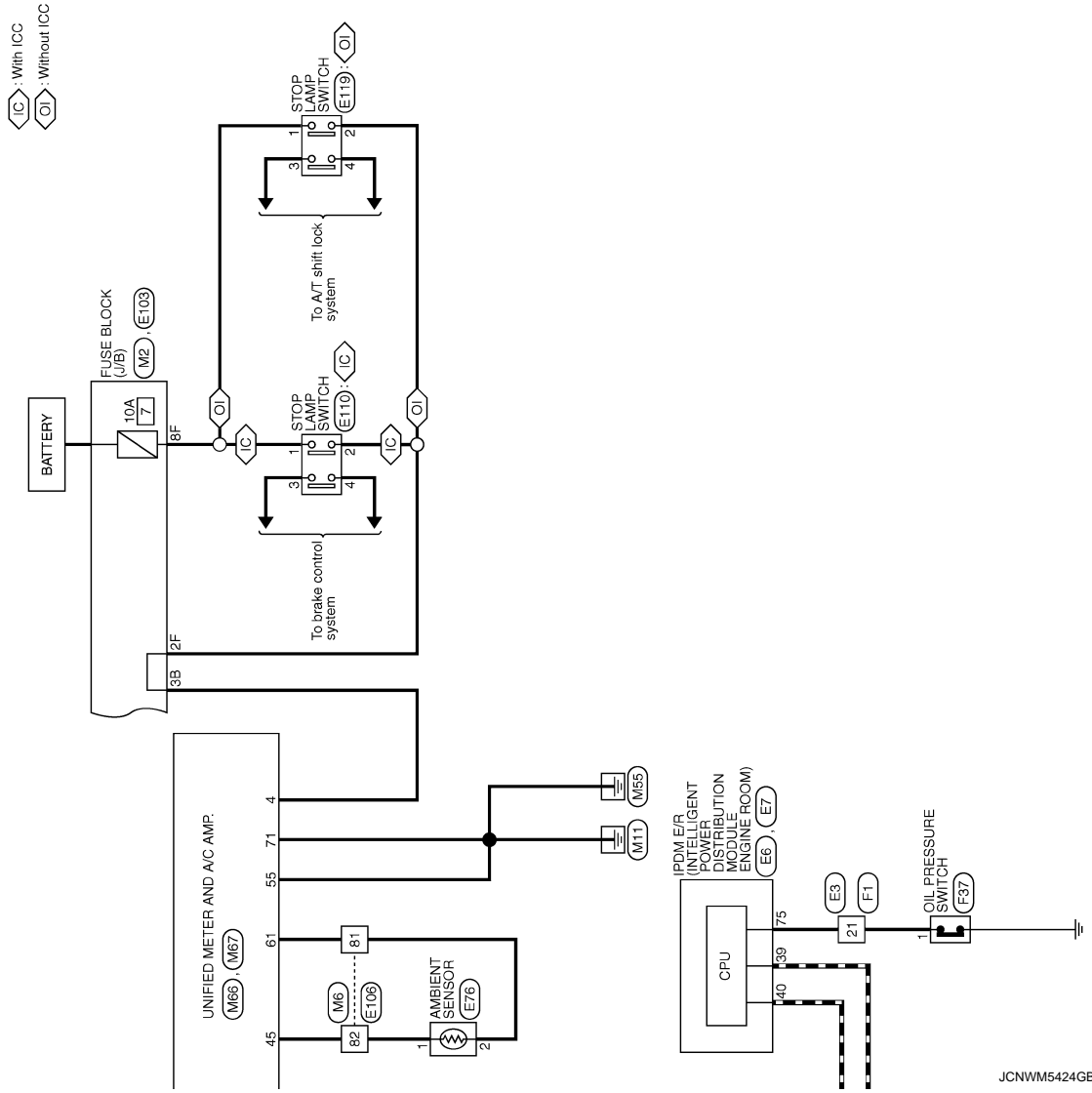

JCNWM5424GB

COMBINATION METER

< ECU DIAGNOSIS INFORMATION >

METER

Connector No.	B1
Connector Name	WIRE TO WIRE
Connector Type	TH80FW-CS16-TM4

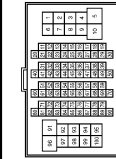

Terminal No.	Color of Wire	Signal Name [Specification]
1	GR	-
2	G	-
3	SB	-
4	Y	-
6	Y	-
15	V	-
16	BR	-
17	LG	-
18	W	-
20	L	-
21	P	-
22	L	-
23	P	-
24	GR	-
25	SB	-
26	G	-
27	W	-
28	G	-
31	V	-
32	SB	-
33	SHIELD	-
34	W	-
35	BR	-
36	Y	-
37	SHIELD	-
38	Y	-
39	LG	-
40	P	-
41	L	-
42	SHIELD	-
43	R	-
44	G	-
45	SHIELD	-
46	SB	-
48	L	-
50	P	-
55	P	-
56	G	-

Connector No.	B14
Connector Name	PARKING BRAKE SWITCH
Connector Type	P01FE-A



Terminal No.	Color of Wire	Signal Name [Specification]
1	V	-

Connector No.	B21
Connector Name	FUEL LEVEL SENSOR UNIT (SUB)
Connector Type	E02FGY-RS



Terminal No.	Color of Wire	Signal Name [Specification]
1	B	-
2	W	-

Connector No.	B22
Connector Name	FUEL LEVEL SENSOR UNIT AND FUEL PUMP (MAIN)
Connector Type	E02FGY-RS

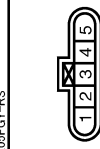

Terminal No.	Color of Wire	Signal Name [Specification]
1	P	-
2	W	-
3	B	-

4	R	-
5	Y	-

Connector No.	B54
Connector Name	4WAS MAIN CONTROL UNIT
Connector Type	A30FW-M4



Terminal No.	Color of Wire	Signal Name [Specification]
1	L	CAN-H
4	BR	R-ANG GND
5	W	R-ANG VCC
7	R	R-ANG SUB SIG
8	P	CAN-L
15	G	R-ANG MAIN SIG
22	GR	STOP LAMP
25	SB	R-MTR RLY
27	V	IGN
31	BR	CAN-H
32	Y	CAN-L
34	B	GND
36	LG	P/S SOL
37	P	R-MTR PWR SUPPLY
38	Y	R-MTR (RH)
39	G	R-MTR (LH)
40	B	R-MTR GND

A
B
C
D
E
F
G
H
I
J
K
L
M
N
O
P

INL

COMBINATION METER

< ECU DIAGNOSIS INFORMATION >

METER

Connector No.	E3
Connector Name	WIRE TO WIRE
Connector Type	SA33MB-FSS-SHZ8

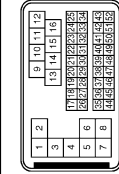

Terminal No.	Color of Wire	Signal Name [Specification]
1	L/Y	-
2	SHIELD	-
3	L/B	-
4	SHIELD	-
5	BR	-
7	G	-
8	W	-
9	W	-
10	Y	-
11	P	-
12	SB	-
13	BR	-
14	G	-
15	R	-
16	LG	-
17	P	-
18	Y	-
19	BG	-
20	B	-
21	SB	-
22	W	-
23	L	-
24	G	-
25	Y	-
27	GR	-
28	Y	-
28	P	-
30	R	-
31	BR	-
32	Y	-
33	G	-
34	BG	-
37	SHIELD	-
38	L	-
39	P	-
40	R	-
41	W	-
42	LG	-

43	G	-
45	BG	-
46	SHIELD	-
47	W	-
48	BR	-
49	G	-
50	B	-
51	SB	-
52	R	-

Connector No.	E6
Connector Name	IPM L/R INTELLIGENT POWER DISTRIBUTION MODULE (ENGINE ROOM)
Connector Type	TH08FW-NH

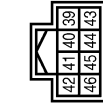

Terminal No.	Color of Wire	Signal Name [Specification]
39	P	-
40	L	-
41	B/W	-
42	Y	-
43	SB	-
44	LG	-
45	G	-
46	W	-

Connector No.	E7
Connector Name	IPM L/R INTELLIGENT POWER DISTRIBUTION MODULE (ENGINE ROOM)
Connector Type	TH20FW-CS12-M4

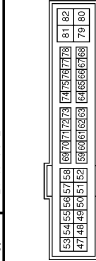

Terminal No.	Color of Wire	Signal Name [Specification]
48	BR	-
49	BG	-
51	Y	-

53	W	-
54	P	-
55	SB	-
56	LG	-
37	G	-
38	GR	-
69	BR	-
70	BG	-
73	P	-
74	G	-
75	SB	-
76	Y	-
77	R	-
80	W	-

Connector No.	E32
Connector Name	WASHER LEVEL SWITCH
Connector Type	E32FBR

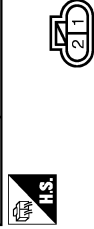

Terminal No.	Color of Wire	Signal Name [Specification]
1	LG	-
2	B	-

Connector No.	E41
Connector Name	ABS ACTUATOR AND ELECTRIC UNIT (CONTROL UNIT)
Connector Type	BA42FB-ANZ4-LH

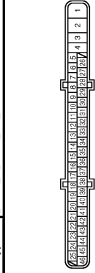

Terminal No.	Color of Wire	Signal Name [Specification]
1	B	GND
2	L	UBMR
3	R	LUVR
4	B	GND

5	Y	DS FL
6	BG	DP RL
7	BR	DP RR
8	B	DP FR
10	W	DS FR
11	V	DIAG-K
14	P	CAN-L
25	Y	BUS-L
26	LG	DP FL
27	GR	DS RL
28	G	UZ
29	P	DS RR
30	SB	BLS
31	R	VDC OFF SW
35	L	CAN-H
45	B	BUS-H

Connector No.	E47
Connector Name	BRAKE FLUID LEVEL SWITCH
Connector Type	YY02FGY



Terminal No.	Color of Wire	Signal Name [Specification]
1	W	-
2	B	-

JCNWM5426GB

COMBINATION METER

< ECU DIAGNOSIS INFORMATION >

METER

Connector No.	E67
Connector Name	ICC SENSOR INTEGRATED UNIT
Connector Type	RS08FB-PR



Terminal No.	Color of Wire	Signal Name [Specification]
1	R	IGNITION
2	V	BRAKE HOLD RLY DRIVE SIGNAL
3	L	CAN-H
4	B	GND
6	P	CAN-L

Connector No.	E76
Connector Name	AMBIENT SENSOR
Connector Type	RS02FB



Terminal No.	Color of Wire	Signal Name [Specification]
1	G	
2	P	

Connector No.	E103
Connector Name	FUSE BLOCK (J/F)
Connector Type	NS16FV-CS



Terminal No.	Color of Wire	Signal Name [Specification]
1F	SB	
2F	V	
4F	G	
6F	BG	
8F	L	
9F	R	

Connector No.	E106
Connector Name	WIRE TO WIRE
Connector Type	TH80FW-CS16-TM4

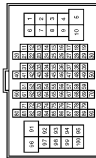

Terminal No.	Color of Wire	Signal Name [Specification]
1	GR	
3	BG	
5	G	
6	BG	
7	V	- [With daytime running light] - [Without daytime running light]
9	L	- [With daytime running light] - [Without daytime running light]
9	R	
10	W	
11	V	
12	R	
13	L	
14	GR	
15	P	
16	W	
17	V	
18	BG	
19	GR	
20	LG	
30	R	
31	L	
32	BG	
33	P	
34	V	
35	BR	
36	W	
37	Y	
38	R	

39	B	
40	G	
41	W	
42	LG	
43	SB	
44	GR	
45	BG	
46	LG	
47	V	
48	P	
49	L	
59	B	
66	LG	
67	SB	
68	R	
69	W	
70	G	
80	W	
81	P	
82	G	
83	V	
84	L	
85	BG	
86	LG	
87	Y	
88	GR	
89	W	
91	G	
93	GR	
95	Y	
96	Y	
97	BR	
98	SHIELD	
99	L	
100	P	

Connector No.	E107
Connector Name	PARKING BRAKE SWITCH
Connector Type	TB01FW



Terminal No.	Color of Wire	Signal Name [Specification]
1	BG	

Connector No.	E110
Connector Name	STOP LAMP SWITCH
Connector Type	MM4FW-LC



Terminal No.	Color of Wire	Signal Name [Specification]
1	L	
2	V	
3	L	
4	SB	

Connector No.	E119
Connector Name	STOP LAMP SWITCH
Connector Type	MM4FW-LC



Terminal No.	Color of Wire	Signal Name [Specification]
1	L	
2	V	
3	Y	
4	W	

A
B
C
D
E
F
G
H
I
J
K
L
M
N
O
P

INL

COMBINATION METER

< ECU DIAGNOSIS INFORMATION >

METER

Connector No.	F1
Connector Name	WIRE TO WIRE
Connector Type	SA33FW-RS8-SH2B

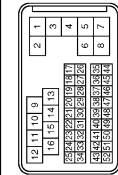

Terminal No.	Color of Wire	Signal Name [Specification]
1	L/Y	-
2	SHIELD	-
3	L/B	-
4	SHIELD	-
5	BR	-
7	G	-
8	W	-
9	W	-
10	G	-
11	R	-
12	P	-
13	L	-
14	LG	-
15	R	-
16	Y	- [2WD models]
16	O	- [AWD models]
17	W	-
18	LG	-
19	P	- [2WD models]
19	SB	- [AWD models]
20	O	-
21	BR	-
22	G	-
23	Y	-
24	LG	-
25	V	-
27	GR	-
28	BR	-
29	L	-
30	R	-
31	P	-
32	W	-
33	SB	-
34	O	- [2WD models]
34	BR	- [AWD models]
37	SHIELD	-
38	W	-
38	Y	-

40	G	-
41	B	-
42	GR	-
43	R	-
46	SHIELD	-
47	W/L	-
48	LG	-
49	O/L	-
50	L/Y	-
51	W	-
52	L/G	-

Connector No.	F36
Connector Name	ALTERNATOR
Connector Type	H303FB



Terminal No.	Color of Wire	Signal Name [Specification]
2	G	L
3	V	S
4	W	C

Connector No.	F37
Connector Name	OIL PRESSURE SWITCH
Connector Type	E01FGY-RS-AR

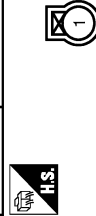

Terminal No.	1	BR	Signal Name [Specification]	-
--------------	---	----	-----------------------------	---

Connector No.	F51
Connector Name	A-T ASSEMBLY
Connector Type	RK10FG-DCY

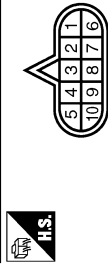

Terminal No.	Color of Wire	Signal Name [Specification]
1	Y	-
2	R	-
3	L	-
4	V	-
5	B	-
6	G	-
7	R	-
8	P	-
9	GR	-
10	B	-

Connector No.	F103
Connector Name	WIRE TO WIRE
Connector Type	TK33FW-NS10

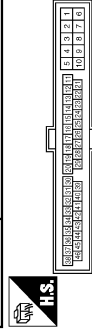

Terminal No.	Color of Wire	Signal Name [Specification]
2	G	-
3	W	-
4	R	-
5	B	-
9	Y	-
10	GR	-
19	O	-
20	Y	-
28	B	-
29	LG	-
30	R	-
31	R	-

33	B	-
34	B	-
35	L	-
36	P	-
37	Y	-
38	G	-
41	O	-
42	BR	-
43	P	-
44	L	-
45	G	-
46	V	-

Connector No.	F108
Connector Name	AMD CONTROL UNIT
Connector Type	TH18FW-NH

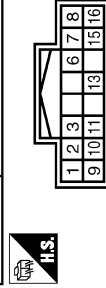

Terminal No.	Color of Wire	Signal Name [Specification]
1	BR	AWD SOL (+)
2	Y	AWD SOL (-)
3	W	OIL TEMP (-)
7	G	IGN
8	L	CAN-H
9	O	AWD SOL BAT
10	B	GND
11	B	GND
12	LG	OIL TEMP (+)
13	Y	VB
16	P	CAN-L

JCNWM5428GB

COMBINATION METER

< ECU DIAGNOSIS INFORMATION >

METER

Connector No.	F157
Connector Name	TCM (TRANSMISSION CONTROL MODULE)
Connector Type	SP10FG

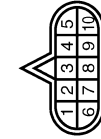

Terminal No.	Color of Wire	Signal Name [Specification]
1	-	VIGN
2	-	BATT
3	-	CAN-H
4	-	K-LINE
5	-	GND
6	-	VIGN
7	-	REV LAMP RLY
8	-	CAN-L
9	-	STARTER RLY
10	-	GND

Connector No.	M1
Connector Name	FUSE BLOCK (J/B)
Connector Type	NS08FW-M2



Terminal No.	Color of Wire	Signal Name [Specification]
1A	V	-
2A	G	-
3A	L	-
4A	P	-
5A	L	-
6A	Y	-
7A	R	-
8A	L	-

Connector No.	M2
Connector Name	FUSE BLOCK (J/B)
Connector Type	NS12FW-CS

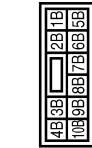

Terminal No.	Color of Wire	Signal Name [Specification]
1B	SB	-
2B	P	-
3B	G	-
4B	LG	-
5B	BG	-
6B	Y	-
7B	P	-
8B	R	-
9B	SB	-

Connector No.	M3
Connector Name	FUSE BLOCK (J/B)
Connector Type	NS12FW-CS

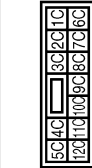

Terminal No.	Color of Wire	Signal Name [Specification]
6C	SB	-
7C	B	-
8C	W	-
9C	BG	-
10C	L	-
11C	LG	-
12C	G	-

Connector No.	M5
Connector Name	WIRE TO WIRE
Connector Type	TH02MM-CS1.6-TM4

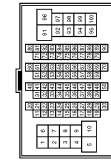

Terminal No.	Color of Wire	Signal Name [Specification]
1	BG	-
2	R	-
3	G	-
4	LG	-
5	W	-
6	LG	-
7	Y	-
8	G	-
9	W	-
10	W	-
11	V	-
12	R	-
13	L	-
14	GR	-
15	P	-
16	W	-
17	BR	-
18	P	-
19	L	-
20	L	-
30	BR	-
31	L	-
32	Y	-
33	BG	-
34	W	-
35	BR	-
36	R	-
37	Y	-
38	R	-
39	SB	-
40	G	-
41	V	-
42	LG	-
43	P	-
44	B	- [With A/T]
44	R	- [With M/T]
45	BG	-
46	G	-
47	L	-
48	P	-
48	L	-

59	B	-
66	Y	-
67	G	-
68	R	-
69	W	-
70	G	-
80	SB	-
81	B	-
82	V	-
83	W	-
84	L	-
85	GR	-
86	G	-
87	R	-
88	B	-
89	LG	-
91	W	-
93	Y	-
95	Y	-
96	R	-
97	GR	-
98	SHIELD	-
99	V	-
100	SB	-

A
B
C
D
E
F
G
H
I
J
K
L
M
N
O
P

INL

COMBINATION METER

< ECU DIAGNOSIS INFORMATION >

METER

Connector No.	M7
Connector Name	WIRE TO WIRE
Connector Type	THB0WV-CS16-TM4



Terminal No.	Color of Wire	Signal Name [Specification]
1	GR	-
2	P	-
3	SB	- [With automatic drive positioner]
4	Y	- [Without automatic drive positioner]
6	L	-
15	R	-
16	BR	-
17	P	-
18	V	-
20	L	-
21	P	-
22	L	-
23	P	-
24	V	-
25	LG	-
26	BR	-
27	BG	-
28	LG	-
31	V	-
32	LG	-
33	SHIELD	-
34	GR	-
35	BR	-
36	Y	-
37	SHIELD	-
38	SB	-
39	LG	-
40	O	-
41	W	-
42	SHIELD	-
43	R	-
44	G	-
45	SHIELD	-
46	SB	-
48	L	-
50	P	-
55	W	-

Connector No.	M32
Connector Name	PADDLE SHIFTER (SHIFT-DOWN)
Connector Type	A03FW

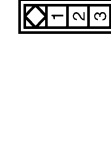

Terminal No.	Color of Wire	Signal Name [Specification]
1	B	-
3	G	-

Connector No.	M39
Connector Name	PADDLE SHIFTER (SHIFT-UP)
Connector Type	A03FW



Terminal No.	Color of Wire	Signal Name [Specification]
1	B	-
3	BG	-

Connector No.	M53
Connector Name	COMBINATION METER
Connector Type	SAB40FW

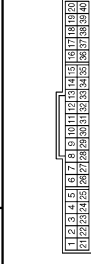

Terminal No.	Color of Wire	Signal Name [Specification]
1	V	BATTERY POWER SUPPLY
2	LG	COMMUNICATION SIGNAL (METER->AMP.)

3	GR	COMMUNICATION SIGNAL (AMP->METER)
5	B	GROUND
6	W	ALTERNATOR SIGNAL
7	LG	AIR BAG SIGNAL
10	W	SECURITY SIGNAL
15	B	GROUND
16	BR	METER CONTROL SWITCH GROUND
18	GR	ILL. GRD
19	B	ILL.
20	R	IGNITION SIGNAL
21	G	GROUND
22	B	COMMUNICATION SIGNAL (LCD->AMP.)
24	BR	COMMUNICATION SIGNAL (AMP->LCD)
25	Y	VEHICLE SPEED SIGNAL (AMP->LGD)
26	R	PARKING BRAKE SWITCH SIGNAL
27	P	BRAKE FLUID LEVEL SWITCH
28	SB	SEAT BELT BUCKLE SW SIGNAL (DRIVER SIDE)
29	P	SEAT BELT BUCKLE SW SIGNAL (PASSENGER SIDE)
30	G	WASHER LEVEL SWITCH SIGNAL
31	L	ILLUMINATION CONTROL SIGNAL
33	R	SELECT SWITCH SIGNAL
36	LG	ENTER SWITCH SIGNAL
37	Y	TRIP A/B RESET SWITCH SIGNAL
38	G	ILLUMINATION CONTROL SWITCH SIGNAL (-)
39	P	ILLUMINATION CONTROL SWITCH SIGNAL (+)
40	BG	ILLUMINATION CONTROL SWITCH SIGNAL (+)

Connector No.	M54
Connector Name	METER CONTROL SWITCH
Connector Type	TH12FW-NH



Terminal No.	Color of Wire	Signal Name [Specification]
1	Y	-
2	LG	-
3	B	-
4	R	-
5	G	-
7	BR	-
8	GR	-
9	BG	-
10	P	-

JCNWM5430GB

COMBINATION METER

< ECU DIAGNOSIS INFORMATION >

METER

Connector No.	M66
Connector Name	UNIFIED METER AND A/C AMP.
Connector Type	TH42PV-NH



Terminal No.	Color of Wire	Signal Name [Specification]
4	G	STOP LAMP SWITCH SIGNAL
5	L	MANUAL MODE SHIFT UP SIGNAL
6	BG	PADDLE SHIFTER UP SIGNAL
7	GR	COMMUNICATION SIGNAL (AMP->METER)
8	L	VEHICLE SPEED SIGNAL (2-PULSE)
9	SB	SEAT BELT BUCKLE SWITCH SIGNAL (DRIVER SIDE)
10	W	MANUAL MODE SIGNAL
11	G	NON-MANUAL MODE SIGNAL
14	BR	COMMUNICATION SIGNAL (LCD->AMP)
20	BR	ION ON / OFF SIGNAL
23	Y	AT SNOW SWITCH SIGNAL
25	V	MANUAL MODE SHIFT DOWN SIGNAL
26	G	PADDLE SHIFTER DOWN SIGNAL
27	LG	COMMUNICATION SIGNAL (METER->AMP)
28	R	VEHICLE SPEED SIGNAL (8-PULSE)
30	V	PARKING BRAKE SWITCH SIGNAL
34	P	COMMUNICATION SIGNAL (AMP->LCD)
38	P	BLOWER MOTOR CONTROL SIGNAL

Connector No.	M67
Connector Name	UNIFIED METER AND A/C AMP.
Connector Type	TH22PV-NH



Terminal No.	Color of Wire	Signal Name [Specification]
41	L	ACC POWER SUPPLY
42	BR	FUEL LEVEL SENSOR SIGNAL
43	BR	INTAKE SENSOR SIGNAL
44	LG	IN-VEHICLE SENSOR SIGNAL

45	V	AMBIENT SENSOR SIGNAL
46	Y	SUNLOAD SENSOR SIGNAL
47	G	SWAYBAR ASSEMBLY ASSEMBLY SENSOR SIGNAL
53	W	IGNITION POWER SUPPLY
54	SB	BATTERY POWER SUPPLY
55	B	GROUND
56	L	CAN-H
57	LG	BRAKE FLUID LEVEL SWITCH
58	Y	FUEL LEVEL SENSOR GROUND
59	GR	INTAKE SENSOR GROUND
60	W	IN-VEHICLE SENSOR GROUND
61	B	AMBIENT SENSOR GROUND
62	SB	SUNLOAD SENSOR GROUND
63	L	ION CONTROL MODE OUTPUT SIGNAL
65	BG	ECV SIGNAL
69	P	A/C LAN SIGNAL
70	R	EACH DOOR MOTOR POWER SUPPLY
71	GR	GROUND
72	P	CAN-L

Connector No.	M107
Connector Name	ECM
Connector Type	RH24FGY-RZ8-R-LH-Z



Terminal No.	Color of Wire	Signal Name [Specification]
97	R	APP SEN 1
98	P	APP SEN 2
99	L	SENSOR POWER SUPPLY
100	W	SENSOR GROUND
101	SB	ASD/TCC STEERING SW
102	LG	EVAP CONTROL SYSTEM PRESS SEN
103	GR	SENSOR POWER SUPPLY
104	V	SENSOR GROUND
105	L	REFRIGERANT PRESS SEN
106	W	FUEL TANK TEMP SEN
107	GR	SENSOR POWER SUPPLY
108	Y	SENSOR GROUND
109	G	PNP SIGNAL
110	R	ENGINE SPEED OUTPUT SIGNAL
112	V	SENSOR GROUND
113	P	CAN COMMUNICATION LINE
114	L	CAN COMMUNICATION LINE

117	V	DATA LINK CONNECTOR
121	LG	EVAP CANISTER VENT CONTROL VALVE
122	B	STOP LAMP SW
123	B	ECM GROUND
124	B	ECM GROUND
125	R	POWER SUPPLY FOR ECM
126	BR	ASD/TCC BRAKE SW
127	B	ECM GROUND
128	B	ECM GROUND

Connector No.	M110
Connector Name	PRE-OASH SEAT BELT CONTROL UNIT
Connector Type	TH20FW-TB6



Terminal No.	Color of Wire	Signal Name [Specification]
1	P	MOTOR (RH) (RELEASE)
2	W	"B
3	L	MOTOR (RH) (FASTEN)
4	BG	MOTOR (LH) (FASTEN)
5	W	GND (DRIVE)
6	Y	MOTOR (LH) (RELEASE)
7	G	INDICATOR
8	LG	BUCKLE SW RH
10	SB	BUCKLE SW LH
13	W	IGN
16	W	SENS OUTPUT 1
18	R	SENS POWER
20	G	SENS OUTPUT 2
21	B	SENS GND
22	P	CAN-L
24	L	CAN-H
26	B	GND (CONT)

Connector No.	M116
Connector Name	WIRE TO WIRE
Connector Type	TK36MF-NS10



Terminal No.	Color of Wire	Signal Name [Specification]
2	W	-
3	BG	-
4	P	-
5	B	-
9	R	-
10	R	-
19	BG	-
20	Y	-
28	B	-
29	LG	-
30	LG	-
31	W	-
33	B	-
34	B	-
35	L	-
36	P	-
37	R	-
38	SB	-
41	BG	-
42	G	-
43	P	-
44	L	-
45	Y	-
46	SB	-

A B C D E F G H I J K M N O P

INL

COMBINATION METER

< ECU DIAGNOSIS INFORMATION >

METER

Connector No.	M122
Connector Name	BCM (BODY CONTROL MODULE)
Connector Type	TH4CFB-NH

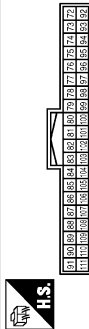

Connector No.	M123
Connector Name	BCM (BODY CONTROL MODULE)
Connector Type	TH4CFG-NH

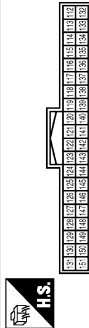

Connector No.	M137
Connector Name	A/T SHIFT SELECTOR
Connector Type	TH12FW-NH



24	G	SEAT BELT
45	Y	DR 2 (-)
46	P	CAN-L
47	Y	AS 2 (-)
48	Y	AS 2 (+)
49	L	ODS INPUT

Terminal No.	Color of Wire	Signal Name [Specification]
72	R	ROOM ANT 2-
73	G	ROOM ANT 2+
74	SB	PASSENGER DOOR ANT-
75	BR	PASSENGER DOOR ANT+
76	V	DRIVER DOOR ANT-
77	LG	DRIVER DOOR ANT+
78	Y	ROOM ANT 1-
79	BR	ROOM ANT 1+
80	GR	NATS ANT AMP
81	W	NATS ANT AMP
82	SB	IGN RELAY (F/B) CONT
83	Y	KEYLESS ENTRY RECEIVER COMM
87	Y	COMBI SW INPUT 5
88	BG	COMBI SW INPUT 3
89	BR	PUSH SW
90	P	CAN-L
91	L	CAN-H
92	LG	KEY SLOT ILL
93	GR	ON IND
95	BG	ACC RELAY CONT
96	GR	A/T SHIFT SELECTOR POWER SUPPLY
97	L	S/L CONDITION 1
98	P	S/L CONDITION 2
99	R	SHIFT P. [Ign A/T]
99	BR	ASCD CLUTCH SW [Ign.M.T]
100	Y	PASSENGER DOOR REQUEST SW
101	P	DRIVER DOOR REQUEST SW
102	BG	BLOWER FAN MOTOR RELAY CONT
103	P	KEYLESS ENTRY RECEIVER POWER SUPPLY
106	SB	S/L UNIT POWER SUPPLY
107	LG	COMBI SW INPUT 1
108	R	COMBI SW INPUT 4
109	W	COMBI SW INPUT 2
110	G	HAZARD SW
111	Y	S/L UNIT COMM

Terminal No.	Color of Wire	Signal Name [Specification]
112	R	RAIN SENSOR SERIAL LINK
113	BG	OPTICAL SENSOR
114	R	CLUTCH INTERLOCK SW
116	SB	STOP LAMP SW 1
118	BR	STOP LAMP SW 2
119	SB	DR DOOR UNLOCK SENSOR
121	SB	KEY SWITCH
123	V	IGN F/B
124	R	PASSENGER DOOR SW
129	BG	TRUNK CANCEL SW
132	V	POWER WINDOW SW COMM
133	L	PUSH-BUTTON IGNITION SW/ILL POWER
134	LG	LOCK IND
137	BG	RECEIVER / SENSOR GND
138	V	RECEIVER / SENSOR POWER SUPPLY
139	L	TIRE PRESSURE RECEIVER COMM
140	B	SHIFT N/P
141	W	SECURITY INDICATOR LAMP
142	BR	COMBI SW OUTPUT 5
143	P	COMBI SW OUTPUT 1
144	G	COMBI SW OUTPUT 2
145	L	COMBI SW OUTPUT 3
146	SB	COMBI SW OUTPUT 4
150	GR	DRIVER DOOR SW
151	G	REAR WINDOW DEFROGGER RELAY CONT

Terminal No.	Color of Wire	Signal Name [Specification]
1	W	-
2	V	-
3	L	-
4	B	-
5	G	-
7	V	-
8	LG	-
9	B	-
10	GR	-
11	R	-

Connector No.	M147
Connector Name	AIR BAG DIAGNOSIS SENSOR UNIT
Connector Type	TK28FY-EX-SC

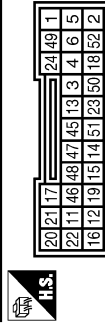

Terminal No.	Color of Wire	Signal Name [Specification]
1	LG	IGN
2	B	GND
3	Y	DR 1 (+)
4	Y	DR 1 (-) DR 2 (-)
5	Y	AS 1 (+)
6	Y	AS 1 (-)
11	SB	ECZS (+)
12	V	ECZS (-)
15	LG	AIR BAG W/L
16	SHIELD	GND
18	R	CUTOFF TELLTALE
21	L	CAN-H

Fail-safe

FAIL SAFE

Combination meter performs fail-safe operation when unified meter and A/C amp. communication is malfunction.

Solution for communication error between the unified meter and A/C amp. and combination meter.

JCNWM5432GB

INFOID:000000006956839

COMBINATION METER

< ECU DIAGNOSIS INFORMATION >

Function	Specifications	A	
Speedometer	Reset to zero by suspending communication.	B	
Tachometer			
Fuel gauge			
Water temperature gauge			
Illumination control	When suspending communication, change to nighttime mode.	C	
Information display	Door open warning	The display turns off by suspending communication.	
	Parking brake release warning		
	Low tire pressure warning		
	Fuel filler cap warning		
	Instantaneous fuel warning		<ul style="list-style-type: none"> • When reception time of an abnormal signal is 2 seconds or less, the last received datum is used for calculation to indicate the result. • When reception time of an abnormal signal is more than two seconds, the last result calculated during normal condition is indicated.
	Average fuel consumption		
	Average vehicle speed		
Travel distance			
Buzzer	The buzzer turns off by suspending communication.	D	
Warning lamp/indicator lamp	ABS warning lamp	The lamp turns on by suspending communication.	
	VDC warning lamp		
	Brake warning lamp		
	CRUISE warning lamp		
	Malfunction indicator lamp		
	High beam indicator		The lamp turns off by suspending communication.
	Turn signal indicator lamp		
	Oil pressure warning lamp		
	A/T CHECK warning lamp		
	VDC OFF indicator lamp		
	Low tire pressure warning lamp		
	Key warning lamp		
	AFS OFF indicator lamp		
	4WAS warning lamp		
	Master warning lamp		
	AWD warning lamp	E	
Tail lamp indicator lamp	F		
Front fog lamp indicator lamp	G		

DTC Index

INFOID:000000006956840

Refer to [MWI-102. "DTC Index"](#).

INL

INTERIOR LIGHTING SYSTEM SYMPTOMS

< SYMPTOM DIAGNOSIS >

SYMPTOM DIAGNOSIS

INTERIOR LIGHTING SYSTEM SYMPTOMS

Symptom Table

INFOID:000000006456972

CAUTION:

Perform the self-diagnosis with CONSULT-III before the symptom diagnosis. Perform the trouble diagnosis if any DTC is detected.

Symptom	Possible cause	Inspection item
All the following lamps do not turn ON. <ul style="list-style-type: none"> • Map lamp • Trunk room lamp • Step lamp • Vanity mirror lamp 	<ul style="list-style-type: none"> • Harness between BCM and each interior room lamp • BCM 	Interior room lamp power supply circuit Refer to INL-20 .
<ul style="list-style-type: none"> • Interior room lamp does not turn ON even though the door is open. (It turns ON when turning the interior room lamp ON.) • Interior room lamp does not turn OFF even though the door is closed. 	<ul style="list-style-type: none"> • Harness between BCM and each door switch • Harness between BCM and each interior room lamp • BCM 	Door switch circuit Refer to DLK-63 . Interior room lamp control circuit Refer to INL-22 .
Interior room lamp timer does not activate. (It turns ON/ OFF when the door opens/closes.)	—	Check the interior room lamp setting. Refer to INL-16 .
Step lamps (driver side and passenger side) do not turn ON. (Map lamp is turned ON.)	<ul style="list-style-type: none"> • Harness between BCM and each step lamp • BCM 	Step lamp circuit Refer to INL-24 .
Step lamps (driver side and passenger side) do not turn OFF. (Map lamp is turned OFF.)		
<ul style="list-style-type: none"> • Trunk room lamp does not turn ON. (Bulb is normal.) • Trunk room lamp does not turn OFF. 	<ul style="list-style-type: none"> • Harness between BCM and trunk room lamp switch • Harness between BCM and trunk room lamp • BCM 	Trunk room lamp switch circuit Refer to DLK-72 . Trunk room lamp circuit Refer to INL-26 .
Push-button ignition switch illumination does not illuminate.	<ul style="list-style-type: none"> • Harness between BCM and push-button ignition switch • BCM 	Push-button ignition switch illumination circuit Refer to INL-28 .
Interior room lamp battery saver does not activate.	—	Check the interior room lamp battery saver setting. Refer to INL-17 .

PRECAUTIONS

< PRECAUTION >

PRECAUTION

PRECAUTIONS

Precaution for Supplemental Restraint System (SRS) "AIR BAG" and "SEAT BELT PRE-TENSIONER"

INFOID:000000006456973

The Supplemental Restraint System such as "AIR BAG" and "SEAT BELT PRE-TENSIONER", used along with a front seat belt, helps to reduce the risk or severity of injury to the driver and front passenger for certain types of collision. This system includes seat belt switch inputs and dual stage front air bag modules. The SRS system uses the seat belt switches to determine the front air bag deployment, and may only deploy one front air bag, depending on the severity of a collision and whether the front occupants are belted or unbelted. Information necessary to service the system safely is included in the "SRS AIR BAG" and "SEAT BELT" of this Service Manual.

WARNING:

Always observe the following items for preventing accidental activation.

- To avoid rendering the SRS inoperative, which could increase the risk of personal injury or death in the event of a collision that would result in air bag inflation, all maintenance must be performed by an authorized NISSAN/INFINITI dealer.
- Improper maintenance, including incorrect removal and installation of the SRS, can lead to personal injury caused by unintentional activation of the system. For removal of Spiral Cable and Air Bag Module, see "SRS AIR BAG".
- Never use electrical test equipment on any circuit related to the SRS unless instructed to in this Service Manual. SRS wiring harnesses can be identified by yellow and/or orange harnesses or harness connectors.

PRECAUTIONS WHEN USING POWER TOOLS (AIR OR ELECTRIC) AND HAMMERS

WARNING:

Always observe the following items for preventing accidental activation.

- When working near the Air Bag Diagnosis Sensor Unit or other Air Bag System sensors with the ignition ON or engine running, never use air or electric power tools or strike near the sensor(s) with a hammer. Heavy vibration could activate the sensor(s) and deploy the air bag(s), possibly causing serious injury.
- When using air or electric power tools or hammers, always switch the ignition OFF, disconnect the battery, and wait at least 3 minutes before performing any service.

Precaution for Battery Service

INFOID:000000006456974

Before disconnecting the battery, lower both the driver and passenger windows. This will prevent any interference between the window edge and the vehicle when the door is opened/closed. During normal operation, the window slightly raises and lowers automatically to prevent any window to vehicle interference. The automatic window function will not work with the battery disconnected.

A

B

C

D

E

F

G

H

I

J

K

INL

M

N

O

P

MAP LAMP

< REMOVAL AND INSTALLATION >

REMOVAL AND INSTALLATION

MAP LAMP

Exploded View

INFOID:000000006456975

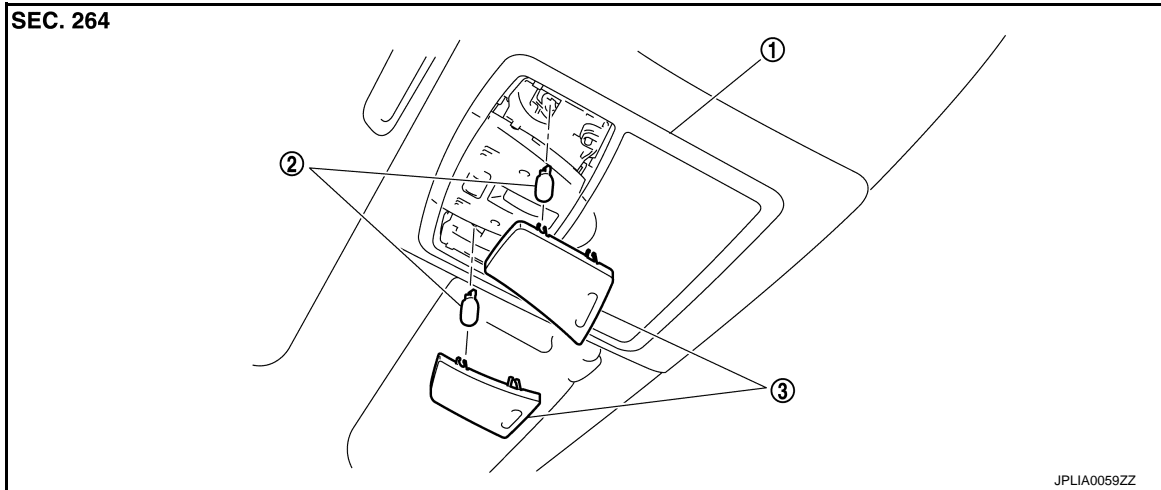

1. Map lamp assembly

2. Bulb

3. Lens

Removal and Installation

INFOID:000000006456976

Refer to [INL-106, "Exploded View"](#) for the map lamp assembly installation/removal.

Replacement

INFOID:000000006456977

CAUTION:

- Disconnect the battery negative terminal or remove the fuse.
- Never touch the glass of bulb directly by hand. Keep grease and other oily matters away from it.
- Never touch bulb by hand while it is lit or right after being turned off.
- Never leave bulb out of lamp reflector for a long time because dust, moisture smoke, etc. may affect the performance of lamp. When replacing bulb, be sure to replace it with new one.

MAP LAMP BULB

1. Insert any appropriate tool into the gap between the lens. Remove the lens.
2. Remove the bulb.

VANITY MIRROR LAMP

< REMOVAL AND INSTALLATION >

VANITY MIRROR LAMP

Exploded View

INFOID:000000006456978

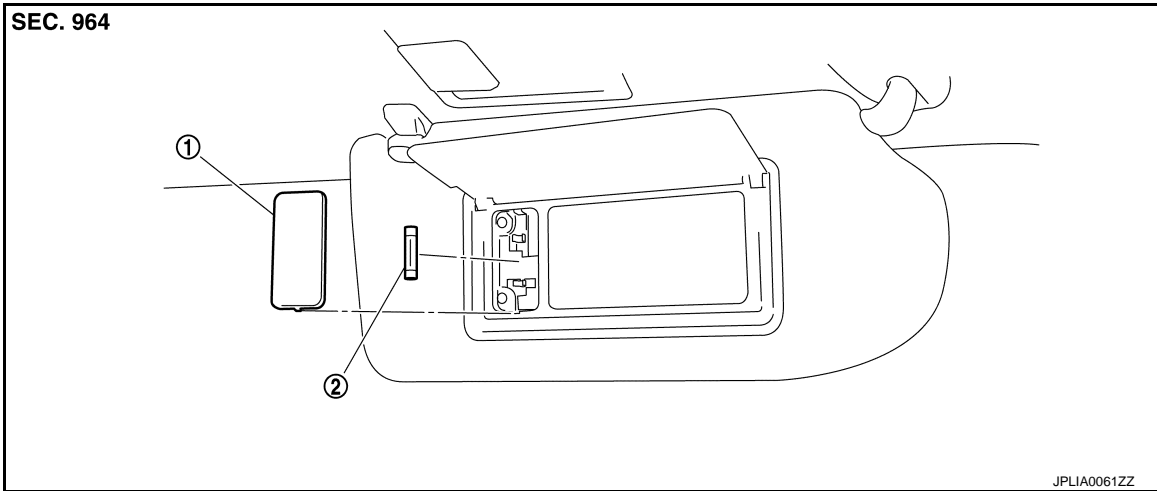

1. Lens

2. Bulb

Replacement

INFOID:000000006456979

CAUTION:

- Disconnect the battery negative terminal or remove the fuse.
- Never touch the glass of bulb directly by hand. Keep grease and other oily matters away from it.
- Never touch bulb by hand while it is lit or right after being turned off.
- Never leave bulb out of lamp reflector for a long time because dust, moisture smoke, etc. may affect the performance of lamp. When replacing bulb, be sure to replace it with new one.

VANITY MIRROR LAMP BULB

1. Insert any appropriate tool into the gap between the lens. Remove the lens.
2. Remove the bulb.

A
B
C
D
E
F
G
H
I
J
K
INL
M
N
O
P

CIGARETTE LIGHTER ILLUMINATION

< REMOVAL AND INSTALLATION >

CIGARETTE LIGHTER ILLUMINATION

Exploded View

INFOID:000000006456980

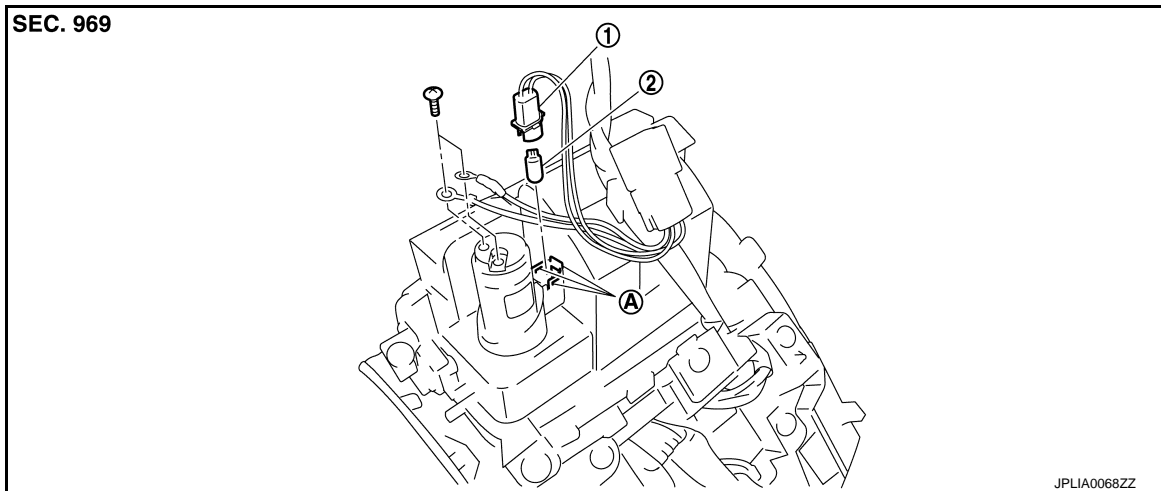

1. Bulb socket

2. Bulb
(Share with the ashtray illumination)

A Hook

Replacement

INFOID:000000006456981

CAUTION:

- Disconnect the battery negative terminal or remove the fuse.
- Never touch the glass of bulb directly by hand. Keep grease and other oily matters away from it.
- Never touch bulb by hand while it is lit or right after being turned off.
- Never leave bulb out of lamp reflector for a long time because dust, moisture smoke, etc. may affect the performance of lamp. When replacing bulb, be sure to replace it with new one.

CIGARETTE LIGHTER ILLUMINATION BULB

1. Remove the console finisher.
Refer to [JP-34. "A/T MODELS : Exploded View"](#) (A/T models).
Refer to [JP-39. "M/T MODELS : Exploded View"](#) (M/T models).
2. Insert any appropriate tool into the gap of the bulb socket. Widen the hook and remove the bulb socket.
3. Remove the bulb.

GLOVE BOX LAMP

< REMOVAL AND INSTALLATION >

GLOVE BOX LAMP

Exploded View

INFOID:000000006456982

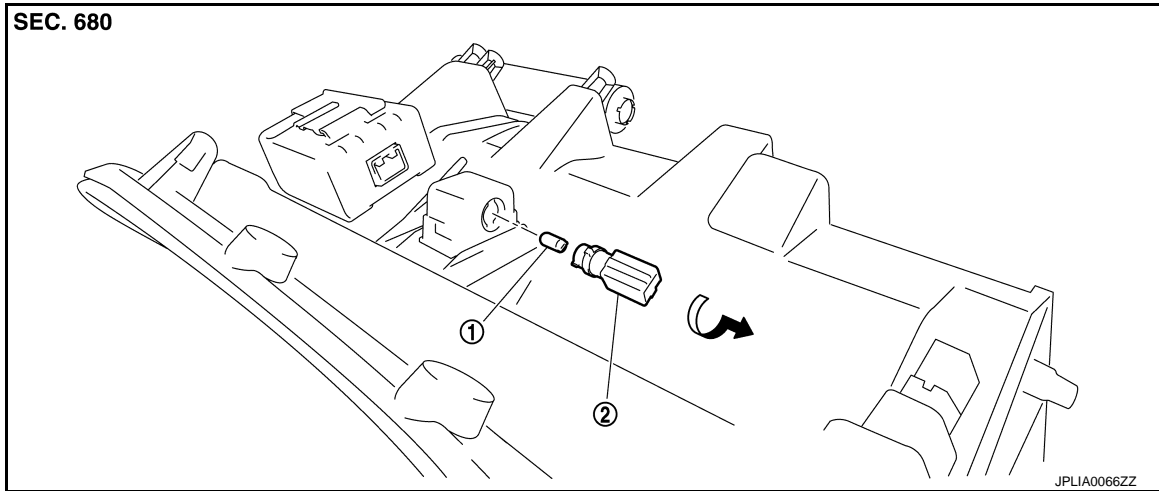

1. Bulb

2. Bulb socket

Replacement

INFOID:000000006456983

CAUTION:

- Disconnect the battery negative terminal or remove the fuse.
- Never touch the glass of bulb directly by hand. Keep grease and other oily matters away from it.
- Never touch bulb by hand while it is lit or right after being turned off.
- Never leave bulb out of lamp reflector for a long time because dust, moisture smoke, etc. may affect the performance of lamp. When replacing bulb, be sure to replace it with new one.

GLOVE BOX LAMP BULB

1. Remove the instrument assist lower panel.
Refer to [IP-34, "A/T MODELS : Exploded View"](#) (A/T models).
Refer to [IP-39, "M/T MODELS : Exploded View"](#) (M/T models).
2. Rotate the bulb socket counterclockwise and unlock it.
3. Remove the bulb.

A
B
C
D
E
F
G
H
I
J
K
INL
M
N
O
P

STEP LAMP

< REMOVAL AND INSTALLATION >

STEP LAMP

Exploded View

INFOID:000000006456984

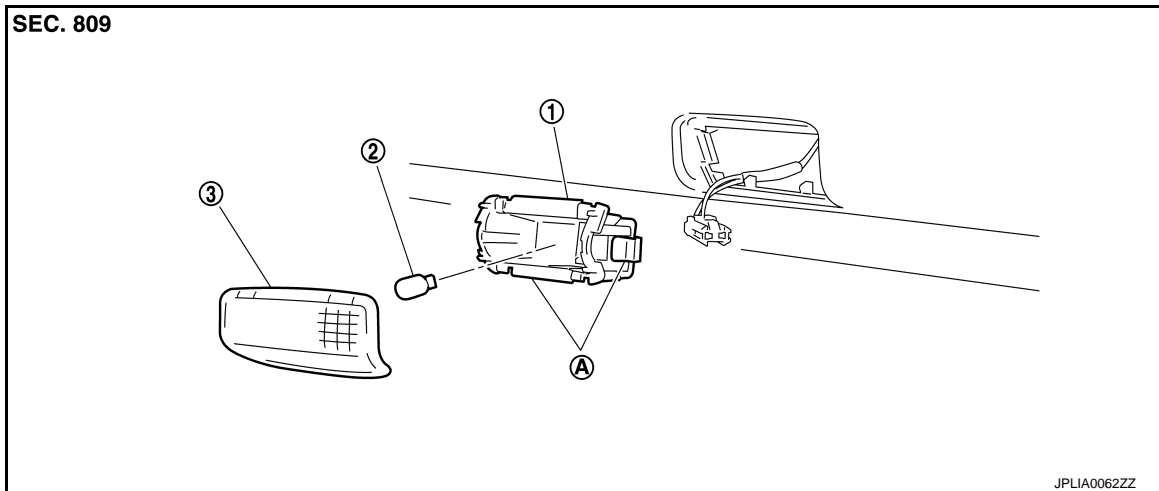

1. Step lamp case
A Metal clip
2. Bulb
3. Lens

Removal and Installation

INFOID:000000006456985

CAUTION:

Disconnect the battery negative terminal or remove the fuse.

REMOVAL

1. Insert any appropriate tool into the gap between the step lamp and the door trim. Remove the step lamp.
2. Disconnect the connector.

INSTALLATION

Install in the reverse order of removal.

Replacement

INFOID:000000006456986

CAUTION:

- **Disconnect the battery negative terminal or remove the fuse.**
- **Never touch the glass of bulb directly by hand. Keep grease and other oily matters away from it.**
- **Never touch bulb by hand while it is lit or right after being turned off.**
- **Never leave bulb out of lamp reflector for a long time because dust, moisture smoke, etc. may affect the performance of lamp. When replacing bulb, be sure to replace it with new one.**

STEP LAMP BULB

1. Remove the step lamp. Refer to [INL-110, "Exploded View"](#).
2. Remove the lens.
3. Remove the bulb.

TRUNK ROOM LAMP

< REMOVAL AND INSTALLATION >

TRUNK ROOM LAMP

Exploded View

INFOID:000000006456987

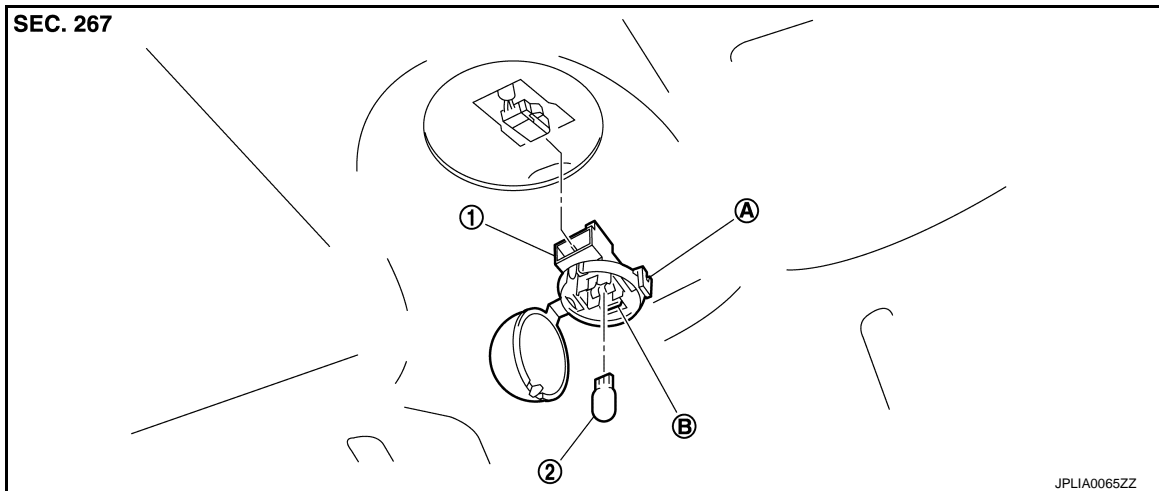

- | | |
|--------------------------|---------------------------------|
| 1. Trunk room lamp | 2. Bulb |
| A Pawl (for lens fixing) | B. Pawl (for case installation) |

Removal and Installation

INFOID:000000006456988

CAUTION:

Disconnect the battery negative terminal or remove the fuse.

REMOVAL

1. Widen the pawl (A). Open the lens (1).
2. Remove the bulb.
3. Pressing the pawl (B) to the arrow direction (←). Pull out the trunk room lamp.
4. Disconnect the connector.
5. Remove the trunk room lamp.

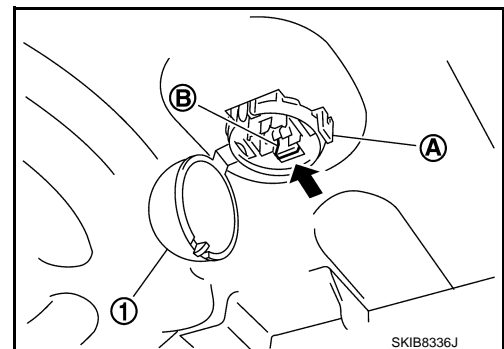

INSTALLATION

Install in the reverse order of removal.

Replacement

INFOID:000000006456989

CAUTION:

- **Disconnect the battery negative terminal or remove the fuse.**
- **Never touch the glass of bulb directly by hand. Keep grease and other oily matters away from it.**
- **Never touch bulb by hand while it is lit or right after being turned off.**
- **Never leave bulb out of lamp reflector for a long time because dust, moisture smoke, etc. may affect the performance of lamp. When replacing bulb, be sure to replace it with new one.**

TRUNK ROOM LAMP BULB

1. Widen the lens pawl. Open the lens.
2. Remove the bulb.

SERVICE DATA AND SPECIFICATIONS (SDS)

< SERVICE DATA AND SPECIFICATIONS (SDS)

SERVICE DATA AND SPECIFICATIONS (SDS)

SERVICE DATA AND SPECIFICATIONS (SDS)

Bulb Specifications

INFOID:000000006456990

Item	Type	Wattage (W)
Push-button ignition switch illumination	LED	—
Map lamp	Wedge	8
Center console indirect illumination (Integrated into the map lamp assembly)	LED	—
Vanity mirror lamp	—	2
Glove box lamp	—	1.4
Cigarette lighter illumination (Shared with ash tray illumination)	—	1.4
Step lamp	Wedge	8
Trunk room lamp	Wedge	3.4