

SECTION **DEF**
DEFOGGER

A
B
C

CONTENTS

BASIC INSPECTION	3	Description	15	F
DIAGNOSIS AND REPAIR WORK FLOW	3	Component Function Check	15	
Work Flow	3	Diagnosis Procedure	15	
SYSTEM DESCRIPTION	4	DRIVER SIDE DOOR MIRROR DEFOGGER ...	17	G
REAR WINDOW DEFOGGER SYSTEM	4	Description	17	
System Diagram	4	Component Function Check	17	
System Description	4	Diagnosis Procedure	17	H
Component Parts Location	5	PASSENGER SIDE DOOR MIRROR DEFOGGER	19	I
Component Description	5	Description	19	
DIAGNOSIS SYSTEM (BCM)	6	Component Function Check	19	
COMMON ITEM	6	Diagnosis Procedure	19	J
COMMON ITEM : CONSULT Function (BCM -		REAR WINDOW DEFOGGER SYSTEM	21	
COMMON ITEM)	6	Wiring Diagram - DEFOGGER CONTROL SYS-		
REAR WINDOW DEFOGGER	7	TEM -	21	K
REAR WINDOW DEFOGGER : CONSULT Func-		ECU DIAGNOSIS INFORMATION	23	
tion (BCM - REAR DEFOGGER)	7	BCM (BODY CONTROL MODULE)	23	DEF
DTC/CIRCUIT DIAGNOSIS	9	Reference Value	23	
REAR WINDOW DEFOGGER SWITCH	9	Wiring Diagram - BCM -	46	
Description	9	Fail-safe	49	M
Component Function Check	9	DTC Inspection Priority Chart	50	
Diagnosis Procedure	9	DTC Index	51	
REAR WINDOW DEFOGGER RELAY	10	SYMPTOM DIAGNOSIS	54	N
Description	10	REAR WINDOW DEFOGGER DOES NOT		
Component Function Check	10	OPERATE	54	O
Diagnosis Procedure	10	Diagnosis Procedure	54	
Component Inspection	11	REAR WINDOW DEFOGGER AND DOOR		
REAR WINDOW DEFOGGER	12	MIRROR DEFOGGERS DO NOT OPERATE ...	55	P
Description	12	Diagnosis Procedure	55	
Component Function Check	12	REAR WINDOW DEFOGGER DOES NOT		
Diagnosis Procedure	12	OPERATE BUT BOTH DOOR MIRROR DE-		
Component Inspection	14	FOGGERS OPERATE	56	
DOOR MIRROR DEFOGGER	15	Diagnosis Procedure	56	

D
E

F
G

H
I

J
K

L
M

N
O

P

DOOR MIRROR DEFOGGER DOES NOT OPERATE	57	Diagnosis Procedure	59
BOTH SIDES	57	PRECAUTION	60
BOTH SIDES : Diagnosis Procedure	57	PRECAUTIONS	60
DRIVER SIDE	57	Precaution for Supplemental Restraint System (SRS) "AIR BAG" and "SEAT BELT PRE-TENSIONER"	60
DRIVER SIDE : Diagnosis Procedure	57	Precaution for Battery Service	60
PASSENGER SIDE	57	REMOVAL AND INSTALLATION	61
PASSENGER SIDE : Diagnosis Procedure	57	FILAMENT	61
ON IS NOT DISPLAYED WHEN PRESSING REAR WINDOW DEFOGGER SWITCH BUT IT IS OPERATED	58	Inspection and Repair	61
Diagnosis Procedure	58	CONDENSER	63
REAR WINDOW DEFOGGER INDICATOR DOES NOT ILLUMINATE	59	Exploded View	63
		Removal and Installation	63

DIAGNOSIS AND REPAIR WORK FLOW

< BASIC INSPECTION >

BASIC INSPECTION

DIAGNOSIS AND REPAIR WORK FLOW

Work Flow

INFOID:000000008161274

DETAILED FLOW

1.OBTAIN INFORMATION ABOUT SYMPTOM

Interview the customer to obtain the malfunction information (conditions and environment when the malfunction occurred) as much as possible when the customer brings the vehicle in.

>> GO TO 2.

2.CHECK DTC

Perform self diagnosis with CONSULT.

Is any DTC detected?

YES >> Refer to [BCS-73. "DTC Index"](#)

NO >> GO TO 3.

3.REPRODUCE THE MALFUNCTION INFORMATION

Check the malfunction on the vehicle that the customer describes.
Inspect the relation of the symptoms and the condition when the symptoms occur.

>> GO TO 4.

4.IDENTIFY THE MALFUNCTIONING SYSTEM WITH "SYMPTOM DIAGNOSIS"

Use "Symptom diagnosis" from the symptom inspection result in step 3. Then identify where to start performing the diagnosis based on possible causes and symptoms.

>> GO TO 5.

5.IDENTIFY MALFUNCTIONING PARTS WITH "COMPONENT DIAGNOSIS"

Perform the diagnosis with "Component diagnosis" of the applicable system.

>> GO TO 6.

6.REPAIR OR REPLACE THE MALFUNCTIONING PARTS

Repair or replace the specified malfunctioning parts.

>> GO TO 7.

7.FINAL CHECK

Check that malfunctions are not reproduced when obtaining the malfunction information from the customer, referring to the symptom inspection result in step 3.

Are all malfunctions corrected?

YES >> INSPECTION END

NO >> GO TO 4.

A
B
C
D
E
F
G
H
I
J
K
DEF
M
N
O
P

REAR WINDOW DEFOGGER SYSTEM

< SYSTEM DESCRIPTION >

SYSTEM DESCRIPTION

REAR WINDOW DEFOGGER SYSTEM

System Diagram

INFOID:000000008161275

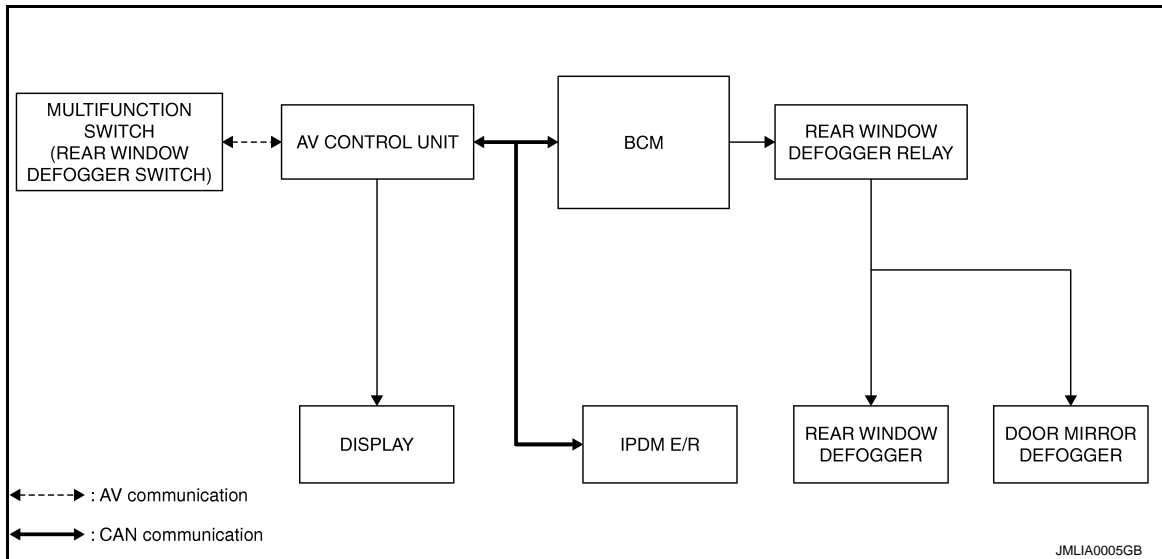

System Description

INFOID:000000008161276

Operation Description

- Turn rear window defogger switch ON when the ignition switch is turned ON. Then multifunction switch (rear window defogger switch) transmits rear window defogger switch signal to AV control unit via AV communication. AV control unit transmits rear window defogger switch signal to BCM via CAN communication.
- BCM turns rear window defogger relay ON and transmit rear window defogger ON signal to IPDM E/R via CAN communication when rear window defogger switch signal is received.
- Rear window defogger and door mirror defogger (with mirror defogger) are supplied with power and operate when rear window defogger relay turns ON.
- AV control unit transmit rear window defogger control signal to multifunction switch (rear window defogger switch) via AV communication.
- IPDM E/R transmits rear window defogger control signal to AV control unit via CAN communication.

Timer function

- BCM turns rear window defogger relay ON for approximately 15 minutes when rear window defogger switch is turned ON. It makes rear window defogger and door mirror defogger (with mirror defogger) operate.
- Timer is canceled after pressing rear window defogger switch again during timer operation. Then BCM turns rear window defogger relay OFF. The same reaction also occurs during timer operation, if the ignition switch is turned OFF.

REAR WINDOW DEFOGGER SYSTEM

< SYSTEM DESCRIPTION >

Component Parts Location

INFOID:000000008161277

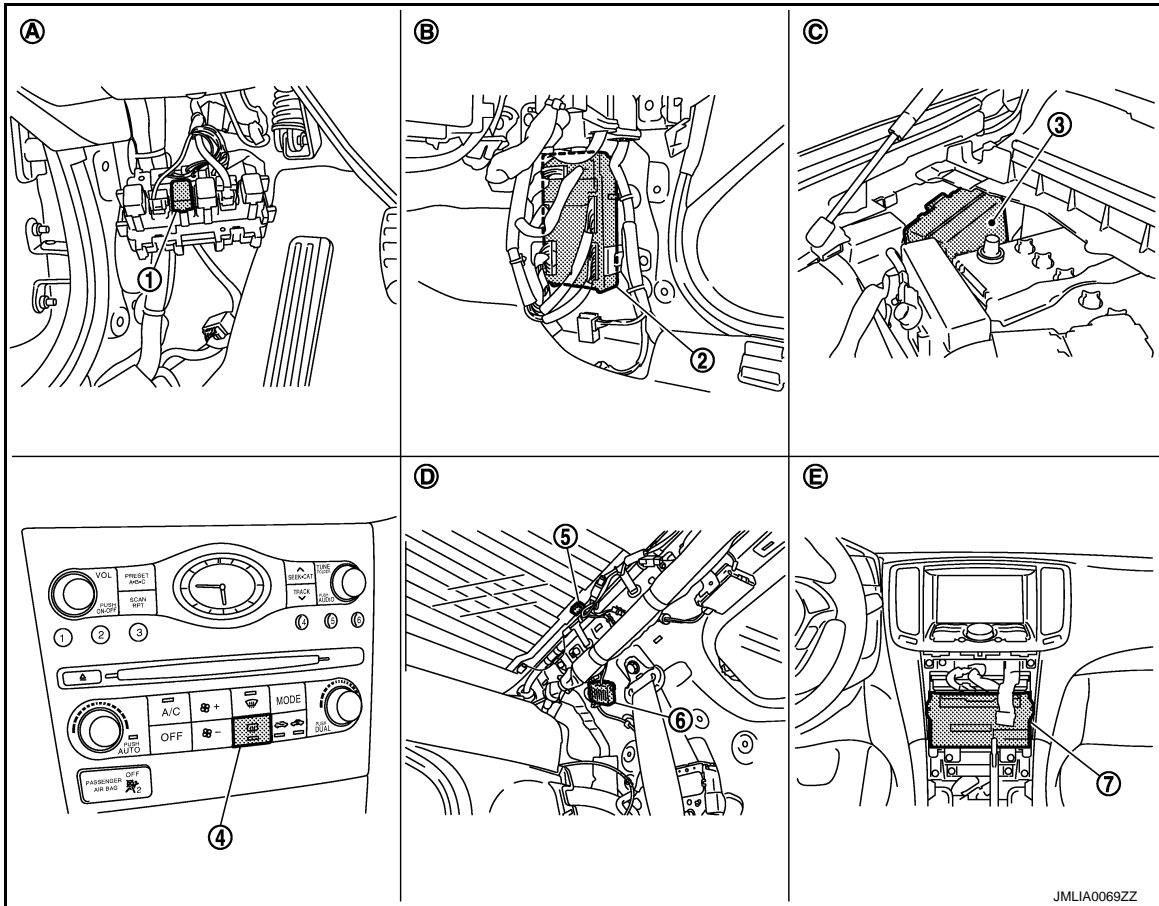

- | | | |
|--|-------------------------------------|--------------------------------|
| 1. Rear window defogger relay | 2. BCM | 3. IPDM E/R |
| 4. Rear window defogger switch (built-in multifunction switch) | 5. Rear window defogger connector | 6. Condenser |
| 7. AV control unit | | |
| A. Dash side lower (driver side) | B. Dash side lower (passenger side) | C. Engine room dash panel (RH) |
| D. Behind rear pillar finisher (LH) | E. Behind cluster lid C | |

Component Description

INFOID:000000008161278

BCM	<ul style="list-style-type: none"> Operates the rear window defogger with the operation of rear window defogger switch Performs the timer control of rear window defogger
Rear window defogger relay	Operates the rear window defogger and the door mirror defogger with the control signal from BCM
IPDM E/R	Transmit rear window defogger ON signal to AV control unit via CAN communication
Multifunction switch (Rear window defogger switch)	<ul style="list-style-type: none"> The rear window defogger switch is installed Turns the indicator lamp ON when detecting the operation of rear window defogger
AV control unit	Displays the rear window defogger ON to the display when detecting the operation of rear window defogger
Rear window defogger	Heats the heating wire with the power supply from the rear window defogger relay to prevent the rear window from fogging up
Door mirror defogger*	Heats the heating wire with the power supply from the rear window defogger relay to prevent the door mirror from fogging up

*: With mirror defogger

A
B
C
D
E
F
G
H
I
J
K
DEF
M
N
O
P

DIAGNOSIS SYSTEM (BCM)

< SYSTEM DESCRIPTION >

DIAGNOSIS SYSTEM (BCM) COMMON ITEM

COMMON ITEM : CONSULT Function (BCM - COMMON ITEM)

INFOID:000000008832629

APPLICATION ITEM

CONSULT performs the following functions via CAN communication with BCM.

Diagnosis mode	Function Description
Work Support	Changes the setting for each system function.
Self Diagnostic Result	Displays the diagnosis results judged by BCM.
CAN Diag Support Monitor	Monitors the reception status of CAN communication viewed from BCM.
Data Monitor	The BCM input/output signals are displayed.
Active Test	The signals used to activate each device are forcibly supplied from BCM.
Ecu Identification	The BCM part number is displayed.
Configuration	This function is not used even though it is displayed.

SYSTEM APPLICATION

BCM can perform the following functions for each system.

NOTE:

It can perform the diagnosis modes except the following for all sub system selection items.

×: Applicable item

System	Sub system selection item	Diagnosis mode		
		Work Support	Data Monitor	Active Test
Door lock	DOOR LOCK	×	×	×
Rear window defogger	REAR DEFOGGER		×	×
Warning chime	BUZZER		×	×
Interior room lamp timer	INT LAMP	×	×	×
Exterior lamp	HEAD LAMP	×	×	×
Wiper and washer	WIPER	×	×	×
Turn signal and hazard warning lamps	FLASHER	×	×	×
—	AIR CONDITONER*			
<ul style="list-style-type: none"> • Intelligent Key system • Engine start system 	INTELLIGENT KEY	×	×	×
Combination switch	COMB SW		×	
Body control system	BCM	×		
IVIS - NATS	IMMU		×	×
Interior room lamp battery saver	BATTERY SAVER	×	×	×
Trunk lid open	TRUNK		×	×
Vehicle security system	THEFT ALM	×	×	×
RAP system	RETAINED PWR		×	
Signal buffer system	SIGNAL BUFFER		×	×
TPMS	AIR PRESSURE MONITOR	×	×	×

NOTE:

*: This item is displayed, but is not used.

FREEZE FRAME DATA (FFD)

The BCM records the following vehicle condition at the time a particular DTC is detected, and displays on CONSULT.

DIAGNOSIS SYSTEM (BCM)

< SYSTEM DESCRIPTION >

CONSULT screen item	Indication/Unit	Description		
Vehicle Speed	km/h	Vehicle speed of the moment a particular DTC is detected		A
Odo/Trip Meter	km	Total mileage (Odometer value) of the moment a particular DTC is detected		B
Vehicle Condition	SLEEP>LOCK	Power supply position status of the moment a particular DTC is detected	While turning BCM status from low power consumption mode to normal mode (Power supply position is "LOCK"*)	B
	SLEEP>OFF		While turning BCM status from low power consumption mode to normal mode (Power supply position is "OFF".)	C
	LOCK>ACC		While turning power supply position from "LOCK"* to "ACC"	D
	ACC>ON		While turning power supply position from "ACC" to "IGN"	D
	RUN>ACC		While turning power supply position from "RUN" to "ACC" (Except emergency stop operation)	E
	CRANK>RUN		While turning power supply position from "CRANKING" to "RUN" (From cranking up the engine to run it)	E
	RUN>URGENT		While turning power supply position from "RUN" to "ACC" (Emergency stop operation)	F
	ACC>OFF		While turning power supply position from "ACC" to "OFF"	F
	OFF>LOCK		While turning power supply position from "OFF" to "LOCK"*	G
	OFF>ACC		While turning power supply position from "OFF" to "ACC"	G
	ON>CRANK		While turning power supply position from "IGN" to "CRANKING"	H
	OFF>SLEEP		While turning BCM status from normal mode (Power supply position is "OFF".) to low power consumption mode	H
	LOCK>SLEEP		While turning BCM status from normal mode (Power supply position is "LOCK"*.) to low power consumption mode	I
	LOCK		Power supply position is "LOCK"*	I
	OFF		Power supply position is "OFF" (Ignition switch OFF)	J
	ACC		Power supply position is "ACC" (Ignition switch ACC)	J
	ON		Power supply position is "IGN" (Ignition switch ON with engine stopped)	K
ENGINE RUN	Power supply position is "RUN" (Ignition switch ON with engine running)	K		
CRANKING	Power supply position is "CRANKING" (At engine cranking)	K		
IGN Counter	0 - 39	The number of times that ignition switch is turned ON after DTC is detected <ul style="list-style-type: none"> • The number is 0 when a malfunction is detected now. • The number increases like 1 → 2 → 3...38 → 39 after returning to the normal condition whenever ignition switch OFF → ON. • The number is fixed to 39 until the self-diagnosis results are erased if it is over 39. 		DEF

NOTE:

*: Power supply position shifts to "LOCK" from "OFF", when ignition switch is in the OFF position, selector lever is in the P position (A/T models), and any of the following conditions are met.

- Closing door
- Opening door
- Door is locked using door request switch
- Door is locked using Intelligent Key

The power supply position shifts to "ACC" when the push-button ignition switch (push switch) is pushed at "LOCK".

REAR WINDOW DEFOGGER

REAR WINDOW DEFOGGER : CONSULT Function (BCM - REAR DEFOGGER)

INFOID:000000008161280

Data monitor

NOTE:

DIAGNOSIS SYSTEM (BCM)

< SYSTEM DESCRIPTION >

The following table includes information (items) inapplicable to this vehicle. For information (items) applicable to this vehicle, refer to CONSULT display items.

Monitor Item	Description
REAR DEF SW	This is displayed even when it is not equipped.
PUSH SW	Indicates [ON/OFF] condition of push switch.

ACTIVE TEST

Test Item	Description
REAR DEFOGGER	Rear window defogger operates when "ON" on CONSULT screen is touched.

REAR WINDOW DEFOGGER SWITCH

< DTC/CIRCUIT DIAGNOSIS >

DTC/CIRCUIT DIAGNOSIS

REAR WINDOW DEFOGGER SWITCH

Description

INFOID:000000008161281

- The rear window defogger is operated by turning the rear window defogger switch ON.
- The indicator lamp in the rear window defogger illuminates when the rear window defogger is operating.

Component Function Check

INFOID:000000008161282

1. CHECK REAR WINDOW DEFOGGER SWITCH FUNCTION

Check that the indicator lamp of rear window defogger illuminates when rear window defogger switch ON.

Is the inspection result normal?

- YES >> Rear window defogger switch function is OK.
- NO >> Refer to [DEF-9, "Diagnosis Procedure"](#)

Diagnosis Procedure

INFOID:000000008161283

1. CHECK MULTIFUNCTION SWITCH (REAR WINDOW DEFOGGER SWITCH)

Does multifunction switch operate normally?

- Base audio without rear view camera. Refer to [AV-20, "Diagnosis Description"](#)
- Base audio with rear view camera. Refer to [AV-105, "On Board Diagnosis Function"](#)
- BOSE audio without navigation. Refer to [AV-215, "On Board Diagnosis Function"](#)
- BOSE audio with navigation. Refer to [AV-340, "On Board Diagnosis Function"](#)

Is the inspection result normal?

- YES >> INSPECTION END
- NO >> Replace multifunction switch (rear window defogger switch). Refer to [AV-91, "Removal and Installation"](#)

A
B
C
D
E
F
G
H
I
J
K
L
M
N
O
P

DEF

REAR WINDOW DEFOGGER RELAY

< DTC/CIRCUIT DIAGNOSIS >

REAR WINDOW DEFOGGER RELAY

Description

INFOID:000000008161284

Power is supplied to the rear window defogger with BCM control.

Component Function Check

INFOID:000000008161285

1.CHECK REAR WINDOW DEFOGGER RELAY POWER SUPPLY CIRCUIT

1. Perform Active Test ("REAR DEFOGGER") with CONSULT.
2. Touch "ON".
3. Check that the rear window heating wire is getting warmer.

Is the inspection result normal?

- YES >> Rear window defogger relay power supply circuit is OK.
NO >> Refer to [DEF-10, "Diagnosis Procedure"](#).

Diagnosis Procedure

INFOID:000000008161286

1.CHECK FUSE

1. Turn ignition switch off.
2. Check the following.
 - 10A fuse [No.3, located in fuse block (J/B)]

Is the inspection result normal?

- YES >> GO TO 2.
NO >> Replace the blown fuse after repairing the affected circuit if a fuse is blown.

2.CHECK REAR WINDOW DEFOGGER CIRCUIT 1

1. Turn ignition switch ON.
2. Check voltage between BCM harness connector and ground.

(+)		(-)	Condition	Voltage (V) (Approx.)	
BCM					
Connector	Terminal				
M123	151	Ground	Rear window defogger switch	ON	0
				OFF	Battery voltage

Is the inspection result normal?

- YES >> GO TO 6.
NO >> GO TO 3.

3.CHECK REAR WINDOW DEFOGGER CIRCUIT 2

1. Turn ignition switch OFF.
2. Disconnect BCM connector and rear window defogger relay.
3. Check continuity between BCM harness connector and fuse block (J/B) harness connector.

BCM		Fuse block (J/B)		Continuity
Connector	Terminal	Connector	Terminal	
M123	151	M2	4B	Existed

Is the inspection result normal?

- YES >> GO TO 4.
NO >> Repair or replace harness.

4.CHECK REAR WINDOW DEFOGGER RELAY

Check rear window defogger relay.
Refer to [DEF-11, "Component Inspection"](#).

Is the inspection result normal?

REAR WINDOW DEFOGGER RELAY

< DTC/CIRCUIT DIAGNOSIS >

- YES >> GO TO 5.
 NO >> Replace rear window defogger relay.

5.CHECK FUSE BLOCK (J/B)

1. Install the rear window defogger relay.
2. Turn ignition switch ON.
3. Check voltage between fuse block (J/B) (fuse block side) and ground.

(+)		(-)	Voltage (V) (Approx.)
Fuse block (J/B)			
Connector	Terminal		
M2	4B	Ground	Battery voltage

Is the inspection result normal?

- YES >> GO TO 6.
 NO >> Repair or replace fuse block (J/B).

6.CHECK INTERMITTENT INCIDENT

Check intermittent incident.
 Refer to [GI-43. "Intermittent Incident"](#).

>> INSPECTION END

Component Inspection

INFOID:000000008161287

1.CHECK REAR WINDOW DEFOGGER RELAY

1. Turn ignition switch OFF.
2. Disconnect rear window defogger relay.
3. Check rear window defogger relay.

Terminal		Condition	Continuity
Rear window defogger relay			
3	5	12 V direct current supply between terminals 1 and 2.	Existed
		No current supply	Not existed

Is the inspection result normal?

- YES >> INSPECTION END
 NO >> Replace rear window defogger relay.

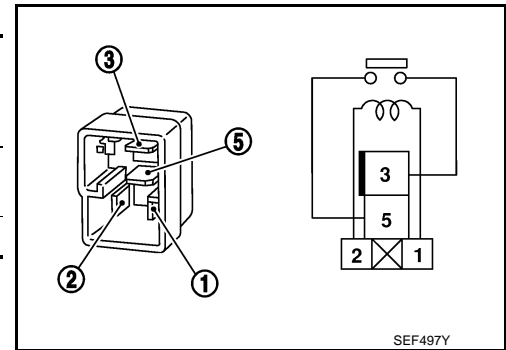

SEF497Y

A
B
C
D
E
F
G
H
I
J
K
DEF
M
N
O
P

REAR WINDOW DEFOGGER

< DTC/CIRCUIT DIAGNOSIS >

REAR WINDOW DEFOGGER

Description

INFOID:000000008161288

Heats the heating wire with the power supply from the rear window defogger relay to prevent the rear window from fogging up.

Component Function Check

INFOID:000000008161289

1.CHECK REAR WINDOW DEFOGGER

1. Perform Active Test ("REAR DEFOGGER") with CONSULT.
2. Touch "ON".
3. Check that the rear window heating wire is getting warmer.

Is the inspection result normal?

- YES >> Rear window defogger is OK.
NO >> Refer to [DEF-12. "Diagnosis Procedure"](#).

Diagnosis Procedure

INFOID:000000008161290

1.CHECK FUSE

1. Turn ignition switch OFF.
2. Check the following.
 - 20A fuse [No.14, located in fuse block (J/B)]
 - 20A fuse [No.15, located in fuse block (J/B)]

Is the inspection result normal?

- YES >> GO TO 2.
NO >> Replace the blown fuse after repairing the affected circuit if a fuse is blown.

2.CHECK POWER SUPPLY CIRCUIT

1. Turn ignition switch ON.
2. Check voltage between rear window defogger connector and ground.

(+)		(-)	Condition		Voltage (V) (Approx.)
Connector	Terminal				
B401	1	Ground	Rear window defogger switch	ON	Battery voltage
			OFF	0	

Is the inspection result normal?

- YES >> GO TO 3.
NO >> GO TO 4.

3.CHECK GROUND CIRCUIT

1. Turn ignition switch OFF.
2. Disconnect rear window defogger connector.
3. Check continuity between rear window defogger harness connector and ground.

Rear window defogger		Ground	Continuity
Connector	Terminal		
B402	2		Existed

Is the inspection result normal?

- YES >> GO TO 7.
NO >> Repair or replace harness.

4.CHECK REAR WINDOW DEFOGGER CIRCUIT 1

REAR WINDOW DEFOGGER

< DTC/CIRCUIT DIAGNOSIS >

1. Turn ignition switch OFF.
2. Disconnect condenser connector and rear window defogger connector.
3. Check continuity between condenser (condenser side) and rear window defogger harness connector.

Condenser		Rear window defogger		Continuity
Connector	Terminal	Connector	Terminal	
B26	1	B401	1	Existed

4. Check continuity between condenser (condenser side) connector and ground.

Condenser		Ground	Continuity
Connector	Terminal		
B26	1		Not existed

Is the inspection result normal?

YES >> GO TO 5.

NO >> Replace condenser. Refer to [DEF-63, "Removal and Installation"](#).

5.CHECK REAR WINDOW DEFOGGER CIRCUIT 2

1. Disconnect fuse block (J/B) connector.
2. Check continuity between fuse block (J/B) harness connector and condenser harness connector.

Fuse block (J/B)		Condenser		Continuity
Connector	Terminal	Connector	Terminal	
B6	10G	B26	1	Existed
	11G			

3. Check continuity between fuse block (J/B) harness connector and ground.

Fuse block (J/B)		Ground	Continuity
Connector	Terminal		
B6	10G		Not existed
	11G		

Is the inspection result normal?

YES >> GO TO 6.

NO >> Repair or replace harness.

6.CHECK FUSE BLOCK (J/B)

1. Turn ignition switch ON.
2. Check voltage between fuse block (J/B) (fuse block side) and ground.

(+)		(-)	Condition	Voltage (V) (Approx.)
Fuse block (J/B)				
Connector	Terminal			
B6	10G	Ground	Rear window defogger switch ON	Battery voltage
			Rear window defogger switch OFF	0
	11G		Rear window defogger switch ON	Battery voltage
			Rear window defogger switch OFF	0

Is the inspection result normal?

YES >> GO TO 8.

NO >> Repair or replace fuse block (J/B).

7.CHECK FILAMENT

Check filament.

Refer to [DEF-14, "Component Inspection"](#).

REAR WINDOW DEFOGGER

< DTC/CIRCUIT DIAGNOSIS >

Is the inspection result normal?

YES >> GO TO 8.

NO >> Repair filament.

8.CHECK INTERMITTENT INCIDENT

Check intermittent incident.

Refer to [GI-43, "Intermittent Incident"](#).

>> INSPECTION END

Component Inspection

INFOID:000000008161291

1.CHECK FILAMENT

Check the filament for damage or blown.

Refer to [DEF-61, "Inspection and Repair"](#).

Is the inspection result normal?

YES >> INSPECTION END

NO >> Repair filament.

DOOR MIRROR DEFOGGER

< DTC/CIRCUIT DIAGNOSIS >

DOOR MIRROR DEFOGGER

Description

INFOID:000000008161292

Power is supplied to the door mirror defogger with BCM control.

Component Function Check

INFOID:000000008161293

1.CHECK DOOR MIRROR DEFOGGER

1. Perform Active Test ("REAR DEFOGGER") with CONSULT.
2. Touch "ON".
3. Check that both side door mirror glass is getting warmer.

Is the inspection result normal?

- YES >> Door mirror defogger is OK.
NO >> Refer to [DEF-15. "Diagnosis Procedure"](#).

Diagnosis Procedure

INFOID:000000008161294

1.CHECK FUSE

1. Turn ignition switch OFF.
2. Check 10A fuse [No.13, located in fuse block (J/B)].

Is the inspection result normal?

- YES >> GO TO 2.
NO >> Replace the blown fuse after repairing the affected circuit if a fuse is blown.

2.CHECK POWER SUPPLY CIRCUIT

1. Disconnect door mirror (driver side) connector.
2. Turn ignition switch ON.
3. Check voltage between door mirror (driver side) harness connector and ground.

(+)		(-)	Condition		Voltage (V) (Approx.)
Door mirror (driver side) Connector	Terminal				
D3	4	Ground	Rear window defogger switch	ON OFF	Battery voltage 0

Is the inspection result normal?

- YES >> GO TO 5.
NO >> GO TO 3.

3.CHECK DRIVER SIDE DOOR MIRROR DEFOGGER CIRCUIT

1. Turn ignition switch OFF.
2. Disconnect fuse block (J/B) connector.
3. Check continuity between fuse block (J/B) harness connector and door mirror (driver side) harness connector.

Fuse block (J/B)		Door mirror (driver side)		Continuity
Connector	Terminal	Connector	Terminal	
M3	10C	D3	4	Existed

4. Check continuity between fuse block (J/B) harness connector and ground.

Fuse block (J/B)		Ground	Continuity
Connector	Terminal		
M3	10C		Not existed

Is the inspection result normal?

A
B
C
D
E
F
G
H
I
J
K
M
N
O
P

DEF

DOOR MIRROR DEFOGGER

< DTC/CIRCUIT DIAGNOSIS >

- YES >> GO TO 4.
NO >> Repair or replace harness.

4.CHECK FUSE BLOCK (J/B)

1. Turn ignition switch ON.
2. Check voltage between fuse block (J/B) (fuse block side) and ground.

(+)		(-)	Condition	Voltage (V) (Approx.)	
Fuse block (J/B)					
Connector	Terminal				
M3	10C	Ground	Rear window defogger	ON	Battery voltage
			switch	OFF	0

Is the inspection result normal?

- YES >> GO TO 5.
NO >> Repair or replace fuse block (J/B).

5.CHECK INTERMITTENT INCIDENT

Check intermittent incident.
Refer to [GI-43. "Intermittent Incident"](#).

>> INSPECTION END

DRIVER SIDE DOOR MIRROR DEFOGGER

< DTC/CIRCUIT DIAGNOSIS >

DRIVER SIDE DOOR MIRROR DEFOGGER

Description

INFOID:000000008161295

Heats the heating wire with the power supply from the rear window defogger relay to prevent the door mirror from fogging up.

Component Function Check

INFOID:000000008161296

1.CHECK DRIVER SIDE DOOR MIRROR DEFOGGER

1. Perform Active Test ("REAR DEFOGGER") with CONSULT.
2. Touch "ON".
3. Check that the driver side door mirror glass is getting warmer.

Is the inspection result normal?

- YES >> Driver side door mirror defogger is OK.
NO >> Refer to [DEF-17, "Diagnosis Procedure"](#).

Diagnosis Procedure

INFOID:000000008161297

1.CHECK POWER SUPPLY CIRCUIT

1. Turn ignition switch OFF.
2. Disconnect door mirror (driver side) connector.
3. Turn ignition switch ON.
4. Check voltage between door mirror (driver side) harness connector and ground.

(+)		(-)	Condition		Voltage (V) (Approx.)
Door mirror (driver side) Connector	Terminal				
D3	4	Ground	Rear window defogger switch	ON	Battery voltage
				OFF	0

Is the inspection result normal?

- YES >> GO TO 3.
NO >> GO TO 2.

2.CHECK DRIVER SIDE DOOR MIRROR DEFOGGER CIRCUIT

1. Turn ignition switch OFF.
2. Check continuity between fuse block (J/B) harness connector and door mirror (driver side) harness connector.

Fuse block (J/B)		Door mirror (driver side)		Continuity
Connector	Terminal	Connector	Terminal	
M3	10C	D3	4	Existed

3. Check continuity between fuse block (J/B) harness connector and ground.

Fuse block (J/B)		Ground	Continuity
Connector	Terminal		
M3	10C		Not existed

Is the inspection result normal?

- YES >> GO TO 4.
NO >> Repair or replace harness.

3.CHECK GROUND CIRCUIT

1. Turn ignition switch OFF.
2. Check continuity between door mirror (driver side) harness connector and ground.

DRIVER SIDE DOOR MIRROR DEFOGGER

< DTC/CIRCUIT DIAGNOSIS >

Door mirror (driver side)		Ground	Continuity
Connector	Terminal		Existed
D3	8		

Is the inspection result normal?

YES >> Replace door mirror glass (driver side). Refer to [MIR-37, "GLASS MIRROR : Disassembly and Assembly"](#).

NO >> Repair or replace harness.

4. CHECK INTERMITTENT INCIDENT

Check intermittent incident.

Refer to [GI-43, "Intermittent Incident"](#).

Is the inspection result normal?

>> INSPECTION END

PASSENGER SIDE DOOR MIRROR DEFOGGER

< DTC/CIRCUIT DIAGNOSIS >

PASSENGER SIDE DOOR MIRROR DEFOGGER

Description

INFOID:000000008161298

Heats the heating wire with the power supply from the rear window defogger relay to prevent the door mirror from fogging up.

Component Function Check

INFOID:000000008161299

1.CHECK PASSENGER SIDE DOOR MIRROR DEFOGGER

1. Perform Active Test ("REAR DEFOGGER") with CONSULT.
2. Touch "ON".
3. Check that the passenger side door mirror glass is getting warmer.

Is the inspection result normal?

- YES >> Passenger side door mirror defogger is OK.
NO >> Refer to [DEF-19, "Diagnosis Procedure"](#).

Diagnosis Procedure

INFOID:000000008161300

1.CHECK POWER SUPPLY CIRCUIT

1. Turn ignition switch OFF.
2. Disconnect door mirror (passenger side) connector.
3. Turn ignition switch ON.
4. Check voltage between door mirror (passenger side) harness connector and ground.

(+)		(-)	Condition		Voltage (V) (Approx.)
Door mirror (passenger side) Connector	Terminal				
D33	4	Ground	Rear window defogger switch	ON	Battery voltage
				OFF	0

Is the inspection result normal?

- YES >> GO TO 3.
NO >> GO TO 2.

2.CHECK PASSENGER SIDE DOOR MIRROR DEFOGGER CIRCUIT

1. Turn ignition switch OFF.
2. Check continuity between fuse block (J/B) harness connector and door mirror (passenger side) harness connector.

Fuse block (J/B)		Door mirror (passenger side)		Continuity
Connector	Terminal	Connector	Terminal	
M3	9C	D33	4	Existed

3. Check continuity between fuse block (J/B) harness connector and ground.

Fuse block (J/B)		Ground	Continuity
Connector	Terminal		
M3	9C		Not existed

Is the inspection result normal?

- YES >> GO TO 4.
NO >> Repair or replace harness.

3.CHECK GROUND CIRCUIT

1. Turn ignition switch OFF.
2. Check continuity between door mirror (passenger side) harness connector and ground.

PASSENGER SIDE DOOR MIRROR DEFOGGER

< DTC/CIRCUIT DIAGNOSIS >

Door mirror (passenger side)		Ground	Continuity
Connector	Terminal		Existed
D33	8		

Is the inspection result normal?

YES >> Replace door mirror glass (passenger side). Refer to [MIR-37, "GLASS MIRROR : Disassembly and Assembly"](#).

NO >> Repair or replace harness.

4. CHECK INTERMITTENT INCIDENT

Check intermittent incident.

Refer to [GI-43, "Intermittent Incident"](#).

>> INSPECTION END

REAR WINDOW DEFOGGER SYSTEM

< DTC/CIRCUIT DIAGNOSIS >

REAR WINDOW DEFOGGER SYSTEM

Wiring Diagram - DEFOGGER CONTROL SYSTEM -

INFOID:000000008161301

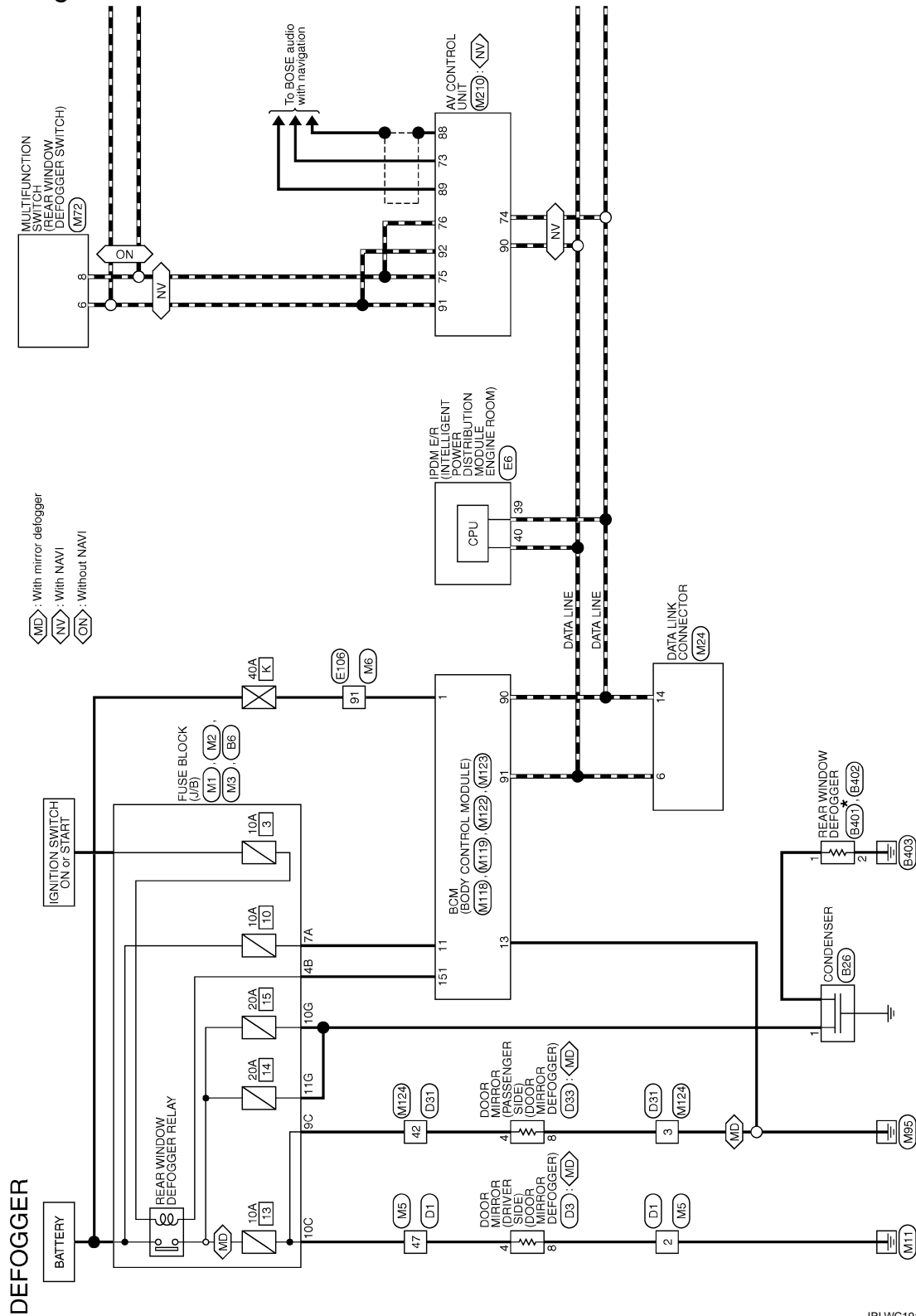

*: This connector is not shown in "Harness Layout".

2012/02/28

JRLWC1919GB

A
B
C
D
E
F
G
H
I
J
K
M
N
O
P

REAR WINDOW DEFOGGER SYSTEM

< DTC/CIRCUIT DIAGNOSIS >

- *6 88: <OM>
 - 79: <RM>
 - *7 89: <OM>
 - 78: <RM>
 - *8 90: <OM>
 - 77: <RM>
 - *9 91: <OM>
 - 76: <RM>
- *1 86: <OM>
 - 81: <RM>
 - *2 87: <OM>
 - 80: <RM>
 - *3 44: <OM>
 - 39: <RM>
 - *4 56: <OM>
 - 51: <RM>
 - *5 55: <OM>
 - 52: <RM>

<ON> : Without NAVI
 <RM> : With rear view monitor
 <OM> : Without rear view monitor

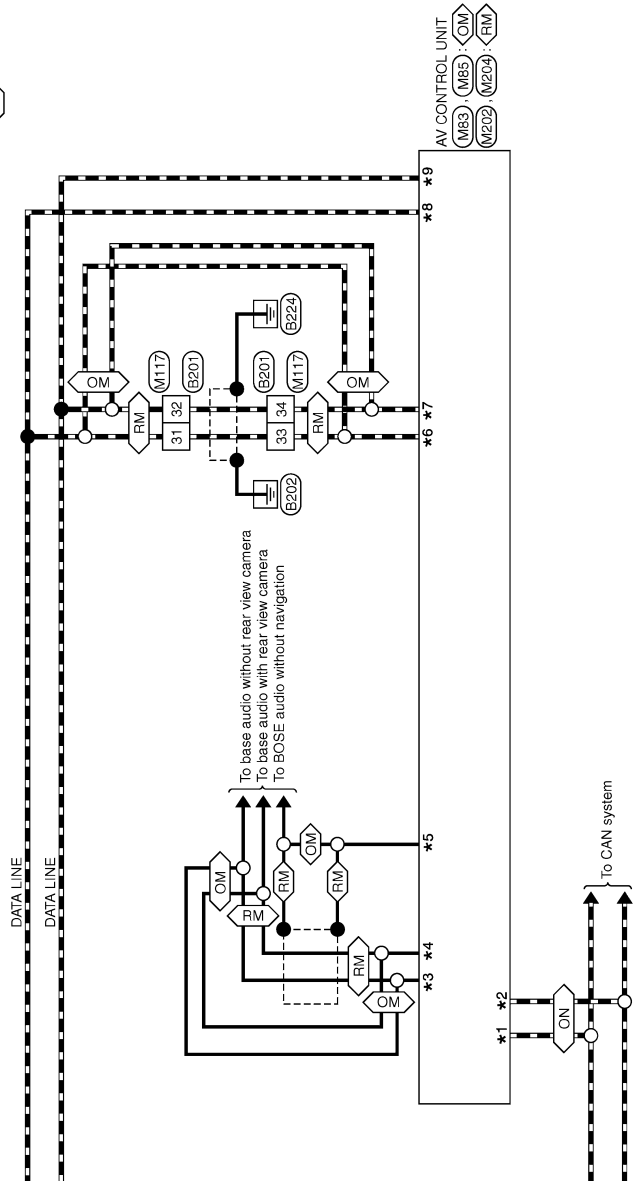

JRLWC1920GB

BCM (BODY CONTROL MODULE)

< ECU DIAGNOSIS INFORMATION >

ECU DIAGNOSIS INFORMATION

BCM (BODY CONTROL MODULE)

Reference Value

INFOID:000000008814776

VALUES ON THE DIAGNOSIS TOOL

NOTE:

The following table includes information (items) inapplicable to this vehicle. For information (items) applicable to this vehicle, refer to CONSULT display items.

CONSULT MONITOR ITEM

Monitor Item	Condition	Value/Status
FR WIPER HI	Other than front wiper switch HI	Off
	Front wiper switch HI	On
FR WIPER LOW	Other than front wiper switch LO	Off
	Front wiper switch LO	On
FR WASHER SW	Front washer switch OFF	Off
	Front washer switch ON	On
FR WIPER INT	Other than front wiper switch INT/AUTO	Off
	Front wiper switch INT/AUTO	On
FR WIPER STOP	Front wiper is not in STOP position	Off
	Front wiper is in STOP position	On
INT VOLUME	Wiper volume dial is in a dial position 1 - 7	Wiper volume dial position
TURN SIGNAL R	Other than turn signal switch RH	Off
	Turn signal switch RH	On
TURN SIGNAL L	Other than turn signal switch LH	Off
	Turn signal switch LH	On
TAIL LAMP SW	Other than lighting switch 1ST and 2ND	Off
	Lighting switch 1ST or 2ND	On
HI BEAM SW	Other than lighting switch HI	Off
	Lighting switch HI	On
HEAD LAMP SW 1	Other than lighting switch 2ND	Off
	Lighting switch 2ND	On
HEAD LAMP SW 2	Other than lighting switch 2ND	Off
	Lighting switch 2ND	On
PASSING SW	Other than lighting switch PASS	Off
	Lighting switch PASS	On
AUTO LIGHT SW	Other than lighting switch AUTO	Off
	Lighting switch AUTO	On
FR FOG SW	Front fog lamp switch OFF	Off
	Front fog lamp switch ON	On
RR FOG SW	NOTE: The item is indicated, but not monitored.	Off
DOOR SW-DR	Driver door closed	Off
	Driver door opened	On
DOOR SW-AS	Passenger door closed	Off
	Passenger door opened	On

BCM (BODY CONTROL MODULE)

< ECU DIAGNOSIS INFORMATION >

Monitor Item	Condition	Value/Status
DOOR SW-RR	NOTE: The item is indicated, but not monitored.	Off
DOOR SW-RL	NOTE: The item is indicated, but not monitored.	Off
DOOR SW-BK	NOTE: The item is indicated, but not monitored.	Off
CDL LOCK SW	Other than power door lock switch LOCK	Off
	Power door lock switch LOCK	On
CDL UNLOCK SW	Other than power door lock switch UNLOCK	Off
	Power door lock switch UNLOCK	On
KEY CYL LK-SW	Other than driver door key cylinder LOCK position	Off
	Driver door key cylinder LOCK position	On
KEY CYL UN-SW	Other than driver door key cylinder UNLOCK position	Off
	Driver door key cylinder UNLOCK position	On
KEY CYL SW-TR	NOTE: The item is indicated, but not monitored.	Off
HAZARD SW	Hazard switch is OFF	Off
	Hazard switch is ON	On
REAR DEF SW	NOTE: The item is indicated, but not monitored.	Off
TR CANCEL SW	Trunk lid opener cancel switch OFF	Off
	Trunk lid opener cancel switch ON	On
TR/BD OPEN SW	Trunk lid opener switch OFF	Off
	While the trunk lid opener switch is turned ON	On
TRNK/HAT MNTR	Trunk lid closed	Off
	Trunk lid opened	On
REVERSE SW	NOTE: The item is indicated, but not monitored.	Off
RKE-LOCK	LOCK button of the Intelligent Key is not pressed	Off
	LOCK button of the Intelligent Key is pressed	On
RKE-UNLOCK	UNLOCK button of the Intelligent Key is not pressed	Off
	UNLOCK button of the Intelligent Key is pressed	On
RKE-TR/BD	TRUNK OPEN button of the Intelligent Key is not pressed	Off
	TRUNK OPEN button of the Intelligent Key is pressed	On
RKE-PANIC	PANIC button of the Intelligent Key is not pressed	Off
	PANIC button of the Intelligent Key is pressed	On
RKE-P/W OPEN	UNLOCK button of the Intelligent Key is not pressed	Off
	UNLOCK button of the Intelligent Key is pressed and held	On
RKE-MODE CHG	LOCK/UNLOCK button of the Intelligent Key is not pressed and held simultaneously	Off
	LOCK/UNLOCK button of the Intelligent Key is pressed and held simultaneously	On
OPTICAL SENSOR	Bright outside of the vehicle	Close to 5 V
	Dark outside of the vehicle	Close to 0 V
REQ SW -DR	Driver door request switch is not pressed	Off
	Driver door request switch is pressed	On
REQ SW -AS	Passenger door request switch is not pressed	Off
	Passenger door request switch is pressed	On

BCM (BODY CONTROL MODULE)

< ECU DIAGNOSIS INFORMATION >

Monitor Item	Condition	Value/Status	
REQ SW -RR	NOTE: The item is indicated, but not monitored.	Off	A
REQ SW -RL	NOTE: The item is indicated, but not monitored.	Off	B
REQ SW -BD/TR	Trunk lid opener request switch is not pressed	Off	C
	Trunk lid opener request switch is pressed	On	
PUSH SW	Push-button ignition switch (push switch) is not pressed	Off	D
	Push-button ignition switch (push switch) is pressed	On	
IGN RLY2 -F/B	NOTE: The item is indicated, but not monitored.	Off	E
ACC RLY -F/B	NOTE: The item is indicated, but not monitored.	Off	F
CLUCH SW	The clutch pedal is not depressed	Off	G
	The clutch pedal is depressed	On	
BRAKE SW 1	The brake pedal is depressed when No. 7 fuse is blown	Off	H
	The brake pedal is not depressed when No. 7 fuse is blown, or No. 7 fuse is normal	On	
BRAKE SW 2	The brake pedal is not depressed	Off	I
	The brake pedal is depressed	On	
DETE/CANCL SW	<ul style="list-style-type: none"> • Selector lever in P position (Except M/T models) • The clutch pedal is depressed (M/T models) 	Off	J
	<ul style="list-style-type: none"> • Selector lever in any position other than P (Except M/T models) • The clutch pedal is not depressed (M/T models) 	On	
SFT PN/N SW	Selector lever in any position other than P and N	Off	K
	Selector lever in P or N position	On	
S/L -LOCK	NOTE: The item is indicated, but not monitored.	Off	
S/L -UNLOCK	NOTE: The item is indicated, but not monitored.	Off	
S/L RELAY-F/B	NOTE: The item is indicated, but not monitored.	Off	
UNLK SEN -DR	Driver door is unlocked	Off	DEF
	Driver door is locked	On	
PUSH SW -IPDM	Push-button ignition switch (push-switch) is not pressed	Off	M
	Push-button ignition switch (push-switch) is pressed	On	
IGN RLY1 -F/B	Ignition switch in OFF or ACC position	Off	N
	Ignition switch in ON position	On	
DETE SW -IPDM	Selector lever in any position other than P	Off	O
	Selector lever in P position	On	
SFT PN -IPDM	<ul style="list-style-type: none"> • Selector lever in any position other than P and N (Except M/T models) • The clutch pedal is not depressed (M/T models) 	Off	P
	<ul style="list-style-type: none"> • Selector lever in P or N position • The clutch pedal is depressed 	On	
SFT P -MET	Selector lever in any position other than P	Off	
	Selector lever in P position	On	
SFT N -MET	Selector lever in any position other than N	Off	
	Selector lever in N position	On	

BCM (BODY CONTROL MODULE)

< ECU DIAGNOSIS INFORMATION >

Monitor Item	Condition	Value/Status
ENGINE STATE	Engine stopped	Stop
	While the engine stalls	Stall
	At engine cranking	Crank
	Engine running	Run
S/L LOCK-IPDM	NOTE: The item is indicated, but not monitored.	Off
S/L UNLK-IPDM	NOTE: The item is indicated, but not monitored.	Off
S/L RELAY-REQ	NOTE: The item is indicated, but not monitored.	Off
VEH SPEED 1	While driving	Equivalent to speedometer reading
VEH SPEED 2	While driving	Equivalent to speedometer reading
DOOR STAT-DR	Driver door is locked	LOCK
	Wait with selective UNLOCK operation (60 seconds)	READY
	Driver door is unlocked	UNLOCK
DOOR STAT-AS	Passenger door is locked	LOCK
	Wait with selective UNLOCK operation (60 seconds)	READY
	Passenger door is unlocked	UNLOCK
ID OK FLAG	Driver side door is open after ignition switch is turned OFF (Selector lever is in the P position except for M/T models)	Reset
	Ignition switch is ON	Set
PRMT ENG STRT	The engine start is prohibited	Reset
	The engine start is permitted	Set
PRMT RKE STRT	NOTE: The item is indicated, but not monitored.	Reset
KEY SW -SLOT	The Intelligent Key is not inserted into key slot	Off
	The Intelligent Key is inserted into key slot	On
RKE OPE COUN1	During the operation of the Intelligent Key	Operation frequency of the Intelligent Key
RKE OPE COUN2	NOTE: The item is indicated, but not monitored.	—
CONFIRM ID ALL	The key ID that the key slot receives is not recognized by any key ID registered to BCM.	Yet
	The key ID that the key slot receives is recognized by any key ID registered to BCM.	Done
CONFIRM ID4	The key ID that the key slot receives is not recognized by the fourth key ID registered to BCM.	Yet
	The key ID that the key slot receives is recognized by the fourth key ID registered to BCM.	Done
CONFIRM ID3	The key ID that the key slot receives is not recognized by the third key ID registered to BCM.	Yet
	The key ID that the key slot receives is recognized by the third key ID registered to BCM.	Done
CONFIRM ID2	The key ID that the key slot receives is not recognized by the second key ID registered to BCM.	Yet
	The key ID that the key slot receives is recognized by the second key ID registered to BCM.	Done

BCM (BODY CONTROL MODULE)

< ECU DIAGNOSIS INFORMATION >

Monitor Item	Condition	Value/Status
CONFIRM ID1	The key ID that the key slot receives is not recognized by the first key ID registered to BCM.	Yet
	The key ID that the key slot receives is recognized by the first key ID registered to BCM.	Done
TP 4	The ID of fourth Intelligent Key is not registered to BCM	Yet
	The ID of fourth Intelligent Key is registered to BCM	Done
TP 3	The ID of third Intelligent Key is not registered to BCM	Yet
	The ID of third Intelligent Key is registered to BCM	Done
TP 2	The ID of second Intelligent Key is not registered to BCM	Yet
	The ID of second Intelligent Key is registered to BCM	Done
TP 1	The ID of first Intelligent Key is not registered to BCM	Yet
	The ID of first Intelligent Key is registered to BCM	Done
AIR PRESS FL	Ignition switch ON (Only when the signal from the transmitter is received)	Air pressure of front LH tire
AIR PRESS FR	Ignition switch ON (Only when the signal from the transmitter is received)	Air pressure of front RH tire
AIR PRESS RR	Ignition switch ON (Only when the signal from the transmitter is received)	Air pressure of rear RH tire
AIR PRESS RL	Ignition switch ON (Only when the signal from the transmitter is received)	Air pressure of rear LH tire
ID REGST FL1	ID of front LH tire transmitter is registered	Done
	ID of front LH tire transmitter is not registered	Yet
ID REGST FR1	ID of front RH tire transmitter is registered	Done
	ID of front RH tire transmitter is not registered	Yet
ID REGST RR1	ID of rear RH tire transmitter is registered	Done
	ID of rear RH tire transmitter is not registered	Yet
ID REGST RL1	ID of rear LH tire transmitter is registered	Done
	ID of rear LH tire transmitter is not registered	Yet
WARNING LAMP	Tire pressure indicator OFF	Off
	Tire pressure indicator ON	On
BUZZER	Tire pressure warning alarm is not sounding	Off
	Tire pressure warning alarm is sounding	On

A
B
C
D
E
F
G
H
I
J
K
DEF
M
N
O
P

BCM (BODY CONTROL MODULE)

< ECU DIAGNOSIS INFORMATION >

TERMINAL LAYOUT

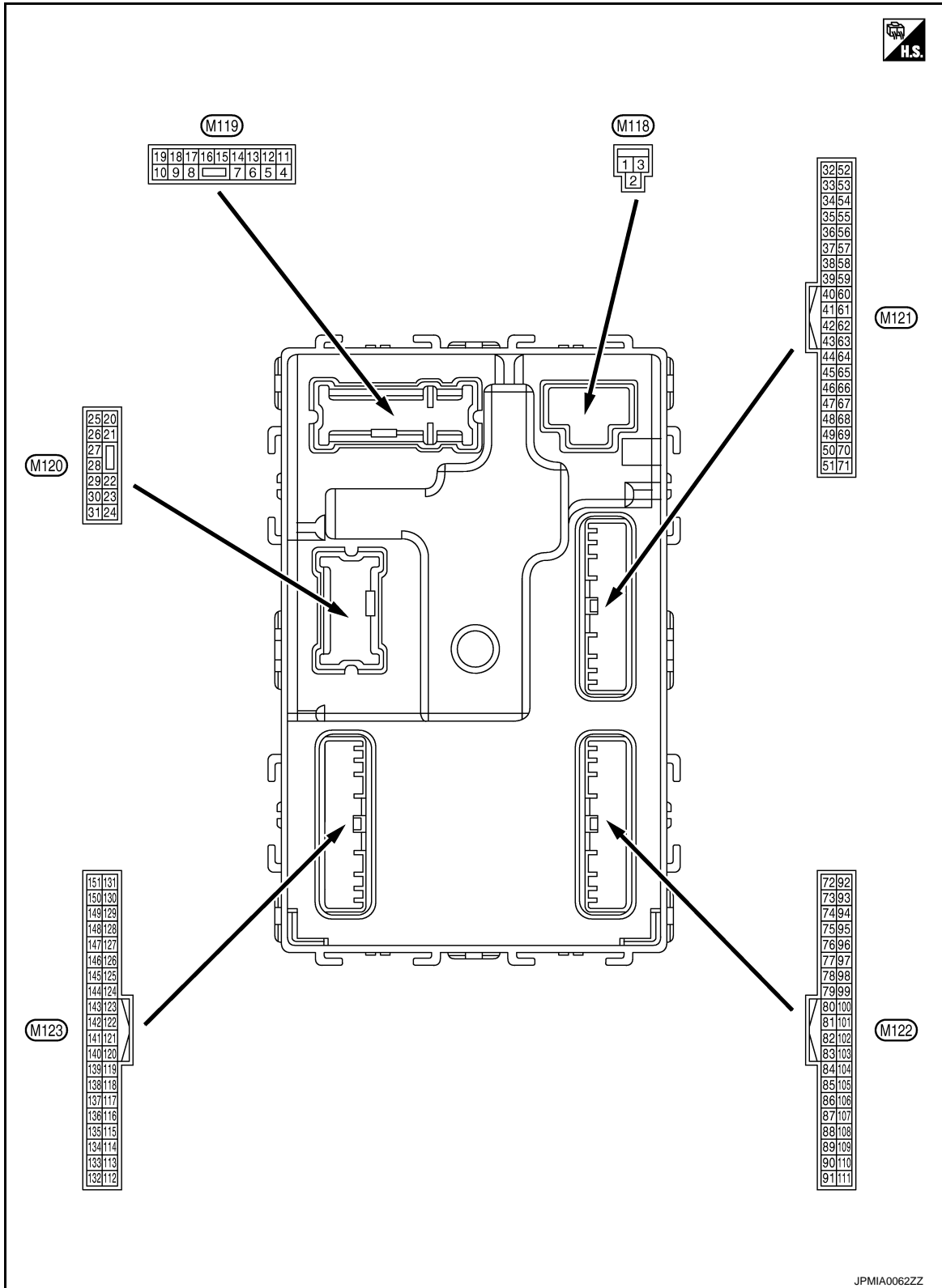

PHYSICAL VALUES

BCM (BODY CONTROL MODULE)

< ECU DIAGNOSIS INFORMATION >

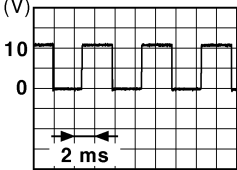
Terminal No. (Wire color)		Description		Condition		Value (Approx.)
		Signal name	Input/ Output			
+	-					
1 (W)	Ground	Battery power supply	Input	Ignition switch OFF		Battery voltage
2 (Y)	Ground	P/W power supply (BAT)	Output	Ignition switch OFF		12 V
3 (BG)	Ground	P/W power supply (RAP)	Output	Ignition switch ON		12 V
4 (LG)	Ground	Interior room lamp power supply	Output	Interior room lamp battery saver is activated. (Cuts the interior room lamp power supply)		0 V
				Interior room lamp battery saver is not activated. (Outputs the interior room lamp power supply)		12 V
5 (P)	Ground	Passenger door UN- LOCK	Output	Passenger door	UNLOCK (Actuator is activated)	12 V
					Other than UNLOCK (Ac- tuator is not activated)	0 V
7 (SB)	Ground	Step lamp	Output	Step lamp	ON	0 V
					OFF	12 V
8 (V)	Ground	All doors, fuel lid LOCK	Output	All doors, fuel lid	LOCK (Actuator is activated)	12 V
					Other than LOCK (Actuator is not activated)	0 V
9 (G)	Ground	Driver door, fuel lid UNLOCK	Output	Driver door, fuel lid	UNLOCK (Actuator is activated)	12 V
					Other than UNLOCK (Actuator is not activated)	0 V
11 (R)	Ground	Battery power supply	Input	Ignition switch OFF		Battery voltage
13 (B)	Ground	Ground	—	Ignition switch ON		0 V
14 (W)	Ground	Push-button ignition switch illumination ground	Output	Tail lamp	OFF	<p style="text-align: center;">NOTE: When the illumination brighten- ing/dimming level is in the neutral position.</p>  <p style="text-align: right; font-size: small;">JSNIA0010GB</p>
					ON	
15 (BG)	Ground	ACC indicator lamp	Output	Ignition switch	OFF (LOCK indicator is not illuminated)	Battery voltage
					ACC	0 V

BCM (BODY CONTROL MODULE)

< ECU DIAGNOSIS INFORMATION >

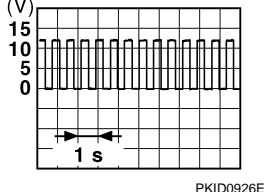
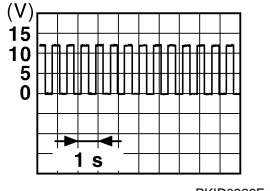
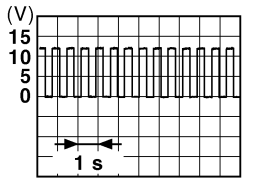
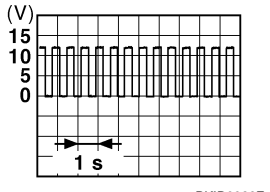
Terminal No. (Wire color)		Description		Condition	Value (Approx.)
+	-	Signal name	Input/ Output		
17 (W)	Ground	Turn signal RH (Front)	Output	Ignition switch ON	Turn signal switch OFF 0 V
				Turn signal switch RH	 <p style="text-align: right; font-size: small;">PKID0926E</p>
18 (BG)	Ground	Turn signal LH (Front)	Output	Ignition switch ON	Turn signal switch OFF 0 V
				Turn signal switch LH	 <p style="text-align: right; font-size: small;">PKID0926E</p>
19 (V)	Ground	Interior room lamp control	Output	Interior room lamp	OFF 12 V
				ON	0 V
20 (V)	Ground	Turn signal RH (Rear)	Output	Ignition switch ON	Turn signal switch OFF 0 V
				Turn signal switch RH	 <p style="text-align: right; font-size: small;">PKID0926E</p>
23 (LG)	Ground	Trunk lid open	Output	Trunk lid	OPEN (Trunk lid opener actuator is activated) 12 V
				Other than OPEN (Trunk lid opener actuator is not activated)	0 V
25 (Y)	Ground	Turn signal LH (Rear)	Output	Ignition switch ON	Turn signal switch OFF 0 V
				Turn signal switch LH	 <p style="text-align: right; font-size: small;">PKID0926E</p>
30 (P)	Ground	Trunk room lamp	Output	Trunk room lamp	ON 0 V
				OFF	12 V

BCM (BODY CONTROL MODULE)

< ECU DIAGNOSIS INFORMATION >

Terminal No. (Wire color)		Description		Condition	Value (Approx.)
+	-	Signal name	Input/ Output		
34 (SB)	Ground	Trunk room antenna (-)	Output	Ignition switch OFF	
				When Intelligent Key is not in the passenger compart- ment	
35 (V)	Ground	Trunk room antenna (+)	Output	Ignition switch OFF	
				When Intelligent Key is not in the passenger compart- ment	
38 (B)	Ground	Rear bumper anten- na (-)	Output	When the trunk lid opener re- quest switch is operated with ignition switch OFF	
				When Intelligent Key is not in the antenna detection area	

A
B
C
D
E
F
G
H
I
J
K
DEF
M
N
O
P

BCM (BODY CONTROL MODULE)

< ECU DIAGNOSIS INFORMATION >

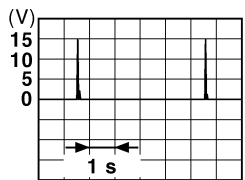
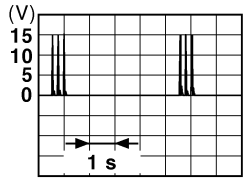
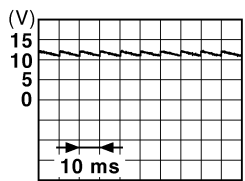
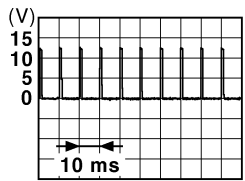
Terminal No. (Wire color)		Description		Condition	Value (Approx.)	
		Signal name	Input/ Output			
+	-					
39 (W)	Ground	Rear bumper antenna (+)	Output	When the trunk lid opener request switch is operated with ignition switch OFF	When Intelligent Key is in the antenna detection area	 <small>JMKIA0062GB</small>
				When Intelligent Key is not in the antenna detection area	 <small>JMKIA0063GB</small>	
47 (Y)	Ground	Ignition relay (IPDM E/R) control	Output	Ignition switch	OFF or ACC	12 V
					ON	0 V
50 (BG)	Ground	Trunk room lamp switch	Input	Trunk room lamp switch	OFF (Trunk lid is closed)	 <small>JPMIA0011GB</small> 11.8 V
					ON (Trunk lid is opened)	0 V
52 (R)	Ground	Starter relay control	Output	Ignition switch ON (A/T models)	When selector lever is in P or N position	12 V
					When selector lever is not in P or N position	0 V
				Ignition switch ON (M/T models)	When the clutch pedal is depressed	Battery voltage
					When the clutch pedal is not depressed	0 V
60 (BR)	Ground	Push-button ignition switch (Push switch)	Input	Push-button ignition switch (Push switch)	Pressed	0 V
					Not pressed	Battery voltage
61 (SB)	Ground	Trunk lid opener request switch	Input	Trunk lid opener request switch	ON (Pressed)	0 V
					OFF (Not pressed)	 <small>JPMIA0016GB</small> 1.0 V
64 (G)	Ground	Intelligent Key warning buzzer (Engine room)	Output	Intelligent Key warning buzzer (Engine room)	Sounding	0 V
					Not sounding	12 V

BCM (BODY CONTROL MODULE)

< ECU DIAGNOSIS INFORMATION >

Terminal No. (Wire color)		Description		Condition	Value (Approx.)
+	-	Signal name	Input/ Output		
67 (GR)	Ground	Trunk lid opener switch	Input	Trunk lid open- er switch	0 V
				Not pressed	<p style="text-align: right; font-size: small;">JPMIA0011GB 11.8 V</p>
72 (R)	Ground	Room antenna 2 (-) (Center console)	Output	Ignition switch OFF	<p style="text-align: right; font-size: small;">JMKIA0062GB</p>
				When Intelligent Key is not in the passenger compart- ment	<p style="text-align: right; font-size: small;">JMKIA0063GB</p>
73 (G)	Ground	Room antenna 2 (+) (Center console)	Output	Ignition switch OFF	<p style="text-align: right; font-size: small;">JMKIA0062GB</p>
				When Intelligent Key is not in the passenger compart- ment	<p style="text-align: right; font-size: small;">JMKIA0063GB</p>

A
B
C
D
E
F
G
H
I
J
K
DEF
M
N
O
P

DEF

BCM (BODY CONTROL MODULE)

< ECU DIAGNOSIS INFORMATION >

Terminal No. (Wire color)		Description		Condition	Value (Approx.)
+	-	Signal name	Input/ Output		
74 (SB)	Ground	Passenger door antenna (-)	Output	When Intelligent Key is in the antenna detection area	
				When the passenger door request switch is operated with ignition switch OFF	
75 (BR)	Ground	Passenger door antenna (+)	Output	When Intelligent Key is in the antenna detection area	
				When the passenger door request switch is operated with ignition switch OFF	
76 (V)	Ground	Driver door antenna (-)	Output	When Intelligent Key is in the antenna detection area	
				When the driver door request switch is operated with ignition switch OFF	

BCM (BODY CONTROL MODULE)

< ECU DIAGNOSIS INFORMATION >



Terminal No. (Wire color)		Description		Condition	Value (Approx.)
+	-	Signal name	Input/ Output		
77 (LG)	Ground	Driver door antenna (+)	Output	When the driver door request switch is operated with ignition switch OFF	<p style="text-align: right; font-size: small;">JMkia0062GB</p>
				When Intelligent Key is not in the antenna detection area	<p style="text-align: right; font-size: small;">JMkia0063GB</p>
78 (Y)	Ground	Room antenna 1 (-) (Instrument panel)	Output	Ignition switch OFF	<p style="text-align: right; font-size: small;">JMkia0062GB</p>
				When Intelligent Key is not in the passenger compartment	<p style="text-align: right; font-size: small;">JMkia0063GB</p>
79 (BR)	Ground	Room antenna 1 (+) (Instrument panel)	Output	Ignition switch OFF	<p style="text-align: right; font-size: small;">JMkia0062GB</p>
				When Intelligent Key is not in the passenger compartment	<p style="text-align: right; font-size: small;">JMkia0063GB</p>

A
B
C
D
E
F
G
H
I
J
K
DEF
M
N
O
P





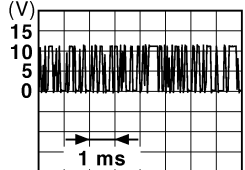
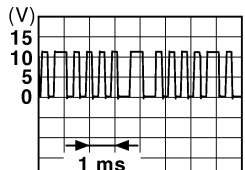

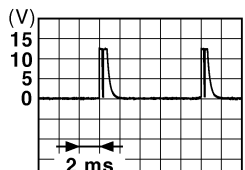
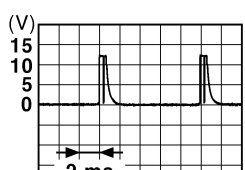
BCM (BODY CONTROL MODULE)

< ECU DIAGNOSIS INFORMATION >

Terminal No. (Wire color)		Description		Condition		Value (Approx.)
+	-	Signal name	Input/ Output			
80 (GR)	Ground	NATS antenna amp.	Input/ Output	During waiting	Ignition switch is pressed while inserting the Intelligent Key into the key slot.	Just after pressing ignition switch. Pointer of tester should move.
81 (W)	Ground	NATS antenna amp.	Input/ Output	During waiting	Ignition switch is pressed while inserting the Intelligent Key into the key slot.	Just after pressing ignition switch. Pointer of tester should move.
82 (SB)	Ground	Ignition relay [Fuse block (J/B)] control	Output	Ignition switch	OFF or ACC	0 V
					ON	12 V
83 (Y)	Ground	Remote keyless entry receiver communication	Input/ Output	During waiting		 <p style="text-align: right; font-size: small;">JMKIA0064GB</p>
				When operating either button on the Intelligent Key		 <p style="text-align: right; font-size: small;">JMKIA0065GB</p>
87 (Y)	Ground	Combination switch INPUT 5	Input	Combination switch	All switches OFF (Wiper volume dial 4)	 <p style="text-align: right; font-size: small;">JPMIA0041GB</p> <p style="text-align: center;">1.4 V</p>
					Front fog lamp switch ON (Wiper volume dial 4)	 <p style="text-align: right; font-size: small;">JPMIA0037GB</p> <p style="text-align: center;">1.3 V</p>
					Any of the conditions below with all switches OFF <ul style="list-style-type: none"> • Wiper volume dial 1 • Wiper volume dial 2 • Wiper volume dial 6 • Wiper volume dial 7 	 <p style="text-align: right; font-size: small;">JPMIA0040GB</p> <p style="text-align: center;">1.3 V</p>

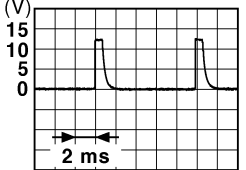
BCM (BODY CONTROL MODULE)

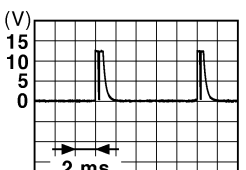
< ECU DIAGNOSIS INFORMATION >

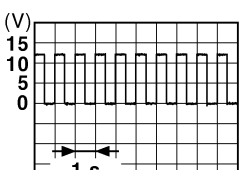
Terminal No. (Wire color)		Description		Condition	Value (Approx.)	
+	-	Signal name	Input/ Output			
88 (BG)	Ground	Combination switch INPUT 3	Input	Combination switch	All switches OFF (Wiper volume dial 4)	 <p style="text-align: right; font-size: small;">JPMIA0041GB</p> <p style="text-align: center;">1.4 V</p>
					Lighting switch HI (Wiper volume dial 4)	 <p style="text-align: right; font-size: small;">JPMIA0036GB</p> <p style="text-align: center;">1.3 V</p>
					Lighting switch 2ND (Wiper volume dial 4)	 <p style="text-align: right; font-size: small;">JPMIA0037GB</p> <p style="text-align: center;">1.3 V</p>
					Any of the conditions be- low with all switches OFF	<ul style="list-style-type: none"> • Wiper volume dial 1 • Wiper volume dial 2 • Wiper volume dial 3  <p style="text-align: right; font-size: small;">JPMIA0040GB</p> <p style="text-align: center;">1.3 V</p>
90 (P)	Ground	CAN-L	Input/ Output	—	—	
91 (L)	Ground	CAN-H	Input/ Output	—	—	
92 (LG)	Ground	Key slot illumination	Output	Key slot illumi- nation	OFF	12 V
					Blinking	 <p style="text-align: right; font-size: small;">JPMIA0015GB</p> <p style="text-align: center;">6.5 V</p>
93 (GR)	Ground	ON indicator lamp	Output	Ignition switch	OFF (LOCK indicator is not illuminated)	Battery voltage
					ON	0 V

A
B
C
D
E
F
G
H
I
J
K

DEF

M
N
O
P



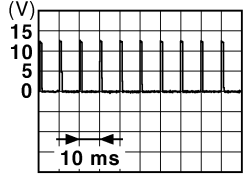
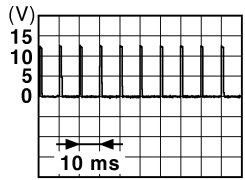

BCM (BODY CONTROL MODULE)

< ECU DIAGNOSIS INFORMATION >

Terminal No. (Wire color)		Description		Condition		Value (Approx.)
+	-	Signal name	Input/ Output			
95 (BG)	Ground	ACC relay control	Output	Ignition switch	OFF	0 V
					ACC or ON	12 V
96 (GR)	Ground	A/T shift selector (Detention switch) power supply	Output	—		12 V
99 (R)*1 (BR)*2	Ground	Selector lever P position switch (A/T models)	Input	Selector lever	P position	0 V
					Any position other than P	12 V
		ASCD clutch switch (M/T models)		ASCD clutch switch	OFF (Clutch pedal is depressed)	0 V
					ON (Clutch pedal is not depressed)	12 V
100 (Y)	Ground	Passenger door request switch	Input	Passenger door request switch	ON (Pressed)	0 V
					OFF (Not pressed)	 <p style="text-align: right; font-size: small;">JPMIA0016GB</p> <p style="text-align: center;">1.0 V</p>
101 (P)	Ground	Driver door request switch	Input	Driver door request switch	ON (Pressed)	0 V
					OFF (Not pressed)	 <p style="text-align: right; font-size: small;">JPMIA0016GB</p> <p style="text-align: center;">1.0 V</p>
102 (BG)	Ground	Blower fan motor relay control	Output	Ignition switch	OFF or ACC	0 V
					ON	12 V
103 (P)	Ground	Remote keyless entry receiver power supply	Output	Ignition switch OFF		12 V

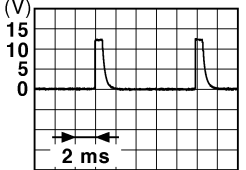
BCM (BODY CONTROL MODULE)

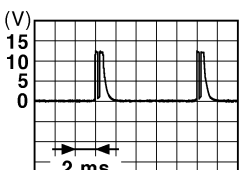
< ECU DIAGNOSIS INFORMATION >

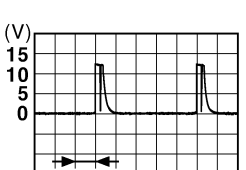
Terminal No. (Wire color)		Description		Condition	Value (Approx.)	
+	-	Signal name	Input/ Output			
107 (LG)	Ground	Combination switch INPUT 1	Input	Combination switch (Wiper volume dial 4)	All switches OFF	 <p>1.4 V</p>
					Turn signal switch LH	 <p>1.3 V</p>
					Turn signal switch RH	 <p>1.3 V</p>
					Front wiper switch LO	 <p>1.3 V</p>
					Front washer switch ON	 <p>1.3 V</p>

A
B
C
D
E
F
G
H
I
J
K
DEF
M
N
O
P

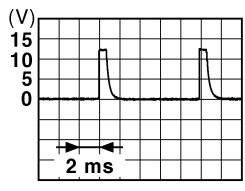
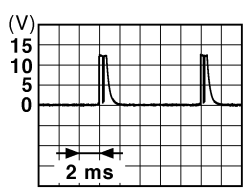
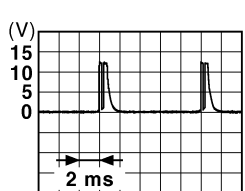
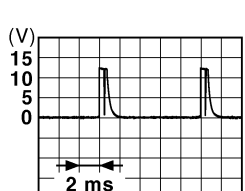

BCM (BODY CONTROL MODULE)

< ECU DIAGNOSIS INFORMATION >

Terminal No. (Wire color)		Description		Condition	Value (Approx.)	
		Signal name	Input/ Output			
+	-					
108 (R)	Ground	Combination switch INPUT 4	Input	Combination switch	All switches OFF (Wiper volume dial 4)	 <p style="text-align: right; margin-right: 50px;">1.4 V</p>
					Lighting switch AUTO (Wiper volume dial 4)	 <p style="text-align: right; margin-right: 50px;">1.3 V</p>
					Lighting switch 1ST (Wiper volume dial 4)	 <p style="text-align: right; margin-right: 50px;">1.3 V</p>
					Any of the conditions below with all switches OFF <ul style="list-style-type: none"> • Wiper volume dial 1 • Wiper volume dial 5 • Wiper volume dial 6 	 <p style="text-align: right; margin-right: 50px;">1.3 V</p>

BCM (BODY CONTROL MODULE)

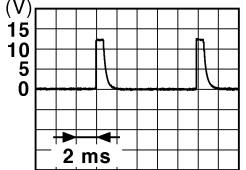
< ECU DIAGNOSIS INFORMATION >

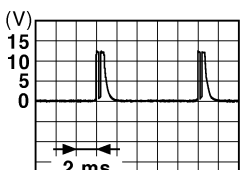
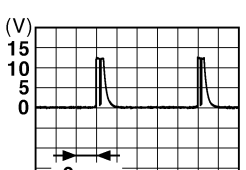
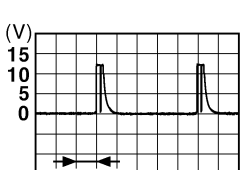
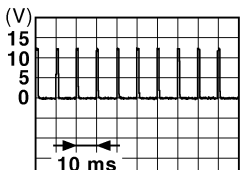
Terminal No. (Wire color)		Description		Condition	Value (Approx.)	
+	-	Signal name	Input/ Output			
109 (W)	Ground	Combination switch INPUT 2	Input	Combination switch (Wiper volume dial 4)	All switches OFF	 <p style="text-align: right;">JPMA0041GB</p> <p style="text-align: center;">1.4 V</p>
					Lighting switch PASS	 <p style="text-align: right;">JPMA0037GB</p> <p style="text-align: center;">1.3 V</p>
					Lighting switch 2ND	 <p style="text-align: right;">JPMA0036GB</p> <p style="text-align: center;">1.3 V</p>
					Front wiper switch INT/ AUTO	 <p style="text-align: right;">JPMA0038GB</p> <p style="text-align: center;">1.3 V</p>
					Front wiper switch HI	 <p style="text-align: right;">JPMA0040GB</p> <p style="text-align: center;">1.3 V</p>
					ON	0 V
110 (G)	Ground	Hazard switch	Input	Hazard switch		
				OFF	 <p style="text-align: right;">JPMA0012GB</p> <p style="text-align: center;">1.1 V</p>	

A
B
C
D
E
F
G
H
I
J
K
DEF
M
N
O
P



BCM (BODY CONTROL MODULE)

< ECU DIAGNOSIS INFORMATION >

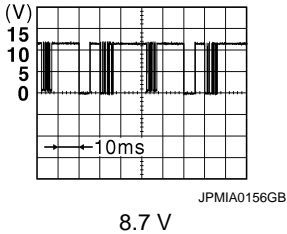
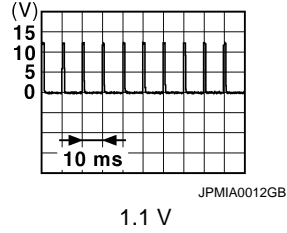
Terminal No. (Wire color)		Description		Condition		Value (Approx.)
+	-	Signal name	Input/ Output			
112 (R)	Ground	Rain sensor serial link	Input/ Output	Ignition switch ON		
113 (BG)	Ground	Optical sensor	Input	Ignition switch ON	When bright outside of the vehicle	Close to 5 V
					When dark outside of the vehicle	Close to 0 V
114 (R)	Ground	Clutch interlock switch	Input	Clutch interlock switch	OFF (Clutch pedal is not depressed)	0 V
					ON (Clutch pedal is depressed)	Battery voltage
116 (SB)	Ground	Stop lamp switch 1	Input	—		Battery voltage
118 (BR)	Ground	Stop lamp switch 2 (Without ICC)	Input	Stop lamp switch	OFF (Brake pedal is not depressed)	0 V
					ON (Brake pedal is depressed)	Battery voltage
		Stop lamp switch 2 (With ICC)		Stop lamp switch OFF (Brake pedal is not depressed) and ICC brake hold relay OFF	0 V	
				Stop lamp switch ON (Brake pedal is depressed) or ICC brake hold relay ON	Battery voltage	
119 (SB)	Ground	Driver side door lock assembly (Unlock sensor)	Input	Driver door	LOCK status (Unlock sensor switch OFF)	
					UNLOCK status (Unlock switch sensor ON)	0 V
121 (SB)	Ground	Key slot switch	Input	When the Intelligent Key is inserted into key slot	12 V	
				When the Intelligent Key is not inserted into key slot	0 V	
123 (V)	Ground	IGN feedback	Input	Ignition switch	OFF or ACC	0 V
					ON	Battery voltage

BCM (BODY CONTROL MODULE)

< ECU DIAGNOSIS INFORMATION >

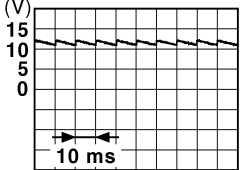
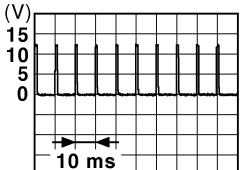
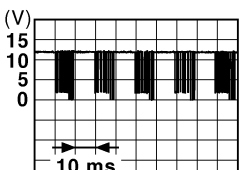
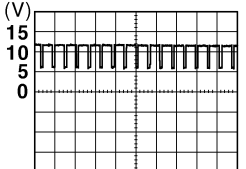
Terminal No. (Wire color)		Description		Condition		Value (Approx.)
+	-	Signal name	Input/ Output			
124 (R)	Ground	Passenger door switch	Input	Passenger door switch	OFF (Door close)	 <p style="text-align: right; font-size: small;">JPMA0011GB</p> <p style="text-align: center;">11.8 V</p>
					ON (Door open)	0 V
129 (BG)	Ground	Trunk lid opener cancel switch	Input	Trunk lid opener cancel switch	CANCEL	 <p style="text-align: right; font-size: small;">JPMA0012GB</p> <p style="text-align: center;">1.1 V</p>
					ON	0 V
132 (V)	Ground	Power window switch communication	Input/ Output	Ignition switch ON	 <p style="text-align: right; font-size: small;">JPMA0013GB</p> <p style="text-align: center;">10.2 V</p>	
				Ignition switch OFF or ACC	12 V	
133 (L)	Ground	Push-button ignition switch illumination	Output	Push-button ignition switch illumination	<p style="text-align: center;">NOTE: The pulse width of this wave is varied by the illumination brightening/dimming level.</p>  <p style="text-align: right; font-size: small;">JPMA0159GB</p>	
				ON (Tail lamps OFF)	9.5 V	
				ON (Tail lamps ON)		
134 (LG)	Ground	LOCK indicator lamp	Output	LOCK indicator lamp	OFF	Battery voltage
				ON	0 V	
137 (BG)	Ground	Receiver and sensor ground	Input	Ignition switch ON		0 V
138 (V)	Ground	Receiver and sensor power supply	Output	Ignition switch	OFF	0 V
					ACC or ON	5.0 V

A
B
C
D
E
F
G
H
I
J
K
DEF
M
N
O
P



BCM (BODY CONTROL MODULE)

< ECU DIAGNOSIS INFORMATION >

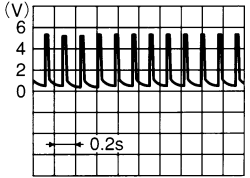
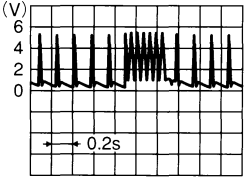
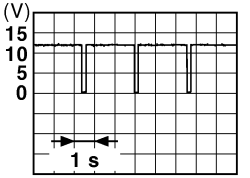
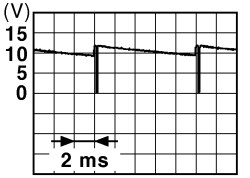
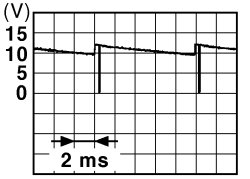
Terminal No. (Wire color)		Description		Condition	Value (Approx.)
+	-	Signal name	Input/ Output		
139 (L)	Ground	Tire pressure receiver communication	Input/ Output	Ignition switch ON	Standby state  OCC3881D
				When receiving the signal from the transmitter  OCC3880D	
140*1 (B)	Ground	Selector lever P/N position	Input	Selector lever	P or N position 12 V
				Except P and N positions 0 V	
141 (W)	Ground	Security indicator lamp	Output	Security indicator lamp	ON 0 V
				Blinking  JPMIA0014GB 11.3 V	
142 (BR)	Ground	Combination switch OUTPUT 5	Output	Combination switch (Wiper volume dial 4)	All switches OFF 0 V
				Lighting switch 1ST	 JPMIA0031GB 10.7 V
				Lighting switch HI	
				Lighting switch 2ND	
Turn signal switch RH					
143 (P)	Ground	Combination switch OUTPUT 1	Output	Combination switch	All switches OFF (Wiper volume dial 4) 0 V
				Front wiper switch HI (Wiper volume dial 4) Any of the conditions below with all switches OFF • Wiper volume dial 1 • Wiper volume dial 2 • Wiper volume dial 3 • Wiper volume dial 6 • Wiper volume dial 7  JPMIA0032GB 10.7 V	

BCM (BODY CONTROL MODULE)

< ECU DIAGNOSIS INFORMATION >

Terminal No. (Wire color)		Description		Condition	Value (Approx.)		
+	-	Signal name	Input/ Output				
144 (G)	Ground	Combination switch OUTPUT 2	Output	Combination switch	All switches OFF (Wiper volume dial 4)	0 V	
					Front washer switch ON (Wiper volume dial 4)		
					Any of the conditions below with all switches OFF		<ul style="list-style-type: none"> • Wiper volume dial 1 • Wiper volume dial 5 • Wiper volume dial 6
145 (L)	Ground	Combination switch OUTPUT 3	Output	Combination switch (Wiper volume dial 4)	All switches OFF	0 V	
					Front wiper switch INT/ AUTO		
					Front wiper switch LO		
					Lighting switch AUTO		10.7 V
146 (SB)	Ground	Combination switch OUTPUT 4	Output	Combination switch (Wiper volume dial 4)	All switches OFF	0 V	
					Front fog lamp switch ON		
					Lighting switch 2ND		
					Lighting switch PASS		
					Turn signal switch LH		10.7 V
150 (GR)	Ground	Driver door switch	Input	Driver door switch	OFF (Door close)		
					11.8 V		
					ON (Door open)	0 V	
151 (G)	Ground	Rear window defogger relay control	Output	Rear window defogger	Active	0 V	
				Not activated	Battery voltage		

- *1: A/T models
- *2: M/T models

A
B
C
D
E
F
G
H
I
J
K
DEF
M
N
O
P

DEF

BCM (BODY CONTROL MODULE)

< ECU DIAGNOSIS INFORMATION >

Wiring Diagram - BCM -

INFOID:000000008814777

For connector terminal arrangements, harness layouts, and alphabets in a ◊ (option abbreviation; if not described in wiring diagram), refer to [GI-12, "Connector Information"](#).

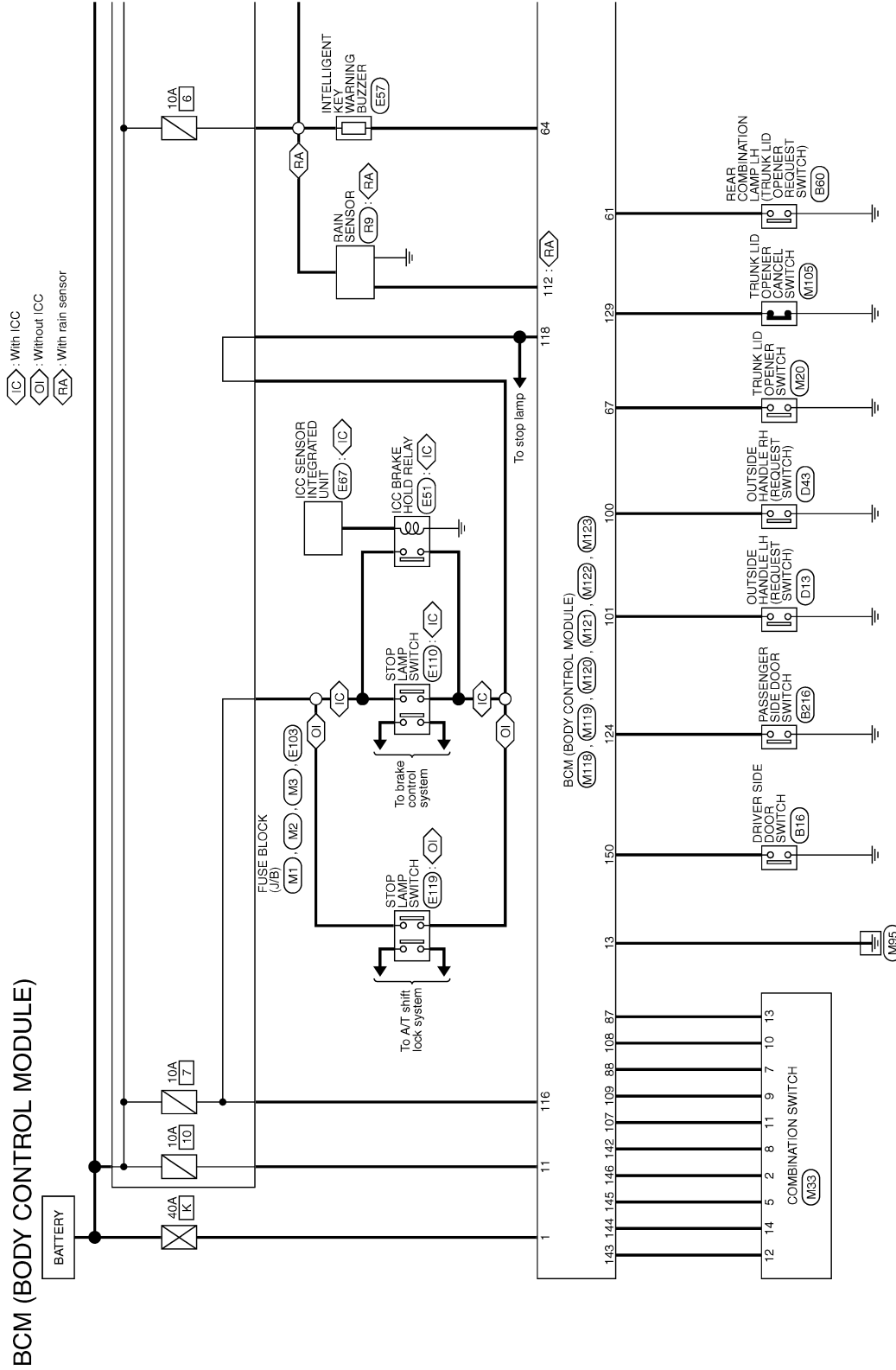

2011/07/13

JRMWC4423GB

BCM (BODY CONTROL MODULE)

< ECU DIAGNOSIS INFORMATION >

M: With M/T

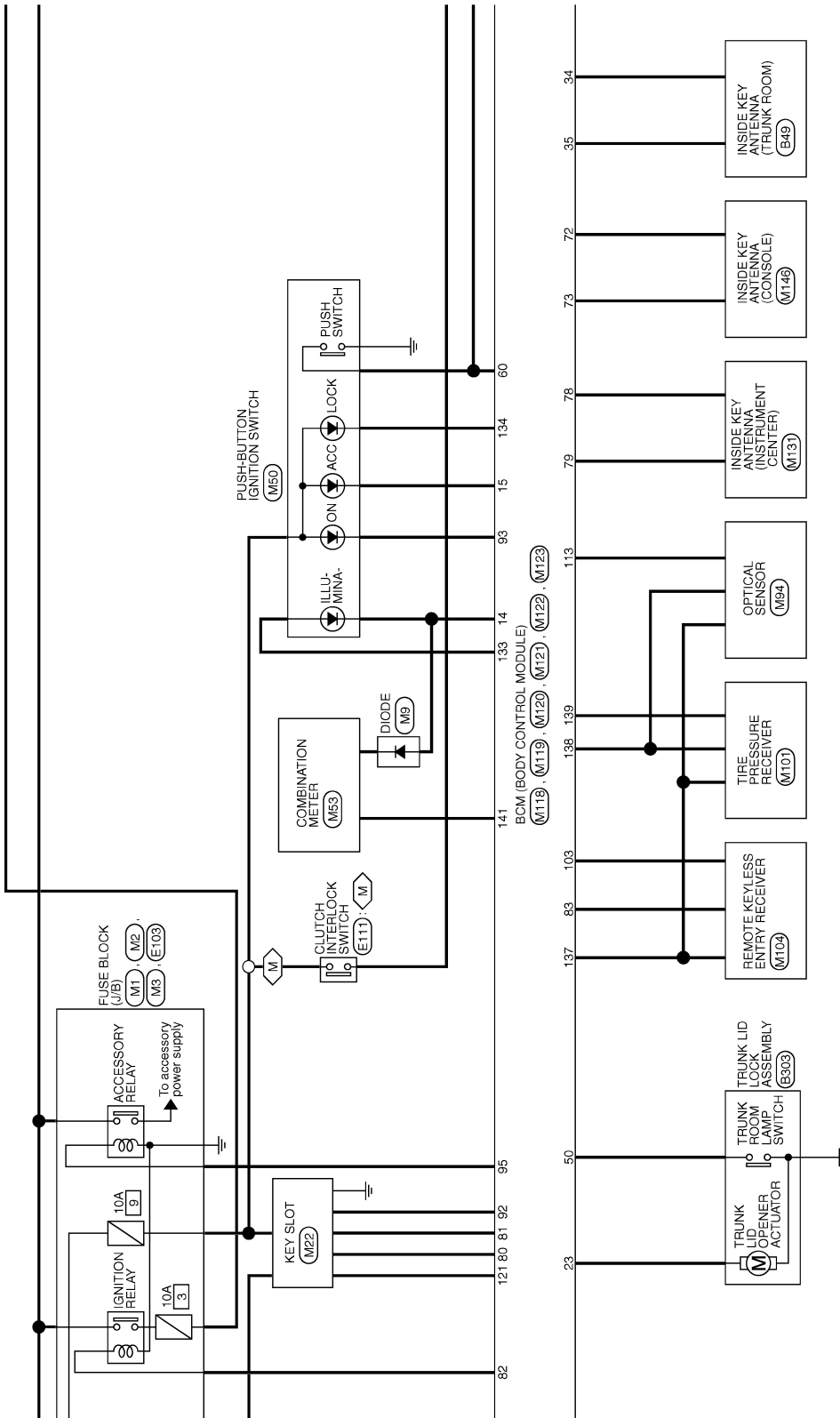

JRMWC4424GB

A
B
C
D
E
F
G
H
I
J
K
DEF
M
N
O
P

BCM (BODY CONTROL MODULE)

< ECU DIAGNOSIS INFORMATION >

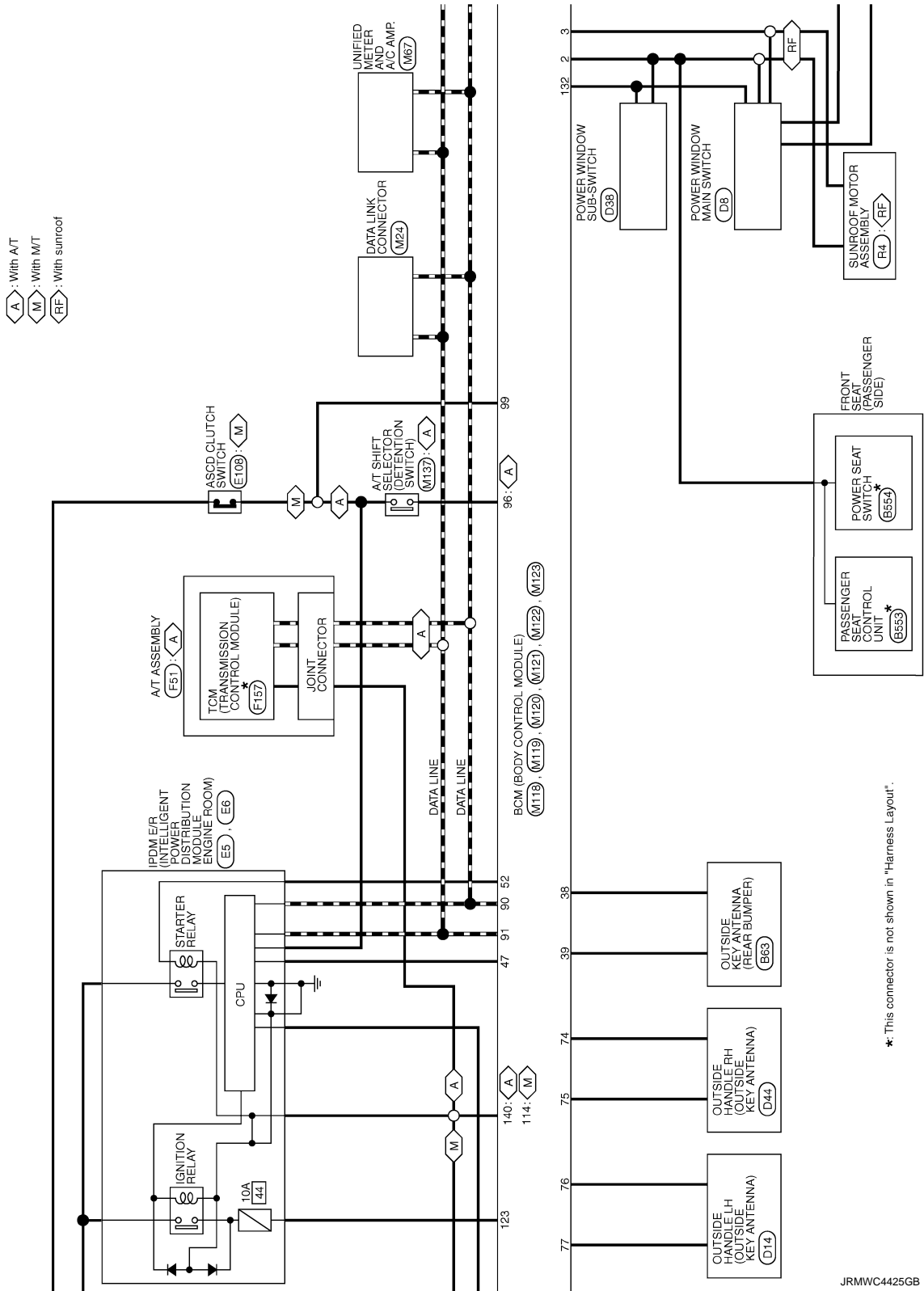

*: This connector is not shown in "Harness Layout".

JRMWC4425GB

BCM (BODY CONTROL MODULE)

< ECU DIAGNOSIS INFORMATION >

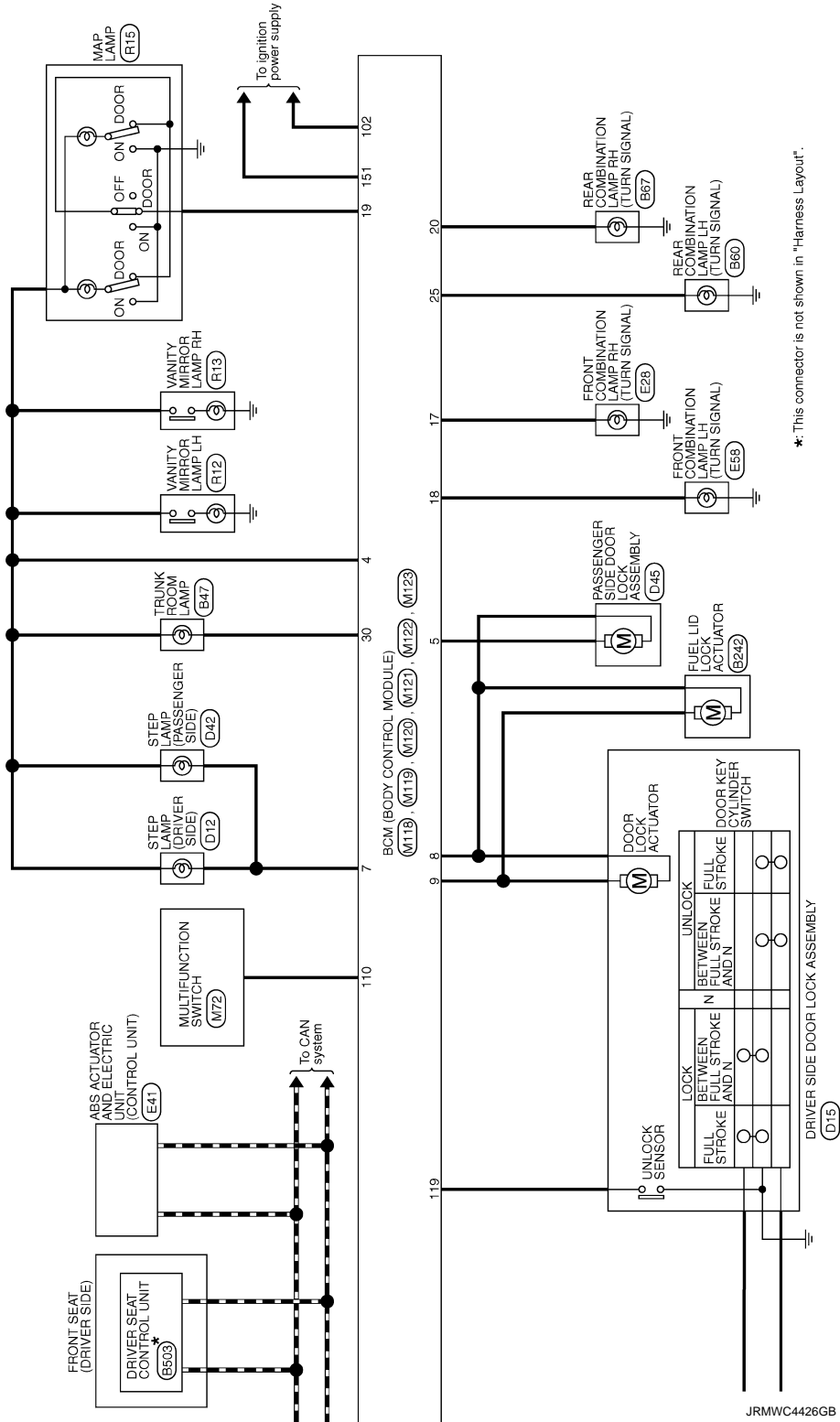

*: This connector is not shown in "Harness Layout".

A
B
C
D
E
F
G
H
I
J
K
L
M
N
O
P

DEF

Fail-safe

FAIL-SAFE CONTROL BY DTC

BCM performs fail-safe control when any DTC are detected.

INFOID:000000008814778

BCM (BODY CONTROL MODULE)

< ECU DIAGNOSIS INFORMATION >

Display contents of CONSULT	Fail-safe	Cancellation
B2190: NATS ANTENNA AMP	Inhibit engine cranking	Erase DTC
B2191: DIFFERENCE OF KEY	Inhibit engine cranking	Erase DTC
B2192: ID DISCORD BCM-ECM	Inhibit engine cranking	Erase DTC
B2193: CHAIN OF BCM-ECM	Inhibit engine cranking	Erase DTC
B2195: ANTI-SCANNING	Inhibit engine cranking	Ignition switch ON → OFF
B2560: STARTER CONT RELAY	Inhibit engine cranking	500 ms after the following CAN signal communication status becomes consistent <ul style="list-style-type: none"> • Starter control relay signal • Starter relay status signal
B2608: STARTER RELAY	Inhibit engine cranking	500 ms after the following signal communication status becomes consistent <ul style="list-style-type: none"> • Starter motor relay control signal • Starter relay status signal (CAN)
B260A: IGNITION RELAY	Inhibit engine cranking	500 ms after the following conditions are fulfilled <ul style="list-style-type: none"> • IGN relay (IPDM E/R) control signal: OFF (12 V) • Ignition ON signal (CAN to IPDM E/R): OFF (Request signal) • Ignition ON signal (CAN from IPDM E/R): OFF (Condition signal)
B260F: ENG STATE SIG LOST	Maintains the power supply position attained at the time of DTC detection	When any of the following conditions are fulfilled <ul style="list-style-type: none"> • Power position changes to ACC • Receives engine status signal (CAN)
B2617: BCM	Inhibit engine cranking	1 second after the starter motor relay control inside BCM becomes normal
B2618: BCM	Inhibit engine cranking	1 second after the ignition relay (IPDM E/R) control inside BCM becomes normal
B261E: VEHICLE TYPE	Inhibit engine cranking	BCM initialization
B26E8: CLUTCH SW	Inhibit engine cranking	When any of the following BCM recognition conditions are fulfilled <ul style="list-style-type: none"> • Status 1 <ul style="list-style-type: none"> - Clutch switch signal (CAN from ECM): ON - Clutch interlock switch signal: OFF (0 V) • Status 2 <ul style="list-style-type: none"> - Clutch switch signal (CAN from ECM): OFF - Clutch interlock switch signal: ON (Battery voltage)

DTC Inspection Priority Chart

INFOID:000000008814779

If some DTCs are displayed at the same time, perform inspections one by one based on the following priority chart.

Priority	DTC
1	B2562: LOW VOLTAGE
2	<ul style="list-style-type: none"> • U1000: CAN COMM • U1010: CONTROL UNIT(CAN)
3	<ul style="list-style-type: none"> • B2190: NATS ANTENNA AMP • B2191: DIFFERENCE OF KEY • B2192: ID DISCORD BCM-ECM • B2193: CHAIN OF BCM-ECM • B2195: ANTI-SCANNING

BCM (BODY CONTROL MODULE)

< ECU DIAGNOSIS INFORMATION >

Priority	DTC	
4	• B2553: IGNITION RELAY	A
	• B2555: STOP LAMP	
	• B2556: PUSH-BTN IGN SW	
	• B2557: VEHICLE SPEED	B
	• B2560: STARTER CONT RELAY	
	• B2601: SHIFT POSITION	
	• B2602: SHIFT POSITION	
	• B2603: SHIFT POSI STATUS	C
	• B2604: PNP/CLUTCH SW	
	• B2605: PNP/CLUTCH SW	
	• B2608: STARTER RELAY	
	• B260A: IGNITION RELAY	D
	• B260F: ENG STATE SIG LOST	
	• B2614: BCM	
	• B2615: BCM	
	• B2616: BCM	E
	• B2617: BCM	
	• B2618: BCM	
	• B261A: PUSH-BTN IGN SW	F
	• B261E: VEHICLE TYPE	
• B26E8: CLUTCH SW		
• B26EA: KEY REGISTRATION		
• C1729: VHCL SPEED SIG ERR	G	
• U0415: VEHICLE SPEED		
5	• C1704: LOW PRESSURE FL	
	• C1705: LOW PRESSURE FR	H
	• C1706: LOW PRESSURE RR	
	• C1707: LOW PRESSURE RL	
	• C1708: [NO DATA] FL	
	• C1709: [NO DATA] FR	I
	• C1710: [NO DATA] RR	
	• C1711: [NO DATA] RL	
	• C1716: [PRESSDATA ERR] FL	
	• C1717: [PRESSDATA ERR] FR	J
	• C1718: [PRESSDATA ERR] RR	
	• C1719: [PRESSDATA ERR] RL	
	• C1734: CONTROL UNIT	K
6	• B2621: INSIDE ANTENNA	
	• B2622: INSIDE ANTENNA	
	• B2623: INSIDE ANTENNA	

DEF

DTC Index

INFOID:000000008814780

NOTE:

The details of time display are as follows.

- CRNT: A malfunction is detected now.
- PAST: A malfunction was detected in the past.

IGN counter is displayed on Freeze Frame Data. For details of Freeze Frame Data, refer to [BCS-16. "COMMON ITEM : CONSULT Function \(BCM - COMMON ITEM\)"](#).

CONSULT display	Fail-safe	Freeze Frame Data •Vehicle Speed •Odo/Trip Meter •Vehicle condition	Intelligent Key warning lamp ON	Tire pressure monitor warning lamp ON	Refer- ence page
No DTC is detected. further testing may be required.	—	—	—	—	—
U1000: CAN COMM	—	—	—	—	BCS-36
U1010: CONTROL UNIT(CAN)	—	—	—	—	BCS-37
U0415: VEHICLE SPEED	—	—	—	—	BCS-38
B2190: NATS ANTENNA AMP	×	—	—	—	SEC-51

BCM (BODY CONTROL MODULE)

< ECU DIAGNOSIS INFORMATION >

CONSULT display	Fail-safe	Freeze Frame Data •Vehicle Speed •Odo/Trip Meter •Vehicle condition	Intelligent Key warning lamp ON	Tire pressure monitor warning lamp ON	Refer- ence page
B2191: DIFFERENCE OF KEY	×	—	—	—	SEC-54
B2192: ID DISCORD BCM-ECM	×	—	—	—	SEC-55
B2193: CHAIN OF BCM-ECM	×	—	—	—	SEC-57
B2195: ANTI-SCANNING	×	—	—	—	SEC-58
B2553: IGNITION RELAY	—	×	—	—	PCS-48
B2555: STOP LAMP	—	×	—	—	SEC-59
B2556: PUSH-BTN IGN SW	—	×	×	—	SEC-61
B2557: VEHICLE SPEED	×	×	×	—	SEC-63
B2560: STARTER CONT RELAY	×	×	×	—	SEC-64
B2562: LOW VOLTAGE	—	×	—	—	BCS-39
B2601: SHIFT POSITION	×	×	×	—	SEC-65
B2602: SHIFT POSITION	×	×	×	—	SEC-68
B2603: SHIFT POSI STATUS	×	×	×	—	SEC-70
B2604: PNP/CLUTCH SW	×	×	×	—	SEC-73
B2605: PNP/CLUTCH SW	×	×	×	—	SEC-75
B2608: STARTER RELAY	×	×	×	—	SEC-77
B260A: IGNITION RELAY	×	×	×	—	PCS-50
B260F: ENG STATE SIG LOST	×	×	×	—	SEC-79
B2614: BCM	—	×	×	—	PCS-52
B2615: BCM	—	×	×	—	PCS-54
B2616: BCM	—	×	×	—	PCS-56
B2617: BCM	×	×	×	—	SEC-83
B2618: BCM	×	×	×	—	PCS-58
B261A: PUSH-BTN IGN SW	—	×	×	—	PCS-59
B261E: VEHICLE TYPE	×	×	× (Turn ON for 15 seconds)	—	SEC-85
B2621: INSIDE ANTENNA	—	×	—	—	DLK-55
B2622: INSIDE ANTENNA	—	×	—	—	DLK-57
B2623: INSIDE ANTENNA	—	×	—	—	DLK-59
B26E8: CLUTCH SW	×	×	×	—	SEC-80
B26EA: KEY REGISTRATION	—	×	× (Turn ON for 15 seconds)	—	SEC-82
C1704: LOW PRESSURE FL	—	—	—	×	WT-19
C1705: LOW PRESSURE FR	—	—	—	×	
C1706: LOW PRESSURE RR	—	—	—	×	
C1707: LOW PRESSURE RL	—	—	—	×	
C1708: [NO DATA] FL	—	—	—	×	WT-21
C1709: [NO DATA] FR	—	—	—	×	
C1710: [NO DATA] RR	—	—	—	×	
C1711: [NO DATA] RL	—	—	—	×	

BCM (BODY CONTROL MODULE)

< ECU DIAGNOSIS INFORMATION >

CONSULT display	Fail-safe	Freeze Frame Data •Vehicle Speed •Odo/Trip Meter •Vehicle condition	Intelligent Key warning lamp ON	Tire pressure monitor warning lamp ON	Refer- ence page	A
C1716: [PRESSDATA ERR] FL	—	—	—	×	WT-24	B
C1717: [PRESSDATA ERR] FR	—	—	—	×		
C1718: [PRESSDATA ERR] RR	—	—	—	×		C
C1719: [PRESSDATA ERR] RL	—	—	—	×	WT-25	
C1729: VHCL SPEED SIG ERR	—	—	—	×		D
C1734: CONTROL UNIT	—	—	—	×	WT-26	

A
B
C
D
E
F
G
H
I
J
K

DEF

M
N
O
P

REAR WINDOW DEFOGGER DOES NOT OPERATE

< SYMPTOM DIAGNOSIS >

SYMPTOM DIAGNOSIS

REAR WINDOW DEFOGGER DOES NOT OPERATE

Diagnosis Procedure

INFOID:000000008161307

1. CHECK REAR WINDOW DEFOGGER SWITCH

Check rear window defogger switch.

Refer to [DEF-9, "Component Function Check"](#).

Is the inspection result normal?

YES >> GO TO 2.

NO >> Repair or replace the malfunctioning parts.

2. CHECK REAR WINDOW DEFOGGER RELAY

Check rear window defogger relay.

Refer to [DEF-10, "Component Function Check"](#).

Is the inspection result normal?

YES >> GO TO 3.

NO >> Repair or replace the malfunctioning parts.

3. CHECK REAR WINDOW DEFOGGER

Check rear window defogger.

Refer to [DEF-12, "Component Function Check"](#).

Is the inspection result normal?

YES >> GO TO 4.

NO >> Repair or replace the malfunctioning parts.

4. CONFIRM THE OPERATION

Confirm the operation again.

Is the inspection result normal?

YES >> Check intermittent incident. Refer to [GI-43, "Intermittent Incident"](#).

NO >> GO TO 1.

REAR WINDOW DEFOGGER AND DOOR MIRROR DEFOGGER DO NOT OPERATE

< SYMPTOM DIAGNOSIS >

REAR WINDOW DEFOGGER AND DOOR MIRROR DEFOGGER DO NOT OPERATE

Diagnosis Procedure

INFOID:000000008161308

1. CHECK REAR WINDOW DEFOGGER SWITCH

Check rear window defogger switch.

Refer to [DEF-9, "Component Function Check"](#).

Is the inspection result normal?

YES >> GO TO 2.

NO >> Repair or replace the malfunctioning parts.

2. CHECK REAR WINDOW DEFOGGER RELAY

Check rear window defogger relay.

Refer to [DEF-10, "Component Function Check"](#).

Is the inspection result normal?

YES >> GO TO 3.

NO >> Repair or replace the malfunctioning parts.

3. CONFIRM THE OPERATION

Confirm the operation again.

Is the inspection result normal?

YES >> Check intermittent incident. Refer to [GI-43, "Intermittent Incident"](#).

NO >> GO TO 1.

A
B
C
D
E
F
G
H
I
J
K
M
N
O
P

DEF

REAR WINDOW DEFOGGER DOES NOT OPERATE BUT BOTH DOOR MIRROR DEFOGGERS OPERATE

< SYMPTOM DIAGNOSIS >

REAR WINDOW DEFOGGER DOES NOT OPERATE BUT BOTH DOOR MIRROR DEFOGGERS OPERATE

Diagnosis Procedure

INFOID:000000008161309

1. CHECK REAR WINDOW DEFOGGER

Check rear window defogger.

Refer to [DEF-12, "Component Function Check"](#).

Is the inspection result normal?

YES >> GO TO 2.

NO >> Repair or replace the malfunctioning parts.

2. CONFIRM THE OPERATION

Confirm the operation again

Is the inspection result normal?

YES >> Check intermittent incident. Refer to [GI-43, "Intermittent Incident"](#).

NO >> GO TO 1.

DOOR MIRROR DEFOGGER DOES NOT OPERATE

< SYMPTOM DIAGNOSIS >

DOOR MIRROR DEFOGGER DOES NOT OPERATE BOTH SIDES

BOTH SIDES : Diagnosis Procedure

INFOID:000000008161310

1.CHECK DOOR MIRROR DEFOGGER

Check door mirror defogger.

Refer to [DEF-15, "Component Function Check"](#).

Is the inspection result normal?

YES >> GO TO 2.

NO >> Repair or replace the malfunctioning parts.

2.CONFIRM THE OPERATION

Confirm the operation again.

Is the inspection result normal?

YES >> Check intermittent incident. Refer to [GI-43, "Intermittent Incident"](#).

NO >> GO TO 1.

DRIVER SIDE

DRIVER SIDE : Diagnosis Procedure

INFOID:000000008161311

1.CHECK DRIVER SIDE DOOR MIRROR DEFOGGER

Check driver side door mirror defogger.

Refer to [DEF-17, "Component Function Check"](#).

Is the inspection result normal?

YES >> GO TO 2.

NO >> Repair or replace the malfunctioning parts.

2.CONFIRM THE OPERATION

Confirm the operation again.

Is the inspection result normal?

YES >> Check intermittent incident. Refer to [GI-43, "Intermittent Incident"](#).

NO >> GO TO 1.

PASSENGER SIDE

PASSENGER SIDE : Diagnosis Procedure

INFOID:000000008161312

1.CHECK PASSENGER SIDE DOOR MIRROR DEFOGGER.

Check passenger side door mirror defogger.

Refer to [DEF-19, "Component Function Check"](#).

Is the inspection result normal?

YES >> GO TO 2.

NO >> Repair or replace the malfunctioning parts.

2.CONFIRM THE OPERATION

Confirm the operation again.

Is the inspection result normal?

YES >> Check intermittent incident. Refer to [GI-43, "Intermittent Incident"](#).

NO >> GO TO 1.

A
B
C
D
E
F
G
H
I
J
K
M
N
O
P

DEF

ON IS NOT DISPLAYED WHEN PRESSING REAR WINDOW DEFOGGER SWITCH BUT IT IS OPERATED

< SYMPTOM DIAGNOSIS >

ON IS NOT DISPLAYED WHEN PRESSING REAR WINDOW DEFOGGER SWITCH BUT IT IS OPERATED

Diagnosis Procedure

INFOID:000000008161313

1. CHECK AV CONTROL UNIT FUNCTION

Check that the AV control unit is operating normally.

Base audio without rear view camera refer to [AV-11, "Work Flow"](#).

Base audio with rear view camera refer to [AV-139, "Work Flow"](#).

BOSE audio without navigation refer to [AV-253, "Work Flow"](#).

BOSE audio with navigation refer to [AV-374, "Work Flow"](#).

Is the inspection result normal?

YES >> GO TO 2.

NO >> Repair or replace the malfunctioning parts.

2. CONFIRM THE OPERATION

Confirm the operation again.

Is the inspection result normal?

YES >> Check intermittent incident. Refer to [GI-43, "Intermittent Incident"](#).

NO >> GO TO 1.

REAR WINDOW DEFOGGER INDICATOR DOES NOT ILLUMINATE

< SYMPTOM DIAGNOSIS >

REAR WINDOW DEFOGGER INDICATOR DOES NOT ILLUMINATE

Diagnosis Procedure

INFOID:000000008161314

1. CHECK MULTIFUNCTION SWITCH (REAR WINDOW DEFOGGER SWITCH)

Check rear window defogger operate.

- YES >> Replace multifunction switch (rear window defogger switch). Refer to [AV-91. "Removal and Installation"](#)
- NO >> Check rear window defogger system. Refer to [DEF-3. "Work Flow"](#)

A
B
C
D
E
F
G
H
I
J
K
DEF
M
N
O
P

PRECAUTIONS

< PRECAUTION >

PRECAUTION

PRECAUTIONS

Precaution for Supplemental Restraint System (SRS) "AIR BAG" and "SEAT BELT PRE-TENSIONER"

INFOID:000000008161315

The Supplemental Restraint System such as "AIR BAG" and "SEAT BELT PRE-TENSIONER", used along with a front seat belt, helps to reduce the risk or severity of injury to the driver and front passenger for certain types of collision. This system includes seat belt switch inputs and dual stage front air bag modules. The SRS system uses the seat belt switches to determine the front air bag deployment, and may only deploy one front air bag, depending on the severity of a collision and whether the front occupants are belted or unbelted. Information necessary to service the system safely is included in the "SRS AIR BAG" and "SEAT BELT" of this Service Manual.

WARNING:

Always observe the following items for preventing accidental activation.

- To avoid rendering the SRS inoperative, which could increase the risk of personal injury or death in the event of a collision that would result in air bag inflation, all maintenance must be performed by an authorized NISSAN/INFINITI dealer.
- Improper maintenance, including incorrect removal and installation of the SRS, can lead to personal injury caused by unintentional activation of the system. For removal of Spiral Cable and Air Bag Module, see "SRS AIR BAG".
- Never use electrical test equipment on any circuit related to the SRS unless instructed to in this Service Manual. SRS wiring harnesses can be identified by yellow and/or orange harnesses or harness connectors.

PRECAUTIONS WHEN USING POWER TOOLS (AIR OR ELECTRIC) AND HAMMERS

WARNING:

Always observe the following items for preventing accidental activation.

- When working near the Air Bag Diagnosis Sensor Unit or other Air Bag System sensors with the ignition ON or engine running, never use air or electric power tools or strike near the sensor(s) with a hammer. Heavy vibration could activate the sensor(s) and deploy the air bag(s), possibly causing serious injury.
- When using air or electric power tools or hammers, always switch the ignition OFF, disconnect the battery, and wait at least 3 minutes before performing any service.

Precaution for Battery Service

INFOID:000000008161316

Before disconnecting the battery, lower both the driver and passenger windows. This will prevent any interference between the window edge and the vehicle when the door is opened/closed. During normal operation, the window slightly raises and lowers automatically to prevent any window to vehicle interference. The automatic window function will not work with the battery disconnected.

FILAMENT

< REMOVAL AND INSTALLATION >

REMOVAL AND INSTALLATION

FILAMENT

Inspection and Repair

INFOID:000000008161317

INSPECTION

1. When measuring voltage, wrap tin foil around the top of the negative probe. Then press the foil against the wire with your finger.

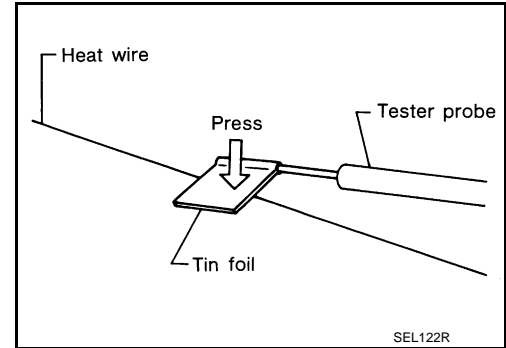

2. Attach probe circuit tester (in Volt range) to middle portion of each filament.

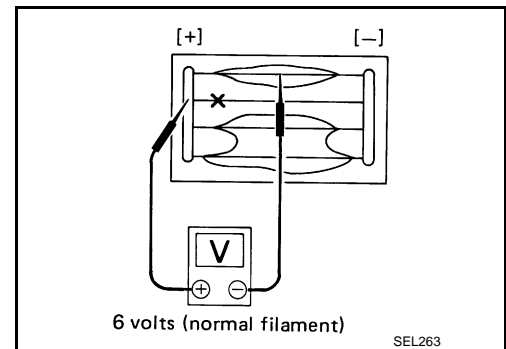

3. If a filament is burned out, circuit tester registers 0 or battery voltage.
4. To locate burned out point, move probe to left and right along filament. Test needle will swing abruptly when probe passes the point.

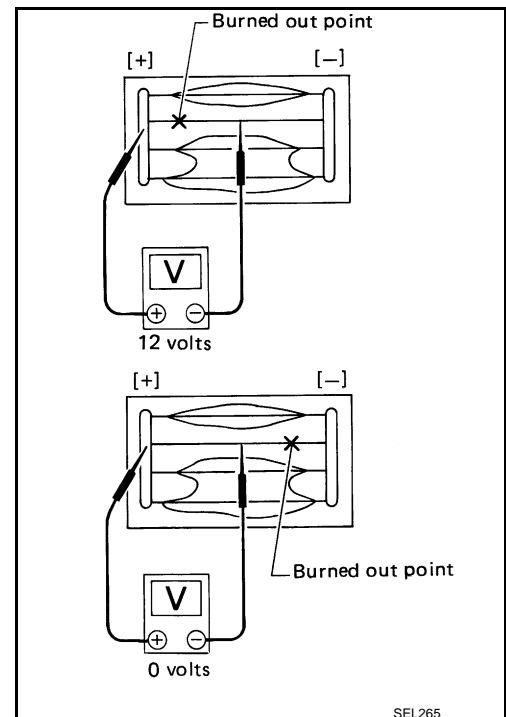

REPAIR

REPAIR EQUIPMENT

- Conductive silver composition (Dupont No. 4817 or equivalent)

A
B
C
D
E
F
G
H
I
J
K
DEF
M
N
O
P

FILAMENT

< REMOVAL AND INSTALLATION >

- Ruler 30 cm (11.8 in) long
- Drawing pen
- Heat gun
- Alcohol
- Cloth

REPAIRING PROCEDURE

1. Wipe broken heat wire and its surrounding area clean with a cloth dampened in alcohol.
2. Apply a small amount of conductive silver composition to tip of drawing pen.
Shake silver composition container before use.
3. Place ruler on glass along broken line. Deposit conductive silver composition on break with drawing pen. Slightly overlap existing heat wire on both sides [preferably 5 mm (0.20 in)] of the break.

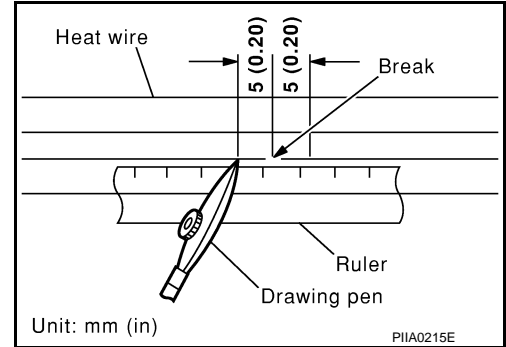

4. After repair has been completed, check repaired wire for continuity. This check should be conducted 10 minutes after silver composition is deposited.
Do not touch repaired area while test is being conducted.

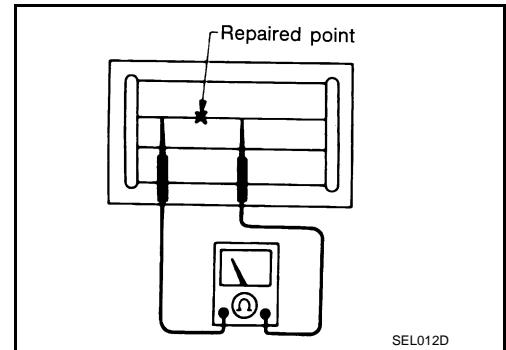

5. Apply a constant stream of hot air directly to the repaired area for approximately 20 minutes with a heat gun. A minimum distance of 3 cm (1.2 in) should be kept between repaired area and hot air outlet.
If a heat gun is not available, let the repaired area dry for 24 hours.

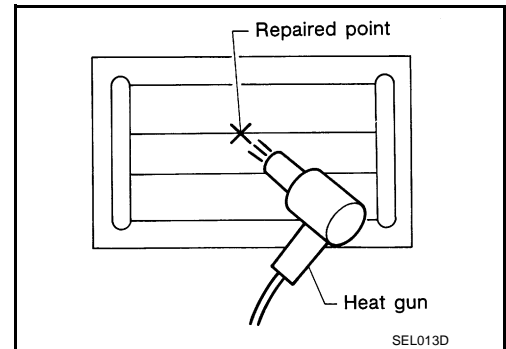

CONDENSER

< REMOVAL AND INSTALLATION >

CONDENSER

Exploded View

INFOID:000000008161318

Refer to [INT-15, "Exploded View"](#)

Removal and Installation

INFOID:000000008161319

REMOVAL

1. Remove the rear seat cushion and the rear seatback.
Refer to [SE-176, "Removal and Installation"](#)
2. Remove the rear kickplate, rear wheel well garnish and the rear pillar finisher.
Refer to [INT-15, "Removal and Installation"](#)
3. Remove bolt (A), and then remove condenser (1) from the vehicle body.

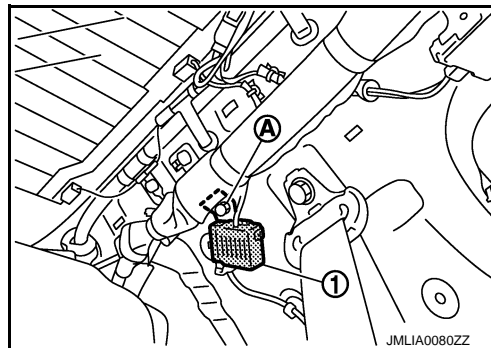

INSTALLATION

Install in the reverse order of removal.

A
B
C
D
E
F
G
H
I
J
K
DEF
M
N
O
P