

SECTION **WCS**

WARNING CHIME SYSTEM

A
B
C

CONTENTS

<p>BASIC INSPECTION 3</p> <p>DIAGNOSIS AND REPAIR WORKFLOW 3</p> <p style="padding-left: 20px;">Work Flow3</p> <p>SYSTEM DESCRIPTION 5</p> <p>WARNING CHIME SYSTEM 5</p> <p>WARNING CHIME SYSTEM5</p> <p style="padding-left: 20px;">WARNING CHIME SYSTEM : System Diagram5</p> <p style="padding-left: 20px;">WARNING CHIME SYSTEM : System Description5</p> <p style="padding-left: 20px;">WARNING CHIME SYSTEM : Component Parts Location6</p> <p style="padding-left: 20px;">WARNING CHIME SYSTEM : Component Description6</p> <p>LIGHT REMINDER WARNING CHIME7</p> <p style="padding-left: 20px;">LIGHT REMINDER WARNING CHIME : System Diagram7</p> <p style="padding-left: 20px;">LIGHT REMINDER WARNING CHIME : System Description7</p> <p style="padding-left: 20px;">LIGHT REMINDER WARNING CHIME : Component Parts Location8</p> <p style="padding-left: 20px;">LIGHT REMINDER WARNING CHIME : Component Description8</p> <p>SEAT BELT WARNING CHIME8</p> <p style="padding-left: 20px;">SEAT BELT WARNING CHIME : System Diagram9</p> <p style="padding-left: 20px;">SEAT BELT WARNING CHIME : System Description9</p> <p style="padding-left: 20px;">SEAT BELT WARNING CHIME : Component Parts Location10</p> <p style="padding-left: 20px;">SEAT BELT WARNING CHIME : Component Description10</p> <p>PARKING BRAKE RELEASE WARNING CHIME.... 10</p> <p style="padding-left: 20px;">PARKING BRAKE RELEASE WARNING CHIME : System Diagram 11</p>	<p style="padding-left: 20px;">PARKING BRAKE RELEASE WARNING CHIME : System Description11</p> <p style="padding-left: 20px;">PARKING BRAKE RELEASE WARNING CHIME : Component Parts Location12</p> <p style="padding-left: 20px;">PARKING BRAKE RELEASE WARNING CHIME : Component Description12</p> <p>DIAGNOSIS SYSTEM (UNIFIED METER AND A/C AMP.)13</p> <p style="padding-left: 20px;">CONSULT-III Function (METER/M&A)13</p> <p>DIAGNOSIS SYSTEM (BCM)17</p> <p>COMMON ITEM17</p> <p style="padding-left: 20px;">COMMON ITEM : CONSULT-III Function (BCM - COMMON ITEM)17</p> <p>BUZZER18</p> <p style="padding-left: 20px;">BUZZER : CONSULT-III Function (BCM - BUZZER)18</p> <p>DTC/CIRCUIT DIAGNOSIS20</p> <p>POWER SUPPLY AND GROUND CIRCUIT20</p> <p>COMBINATION METER20</p> <p style="padding-left: 20px;">COMBINATION METER : Diagnosis Procedure20</p> <p>UNIFIED METER AND A/C AMP.20</p> <p style="padding-left: 20px;">UNIFIED METER AND A/C AMP. : Diagnosis Procedure20</p> <p>BCM (BODY CONTROL MODULE)21</p> <p style="padding-left: 20px;">BCM (BODY CONTROL MODULE) : Diagnosis Procedure21</p> <p>METER BUZZER CIRCUIT23</p> <p style="padding-left: 20px;">Description23</p> <p style="padding-left: 20px;">Component Function Check23</p> <p style="padding-left: 20px;">Diagnosis Procedure23</p> <p>SEAT BELT BUCKLE SWITCH SIGNAL CIRCUIT24</p>
--	---

D
E
F
G
H
I
J
K
L
M
WCS

Description	24	DTC Index	96
Component Function Check	24	SYMPTOM DIAGNOSIS	99
Diagnosis Procedure	24	THE PARKING BRAKE RELEASE WARNING	
Component Inspection	25	CONTINUES SOUNDING, OR DOES NOT	
WARNING CHIME SYSTEM	26	SOUND	99
Wiring Diagram - WARNING CHIME -	26	Description	99
ECU DIAGNOSIS INFORMATION	30	Diagnosis Procedure	99
COMBINATION METER	30	THE LIGHT REMINDER WARNING DOES	
Reference Value	30	NOT SOUND	100
Wiring Diagram - METER -	33	Description	100
Fail-safe	42	Diagnosis Procedure	100
DTC Index	43	THE SEAT BELT WARNING CONTINUES	
UNIFIED METER AND A/C AMP.	44	SOUNDING, OR DOES NOT SOUND	101
Reference Value	44	Description	101
Wiring Diagram - METER -	52	Diagnosis Procedure	101
Fail-safe	61	PRECAUTION	102
DTC Index	62	PRECAUTIONS	102
BCM (BODY CONTROL MODULE)	63	Precaution for Supplemental Restraint System	
Reference Value	63	(SRS) "AIR BAG" and "SEAT BELT PRE-TEN-	
Wiring Diagram - BCM -	87	SIONER"	102
Fail-safe	92		
DTC Inspection Priority Chart	94		

DIAGNOSIS AND REPAIR WORKFLOW

< BASIC INSPECTION >

BASIC INSPECTION

DIAGNOSIS AND REPAIR WORKFLOW

Work Flow

INFOID:000000004238389

OVERALL SEQUENCE

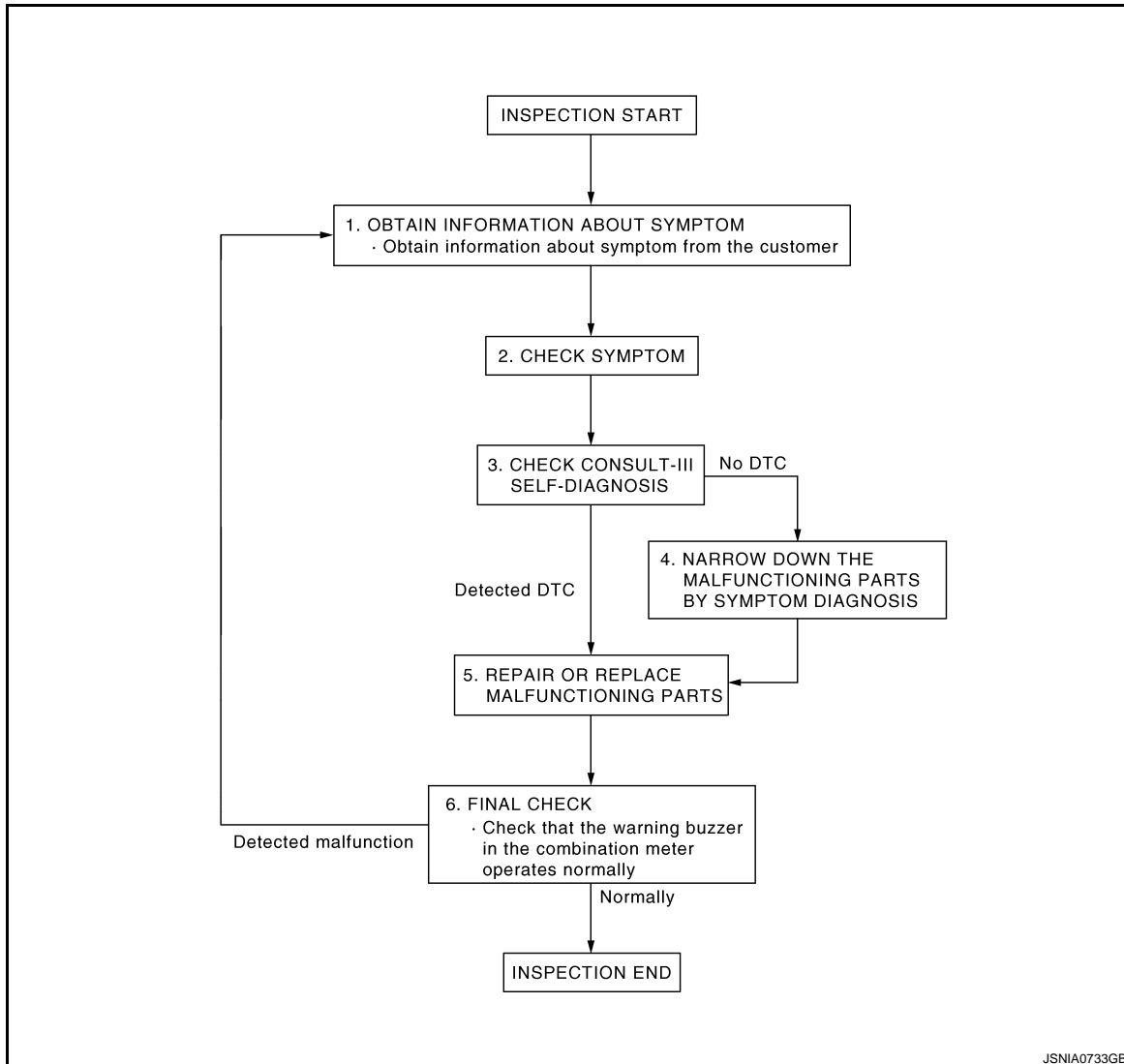

DETAILED FLOW

1. OBTAIN INFORMATION ABOUT SYMPTOM

Interview the customer to obtain as much information as possible about the conditions and environment under which the malfunction occurred.

>> GO TO 2.

2. CHECK SYMPTOM

- Check the symptom based on the information obtained from the customer.
- Check that any other malfunctions are present.

>> GO TO 3.

3. CHECK CONSULT-III SELF-DIAGNOSIS RESULTS

Connect CONSULT-III and perform self-diagnosis. Refer to [WCS-13. "CONSULT-III Function \(METER/M&A\)".](#)

A
B
C
D
E
F
G
H
I
J
K
L
M

WCS

O
P

DIAGNOSIS AND REPAIR WORKFLOW

< BASIC INSPECTION >

Are self-diagnosis results normal?

YES >> GO TO 4.

NO >> GO TO 5.

4. NARROW DOWN MALFUNCTIONING PARTS BY SYMPTOM DIAGNOSIS

Perform symptom diagnosis and narrow down the malfunctioning parts.

>> GO TO 5.

5. REPAIR OR REPLACE MALFUNCTIONING PARTS

Repair or replace malfunctioning parts.

NOTE:

If DTC is displayed, erase DTC after repair or replace malfunctioning parts.

>> GO TO 6.

6. FINAL CHECK

Check that the warning buzzer in the combination meter operates normally.

Does it operate normally?

YES >> INSPECTION END

NO >> GO TO 1.

WARNING CHIME SYSTEM

< SYSTEM DESCRIPTION >

SYSTEM DESCRIPTION

WARNING CHIME SYSTEM

WARNING CHIME SYSTEM

WARNING CHIME SYSTEM : System Diagram

INFOID:000000004238390

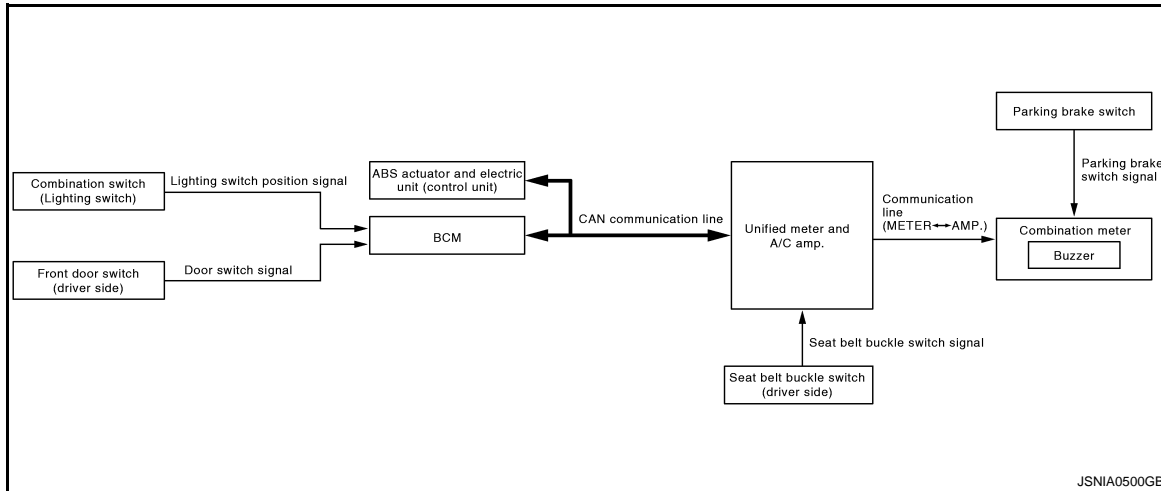

WARNING CHIME SYSTEM : System Description

INFOID:000000004238391

COMBINATION METER

- The buzzer (1) for warning chime system is installed in the combination meter.
- The buzzer sounds when the combination meter receives buzzer output signal from each unit through unified meter and A/C amp.

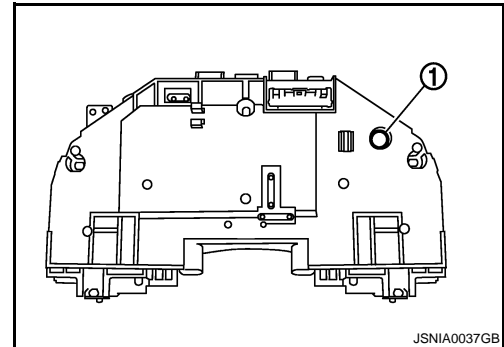

UNIFIED METER AND A/C AMP.

The unified meter and A/C amp. transmits the buzzer output signal received from BCM with CAN communication line to the combination meter.

BCM

BCM receives signals from various units and transmits a buzzer output signal to the unified meter and A/C amp. with CAN communication line if it judges that the warning buzzer should be activated.

BCM warning function list

Warning functions	Signal name
Light reminder warning chime	<ul style="list-style-type: none"> • Lighting switch position signal • Door switch signal
Seat belt warning chime	Seat belt buckle switch signal

A
B
C
D
E
F
G
H
I
J
K
L
M
O
P

WCS

WARNING CHIME SYSTEM

< SYSTEM DESCRIPTION >

WARNING CHIME SYSTEM : Component Parts Location

INFOID:000000004238392

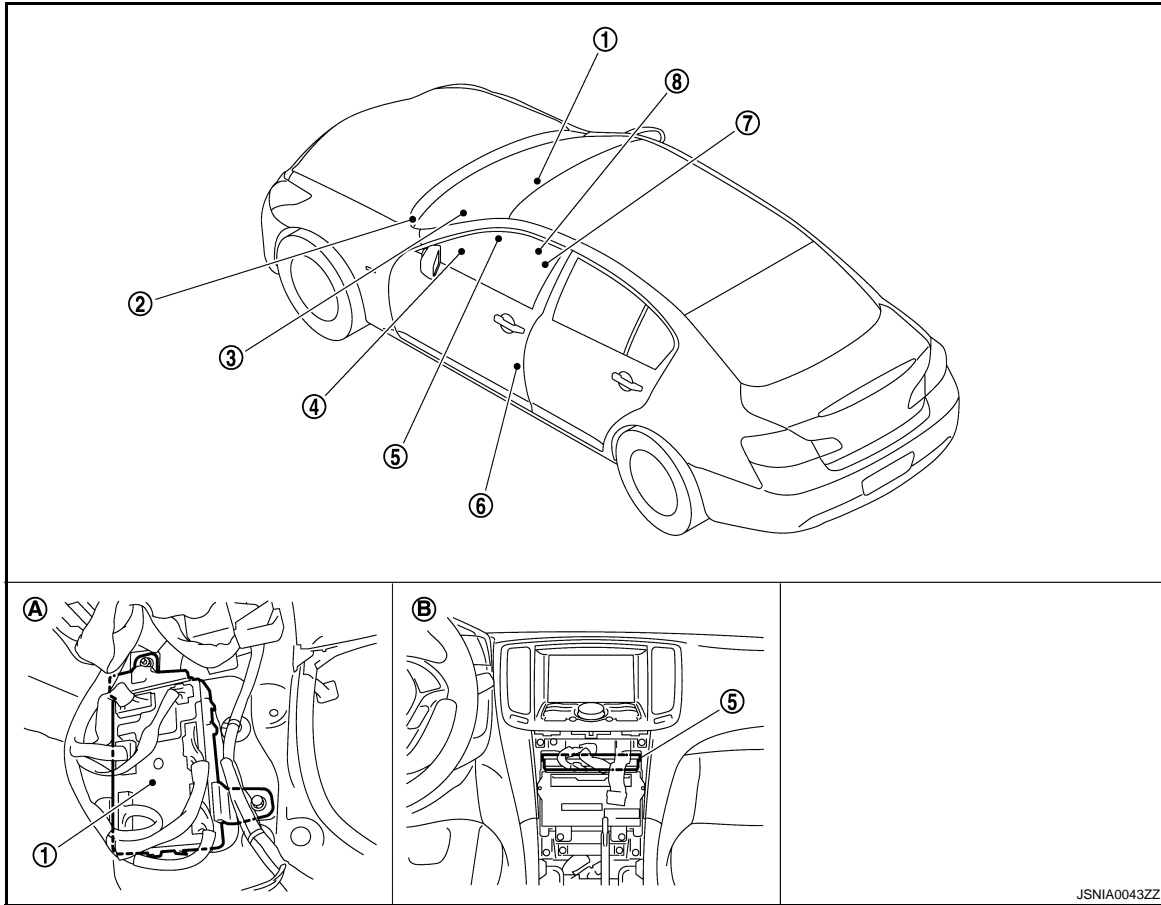

JSNIA0043ZZ

- | | | |
|--|-------------------------------|------------------------------------|
| 1. BCM | 2. Parking brake switch (A/T) | 3. Combination meter |
| 4. Combination switch
(Lighting switch) | 5. Unified meter and A/C amp. | 6. Front door switch (driver side) |
| 7. Seat belt buckle switch | 8. Parking brake switch (M/T) | |
| A. Dash side lower (passenger side) | B. Behind cluster lid C | |

WARNING CHIME SYSTEM : Component Description

INFOID:000000004238393

Unit	Description
Combination meter	<ul style="list-style-type: none"> Receives a buzzer output signal from the unified meter and A/C amp. and sounds the buzzer. Judges whether the parking brake is released from the vehicle speed signal received from the unified meter and A/C amp. with CAN communication line and the parking brake switch signal from the parking brake switch, and sounds the buzzer if necessary.
Unified meter and A/C amp.	<ul style="list-style-type: none"> Receives the seat belt buckle switch signal from the seat belt buckle switch and transmits it to BCM with CAN communication line. Receives a buzzer output signal from BCM with CAN communication line and transmits it to the combination meter by means of communication line.
BCM	Transmits signals provided by various units to the unified meter and A/C amp. with CAN communication line.
ABS actuator and electric unit (control unit)	Transmits the vehicle speed signal to BCM with CAN communication line.
Seat belt buckle switch (driver side)	Transmits a seat belt buckle switch signal to the unified meter and A/C amp.
Combination switch (Lighting switch)	Transmits the lighting switch position signal to BCM.

WARNING CHIME SYSTEM

< SYSTEM DESCRIPTION >

Unit	Description
Front door switch (driver side)	Transmits the door switch signal to BCM.
Parking brake switch	Refer to MWI-61, "Description" .

LIGHT REMINDER WARNING CHIME

LIGHT REMINDER WARNING CHIME : System Diagram

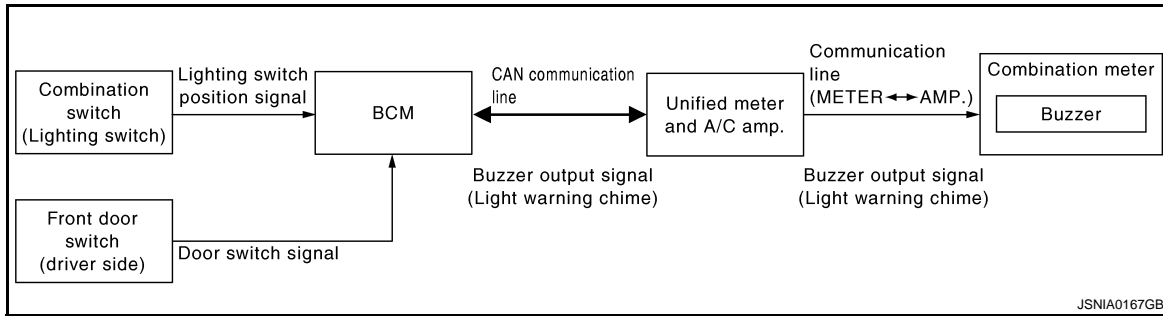

LIGHT REMINDER WARNING CHIME : System Description

INFOID:000000004238395

DESCRIPTION

With ignition switch in OFF or ACC position, driver door open, and lighting switch in 1ST or 2ND position, the light reminder warning chime will sound.

- BCM detects ignition switch in OFF or ACC position, front door switch (driver side) ON, and lighting switch in 1ST or 2ND position. And then transmits buzzer output signal (light reminder warning chime) to unified meter and A/C amp. with CAN communication line.
- Unified meter and A/C amp. transmits buzzer output signal (light reminder warning chime) to combination meter with communication line.
- When combination meter receives buzzer output signal (light reminder warning chime), it sounds the buzzer.

WARNING OPERATION CONDITIONS

If all of the following conditions are fulfilled.

- Lighting switch is at 1st or 2nd position
- Ignition switch is at OFF or ACC
- Front door switch (driver side) is ON

WARNING CANCEL CONDITIONS

Warning is canceled if any of the following conditions is fulfilled.

- Lighting switch OFF
- Ignition switch ON
- Front door switch (driver side) is OFF

A
B
C
D
E
F
G
H
I
J
K
L
M
O
P

WCS

WARNING CHIME SYSTEM

< SYSTEM DESCRIPTION >

LIGHT REMINDER WARNING CHIME : Component Parts Location

INFOID:000000004238396

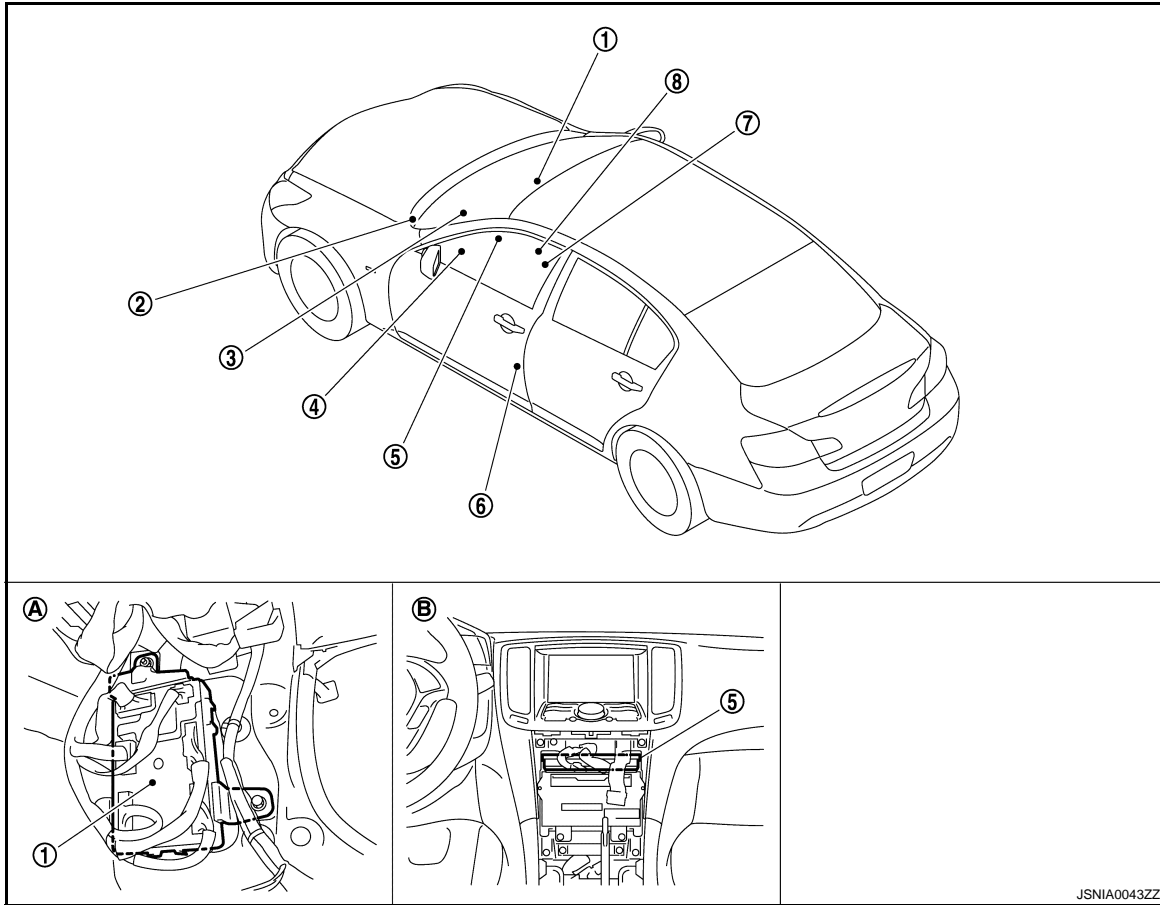

JSNIA0043ZZ

- | | | |
|---|-------------------------------|------------------------------------|
| 1. BCM | 2. Parking brake switch (A/T) | 3. Combination meter |
| 4. Combination switch (Lighting switch) | 5. Unified meter and A/C amp. | 6. Front door switch (driver side) |
| 7. Seat belt buckle switch | 8. Parking brake switch (M/T) | |
| A. Dash side lower (passenger side) | B. Behind cluster lid C | |

LIGHT REMINDER WARNING CHIME : Component Description

INFOID:000000004238397

Unit	Description
Combination meter	Receives a buzzer output signal from the unified meter and A/C amp. and sounds the buzzer.
Unified meter and A/C amp.	Receives a buzzer output signal from BCM via CAN communication line and transmits it to the combination meter by means of communication line.
BCM	Judges the light warning conditions from the signals provided by various switches and transmits a buzzer output signal to the unified meter and A/C amp. via CAN communication line if necessary.
Combination switch (Lighting switch)	Transmits the lighting switch position signal to BCM.
Front door switch (driver side)	Transmits the door switch signal to BCM.

SEAT BELT WARNING CHIME

WARNING CHIME SYSTEM

< SYSTEM DESCRIPTION >

SEAT BELT WARNING CHIME : System Diagram

INFOID:000000004238398

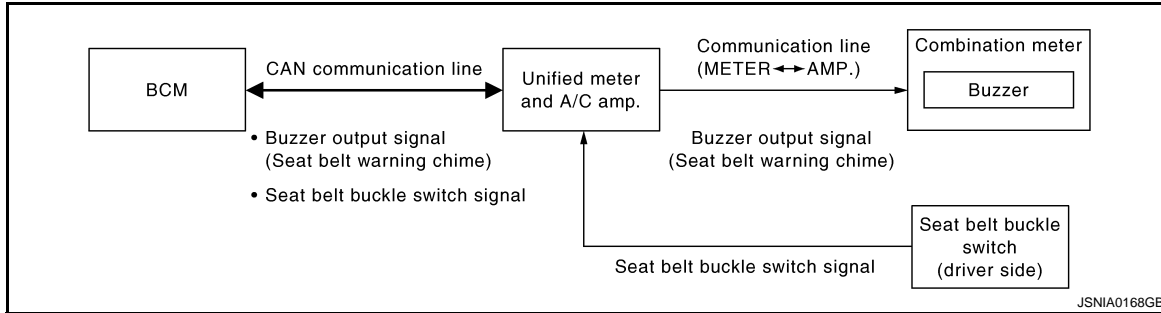

SEAT BELT WARNING CHIME : System Description

INFOID:000000004675513

DESCRIPTION

With ignition switch turned ON and driver seat belt unfastened, seat belt warning chime will sound for approximately 6 seconds.

- BCM receives seat belt buckle switch signal from unified meter and A/C amp. with CAN communication line.
- BCM detects ignition switch turned ON and seat belt buckle switch (driver side) ON. And then transmits buzzer output signal (seat belt warning chime) to unified meter and A/C amp. with CAN communication line.
- Unified meter and A/C amp. transmits buzzer output signal (seat belt warning chime) to combination meter with communication line.
- When combination meter receives buzzer output signal (seat belt warning chime), it sounds the buzzer.

WARNING OPERATION CONDITIONS

If all of the following conditions are fulfilled.

- Ignition switch OFF→ON
- Seat buckle switch (driver side) is ON (driver seat belt unfastened)

WARNING CANCEL CONDITIONS

Warning is canceled if any of the following conditions is fulfilled.

- Ignition switch OFF
- Seat buckle switch (driver side) is OFF (driver seat belt fastened)

A
B
C
D
E
F
G
H
I
J
K
L
M
O
P

WCS

WARNING CHIME SYSTEM

< SYSTEM DESCRIPTION >

SEAT BELT WARNING CHIME : Component Parts Location

INFOID:000000004238400

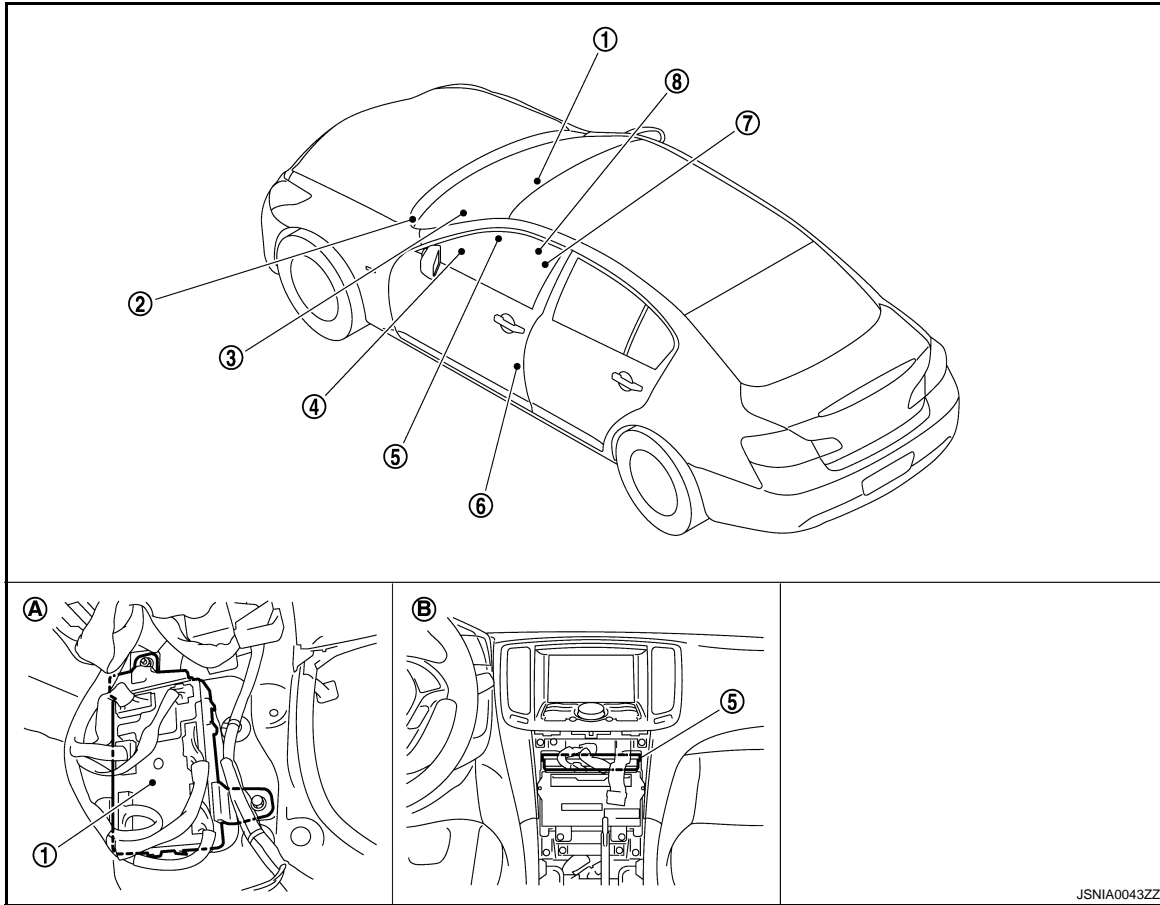

JSNIA0043ZZ

- | | | |
|--|-------------------------------|------------------------------------|
| 1. BCM | 2. Parking brake switch (A/T) | 3. Combination meter |
| 4. Combination switch
(Lighting switch) | 5. Unified meter and A/C amp. | 6. Front door switch (driver side) |
| 7. Seat belt buckle switch | 8. Parking brake switch (M/T) | |
| A. Dash side lower (passenger side) | B. Behind cluster lid C | |

SEAT BELT WARNING CHIME : Component Description

INFOID:000000004238401

Unit	Description
Combination meter	Receives a buzzer output signal from the unified meter and A/C amp. and sounds the buzzer.
Unified meter and A/C amp.	<ul style="list-style-type: none"> Receives the seat belt buckle switch signal from the seat belt buckle switch and transmits it to BCM via CAN communication line. Receives a buzzer output signal from BCM via CAN communication line and transmits it to the combination meter by means of communication line.
BCM	Judges the seat belt warning condition from the seat belt buckle switch signal received from the unified meter and A/C amp. and transmits a buzzer output signal to the unified meter and A/C amp via CAN communication line if necessary.
Seat belt buckle switch (driver side)	Refer to WCS-24. "Description" .

PARKING BRAKE RELEASE WARNING CHIME

WARNING CHIME SYSTEM

< SYSTEM DESCRIPTION >

PARKING BRAKE RELEASE WARNING CHIME : System Diagram

INFOID:000000004238402

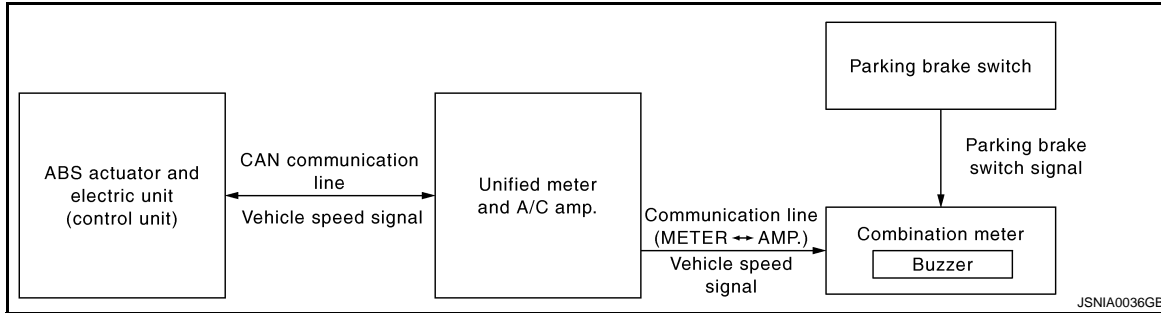

PARKING BRAKE RELEASE WARNING CHIME : System Description

INFOID:000000004238403

DESCRIPTION

- The unified meter and A/C amp. receives the vehicle speed signal from the ABS actuator and electric unit (control unit) via CAN communication line and transmits it to the combination meter by means of communication line.
- The combination meter judges whether the parking brake is released from the vehicle speed signal received from the unified meter and A/C amp. and the parking brake switch signal from the parking brake switch, and sounds the warning buzzer if necessary.

WARNING OPERATION CONDITIONS

If all of the following conditions are fulfilled.

- Vehicle speed is 7 km/h (4.3 MPH) or higher
- Parking brake switch ON

WARNING CANCEL CONDITIONS

Warning is canceled if any of the following conditions is fulfilled.

- Vehicle speed is approximately 3 km/h (1.9 MPH) or less
- Parking brake switch OFF

A
B
C
D
E
F
G
H
I
J
K
L
M
O
P

WCS

WARNING CHIME SYSTEM

< SYSTEM DESCRIPTION >

PARKING BRAKE RELEASE WARNING CHIME : Component Parts Location

INFOID:000000004238404

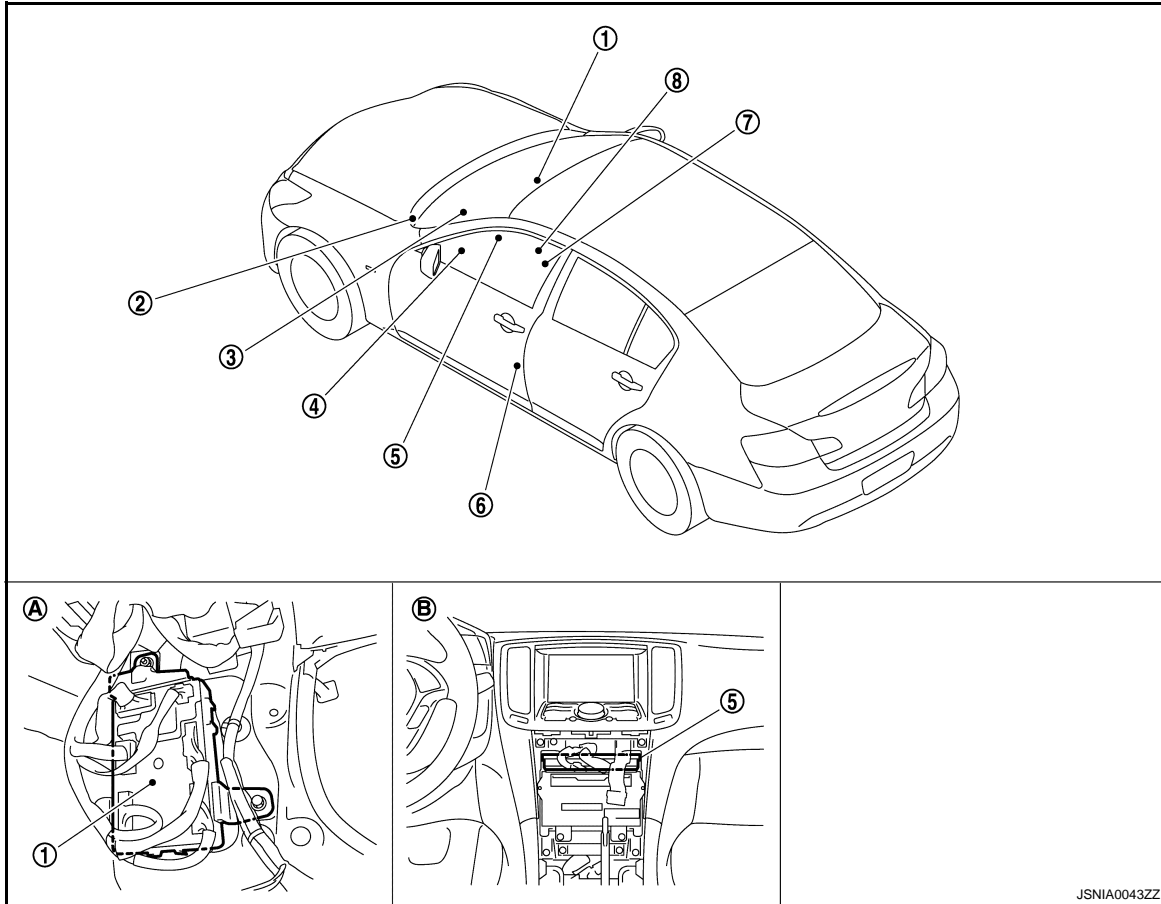

JSNIA0043ZZ

- | | | |
|--|-------------------------------|------------------------------------|
| 1. BCM | 2. Parking brake switch (A/T) | 3. Combination meter |
| 4. Combination switch
(Lighting switch) | 5. Unified meter and A/C amp. | 6. Front door switch (driver side) |
| 7. Seat belt buckle switch | 8. Parking brake switch (M/T) | |
| A. Dash side lower (passenger side) | B. Behind cluster lid C | |

PARKING BRAKE RELEASE WARNING CHIME : Component Description

INFOID:000000004238405

Unit	Description
Combination meter	Judges whether the parking brake is released from the vehicle speed signal received from the unified meter and A/C amp. via CAN communication line and the parking brake switch signal from the parking brake switch, and sounds the buzzer if necessary.
Unified meter and A/C amp.	Receives a vehicle speed signal from ABS actuator and electric unit (control unit) via CAN communication line and transmits it to the combination meter by means of communication line.
ABS actuator and electric unit (control unit)	Transmits the vehicle speed signal to combination meter via CAN communication line.
Parking brake switch	Refer to MWI-61, "Description" .

DIAGNOSIS SYSTEM (UNIFIED METER AND A/C AMP.)

< SYSTEM DESCRIPTION >

DIAGNOSIS SYSTEM (UNIFIED METER AND A/C AMP.)

CONSULT-III Function (METER/M&A)

INFOID:000000004675458

CONSULT-III APPLICATION ITEMS

CONSULT-III can perform the following diagnosis modes with CAN communication with the unified meter and A/C amp.

System	Diagnosis mode	Description
METER/M&A	Self Diagnostic Result	Unified meter and A/C amp. checks the conditions and displays memorized error.
	Data Monitor	Displays unified meter and A/C amp. input/output data in real time.

SELF DIAG RESULT

Refer to [MWI-101, "DTC Index"](#).

DATA MONITOR

Display Item List

X: Applicable

Display item [Unit]	MAIN SIGNALS	Description
SPEED METER [km/h]	X	Value of vehicle speed signal received from ABS actuator and electric unit (control unit) with CAN communication line. NOTE: 655.35 is displayed when the malfunction signal is received.
SPEED OUTPUT [km/h]	X	Vehicle speed signal value transmitted to other units with CAN communication line. NOTE: 655.35 is displayed when the malfunction signal is received.
ODO OUTPUT [km/h or mph]		Odometer signal value transmitted to other units with CAN communication line.
TACHO METER [rpm]	X	Value of the engine speed signal received from ECM with CAN communication line. NOTE: 8191.875 is displayed when the malfunction signal is received.
FUEL METER [lit.]	X	Fuel level indicated on combination meter.
W TEMP METER [°C]	X	Value of engine coolant temperature signal received from ECM with CAN communication line. NOTE: 215 is displayed when the malfunction signal is input.
ABS W/L [On/Off]		Status of ABS warning lamp judged from ABS warning lamp signal received from ABS actuator and electric unit (control unit) with CAN communication line.
VDC/TCS IND [On/Off]		Status of VDC OFF indicator lamp judged from VDC OFF indicator lamp signal received from ABS actuator and electric unit (control unit) with CAN communication line.
SLIP IND [On/Off]		Status of SLIP indicator lamp judged from slip indicator lamp signal received from ABS actuator and electric unit (control unit) with CAN communication line.
BRAKE W/L [On/Off]		Status of brake warning lamp judged from brake warning lamp signal received from ABS actuator and electric unit (control unit) with CAN communication line. NOTE: Displays "Off" if the brake warning lamp is illuminated when the valve check starts, the parking brake switch is turned ON or the brake fluid level switch is turned ON.
DOOR W/L [On/Off]		Status of door warning judged from door switch signal received from BCM with CAN communication line.
TRUNK/GLAS-H [On/Off]		Status of trunk warning judged from trunk switch signal received from BCM with CAN communication line.

DIAGNOSIS SYSTEM (UNIFIED METER AND A/C AMP.)

< SYSTEM DESCRIPTION >

Display item [Unit]	MAIN SIGNALS	Description
HI-BEAM IND [On/Off]		Status of high beam indicator lamp judged from high beam request signal received from BCM with CAN communication line.
TURN IND [On/Off]		Status of turn indicator lamp judged from turn indicator signal received from BCM with CAN communication line.
FR FOG IND [On/Off]		This item is displayed, but cannot be monitored.
RR FOG IND [Off]		This item is displayed, but cannot be monitored.
LIGHT IND [On/Off]		This item is displayed, but cannot be monitored.
OIL W/L [On/Off]		Status of oil pressure warning lamp judged from oil pressure switch signal received from IPDM E/R with CAN communication line.
MIL [On/Off]		Status of malfunction indicator lamp judged from malfunctioning indicator lamp signal received from ECM with CAN communication line.
GLOW IND [On/Off]		This item is displayed, but cannot be monitored.
C-ENG2 W/L [On/Off]		This item is displayed, but cannot be monitored.
CRUISE IND [On/Off]		Status of CRUISE indicator judged from ASCD status signal received from ECM with CAN communication line.
SET IND [On/Off]		Status of set indicator judged from ASCD SET indicator signal received from ECM with CAN communication line.
CRUISE W/L [On/Off]		Status of CRUISE warning lamp judged from ASCD status signal received from ECM with CAN communication line.
BA W/L [Off]		This item is displayed, but cannot be monitored.
ATC/T-AMT W/L [On/Off]		Status of A/T check warning lamp judged from A/T check indicator signal received from TCM with CAN communication line.
4WD W/L [On/Off]		Status of AWD warning lamp judged from AWD warning lamp signal received from AWD control unit with CAN communication line.
4WD LOCK IND [Off]		This item is displayed, but cannot be monitored.
FUEL W/L [On/Off]		Low-fuel warning lamp status judged by the identified fuel level.
WASHER W/L [On/Off]		Status of washer warning lamp judged from washer level switch input to combination meter.
AIR PRES W/L [On/Off]		Status of low tire pressure warning lamp judged from tire pressure signal received from BCM with CAN communication line.
KEY G/Y W/L [On/Off]		Status of key warning lamp (G/Y) judged from key warning signal received from BCM with CAN communication line.
AFS OFF IND [On/Off]		Status of AFS OFF indicator lamp judged from AFS OFF indicator lamp signal received from AFS control unit with CAN communication line.
4WAS/RAS W/L [On/Off]		Status of 4WAS warning lamp judged from 4WAS warning lamp signal received from 4WAS main control unit with CAN communication line.
DDS W/L [On/Off]		This item is displayed, but cannot be monitored.
LANE W/L [On/Off]		This item is displayed, but cannot be monitored.
LDP IND [On/Off]		This item is displayed, but cannot be monitored.

DIAGNOSIS SYSTEM (UNIFIED METER AND A/C AMP.)

< SYSTEM DESCRIPTION >

Display item [Unit]	MAIN SIGNALS	Description	A
LCD [B&P N, B&P I, ID NG, ROTAT, SFT P, INSRT, BATT, NO KY,OUTKY, LK WN, C&P N,C&P I]		Displays status of Intelligent Key system warning judged from meter display signal received from BCM with CAN communication line.	B
ACC TARGET [On/Off]		Status of vehicle ahead detection indicator judged from meter display signal received from ICC sensor integrated unit with CAN communication line.	C
ACC DISTANCE [Off, SHOR, MID, LONG]		Status of set distance indicator judged from meter display signal received from ICC sensor integrated unit with CAN communication line.	D
ACC OWN VHL [On/Off]		Status of own vehicle indicator judged from meter display signal received from ICC sensor integrated unit with CAN communication line.	E
ACC SET SPEED [On/Off]		Status of set vehicle speed indicator judged from meter display signal received from ICC sensor integrated unit with CAN communication line.	F
ACC UNIT [On/Off]		Status of display unit judged from meter display signal received from ICC sensor integrated unit with CAN communication line.	G
O/D OFF SW [On/Off]		This item is displayed, but cannot be monitored.	H
SHIFT IND [P, R, N, D, M1, M2, M3, M4, M5, M6, M7]		Status of shift position indicator judged from shift position signal and manual mode indicator signal received from TCM with CAN communication line.	I
AT S MODE SW [On/Off]		Status of snow mode switch.	J
AT P MODE SW [On/Off]		This item is displayed, but cannot be monitored.	K
M RANGE SW [On/Off]		Status of manual mode switch.	L
NM RANGE SW [On/Off]		Status of not manual mode switch.	M
AT SFT UP SW [On/Off]		Status of manual mode shift up switch.	WCS
AT SFT DWN SW [On/Off]		Status of manual mode shift down switch.	O
ST SFT UP SW [On/Off]		Status of paddle shifter up switch.	P
ST SFT DWN SW [On/Off]		Status of paddle shifter down switch.	
COMP FB SIG [On/Off]		A/C compressor activation condition that ECM judges according to the water temperature and the acceleration degree.	
4WD LOCK SW [Off]		This item is displayed, but cannot be monitored.	
PKB SW [On/Off]		Status of parking brake switch.	
BUCKLE SW [On/Off]		Status of seat belt buckle switch.	
BRAKE OIL SW [On/Off]		Status of brake fluid level switch.	
DISTANCE [km]		Value of possible driving distance calculated by unified meter and A/C amp.	
OUTSIDE TEMP [°C or °F]		Ambient air temperature value converted from ambient sensor signal received from ambient sensor. NOTE: This may not match with the temperature value indicated on the information display. (Because the information display value is a corrected value from the ambient sensor input value.)	

DIAGNOSIS SYSTEM (UNIFIED METER AND A/C AMP.)

< SYSTEM DESCRIPTION >

Display item [Unit]	MAIN SIGNALS	Description
FUEL LOW SIG [On/Off]		Status of fuel level low warning signal to output to AV control unit with CAN communication line.
BUZZER [On/Off]	X	Buzzer status (in the combination meter) is judged with the buzzer output signal received from each unit with CAN communication line and the warning output condition of the combination meter.

NOTE:

Some items are not available according to vehicle specification.

DIAGNOSIS SYSTEM (BCM)

< SYSTEM DESCRIPTION >

DIAGNOSIS SYSTEM (BCM)

COMMON ITEM

COMMON ITEM : CONSULT-III Function (BCM - COMMON ITEM)

INFOID:000000004675372

APPLICATION ITEM

CONSULT-III performs the following functions via CAN communication with BCM.

Diagnosis mode	Function Description
Work Support	Changes the setting for each system function.
Self Diagnostic Result	Displays the diagnosis results judged by BCM.
CAN Diag Support Monitor	Monitors the reception status of CAN communication viewed from BCM. Refer to CONSULT-III operation manual.
Data Monitor	The BCM input/output signals are displayed.
Active Test	The signals used to activate each device are forcibly supplied from BCM.
Ecu Identification	The BCM part number is displayed.
Configuration	This function is not used even though it is displayed.

SYSTEM APPLICATION

BCM can perform the following functions for each system.

NOTE:

It can perform the diagnosis modes except the following for all sub system selection items.

×: Applicable item

System	Sub system selection item	Diagnosis mode		
		Work Support	Data Monitor	Active Test
Door lock	DOOR LOCK	×	×	×
Rear window defogger	REAR DEFOGGER		×	×
Warning chime	BUZZER		×	×
Interior room lamp timer	INT LAMP	×	×	×
Exterior lamp	HEAD LAMP	×	×	×
Wiper and washer	WIPER	×	×	×
Turn signal and hazard warning lamps	FLASHER	×	×	×
—	AIR CONDITONER*			
• Intelligent Key system • Engine start system	INTELLIGENT KEY	×	×	×
Combination switch	COMB SW		×	
Body control system	BCM	×		
IVIS - NATS	IMMU		×	×
Interior room lamp battery saver	BATTERY SAVER	×	×	×
Trunk lid open	TRUNK		×	×
Vehicle security system	THEFT ALM	×	×	×
RAP system	RETAINED PWR		×	
Signal buffer system	SIGNAL BUFFER		×	×
TPMS	TPMS (AIR PRESSURE MONITOR)	×	×	×

NOTE:

*: This item is displayed, but is not used.

FREEZE FRAME DATA (FFD)

The BCM records the following vehicle condition at the time a particular DTC is detected, and displays on CONSULT-III.

DIAGNOSIS SYSTEM (BCM)

< SYSTEM DESCRIPTION >

CONSULT screen item	Indication/Unit	Description	
Vehicle Speed	km/h	Vehicle speed of the moment a particular DTC is detected	
Odo/Trip Meter	km	Total mileage (Odometer value) of the moment a particular DTC is detected	
Vehicle Condition	SLEEP>LOCK	Power position status of the moment a particular DTC is detected	While turning BCM status from low power consumption mode to normal mode (Power supply position is "LOCK")
	SLEEP>OFF		While turning BCM status from low power consumption mode to normal mode (Power supply position is "OFF".)
	LOCK>ACC		While turning power supply position from "LOCK" to "ACC"
	ACC>ON		While turning power supply position from "ACC" to "IGN"
	RUN>ACC		While turning power supply position from "RUN" to "ACC" (Vehicle is stopping and selector lever is except P position.)
	CRANK>RUN		While turning power supply position from "CRANKING" to "RUN" (From cranking up the engine to run it)
	RUN>URGENT		While turning power supply position from "RUN" to "ACC" (Emergency stop operation)
	ACC>OFF		While turning power supply position from "ACC" to "OFF"
	OFF>LOCK		While turning power supply position from "OFF" to "LOCK"
	OFF>ACC		While turning power supply position from "OFF" to "ACC"
	ON>CRANK		While turning power supply position from "IGN" to "CRANKING"
	OFF>SLEEP		While turning BCM status from normal mode (Power supply position is "OFF".) to low power consumption mode
	LOCK>SLEEP		While turning BCM status from normal mode (Power supply position is "LOCK".) to low power consumption mode
	LOCK		Power supply position is "LOCK" (Ignition switch OFF with steering is locked.)
	OFF		Power supply position is "OFF" (Ignition switch OFF with steering is unlocked.)
	ACC		Power supply position is "ACC" (Ignition switch ACC)
	ON		Power supply position is "IGN" (Ignition switch ON with engine stopped)
ENGINE RUN	Power supply position is "RUN" (Ignition switch ON with engine running)		
CRANKING	Power supply position is "CRANKING" (At engine cranking)		
IGN Counter	0 - 39	The number of times that ignition switch is turned ON after DTC is detected <ul style="list-style-type: none"> • The number is 0 when a malfunction is detected now. • The number increases like 1 → 2 → 3...38 → 39 after returning to the normal condition whenever ignition switch OFF → ON. • The number is fixed to 39 until the self-diagnosis results are erased if it is over 39. 	

BUZZER

BUZZER : CONSULT-III Function (BCM - BUZZER)

INFOID:000000004238408

CONSULT-III APPLICATION ITEMS

Test item	Diagnosis mode	Description
BUZZER	Data Monitor	Displays BCM input data in real time.
	Active Test	Operation of electrical loads can be checked by sending driving signal to them.

DATA MONITOR

DIAGNOSIS SYSTEM (BCM)

< SYSTEM DESCRIPTION >

Display item [Unit]	Description	
VEH SPEED 1 [Km/h]	Value of vehicle speed signal received from ABS actuator and electric unit (control unit) with CAN communication line.	A
PUSH SW [On/Off]	Status of push button ignition switch judged by BCM.	B
UNLK SEN-DR [On/Off]	Status of unlock sensor judged by BCM.	C
KEY SW-SLOT [On/Off]	Status of key slot judged by BCM.	D
TAIL LAMP SW [On/Off]	Status of each switch judged by BCM using the combination switch readout function.	E
FR FOG SW [On/Off]	Status of front fog lamp switch judged by BCM.	F
DOOR SW-DR [On/Off]	Status of driver side door switch judged by BCM.	F

ACTIVE TEST

Display item [Unit]	Description	
IGN KEY WARN ALM	The key warning chime operation can be checked by operating the relevant function (On/Off).	G
SEAT BELT WARN TEST	The seat belt warning chime operation can be checked by operating the relevant function (On/Off).	H
ID REGIST WARNING	The ID regist warning chime operation can be checked by operating the relevant function (On/Off).	I
LIGHT WARN ALM	The light warning chime operation can be checked by operating the relevant function (On/Off).	I
RUN FLAT/T WARN BUZZER	The run-flat tire warning chime operation can be checked by operating the relevant function (On/Off).	I

WCS

POWER SUPPLY AND GROUND CIRCUIT

< DTC/CIRCUIT DIAGNOSIS >

DTC/CIRCUIT DIAGNOSIS

POWER SUPPLY AND GROUND CIRCUIT COMBINATION METER

COMBINATION METER : Diagnosis Procedure

INFOID:000000004675456

1.CHECK FUSE

Check for blown fuses.

Power source	Fuse No.
Battery	11
Ignition switch ON or START	4

Is the inspection result normal?

YES >> GO TO 2.

NO >> Be sure to eliminate cause of malfunction before installing new fuse.

2.CHECK POWER SUPPLY CIRCUIT

Check voltage between combination meter harness connector terminal and ground.

Terminals		Ignition switch	Voltage (Approx.)
(+)	(-)		
Combination meter	Ground	OFF	Battery voltage
Connector		ON	
M53	1		
	21		

Is the inspection result normal?

YES >> GO TO 3.

NO >> Check harness between combination meter and fuse.

3.CHECK GROUND CIRCUIT

1. Turn ignition switch OFF.
2. Disconnect combination meter connector.
3. Check continuity between combination meter harness connector terminal and ground.

Combination meter		Ground	Continuity
Connector	Terminals		
M53	5	Ground	Existed
	15		
	22		

Is the inspection result normal?

YES >> INSPECTION END

NO >> Repair harness or connector.

UNIFIED METER AND A/C AMP.

UNIFIED METER AND A/C AMP. : Diagnosis Procedure

INFOID:000000004675457

1.CHECK FUSE

Check for blown fuses.

POWER SUPPLY AND GROUND CIRCUIT

< DTC/CIRCUIT DIAGNOSIS >

Power source	Fuse No.
Battery	11
Ignition switch ACC or ON	19
Ignition switch ON or START	3

Is the inspection result normal?

YES >> GO TO 2.

NO >> Be sure to eliminate cause of malfunction before installing new fuse.

2.CHECK POWER SUPPLY CIRCUIT

Check voltage between unified meter and A/C amp. harness connector terminal and ground.

Terminals		Ignition switch	Voltage (Approx.)
(+)	(-)		
Unified meter and A/C amp.	Ground	OFF	Battery voltage
Connector		ACC	
Terminals		ON	
M67	54		
	41		
	53		

Is the inspection result normal?

YES >> GO TO 3.

NO >> Check harness between unified meter and A/C amp. and fuse.

3.CHECK GROUND CIRCUIT

1. Turn ignition switch OFF.
2. Disconnect unified meter and A/C amp. connector.
3. Check continuity between unified meter and A/C amp. harness connector terminal and ground.

Unified meter and A/C amp.		Ground	Continuity
Connector	Terminals		
M67	55		Existed
	71		

Is the inspection result normal?

YES >> INSPECTION END

NO >> Repair harness or connector.

BCM (BODY CONTROL MODULE)

BCM (BODY CONTROL MODULE) : Diagnosis Procedure

INFOID:000000004675373

1.CHECK FUSE AND FUSIBLE LINK

Check that the following fuse and fusible link are not blown.

Signal name	Fuse and fusible link No.
Battery power supply	K
	10

Is the fuse fusing?

YES >> Replace the blown fuse or fusible link after repairing the affected circuit if a fuse or fusible link is blown.

NO >> GO TO 2.

2.CHECK POWER SUPPLY CIRCUIT

POWER SUPPLY AND GROUND CIRCUIT

< DTC/CIRCUIT DIAGNOSIS >

1. Turn ignition switch OFF.
2. Disconnect BCM connectors.
3. Check voltage between BCM harness connector and ground.

Terminals		Voltage (Approx.)
(+)	(-)	
BCM		Ground
Connector	Terminal	
M118	1	
M119	11	Battery voltage

Is the measurement value normal?

YES >> GO TO 3.

NO >> Repair harness or connector.

3.CHECK GROUND CIRCUIT

Check continuity between BCM harness connector and ground.

BCM		Ground	Continuity
Connector	Terminal		
M119	13		Existed

Does continuity exist?

YES >> INSPECTION END

NO >> Repair harness or connector.

METER BUZZER CIRCUIT

< DTC/CIRCUIT DIAGNOSIS >

METER BUZZER CIRCUIT

Description

INFOID:000000004238413

- The buzzer for warning chime system is installed in the combination meter.
- The combination meter sounds the alarm buzzer based on the signals transmitted from various units.

Component Function Check

INFOID:000000004238414

1. CHECK OPERATION OF METER BUZZER

1. Select "BUZZER" of "BCM" on CONSULT-III.
2. Perform "LIGHT WARN ALM" of "ACTIVE TEST".

Does meter buzzer beep?

- YES >> INSPECTION END
NO >> GO TO 2.

2. CHECK UNIFIED METER AND A/C AMP. INPUT SIGNAL

Select the "Data Monitor" for the "METER/M&A" and check the "BUZZER" monitor value.

BUZZER
Under the condition of buzzer input : ON
Except above : OFF

Is the inspection result normal?

- YES >> Replace combination meter.
NO >> Replace BCM. Refer to [BCS-82, "Removal and Installation"](#).

Diagnosis Procedure

INFOID:000000004238415

1. CHECK POWER SUPPLY OF COMBINATION METER

Check power supply of combination meter. Refer to [MWI-51, "COMBINATION METER : Diagnosis Procedure"](#).

Is the inspection result normal?

- YES >> GO TO 2.
NO >> Repair power supply circuit of combination meter.

2. CHECK BATTERY POWER SUPPLY OF UNIFIED METER AND A/C AMP.

Check battery power supply of unified meter and A/C amp. Refer to [MWI-51, "UNIFIED METER AND A/C AMP. : Diagnosis Procedure"](#).

Is the inspection result normal?

- YES >> INSPECTION END
NO >> Repair power supply circuit of unified meter and A/C amp.

A
B
C
D
E
F
G
H
I
J
K
L
M
O
P

WCS

SEAT BELT BUCKLE SWITCH SIGNAL CIRCUIT

< DTC/CIRCUIT DIAGNOSIS >

SEAT BELT BUCKLE SWITCH SIGNAL CIRCUIT

Description

INFOID:0000000046752.14

Transmits a seat belt buckle switch signal to the unified meter and A/C amp.

Component Function Check

INFOID:0000000046752.15

1.CHECK UNIFIED METER AND A/C AMP. INPUT SIGNAL

1. Connect the CONSULT-III.
2. Select the "Data Monitor" of the "METER/M&A" and check the "BUCKLE SW" monitor value.

"BUCKLE SW"

When seat belt is fastened : Off

When seat belt is unfastened : On

>> INSPECTION END

Diagnosis Procedure

INFOID:0000000046752.16

1.CHECK UNIFIED METER AND A/C AMP. INPUT SIGNAL

1. Turn ignition switch ON.
2. Check voltage between unified meter and A/C amp. harness connector terminal and ground.

Terminal		(-)	Condition	Voltage (Approx.)
(+)				
Combination meter	Connector			
M66	9	Ground	When seat belt is fastened	12 V
			When seat belt is unfastened	0 V

Is the inspection result normal?

YES >> Replace unified meter and A/C amp.

NO >> GO TO 2.

2.CHECK SEAT BELT BUCKLE SWITCH (DRIVER SIDE) SIGNAL CIRCUIT

1. Turn ignition switch OFF.
2. Disconnect unified meter and A/C amp. connector and seat belt buckle switch (driver side) connector.
3. Check continuity between unified meter and A/C amp. harness connector terminal and seat belt buckle switch (driver side) harness connector terminal.

Unified meter and A/C amp.		Seat belt buckle switch (driver side)		Continuity
Connector	Terminal	Connector	Terminal	
M66	9	B13	1	Existed

4. Check harness continuity between unified meter and A/C amp. harness connector terminal and ground.

Unified meter and A/C amp.		Ground	Continuity
Connector	Terminal		
M66	9		Not existed

Is the inspection result normal?

YES >> GO TO 3.

NO >> Repair harness or connector.

3.CHECK SEAT BELT BUCKLE SWITCH (DRIVER SIDE) GROUND CIRCUIT

SEAT BELT BUCKLE SWITCH SIGNAL CIRCUIT

< DTC/CIRCUIT DIAGNOSIS >

Check harness continuity between seat belt buckle switch (driver side) harness connector terminal and ground.

Seat belt buckle switch (driver side)		Ground	Continuity
Connector	Terminal		
B13	2		Existed

Is the inspection result normal?

YES >> INSPECTION END

NO >> Repair harness or connector.

Component Inspection

INFOID:000000004675217

1. CHECK SEAT BELT BUCKLE SWITCH (DRIVER SIDE)

1. Turn ignition switch OFF.
2. Disconnect the seat belt buckle switch (driver side) connector.
3. Check continuity between terminals 1 and 2.

Terminal		Seat belt buckle switch (driver side)	Continuity
1	2	When seat belt is fastened	Not existed
		When seat belt is unfastened	Existed

Is the inspection result normal?

YES >> INSPECTION END

NO >> Replace the seat belt buckle switch (driver side). Refer to [SB-8, "SEAT BELT BUCKLE : Removal and Installation"](#).

WCS

WARNING CHIME SYSTEM

< DTC/CIRCUIT DIAGNOSIS >

WARNING CHIME SYSTEM

Wiring Diagram - WARNING CHIME -

INFOID:000000004238420

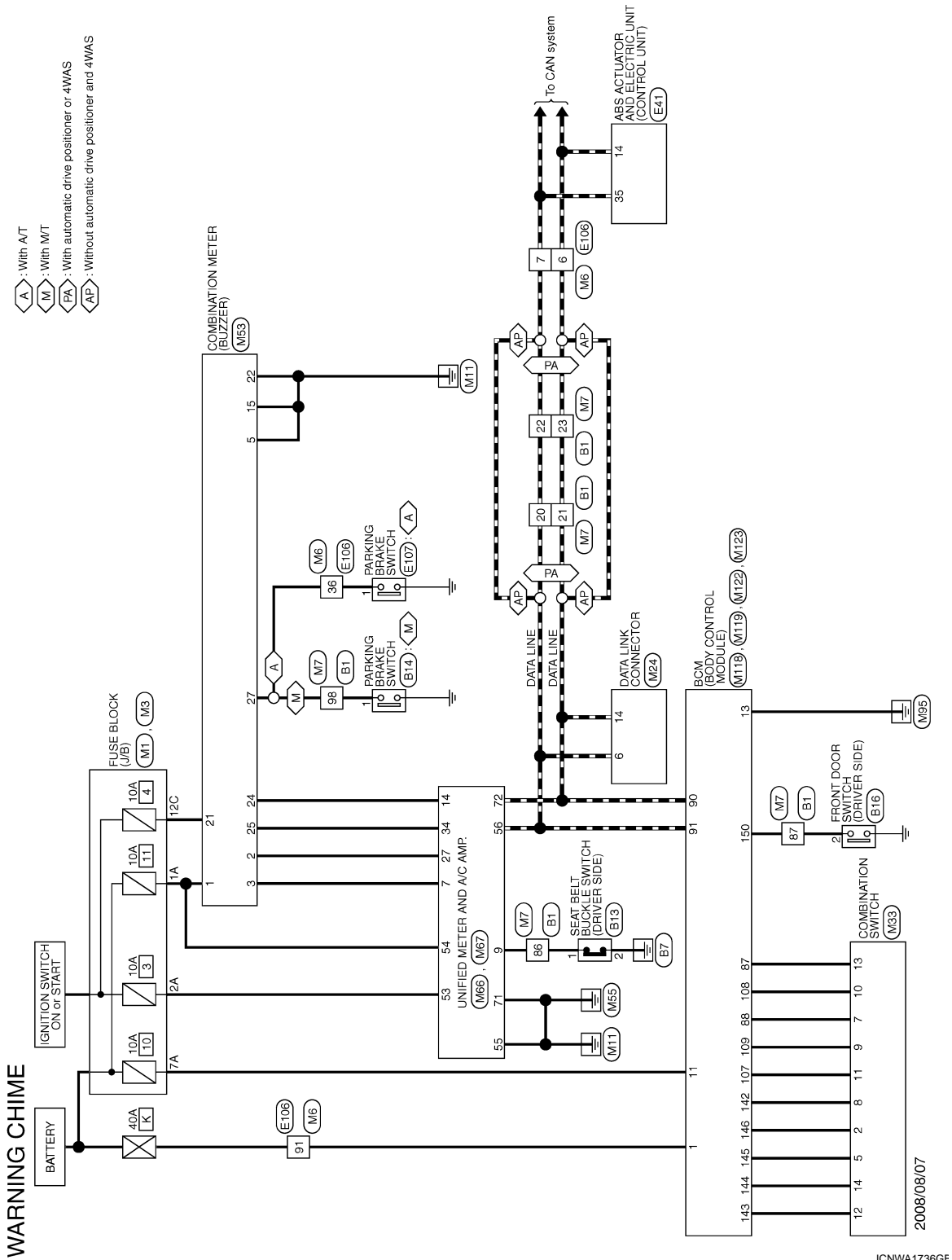

WARNING CHIME SYSTEM

< DTC/CIRCUIT DIAGNOSIS >

WARNING CHIME

Connector No.	B1
Connector Name	WIRE TO WIRE
Connector Type	TH80FW-CS16-TM4



Terminal No.	Color of Wire	Signal Name [Specification]
20	L	-
21	P	-
22	L	-
23	P	-
86	SB	-
87	B	-
98	V	-

Connector No.	B13
Connector Name	SEAT BELT BUCKLE SWITCH (DRIVER SIDE)
Connector Type	A03FW

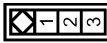

Terminal No.	Color of Wire	Signal Name [Specification]
1	SB	-
2	B	-

Connector No.	B14
Connector Name	PARKING BRAKE SWITCH (WITH M/T)
Connector Type	P01FB-A



Terminal No.	Color of Wire	Signal Name [Specification]
1	V	-

Connector No.	B16
Connector Name	FRONT DOOR SWITCH (DRIVER SIDE)
Connector Type	A03FW

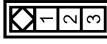

Terminal No.	Color of Wire	Signal Name [Specification]
2	B	-

Connector No.	E41
Connector Name	ABS ACTUATOR AND ELECTRIC UNIT (CONTROL UNIT)
Connector Type	BA442FB-AT24-LH



Terminal No.	Color of Wire	Signal Name [Specification]
14	P	CAN-L
35	L	CAN-H

Connector No.	E106
Connector Name	WIRE TO WIRE
Connector Type	TH80FW-CS16-TM4

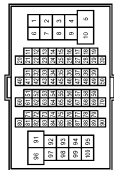

Terminal No.	Color of Wire	Signal Name [Specification]
6	P	-
7	L	-
.36	O	-
91	W	-

Connector No.	E107
Connector Name	PARKING BRAKE SWITCH (WITH A/T)
Connector Type	TB01FW



Terminal No.	Color of Wire	Signal Name [Specification]
1	O	-

Connector No.	M1
Connector Name	FUSE BLOCK (J/B)
Connector Type	NS06FW-M2



Terminal No.	Color of Wire	Signal Name [Specification]
1A	V	-
2A	G	-
7A	R	-

A
B
C
D
E
F
G
H
I
J
K
L
M
O
P

WCS

WARNING CHIME SYSTEM

< DTC/CIRCUIT DIAGNOSIS >

WARNING CHIME

Connector No.	M3
Connector Name	FUSE BLOCK (J/B)
Connector Type	NS12FW-CS

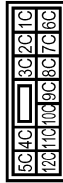

Terminal No.	Color of Wire	Signal Name [Specification]
12C	R	-

Connector No.	M6
Connector Name	WIRE TO WIRE
Connector Type	TH80MW-CS (B-TM4)



Terminal No.	Color of Wire	Signal Name [Specification]
6	P	-
7	L	-
36	O	-
91	W	-

Connector No.	M7
Connector Name	WIRE TO WIRE
Connector Type	TH80MW-CS (B-TM4)



Terminal No.	Color of Wire	Signal Name [Specification]
20	L	-
21	P	-
22	L	-
23	P	-
86	L	-
87	GR	-
98	O	-

Connector No.	M24
Connector Name	DATA LINK CONNECTOR
Connector Type	BD18FW-P

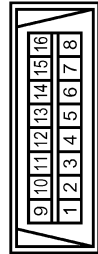

Terminal No.	Color of Wire	Signal Name [Specification]
6	L	-
14	P	-

Connector No.	M33
Connector Name	COMBINATION SWITCH
Connector Type	TH18FW-NH

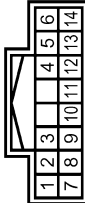

Terminal No.	Color of Wire	Signal Name [Specification]
2	SB	OUTPUT 4
5	L	OUTPUT 3
7	O	INPUT 3
8	BR	OUTPUT 5
9	W	INPUT 2
10	R	INPUT 4
11	LG	INPUT 1
12	P	OUTPUT 1
13	Y	INPUT 5
14	G	OUTPUT 2

Connector No.	M53
Connector Name	COMBINATION METER
Connector Type	SAB40FW



Terminal No.	Color of Wire	Signal Name [Specification]
1	V	BATTERY POWER SUPPLY
2	LG	COMMUNICATION SIGNAL (METER->METER)
3	GR	COMMUNICATION SIGNAL (AMP->METER)
5	B	GROUND
15	B	GROUND
21	R	IGNITION SIGNAL
22	B	GROUND
24	BR	COMMUNICATION SIGNAL (LCD->AMP)
25	Y	COMMUNICATION SIGNAL (AMP->LCD)
27	O	PARKING BRAKE SWITCH SIGNAL

Connector No.	M66
Connector Name	UNIFIED METER AND A/C AMP.
Connector Type	TH40FW-NH

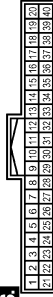

Terminal No.	Color of Wire	Signal Name [Specification]
7	GR	COMMUNICATION SIGNAL (AMP->METER)
9	SD	SEAT BELT BUCKLE SWITCH SIGNAL (DRIVER SIDE)
14	BR	COMMUNICATION SIGNAL (LCD->AMP)
27	LG	COMMUNICATION SIGNAL (METER->AMP)
34	Y	COMMUNICATION SIGNAL (AMP->LCD)

Connector No.	M67
Connector Name	UNIFIED METER AND A/C AMP.
Connector Type	TH32FW-NH



Terminal No.	Color of Wire	Signal Name [Specification]
53	W	IGNITION POWER SUPPLY
54	Y	BATTERY POWER SUPPLY
55	B	GROUND
56	L	CAN-H
71	GR	GROUND
72	P	CAN-L

WARNING CHIME SYSTEM

< DTC/CIRCUIT DIAGNOSIS >

WARNING CHIME

Connector No.	M118
Connector Name	BCM (BODY CONTROL MODULE)
Connector Type	MS8FE-LC



Terminal No.	Color of Wire	Signal Name [Specification]
1	W	BAT (F/L)

Connector No.	M119
Connector Name	BCM (BODY CONTROL MODULE)
Connector Type	NS16FW-CS



Terminal No.	Color of Wire	Signal Name [Specification]
11	R	BAT (FUSE)
13	B	GND

Connector No.	M122
Connector Name	BCM (BODY CONTROL MODULE)
Connector Type	TH40FB-NH



Terminal No.	Color of Wire	Signal Name [Specification]
87	Y	COMBI SW INPUT 5
88	O	COMBI SW INPUT 3
90	P	CAN-L
91	L	CAN-H
107	LG	COMBI SW INPUT 1
108	R	COMBI SW INPUT 4
109	W	COMBI SW INPUT 2

Connector No.	M123
Connector Name	BCM (BODY CONTROL MODULE)
Connector Type	TH40FC-NH



Terminal No.	Color of Wire	Signal Name [Specification]
142	BR	COMBI SW OUTPUT 5
143	P	COMBI SW OUTPUT 1
144	G	COMBI SW OUTPUT 2
145	L	COMBI SW OUTPUT 3
146	SB	COMBI SW OUTPUT 4
150	GR	DRIVER DOOR SW

A
B
C
D
E
F
G
H
I
J
K
L
M
O
P

WCS

JCNWA1739GE

COMBINATION METER

< ECU DIAGNOSIS INFORMATION >

ECU DIAGNOSIS INFORMATION

COMBINATION METER

Reference Value

INFOID:000000004675206

VALUES ON THE DIAGNOSIS TOOL

Refer to [WCS-44. "Reference Value"](#).

TERMINAL LAYOUT

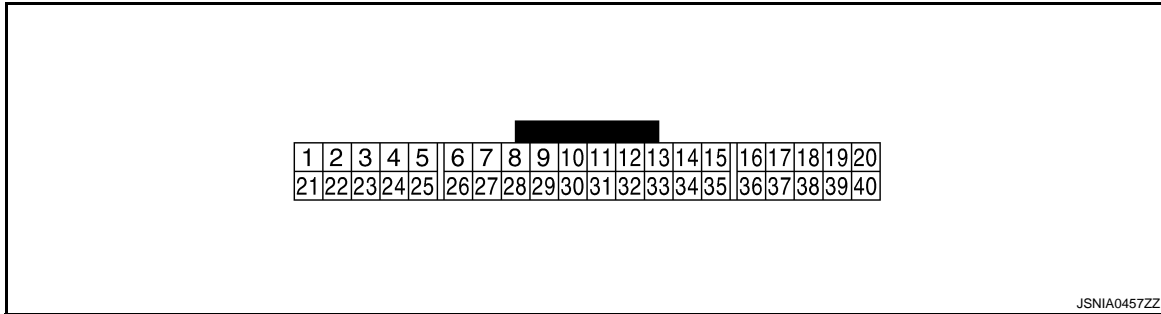

PHYSICAL VALUES

Terminal No. (Wire color)		Description		Condition		Value (Approx.)
+	-	Signal name	Input/ Output			
1 (V)	Ground	Battery power supply	Input	Ignition switch OFF	—	Battery voltage
2 (LG)	Ground	Communication signal (METER→ AMP.)	Output	Ignition switch ON	—	<p style="text-align: right; font-size: x-small;">JSNIA0027GB</p>
3 (GR)	Ground	Communication signal (AMP.→ METER)	Input	Ignition switch ON	—	<p style="text-align: right; font-size: x-small;">JSNIA0027GB</p>
5 (B)	Ground	Ground	—	Ignition switch ON	—	0 V
6 (W)	Ground	Alternator signal	Input	Ignition switch ON	Charge warning lamp ON	0 V
					Charge warning lamp OFF	12 V
7 (LG)	Ground	Air bag signal	Input	Ignition switch ON	Air bag warning lamp ON	4 V
					Air bag warning lamp OFF	0 V
10 (R)	Ground	Security signal	Input	Ignition switch OFF	Security warning lamp ON	0 V
					Security warning lamp OFF	12 V

COMBINATION METER

< ECU DIAGNOSIS INFORMATION >

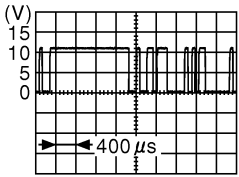
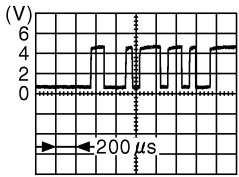
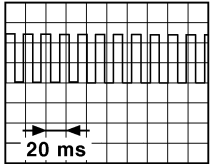
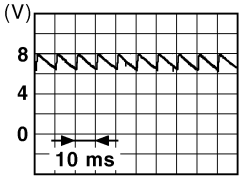
Terminal No. (Wire color)		Description		Condition		Value (Approx.)
+	-	Signal name	Input/ Output			
15 (B)	Ground	Ground	—	Ignition switch ON	—	0 V
16 (BR)	Ground	Meter control switch ground	—	Ignition switch ON	—	0 V
21 (R)	Ground	Ignition signal	Input	Ignition switch ON	—	12 V
22 (B)	Ground	Ground	—	Ignition switch ON	—	0 V
24 (BR)	Ground	Communication signal (LCD→ AMP.)	Output	Ignition switch ON	—	 <small>JSNIA0028GB</small>
25 (Y)	Ground	Communication signal (AMP.→ LCD)	Input	Ignition switch ON	—	 <small>JSNIA0027GB</small>
26 (R)	Ground	Vehicle speed signal (8-pulse)	Input	Ignition switch ON	Speedometer operated [When vehicle speed is ap- prox. 40 km/h (25 MPH)]	<p>NOTE: The maximum voltage varies de- pending on the specification (destination unit).</p>  <small>JSNIA0012GB</small>
27 (O)	Ground	Parking brake switch signal	Input	Ignition switch ON	Parking brake ON	0 V
					Parking brake OFF	 <small>JSNIA0007GB</small>

A
B
C
D
E
F
G
H
I
J
K
L
M
O
P

WCS

COMBINATION METER

< ECU DIAGNOSIS INFORMATION >

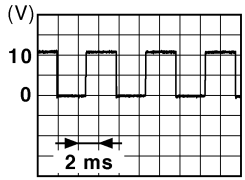
Terminal No. (Wire color)		Description		Condition	Value (Approx.)
+	-	Signal name	Input/ Output		
28 (SB)	Ground	Brake fluid level switch signal	Input	Ignition switch ON	Brake fluid level is normal.
					The brake fluid level is lower than the low level
29 (L)	Ground	Seat belt buckle switch signal (driver side)	Input	Ignition switch ON	When driver seat belt is fastened
					When driver seat belt is unfastened
30 (G)	Ground	Seat belt buckle switch signal (passenger side)	Input	Ignition switch ON	<ul style="list-style-type: none"> When getting in the passenger seat When passenger seat belt is fastened
					<ul style="list-style-type: none"> When getting in the passenger seat When passenger seat belt is unfastened
31 (L)	Ground	Washer level switch signal	Input	Ignition switch ON	Washer level switch ON
					Washer level switch OFF
33 (R)	Ground	Illumination control signal	Output	Ignition switch ON	Lighting switch ON, then operate the illumination control switch.
					NOTE: When brightness level is midway 
36 (LG)	16 (BR)	Select switch signal	Input	Ignition switch ON	When ● is pressed
					Other than the above
37 (SB)	16 (BR)	Enter switch signal	Input	Ignition switch ON	When □ is pressed
					Other than the above
38 (L)	16 (BR)	Trip A/B reset switch signal	Input	Ignition switch ON	When trip A/B reset switch is pressed
					Other than the above
39 (P)	16 (BR)	Illumination control switch signal (-)	Input	Ignition switch ON	When ⏻ switch is pressed
					Other than the above
40 (O)	16 (BR)	Illumination control switch signal (+)	Input	Ignition switch ON	When ⏩ switch is pressed
					Other than the above

COMBINATION METER

< ECU DIAGNOSIS INFORMATION >

Wiring Diagram - METER -

INFOID:000000004675207

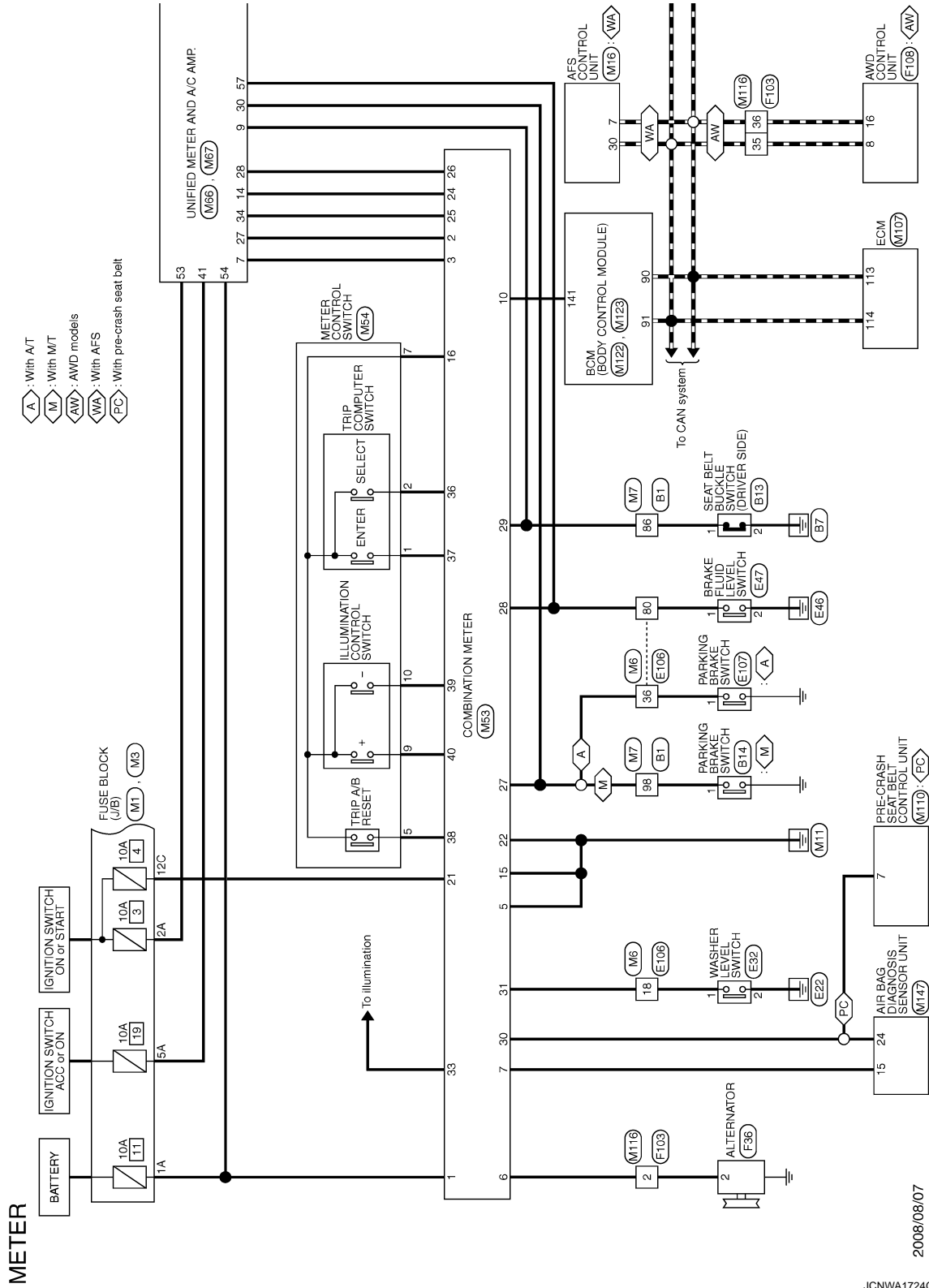

2008/08/07

JCNWA1724GE

A
B
C
D
E
F
G
H
I
J
K
L
M
N
O
P

WCS

COMBINATION METER

< ECU DIAGNOSIS INFORMATION >

- <A> : With A/T
- <NV> : With NAVI
- <ON> : Without NAVI
- <AS> : With 4WAS
- <FA> : With automatic drive positioner or 4WAS
- <AP> : Without automatic drive positioner and 4WAS
- <SS> : With paddle shifter

*: This connector is not shown in "Harness Layout".

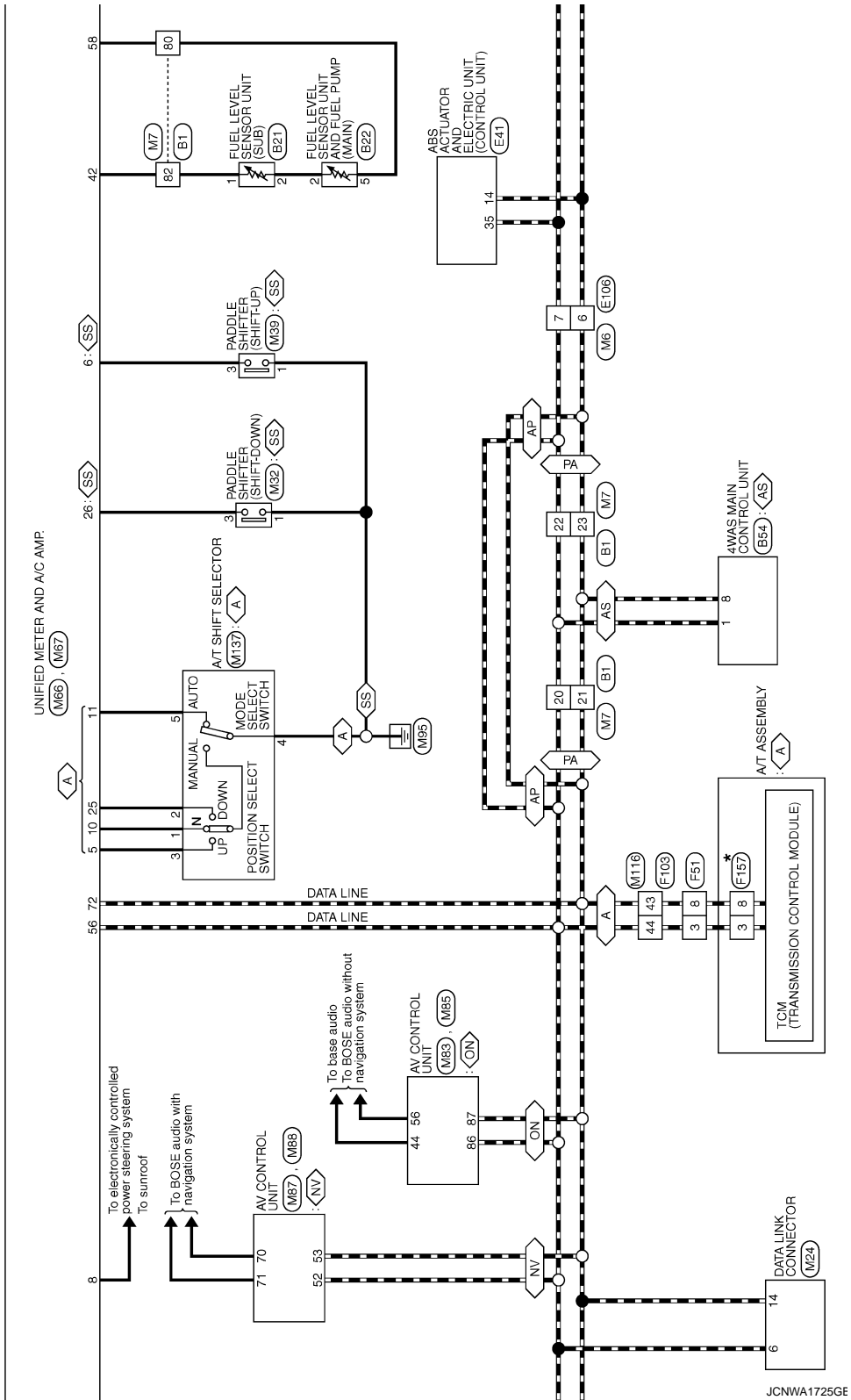

JCNWA1725GE

COMBINATION METER

< ECU DIAGNOSIS INFORMATION >

Ⓜ : With ICC

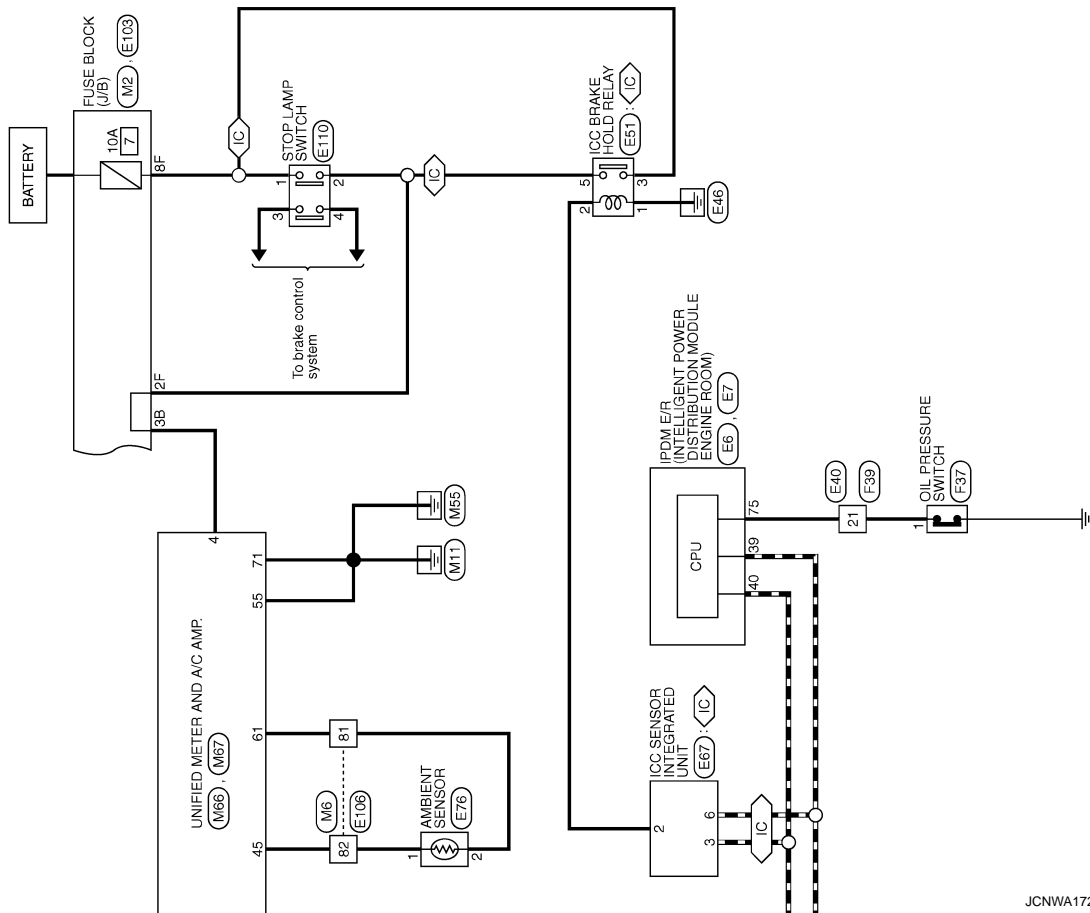

JCNWA1726GE













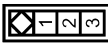

A
B
C
D
E
F
G
H
I
J
K
L
M
N
O
P

WCS

COMBINATION METER

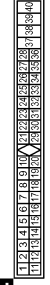
< ECU DIAGNOSIS INFORMATION >

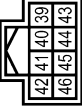
METER

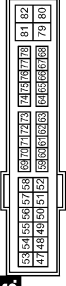
Connector No. B1	WIRE TO WIRE THBDFW-GS16-TM4	 	Terminal No.	Color of Wire	Signal Name [Specification]
			20	L	
			21	P	
			22	L	
			23	P	
			80	Y	
			82	B	- [With A/T]
			86	SB	- [With M/T]
			98	V	
Connector No. B2	FUEL LEVEL SENSOR UNIT AND FUEL PUMP (MAN) EGDFGY-RS	 	Terminal No.	Color of Wire	Signal Name [Specification]
			2	W	
			5	Y	
Connector No. B13	SEAT BELT BUCKLE SWITCH (DRIVER SIDE) A3BFW	 	Terminal No.	Color of Wire	Signal Name [Specification]
			1	SB	
			2	B	
Connector No. B14	PARKING BRAKE SWITCH (WITH M/T) P01FB-A	 	Terminal No.	Color of Wire	Signal Name [Specification]
			1	V	
Connector No. B21	FUEL LEVEL SENSOR UNIT (SUB) EGDFGY-RS	 	Terminal No.	Color of Wire	Signal Name [Specification]
			1	B	
			2	W	
Connector No. B54	4WAS MAIN CONTROL UNIT A3BFW-M4	 	Terminal No.	Color of Wire	Signal Name [Specification]
			1	L	
			8	P	CAN-H
					CAN-L
Connector No. E6	FROM I/R INTELLIGENT POWER DISTRIBUTION MODULE (ENGINE ROOM) THBDFW-NH	 	Terminal No.	Color of Wire	Signal Name [Specification]
			39	P	
			40	L	
Connector No. E7	FROM I/R INTELLIGENT POWER DISTRIBUTION MODULE (ENGINE ROOM) THBDFW-CS12-NH	 	Terminal No.	Color of Wire	Signal Name [Specification]
			75	SB	

JCNWA1727GE

COMBINATION METER

< ECU DIAGNOSIS INFORMATION >

METER

Connector No.	E32
Connector Name	WASHER LEVEL SWITCH
Connector Type	Z02FBR



Terminal No.	Color of Wire	Signal Name [Specification]
1	LG	-
2	B	-

Connector No.	E40
Connector Name	WIRE TO WIRE
Connector Type	SXA38MB-RSS-SHZ8

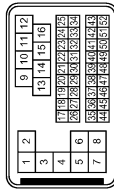

Terminal No.	Color of Wire	Signal Name [Specification]
21	SB	-

Connector No.	E41
Connector Name	ABS ACTUATOR AND ELECTRIC UNIT (CONTROL UNIT)
Connector Type	BAA42FB-AH24-LH



Terminal No.	Color of Wire	Signal Name [Specification]
14	P	CAN-L
35	L	CAN-H

Connector No.	E47
Connector Name	BRAKE FLUID LEVEL SWITCH
Connector Type	Y102FGY



Terminal No.	Color of Wire	Signal Name [Specification]
1	R	-
2	B	-

Connector No.	E51
Connector Name	ICC BRAKE HOLD RELAY
Connector Type	MS22FL-W2



Terminal No.	Color of Wire	Signal Name [Specification]
1	B	-
2	SB	-
3	L	-
5	W	-

Connector No.	E67
Connector Name	ICC SENSOR INTEGRATED UNIT
Connector Type	RS06FB-PR



Terminal No.	Color of Wire	Signal Name [Specification]
2	SB	BRAKE HOLD RELY DRIVE SIGNAL
3	L	CAN-H
6	P	CAN-L

Connector No.	E76
Connector Name	AMBIENT SENSOR
Connector Type	RS02FB



Terminal No.	Color of Wire	Signal Name [Specification]
1	G	-
2	P	-

Connector No.	E103
Connector Name	FUSE BLOCK (J/B)
Connector Type	NS16FY-CS



Terminal No.	Color of Wire	Signal Name [Specification]
2F	W	-
8F	L	-

A
B
C
D
E
F
G
H
I
J
K
L
M
O
P

WCS

COMBINATION METER

< ECU DIAGNOSIS INFORMATION >

METER

Connector No.	F36
Connector Name	ALTERNATOR
Connector Type	HS36FB



Terminal No.	Color of Wire	Signal Name [Specification]
2	G	L

Connector No.	E110
Connector Name	STOP LAMP SWITCH
Connector Type	MS4FW-LC



Terminal No.	Color of Wire	Signal Name [Specification]
1	L	-
2	W	-
3	L	-
4	SB	-

Connector No.	E107
Connector Name	PARKING BRAKE SWITCH (WITH A/T)
Connector Type	TE01FW



Terminal No.	Color of Wire	Signal Name [Specification]
1	O	-

Connector No.	E106
Connector Name	WIRE TO WIRE
Connector Type	TH06FW-GS16-TM4

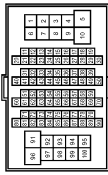

Terminal No.	Color of Wire	Signal Name [Specification]
6	P	-
7	L	-
18	LG	-
36	O	-
80	R	-
81	P	-
82	G	-

Connector No.	F103
Connector Name	WIRE TO WIRE
Connector Type	TK36FW-NS10

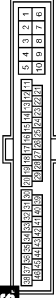

Terminal No.	Color of Wire	Signal Name [Specification]
2	G	-
35	L	-
36	P	-
43	P	-
44	L	-

Connector No.	F51
Connector Name	A/T ASSEMBLY
Connector Type	RK10FG-DGY

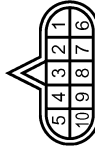

Terminal No.	Color of Wire	Signal Name [Specification]
3	L	-
8	P	-

Connector No.	F39
Connector Name	WIRE TO WIRE
Connector Type	SA36FB-RSS-SH23

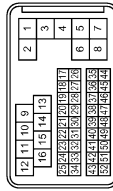

Terminal No.	Color of Wire	Signal Name [Specification]
21	Y	-

Connector No.	F37
Connector Name	OIL PRESSURE SWITCH
Connector Type	ED1GY-RS-AR



Terminal No.	Color of Wire	Signal Name [Specification]
1	Y	-

JCNWA1729GE

COMBINATION METER

< ECU DIAGNOSIS INFORMATION >

METER

Connector No.	F108
Connector Name	AWD CONTROL UNIT
Connector Type	TH16FW-NH

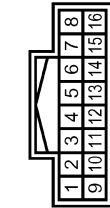

Terminal No.	Color of Wire	Signal Name [Specification]
8	L	CAN-H
16	P	CAN-L

Connector No.	F157
Connector Name	TOM (TRANSMISSION CONTROL MODULE)
Connector Type	SPT0FG

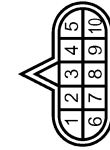

Terminal No.	Color of Wire	Signal Name [Specification]
3	R	CAN-H
8	BR	CAN-L

Connector No.	M1
Connector Name	FUSE BLOCK (J/B)
Connector Type	NS36FW-M2

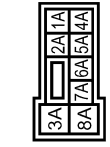

Terminal No.	Color of Wire	Signal Name [Specification]
1A	V	
2A	G	
5A	L	

Connector No.	M2
Connector Name	FUSE BLOCK (J/B)
Connector Type	NS10FY-CS

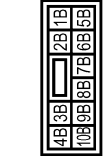

Terminal No.	Color of Wire	Signal Name [Specification]
3B	P	

Connector No.	M3
Connector Name	FUSE BLOCK (J/B)
Connector Type	NS12FW-CS

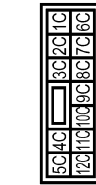

Terminal No.	Color of Wire	Signal Name [Specification]
12C	R	

Connector No.	M6
Connector Name	WIRE TO WIRE
Connector Type	TH60MW-CS16-TM4



Terminal No.	Color of Wire	Signal Name [Specification]
6	P	
7	L	
18	L	
36	O	
80	SR	
81	R	
82	V	

Connector No.	M7
Connector Name	WIRE TO WIRE
Connector Type	TH60MW-CS16-TM4



Terminal No.	Color of Wire	Signal Name [Specification]
20	L	
22	L	
23	P	
80	Y	
82	BR	- [With A/T]
86	B	- [With M/T]
88	O	

Connector No.	M16
Connector Name	AFS CONTROL UNIT
Connector Type	TH46FW-NH

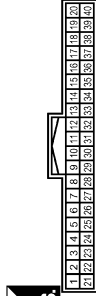

Terminal No.	Color of Wire	Signal Name [Specification]
7	P	CAN-L
30	L	CAN-H

JCNWA1730GE

A
B
C
D
E
F
G
H
I
J
K
L
M
O
P

WCS

COMBINATION METER

< ECU DIAGNOSIS INFORMATION >

METER

Connector No.	M24
Connector Name	DATA LINK CONNECTOR
Connector Type	BD16FW-P



Terminal No.	Color of Wire	Signal Name [Specification]
6	L	-
14	P	-

Connector No.	M32
Connector Name	PADDLE SHIFTER (SHIFT-DOWN)
Connector Type	A03FW

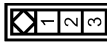

Terminal No.	Color of Wire	Signal Name [Specification]
1	W	-
3	G	-

Connector No.	M39
Connector Name	PADDLE SHIFTER (SHIFT-UP)
Connector Type	A04FW



Terminal No.	Color of Wire	Signal Name [Specification]
1	P	-
3	O	-

Connector No.	M53
Connector Name	COMBINATION METER
Connector Type	SAB4FW

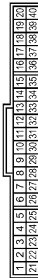

Terminal No.	Color of Wire	Signal Name [Specification]
1	V	BATTERY POWER SUPPLY
2	LG	COMMUNICATION SIGNAL (METER->AMP.)
3	GR	COMMUNICATION SIGNAL (AMP->METER)
5	B	GROUND
6	W	ALTERNATOR SIGNAL
7	LG	AIR BAG SIGNAL
10	R	SECURITY SIGNAL
15	B	GROUND
16	BR	METER CONTROL SWITCH GROUND
21	R	IGNITION SIGNAL
22	B	GROUND

24	BR	COMMUNICATION SIGNAL (LCD->AMP.)
25	V	COMMUNICATION SIGNAL (AMP->LCD)
26	R	VEHICLE SPEED SIGNAL (PULSE)
27	O	PARKING BRAKE SWITCH SIGNAL
28	SB	BRAKE FLUID LEVEL SWITCH
29	L	SEAT BELT BUCKLE SWITCH (DRIVER SIDE)
30	G	SEAT BELT BUCKLE SWITCH SIGNAL (PASSENGER SIDE)
31	L	WASHER LEVEL SWITCH SIGNAL
33	R	ILLUMINATION CONTROL SIGNAL
36	LG	SELECT SWITCH SIGNAL
37	SB	ENTER SWITCH SIGNAL
38	L	TRIP A/B RESET SWITCH SIGNAL
39	P	ILLUMINATION CONTROL SWITCH SIGNAL (-)
40	O	ILLUMINATION CONTROL SWITCH SIGNAL (+)

Connector No.	M54
Connector Name	METER CONTROL SWITCH
Connector Type	TH12FW-NH

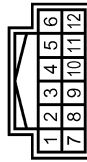

Terminal No.	Color of Wire	Signal Name [Specification]
1	SB	-
2	LG	-
5	L	-
7	BR	-
9	O	-
10	P	-

COMBINATION METER

< ECU DIAGNOSIS INFORMATION >

METER

71	GR	GROUND
72	P	CAN-L

Connector No.	M87
Connector Name	UNIFIED METER AND A/C AMP.
Connector Type	TH42FW-NH



41	42	43	44	45	46	47	48	49	50	51	52	53	54	55	56
----	----	----	----	----	----	----	----	----	----	----	----	----	----	----	----

Terminal No.	Color of Wire	Signal Name [Specification]
41	L	ACC POWER SUPPLY
42	BR	FUEL LEVEL SENSOR SIGNAL [With A/T]
43	B	FUEL LEVEL SENSOR SIGNAL [With M/T]
44	V	AMBIENT SENSOR SIGNAL
45	W	IGNITION POWER SUPPLY
54	Y	BATTERY POWER SUPPLY
55	B	GROUND
56	L	CAN-H
57	LG	BRAKE FLUID LEVEL SWITCH
58	Y	FUEL LEVEL SENSOR GROUND
61	R	AMBIENT SENSOR GROUND

27	LG	COMMUNICATION SIGNAL (METER->AMP.)
28	R	VEHICLE SPEED SIGNAL (8-PULSE)
30	V	PARKING BRAKE SWITCH SIGNAL
34	Y	COMMUNICATION SIGNAL (AMP->LCD)



1	2	3	4	5	6	7	8	9	10	11	12	13	14	15	16	17	18	19	20
---	---	---	---	---	---	---	---	---	----	----	----	----	----	----	----	----	----	----	----

Terminal No.	Color of Wire	Signal Name [Specification]
4	G	STOP LAMP SWITCH SIGNAL
5	L	MANUAL MODE SHIFT UP SIGNAL
6	O	PADDLE SHIFTER UP SIGNAL
7	GR	COMMUNICATION SIGNAL (AMP->METER)
8	L	VEHICLE SPEED SIGNAL (2-PULSE)
9	SB	SEAT BELT BUCKLE SWITCH SIGNAL (DRIVER SIDE)
10	W	MANUAL MODE SIGNAL
11	G	NOT MANUAL MODE SIGNAL
14	BR	COMMUNICATION SIGNAL (LCD->AMP.)
25	V	MANUAL MODE SHIFT DOWN SIGNAL
28	G	PADDLE SHIFTER DOWN SIGNAL

Connector No.	M86
Connector Name	UNIFIED METER AND A/C AMP.
Connector Type	TH40FW-NH



1	2	3	4	5	6	7	8	9	10	11	12	13	14	15	16	17	18	19	20
---	---	---	---	---	---	---	---	---	----	----	----	----	----	----	----	----	----	----	----

Connector No.	M88
Connector Name	AV CONTROL UNIT (WITH NAVI)
Connector Type	TH12FW-NH



62	64	66	68	70	72
61	63	65	67	69	71

Connector No.	M87
Connector Name	AV CONTROL UNIT (WITH NAVI)
Connector Type	TH40FW-NH



22	24	26	28	30	32	34	36	38	40	42	44	46	48	50	52	54	56	58	60
21	23	25	27	29	31	33	35	37	39	41	43	45	47	49	51	53	55	57	59

Connector No.	M85
Connector Name	AV CONTROL UNIT (WITHOUT NAVI)
Connector Type	TH42FW-NH



31	33	35	37	39	41	43	45	47	49	51	53	55	57	59	61	63	65	67	69	71	73	75	77	79	
107	109	111	113	115	117	119	121	123	125	127	129	131	133	135	137	139	141	143	145	147	149	151	153	155	157

Connector No.	M83
Connector Name	AV CONTROL UNIT (WITHOUT NAVI)
Connector Type	TH42FW-NH



47	48	45	44	43	42	41	40	39	38	37	36
59	58	57	56	55	54	53	52	51	50	49	48

Terminal No.	Color of Wire	Signal Name [Specification]
70	L	COMM (CONT->DISP)
71	LG	COMM (DISP->CONT)

Terminal No.	Color of Wire	Signal Name [Specification]
52	L	CAN-H
53	P	CAN-L

Terminal No.	Color of Wire	Signal Name [Specification]
86	L	CAN-H
87	P	CAN-L

Terminal No.	Color of Wire	Signal Name [Specification]
44	BR	COMM (DISP->CONT)
56	Y	COMM (CONT->DISP)

A
B
C
D
E
F
G
H
I
J
K
L
M
O
P

WCS

COMBINATION METER

< ECU DIAGNOSIS INFORMATION >

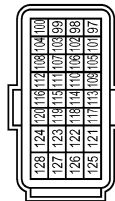
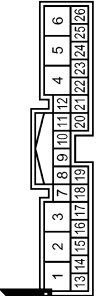
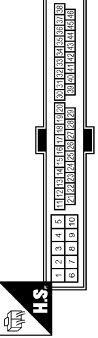
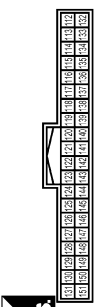
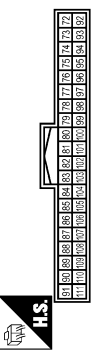
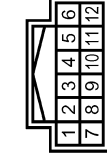
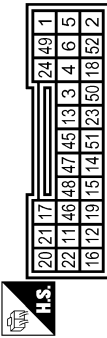
METER	<table border="1"> <tr><td>Connector No.</td><td>M107</td></tr> <tr><td>Connector Name</td><td>ECM</td></tr> <tr><td>Connector Type</td><td>RH24FGY-RZ6-R-LH-Z</td></tr> </table>  <table border="1"> <tr><td>Terminal No.</td><td>113</td><td>P</td></tr> <tr><td>Terminal No.</td><td>114</td><td>L</td></tr> </table> <table border="1"> <tr><td>Color of Wire</td><td>Signal Name [Specification]</td></tr> <tr><td>P</td><td>VEHCAN-LI</td></tr> <tr><td>L</td><td>VEHCAN-HI</td></tr> </table>	Connector No.	M107	Connector Name	ECM	Connector Type	RH24FGY-RZ6-R-LH-Z	Terminal No.	113	P	Terminal No.	114	L	Color of Wire	Signal Name [Specification]	P	VEHCAN-LI	L	VEHCAN-HI	<table border="1"> <tr><td>Connector No.</td><td>M10</td></tr> <tr><td>Connector Name</td><td>PRE-CRASH SEAT BELT CONTROL UNIT</td></tr> <tr><td>Connector Type</td><td>TH20FW-1E6</td></tr> </table>  <table border="1"> <tr><td>Terminal No.</td><td>7</td><td>G</td></tr> </table> <table border="1"> <tr><td>Color of Wire</td><td>Signal Name [Specification]</td></tr> <tr><td>G</td><td>INDICATOR</td></tr> </table>	Connector No.	M10	Connector Name	PRE-CRASH SEAT BELT CONTROL UNIT	Connector Type	TH20FW-1E6	Terminal No.	7	G	Color of Wire	Signal Name [Specification]	G	INDICATOR	<table border="1"> <tr><td>Connector No.</td><td>M116</td></tr> <tr><td>Connector Name</td><td>WIRE TO WIRE</td></tr> <tr><td>Connector Type</td><td>TK38MW-NS/D</td></tr> </table>  <table border="1"> <tr><td>Terminal No.</td><td>2</td><td>W</td></tr> <tr><td>Terminal No.</td><td>35</td><td>L</td></tr> <tr><td>Terminal No.</td><td>36</td><td>P</td></tr> <tr><td>Terminal No.</td><td>43</td><td>P</td></tr> <tr><td>Terminal No.</td><td>44</td><td>L</td></tr> </table> <table border="1"> <tr><td>Color of Wire</td><td>Signal Name [Specification]</td></tr> <tr><td>W</td><td>-</td></tr> <tr><td>L</td><td>-</td></tr> <tr><td>P</td><td>-</td></tr> <tr><td>P</td><td>-</td></tr> <tr><td>L</td><td>-</td></tr> </table>	Connector No.	M116	Connector Name	WIRE TO WIRE	Connector Type	TK38MW-NS/D	Terminal No.	2	W	Terminal No.	35	L	Terminal No.	36	P	Terminal No.	43	P	Terminal No.	44	L	Color of Wire	Signal Name [Specification]	W	-	L	-	P	-	P	-	L	-	<table border="1"> <tr><td>Connector No.</td><td>M123</td></tr> <tr><td>Connector Name</td><td>BCM (BODY CONTROL MODULE)</td></tr> <tr><td>Connector Type</td><td>TH40FG-NH</td></tr> </table>  <table border="1"> <tr><td>Terminal No.</td><td>141</td><td>R</td></tr> </table> <table border="1"> <tr><td>Color of Wire</td><td>Signal Name [Specification]</td></tr> <tr><td>R</td><td>SECURITY INDICATOR</td></tr> </table>	Connector No.	M123	Connector Name	BCM (BODY CONTROL MODULE)	Connector Type	TH40FG-NH	Terminal No.	141	R	Color of Wire	Signal Name [Specification]	R	SECURITY INDICATOR	<table border="1"> <tr><td>Connector No.</td><td>M122</td></tr> <tr><td>Connector Name</td><td>BCM (BODY CONTROL MODULE)</td></tr> <tr><td>Connector Type</td><td>TH40FEB-NH</td></tr> </table>  <table border="1"> <tr><td>Terminal No.</td><td>90</td><td>P</td></tr> <tr><td>Terminal No.</td><td>91</td><td>L</td></tr> </table> <table border="1"> <tr><td>Color of Wire</td><td>Signal Name [Specification]</td></tr> <tr><td>P</td><td>CAN-L</td></tr> <tr><td>L</td><td>CAN-H</td></tr> </table>	Connector No.	M122	Connector Name	BCM (BODY CONTROL MODULE)	Connector Type	TH40FEB-NH	Terminal No.	90	P	Terminal No.	91	L	Color of Wire	Signal Name [Specification]	P	CAN-L	L	CAN-H
Connector No.	M107																																																																																																			
Connector Name	ECM																																																																																																			
Connector Type	RH24FGY-RZ6-R-LH-Z																																																																																																			
Terminal No.	113	P																																																																																																		
Terminal No.	114	L																																																																																																		
Color of Wire	Signal Name [Specification]																																																																																																			
P	VEHCAN-LI																																																																																																			
L	VEHCAN-HI																																																																																																			
Connector No.	M10																																																																																																			
Connector Name	PRE-CRASH SEAT BELT CONTROL UNIT																																																																																																			
Connector Type	TH20FW-1E6																																																																																																			
Terminal No.	7	G																																																																																																		
Color of Wire	Signal Name [Specification]																																																																																																			
G	INDICATOR																																																																																																			
Connector No.	M116																																																																																																			
Connector Name	WIRE TO WIRE																																																																																																			
Connector Type	TK38MW-NS/D																																																																																																			
Terminal No.	2	W																																																																																																		
Terminal No.	35	L																																																																																																		
Terminal No.	36	P																																																																																																		
Terminal No.	43	P																																																																																																		
Terminal No.	44	L																																																																																																		
Color of Wire	Signal Name [Specification]																																																																																																			
W	-																																																																																																			
L	-																																																																																																			
P	-																																																																																																			
P	-																																																																																																			
L	-																																																																																																			
Connector No.	M123																																																																																																			
Connector Name	BCM (BODY CONTROL MODULE)																																																																																																			
Connector Type	TH40FG-NH																																																																																																			
Terminal No.	141	R																																																																																																		
Color of Wire	Signal Name [Specification]																																																																																																			
R	SECURITY INDICATOR																																																																																																			
Connector No.	M122																																																																																																			
Connector Name	BCM (BODY CONTROL MODULE)																																																																																																			
Connector Type	TH40FEB-NH																																																																																																			
Terminal No.	90	P																																																																																																		
Terminal No.	91	L																																																																																																		
Color of Wire	Signal Name [Specification]																																																																																																			
P	CAN-L																																																																																																			
L	CAN-H																																																																																																			
	<table border="1"> <tr><td>Connector No.</td><td>M137</td></tr> <tr><td>Connector Name</td><td>A/T SHIFT SELECTOR</td></tr> <tr><td>Connector Type</td><td>TH12FW-NH</td></tr> </table>  <table border="1"> <tr><td>Terminal No.</td><td>1</td><td>W</td></tr> <tr><td>Terminal No.</td><td>2</td><td>V</td></tr> <tr><td>Terminal No.</td><td>3</td><td>L</td></tr> <tr><td>Terminal No.</td><td>4</td><td>BR</td></tr> <tr><td>Terminal No.</td><td>5</td><td>G</td></tr> </table> <table border="1"> <tr><td>Color of Wire</td><td>Signal Name [Specification]</td></tr> <tr><td>W</td><td>-</td></tr> <tr><td>V</td><td>-</td></tr> <tr><td>L</td><td>-</td></tr> <tr><td>BR</td><td>-</td></tr> <tr><td>G</td><td>-</td></tr> </table>	Connector No.	M137	Connector Name	A/T SHIFT SELECTOR	Connector Type	TH12FW-NH	Terminal No.	1	W	Terminal No.	2	V	Terminal No.	3	L	Terminal No.	4	BR	Terminal No.	5	G	Color of Wire	Signal Name [Specification]	W	-	V	-	L	-	BR	-	G	-	<table border="1"> <tr><td>Connector No.</td><td>M147</td></tr> <tr><td>Connector Name</td><td>AIR BAG DIAGNOSIS SENSOR UNIT</td></tr> <tr><td>Connector Type</td><td>TK28FY-EX-SC</td></tr> </table>  <table border="1"> <tr><td>Terminal No.</td><td>15</td><td>LG</td></tr> <tr><td>Terminal No.</td><td>24</td><td>G</td></tr> </table> <table border="1"> <tr><td>Color of Wire</td><td>Signal Name [Specification]</td></tr> <tr><td>LG</td><td>AIR BAG W/L</td></tr> <tr><td>G</td><td>SEAT BELT</td></tr> </table>	Connector No.	M147	Connector Name	AIR BAG DIAGNOSIS SENSOR UNIT	Connector Type	TK28FY-EX-SC	Terminal No.	15	LG	Terminal No.	24	G	Color of Wire	Signal Name [Specification]	LG	AIR BAG W/L	G	SEAT BELT																																															
Connector No.	M137																																																																																																			
Connector Name	A/T SHIFT SELECTOR																																																																																																			
Connector Type	TH12FW-NH																																																																																																			
Terminal No.	1	W																																																																																																		
Terminal No.	2	V																																																																																																		
Terminal No.	3	L																																																																																																		
Terminal No.	4	BR																																																																																																		
Terminal No.	5	G																																																																																																		
Color of Wire	Signal Name [Specification]																																																																																																			
W	-																																																																																																			
V	-																																																																																																			
L	-																																																																																																			
BR	-																																																																																																			
G	-																																																																																																			
Connector No.	M147																																																																																																			
Connector Name	AIR BAG DIAGNOSIS SENSOR UNIT																																																																																																			
Connector Type	TK28FY-EX-SC																																																																																																			
Terminal No.	15	LG																																																																																																		
Terminal No.	24	G																																																																																																		
Color of Wire	Signal Name [Specification]																																																																																																			
LG	AIR BAG W/L																																																																																																			
G	SEAT BELT																																																																																																			

JCNWA1733GE

Fail-safe

FAIL-SAFE

Combination meter performs fail-safe operation when unified meter and A/C amp. communication is malfunction. Solution for communication error between the unified meter and A/C amp. and combination meter.

COMBINATION METER

< ECU DIAGNOSIS INFORMATION >

Function		Specifications	
Speedometer		Reset to zero by suspending communication.	A
Tachometer			B
Fuel gauge			C
Water temperature gauge			D
Illumination control		When suspending communication, change to nighttime mode.	E
Information display		The display turns off by suspending communication.	F
Buzzer		The buzzer turns off by suspending communication.	G
Warning lamp/indicator lamp	ABS warning lamp	The lamp turns on by suspending communication.	H
	VDC OFF indicator lamp		I
	SLIP indicator lamp		J
	Brake warning lamp		K
	CRUISE warning lamp		L
	High beam indicator	The lamp turns off by suspending communication.	M
	Turn signal indicator lamp		N
	Oil pressure warning lamp		O
	Malfunction indicator lamp		P
	A/T CHECK warning lamp		Q
	AWD warning lamp		R
	Low tire pressure warning lamp		S
	Key warning lamp		T
	AFS OFF indicator lamp		U
	4WAS warning lamp		V
Master warning lamp	W		

DTC Index

INFOID:000000004675209

Refer to [WCS-62, "DTC Index"](#).

WCS

UNIFIED METER AND A/C AMP.

< ECU DIAGNOSIS INFORMATION >

UNIFIED METER AND A/C AMP.

Reference Value

INFOID:0000000046752.10

VALUES ON THE DIAGNOSIS TOOL

CONSULT-III MONITOR ITEM

Monitor Item	Condition		Value/Status
SPEED METER [km/h]	Ignition switch ON	While driving	Equivalent to speedometer reading NOTE: 655.35 is displayed when the malfunction signal is received
SPEED OUTPUT [km/h]	Ignition switch ON	While driving	Equivalent to speedometer reading NOTE: 655.35 is displayed when the malfunction signal is received
ODO OUTPUT [km/h] or [mph]	Ignition switch ON	—	Equivalent to odometer reading in combination meter
TACHO METER [rpm]	Ignition switch ON	While driving	Equivalent to tachometer reading NOTE: 8191.875 is displayed when the malfunction signal is received
FUEL METER [lit.]	Ignition switch ON	—	Values according to fuel level
W TEMP METER [°C]	Ignition switch ON	—	Values according to engine coolant temperature NOTE: 215 is displayed when the malfunction signal is input
ABS W/L	Ignition switch ON	ABS warning lamp ON	On
		ABS warning lamp OFF	Off
VDC/TCS IND	Ignition switch ON	VDC OFF indicator lamp ON	On
		VDC OFF indicator lamp OFF	Off
SLIP IND	Ignition switch ON	SLIP indicator lamp ON	On
		SLIP indicator lamp OFF	Off
BRAKE W/L	Ignition switch ON	Brake warning lamp ON	On
		Brake warning lamp OFF	Off
DOOR W/L	Ignition switch ON	Door warning displayed	On
		Door warning not displayed	Off
TRUNK/GLAS-H	Ignition switch ON	Trunk warning displayed	On
		Trunk warning not displayed	Off
HI-BEAM IND	Ignition switch ON	Hi-beam indicator lamp ON	On
		Hi-beam indicator lamp OFF	Off
TURN IND	Ignition switch ON	Turn indicator lamp ON	On
		Turn indicator lamp OFF	Off
FR FOG IND	Ignition switch ON	NOTE: This item is displayed, but cannot be monitored.	Off
RR FOG IND	Ignition switch ON	NOTE: This item is displayed, but cannot be monitored.	Off
LIGHT IND	Ignition switch ON	NOTE: This item is displayed, but cannot be monitored.	Off

UNIFIED METER AND A/C AMP.

< ECU DIAGNOSIS INFORMATION >

Monitor Item	Condition		Value/Status	
OIL W/L	Ignition switch ON	Oil pressure warning lamp ON	On	A
		Oil pressure warning lamp OFF	Off	
MIL	Ignition switch ON	Malfunction warning lamp ON	On	B
		Malfunction warning lamp OFF	Off	
GLOW IND	Ignition switch ON	NOTE: This item is displayed, but cannot be monitored.	Off	C
C-ENG2 W/L	Ignition switch ON	NOTE: This item is displayed, but cannot be monitored.	Off	D
CRUISE IND	Ignition switch ON	Cruise indicator displayed	On	
		Cruise indicator not displayed	Off	E
SET IND	Ignition switch ON	Set indicator lamp ON	On	
		Set indicator lamp OFF	Off	F
CRUISE W/L	Ignition switch ON	Cruise warning lamp ON	On	
		Cruise warning lamp OFF	Off	G
BA W/L	Ignition switch ON	NOTE: This item is displayed, but cannot be monitored.	Off	H
ATC/T-AMT W/L	Ignition switch ON	A/T check warning lamp ON	On	
		A/T check warning lamp OFF	Off	I
4WD W/L	Ignition switch ON	AWD warning lamp ON	On	
		AWD warning lamp OFF	Off	J
4WD LOCK IND	Ignition switch ON	NOTE: This item is displayed, but cannot be monitored.	Off	K
FUEL W/L	Ignition switch ON	Low-fuel warning displayed	On	
		Low-fuel warning not displayed	Off	L
WASHER W/L	Ignition switch ON	Washer warning displayed	On	
		Washer warning not displayed	Off	M
AIR PRES W/L	Ignition switch ON	Low tire pressure lamp ON	On	
		Low tire pressure lamp OFF	Off	
KEY G/Y W/L	Ignition switch ON	Key warning lamp ON	On	
		Key warning lamp OFF	Off	
AFS OFF IND	Ignition switch ON	AFS OFF indicator lamp ON	On	
		AFS OFF indicator lamp OFF	Off	WCS
4WAS/RAS W/L	Ignition switch ON	4WAS warning lamp ON	On	
		4WAS warning lamp OFF	Off	
DDS W/L	Ignition switch ON	NOTE: This item is displayed, but cannot be monitored.	Off	O
LANE W/L	Ignition switch ON	NOTE: This item is displayed, but cannot be monitored.	Off	P
LDP IND	Ignition switch ON	NOTE: This item is displayed, but cannot be monitored.	Off	

UNIFIED METER AND A/C AMP.

< ECU DIAGNOSIS INFORMATION >

Monitor Item	Condition		Value/Status
LCD	Ignition switch ON	Engine start information display (A/T model)	B&P I
		Engine start information display (M/T model)	C&P I
	Ignition switch ACC	Engine start information display (A/T model)	B&P N
		Engine start information display (M/T model)	C&P N
	Ignition switch LOCK	Key ID warning display	ID NG
	Ignition switch LOCK	Steering lock information display	ROTAT
	Ignition switch LOCK	P position warning display	SFT P
	Ignition switch LOCK	Intelligent Key insert information display	INSRT
	Ignition switch LOCK	Intelligent Key low battery warning display	BATT
	Ignition switch ON	Take away warning display	NO KY
	Ignition switch LOCK	Key warning display	OUTKY
Ignition switch ON	ACC warning display	LK WN	
ACC TARGET	Ignition switch ON	Vehicle ahead detection indicator displayed	On
		Vehicle ahead detection indicator not displayed	Off
ACC DISTANCE	Ignition switch ON	When following distance set to "LONG"	LONG
		When following distance set to "MIDDLE"	MID
		When following distance set to "SHORT"	SHORT
		Set distance indicator not displayed	Off
ACC OWN VHL	Ignition switch ON	Own vehicle indicator displayed	On
		Own vehicle indicator not displayed	Off
ACC SET SPEED	Ignition switch ON	Set vehicle speed indicator not displayed	Off
		Set vehicle speed indicator displayed	On
ACC UNIT	Ignition switch ON	Set vehicle speed indicator unit display ON	On
		Set vehicle speed indicator unit display OFF	Off
O/D OFF SW	Ignition switch ON	NOTE: This item is displayed, but cannot be monitored.	Off
SHIFT IND	Ignition switch ON	Shift position indicator P display	P
		Shift position indicator R display	R
		Shift position indicator N display	N
		Shift position indicator D display	D
		Shift position indicator M1 display	M1
		Shift position indicator M2 display	M2
		Shift position indicator M3 display	M3
		Shift position indicator M4 display	M4
		Shift position indicator M5 display	M5
		Shift position indicator M6 display	M6
		Shift position indicator M7 display	M7

UNIFIED METER AND A/C AMP.

< ECU DIAGNOSIS INFORMATION >

Monitor Item	Condition		Value/Status
AT S MODE SW	Ignition switch ON	Snow mode switch ON	On
		Snow mode switch OFF	Off
AT P MODE SW	Ignition switch ON	NOTE: This item is displayed, but cannot be monitored.	Off
M RANGE SW	Ignition switch ON	Selector lever manual mode position	On
		Other than the above	Off
NM RANGE SW	Ignition switch ON	Selector lever manual mode position	Off
		Other than the above	On
AT SFT UP SW	Ignition switch ON	Selector lever + position	On
		Other than the above	Off
AT SFT DWN SW	Ignition switch ON	Selector lever – position	On
		Other than the above	Off
ST SFT UP SW	Ignition switch ON	Paddle shifter switch up operation	On
		Other than the above	Off
ST SFT DWN SW	Ignition switch ON	Paddle shifter switch down operation	On
		Other than the above	Off
COMP F/B SIG	Ignition switch ON	A/C compressor activation condition	On
		A/C compressor deactivation condition	Off
4WD LOCK SW	Ignition switch ON	NOTE: This item is displayed, but cannot be monitored.	Off
PKB SW	Ignition switch ON	Parking brake switch ON	On
		Parking brake switch OFF	Off
BUCKLE SW	Ignition switch ON	Seat belt not fastened	On
		Seat belt fastened	Off
BRAKE OIL SW	Ignition switch ON	Brake fluid level switch ON	On
		Brake fluid level switch OFF	Off
DISTANCE [km]	Ignition switch ON	—	Possible driving distance calculated by unified meter and A/C amp.
OUTSIDE TEMP [°C] or [°F]	Ignition switch ON	—	Equivalent to ambient temperature NOTE: This may not match the indicated value on the information display.
FUEL LOW SIG	Ignition switch ON	Low-fuel warning displayed	On
		Low-fuel warning not displayed	Off
BUZZER	Ignition switch ON	Buzzer ON	On
		Buzzer OFF	Off

NOTE:

Some items are not available according to vehicle specification.

TERMINAL LAYOUT

UNIFIED METER AND A/C AMP.

< ECU DIAGNOSIS INFORMATION >

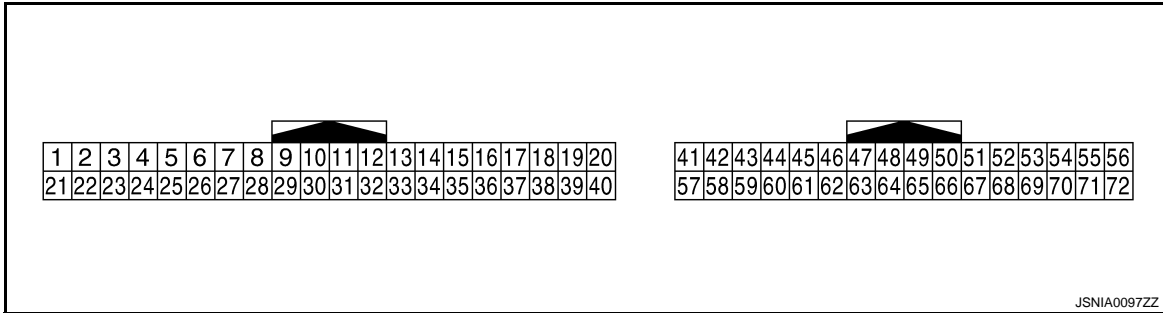

JSNIA0097ZZ

PHYSICAL VALUES

Terminal No. (Wire color)		Description		Condition		Value (Approx.)
+	-	Signal name	Input/ Output			
4 (G)	Ground	Stop lamp switch signal	Input	Ignition switch OFF	Brake pedal is depressed	12 V
					Other than the above	0 V
5 (L)	Ground	Manual mode shift up signal	Input	Ignition switch ON	Selector lever UP operation	0 V
					Other than the above	12 V
6 (O)	Ground	Paddle shifter up signal	Input	Ignition switch ON	<ul style="list-style-type: none"> • Selector lever DS position • Paddle shift up operation 	0 V
					Other than the above	12 V
7 (GR)	Ground	Communication signal (AMP. → METER)	Output	Ignition switch ON	—	<p style="text-align: right; font-size: small;">SKIA3362E</p>
8 (L)	Ground	Vehicle speed signal output (2-pulse)	Output	Ignition switch ON	Speedometer operated [When vehicle speed is approx. 40 km/h (25 MPH)]	<p>NOTE: The maximum voltage varies depending on the specification (destination unit).</p> <p style="text-align: right; font-size: small;">JSNIA0015GB</p>
9 (SB)	Ground	Seat belt buckle switch signal (driver side)	Input	Ignition switch ON	When seat belt is fastened	12 V
					When seat belt is not fastened	0 V
10 (W)	Ground	Manual mode signal	Input	Ignition switch ON	Selector lever DS position	0 V
					Other than the above	12 V
11 (G)	Ground	Not manual mode signal	Input	Ignition switch ON	Selector lever DS position	12 V
					Other than the above	0 V

UNIFIED METER AND A/C AMP.

< ECU DIAGNOSIS INFORMATION >

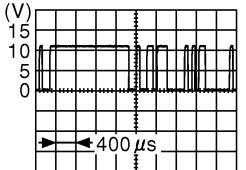
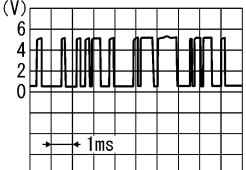
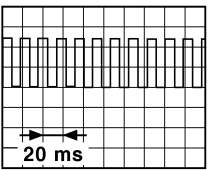
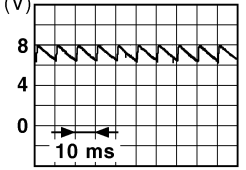
Terminal No. (Wire color)		Description		Condition		Value (Approx.)
+	-	Signal name	Input/ Output			
14 (BR)	Ground	Communication signal (LCD → AMP.)	Input	Ignition switch ON	—	 <p style="text-align: right; font-size: small;">JSNIA0028GB</p>
23 (Y)	Ground	A/T snow switch signal	Input	Ignition switch ON	Snow mode switch ON	12 V
					Snow mode switch OFF	0 V
25 (V)	Ground	Manual mode shift down signal	Input	Ignition switch ON	Selector lever down opera- tion	0 V
					Other than the above	12 V
26 (G)	Ground	Paddle shifter down signal	Input	Ignition switch ON	<ul style="list-style-type: none"> • Selector lever DS posi- tion • Paddle shift down opera- tion 	0 V
					Other than the above	12 V
27 (LG)	Ground	Communication signal (METER → AMP.)	Input	Ignition switch ON	—	 <p style="text-align: right; font-size: small;">SKIA3361E</p>
28 (R)	Ground	Vehicle speed signal (8-pulse)	Output	Ignition switch ON	Speedometer operated [When vehicle speed is ap- prox. 40 km/h (25 MPH)]	<p>NOTE: The maximum voltage varies de- pending on the specification (destination unit).</p>  <p style="text-align: right; font-size: small;">JSNIA0012GB</p>
30 (V)	Ground	Parking brake switch signal	Input	Ignition switch ON	Parking brake ON	0 V
					Parking brake OFF	 <p style="text-align: right; font-size: small;">JSNIA0007GB</p>

A
B
C
D
E
F
G
H
I
J
K
L
M
N
O
P

WCS

UNIFIED METER AND A/C AMP.

< ECU DIAGNOSIS INFORMATION >

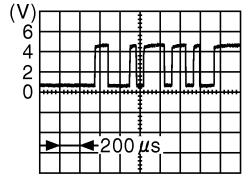
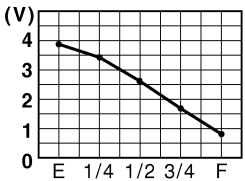
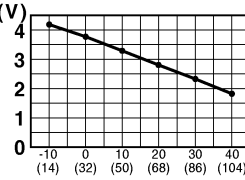
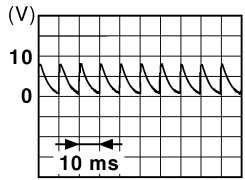
Terminal No. (Wire color)		Description		Condition		Value (Approx.)
+	-	Signal name	Input/ Output			
34 (Y)	Ground	Communication signal (AMP. → LCD)	Output	Ignition switch ON	—	 <p style="text-align: right; font-size: small;">JSNIA0027GB</p>
41 (L)	Ground	ACC power supply	Input	Ignition switch ACC	—	Battery voltage
42 (B) ^{*1} (BR) ^{*2}	Ground	Fuel level sensor signal	Input	Ignition switch ON	—	 <p style="text-align: right; font-size: small;">JSNIA0013GB</p>
45 (V)	Ground	Ambient sensor signal	Input	—	—	 <p style="text-align: right; font-size: small;">JSNIA0014GB</p>
53 (W)	Ground	Ignition signal	Input	Ignition switch ON	—	Battery voltage
54 (Y)	Ground	Battery power supply	Input	Ignition switch OFF	—	Battery voltage
55 (B)	Ground	Ground	—	Ignition switch ON	—	0 V
56 (L)	Ground	CAN-H	—	—	—	—
57 (LG)	Ground	Brake fluid level switch sig- nal	Input	Ignition switch ON	Brake fluid level is normal.	 <p style="text-align: right; font-size: small;">JSNIA0008GB</p>
				—	The brake fluid level is low- er than the low level	0 V
58 (Y)	Ground	Fuel level sensor ground	—	Ignition switch ON	—	0 V
61 (R)	Ground	Ambient sensor ground	—	Ignition switch ON	—	0 V

UNIFIED METER AND A/C AMP.

< ECU DIAGNOSIS INFORMATION >

Terminal No. (Wire color)		Description		Condition		Value (Approx.)
+	-	Signal name	Input/ Output			
71 (GR)	Ground	Ground	—	Ignition switch ON	—	0 V
72 (P)	Ground	CAN-L	—	—	—	—

- *1: M/T models
- *2: A/T models

A
B
C
D
E
F
G
H
I
J
K
L
M
O
P

WCS

UNIFIED METER AND A/C AMP.

< ECU DIAGNOSIS INFORMATION >

- <A> : With A/T
- <NV> : With NAVI
- <ON> : Without NAVI
- <AS> : With 4WAS
- <FA> : With automatic drive positioner or 4WAS
- <AP> : Without automatic drive positioner and 4WAS
- <SS> : With paddle shifter

*: This connector is not shown in "Harness Layout".

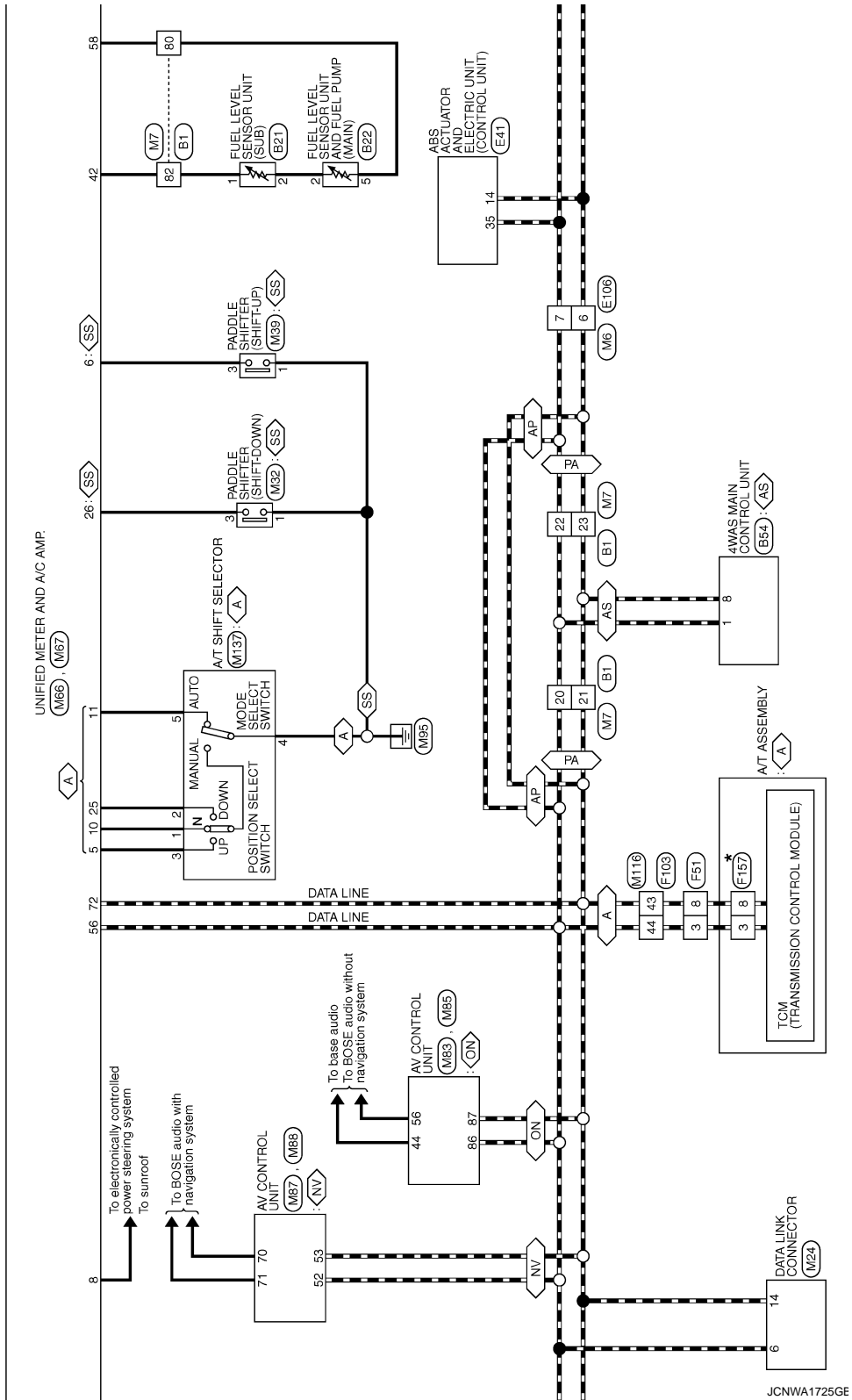

A
B
C
D
E
F
G
H
I
J
K
L
M
N
O
P

WCS

UNIFIED METER AND A/C AMP.

< ECU DIAGNOSIS INFORMATION >

METER

Connector No.	E32
Connector Name	WASHER LEVEL SWITCH
Connector Type	Z02FBR



Terminal No.	Color of Wire	Signal Name [Specification]
1	LG	-
2	B	-

Connector No.	E40
Connector Name	WIRE TO WIRE
Connector Type	SA438MB-RSS-SHZ8

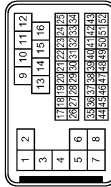

Terminal No.	Color of Wire	Signal Name [Specification]
21	SB	-

Connector No.	E41
Connector Name	ABS ACTUATOR AND ELECTRIC UNIT (CONTROL UNIT)
Connector Type	BA442FB-AH24-LH



Terminal No.	Color of Wire	Signal Name [Specification]
14	P	CAN-L
35	L	CAN-H

Connector No.	E47
Connector Name	BRAKE FLUID LEVEL SWITCH
Connector Type	Y102EGY



Terminal No.	Color of Wire	Signal Name [Specification]
1	R	-
2	B	-

Connector No.	E51
Connector Name	ICC BRAKE HOLD RELAY
Connector Type	MS02FL-M2



Terminal No.	Color of Wire	Signal Name [Specification]
1	B	-
2	SB	-
3	L	-
5	W	-

Connector No.	E67
Connector Name	ICC SENSOR INTEGRATED UNIT
Connector Type	RS06FB-PR



Terminal No.	Color of Wire	Signal Name [Specification]
2	SB	BRAKE HOLD RLY DRIVE SIGNAL
3	L	CAN-H
6	P	CAN-L

Connector No.	E76
Connector Name	AMBIENT SENSOR
Connector Type	RS02FB



Terminal No.	Color of Wire	Signal Name [Specification]
1	G	-
2	P	-

Connector No.	E103
Connector Name	FUSE BLOCK (J/B)
Connector Type	NS16FY-CS



Terminal No.	Color of Wire	Signal Name [Specification]
2F	W	-
8F	L	-

JCNWA1728GE

UNIFIED METER AND A/C AMP.

< ECU DIAGNOSIS INFORMATION >

METER

Connector No.	F38
Connector Name	ALTERNATOR
Connector Type	H30CFE



Terminal No.	Color of Wire	Signal Name [Specification]
2	G	L

Connector No.	E110
Connector Name	STOP LAMP SWITCH
Connector Type	MDAFW-LC



Terminal No.	Color of Wire	Signal Name [Specification]
1	L	-
2	W	-
3	L	-
4	SB	-

Connector No.	E107
Connector Name	PARKING BRAKE SWITCH (WITH A/T)
Connector Type	TB01FW



Terminal No.	Color of Wire	Signal Name [Specification]
1	O	-

Connector No.	E106
Connector Name	WIRE TO WIRE
Connector Type	TH00FW-GS16-TM4



Terminal No.	Color of Wire	Signal Name [Specification]
6	P	-
7	L	-
18	LG	-
36	O	-
80	R	-
81	P	-
82	G	-

Connector No.	F103
Connector Name	WIRE TO WIRE
Connector Type	TK38FW-NS10



Terminal No.	Color of Wire	Signal Name [Specification]
2	G	-
35	L	-
36	P	-
43	P	-
44	L	-

Connector No.	F51
Connector Name	A/T ASSEMBLY
Connector Type	PK10FG-DGY

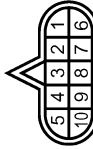

Terminal No.	Color of Wire	Signal Name [Specification]
3	L	-
8	P	-

Connector No.	F38
Connector Name	WIRE TO WIRE
Connector Type	SA38FE-RSS-SH28

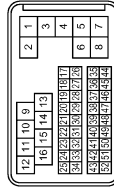

Terminal No.	Color of Wire	Signal Name [Specification]
21	Y	-

Connector No.	F37
Connector Name	OIL PRESSURE SWITCH
Connector Type	E01FGY-RS-AR



Terminal No.	Color of Wire	Signal Name [Specification]
1	Y	-

A
B
C
D
E
F
G
H
I
J
K
L
M
O
P

WCS

UNIFIED METER AND A/C AMP.

< ECU DIAGNOSIS INFORMATION >

METER

Connector No.	F108
Connector Name	AWD CONTROL UNIT
Connector Type	TH16FW-NH

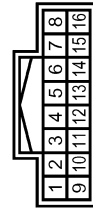

Terminal No.	Color of Wire	Signal Name [Specification]
8	L	CAN-H
16	P	CAN-L

Connector No.	F157
Connector Name	TOM (TRANSMISSION CONTROL MODULE)
Connector Type	SPT0FG

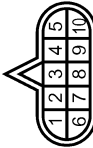

Terminal No.	Color of Wire	Signal Name [Specification]
3	R	CAN-H
8	BR	CAN-L

Connector No.	M1
Connector Name	FUSE BLOCK (J/B)
Connector Type	NS30FW-M2



Terminal No.	Color of Wire	Signal Name [Specification]
1A	V	
2A	G	
5A	L	

Connector No.	M2
Connector Name	FUSE BLOCK (J/B)
Connector Type	NS10FY-CS



Terminal No.	Color of Wire	Signal Name [Specification]
3B	P	

Connector No.	M3
Connector Name	FUSE BLOCK (J/B)
Connector Type	NS12FW-CS



Terminal No.	Color of Wire	Signal Name [Specification]
12C	R	

Connector No.	M6
Connector Name	WIRE TO WIRE
Connector Type	TH60MW-CS16-TM4



Terminal No.	Color of Wire	Signal Name [Specification]
6	P	
7	L	
18	L	
36	O	
80	SB	
81	R	
82	V	

Connector No.	M7
Connector Name	WIRE TO WIRE
Connector Type	TH60MW-CS16-TM4

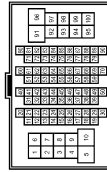

Terminal No.	Color of Wire	Signal Name [Specification]
20	L	
21	P	
22	L	
23	P	
80	Y	
82	BR	- [With A/T]
86	B	- [With M/T]
88	O	

Connector No.	M16
Connector Name	AFS CONTROL UNIT
Connector Type	TH40FY-NH

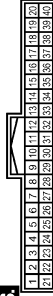

Terminal No.	Color of Wire	Signal Name [Specification]
7	P	CAN-L
30	L	CAN-H

UNIFIED METER AND A/C AMP.

< ECU DIAGNOSIS INFORMATION >

METER

Connector No.	M24
Connector Name	DATA LINK CONNECTOR
Connector Type	BD16FW-P

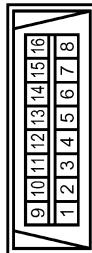

Terminal No.	Color of Wire	Signal Name [Specification]
6	L	-
14	P	-

Connector No.	M32
Connector Name	PADDLE SHIFTER (SHIFT-DOWN)
Connector Type	A03FW

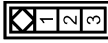

Terminal No.	Color of Wire	Signal Name [Specification]
1	W	-
3	G	-

Connector No.	M39
Connector Name	PADDLE SHIFTER (SHIFT-UP)
Connector Type	A04FW



Terminal No.	Color of Wire	Signal Name [Specification]
1	P	-
3	O	-

Connector No.	M35
Connector Name	COMBINATION METER
Connector Type	SAG4FW



Terminal No.	Color of Wire	Signal Name [Specification]
1	V	BATTERY POWER SUPPLY
2	LG	COMMUNICATION SIGNAL (METER->AMP.)
3	GR	COMMUNICATION SIGNAL (AMP->METER)
5	B	GROUND
6	W	ALTERNATOR SIGNAL
7	LG	AIR BAG SIGNAL
10	B	SECURITY SIGNAL
15	B	GROUND
16	BR	METER CONTROL SWITCH GROUND
21	R	IGNITION SIGNAL
22	B	GROUND

24	BR	COMMUNICATION SIGNAL (LSD->AMP.)
25	Y	COMMUNICATION SIGNAL (AMP->LSD)
26	R	VEHICLE SPEED SIGNAL (3-PULSE)
27	O	PARKING BRAKE SWITCH SIGNAL
28	SB	BRAKE FLUID LEVEL SWITCH
29	L	SEAT BELT BUCKLE SWITCH (DRIVER SIDE)
30	G	SEAT BELT BUCKLE SWITCH SIGNAL (PASSENGER SIDE)
31	L	WASHER LEVEL SWITCH SIGNAL
33	R	ILLUMINATION CONTROL SIGNAL
36	LG	SELECT SWITCH SIGNAL
37	SB	ENTER SWITCH SIGNAL
38	L	TRIP A/B RESET SWITCH SIGNAL
39	P	ILLUMINATION CONTROL SWITCH SIGNAL (-)
40	O	ILLUMINATION CONTROL SWITCH SIGNAL (+)

Connector No.	M34
Connector Name	METER CONTROL SWITCH
Connector Type	FH12FW-NH

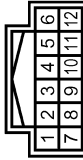

Terminal No.	Color of Wire	Signal Name [Specification]
1	SB	-
2	LG	-
5	L	-
7	BR	-
9	O	-
10	P	-

JCNWA1731GE

A
B
C
D
E
F
G
H
I
J
K
L
M
N
O
P

WCS

UNIFIED METER AND A/C AMP.

< ECU DIAGNOSIS INFORMATION >

METER

Connector No.	M86
Connector Name	UNIFIED METER AND A/C AMP.
Connector Type	TH40FW-NH



1	2	3	4	5	6	7	8	9	10	11	12	13	14	15	16	17	18	19	20	21	22	23	24	25	26	27	28	29	30	31	32	33	34	35	36	37	38	39	40
---	---	---	---	---	---	---	---	---	----	----	----	----	----	----	----	----	----	----	----	----	----	----	----	----	----	----	----	----	----	----	----	----	----	----	----	----	----	----	----

Terminal No.	Color of Wire	Signal Name [Specification]
4	G	STOP LAMP SWITCH SIGNAL
5	L	MANUAL MODE SHIFT UP SIGNAL
6	O	PADDLE SHIFTER UP SIGNAL
7	GR	COMMUNICATION SIGNAL (AMP->METER)
8	L	VEHICLE SPEED SIGNAL (2-PULSE)
9	SB	SEAT BELT BUCKLE SWITCH SIGNAL (DRIVER SIDE)
10	W	MANUAL MODE SIGNAL
11	G	NOT MANUAL MODE SIGNAL
14	BR	COMMUNICATION SIGNAL (LCD->AMP.)
25	V	MANUAL MODE SHIFT DOWN SIGNAL
26	G	PADDLE SHIFTER DOWN SIGNAL

Connector No.	M83
Connector Name	AV CONTROL UNIT (WITHOUT NAVI)
Connector Type	TH34FW-NH



47	48	45	44	43	42	41	40	39	38	37	36	59	58	57	56	55	54	53	52	51	50	49	48
----	----	----	----	----	----	----	----	----	----	----	----	----	----	----	----	----	----	----	----	----	----	----	----

Terminal No.	Color of Wire	Signal Name [Specification]
44	BR	COMM (DISP->CONT)
56	Y	COMM (CONT->DISP)

27	LG	COMMUNICATION SIGNAL (METER->AMP.)
28	R	VEHICLE SPEED SIGNAL (8-PULS SE)
30	V	PARKING BRAKE SWITCH SIGNAL
34	Y	COMMUNICATION SIGNAL (AMP->LCD)



1	2	3	4	5	6	7	8	9	10	11	12	13	14	15	16	17	18	19	20	21	22	23	24	25	26	27	28	29	30	31	32	33	34	35	36	37	38	39	40
---	---	---	---	---	---	---	---	---	----	----	----	----	----	----	----	----	----	----	----	----	----	----	----	----	----	----	----	----	----	----	----	----	----	----	----	----	----	----	----

Terminal No.	Color of Wire	Signal Name [Specification]
41	L	ACC POWER SUPPLY
42	BR	FUEL LEVEL SENSOR SIGNAL [With A/T]
42	B	FUEL LEVEL SENSOR SIGNAL [With M/T]
45	V	AMBIENT SENSOR SIGNAL
53	W	IGNITION POWER SUPPLY
54	Y	BATTERY POWER SUPPLY
55	B	GROUND
56	L	CAN-H
57	LG	BRAKE FLUID LEVEL SWITCH
58	Y	FUEL LEVEL SENSOR GROUND
61	R	AMBIENT SENSOR GROUND

Connector No.	M87
Connector Name	AV CONTROL UNIT (WITH NAVI)
Connector Type	TH40FW-NH



27	28	29	30	31	32	33	34	35	36	37	38	39	40	41	42	43	44	45	46	47	48	49	50	51	52	53	54	55	56	57	58	59	60	61	62	63	64	65	66	67	68	69	70	71	72
----	----	----	----	----	----	----	----	----	----	----	----	----	----	----	----	----	----	----	----	----	----	----	----	----	----	----	----	----	----	----	----	----	----	----	----	----	----	----	----	----	----	----	----	----	----

Terminal No.	Color of Wire	Signal Name [Specification]
52	L	CAN-H
53	P	CAN-L

71	GR	GROUND
72	P	CAN-L

Connector No.	M88
Connector Name	AV CONTROL UNIT (WITH NAVI)
Connector Type	TH12FW-NH



62	64	66	68	70	72	61	63	65	67	69	71
----	----	----	----	----	----	----	----	----	----	----	----

Terminal No.	Color of Wire	Signal Name [Specification]
70	L	COMM (CONT->DISP)
71	LG	COMM (DISP->CONT)

UNIFIED METER AND A/C AMP.

< ECU DIAGNOSIS INFORMATION >

Connector No.	M107	M110	M116	M122
Connector Name	ECM	PRE -ORASH SEAT BELT CONTROL UNIT	WIRE TO WIRE	BCM (BODY CONTROL MODULE)
Connector Type	RH24FY-R26-R-LH-Z	TH20FW-T66	TK38MW-NS/D	TH4GFB-NH
Terminal No.	113	7	2	90
Color of Wire	P	G	W	P
Terminal No.	114		35	91
Color of Wire	L		L	L
Terminal No.			43	
Color of Wire			P	
Terminal No.			44	
Color of Wire			L	

METER

Fail-safe

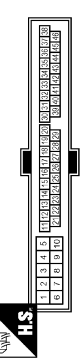
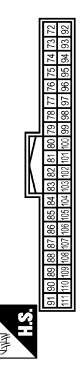

Terminal No.	Color of Wire	Signal Name [Specification]
90	P	CAN-L
91	L	CAN-H

Terminal No.	Color of Wire	Signal Name [Specification]
2	W	-
35	L	-
43	P	-
44	L	-

Terminal No.	Color of Wire	Signal Name [Specification]
7	G	INDICATOR

Terminal No.	Color of Wire	Signal Name [Specification]
113	P	VEHCAN-L1
114	L	VEHCAN-H1

Connector No.	M123	M137	M147
Connector Name	BCM (BODY CONTROL MODULE)	A/T SHIFT SELECTOR	AIR BAG DIAGNOSIS SENSOR UNIT
Connector Type	TH4UFG-NH	TH12FW-NH	TK28FY-EX-SC
Terminal No.	141	1	15
Color of Wire	R	W	LG
Terminal No.		2	24
Color of Wire		V	G
Terminal No.		3	
Color of Wire		L	
Terminal No.		4	
Color of Wire		BR	
Terminal No.		5	
Color of Wire		G	

METER

WCS

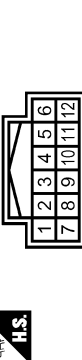
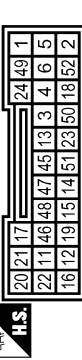

Terminal No.	Color of Wire	Signal Name [Specification]
141	R	SECURITY INDICATOR

Terminal No.	Color of Wire	Signal Name [Specification]
1	W	-
2	V	-
3	L	-
4	BR	-
5	G	-

Terminal No.	Color of Wire	Signal Name [Specification]
15	LG	AIR BAG W/L
24	G	SEAT BELT

Terminal No.	Color of Wire	Signal Name [Specification]
20	L	24-91
21	L	17
22	L	11
23	L	48
24	L	49
25	L	47
26	L	13
27	L	3
28	L	4
29	L	16
30	L	5
31	L	16
32	L	52
33	L	2

JCNWA1733GE

INFOID:0000000046752.12

A
B
C
D
E
F
G
H
I
J
K
L
M
N
O
P

UNIFIED METER AND A/C AMP.

< ECU DIAGNOSIS INFORMATION >

Function	Specifications	
Speedometer	Reset to zero by suspending communication.	
Tachometer		
Fuel gauge		
Water temperature gauge		
Illumination control	When suspending communication, change to nighttime mode.	
Information display	The display turns off by suspending communication.	
Buzzer	The buzzer turns off by suspending communication.	
Warning lamp/indicator lamp	ABS warning lamp	The lamp turns on by suspending communication.
	VDC OFF indicator lamp	
	SLIP indicator lamp	
	Brake warning lamp	
	CRUISE warning lamp	
	AWD warning lamp	
	Low tire pressure warning lamp	
	4WAS warning lamp	The lamp blinking caused by communication malfunction
	AFS OFF indicator lamp	
	High beam indicator	The lamp turns off by suspending communication.
	Turn signal indicator lamp	
	Oil pressure warning lamp	
	Malfunction indicator lamp	
	A/T CHECK warning lamp	
	Key warning lamp	
Master warning lamp		

DTC Index

INFOID:000000004675213

Display contents of CONSULT-III	Time	Diagnostic item is detected when ...	Refer to
CAN COMM CIRCUIT [U1000]	CRNT, 1 - 39	When unified meter and A/C amp. is not transmitting or receiving CAN communication signal for 2 seconds or more.	MWI-42. "Diagnosis Procedure"
CONTROL UNIT (CAN) [U1010]	CRNT, 1 - 39	When detecting error during the initial diagnosis of CAN controller of unified meter and A/C amp.	MWI-43. "Diagnosis Procedure"
COMM ERROR 1 [B2201]	CRNT, 1 - 39	If a communication error is present in the communication line between unified meter and A/C amp. and combination meter for 2 seconds or more.	MWI-44. "Diagnosis Procedure"
COMM ERROR 2 [B2202]	CRNT, 1 - 39	If a communication error is present in the communication line between unified meter and A/C amp. and combination meter for 2 seconds or more.	MWI-46. "Diagnosis Procedure"
VEHICLE SPEED [B2205]	CRNT, 1 - 39	The abnormal vehicle speed signal is input from ABS actuator and electric unit (control unit) for 2 seconds or more.	MWI-48. "Diagnosis Procedure"
ENGINE SPEED [B2267]	CRNT, 1 - 39	If ECM continuously transmits abnormal engine speed signals for 2 seconds or more.	MWI-49. "Diagnosis Procedure"
WATER TEMP [B2268]	CRNT, 1 - 39	If ECM continuously transmits abnormal engine coolant temperature signals for 60 seconds or more.	MWI-50. "Diagnosis Procedure"

BCM (BODY CONTROL MODULE)

< ECU DIAGNOSIS INFORMATION >

BCM (BODY CONTROL MODULE)

Reference Value

INFOID:000000004675401

VALUES ON THE DIAGNOSIS TOOL

CONSULT-III MONITOR ITEM

Monitor Item	Condition	Value/Status
FR WIPER HI	Other than front wiper switch HI	Off
	Front wiper switch HI	On
FR WIPER LOW	Other than front wiper switch LO	Off
	Front wiper switch LO	On
FR WASHER SW	Front washer switch OFF	Off
	Front washer switch ON	On
FR WIPER INT	Other than front wiper switch INT	Off
	Front wiper switch INT	On
FR WIPER STOP	Front wiper is not in STOP position	Off
	Front wiper is in STOP position	On
INT VOLUME	Wiper intermittent dial is in a dial position 1 - 7	Wiper intermittent dial position
TURN SIGNAL R	Other than turn signal switch RH	Off
	Turn signal switch RH	On
TURN SIGNAL L	Other than turn signal switch LH	Off
	Turn signal switch LH	On
TAIL LAMP SW	Other than lighting switch 1ST and 2ND	Off
	Lighting switch 1ST or 2ND	On
HI BEAM SW	Other than lighting switch HI	Off
	Lighting switch HI	On
HEAD LAMP SW 1	Other than lighting switch 2ND	Off
	Lighting switch 2ND	On
HEAD LAMP SW 2	Other than lighting switch 2ND	Off
	Lighting switch 2ND	On
PASSING SW	Other than lighting switch PASS	Off
	Lighting switch PASS	On
AUTO LIGHT SW	Other than lighting switch AUTO	Off
	Lighting switch AUTO	On
FR FOG SW	Front fog lamp switch OFF	Off
	Front fog lamp switch ON	On
RR FOG SW	NOTE: The item is indicated, but not monitored.	Off
DOOR SW-DR	Driver door closed	Off
	Driver door opened	On
DOOR SW-AS	Passenger door closed	Off
	Passenger door opened	On
DOOR SW-RR	Rear RH door closed	Off
	Rear LH door opened	On
DOOR SW-RL	Rear LH door closed	Off
	Rear LH door opened	On

A

B

C

D

E

F

G

H

I

J

K

L

M

WCS

O

P

BCM (BODY CONTROL MODULE)

< ECU DIAGNOSIS INFORMATION >

Monitor Item	Condition	Value/Status
DOOR SW-BK	NOTE: The item is indicated, but not monitored.	Off
CDL LOCK SW	Other than power door lock switch LOCK	Off
	Power door lock switch LOCK	On
CDL UNLOCK SW	Other than power door lock switch UNLOCK	Off
	Power door lock switch UNLOCK	On
KEY CYL LK-SW	Other than driver door key cylinder LOCK	Off
	Driver door key cylinder LOCK	On
KEY CYL UN-SW	Other than driver door key cylinder UNLOCK	Off
	Driver door key cylinder LOCK	On
KEY CYL SW-TR	NOTE: The item is indicated, but not monitored.	Off
HAZARD SW	Hazard switch is OFF	Off
	Hazard switch is ON	On
REAR DEF SW	NOTE: The item is indicated, but not monitored.	Off
H/L WASH SW	NOTE: The item is indicated, but not monitored.	Off
TR CANCEL SW	Trunk lid opener cancel switch OFF	Off
	Trunk lid opener cancel switch ON	On
TR/BD OPEN SW	Trunk lid opener switch OFF	Off
	While the trunk lid opener switch is turned ON	On
TRNK/HAT MNTR	Trunk lid closed	Off
	Trunk lid opened	On
RKE-LOCK	LOCK button of the Intelligent Key is not pressed	Off
	LOCK button of the Intelligent Key is pressed	On
RKE-UNLOCK	UNLOCK button of the Intelligent Key is not pressed	Off
	UNLOCK button of the Intelligent Key is pressed	On
RKE-TR/BD	TRUNK OPEN button of the Intelligent Key is not pressed	Off
	TRUNK OPEN button of the Intelligent Key is pressed	On
RKE-PANIC	PANIC button of the Intelligent Key is not pressed	Off
	PANIC button of the Intelligent Key is pressed	On
RKE-P/W OPEN	UNLOCK button of the Intelligent Key is not pressed	Off
	UNLOCK button of the Intelligent Key is pressed and held	On
RKE-MODE CHG	LOCK/UNLOCK button of the Intelligent Key is not pressed and held simultaneously	Off
	LOCK/UNLOCK button of the Intelligent Key is pressed and held simultaneously	On
OPTICAL SENSOR	Bright outside of the vehicle	Close to 5 V
	Dark outside of the vehicle	Close to 0 V
REQ SW -DR	Driver door request switch is not pressed	Off
	Driver door request switch is pressed	On
REQ SW -AS	Passenger door request switch is not pressed	Off
	Passenger door request switch is pressed	On
REQ SW -RR	NOTE: The item is indicated, but not monitored.	Off
REQ SW -RL	NOTE: The item is indicated, but not monitored.	Off

BCM (BODY CONTROL MODULE)

< ECU DIAGNOSIS INFORMATION >

Monitor Item	Condition	Value/Status	
REQ SW -BD/TR	Trunk lid opener request switch is not pressed	Off	A
	Trunk lid opener request switch is pressed	On	
PUSH SW	Push-button ignition switch (push switch) is not pressed	Off	B
	Push-button ignition switch (push switch) is pressed	On	
IGN RLY2 -F/B	Ignition switch in OFF or ACC position	Off	C
	Ignition switch in ON position	On	
ACC RLY -F/B	NOTE: The item is indicated, but not monitored.	Off	D
CLUCH SW	The clutch pedal is not depressed	Off	D
	The clutch pedal is depressed	On	
BRAKE SW 1	The brake pedal is depressed when No. 7 fuse is blown	Off	E
	The brake pedal is not depressed when No. 7 fuse is blown, or No. 7 fuse is normal	On	
BRAKE SW 2	The brake pedal is not depressed	Off	F
	The brake pedal is depressed	On	
DETE/CANCL SW	<ul style="list-style-type: none"> • Selector lever in P position (Except M/T models) • The clutch pedal is depressed (M/T models) 	Off	G
	<ul style="list-style-type: none"> • Selector lever in any position other than P (Except M/T models) • The clutch pedal is not depressed (M/T models) 	On	
SFT PN/N SW	Selector lever in any position other than P and N	Off	H
	Selector lever in P or N position	On	
S/L -LOCK	Steering is unlocked	Off	I
	Steering is locked	On	
S/L -UNLOCK	Steering is locked	Off	J
	Steering is unlocked	On	
S/L RELAY-F/B	Ignition switch in OFF or ACC position	Off	K
	Ignition switch in ON position	On	
UNLK SEN -DR	Driver door is unlocked	Off	L
	Driver door is locked	On	
PUSH SW -IPDM	Push-button ignition switch (push-switch) is not pressed	Off	L
	Push-button ignition switch (push-switch) is pressed	On	
IGN RLY1 -F/B	Ignition switch in OFF or ACC position	Off	M
	Ignition switch in ON position	On	
DETE SW -IPDM	Selector lever in any position other than P	Off	
	Selector lever in P position	On	WCS
SFT PN -IPDM	<ul style="list-style-type: none"> • Selector lever in any position other than P and N (Except M/T models) • The clutch pedal is not depressed (M/T models) 	Off	
	<ul style="list-style-type: none"> • Selector lever in P or N position (Except M/T models) • The clutch pedal is depressed (M/T models) 	On	O
SFT P -MET	Selector lever in any position other than P	Off	
	Selector lever in P position	On	P
SFT N -MET	Selector lever in any position other than N	Off	
	Selector lever in N position	On	

BCM (BODY CONTROL MODULE)

< ECU DIAGNOSIS INFORMATION >

Monitor Item	Condition	Value/Status
ENGINE STATE	Engine stopped	Stop
	While the engine stalls	Stall
	At engine cranking	Crank
	Engine running	Run
S/L LOCK-IPDM	Steering is unlocked	Off
	Steering is locked	On
S/L UNLK-IPDM	Steering is locked	Off
	Steering is unlocked	On
S/L RELAY-REQ	Steering lock system is not the LOCK condition and the changing condition from LOCK to UNLOCK	Off
	Steering lock system is the LOCK condition or the changing condition from LOCK to UNLOCK	On
VEH SPEED 1	While driving	Equivalent to speedometer reading
VEH SPEED 2	While driving	Equivalent to speedometer reading
DOOR STAT-DR	Driver door is locked	LOCK
	Wait with selective UNLOCK operation (60 seconds)	READY
	Driver door is unlocked	UNLOCK
DOOR STAT-AS	Passenger door is locked	LOCK
	Wait with selective UNLOCK operation (60 seconds)	READY
	Passenger door is unlocked	UNLOCK
ID OK FLAG	Steering is locked	Reset
	Steering is unlocked	Set
PRMT ENG STRT	The engine start is prohibited	Reset
	The engine start is permitted	Set
PRMT RKE STRT	NOTE: The item is indicated, but not monitored.	Reset
KEY SW -SLOT	The Intelligent Key is not inserted into key slot	Off
	The Intelligent Key is inserted into key slot	On
RKE OPE COUN1	During the operation of the Intelligent Key	Operation frequency of the Intelligent Key
RKE OPE COUN2	NOTE: The item is indicated, but not monitored.	—
CONFIRM ID ALL	The key ID that the key slot receives is not recognized by any key ID registered to BCM.	Yet
	The key ID that the key slot receives is recognized by any key ID registered to BCM.	Done
CONFIRM ID4	The key ID that the key slot receives is not recognized by the fourth key ID registered to BCM.	Yet
	The key ID that the key slot receives is recognized by the fourth key ID registered to BCM.	Done
CONFIRM ID3	The key ID that the key slot receives is not recognized by the third key ID registered to BCM.	Yet
	The key ID that the key slot receives is recognized by the third key ID registered to BCM.	Done

BCM (BODY CONTROL MODULE)

< ECU DIAGNOSIS INFORMATION >

Monitor Item	Condition	Value/Status	
CONFIRM ID2	The key ID that the key slot receives is not recognized by the second key ID registered to BCM.	Yet	A
	The key ID that the key slot receives is recognized by the second key ID registered to BCM.	Done	B
CONFIRM ID1	The key ID that the key slot receives is not recognized by the first key ID registered to BCM.	Yet	C
	The key ID that the key slot receives is recognized by the first key ID registered to BCM.	Done	
TP 4	The ID of fourth Intelligent Key is not registered to BCM	Yet	D
	The ID of fourth Intelligent Key is registered to BCM	Done	
TP 3	The ID of third Intelligent Key is not registered to BCM	Yet	E
	The ID of third Intelligent Key is registered to BCM	Done	
TP 2	The ID of second Intelligent Key is not registered to BCM	Yet	F
	The ID of second Intelligent Key is registered to BCM	Done	
TP 1	The ID of first Intelligent Key is not registered to BCM	Yet	
	The ID of first Intelligent Key is registered to BCM	Done	
AIR PRESS FL	Ignition switch ON (Only when the signal from the transmitter is received)	Air pressure of front LH tire	G
AIR PRESS FR	Ignition switch ON (Only when the signal from the transmitter is received)	Air pressure of front RH tire	H
AIR PRESS RR	Ignition switch ON (Only when the signal from the transmitter is received)	Air pressure of rear RH tire	I
AIR PRESS RL	Ignition switch ON (Only when the signal from the transmitter is received)	Air pressure of rear LH tire	
ID REGST FL1	ID of front LH tire transmitter is registered	Done	J
	ID of front LH tire transmitter is not registered	Yet	
ID REGST FR1	ID of front RH tire transmitter is registered	Done	K
	ID of front RH tire transmitter is not registered	Yet	
ID REGST RR1	ID of rear RH tire transmitter is registered	Done	L
	ID of rear RH tire transmitter is not registered	Yet	
ID REGST RL1	ID of rear LH tire transmitter is registered	Done	M
	ID of rear LH tire transmitter is not registered	Yet	
WARNING LAMP	Tire pressure indicator OFF	Off	
	Tire pressure indicator ON	On	
BUZZER	Tire pressure warning alarm is not sounding	Off	
	Tire pressure warning alarm is sounding	On	

WCS

O

P

BCM (BODY CONTROL MODULE)

< ECU DIAGNOSIS INFORMATION >

TERMINAL LAYOUT

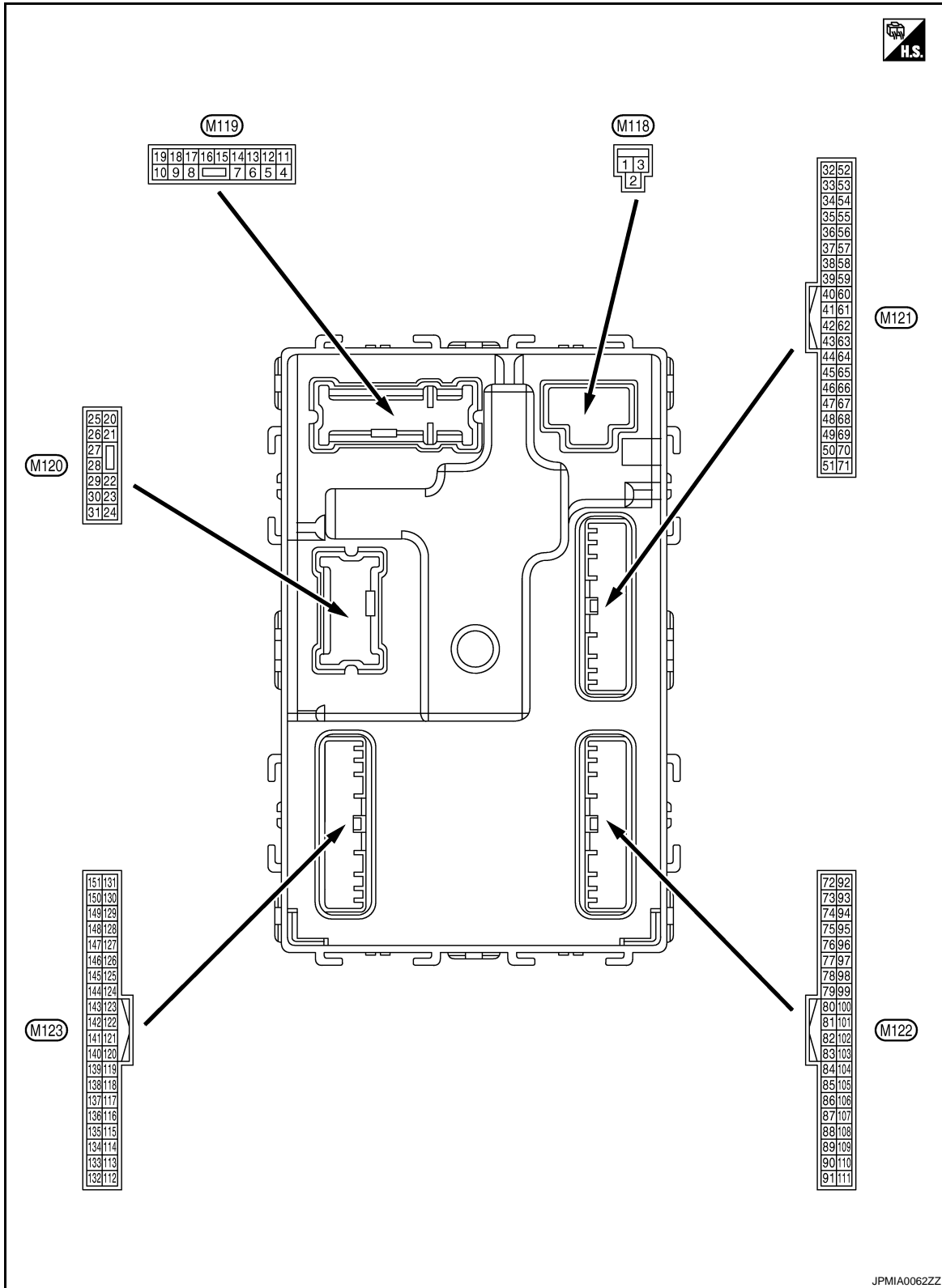

PHYSICAL VALUES

BCM (BODY CONTROL MODULE)

< ECU DIAGNOSIS INFORMATION >

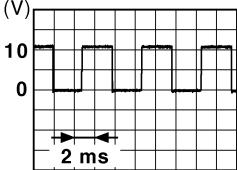
Terminal No. (Wire color)		Description		Condition		Value (Approx.)
+	-					
1 (W)	Ground	Battery power supply	Input	Ignition switch OFF		Battery voltage
2 (Y)	Ground	P/W power supply (BAT)	Output	Ignition switch OFF		12 V
3 (O)	Ground	P/W power supply (RAP)	Output	Ignition switch ON		12 V
4 (LG)	Ground	Interior room lamp power supply	Output	Interior room lamp battery saver is activated. (Cuts the interior room lamp power supply)		0 V
				Interior room lamp battery saver is not activated. (Outputs the interior room lamp power supply)		12 V
5 (P)	Ground	Passenger door UN- LOCK	Output	Passenger door	UNLOCK (Actuator is activated)	12 V
					Other than UNLOCK) Ac- tuator is not activated	0 V
7 (BR)	Ground	Step lamp	Output	Step lamp	ON	0 V
					OFF	12 V
8 (V)	Ground	All doors, fuel lid LOCK	Output	All doors, fuel lid	LOCK (Actuator is activated)	12 V
					Other than LOCK (Actuator is not activated)	0 V
9 (G)	Ground	Driver door, fuel lid UNLOCK	Output	Driver door, fuel lid	UNLOCK (Actuator is activated)	12 V
					Other than UNLOCK (Actuator is not activated)	0 V
10 (BR)	Ground	Rear RH door and rear LH UNLOCK	Output	Rear RH door and rear LH door	UNLOCK (Actuator is activated)	12 V
					Other than UNLOCK (Actuator is not activated)	0 V
11 (R)	Ground	Battery power supply	Input	Ignition switch OFF		Battery voltage
13 (B)	Ground	Ground	—	Ignition switch ON		0 V
14 (W)	Ground	Push-button ignition switch illumination ground	Output	Tail lamp	OFF	0 V
					ON	<p>NOTE: When the illumination brightening/dimming level is in the neutral position</p>  <p style="text-align: right; font-size: small;">JSNIA0010GB</p>
15 (O)	Ground	ACC indicator lamp	Output	Ignition switch	OFF (LOCK indicator is not illuminated)	Battery voltage
					ACC	0 V

A

B

C

D

E

F

G

H

I

J

K

L

M

WCS

O

P

BCM (BODY CONTROL MODULE)

< ECU DIAGNOSIS INFORMATION >

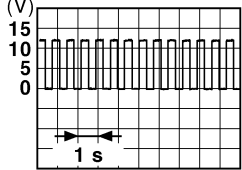
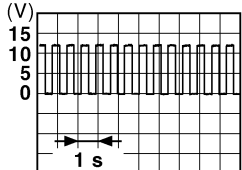
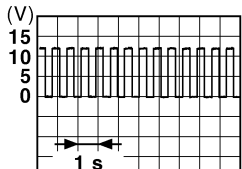
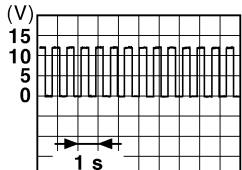
Terminal No. (Wire color)		Description		Condition	Value (Approx.)
+	-	Signal name	Input/ Output		
17 (W)	Ground	Turn signal RH (Front)	Output	Ignition switch ON	Turn signal switch OFF 0 V
				Turn signal switch RH	 6.5 V <small>PKID0926E</small>
18 (O)	Ground	Turn signal LH (Front)	Output	Ignition switch ON	Turn signal switch OFF 0 V
				Turn signal switch LH	 6.5 V <small>PKID0926E</small>
19 (V)	Ground	Room lamp timer control	Output	Interior room lamp	OFF 12 V
				ON	0 V
20 (V)	Ground	Turn signal RH (Rear)	Output	Ignition switch ON	Turn signal switch OFF 0 V
				Turn signal switch RH	 6.5 V <small>PKID0926E</small>
23 (L)	Ground	Trunk lid open	Output	Trunk lid	OPEN (Trunk lid opener actuator is activated) 12 V
				Other than OPEN (Trunk lid opener actuator is not activated)	0 V
25 (Y)	Ground	Turn signal LH (Rear)	Output	Ignition switch ON	Turn signal switch OFF 0 V
				Turn signal switch LH	 6.5 V <small>PKID0926E</small>
30 (P)	Ground	Trunk room lamp	Output	Trunk room lamp	ON 0 V
				OFF	12 V

BCM (BODY CONTROL MODULE)

< ECU DIAGNOSIS INFORMATION >

Terminal No. (Wire color)		Description		Condition	Value (Approx.)
+	-	Signal name	Input/ Output		
34 (SB)	Ground	Trunk room antenna (-)	Output	Ignition switch OFF	<p style="text-align: right; font-size: small;">JMKIA0062GB</p>
				When Intelligent Key is not in the passenger compart- ment	<p style="text-align: right; font-size: small;">JMKIA0063GB</p>
35 (V)	Ground	Trunk room antenna (+)	Output	Ignition switch OFF	<p style="text-align: right; font-size: small;">JMKIA0062GB</p>
				When Intelligent Key is not in the passenger compart- ment	<p style="text-align: right; font-size: small;">JMKIA0063GB</p>
38 (B)	Ground	Rear bumper anten- na (-)	Output	When the trunk lid opener re- quest switch is operated with ignition switch OFF	<p style="text-align: right; font-size: small;">JMKIA0062GB</p>
				When Intelligent Key is not in the antenna detection area	<p style="text-align: right; font-size: small;">JMKIA0063GB</p>

A
B
C
D
E
F
G
H
I
J
K
L
M
O
P

WCS

BCM (BODY CONTROL MODULE)

< ECU DIAGNOSIS INFORMATION >

Terminal No. (Wire color)		Description		Condition	Value (Approx.)				
+	-	Signal name	Input/ Output						
39 (W)	Ground	Rear bumper antenna (+)	Output	When Intelligent Key is in the antenna detection area	<p style="text-align: right; font-size: small;">JMKIA0062GB</p>				
				When the trunk lid opener request switch is operated with ignition switch OFF	<p style="text-align: right; font-size: small;">JMKIA0063GB</p>				
47 (Y)	Ground	Ignition relay (IPDM E/R) control	Output	Ignition switch	<table border="0" style="width: 100%;"> <tr> <td style="width: 50%;">OFF or ACC</td> <td style="text-align: right;">12 V</td> </tr> <tr> <td>ON</td> <td style="text-align: right;">0 V</td> </tr> </table>	OFF or ACC	12 V	ON	0 V
				OFF or ACC	12 V				
ON	0 V								
50 (O)	Ground	Trunk room lamp switch	Input	Trunk room lamp switch	<table border="0" style="width: 100%;"> <tr> <td style="width: 50%;">OFF (Trunk lid is closed)</td> <td> <p style="text-align: right; font-size: small;">JPMIA0011GB</p> </td> </tr> <tr> <td>ON (Trunk lid is opened)</td> <td style="text-align: right;">0 V</td> </tr> </table>	OFF (Trunk lid is closed)	<p style="text-align: right; font-size: small;">JPMIA0011GB</p>	ON (Trunk lid is opened)	0 V
				OFF (Trunk lid is closed)	<p style="text-align: right; font-size: small;">JPMIA0011GB</p>				
ON (Trunk lid is opened)	0 V								
52 (SB)	Ground	Starter relay control	Output	Ignition switch ON (A/T models)	When selector lever is in P or N position	12 V			
				Ignition switch ON (M/T models)	When selector lever is not in P or N position	0 V			
			Input	Ignition switch ON (A/T models)	When the clutch pedal is depressed	Battery voltage			
				Ignition switch ON (M/T models)	When the clutch pedal is not depressed	0 V			
61 (SB)	Ground	Trunk lid opener request switch	Input	Trunk lid opener request switch	<table border="0" style="width: 100%;"> <tr> <td style="width: 50%;">ON (Pressed)</td> <td style="text-align: right;">0 V</td> </tr> <tr> <td>OFF (Not pressed)</td> <td> <p style="text-align: right; font-size: small;">JPMIA0016GB</p> </td> </tr> </table>	ON (Pressed)	0 V	OFF (Not pressed)	<p style="text-align: right; font-size: small;">JPMIA0016GB</p>
				ON (Pressed)	0 V				
OFF (Not pressed)	<p style="text-align: right; font-size: small;">JPMIA0016GB</p>								
1.0 V									
64 (G)	Ground	Intelligent Key warning buzzer (Engine room)	Output	Intelligent Key warning buzzer (Engine room)	<table border="0" style="width: 100%;"> <tr> <td style="width: 50%;">Sounding</td> <td style="text-align: right;">0 V</td> </tr> <tr> <td>Not sounding</td> <td style="text-align: right;">12 V</td> </tr> </table>	Sounding	0 V	Not sounding	12 V
				Sounding	0 V				
Not sounding	12 V								

BCM (BODY CONTROL MODULE)

< ECU DIAGNOSIS INFORMATION >

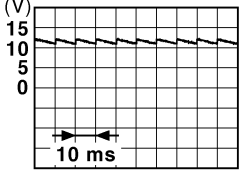
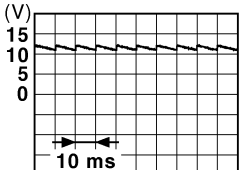
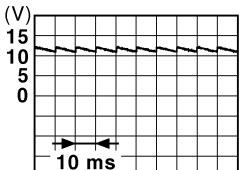
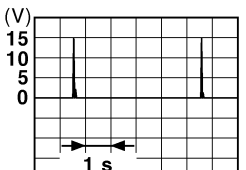
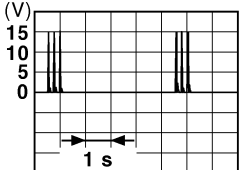
Terminal No. (Wire color)		Description		Condition	Value (Approx.)	
		Signal name	Input/ Output			
+	-					
67 (GR)	Ground	Trunk lid opener switch	Input	Trunk lid open- er switch	Pressed	0 V
					Not pressed	 <p style="text-align: right; font-size: small;">JPMIA0011GB</p>
68 (BR)	Ground	Rear RH door switch	Input	Rear RH door switch	OFF (When rear RH door closes)	 <p style="text-align: right; font-size: small;">JPMIA0011GB</p>
					ON (When rear RH door opens)	0 V
69 (R)	Ground	Rear LH door switch	Input	Rear LH door switch	OFF (When rear LH door closes)	 <p style="text-align: right; font-size: small;">JPMIA0011GB</p>
					ON (When rear LH door opens)	0 V
72 (R)	Ground	Room antenna 2 (-) (Center console)	Output	Ignition switch OFF	When Intelligent Key is in the passenger compart- ment	 <p style="text-align: right; font-size: small;">JMKIA0062GB</p>
					When Intelligent Key is not in the passenger compart- ment	 <p style="text-align: right; font-size: small;">JMKIA0063GB</p>

A
B
C
D
E
F
G
H
I
J
K
L
M
O
P

WCS

BCM (BODY CONTROL MODULE)

< ECU DIAGNOSIS INFORMATION >

Terminal No. (Wire color)		Description		Condition	Value (Approx.)
+	-	Signal name	Input/ Output		
73 (G)	Ground	Room antenna 2 (+) (Center console)	Output	Ignition switch OFF	<p>JMKIA0062GB</p>
				When Intelligent Key is not in the passenger compart- ment	<p>JMKIA0063GB</p>
74 (SB)	Ground	Passenger door an- tenna (-)	Output	When the pas- senger door re- quest switch is operated with ignition switch OFF	<p>JMKIA0062GB</p>
				When Intelligent Key is not in the antenna detection area	<p>JMKIA0063GB</p>
75 (BR)	Ground	Passenger door an- tenna (+)	Output	When the pas- senger door re- quest switch is operated with ignition switch OFF	<p>JMKIA0062GB</p>
				When Intelligent Key is not in the antenna detection area	<p>JMKIA0063GB</p>

BCM (BODY CONTROL MODULE)

< ECU DIAGNOSIS INFORMATION >

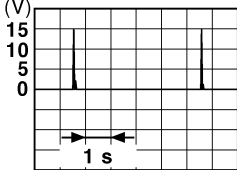
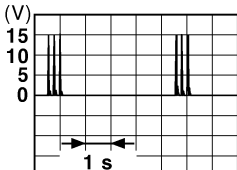
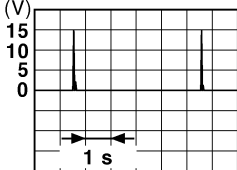
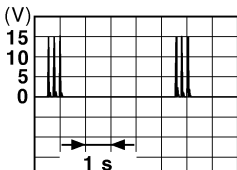
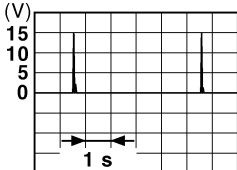
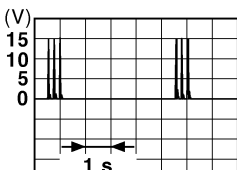
Terminal No. (Wire color)		Description		Condition	Value (Approx.)	
		Signal name	Input/ Output			
+	-					
76 (V)	Ground	Driver door antenna (-)	Output	When the driver door request switch is operated with ignition switch OFF	When Intelligent Key is in the antenna detection area	 <small>JMKIA0062GB</small>
				When the driver door request switch is operated with ignition switch OFF	When Intelligent Key is not in the antenna detection area	 <small>JMKIA0063GB</small>
77 (LG)	Ground	Driver door antenna (+)	Output	When the driver door request switch is operated with ignition switch OFF	When Intelligent Key is in the antenna detection area	 <small>JMKIA0062GB</small>
				When the driver door request switch is operated with ignition switch OFF	When Intelligent Key is not in the antenna detection area	 <small>JMKIA0063GB</small>
78 (Y)	Ground	Room antenna 1 (-) (Instrument panel)	Output	Ignition switch OFF	When Intelligent Key is in the passenger compartment	 <small>JMKIA0062GB</small>
					When Intelligent Key is not in the passenger compartment	 <small>JMKIA0063GB</small>

A
B
C
D
E
F
G
H
I
J
K
L
M
O
P

WCS

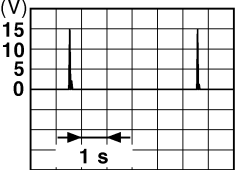
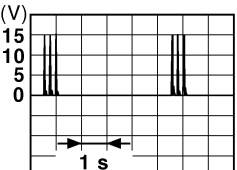
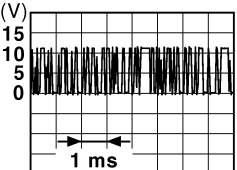
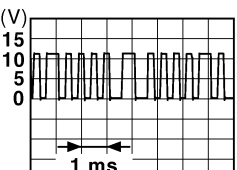

BCM (BODY CONTROL MODULE)

< ECU DIAGNOSIS INFORMATION >

Terminal No. (Wire color)		Description		Condition	Value (Approx.)	
+	-	Signal name	Input/ Output			
79 (BR)	Ground	Room antenna 1 (+) (Instrument panel)	Output	Ignition switch OFF		
				When Intelligent Key is not in the passenger compart- ment		
80 (GR)	Ground	NATS antenna amp (Built in key slot)	Input/ Output	During waiting	Ignition switch is pressed while inserting the Intelli- gent Key into the key slot.	
81 (W)	Ground	NATS antenna amp (Built in key slot)	Input/ Output	During waiting	Ignition switch is pressed while inserting the Intelli- gent Key into the key slot.	
82 (R)	Ground	Ignition relay [Fuse block (J/B)] control	Output	Ignition switch	OFF or ACC	0 V
					ON	12 V
83 (Y)	Ground	Remote keyless entry receiver communica- tion	Input/ Output	During waiting		
				When operating either button on the Intelli- gent Key		

BCM (BODY CONTROL MODULE)

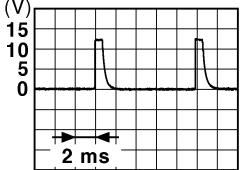
< ECU DIAGNOSIS INFORMATION >

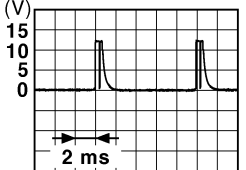

Terminal No. (Wire color)		Description		Condition	Value (Approx.)
+	-	Signal name	Input/ Output		
87 (Y)	Ground	Combination switch INPUT 5	Input	Combination switch	All switches OFF (Wiper intermittent dial 4)  <p style="text-align: right; font-size: small;">JPMIA0041GB</p> <p style="text-align: center;">1.4 V</p>
					Front fog lamp switch ON (Wiper intermittent dial 4)  <p style="text-align: right; font-size: small;">JPMIA0037GB</p> <p style="text-align: center;">1.3 V</p>
					Any of the conditions below with all switches OFF <ul style="list-style-type: none"> • Wiper intermittent dial 1 • Wiper intermittent dial 2 • Wiper intermittent dial 6 • Wiper intermittent dial 7  <p style="text-align: right; font-size: small;">JPMIA0040GB</p> <p style="text-align: center;">1.3 V</p>

A
B
C
D
E
F
G
H
I
J
K
L
M
O
P

WCS

BCM (BODY CONTROL MODULE)

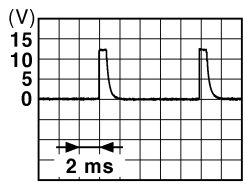
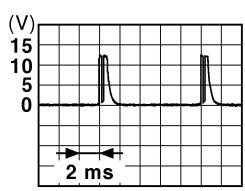
< ECU DIAGNOSIS INFORMATION >

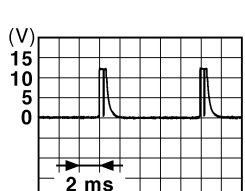
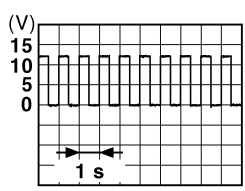
Terminal No. (Wire color)		Description		Condition	Value (Approx.)	
+	-	Signal name	Input/ Output			
88 (O)	Ground	Combination switch INPUT 3	Input	Combination switch	All switches OFF (Wiper intermittent dial 4)	 <p style="text-align: right; font-size: small;">JPMIA0041GB</p> <p style="text-align: center;">1.4 V</p>
					Lighting switch HI (Wiper intermittent dial 4)	 <p style="text-align: right; font-size: small;">JPMIA0036GB</p> <p style="text-align: center;">1.3 V</p>
					Lighting switch 2ND (Wiper intermittent dial 4)	 <p style="text-align: right; font-size: small;">JPMIA0037GB</p> <p style="text-align: center;">1.3 V</p>
					Any of the conditions below with all switches OFF <ul style="list-style-type: none"> • Wiper intermittent dial 1 • Wiper intermittent dial 2 • Wiper intermittent dial 3 	 <p style="text-align: right; font-size: small;">JPMIA0040GB</p> <p style="text-align: center;">1.3 V</p>
89 (BR)	Ground	Push-button ignition switch (Push switch)	Input	Push-button ignition switch (push switch)	Pressed Not pressed	0 V Battery voltage
90 (P)	Ground	CAN-L	Input/ Output	—	—	—
91 (L)	Ground	CAN-H	Input/ Output	—	—	—
92 (LG)	Ground	Key slot illumination	Output	Key slot illumina- tion	OFF	0 V
					Blinking	 <p style="text-align: right; font-size: small;">JPMIA0015GB</p> <p style="text-align: center;">6.5 V</p>
					ON	12 V

BCM (BODY CONTROL MODULE)

< ECU DIAGNOSIS INFORMATION >

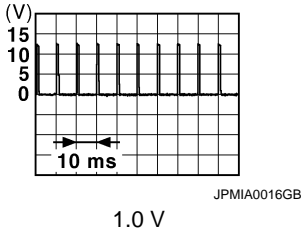
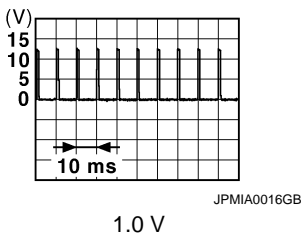
Terminal No. (Wire color)		Description		Condition		Value (Approx.)
		Signal name	Input/ Output			
+	-					
93 (V)	Ground	ON indicator lamp	Output	Ignition switch	OFF (LOCK indicator is not illuminated)	Battery voltage
					ON	0 V
95 (O)	Ground	ACC relay control	Output	Ignition switch	OFF	0 V
					ACC or ON	12 V
96 (GR)	Ground	A/T shift selector (Detention switch) power supply	Output	—		12 V
97 (L)	Ground	Steering lock condition No. 1	Input	Steering lock	LOCK status	0 V
					UNLOCK status	12 V
98 (P)	Ground	Steering lock condition No. 2	Input	Steering lock	LOCK status	12 V
					UNLOCK status	0 V
99 (R)*1 (BR)*2	Ground	Selector lever P position switch (A/T models)	Input	Selector lever	P position	0 V
					Any position other than P	12 V
		ASCD clutch switch (M/T models without ICC)		ASCD clutch switch	OFF (Clutch pedal is depressed)	0 V
					ON (Clutch pedal is not depressed)	12 V
		ICC clutch switch (M/T models with ICC)		ICC clutch switch	OFF (Clutch pedal is depressed)	0 V
					ON (Clutch pedal is not depressed)	12 V
100 (Y)	Ground	Passenger door request switch	Input	Passenger door request switch	ON (Pressed)	0 V
					OFF (Not pressed)	
101 (P)	Ground	Driver door request switch	Input	Driver door request switch	ON (Pressed)	0 V
					OFF (Not pressed)	
102 (O)	Ground	Blower fan motor relay control	Output	Ignition switch	OFF or ACC	0 V
					ON	12 V
103 (L)	Ground	Remote keyless entry receiver power supply	Output	Ignition switch OFF		12 V
106 (W)	Ground	Steering lock unit power supply	Output	Ignition switch	OFF or ACC	12 V
					ON	0 V





A
B
C
D
E
F
G
H
I
J
K
L
M

WCS

O
P

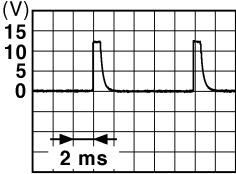

BCM (BODY CONTROL MODULE)

< ECU DIAGNOSIS INFORMATION >

Terminal No. (Wire color)		Description		Condition	Value (Approx.)	
+	-	Signal name	Input/ Output			
107 (LG)	Ground	Combination switch INPUT 1	Input	Combination switch (Wiper intermit- tent dial 4)	All switches OFF	 <p style="text-align: right;">JPMIA0041GB</p> <p style="text-align: center;">1.4 V</p>
					Turn signal switch LH	 <p style="text-align: right;">JPMIA0037GB</p> <p style="text-align: center;">1.3 V</p>
					Turn signal switch RH	 <p style="text-align: right;">JPMIA0036GB</p> <p style="text-align: center;">1.3 V</p>
					Front wiper switch LO	 <p style="text-align: right;">JPMIA0038GB</p> <p style="text-align: center;">1.3 V</p>
					Front washer switch ON	 <p style="text-align: right;">JPMIA0039GB</p> <p style="text-align: center;">1.3 V</p>

BCM (BODY CONTROL MODULE)

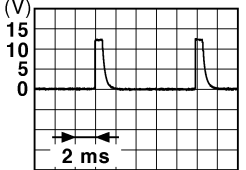
< ECU DIAGNOSIS INFORMATION >

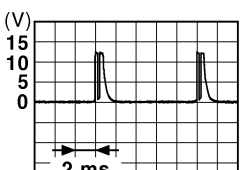
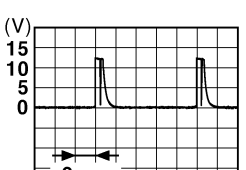
Terminal No. (Wire color)		Description		Condition	Value (Approx.)
+	-	Signal name	Input/ Output		
108 (R)	Ground	Combination switch INPUT 4	Input	Combination switch	All switches OFF (Wiper intermittent dial 4)  1.4 V
					Lighting switch AUTO (Wiper intermittent dial 4)  1.3 V
					Lighting switch 1ST (Wiper intermittent dial 4)  1.3 V
					Any of the conditions below with all switches OFF <ul style="list-style-type: none"> • Wiper intermittent dial 1 • Wiper intermittent dial 5 • Wiper intermittent dial 6  1.3 V

A
B
C
D
E
F
G
H
I
J
K
L
M

WCS

BCM (BODY CONTROL MODULE)

< ECU DIAGNOSIS INFORMATION >

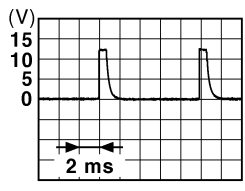
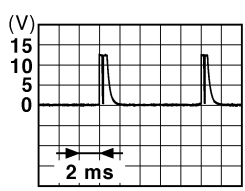
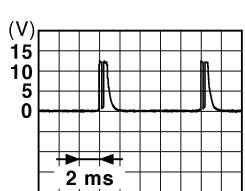
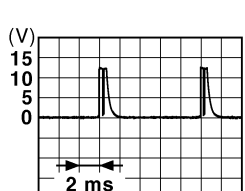
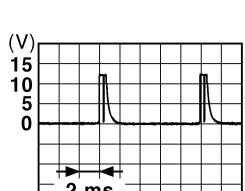
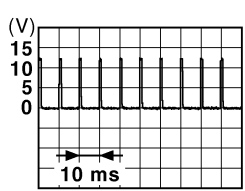
Terminal No. (Wire color)		Description		Condition	Value (Approx.)	
+	-	Signal name	Input/ Output			
109 (W)	Ground	Combination switch INPUT 2	Input	Combination switch (Wiper intermittent dial 4)	All switches OFF	 <p style="text-align: right; font-size: small;">JPMIA0041GB</p> <p style="text-align: center;">1.4 V</p>
					Lighting switch PASS	 <p style="text-align: right; font-size: small;">JPMIA0037GB</p> <p style="text-align: center;">1.3 V</p>
					Lighting switch 2ND	 <p style="text-align: right; font-size: small;">JPMIA0036GB</p> <p style="text-align: center;">1.3 V</p>
					Front wiper switch INT	 <p style="text-align: right; font-size: small;">JPMIA0038GB</p> <p style="text-align: center;">1.3 V</p>
					Front wiper switch HI	 <p style="text-align: right; font-size: small;">JPMIA0040GB</p> <p style="text-align: center;">1.3 V</p>
110 (G)	Ground	Hazard switch	Input	Hazard switch	ON	0 V
					OFF	 <p style="text-align: right; font-size: small;">JPMIA0012GB</p> <p style="text-align: center;">1.1 V</p>

BCM (BODY CONTROL MODULE)

< ECU DIAGNOSIS INFORMATION >

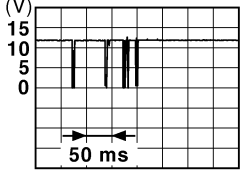
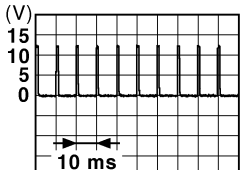
Terminal No. (Wire color)		Description		Condition	Value (Approx.)			
+	-	Signal name	Input/ Output					
111 (Y)	Ground	Steering lock unit communication	Input/ Output	Steering lock	LOCK status	12 V		
					LOCK or UNLOCK	 <p style="text-align: right; font-size: small;">JMkia0066GB</p>		
							For 15 seconds after UNLOCK	12 V
							15 seconds or later after UNLOCK	0 V
113 (O)	Ground	Optical sensor	Input	Ignition switch ON	When bright outside of the vehicle	Close to 5 V		
				When dark outside of the vehicle	Close to 0 V			
114 (R)	Ground	Clutch interlock switch	Input	Clutch interlock switch	OFF (Clutch pedal is not depressed)	0 V		
					ON (Clutch pedal is depressed)	Battery voltage		
116 (SB)	Ground	Stop lamp switch 1	Input	—	Battery voltage			
118 (BR)	Ground	Stop lamp switch 2 (Without ICC)	Input	Stop lamp switch	OFF (Brake pedal is not depressed)	0 V		
					ON (Brake pedal is depressed)	Battery voltage		
		Stop lamp switch 2 (With ICC)		Stop lamp switch OFF (Brake pedal is not depressed) and ICC brake hold relay OFF	0 V			
				Stop lamp switch ON (Brake pedal is depressed) or ICC brake hold relay ON	Battery voltage			
119 (SB)	Ground	Front door lock assembly driver side (Unlock sensor)	Input	Driver door	LOCK status (Unlock sensor switch OFF)	 <p style="text-align: right; font-size: small;">JPMIA0012GB</p>		
					UNLOCK status (Unlock switch sensor ON)		1.1 V	
					UNLOCK status (Unlock switch sensor ON)	0 V		
121 (SB)	Ground	Key slot switch	Input	When the Intelligent Key is inserted into key slot	12 V			
				When the Intelligent Key is not inserted into key slot	0 V			
123 (W)	Ground	IGN feedback	Input	Ignition switch	OFF or ACC	0 V		
				ON	Battery voltage			

A
B
C
D
E
F
G
H
I
J
K
L
M
O
P

WCS



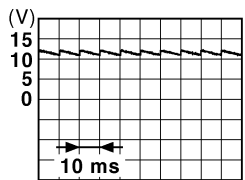
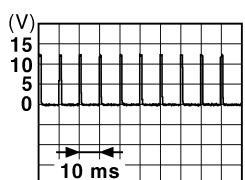
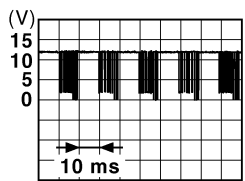
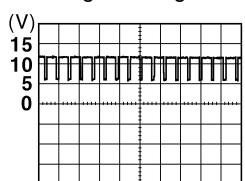

BCM (BODY CONTROL MODULE)

< ECU DIAGNOSIS INFORMATION >

Terminal No. (Wire color)		Description		Condition	Value (Approx.)	
		Signal name	Input/ Output			
+	-					
124 (LG)	Ground	Passenger door switch	Input	Passenger door switch	OFF (Door close)	 <p style="text-align: right; font-size: small;">JPMIA0011GB</p>
					ON (Door open)	0 V
129 (O)	Ground	Trunk lid opener cancel switch	Input	Trunk lid open- er cancel switch	CANCEL	 <p style="text-align: right; font-size: small;">JPMIA0012GB</p>
					ON	0 V
132 (V)	Ground	Power window switch communication	Input/ Output	Ignition switch ON	Ignition switch ON	 <p style="text-align: right; font-size: small;">JPMIA0013GB</p>
					Ignition switch OFF or ACC	12 V
133 (L)	Ground	Push-button ignition switch illumination	Output	Push-button ig- nition switch il- lumination	ON (Tail lamps OFF)	9.5 V
					ON (Tail lamps ON)	<p style="text-align: center;">NOTE: The pulse width of this wave is varied by the illumination bright- ening/dimming level.</p>  <p style="text-align: right; font-size: small;">JPMIA0159GB</p>
					OFF	0 V
134 (LG)	Ground	LOCK indicator lamp	Output	LOCK indicator lamp	OFF	Battery voltage
					ON	0 V
137 (O)	Ground	Receiver and sensor ground	Input	Ignition switch ON	Ignition switch ON	0 V
138 (V)	Ground	Receiver and sensor power supply	Output	Ignition switch	OFF	0 V
					ACC or ON	5.0 V

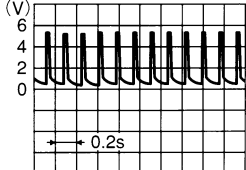
BCM (BODY CONTROL MODULE)

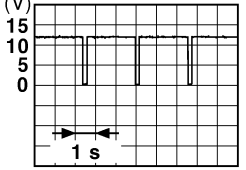
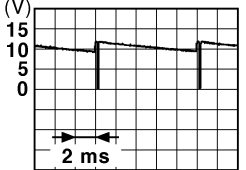
< ECU DIAGNOSIS INFORMATION >

Terminal No. (Wire color)		Description		Condition	Value (Approx.)	
		Signal name	Input/ Output			
+	-					
139 (L)	Ground	Tire pressure receiver communication	Input/ Output	Ignition switch ON	Standby state  OCC3881D	
					When receiving the signal from the transmitter  OCC3880D	
140 (GR)	Ground	Selector lever P/N position	Input	Selector lever	P or N position 12 V	
					Except P and N positions 0 V	
141 (R)	Ground	Security indicator	Output	Security indicator	ON 0 V	
					Blinking  11.3 V JPMA0014GB	
					OFF 12 V	
142 (BR)	Ground	Combination switch OUTPUT 5	Output	Combination switch (Wiper intermittent dial 4)	All switches OFF 0 V	
					Lighting switch 1ST	 10.7 V JPMA0031GB
					Lighting switch HI	
					Lighting switch 2ND	
		Turn signal switch RH				
143 (P)	Ground	Combination switch OUTPUT 1	Output	Combination switch	All switches OFF (Wiper intermittent dial 4) 0 V	
					Front wiper switch HI (Wiper intermittent dial 4) Any of the conditions below with all switches OFF • Wiper intermittent dial 1 • Wiper intermittent dial 2 • Wiper intermittent dial 3 • Wiper intermittent dial 6 • Wiper intermittent dial 7  10.7 V JPMA0032GB	

A
B
C
D
E
F
G
H
I
J
K
L
M
N
O
P

WCS

BCM (BODY CONTROL MODULE)

< ECU DIAGNOSIS INFORMATION >

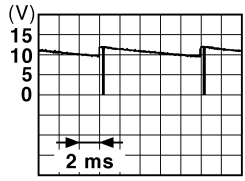
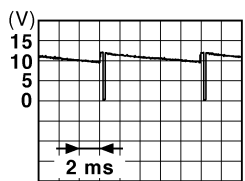
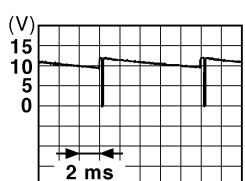
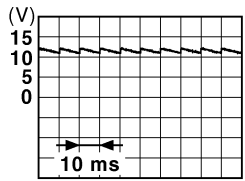
Terminal No. (Wire color)		Description		Condition	Value (Approx.)		
+	-	Signal name	Input/ Output				
144 (G)	Ground	Combination switch OUTPUT 2	Output	Combination switch	All switches OFF (Wiper intermittent dial 4)	0 V	
					Front washer switch ON (Wiper intermittent dial 4)		
					Any of the conditions below with all switches OFF		10.7 V
145 (L)	Ground	Combination switch OUTPUT 3	Output	Combination switch (Wiper intermittent dial 4)	All switches OFF	0 V	
					Front wiper switch INT		
					Front wiper switch LO		10.7 V
					Lighting switch AUTO		
146 (SB)	Ground	Combination switch OUTPUT 4	Output	Combination switch (Wiper intermittent dial 4)	All switches OFF	0 V	
					Front fog lamp switch ON		
					Lighting switch 2ND		10.7 V
					Lighting switch PASS		
					Turn signal switch LH		
149 (W)	Ground	Tire pressure warning check switch	Input	—	12 V		
150 (GR)	Ground	Driver door switch	Input	Driver door switch	OFF (Door close)		
					ON (Door open)		11.8 V
151 (G)	Ground	Rear window defogger relay control	Output	Rear window defogger	Active	0 V	
					Not activated	Battery voltage	

- *1: A/T models
- *2: M/T models

BCM (BODY CONTROL MODULE)

< ECU DIAGNOSIS INFORMATION >

Wiring Diagram - BCM -

INFOID:000000004675402

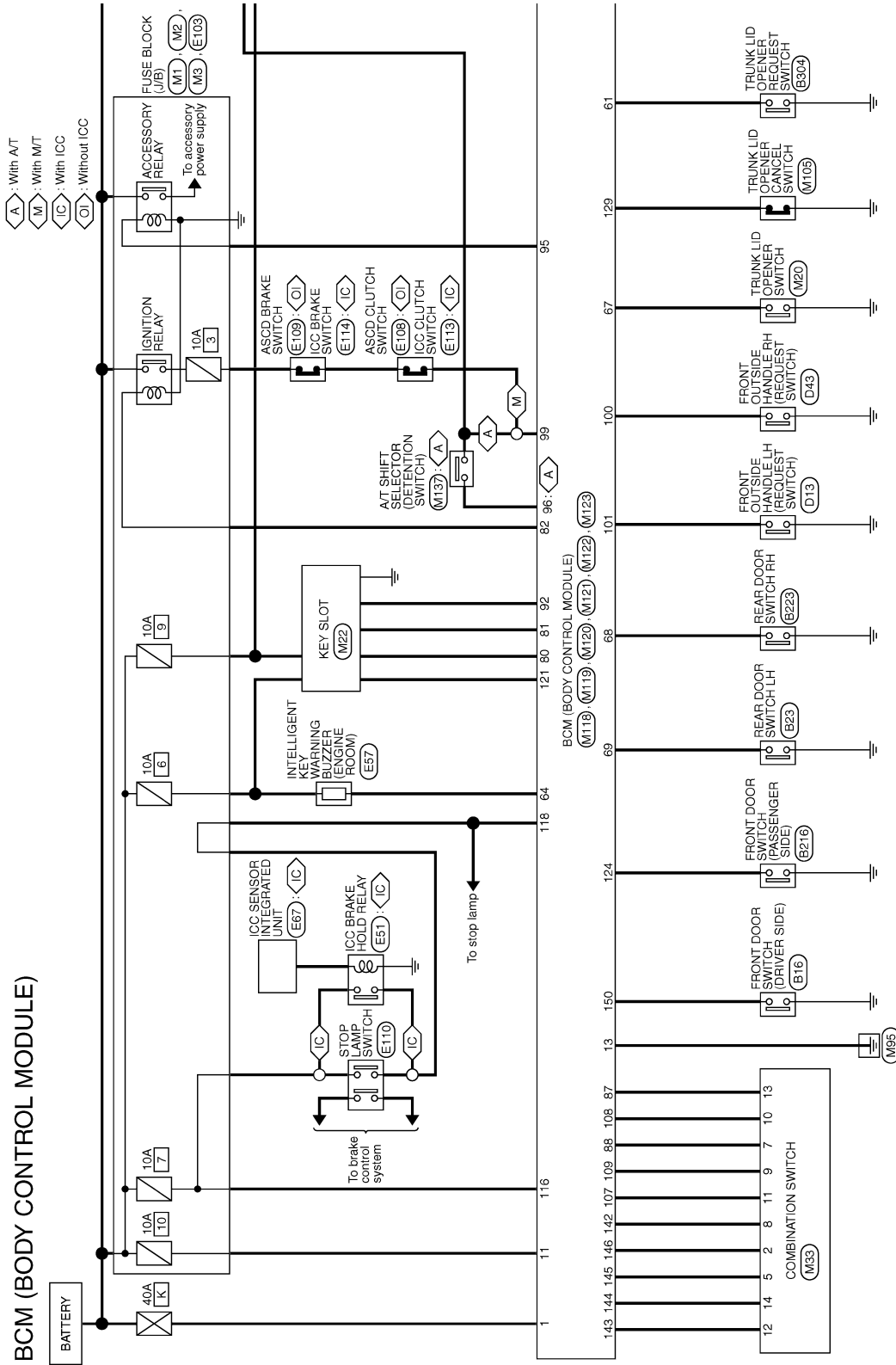

2008/08/07

JCMWA3019GE

A
B
C
D
E
F
G
H
I
J
K
L
M
O
P

WCS

BCM (BODY CONTROL MODULE)

< ECU DIAGNOSIS INFORMATION >

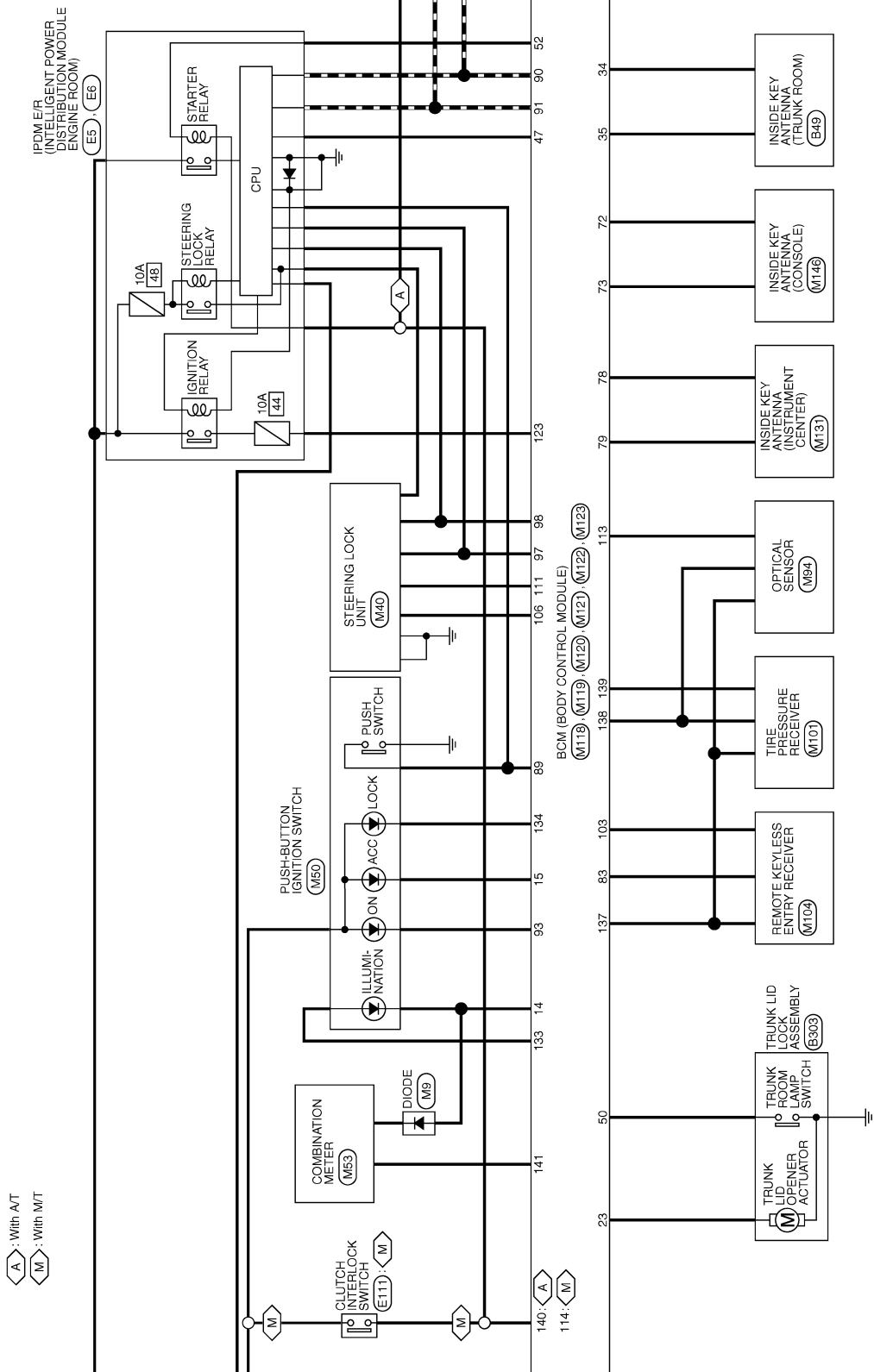

JCMWA3020Gf

BCM (BODY CONTROL MODULE)

< ECU DIAGNOSIS INFORMATION >

- ◁ A ▷ : With AT
- ◁ RF ▷ : With sunroof
- ◁ AN ▷ : With rear anti-pinch system
- ◁ OA ▷ : Without rear anti-pinch system
- ◁ SR ▷ : With sports seat without automatic drive positioner
- ◁ PM ▷ : With automatic drive positioner
- ◁ OP ▷ : Without automatic drive positioner

* : This connector is not shown in "Harness Layout".

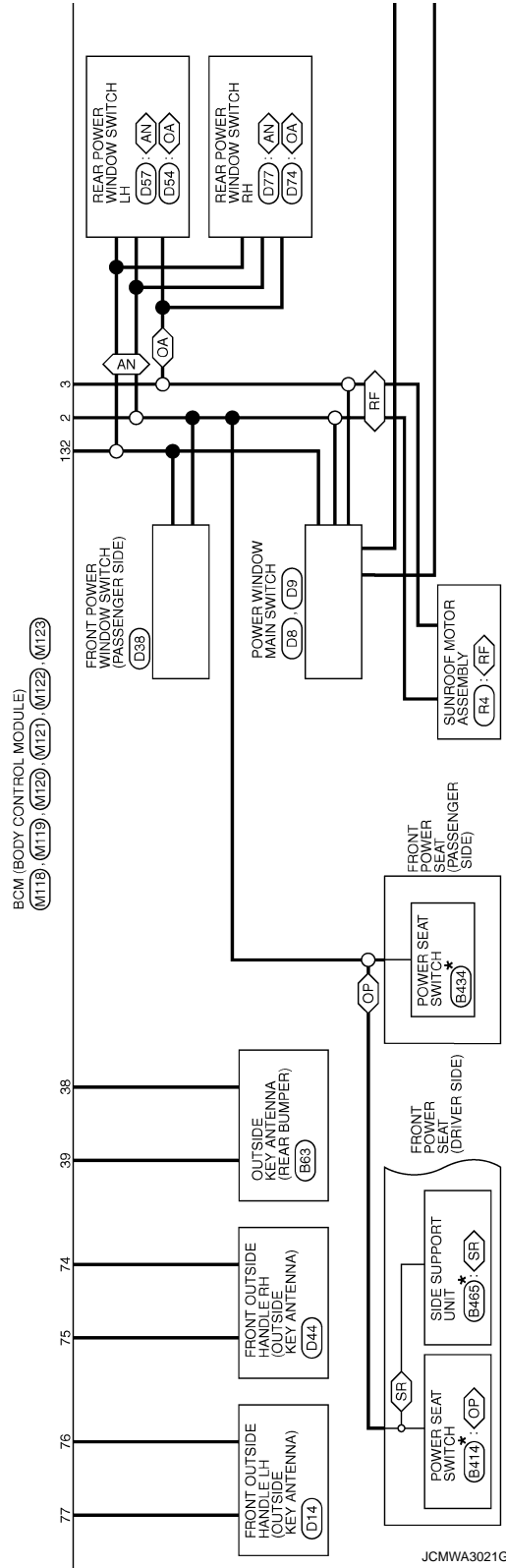
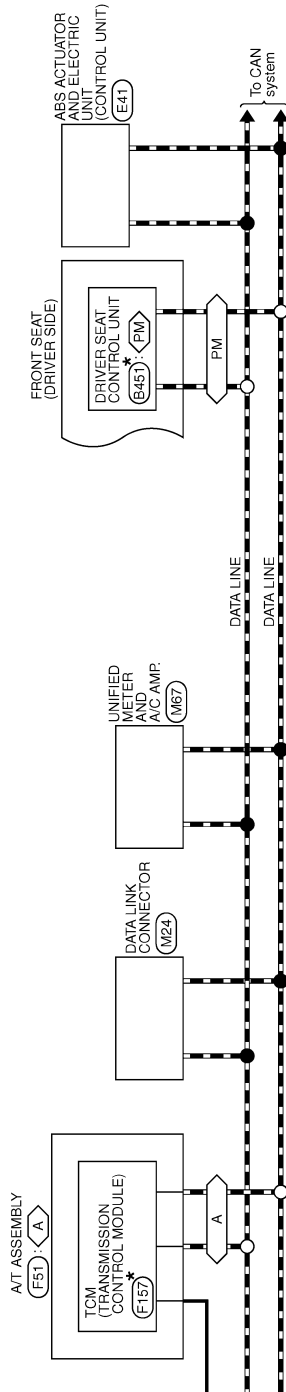

JCMWA3021GE

A
B
C
D
E
F
G
H
I
J
K
L
M
N
O
P

WCS

BCM (BODY CONTROL MODULE)

< ECU DIAGNOSIS INFORMATION >

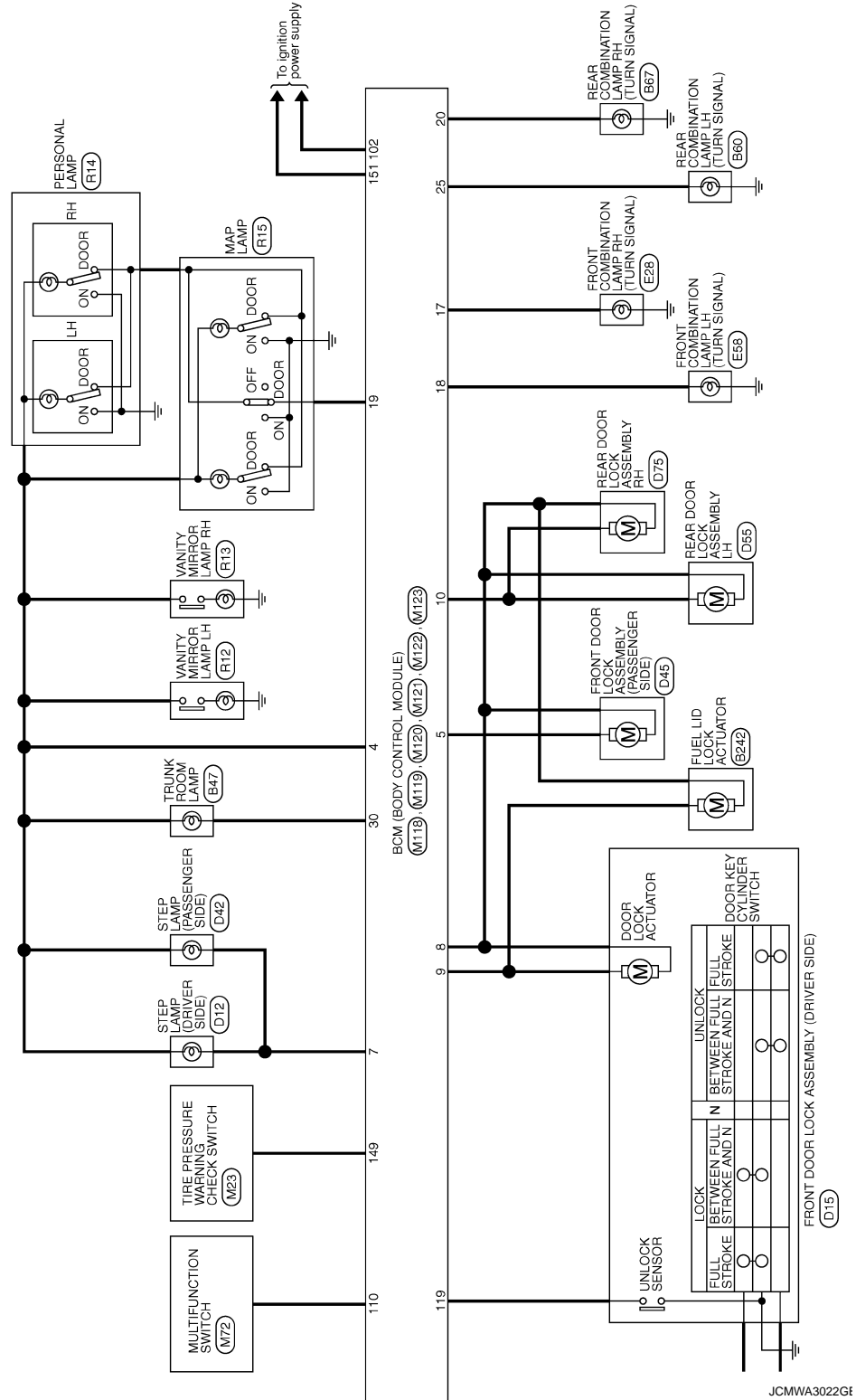

BCM (BODY CONTROL MODULE)

< ECU DIAGNOSIS INFORMATION >

BCM (BODY CONTROL MODULE)

Connector No.	M33
Connector Name	COMBINATION SWITCH
Connector Type	TH16FW-RH

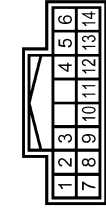

Terminal No.	Color of Wire	Signal Name [Specification]
2	SB	OUTPUT 4
5	L	OUTPUT 3
7	O	INPUT 3
8	BR	OUTPUT 5
9	W	INPUT 2
10	R	INPUT 4
11	LG	INPUT 1
12	P	OUTPUT 1
13	Y	INPUT 5
14	G	OUTPUT 2



Connector No.	M120
Connector Name	BCM (BODY CONTROL MODULE)
Connector Type	MS12FW-CS



Terminal No.	Color of Wire	Signal Name [Specification]
20	V	TURN SIGNAL RH (REAR)
23	L	TRUNK LID OPEN OUTPUT
25	Y	TURN SIGNAL LH (REAR)
30	P	TRUNK ROOM LAMP

Connector No.	M118
Connector Name	BCM (BODY CONTROL MODULE)
Connector Type	MS3FB-LC



Terminal No.	Color of Wire	Signal Name [Specification]
1	W	BAT (+/L)
2	Y	POWER WINDOW POWER SUPPLY(BAT)
3	O	POWER WINDOW POWER SUPPLY(IRAP)

Connector No.	M121
Connector Name	BCM (BODY CONTROL MODULE)
Connector Type	TH40FGY-NH

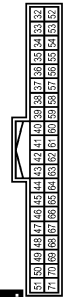

Terminal No.	Color of Wire	Signal Name [Specification]
34	SB	TRUNK ROOM ANT-
35	V	TRUNK ROOM ANT+
38	B	REAR BUMPER ANT-
39	W	REAR BUMPER ANT+
47	Y	IGN RELAY (IPDM E/R) CONT
50	O	TRUNK ROOM LAMP SW
52	SB	STARTER RELAY CONT
61	SB	TRUNK LID OPENER REQUEST SW
64	G	P-KEY WARN BUZZER (ENG ROOM)
67	GR	TRUNK LID OPENER SW
68	BR	REAR RH DOOR SW

Connector No.	M119
Connector Name	BCM (BODY CONTROL MODULE)
Connector Type	MS16FW-CS

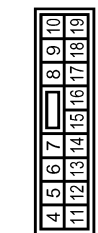

Terminal No.	Color of Wire	Signal Name [Specification]
4	LG	INTERIOR ROOM LAMP POWER SUPPLY
5	P	PASSENGER DOOR UNLOCK OUTPUT
7	BR	STEP LAMP OUTPUT
8	V	ALL DOOR FUEL LID LOCK OUTPUT
9	G	DRIVER DOOR FUEL LID UNLOCK OUTPUT
10	BR	REAR DOOR UNLOCK OUTPUT
11	R	BAT. (FUSE)
13	B	GND
14	W	PUSH-BUTTON IGNITION SW ILL GND
15	O	ACC. IND
17	W	TURN SIGNAL RH (FRONT)

69	R	REAR LH DOOR SW
----	---	-----------------

18	O	TURN SIGNAL LH (FRONT)
19	V	ROOM LAMP TIMER CONTROL

A
B
C
D
E
F
G
H
I
J
K
L
M
N
O
P



BCM (BODY CONTROL MODULE)

< ECU DIAGNOSIS INFORMATION >

134	LG	LOCK IND
137	O	RECEIVER/SENSOR GND
138	V	RECEIVER/SENSOR POWER SUPPLY
139	L	TIRE PRESSURE RECEIVER COMM
140	GR	SHIFT N/P
141	R	SECURITY INDICATOR
142	BR	COMBI SW OUTPUT 3
143	P	COMBI SW OUTPUT 1
144	G	COMBI SW OUTPUT 2
145	L	COMBI SW OUTPUT 3
146	SB	COMBI SW OUTPUT 4
149	W	TIRE PRESSURE WARN CHECK SW
150	GR	DRIVER DOOR SW
151	G	REAR WINDOW DEFOGGER RELAY CONT

Connector No.	M123
Connector Name	BCM (BODY CONTROL MODULE)
Connector Type	TH40FG-NH



Terminal No.	Color of Wire	Signal Name [Specification]
113	O	OPTICAL SENSOR
114	R	CLUTCH INTERLOCK SW
116	SB	STOP LAMP SW 1
118	BR	STOP LAMP SW 2
119	SB	DR DOOR UNLOCK SENSOR
121	SB	KEY SLOT SW
123	W	IGN F/B
124	LG	PASSENGER DOOR SW
129	O	TRUNK LID OPENER CANCEL SW
132	V	POWER WINDOW SW COMM
133	L	PUSH-BUTTON IGNITION SW ILL POWER

83	Y	KEYLESS ENTRY RECEIVER COMM
87	Y	COMBI SW INPUT 5
88	O	COMBI SW INPUT 3
89	BR	PUSH SW
90	P	CAN-L
91	L	CAN-H
92	LG	KEY SLOT ILL
93	V	GR IND
95	O	ACC RELAY CONT
96	GR	A/T SHIFT SELECTOR POWER SUPPLY
97	L	S/L CONDITION 1
98	P	S/L CONDITION 2
99	BR	ASCD CLUTCH SW [With M/T without ICC]
99	BR	ICC CLUTCH SW [With M/T and ICC]
99	R	SHIFT P [With A/T]
100	Y	PASSENGER DOOR REQUEST SW
101	P	DRIVER DOOR REQUEST SW
102	O	BLOWER FAN MOTOR RELAY CONT
103	L	KEYLESS ENTRY RECEIVER POWER SUPPLY
106	W	S/L UNIT POWER SUPPLY
107	LG	COMBI SW INPUT 1
108	R	COMBI SW INPUT 4
109	W	COMBI SW INPUT 2
110	G	HAZARD SW
111	Y	S/L UNIT COMM

BCM (BODY CONTROL MODULE)

Connector No.	M122
Connector Name	BCM (BODY CONTROL MODULE)
Connector Type	TH40FB-NH



Terminal No.	Color of Wire	Signal Name [Specification]
72	R	ROOM ANT2-
73	G	ROOM ANT2+
74	SB	PASSENGER DOOR ANT-
75	BR	PASSENGER DOOR ANT+
76	V	DRIVER DOOR ANT-
77	LG	DRIVER DOOR ANT+
78	Y	ROOM ANT1-
79	BR	ROOM ANT1+
80	GR	IMMOBI ANTENNA CONTROL
81	W	IMMOBI ANTENNA SIGNAL
82	R	IGN RELAY (F/B) CONT

JCMWA3024GE

Fail-safe

INFOID:000000004675403

FAIL-SAFE CONTROL BY DTC

BCM performs fail-safe control when any DTC are detected.

BCM (BODY CONTROL MODULE)

< ECU DIAGNOSIS INFORMATION >

Display contents of CONSULT	Fail-safe	Cancellation	
B2013: ID DISCORD BCM-S/L	Inhibit engine cranking	Erase DTC	A
B2014: CHAIN OF S/L-BCM	Inhibit engine cranking	Erase DTC	
B2190: NATS ANTENNA AMP	Inhibit engine cranking	Erase DTC	B
B2191: DIFFERENCE OF KEY	Inhibit engine cranking	Erase DTC	
B2192: ID DISCORD BCM-ECM	Inhibit engine cranking	Erase DTC	C
B2193: CHAIN OF BCM-ECM	Inhibit engine cranking	Erase DTC	
B2195: ANTI SCANNING	Inhibit engine cranking	Ignition switch ON → OFF	
B2557: VEHICLE SPEED	Inhibit steering lock	When normal vehicle speed signals are received from ABS actuator and electric unit (control unit) for 500 ms	D
B2560: STARTER CONT RELAY	Inhibit engine cranking	500 ms after the following CAN signal communication status becomes consistent <ul style="list-style-type: none"> • Starter control relay signal • Starter relay status signal 	E
B2601: SHIFT POSITION	Inhibit steering lock	500 ms after the following signal reception status becomes consistent <ul style="list-style-type: none"> • Selector lever P position switch signal • P range signal (CAN) 	F
B2602: SHIFT POSITION	Inhibit steering lock	5 seconds after the following BCM recognition conditions are fulfilled <ul style="list-style-type: none"> • Ignition switch is in the ON position • Selector lever P position switch signal: Except P position (battery voltage) • Vehicle speed: 4 km/h (2.5 MPH) or more 	G
B2603: SHIFT POSI STATUS	Inhibit steering lock	500 ms after the following BCM recognition conditions are fulfilled <ul style="list-style-type: none"> • Ignition switch is in the ON position • Selector lever P position switch signal: Except P position (battery voltage) • Selector lever P/N position signal: Except P and N positions (0 V) 	H
B2604: PNP SW	Inhibit steering lock	500 ms after any of the following BCM recognition conditions are fulfilled <ul style="list-style-type: none"> • Status 1 <ul style="list-style-type: none"> - Ignition switch is in the ON position - Selector lever P/N position signal: P and N position (battery voltage) - P range signal or N range signal (CAN): ON • Status 2 <ul style="list-style-type: none"> - Ignition switch is in the ON position - Selector lever P/N position signal: Except P and N positions (0 V) - P range signal and N range signal (CAN): OFF 	I
B2605: PNP SW	Inhibit steering lock	500 ms after any of the following BCM recognition conditions are fulfilled <ul style="list-style-type: none"> • Status 1 <ul style="list-style-type: none"> - Ignition switch is in the ON position - Selector lever P/N position signal: Except P and N positions (0 V) - Interlock/PNP switch signal (CAN): OFF • Status 2 <ul style="list-style-type: none"> - Ignition switch is in the ON position - Selector lever P/N position signal: P or N position (battery voltage) - PNP switch signal (CAN): ON 	J
B2606: S/L RELAY	Inhibit engine cranking	500 ms after the following CAN signal communication status becomes consistent <ul style="list-style-type: none"> • Steering lock relay signal (Request signal) • Steering lock relay signal (Condition signal) 	K
			L
			M
			WCS
			O
			P

BCM (BODY CONTROL MODULE)

< ECU DIAGNOSIS INFORMATION >

Display contents of CONSULT	Fail-safe	Cancellation
B2607: S/L RELAY	Inhibit engine cranking	500 ms after the following CAN signal communication status has becomes consistent <ul style="list-style-type: none"> • Steering lock relay signal (Request signal) • Steering lock relay signal (Condition signal)
B2608: STARTER RELAY	Inhibit engine cranking	500 ms after the following signal communication status becomes consistent <ul style="list-style-type: none"> • Starter motor relay control signal • Starter relay status signal (CAN)
B2609: S/L STATUS	<ul style="list-style-type: none"> • Inhibit engine cranking • Inhibit steering lock 	When the following steering lock conditions agree <ul style="list-style-type: none"> • BCM steering lock control status • Steering lock condition No. 1 signal status • Steering lock condition No. 2 signal status
B260A: IGNITION RELAY	Inhibit engine cranking	500 ms after the following conditions are fulfilled <ul style="list-style-type: none"> • IGN relay (IPDM E/R) control signal: OFF (Battery voltage) • Ignition ON signal (CAN to IPDM E/R): OFF (Request signal) • Ignition ON signal (CAN from IPDM E/R): OFF (Condition signal)
B260F: ENG STATE SIG LOST	Maintains the power supply position attained at the time of DTC detection	When any of the following conditions are fulfilled <ul style="list-style-type: none"> • Power position changes to ACC • Receives engine status signal (CAN)
B2612: S/L STATUS	<ul style="list-style-type: none"> • Inhibit engine cranking • Inhibit steering lock 	When any of the following conditions are fulfilled <ul style="list-style-type: none"> • Steering lock unit status signal (CAN) is received normally • The BCM steering lock control status matches the steering lock status recognized by the steering lock unit status signal (CAN from IPDM E/R)
B2617: STARTER RELAY CIRC	Inhibit engine cranking	1 second after the starter motor relay control inside BCM becomes normal
B2618: BCM	Inhibit engine cranking	1 second after the ignition relay (IPDM E/R) control inside BCM becomes normal
B2619: BCM	Inhibit engine cranking	1 second after the steering lock unit power supply output control inside BCM becomes normal
B261E: VEHICLE TYPE	Inhibit engine cranking	BCM initialization
B26E8: CLUTCH SW	Inhibit engine cranking	When any of the following BCM recognition conditions are fulfilled <ul style="list-style-type: none"> • Status 1 <ul style="list-style-type: none"> - Clutch switch signal (CAN from ECM): ON - Clutch interlock switch signal: OFF (0 V) • Status 2 <ul style="list-style-type: none"> - Clutch switch signal (CAN from ECM): OFF - Clutch interlock switch signal: ON (Battery voltage)
B26E9: S/L STATUS	<ul style="list-style-type: none"> • Inhibit engine cranking • Inhibit steering lock 	When BCM transmits the LOCK request signal to steering lock unit, and receives LOCK response signal from steering lock unit, the following conditions are fulfilled <ul style="list-style-type: none"> • Steering condition No. 1 signal: LOCK (0 V) • Steering condition No. 2 signal: LOCK (Battery voltage)

HIGH FLASHER OPERATION

BCM detects the turn signal lamp circuit status by the current value.

BCM increases the turn signal lamp blinking speed if the bulb or harness open is detected with the turn signal lamp operating.

NOTE:

The blinking speed is normal while activating the hazard warning lamp.

DTC Inspection Priority Chart

INFOID:000000004675404

If some DTCs are displayed at the same time, perform inspections one by one based on the following priority chart.

BCM (BODY CONTROL MODULE)

< ECU DIAGNOSIS INFORMATION >

Priority	DTC	A
1	B2562: LOW VOLTAGE	A
2	<ul style="list-style-type: none"> • U1000: CAN COMM • U1010: CONTROL UNIT(CAN) 	B
3	<ul style="list-style-type: none"> • B2190: NATS ANTENNA AMP • B2191: DIFFERENCE OF KEY • B2192: ID DISCORD BCM-ECM • B2193: CHAIN OF BCM-ECM • B2195: ANTI SCANNING 	C
4	<ul style="list-style-type: none"> • B2013: ID DISCORD BCM-S/L • B2014: CHAIN OF S/L-BCM • B2553: IGNITION RELAY • B2555: STOP LAMP • B2556: PUSH-BTN IGN SW • B2557: VEHICLE SPEED • B2560: STARTER CONT RELAY • B2601: SHIFT POSITION • B2602: SHIFT POSITION • B2603: SHIFT POSI STATUS • B2604: PNP SW • B2605: PNP SW • B2606: S/L RELAY • B2607: S/L RELAY • B2608: STARTER RELAY • B2609: S/L STATUS • B260A: IGNITION RELAY • B260B: STEERING LOCK UNIT • B260C: STEERING LOCK UNIT • B260D: STEERING LOCK UNIT • B260F: ENG STATE SIG LOST • B2612: S/L STATUS • B2614: ACC RELAY CIRC • B2615: BLOWER RELAY CIRC • B2616: IGN RELAY CIRC • B2617: STARTER RELAY CIRC • B2618: BCM • B2619: BCM • B261A: PUSH-BTN IGN SW • B261E: VEHICLE TYPE • B26E8: CLUTCH SW • B26E9: S/L STATUS • B26EA: KEY REGISTRATION • C1729: VHCL SPEED SIG ERR • U0415: VEHICLE SPEED SIG 	D E F G H I J K L M

WCS

O

P

BCM (BODY CONTROL MODULE)

< ECU DIAGNOSIS INFORMATION >

Priority	DTC
5	<ul style="list-style-type: none"> • C1704: LOW PRESSURE FL • C1705: LOW PRESSURE FR • C1706: LOW PRESSURE RR • C1707: LOW PRESSURE RL • C1708: [NO DATA] FL • C1709: [NO DATA] FR • C1710: [NO DATA] RR • C1711: [NO DATA] RL • C1712: [CHECKSUM ERR] FL • C1713: [CHECKSUM ERR] FR • C1714: [CHECKSUM ERR] RR • C1715: [CHECKSUM ERR] RL • C1716: [PRESSDATA ERR] FL • C1717: [PRESSDATA ERR] FR • C1718: [PRESSDATA ERR] RR • C1719: [PRESSDATA ERR] RL • C1720: [CODE ERR] FL • C1721: [CODE ERR] FR • C1722: [CODE ERR] RR • C1723: [CODE ERR] RL • C1724: [BATT VOLT LOW] FL • C1725: [BATT VOLT LOW] FR • C1726: [BATT VOLT LOW] RR • C1727: [BATT VOLT LOW] RL • C1734: CONTROL UNIT
6	<ul style="list-style-type: none"> • B2621: INSIDE ANTENNA • B2622: INSIDE ANTENNA • B2623: INSIDE ANTENNA

DTC Index

INFOID:000000004675405

NOTE:

The details of time display are as follows.

- CRNT: A malfunction is detected now.
- PAST: A malfunction was detected in the past.

IGN counter is displayed on Freeze Frame Data. For details of Freeze Frame Data, refer to [WCS-17. "COMMON ITEM : CONSULT-III Function \(BCM - COMMON ITEM\)".](#)

CONSULT display	Fail-safe	Freeze Frame Data •Vehicle Speed •Odo/Trip Meter •Vehicle condition	Intelligent Key warning lamp ON	Tire pressure monitor warning lamp ON	Refer- ence page
No DTC is detected. further testing may be required.	—	—	—	—	—
U1000: CAN COMM	—	—	—	—	BCS-35
U1010: CONTROL UNIT(CAN)	—	—	—	—	BCS-36
U0415: VEHICLE SPEED SIG	—	—	—	—	BCS-37
B2013: ID DISCORD BCM-S/L	×	×	—	—	SEC-55
B2014: CHAIN OF S/L-BCM	×	×	—	—	SEC-56
B2190: NATS ANTENNA AMP	×	—	—	—	SEC-47
B2191: DIFFERENCE OF KEY	×	—	—	—	SEC-50
B2192: ID DISCORD BCM-ECM	×	—	—	—	SEC-51
B2193: CHAIN OF BCM-ECM	×	—	—	—	SEC-53
B2195: ANTI SCANNING	×	—	—	—	SEC-54
B2553: IGNITION RELAY	—	×	—	—	PCS-49
B2555: STOP LAMP	—	×	—	—	SEC-59

BCM (BODY CONTROL MODULE)

< ECU DIAGNOSIS INFORMATION >

CONSULT display	Fail-safe	Freeze Frame Data •Vehicle Speed •Odo/Trip Meter •Vehicle condition	Intelligent Key warning lamp ON	Tire pressure monitor warning lamp ON	Refer- ence page
B2556: PUSH-BTN IGN SW	—	×	×	—	SEC-61
B2557: VEHICLE SPEED	×	×	×	—	SEC-63
B2560: STARTER CONT RELAY	×	×	×	—	SEC-64
B2562: LOW VOLTAGE	—	×	—	—	BCS-38
B2601: SHIFT POSITION	×	×	×	—	SEC-65
B2602: SHIFT POSITION	×	×	×	—	SEC-68
B2603: SHIFT POSI STATUS	×	×	×	—	SEC-70
B2604: PNP SW	×	×	×	—	SEC-73
B2605: PNP SW	×	×	×	—	SEC-75
B2606: S/L RELAY	×	×	×	—	SEC-77
B2607: S/L RELAY	×	×	×	—	SEC-78
B2608: STARTER RELAY	×	×	×	—	SEC-80
B2609: S/L STATUS	×	×	×	—	SEC-82
B260A: IGNITION RELAY	×	×	×	—	PCS-51
B260B: STEERING LOCK UNIT	—	×	×	—	SEC-86
B260C: STEERING LOCK UNIT	—	×	×	—	SEC-87
B260D: STEERING LOCK UNIT	—	×	×	—	SEC-88
B260F: ENG STATE SIG LOST	×	×	×	—	SEC-89
B2612: S/L STATUS	×	×	×	—	SEC-94
B2614: ACC RELAY CIRC	—	×	×	—	PCS-53
B2615: BLOWER RELAY CIRC	—	×	×	—	PCS-55
B2616: IGN RELAY CIRC	—	×	×	—	PCS-57
B2617: STARTER RELAY CIRC	×	×	×	—	SEC-98
B2618: BCM	×	×	×	—	PCS-59
B2619: BCM	×	×	×	—	SEC-100
B261A: PUSH-BTN IGN SW	—	×	×	—	PCS-60
B261E: VEHICLE TYPE	×	×	× (Turn ON for 15 seconds)	—	SEC-101
B2621: INSIDE ANTENNA	—	×	—	—	DLK-59
B2622: INSIDE ANTENNA	—	×	—	—	DLK-61
B2623: INSIDE ANTENNA	—	×	—	—	DLK-63
B26E8: CLUTCH SW	×	×	×	—	SEC-90
B26E9: S/L STATUS	×	×	× (Turn ON for 15 seconds)	—	SEC-92
B26EA: KEY REGISTRATION	—	×	× (Turn ON for 15 seconds)	—	SEC-93
C1704: LOW PRESSURE FL	—	—	—	×	WT-17
C1705: LOW PRESSURE FR	—	—	—	×	
C1706: LOW PRESSURE RR	—	—	—	×	
C1707: LOW PRESSURE RL	—	—	—	×	

A
B
C
D
E
F
G
H
I
J
K
L
M
O
P

WCS

BCM (BODY CONTROL MODULE)

< ECU DIAGNOSIS INFORMATION >

CONSULT display	Fail-safe	Freeze Frame Data •Vehicle Speed •Odo/Trip Meter •Vehicle condition	Intelligent Key warning lamp ON	Tire pressure monitor warning lamp ON	Refer- ence page
C1708: [NO DATA] FL	—	—	—	×	WT-19
C1709: [NO DATA] FR	—	—	—	×	
C1710: [NO DATA] RR	—	—	—	×	
C1711: [NO DATA] RL	—	—	—	×	
C1712: [CHECKSUM ERR] FL	—	—	—	×	WT-21
C1713: [CHECKSUM ERR] FR	—	—	—	×	
C1714: [CHECKSUM ERR] RR	—	—	—	×	
C1715: [CHECKSUM ERR] RL	—	—	—	×	
C1716: [PRESSDATA ERR] FL	—	—	—	×	WT-24
C1717: [PRESSDATA ERR] FR	—	—	—	×	
C1718: [PRESSDATA ERR] RR	—	—	—	×	
C1719: [PRESSDATA ERR] RL	—	—	—	×	
C1720: [CODE ERR] FL	—	—	—	×	WT-26
C1721: [CODE ERR] FR	—	—	—	×	
C1722: [CODE ERR] RR	—	—	—	×	
C1723: [CODE ERR] RL	—	—	—	×	
C1724: [BATT VOLT LOW] FL	—	—	—	×	WT-29
C1725: [BATT VOLT LOW] FR	—	—	—	×	
C1726: [BATT VOLT LOW] RR	—	—	—	×	
C1727: [BATT VOLT LOW] RL	—	—	—	×	
C1729: VHCL SPEED SIG ERR	—	—	—	×	WT-32
C1734: CONTROL UNIT	—	—	—	×	WT-33

THE PARKING BRAKE RELEASE WARNING CONTINUES SOUNDING, OR DOES NOT SOUND

< SYMPTOM DIAGNOSIS >

SYMPTOM DIAGNOSIS

THE PARKING BRAKE RELEASE WARNING CONTINUES SOUNDING, OR DOES NOT SOUND

Description

INFOID:000000004238434

- The parking brake warning buzzer sounds continuously during vehicle travel though the parking brake is released.
- The parking brake warning buzzer does not sound at all even though driving the vehicle with the parking brake applied.

Diagnosis Procedure

INFOID:000000004238435

1. CHECK PARKING BRAKE WARNING LAMP

1. Start the engine.
2. Check the operation of the brake warning lamp by operating the parking brake.

Parking brake ON : ON
Parking brake OFF : OFF

Is the inspection result normal?

- YES >> Replace the combination meter.
NO >> GO TO 2.

2. CHECK PARKING BRAKE SWITCH SIGNAL CIRCUIT

Perform a check for the parking brake switch signal circuit. Refer to [MWI-61, "Diagnosis Procedure \(A/T models\)"](#) (A/T models) or [MWI-62, "Diagnosis Procedure \(M/T models\)"](#) (M/T models).

Is the inspection result normal?

- YES >> GO TO 3.
NO >> Repair harness or connector.

3. CHECK PARKING BRAKE SWITCH UNIT

Perform a unit check for the parking brake switch. Refer to [BRC-72, "Component Inspection"](#).

Is the inspection result normal?

- YES >> Replace the combination meter.
NO >> Replace the parking brake switch. Refer to [PB-6, "PEDAL TYPE : Exploded View"](#) (pedal type) or [PB-7, "LEVER TYPE : Exploded View"](#) (lever type).

A
B
C
D
E
F
G
H
I
J
K
L
M

WCS

THE LIGHT REMINDER WARNING DOES NOT SOUND

< SYMPTOM DIAGNOSIS >

THE LIGHT REMINDER WARNING DOES NOT SOUND

Description

INFOID:000000004238436

Light reminder warning chime does not sound even though headlamp is illuminated.

Diagnosis Procedure

INFOID:000000004238437

1. CHECK COMBINATION SWITCH (LIGHT SWITCH) OPERATION

Check that the headlamps operate normally by operating the combination switch (light switch).

Do they operate normally?

YES >> GO TO 2.

NO >> Refer to [BCS-40, "Diagnosis Procedure"](#).

2. CHECK FRONT DOOR SWITCH (DRIVER SIDE) SIGNAL CIRCUIT

Perform the check for the front door switch (driver side) signal circuit. Refer to [DLK-66, "Diagnosis Procedure"](#).

Is the inspection result normal?

YES >> GO TO 3.

NO >> Repair harness or connector.

3. CHECK FRONT DOOR SWITCH (DRIVER SIDE) UNIT

Perform a unit check for the front door switch (driver side). Refer to [DLK-68, "Component Inspection"](#).

Is the inspection result normal?

YES >> Replace the BCM. Refer to [BCS-82, "Removal and Installation"](#).

NO >> Replace the front door switch (driver side). Refer to [DLK-246, "Removal and Installation"](#).

THE SEAT BELT WARNING CONTINUES SOUNDING, OR DOES NOT SOUND

< SYMPTOM DIAGNOSIS >

THE SEAT BELT WARNING CONTINUES SOUNDING, OR DOES NOT SOUND

Description

INFOID:000000004238438

- Seat belt warning does not sound even though driver seat belt is not fastened.
- Seat belt warning sounds even though driver seat belt is fastened.

Diagnosis Procedure

INFOID:000000004238439

1. CHECK SEAT BELT WARNING LAMP

1. Turn ignition switch ON.
2. Check the operation of the seat belt warning lamp in the combination meter.

Seat belt fastened : OFF
Seat belt not fastened : ON

Is the inspection result normal?

- YES >> GO TO 2.
NO >> GO TO 4.

2. CHECK UNIFIED METER AND A/C AMP. INPUT SIGNAL

Check the buckle switch input signal with the "Data Monitor". Refer to [WCS-24, "Component Function Check"](#).

Is the inspection result normal?

- YES >> Replace the unified meter and A/C amp.
NO >> GO TO 3.

3. CHECK SEAT BELT BUCKLE SWITCH CIRCUIT

Perform the check for the seat belt buckle switch circuit. Refer to [WCS-24, "Diagnosis Procedure"](#).

Is the inspection result normal?

- YES >> Replace the unified meter and A/C amp.
NO >> Repair harness or connector.

4. CHECK SEAT BELT BUCKLE SWITCH UNIT

Perform a unit check for the seat belt buckle switch (driver side). Refer to [SBC-21, "DRIVER SIDE : Component Inspection"](#).

Is the inspection result normal?

- YES >> Replace the combination meter.
NO >> Replace the seat belt buckle. Refer to [SB-8, "SEAT BELT BUCKLE : Removal and Installation"](#).

A
B
C
D
E
F
G
H
I
J
K
L
M

WCS

O
P

PRECAUTIONS

< PRECAUTION >

PRECAUTION

PRECAUTIONS

Precaution for Supplemental Restraint System (SRS) "AIR BAG" and "SEAT BELT PRE-TENSIONER"

INFOID:000000004713205

The Supplemental Restraint System such as "AIR BAG" and "SEAT BELT PRE-TENSIONER", used along with a front seat belt, helps to reduce the risk or severity of injury to the driver and front passenger for certain types of collision. This system includes seat belt switch inputs and dual stage front air bag modules. The SRS system uses the seat belt switches to determine the front air bag deployment, and may only deploy one front air bag, depending on the severity of a collision and whether the front occupants are belted or unbelted. Information necessary to service the system safely is included in the "SRS AIR BAG" and "SEAT BELT" of this Service Manual.

WARNING:

- To avoid rendering the SRS inoperative, which could increase the risk of personal injury or death in the event of a collision which would result in air bag inflation, all maintenance must be performed by an authorized NISSAN/INFINITI dealer.
- Improper maintenance, including incorrect removal and installation of the SRS, can lead to personal injury caused by unintentional activation of the system. For removal of Spiral Cable and Air Bag Module, see the "SRS AIR BAG".
- Do not use electrical test equipment on any circuit related to the SRS unless instructed to in this Service Manual. SRS wiring harnesses can be identified by yellow and/or orange harnesses or harness connectors.

PRECAUTIONS WHEN USING POWER TOOLS (AIR OR ELECTRIC) AND HAMMERS

WARNING:

- When working near the Air Bag Diagnosis Sensor Unit or other Air Bag System sensors with the ignition ON or engine running, DO NOT use air or electric power tools or strike near the sensor(s) with a hammer. Heavy vibration could activate the sensor(s) and deploy the air bag(s), possibly causing serious injury.
- When using air or electric power tools or hammers, always switch the ignition OFF, disconnect the battery, and wait at least 3 minutes before performing any service.