

A
B
C

SECTION **WW**

WIPER & WASHER

CONTENTS

<p>BASIC INSPECTION 3</p> <p>DIAGNOSIS AND REPAIR WORKFLOW 3</p> <p style="padding-left: 20px;">Work Flow3</p> <p>SYSTEM DESCRIPTION 5</p> <p>FRONT WIPER AND WASHER SYSTEM 5</p> <p style="padding-left: 20px;">System Diagram5</p> <p style="padding-left: 20px;">System Description5</p> <p style="padding-left: 20px;">Component Parts Location8</p> <p style="padding-left: 20px;">Component Description8</p> <p>DIAGNOSIS SYSTEM (BCM)10</p> <p>COMMON ITEM10</p> <p style="padding-left: 20px;">COMMON ITEM : CONSULT-III Function (BCM - COMMON ITEM) 10</p> <p>WIPER11</p> <p style="padding-left: 20px;">WIPER : CONSULT-III Function (BCM - WIPER)... 11</p> <p>DIAGNOSIS SYSTEM (IPDM E/R)13</p> <p style="padding-left: 20px;">Diagnosis Description 13</p> <p style="padding-left: 20px;">CONSULT-III Function (IPDM E/R) 15</p> <p>DTC/CIRCUIT DIAGNOSIS18</p> <p>WIPER AND WASHER FUSE18</p> <p style="padding-left: 20px;">Description 18</p> <p style="padding-left: 20px;">Diagnosis Procedure 18</p> <p>POWER SUPPLY AND GROUND CIRCUIT19</p> <p>BCM (BODY CONTROL MODULE)19</p> <p style="padding-left: 20px;">BCM (BODY CONTROL MODULE) : Diagnosis Procedure 19</p> <p>IPDM E/R (INTELLIGENT POWER DISTRIBUTION MODULE ENGINE ROOM)19</p> <p style="padding-left: 20px;">IPDM E/R (INTELLIGENT POWER DISTRIBUTION MODULE ENGINE ROOM) : Diagnosis Procedure 19</p>	<p>FRONT WIPER MOTOR LO CIRCUIT21</p> <p style="padding-left: 20px;">Component Function Check21</p> <p style="padding-left: 20px;">Diagnosis Procedure21</p> <p>FRONT WIPER MOTOR HI CIRCUIT23</p> <p style="padding-left: 20px;">Component Function Check23</p> <p style="padding-left: 20px;">Diagnosis Procedure23</p> <p>FRONT WIPER AUTO STOP SIGNAL CIRCUIT25</p> <p style="padding-left: 20px;">Component Function Check25</p> <p style="padding-left: 20px;">Diagnosis Procedure25</p> <p>FRONT WIPER MOTOR GROUND CIRCUIT ...27</p> <p style="padding-left: 20px;">Diagnosis Procedure27</p> <p>WASHER SWITCH28</p> <p style="padding-left: 20px;">Description28</p> <p style="padding-left: 20px;">Component Inspection28</p> <p>FRONT WIPER AND WASHER SYSTEM29</p> <p style="padding-left: 20px;">Wiring Diagram - FRONT WIPER AND WASHER SYSTEM -29</p> <p>ECU DIAGNOSIS INFORMATION33</p> <p>BCM (BODY CONTROL MODULE)33</p> <p style="padding-left: 20px;">Reference Value33</p> <p style="padding-left: 20px;">Wiring Diagram - BCM -57</p> <p style="padding-left: 20px;">Fail-safe62</p> <p style="padding-left: 20px;">DTC Inspection Priority Chart64</p> <p style="padding-left: 20px;">DTC Index66</p> <p>IPDM E/R (INTELLIGENT POWER DISTRIBUTION MODULE ENGINE ROOM)69</p> <p style="padding-left: 20px;">Reference Value69</p> <p style="padding-left: 20px;">Wiring Diagram - IPDM E/R -76</p> <p style="padding-left: 20px;">Fail-safe79</p> <p style="padding-left: 20px;">DTC Index81</p> <p>SYMPTOM DIAGNOSIS82</p>
--	---

A
B
C
D
E
F
G
H
I
J
K
WW
M
N
O
P

FRONT WIPER AND WASHER SYSTEM	
SYMPTOMS	82
Symptom Table	82
FRONT WIPER DOES NOT OPERATE	84
Description	84
Diagnosis Procedure	84
NORMAL OPERATING CONDITION	86
Description	86
PRECAUTION	87
PRECAUTIONS	87
Precaution for Supplemental Restraint System (SRS) "AIR BAG" and "SEAT BELT PRE-TEN- SIONER"	87
Precaution for Procedure without Cowl Top Cover..	87
REMOVAL AND INSTALLATION	88
WASHER TANK	88
Exploded View	88
Removal and Installation	88
FRONT WASHER PUMP	89
Exploded View	89
Removal and Installation	89
WASHER LEVEL SWITCH	90
Removal and Installation	90
FRONT WASHER NOZZLE AND TUBE	91
Hydraulic Layout	91
Removal and Installation	91
Inspection and Adjustment	91
FRONT WIPER ARM	94
Exploded View	94
Removal and Installation	94
Adjustment	94
WIPER BLADE	96
Exploded View	96
Removal and Installation	96
Replacement	96
FRONT WIPER DRIVE ASSEMBLY	98
Exploded View	98
Removal and Installation	98
Disassembly and Assembly	99
FRONT WIPER AND WASHER SWITCH	100
Exploded View	100

DIAGNOSIS AND REPAIR WORKFLOW

< BASIC INSPECTION >

BASIC INSPECTION

DIAGNOSIS AND REPAIR WORKFLOW

Work Flow

INFOID:000000004239812

OVERALL SEQUENCE

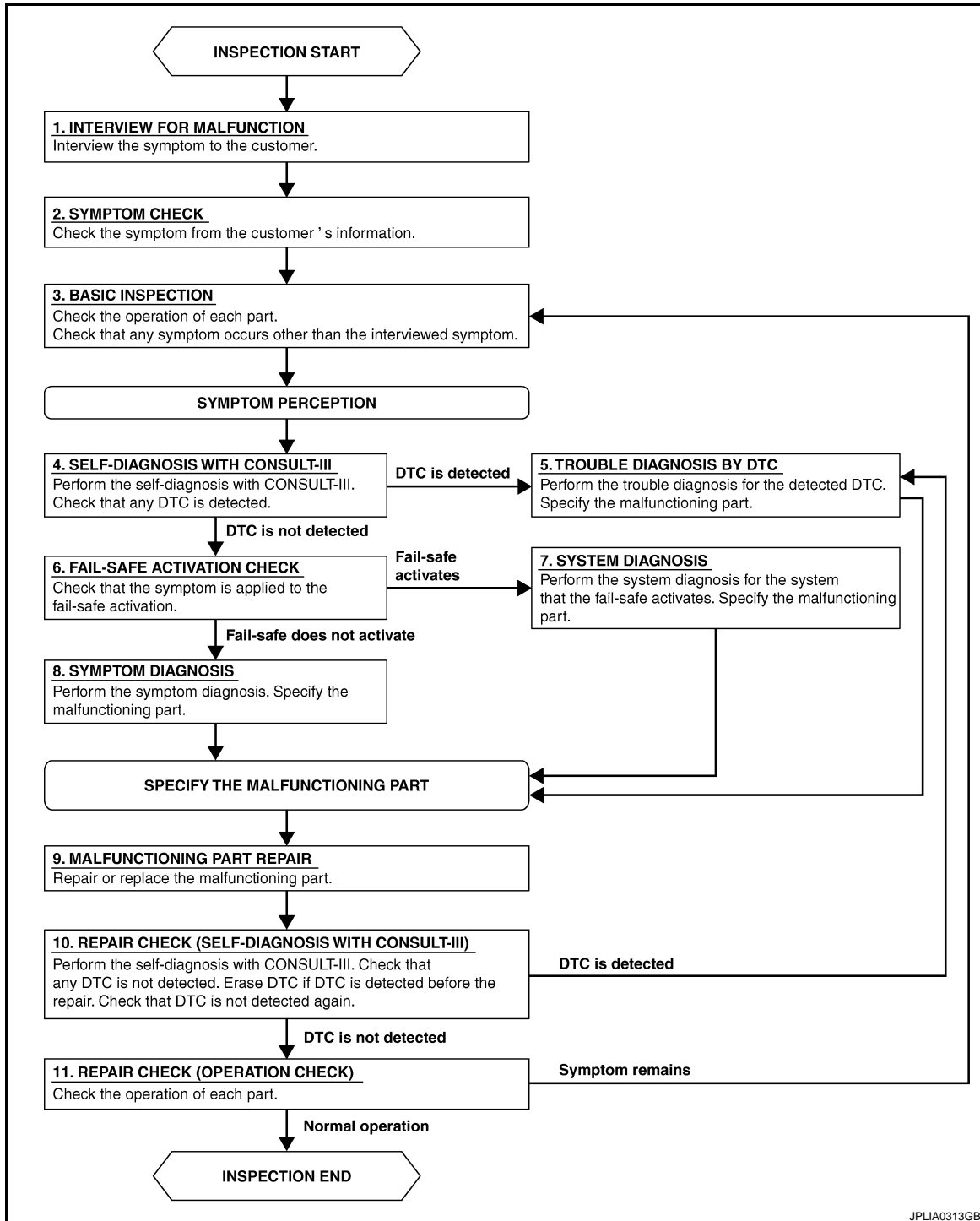

DETAILED FLOW

1. INTERVIEW FOR MALFUNCTION

Interview the symptom to the customer.

DIAGNOSIS AND REPAIR WORKFLOW

< BASIC INSPECTION >

>> GO TO 2.

2. SYMPTOM CHECK

Check the symptom from the customer's information.

>> GO TO 3.

3. BASIC INSPECTION

Check the operation of each part. Check that any symptom occurs other than the interviewed symptom.

>> GO TO 4.

4. SELF-DIAGNOSIS WITH CONSULT-III

Perform the self-diagnosis with CONSULT-III. Check that any DTC is detected.

Is any DTC detected?

YES >> GO TO 5.

NO >> GO TO 6.

5. TROUBLE DIAGNOSIS BY DTC

Perform the trouble diagnosis for the detected DTC. Specify the malfunctioning part.

>> GO TO 9.

6. FAIL-SAFE ACTIVATION CHECK

Check that the symptom is applied to the fail-safe activation.

Does the fail-safe activate?

YES >> GO TO 7.

NO >> GO TO 8.

7. SYSTEM DIAGNOSIS

Perform the system diagnosis for the system that the fail-safe activates. Specify the malfunctioning part.

>> GO TO 9.

8. SYMPTOM DIAGNOSIS

Perform the symptom diagnosis. Specify the malfunctioning part.

>> GO TO 9.

9. MALFUNCTION PART REPAIR

Repair or replace the malfunctioning part.

>> GO TO 10.

10. REPAIR CHECK (SELF-DIAGNOSIS WITH CONSULT-III)

Perform the self-diagnosis with CONSULT-III. Check that any DTC is not detected. Erase DTC if DTC is detected before the repair. Check that DTC is not detected again.

Is any DTC detected?

YES >> GO TO 5.

NO >> GO TO 11.

11. REPAIR CHECK (OPERATION CHECK)

Check the operation of each part.

Does it operate normally?

YES >> INSPECTION END

NO >> GO TO 3.

FRONT WIPER AND WASHER SYSTEM

< SYSTEM DESCRIPTION >

SYSTEM DESCRIPTION

FRONT WIPER AND WASHER SYSTEM

System Diagram

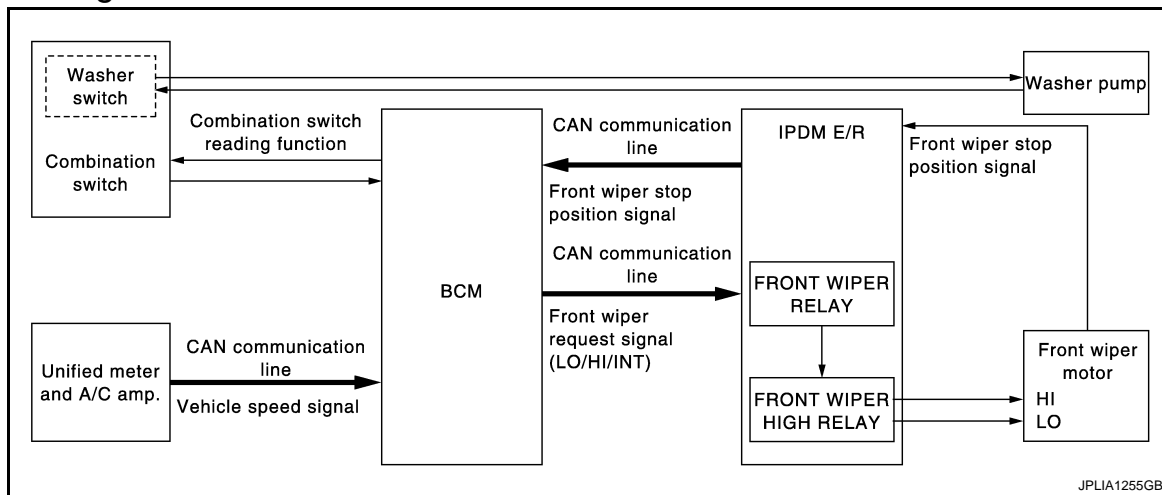

System Description

INFOID:000000004500448

OUTLINE

The front wiper is controlled by each function of BCM and IPDM E/R.

Control by BCM

- Combination switch reading function
- Front wiper control function

Control by IPDM E/R

- Front wiper control function
- Relay control function

Combination meter indicates low washer fluid warning judged with the signal from the washer level switch. For details of low washer fluid warning, refer to [MWI-27, "INFORMATION DISPLAY : System Description"](#).

FRONT WIPER BASIC OPERATION

- BCM detects the combination switch condition by the combination switch reading function.
- BCM transmits the front wiper request signal to IPDM E/R with CAN communication depending on each operating condition of the front wiper.
- IPDM E/R turns ON/OFF the integrated front wiper relay and the front wiper high relay according to the front wiper request signal. IPDM E/R provides the power supply to operate the front wiper HI/LO operation.

FRONT WIPER LO OPERATION

- BCM transmits the front wiper request signal (LO) to IPDM E/R with CAN communication according to the front wiper LO operating condition.

Front wiper LO operating condition

- Ignition switch ON
- Front wiper switch LO or front wiper switch MIST (while pressing)
- IPDM E/R turns ON the integrated front wiper relay according to the front wiper request signal (LO).

FRONT WIPER HI OPERATION

- BCM transmits the front wiper request signal (HI) to IPDM E/R with CAN communication according to the front wiper HI operating condition.

Front wiper HI operating condition

- Ignition switch ON
- Front wiper switch HI
- IPDM E/R turns ON the integrated front wiper relay and the front wiper high relay according to the front wiper request signal (HI).

FRONT WIPER AND WASHER SYSTEM

< SYSTEM DESCRIPTION >

FRONT WIPER INT OPERATION

- BCM transmits the front wiper request signal (INT) to IPDM E/R with CAN communication depending on the front wiper INT operating condition and intermittent operation delay interval according to the wiper intermittent dial position.

Front wiper INT operating condition

- Ignition switch ON
- Front wiper switch INT
- IPDM E/R turns ON the integrated front wiper relay so that the front wiper is operated only once according to the front wiper request signal (INT).
- BCM detects stop position/except stop position of the front wiper motor according to the front wiper stop position signal received from IPDM E/R with CAN communication.
- BCM transmits the front wiper request signal (INT) again after the intermittent operation delay interval.

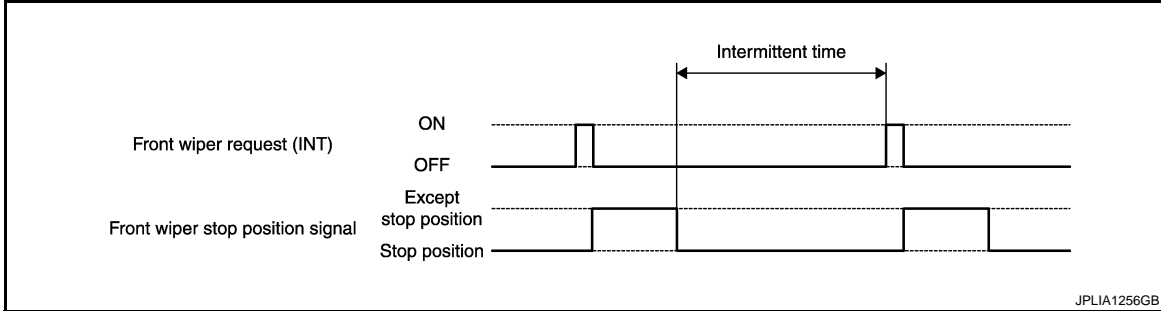

NOTE:

Factory setting of the front wiper intermittent operation is the operation without vehicle speed. Front wiper intermittent operation can be set to the operation with vehicle speed by CONSULT-III. Refer to [WW-11, "WIPER : CONSULT-III Function \(BCM - WIPER\)"](#).

Front wiper intermittent operation with vehicle speed

- BCM calculates the intermittent operation delay interval from the following
 - Vehicle speed signal (received from the unified meter and A/C amp. with CAN communication)
 - Wiper intermittent dial position

Unit: Second

Wiper intermittent dial position	Intermittent operation interval	Intermittent operation delay Interval			
		Vehicle speed			
		0 – 5 km/h (0 – 3.1 MPH)	5 – 35 km/h (3.1 – 21.7 MPH)	35 – 65 km/h (21.7 – 40.4 MPH)*	65 km/h (40.4 MPH) or more
1	Short ↑	0.8	0.6	0.4	0.24
2		4	3	2	1.2
3		10	7.5	5	3
4		16	12	8	4.8
5		24	18	12	7.2
6	Long ↓	32	24	16	9.6
7		42	31.5	21	12.6

*: When without vehicle speed setting

FRONT WIPER AUTO STOP OPERATION

- BCM stops transmitting the front wiper request signal when the front wiper switch is turned OFF.
- IPDM E/R detects the front wiper stop position signal from the front wiper motor and detects the front wiper motor position (stop position/except stop position).

FRONT WIPER AND WASHER SYSTEM

< SYSTEM DESCRIPTION >

- When the front wiper request signal is stopped, IPDM E/R turns ON the front wiper relay until the front wiper motor returns to the stop position.

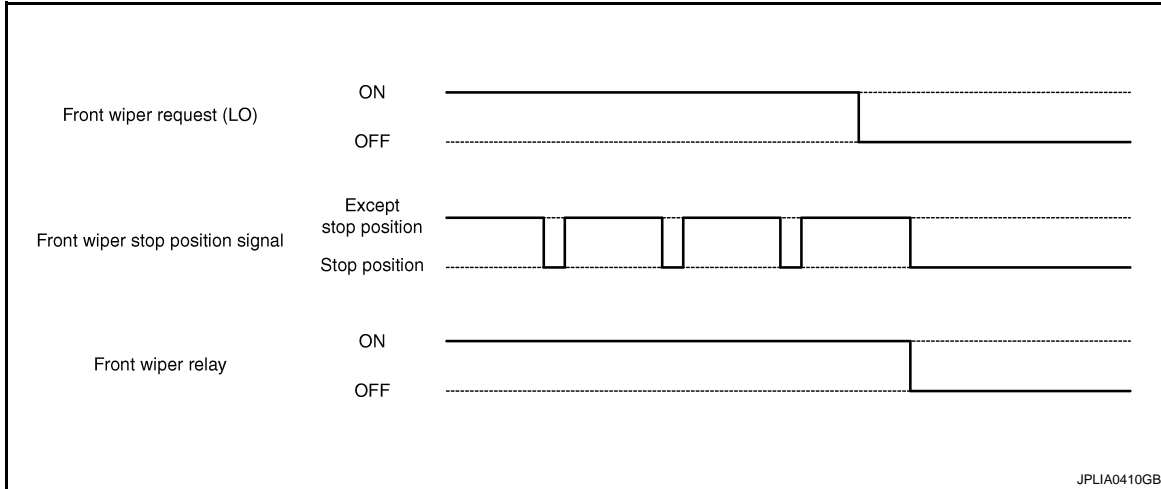

NOTE:

- BCM stops the transmitting of the front wiper request signal when the ignition switch is OFF.
- IPDM E/R turns the front wiper relay OFF when the ignition switch is OFF.

FRONT WIPER OPERATION LINKED WITH WASHER

- BCM transmits the front wiper request signal (LO) to IPDM E/R with CAN communication according to the washer linked operating condition of the front wiper.
- BCM transmits the front wiper request signal (LO) so that the front wiper operates approximately 2 times when the front washer switch OFF is detected.

Washer linked operating condition of front wiper

- Ignition switch ON
- Front washer switch ON (0.4 second or more)
- IPDM E/R turns ON the integrated front wiper relay according to the front wiper request signal (LO).
- The washer pump is grounded through the combination switch with the front washer switch ON.

FRONT WIPER FAIL-SAFE OPERATION

IPDM E/R performs the fail-safe function when the front wiper auto stop circuit is malfunctioning. Refer to [PCS-29. "Fail-safe"](#).

A
B
C
D
E
F
G
H
I
J
K

WW

M
N
O
P

FRONT WIPER AND WASHER SYSTEM

< SYSTEM DESCRIPTION >

Component Parts Location

INFOID:000000004239815

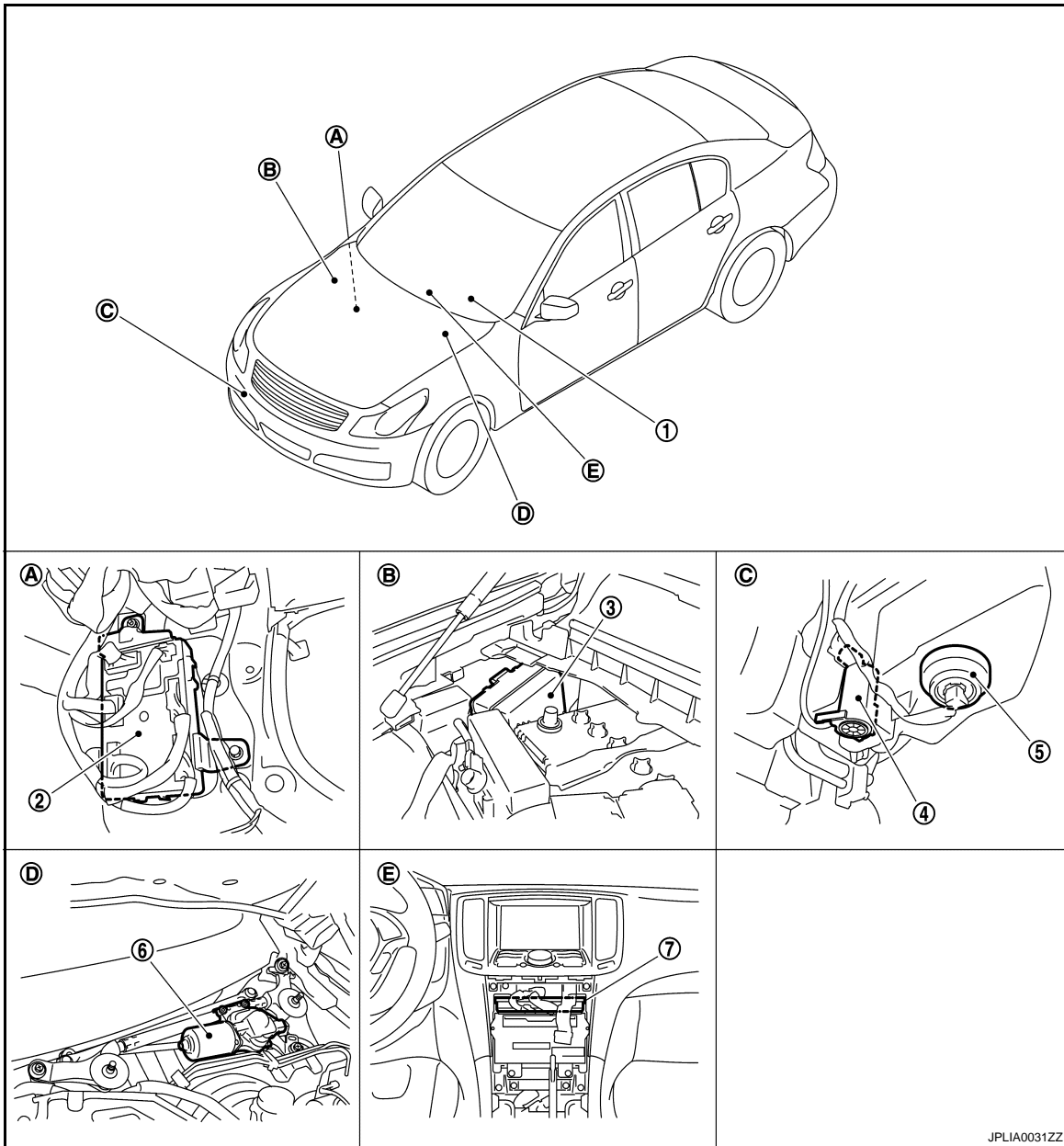

JPLIA0031ZZ

- | | | |
|---------------------------------------|--------------------------------|-------------------------------|
| 1. Combination switch | 2. BCM | 3. IPDM E/R |
| 4. Washer pump | 5. Washer level switch | 6. Front wiper motor |
| 7. Unified meter and A/C amp. | | |
| A. Dash side lower (Passenger side) | B. Engine room dash panel (RH) | C. Radiator core support (RH) |
| D. Cowl top, left side of engine room | E. Behind cluster lid C | |

Component Description

INFOID:000000004500449

Part	Description
BCM	<ul style="list-style-type: none"> Judges each switch status by the combination switch reading function. Requests (with CAN communication) the front wiper relay and the front wiper high relay ON to IPDM E/R.
IPDM E/R	<ul style="list-style-type: none"> Controls the integrated relay according to the request (with CAN communication) from BCM. Performs the auto stop control of the front wiper.

FRONT WIPER AND WASHER SYSTEM

< SYSTEM DESCRIPTION >

Part	Description
Combination switch (Wiper & washer switch)	Refer to BCS-6, "System Description" .
Unified meter and A/C amp.	Transmits the vehicle speed signal to BCM with CAN communication.

A

B

C

D

E

F

G

H

I

J

K

WW

M

N

O

P

DIAGNOSIS SYSTEM (BCM)

< SYSTEM DESCRIPTION >

DIAGNOSIS SYSTEM (BCM)

COMMON ITEM

COMMON ITEM : CONSULT-III Function (BCM - COMMON ITEM)

INFOID:00000000468527

APPLICATION ITEM

CONSULT-III performs the following functions via CAN communication with BCM.

Diagnosis mode	Function Description
Work Support	Changes the setting for each system function.
Self Diagnostic Result	Displays the diagnosis results judged by BCM.
CAN Diag Support Monitor	Monitors the reception status of CAN communication viewed from BCM. Refer to CONSULT-III operation manual.
Data Monitor	The BCM input/output signals are displayed.
Active Test	The signals used to activate each device are forcibly supplied from BCM.
Ecu Identification	The BCM part number is displayed.
Configuration	This function is not used even though it is displayed.

SYSTEM APPLICATION

BCM can perform the following functions for each system.

NOTE:

It can perform the diagnosis modes except the following for all sub system selection items.

×: Applicable item

System	Sub system selection item	Diagnosis mode		
		Work Support	Data Monitor	Active Test
Door lock	DOOR LOCK	×	×	×
Rear window defogger	REAR DEFOGGER		×	×
Warning chime	BUZZER		×	×
Interior room lamp timer	INT LAMP	×	×	×
Exterior lamp	HEAD LAMP	×	×	×
Wiper and washer	WIPER	×	×	×
Turn signal and hazard warning lamps	FLASHER	×	×	×
—	AIR CONDITONER*			
<ul style="list-style-type: none"> • Intelligent Key system • Engine start system 	INTELLIGENT KEY	×	×	×
Combination switch	COMB SW		×	
Body control system	BCM	×		
IVIS - NATS	IMMU		×	×
Interior room lamp battery saver	BATTERY SAVER	×	×	×
Trunk lid open	TRUNK		×	×
Vehicle security system	THEFT ALM	×	×	×
RAP system	RETAINED PWR		×	
Signal buffer system	SIGNAL BUFFER		×	×
TPMS	TPMS (AIR PRESSURE MONITOR)	×	×	×

NOTE:

*: This item is displayed, but is not used.

FREEZE FRAME DATA (FFD)

The BCM records the following vehicle condition at the time a particular DTC is detected, and displays on CONSULT-III.

DIAGNOSIS SYSTEM (BCM)

< SYSTEM DESCRIPTION >

CONSULT screen item	Indication/Unit	Description		
Vehicle Speed	km/h	Vehicle speed of the moment a particular DTC is detected		A
Odo/Trip Meter	km	Total mileage (Odometer value) of the moment a particular DTC is detected		B
Vehicle Condition	SLEEP>LOCK	Power position status of the moment a particular DTC is detected	While turning BCM status from low power consumption mode to normal mode (Power supply position is "LOCK")	C
	SLEEP>OFF		While turning BCM status from low power consumption mode to normal mode (Power supply position is "OFF".)	D
	LOCK>ACC		While turning power supply position from "LOCK" to "ACC"	E
	ACC>ON		While turning power supply position from "ACC" to "IGN"	F
	RUN>ACC		While turning power supply position from "RUN" to "ACC" (Vehicle is stopping and selector lever is except P position.)	G
	CRANK>RUN		While turning power supply position from "CRANKING" to "RUN" (From cranking up the engine to run it)	H
	RUN>URGENT		While turning power supply position from "RUN" to "ACC" (Emergency stop operation)	I
	ACC>OFF		While turning power supply position from "ACC" to "OFF"	J
	OFF>LOCK		While turning power supply position from "OFF" to "LOCK"	K
	OFF>ACC		While turning power supply position from "OFF" to "ACC"	WW
	ON>CRANK		While turning power supply position from "IGN" to "CRANKING"	
	OFF>SLEEP		While turning BCM status from normal mode (Power supply position is "OFF".) to low power consumption mode	
	LOCK>SLEEP		While turning BCM status from normal mode (Power supply position is "LOCK".) to low power consumption mode	
	LOCK		Power supply position is "LOCK" (Ignition switch OFF with steering is locked.)	
	OFF		Power supply position is "OFF" (Ignition switch OFF with steering is unlocked.)	
	ACC		Power supply position is "ACC" (Ignition switch ACC)	
ON	Power supply position is "IGN" (Ignition switch ON with engine stopped)			
ENGINE RUN	Power supply position is "RUN" (Ignition switch ON with engine running)			
CRANKING	Power supply position is "CRANKING" (At engine cranking)			
IGN Counter	0 - 39	The number of times that ignition switch is turned ON after DTC is detected <ul style="list-style-type: none"> • The number is 0 when a malfunction is detected now. • The number increases like 1 → 2 → 3...38 → 39 after returning to the normal condition whenever ignition switch OFF → ON. • The number is fixed to 39 until the self-diagnosis results are erased if it is over 39. 		M

WIPER

WIPER : CONSULT-III Function (BCM - WIPER)

INFOID:000000004239818

WORK SUPPORT

Service item	Setting item	Description
WIPER SPEED SETTING	On	With vehicle speed (Front wiper intermittent time linked with the vehicle speed and wiper intermittent dial position)
	Off*	Without vehicle speed (Front wiper intermittent time linked with the wiper intermittent dial position)

*:Initial setting

DATA MONITOR

DIAGNOSIS SYSTEM (BCM)

< SYSTEM DESCRIPTION >

Monitor Item [Unit]	Description
VEH SPEED 1 [km/h]	Displays the value of the vehicle speed signal received from unified meter and A/C amp. with CAN communication.
PUSH SW [Off/On]	The switch status input from push-button ignition switch.
FR WIPER HI [Off/On]	Status of each switch judged by BCM using the combination switch reading function
FR WIPER LOW [Off/On]	
FR WASHER SW [Off/On]	
FR WIPER INT [Off/On]	
FR WIPER STOP [Off/On]	Displays the status of the front wiper stop position signal received from IPDM E/R with CAN communication.
INT VOLUME [1 – 7]	Status of each switch judged by BCM using the combination switch reading function

ACTIVE TEST

Test item	Operation	Description
FRONT WIPER	Hi	Transmits the front wiper request signal (HI) to IPDM E/R with CAN communication to operate the front wiper HI operation.
	Lo	Transmits the front wiper request signal (LO) to IPDM E/R with CAN communication to operate the front wiper LO operation.
	INT	Transmits the front wiper request signal (INT) to IPDM E/R with CAN communication to operate the front wiper INT operation.
	Off	Stops transmitting the front wiper request signal to stop the front wiper operation.

DIAGNOSIS SYSTEM (IPDM E/R)

< SYSTEM DESCRIPTION >

DIAGNOSIS SYSTEM (IPDM E/R)

Diagnosis Description

INFOID:000000004685229

AUTO ACTIVE TEST

Description

In auto active test mode, the IPDM E/R sends a drive signal to the following systems to check their operation.

- Oil pressure warning lamp
- Front wiper (LO, HI)
- Parking lamps
- License plate lamps
- Side maker lamps
- Tail lamps
- Front fog lamps
- Headlamps (LO, HI)
- A/C compressor (magnet clutch)
- Cooling fan (cooling fan control module)

Operation Procedure

1. Close the hood and lift the wiper arms from the windshield. (Prevent windshield damage due to wiper operation)
NOTE:
When auto active test is performed with hood opened, sprinkle water on windshield beforehand.
2. Turn the ignition switch OFF.
3. Turn the ignition switch ON, and within 20 seconds, press the front door switch (driver side) 10 times. Then turn the ignition switch OFF.
CAUTION:
Close passenger door.
4. Turn the ignition switch ON within 10 seconds. After that the horn sounds once and the auto active test starts.
5. The oil pressure warning lamp starts blinking when the auto active test starts.
6. After a series of the following operations is repeated 3 times, auto active test is completed.

NOTE:

When auto active test mode has to be cancelled halfway through test, turn the ignition switch OFF.

CAUTION:

- If auto active test mode cannot be actuated, check door switch system. Refer to [DLK-66](#), "[Component Function Check](#)".
- Do not start the engine.

Inspection in Auto Active Test Mode

When auto active test mode is actuated, the following 6 steps are repeated 3 times.

Operation sequence	Inspection location	Operation
1	Oil pressure warning lamp	Blinks continuously during operation of auto active test
2	Front wiper	LO for 5 seconds → HI for 5 seconds
3	<ul style="list-style-type: none">• Parking lamps• License plate lamps• Side maker lamps• Tail lamps• Front fog lamps	10 seconds
4	Headlamps	LO ↔ HI 5 times
5	A/C compressor (magnet clutch)	ON ↔ OFF 5 times
6*	Cooling fan	MID for 5 seconds → HI for 5 seconds

*: Outputs duty ratio of 50% for 5 seconds → duty ratio of 100% for 5 seconds on the cooling fan control module.

DIAGNOSIS SYSTEM (IPDM E/R)

< SYSTEM DESCRIPTION >

Concept of auto active test

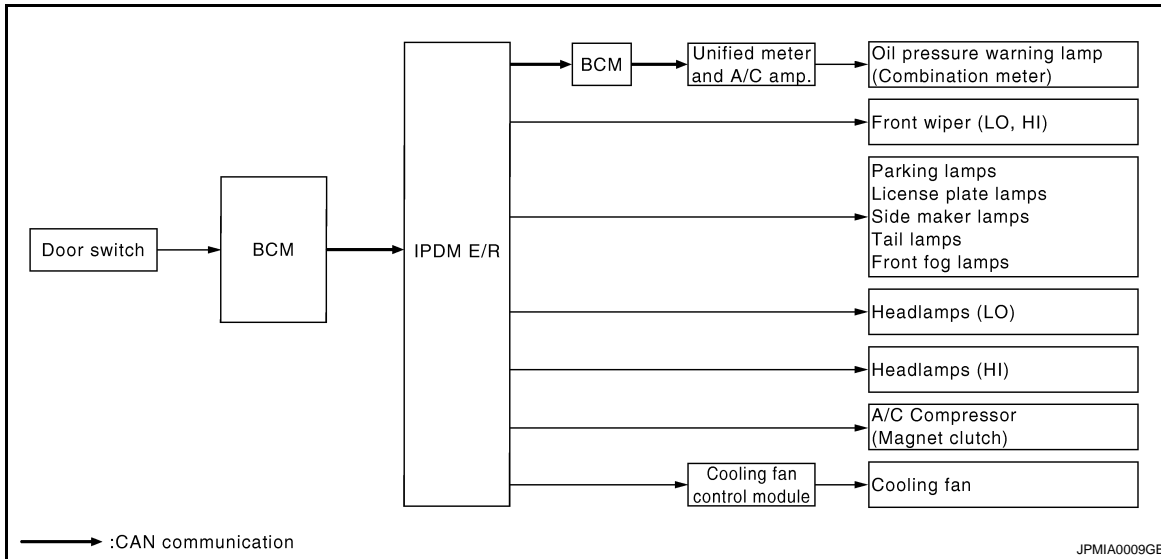

- IPDM E/R starts the auto active test with the door switch signals transmitted by BCM via CAN communication. Therefore, the CAN communication line between IPDM E/R and BCM is considered normal if the auto active test starts successfully.
- The auto active test facilitates troubleshooting if any systems controlled by IPDM E/R cannot be operated.

Diagnosis chart in auto active test mode

Symptom	Inspection contents	Possible cause
Any of the following components do not operate <ul style="list-style-type: none"> • Parking lamps • License plate lamps • Side maker lamps • Tail lamps • Front fog lamps • Headlamp (HI, LO) • Front wiper (HI, LO) 	Perform auto active test. Does the applicable system operate?	YES BCM signal input circuit
		NO <ul style="list-style-type: none"> • Lamp or motor • Lamp or motor ground circuit • Harness or connector between IPDM E/R and applicable system • IPDM E/R
A/C compressor does not operate	Perform auto active test. Does the magnet clutch operate?	YES <ul style="list-style-type: none"> • Unified meter and A/C amp. signal input circuit • CAN communication signal between unified meter and A/C amp. and ECM • CAN communication signal between ECM and IPDM E/R
		NO <ul style="list-style-type: none"> • Magnet clutch • Harness or connector between IPDM E/R and magnet clutch • IPDM E/R
Oil pressure warning lamp does not operate	Perform auto active test. Does the oil pressure warning lamp blink?	YES <ul style="list-style-type: none"> • Harness or connector between IPDM E/R and oil pressure switch • Oil pressure switch • IPDM E/R
		NO <ul style="list-style-type: none"> • CAN communication signal between IPDM E/R and BCM • CAN communication signal between BCM and unified meter and A/C amp. • Combination meter

DIAGNOSIS SYSTEM (IPDM E/R)

< SYSTEM DESCRIPTION >

Symptom	Inspection contents	Possible cause
Cooling fan does not operate	Perform auto active test. Does the cooling fan operate?	YES <ul style="list-style-type: none"> ECM signal input circuit CAN communication signal between ECM and IPDM E/R
		NO <ul style="list-style-type: none"> Cooling fan Harness or connector between cooling fan and cooling fan control module Cooling fan control module Harness or connector between IPDM E/R and cooling fan control module Cooling fan relay Harness or connector between IPDM E/R and cooling fan relay IPDM E/R

CONSULT-III Function (IPDM E/R)

INFOID:000000004685230

APPLICATION ITEM

CONSULT-III performs the following functions via CAN communication with IPDM E/R.

Diagnosis mode	Description
Ecu Identification	Allows confirmation of IPDM E/R part number.
Self Diagnostic Result	Displays the diagnosis results judged by IPDM E/R.
Data Monitor	Displays the real-time input/output data from IPDM E/R input/output data.
Active Test	IPDM E/R can provide a drive signal to electronic components to check their operations.
CAN Diag Support Monitor	The results of transmit/receive diagnosis of CAN communication can be read.

SELF DIAGNOSTIC RESULT

Refer to [WW-81, "DTC Index"](#).

DATA MONITOR

Monitor item

Monitor Item [Unit]	MAIN SIGNALS	Description
RAD FAN REQ [%]	×	Displays the value of the cooling fan speed signal received from ECM via CAN communication.
AC COMP REQ [Off/On]	×	Displays the status of the A/C compressor request signal received from ECM via CAN communication.
TAIL&CLR REQ [Off/On]	×	Displays the status of the position light request signal received from BCM via CAN communication.
HL LO REQ [Off/On]	×	Displays the status of the low beam request signal received from BCM via CAN communication.
HL HI REQ [Off/On]	×	Displays the status of the high beam request signal received from BCM via CAN communication.
FR FOG REQ [Off/On]	×	Displays the status of the front fog light request signal received from BCM via CAN communication.
FR WIP REQ [Stop/1LOW/Low/Hi]	×	Displays the status of the front wiper request signal received from BCM via CAN communication.
WIP AUTO STOP [STOP P/ACT P]	×	Displays the status of the front wiper auto stop signal judged by IPDM E/R.
WIP PROT [Off/BLOCK]	×	Displays the status of the front wiper fail-safe operation judged by IPDM E/R.

DIAGNOSIS SYSTEM (IPDM E/R)

< SYSTEM DESCRIPTION >

Monitor Item [Unit]	MAIN SIG- NALS	Description
IGN RLY1 -REQ [Off/On]		Displays the status of the ignition switch ON signal received from BCM via CAN communication.
IGN RLY [Off/On]	×	Displays the status of the ignition relay judged by IPDM E/R.
PUSH SW [Off/On]		Displays the status of the push-button ignition switch judged by IPDM E/R.
INTER/NP SW [Off/On]		Displays the status of the clutch interlock switch (M/T models) or shift position (A/T models) judged by IPDM E/R.
ST RLY CONT [Off/On]		Displays the status of the starter relay status signal received from BCM via CAN communication.
IHBT RLY -REQ [Off/On]		Displays the status of the starter control relay signal received from BCM via CAN communication.
ST/INH RLY [Off/ ST ON/INH ON/UNKWN]		Displays the status of the starter relay and starter control relay judged by IPDM E/R.
DETENT SW [Off/On]		Displays the status of the A/T shift selector (detention switch) judged by IPDM E/R.
S/L RLY -REQ [Off/On]		Displays the status of the steering lock relay request received from BCM via CAN communication.
S/L STATE [LOCK/UNLOCK/UNKWN]		Displays the status of the steering lock judged by IPDM E/R.
DTRL REQ [Off/On]		NOTE: The item is indicated, but not monitored.
OIL P SW [Open/Close]		Displays the status of the oil pressure switch judged by IPDM E/R.
HOOD SW [Off/On]		Displays the status of the hood switch judged by IPDM E/R.
HL WASHER REQ [Off/On]		NOTE: The item is indicated, but not monitored.
THFT HRN REQ [Off/On]		Displays the status of the theft warning horn request signal received from BCM via CAN communication.
HORN CHIRP [Off/On]		Displays the status of the horn reminder signal received from BCM via CAN communication.
CRNRNG LMP REQ [Off/On]		NOTE: The item is indicated, but not monitored.

ACTIVE TEST

Test item

Test item	Operation	Description
CORNERING LAMP	Off	NOTE: The item is indicated, but cannot be tested.
	LH	
	RH	
HORN	On	Operates horn relay 1 and horn relay 2 for 20 ms.
FRONT WIPER	Off	OFF
	Lo	Operates the front wiper relay.
	Hi	Operates the front wiper relay and front wiper high relay.
MOTOR FAN	1	OFF
	2	Outputs 50% pulse duty signal (PWM signal) to the cooling fan control module.
	3	Outputs 80% pulse duty signal (PWM signal) to the cooling fan control module.
	4	Outputs 100% pulse duty signal (PWM signal) to the cooling fan control module.

DIAGNOSIS SYSTEM (IPDM E/R)

< SYSTEM DESCRIPTION >

Test item	Operation	Description
HEAD LAMP WASHER	On	NOTE: The item is indicated, but cannot be tested.
EXTERNAL LAMPS	Off	OFF
	TAIL	Operates the tail lamp relay.
	Lo	Operates the headlamp low relay.
	Hi	Operates the headlamp low relay and ON/OFF the headlamp high relay at 1 second intervals.
	Fog	Operates the front fog lamp relay.

A
B
C
D
E
F
G
H
I
J
K
M
N
O
P

WW

WIPER AND WASHER FUSE

< DTC/CIRCUIT DIAGNOSIS >

DTC/CIRCUIT DIAGNOSIS

WIPER AND WASHER FUSE

Description

INFOID:000000004239821

Fuse list

Unit	Location	Fuse No.	Capacity
Front wiper motor	IPDM E/R	#60	30 A
Washer pump	IPDM E/R	#47	10 A

Diagnosis Procedure

INFOID:000000004239822

1.CHECK FUSES

Check that the following fuses are not fusing.

Unit	Location	Fuse No.	Capacity
Front wiper motor	IPDM E/R	#60	30 A
Washer pump	IPDM E/R	#47	10 A

Is the fuse fusing?

- YES >> Replace the fuse with a new one after repairing the applicable circuit.
NO >> The fuse is normal.

POWER SUPPLY AND GROUND CIRCUIT

< DTC/CIRCUIT DIAGNOSIS >

POWER SUPPLY AND GROUND CIRCUIT BCM (BODY CONTROL MODULE)

BCM (BODY CONTROL MODULE) : Diagnosis Procedure

INFOID:000000004685241

1. CHECK FUSE AND FUSIBLE LINK

Check that the following fuse and fusible link are not blown.

Signal name	Fuse and fusible link No.
Battery power supply	K
	10

Is the fuse fusing?

- YES >> Replace the blown fuse or fusible link after repairing the affected circuit if a fuse or fusible link is blown.
NO >> GO TO 2.

2. CHECK POWER SUPPLY CIRCUIT

1. Turn ignition switch OFF.
2. Disconnect BCM connectors.
3. Check voltage between BCM harness connector and ground.

Terminals		Voltage (Approx.)
(+)	(-)	
BCM		Ground Battery voltage
Connector	Terminal	
M118	1	
M119	11	

Is the measurement value normal?

- YES >> GO TO 3.
NO >> Repair harness or connector.

3. CHECK GROUND CIRCUIT

Check continuity between BCM harness connector and ground.

BCM		Ground	Continuity
Connector	Terminal		
M119	13		Existed

Does continuity exist?

- YES >> INSPECTION END
NO >> Repair harness or connector.

IPDM E/R (INTELLIGENT POWER DISTRIBUTION MODULE ENGINE ROOM)

IPDM E/R (INTELLIGENT POWER DISTRIBUTION MODULE ENGINE ROOM) : Diagnosis Procedure

INFOID:000000004685240

1. CHECK FUSES AND FUSIBLE LINK

Check that the following IPDM E/R fuses or fusible links are not blown.

POWER SUPPLY AND GROUND CIRCUIT

< DTC/CIRCUIT DIAGNOSIS >

Signal name	Fuses and fusible link No.
Battery power supply	C
	50
	51

Is the fuse fusing?

- YES >> Replace the blown fuse or fusible link after repairing the affected circuit if a fuse or fusible link is blown.
 NO >> GO TO 2.

2. CHECK POWER SUPPLY CIRCUIT

1. Turn the ignition switch OFF.
2. Disconnect IPDM E/R connector.
3. Check voltage between IPDM E/R harness connector and the ground.

Terminals			
(+)	(-)		
IPDM E/R		Ground	Battery voltage
Connector	Terminal		
E4	1 2		

Is the measurement value normal?

- YES >> GO TO 3.
 NO >> Repair the harness or connector.

3. CHECK GROUND CIRCUIT

Check continuity between IPDM E/R harness connectors and the ground.

IPDM E/R			
Connector	Terminal		
E5	12	Ground	Existed
E6	41		

Does continuity exist?

- YES >> INSPECTION END
 NO >> Repair the harness or connector.

FRONT WIPER MOTOR LO CIRCUIT

< DTC/CIRCUIT DIAGNOSIS >

FRONT WIPER MOTOR LO CIRCUIT

Component Function Check

INFOID:000000004239823

1. CHECK FRONT WIPER LO OPERATION

⊗ IPDM E/R AUTO ACTIVE TEST

1. Start IPDM E/R auto active test. Refer to [PCS-10, "Diagnosis Description"](#).
2. Check that the front wiper operates at the LO operation.

Ⓜ CONSULT-III ACTIVE TEST

1. Select "FRONT WIPER" of IPDM E/R active test item.
2. With operating the test item, check front wiper operation.

Lo : Front wiper (LO) operation

Off : Stop the front wiper.

Is front wiper (LO) operation normally?

- YES >> Front wiper motor LO circuit is normal.
 NO >> Refer to [WW-21, "Diagnosis Procedure"](#).

Diagnosis Procedure

INFOID:000000004239824

1. CHECK FRONT WIPER MOTOR (LO) OUTPUT VOLTAGE

Ⓜ CONSULT-III ACTIVE TEST

1. Turn the ignition switch OFF.
2. Disconnect front wiper motor connector.
3. Turn the ignition switch ON.
4. Select "FRONT WIPER" of IPDM E/R active test item.
5. With operating the test item, check voltage between IPDM E/R harness connector and ground.

Terminals		Test item	Voltage (Approx.)
(+)	(-)		
IPDM E/R		FRONT WIPER	Battery voltage
Connector	Terminal		
E5	4		
		Lo	Battery voltage
		Off	0 V

Is the measurement value normal?

- YES >> GO TO 2.
 NO >> Replace IPDM E/R.

2. CHECK FRONT WIPER MOTOR (LO) OPEN CIRCUIT

1. Turn the ignition switch OFF.
2. Disconnect IPDM E/R connector.
3. Check continuity between IPDM E/R harness connector and front wiper motor harness connector.

IPDM E/R		Front wiper motor		Continuity
Connector	Terminal	Connector	Terminal	
E5	4	E42	1	Existed

Does continuity exist?

- YES >> GO TO 3.
 NO >> Repair the harness or connector.

3. CHECK FRONT WIPER MOTOR (LO) SHORT CIRCUIT

Check continuity between IPDM E/R harness connector and ground.

A
B
C
D
E
F
G
H
I
J
K
M
N
O
P

WW

FRONT WIPER MOTOR LO CIRCUIT

< DTC/CIRCUIT DIAGNOSIS >

IPDM E/R		Ground	Continuity
Connector	Terminal		
E5	4		Not existed

Does continuity exist?

YES >> Repair the harness or connector.

NO >> Replace front wiper motor.

FRONT WIPER MOTOR HI CIRCUIT

< DTC/CIRCUIT DIAGNOSIS >

FRONT WIPER MOTOR HI CIRCUIT

Component Function Check

INFOID:000000004239825

1. CHECK FRONT WIPER HI OPERATION

IPDM E/R AUTO ACTIVE TEST

1. Start IPDM E/R auto active test. Refer to [PCS-10, "Diagnosis Description"](#).
2. Check that the front wiper operates at the HI operation.

CONSULT-III ACTIVE TEST

1. Select "FRONT WIPER" of IPDM E/R active test item.
2. With operating the test item, check front wiper operation.

Hi : Front wiper (HI) operation

Off : Stop the front wiper.

Is front wiper (HI) operation normally?

YES >> Front wiper motor HI circuit is normal.

NO >> Refer to [WW-23, "Diagnosis Procedure"](#).

Diagnosis Procedure

INFOID:000000004239826

1. CHECK FRONT WIPER MOTOR (HI) OUTPUT VOLTAGE

CONSULT-III ACTIVE TEST

1. Turn the ignition switch OFF.
2. Disconnect front wiper motor connector.
3. Turn the ignition switch ON.
4. Select "FRONT WIPER" of IPDM E/R active test item.
5. With operating the test item, check voltage between IPDM E/R harness connector and ground.

Terminals		Test item	Voltage (Approx.)
(+)	(-)		
IPDM E/R		FRONT WIPER	Battery voltage
Connector	Terminal		
E5	5		
		Hi	Battery voltage
		Off	0 V

Is the measurement value normal?

YES >> GO TO 2.

NO >> Replace IPDM E/R.

2. CHECK FRONT WIPER MOTOR (HI) OPEN CIRCUIT

1. Turn the ignition switch OFF.
2. Disconnect IPDM E/R connector.
3. Check continuity between IPDM E/R harness connector and front wiper motor harness connector.

IPDM E/R		Front wiper motor		Continuity
Connector	Terminal	Connector	Terminal	
E5	5	E42	4	Existed

Does continuity exist?

YES >> GO TO 3.

NO >> Repair the harness or connector.

3. CHECK FRONT WIPER MOTOR (HI) SHORT CIRCUIT

Check continuity between IPDM E/R harness connector and ground.

A
B
C
D
E
F
G
H
I
J
K
M
N
O
P

WW

FRONT WIPER MOTOR HI CIRCUIT

< DTC/CIRCUIT DIAGNOSIS >

IPDM E/R		Ground	Continuity
Connector	Terminal		
E5	5		Not existed

Does continuity exist?

YES >> Repair the harness or connector.

NO >> Replace front wiper motor.

FRONT WIPER AUTO STOP SIGNAL CIRCUIT

< DTC/CIRCUIT DIAGNOSIS >

FRONT WIPER AUTO STOP SIGNAL CIRCUIT

Component Function Check

INFOID:000000004239827

1. CHECK FRONT WIPER (AUTO STOP) SIGNAL

CONSULT-III DATA MONITOR

1. Select "WIP AUTO STOP" of IPDM E/R data monitor item.
2. Operate the front wiper.
3. With the front wiper operation, check the monitor status.

Monitor item	Condition		Monitor status
WIP AUTO STOP	Front wiper motor	Stop position	STOP P
		Except stop position	ACT P

Is the status of item normal?

- YES >> Auto stop signal circuit is normal.
NO >> Refer to [WW-25, "Diagnosis Procedure"](#).

Diagnosis Procedure

INFOID:000000004239828

1. CHECK FRONT WIPER MOTOR (AUTO STOP) OUTPUT VOLTAGE

1. Turn the ignition switch OFF.
2. Disconnect front wiper motor connector.
3. Turn the ignition switch ON.
4. Check voltage between IPDM E/R harness connector and ground.

Terminals		Voltage (Approx.)
(+)	(-)	
IPDM E/R		Battery voltage
Connector	Terminal	
E5	16	

Is the measurement value normal?

- YES >> GO TO 3.
NO >> GO TO 2.

2. CHECK FRONT WIPER MOTOR (AUTO STOP) SHORT CIRCUIT

1. Turn the ignition switch OFF.
2. Disconnect IPDM E/R connector.
3. Check continuity between IPDM E/R harness connector and ground.

IPDM E/R		Ground	Continuity
Connector	Terminal		
E5	16		Not existed

Does continuity exist?

- YES >> Repair the harnesses or connectors.
NO >> Replace IPDM E/R.

3. CHECK FRONT WIPER MOTOR (AUTO STOP) CIRCUIT CONTINUITY

Check continuity between IPDM E/R harness connector and front wiper motor harness connector.

IPDM E/R		Front wiper motor		Continuity
Connector	Terminal	Connector	Terminal	
E5	16	E42	5	Existed

A
B
C
D
E
F
G
H
I
J
K
M
N
O
P

WW

FRONT WIPER AUTO STOP SIGNAL CIRCUIT

< DTC/CIRCUIT DIAGNOSIS >

Does continuity exist?

- YES >> Replace front wiper motor.
- NO >> Repair the harnesses or connectors.

FRONT WIPER MOTOR GROUND CIRCUIT

< DTC/CIRCUIT DIAGNOSIS >

FRONT WIPER MOTOR GROUND CIRCUIT

Diagnosis Procedure

INFOID:000000004239829

1. CHECK FRONT WIPER MOTOR (GND) OPEN CIRCUIT

1. Turn the ignition switch OFF.
2. Disconnect front wiper motor connector.
3. Check continuity between front wiper motor harness connector and ground.

Front wiper motor		Ground	Continuity
Connector	Terminal		Existed
E42	2		

Does continuity exist?

- YES >> Front wiper motor ground circuit is normal.
NO >> Repair the harnesses or connectors.

A
B
C
D
E
F
G
H
I
J
K
M
N
O
P

WW

WASHER SWITCH

< DTC/CIRCUIT DIAGNOSIS >

WASHER SWITCH

Description

INFOID:000000004239830

Washer switch is integrated with combination switch.

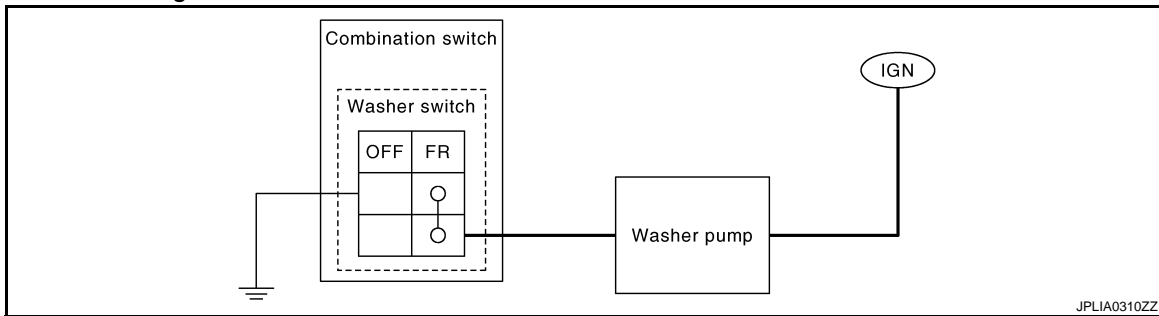

JPLIA0310ZZ

Component Inspection

INFOID:000000004239831

1. CHECK WIPER SWITCH

1. Turn the ignition switch OFF.
2. Disconnect combination switch connector.
3. Check continuity between the combination switch terminals.

Combination switch		Condition	Continuity
Terminal			
1	6	Front washer switch ON	Existed

Does continuity exist?

- YES >> Wiper and washer switch is normal.
NO >> Replace wiper and washer switch.

FRONT WIPER AND WASHER SYSTEM

< DTC/CIRCUIT DIAGNOSIS >

FRONT WIPER AND WASHER SYSTEM

Wiring Diagram - FRONT WIPER AND WASHER SYSTEM -

INFOID:000000004239832

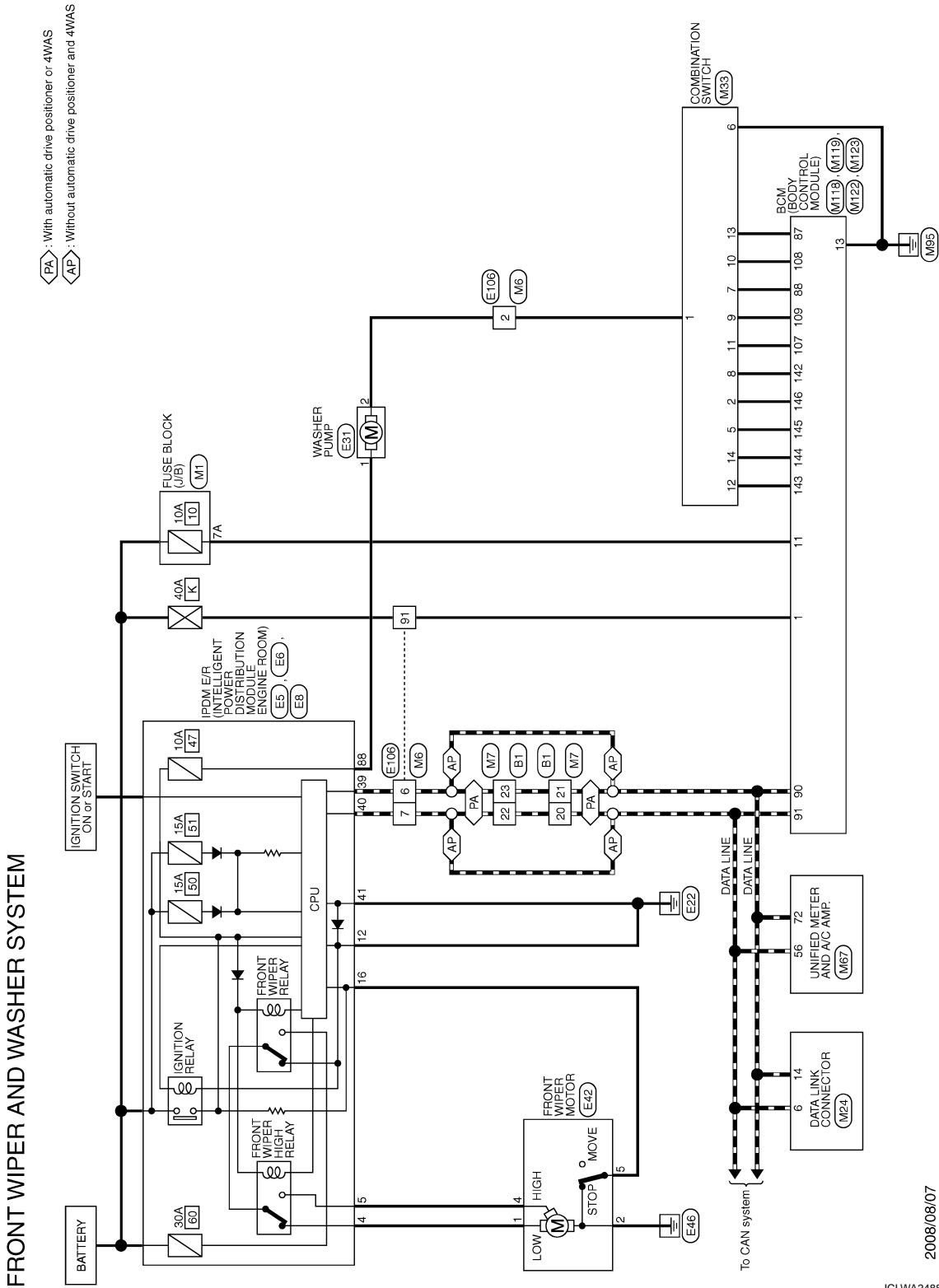

2008/08/07

JCLWA2488GB

WW

FRONT WIPER AND WASHER SYSTEM

< DTC/CIRCUIT DIAGNOSIS >

FRONT WIPER AND WASHER SYSTEM

Connector No.	B1
Connector Name	WIRE TO WIRE
Connector Type	TH80FW-CS16-TM4



Terminal No.	Color of Wire	Signal Name [Specification]
20	L	-
21	P	-
22	L	-
23	P	-

Connector No.	E5
Connector Name	IPDM E/R INTELLIGENT POWER DISTRIBUTION MODULE (ENGINE ROOM)
Connector Type	TH20FW-CS12-M4-TV



Terminal No.	Color of Wire	Signal Name [Specification]
4	V	-
5	L	-
12	B/W	-
16	LG	-

Connector No.	E6
Connector Name	IPDM E/R INTELLIGENT POWER DISTRIBUTION MODULE (ENGINE ROOM)
Connector Type	TH80FW-NH

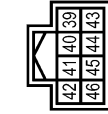

Terminal No.	Color of Wire	Signal Name [Specification]
39	P	-
40	L	-
41	B/W	-

Connector No.	E8
Connector Name	IPDM E/R INTELLIGENT POWER DISTRIBUTION MODULE (ENGINE ROOM)
Connector Type	NS80FW-CS

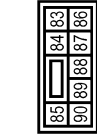

Terminal No.	Color of Wire	Signal Name [Specification]
88	G	-

Connector No.	E31
Connector Name	WASHER PUMP
Connector Type	E02FGY-RS



Terminal No.	Color of Wire	Signal Name [Specification]
1	G	-
2	SB	-

Connector No.	E42
Connector Name	FRONT WIPER MOTOR
Connector Type	HS05FGY

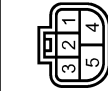

Terminal No.	Color of Wire	Signal Name [Specification]
1	V	-
2	B/W	-
4	L	-
5	LG	-

Connector No.	E106
Connector Name	WIRE TO WIRE
Connector Type	TH80FW-CS16-TM4



Terminal No.	Color of Wire	Signal Name [Specification]
2	SB	-
6	P	-
7	L	-
91	W	-

Connector No.	M1
Connector Name	FUSE BLOCK (J/B)
Connector Type	NS80FW-M2

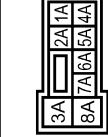

Terminal No.	Color of Wire	Signal Name [Specification]
7A	R	-

JCLWA2489GB

FRONT WIPER AND WASHER SYSTEM

< DTC/CIRCUIT DIAGNOSIS >

FRONT WIPER AND WASHER SYSTEM

Connector No.	M6
Connector Name	WIRE TO WIRE
Connector Type	TH80MW-CS16-TM4

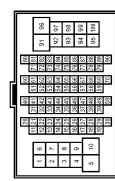

Terminal No.	Color of Wire	Signal Name [Specification]
2	P	-
6	P	-
7	L	-
9	W	-

Connector No.	M7
Connector Name	WIRE TO WIRE
Connector Type	TH80MW-CS16-TM4

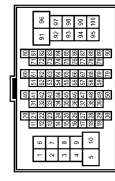

Terminal No.	Color of Wire	Signal Name [Specification]
20	L	-
21	P	-
22	L	-
23	P	-

Connector No.	M24
Connector Name	DATA LINK CONNECTOR
Connector Type	BD16FW-P

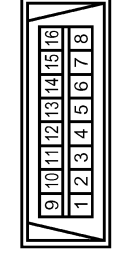

Terminal No.	Color of Wire	Signal Name [Specification]
6	L	-
14	P	-

Connector No.	M33
Connector Name	COMBINATION SWITCH
Connector Type	TH16FW-NH

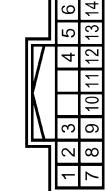

Terminal No.	Color of Wire	Signal Name [Specification]
1	P	FR WASHER(-)
2	SB	OUTPUT 4
5	L	OUTPUT 3
6	B	GROUND
7	O	INPUT 3
8	BR	OUTPUT 5
9	W	INPUT 2
10	R	INPUT 4
11	LG	INPUT 1
12	P	OUTPUT 1
13	Y	INPUT 3

14	G	OUTPUT 2
----	---	----------

Connector No.	M67
Connector Name	UNIFIED METER AND A/C AMP.
Connector Type	TH32FW-NH



Terminal No.	Color of Wire	Signal Name [Specification]
56	L	CAN-H
72	P	CAN-L

Connector No.	M118
Connector Name	BCM (BODY CONTROL MODULE)
Connector Type	M03FB-LC



Terminal No.	Color of Wire	Signal Name [Specification]
1	W	BAT (F/L)

JCLWA2490GB

A
B
C
D
E
F
G
H
I
J
K
M
N
O
P
WW

FRONT WIPER AND WASHER SYSTEM

< DTC/CIRCUIT DIAGNOSIS >

FRONT WIPER AND WASHER SYSTEM

Connector No.	M119
Connector Name	BCM (BODY CONTROL MODULE)
Connector Type	NS16FW-GS



Terminal No.	Color of Wire	Signal Name [Specification]
11	R	BAT (FUSE)
13	B	GND

Connector No.	M122
Connector Name	BCM (BODY CONTROL MODULE)
Connector Type	TH40FB-NH



Terminal No.	Color of Wire	Signal Name [Specification]
87	Y	COMBI SW INPUT 5
88	O	COMBI SW INPUT 3
90	P	CAN-L
91	L	CAN-H
107	LG	COMBI SW INPUT 1
108	R	COMBI SW INPUT 4
109	W	COMBI SW INPUT 2

Connector No.	M123
Connector Name	BCM (BODY CONTROL MODULE)
Connector Type	TH40FG-NH



Terminal No.	Color of Wire	Signal Name [Specification]
142	BR	COMBI SW OUTPUT 5
143	P	COMBI SW OUTPUT 1
144	G	COMBI SW OUTPUT 2
145	L	COMBI SW OUTPUT 3
146	SB	COMBI SW OUTPUT 4

JCLWA2491 GB

BCM (BODY CONTROL MODULE)

< ECU DIAGNOSIS INFORMATION >

ECU DIAGNOSIS INFORMATION

BCM (BODY CONTROL MODULE)

Reference Value

INFOID:000000004685235

VALUES ON THE DIAGNOSIS TOOL

CONSULT-III MONITOR ITEM

Monitor Item	Condition	Value/Status
FR WIPER HI	Other than front wiper switch HI	Off
	Front wiper switch HI	On
FR WIPER LOW	Other than front wiper switch LO	Off
	Front wiper switch LO	On
FR WASHER SW	Front washer switch OFF	Off
	Front washer switch ON	On
FR WIPER INT	Other than front wiper switch INT	Off
	Front wiper switch INT	On
FR WIPER STOP	Front wiper is not in STOP position	Off
	Front wiper is in STOP position	On
INT VOLUME	Wiper intermittent dial is in a dial position 1 - 7	Wiper intermittent dial position
TURN SIGNAL R	Other than turn signal switch RH	Off
	Turn signal switch RH	On
TURN SIGNAL L	Other than turn signal switch LH	Off
	Turn signal switch LH	On
TAIL LAMP SW	Other than lighting switch 1ST and 2ND	Off
	Lighting switch 1ST or 2ND	On
HI BEAM SW	Other than lighting switch HI	Off
	Lighting switch HI	On
HEAD LAMP SW 1	Other than lighting switch 2ND	Off
	Lighting switch 2ND	On
HEAD LAMP SW 2	Other than lighting switch 2ND	Off
	Lighting switch 2ND	On
PASSING SW	Other than lighting switch PASS	Off
	Lighting switch PASS	On
AUTO LIGHT SW	Other than lighting switch AUTO	Off
	Lighting switch AUTO	On
FR FOG SW	Front fog lamp switch OFF	Off
	Front fog lamp switch ON	On
RR FOG SW	NOTE: The item is indicated, but not monitored.	Off
DOOR SW-DR	Driver door closed	Off
	Driver door opened	On
DOOR SW-AS	Passenger door closed	Off
	Passenger door opened	On
DOOR SW-RR	Rear RH door closed	Off
	Rear LH door opened	On

BCM (BODY CONTROL MODULE)

< ECU DIAGNOSIS INFORMATION >

Monitor Item	Condition	Value/Status
DOOR SW-RL	Rear LH door closed	Off
	Rear LH door opened	On
DOOR SW-BK	NOTE: The item is indicated, but not monitored.	Off
CDL LOCK SW	Other than power door lock switch LOCK	Off
	Power door lock switch LOCK	On
CDL UNLOCK SW	Other than power door lock switch UNLOCK	Off
	Power door lock switch UNLOCK	On
KEY CYL LK-SW	Other than driver door key cylinder LOCK	Off
	Driver door key cylinder LOCK	On
KEY CYL UN-SW	Other than driver door key cylinder UNLOCK	Off
	Driver door key cylinder LOCK	On
KEY CYL SW-TR	NOTE: The item is indicated, but not monitored.	Off
HAZARD SW	Hazard switch is OFF	Off
	Hazard switch is ON	On
REAR DEF SW	NOTE: The item is indicated, but not monitored.	Off
H/L WASH SW	NOTE: The item is indicated, but not monitored.	Off
TR CANCEL SW	Trunk lid opener cancel switch OFF	Off
	Trunk lid opener cancel switch ON	On
TR/BD OPEN SW	Trunk lid opener switch OFF	Off
	While the trunk lid opener switch is turned ON	On
TRNK/HAT MNTR	Trunk lid closed	Off
	Trunk lid opened	On
RKE-LOCK	LOCK button of the Intelligent Key is not pressed	Off
	LOCK button of the Intelligent Key is pressed	On
RKE-UNLOCK	UNLOCK button of the Intelligent Key is not pressed	Off
	UNLOCK button of the Intelligent Key is pressed	On
RKE-TR/BD	TRUNK OPEN button of the Intelligent Key is not pressed	Off
	TRUNK OPEN button of the Intelligent Key is pressed	On
RKE-PANIC	PANIC button of the Intelligent Key is not pressed	Off
	PANIC button of the Intelligent Key is pressed	On
RKE-P/W OPEN	UNLOCK button of the Intelligent Key is not pressed	Off
	UNLOCK button of the Intelligent Key is pressed and held	On
RKE-MODE CHG	LOCK/UNLOCK button of the Intelligent Key is not pressed and held simultaneously	Off
	LOCK/UNLOCK button of the Intelligent Key is pressed and held simultaneously	On
OPTICAL SENSOR	Bright outside of the vehicle	Close to 5 V
	Dark outside of the vehicle	Close to 0 V
REQ SW -DR	Driver door request switch is not pressed	Off
	Driver door request switch is pressed	On
REQ SW -AS	Passenger door request switch is not pressed	Off
	Passenger door request switch is pressed	On

BCM (BODY CONTROL MODULE)

< ECU DIAGNOSIS INFORMATION >

Monitor Item	Condition	Value/Status	
REQ SW -RR	NOTE: The item is indicated, but not monitored.	Off	A
REQ SW -RL	NOTE: The item is indicated, but not monitored.	Off	B
REQ SW -BD/TR	Trunk lid opener request switch is not pressed	Off	C
	Trunk lid opener request switch is pressed	On	
PUSH SW	Push-button ignition switch (push switch) is not pressed	Off	D
	Push-button ignition switch (push switch) is pressed	On	
IGN RLY2 -F/B	Ignition switch in OFF or ACC position	Off	E
	Ignition switch in ON position	On	
ACC RLY -F/B	NOTE: The item is indicated, but not monitored.	Off	F
CLUCH SW	The clutch pedal is not depressed	Off	G
	The clutch pedal is depressed	On	
BRAKE SW 1	The brake pedal is depressed when No. 7 fuse is blown	Off	H
	The brake pedal is not depressed when No. 7 fuse is blown, or No. 7 fuse is normal	On	
BRAKE SW 2	The brake pedal is not depressed	Off	I
	The brake pedal is depressed	On	
DETE/CANCL SW	<ul style="list-style-type: none"> • Selector lever in P position (Except M/T models) • The clutch pedal is depressed (M/T models) 	Off	J
	<ul style="list-style-type: none"> • Selector lever in any position other than P (Except M/T models) • The clutch pedal is not depressed (M/T models) 	On	
SFT PN/N SW	Selector lever in any position other than P and N	Off	K
	Selector lever in P or N position	On	
S/L -LOCK	Steering is unlocked	Off	WW
	Steering is locked	On	
S/L -UNLOCK	Steering is locked	Off	M
	Steering is unlocked	On	
S/L RELAY-F/B	Ignition switch in OFF or ACC position	Off	N
	Ignition switch in ON position	On	
UNLK SEN -DR	Driver door is unlocked	Off	O
	Driver door is locked	On	
PUSH SW -IPDM	Push-button ignition switch (push-switch) is not pressed	Off	P
	Push-button ignition switch (push-switch) is pressed	On	
IGN RLY1 -F/B	Ignition switch in OFF or ACC position	Off	
	Ignition switch in ON position	On	
DETE SW -IPDM	Selector lever in any position other than P	Off	
	Selector lever in P position	On	
SFT PN -IPDM	<ul style="list-style-type: none"> • Selector lever in any position other than P and N (Except M/T models) • The clutch pedal is not depressed (M/T models) 	Off	
	<ul style="list-style-type: none"> • Selector lever in P or N position (Except M/T models) • The clutch pedal is depressed (M/T models) 	On	
SFT P -MET	Selector lever in any position other than P	Off	
	Selector lever in P position	On	
SFT N -MET	Selector lever in any position other than N	Off	
	Selector lever in N position	On	

BCM (BODY CONTROL MODULE)

< ECU DIAGNOSIS INFORMATION >

Monitor Item	Condition	Value/Status
ENGINE STATE	Engine stopped	Stop
	While the engine stalls	Stall
	At engine cranking	Crank
	Engine running	Run
S/L LOCK-IPDM	Steering is unlocked	Off
	Steering is locked	On
S/L UNLK-IPDM	Steering is locked	Off
	Steering is unlocked	On
S/L RELAY-REQ	Steering lock system is not the LOCK condition and the changing condition from LOCK to UNLOCK	Off
	Steering lock system is the LOCK condition or the changing condition from LOCK to UNLOCK	On
VEH SPEED 1	While driving	Equivalent to speedometer reading
VEH SPEED 2	While driving	Equivalent to speedometer reading
DOOR STAT-DR	Driver door is locked	LOCK
	Wait with selective UNLOCK operation (60 seconds)	READY
	Driver door is unlocked	UNLOCK
DOOR STAT-AS	Passenger door is locked	LOCK
	Wait with selective UNLOCK operation (60 seconds)	READY
	Passenger door is unlocked	UNLOCK
ID OK FLAG	Steering is locked	Reset
	Steering is unlocked	Set
PRMT ENG STRT	The engine start is prohibited	Reset
	The engine start is permitted	Set
PRMT RKE STRT	NOTE: The item is indicated, but not monitored.	Reset
KEY SW -SLOT	The Intelligent Key is not inserted into key slot	Off
	The Intelligent Key is inserted into key slot	On
RKE OPE COUN1	During the operation of the Intelligent Key	Operation frequency of the Intelligent Key
RKE OPE COUN2	NOTE: The item is indicated, but not monitored.	—
CONFIRM ID ALL	The key ID that the key slot receives is not recognized by any key ID registered to BCM.	Yet
	The key ID that the key slot receives is recognized by any key ID registered to BCM.	Done
CONFIRM ID4	The key ID that the key slot receives is not recognized by the fourth key ID registered to BCM.	Yet
	The key ID that the key slot receives is recognized by the fourth key ID registered to BCM.	Done
CONFIRM ID3	The key ID that the key slot receives is not recognized by the third key ID registered to BCM.	Yet
	The key ID that the key slot receives is recognized by the third key ID registered to BCM.	Done

BCM (BODY CONTROL MODULE)

< ECU DIAGNOSIS INFORMATION >

Monitor Item	Condition	Value/Status	
CONFIRM ID2	The key ID that the key slot receives is not recognized by the second key ID registered to BCM.	Yet	A
	The key ID that the key slot receives is recognized by the second key ID registered to BCM.	Done	B
CONFIRM ID1	The key ID that the key slot receives is not recognized by the first key ID registered to BCM.	Yet	C
	The key ID that the key slot receives is recognized by the first key ID registered to BCM.	Done	
TP 4	The ID of fourth Intelligent Key is not registered to BCM	Yet	D
	The ID of fourth Intelligent Key is registered to BCM	Done	
TP 3	The ID of third Intelligent Key is not registered to BCM	Yet	E
	The ID of third Intelligent Key is registered to BCM	Done	
TP 2	The ID of second Intelligent Key is not registered to BCM	Yet	F
	The ID of second Intelligent Key is registered to BCM	Done	
TP 1	The ID of first Intelligent Key is not registered to BCM	Yet	
	The ID of first Intelligent Key is registered to BCM	Done	
AIR PRESS FL	Ignition switch ON (Only when the signal from the transmitter is received)	Air pressure of front LH tire	G
AIR PRESS FR	Ignition switch ON (Only when the signal from the transmitter is received)	Air pressure of front RH tire	H
AIR PRESS RR	Ignition switch ON (Only when the signal from the transmitter is received)	Air pressure of rear RH tire	I
AIR PRESS RL	Ignition switch ON (Only when the signal from the transmitter is received)	Air pressure of rear LH tire	
ID REGST FL1	ID of front LH tire transmitter is registered	Done	J
	ID of front LH tire transmitter is not registered	Yet	
ID REGST FR1	ID of front RH tire transmitter is registered	Done	
	ID of front RH tire transmitter is not registered	Yet	
ID REGST RR1	ID of rear RH tire transmitter is registered	Done	K
	ID of rear RH tire transmitter is not registered	Yet	
ID REGST RL1	ID of rear LH tire transmitter is registered	Done	WW
	ID of rear LH tire transmitter is not registered	Yet	
WARNING LAMP	Tire pressure indicator OFF	Off	
	Tire pressure indicator ON	On	M
BUZZER	Tire pressure warning alarm is not sounding	Off	
	Tire pressure warning alarm is sounding	On	N

BCM (BODY CONTROL MODULE)

< ECU DIAGNOSIS INFORMATION >

TERMINAL LAYOUT

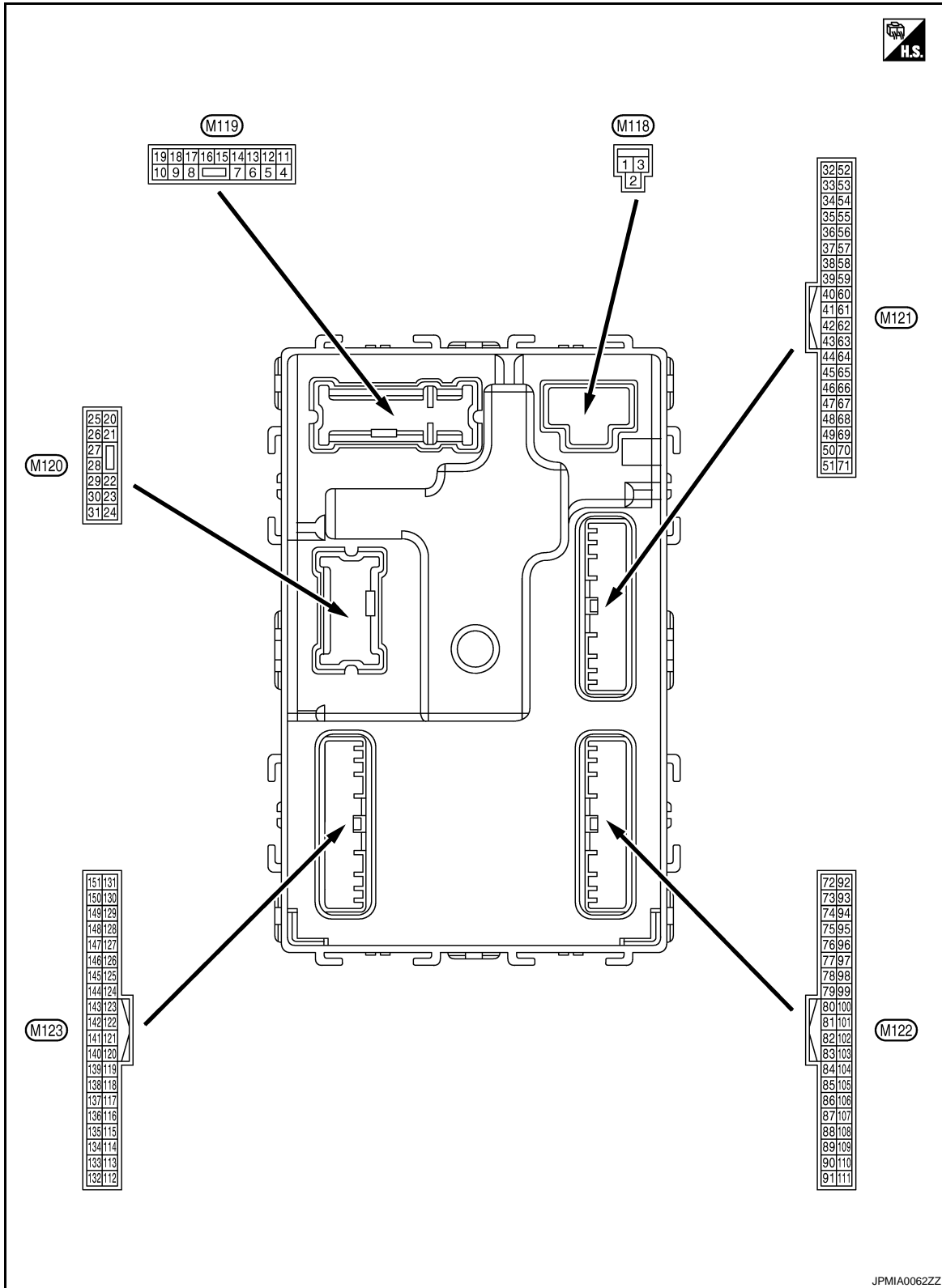

PHYSICAL VALUES

BCM (BODY CONTROL MODULE)

< ECU DIAGNOSIS INFORMATION >

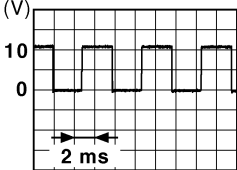
Terminal No. (Wire color)		Description		Condition		Value (Approx.)
+	-					
1 (W)	Ground	Battery power supply	Input	Ignition switch OFF		Battery voltage
2 (Y)	Ground	P/W power supply (BAT)	Output	Ignition switch OFF		12 V
3 (O)	Ground	P/W power supply (RAP)	Output	Ignition switch ON		12 V
4 (LG)	Ground	Interior room lamp power supply	Output	Interior room lamp battery saver is activated. (Cuts the interior room lamp power supply)		0 V
				Interior room lamp battery saver is not activated. (Outputs the interior room lamp power supply)		12 V
5 (P)	Ground	Passenger door UN- LOCK	Output	Passenger door	UNLOCK (Actuator is activated)	12 V
					Other than UNLOCK) Ac- tuator is not activated	0 V
7 (BR)	Ground	Step lamp	Output	Step lamp	ON	0 V
					OFF	12 V
8 (V)	Ground	All doors, fuel lid LOCK	Output	All doors, fuel lid	LOCK (Actuator is activated)	12 V
					Other than LOCK (Actuator is not activated)	0 V
9 (G)	Ground	Driver door, fuel lid UNLOCK	Output	Driver door, fuel lid	UNLOCK (Actuator is activated)	12 V
					Other than UNLOCK (Actuator is not activated)	0 V
10 (BR)	Ground	Rear RH door and rear LH UNLOCK	Output	Rear RH door and rear LH door	UNLOCK (Actuator is activated)	12 V
					Other than UNLOCK (Actuator is not activated)	0 V
11 (R)	Ground	Battery power supply	Input	Ignition switch OFF		Battery voltage
13 (B)	Ground	Ground	—	Ignition switch ON		0 V
14 (W)	Ground	Push-button ignition switch illumination ground	Output	Tail lamp	OFF	0 V
					ON	<p>NOTE: When the illumination brighten- ing/dimming level is in the neutral position</p>  <p style="text-align: right; font-size: small;">JSNIA0010GB</p>
15 (O)	Ground	ACC indicator lamp	Output	Ignition switch	OFF (LOCK indicator is not illuminated)	Battery voltage
					ACC	0 V

BCM (BODY CONTROL MODULE)

< ECU DIAGNOSIS INFORMATION >

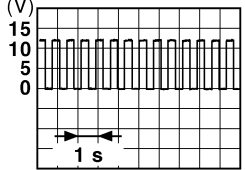
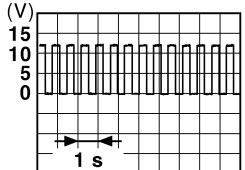
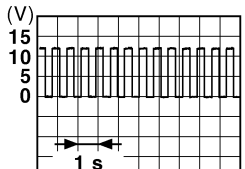
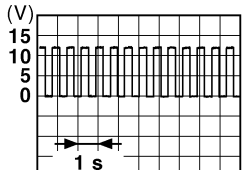
Terminal No. (Wire color)		Description		Condition	Value (Approx.)
+	-	Signal name	Input/ Output		
17 (W)	Ground	Turn signal RH (Front)	Output	Ignition switch ON	Turn signal switch OFF 0 V
				Turn signal switch RH	 6.5 V <small>PKID0926E</small>
18 (O)	Ground	Turn signal LH (Front)	Output	Ignition switch ON	Turn signal switch OFF 0 V
				Turn signal switch LH	 6.5 V <small>PKID0926E</small>
19 (V)	Ground	Room lamp timer control	Output	Interior room lamp	OFF 12 V
				ON	0 V
20 (V)	Ground	Turn signal RH (Rear)	Output	Ignition switch ON	Turn signal switch OFF 0 V
				Turn signal switch RH	 6.5 V <small>PKID0926E</small>
23 (L)	Ground	Trunk lid open	Output	Trunk lid	OPEN (Trunk lid opener actuator is activated) 12 V
				Other than OPEN (Trunk lid opener actuator is not activated)	0 V
25 (Y)	Ground	Turn signal LH (Rear)	Output	Ignition switch ON	Turn signal switch OFF 0 V
				Turn signal switch LH	 6.5 V <small>PKID0926E</small>
30 (P)	Ground	Trunk room lamp	Output	Trunk room lamp	ON 0 V
				OFF	12 V

BCM (BODY CONTROL MODULE)

< ECU DIAGNOSIS INFORMATION >

Terminal No. (Wire color)		Description		Condition	Value (Approx.)
+	-	Signal name	Input/ Output		
34 (SB)	Ground	Trunk room antenna (-)	Output	Ignition switch OFF	<p style="text-align: right; font-size: small;">JMKIA0062GB</p>
				When Intelligent Key is not in the passenger compart- ment	<p style="text-align: right; font-size: small;">JMKIA0063GB</p>
35 (V)	Ground	Trunk room antenna (+)	Output	Ignition switch OFF	<p style="text-align: right; font-size: small;">JMKIA0062GB</p>
				When Intelligent Key is not in the passenger compart- ment	<p style="text-align: right; font-size: small;">JMKIA0063GB</p>
38 (B)	Ground	Rear bumper anten- na (-)	Output	When the trunk lid opener re- quest switch is operated with ignition switch OFF	<p style="text-align: right; font-size: small;">JMKIA0062GB</p>
				When Intelligent Key is not in the antenna detection area	<p style="text-align: right; font-size: small;">JMKIA0063GB</p>

A
B
C
D
E
F
G
H
I
J
K
M
N
O
P

WW

BCM (BODY CONTROL MODULE)

< ECU DIAGNOSIS INFORMATION >

Terminal No. (Wire color)		Description		Condition	Value (Approx.)				
+	-	Signal name	Input/ Output						
39 (W)	Ground	Rear bumper antenna (+)	Output	When Intelligent Key is in the antenna detection area	<p style="text-align: right; font-size: small;">JMKIA0062GB</p>				
				When the trunk lid opener request switch is operated with ignition switch OFF	<p style="text-align: right; font-size: small;">JMKIA0063GB</p>				
47 (Y)	Ground	Ignition relay (IPDM E/R) control	Output	Ignition switch	<table border="1" style="width: 100%; border-collapse: collapse;"> <tr> <td>OFF or ACC</td> <td style="text-align: center;">12 V</td> </tr> <tr> <td>ON</td> <td style="text-align: center;">0 V</td> </tr> </table>	OFF or ACC	12 V	ON	0 V
				OFF or ACC	12 V				
ON	0 V								
50 (O)	Ground	Trunk room lamp switch	Input	Trunk room lamp switch	<table border="1" style="width: 100%; border-collapse: collapse;"> <tr> <td>OFF (Trunk lid is closed)</td> <td> <p style="text-align: right; font-size: small;">JPMIA0011GB</p> </td> </tr> <tr> <td>ON (Trunk lid is opened)</td> <td style="text-align: center;">0 V</td> </tr> </table>	OFF (Trunk lid is closed)	<p style="text-align: right; font-size: small;">JPMIA0011GB</p>	ON (Trunk lid is opened)	0 V
				OFF (Trunk lid is closed)	<p style="text-align: right; font-size: small;">JPMIA0011GB</p>				
ON (Trunk lid is opened)	0 V								
52 (SB)	Ground	Starter relay control	Output	Ignition switch ON (A/T models)	12 V				
				When selector lever is not in P or N position	0 V				
			Ignition switch ON (M/T models)	When the clutch pedal is depressed	Battery voltage				
				When the clutch pedal is not depressed	0 V				
61 (SB)	Ground	Trunk lid opener request switch	Input	Trunk lid opener request switch	<table border="1" style="width: 100%; border-collapse: collapse;"> <tr> <td>ON (Pressed)</td> <td style="text-align: center;">0 V</td> </tr> <tr> <td>OFF (Not pressed)</td> <td> <p style="text-align: right; font-size: small;">JPMIA0016GB</p> </td> </tr> </table>	ON (Pressed)	0 V	OFF (Not pressed)	<p style="text-align: right; font-size: small;">JPMIA0016GB</p>
				ON (Pressed)	0 V				
OFF (Not pressed)	<p style="text-align: right; font-size: small;">JPMIA0016GB</p>								
1.0 V									
64 (G)	Ground	Intelligent Key warning buzzer (Engine room)	Output	Intelligent Key warning buzzer (Engine room)	<table border="1" style="width: 100%; border-collapse: collapse;"> <tr> <td>Sounding</td> <td style="text-align: center;">0 V</td> </tr> <tr> <td>Not sounding</td> <td style="text-align: center;">12 V</td> </tr> </table>	Sounding	0 V	Not sounding	12 V
				Sounding	0 V				
Not sounding	12 V								

BCM (BODY CONTROL MODULE)

< ECU DIAGNOSIS INFORMATION >

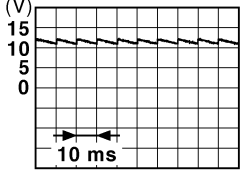
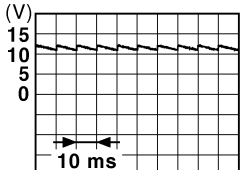
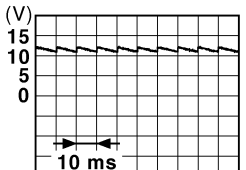
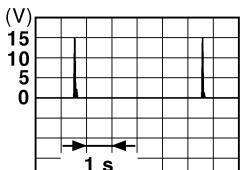
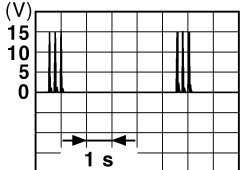
Terminal No. (Wire color)		Description		Condition	Value (Approx.)	
		Signal name	Input/ Output			
+	-					
67 (GR)	Ground	Trunk lid opener switch	Input	Trunk lid opener switch	Pressed	0 V
					Not pressed	 <p style="text-align: right; font-size: small;">JPMIA0011GB</p>
68 (BR)	Ground	Rear RH door switch	Input	Rear RH door switch	OFF (When rear RH door closes)	 <p style="text-align: right; font-size: small;">JPMIA0011GB</p>
					ON (When rear RH door opens)	0 V
69 (R)	Ground	Rear LH door switch	Input	Rear LH door switch	OFF (When rear LH door closes)	 <p style="text-align: right; font-size: small;">JPMIA0011GB</p>
					ON (When rear LH door opens)	0 V
72 (R)	Ground	Room antenna 2 (-) (Center console)	Output	Ignition switch OFF	When Intelligent Key is in the passenger compart- ment	 <p style="text-align: right; font-size: small;">JMKIA0062GB</p>
					When Intelligent Key is not in the passenger compart- ment	 <p style="text-align: right; font-size: small;">JMKIA0063GB</p>

A
B
C
D
E
F
G
H
I
J
K
M
N
O
P

WW

BCM (BODY CONTROL MODULE)

< ECU DIAGNOSIS INFORMATION >

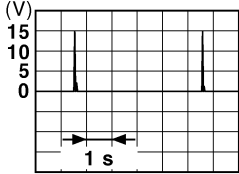
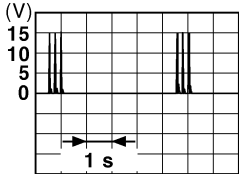
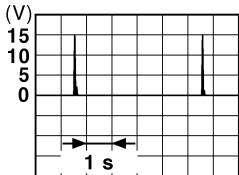
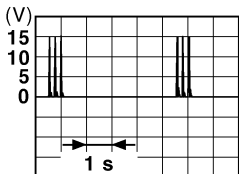
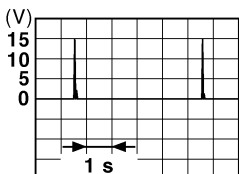
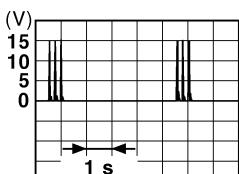
Terminal No. (Wire color)		Description		Condition	Value (Approx.)
+	-	Signal name	Input/ Output		
73 (G)	Ground	Room antenna 2 (+) (Center console)	Output	Ignition switch OFF	 <p style="text-align: right; font-size: small;">JMKIA0062GB</p>
				When Intelligent Key is not in the passenger compart- ment	 <p style="text-align: right; font-size: small;">JMKIA0063GB</p>
74 (SB)	Ground	Passenger door an- tenna (-)	Output	When the pas- senger door re- quest switch is operated with ignition switch OFF	 <p style="text-align: right; font-size: small;">JMKIA0062GB</p>
				When Intelligent Key is not in the antenna detection area	 <p style="text-align: right; font-size: small;">JMKIA0063GB</p>
75 (BR)	Ground	Passenger door an- tenna (+)	Output	When the pas- senger door re- quest switch is operated with ignition switch OFF	 <p style="text-align: right; font-size: small;">JMKIA0062GB</p>
				When Intelligent Key is not in the antenna detection area	 <p style="text-align: right; font-size: small;">JMKIA0063GB</p>

BCM (BODY CONTROL MODULE)

< ECU DIAGNOSIS INFORMATION >

Terminal No. (Wire color)		Description		Condition	Value (Approx.)
+	-	Signal name	Input/ Output		
76 (V)	Ground	Driver door antenna (-)	Output	When the driver door request switch is operated with ignition switch OFF	<p style="text-align: right; font-size: small;">JMKIA0062GB</p>
				When Intelligent Key is not in the antenna detection area	<p style="text-align: right; font-size: small;">JMKIA0063GB</p>
77 (LG)	Ground	Driver door antenna (+)	Output	When the driver door request switch is operated with ignition switch OFF	<p style="text-align: right; font-size: small;">JMKIA0062GB</p>
				When Intelligent Key is not in the antenna detection area	<p style="text-align: right; font-size: small;">JMKIA0063GB</p>
78 (Y)	Ground	Room antenna 1 (-) (Instrument panel)	Output	Ignition switch OFF	<p style="text-align: right; font-size: small;">JMKIA0062GB</p>
				When Intelligent Key is not in the passenger compartment	<p style="text-align: right; font-size: small;">JMKIA0063GB</p>

A
B
C
D
E
F
G
H
I
J
K
M
N
O
P

WW



BCM (BODY CONTROL MODULE)

< ECU DIAGNOSIS INFORMATION >

Terminal No. (Wire color)		Description		Condition	Value (Approx.)	
+	-	Signal name	Input/ Output			
79 (BR)	Ground	Room antenna 1 (+) (Instrument panel)	Output	Ignition switch OFF		
				When Intelligent Key is not in the passenger compart- ment		
80 (GR)	Ground	NATS antenna amp (Built in key slot)	Input/ Output	During waiting	Ignition switch is pressed while inserting the Intelli- gent Key into the key slot.	Just after pressing ignition switch. Pointer of tester should move.
81 (W)	Ground	NATS antenna amp (Built in key slot)	Input/ Output	During waiting	Ignition switch is pressed while inserting the Intelli- gent Key into the key slot.	Just after pressing ignition switch. Pointer of tester should move.
82 (R)	Ground	Ignition relay [Fuse block (J/B)] control	Output	Ignition switch	OFF or ACC	0 V
					ON	12 V
83 (Y)	Ground	Remote keyless entry receiver communica- tion	Input/ Output	During waiting		
				When operating either button on the Intelli- gent Key		

BCM (BODY CONTROL MODULE)

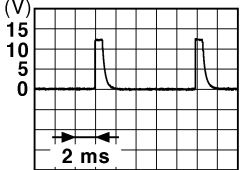
< ECU DIAGNOSIS INFORMATION >

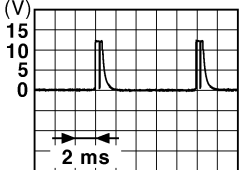
Terminal No. (Wire color)		Description		Condition	Value (Approx.)	
		Signal name	Input/ Output			
+	-					
87 (Y)	Ground	Combination switch INPUT 5	Input	Combination switch	All switches OFF (Wiper intermittent dial 4)	 <p style="text-align: right; margin-right: 50px;">JPMA0041GB</p> <p style="text-align: center;">1.4 V</p>
					Front fog lamp switch ON (Wiper intermittent dial 4)	 <p style="text-align: right; margin-right: 50px;">JPMA0037GB</p> <p style="text-align: center;">1.3 V</p>
					Any of the conditions below with all switches OFF <ul style="list-style-type: none"> • Wiper intermittent dial 1 • Wiper intermittent dial 2 • Wiper intermittent dial 6 • Wiper intermittent dial 7 	 <p style="text-align: right; margin-right: 50px;">JPMA0040GB</p> <p style="text-align: center;">1.3 V</p>



A
B
C
D
E
F
G
H
I
J
K

WW

M
N
O
P

BCM (BODY CONTROL MODULE)

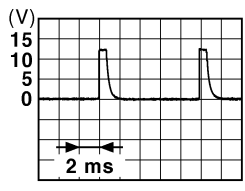
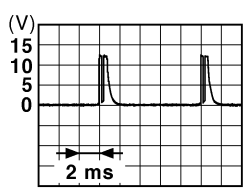
< ECU DIAGNOSIS INFORMATION >

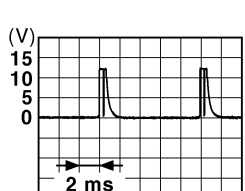
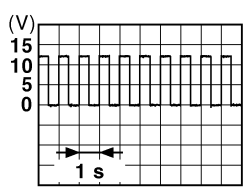
Terminal No. (Wire color)		Description		Condition	Value (Approx.)	
+	-	Signal name	Input/ Output			
88 (O)	Ground	Combination switch INPUT 3	Input	Combination switch	All switches OFF (Wiper intermittent dial 4)	 <p style="text-align: right; font-size: small;">JPMIA0041GB</p> <p style="text-align: center;">1.4 V</p>
					Lighting switch HI (Wiper intermittent dial 4)	 <p style="text-align: right; font-size: small;">JPMIA0036GB</p> <p style="text-align: center;">1.3 V</p>
					Lighting switch 2ND (Wiper intermittent dial 4)	 <p style="text-align: right; font-size: small;">JPMIA0037GB</p> <p style="text-align: center;">1.3 V</p>
					Any of the conditions below with all switches OFF <ul style="list-style-type: none"> • Wiper intermittent dial 1 • Wiper intermittent dial 2 • Wiper intermittent dial 3 	 <p style="text-align: right; font-size: small;">JPMIA0040GB</p> <p style="text-align: center;">1.3 V</p>
89 (BR)	Ground	Push-button ignition switch (Push switch)	Input	Push-button ignition switch (push switch)	Pressed	0 V
					Not pressed	Battery voltage
90 (P)	Ground	CAN-L	Input/ Output	—	—	
91 (L)	Ground	CAN-H	Input/ Output	—	—	
92 (LG)	Ground	Key slot illumination	Output	Key slot illumination	OFF	0 V
					Blinking	 <p style="text-align: right; font-size: small;">JPMIA0015GB</p> <p style="text-align: center;">6.5 V</p>
					ON	12 V

BCM (BODY CONTROL MODULE)

< ECU DIAGNOSIS INFORMATION >

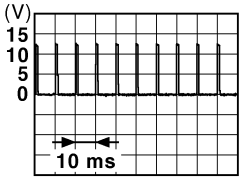
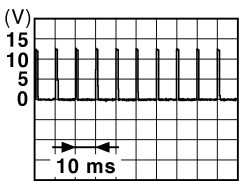
Terminal No. (Wire color)		Description		Condition		Value (Approx.)
+	-	Signal name	Input/ Output			
93 (V)	Ground	ON indicator lamp	Output	Ignition switch	OFF (LOCK indicator is not illuminated)	Battery voltage
					ON	0 V
95 (O)	Ground	ACC relay control	Output	Ignition switch	OFF	0 V
					ACC or ON	12 V
96 (GR)	Ground	A/T shift selector (Detention switch) power supply	Output	—		12 V
97 (L)	Ground	Steering lock condition No. 1	Input	Steering lock	LOCK status	0 V
					UNLOCK status	12 V
98 (P)	Ground	Steering lock condition No. 2	Input	Steering lock	LOCK status	12 V
					UNLOCK status	0 V
99 (R) ^{*1} (BR) ^{*2}	Ground	Selector lever P position switch (A/T models)	Input	Selector lever	P position	0 V
					Any position other than P	12 V
		ASCD clutch switch (M/T models without ICC)		ASCD clutch switch	OFF (Clutch pedal is depressed)	0 V
					ON (Clutch pedal is not depressed)	12 V
		ICC clutch switch (M/T models with ICC)		ICC clutch switch	OFF (Clutch pedal is depressed)	0 V
					ON (Clutch pedal is not depressed)	12 V
100 (Y)	Ground	Passenger door request switch	Input	Passenger door request switch	ON (Pressed)	0 V
					OFF (Not pressed)	 <p style="text-align: right; font-size: small;">JPMIA0016GB</p>
101 (P)	Ground	Driver door request switch	Input	Driver door request switch	ON (Pressed)	0 V
					OFF (Not pressed)	 <p style="text-align: right; font-size: small;">JPMIA0016GB</p>
102 (O)	Ground	Blower fan motor relay control	Output	Ignition switch	OFF or ACC	0 V
					ON	12 V
103 (L)	Ground	Remote keyless entry receiver power supply	Output	Ignition switch OFF		12 V
106 (W)	Ground	Steering lock unit power supply	Output	Ignition switch	OFF or ACC	12 V
					ON	0 V





A
B
C
D
E
F
G
H
I
J
K

WW

M
N
O
P

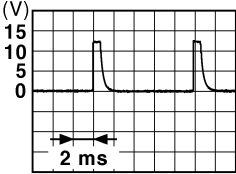

BCM (BODY CONTROL MODULE)

< ECU DIAGNOSIS INFORMATION >

Terminal No. (Wire color)		Description		Condition	Value (Approx.)	
+	-	Signal name	Input/ Output			
107 (LG)	Ground	Combination switch INPUT 1	Input	Combination switch (Wiper intermit- tent dial 4)	All switches OFF	 1.4 V
					Turn signal switch LH	 1.3 V
					Turn signal switch RH	 1.3 V
					Front wiper switch LO	 1.3 V
					Front washer switch ON	 1.3 V

BCM (BODY CONTROL MODULE)

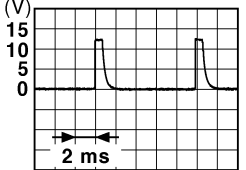
< ECU DIAGNOSIS INFORMATION >

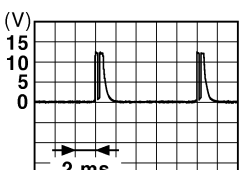
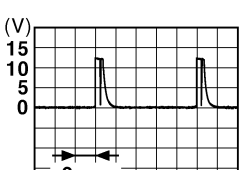
Terminal No. (Wire color)		Description		Condition	Value (Approx.)
		Signal name	Input/ Output		
+	-				
108 (R)	Ground	Combination switch INPUT 4	Input	Combination switch	All switches OFF (Wiper intermittent dial 4) <div style="text-align: right;">  <p>1.4 V</p> </div>
					Lighting switch AUTO (Wiper intermittent dial 4) <div style="text-align: right;">  <p>1.3 V</p> </div>
					Lighting switch 1ST (Wiper intermittent dial 4) <div style="text-align: right;">  <p>1.3 V</p> </div>
					Any of the conditions below with all switches OFF <ul style="list-style-type: none"> • Wiper intermittent dial 1 • Wiper intermittent dial 5 • Wiper intermittent dial 6 <div style="text-align: right;">  <p>1.3 V</p> </div>

A
B
C
D
E
F
G
H
I
J
K
M
N
O
P

WW

BCM (BODY CONTROL MODULE)

< ECU DIAGNOSIS INFORMATION >

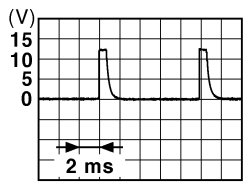
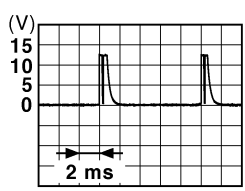
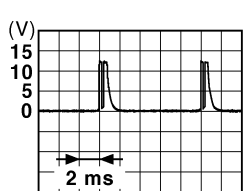
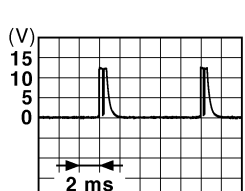
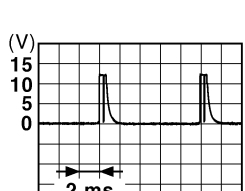
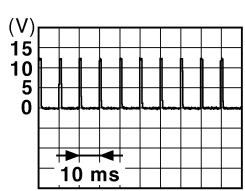
Terminal No. (Wire color)		Description		Condition	Value (Approx.)	
+	-	Signal name	Input/ Output			
109 (W)	Ground	Combination switch INPUT 2	Input	Combination switch (Wiper intermittent dial 4)	All switches OFF	 <small>JPMIA0041GB</small> 1.4 V
					Lighting switch PASS	 <small>JPMIA0037GB</small> 1.3 V
					Lighting switch 2ND	 <small>JPMIA0036GB</small> 1.3 V
					Front wiper switch INT	 <small>JPMIA0038GB</small> 1.3 V
					Front wiper switch HI	 <small>JPMIA0040GB</small> 1.3 V
110 (G)	Ground	Hazard switch	Input	Hazard switch	ON	0 V
				Hazard switch	OFF	 <small>JPMIA0012GB</small> 1.1 V

BCM (BODY CONTROL MODULE)

< ECU DIAGNOSIS INFORMATION >

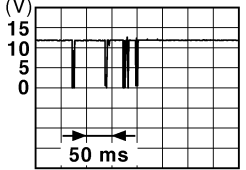
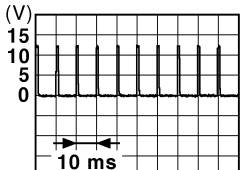
Terminal No. (Wire color)		Description		Condition	Value (Approx.)	
		Signal name	Input/ Output			
+	-					
111 (Y)	Ground	Steering lock unit communication	Input/ Output	Steering lock	LOCK status	12 V
					LOCK or UNLOCK	
					For 15 seconds after UNLOCK	12 V
					15 seconds or later after UNLOCK	0 V
113 (O)	Ground	Optical sensor	Input	Ignition switch ON	When bright outside of the vehicle	Close to 5 V
					When dark outside of the vehicle	Close to 0 V
114 (R)	Ground	Clutch interlock switch	Input	Clutch interlock switch	OFF (Clutch pedal is not depressed)	0 V
					ON (Clutch pedal is depressed)	Battery voltage
116 (SB)	Ground	Stop lamp switch 1	Input	—	Battery voltage	
118 (BR)	Ground	Stop lamp switch 2 (Without ICC)	Input	Stop lamp switch	OFF (Brake pedal is not depressed)	0 V
					ON (Brake pedal is depressed)	Battery voltage
		Stop lamp switch 2 (With ICC)		Stop lamp switch OFF (Brake pedal is not depressed) and ICC brake hold relay OFF	0 V	
				Stop lamp switch ON (Brake pedal is depressed) or ICC brake hold relay ON	Battery voltage	
119 (SB)	Ground	Front door lock assembly driver side (Unlock sensor)	Input	Driver door	LOCK status (Unlock sensor switch OFF)	
					UNLOCK status (Unlock switch sensor ON)	0 V
121 (SB)	Ground	Key slot switch	Input	When the Intelligent Key is inserted into key slot	12 V	
				When the Intelligent Key is not inserted into key slot	0 V	
123 (W)	Ground	IGN feedback	Input	Ignition switch	OFF or ACC	0 V
					ON	Battery voltage

A
B
C
D
E
F
G
H
I
J
K
WW
M
N
O
P



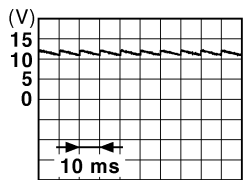
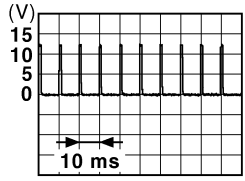
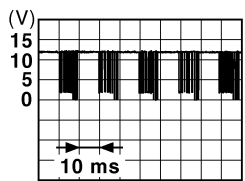
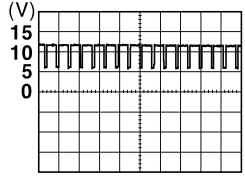

BCM (BODY CONTROL MODULE)

< ECU DIAGNOSIS INFORMATION >

Terminal No. (Wire color)		Description		Condition	Value (Approx.)	
+	-	Signal name	Input/ Output			
124 (LG)	Ground	Passenger door switch	Input	Passenger door switch	 <p style="text-align: right; font-size: small;">JPMIA0011GB</p> <p style="text-align: center;">11.8 V</p>	
				OFF (Door close)	0 V	
129 (O)	Ground	Trunk lid opener cancel switch	Input	Trunk lid open- er cancel switch	 <p style="text-align: right; font-size: small;">JPMIA0012GB</p> <p style="text-align: center;">1.1 V</p>	
				CANCEL	0 V	
132 (V)	Ground	Power window switch communication	Input/ Output	Ignition switch ON	 <p style="text-align: right; font-size: small;">JPMIA0013GB</p> <p style="text-align: center;">10.2 V</p>	
				Ignition switch OFF or ACC	12 V	
133 (L)	Ground	Push-button ignition switch illumination	Output	Push-button ig- nition switch il- lumination	<p style="text-align: center;">NOTE: The pulse width of this wave is varied by the illumination bright- ening/dimming level.</p>  <p style="text-align: right; font-size: small;">JPMIA0159GB</p>	
				ON (Tail lamps ON)	9.5 V	
				OFF	0 V	
134 (LG)	Ground	LOCK indicator lamp	Output	LOCK indicator lamp	OFF	Battery voltage
				ON	0 V	
137 (O)	Ground	Receiver and sensor ground	Input	Ignition switch ON	0 V	
138 (V)	Ground	Receiver and sensor power supply	Output	Ignition switch	OFF	0 V
				ACC or ON	5.0 V	

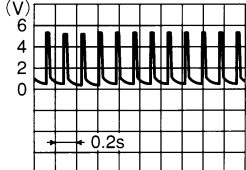
BCM (BODY CONTROL MODULE)

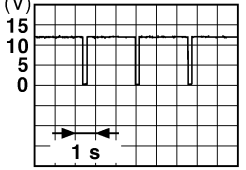
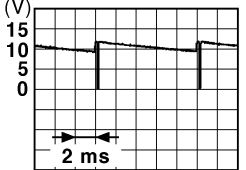
< ECU DIAGNOSIS INFORMATION >

Terminal No. (Wire color)		Description		Condition	Value (Approx.)	
+	-	Signal name	Input/ Output			
139 (L)	Ground	Tire pressure receiver communication	Input/ Output	Ignition switch ON	Standby state  OCC3881D	
				When receiving the signal from the transmitter  OCC3880D		
140 (GR)	Ground	Selector lever P/N position	Input	Selector lever	P or N position 12 V Except P and N positions 0 V	
				141 (R)	Ground	Security indicator
Blinking  JPMA0014GB 11.3 V						
142 (BR)	Ground	Combination switch OUTPUT 5	Output	Combination switch (Wiper intermittent dial 4)	All switches OFF 0 V	
					Lighting switch 1ST Lighting switch HI Lighting switch 2ND Turn signal switch RH  JPMA0031GB 10.7 V	
143 (P)	Ground	Combination switch OUTPUT 1	Output	Combination switch	All switches OFF (Wiper intermittent dial 4) 0 V	
					Front wiper switch HI (Wiper intermittent dial 4) Any of the conditions below with all switches OFF • Wiper intermittent dial 1 • Wiper intermittent dial 2 • Wiper intermittent dial 3 • Wiper intermittent dial 6 • Wiper intermittent dial 7  JPMA0032GB 10.7 V	

A
B
C
D
E
F
G
H
I
J
K
L
M
N
O
P

WW

BCM (BODY CONTROL MODULE)

< ECU DIAGNOSIS INFORMATION >

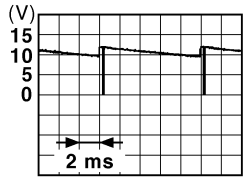
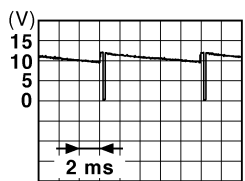
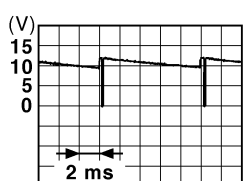
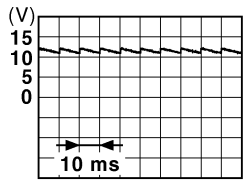
Terminal No. (Wire color)		Description		Condition	Value (Approx.)	
+	-	Signal name	Input/ Output			
144 (G)	Ground	Combination switch OUTPUT 2	Output	Combination switch	All switches OFF (Wiper intermittent dial 4)	0 V
					Front washer switch ON (Wiper intermittent dial 4)	
					Any of the conditions below with all switches OFF	
					<ul style="list-style-type: none"> • Wiper intermittent dial 1 • Wiper intermittent dial 5 • Wiper intermittent dial 6 	
145 (L)	Ground	Combination switch OUTPUT 3	Output	Combination switch (Wiper intermittent dial 4)	All switches OFF	0 V
					Front wiper switch INT	
					Front wiper switch LO	
					Lighting switch AUTO	
						10.7 V
146 (SB)	Ground	Combination switch OUTPUT 4	Output	Combination switch (Wiper intermittent dial 4)	All switches OFF	0 V
					Front fog lamp switch ON	
					Lighting switch 2ND	
					Lighting switch PASS	
					Turn signal switch LH	
						10.7 V
149 (W)	Ground	Tire pressure warning check switch	Input	—	12 V	
150 (GR)	Ground	Driver door switch	Input	Driver door switch	OFF (Door close)	
					ON (Door open)	
151 (G)	Ground	Rear window defogger relay control	Output	Rear window defogger	Active	0 V
				Not activated	Battery voltage	

- *1: A/T models
- *2: M/T models

BCM (BODY CONTROL MODULE)

< ECU DIAGNOSIS INFORMATION >

Wiring Diagram - BCM -

INFOID:000000004685236

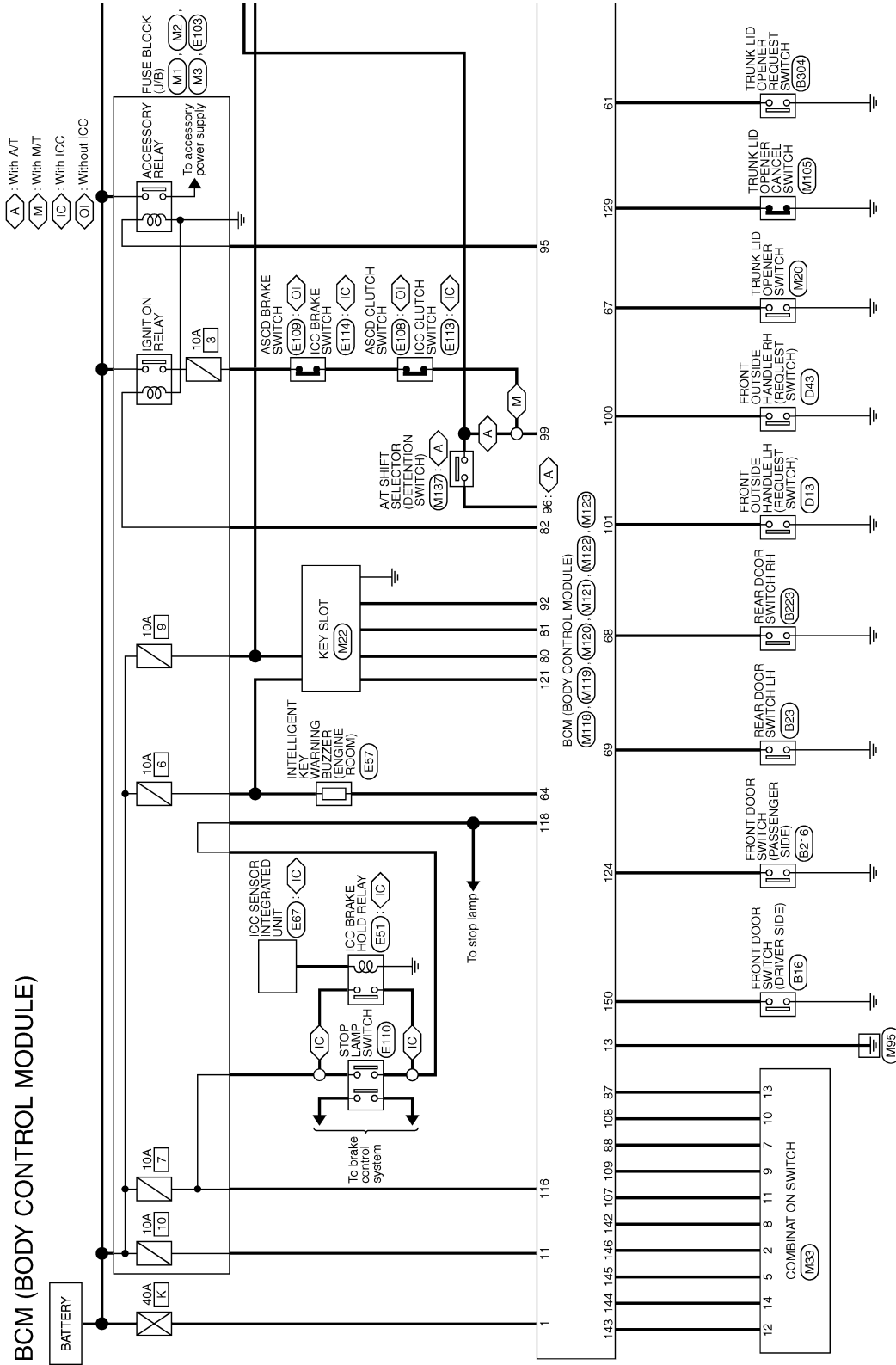

2008/08/07

JCMWA3019GE

A
B
C
D
E
F
G
H
I
J
K
L
M
N
O
P

WW

BCM (BODY CONTROL MODULE)

< ECU DIAGNOSIS INFORMATION >

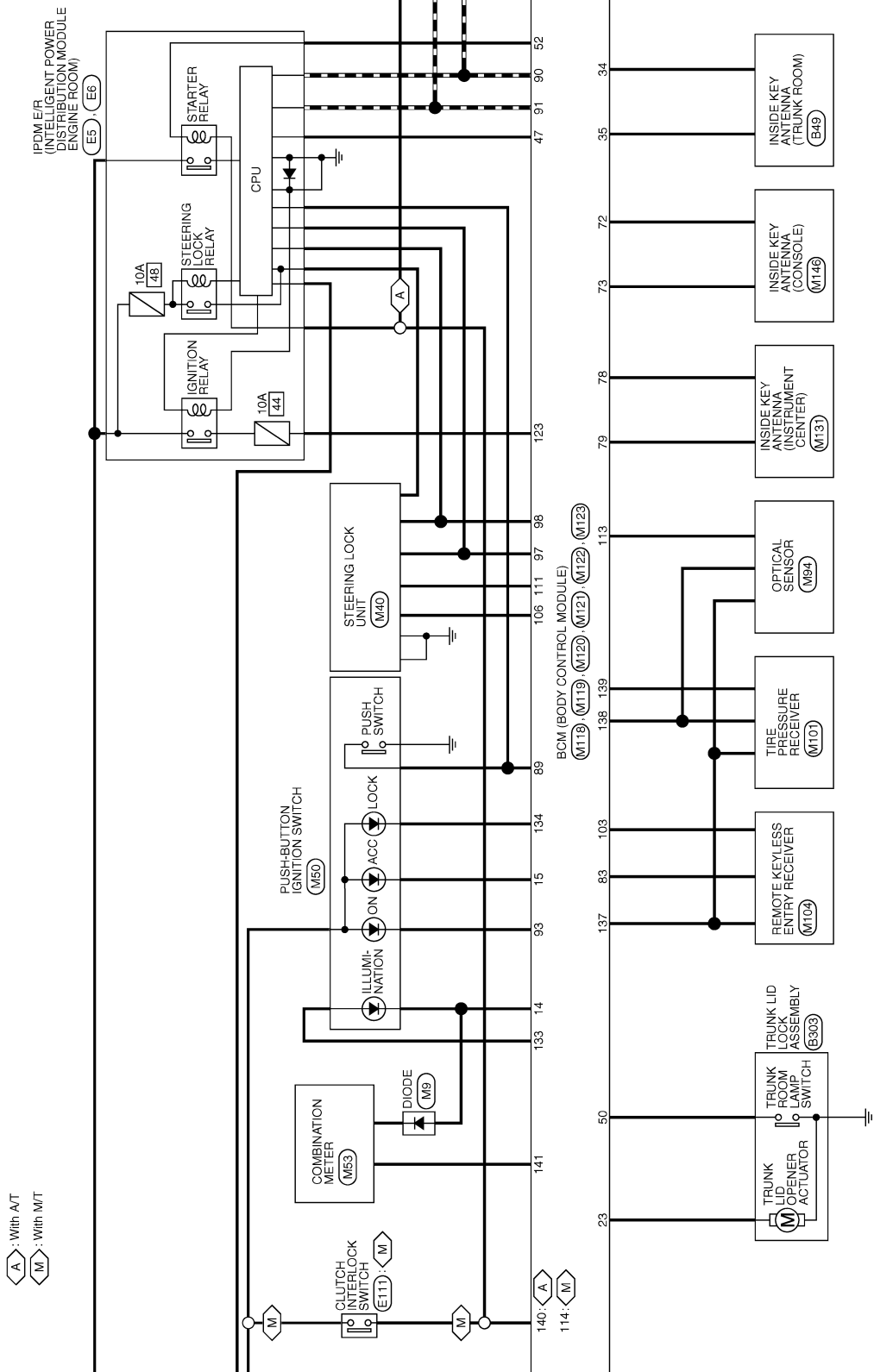

JCMWA3020Gf

BCM (BODY CONTROL MODULE)

< ECU DIAGNOSIS INFORMATION >

- ◁ A ▷ : With A/T
- ◁ RF ▷ : With sunroof
- ◁ AN ▷ : With rear anti-pinch system
- ◁ OA ▷ : Without rear anti-pinch system
- ◁ SR ▷ : With sports seat without automatic drive positioner
- ◁ PM ▷ : With automatic drive positioner
- ◁ OP ▷ : Without automatic drive positioner

* : This connector is not shown in "Harness Layout".

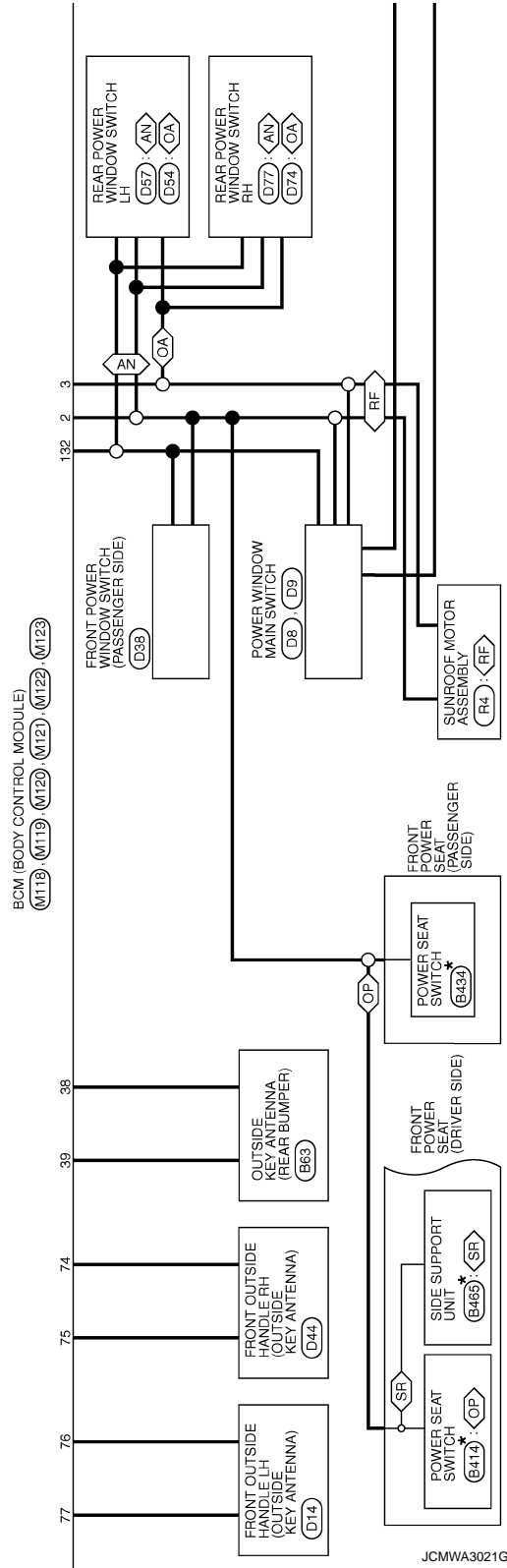
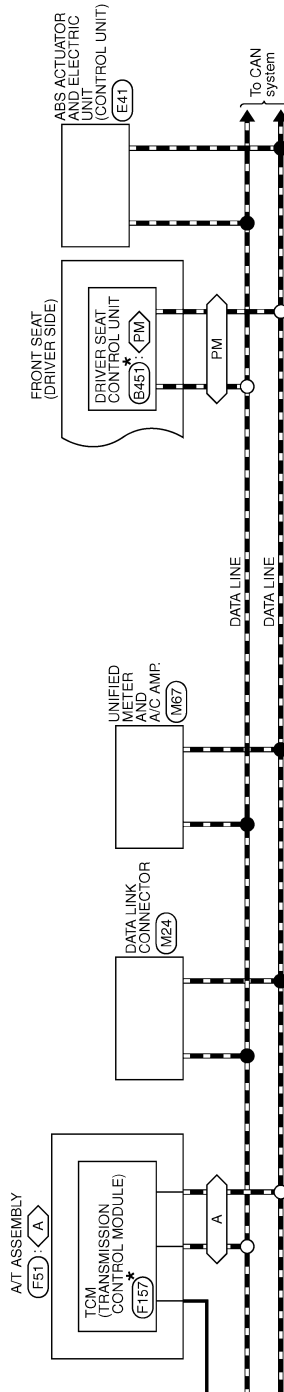

A
B
C
D
E
F
G
H
I
J
K
L
M
N
O
P

WW

BCM (BODY CONTROL MODULE)

< ECU DIAGNOSIS INFORMATION >

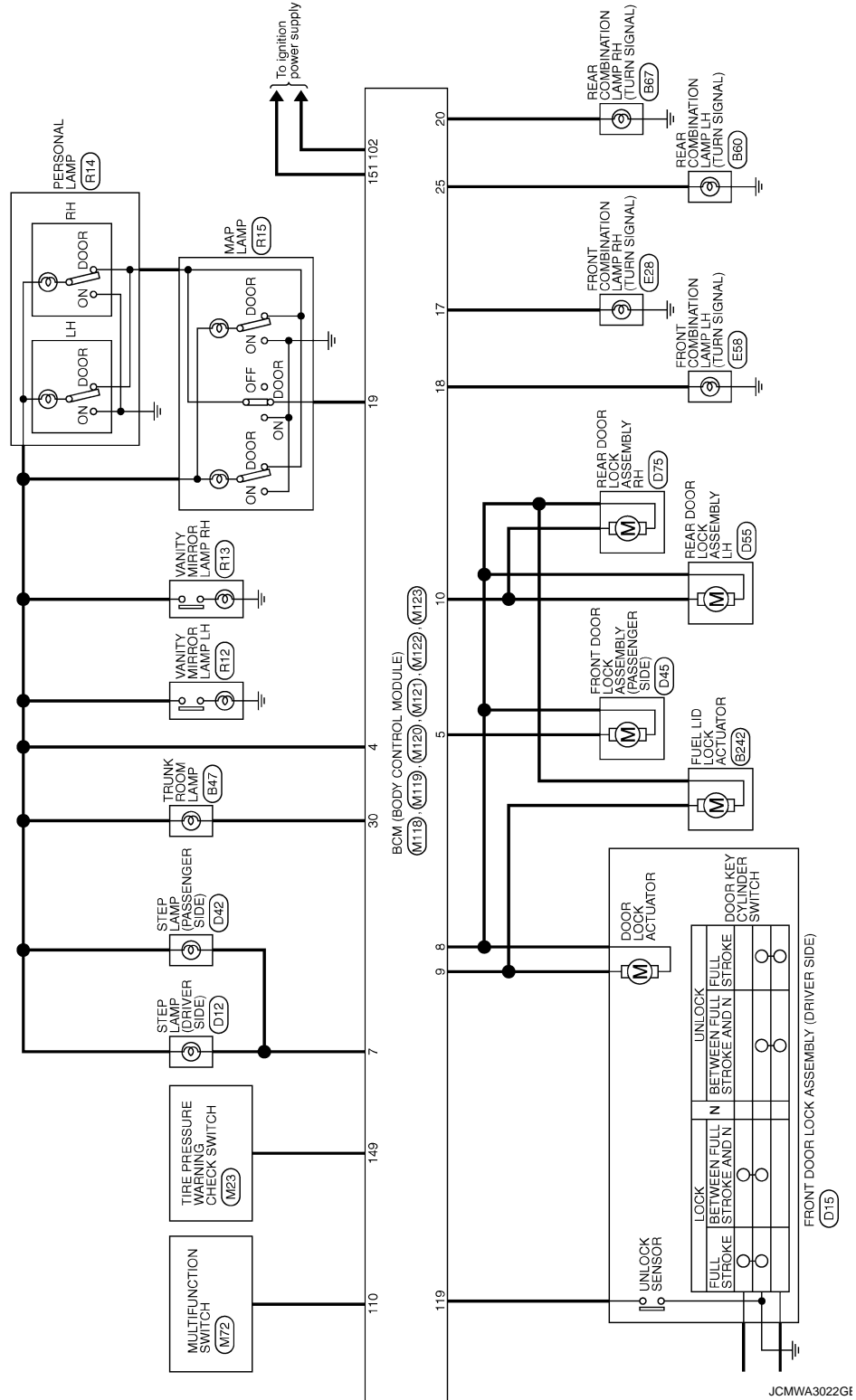

BCM (BODY CONTROL MODULE)

< ECU DIAGNOSIS INFORMATION >

BCM (BODY CONTROL MODULE)

Connector No.	M33
Connector Name	COMBINATION SWITCH
Connector Type	TH16FW-RH

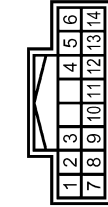

Terminal No.	Color of Wire	Signal Name [Specification]
2	SB	OUTPUT 4
5	L	OUTPUT 3
7	O	INPUT 3
8	BR	OUTPUT 5
9	W	INPUT 2
10	R	INPUT 4
11	LG	INPUT 1
12	P	OUTPUT 1
13	Y	INPUT 5
14	G	OUTPUT 2

Connector No.	M120
Connector Name	BCM (BODY CONTROL MODULE)
Connector Type	MS12FW-CS

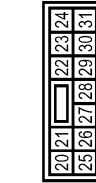

Terminal No.	Color of Wire	Signal Name [Specification]
20	V	TURN SIGNAL RH (REAR)
23	L	TRUNK LID OPEN OUTPUT
25	Y	TURN SIGNAL LH (REAR)
30	P	TRUNK ROOM LAMP

Connector No.	M118
Connector Name	BCM (BODY CONTROL MODULE)
Connector Type	MS3FB-LC



Terminal No.	Color of Wire	Signal Name [Specification]
1	W	BAT (+/L)
2	Y	POWER WINDOW POWER SUPPLY(BAT)
3	O	POWER WINDOW POWER SUPPLY(RAP)

Connector No.	M121
Connector Name	BCM (BODY CONTROL MODULE)
Connector Type	TH40FGY-NH

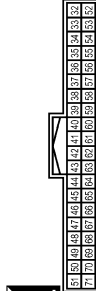

Terminal No.	Color of Wire	Signal Name [Specification]
34	SB	TRUNK ROOM ANT-
35	V	TRUNK ROOM ANT+
38	B	REAR BUMPER ANT-
39	W	REAR BUMPER ANT+
47	Y	IGN RELAY (IPDM E/R) CONT
50	O	TRUNK ROOM LAMP SW
52	SB	STARTER RELAY CONT
61	SB	TRUNK LID OPENER REQUEST SW
64	G	P-KEY WARN BUZZER (ENG ROOM)
67	GR	TRUNK LID OPENER SW
68	BR	REAR RH DOOR SW

Connector No.	M119
Connector Name	BCM (BODY CONTROL MODULE)
Connector Type	MS16FW-CS

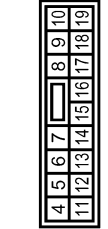

Terminal No.	Color of Wire	Signal Name [Specification]
4	LG	INTERIOR ROOM LAMP POWER SUPPLY
5	P	PASSENGER DOOR UNLOCK OUTPUT
7	BR	STEP LAMP OUTPUT
8	V	ALL DOOR FUEL LID LOCK OUTPUT
9	G	DRIVER DOOR FUEL LID UNLOCK OUTPUT
10	BR	REAR DOOR UNLOCK OUTPUT
11	R	BAT. (FUSE)
13	B	GND
14	W	PUSH-BUTTON IGNITION SW ILL GND
15	O	ACC. IND
17	W	TURN SIGNAL RH (FRONT)

69	R	REAR LH DOOR SW
----	---	-----------------

18	O	TURN SIGNAL LH (FRONT)
19	V	ROOM LAMP TIMER CONTROL

A
B
C
D
E
F
G
H
I
J
K
M
N
O
P

WW

BCM (BODY CONTROL MODULE)

< ECU DIAGNOSIS INFORMATION >

134	LG	LOCK IND
137	O	RECEIVER/SENSOR GND
138	V	RECEIVER/SENSOR POWER SUPPLY
139	L	TIRE PRESSURE RECEIVER COMM
140	GR	SHIFT N/P
141	R	SECURITY INDICATOR
142	BR	COMBI SW OUTPUT 3
143	P	COMBI SW OUTPUT 1
144	G	COMBI SW OUTPUT 2
145	L	COMBI SW OUTPUT 3
146	SB	COMBI SW OUTPUT 4
149	W	TIRE PRESSURE WARN CHECK SW
150	GR	DRIVER DOOR SW
151	G	REAR WINDOW DEFOGGER RELAY CONT

Connector No.	M123
Connector Name	BCM (BODY CONTROL MODULE)
Connector Type	TH40FG-NH



Terminal No.	Color of Wire	Signal Name [Specification]
113	O	OPTICAL SENSOR
114	R	CLUTCH INTERLOCK SW
116	SB	STOP LAMP SW 1
118	BR	STOP LAMP SW 2
119	SB	DR DOOR UNLOCK SENSOR
121	SB	KEY SLOT SW
123	W	IGN F/B
124	LG	PASSENGER DOOR SW
129	O	TRUNK LID OPENER CANCEL SW
132	V	POWER WINDOW SW COMM
133	L	PUSH-BUTTON IGNITION SW (ILL POWER)

83	Y	KEYLESS ENTRY RECEIVER COMM
87	Y	COMBI SW INPUT 5
88	O	COMBI SW INPUT 3
89	BR	PUSH SW
90	P	CAN-L
91	L	CAN-H
92	LG	KEY SLOT ILL
93	V	GR IND
95	O	ACC RELAY CONT
96	GR	A/T SHIFT SELECTOR POWER SUPPLY
97	L	S/L CONDITION 1
98	P	S/L CONDITION 2
99	BR	ASCD CLUTCH SW [With M/T without ICC]
99	BR	ICC CLUTCH SW [With M/T and ICC]
99	R	SHIFT P [With A/T]
100	Y	PASSENGER DOOR REQUEST SW
101	P	DRIVER DOOR REQUEST SW
102	O	BLOWER FAN MOTOR RELAY CONT
103	L	KEYLESS ENTRY RECEIVER POWER SUPPLY
106	W	S/L UNIT POWER SUPPLY
107	LG	COMBI SW INPUT 1
108	R	COMBI SW INPUT 4
109	W	COMBI SW INPUT 2
110	G	HAZARD SW
111	Y	S/L UNIT COMM

BCM (BODY CONTROL MODULE)

Connector No.	M122
Connector Name	BCM (BODY CONTROL MODULE)
Connector Type	TH40FB-NH



Terminal No.	Color of Wire	Signal Name [Specification]
72	R	ROOM ANT2-
73	G	ROOM ANT2+
74	SB	PASSENGER DOOR ANT-
75	BR	PASSENGER DOOR ANT+
76	V	DRIVER DOOR ANT-
77	LG	DRIVER DOOR ANT+
78	Y	ROOM ANT1-
79	BR	ROOM ANT1+
80	GR	IMMOBI ANTENNA CONTROL
81	W	IMMOBI ANTENNA SIGNAL
82	R	IGN RELAY (F/B) CONT

JCMWA3024GE

Fail-safe

INFOID:000000004685237

FAIL-SAFE CONTROL BY DTC

BCM performs fail-safe control when any DTC are detected.

BCM (BODY CONTROL MODULE)

< ECU DIAGNOSIS INFORMATION >

Display contents of CONSULT	Fail-safe	Cancellation	A
B2013: ID DISCORD BCM-S/L	Inhibit engine cranking	Erase DTC	A
B2014: CHAIN OF S/L-BCM	Inhibit engine cranking	Erase DTC	B
B2190: NATS ANTENNA AMP	Inhibit engine cranking	Erase DTC	B
B2191: DIFFERENCE OF KEY	Inhibit engine cranking	Erase DTC	C
B2192: ID DISCORD BCM-ECM	Inhibit engine cranking	Erase DTC	C
B2193: CHAIN OF BCM-ECM	Inhibit engine cranking	Erase DTC	D
B2195: ANTI SCANNING	Inhibit engine cranking	Ignition switch ON → OFF	D
B2557: VEHICLE SPEED	Inhibit steering lock	When normal vehicle speed signals are received from ABS actuator and electric unit (control unit) for 500 ms	E
B2560: STARTER CONT RELAY	Inhibit engine cranking	500 ms after the following CAN signal communication status becomes consistent <ul style="list-style-type: none"> • Starter control relay signal • Starter relay status signal 	E
B2601: SHIFT POSITION	Inhibit steering lock	500 ms after the following signal reception status becomes consistent <ul style="list-style-type: none"> • Selector lever P position switch signal • P range signal (CAN) 	F
B2602: SHIFT POSITION	Inhibit steering lock	5 seconds after the following BCM recognition conditions are fulfilled <ul style="list-style-type: none"> • Ignition switch is in the ON position • Selector lever P position switch signal: Except P position (battery voltage) • Vehicle speed: 4 km/h (2.5 MPH) or more 	G
B2603: SHIFT POSI STATUS	Inhibit steering lock	500 ms after the following BCM recognition conditions are fulfilled <ul style="list-style-type: none"> • Ignition switch is in the ON position • Selector lever P position switch signal: Except P position (battery voltage) • Selector lever P/N position signal: Except P and N positions (0 V) 	H
B2604: PNP SW	Inhibit steering lock	500 ms after any of the following BCM recognition conditions are fulfilled <ul style="list-style-type: none"> • Status 1 <ul style="list-style-type: none"> - Ignition switch is in the ON position - Selector lever P/N position signal: P and N position (battery voltage) - P range signal or N range signal (CAN): ON • Status 2 <ul style="list-style-type: none"> - Ignition switch is in the ON position - Selector lever P/N position signal: Except P and N positions (0 V) - P range signal and N range signal (CAN): OFF 	I
B2605: PNP SW	Inhibit steering lock	500 ms after any of the following BCM recognition conditions are fulfilled <ul style="list-style-type: none"> • Status 1 <ul style="list-style-type: none"> - Ignition switch is in the ON position - Selector lever P/N position signal: Except P and N positions (0 V) - Interlock/PNP switch signal (CAN): OFF • Status 2 <ul style="list-style-type: none"> - Ignition switch is in the ON position - Selector lever P/N position signal: P or N position (battery voltage) - PNP switch signal (CAN): ON 	J
B2606: S/L RELAY	Inhibit engine cranking	500 ms after the following CAN signal communication status becomes consistent <ul style="list-style-type: none"> • Steering lock relay signal (Request signal) • Steering lock relay signal (Condition signal) 	K

WW

BCM (BODY CONTROL MODULE)

< ECU DIAGNOSIS INFORMATION >

Display contents of CONSULT	Fail-safe	Cancellation
B2607: S/L RELAY	Inhibit engine cranking	500 ms after the following CAN signal communication status has becomes consistent <ul style="list-style-type: none"> • Steering lock relay signal (Request signal) • Steering lock relay signal (Condition signal)
B2608: STARTER RELAY	Inhibit engine cranking	500 ms after the following signal communication status becomes consistent <ul style="list-style-type: none"> • Starter motor relay control signal • Starter relay status signal (CAN)
B2609: S/L STATUS	<ul style="list-style-type: none"> • Inhibit engine cranking • Inhibit steering lock 	When the following steering lock conditions agree <ul style="list-style-type: none"> • BCM steering lock control status • Steering lock condition No. 1 signal status • Steering lock condition No. 2 signal status
B260A: IGNITION RELAY	Inhibit engine cranking	500 ms after the following conditions are fulfilled <ul style="list-style-type: none"> • IGN relay (IPDM E/R) control signal: OFF (Battery voltage) • Ignition ON signal (CAN to IPDM E/R): OFF (Request signal) • Ignition ON signal (CAN from IPDM E/R): OFF (Condition signal)
B260F: ENG STATE SIG LOST	Maintains the power supply position attained at the time of DTC detection	When any of the following conditions are fulfilled <ul style="list-style-type: none"> • Power position changes to ACC • Receives engine status signal (CAN)
B2612: S/L STATUS	<ul style="list-style-type: none"> • Inhibit engine cranking • Inhibit steering lock 	When any of the following conditions are fulfilled <ul style="list-style-type: none"> • Steering lock unit status signal (CAN) is received normally • The BCM steering lock control status matches the steering lock status recognized by the steering lock unit status signal (CAN from IPDM E/R)
B2617: STARTER RELAY CIRC	Inhibit engine cranking	1 second after the starter motor relay control inside BCM becomes normal
B2618: BCM	Inhibit engine cranking	1 second after the ignition relay (IPDM E/R) control inside BCM becomes normal
B2619: BCM	Inhibit engine cranking	1 second after the steering lock unit power supply output control inside BCM becomes normal
B261E: VEHICLE TYPE	Inhibit engine cranking	BCM initialization
B26E8: CLUTCH SW	Inhibit engine cranking	When any of the following BCM recognition conditions are fulfilled <ul style="list-style-type: none"> • Status 1 <ul style="list-style-type: none"> - Clutch switch signal (CAN from ECM): ON - Clutch interlock switch signal: OFF (0 V) • Status 2 <ul style="list-style-type: none"> - Clutch switch signal (CAN from ECM): OFF - Clutch interlock switch signal: ON (Battery voltage)
B26E9: S/L STATUS	<ul style="list-style-type: none"> • Inhibit engine cranking • Inhibit steering lock 	When BCM transmits the LOCK request signal to steering lock unit, and receives LOCK response signal from steering lock unit, the following conditions are fulfilled <ul style="list-style-type: none"> • Steering condition No. 1 signal: LOCK (0 V) • Steering condition No. 2 signal: LOCK (Battery voltage)

HIGH FLASHER OPERATION

BCM detects the turn signal lamp circuit status by the current value.

BCM increases the turn signal lamp blinking speed if the bulb or harness open is detected with the turn signal lamp operating.

NOTE:

The blinking speed is normal while activating the hazard warning lamp.

DTC Inspection Priority Chart

INFOID:000000004685238

If some DTCs are displayed at the same time, perform inspections one by one based on the following priority chart.

BCM (BODY CONTROL MODULE)

< ECU DIAGNOSIS INFORMATION >

Priority	DTC	A
1	B2562: LOW VOLTAGE	A
2	<ul style="list-style-type: none"> • U1000: CAN COMM • U1010: CONTROL UNIT(CAN) 	B
3	<ul style="list-style-type: none"> • B2190: NATS ANTENNA AMP • B2191: DIFFERENCE OF KEY • B2192: ID DISCORD BCM-ECM • B2193: CHAIN OF BCM-ECM • B2195: ANTI SCANNING 	C
4	<ul style="list-style-type: none"> • B2013: ID DISCORD BCM-S/L • B2014: CHAIN OF S/L-BCM • B2553: IGNITION RELAY • B2555: STOP LAMP • B2556: PUSH-BTN IGN SW • B2557: VEHICLE SPEED • B2560: STARTER CONT RELAY • B2601: SHIFT POSITION • B2602: SHIFT POSITION • B2603: SHIFT POSI STATUS • B2604: PNP SW • B2605: PNP SW • B2606: S/L RELAY • B2607: S/L RELAY • B2608: STARTER RELAY • B2609: S/L STATUS • B260A: IGNITION RELAY • B260B: STEERING LOCK UNIT • B260C: STEERING LOCK UNIT • B260D: STEERING LOCK UNIT • B260F: ENG STATE SIG LOST • B2612: S/L STATUS • B2614: ACC RELAY CIRC • B2615: BLOWER RELAY CIRC • B2616: IGN RELAY CIRC • B2617: STARTER RELAY CIRC • B2618: BCM • B2619: BCM • B261A: PUSH-BTN IGN SW • B261E: VEHICLE TYPE • B26E8: CLUTCH SW • B26E9: S/L STATUS • B26EA: KEY REGISTRATION • C1729: VHCL SPEED SIG ERR • U0415: VEHICLE SPEED SIG 	D E F G H I J K

WW

M

N

O

P

BCM (BODY CONTROL MODULE)

< ECU DIAGNOSIS INFORMATION >

Priority	DTC
5	<ul style="list-style-type: none"> • C1704: LOW PRESSURE FL • C1705: LOW PRESSURE FR • C1706: LOW PRESSURE RR • C1707: LOW PRESSURE RL • C1708: [NO DATA] FL • C1709: [NO DATA] FR • C1710: [NO DATA] RR • C1711: [NO DATA] RL • C1712: [CHECKSUM ERR] FL • C1713: [CHECKSUM ERR] FR • C1714: [CHECKSUM ERR] RR • C1715: [CHECKSUM ERR] RL • C1716: [PRESSDATA ERR] FL • C1717: [PRESSDATA ERR] FR • C1718: [PRESSDATA ERR] RR • C1719: [PRESSDATA ERR] RL • C1720: [CODE ERR] FL • C1721: [CODE ERR] FR • C1722: [CODE ERR] RR • C1723: [CODE ERR] RL • C1724: [BATT VOLT LOW] FL • C1725: [BATT VOLT LOW] FR • C1726: [BATT VOLT LOW] RR • C1727: [BATT VOLT LOW] RL • C1734: CONTROL UNIT
6	<ul style="list-style-type: none"> • B2621: INSIDE ANTENNA • B2622: INSIDE ANTENNA • B2623: INSIDE ANTENNA

DTC Index

INFOID:000000004685239

NOTE:

The details of time display are as follows.

- CRNT: A malfunction is detected now.
- PAST: A malfunction was detected in the past.

IGN counter is displayed on Freeze Frame Data. For details of Freeze Frame Data, refer to [WW-10, "COMMON ITEM : CONSULT-III Function \(BCM - COMMON ITEM\)"](#).

CONSULT display	Fail-safe	Freeze Frame Data •Vehicle Speed •Odo/Trip Meter •Vehicle condition	Intelligent Key warning lamp ON	Tire pressure monitor warning lamp ON	Refer- ence page
No DTC is detected. further testing may be required.	—	—	—	—	—
U1000: CAN COMM	—	—	—	—	BCS-35
U1010: CONTROL UNIT(CAN)	—	—	—	—	BCS-36
U0415: VEHICLE SPEED SIG	—	—	—	—	BCS-37
B2013: ID DISCORD BCM-S/L	×	×	—	—	SEC-55
B2014: CHAIN OF S/L-BCM	×	×	—	—	SEC-56
B2190: NATS ANTENNA AMP	×	—	—	—	SEC-47
B2191: DIFFERENCE OF KEY	×	—	—	—	SEC-50
B2192: ID DISCORD BCM-ECM	×	—	—	—	SEC-51
B2193: CHAIN OF BCM-ECM	×	—	—	—	SEC-53
B2195: ANTI SCANNING	×	—	—	—	SEC-54
B2553: IGNITION RELAY	—	×	—	—	PCS-49
B2555: STOP LAMP	—	×	—	—	SEC-59

BCM (BODY CONTROL MODULE)

< ECU DIAGNOSIS INFORMATION >

CONSULT display	Fail-safe	Freeze Frame Data •Vehicle Speed •Odo/Trip Meter •Vehicle condition	Intelligent Key warning lamp ON	Tire pressure monitor warning lamp ON	Refer- ence page
B2556: PUSH-BTN IGN SW	—	×	×	—	SEC-61
B2557: VEHICLE SPEED	×	×	×	—	SEC-63
B2560: STARTER CONT RELAY	×	×	×	—	SEC-64
B2562: LOW VOLTAGE	—	×	—	—	BCS-38
B2601: SHIFT POSITION	×	×	×	—	SEC-65
B2602: SHIFT POSITION	×	×	×	—	SEC-68
B2603: SHIFT POSI STATUS	×	×	×	—	SEC-70
B2604: PNP SW	×	×	×	—	SEC-73
B2605: PNP SW	×	×	×	—	SEC-75
B2606: S/L RELAY	×	×	×	—	SEC-77
B2607: S/L RELAY	×	×	×	—	SEC-78
B2608: STARTER RELAY	×	×	×	—	SEC-80
B2609: S/L STATUS	×	×	×	—	SEC-82
B260A: IGNITION RELAY	×	×	×	—	PCS-51
B260B: STEERING LOCK UNIT	—	×	×	—	SEC-86
B260C: STEERING LOCK UNIT	—	×	×	—	SEC-87
B260D: STEERING LOCK UNIT	—	×	×	—	SEC-88
B260F: ENG STATE SIG LOST	×	×	×	—	SEC-89
B2612: S/L STATUS	×	×	×	—	SEC-94
B2614: ACC RELAY CIRC	—	×	×	—	PCS-53
B2615: BLOWER RELAY CIRC	—	×	×	—	PCS-55
B2616: IGN RELAY CIRC	—	×	×	—	PCS-57
B2617: STARTER RELAY CIRC	×	×	×	—	SEC-98
B2618: BCM	×	×	×	—	PCS-59
B2619: BCM	×	×	×	—	SEC-100
B261A: PUSH-BTN IGN SW	—	×	×	—	PCS-60
B261E: VEHICLE TYPE	×	×	× (Turn ON for 15 seconds)	—	SEC-101
B2621: INSIDE ANTENNA	—	×	—	—	DLK-59
B2622: INSIDE ANTENNA	—	×	—	—	DLK-61
B2623: INSIDE ANTENNA	—	×	—	—	DLK-63
B26E8: CLUTCH SW	×	×	×	—	SEC-90
B26E9: S/L STATUS	×	×	× (Turn ON for 15 seconds)	—	SEC-92
B26EA: KEY REGISTRATION	—	×	× (Turn ON for 15 seconds)	—	SEC-93
C1704: LOW PRESSURE FL	—	—	—	×	WT-17
C1705: LOW PRESSURE FR	—	—	—	×	
C1706: LOW PRESSURE RR	—	—	—	×	
C1707: LOW PRESSURE RL	—	—	—	×	

A

B

C

D

E

F

G

H

I

J

K

WW

M

N

O

P

BCM (BODY CONTROL MODULE)

< ECU DIAGNOSIS INFORMATION >

CONSULT display	Fail-safe	Freeze Frame Data •Vehicle Speed •Odo/Trip Meter •Vehicle condition	Intelligent Key warning lamp ON	Tire pressure monitor warning lamp ON	Refer- ence page
C1708: [NO DATA] FL	—	—	—	×	WT-19
C1709: [NO DATA] FR	—	—	—	×	
C1710: [NO DATA] RR	—	—	—	×	
C1711: [NO DATA] RL	—	—	—	×	
C1712: [CHECKSUM ERR] FL	—	—	—	×	WT-21
C1713: [CHECKSUM ERR] FR	—	—	—	×	
C1714: [CHECKSUM ERR] RR	—	—	—	×	
C1715: [CHECKSUM ERR] RL	—	—	—	×	
C1716: [PRESSDATA ERR] FL	—	—	—	×	WT-24
C1717: [PRESSDATA ERR] FR	—	—	—	×	
C1718: [PRESSDATA ERR] RR	—	—	—	×	
C1719: [PRESSDATA ERR] RL	—	—	—	×	
C1720: [CODE ERR] FL	—	—	—	×	WT-26
C1721: [CODE ERR] FR	—	—	—	×	
C1722: [CODE ERR] RR	—	—	—	×	
C1723: [CODE ERR] RL	—	—	—	×	
C1724: [BATT VOLT LOW] FL	—	—	—	×	WT-29
C1725: [BATT VOLT LOW] FR	—	—	—	×	
C1726: [BATT VOLT LOW] RR	—	—	—	×	
C1727: [BATT VOLT LOW] RL	—	—	—	×	
C1729: VHCL SPEED SIG ERR	—	—	—	×	WT-32
C1734: CONTROL UNIT	—	—	—	×	WT-33

IPDM E/R (INTELLIGENT POWER DISTRIBUTION MODULE ENGINE ROOM)

< ECU DIAGNOSIS INFORMATION >

IPDM E/R (INTELLIGENT POWER DISTRIBUTION MODULE ENGINE ROOM)

Reference Value

INFOID:000000004685231

VALUES ON THE DIAGNOSIS TOOL

Monitor Item	Condition		Value/Status
RAD FAN REQ	Engine idle speed	Changes depending on engine coolant temperature, air conditioner operation status, vehicle speed, etc.	0 - 100 %
AC COMP REQ	Engine running	A/C switch OFF	Off
		A/C switch ON (Compressor is operating)	On
TAIL&CLR REQ	Lighting switch OFF		Off
	Lighting switch 1ST, 2ND, HI or AUTO (Light is illuminated)		On
HL LO REQ	Lighting switch OFF		Off
	Lighting switch 2ND HI or AUTO (Light is illuminated)		On
HL HI REQ	Lighting switch OFF		Off
	Lighting switch HI		On
FR FOG REQ	Lighting switch 2ND or AUTO (Light is illuminated)	Front fog lamp switch OFF	Off
		<ul style="list-style-type: none"> • Front fog lamp switch ON • Daytime running light activated (Only for Canada) 	On
FR WIP REQ	Ignition switch ON	Front wiper switch OFF	Stop
		Front wiper switch INT	1LOW
		Front wiper switch LO	Low
		Front wiper switch HI	Hi
WIP AUTO STOP	Ignition switch ON	Front wiper stop position	STOP P
		Any position other than front wiper stop position	ACT P
WIP PROT	Ignition switch ON	Front wiper operates normally	Off
		Front wiper stops at fail-safe operation	BLOCK
IGN RLY1 -REQ	Ignition switch OFF or ACC		Off
	Ignition switch ON		On
IGN RLY	Ignition switch OFF or ACC		Off
	Ignition switch ON		On
PUSH SW	Release the push-button ignition switch		Off
	Press the push-button ignition switch		On
INTER/NP SW	Ignition switch ON	Selector lever in any position other than P or N (A/T models)	Off
		Release clutch pedal (M/T models)	
	Ignition switch ON	Selector lever in P or N position (A/T models)	On
		Depress clutch pedal (M/T models)	
ST RLY CONT	Ignition switch ON		Off
	At engine cranking		On

IPDM E/R (INTELLIGENT POWER DISTRIBUTION MODULE ENGINE ROOM)

< ECU DIAGNOSIS INFORMATION >

Monitor Item	Condition	Value/Status
IHBT RLY -REQ	Ignition switch ON	Off
	At engine cranking	On
ST/INHI RLY	Ignition switch ON	Off
	At engine cranking	INHI ON → ST ON
	The status of starter relay or starter control relay cannot be recognized by the battery voltage malfunction, etc. when the starter relay is ON and the starter control relay is OFF	UNKWN
DETENT SW	Ignition switch ON <ul style="list-style-type: none"> • Press the selector button with selector lever in P position • Selector lever in any position other than P 	Off
	Release the selector button with selector lever in P position NOTE: Fixed On for M/T models	On
S/L RLY -REQ	None of the conditions below are present	Off
	<ul style="list-style-type: none"> • Open the driver door after the ignition switch is turned OFF (for a few seconds) • Press the push-button ignition switch when the steering lock is activated • Depress the clutch pedal when the steering lock is activated 	On
S/L STATE	Steering lock is activated	LOCK
	Steering lock is deactivated	UNLOCK
	[DTC: B210A] is detected	UNKWN
DTRL REQ	NOTE: The item is indicated, but not monitored.	Off
OIL P SW	Ignition switch OFF, ACC or engine running	Open
	Ignition switch ON	Close
HOOD SW	Close the hood	Off
	Open the hood	On
HL WASHER REQ	NOTE: The item is indicated, but not monitored.	Off
THFT HRN REQ	Not operation	Off
	<ul style="list-style-type: none"> • Panic alarm is activated • Horn is activated with VEHICLE SECURITY (THEFT WARNING) SYSTEM 	On
HORN CHIRP	Not operating	Off
	Door locking with Intelligent Key (horn chirp mode)	On
CRNRNG LMP REQ	NOTE: The item is indicated, but not monitored.	Off

IPDM E/R (INTELLIGENT POWER DISTRIBUTION MODULE ENGINE ROOM)

< ECU DIAGNOSIS INFORMATION >

TERMINAL LAYOUT

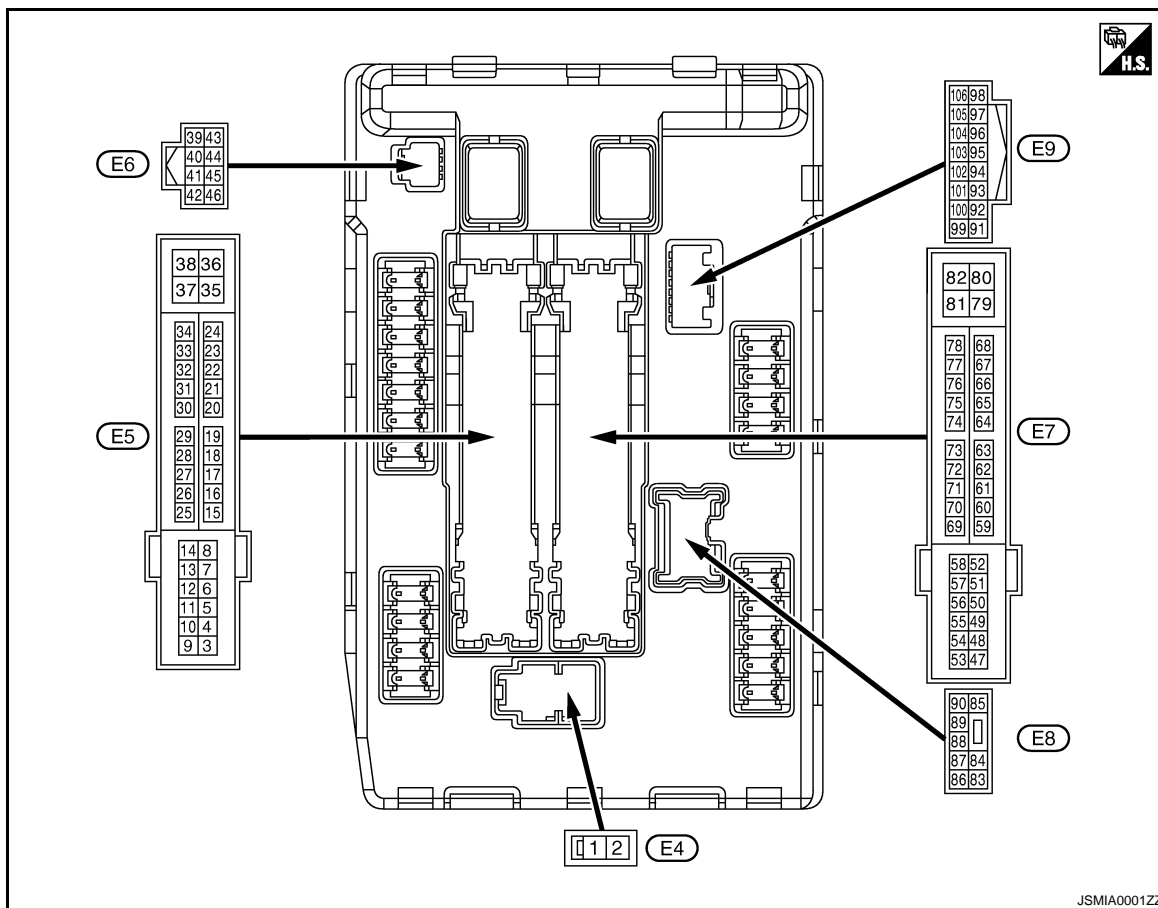

PHYSICAL VALUES

Terminal No. (Wire color)		Description		Condition		Value (Approx.)
+	-	Signal name	Input/ Output			
1 (W)	Ground	Battery power supply	Input	Ignition switch OFF		Battery voltage
2 (L)	Ground	Battery power supply	Input	Ignition switch OFF		Battery voltage
4 (V)	Ground	Front wiper LO	Output	Ignition switch OFF	Front wiper switch OFF	0 V
				Ignition switch ON	Front wiper switch LO	Battery voltage
5 (L)	Ground	Front wiper HI	Output	Ignition switch OFF	Front wiper switch OFF	0 V
				Ignition switch ON	Front wiper switch HI	Battery voltage
7 (R)	Ground	Tail, license plate lamps & interior lamps	Output	Ignition switch OFF	Lighting switch OFF	0 V
				Ignition switch ON	Lighting switch 1ST	Battery voltage
11 (W)	Ground	Steering lock unit power supply	Output	Ignition switch OFF	A few seconds after opening the driver door	Battery voltage
				Ignition switch LOCK	Press the push-button ignition switch	Battery voltage
				Ignition switch ACC or ON		0 V
12 (B/W)	Ground	Ground	—	Ignition switch ON		0 V

IPDM E/R (INTELLIGENT POWER DISTRIBUTION MODULE ENGINE ROOM)

< ECU DIAGNOSIS INFORMATION >

Terminal No. (Wire color)		Description		Condition		Value (Approx.)
+	-	Signal name	Input/ Output			
13 (Y)	Ground	Fuel pump power supply	Output	Approximately 1 second or more after turning the ignition switch ON		0 V
				<ul style="list-style-type: none"> Approximately 1 second after turning the ignition switch ON Engine running 		Battery voltage
16 (LG)	Ground	Front wiper auto stop	Input	Ignition switch ON	Front wiper stop position	0 V
					Any position other than front wiper stop position	Battery voltage
19 (R)	Ground	Ignition relay power supply	Output	Ignition switch OFF		0 V
				Ignition switch ON		Battery voltage
25 (G)	Ground	Ignition relay power supply	Output	Ignition switch OFF		0 V
				Ignition switch ON		Battery voltage
26*1 (R)	Ground	Ignition relay power supply	Output	Ignition switch OFF		0 V
				Ignition switch ON		Battery voltage
27 (O)	Ground	Ignition relay monitor	Input	Ignition switch OFF or ACC		Battery voltage
				Ignition switch ON		0 V
28 (L)	Ground	Push-button ignition switch	Input	Press the push-button ignition switch		0 V
				Release the push-button ignition switch		Battery voltage
30 (GR)	Ground	Starter relay control	Input	A/T models	Selector lever in any position other than P or N (Ignition switch ON)	0 V
					Selector lever P or N (Ignition switch ON)	Battery voltage
				M/T models	Release the clutch pedal	0 V
					Depress the clutch pedal	Battery voltage
32 (V)	Ground	Steering lock unit condition-1	Input	Steering lock is activated		0 V
				Steering lock is deactivated		Battery voltage
33 (P)	Ground	Steering lock unit condition-2	Input	Steering lock is activated		Battery voltage
				Steering lock is deactivated		0 V
36 (G)	Ground	Battery power supply	Input	Ignition switch OFF		Battery voltage
39 (P)	—	CAN-L	Input/ Output	—		—
40 (L)	—	CAN-H	Input/ Output	—		—
41 (B/W)	Ground	Ground	—	Ignition switch ON		0 V
42 (GR)	Ground	Cooling fan relay control	Input	Ignition switch OFF or ACC		0 V
				Ignition switch ON		0.7 V
43*2 (G)	Ground	A/T shift selector (Detention switch)	Input	Ignition switch ON	Press the selector button (selector lever P)	Battery voltage
					<ul style="list-style-type: none"> Selector lever in any position other than P Release the selector button (selector lever P) 	
44 (LG)	Ground	Horn relay control	Input	The horn is deactivated		Battery voltage
				The horn is activated		0 V

IPDM E/R (INTELLIGENT POWER DISTRIBUTION MODULE ENGINE ROOM)

< ECU DIAGNOSIS INFORMATION >

Terminal No. (Wire color)		Description		Condition	Value (Approx.)	
+	-	Signal name	Input/ Output			
45 (G)	Ground	Anti theft horn relay control	Input	The horn is deactivated	Battery voltage	
				The horn is activated	0 V	
46 (SB)	Ground	Starter relay control	Input	A/T models	Selector lever in any position other than P or N (Ignition switch ON)	0 V
					Selector lever P or N (Ignition switch ON)	Battery voltage
				M/T models	Release the clutch pedal	0 V
					Depress the clutch pedal	Battery voltage
48 (L)	Ground	A/C relay power supply	Output	Engine running	A/C switch OFF	0 V
					A/C switch ON (A/C compressor is operating)	Battery voltage
49 (O)	Ground	ECM relay power supply	Output	Ignition switch OFF (More than a few seconds after turning ignition switch OFF)	0 V	
				<ul style="list-style-type: none"> Ignition switch ON Ignition switch OFF (For a few seconds after turning ignition switch OFF) 	Battery voltage	
51 (G)	Ground	Ignition relay power supply	Output	Ignition switch OFF	0 V	
				Ignition switch ON	Battery voltage	
53 (W)	Ground	ECM relay power supply	Output	Ignition switch OFF (More than a few seconds after turning ignition switch OFF)	0 V	
				<ul style="list-style-type: none"> Ignition switch ON Ignition switch OFF (For a few seconds after turning ignition switch OFF) 	Battery voltage	
54 (P)	Ground	Throttle control motor relay power supply	Output	Ignition switch OFF (More than a few seconds after turning ignition switch OFF)	0 V	
				<ul style="list-style-type: none"> Ignition switch ON Ignition switch OFF (For a few seconds after turning ignition switch OFF) 	Battery voltage	
55 (SB)	Ground	ECM power supply	Output	Ignition switch OFF	Battery voltage	
56 (LG)	Ground	Ignition relay power supply	Output	Ignition switch OFF	0 V	
				Ignition switch ON	Battery voltage	
57 (G)	Ground	Ignition relay power supply	Output	Ignition switch OFF	0 V	
				Ignition switch ON	Battery voltage	
58*2 (GR)	Ground	Ignition relay power supply	Output	Ignition switch OFF	0 V	
				Ignition switch ON	Battery voltage	
69 (BR)	Ground	ECM relay control	Output	Ignition switch OFF (More than a few seconds after turning ignition switch OFF)	Battery voltage	
				<ul style="list-style-type: none"> Ignition switch ON Ignition switch OFF (For a few seconds after turning ignition switch OFF) 	0 - 1.5 V	

A
B
C
D
E
F
G
H
I
J
K
WW
M
N
O
P

IPDM E/R (INTELLIGENT POWER DISTRIBUTION MODULE ENGINE ROOM)

< ECU DIAGNOSIS INFORMATION >

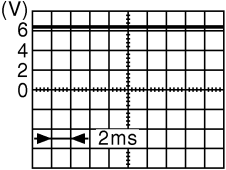
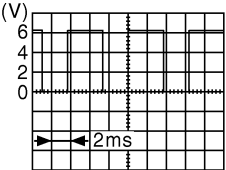
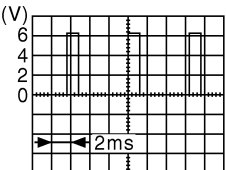
Terminal No. (Wire color)		Description		Condition		Value (Approx.)
+	-	Signal name	Input/ Output			
70 (O)	Ground	Throttle control motor re- lay control	Output	Ignition switch ON → OFF		0 - 1.0 V ↓ Battery voltage ↓ 0 V
				Ignition switch ON		0 - 1.0 V
73*3 (P)	Ground	Ignition relay power supply	Output	Ignition switch OFF		0 V
				Ignition switch ON		Battery voltage
74 (G)	Ground	Ignition relay power supply	Output	Ignition switch OFF		0 V
				Ignition switch ON		Battery voltage
75 (SB)	Ground	Oil pressure switch	Input	Ignition switch ON	Engine stopped	0 V
				Ignition switch ON	Engine running	Battery voltage
76 (Y)	Ground	Power generation com- mand signal	Output	Ignition switch ON		 <p style="text-align: right; font-size: small;">JPMA0001GB</p> <p style="text-align: center;">6.3 V</p>
				40% is set on "ACTIVE TEST", "AL- TERNATOR DUTY" of "ENGINE"		 <p style="text-align: right; font-size: small;">JPMA0002GB</p> <p style="text-align: center;">3.8 V</p>
				80% is set on "ACTIVE TEST", "AL- TERNATOR DUTY" of "ENGINE"		 <p style="text-align: right; font-size: small;">JPMA0003GB</p> <p style="text-align: center;">1.4 V</p>
77 (R)	Ground	Fuel pump relay control	Output	<ul style="list-style-type: none"> Approximately 1 second after turning the ignition switch ON Engine running 		0 - 1.0 V
				Approximately 1 second or more after turning the ignition switch ON		Battery voltage
80 (W)	Ground	Starter motor	Output	At engine cranking		Battery voltage
83 (R)	Ground	Headlamp LO (RH)	Output	Ignition switch ON	Lighting switch OFF	0 V
				Ignition switch ON	Lighting switch 2ND	Battery voltage
84 (V)	Ground	Headlamp LO (LH)	Output	Ignition switch ON	Lighting switch OFF	0 V
				Ignition switch ON	Lighting switch 2ND	Battery voltage

IPDM E/R (INTELLIGENT POWER DISTRIBUTION MODULE ENGINE ROOM)

< ECU DIAGNOSIS INFORMATION >

Terminal No. (Wire color)		Description		Condition		Value (Approx.)
+	-	Signal name	Input/ Output			
86 (W)	Ground	Front fog lamp (RH)	Output	Lighting switch 2ND	Front fog lamp switch OFF	0 V
					<ul style="list-style-type: none"> Front fog lamp switch ON Daytime running light activated (Only for Canada) 	Battery voltage
87 (L)	Ground	Front fog lamp (LH)	Output	Lighting switch 2ND	Front fog lamp switch OFF	0 V
					<ul style="list-style-type: none"> Front fog lamp switch ON Daytime running light activated (Only for Canada) 	Battery voltage
88 (G)	Ground	Washer pump power supply	Output	Ignition switch ON		Battery voltage
89 (BR)	Ground	Headlamp HI (RH)	Output	Ignition switch ON	Lighting switch OFF	0 V
					<ul style="list-style-type: none"> Lighting switch HI Lighting switch PASS 	Battery voltage
90 (P)	Ground	Headlamp HI (LH)	Output	Ignition switch ON	Lighting switch OFF	0 V
					<ul style="list-style-type: none"> Lighting switch HI Lighting switch PASS 	Battery voltage
91 (G)	Ground	Parking lamp (RH)	Output	Ignition switch ON	Lighting switch OFF	0 V
					Lighting switch 1ST	Battery voltage
92 (O)	Ground	Parking lamp (LH)	Output	Ignition switch ON	Lighting switch OFF	0 V
					Lighting switch 1ST	Battery voltage
97 (V)	Ground	Cooling fan control	Output	Engine idling		0 - 5 V
104 (LG)	Ground	Hood switch	Input	Close the hood		Battery voltage
				Open the hood		0 V

*1: Only for the models with ICC system

*2: A/T models only

*3: M/T models only

WW

M

N

O

P

IPDM E/R (INTELLIGENT POWER DISTRIBUTION MODULE ENGINE ROOM)

< ECU DIAGNOSIS INFORMATION >

Wiring Diagram - IPDM E/R -

INFOID:000000004685232

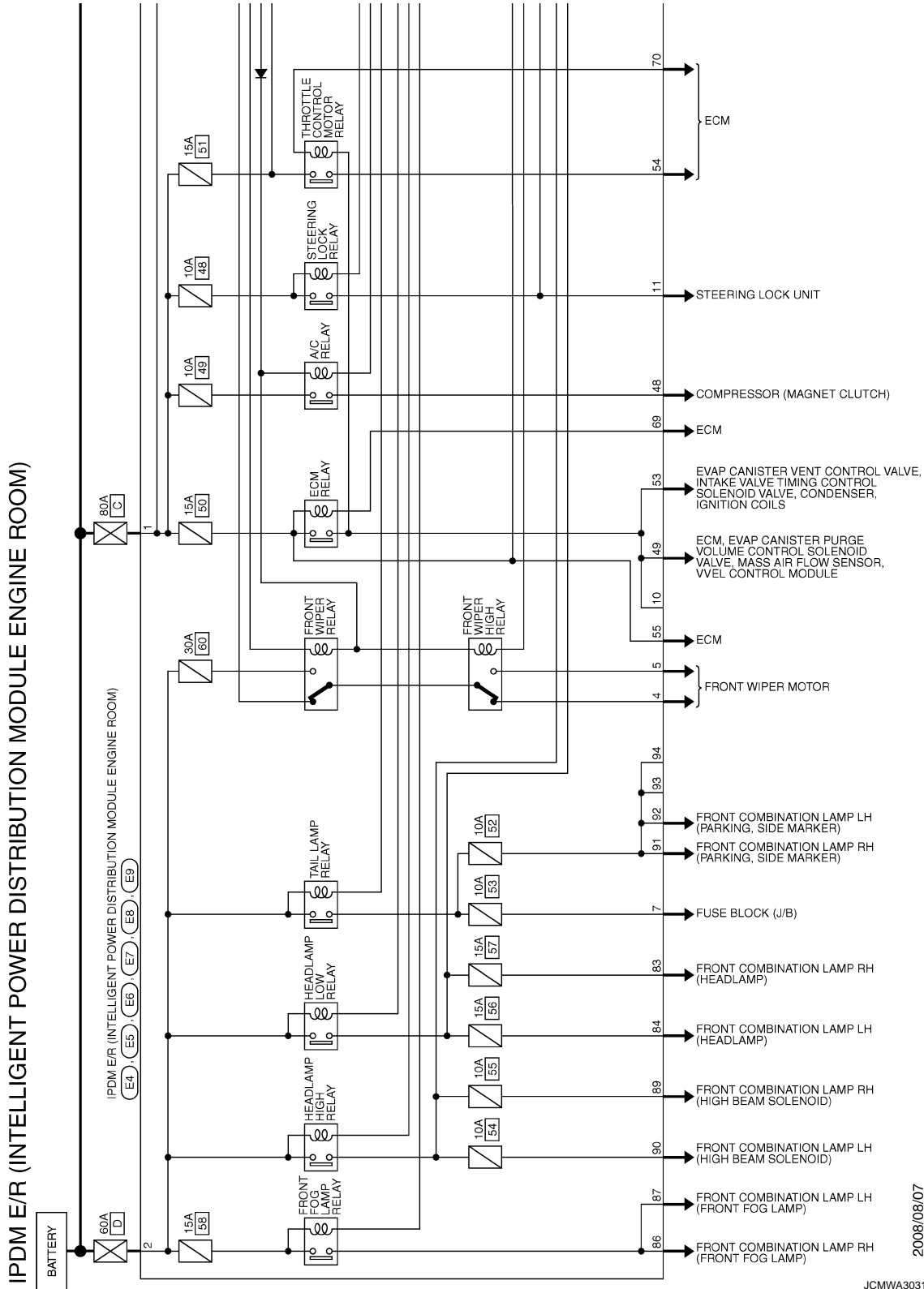

IPDM E/R (INTELLIGENT POWER DISTRIBUTION MODULE ENGINE ROOM)

< ECU DIAGNOSIS INFORMATION >

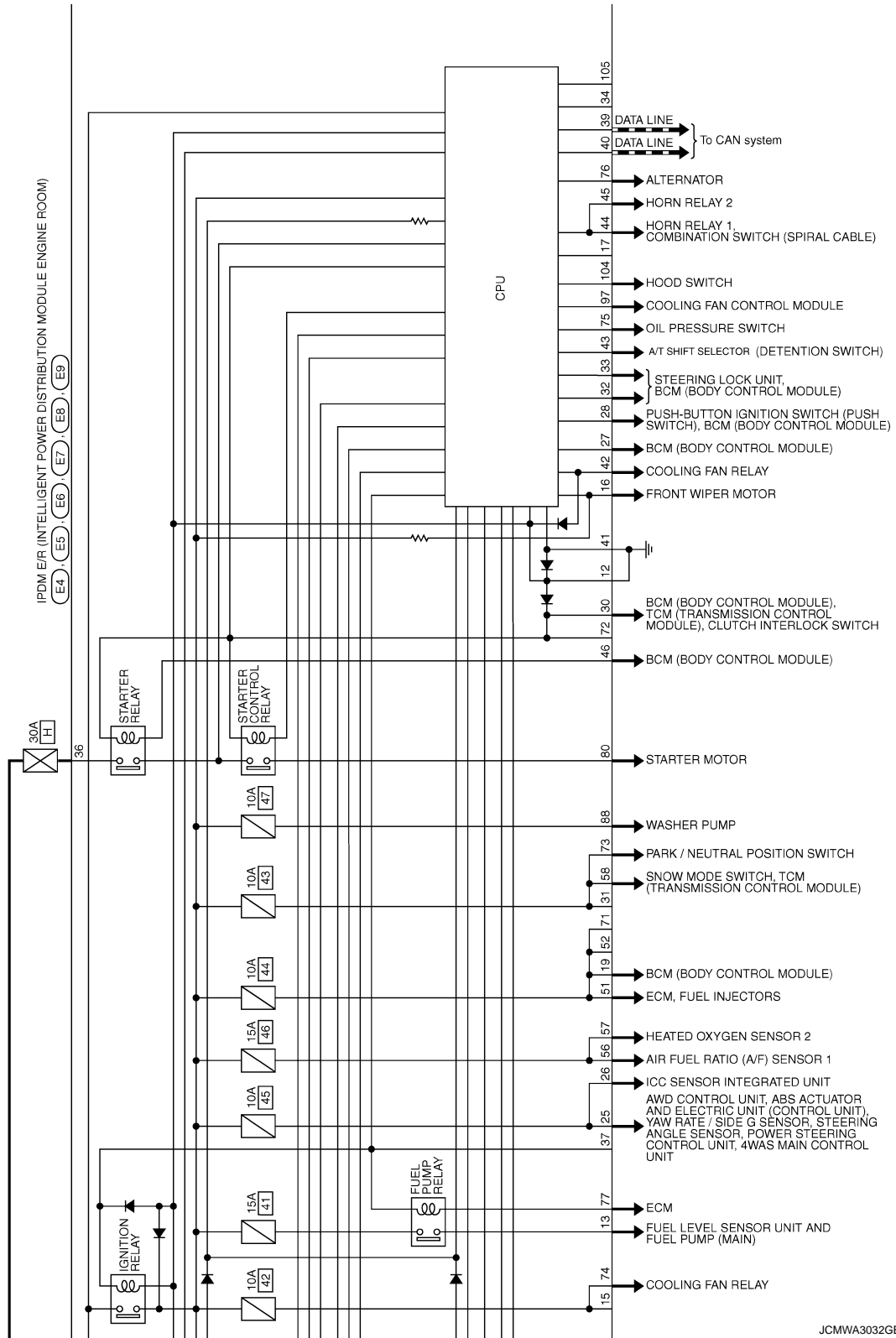

JCMWA3032GE

A
B
C
D
E
F
G
H
I
J
K
L
M
N
O
P

WW

IPDM E/R (INTELLIGENT POWER DISTRIBUTION MODULE ENGINE ROOM)

< ECU DIAGNOSIS INFORMATION >

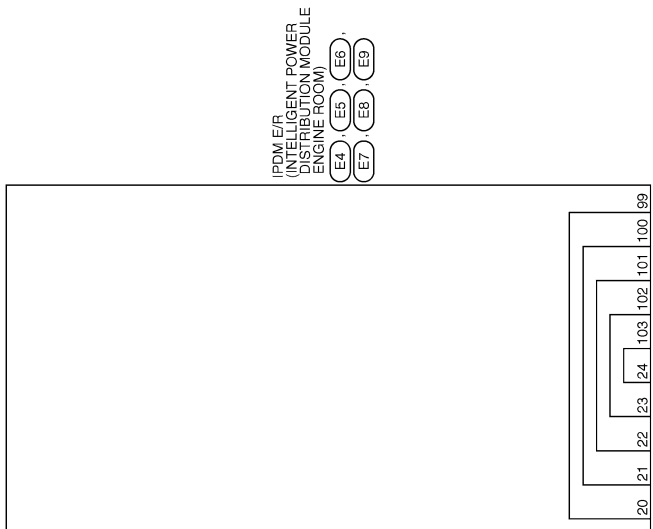



JCMWA3033GE

IPDM E/R (INTELLIGENT POWER DISTRIBUTION MODULE ENGINE ROOM)

< ECU DIAGNOSIS INFORMATION >

IPDM E/R (INTELLIGENT POWER DISTRIBUTION MODULE ENGINE ROOM)

Connector No.	E4
Connector Name	IPDM E/R (INTELLIGENT POWER DISTRIBUTION MODULE ENGINE ROOM)
Connector Type	L02FB-MC

Terminal No.	Color of Wire	Signal Name [Specification]
1	W	-
2	L	-

IPDM E/R (INTELLIGENT POWER DISTRIBUTION MODULE ENGINE ROOM)

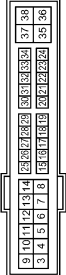

Connector No.	E5
Connector Name	IPDM E/R (INTELLIGENT POWER DISTRIBUTION MODULE ENGINE ROOM)
Connector Type	TH20FW-CS12-M4-TV

Terminal No.	Color of Wire	Signal Name [Specification]
4	V	-
5	L	-
7	R	-
11	W	-
12	B/W	-
13	Y	-
16	LG	-
19	R	-
25	G	-
26	Y	-
27	O	-

IPDM E/R (INTELLIGENT POWER DISTRIBUTION MODULE ENGINE ROOM)

Connector No.	E6
Connector Name	IPDM E/R (INTELLIGENT POWER DISTRIBUTION MODULE ENGINE ROOM)
Connector Type	TH08FW-NH

Terminal No.	Color of Wire	Signal Name [Specification]
39	P	-
40	L	-
41	B/W	-
42	GR	-
43	G	-
44	LG	-
45	V	-
46	SB	-

IPDM E/R (INTELLIGENT POWER DISTRIBUTION MODULE ENGINE ROOM)

Connector No.	E7
Connector Name	IPDM E/R (INTELLIGENT POWER DISTRIBUTION MODULE ENGINE ROOM)
Connector Type	TH20FW-CS12-M8

Terminal No.	Color of Wire	Signal Name [Specification]
48	L	-
49	O	-
51	Y	-
53	W	-
54	P	-
55	SB	-
56	LG	-
59	G	-
58	GR	-
59	BR	-
70	O	-

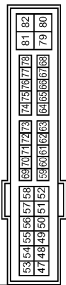
IPDM E/R (INTELLIGENT POWER DISTRIBUTION MODULE ENGINE ROOM)

Connector No.	E8
Connector Name	IPDM E/R (INTELLIGENT POWER DISTRIBUTION MODULE ENGINE ROOM)
Connector Type	NS38FW-CS

Terminal No.	Color of Wire	Signal Name [Specification]
83	R	-
84	V	-
86	W	-
87	L	-
88	G	-
89	BR	-
90	P	-

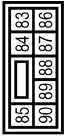
IPDM E/R (INTELLIGENT POWER DISTRIBUTION MODULE ENGINE ROOM)

Connector No.	E9
Connector Name	IPDM E/R (INTELLIGENT POWER DISTRIBUTION MODULE ENGINE ROOM)
Connector Type	TH16FW-NH

Terminal No.	Color of Wire	Signal Name [Specification]
91	G	-
92	O	-
97	V	-
104	LG	-

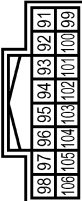
A
B
C
D
E
F
G
H
I
J
K
L
M
N
O
P

WW

Fail-safe

CAN COMMUNICATION CONTROL

When CAN communication with ECM and BCM is impossible, IPDM E/R performs fail-safe control. After CAN communication recovers normally, it also returns to normal control.

If No CAN Communication Is Available With ECM

IPDM E/R (INTELLIGENT POWER DISTRIBUTION MODULE ENGINE ROOM)

< ECU DIAGNOSIS INFORMATION >

Control part	Fail-safe operation
Cooling fan	<ul style="list-style-type: none"> • Outputs the pulse duty signal (PWM signal) 100% when the ignition switch is turned ON • Outputs the pulse duty signal (PWM signal) 0% when the ignition switch is turned OFF
A/C compressor	A/C relay OFF
Alternator	Outputs the power generation command signal (PWM signal) 0%

If No CAN Communication Is Available With BCM

Control part	Fail-safe operation
Headlamp	<ul style="list-style-type: none"> • Turns ON the headlamp low relay when the ignition switch is turned ON • Turns OFF the headlamp low relay when the ignition switch is turned OFF • Headlamp high relay OFF
<ul style="list-style-type: none"> • Parking lamps • Side maker lamp • License plate lamps • Illuminations • Tail lamps 	<ul style="list-style-type: none"> • Turns ON the tail lamp relay when the ignition switch is turned ON • Turns OFF the tail lamp relay when the ignition switch is turned OFF
Front wiper	<ul style="list-style-type: none"> • The status just before activation of fail-safe control is maintained until the ignition switch is turned OFF while the front wiper is operating at LO or HI speed. • The wiper is operated at LO speed until the ignition switch is turned OFF if the fail-safe control is activated while the front wiper is set in the INT mode and the front wiper motor is operating.
Horn	Horn relay OFF
Ignition relay	The status just before activation of fail-safe is maintained.
Starter motor	Starter control relay OFF
Steering lock unit	Steering lock relay OFF

IGNITION RELAY MALFUNCTION DETECTION FUNCTION

- IPDM E/R monitors the voltage at the contact circuit and excitation coil circuit of the ignition relay inside it.
- IPDM E/R judges the ignition relay error if the voltage differs between the contact circuit and the excitation coil circuit.
- If the ignition relay cannot turn OFF due to contact seizure, it activates the tail lamp relay for 10 minutes to alert the user to the ignition relay malfunction when the ignition switch is turned OFF.

Voltage judgment		IPDM E/R judgment	Operation
Ignition relay contact side	Ignition relay excitation coil side		
ON	ON	Ignition relay ON normal	—
OFF	OFF	Ignition relay OFF normal	—
ON	OFF	Ignition relay ON stuck	<ul style="list-style-type: none"> • Detects DTC “B2098: IGN RELAY ON” • Turns ON the tail lamp relay for 10 minutes
OFF	ON	Ignition relay OFF stuck	Detects DTC “B2099: IGN RELAY OFF”

FRONT WIPER CONTROL

IPDM E/R detects front wiper stop position by a front wiper stop position signal.

When a front wiper stop position signal is in the conditions listed below, IPDM E/R stops power supply to wiper after repeating a front wiper 10 seconds activation and 20 seconds stop five times.

Ignition switch	Front wiper switch	Front wiper stop position signal
ON	OFF	The front wiper stop position signal (stop position) cannot be input for 10 seconds.
	ON	The front wiper stop position signal does not change for 10 seconds.

IPDM E/R (INTELLIGENT POWER DISTRIBUTION MODULE ENGINE ROOM)

< ECU DIAGNOSIS INFORMATION >

NOTE:

This operation status can be confirmed on the IPDM E/R “Data Monitor” that displays “BLOCK” for the item “WIP PROT” while the wiper is stopped.

STARTER MOTOR PROTECTION FUNCTION

IPDM E/R turns OFF the starter control relay to protect the starter motor when the starter control relay remains active for 90 seconds.

DTC Index

INFOID:000000004685234

NOTE:

- The details of time display are as follows.
- CRNT: A malfunction is detected now.
- PAST: A malfunction was detected in the past.
- IGN counter is displayed on FFD (Freeze Frame data).
- The number is 0 when is detected now.
- The number increases like 1 → 2 ... 38 → 39 after returning to the normal condition whenever IGN OFF → ON.
- The number is fixed to 39 until the self-diagnosis results are erased if it is over 39.

×: Applicable

CONSULT display	Fail-safe	Refer to
No DTC is detected. further testing may be required.	—	—
U1000: CAN COMM CIRCUIT	×	PCS-15
B2098: IGN RELAY ON	×	PCS-16
B2099: IGN RELAY OFF	—	PCS-17
B2108: STRG LCK RELAY ON	—	SEC-104
B2109: STRG LCK RELAY OFF	—	SEC-106
B210A: STRG LCK STATE SW	—	SEC-107
B210B: START CONT RLY ON	—	SEC-111
B210C: START CONT RLY OFF	—	SEC-112
B210D: STARTER RELAY ON	—	SEC-113
B210E: STARTER RELAY OFF	—	SEC-114
B210F: INTRLCK/PNP SW ON	—	SEC-116
B2110: INTRLCK/PNP SW OFF	—	SEC-118

WW

FRONT WIPER AND WASHER SYSTEM SYMPTOMS

< SYMPTOM DIAGNOSIS >

SYMPTOM DIAGNOSIS

FRONT WIPER AND WASHER SYSTEM SYMPTOMS

Symptom Table

INFOID:000000004239842

CAUTION:

Perform the self-diagnosis with CONSULT-III before performing the diagnosis by symptom. Perform the diagnosis by DTC if DTC is detected.

Symptom	Probable malfunction location	Inspection item	
Front wiper does not operate	HI only	<ul style="list-style-type: none"> Combination switch Harness between combination switch and BCM BCM 	Combination switch Refer to BCS-80, "Symptom Table" .
		<ul style="list-style-type: none"> IPDM E/R Harness between IPDM E/R and front wiper motor Front wiper motor 	Front wiper motor (HI) circuit Refer to WW-23, "Component Function Check" .
		Front wiper request signal <ul style="list-style-type: none"> BCM IPDM E/R 	IPDM E/R Data monitor "FR WIP REQ"
	LO and INT	<ul style="list-style-type: none"> Combination switch Harness between combination switch and BCM BCM 	Combination switch Refer to BCS-80, "Symptom Table" .
		<ul style="list-style-type: none"> IPDM E/R Harness between IPDM E/R and front wiper motor Front wiper motor 	Front wiper motor (LO) circuit Refer to WW-21, "Component Function Check" .
		Front wiper request signal <ul style="list-style-type: none"> BCM IPDM E/R 	IPDM E/R Data monitor "FR WIP REQ"
	INT only	<ul style="list-style-type: none"> Combination switch Harness between combination switch and BCM BCM 	Combination switch Refer to BCS-80, "Symptom Table" .
		Front wiper request signal <ul style="list-style-type: none"> BCM IPDM E/R 	IPDM E/R Data monitor "FR WIP REQ"
	HI, LO and INT	SYMPTOM DIAGNOSIS Refer to WW-84, "Diagnosis Procedure" .	

FRONT WIPER AND WASHER SYSTEM SYMPTOMS

< SYMPTOM DIAGNOSIS >

Symptom	Probable malfunction location	Inspection item
Front wiper does not stop	HI only	<ul style="list-style-type: none"> • Combination switch • BCM Refer to BCS-80, "Symptom Table" .
		Front wiper request signal <ul style="list-style-type: none"> • BCM • IPDM E/R IPDM E/R Data monitor "FR WIP REQ"
		—
	LO only	<ul style="list-style-type: none"> • Combination switch • BCM Refer to BCS-80, "Symptom Table" .
		Front wiper request signal <ul style="list-style-type: none"> • BCM • IPDM E/R IPDM E/R Data monitor "FR WIP REQ"
		—
	INT only	<ul style="list-style-type: none"> • Combination switch • BCM Refer to BCS-80, "Symptom Table" .
		Front wiper request signal <ul style="list-style-type: none"> • BCM • IPDM E/R IPDM E/R Data monitor "FR WIP REQ"
	Front wiper does not operate normally	Intermittent adjustment cannot be performed
—		
Intermittent control linked with vehicle speed cannot be performed		Check the vehicle speed detection wiper setting. Refer to WW-11, "WIPER : CONSULT-III Function (BCM - WIPER)" .
Wiper is not linked to the washer operation		<ul style="list-style-type: none"> • Combination switch • Harness between combination switch and BCM • BCM Refer to BCS-80, "Symptom Table" .
	—	
Does not return to stop position [Repeatedly operates for 10 seconds and then stops for 20 seconds. After that, it stops the operation. (Fail-safe)]	<ul style="list-style-type: none"> • IPDM E/R • Harness between IPDM E/R and front wiper motor • Front wiper motor Front wiper auto stop signal circuit Refer to WW-25, "Component Function Check" .	

A
B
C
D
E
F
G
H
I
J
K
M
N
O
P

WW

FRONT WIPER DOES NOT OPERATE

< SYMPTOM DIAGNOSIS >

FRONT WIPER DOES NOT OPERATE

Description

INFOID:000000004239843

The front wiper does not operate under any operating conditions.

Diagnosis Procedure

INFOID:000000004239844

1. CHECK WIPER RELAY OPERATION

IPDM E/R AUTO ACTIVE TEST

1. Start IPDM E/R auto active test. Refer to [PCS-10. "Diagnosis Description"](#).
2. Check that the front wiper operates at the LO/HI operation.

CONSULT-III ACTIVE TEST

1. Select "FRONT WIPER" of IPDM E/R active test item.
2. With operating the test item, check that front wiper LO/HI operation and OFF.

Lo : Front wiper LO operation

Hi : Front wiper HI operation

Off : Stop the front wiper.

Does the front wiper operate?

- YES >> GO TO 5.
NO >> GO TO 2.

2. CHECK FRONT WIPER MOTOR FUSE

1. Turn the ignition switch OFF.
2. Check that the front wiper motor 30 A (#60) fuse is not fusing.

Is the fuse fusing?

- YES >> Replace the fuse after repairing the applicable circuit.
NO >> GO TO 3.

3. CHECK FRONT WIPER MOTOR (GND) OPEN CIRCUIT

1. Disconnect front wiper motor connector.
2. Check continuity between front wiper motor harness connector and ground.

Front wiper motor		Ground	Continuity
Connector	Terminal		Existed
E42	2		

Does continuity exist?

- YES >> GO TO 4.
NO >> Repair the harnesses or connectors.

4. CHECK FRONT WIPER MOTOR OUTPUT VOLTAGE

CONSULT-III ACTIVE TEST

1. Disconnect front wiper motor connector.
2. Turn the ignition switch ON.
3. Select "FRONT WIPER" of IPDM E/R active test item.
4. With operating the test item, check voltage between IPDM E/R harness connector and ground.

FRONT WIPER DOES NOT OPERATE

< SYMPTOM DIAGNOSIS >

Terminals		Test item	Voltage (Approx.)
(+)	(-)		
IPDM E/R		FRONT WIPER	
Connector	Terminal		
E5	4	Lo	Battery voltage
		Off	0 V
	5	Hi	Battery voltage
		Off	0 V

Is the measurement normal?

- YES >> Replace front wiper motor.
 NO >> Replace IPDM E/R.

5.CHECK FRONT WIPER REQUEST SIGNAL INPUT

CONSULT-III DATA MONITOR

1. Select "FR WIP REQ" of IPDM E/R data monitor item.
2. Switch the front wiper switch to HI and LO.
3. With operating the front wiper switch, check the monitor status.

Monitor item	Condition		Monitor status
FR WIPER REQ	Front wiper switch HI	ON	Hi
		OFF	Stop
	Front wiper switch LO	ON	Low
		OFF	Stop

Is the status of item normal?

- YES >> Replace IPDM E/R.
 NO >> GO TO 6.

6.CHECK COMBINATION SWITCH

Perform the inspection of the combination switch. Refer to [BCS-80. "Symptom Table"](#).

Is combination switch normal?

- YES >> Replace BCM. Refer to [BCS-82. "Exploded View"](#).
 NO >> Repair or replace the applicable parts.

A
B
C
D
E
F
G
H
I
J
K
M
N
O
P

WW

NORMAL OPERATING CONDITION

< SYMPTOM DIAGNOSIS >

NORMAL OPERATING CONDITION

Description

INFOID:000000004239845

FRONT WIPER MOTOR PROTECTION FUNCTION

- IPDM E/R may stop the front wiper to protect the front wiper motor if any obstruction (operation resistance) such as a large amount of snow is detected during the front wiper operation.
- At that time turn OFF the front wiper and remove the foreign object. Then wait for approximately 20 seconds or more and reactivate the front wiper. The wiper will operate normally.

PRECAUTIONS

< PRECAUTION >

PRECAUTION

PRECAUTIONS

Precaution for Supplemental Restraint System (SRS) "AIR BAG" and "SEAT BELT PRE-TENSIONER"

INFOID:000000004239846

The Supplemental Restraint System such as "AIR BAG" and "SEAT BELT PRE-TENSIONER", used along with a front seat belt, helps to reduce the risk or severity of injury to the driver and front passenger for certain types of collision. This system includes seat belt switch inputs and dual stage front air bag modules. The SRS system uses the seat belt switches to determine the front air bag deployment, and may only deploy one front air bag, depending on the severity of a collision and whether the front occupants are belted or unbelted. Information necessary to service the system safely is included in the "SRS AIR BAG" and "SEAT BELT" of this Service Manual.

WARNING:

- To avoid rendering the SRS inoperative, which could increase the risk of personal injury or death in the event of a collision which would result in air bag inflation, all maintenance must be performed by an authorized NISSAN/INFINITI dealer.
- Improper maintenance, including incorrect removal and installation of the SRS, can lead to personal injury caused by unintentional activation of the system. For removal of Spiral Cable and Air Bag Module, see the "SRS AIR BAG".
- Do not use electrical test equipment on any circuit related to the SRS unless instructed to in this Service Manual. SRS wiring harnesses can be identified by yellow and/or orange harnesses or harness connectors.

PRECAUTIONS WHEN USING POWER TOOLS (AIR OR ELECTRIC) AND HAMMERS

WARNING:

- When working near the Air Bag Diagnosis Sensor Unit or other Air Bag System sensors with the ignition ON or engine running, DO NOT use air or electric power tools or strike near the sensor(s) with a hammer. Heavy vibration could activate the sensor(s) and deploy the air bag(s), possibly causing serious injury.
- When using air or electric power tools or hammers, always switch the ignition OFF, disconnect the battery, and wait at least 3 minutes before performing any service.

Precaution for Procedure without Cowl Top Cover

INFOID:000000004239847

When performing the procedure after removing cowl top cover, cover the lower end of windshield with urethane, etc.

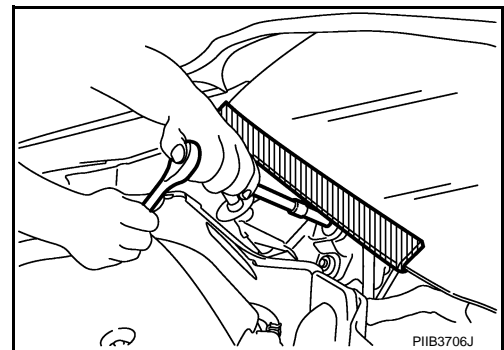

WASHER TANK

< REMOVAL AND INSTALLATION >

REMOVAL AND INSTALLATION

WASHER TANK

Exploded View

INFOID:000000004239848

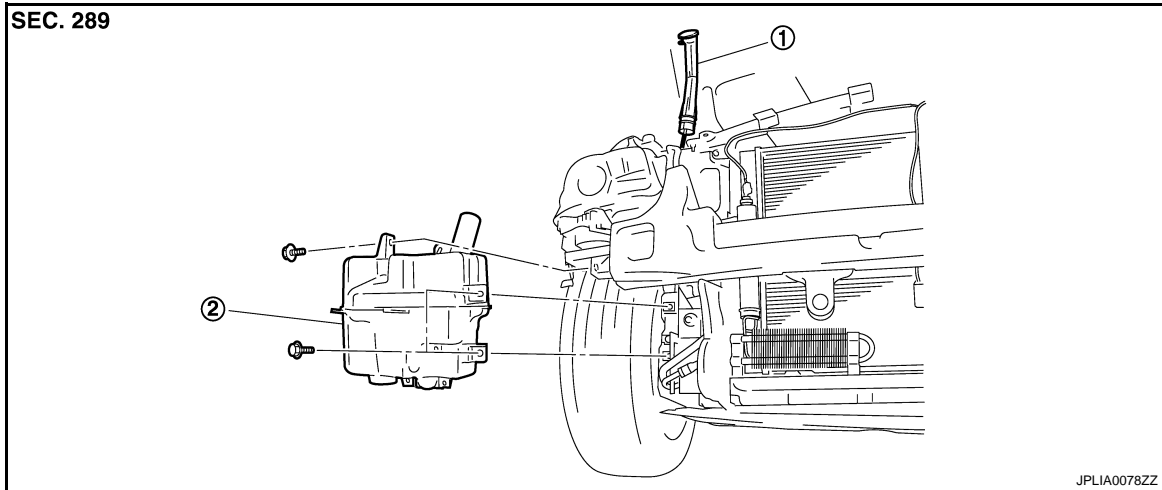

1. Washer tank inlet

2. Washer tank

Removal and Installation

INFOID:000000004239849

REMOVAL

1. Remove the clip (A).

⇐ : Vehicle front

2. Pull out the washer tank inlet from the washer tank.
3. Remove the front bumper fascia. Refer to [EXT-13, "Removal and Installation"](#).
4. Disconnect the washer pump connector.
5. Disconnect the washer level switch connector.
6. Disconnect the washer tube.
7. Remove the washer tank mounting bolts.
8. Remove the washer tank from the vehicle.

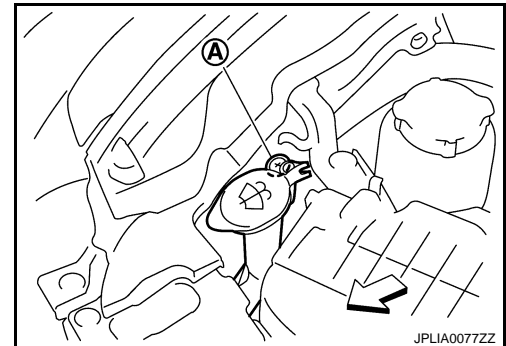

INSTALLATION

Install in the reverse order of removal.

CAUTION:

Add water up to the top of the washer tank inlet after installing. Check that there is no leakage.

FRONT WASHER PUMP

< REMOVAL AND INSTALLATION >

FRONT WASHER PUMP

Exploded View

INFOID:000000004239850

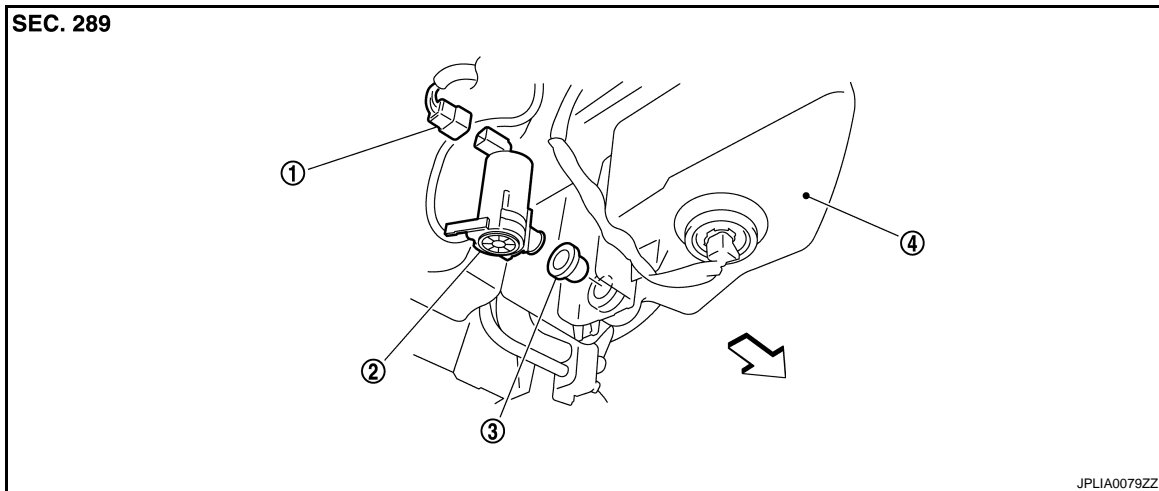

1. Washer pump connector
2. Washer pump
3. Packing
4. Washer tank

↩ : Vehicle front

Removal and Installation

INFOID:000000004239851

REMOVAL

1. Remove the fender protector RH (front). Refer to [EXT-23, "FENDER PROTECTOR : Removal and Installation"](#).
2. Disconnect the washer pump connector.
3. Disconnect the washer tube.
4. Remove the washer pump from the washer tank.
5. Remove the packing from the washer tank.

INSTALLATION

Install in the reverse order of removal.

CAUTION:

Never twist the packing when installing the washer pump.

A
B
C
D
E
F
G
H
I
J
K
L
M
N
O
P

WW

WASHER LEVEL SWITCH

< REMOVAL AND INSTALLATION >

WASHER LEVEL SWITCH

Removal and Installation

INFOID:000000004239852

The washer level switch must be replaced together with the washer tank as an assembly. Refer to [WW-88](#), "[Removal and Installation](#)".

FRONT WASHER NOZZLE AND TUBE

< REMOVAL AND INSTALLATION >

FRONT WASHER NOZZLE AND TUBE

Hydraulic Layout

INFOID:000000004239853

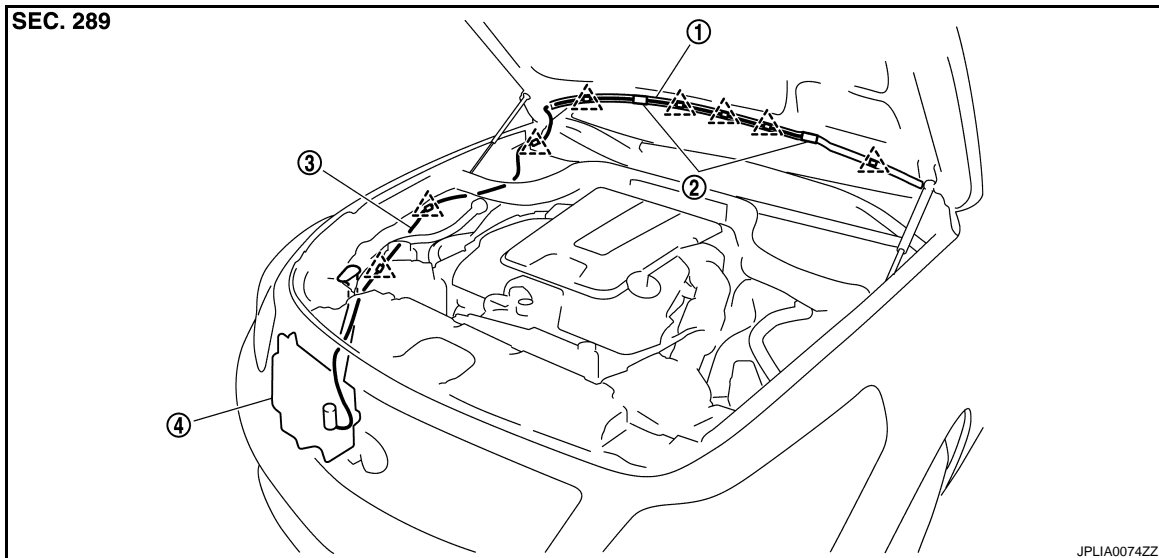

- 1. Seal rubber
 - 2. Washer nozzle
 - 3. Washer tube
 - 4. Washer tank
- △ : Clip

Removal and Installation

INFOID:000000004239854

REMOVAL

1. Open the hood.
2. Use the stop point of washer nozzle (1) as the support point and rotate nozzle to remove it from body, while pushing nozzle spray point side along the hood.
CAUTION:
Never break the seal rubber bonded to the washer nozzle.
3. Remove the seal rubber from the washer nozzle.
4. Remove the washer tube (2) from the washer nozzle.

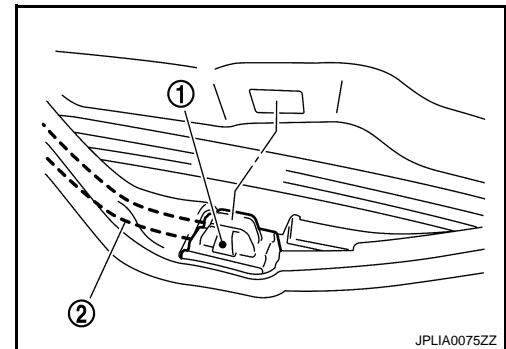

INSTALLATION

1. Install washer tube into the washer nozzle.
2. Install the seal rubber.
NOTE:
When the washer nozzle is removed, bond the seal rubber to the washer nozzle using commercially available instantaneous adhesive.
3. Install the washer nozzle to the hood.
4. Adjust the washer nozzle spray position. Refer to [WW-91, "Inspection and Adjustment"](#).
CAUTION:
The spray positions differ. Check that left and right nozzles are installed correctly.

Inspection and Adjustment

INFOID:000000004239855

INSPECTION

FRONT WASHER NOZZLE AND TUBE

< REMOVAL AND INSTALLATION >

Washer Nozzle Inspection

Check that air can pass through the hose by blowing forward (toward the nozzle), and check that air cannot pass through by sucking.

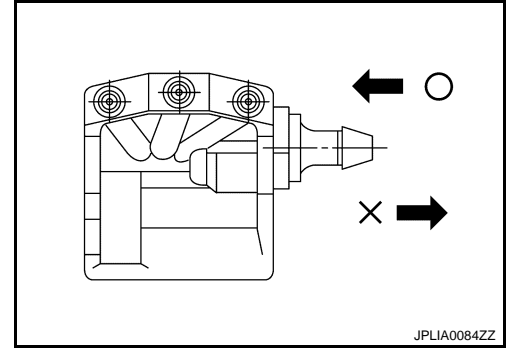

ADJUSTMENT

Washer Nozzle Spray Position Adjustment

Adjust spray positions to match the positions shown in the figure.

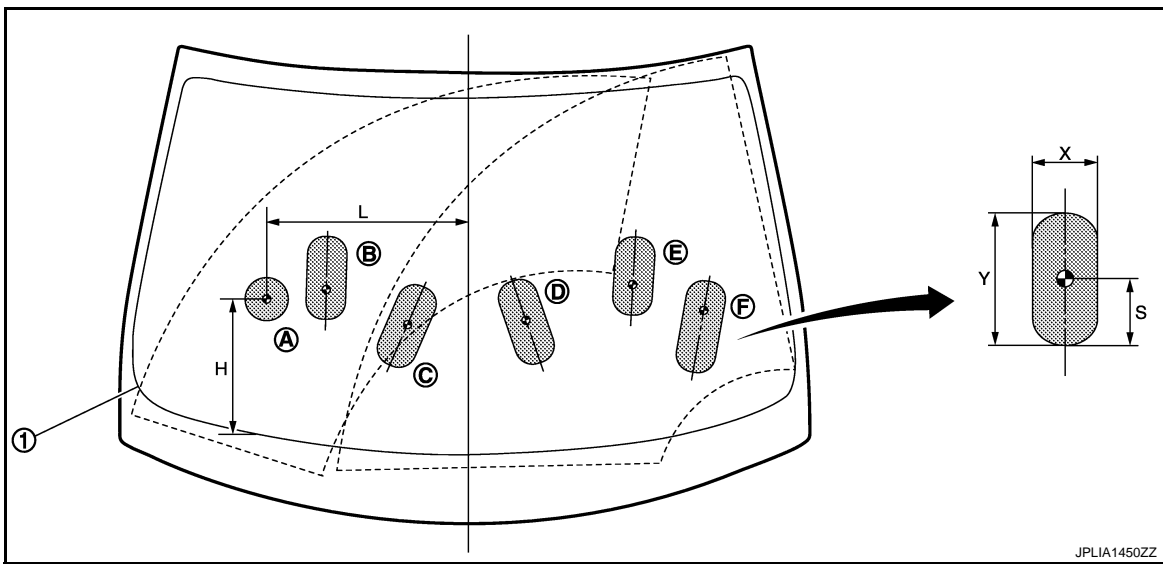

1. Black printed frame line

 : Spray area

 : Target spray position

Unit: mm (in)

Spray position	H	L	X	Y	S
A	280 (11.02)	396 (15.59)	80 (3.15)	80 (3.15)	40 (1.57)
B	320 (12.60)	277 (10.91)	80 (3.15)	153 (6.02)	61 (2.40)
C	261 (10.28)	114 (4.49)	80 (3.15)	175 (6.89)	87 (3.43)
D	267 (10.51)	123 (4.84)	80 (3.15)	177 (6.97)	88 (3.46)
E	321 (12.64)	336 (13.23)	80 (3.15)	160 (6.30)	63 (2.48)
F	239 (9.41)	477 (18.78)	80 (3.15)	190 (7.48)	127 (5.00)

FRONT WASHER NOZZLE AND TUBE

< REMOVAL AND INSTALLATION >

Insert a needle or similar object (A) into the spray opening (1) and move up/down and left/right to adjust the spray position.

NOTE:

If wax or dust gets into the nozzle, remove wax or dust with a needle or small pin.

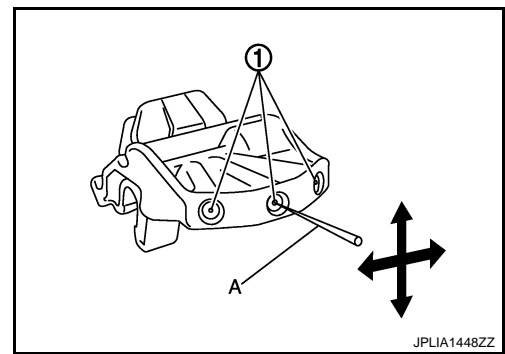

A
B
C
D
E
F
G
H
I
J
K
WW
M
N
O
P

FRONT WIPER ARM

< REMOVAL AND INSTALLATION >

FRONT WIPER ARM

Exploded View

INFOID:000000004239856

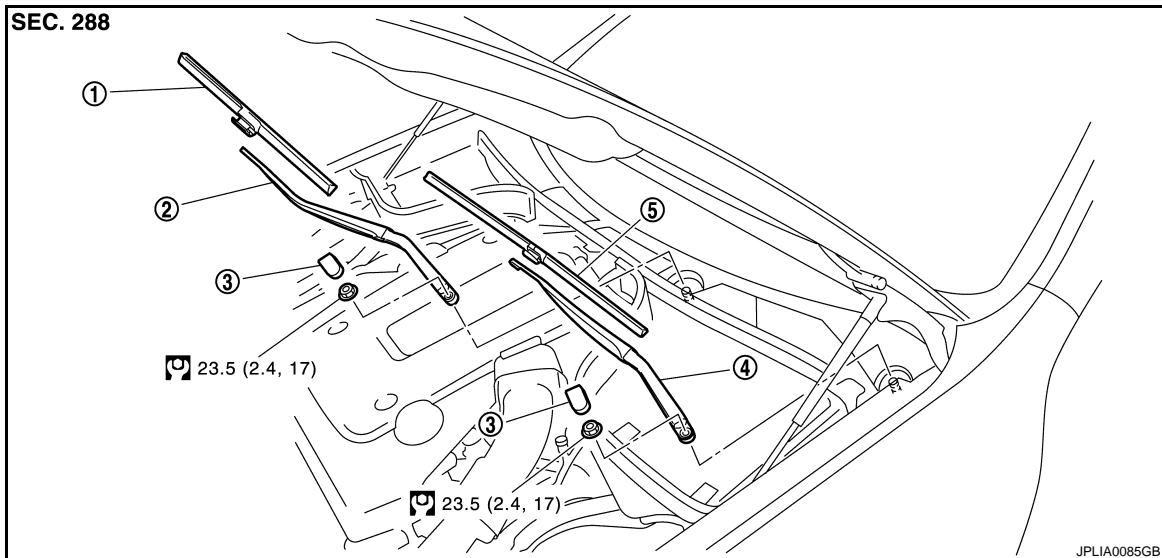

- | | | |
|---------------------|---------------------|------------------|
| 1. Wiper blade (RH) | 2. Wiper arm (RH) | 3. Wiper arm cap |
| 4. Wiper arm (LH) | 5. Wiper blade (LH) | |

Refer to [GI-4, "Components"](#) for symbols in the figure.

Removal and Installation

INFOID:000000004239857

REMOVAL

1. Operate the front wiper to move it to the auto stop position.
2. Open the hood.
3. Remove the wiper arm cap.
4. Remove the wiper arm mounting nut.
5. Raise wiper arm, and remove the wiper arm from the vehicle.

INSTALLATION

1. Clean wiper arm mount as shown in the figure to prevent nuts from being loosened.
2. Operate the front wiper motor to move the wiper to the auto stop position.
3. Adjust the wiper blade position. Refer to [WW-94, "Adjustment"](#).
4. Install the wiper arm by tightening the mounting nut.
5. Inject the washer fluid.
6. Operate the front wiper to move it to the auto stop position.
7. Check that the wiper blades stop at the specified position.
8. Install the wiper arm cap.

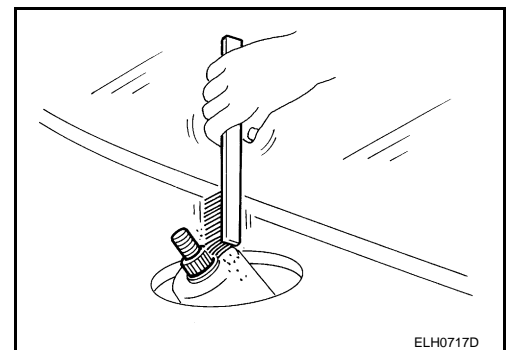

Adjustment

INFOID:000000004239858

WIPER BLADE POSITION ADJUSTMENT

Clearance between the end of cowl top cover and the top of wiper blade center

FRONT WIPER ARM

< REMOVAL AND INSTALLATION >

Standard clearance

R : $35.0 \pm 7.5 \text{ mm}$ ($1.38 \pm 0.295 \text{ in}$)

L : $72.0 \pm 7.5 \text{ mm}$ ($2.84 \pm 0.295 \text{ in}$)

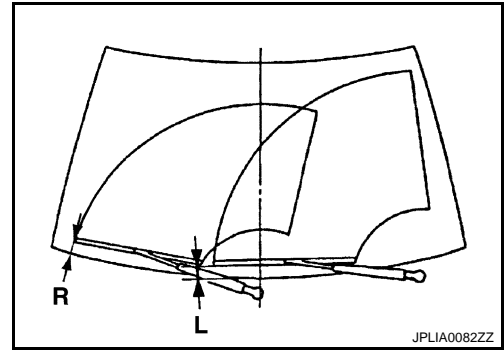

A

B

C

D

E

F

G

H

I

J

K

WW

M

N

O

P

WIPER BLADE

< REMOVAL AND INSTALLATION >

WIPER BLADE

Exploded View

INFOID:000000004702072

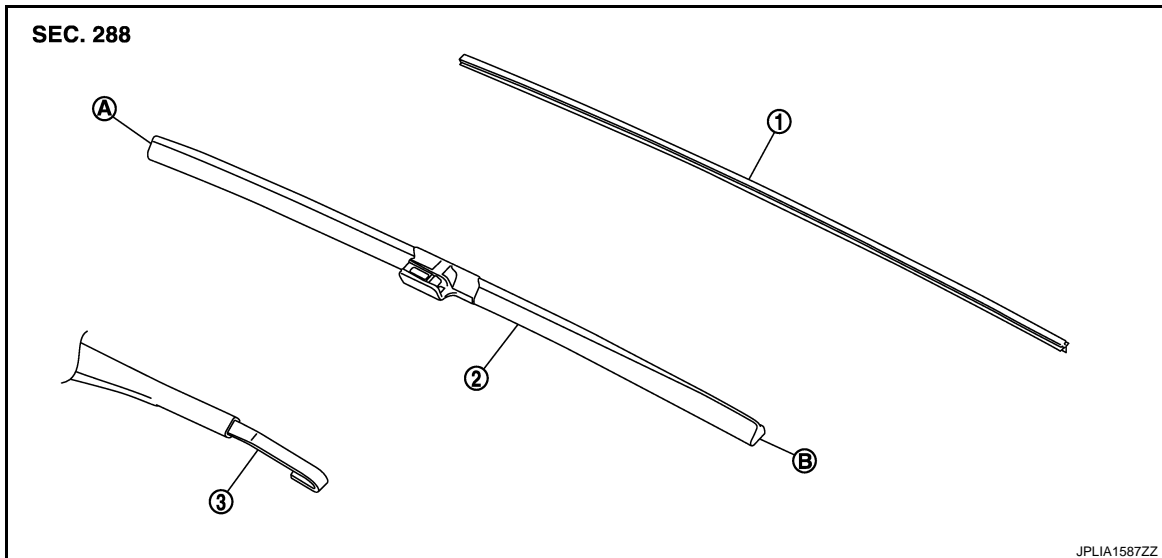

- | | | |
|--------------------|--------------------|--------------|
| 1. Wiper refill | 2. Wiper blade | 3. Wiper arm |
| A. Wiper blade end | B. Wiper blade tip | |

Removal and Installation

INFOID:000000004702073

REMOVAL

Remove the wiper blade from the wiper arm.

INSTALLATION

Install the front wiper blade to the wiper arm.

Replacement

INFOID:000000004702074

1. Hold the rip of old wiper refill (1) at the rear end of the wiper blade with long-nose pliers, and pull out the wiper refill to the direction (A).

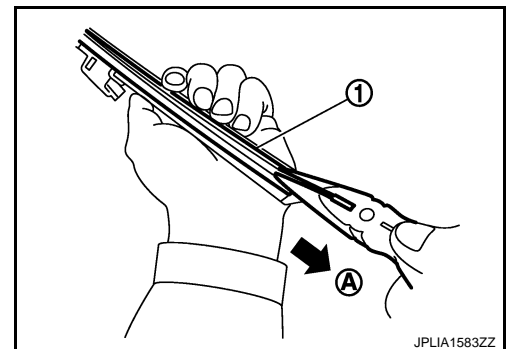

2. Insert the tip of new wiper refill (1) into the rear end of wiper blade. Slide the wiper refill to the direction (A) while pressing the wiper refill onto the wiper blade rear end.

NOTE:

- Insert the wiper refill to be held securely by tab (B) of wiper blade.
- After the wiper refill is fully inserted, remove the holder* (2).

*: Attached to service parts.

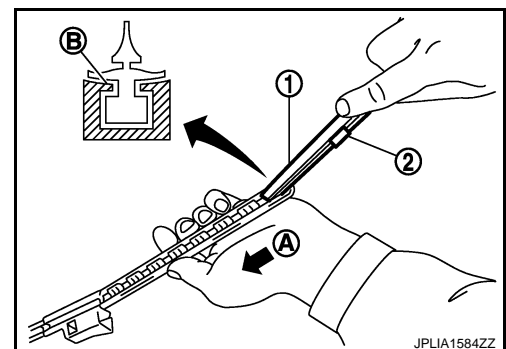

WIPER BLADE

< REMOVAL AND INSTALLATION >

3. Inert the wiper refill until the stopper at the rear end of wiper refill fits in the tab. Check that "LOCK" mark on wiper refill is aligned with "▼" mark on wiper blade.
4. Untwist the twisted wiper refill (▨) at the rear end of wiper blade, if any.
5. Check the following items after replacing wiper refill.
 - Wiper refill is not twisted at all.
 - Wiper refill thoroughly fits in the tab on wiper blade.
 - Wiper refill is inserted from the proper direction.

NOTE:

When the vertebra is detached.

- Insert the vertebra (1) into the wiper blade to the same bending direction.
- If a vertebra has a notch, fit it to a protrusion inside the wiper refill.

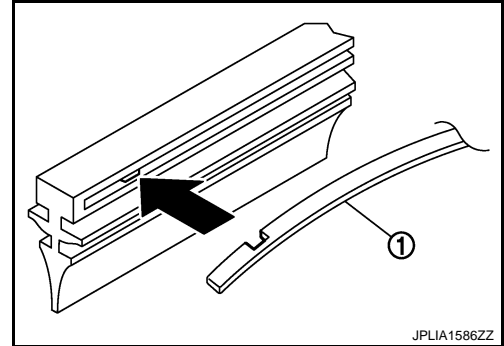
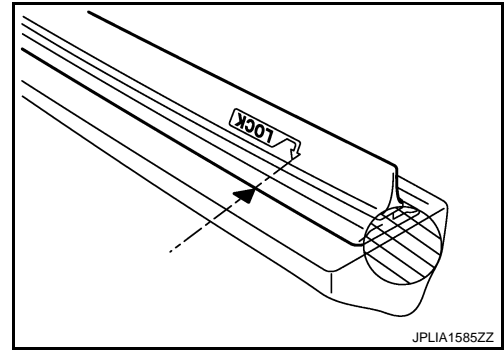

A
B
C
D
E
F
G
H
I
J
K
M
N
O
P

WW

FRONT WIPER DRIVE ASSEMBLY

< REMOVAL AND INSTALLATION >

FRONT WIPER DRIVE ASSEMBLY

Exploded View

INFOID:000000004239859

REMOVAL VIEW

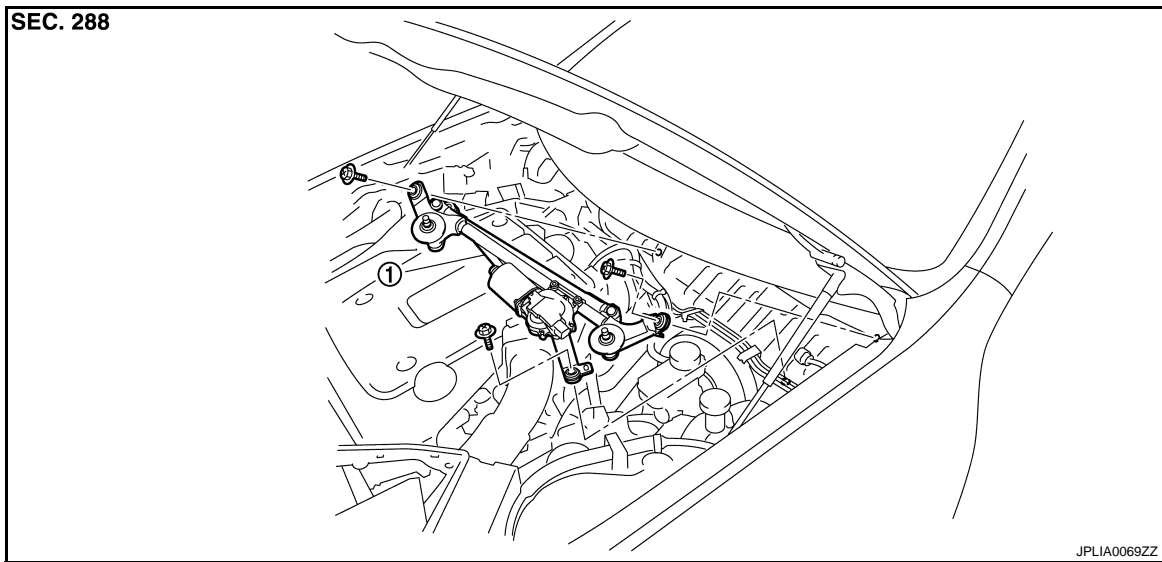

1. Front wiper drive assembly

DISASSEMBLY VIEW

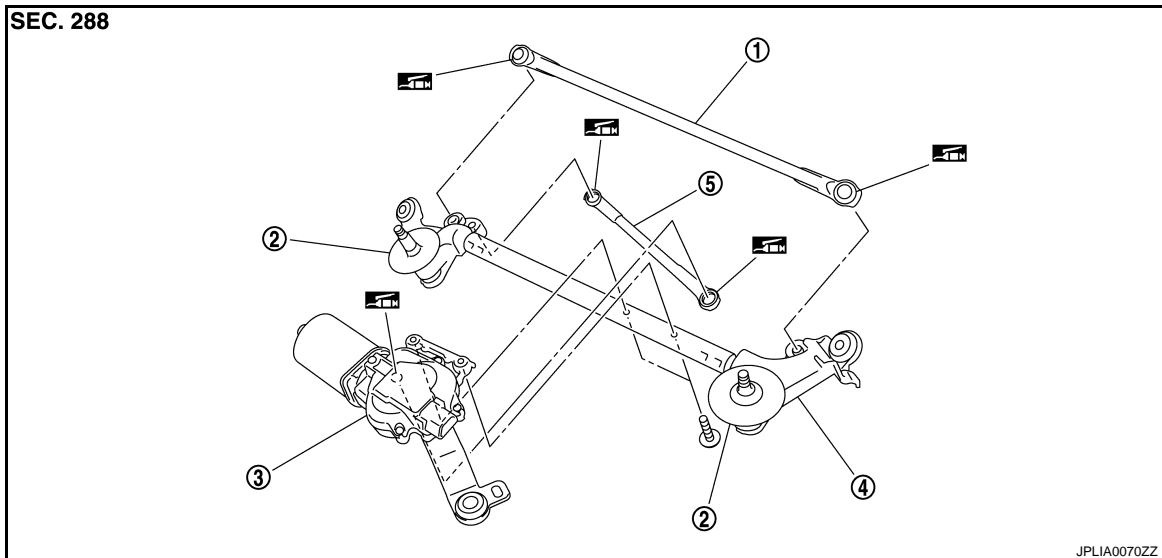

- | | | |
|--------------------|--------------------|----------------------|
| 1. Wiper linkage 1 | 2. Shaft seal | 3. Front wiper motor |
| 4. Wiper frame | 5. Wiper linkage 2 | |

: Multi-purpose grease or an equivalent.

Removal and Installation

INFOID:000000004239860

REMOVAL

1. Remove the wiper arm. Refer to [WW-94, "Removal and Installation"](#).
2. Remove the cowl top cover. Refer to [EXT-20, "Removal and Installation"](#).
3. Remove bolts from the front wiper drive assembly.

FRONT WIPER DRIVE ASSEMBLY

< REMOVAL AND INSTALLATION >

4. Disconnect the front wiper motor connector.
5. Remove the front wiper drive assembly from the vehicle.

A

INSTALLATION

1. Install the front wiper drive assembly to the vehicle.
2. Connect the front wiper motor connector.
3. Operate the front wiper to move it to the auto stop position.
4. Install the cowl top cover. Refer to [EXT-20. "Removal and Installation"](#).
5. Install the wiper arms. Refer to [WW-94. "Removal and Installation"](#).

B

C

Disassembly and Assembly

INFOID:000000004239861

D

DISASSEMBLY

1. Remove the wiper linkage 1 and 2 from the front wiper drive assembly.
CAUTION:
Never bend the linkage or damage the plastic part of the ball joint when removing the wiper linkage.
2. Remove the front wiper motor mounting screws, and then remove the front wiper motor from the wiper frame.

E

F

ASSEMBLY

1. Connect the front wiper motor connector.
2. Operate the front wiper to move it to the auto stop position.
3. Disconnect the front wiper motor connector.
4. Install front wiper motor to wiper frame.
5. Install the wiper linkage 2 to the wiper motor and the wiper frame.
6. Install the wiper linkage 1 to the wiper frame.
CAUTION:
 - **Never drop front wiper motor or cause it to come into contact with other parts.**
 - **Be careful for the grease condition at the wiper motor and wiper linkage joint (retainer). Apply Multi-purpose grease or an equivalent if necessary.**

G

H

I

J

K

WW

M

N

O

P

FRONT WIPER AND WASHER SWITCH

< REMOVAL AND INSTALLATION >

FRONT WIPER AND WASHER SWITCH

Exploded View

INFOID:000000004239862

Refer to [BCS-83, "Exploded View"](#).