

A
B
C

SECTION INL

INTERIOR LIGHTING SYSTEM

CONTENTS

<p>BASIC INSPECTION 3</p> <p>DIAGNOSIS AND REPAIR WORKFLOW 3</p> <p style="padding-left: 20px;">Work Flow3</p> <p>SYSTEM DESCRIPTION 5</p> <p>INTERIOR ROOM LAMP CONTROL SYSTEM 5</p> <p style="padding-left: 20px;">System Diagram5</p> <p style="padding-left: 20px;">System Description5</p> <p style="padding-left: 20px;">Component Parts Location7</p> <p style="padding-left: 20px;">Component Description8</p> <p>INTERIOR ROOM LAMP BATTERY SAVER SYSTEM 9</p> <p style="padding-left: 20px;">System Diagram9</p> <p style="padding-left: 20px;">System Description9</p> <p style="padding-left: 20px;">Component Parts Location10</p> <p style="padding-left: 20px;">Component Description10</p> <p>ILLUMINATION CONTROL SYSTEM12</p> <p style="padding-left: 20px;">System Diagram12</p> <p style="padding-left: 20px;">System Description12</p> <p style="padding-left: 20px;">Component Parts Location13</p> <p style="padding-left: 20px;">Component Description13</p> <p>DIAGNOSIS SYSTEM (BCM)14</p> <p>COMMON ITEM14</p> <p style="padding-left: 20px;">COMMON ITEM : CONSULT-III Function (BCM - COMMON ITEM)14</p> <p>INT LAMP15</p> <p style="padding-left: 20px;">INT LAMP : CONSULT-III Function (BCM - INT LAMP)16</p> <p>BATTERY SAVER17</p> <p style="padding-left: 20px;">BATTERY SAVER : CONSULT-III Function (BCM - BATTERY SAVER)17</p> <p>DTC/CIRCUIT DIAGNOSIS19</p>	<p>POWER SUPPLY AND GROUND CIRCUIT19</p> <p>BCM19</p> <p style="padding-left: 20px;">BCM : Diagnosis Procedure19</p> <p>INTERIOR ROOM LAMP POWER SUPPLY CIRCUIT20</p> <p style="padding-left: 20px;">Description20</p> <p style="padding-left: 20px;">Component Function Check20</p> <p style="padding-left: 20px;">Diagnosis Procedure20</p> <p>INTERIOR ROOM LAMP CONTROL CIRCUIT22</p> <p style="padding-left: 20px;">Description22</p> <p style="padding-left: 20px;">Component Function Check22</p> <p style="padding-left: 20px;">Diagnosis Procedure22</p> <p>STEP LAMP CIRCUIT24</p> <p style="padding-left: 20px;">Description24</p> <p style="padding-left: 20px;">Component Function Check24</p> <p style="padding-left: 20px;">Diagnosis Procedure24</p> <p>TRUNK ROOM LAMP CIRCUIT26</p> <p style="padding-left: 20px;">Description26</p> <p style="padding-left: 20px;">Component Function Check26</p> <p style="padding-left: 20px;">Diagnosis Procedure26</p> <p>PUSH-BUTTON IGNITION SWITCH ILLUMINATION CIRCUIT28</p> <p style="padding-left: 20px;">Description28</p> <p style="padding-left: 20px;">Component Function Check28</p> <p style="padding-left: 20px;">Diagnosis Procedure28</p> <p>INTERIOR ROOM LAMP CONTROL SYSTEM30</p> <p style="padding-left: 20px;">Wiring Diagram - INTERIOR ROOM LAMP -30</p> <p>ILLUMINATION40</p> <p style="padding-left: 20px;">Wiring Diagram - ILLUMINATION -40</p> <p>ECU DIAGNOSIS INFORMATION53</p>
--	--

A
B
C
D
E
F
G
H
I
J
K
INL



M
N
O
P

BCM (BODY CONTROL MODULE)	53	Exploded View	109
Reference Value	53	Replacement	109
Wiring Diagram - BCM -	77	CIGARETTE LIGHTER ILLUMINATION	110
Fail-safe	83	Exploded View	110
DTC Inspection Priority Chart	85	Replacement	110
DTC Index	86	GLOVE BOX LAMP	111
COMBINATION METER	89	Exploded View	111
Reference Value	89	Replacement	111
Wiring Diagram - METER -	92	STEP LAMP	112
Fail-safe	104	Exploded View	112
DTC Index	105	Removal and Installation	112
SYMPTOM DIAGNOSIS	106	Replacement	112
INTERIOR LIGHTING SYSTEM SYMPTOMS.	106	PERSONAL LAMP	113
Symptom Table	106	Exploded View	113
PRECAUTION	107	Removal and Installation	113
PRECAUTIONS	107	Replacement	114
Precaution for Supplemental Restraint System (SRS) "AIR BAG" and "SEAT BELT PRE-TEN- SIONER"	107	TRUNK ROOM LAMP	115
REMOVAL AND INSTALLATION	108	Exploded View	115
MAP LAMP	108	Removal and Installation	115
Exploded View	108	Replacement	115
Removal and Installation	108	SERVICE DATA AND SPECIFICATIONS	
Replacement	108	(SDS)	116
VANITY MIRROR LAMP	109	SERVICE DATA AND SPECIFICATIONS	
		(SDS)	116
		Bulb Specifications	116

DIAGNOSIS AND REPAIR WORKFLOW

< BASIC INSPECTION >

BASIC INSPECTION

DIAGNOSIS AND REPAIR WORKFLOW

Work Flow

INFOID:0000000005628246

OVERALL SEQUENCE

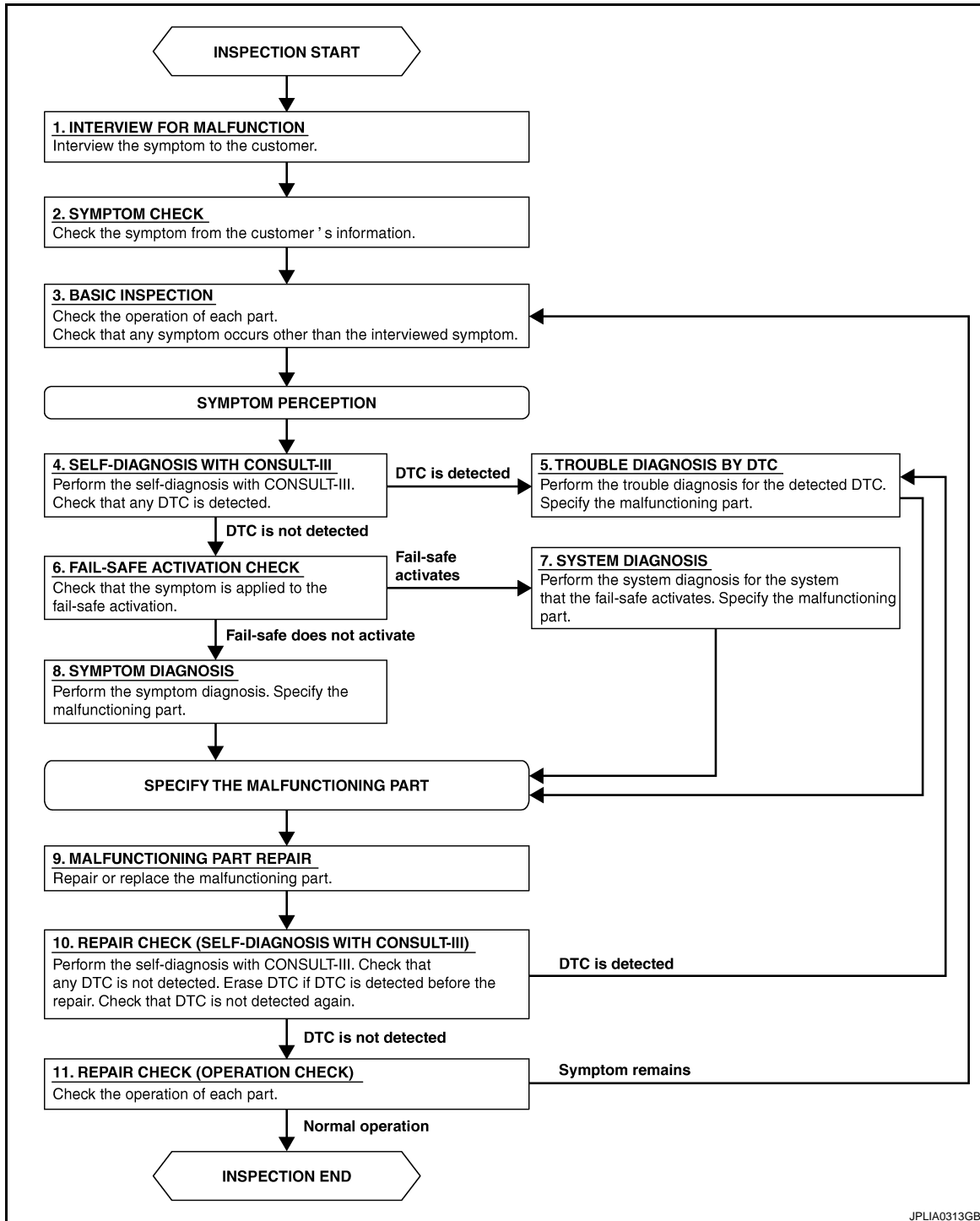

DETAILED FLOW

1. INTERVIEW FOR MALFUNCTION

Interview the symptom to the customer.

DIAGNOSIS AND REPAIR WORKFLOW

< BASIC INSPECTION >

>> GO TO 2.

2. SYMPTOM CHECK

Check the symptom from the customer's information.

>> GO TO 3.

3. BASIC INSPECTION

Check the operation of each part. Check that any symptom occurs other than the interviewed symptom.

>> GO TO 4.

4. SELF-DIAGNOSIS WITH CONSULT-III

Perform the self-diagnosis with CONSULT-III. Check that any DTC is detected.

Is any DTC detected?

YES >> GO TO 5.

NO >> GO TO 6.

5. TROUBLE DIAGNOSIS BY DTC

Perform the trouble diagnosis for the detected DTC. Specify the malfunctioning part.

>> GO TO 9.

6. FAIL-SAFE ACTIVATION CHECK

Check that the symptom is applied to the fail-safe activation.

Does the fail-safe activate?

YES >> GO TO 7.

NO >> GO TO 8.

7. SYSTEM DIAGNOSIS

Perform the system diagnosis for the system that the fail-safe activates. Specify the malfunctioning part.

>> GO TO 9.

8. SYMPTOM DIAGNOSIS

Perform the symptom diagnosis. Specify the malfunctioning part.

>> GO TO 9.

9. MALFUNCTION PART REPAIR

Repair or replace the malfunctioning part.

>> GO TO 10.

10. REPAIR CHECK (SELF-DIAGNOSIS WITH CONSULT-III)

Perform the self-diagnosis with CONSULT-III. Check that any DTC is not detected. Erase DTC if DTC is detected before the repair. Check that DTC is not detected again.

Is any DTC detected?

YES >> GO TO 5.

NO >> GO TO 11.

11. REPAIR CHECK (OPERATION CHECK)

Check the operation of each part.

Does it operate normally?

YES >> INSPECTION END

NO >> GO TO 3.

INTERIOR ROOM LAMP CONTROL SYSTEM

< SYSTEM DESCRIPTION >

SYSTEM DESCRIPTION

INTERIOR ROOM LAMP CONTROL SYSTEM

System Diagram

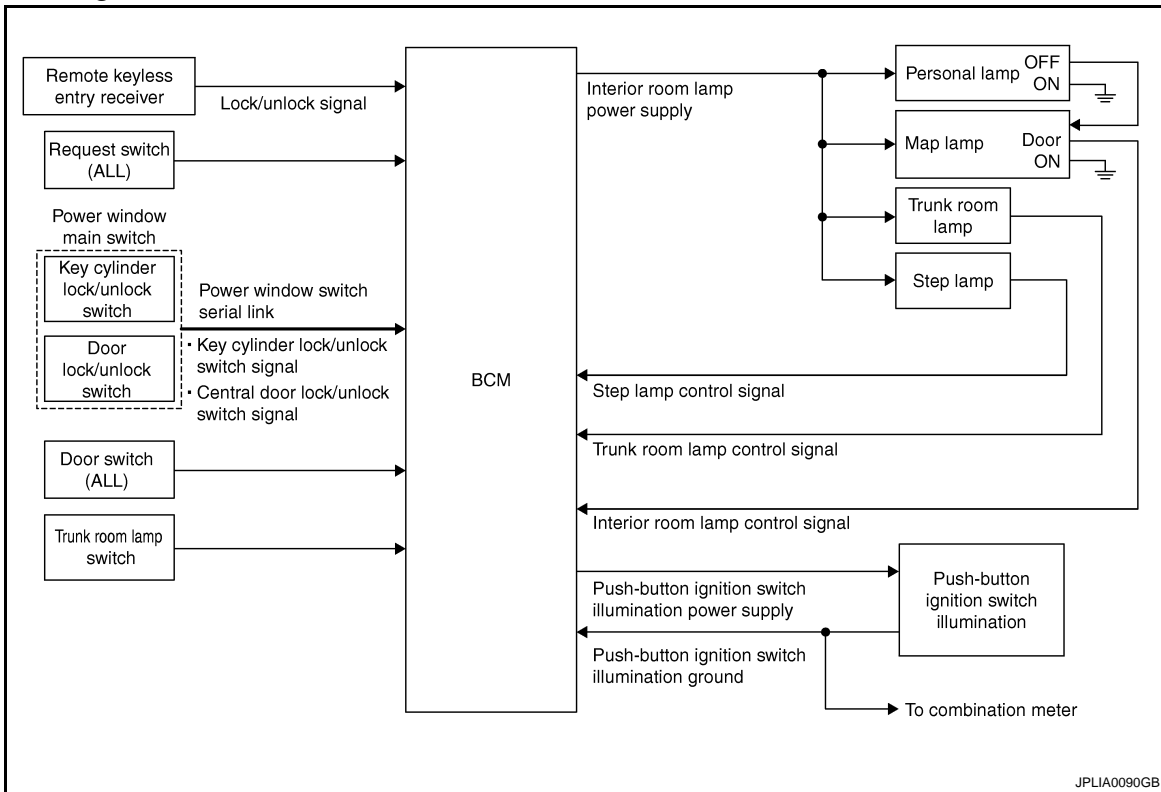

System Description

INFOID:0000000005628248

OUTLINE

- Interior room lamps* are controlled by interior room lamp timer control function of BCM.
- *: Map lamp and personal lamp (when map lamp switch is in DOOR position).
- Trunk room lamp is controlled by trunk room lamp control function of BCM.
- Step lamp is controlled by step lamp control function of BCM.
- Push-button ignition switch illumination is controlled by the push-button ignition switch illumination control function of BCM.

INTERIOR ROOM LAMP TIMER CONTROL

Interior Room Lamp Timer Basic Operation

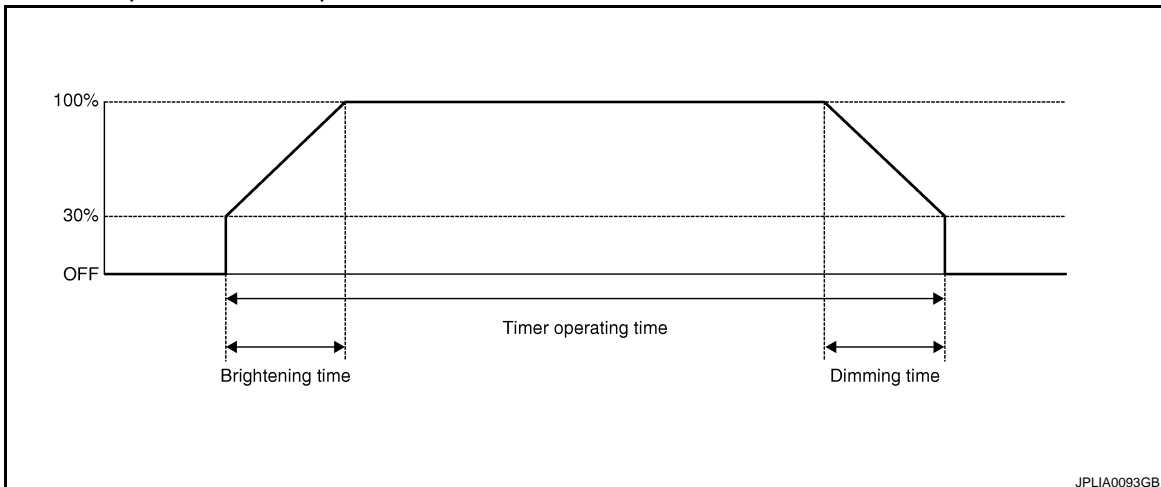

INTERIOR ROOM LAMP CONTROL SYSTEM

< SYSTEM DESCRIPTION >

- The interior room lamp turns ON and OFF (gradual brightening and dimming) by the interior room timer.
- BCM judges the vehicle condition with the following items. It activates the interior room timer.
 - Ignition switch status
 - Door switch signal (ALL)
 - Door lock/unlock signal (Remote keyless entry receiver, each request switch, key cylinder lock/unlock switch, door lock/unlock switch)

NOTE:

Each function of interior room lamp timer can be set by CONSULT-III. Refer to [INL-16, "INT LAMP : CONSULT-III Function \(BCM - INT LAMP\)"](#).

Interior Room Lamp ON Operation

- BCM always turns the interior room lamp ON when any door opens.
- BCM activates the interior room lamp timer in any of the following conditions to turn the interior room lamp ON for a period of time.
 - Any door opens before all doors close.
 - Ignition switch is turned ON → OFF.
 - Any door unlock signal is detected when all doors close with ignition switch OFF.

NOTE:

Restart the timer if new condition is input during the timer operating time.

Interior Room Lamp OFF Operation

BCM stops the timer in any of the following conditions to turn the interior room lamp OFF.

- The timer operating time is expired.
- Ignition switch position is other than OFF with all doors close.
- Any door lock operation is detected with all doors close.

TRUNK ROOM LAMP CONTROL

BCM controls the trunk room lamp (ground-side) to turn ON with the trunk room lamp switch ON.

STEP LAMP CONTROL

BCM controls the step lamp (ground-side) to turn ON with any door switch ON.

PUSH-BUTTON IGNITION SWITCH ILLUMINATION CONTROL

Push-button Ignition Switch Illumination Basic Operation

- BCM provides the power supply and the ground to turn the push-button ignition switch illumination ON.
- BCM cuts the ground supply while the each illumination (tail lamp) ON. BCM switches to the ground control with the meter illumination control function.

Push-button Ignition Switch Illumination ON Operation

BCM turns the push-button ignition switch illumination ON in the following conditions.

- Ignition switch ON
- Each illumination (tail lamp) ON
- Any of the following conditions with ignition switch OFF
 - Engine start permission is entered.
 - Intelligent Key inserted into the key slot.
 - Driver door is LOCK → UNLOCK.
 - Driver door is open.

Push-button Ignition Switch Illumination OFF Operation

BCM turns the push-button ignition switch illumination OFF in any of the following conditions.

- The push-button ignition switch illumination ON conditions do not satisfy.
- All of the following conditions with ignition switch OFF
 - Each illumination (tail lamp) OFF
 - The push-button ignition switch illumination ON conditions do not change (15 seconds after the ignition switch OFF) or the driver door is UNLOCK → LOCK

INTERIOR ROOM LAMP CONTROL SYSTEM

< SYSTEM DESCRIPTION >

Component Parts Location

INFOID:000000005628249

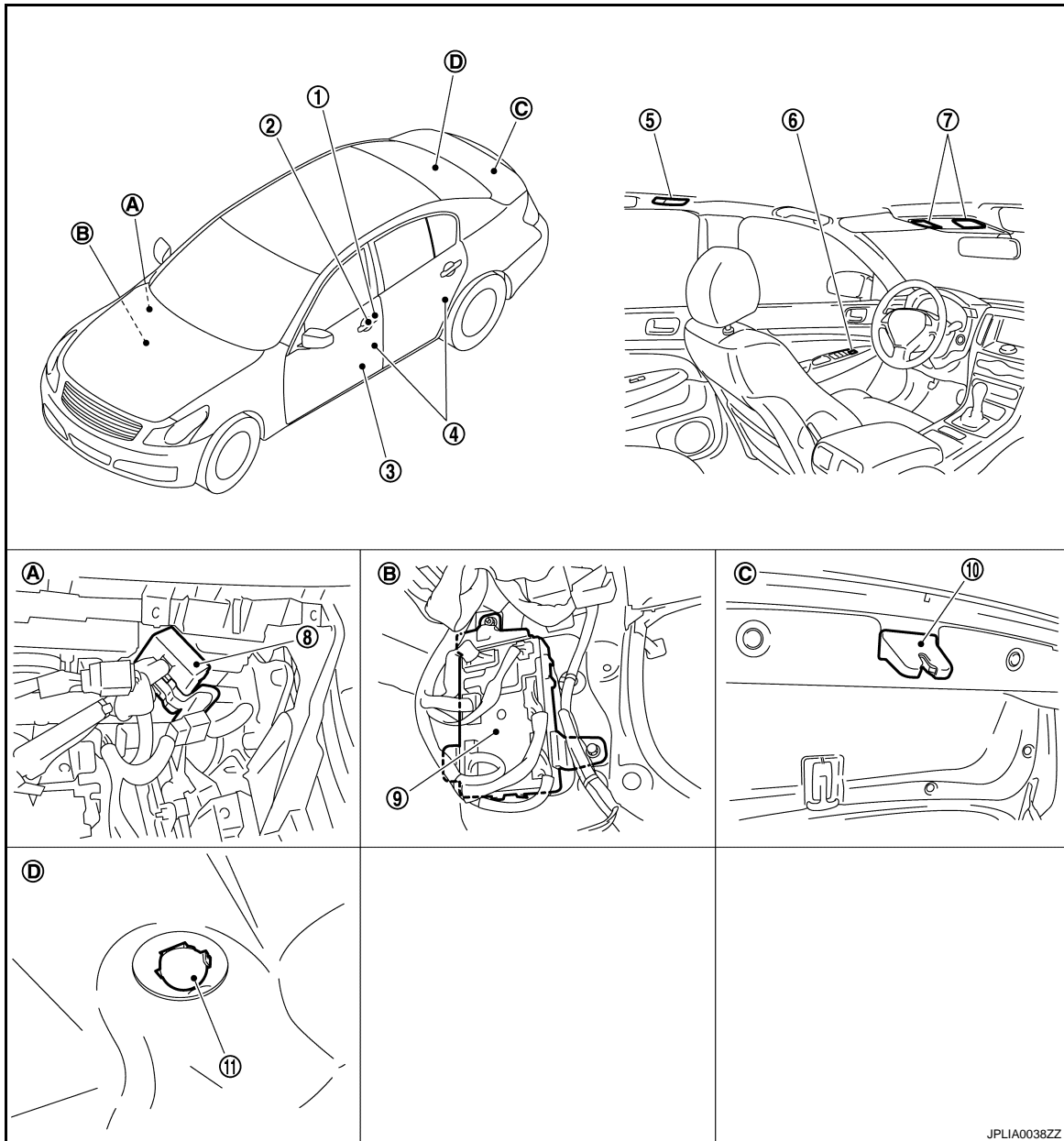

- | | | |
|----------------------------|-------------------------------------|----------------------------|
| 1. Key cylinder switch | 2. Request switch | 3. Step lamp |
| 4. Door switch | 5. Personal lamp | 6. Door lock/unlock switch |
| 7. Map lamp | 8. Remote keyless entry receiver | 9. BCM |
| 10. Trunk room lamp switch | 11. Trunk room lamp | |
| A. Behind the glove box | B. Dash side lower (passenger side) | C. Trunk lid lock assembly |
| D. Trunk room upward | | |

A
B
C
D
E
F
G
H
I
J
K
L
M
N
O
P

INL

JPLIA0038ZZ

INTERIOR ROOM LAMP CONTROL SYSTEM

< SYSTEM DESCRIPTION >

Component Description

INFOID:000000005628250

Part	Description
BCM	<ul style="list-style-type: none">• Activates the interior room lamp timer depending on the vehicle condition to turn the interior room lamp ON/OFF.• Turns the trunk room lamp ON /OFF according to the trunk room lamp switch status.• Turns the step lamp ON /OFF according to any door switch status.
Remote keyless entry receiver	Transmits the lock/unlock signal to BCM.
<ul style="list-style-type: none">• Door lock/unlock switch• Key cylinder lock/unlock switch	Transmits a switch signal by power window switch serial link.
<ul style="list-style-type: none">• Request switch• Door switch• Trunk room lamp switch	Inputs a switch signal to BCM.

INTERIOR ROOM LAMP BATTERY SAVER SYSTEM

< SYSTEM DESCRIPTION >

INTERIOR ROOM LAMP BATTERY SAVER SYSTEM

System Diagram

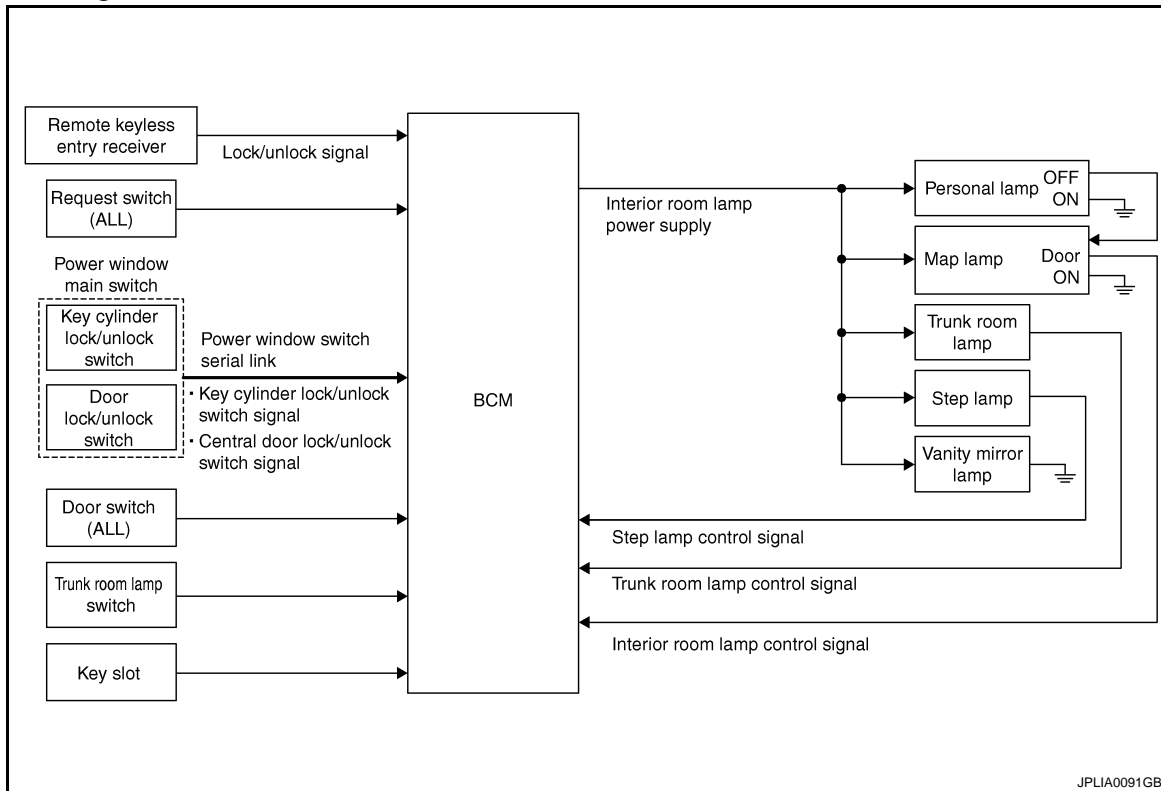

System Description

INFOID:000000005628252

OUTLINE

- Interior room lamp battery saver is controlled by BCM.
- BCM turns applicable lamps OFF depending on the vehicle condition. This function prevents the battery from over-discharging if the driver neglect turning OFF the any lamps.

Applicable lamps

- Map lamp
- Personal lamp
- Step lamp
- Trunk room lamp
- Vanity mirror lamp

INTERIOR ROOM LAMP BATTERY SAVER FUNCTION

- When the ignition switch is turned OFF, BCM operates the timer for a period of time to cut the interior room lamp power supply.
- BCM restart the timer when any of the following signals changes while operating the timer.
 - Ignition switch status
 - Door switch signal (ALL)
 - Door lock/unlock signal (Remote keyless entry receiver, each request switch, key cylinder lock/unlock switch, door lock/unlock switch)
 - Trunk room lamp switch signal
 - Key switch signal (Key slot)
- BCM provides the interior room lamp power supply continuously when the ignition switch position is other than OFF.

NOTE:

Each function of interior room lamp battery saver can be set by CONSULT-III. Refer to [INL-17, "BATTERY SAVER : CONSULT-III Function \(BCM - BATTERY SAVER\)"](#).

INTERIOR ROOM LAMP BATTERY SAVER SYSTEM

< SYSTEM DESCRIPTION >

Component Parts Location

INFOID:000000005628253

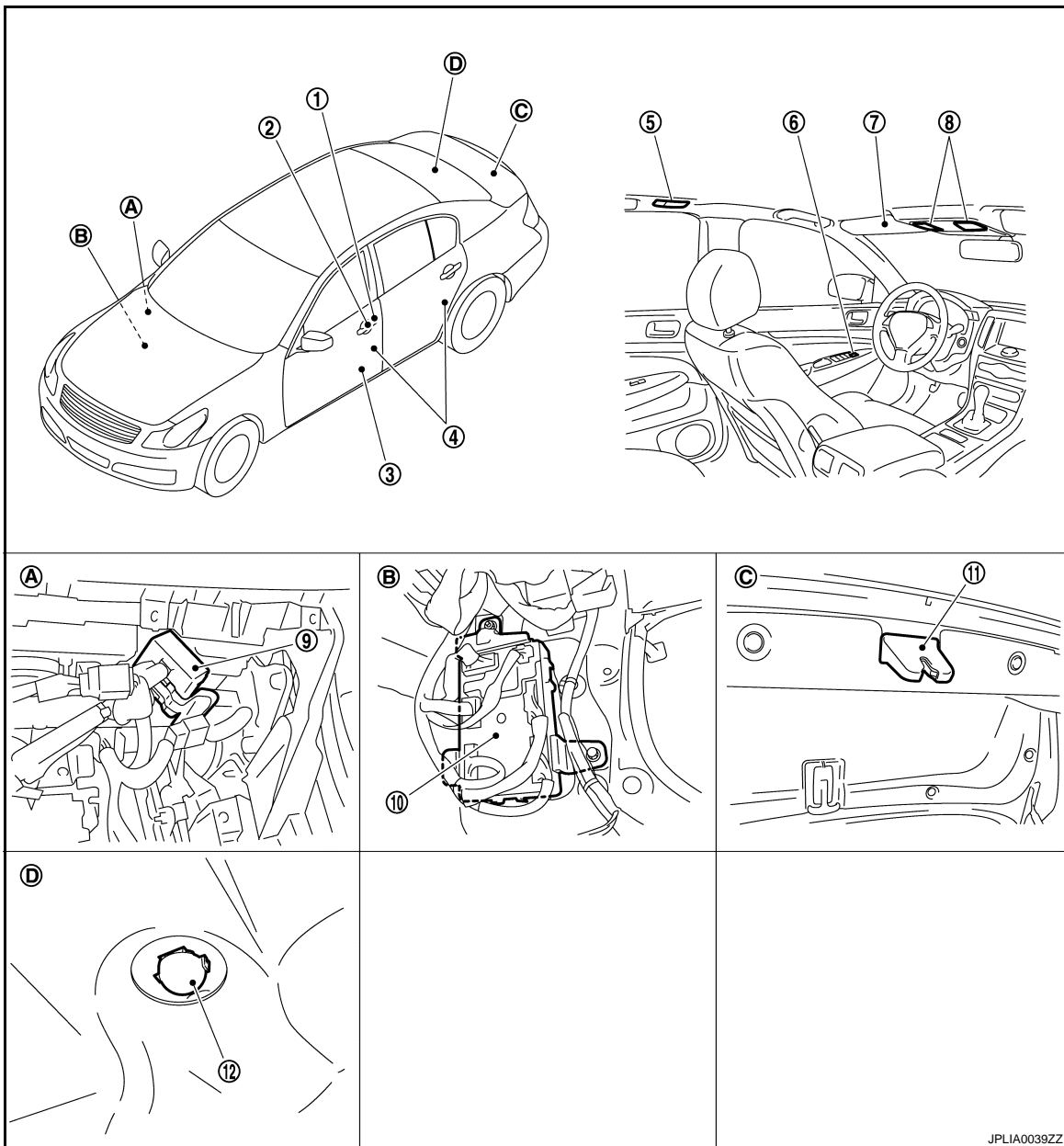

JPLIA0039ZZ

- | | | |
|-------------------------|-------------------------------------|----------------------------------|
| 1. Key cylinder switch | 2. Request switch | 3. Step lamp |
| 4. Door switch | 5. Personal lamp | 6. Door lock/unlock switch |
| 7. Vanity mirror lamp | 8. Map lamp | 9. Remote keyless entry receiver |
| 10. BCM | 11. Trunk room lamp switch | 12. Trunk room lamp |
| A. Behind the glove box | B. Dash side lower (passenger side) | C. Trunk lid lock assembly |
| D. Trunk room upward | | |

Component Description

INFOID:000000005628254

Part	Description
BCM	Operates the interior room lamp battery saver depending on the vehicle condition to cut the interior room lamp power supply.
Remote keyless entry receiver	Transmits the lock/unlock signal to BCM.

INTERIOR ROOM LAMP BATTERY SAVER SYSTEM

< SYSTEM DESCRIPTION >

Part	Description
<ul style="list-style-type: none">• Door lock/unlock switch• Key cylinder lock/unlock switch	Transmits a switch signal by power window switch serial link.
<ul style="list-style-type: none">• Request switch• Door switch• Trunk room lamp switch	Inputs a switch signal to BCM.
Key slot	Inputs the key switch status to BCM.

A

B

C

D

E

F

G

H

I

J

K

INL

M

N

O

P

ILLUMINATION CONTROL SYSTEM

< SYSTEM DESCRIPTION >

ILLUMINATION CONTROL SYSTEM

System Diagram

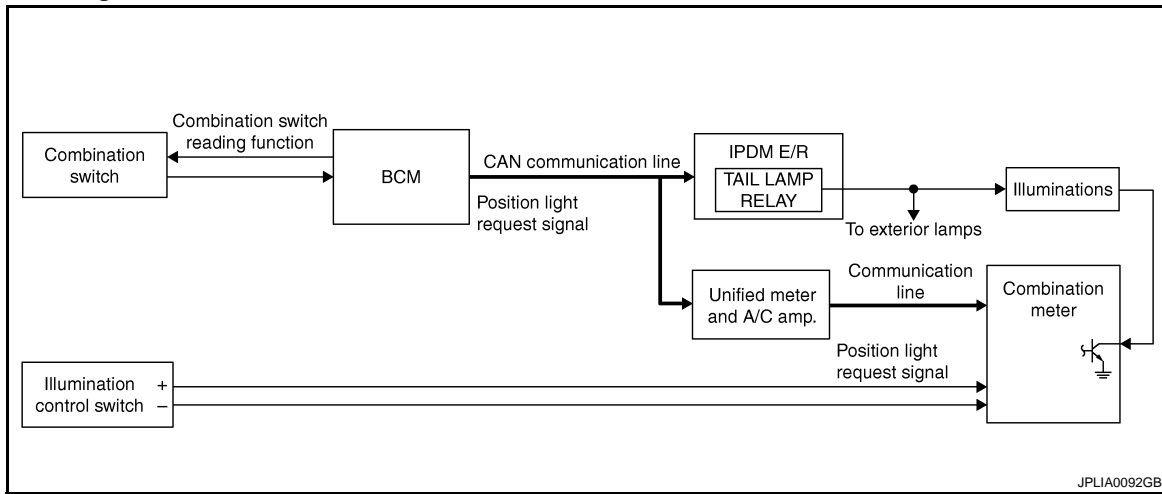

System Description

INFOID:000000005628256

OUTLINE

Each illumination lamp is controlled by each function of BCM, IPDM E/R and combination meter.

Control by BCM

- Combination switch reading function
- Headlamp control function

Control by IPDM E/R

- Relay control function

Control by combination meter

- Meter illumination control function (Refer to [MWI-25, "METER ILLUMINATION CONTROL : System Diagram."](#))

ILLUMINATION CONTROL

- BCM detects the combination switch condition by the combination switch reading function.
- BCM transmits position light request signal to IPDM E/R and combination meter (through the unified meter and A/C amp.) according to tail lamp ON condition.

Tail lamp ON condition

- Lighting switch 1ST
- Lighting switch 2ND
- Lighting switch AUTO, and the auto light function ON judgment (With auto light system)
- IPDM E/R turns the integrated tail lamp relay ON according to position light request signal. It provides the power supply to each illumination lamp.
- Combination meter enters in the nighttime mode according to position light request signal. Under the nighttime mode the combination meter controls the illuminance by controlling the each illumination lamp (ground side).

ILLUMINATION CONTROL SYSTEM

< SYSTEM DESCRIPTION >

Component Parts Location

INFOID:000000005628257

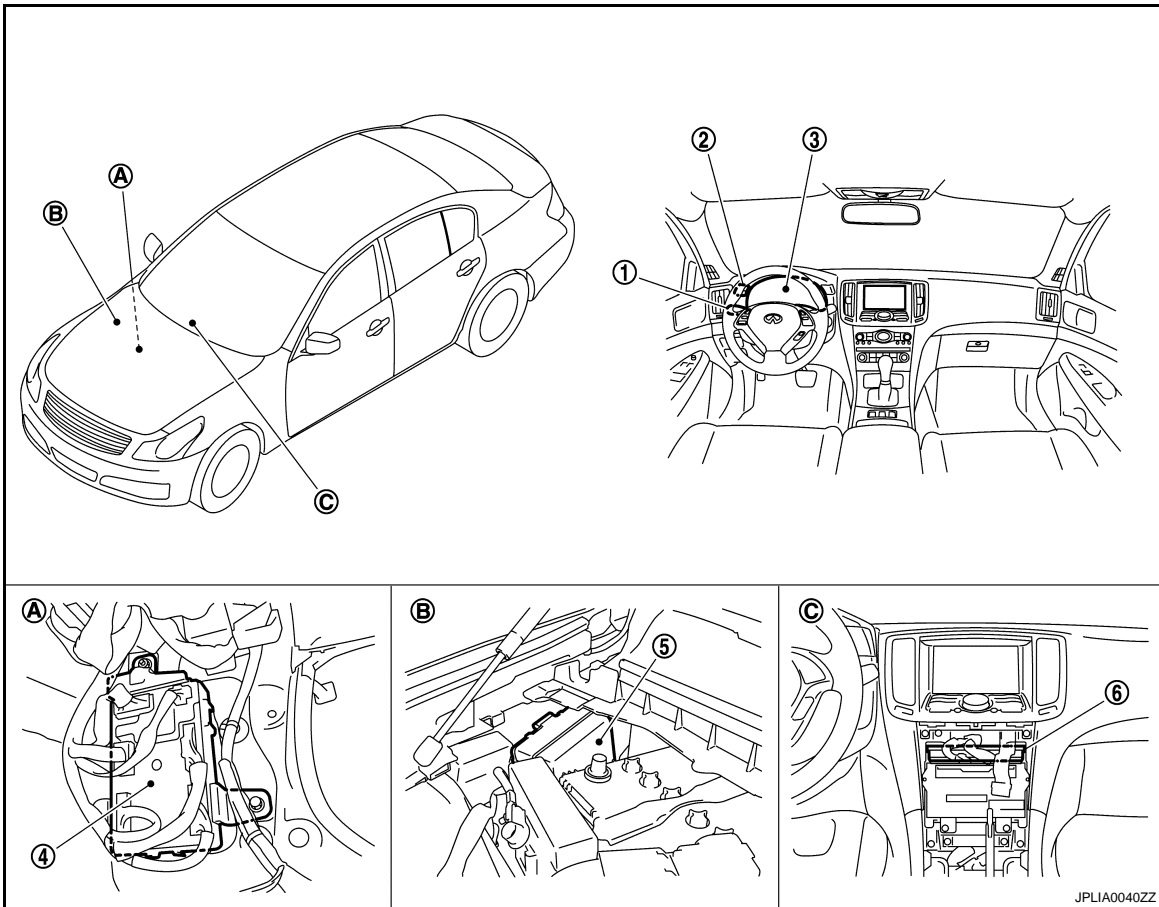

- | | | |
|------------------------------------|--------------------------------|-------------------------------|
| 1. Combination switch | 2. Illumination control switch | 3. Combination meter |
| 4. BCM | 5. IPDM E/R | 6. Unified meter and A/C amp. |
| A Dash side lower (passenger side) | B. Engine room dash panel (RH) | C. Behind the cluster lid C |

Component Description

INFOID:000000005628258

Part	Description
BCM	<ul style="list-style-type: none"> • Detects each switch condition by the combination switch reading function. • Judges the illumination lamp ON/OFF status depending on the vehicle condition. And then it transmits position light request signal to IPDM E/R and combination meter [with CAN communication (through the unified meter and A/C amp.)].
IPDM E/R	Controls the integrated relay according to the request from BCM (with CAN communication).
Combination meter	<ul style="list-style-type: none"> • Enters in nighttime mode according to the request from BCM (with CAN communication). • Controls the each illumination in the nighttime mode. Refer to MWI-25, "METER ILLUMINATION CONTROL : System Diagram" .
Combination switch (Lighting & turn signal switch)	Refer to BCS-6, "System Diagram" .

DIAGNOSIS SYSTEM (BCM)

< SYSTEM DESCRIPTION >

DIAGNOSIS SYSTEM (BCM)

COMMON ITEM

COMMON ITEM : CONSULT-III Function (BCM - COMMON ITEM)

INFOID:000000005628259

APPLICATION ITEM

CONSULT-III performs the following functions via CAN communication with BCM.

Diagnosis mode	Function Description
Work Support	Changes the setting for each system function.
Self Diagnostic Result	Displays the diagnosis results judged by BCM.
CAN Diag Support Monitor	Monitors the reception status of CAN communication viewed from BCM. Refer to CONSULT-III operation manual.
Data Monitor	The BCM input/output signals are displayed.
Active Test	The signals used to activate each device are forcibly supplied from BCM.
Ecu Identification	The BCM part number is displayed.
Configuration	This function is not used even though it is displayed.

SYSTEM APPLICATION

BCM can perform the following functions for each system.

NOTE:

It can perform the diagnosis modes except the following for all sub system selection items.

×: Applicable item

System	Sub system selection item	Diagnosis mode		
		Work Support	Data Monitor	Active Test
Door lock	DOOR LOCK	×	×	×
Rear window defogger	REAR DEFOGGER		×	×
Warning chime	BUZZER		×	×
Interior room lamp timer	INT LAMP	×	×	×
Exterior lamp	HEAD LAMP	×	×	×
Wiper and washer	WIPER	×	×	×
Turn signal and hazard warning lamps	FLASHER	×	×	×
—	AIR CONDITONER*			
<ul style="list-style-type: none"> • Intelligent Key system • Engine start system 	INTELLIGENT KEY	×	×	×
Combination switch	COMB SW		×	
Body control system	BCM	×		
IVIS - NATS	IMMU		×	×
Interior room lamp battery saver	BATTERY SAVER	×	×	×
Trunk lid open	TRUNK		×	×
Vehicle security system	THEFT ALM	×	×	×
RAP system	RETAINED PWR		×	
Signal buffer system	SIGNAL BUFFER		×	×
TPMS	TPMS (AIR PRESSURE MONITOR)	×	×	×

NOTE:

*: This item is displayed, but is not used.

FREEZE FRAME DATA (FFD)

The BCM records the following vehicle condition at the time a particular DTC is detected, and displays on CONSULT-III.

DIAGNOSIS SYSTEM (BCM)

< SYSTEM DESCRIPTION >

CONSULT screen item	Indication/Unit	Description		
Vehicle Speed	km/h	Vehicle speed of the moment a particular DTC is detected		A
Odo/Trip Meter	km	Total mileage (Odometer value) of the moment a particular DTC is detected		
Vehicle Condition	SLEEP>LOCK	Power position status of the moment a particular DTC is detected	While turning BCM status from low power consumption mode to normal mode (Power supply position is "LOCK")	B
	SLEEP>OFF		While turning BCM status from low power consumption mode to normal mode (Power supply position is "OFF".)	C
	LOCK>ACC		While turning power supply position from "LOCK" to "ACC"	
	ACC>ON		While turning power supply position from "ACC" to "IGN"	D
	RUN>ACC		While turning power supply position from "RUN" to "ACC" (Vehicle is stopping and selector lever is except P position.)	
	CRANK>RUN		While turning power supply position from "CRANKING" to "RUN" (From cranking up the engine to run it)	E
	RUN>URGENT		While turning power supply position from "RUN" to "ACC" (Emergency stop operation)	
	ACC>OFF		While turning power supply position from "ACC" to "OFF"	F
	OFF>LOCK		While turning power supply position from "OFF" to "LOCK"	
	OFF>ACC		While turning power supply position from "OFF" to "ACC"	G
	ON>CRANK		While turning power supply position from "IGN" to "CRANKING"	
	OFF>SLEEP		While turning BCM status from normal mode (Power supply position is "OFF".) to low power consumption mode	H
	LOCK>SLEEP		While turning BCM status from normal mode (Power supply position is "LOCK".) to low power consumption mode	
	LOCK		Power supply position is "LOCK" (Ignition switch OFF with steering is locked.)	I
	OFF		Power supply position is "OFF" (Ignition switch OFF with steering is unlocked.)	J
	ACC		Power supply position is "ACC" (Ignition switch ACC)	
	ON		Power supply position is "IGN" (Ignition switch ON with engine stopped)	K
	ENGINE RUN		Power supply position is "RUN" (Ignition switch ON with engine running)	
CRANKING	Power supply position is "CRANKING" (At engine cranking)	INL		
IGN Counter	0 - 39	The number of times that ignition switch is turned ON after DTC is detected <ul style="list-style-type: none"> • The number is 0 when a malfunction is detected now. • The number increases like 1 → 2 → 3...38 → 39 after returning to the normal condition whenever ignition switch OFF → ON. • The number is fixed to 39 until the self-diagnosis results are erased if it is over 39. 		M

INT LAMP

DIAGNOSIS SYSTEM (BCM)

< SYSTEM DESCRIPTION >

INT LAMP : CONSULT-III Function (BCM - INT LAMP)

INFOID:000000005628260

WORK SUPPORT

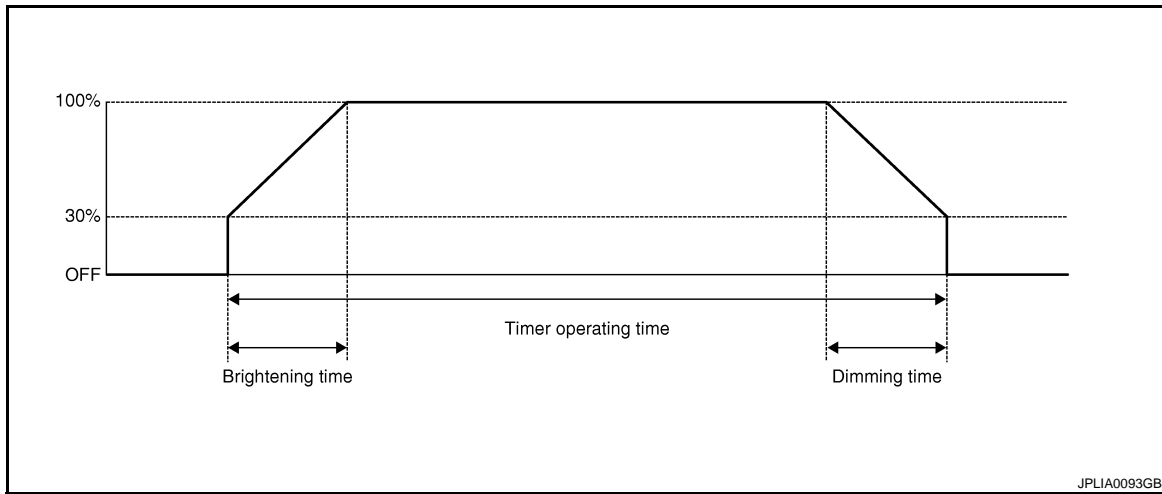

JPLIA0093GB

Service item	Setting item	Setting	
SET I/L D-UNLCK INTCON	ON*	With the interior room lamp timer function	
	OFF	Without the interior room lamp timer function	
ROOM LAMP TIMER SET	MODE 2	7.5 sec.	Sets the interior room lamp ON time. (Timer operating time)
	MODE 3*	15 sec.	
	MODE 4	30 sec.	
ROOM LAMP ON TIME SET	MODE 1	0.5 sec.	Sets the interior room lamp gradual brightening time.
	MODE 2*	1 sec.	
	MODE 3	2 sec.	
	MODE 4	3 sec.	
ROOM LAMP OFF TIME SET	MODE 1	0.5 sec.	Sets the interior room lamp gradual dimming time.
	MODE 2	1 sec.	
	MODE 3	2 sec.	
	MODE 4*	3 sec.	
R LAMP TIMER LOGIC SET	MODE 1*	Interior room lamp timer activates with synchronizing all doors.	
	MODE 2	Interior room lamp timer activates with synchronizing the driver door only.	

*: Factory setting

DATA MONITOR

Monitor item [Unit]	Description
REQ SW-DR [On/Off]	The switch status input from request switch (driver side)
REQ SW-AS [On/Off]	The switch status input from request switch (passenger side)
PUSH SW [On/Off]	The switch status input from push-button ignition switch
ACC RLY-F/B [On/Off]	NOTE: The item is indicated, but not monitored.
KEY SW-SLOT [On/Off]	Key switch status input from key slot

DIAGNOSIS SYSTEM (BCM)

< SYSTEM DESCRIPTION >

Monitor item [Unit]	Description
DOOR SW-DR [On/Off]	The switch status input from front door switch (driver side)
DOOR SW-AS [On/Off]	The switch status input from front door switch (passenger side)
DOOR SW-RR [On/Off]	The switch status input from rear door switch RH
DOOR SW- RL [On/Off]	The switch status input from rear door switch LH
DOOR SW-BK [On/Off]	NOTE: The item is indicated, but not monitored.
CDL LOCK SW [On/Off]	Lock switch status received from door lock/unlock switch by power window switch serial link
CDL UNLOCK SW [On/Off]	Unlock switch status received from door lock/unlock switch by power window switch serial link
KEY CYL LK-SW [On/Off]	Lock switch status received from key cylinder switch by power window switch serial link
KEY CYL UN-SW [On/Off]	Unlock switch status received from key cylinder switch by power window switch serial link
TRNK/HAT MNTR [On/Off]	The switch status input from trunk room lamp switch
RKE-LOCK [On/Off]	Lock signal status received from remote keyless entry receiver
RKE-UNLOCK [On/Off]	Unlock signal status received from remote keyless entry receiver

ACTIVE TEST

Test item	Operation	Description
INT LAMP	On	Outputs the interior room lamp control signal to turn map lamp and personal lamp ON (Map lamp switch is in DOOR position).
	Off	Stops the interior room lamp control signal to turn map lamp and personal lamp OFF.
STEP LAMP TEST	On	Outputs the step lamp control signal to turn step lamp ON.
	Off	Stops the step lamp control signal to turn step lamp OFF.
LUGGAGE LAMP TEST	On	Outputs the trunk room lamp control signal to turn trunk room lamp ON.
	Off	Stops the trunk room lamp control signal to turn trunk room lamp OFF.

BATTERY SAVER

BATTERY SAVER : CONSULT-III Function (BCM - BATTERY SAVER)

INFOID:000000005628261

WORK SUPPORT

Service item	Setting item	Setting	
BATTERY SAVER SET	On*	With the exterior lamp battery saver function	
	Off	Without the exterior lamp battery saver function	
ROOM LAMP BAT SAV SET	On*	With the interior room lamp battery saver function	
	Off	Without the interior room lamp battery saver function	
ROOM LAMP TIMER SET	MODE 1*	30 min.	Sets the interior room lamp battery saver timer operating time.
	MODE 2	60 min.	

*: Factory setting

DATA MONITOR

DIAGNOSIS SYSTEM (BCM)

< SYSTEM DESCRIPTION >

Monitor item [Unit]	Description
REQ SW-DR [On/Off]	The switch status input from request switch (driver side)
REQ SW-AS [On/Off]	The switch status input from request switch (passenger side)
REQ SW-RR [On/Off]	NOTE: The item is indicated, but not monitored.
REQ SW-RL [On/Off]	
PUSH SW [On/Off]	The switch status input from push-button ignition switch
ACC RLY-F/B [On/Off]	NOTE: The item is indicated, but not monitored.
KEY SW-SLOT [On/Off]	Key switch status input from key slot
UNLK SEN-DR [On/Off]	Driver door unlock status input from unlock sensor
DOOR SW-DR [On/Off]	The switch status input from front door switch (driver side)
DOOR SW-AS [On/Off]	The switch status input from front door switch (passenger side)
DOOR SW-RR [On/Off]	The switch status input from rear door switch RH
DOOR SW-RL [On/Off]	The switch status input from rear door switch LH
DOOR SW-BK [On/Off]	NOTE: The item is indicated, but not monitored.
CDL LOCK SW [On/Off]	Lock switch status received from door lock/unlock switch by power window switch serial link
CDL UNLOCK SW [On/Off]	Unlock switch status received from door lock/unlock switch by power window switch serial link
KEY CYL LK-SW [On/Off]	Lock switch status received from key cylinder switch by power window switch serial link
KEY CYL UN-SW [On/Off]	Unlock switch status received from key cylinder switch by power window switch serial link
TRNK/HAT MNTR [On/Off]	The switch status input from trunk room lamp switch
RKE-LOCK [On/Off]	Lock signal status received from remote keyless entry receiver
RKE-UNLOCK [On/Off]	Unlock signal status received from remote keyless entry receiver

ACTIVE TEST

Test item	Operation	Description
BATTERY SAVER	Off	Cuts the interior room lamp power supply to turn interior room lamp OFF.
	On	Outputs the interior room lamp power supply to turn interior room lamp ON.*

*: Each lamp switch is in ON position.

POWER SUPPLY AND GROUND CIRCUIT

< DTC/CIRCUIT DIAGNOSIS >

DTC/CIRCUIT DIAGNOSIS

POWER SUPPLY AND GROUND CIRCUIT

BCM

BCM : Diagnosis Procedure

INFOID:000000005628262

1. CHECK FUSE AND FUSIBLE LINK

Check that the following fuse and fusible link are not blown.

Signal name	Fuse and fusible link No.
Battery power supply	K
	10

Is the fuse fusing?

YES >> Replace the blown fuse or fusible link after repairing the affected circuit if a fuse or fusible link is blown.

NO >> GO TO 2.

2. CHECK POWER SUPPLY CIRCUIT

1. Turn ignition switch OFF.
2. Disconnect BCM connectors.
3. Check voltage between BCM harness connector and ground.

Terminals		Voltage (Approx.)
(+)	(-)	
BCM		Ground Battery voltage
Connector	Terminal	
M118	1	
M119	11	

Is the measurement value normal?

YES >> GO TO 3.

NO >> Repair harness or connector.

3. CHECK GROUND CIRCUIT

Check continuity between BCM harness connector and ground.

BCM		Ground	Continuity
Connector	Terminal		
M119	13		Existed

Does continuity exist?

YES >> INSPECTION END

NO >> Repair harness or connector.

INTERIOR ROOM LAMP POWER SUPPLY CIRCUIT

< DTC/CIRCUIT DIAGNOSIS >

INTERIOR ROOM LAMP POWER SUPPLY CIRCUIT

Description

INFOID:000000005628263

Provides the interior room lamp power supply. Also cuts the power supply when the interior room lamp battery saver activating.

Component Function Check

INFOID:000000005628264

1. CHECK INTERIOR ROOM LAMP POWER SUPPLY FUNCTION

Ⓟ CONSULT-III ACTIVE TEST

1. Turn the ignition switch ON.
2. Turn each interior room lamp ON.
 - Map lamp
 - Personal lamp
 - Step lamp
 - Vanity mirror lamp
 - Trunk room lamp
3. Select "BATTERY SAVER" of BCM (BATTERY SAVER) active test item.
4. With operating the test items, check that each interior room lamp turns ON/OFF.

Off : Interior room lamp OFF

On : Interior room lamp ON

Does the interior room lamp turn ON/OFF?

YES >> Interior room lamp power supply circuit is normal.

NO >> Refer to [INL-20. "Diagnosis Procedure"](#).

Diagnosis Procedure

INFOID:000000005628265

1. CHECK INTERIOR ROOM LAMP POWER SUPPLY OUTPUT

Ⓟ CONSULT-III ACTIVE TEST

1. Turn the ignition switch ON.
2. Select "BATTERY SAVER" of BCM (BATTERY SAVER) active test item.
3. With operating the test item, check voltage between BCM harness connector and the ground.

Terminals		Test item	Voltage (Approx.)
(+)	(-)		
BCM		BATTERY SAVER	0 V
Connector	Terminal		
M119	4	Off	0 V
		On	Battery voltage

Is the measurement value normal?

YES >> GO TO 2.

NO >> Replace BCM.

2. CHECK INTERIOR ROOM LAMP POWER SUPPLY OPEN CIRCUIT

1. Turn the ignition switch OFF.
2. Disconnect the following connectors.
 - Map lamp
 - Personal lamp
 - Vanity mirror lamp (LH)
 - Vanity mirror lamp (RH)
 - Trunk room lamp
 - Step lamp (driver side)
 - Step lamp (passenger side)

INTERIOR ROOM LAMP POWER SUPPLY CIRCUIT

< DTC/CIRCUIT DIAGNOSIS >

3. Check continuity between BCM harness connector and each interior room lamp harness connector.

BCM		Each interior room lamp		Continuity	
Connector	Terminal	Connector	Terminal		
M119	4	Map lamp	R15	1	Existed
		Personal lamp	R14	1	
		Vanity mirror lamp (LH)	R12	2	
		Vanity mirror lamp (RH)	R13	2	
		Trunk room lamp	B47	1	
		Step lamp (driver side)	D12	1	
		Step lamp (passenger side)	D42	1	

Does continuity exist?

YES >> GO TO 3.

NO >> Repair the harnesses or connectors.

3. CHECK INTERIOR ROOM LAMP POWER SUPPLY SHORT CIRCUIT

Check continuity between BCM harness connector and the ground.

BCM		Ground	Continuity
Connector	Terminal		
M119	4		Not existed

Does continuity exist?

YES >> Repair the harnesses or connectors.

NO >> Check that each interior room lamp has no internal short circuit.

A
B
C
D
E
F
G
H
I
J
K

INL

M
N
O
P

INTERIOR ROOM LAMP CONTROL CIRCUIT

< DTC/CIRCUIT DIAGNOSIS >

INTERIOR ROOM LAMP CONTROL CIRCUIT

Description

INFOID:000000005628266

Controls each interior room lamp (ground side) by PWM signal.

NOTE:

PWM signal control period is approximately 250 Hz (in the gradual brightening/dimming).

Component Function Check

INFOID:000000005628267

CAUTION:

Before performing the diagnosis, check that the following is normal.

- Interior room lamp power supply
- Map lamp bulb
- Personal lamp bulb

1. CHECK INTERIOR ROOM LAMP CONTROL FUNCTION

CONSULT-III ACTIVE TEST

1. Switch the map lamp switch to DOOR.
2. Turn the ignition switch ON.
3. Select "INT LAMP" of BCM (INT LAMP) active test item.
4. With operating the test items, check that each interior room lamp turns ON/OFF (gradual brightening/dimming).

On : Interior room lamp gradual brightening

Off : Interior room lamp gradual dimming

Does the interior room lamp turns ON/OFF (gradual brightening/dimming)?

YES >> Interior room lamp control circuit is normal.

NO >> Refer to [INL-22, "Diagnosis Procedure"](#).

Diagnosis Procedure

INFOID:000000005628268

1. CHECK INTERIOR ROOM LAMP CONTROL OUTPUT

CONSULT-III ACTIVE TEST

1. Turn the ignition switch OFF.
2. Remove all the bulbs of map lamp and personal lamp.
3. Select "INT LAMP" of BCM (INT LAMP) active test item.
4. With operating the test item, check continuity between BCM harness connector and the ground.

BCM		Ground	Test item	Continuity
Connector	Terminal		INT LAMP	
M119	19	Ground	On	Existed
			Off	Not existed

Is the measurement value normal?

YES >> GO TO 2.

Fixed ON>>GO TO 3.

Fixed OFF>>Replace BCM.

2. CHECK INTERIOR ROOM LAMP CONTROL OPEN CIRCUIT

1. Turn the ignition switch OFF.
2. Disconnect BCM connector, map lamp connector and personal lamp connector.
3. Check continuity between BCM harness connector, map lamp harness connector, and personal lamp harness connector.

INTERIOR ROOM LAMP CONTROL CIRCUIT

< DTC/CIRCUIT DIAGNOSIS >

BCM		Map lamp/personal lamp		Continuity	
Connector	Terminal	Connector	Terminal		
M119	19	Map lamp	R15	2	Existed
		Personal lamp	R14	3	

Does continuity exist?

YES >> Replace the map lamp or the personal lamp.

NO >> Repair the harnesses or connectors.

3. CHECK INTERIOR ROOM LAMP CONTROL SHORT CIRCUIT

1. Turn the ignition switch OFF.
2. Disconnect BCM connector, map lamp connector and personal lamp connector.
3. Check continuity between BCM harness connector and the ground.

BCM		Ground	Continuity
Connector	Terminal		
M119	19		Not existed

Does continuity exist?

YES >> Repair the harnesses or connectors.

NO >> Replace BCM.

A
B
C
D
E
F
G
H
I
J
K
M
N
O
P

INL

STEP LAMP CIRCUIT

< DTC/CIRCUIT DIAGNOSIS >

STEP LAMP CIRCUIT

Description

INFOID:000000005628269

Controls the step lamp (ground side) to turn the step lamp ON and OFF.

Component Function Check

INFOID:000000005628270

CAUTION:

Before performing the diagnosis, check that the following is normal.

- Interior room lamp power supply
- Step lamp bulb

1.CHECK STEP LAMP OPERATION

CONSULT-III ACTIVE TEST

1. Turn the ignition switch ON.
2. Select "STEP LAMP TEST" of BCM (INT LAMP) active test item.
3. With operating the test items, check that step lamp turns ON/OFF.

On : Step lamp ON

Off : Step lamp OFF

Does the step lamp turn ON/OFF?

- YES >> Step lamp circuit is normal.
NO >> Refer to [INL-24, "Diagnosis Procedure"](#).

Diagnosis Procedure

INFOID:000000005628271

1.CHECK STEP LAMP OUTPUT

CONSULT-III ACTIVE TEST

1. Turn the ignition switch OFF.
2. Remove the step lamp bulbs (driver side and passenger side).
3. Turn ignition switch ON.
4. Select "STEP LAMP TEST" of BCM (INT LAMP) active test item.
5. With operating the test item, check continuity between BCM harness connector and the ground.

BCM		Ground	Test item	Continuity
Connector	Terminal		STEP LAMP TEST	
M119	7		On	Existed
			Off	Not existed

Is the measurement value normal?

- YES >> GO TO 2.
Fixed ON>>GO TO 3.
Fixed OFF>>Replace BCM.

2.CHECK STEP LAMP OPEN CIRCUIT

1. Turn the ignition switch OFF.
2. Disconnect BCM connector, and step lamp connector.
3. Check continuity between BCM harness connector and step lamp harness connector.

BCM		Step lamp			Continuity
Connector	Terminal	Connector	Terminal		
M119	7	Driver side	D12	2	Existed
		Passenger side	D42	2	

STEP LAMP CIRCUIT

< DTC/CIRCUIT DIAGNOSIS >

Does continuity exist?

- YES >> Replace the step lamp.
NO >> Repair the harnesses or connectors.

3. CHECK STEP LAMP SHORT CIRCUIT

1. Turn the ignition switch OFF.
2. Check continuity between BCM harness connector and the ground.

BCM		Ground	Continuity
Connector	Terminal		
M119	7		Not existed

Does continuity exist?

- YES >> Repair the harnesses or connectors.
NO >> Replace BCM.

A
B
C
D
E
F
G
H
I
J
K
M
N
O
P

INL

TRUNK ROOM LAMP CIRCUIT

< DTC/CIRCUIT DIAGNOSIS >

TRUNK ROOM LAMP CIRCUIT

Description

INFOID:000000005628272

Controls the trunk room lamp (ground side) to turn the trunk room lamp ON and OFF.

Component Function Check

INFOID:000000005628273

CAUTION:

Before performing the diagnosis, check that the following is normal.

- Interior room lamp power supply
- Trunk room lamp bulb

1.CHECK TRUNK ROOM LAMP OPERATION

CONSULT-III ACTIVE TEST

1. Turn the ignition switch ON.
2. Select "LUGGAGE LAMP TEST" of BCM (INT LAMP) active test item.
3. With operating the test items, check that trunk room lamp turns ON/OFF.

On : Trunk room lamp ON

Off : Trunk room lamp OFF

Does the trunk room lamp turn ON/OFF?

- YES >> Trunk room lamp circuit is normal.
NO >> Refer to [INL-26, "Diagnosis Procedure"](#).

Diagnosis Procedure

INFOID:000000005628274

1.CHECK TRUNK ROOM LAMP OUTPUT

CONSULT-III ACTIVE TEST

1. Turn the ignition switch OFF.
2. Remove the trunk room lamp bulb.
3. Turn the ignition switch ON.
4. Select "LUGGAGE LAMP TEST" of BCM (INT LAMP) active test item.
5. With operating the test item, check continuity between BCM harness connector and the ground.

BCM		Ground	Test item	Continuity
Connector	Terminal		LUGGAGE LAMP TEST	
M120	30		On	Existed
			Off	Not existed

Is the measurement value normal?

- YES >> GO TO 2.
Fixed ON>>GO TO 3.
Fixed OFF>>Replace BCM.

2.CHECK TRUNK ROOM LAMP OPEN CIRCUIT

1. Turn the ignition switch OFF.
2. Disconnect BCM connector and trunk room lamp connector.
3. Check continuity between BCM harness connector and trunk room lamp harness connector.

BCM		Trunk room lamp		Continuity
Connector	Terminal	Connector	Terminal	
M120	30	B47	2	Existed

Does continuity exist?

- YES >> Replace trunk room lamp.

TRUNK ROOM LAMP CIRCUIT

< DTC/CIRCUIT DIAGNOSIS >

NO >> Repair harnesses or connectors.

3. CHECK TRUNK ROOM LAMP SHORT CIRCUIT

1. Turn the ignition switch OFF.
2. Disconnect BCM connector and trunk room lamp connector.
3. Check continuity between BCM harness connector and the ground.

BCM		Ground	Continuity
Connector	Terminal		
M120	30		Not existed

Does continuity exist?

YES >> Repair the harnesses or connectors.

NO >> Replace BCM.

A

B

C

D

E

F

G

H

I

J

K

INL

M

N

O

P

PUSH-BUTTON IGNITION SWITCH ILLUMINATION CIRCUIT

< DTC/CIRCUIT DIAGNOSIS >

PUSH-BUTTON IGNITION SWITCH ILLUMINATION CIRCUIT

Description

INFOID:000000005628275

Provides the power supply and the ground to control the push-button ignition switch illumination.

Component Function Check

INFOID:000000005628276

1.CHECK PUSH-BUTTON IGNITION SWITCH ILLUMINATION OPERATION

CONSULT-III ACTIVE TEST

1. Turn the ignition switch ON.
2. Select "ENGINE SW ILLUMI" of BCM (INTELLIGENT KEY) active test item.
3. With operating the test items, check that the push-button ignition switch illumination turns ON/OFF.

On : Push-button ignition switch illumination ON

Off : Push-button ignition switch illumination OFF

Does the push-button ignition switch illumination turn ON/OFF?

- YES >> Push-button ignition switch illumination circuit is normal.
NO >> Refer to [INL-28, "Diagnosis Procedure"](#).

Diagnosis Procedure

INFOID:000000005628277

1.CHECK ILLUMINATION CONTROL SWITCHING OPERATION

1. Turn the ignition switch ON.
2. With operating the lighting switch, check that the push-button ignition switch illumination turns ON/OFF.

Condition	Push-button ignition switch illumination
<ul style="list-style-type: none">• Ignition switch ON• Lighting switch 1ST	ON
<ul style="list-style-type: none">• Ignition switch OFF• Lighting switch OFF• Driver door LOCK	OFF

Does the push-button ignition switch illumination turn ON/OFF?

- YES >> GO TO 2.
NO >> GO TO 3.

2.CHECK PUSH-BUTTON IGNITION SWITCH ILLUMINATION GROUND CIRCUIT

1. Turn the ignition switch OFF.
2. Disconnect BCM connector and the push-button ignition switch connector.
3. Check continuity between BCM harness connector and the push-button ignition switch harness connector.

BCM		Push-button ignition switch		Continuity
Connector	Terminal	Connector	Terminal	
M119	14	M50	2	Existed

Does the continuity exist?

- YES >> Replace BCM.
NO >> Repair the harness or the connector.

3.CHECK PUSH-BUTTON IGNITION SWITCH ILLUMINATION POWER SUPPLY OUTPUT

CONSULT-III ACTIVE TEST

1. Turn the ignition switch ON.
2. Select "ENGINE SW ILLUMI" of BCM (INTELLIGENT KEY) active test item.
3. With operating the test item, check voltage between BCM harness connector and the ground.

PUSH-BUTTON IGNITION SWITCH ILLUMINATION CIRCUIT

< DTC/CIRCUIT DIAGNOSIS >

Terminals		Test item	Voltage (Approx.)
(+)	(-)		
BCM		ENGINE SW ILLUMI	
Connector	Terminal		
M123	133	ON	5 V
		OFF	0 V

Is the measurement value normal?

YES >> GO TO 4.

NO >> GO TO 5.

4. CHECK PUSH-BUTTON IGNITION SWITCH ILLUMINATION POWER SUPPLY OPEN CIRCUIT

1. Turn the ignition switch OFF.
2. Disconnect BCM connector and the push-button ignition switch connector.
3. Check continuity between BCM harness connector and the push-button ignition switch harness connector.

BCM		Push-button ignition switch		Continuity
Connector	Terminal	Connector	Terminal	
M123	133	M50	3	Existed

Does the continuity exist?

YES >> Replace the push-button ignition switch.

NO >> Repair the harness or the connector.

5. CHECK PUSH-BUTTON IGNITION SWITCH ILLUMINATION POWER SUPPLY SHORT CIRCUIT

1. Turn the ignition switch OFF.
2. Disconnect BCM connector and the push-button ignition switch connector.
3. Check continuity between BCM harness connector and the ground.

BCM		Ground	Continuity
Connector	Terminal		
M123	133		Not existed

Does the continuity exist?

YES >> Repair the harness or the connector.

NO >> Replace BCM.

A
B
C
D
E
F
G
H
I
J
K
M
N
O
P

INL

INTERIOR ROOM LAMP CONTROL SYSTEM

< DTC/CIRCUIT DIAGNOSIS >

INTERIOR ROOM LAMP CONTROL SYSTEM

Wiring Diagram - INTERIOR ROOM LAMP -

INFOID:000000005628278

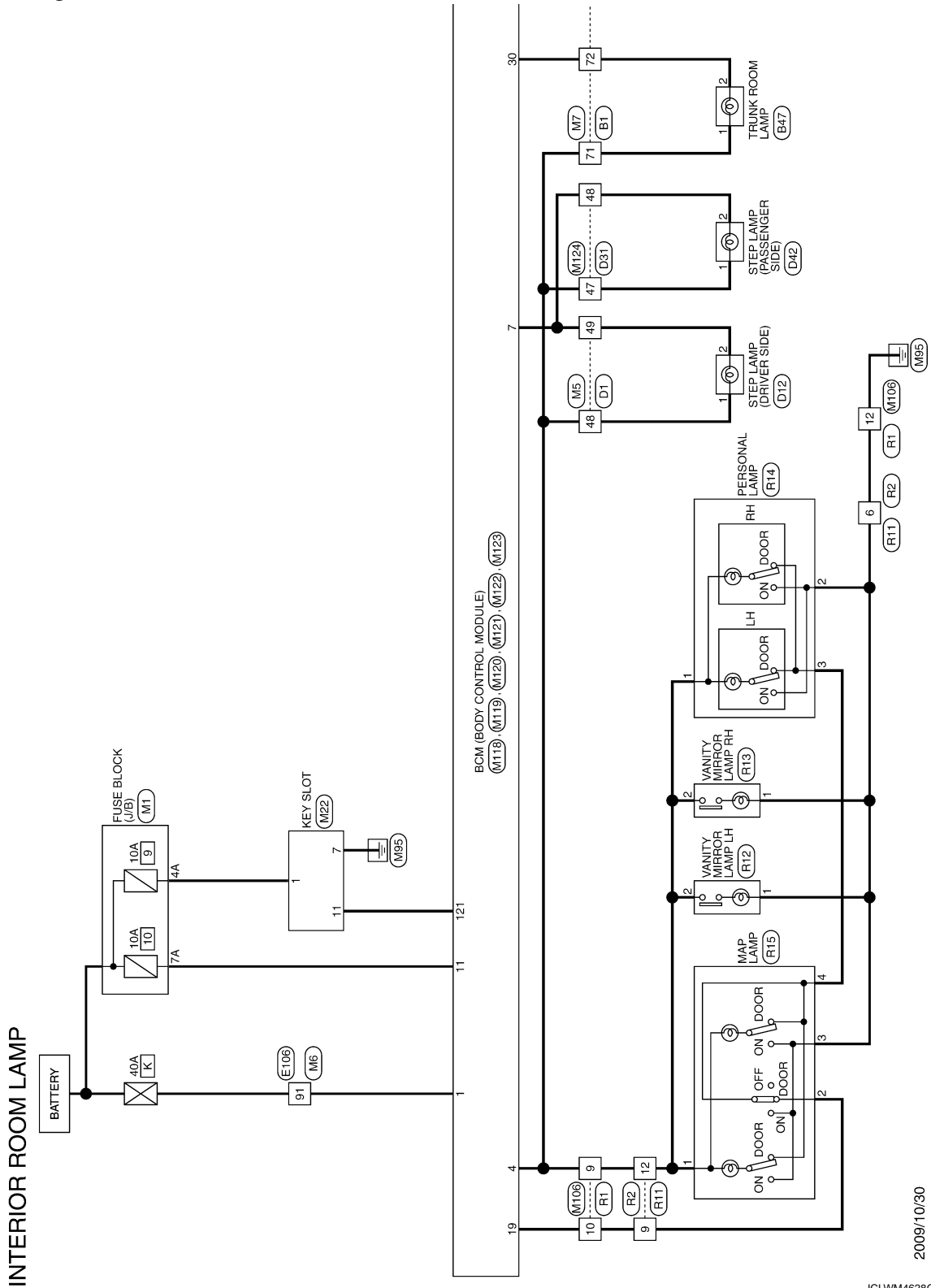

2009/10/30

JCLWM4628GE

INTERIOR ROOM LAMP CONTROL SYSTEM

< DTC/CIRCUIT DIAGNOSIS >

INTERIOR ROOM LAMP

Connector No.	B1
Connector Name	WIRE TO WIRE
Connector Type	TH80YW-CS16-TM4



Terminal No.	Color of Wire	Signal Name [Specification]
1	GR	
2	BG	
3	L	
4	Y	
6	R	
8	W	
9	V	
15	Y	
16	BR	
17	LG	
18	BG	
20	L	
21	P	
22	L	
23	P	
24	V	
25	SB	
26	G	
27	W	
28	R	
31	V	
32	SB	
33	SHIELD	
34	W	
35	BR	
36	Y	
37	SHIELD	
38	Y	
39	SB	
40	P	
41	L	
42	SHIELD	
43	R	
44	G	
45	SHIELD	
46	SB	
55	BR	
56	R	

58	V	
59	SR	
60	BR	
61	W	
62	R	
63	L	
64	Y	
65	SHIELD	
71	BG	
72	GR	
73	P	
74	L	
81	V	
82	B	
84	Y	
85	G	
86	W	
87	R	
88	BR	
89	Y	
90	SB	
91	BG	
92	BR	
93	P	
95	BG	
96	Y	
100	GR	

Connector No.	B16
Connector Name	FRONT DOOR SWITCH (DRIVER SIDE)
Connector Type	A03FW

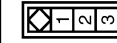

Terminal No.	Color of Wire	Signal Name [Specification]
2	BR	

Connector No.	B23
Connector Name	REAR DOOR SWITCH LH
Connector Type	A03FW

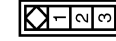

Terminal No.	Color of Wire	Signal Name [Specification]
2	Y	

Connector No.	B27
Connector Name	WIRE TO WIRE
Connector Type	NS1BMW-CS



Terminal No.	Color of Wire	Signal Name [Specification]
2	BG	
3	B	
4	Y	
5	B	
6	W	
10	LG	
11	G	
12	SHIELD	- [With NAVI]
13	G	- [Without NAVI]
14	W	- [With NAVI]
15	R	- [Without NAVI]

Connector No.	B47
Connector Name	TRUNK ROOM LAMP
Connector Type	S02FW



Terminal No.	Color of Wire	Signal Name [Specification]
1	BG	
2	GR	

JCLWM4630GE

INTERIOR ROOM LAMP CONTROL SYSTEM

< DTC/CIRCUIT DIAGNOSIS >

INTERIOR ROOM LAMP

Connector No.	B201
Connector Name	WIRE TO WIRE
Connector Type	TH80FW-CS16-TM4

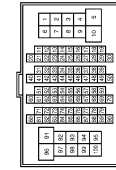

Terminal No.	Color of Wire	Signal Name [Specification]
1	BR	-
5	P	-
6	L	-
7	V	-
8	LG	-
10	L	-
31	L	-
32	P	-
33	G	-
34	R	-
40	GR	-
41	LG	-
42	BG	-
43	R	-
45	G	-
46	SHIELD	-
47	G	-
48	Y	-
48	SHIELD	-
50	W	-
71	R	-
72	V	-
80	BG	-
81	SHIELD	-
82	G	-
83	P	-
84	L	-
85	SHIELD	-
86	G	-
87	R	-
88	W	-
89	B	-
90	Y	-
91	V	-
92	W	-
93	BG	-
94	R	-
95	SB	-

96	G	-
97	GR	-
98	BR	-
99	P	-
100	L	-

Connector No.	B218
Connector Name	FRONT DOOR SWITCH (PASSENGER SIDE)
Connector Type	A03FW

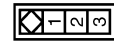

Terminal No.	Color of Wire	Signal Name [Specification]
2	GR	-

Connector No.	B223
Connector Name	REAR DOOR SWITCH RH
Connector Type	A03FW

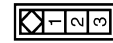

Terminal No.	Color of Wire	Signal Name [Specification]
2	BR	-

Connector No.	B301
Connector Name	WIRE TO WIRE
Connector Type	MS16FW-CS



Terminal No.	Color of Wire	Signal Name [Specification]
2	BG	-
3	B	-
4	G	-
5	B	-
6	W	-
10	LG	-
11	V	-
12	SHIELD	-
13	Y	-
14	W	-
15	R	-

Connector No.	B303
Connector Name	TRUNK LID LOCK ASSEMBLY
Connector Type	TB03FW



Terminal No.	Color of Wire	Signal Name [Specification]
1	V	-
2	B	-
3	G	-

A
B
C
D
E
F
G
H
I
J
K
L
M
N
O
P

INL

JCLWM4631GE

INTERIOR ROOM LAMP CONTROL SYSTEM

< DTC/CIRCUIT DIAGNOSIS >

INTERIOR ROOM LAMP

Connector No.	D1
Connector Name	WIRE TO WIRE
Connector Type	TH40FW-CS15

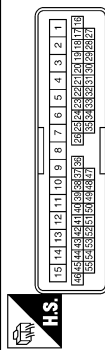

Terminal No.	Color of Wire	Signal Name [Specification]
1	Y	-
2	B	-
3	SB	-
4	V	-
5	L	-
6	P	-
7	LG	-
8	W	-
9	G	-
10	LG	-
11	L	-
12	W	-
13	W	-
14	G	-
15	R	-
16	GR	-
17	L	-
18	BR	-
19	BG	-
20	P	-
21	R	-
25	V	-
26	R	-
27	BR	-
28	W	-
29	Y	-
30	G	-
31	LG	-
32	GR	-
33	B	-
36	W	-
37	P	-
38	V	-
39	BR	-
42	G	-
43	GR	-
44	BG	-
45	G	-
47	R	-
48	SB	-
49	W	-
50	P	-
51	V	-
52	GR	-
53	BG	-
54	G	-

52	V	-
----	---	---

Connector No.	D8
Connector Name	POWER WINDOW MAIN SWITCH
Connector Type	NS16FW-CS

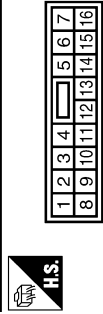

Terminal No.	Color of Wire	Signal Name [Specification]
2	LG	-
4	V	-
6	Y	-
8	L	-
9	BG	-
10	SB	-
11	G	-
13	P	-
14	V	-
15	B	-

Connector No.	D9
Connector Name	POWER WINDOW MAIN SWITCH
Connector Type	NS03FW-CS



Terminal No.	Color of Wire	Signal Name [Specification]
17	B	-
19	Y	-

Connector No.	D12
Connector Name	STEP LAMP (DRIVER SIDE)
Connector Type	TB02FW



Terminal No.	Color of Wire	Signal Name [Specification]
1	R	-
2	SB	-

Connector No.	D15
Connector Name	FRONT DOOR LOCK ASSEMBLY (DRIVER SIDE)
Connector Type	E08FGY-RS

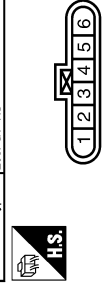

Terminal No.	Color of Wire	Signal Name [Specification]
1	LG	-
2	P	-
3	L	-
4	B	-
5	V	-
8	V	-

Connector No.	D31
Connector Name	WIRE TO WIRE
Connector Type	TH40FW-CS15

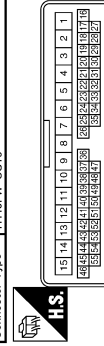

Terminal No.	Color of Wire	Signal Name [Specification]
1	Y	-
2	V	-
3	B	-
7	LG	-
8	P	-
10	L	-
11	W	-
12	G	-
13	R	-
36	W	-
37	P	-
38	V	-
39	BR	-
42	L	-
43	GR	-
44	BG	-
45	G	-
47	R	-
48	SB	-
49	W	-
50	P	-
51	V	-
52	GR	-
53	BG	-
54	G	-

Connector No.	D38
Connector Name	FRONT POWER WINDOW SWITCH (PASSENGER SIDE)
Connector Type	NS16FW-CS



Terminal No.	Color of Wire	Signal Name [Specification]
3	LG	-
4	B	-
8	L	-
9	G	-
10	Y	-
11	B	-
12	P	-
15	BG	-
16	V	-

INTERIOR ROOM LAMP CONTROL SYSTEM

< DTC/CIRCUIT DIAGNOSIS >

INTERIOR ROOM LAMP

Connector No.	D42
Connector Name	STEP LAMP (PASSENGER SIDE)
Connector Type	THB2FW



Terminal No.	Color of Wire	Signal Name [Specification]
1	R	-
2	SB	-

Connector No.	E108
Connector Name	WIRE TO WIRE
Connector Type	THB0FW-CS16-TM4

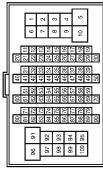

Terminal No.	Color of Wire	Signal Name [Specification]
1	V	-
2	SB	-
3	BG	-
4	W	-
5	P	-
6	L	-
7	V	-
11	V	-
12	P	-
13	R	-
14	W	-
15	L	-
16	GR	-
17	SB	-
18	LG	-
29	G	-
31	L	-
32	BG	-
33	P	-
34	V	-
35	W	-

36	BG	-
37	G	-
38	R	-
40	R	-
41	LG	-
42	SB	-
43	G	-
44	LG	-
45	GR	-
46	BR	-
47	B	-
48	Y	-
49	V	-
50	R	-
51	SB	-
52	P	-
53	G	-
54	B	-
57	GR	-
58	V	-
80	R	-
81	P	-
82	G	-
83	V	-
84	L	-
85	W	-
86	GR	-
87	LG	-
88	L	-
89	BR	-
91	W	-
92	LG	-
93	GR	-
94	SB	-
95	GR	-
96	R	-
97	Y	-
98	SHIELD	-
99	L	-
100	P	-

Connector No.	M1
Connector Name	FUSE BLOCK (L/R)
Connector Type	MSB6FW-M2



Terminal No.	Color of Wire	Signal Name [Specification]
1A	V	-
2A	G	-
3A	L	-
4A	P	-
5A	L	-
6A	Y	-
7A	R	-
8A	L	-

Connector No.	M5
Connector Name	WIRE TO WIRE
Connector Type	TH40MW-CS15

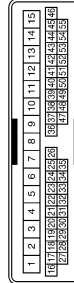

Terminal No.	Color of Wire	Signal Name [Specification]
1	Y	-
2	B	-
3	BG	-
4	V	-
8	SB	-
9	G	-
10	V	-
12	L	-
13	W	-
14	B	-
15	W	-
16	R	-
17	BR	-
18	V	-

19	BG	-
20	P	-
21	W	-
25	Y	-
26	G	-
27	L	-
28	Y	-
29	G	-
30	SB	-
31	LG	-
32	W	-
33	B	-
36	W	-
37	GR	-
38	Y	-
39	B	-
42	Y	-
43	L	-
44	G	-
44	L	-
47	L	-
48	GR	-
49	SB	-
50	P	-
51	LG	-
52	V	-

A
B
C
D
E
F
G
H
I
J
K
L
M
N
O
P

INL

INTERIOR ROOM LAMP CONTROL SYSTEM

< DTC/CIRCUIT DIAGNOSIS >

INTERIOR ROOM LAMP

Connector No.	M6
Connector Name	WIRE TO WIRE
Connector Type	TH80MW-CS16-TM4

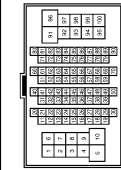

Terminal No.	Color of Wire	Signal Name [Specification]
1	W	
2	GR	
3	R	
5	W	
6	P	
7	L	
11	V	
12	P	
13	R	
14	W	
15	L	
16	GR	
17	BR	
18	L	
28	G	
31	L	
32	Y	
33	BG	
34	W	
35	BR	
36	P	
37	P	
38	G	
40	V	
41	LG	
42	R	
43	G	
44	B	
45	R	
46	BG	
47	SB	
48	Y	
49	L	
50	R	
51	R	
52	W	
53	G	

54	B	
57	B	
58	LG	
60	SB	
61	B	
82	W	
83	W	
84	L	
85	GR	
86	Y	
87	G	
88	G	
89	R	
91	W	
92	Y	
93	BG	
94	L	
95	L	
96	R	
97	LG	
98	SHIELD	
99	V	
100	SB	

Connector No.	M7
Connector Name	WIRE TO WIRE
Connector Type	TH80MW-CS16-TM4

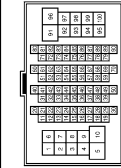

Terminal No.	Color of Wire	Signal Name [Specification]
1	GR	
2	P	
3	SB	
3	P	
4	Y	
6	L	
8	G	
9	Y	
15	R	
16	BR	
17	P	
18	V	
20	L	

21	P	
22	L	
23	P	
24	V	
25	LG	
26	BR	
27	BG	
28	LG	
31	V	
32	LG	
33	SHIELD	
34	GR	
35	R	
37	SHIELD	
38	SB	
39	LG	
40	O	
41	W	
42	SHIELD	
43	R	
44	G	
45	SHIELD	
48	SB	
55	W	
56	B	
58	V	
59	Y	
60	Y	
61	W	
62	R	
63	G	
64	B	
65	SHIELD	
71	V	
72	P	
72	SB	
74	V	
81	W	
82	BR	
84	LG	
85	BG	
86	SB	
87	G	
88	GR	
89	L	
90	P	
91	BG	
92	L	
93	P	
95	BG	
96	Y	

100	P	
-----	---	--

Connector No.	M22
Connector Name	KEY SLOT
Connector Type	TH12FW-NH

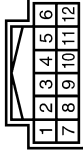

Terminal No.	Color of Wire	Signal Name [Specification]
1	R	BAT
2	GR	GLOCK
3	W	DATA
5	Y	ILL.BAT
6	LG	ILL.
7	B	GND
11	SB	KEY SWITCH SIGNAL

Connector No.	M24
Connector Name	DATA LINK CONNECTOR
Connector Type	BD16FW-P

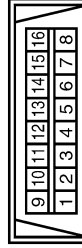

Terminal No.	Color of Wire	Signal Name [Specification]
3	LG	
4	B	
5	B	
6	L	
7	V	
8	G	
11	SB	
14	P	
16	R	

INTERIOR ROOM LAMP CONTROL SYSTEM

< DTC/CIRCUIT DIAGNOSIS >

INTERIOR ROOM LAMP

Connector No.	M159
Connector Name	PUSH-BUTTON IGNITION SWITCH
Connector Type	TK28FBR



1	2	3
4	5	6
7	8	

Terminal No.	Color of Wire	Signal Name [Specification]
1	B	-
2	R	-
3	L	-
4	BR	-
5	LG	-
6	EG	-
7	GR	-
8	P	-

Connector No.	M106
Connector Name	WIRE TO WIRE
Connector Type	NH10MW-CS10



1	2	3	4	5	6
7	8	9	10	11	12
13	14	15	16	17	18
19	20				

Terminal No.	Color of Wire	Signal Name [Specification]
2	L	-
3	SHIELD	-
4	G	-
5	BR	-
6	EG	-
7	Y	-
8	P	-
9	LG	-
10	V	-
11	B	-
12	B	-
13	R	-
14	R	-
15	R	-
16	G	-

17	SHIELD	-
18	B	-
19	Y	-
20	R	-

Connector No.	M117
Connector Name	WIRE TO WIRE
Connector Type	TH80MW-CS16-TM4



1	2	3	4	5	6	7	8	9	10	11	12	13	14	15	16	17	18	19	20
---	---	---	---	---	---	---	---	---	----	----	----	----	----	----	----	----	----	----	----

Terminal No.	Color of Wire	Signal Name [Specification]
1	LG	-
5	P	-
6	G	-
7	SB	-
9	LG	-
10	L	-
31	SB	-
32	LG	-
33	SB	-
34	LG	-
40	Y	-
41	G	-
42	LG	-
43	R	-
45	G	-
46	SHIELD	-
47	P	-
48	L	-
49	SHIELD	-
50	V	-
71	R	-
72	L	-
80	W	-
81	SHIELD	-
82	P	-
83	L	-
84	G	-
85	SHIELD	-
86	W	-
87	B	-
88	R	-
89	G	-

90	Y	-
91	V	-
92	BR	-
93	V	-
94	Y	-
95	G	-
96	G	-
97	R	-
98	BG	-
99	P	-
100	L	-

Connector No.	M118
Connector Name	BCM (BODY CONTROL MODULE)
Connector Type	M03FE-LC



1	2	3
---	---	---

Terminal No.	Color of Wire	Signal Name [Specification]
1	W	BAT (7/L)
2	Y	POWER WINDOW POWER SUPPLY (BAT)
3	BG	POWER WINDOW POWER SUPPLY (RAP)

Connector No.	M119
Connector Name	BCM (BODY CONTROL MODULE)
Connector Type	NS18FW-CS



4	5	6	7	8	9	10
11	12	13	14	15	16	17
18	19					

Terminal No.	Color of Wire	Signal Name [Specification]
4	LG	INTERIOR ROOM LAMP POWER SUPPLY
5	P	PASSENGER DOOR UNLOCK OUTPUT
7	SB	STEP LAMP OUTPUT
8	V	ALL DOOR FUEL LID LOCK OUTPUT
9	G	DRIVER DOOR FUEL LID UNLOCK OUTPUT
10	P	REAR DOOR UNLOCK OUTPUT

11	R	BAT (FUSE)
13	B	GND
14	W	PUSH-BUTTON IGNITION SW ILL GND
15	BG	ACC IND
17	W	TURN SIGNAL RH (FRONT)
18	BG	TURN SIGNAL LH (FRONT)
19	V	ROOM LAMP TIMER CONTROL

Connector No.	M120
Connector Name	BCM (BODY CONTROL MODULE)
Connector Type	NS12FW-CS



20	21	22	23	24
25	26	27	28	29
30	31			

Terminal No.	Color of Wire	Signal Name [Specification]
20	V	TURN SIGNAL RH (REAR)
23	LG	TRUNK LID OPEN OUTPUT
25	Y	TURN SIGNAL LH (REAR)
30	P	TRUNK ROOM LAMP

A
B
C
D
E
F
G
H
I
J
K
L
M
N
O
P

INL

JCLWM4635GE

INTERIOR ROOM LAMP CONTROL SYSTEM

< DTC/CIRCUIT DIAGNOSIS >

INTERIOR ROOM LAMP

Connector No.	M121
Connector Name	BCM (BODY CONTROL MODULE)
Connector Type	TH40FG-NH



1	2	3	4	5	6	7	8	9	10	11	12	13	14	15	16	17	18	19	20
---	---	---	---	---	---	---	---	---	----	----	----	----	----	----	----	----	----	----	----

Terminal No.	Color of Wire	Signal Name [Specification]
34	SB	TRUNK ROOM ANT-
35	V	TRUNK ROOM ANT+
36	B	REAR BUMPER ANT-
39	W	REAR BUMPER ANT+
47	Y	IGN RELAY (IPDM E/R) CONT
50	EG	TRUNK ROOM LAMP SW
52	R	STARTER RELAY CONT
61	SB	TRUNK LID OPENER REQUEST SW
64	G	I-KEY WARN BUZZER (ENG ROOM)
67	GR	TRUNK LID OPENER SW
68	EG	REAR RH DOOR SW
69	L	REAR LH DOOR SW

Connector No.	M122
Connector Name	BCM (BODY CONTROL MODULE)
Connector Type	TH40FB-NH



1	2	3	4	5	6	7	8	9	10	11	12	13	14	15	16	17	18	19	20
---	---	---	---	---	---	---	---	---	----	----	----	----	----	----	----	----	----	----	----

Terminal No.	Color of Wire	Signal Name [Specification]
72	R	ROOM ANT 2-
73	G	ROOM ANT 2+
74	SB	PASSENGER DOOR ANT-
75	BR	PASSENGER DOOR ANT+
76	V	DRIVER DOOR ANT-
77	LG	DRIVER DOOR ANT+
78	Y	ROOM ANT 1-
79	BR	ROOM ANT 1+
80	GR	NAIS ANT AMP
81	W	INATS ANT AMP

82	SB	IGN RELAY (F/B) CONT
83	Y	KEYLESS ENTRY RECEIVER COMM
87	Y	COMBI SW INPUT 5
88	EG	COMBI SW INPUT 3
89	BR	PUSH SW
90	P	CAN-L
91	L	CAN-H
92	LG	KEY SLOT ILL
93	GR	ON IND
95	EG	ACC RELAY CONT
96	GR	A/T SHIFT SELECTOR POWER SUPPLY
97	L	S/L CONDITION 1
98	P	S/L CONDITION 2
99	R	SHIFT P [With A/T]
99	BR	ICC CLUTCH SW [With M/T and ICC]
99	BR	ASGD CLUTCH SW [With M/T without ICC]
100	Y	PASSENGER DOOR REQUEST SW
101	P	DRIVER DOOR REQUEST SW
102	EG	BLOWER FAN MOTOR RELAY CONT
103	P	KEYLESS ENTRY RECEIVER POWER SUPPLY
106	SB	S/L UNIT POWER SUPPLY
107	LG	COMBI SW INPUT 1
108	R	COMBI SW INPUT 4
109	W	COMBI SW INPUT 2
110	G	HAZARD SW
111	Y	S/L UNIT COMM

Connector No.	M123
Connector Name	BCM (BODY CONTROL MODULE)
Connector Type	TH40FG-NH



1	2	3	4	5	6	7	8	9	10	11	12	13	14	15	16	17	18	19	20
---	---	---	---	---	---	---	---	---	----	----	----	----	----	----	----	----	----	----	----

Terminal No.	Color of Wire	Signal Name [Specification]
112	R	RAIN SENSOR SERIAL LINK
113	EG	OPTICAL SENSOR
114	R	CLUTCH INTERLOCK SW
116	SB	STOP LAMP SW 1
118	BR	STOP LAMP SW 2
119	SB	DR DOOR UNLOCK SENSOR
121	SB	KEY SLOT SW
123	V	IGN F/B
124	R	PASSENGER DOOR SW
129	EG	TRUNK LID OPENER CANCEL SW

132	V	POWER WINDOW SW COMM
133	L	PUSH-BUTTON IGNITION SW ILL POWER
134	LG	LOCK IND
137	EG	RECEIVER / SENSOR CMD
138	V	RECEIVER / SENSOR POWER SUPPLY
139	L	TIRE PRESSURE RECEIVER COMM
140	B	SHIFT IN/P
141	W	SECURITY INDICATOR LAMP
142	BR	COMBI SW OUTPUT 5
143	P	COMBI SW OUTPUT 1
144	G	COMBI SW OUTPUT 2
145	L	COMBI SW OUTPUT 3
146	SB	COMBI SW OUTPUT 4
149	W	TIRE PRESSURE WARN CHECK SW
150	GR	DRIVER DOOR SW
151	G	REAR WINDOW DEFOGGER RELAY CONT



Connector No.	M124
Connector Name	WIRE TO WIRE
Connector Type	TH40MW-CS15



1	2	3	4	5	6	7	8	9	10	11	12	13	14	15	16	17	18	19	20
---	---	---	---	---	---	---	---	---	----	----	----	----	----	----	----	----	----	----	----

Terminal No.	Color of Wire	Signal Name [Specification]
1	W	-
2	GR	-
3	B	-
7	V	-
8	P	-
10	BR	-
11	R	-
12	G	-
13	R	-
36	G	-
37	R	-
38	GR	-
39	L	-
42	BG	-
43	BG	-
44	W	-
45	SB	-
47	LG	-
48	P	-
49	Y	-

50	BR	-
51	SB	-
52	L	-
53	L	-
54	Y	-

Connector No.	RT
Connector Name	WIRE TO WIRE
Connector Type	NH10FW-CS10



6	5	4	3	2	1								
20	19	18	17	16	15	14	13	12	11	10	9	8	7

Terminal No.	Color of Wire	Signal Name [Specification]
2	L	-
3	SHIELD	-
4	G	-
5	BR	-
6	Y	-
7	GR	-
8	BR	-
9	R	-
10	V	-
11	B	-
12	B	-
13	Y	-
15	R	-
16	G	-
17	SHIELD	-
18	B	-
19	Y	-
20	R	-

INTERIOR ROOM LAMP CONTROL SYSTEM

< DTC/CIRCUIT DIAGNOSIS >

INTERIOR ROOM LAMP

Connector No.	R2
Connector Name	WIRE TO WIRE
Connector Type	TH12PW-NH

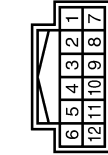

Terminal No.	Color of Wire	Signal Name [Specification]
1	B	-
2	B	-
3	SHIELD	-
4	R	-
5	G	-
6	B	-
7	P	-
8	GR	-
9	V	-
11	Y	-
12	R	-

Connector No.	R11
Connector Name	WIRE TO WIRE
Connector Type	TH12MW-NH

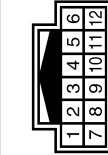

Terminal No.	Color of Wire	Signal Name [Specification]
1	B	-
2	B	-
3	SHIELD	-
4	R	-
5	G	-
6	B	-
7	P	-
8	GR	-
9	V	-
11	Y	-
12	R	-

Connector No.	R12
Connector Name	VANITY MIRROR LAMP LH
Connector Type	MCA02FW



Terminal No.	Color of Wire	Signal Name [Specification]
1	B	-
2	R	-

Connector No.	R13
Connector Name	VANITY MIRROR LAMP RH
Connector Type	MCA02FW



Terminal No.	Color of Wire	Signal Name [Specification]
1	B	-
2	R	-

Connector No.	R14
Connector Name	PERSONAL LAMP
Connector Type	TH04FW-NH

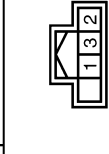

Terminal No.	Color of Wire	Signal Name [Specification]
1	R	-
2	B	-

3	V	-
---	---	---

Connector No.	R15
Connector Name	MAP LAMP
Connector Type	TK08FGY



Terminal No.	Color of Wire	Signal Name [Specification]
1	R	-
2	V	-
3	B	-
4	-	-
5	B	-
6	Y	-

A
B
C
D
E
F
G
H
I
J
K
L
M
N
O
P

INL

ILLUMINATION

< DTC/CIRCUIT DIAGNOSIS >

ILLUMINATION

Wiring Diagram - ILLUMINATION -

INFOID:000000005628279

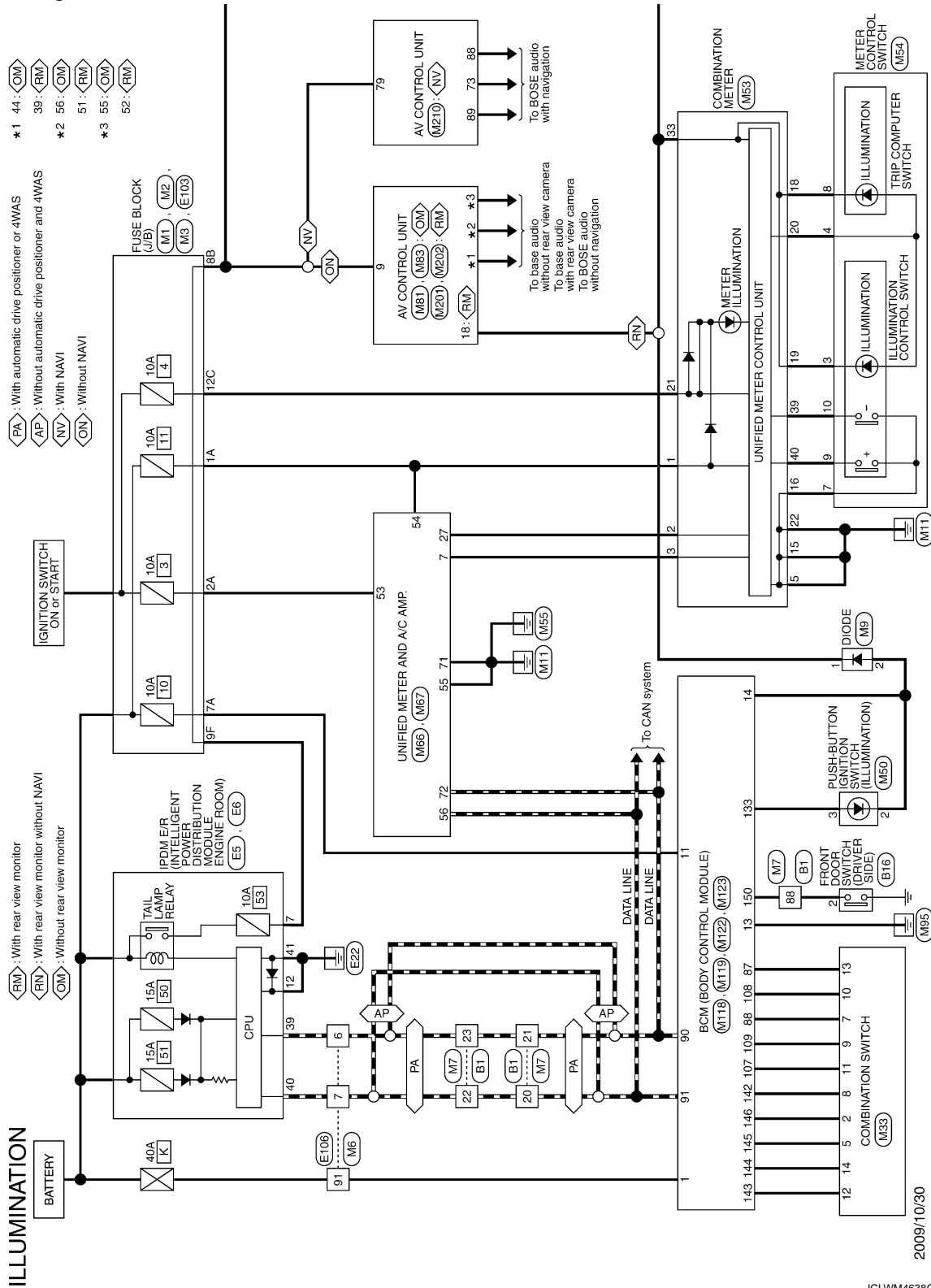

2009/10/30

JCLWM4638GE

ILLUMINATION

< DTC/CIRCUIT DIAGNOSIS >

-  : With A/T
-  : With M/T
-  : AWD models
-  : With automatic drive positioner
-  : Without automatic drive positioner
-  : With sonar system

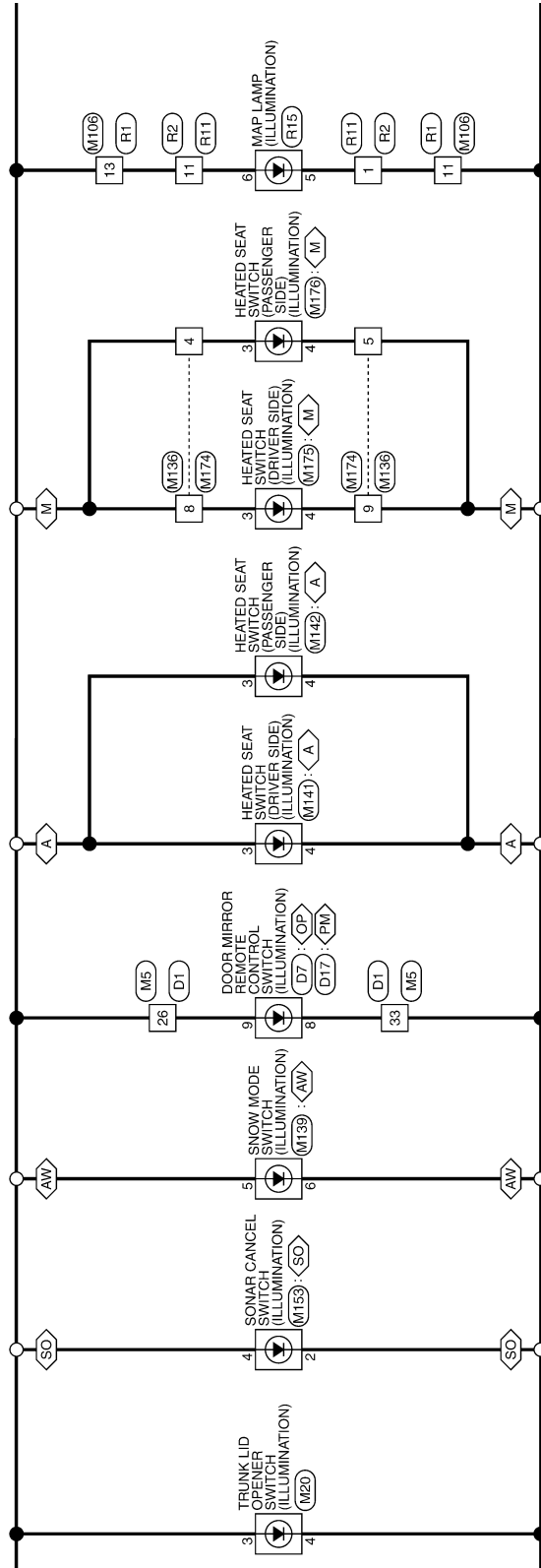

JCLWM4639GE

A
B
C
D
E
F
G
H
I
J
K
INL
M
N
O
P

ILLUMINATION

< DTC/CIRCUIT DIAGNOSIS >

◊ A : With A/T
 * : This connector is not shown in "Harness Layout".

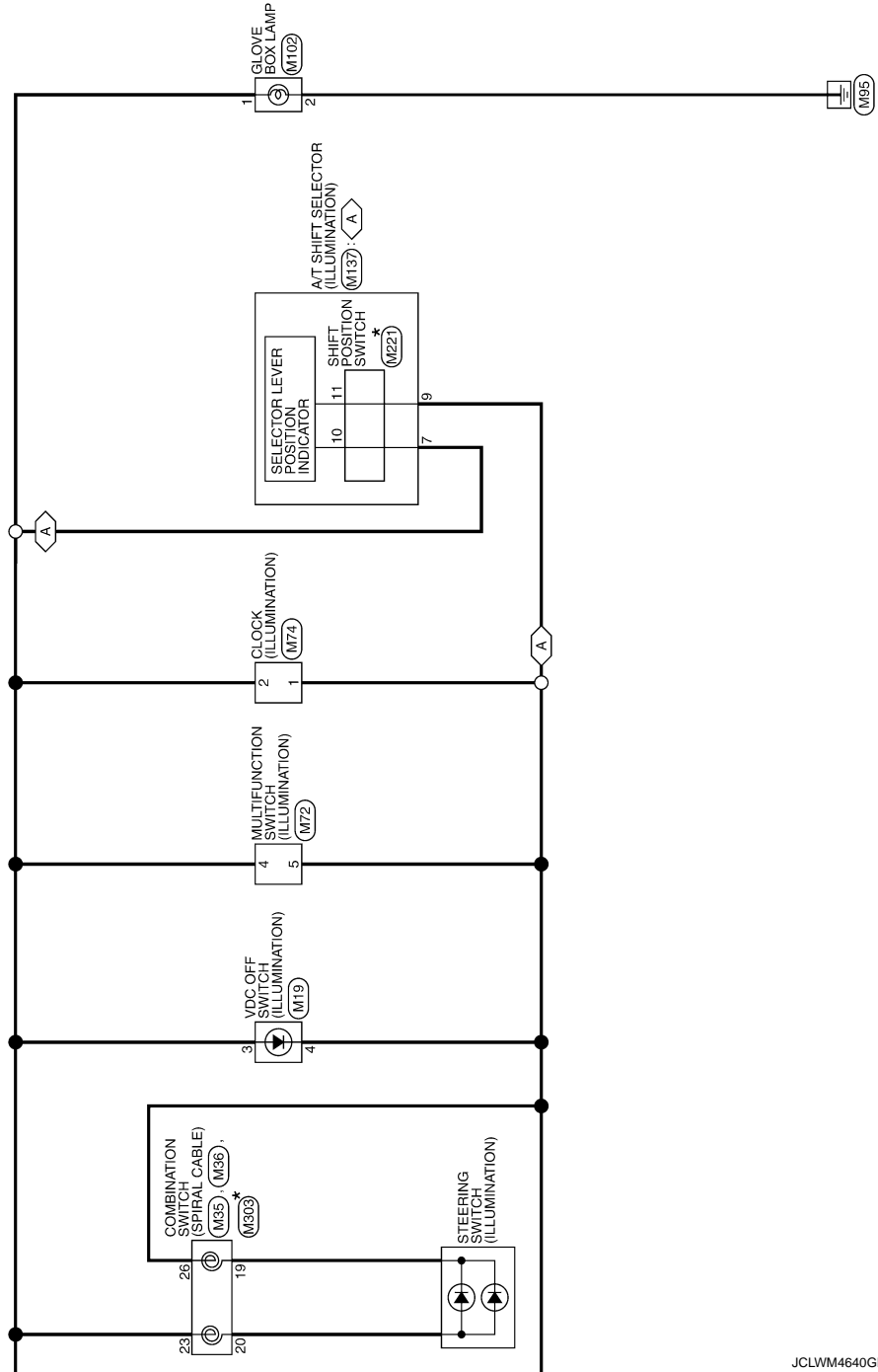

JCLWM4640GE

ILLUMINATION

< DTC/CIRCUIT DIAGNOSIS >

ILLUMINATION

Connector No.	B1
Connector Name	WIRE TO WIRE
Connector Type	TH80FW-CS16-TM4

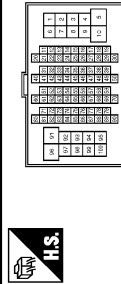

58	V	-
59	SB	-
60	BR	-
61	W	-
62	R	-
63	L	-
64	Y	-
65	SHIELD	-
71	BG	-
72	GR	-
73	P	-
74	L	-
81	V	-
82	B	-
84	Y	-
85	G	-
86	W	-
87	R	-
88	BR	-
89	Y	-
90	SB	-
91	BG	-
92	BR	-
93	P	-
95	BG	-
96	Y	-
100	GR	-

Connector No.	B16
Connector Name	FRONT DOOR SWITCH (DRIVER SIDE)
Connector Type	A03FW

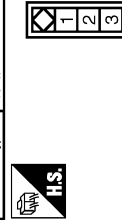

Terminal No.	2	Color of Wire	BR	Signal Name [Specification]	-
--------------	---	---------------	----	-----------------------------	---

Connector No.	D1
Connector Name	WIRE TO WIRE
Connector Type	TH80FW-CS15

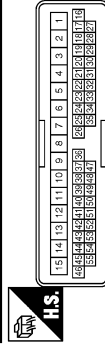

Terminal No.	Color of Wire	Signal Name [Specification]
1	Y	-
2	B	-
3	SB	-
4	V	-
8	L	-
9	P	-
10	LG	-
12	L	-
13	W	-
14	G	-
15	R	-
16	GR	-
17	L	-
18	BR	-
19	BG	-
20	P	-
21	R	-
25	V	-
26	R	-
27	BR	-
28	W	-
29	Y	-
30	G	-
31	LG	-
32	GR	-
33	B	-
36	W	-
37	P	-
38	V	-
39	BR	-
42	G	-
43	GR	-
44	BG	-
47	V	-
48	R	-
49	SB	-
50	W	-
51	P	-

Connector No.	52	V	-
Connector Name	D7	DOOR MIRROR REMOTE CONTROL SWITCH	
Connector Type	TK16FW		

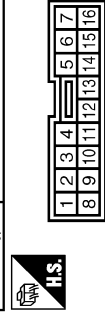

Terminal No.	1	Color of Wire	B	Signal Name [Specification]	-
7	V	-	-	-	
8	B	-	-	-	
9	R	-	-	-	
10	G	-	-	-	
12	G	-	-	-	
13	GR	-	-	-	
14	GR	-	-	-	
15	BG	-	-	-	
16	BG	-	-	-	

Connector No.	D17
Connector Name	DOOR MIRROR REMOTE CONTROL SWITCH
Connector Type	TK16FBR

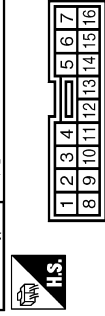

Terminal No.	4	Color of Wire	BR	Signal Name [Specification]	-
7	B	-	-	-	
8	B	-	-	-	
9	R	-	-	-	
10	GR	-	-	-	
11	LG	-	-	-	
12	G	-	-	-	
13	W	-	-	-	
15	Y	-	-	-	

A
B
C
D
E
F
G
H
I
J
K
L
M
N
O
P

INL

ILLUMINATION

< DTC/CIRCUIT DIAGNOSIS >

ILLUMINATION

Connector No.	E5
Connector Name	SMV-E INTELLIGENT POWER DISTRIBUTION MODULE (ENGINE ROOM)
Connector Type	TH20FW-CS12-M4-TV

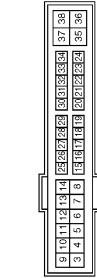

Terminal No.	Color of Wire	Signal Name [Specification]
4	V	
5	L	
6	SB	
7	P	
11	W	
12	B/W	
13	Y	
16	LG	
19	R	
25	G	
26	Y	
27	BG	
28	L	
30	GR	
32	V	
33	P	
36	G	

Connector No.	E6
Connector Name	SMV-E INTELLIGENT POWER DISTRIBUTION MODULE (ENGINE ROOM)
Connector Type	TH20FW-IN1

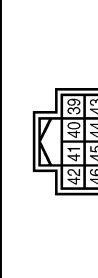

Terminal No.	Color of Wire	Signal Name [Specification]
39	P	
40	L	
41	B/W	
42	GR	
43	G	

44	LG	-
45	V	-
46	SB	-

Connector No.	E103
Connector Name	FUSE BLOCK (J/B)
Connector Type	NS10FW-CS

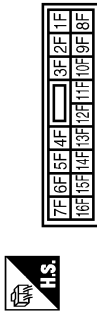

Terminal No.	Color of Wire	Signal Name [Specification]
1F	SB	
2F	W	
4F	G	
6F	BR	
8F	L	
9F	P	

Connector No.	E106
Connector Name	WIRE TO WIRE
Connector Type	TH80FW-CS16-TM4

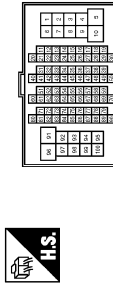

Terminal No.	Color of Wire	Signal Name [Specification]
1	V	
2	SB	
3	BG	
5	W	
6	P	
7	L	
11	V	
12	P	
13	R	
14	W	
15	L	

Connector No.	M1
Connector Name	FUSE BLOCK (J/B)
Connector Type	NS30FW-M2



Terminal No.	Color of Wire	Signal Name [Specification]
1A	V	
2A	G	
3A	L	
4A	P	
5A	L	
6A	Y	
7A	R	
8A	L	

Connector No.	M2
Connector Name	FUSE BLOCK (J/B)
Connector Type	NS10FW-CS



Terminal No.	Color of Wire	Signal Name [Specification]
1B	SB	
3B	P	
4B	G	
5B	BG	
6B	Y	
7B	P	
8B	R	
9B	SB	

16	GR	-
17	SB	-
18	LG	-
23	G	-
31	L	-
32	BG	-
33	P	-
34	V	-
35	W	-
36	BG	-
37	G	-
38	R	-
40	R	-
41	LG	-
42	SB	-
43	G	-
44	LG	-
45	GR	-
46	BR	-
47	B	-
48	Y	-
49	V	-
50	R	-
51	SB	-
52	P	-
53	G	-
54	B	-
57	GR	-
58	V	-
80	R	-
81	P	-
82	G	-
83	V	-
84	L	-
85	W	-
86	GR	-
87	LG	-
88	L	-
89	BR	-
91	W	-
92	LG	-
93	GR	-
94	SB	-
95	GR	-
96	R	-
97	Y	-
98	SHIELD	-
99	L	-
100	P	-

ILLUMINATION

< DTC/CIRCUIT DIAGNOSIS >

ILLUMINATION

Connector No.	M3
Connector Name	FUSE BLOCK (J/B)
Connector Type	MS12PW-CS



5	4C	3C	2C	1C
12C	11C	10C	9C	8C
7C	6C	5C	4C	3C

Terminal No.	Color of Wire	Signal Name [Specification]
6C	SB	-
7C	B	-
8C	W	-
9C	EG	-
10C	L	-
11C	LG	-
12C	G	-

Connector No.	M5
Connector Name	WIRE TO WIPE
Connector Type	TH40MW-CS15



1	2	3	4	5	6	7	8	9	10	11	12	13	14	15
13	14	15	16	17	18	19	20	21	22	23	24	25	26	27
28	29	30	31	32	33	34	35	36	37	38	39	40	41	42
43	44	45	46	47	48	49	50	51	52	53	54	55	56	57

Terminal No.	Color of Wire	Signal Name [Specification]
1	Y	-
2	B	-
3	EG	-
4	V	-
8	SB	-
9	G	-
10	V	-
12	L	-
13	W	-
14	B	-
15	W	-
16	R	-
17	BR	-
18	V	-
18	EG	-

20	P	-
21	W	-
25	Y	-
26	G	-
27	L	-
28	Y	-
29	G	-
30	SB	-
31	LG	-
32	W	-
33	B	-
36	W	-
37	GR	-
38	Y	-
39	B	-
42	Y	-
43	L	-
44	G	-
44	G	- [With automatic drive positioner]
44	L	- [Without automatic drive positioner]
47	L	-
48	GR	-
49	SB	-
50	P	-
51	LG	-
52	V	-

Connector No.	M6
Connector Name	WIRE TO WIPE
Connector Type	TH80MW-CS16-TM4



1	2	3	4	5	6	7	8	9	10	11	12	13	14	15
16	17	18	19	20	21	22	23	24	25	26	27	28	29	30
31	32	33	34	35	36	37	38	39	40	41	42	43	44	45
46	47	48	49	50	51	52	53	54	55	56	57	58	59	60

Terminal No.	Color of Wire	Signal Name [Specification]
1	W	-
2	GR	-
3	R	-
5	W	-
6	P	-
7	L	-
11	V	-
12	P	-
13	R	-
14	W	-
15	L	-

16	GR	-
17	BR	-
18	L	-
28	G	-
31	L	-
32	Y	-
33	BG	-
34	W	-
35	BR	-
36	P	-
37	P	-
38	G	-
40	V	-
41	LG	-
42	R	-
43	G	-
44	G	-
45	B	- [With A/T]
45	B	- [With M/T]
46	EG	-
47	SB	-
48	Y	-
49	L	-
50	R	-
51	R	-
52	W	-
53	G	-
54	B	-
57	B	-
58	LG	-
80	SB	-
81	B	-
82	V	-
83	W	-
84	L	-
85	GR	-
86	Y	-
87	G	-
88	G	-
89	R	-
91	W	-
92	Y	-
93	BG	-
94	L	-
95	Y	-
96	R	-
97	LG	-
98	SHIELD	-
99	V	-
100	SB	-

A
B
C
D
E
F
G
H
I
J
K
L
M
N
O
P

INL

ILLUMINATION

< DTC/CIRCUIT DIAGNOSIS >

ILLUMINATION

Connector No.	M7
Connector Name	WIRE TO WIRE
Connector Type	TH80MW-CS (E-TM4)



Terminal No.	Color of Wire	Signal Name [Specification]
1	GR	-
2	P	-
3	SB	- [With automatic drive positioner]
4	P	- [Without automatic drive positioner]
5	Y	-
6	L	-
8	G	-
9	Y	-
15	R	-
16	BR	-
17	P	-
18	V	-
20	L	-
21	P	-
22	L	-
23	P	-
24	V	-
25	LG	-
26	BR	-
27	EG	-
28	LG	-
31	V	-
32	LG	-
33	SHIELD	-
34	GR	-
35	BR	-
36	Y	-
37	SHIELD	-
38	SB	-
39	LG	-
40	O	-
41	W	-
42	SHIELD	-
43	R	-
44	G	-
45	SHIELD	-
46	SB	-
55	W	-

56	B	-
58	V	-
59	Y	-
60	Y	-
61	W	-
62	R	-
63	G	-
64	B	-
65	SHIELD	-
71	V	-
72	P	-
73	SB	-
74	V	-
81	W	-
82	BR	-
84	LG	-
85	EG	-
86	SB	-
87	G	-
88	GR	-
89	L	-
90	P	-
91	EG	-
92	L	-
93	P	-
95	EG	-
96	Y	-
100	P	-

Connector No.	M9
Connector Name	DIODE
Connector Type	24335 C9900



Terminal No.	Color of Wire	Signal Name [Specification]
1	R	-
2	R	-

Connector No.	M19
Connector Name	VDC OFF SWITCH
Connector Type	TK68FY



Terminal No.	Color of Wire	Signal Name [Specification]
1	R	-
2	B	-
3	SB	-
4	B	-

Connector No.	M20
Connector Name	TRUNK LID OPENER SWITCH
Connector Type	TK64FW



Terminal No.	Color of Wire	Signal Name [Specification]
1	GR	-
2	B	-
3	LG	-
4	R	-

Connector No.	M33
Connector Name	COMBINATION SWITCH
Connector Type	TH16FW-NH

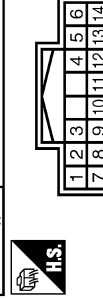

Terminal No.	Color of Wire	Signal Name [Specification]
1	GR	FR WASHER (-)
2	SB	OUTPUT 4
3	L	OUTPUT 3
6	B	GND
7	EG	INPUT 3
8	BR	OUTPUT 5
9	W	INPUT 2
10	R	INPUT 4
11	LG	INPUT 1
12	P	OUTPUT 1
13	Y	INPUT 5
14	G	OUTPUT 2

Connector No.	M35
Connector Name	COMBINATION SWITCH (SPIRAL CABLE)
Connector Type	TK68FY-EX-TV



Terminal No.	Color of Wire	Signal Name [Specification]
23	R	-
28	Y	-
29	Y	-
30	Y	-

ILLUMINATION

< DTC/CIRCUIT DIAGNOSIS >

ILLUMINATION

Connector No.	M33
Connector Name	COMBINATION SWITCH (SPIRAL CABLE)
Connector Type	TK08FY-IV



1	24	25	26	27
2	31	32	33	34

Terminal No.	Color of Wire	Signal Name [Specification]
24	P	-
25	SB	-
26	B	-
31	L	-
32	Y	-
33	B	-
34	LG	-

Connector No.	M50
Connector Name	PUSH-BUTTON IGNITION SWITCH
Connector Type	TK08FBR



1	2	3
4	5	6
7	8	

Terminal No.	Color of Wire	Signal Name [Specification]
1	B	-
2	R	-
3	L	-
4	BR	-
5	LG	-
6	BG	-
7	GR	-
8	P	-

Connector No.	M63
Connector Name	COMBINATION METER
Connector Type	SB40FV



1	2	3	4	5	6	7	8	9	10	11	12	13	14	15	16	17	18	19	20	21	22	23	24	25	26	27	28	29	30	31	32	33	34	35	36	37	38	39	40
---	---	---	---	---	---	---	---	---	----	----	----	----	----	----	----	----	----	----	----	----	----	----	----	----	----	----	----	----	----	----	----	----	----	----	----	----	----	----	----

Terminal No.	Color of Wire	Signal Name [Specification]
1	V	BATTERY POWER SUPPLY
2	LG	COMMUNICATION SIGNAL (METER->AMP.)
3	GR	COMMUNICATION SIGNAL (AMP->METER)
5	B	GROUND
6	W	ALTERNATOR SIGNAL
7	LG	AIR BAG SIGNAL
10	W	SECURITY SIGNAL
15	B	GROUND
16	BR	METER CONTROL SWITCH GROUND
18	GR	ILL GND
19	B	ILL
20	R	ILL
21	G	IGNITION SIGNAL
22	B	GROUND
24	BR	COMMUNICATION SIGNAL (LCD->AMP.)
25	Y	COMMUNICATION SIGNAL (AMP->LCD)
26	R	VEHICLE SPEED SIGNAL (8-PULSE)
27	P	PARKING BRAKE SWITCH SIGNAL
28	SB	BRAKE FLUID LEVEL SWITCH
29	P	SEAT BELT BUCKLE SW SIGNAL (DRIVER SIDE)
30	G	SEAT BELT BUCKLE SWITCH SIGNAL (PASSENGER SIDE)
31	L	WASHER LEVEL SWITCH SIGNAL
33	R	ILLUMINATION CONTROL SIGNAL
36	LG	SELECT SWITCH SIGNAL
37	Y	ENTER SWITCH SIGNAL
38	G	TRIP A/B RESET SWITCH SIGNAL
39	P	ILLUMINATION CONTROL SWITCH SIGNAL (-)
40	BG	ILLUMINATION CONTROL SWITCH SIGNAL (+)

Connector No.	M54
Connector Name	METER CONTROL SWITCH
Connector Type	TH12FW-NH



1	2	3	4	5	6
7	8	9	10	11	12

Terminal No.	Color of Wire	Signal Name [Specification]
1	Y	-
2	LG	-
3	B	-
4	R	-
5	G	-
7	BR	-
8	GR	-
9	BG	-
10	P	-

Connector No.	M66
Connector Name	UNIFIED METER AND A/C AMP.
Connector Type	TH40FW-NH



1	2	3	4	5	6	7	8	9	10	11	12	13	14	15	16	17	18	19	20	21	22	23	24	25	26	27	28	29	30	31	32	33	34	35	36	37	38	39	40
---	---	---	---	---	---	---	---	---	----	----	----	----	----	----	----	----	----	----	----	----	----	----	----	----	----	----	----	----	----	----	----	----	----	----	----	----	----	----	----

Terminal No.	Color of Wire	Signal Name [Specification]
4	G	STOP LAMP SWITCH SIGNAL
5	L	MANUAL MODE SHIFT UP SIGNAL
6	BG	PADDLE SHIFTER UP SIGNAL
7	GR	COMMUNICATION SIGNAL (AMP->METER)
8	L	VEHICLE SPEED SIGNAL (2-PULSE)
9	SB	SEAT BELT BUCKLE SWITCH SIGNAL (DRIVER SIDE)
10	W	MANUAL MODE SIGNAL
11	G	NON-MANUAL MODE SIGNAL
14	BR	COMMUNICATION SIGNAL (LCD->AMP.)
20	BR	ION ON / OFF SIGNAL
23	Y	AT SNOW SWITCH SIGNAL
25	V	MANUAL MODE SHIFT DOWN SIGNAL
26	G	PADDLE SHIFTER DOWN SIGNAL

27	LG	COMMUNICATION SIGNAL (METER->AMP.)
28	R	VEHICLE SPEED SIGNAL (8-PULSE)
30	V	PARKING BRAKE SWITCH SIGNAL
34	Y	COMMUNICATION SIGNAL (AMP->LCD)
38	P	BLOWER MOTOR CONTROL SIGNAL

Connector No.	M67
Connector Name	UNIFIED METER AND A/C AMP.
Connector Type	TH42FW-NH



4	1	2	3	4	5	6	7	8	9	10	11	12	13	14	15	16	17	18	19	20	21	22	23	24	25	26	27	28	29	30	31	32	33	34	35	36	37	38	39	40
---	---	---	---	---	---	---	---	---	---	----	----	----	----	----	----	----	----	----	----	----	----	----	----	----	----	----	----	----	----	----	----	----	----	----	----	----	----	----	----	----

Terminal No.	Color of Wire	Signal Name [Specification]
41	L	ACC-POWER SUPPLY
42	BR	FUEL LEVEL SENSOR SIGNAL
43	BR	INTAKE SENSOR SIGNAL
44	LG	IN-VEHICLE SENSOR SIGNAL
45	V	AMBIENT SENSOR SIGNAL
46	Y	SUNLOAD SENSOR SIGNAL
47	G	GAS SENSOR SIGNAL
53	W	IGNITION POWER SUPPLY
54	SB	BATTERY POWER SUPPLY
55	B	GROUND
56	L	CAN-H
57	LG	BRAKE FLUID LEVEL SWITCH
58	Y	FUEL LEVEL SENSOR GROUND
59	GR	INTAKE SENSOR GROUND
60	W	IN-VEHICLE SENSOR GROUND
61	B	AMBIENT SENSOR GROUND
62	SB	SUNLOAD SENSOR GROUND
63	L	ION CONTROL MODE OUTPUT SIGNAL
65	BG	EVY SIGNAL
69	P	A/C LAM SIGNAL
70	R	EACH DOOR MOTOR POWER SUPPLY
71	GR	GROUND
72	P	CAN-L

A
B
C
D
E
F
G
H
I
J
K
L
M
N
O
P

INL

ILLUMINATION

< DTC/CIRCUIT DIAGNOSIS >

ILLUMINATION

Connector No.	M72
Connector Name	MULTIFUNCTION SWITCH
Connector Type	TH16FW-NH



Terminal No.	Color of Wire	Signal Name [Specification]
1	B	GND
2	G	ACC
3	P	ILL
4	EG	ILL CONT
5	B	AV COMM (H)
6	SB	AV COMM (L)
7	LG	SW GND
8	ER	SW GND
9	V	DISK EJECT SIGNAL
10	G	HAZARD ON

Connector No.	M74
Connector Name	CLOCK
Connector Type	THD4FW-NH

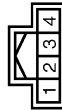

Terminal No.	Color of Wire	Signal Name [Specification]
1	B	ILLUMINATION (-)
2	L	ILLUMINATION (+)
3	B	GND
4	Y	BAT

Connector No.	M81
Connector Name	AV CONTROL UNIT
Connector Type	TH18FW-CS2

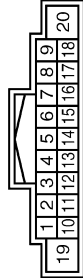

Terminal No.	Color of Wire	Signal Name [Specification]
1	L	SOUND SIGNAL FRONT LH (+)
2	W	SOUND SIGNAL FRONT LH (-)
3	LG	SOUND SIGNAL REAR LH (+)
4	SB	SOUND SIGNAL REAR LH (-)
5	P	STRG SW A
6	Y	ACC
7	L	ILLUMINATION
8	L	SOUND SIGNAL FRONT RH (+)
9	BR	SOUND SIGNAL FRONT RH (-)
10	R	SOUND SIGNAL REAR RH (+)
11	L	SOUND SIGNAL REAR RH (-)
12	P	STRG SW GND
13	L	STRG SW B
14	B	BATTERY
15	L	GND
16	Y	GND
17	Y	GND
18	B	GND
19	B	GND
20	B	GND

Connector No.	M83
Connector Name	AV CONTROL UNIT
Connector Type	TH24FW-NH

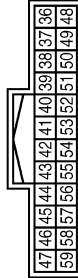

Terminal No.	Color of Wire	Signal Name [Specification]
36	BR	COMPOSITE IMAGE SIGNAL
37	Y	COMPOSITE IMAGE GND
38	P	RGB (BLUE) SIGNAL
39	L	RGB (GREEN) SIGNAL
40	G	RGB (RED) SIGNAL
41	W	RGB SYNC
42	SHIELD	SHIELD

Terminal No.	Color of Wire	Signal Name [Specification]
43	B	RGB AREA (YS) SIGNAL
44	L	COMM (DISP->CONT)
45	R	HP
46	LG	SIGNAL GND
47	EG	SIGNAL VCC
48	BR	COMP SYNC
49	Y	SHIELD
50	SHIELD	SHIELD
51	B	SHIELD
52	G	COMM (CONT->DISP)
53	LG	VP
54	G	INVERTER GND
55	BR	INVERTER VCC
56	Y	VP
57	G	VP
58	BR	VP
59	Y	VP
60	R	VP

Connector No.	M102
Connector Name	GLOVE BOX LAMP
Connector Type	A02FW



Terminal No.	Color of Wire	Signal Name [Specification]
1	R	
2	B	

Connector No.	M106
Connector Name	WIRE TO WIRE
Connector Type	NH10MW-CS10

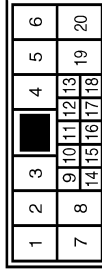

Terminal No.	Color of Wire	Signal Name [Specification]
2	L	
3	SHIELD	
4	G	
5	BR	
6	BG	

Terminal No.	Color of Wire	Signal Name [Specification]
7	Y	
8	P	
9	LG	
10	V	
11	B	
12	B	
13	R	
14	R	
15	R	
16	G	
17	SHIELD	
18	B	
19	Y	
20	R	

Connector No.	M118
Connector Name	BCM (BODY CONTROL MODULE)
Connector Type	MB03FB-LC



Terminal No.	Color of Wire	Signal Name [Specification]
1	W	BAT (F/L)
2	Y	POWER WINDOW POWER SUPPLY (BAT)
3	BG	POWER WINDOW POWER SUPPLY (RAP)

ILLUMINATION

< DTC/CIRCUIT DIAGNOSIS >

ILLUMINATION

Connector No.	M119
Connector Name	BCM (BODY CONTROL MODULE)
Connector Type	MS16FW-CS



4	5	6	7	8	9	10
11	12	13	14	15	16	17
18	19					

Terminal No.	Color of Wire	Signal Name [Specification]
4	LG	INTERIOR ROOM LAMP POWER SUPPLY
5	P	PASSENGER DOOR UNLOCK OUTPUT
7	SB	STEP LAMP OUTPUT
8	V	ALL DOOR FUEL LID LOCK OUTPUT
9	G	DRIVER DOOR UNLOCK OUTPUT
10	P	REAR DOOR UNLOCK OUTPUT
11	R	BAT.(PUSE) GND
13	B	PUSH-BUTTON IGNITION SW ILL GND
14	W	ACC IND
15	BG	TURN SIGNAL RH (FRONT)
17	W	TURN SIGNAL LH (FRONT)
18	BG	ROOM LAMP LH (FRONT)
19	V	ROOM LAMP TIMER CONTROL

Connector No.	M122
Connector Name	BCM (BODY CONTROL MODULE)
Connector Type	TH40FB-NH



11	12	13	14	15	16	17	18	19	20	21	22	23	24	25	26	27	28	29	30	31	32	33	34	35	36	37	38	39	40	41	42	43	44	45	46	47	48	49	50	51	52	53	54	55	56	57	58	59	60	61	62	63	64	65	66	67	68	69	70	71	72	73	74	75	76	77	78	79	80	81	82	83	84	85	86	87	88	89	90	91	92	93	94	95	96	97	98	99	100	101	102	103	104	105	106	107	108	109	110	111	112	113	114	115	116	117	118	119	120	121	122	123	124	125	126	127	128	129	130	131	132	133	134	135	136	137	138	139	140	141	142	143	144	145	146	147	148	149	150	151	152	153	154	155	156	157	158	159	160	161	162	163	164	165	166	167	168	169	170	171	172	173	174	175	176	177	178	179	180	181	182	183	184	185	186	187	188	189	190	191	192	193	194	195	196	197	198	199	200
----	----	----	----	----	----	----	----	----	----	----	----	----	----	----	----	----	----	----	----	----	----	----	----	----	----	----	----	----	----	----	----	----	----	----	----	----	----	----	----	----	----	----	----	----	----	----	----	----	----	----	----	----	----	----	----	----	----	----	----	----	----	----	----	----	----	----	----	----	----	----	----	----	----	----	----	----	----	----	----	----	----	----	----	----	----	----	----	----	-----	-----	-----	-----	-----	-----	-----	-----	-----	-----	-----	-----	-----	-----	-----	-----	-----	-----	-----	-----	-----	-----	-----	-----	-----	-----	-----	-----	-----	-----	-----	-----	-----	-----	-----	-----	-----	-----	-----	-----	-----	-----	-----	-----	-----	-----	-----	-----	-----	-----	-----	-----	-----	-----	-----	-----	-----	-----	-----	-----	-----	-----	-----	-----	-----	-----	-----	-----	-----	-----	-----	-----	-----	-----	-----	-----	-----	-----	-----	-----	-----	-----	-----	-----	-----	-----	-----	-----	-----	-----	-----	-----	-----	-----	-----	-----	-----	-----	-----	-----	-----

Terminal No.	Color of Wire	Signal Name [Specification]
72	R	ROOM ANT 2-
73	G	ROOM ANT 2+
74	SB	PASSENGER DOOR ANT-
75	BR	PASSENGER DOOR ANT+
76	V	DRIVER DOOR ANT-
77	LG	DRIVER DOOR ANT+
78	Y	ROOM ANT 1-
79	BR	ROOM ANT 1+
80	GR	MATS ANT AMP

81	W	MATS ANT AMP
82	SB	IGN RELAY (E/B) CONT
83	Y	KEYLESS ENTRY RECEIVER COMMI
87	Y	COMBI SW INPUT 3
88	BG	PUSH SW
89	BR	CAN-L
90	P	CAN-H
91	L	KEY SLOT ILL
92	LG	ACC RELAY CONT
93	GR	A/T SHIFT SELECTOR POWER SUPPLY
95	BG	S/L CONDITION 1
96	GR	S/L CONDITION 2
97	L	SHIFT P (With A/T)
99	R	ICG GLUTCH SW (With M/T and ICG)
99	BR	ASGD GLUTCH SW (With M/T without ICG)
100	Y	PASSENGER DOOR REQUEST SW
101	P	DRIVER DOOR REQUEST SW
102	BG	BLOWER FAN MOTOR RELAY CONT
103	P	KEYLESS ENTRY RECEIVER POWER SUPPLY
106	SB	S/L UNIT POWER SUPPLY
107	LG	COMBI SW INPUT 1
108	R	COMBI SW INPUT 4
109	W	HAZARD SW
110	G	S/L UNIT COMMI
111	Y	

Connector No.	M123
Connector Name	BCM (BODY CONTROL MODULE)
Connector Type	TH40FG-NH



11	12	13	14	15	16	17	18	19	20	21	22	23	24	25	26	27	28	29	30	31	32	33	34	35	36	37	38	39	40	41	42	43	44	45	46	47	48	49	50	51	52	53	54	55	56	57	58	59	60	61	62	63	64	65	66	67	68	69	70	71	72	73	74	75	76	77	78	79	80	81	82	83	84	85	86	87	88	89	90	91	92	93	94	95	96	97	98	99	100	101	102	103	104	105	106	107	108	109	110	111	112	113	114	115	116	117	118	119	120	121	122	123	124	125	126	127	128	129	130	131	132	133	134	135	136	137	138	139	140	141	142	143	144	145	146	147	148	149	150	151	152	153	154	155	156	157	158	159	160	161	162	163	164	165	166	167	168	169	170	171	172	173	174	175	176	177	178	179	180	181	182	183	184	185	186	187	188	189	190	191	192	193	194	195	196	197	198	199	200
----	----	----	----	----	----	----	----	----	----	----	----	----	----	----	----	----	----	----	----	----	----	----	----	----	----	----	----	----	----	----	----	----	----	----	----	----	----	----	----	----	----	----	----	----	----	----	----	----	----	----	----	----	----	----	----	----	----	----	----	----	----	----	----	----	----	----	----	----	----	----	----	----	----	----	----	----	----	----	----	----	----	----	----	----	----	----	----	----	-----	-----	-----	-----	-----	-----	-----	-----	-----	-----	-----	-----	-----	-----	-----	-----	-----	-----	-----	-----	-----	-----	-----	-----	-----	-----	-----	-----	-----	-----	-----	-----	-----	-----	-----	-----	-----	-----	-----	-----	-----	-----	-----	-----	-----	-----	-----	-----	-----	-----	-----	-----	-----	-----	-----	-----	-----	-----	-----	-----	-----	-----	-----	-----	-----	-----	-----	-----	-----	-----	-----	-----	-----	-----	-----	-----	-----	-----	-----	-----	-----	-----	-----	-----	-----	-----	-----	-----	-----	-----	-----	-----	-----	-----	-----	-----	-----	-----	-----	-----	-----

Terminal No.	Color of Wire	Signal Name [Specification]
112	R	RAIN SENSOR SERIAL LINK
113	BG	OPTICAL SENSOR
114	R	CLUTCH INTERLOCK SW
116	SB	STOP LAMP SW 1
118	BR	STOP LAMP SW 2
119	SB	DR DOOR UNLOCK SENSOR
121	SB	KEY SLOT SW
123	V	IGN/L/B
124	R	PASSENGER DOOR SW

129	BG	TRUNK LID OPENER CANCEL SW
132	V	POWER WINDOW SW COMMI
133	L	PUSH-BUTTON IGNITION SW ILL POWER
134	LG	LOCK IND
137	BG	RECEIVER / SENSOR GND
138	V	RECEIVER / SENSOR POWER SUPPLY
139	L	TIRE PRESSURE RECEIVER COMMI
140	B	SHIFT IN/P
141	W	SECURITY INDICATOR LAMP
142	BR	COMBI SW OUTPUT 5
143	P	COMBI SW OUTPUT 1
144	G	COMBI SW OUTPUT 2
145	L	COMBI SW OUTPUT 3
146	SB	COMBI SW OUTPUT 4
149	W	TIRE PRESSURE WARN CHECK SW
150	GR	DRIVER DOOR SW
151	G	REAR WINDOW DEFROGGER RELAY CONT

Connector No.	M138
Connector Name	WIRE TO WIRE
Connector Type	TH12FW-NH



6	5	4	3	2	1
12	11	10	9	8	7

Terminal No.	Color of Wire	Signal Name [Specification]
1	L	
2	GR	
3	G	
4	V	
5	B	
6	BG	
7	B	
8	R	
9	B	
10	LG	
11	B	
12	SB	

Connector No.	M137
Connector Name	A/T SHIFT SELECTOR
Connector Type	TH12FW-NH



1	2	3	4	5	6
7	8	9	10	11	12

Terminal No.	Color of Wire	Signal Name [Specification]
1	W	
2	V	
3	L	
4	B	
5	G	
7	V	
8	LG	
9	B	
10	GR	
11	R	

Connector No.	M139
Connector Name	SHOW MODE SWITCH
Connector Type	TK08FW



5	4
3	6
1	2

Terminal No.	Color of Wire	Signal Name [Specification]
1	R	
2	GR	
4	Y	
5	P	
6	B	

A B C D E F G H I J K M N O P

INL

ILLUMINATION

< DTC/CIRCUIT DIAGNOSIS >

ILLUMINATION

Connector No.	M141
Connector Name	HEATED SEAT SWITCH (DRIVER SIDE)
Connector Type	TK09FW



Terminal No.	Color of Wire	Signal Name [Specification]
1	L	-
2	GR	-
3	R	-
4	B	-
5	G	-
6	B	-

Connector No.	M142
Connector Name	HEATED SEAT SWITCH (PASSENGER SIDE)
Connector Type	TK09FBR

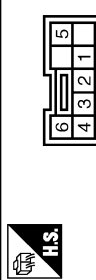

Terminal No.	Color of Wire	Signal Name [Specification]
1	LG	-
2	SB	-
3	V	-
4	B	-
5	BG	-
6	B	-

Connector No.	M153
Connector Name	SONAR CANCEL SWITCH
Connector Type	TK09FW



Terminal No.	Color of Wire	Signal Name [Specification]
1	SB	-
2	B	-
3	B	-
4	R	-
5	L	-
6	B	-

Connector No.	M174
Connector Name	WIRES TO WIRE
Connector Type	TH12MW-NH

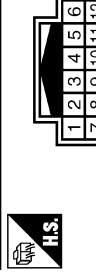

Terminal No.	Color of Wire	Signal Name [Specification]
1	L	-
2	GR	-
3	W	-
4	R	-
5	W	-
6	W	-
7	B	-
8	R	-
9	W	-
10	GR	-
11	GR	-
12	SB	-

Connector No.	M175
Connector Name	HEATED SEAT SWITCH (DRIVER SIDE)
Connector Type	TK09FW



Terminal No.	Color of Wire	Signal Name [Specification]
1	L	-
2	GR	-
3	R	-
4	W	-
5	W	-
6	B	-

Connector No.	M176
Connector Name	HEATED SEAT SWITCH (PASSENGER SIDE)
Connector Type	TK09FBR

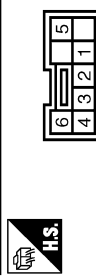

Terminal No.	Color of Wire	Signal Name [Specification]
1	GR	-
2	SB	-
3	R	-
4	W	-
5	W	-
6	GR	-

Connector No.	M201
Connector Name	AV CONTROL UNIT
Connector Type	TH18FW-CS2



Terminal No.	Color of Wire	Signal Name [Specification]
2	L	SOUND SIGNAL FRONT LH (+)
3	W	SOUND SIGNAL FRONT LH (-)
4	LG	SOUND SIGNAL REAR LH (+)
5	SB	SOUND SIGNAL REAR LH (-)
6	P	STRG SW A
7	V	ACC
9	L	ILLUMINATION
11	BR	SOUND SIGNAL FRONT RH (+)
12	R	SOUND SIGNAL FRONT RH (-)
13	L	SOUND SIGNAL REAR RH (+)
14	P	SOUND SIGNAL REAR RH (-)
15	B	STRG SW B
16	L	STRG SW B
18	G	GND
19	Y	BATTERY
20	B	GND

ILLUMINATION

< DTC/CIRCUIT DIAGNOSIS >

ILLUMINATION

Connector No.	M222
Connector Name	AV CONTROL UNIT
Connector Type	TH24FW-NH



36	37	38	39	40	41	42	43	44	45	46	47
48	49	50	51	52	53	54	55	56	57	58	59

Terminal No.	Color of Wire	Signal Name [Specification]
36	BG	SIGNAL V2C
37	LG	SIGNAL GND
38	R	HP
39	L	COMM (DISP->CONT)
40	B	RGB AREA (VS) SIGNAL
41	SHIELD	SHIELD
42	W	RGB SYNC
43	G	RGB (RED) SIGNAL
44	L	RGB (GREEN) SIGNAL
45	P	RGB (BLUE) SIGNAL
46	Y	COMPOSITE IMAGE GND
47	BR	COMPOSITE IMAGE SIGNAL
48	Y	INVERTER VCC
49	BR	INVERTER GND
50	G	VP
51	LG	COMM (CONT->DISP)
52	B	SHIELD
57	SHIELD	SHIELD
58	SHIELD	SHIELD

Connector No.	M210
Connector Name	AV CONTROL UNIT
Connector Type	TH24FW-NH



61	62	63	64	65	66	67	68	69	70	71	72	73	74	75	76
77	78	79	80	81	82	83	84	85	86	87	88	89	90	91	92

Terminal No.	Color of Wire	Signal Name [Specification]
65	SB	PARKING BRAKE
67	P	COMPOSITE IMAGE GND
68	L	COMPOSITE IMAGE SIGNAL

71	SHIELD	MICROPHONE GND
72	G	MICROPHONE VCC
73	LG	COMM (CONT->DISP)
74	P	CAN-L
75	LG	AV COMM (L)
76	LG	AV COMM (L)
79	L	ILLUMINATION
80	G	IGNITION
81	BG	REVERSE
82	R	VEHICLE SPEED (8-PULSE)
83	SHIELD	SHIELD
87	R	MICROPHONE SIGNAL
88	B	SHIELD
89	L	COMM (DISP->CONT)
90	L	CAN-H
91	SB	AV COMM (H)
92	SB	AV COMM (H)

Connector No.	M221
Connector Name	SHIFT POSITION SWITCH
Connector Type	TH12FW



6	5	4	3	2	1
12	11	10	9	8	7

Terminal No.	Color of Wire	Signal Name [Specification]
2	L	N
3	BR	D
4	G	R
5	P	P
6	V	M
7	O	AT
9	Y	MT
10	R	ILL
11	B	GND

Connector No.	M303
Connector Name	COMBINATION SWITCH (SPIRAL CABLE)
Connector Type	TK08FGY



20	19	18	17	16	15	14	13
----	----	----	----	----	----	----	----

Terminal No.	Color of Wire	Signal Name [Specification]
13	R	-
14	W	-
15	L	-
16	B	-
17	BR	-
18	G	-
19	P	-
20	Y	-

Connector No.	R1
Connector Name	WIPE TO WIRE
Connector Type	NH10FW-CS10



6	5	4	3	2	1			
20	19	18	17	16	15	14	8	7

Terminal No.	Color of Wire	Signal Name [Specification]
2	L	-
3	SHIELD	-
4	G	-
5	BR	-
6	Y	-
7	GR	-
8	BR	-
9	R	-
10	V	-
11	B	-
12	B	-
13	Y	-
15	R	-
16	G	-

17	SHIELD	-
18	B	-
19	Y	-
20	R	-

Connector No.	R2
Connector Name	WIPE TO WIRE
Connector Type	TH12FW-NH



6	5	4	3	2	1
12	11	10	9	8	7

Terminal No.	Color of Wire	Signal Name [Specification]
1	B	-
2	B	-
3	SHIELD	-
4	R	-
5	G	-
6	B	-
7	P	-
8	GR	-
9	V	-
11	Y	-
12	R	-

A
B
C
D
E
F
G
H
I
J
K
L
M
N
O
P

INL

ILLUMINATION

< DTC/CIRCUIT DIAGNOSIS >

ILLUMINATION

Connector No.	R11
Connector Name	WIRE TO WIRE
Connector Type	TH2MW-NH

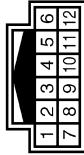

Terminal No.	Color of Wire	Signal Name [Specification]
1	B	-
2	B	-
3	SHIELD	-
4	R	-
5	G	-
6	B	-
7	B	-
8	GR	-
9	V	-
11	Y	-
12	R	-

Connector No.	R15
Connector Name	MAP LAMP
Connector Type	TK08FGY



Terminal No.	Color of Wire	Signal Name [Specification]
1	R	-
2	V	-
3	B	-
4	-	-
5	B	-
6	Y	-

JCLWM4650GE

BCM (BODY CONTROL MODULE)

< ECU DIAGNOSIS INFORMATION >

ECU DIAGNOSIS INFORMATION

BCM (BODY CONTROL MODULE)

Reference Value

INFOID:000000005880604

VALUES ON THE DIAGNOSIS TOOL

CONSULT-III MONITOR ITEM

Monitor Item	Condition	Value/Status
FR WIPER HI	Other than front wiper switch HI	Off
	Front wiper switch HI	On
FR WIPER LOW	Other than front wiper switch LO	Off
	Front wiper switch LO	On
FR WASHER SW	Front washer switch OFF	Off
	Front washer switch ON	On
FR WIPER INT	Other than front wiper switch INT/AUTO	Off
	Front wiper switch INT/AUTO	On
FR WIPER STOP	Front wiper is not in STOP position	Off
	Front wiper is in STOP position	On
INT VOLUME	Wiper volume dial is in a dial position 1 - 7	Wiper volume dial position
TURN SIGNAL R	Other than turn signal switch RH	Off
	Turn signal switch RH	On
TURN SIGNAL L	Other than turn signal switch LH	Off
	Turn signal switch LH	On
TAIL LAMP SW	Other than lighting switch 1ST and 2ND	Off
	Lighting switch 1ST or 2ND	On
HI BEAM SW	Other than lighting switch HI	Off
	Lighting switch HI	On
HEAD LAMP SW 1	Other than lighting switch 2ND	Off
	Lighting switch 2ND	On
HEAD LAMP SW 2	Other than lighting switch 2ND	Off
	Lighting switch 2ND	On
PASSING SW	Other than lighting switch PASS	Off
	Lighting switch PASS	On
AUTO LIGHT SW	Other than lighting switch AUTO	Off
	Lighting switch AUTO	On
FR FOG SW	Front fog lamp switch OFF	Off
	Front fog lamp switch ON	On
RR FOG SW	NOTE: The item is indicated, but not monitored.	Off
DOOR SW-DR	Driver door closed	Off
	Driver door opened	On
DOOR SW-AS	Passenger door closed	Off
	Passenger door opened	On
DOOR SW-RR	Rear RH door closed	Off
	Rear LH door opened	On

BCM (BODY CONTROL MODULE)

< ECU DIAGNOSIS INFORMATION >

Monitor Item	Condition	Value/Status
DOOR SW-RL	Rear LH door closed	Off
	Rear LH door opened	On
DOOR SW-BK	NOTE: The item is indicated, but not monitored.	Off
CDL LOCK SW	Other than power door lock switch LOCK	Off
	Power door lock switch LOCK	On
CDL UNLOCK SW	Other than power door lock switch UNLOCK	Off
	Power door lock switch UNLOCK	On
KEY CYL LK-SW	Other than driver door key cylinder LOCK	Off
	Driver door key cylinder LOCK	On
KEY CYL UN-SW	Other than driver door key cylinder UNLOCK	Off
	Driver door key cylinder LOCK	On
KEY CYL SW-TR	NOTE: The item is indicated, but not monitored.	Off
HAZARD SW	Hazard switch is OFF	Off
	Hazard switch is ON	On
REAR DEF SW	NOTE: The item is indicated, but not monitored.	Off
H/L WASH SW	NOTE: The item is indicated, but not monitored.	Off
TR CANCEL SW	Trunk lid opener cancel switch OFF	Off
	Trunk lid opener cancel switch ON	On
TR/BD OPEN SW	Trunk lid opener switch OFF	Off
	While the trunk lid opener switch is turned ON	On
TRNK/HAT MNTR	Trunk lid closed	Off
	Trunk lid opened	On
RKE-LOCK	LOCK button of the Intelligent Key is not pressed	Off
	LOCK button of the Intelligent Key is pressed	On
RKE-UNLOCK	UNLOCK button of the Intelligent Key is not pressed	Off
	UNLOCK button of the Intelligent Key is pressed	On
RKE-TR/BD	TRUNK OPEN button of the Intelligent Key is not pressed	Off
	TRUNK OPEN button of the Intelligent Key is pressed	On
RKE-PANIC	PANIC button of the Intelligent Key is not pressed	Off
	PANIC button of the Intelligent Key is pressed	On
RKE-P/W OPEN	UNLOCK button of the Intelligent Key is not pressed	Off
	UNLOCK button of the Intelligent Key is pressed and held	On
RKE-MODE CHG	LOCK/UNLOCK button of the Intelligent Key is not pressed and held simultaneously	Off
	LOCK/UNLOCK button of the Intelligent Key is pressed and held simultaneously	On
OPTICAL SENSOR	Bright outside of the vehicle	Close to 5 V
	Dark outside of the vehicle	Close to 0 V
REQ SW -DR	Driver door request switch is not pressed	Off
	Driver door request switch is pressed	On
REQ SW -AS	Passenger door request switch is not pressed	Off
	Passenger door request switch is pressed	On

BCM (BODY CONTROL MODULE)

< ECU DIAGNOSIS INFORMATION >

Monitor Item	Condition	Value/Status	
REQ SW -RR	NOTE: The item is indicated, but not monitored.	Off	A
REQ SW -RL	NOTE: The item is indicated, but not monitored.	Off	B
REQ SW -BD/TR	Trunk lid opener request switch is not pressed	Off	C
	Trunk lid opener request switch is pressed	On	
PUSH SW	Push-button ignition switch (push switch) is not pressed	Off	D
	Push-button ignition switch (push switch) is pressed	On	
IGN RLY2 -F/B	Ignition switch in OFF or ACC position	Off	E
	Ignition switch in ON position	On	
ACC RLY -F/B	NOTE: The item is indicated, but not monitored.	Off	F
CLUCH SW	The clutch pedal is not depressed	Off	G
	The clutch pedal is depressed	On	
BRAKE SW 1	The brake pedal is depressed when No. 7 fuse is blown	Off	H
	The brake pedal is not depressed when No. 7 fuse is blown, or No. 7 fuse is normal	On	
BRAKE SW 2	The brake pedal is not depressed	Off	I
	The brake pedal is depressed	On	
DETE/CANCL SW	<ul style="list-style-type: none"> • Selector lever in P position (Except M/T models) • The clutch pedal is depressed (M/T models) 	Off	J
	<ul style="list-style-type: none"> • Selector lever in any position other than P (Except M/T models) • The clutch pedal is not depressed (M/T models) 	On	
SFT PN/N SW	Selector lever in any position other than P and N	Off	K
	Selector lever in P or N position	On	
S/L -LOCK	Steering is unlocked	Off	INL
	Steering is locked	On	
S/L -UNLOCK	Steering is locked	Off	M
	Steering is unlocked	On	
S/L RELAY-F/B	Ignition switch in OFF or ACC position	Off	N
	Ignition switch in ON position	On	
UNLK SEN -DR	Driver door is unlocked	Off	O
	Driver door is locked	On	
PUSH SW -IPDM	Push-button ignition switch (push-switch) is not pressed	Off	P
	Push-button ignition switch (push-switch) is pressed	On	
IGN RLY1 -F/B	Ignition switch in OFF or ACC position	Off	
	Ignition switch in ON position	On	
DETE SW -IPDM	Selector lever in any position other than P	Off	
	Selector lever in P position	On	
SFT PN -IPDM	<ul style="list-style-type: none"> • Selector lever in any position other than P and N (Except M/T models) • The clutch pedal is not depressed (M/T models) 	Off	
	<ul style="list-style-type: none"> • Selector lever in P or N position (Except M/T models) • The clutch pedal is depressed (M/T models) 	On	
SFT P -MET	Selector lever in any position other than P	Off	
	Selector lever in P position	On	
SFT N -MET	Selector lever in any position other than N	Off	
	Selector lever in N position	On	

BCM (BODY CONTROL MODULE)

< ECU DIAGNOSIS INFORMATION >

Monitor Item	Condition	Value/Status
ENGINE STATE	Engine stopped	Stop
	While the engine stalls	Stall
	At engine cranking	Crank
	Engine running	Run
S/L LOCK-IPDM	Steering is unlocked	Off
	Steering is locked	On
S/L UNLK-IPDM	Steering is locked	Off
	Steering is unlocked	On
S/L RELAY-REQ	Steering lock system is not the LOCK condition and the changing condition from LOCK to UNLOCK	Off
	Steering lock system is the LOCK condition or the changing condition from LOCK to UNLOCK	On
VEH SPEED 1	While driving	Equivalent to speedometer reading
VEH SPEED 2	While driving	Equivalent to speedometer reading
DOOR STAT-DR	Driver door is locked	LOCK
	Wait with selective UNLOCK operation (60 seconds)	READY
	Driver door is unlocked	UNLOCK
DOOR STAT-AS	Passenger door is locked	LOCK
	Wait with selective UNLOCK operation (60 seconds)	READY
	Passenger door is unlocked	UNLOCK
ID OK FLAG	Steering is locked	Reset
	Steering is unlocked	Set
PRMT ENG STRT	The engine start is prohibited	Reset
	The engine start is permitted	Set
PRMT RKE STRT	NOTE: The item is indicated, but not monitored.	Reset
KEY SW -SLOT	The Intelligent Key is not inserted into key slot	Off
	The Intelligent Key is inserted into key slot	On
RKE OPE COUN1	During the operation of the Intelligent Key	Operation frequency of the Intelligent Key
RKE OPE COUN2	NOTE: The item is indicated, but not monitored.	—
CONFIRM ID ALL	The key ID that the key slot receives is not recognized by any key ID registered to BCM.	Yet
	The key ID that the key slot receives is recognized by any key ID registered to BCM.	Done
CONFIRM ID4	The key ID that the key slot receives is not recognized by the fourth key ID registered to BCM.	Yet
	The key ID that the key slot receives is recognized by the fourth key ID registered to BCM.	Done
CONFIRM ID3	The key ID that the key slot receives is not recognized by the third key ID registered to BCM.	Yet
	The key ID that the key slot receives is recognized by the third key ID registered to BCM.	Done

BCM (BODY CONTROL MODULE)

< ECU DIAGNOSIS INFORMATION >

Monitor Item	Condition	Value/Status	
CONFIRM ID2	The key ID that the key slot receives is not recognized by the second key ID registered to BCM.	Yet	A
	The key ID that the key slot receives is recognized by the second key ID registered to BCM.	Done	B
CONFIRM ID1	The key ID that the key slot receives is not recognized by the first key ID registered to BCM.	Yet	C
	The key ID that the key slot receives is recognized by the first key ID registered to BCM.	Done	
TP 4	The ID of fourth Intelligent Key is not registered to BCM	Yet	D
	The ID of fourth Intelligent Key is registered to BCM	Done	
TP 3	The ID of third Intelligent Key is not registered to BCM	Yet	E
	The ID of third Intelligent Key is registered to BCM	Done	
TP 2	The ID of second Intelligent Key is not registered to BCM	Yet	F
	The ID of second Intelligent Key is registered to BCM	Done	
TP 1	The ID of first Intelligent Key is not registered to BCM	Yet	
	The ID of first Intelligent Key is registered to BCM	Done	
AIR PRESS FL	Ignition switch ON (Only when the signal from the transmitter is received)	Air pressure of front LH tire	G
AIR PRESS FR	Ignition switch ON (Only when the signal from the transmitter is received)	Air pressure of front RH tire	H
AIR PRESS RR	Ignition switch ON (Only when the signal from the transmitter is received)	Air pressure of rear RH tire	I
AIR PRESS RL	Ignition switch ON (Only when the signal from the transmitter is received)	Air pressure of rear LH tire	
ID REGST FL1	ID of front LH tire transmitter is registered	Done	J
	ID of front LH tire transmitter is not registered	Yet	
ID REGST FR1	ID of front RH tire transmitter is registered	Done	
	ID of front RH tire transmitter is not registered	Yet	
ID REGST RR1	ID of rear RH tire transmitter is registered	Done	K
	ID of rear RH tire transmitter is not registered	Yet	
ID REGST RL1	ID of rear LH tire transmitter is registered	Done	INL
	ID of rear LH tire transmitter is not registered	Yet	
WARNING LAMP	Tire pressure indicator OFF	Off	
	Tire pressure indicator ON	On	M
BUZZER	Tire pressure warning alarm is not sounding	Off	
	Tire pressure warning alarm is sounding	On	N

BCM (BODY CONTROL MODULE)

< ECU DIAGNOSIS INFORMATION >

TERMINAL LAYOUT

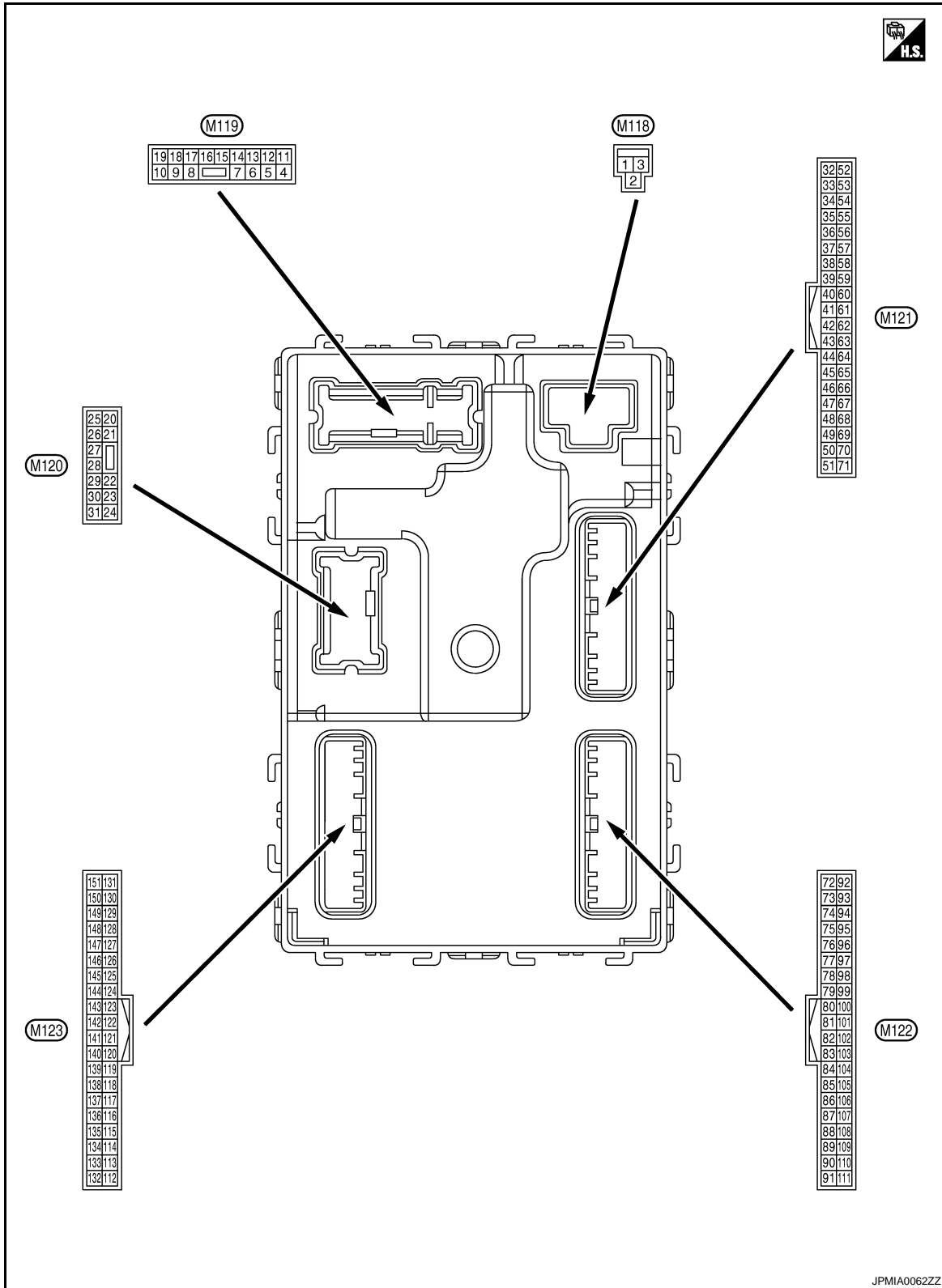

PHYSICAL VALUES

BCM (BODY CONTROL MODULE)

< ECU DIAGNOSIS INFORMATION >

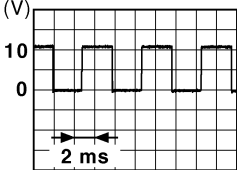
Terminal No. (Wire color)		Description		Condition		Value (Approx.)
+	-					
1 (W)	Ground	Battery power supply	Input	Ignition switch OFF		Battery voltage
2 (Y)	Ground	P/W power supply (BAT)	Output	Ignition switch OFF		12 V
3 (BG)	Ground	P/W power supply (RAP)	Output	Ignition switch ON		12 V
4 (LG)	Ground	Interior room lamp power supply	Output	Interior room lamp battery saver is activated. (Cuts the interior room lamp power supply)		0 V
				Interior room lamp battery saver is not activated. (Outputs the interior room lamp power supply)		12 V
5 (P)	Ground	Passenger door UN- LOCK	Output	Passenger door	UNLOCK (Actuator is activated)	12 V
					Other than UNLOCK) Ac- tuator is not activated	0 V
7 (SB)	Ground	Step lamp	Output	Step lamp	ON	0 V
					OFF	12 V
8 (V)	Ground	All doors, fuel lid LOCK	Output	All doors, fuel lid	LOCK (Actuator is activated)	12 V
					Other than LOCK (Actuator is not activated)	0 V
9 (G)	Ground	Driver door, fuel lid UNLOCK	Output	Driver door, fuel lid	UNLOCK (Actuator is activated)	12 V
					Other than UNLOCK (Actuator is not activated)	0 V
10 (P)	Ground	Rear RH door and rear LH door UN- LOCK	Output	Rear RH door and rear LH door	UNLOCK (Actuator is activated)	12 V
					Other than UNLOCK (Actuator is not activated)	0 V
11 (R)	Ground	Battery power supply	Input	Ignition switch OFF		Battery voltage
13 (B)	Ground	Ground	—	Ignition switch ON		0 V
14 (W)	Ground	Push-button ignition switch illumination ground	Output	Tail lamp	OFF	0 V
					ON	<p>NOTE: When the illumination brighten- ing/dimming level is in the neutral position</p> 
15 (BG)	Ground	ACC indicator lamp	Output	Ignition switch	OFF (LOCK indicator is not illuminated)	Battery voltage
					ACC	0 V

BCM (BODY CONTROL MODULE)

< ECU DIAGNOSIS INFORMATION >

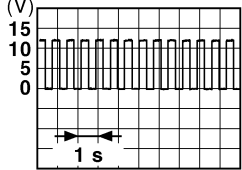
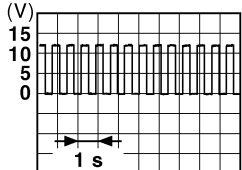
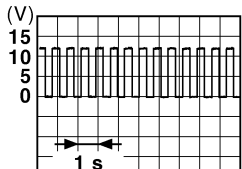
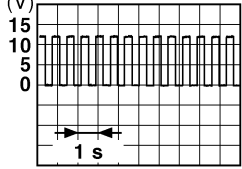
Terminal No. (Wire color)		Description		Condition	Value (Approx.)
+	-	Signal name	Input/ Output		
17 (W)	Ground	Turn signal RH (Front)	Output	Ignition switch ON	Turn signal switch OFF 0 V
				Turn signal switch RH	 <small>PKID0926E</small> 6.5 V
18 (BG)	Ground	Turn signal LH (Front)	Output	Ignition switch ON	Turn signal switch OFF 0 V
				Turn signal switch LH	 <small>PKID0926E</small> 6.5 V
19 (V)	Ground	Room lamp timer control	Output	Interior room lamp	OFF 12 V
				ON	0 V
20 (V)	Ground	Turn signal RH (Rear)	Output	Ignition switch ON	Turn signal switch OFF 0 V
				Turn signal switch RH	 <small>PKID0926E</small> 6.5 V
23 (LG)	Ground	Trunk lid open	Output	Trunk lid	OPEN (Trunk lid opener actuator is activated) 12 V
				Other than OPEN (Trunk lid opener actuator is not activated)	0 V
25 (Y)	Ground	Turn signal LH (Rear)	Output	Ignition switch ON	Turn signal switch OFF 0 V
				Turn signal switch LH	 <small>PKID0926E</small> 6.5 V
30 (P)	Ground	Trunk room lamp	Output	Trunk room lamp	ON 0 V
				OFF	12 V

BCM (BODY CONTROL MODULE)

< ECU DIAGNOSIS INFORMATION >

Terminal No. (Wire color)		Description		Condition	Value (Approx.)
		Signal name	Input/ Output		
+	-				
34 (SB)	Ground	Trunk room antenna (-)	Output	Ignition switch OFF	<p style="text-align: right; font-size: small;">JMKIA0062GB</p>
				When Intelligent Key is not in the passenger compart- ment	<p style="text-align: right; font-size: small;">JMKIA0063GB</p>
35 (V)	Ground	Trunk room antenna (+)	Output	Ignition switch OFF	<p style="text-align: right; font-size: small;">JMKIA0062GB</p>
				When Intelligent Key is not in the passenger compart- ment	<p style="text-align: right; font-size: small;">JMKIA0063GB</p>
38 (B)	Ground	Rear bumper anten- na (-)	Output	When the trunk lid opener re- quest switch is operated with ignition switch OFF	<p style="text-align: right; font-size: small;">JMKIA0062GB</p>
				When Intelligent Key is not in the antenna detection area	<p style="text-align: right; font-size: small;">JMKIA0063GB</p>

A
B
C
D
E
F
G
H
I
J
K
M
N
O
P

INL

BCM (BODY CONTROL MODULE)

< ECU DIAGNOSIS INFORMATION >

Terminal No. (Wire color)		Description		Condition	Value (Approx.)				
+	-	Signal name	Input/ Output						
39 (W)	Ground	Rear bumper antenna (+)	Output	When Intelligent Key is in the antenna detection area	<p style="text-align: right; font-size: small;">JMKIA0062GB</p>				
				When the trunk lid opener request switch is operated with ignition switch OFF	<p style="text-align: right; font-size: small;">JMKIA0063GB</p>				
47 (Y)	Ground	Ignition relay (IPDM E/R) control	Output	Ignition switch	<table border="0" style="width: 100%;"> <tr> <td style="width: 50%;">OFF or ACC</td> <td style="text-align: center;">12 V</td> </tr> <tr> <td>ON</td> <td style="text-align: center;">0 V</td> </tr> </table>	OFF or ACC	12 V	ON	0 V
				OFF or ACC	12 V				
ON	0 V								
50 (BG)	Ground	Trunk room lamp switch	Input	Trunk room lamp switch	<table border="0" style="width: 100%;"> <tr> <td style="width: 50%;">OFF (Trunk lid is closed)</td> <td> <p style="text-align: right; font-size: small;">JPMIA0011GB</p> </td> </tr> <tr> <td>ON (Trunk lid is opened)</td> <td style="text-align: center;">0 V</td> </tr> </table>	OFF (Trunk lid is closed)	<p style="text-align: right; font-size: small;">JPMIA0011GB</p>	ON (Trunk lid is opened)	0 V
				OFF (Trunk lid is closed)	<p style="text-align: right; font-size: small;">JPMIA0011GB</p>				
ON (Trunk lid is opened)	0 V								
52 (R)	Ground	Starter relay control	Output	Ignition switch ON (A/T models)	When selector lever is in P or N position	12 V			
				Ignition switch ON (M/T models)	When selector lever is not in P or N position	0 V			
				When the clutch pedal is depressed	Battery voltage				
				When the clutch pedal is not depressed	0 V				
61 (SB)	Ground	Trunk lid opener request switch	Input	Trunk lid opener request switch	<table border="0" style="width: 100%;"> <tr> <td style="width: 50%;">ON (Pressed)</td> <td style="text-align: center;">0 V</td> </tr> <tr> <td>OFF (Not pressed)</td> <td> <p style="text-align: right; font-size: small;">JPMIA0016GB</p> </td> </tr> </table>	ON (Pressed)	0 V	OFF (Not pressed)	<p style="text-align: right; font-size: small;">JPMIA0016GB</p>
				ON (Pressed)	0 V				
OFF (Not pressed)	<p style="text-align: right; font-size: small;">JPMIA0016GB</p>								
1.0 V									
64 (G)	Ground	Intelligent Key warning buzzer (Engine room)	Output	Intelligent Key warning buzzer (Engine room)	<table border="0" style="width: 100%;"> <tr> <td style="width: 50%;">Sounding</td> <td style="text-align: center;">0 V</td> </tr> <tr> <td>Not sounding</td> <td style="text-align: center;">12 V</td> </tr> </table>	Sounding	0 V	Not sounding	12 V
				Sounding	0 V				
Not sounding	12 V								

BCM (BODY CONTROL MODULE)

< ECU DIAGNOSIS INFORMATION >

Terminal No. (Wire color)		Description		Condition	Value (Approx.)	
+	-	Signal name	Input/ Output			
67 (GR)	Ground	Trunk lid opener switch	Input	Trunk lid opener switch	Pressed	0 V
					Not pressed	<p style="text-align: right;">JPMIA0011GB</p>
68 (BG)	Ground	Rear RH door switch	Input	Rear RH door switch	OFF (When rear RH door closes)	<p style="text-align: right;">JPMIA0011GB</p>
					ON (When rear RH door opens)	0 V
69 (L)	Ground	Rear LH door switch	Input	Rear LH door switch	OFF (When rear LH door closes)	<p style="text-align: right;">JPMIA0011GB</p>
					ON (When rear LH door opens)	0 V
72 (R)	Ground	Room antenna 2 (-) (Center console)	Output	Ignition switch OFF	When Intelligent Key is in the passenger compartment	<p style="text-align: right;">JMKIA0062GB</p>
					When Intelligent Key is not in the passenger compartment	<p style="text-align: right;">JMKIA0063GB</p>

A
B
C
D
E
F
G
H
I
J
K
INL
M
N
O
P

BCM (BODY CONTROL MODULE)

< ECU DIAGNOSIS INFORMATION >

Terminal No. (Wire color)		Description		Condition	Value (Approx.)
+	-	Signal name	Input/ Output		
73 (G)	Ground	Room antenna 2 (+) (Center console)	Output	Ignition switch OFF	<p style="text-align: right; font-size: small;">JMKIA0062GB</p>
				When Intelligent Key is not in the passenger compart- ment	<p style="text-align: right; font-size: small;">JMKIA0063GB</p>
74 (SB)	Ground	Passenger door an- tenna (-)	Output	When the pas- senger door re- quest switch is operated with ignition switch OFF	<p style="text-align: right; font-size: small;">JMKIA0062GB</p>
				When Intelligent Key is not in the antenna detection area	<p style="text-align: right; font-size: small;">JMKIA0063GB</p>
75 (BR)	Ground	Passenger door an- tenna (+)	Output	When the pas- senger door re- quest switch is operated with ignition switch OFF	<p style="text-align: right; font-size: small;">JMKIA0062GB</p>
				When Intelligent Key is not in the antenna detection area	<p style="text-align: right; font-size: small;">JMKIA0063GB</p>

BCM (BODY CONTROL MODULE)

< ECU DIAGNOSIS INFORMATION >

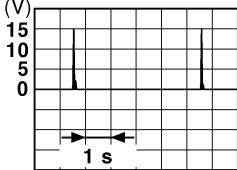
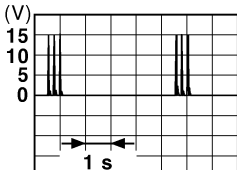
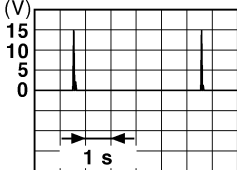
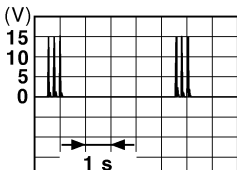
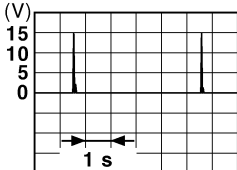
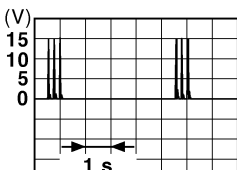
Terminal No. (Wire color)		Description		Condition	Value (Approx.)
+	-	Signal name	Input/ Output		
76 (V)	Ground	Driver door antenna (-)	Output	When the driver door request switch is operated with ignition switch OFF	 <p>JMKIA0062GB</p>
				When Intelligent Key is not in the antenna detection area	 <p>JMKIA0063GB</p>
77 (LG)	Ground	Driver door antenna (+)	Output	When the driver door request switch is operated with ignition switch OFF	 <p>JMKIA0062GB</p>
				When Intelligent Key is not in the antenna detection area	 <p>JMKIA0063GB</p>
78 (Y)	Ground	Room antenna 1 (-) (Instrument panel)	Output	Ignition switch OFF	 <p>JMKIA0062GB</p>
				When Intelligent Key is not in the passenger compartment	 <p>JMKIA0063GB</p>

A
B
C
D
E
F
G
H
I
J
K
M
N
O
P

INL



BCM (BODY CONTROL MODULE)

< ECU DIAGNOSIS INFORMATION >

Terminal No. (Wire color)		Description		Condition	Value (Approx.)	
+	-	Signal name	Input/ Output			
79 (BR)	Ground	Room antenna 1 (+) (Instrument panel)	Output	Ignition switch OFF		
				When Intelligent Key is not in the passenger compart- ment		
80 (GR)	Ground	NATS antenna amp.	Input/ Output	During waiting	Ignition switch is pressed while inserting the Intelli- gent Key into the key slot.	Just after pressing ignition switch. Pointer of tester should move.
81 (W)	Ground	NATS antenna amp.	Input/ Output	During waiting	Ignition switch is pressed while inserting the Intelli- gent Key into the key slot.	Just after pressing ignition switch. Pointer of tester should move.
82 (SB)	Ground	Ignition relay [Fuse block (J/B)] control	Output	Ignition switch	OFF or ACC	0 V
					ON	12 V
83 (Y)	Ground	Remote keyless entry receiver communica- tion	Input/ Output	During waiting		
				When operating either button on the Intelli- gent Key		

BCM (BODY CONTROL MODULE)

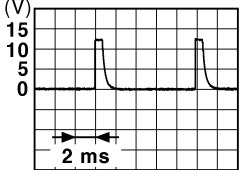
< ECU DIAGNOSIS INFORMATION >

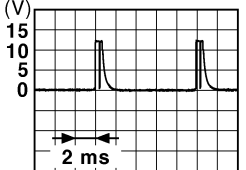

Terminal No. (Wire color)		Description		Condition	Value (Approx.)	
		Signal name	Input/ Output			
+	-					
87 (Y)	Ground	Combination switch INPUT 5	Input	Combination switch	All switches OFF (Wiper volume dial 4)	 1.4 V
				Combination switch	Front fog lamp switch ON (Wiper volume dial 4)	 1.3 V
					Any of the conditions be- low with all switches OFF	 1.3 V

A
B
C
D
E
F
G
H
I
J
K
L
M
N
O
P

INL

BCM (BODY CONTROL MODULE)

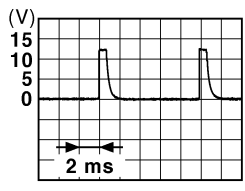
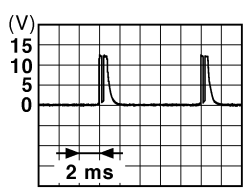
< ECU DIAGNOSIS INFORMATION >

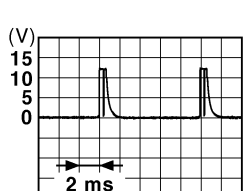
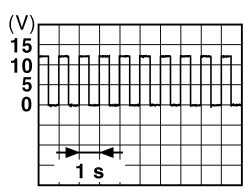
Terminal No. (Wire color)		Description		Condition	Value (Approx.)	
		Signal name	Input/ Output			
+	-					
88 (BG)	Ground	Combination switch INPUT 3	Input	Combination switch	All switches OFF (Wiper volume dial 4)	 <small>JPMIA0041GB</small> 1.4 V
					Lighting switch HI (Wiper volume dial 4)	 <small>JPMIA0036GB</small> 1.3 V
					Lighting switch 2ND (Wiper volume dial 4)	 <small>JPMIA0037GB</small> 1.3 V
					Any of the conditions below with all switches OFF <ul style="list-style-type: none"> • Wiper volume dial 1 • Wiper volume dial 2 • Wiper volume dial 3 	 <small>JPMIA0040GB</small> 1.3 V
89 (BR)	Ground	Push-button ignition switch (Push switch)	Input	Push-button ig- nition switch (push switch)	Pressed	0 V
					Not pressed	Battery voltage
90 (P)	Ground	CAN-L	Input/ Output	—	—	
91 (L)	Ground	CAN-H	Input/ Output	—	—	
92 (LG)	Ground	Key slot illumination	Output	Key slot illumi- nation	OFF	0 V
					Blinking	 <small>JPMIA0015GB</small> 6.5 V
					ON	12 V

BCM (BODY CONTROL MODULE)

< ECU DIAGNOSIS INFORMATION >

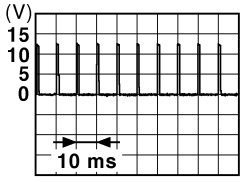
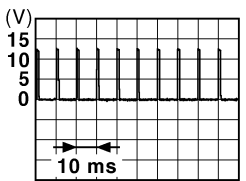



Terminal No. (Wire color)		Description		Condition		Value (Approx.)
		Signal name	Input/ Output			
+	-					
93 (GR)	Ground	ON indicator lamp	Output	Ignition switch	OFF (LOCK indicator is not illuminated)	Battery voltage
					ON	0 V
95 (BG)	Ground	ACC relay control	Output	Ignition switch	OFF	0 V
					ACC or ON	12 V
96 (GR)	Ground	A/T shift selector (Detention switch) power supply	Output	—		12 V
97 (L)	Ground	Steering lock condition No. 1	Input	Steering lock	LOCK status	0 V
					UNLOCK status	12 V
98 (P)	Ground	Steering lock condition No. 2	Input	Steering lock	LOCK status	12 V
					UNLOCK status	0 V
99 (R)*1 (BR)*2	Ground	Selector lever P position switch (A/T models)	Input	Selector lever	P position	0 V
					Any position other than P	12 V
		ASCD clutch switch (M/T models without ICC)		ASCD clutch switch	OFF (Clutch pedal is depressed)	0 V
					ON (Clutch pedal is not depressed)	12 V
		ICC clutch switch (M/T models with ICC)		ICC clutch switch	OFF (Clutch pedal is depressed)	0 V
					ON (Clutch pedal is not depressed)	12 V
100 (Y)	Ground	Passenger door request switch	Input	Passenger door request switch	ON (Pressed)	0 V
					OFF (Not pressed)	 <p style="text-align: right; font-size: small;">JPMIA0016GB</p>
101 (P)	Ground	Driver door request switch	Input	Driver door request switch	ON (Pressed)	0 V
					OFF (Not pressed)	 <p style="text-align: right; font-size: small;">JPMIA0016GB</p>
102 (BG)	Ground	Blower fan motor relay control	Output	Ignition switch	OFF or ACC	0 V
					ON	12 V
103 (P)	Ground	Remote keyless entry receiver power supply	Output	Ignition switch OFF		12 V
106 (SB)	Ground	Steering lock unit power supply	Output	Ignition switch	OFF or ACC	12 V
					ON	0 V

A
B
C
D
E
F
G
H
I
J
K
L
M
N
O
P

INL

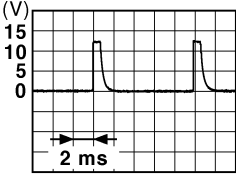

BCM (BODY CONTROL MODULE)

< ECU DIAGNOSIS INFORMATION >

Terminal No. (Wire color)		Description		Condition	Value (Approx.)	
		Signal name	Input/ Output			
+	-					
107 (LG)	Ground	Combination switch INPUT 1	Input	Combination switch (Wiper volume dial 4)	All switches OFF	 <p style="text-align: right; margin-right: 20px;">JPMIA0041GB</p> <p style="text-align: center;">1.4 V</p>
					Turn signal switch LH	 <p style="text-align: right; margin-right: 20px;">JPMIA0037GB</p> <p style="text-align: center;">1.3 V</p>
					Turn signal switch RH	 <p style="text-align: right; margin-right: 20px;">JPMIA0036GB</p> <p style="text-align: center;">1.3 V</p>
					Front wiper switch LO	 <p style="text-align: right; margin-right: 20px;">JPMIA0038GB</p> <p style="text-align: center;">1.3 V</p>
					Front washer switch ON	 <p style="text-align: right; margin-right: 20px;">JPMIA0039GB</p> <p style="text-align: center;">1.3 V</p>

BCM (BODY CONTROL MODULE)

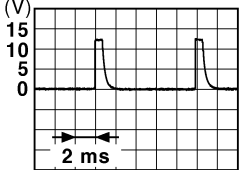
< ECU DIAGNOSIS INFORMATION >

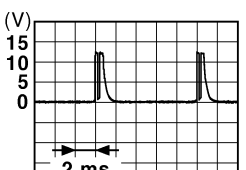
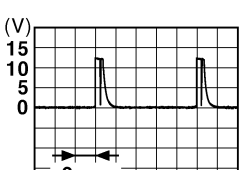



Terminal No. (Wire color)		Description		Condition	Value (Approx.)
+	-	Signal name	Input/ Output		
108 (R)	Ground	Combination switch INPUT 4	Input	Combination switch	All switches OFF (Wiper volume dial 4)  1.4 V
					Lighting switch AUTO (Wiper volume dial 4)  1.3 V
					Lighting switch 1ST (Wiper volume dial 4)  1.3 V
					Any of the conditions below with all switches OFF <ul style="list-style-type: none"> • Wiper volume dial 1 • Wiper volume dial 5 • Wiper volume dial 6  1.3 V

A
B
C
D
E
F
G
H
I
J
K
L
M
N
O
P

INL

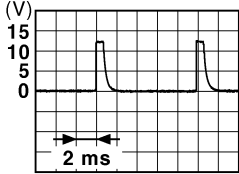
BCM (BODY CONTROL MODULE)

< ECU DIAGNOSIS INFORMATION >

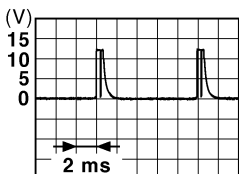
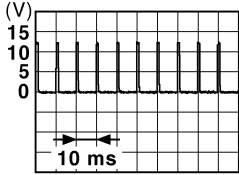
Terminal No. (Wire color)		Description		Condition	Value (Approx.)	
+	-	Signal name	Input/ Output			
109 (W)	Ground	Combination switch INPUT 2	Input	Combination switch (Wiper volume dial 4)	All switches OFF	 <p style="text-align: right; font-size: small;">JPMIA0041GB</p> <p style="text-align: center;">1.4 V</p>
					Lighting switch PASS	 <p style="text-align: right; font-size: small;">JPMIA0037GB</p> <p style="text-align: center;">1.3 V</p>
					Lighting switch 2ND	 <p style="text-align: right; font-size: small;">JPMIA0036GB</p> <p style="text-align: center;">1.3 V</p>
					Front wiper switch INT/ AUTO	 <p style="text-align: right; font-size: small;">JPMIA0038GB</p> <p style="text-align: center;">1.3 V</p>
					Front wiper switch HI	 <p style="text-align: right; font-size: small;">JPMIA0040GB</p> <p style="text-align: center;">1.3 V</p>
					ON	0 V
110 (G)	Ground	Hazard switch	Input	Hazard switch	OFF	 <p style="text-align: right; font-size: small;">JPMIA0012GB</p> <p style="text-align: center;">1.1 V</p>

BCM (BODY CONTROL MODULE)

< ECU DIAGNOSIS INFORMATION >

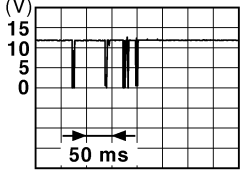
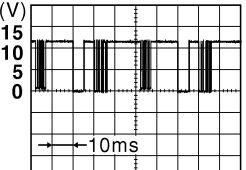
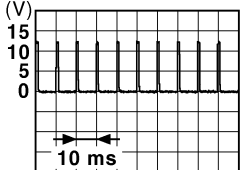
Terminal No. (Wire color)		Description		Condition	Value (Approx.)	
		Signal name	Input/ Output			
+	-					
111 (Y)	Ground	Steering lock unit communication	Input/ Output	Steering lock	LOCK status	12 V
					LOCK or UNLOCK	
					For 15 seconds after UNLOCK	12 V
				15 seconds or later after UNLOCK	0 V	
112 (R)	Ground	Light and rain sensor serial link	Input/ Output	Ignition switch ON	 8.7 V	
113 (BG)	Ground	Optical sensor	Input	Ignition switch ON	When bright outside of the vehicle	Close to 5 V
					When dark outside of the vehicle	Close to 0 V
114 (R)	Ground	Clutch interlock switch	Input	Clutch interlock switch	OFF (Clutch pedal is not depressed)	0 V
					ON (Clutch pedal is depressed)	Battery voltage
116 (SB)	Ground	Stop lamp switch 1	Input	—	Battery voltage	
118 (BR)	Ground	Stop lamp switch 2 (Without ICC)	Input	Stop lamp switch	OFF (Brake pedal is not depressed)	0 V
					ON (Brake pedal is depressed)	Battery voltage
		Stop lamp switch 2 (With ICC)		Stop lamp switch OFF (Brake pedal is not depressed) and ICC brake hold relay OFF	0 V	
				Stop lamp switch ON (Brake pedal is depressed) or ICC brake hold relay ON	Battery voltage	
119 (SB)	Ground	Front door lock assembly driver side (Unlock sensor)	Input	Driver door	LOCK status (Unlock sensor switch OFF)	 1.1 V
					UNLOCK status (Unlock switch sensor ON)	0 V

A
B
C
D
E
F
G
H
I
J
K
L
M
N
O
P

INL

BCM (BODY CONTROL MODULE)

< ECU DIAGNOSIS INFORMATION >

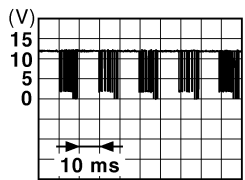
Terminal No. (Wire color)		Description		Condition	Value (Approx.)
+	-	Signal name	Input/ Output		
121 (SB)	Ground	Key slot switch	Input	When the Intelligent Key is inserted into key slot	12 V
				When the Intelligent Key is not inserted into key slot	0 V
123 (V)	Ground	IGN feedback	Input	Ignition switch	OFF or ACC
					ON
124 (R)	Ground	Passenger door switch	Input	Passenger door switch	OFF (Door close)
					ON (Door open)
129 (BG)	Ground	Trunk lid opener cancel switch	Input	Trunk lid opener cancel switch	CANCEL
					ON
132 (V)	Ground	Power window switch communication	Input/ Output	Ignition switch ON	 <p style="text-align: right; font-size: small;">JPMA0013GB</p>
				Ignition switch OFF or ACC	12 V
133 (L)	Ground	Push-button ignition switch illumination	Output	Push-button ignition switch illumination	ON (Tail lamps OFF)
					ON (Tail lamps ON)
134 (LG)	Ground	LOCK indicator lamp	Output	LOCK indicator lamp	OFF
					ON
137 (BG)	Ground	Receiver and sensor ground	Input	Ignition switch ON	0 V

BCM (BODY CONTROL MODULE)

< ECU DIAGNOSIS INFORMATION >

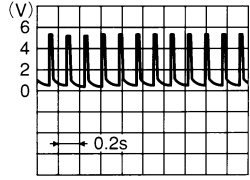
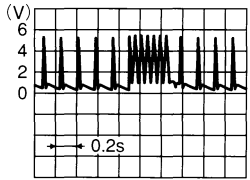
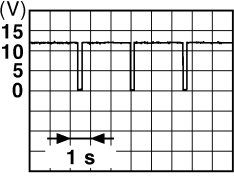
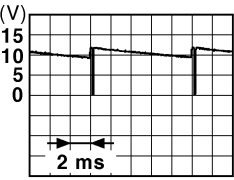
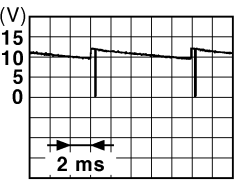
Terminal No. (Wire color)		Description		Condition		Value (Approx.)
		Signal name	Input/ Output			
+	-					
138 (V)	Ground	Receiver and sensor power supply	Output	Ignition switch	OFF	0 V
					ACC or ON	5.0 V
139 (L)	Ground	Tire pressure receiver communication	Input/ Output	Ignition switch ON	Standby state	 OCC3881D
					When receiving the signal from the transmitter	 OCC3880D
140 (B)	Ground	Selector lever P/N position	Input	Selector lever	P or N position	12 V
					Except P and N positions	0 V
141 (W)	Ground	Security indicator	Output	Security indicator	ON	0 V
					Blinking	 JPMA0014GB
					OFF	12 V
142 (BR)	Ground	Combination switch OUTPUT 5	Output	Combination switch (Wiper volume dial 4)	All switches OFF	0 V
					Lighting switch 1ST	 JPMA0031GB
					Lighting switch HI	
					Lighting switch 2ND	
					Turn signal switch RH	
Turn signal switch RH	10.7 V					
143 (P)	Ground	Combination switch OUTPUT 1	Output	Combination switch	All switches OFF (Wiper volume dial 4)	0 V
					Front wiper switch HI (Wiper volume dial 4)	 JPMA0032GB
					Any of the conditions below with all switches OFF <ul style="list-style-type: none"> • Wiper volume dial 1 • Wiper volume dial 2 • Wiper volume dial 3 • Wiper volume dial 6 • Wiper volume dial 7 	
Any of the conditions below with all switches OFF <ul style="list-style-type: none"> • Wiper volume dial 1 • Wiper volume dial 2 • Wiper volume dial 3 • Wiper volume dial 6 • Wiper volume dial 7 	10.7 V					

A
B
C
D
E
F
G
H
I
J
K
L
M
N
O
P

INL

BCM (BODY CONTROL MODULE)

< ECU DIAGNOSIS INFORMATION >

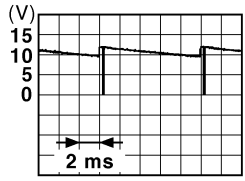
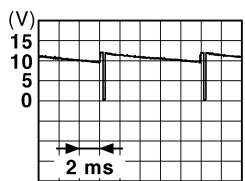
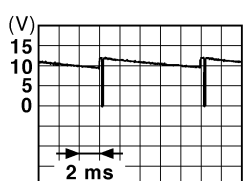
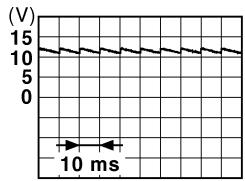
Terminal No. (Wire color)		Description		Condition	Value (Approx.)		
+	-	Signal name	Input/ Output				
144 (G)	Ground	Combination switch OUTPUT 2	Output	Combination switch	All switches OFF (Wiper volume dial 4)	0 V	
					Front washer switch ON (Wiper volume dial 4)		
					Any of the conditions below with all switches OFF		<ul style="list-style-type: none"> • Wiper volume dial 1 • Wiper volume dial 5 • Wiper volume dial 6
10.7 V							
145 (L)	Ground	Combination switch OUTPUT 3	Output	Combination switch (Wiper volume dial 4)	All switches OFF	0 V	
					Front wiper switch INT/ AUTO		
					Front wiper switch LO		
					Lighting switch AUTO		
10.7 V							
146 (SB)	Ground	Combination switch OUTPUT 4	Output	Combination switch (Wiper volume dial 4)	All switches OFF	0 V	
					Front fog lamp switch ON		
					Lighting switch 2ND		
					Lighting switch PASS		
					Turn signal switch LH		
10.7 V							
149 (W)	Ground	Tire pressure warning check switch	Input	—	12 V		
150 (GR)	Ground	Driver door switch	Input	Driver door switch	OFF (Door close)		
					ON (Door open)		0 V
151 (G)	Ground	Rear window defog- ger relay control	Output	Rear window defogger	Active	0 V	
					Not activated	Battery voltage	

- *1: A/T models
- *2: M/T models

BCM (BODY CONTROL MODULE)

< ECU DIAGNOSIS INFORMATION >

◊ A ◊ : With A/T
 ◊ M ◊ : With M/T
 ◊ IC ◊ : With ICC
 ◊ OI ◊ : Without ICC

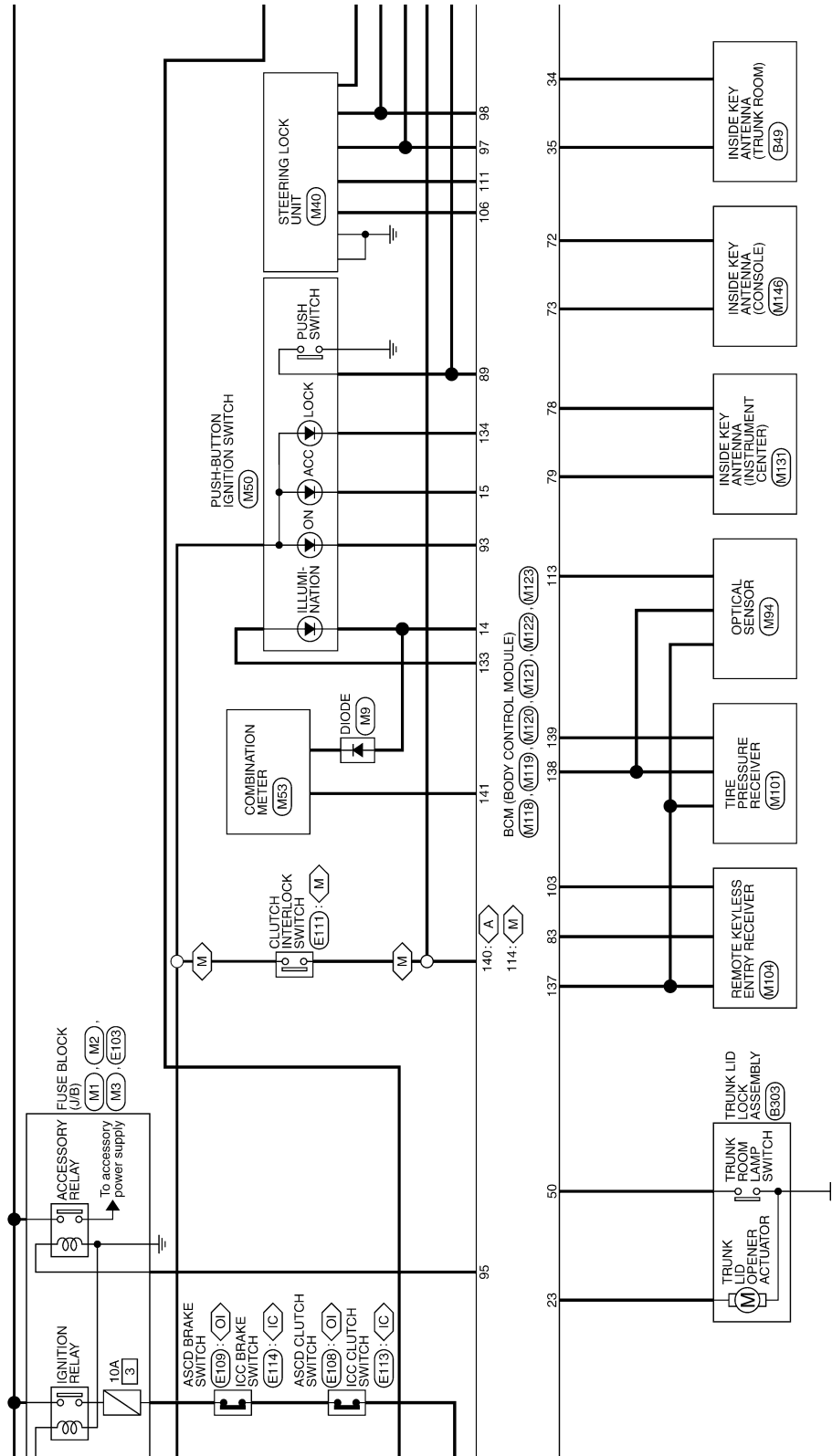

JCMWM5778G

BCM (BODY CONTROL MODULE)

< ECU DIAGNOSIS INFORMATION >

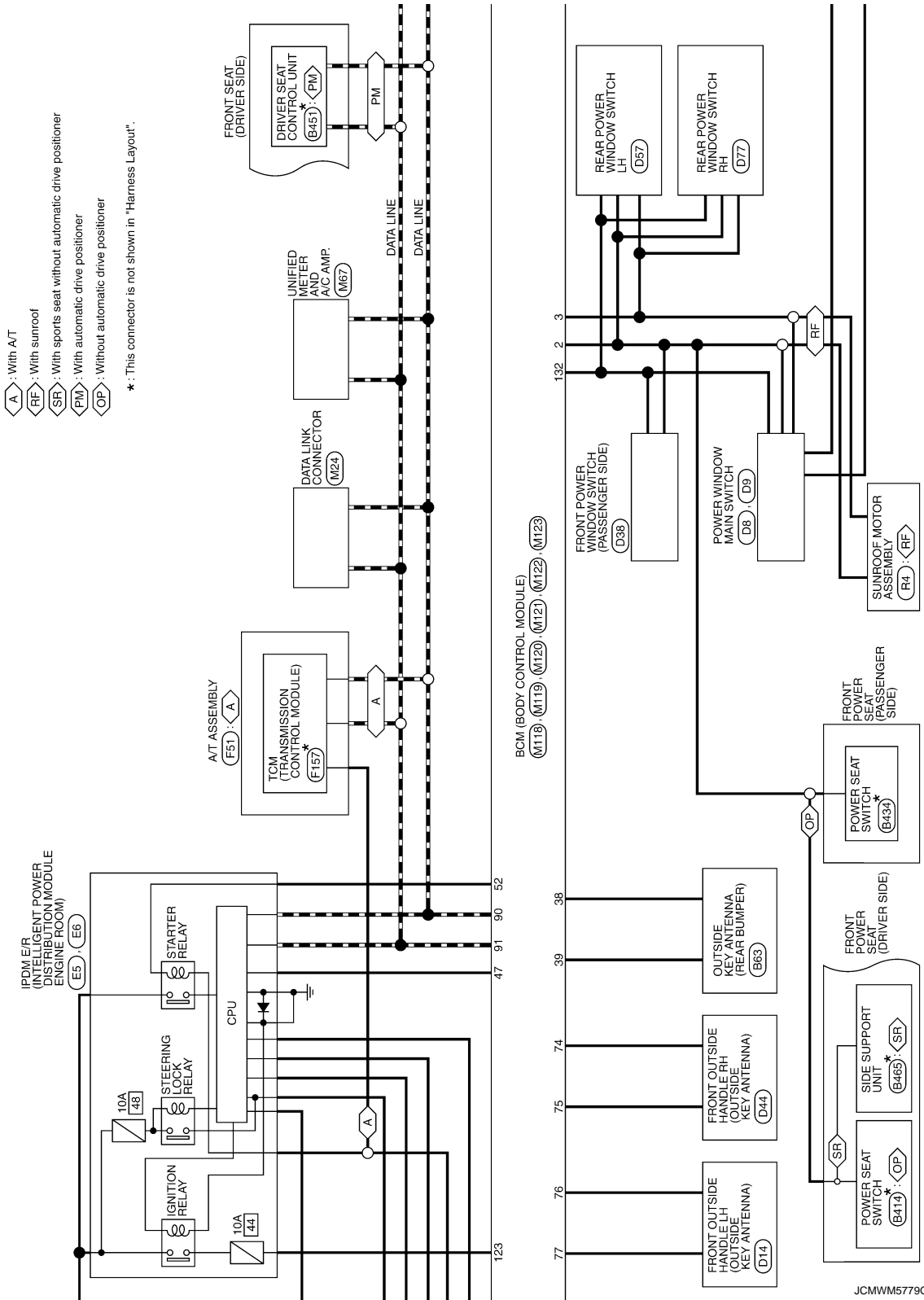

A
B
C
D
E
F
G
H
I
J
K
L
M
N
O
P

INL

BCM (BODY CONTROL MODULE)

< ECU DIAGNOSIS INFORMATION >

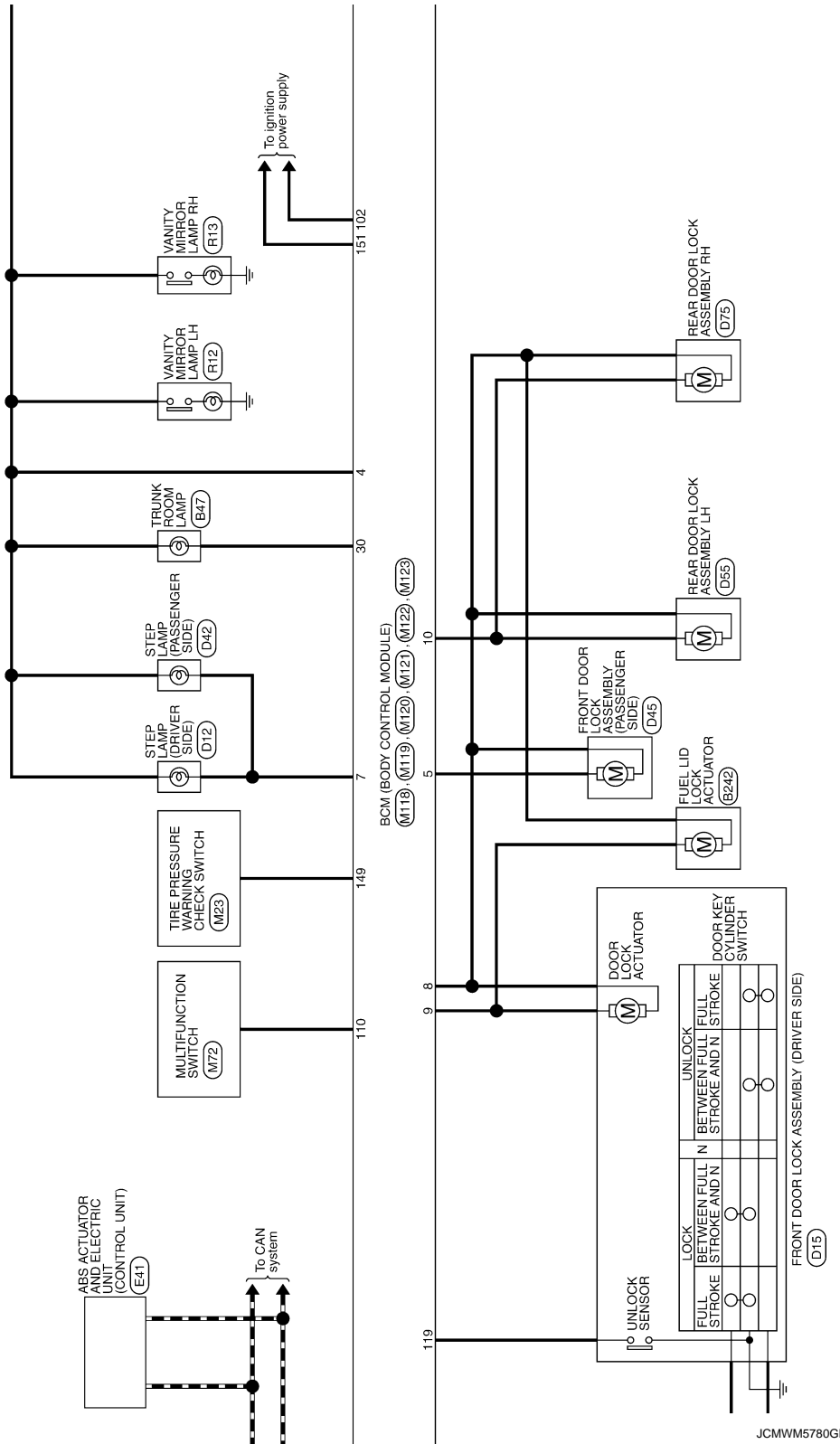

JCMWMM5780G

BCM (BODY CONTROL MODULE)

< ECU DIAGNOSIS INFORMATION >

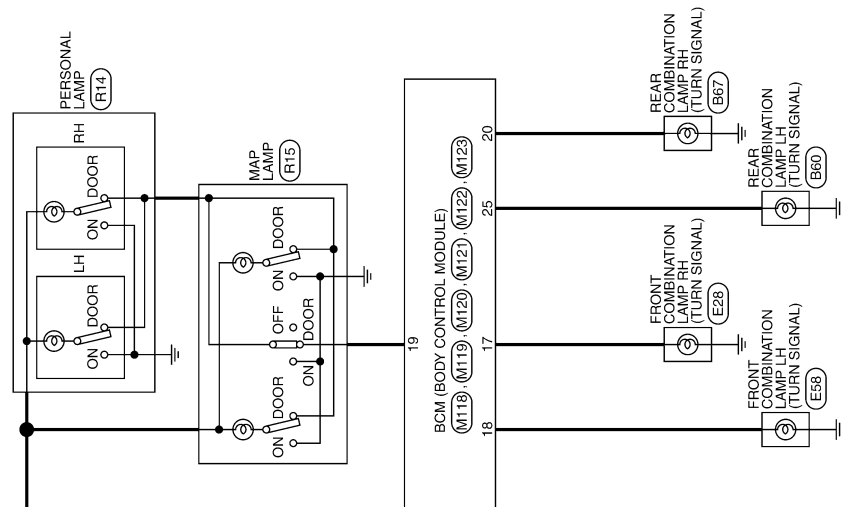

JCMWM5781G1

A
B
C
D
E
F
G
H
I
J
K
INL
M
N
O
P

BCM (BODY CONTROL MODULE)

< ECU DIAGNOSIS INFORMATION >

BCM (BODY CONTROL MODULE)

Connector No.	M33
Connector Name	COMBINATION SWITCH
Connector Type	TH16FW-NH

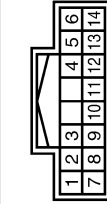

Terminal No.	Color of Wire	Signal Name [Specification]
1	GR	FR WASHER (-)
2	SB	OUTPUT 4
5	L	OUTPUT 3
6	B	GND
7	BG	INPUT 3
8	ER	OUTPUT 5
9	W	INPUT 2
10	R	INPUT 4
11	LG	INPUT 1
12	P	OUTPUT 1
13	Y	INPUT 5
14	G	OUTPUT 2

Connector No.	M18
Connector Name	BCM (BODY CONTROL MODULE)
Connector Type	M03FB-LC



Terminal No.	Color of Wire	Signal Name [Specification]
1	W	BAT (F/L)
2	Y	POWER WINDOW POWER SUPPLY (BAT)
3	BG	POWER WINDOW POWER SUPPLY (RAP)

Connector No.	M119
Connector Name	BCM (BODY CONTROL MODULE)
Connector Type	NS12FW-CS

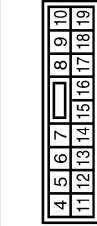

Terminal No.	Color of Wire	Signal Name [Specification]
4	LG	INTERIOR ROOM LAMP POWER SUPPLY
5	P	PASSENGER DOOR UNLOCK OUTPUT
7	SB	STEP LAMP OUTPUT
8	V	ALL DOOR FUEL LID LOCK OUTPUT
9	G	DRIVER DOOR FUEL LID UNLOCK OUTPUT
10	P	REAR DOOR UNLOCK OUTPUT
11	R	BAT (FUSE)
13	B	GND
14	W	PUSH-BUTTON IGNITION SW ILL GND
15	BG	ACC IND
17	W	TURN SIGNAL RH (FRONT)
18	BG	TURN SIGNAL LH (FRONT)
19	V	ROOM LAMP TIMER CONTROL

Connector No.	M120
Connector Name	BCM (BODY CONTROL MODULE)
Connector Type	NS12FW-CS

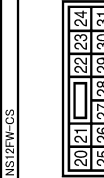

Terminal No.	Color of Wire	Signal Name [Specification]
20	V	TURN SIGNAL RH (REAR)
23	LG	TRUNK LID OPEN OUTPUT
25	Y	TURN SIGNAL LH (REAR)
30	P	TRUNK ROOM LAMP

Connector No.	M121
Connector Name	BCM (BODY CONTROL MODULE)
Connector Type	TH40FGY-NH

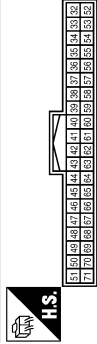

Terminal No.	Color of Wire	Signal Name [Specification]
34	SB	TRUNK ROOM ANT-
35	V	TRUNK ROOM ANT+
38	B	REAR BUMPER ANT-
39	W	REAR BUMPER ANT+
47	Y	IGN RELAY (RPM E/P) CONT
50	BG	TRUNK ROOM LAMP SW
52	R	STARTER RELAY CONT
61	SB	TRUNK LID OPENER REQUEST SW
64	G	I-KEY WARN BUZZER (ENG ROOM)
67	GR	TRUNK LID OPENER SW
68	BG	REAR RH DOOR SW
69	L	REAR LH DOOR SW

Connector No.	M122
Connector Name	BCM (BODY CONTROL MODULE)
Connector Type	TH40FB-NH

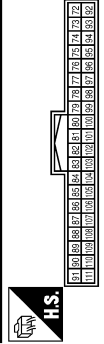

Terminal No.	Color of Wire	Signal Name [Specification]
72	R	ROOM ANT 2-
73	G	ROOM ANT 2+
74	SB	PASSENGER DOOR ANT-
75	BR	PASSENGER DOOR ANT+
76	V	DRIVER DOOR ANT-
77	LG	DRIVER DOOR ANT+
78	Y	ROOM ANT 1-
79	BR	ROOM ANT 1+
80	GR	NATS ANT AMP
81	W	INATS ANT AMP

82	SB	IGN RELAY (F/B) CONT
83	Y	KEYLESS ENTRY RECEIVER COMM
87	Y	COMBI SW INPUT 5
88	BG	COMBI SW INPUT 3
89	BR	PUSH SW
90	P	CAN-L
91	L	CAN-H
92	LG	KEY SLOT ILL
93	GR	ON IND
95	BG	ACC RELAY CONT
96	GR	A/T SHIFT SELECTOR POWER SUPPLY
97	L	S/L CONDITION 1
98	P	S/L CONDITION 2
99	R	SHIFT P [With A/T]
99	BR	ICC CLUTCH SW [With M/T and ICC]
99	BR	ASGD CLUTCH SW [With M/T without ICC]
100	Y	PASSENGER DOOR REQUEST SW
101	P	DRIVER DOOR REQUEST SW
102	BG	BLOWER FAN MOTOR RELAY CONT
103	P	KEYLESS ENTRY RECEIVER POWER SUPPLY
106	SB	S/L UNIT POWER SUPPLY
107	LG	COMBI SW INPUT 1
108	R	COMBI SW INPUT 4
109	W	COMBI SW INPUT 2
110	G	HAZARD SW
111	Y	S/L UNIT COMM

BCM (BODY CONTROL MODULE)

< ECU DIAGNOSIS INFORMATION >

A
B
C
D
E
F
G
H
I
J
K
M
N
O
P

BCM (BODY CONTROL MODULE)

Connector No.	M123
Connector Name	BCM (BODY CONTROL MODULE)
Connector Type	TH40FG-NH

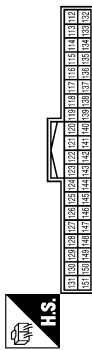

Terminal No.	Color of Wire	Signal Name [Specification]
112	R	RAIN SENSOR SERIAL LINK
113	BG	OPTICAL SENSOR
114	R	CLUTCH INTERLOCK SW
116	SB	STOP LAMP SW 1
118	BR	STOP LAMP SW 2
119	SB	DR DOOR UNLOCK SENSOR
121	SB	KEY SLOT SW
123	V	IGN P/B
124	R	PASSENGER DOOR SW
129	BG	TRUNK LID OPENER CANCEL SW
132	V	POWER WINDOW SW COMM
133	L	PUSH-BUTTON IGNITION SW ILL POWER
134	LG	LOCK IND
137	BG	RECEIVER / SENSOR GND
138	V	RECEIVER / SENSOR POWER SUPPLY
139	L	TIRE PRESSURE RECEIVER COMM
140	B	SHIFT N/P
141	W	SECURITY INDICATOR LAMP
142	BR	COMBI SW OUTPUT 5
143	P	COMBI SW OUTPUT 1
144	G	COMBI SW OUTPUT 2
145	L	COMBI SW OUTPUT 3
146	SB	COMBI SW OUTPUT 4
149	W	TIRE PRESSURE WARN CHECK SW
150	GR	DRIVER DOOR SW
151	G	REAR WINDOW DEFOGGER RELAY COINT

Fail-safe

FAIL-SAFE CONTROL BY DTC

BCM performs fail-safe control when any DTC are detected.

JCMW5783G1

INFOID:000000005880606

BCM (BODY CONTROL MODULE)

< ECU DIAGNOSIS INFORMATION >

Display contents of CONSULT	Fail-safe	Cancellation
B2013: ID DISCORD BCM-S/L	Inhibit engine cranking	Erase DTC
B2014: CHAIN OF S/L-BCM	Inhibit engine cranking	Erase DTC
B2190: NATS ANTENNA AMP	Inhibit engine cranking	Erase DTC
B2191: DIFFERENCE OF KEY	Inhibit engine cranking	Erase DTC
B2192: ID DISCORD BCM-ECM	Inhibit engine cranking	Erase DTC
B2193: CHAIN OF BCM-ECM	Inhibit engine cranking	Erase DTC
B2195: ANTI-SCANNING	Inhibit engine cranking	Ignition switch ON → OFF
B2557: VEHICLE SPEED	Inhibit steering lock	When normal vehicle speed signals are received from ABS actuator and electric unit (control unit) for 500 ms
B2560: STARTER CONT RELAY	Inhibit engine cranking	500 ms after the following CAN signal communication status becomes consistent <ul style="list-style-type: none"> • Starter control relay signal • Starter relay status signal
B2601: SHIFT POSITION	Inhibit steering lock	500 ms after the following signal reception status becomes consistent <ul style="list-style-type: none"> • Selector lever P position switch signal • P range signal (CAN)
B2602: SHIFT POSITION	Inhibit steering lock	5 seconds after the following BCM recognition conditions are fulfilled <ul style="list-style-type: none"> • Ignition switch is in the ON position • Selector lever P position switch signal: Except P position (12 V) • Vehicle speed: 4 km/h (2.5 MPH) or more
B2603: SHIFT POSI STATUS	Inhibit steering lock	500 ms after the following BCM recognition conditions are fulfilled <ul style="list-style-type: none"> • Ignition switch is in the ON position • Selector lever P position switch signal: Except P position (12 V) • Selector lever P/N position signal: Except P and N positions (0 V)
B2604: PNP/CLUTCH SW	Inhibit steering lock	500 ms after any of the following BCM recognition conditions are fulfilled <ul style="list-style-type: none"> • Status 1 <ul style="list-style-type: none"> - Ignition switch is in the ON position - Selector lever P/N position signal: P and N position (12 V) - P range signal or N range signal (CAN): ON • Status 2 <ul style="list-style-type: none"> - Ignition switch is in the ON position - Selector lever P/N position signal: Except P and N positions (0 V) - P range signal and N range signal (CAN): OFF
B2605: PNP/CLUTCH SW	Inhibit steering lock	500 ms after any of the following BCM recognition conditions are fulfilled <ul style="list-style-type: none"> • Status 1 <ul style="list-style-type: none"> - Ignition switch is in the ON position - Selector lever P/N position signal: Except P and N positions (0 V) - Interlock/PNP switch signal (CAN): OFF • Status 2 <ul style="list-style-type: none"> - Ignition switch is in the ON position - Selector lever P/N position signal: P or N position (12 V) - PNP switch signal (CAN): ON
B2606: S/L RELAY	Inhibit engine cranking	500 ms after the following CAN signal communication status becomes consistent <ul style="list-style-type: none"> • Steering lock relay signal (Request signal) • Steering lock relay signal (Condition signal)
B2607: S/L RELAY	Inhibit engine cranking	500 ms after the following CAN signal communication status has become consistent <ul style="list-style-type: none"> • Steering lock relay signal (Request signal) • Steering lock relay signal (Condition signal)

BCM (BODY CONTROL MODULE)

< ECU DIAGNOSIS INFORMATION >

Display contents of CONSULT	Fail-safe	Cancellation
B2608: STARTER RELAY	Inhibit engine cranking	500 ms after the following signal communication status becomes consistent <ul style="list-style-type: none"> • Starter motor relay control signal • Starter relay status signal (CAN)
B2609: S/L STATUS	<ul style="list-style-type: none"> • Inhibit engine cranking • Inhibit steering lock 	When the following steering lock conditions agree <ul style="list-style-type: none"> • BCM steering lock control status • Steering lock condition No. 1 signal status • Steering lock condition No. 2 signal status
B260A: IGNITION RELAY	Inhibit engine cranking	500 ms after the following conditions are fulfilled <ul style="list-style-type: none"> • IGN relay (IPDM E/R) control signal: OFF (12 V) • Ignition ON signal (CAN to IPDM E/R): OFF (Request signal) • Ignition ON signal (CAN from IPDM E/R): OFF (Condition signal)
B260F: ENG STATE SIG LOST	Maintains the power supply position attained at the time of DTC detection	When any of the following conditions are fulfilled <ul style="list-style-type: none"> • Power position changes to ACC • Receives engine status signal (CAN)
B2612: S/L STATUS	<ul style="list-style-type: none"> • Inhibit engine cranking • Inhibit steering lock 	When any of the following conditions are fulfilled <ul style="list-style-type: none"> • Steering lock unit status signal (CAN) is received normally • The BCM steering lock control status matches the steering lock status recognized by the steering lock unit status signal (CAN from IPDM E/R)
B2617: BCM	Inhibit engine cranking	1 second after the starter motor relay control inside BCM becomes normal
B2618: BCM	Inhibit engine cranking	1 second after the ignition relay (IPDM E/R) control inside BCM becomes normal
B2619: BCM	Inhibit engine cranking	1 second after the steering lock unit power supply output control inside BCM becomes normal
B261E: VEHICLE TYPE	Inhibit engine cranking	BCM initialization
B26E8: CLUTCH SW	Inhibit engine cranking	When any of the following BCM recognition conditions are fulfilled <ul style="list-style-type: none"> • Status 1 <ul style="list-style-type: none"> - Clutch switch signal (CAN from ECM): ON - Clutch interlock switch signal: OFF (0 V) • Status 2 <ul style="list-style-type: none"> - Clutch switch signal (CAN from ECM): OFF - Clutch interlock switch signal: ON (Battery voltage)
B26E9: S/L STATUS	<ul style="list-style-type: none"> • Inhibit engine cranking • Inhibit steering lock 	When BCM transmits the LOCK request signal to steering lock unit, and receives LOCK response signal from steering lock unit, the following conditions are fulfilled <ul style="list-style-type: none"> • Steering condition No. 1 signal: LOCK (0 V) • Steering condition No. 2 signal: LOCK (12 V)

DTC Inspection Priority Chart

INFOID:000000005880607

If some DTCs are displayed at the same time, perform inspections one by one based on the following priority chart.

Priority	DTC
1	B2562: LOW VOLTAGE
2	<ul style="list-style-type: none"> • U1000: CAN COMM • U1010: CONTROL UNIT(CAN)
3	<ul style="list-style-type: none"> • B2190: NATS ANTENNA AMP • B2191: DIFFERENCE OF KEY • B2192: ID DISCORD BCM-ECM • B2193: CHAIN OF BCM-ECM • B2195: ANTI-SCANNING

BCM (BODY CONTROL MODULE)

< ECU DIAGNOSIS INFORMATION >

Priority	DTC
4	<ul style="list-style-type: none"> • B2013: ID DISCORD BCM-S/L • B2014: CHAIN OF S/L-BCM • B2553: IGNITION RELAY • B2555: STOP LAMP • B2556: PUSH-BTN IGN SW • B2557: VEHICLE SPEED • B2560: STARTER CONT RELAY • B2601: SHIFT POSITION • B2602: SHIFT POSITION • B2603: SHIFT POSI STATUS • B2604: PNP/CLUTCH SW • B2605: PNP/CLUTCH SW • B2606: S/L RELAY • B2607: S/L RELAY • B2608: STARTER RELAY • B2609: S/L STATUS • B260A: IGNITION RELAY • B260B: STEERING LOCK UNIT • B260C: STEERING LOCK UNIT • B260D: STEERING LOCK UNIT • B260F: ENG STATE SIG LOST • B2612: S/L STATUS • B2614: BCM • B2615: BCM • B2616: BCM • B2617: BCM • B2618: BCM • B2619: BCM • B261A: PUSH-BTN IGN SW • B261E: VEHICLE TYPE • B26E8: CLUTCH SW • B26E9: S/L STATUS • B26EA: KEY REGISTRATION • C1729: VHCL SPEED SIG ERR • U0415: VEHICLE SPEED
5	<ul style="list-style-type: none"> • C1704: LOW PRESSURE FL • C1705: LOW PRESSURE FR • C1706: LOW PRESSURE RR • C1707: LOW PRESSURE RL • C1708: [NO DATA] FL • C1709: [NO DATA] FR • C1710: [NO DATA] RR • C1711: [NO DATA] RL • C1716: [PRESSDATA ERR] FL • C1717: [PRESSDATA ERR] FR • C1718: [PRESSDATA ERR] RR • C1719: [PRESSDATA ERR] RL • C1734: CONTROL UNIT
6	<ul style="list-style-type: none"> • B2621: INSIDE ANTENNA • B2622: INSIDE ANTENNA • B2623: INSIDE ANTENNA

DTC Index

INFOID:000000005880608

NOTE:

The details of time display are as follows.

- CRNT: A malfunction is detected now.
- PAST: A malfunction was detected in the past.

IGN counter is displayed on Freeze Frame Data. For details of Freeze Frame Data, refer to [BCS-14, "COMMON ITEM : CONSULT-III Function \(BCM - COMMON ITEM\)"](#).

BCM (BODY CONTROL MODULE)

< ECU DIAGNOSIS INFORMATION >

CONSULT display	Fail-safe	Freeze Frame Data •Vehicle Speed •Odo/Trip Meter •Vehicle condition	Intelligent Key warning lamp ON	Tire pressure monitor warning lamp ON	Refer- ence page
No DTC is detected. further testing may be required.	—	—	—	—	—
U1000: CAN COMM	—	—	—	—	BCS-33
U1010: CONTROL UNIT(CAN)	—	—	—	—	BCS-34
U0415: VEHICLE SPEED	—	—	—	—	BCS-35
B2013: ID DISCORD BCM-S/L	×	×	—	—	SEC-55
B2014: CHAIN OF S/L-BCM	×	×	—	—	SEC-56
B2190: NATS ANTENNA AMP	×	—	—	—	SEC-47
B2191: DIFFERENCE OF KEY	×	—	—	—	SEC-50
B2192: ID DISCORD BCM-ECM	×	—	—	—	SEC-51
B2193: CHAIN OF BCM-ECM	×	—	—	—	SEC-53
B2195: ANTI-SCANNING	×	—	—	—	SEC-54
B2553: IGNITION RELAY	—	×	—	—	PCS-49
B2555: STOP LAMP	—	×	—	—	SEC-59
B2556: PUSH-BTN IGN SW	—	×	×	—	SEC-61
B2557: VEHICLE SPEED	×	×	×	—	SEC-63
B2560: STARTER CONT RELAY	×	×	×	—	SEC-64
B2562: LOW VOLTAGE	—	×	—	—	BCS-36
B2601: SHIFT POSITION	×	×	×	—	SEC-65
B2602: SHIFT POSITION	×	×	×	—	SEC-68
B2603: SHIFT POSI STATUS	×	×	×	—	SEC-70
B2604: PNP/CLUTCH SW	×	×	×	—	SEC-73
B2605: PNP/CLUTCH SW	×	×	×	—	SEC-75
B2606: S/L RELAY	×	×	×	—	SEC-77
B2607: S/L RELAY	×	×	×	—	SEC-78
B2608: STARTER RELAY	×	×	×	—	SEC-80
B2609: S/L STATUS	×	×	×	—	SEC-82
B260A: IGNITION RELAY	×	×	×	—	PCS-51
B260B: STEERING LOCK UNIT	—	×	×	—	SEC-86
B260C: STEERING LOCK UNIT	—	×	×	—	SEC-87
B260D: STEERING LOCK UNIT	—	×	×	—	SEC-88
B260F: ENG STATE SIG LOST	×	×	×	—	SEC-89
B2612: S/L STATUS	×	×	×	—	SEC-94
B2614: BCM	—	×	×	—	PCS-53
B2615: BCM	—	×	×	—	PCS-55
B2616: BCM	—	×	×	—	PCS-57
B2617: BCM	×	×	×	—	SEC-98
B2618: BCM	×	×	×	—	PCS-59
B2619: BCM	×	×	×	—	SEC-100
B261A: PUSH-BTN IGN SW	—	×	×	—	PCS-60
B261E: VEHICLE TYPE	×	×	× (Turn ON for 15 seconds)	—	SEC-101

A
B
C
D
E
F
G
H
I
J
K
INL
M
N
O
P

BCM (BODY CONTROL MODULE)

< ECU DIAGNOSIS INFORMATION >

CONSULT display	Fail-safe	Freeze Frame Data •Vehicle Speed •Odo/Trip Meter •Vehicle condition	Intelligent Key warning lamp ON	Tire pressure monitor warning lamp ON	Refer- ence page
B2621: INSIDE ANTENNA	—	×	—	—	DLK-59
B2622: INSIDE ANTENNA	—	×	—	—	DLK-61
B2623: INSIDE ANTENNA	—	×	—	—	DLK-63
B26E8: CLUTCH SW	×	×	×	—	SEC-90
B26E9: S/L STATUS	×	×	× (Turn ON for 15 seconds)	—	SEC-92
B26EA: KEY REGISTRATION	—	×	× (Turn ON for 15 seconds)	—	SEC-93
C1704: LOW PRESSURE FL	—	—	—	×	WT-26
C1705: LOW PRESSURE FR	—	—	—	×	
C1706: LOW PRESSURE RR	—	—	—	×	
C1707: LOW PRESSURE RL	—	—	—	×	
C1708: [NO DATA] FL	—	—	—	×	WT-28
C1709: [NO DATA] FR	—	—	—	×	
C1710: [NO DATA] RR	—	—	—	×	
C1711: [NO DATA] RL	—	—	—	×	
C1716: [PRESSDATA ERR] FL	—	—	—	×	WT-31
C1717: [PRESSDATA ERR] FR	—	—	—	×	
C1718: [PRESSDATA ERR] RR	—	—	—	×	
C1719: [PRESSDATA ERR] RL	—	—	—	×	
C1729: VHCL SPEED SIG ERR	—	—	—	×	WT-33
C1734: CONTROL UNIT	—	—	—	×	WT-35

COMBINATION METER

< ECU DIAGNOSIS INFORMATION >

COMBINATION METER

Reference Value

INFOID:000000005880609

VALUES ON THE DIAGNOSIS TOOL

Refer to [MWI-86. "Reference Value"](#).

TERMINAL LAYOUT

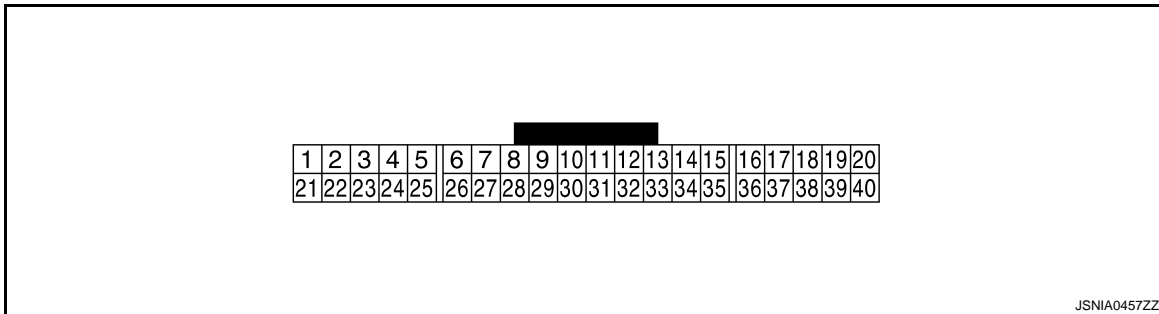

PHYSICAL VALUES

Terminal No. (Wire color)		Description		Condition		Value (Approx.)
+	-	Signal name	Input/ Output			
1 (V)	Ground	Battery power supply	Input	Ignition switch OFF	—	Battery voltage
2 (LG)	Ground	Communication signal (METER→ AMP.)	Output	Ignition switch ON	—	 <small>JSNIA0027GB</small>
3 (GR)	Ground	Communication signal (AMP.→ METER)	Input	Ignition switch ON	—	 <small>JSNIA0027GB</small>
5 (B)	Ground	Ground	—	Ignition switch ON	—	0 V
6 (W)	Ground	Alternator signal	Input	Ignition switch ON	Charge warning lamp ON	0 V
					Charge warning lamp OFF	12 V
7 (LG)	Ground	Air bag signal	Input	Ignition switch ON	Air bag warning lamp ON	4 V
					Air bag warning lamp OFF	0 V
10 (W)	Ground	Security signal	Input	Ignition switch OFF	Security warning lamp ON	0 V
					Security warning lamp OFF	12 V
15 (B)	Ground	Ground	—	Ignition switch ON	—	0 V

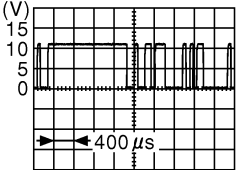
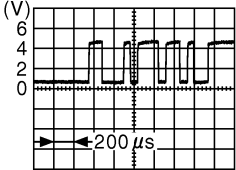
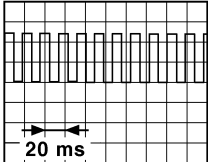
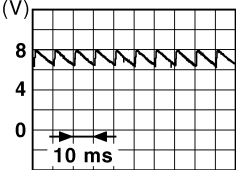
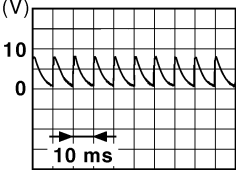

COMBINATION METER

< ECU DIAGNOSIS INFORMATION >

Terminal No. (Wire color)		Description		Condition		Value (Approx.)
+	-	Signal name	Input/ Output			
16 (BR)	Ground	Meter control switch ground	—	Ignition switch ON	—	0 V
21 (G)	Ground	Ignition signal	Input	Ignition switch ON	—	12 V
22 (B)	Ground	Ground	—	Ignition switch ON	—	0 V
24 (BR)	Ground	Communication signal (LCD→ AMP.)	Output	Ignition switch ON	—	 <p style="text-align: right; font-size: small;">JSNIA0028GB</p>
25 (Y)	Ground	Communication signal (AMP.→ LCD)	Input	Ignition switch ON	—	 <p style="text-align: right; font-size: small;">JSNIA0027GB</p>
26 (R)	Ground	Vehicle speed signal (8-pulse)	Input	Ignition switch ON	Speedometer operated [When vehicle speed is ap- prox. 40 km/h (25 MPH)]	<p>NOTE: The maximum voltage varies de- pending on the specification (destination unit).</p>  <p style="text-align: right; font-size: small;">JSNIA0012GB</p>
27 (P)	Ground	Parking brake switch signal	Input	Ignition switch ON	Parking brake ON	0 V
					Parking brake OFF	 <p style="text-align: right; font-size: small;">JSNIA0007GB</p>
28 (SB)	Ground	Brake fluid level switch sig- nal	Input	Ignition switch ON	Brake fluid level is normal.	 <p style="text-align: right; font-size: small;">JSNIA0008GB</p>
					The brake fluid level is low- er than the low level	0 V

COMBINATION METER

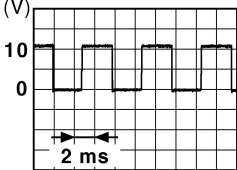
< ECU DIAGNOSIS INFORMATION >

Terminal No. (Wire color)		Description		Condition		Value (Approx.)
+	-	Signal name	Input/ Output			
29 (P)	Ground	Seat belt buckle switch signal (driver side)	Input	Ignition switch ON	When driver seat belt is fastened	12 V
					When driver seat belt is unfastened	0 V
30 (G)	Ground	Seat belt buckle switch signal (passenger side)	Input	Ignition switch ON	<ul style="list-style-type: none"> When getting in the passenger seat When passenger seat belt is fastened 	12 V
					<ul style="list-style-type: none"> When getting in the passenger seat When passenger seat belt is unfastened 	0 V
31 (L)	Ground	Washer level switch signal	Input	Ignition switch ON	Washer level switch ON	0 V
					Washer level switch OFF	5 V
33 (R)	Ground	Illumination control signal	Output	Ignition switch ON	Lighting switch ON, then operate the illumination control switch.	<p>NOTE: When brightness level is midway</p>  <p style="text-align: right; font-size: small;">JSNIA0010GB</p>
36 (LG)	16 (BR)	Select switch signal	Input	Ignition switch ON	When ● is pressed	0 V
					Other than the above	5 V
37 (Y)	16 (BR)	Enter switch signal	Input	Ignition switch ON	When □ is pressed	0 V
					Other than the above	5 V
38 (G)	16 (BR)	Trip A/B reset switch signal	Input	Ignition switch ON	When trip A/B reset switch is pressed	0 V
					Other than the above	5 V
39 (P)	16 (BR)	Illumination control switch signal (-)	Input	Ignition switch ON	When  switch is pressed	0 V
					Other than the above	5 V
40 (BG)	16 (BR)	Illumination control switch signal (+)	Input	Ignition switch ON	When  switch is pressed	0 V
					Other than the above	5 V

A
B
C
D
E
F
G
H
I
J
K
L
M
N
O
P

INL

COMBINATION METER

< ECU DIAGNOSIS INFORMATION >

Wiring Diagram - METER -

INFOID:000000005880610

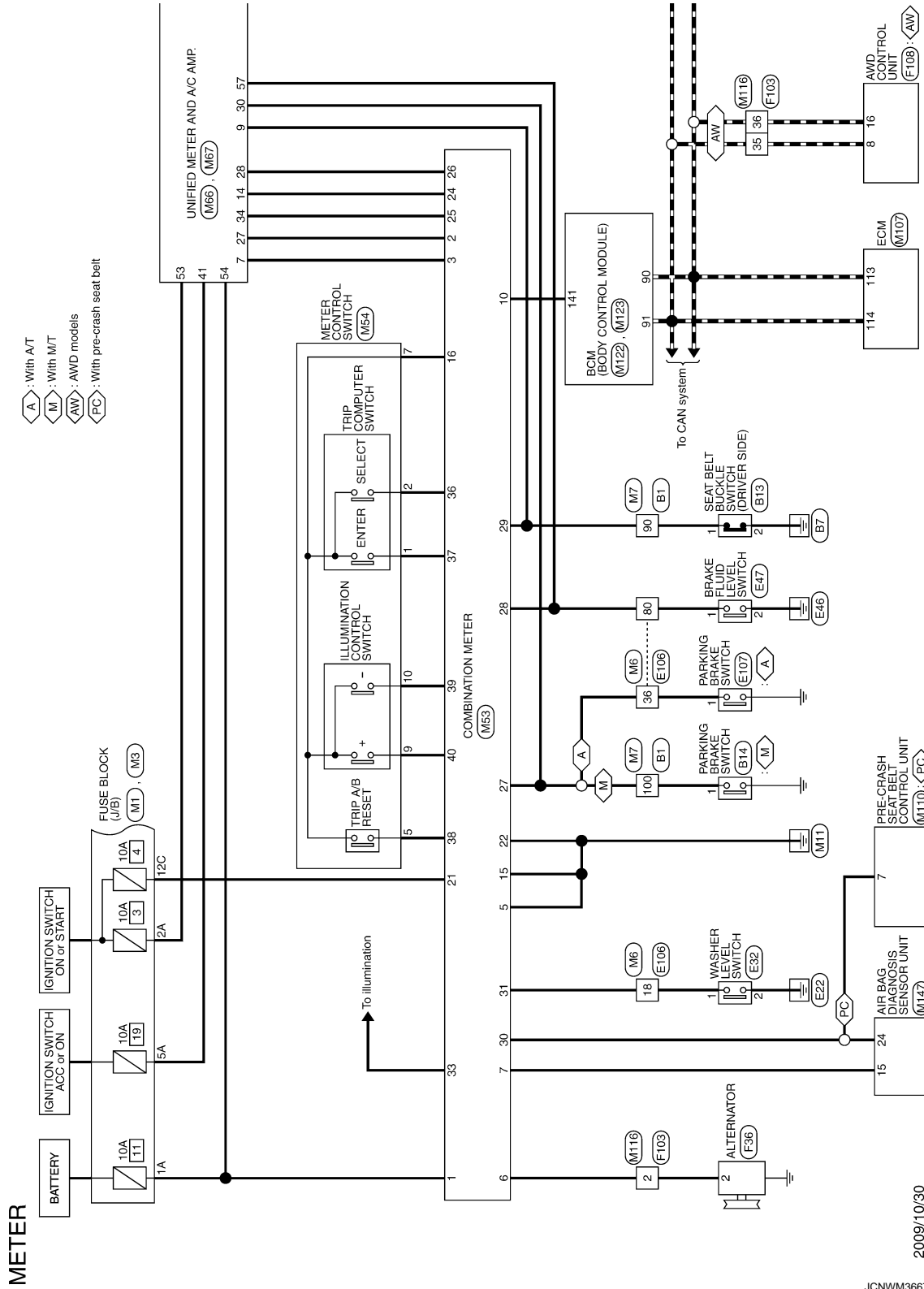

COMBINATION METER

< ECU DIAGNOSIS INFORMATION >

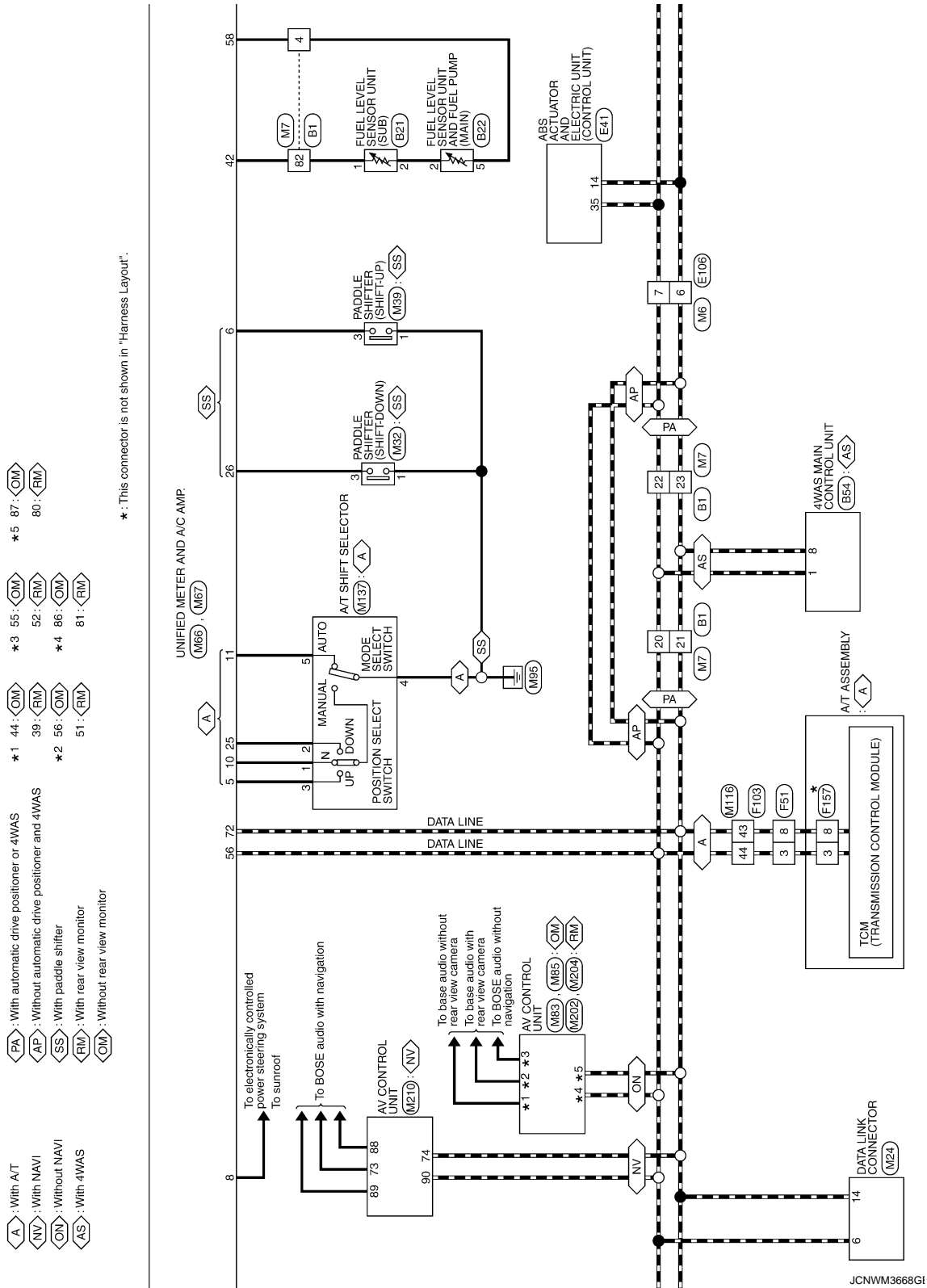

A
B
C
D
E
F
G
H
I
J
K
L
M
N
O
P

INL

COMBINATION METER

< ECU DIAGNOSIS INFORMATION >

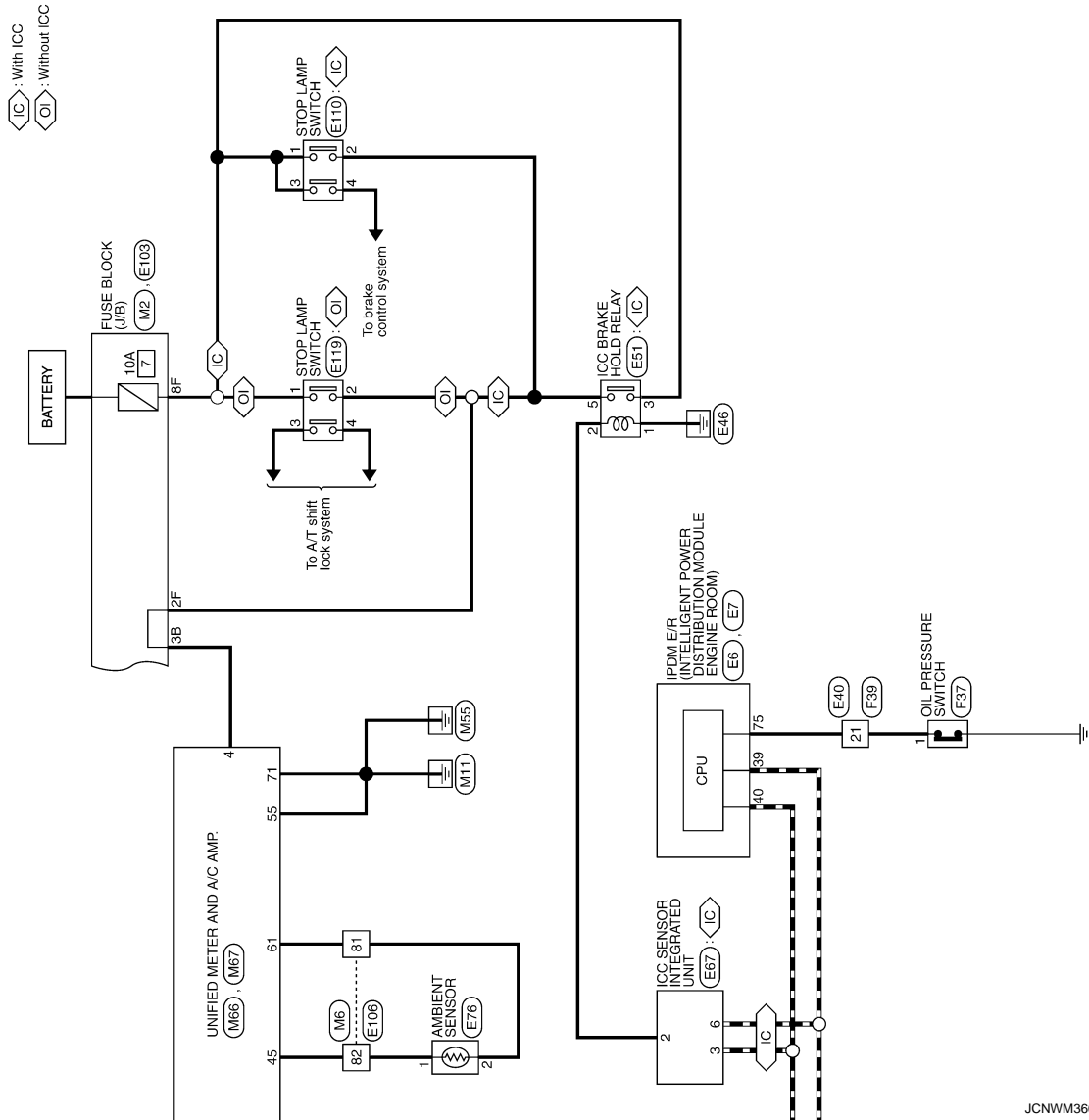

JCNWM3669G1

COMBINATION METER

< ECU DIAGNOSIS INFORMATION >

METER

Connector No.	B1
Connector Name	WIRE TO WIRE
Connector Type	TH80FW-CS16-TM4

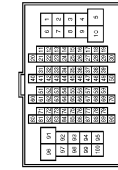

Terminal No.	Color of Wire	Signal Name [Specification]
1	GR	
2	BG	
3	L	
4	Y	
6	R	
8	W	
9	V	
15	Y	
16	BR	
17	LG	
18	BG	
20	L	
21	P	
22	L	
23	P	
24	V	
25	SB	
26	G	
27	W	
28	R	
31	V	
32	SB	
33	SHIELD	
34	W	
35	BR	
36	Y	
37	SHIELD	
38	Y	
39	SB	
40	P	
41	L	
42	SHIELD	
43	R	
44	G	
45	SHIELD	
46	SB	
55	BR	
56	R	

58	V	
59	SB	
60	BR	
61	W	
62	R	
63	L	
64	Y	
65	SHIELD	
71	BG	
72	GR	
73	P	
74	L	
81	V	
82	B	
84	Y	
85	G	
86	W	
87	R	
88	BR	
89	Y	
90	SB	
91	BG	
92	BR	
93	P	
95	BG	
96	Y	
100	GR	

Connector No.	B13
Connector Name	SEAT BELT BUCKLE SWITCH (DRIVER SIDE)
Connector Type	A03FW

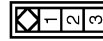

Terminal No.	Color of Wire	Signal Name [Specification]
1	SB	
2	B	

Connector No.	B14
Connector Name	PARKING BRAKE SWITCH
Connector Type	P01FE-A



Terminal No.	Color of Wire	Signal Name [Specification]
1	GR	

Connector No.	B21
Connector Name	FUEL LEVEL SENSOR UNIT (SUB)
Connector Type	E02FGY-RS



Terminal No.	Color of Wire	Signal Name [Specification]
1	B	
2	W	

Connector No.	B22
Connector Name	FUEL LEVEL SENSOR UNIT AND FUEL PUMP (MAIN)
Connector Type	E02FGY-RS



Terminal No.	Color of Wire	Signal Name [Specification]
1	P	
2	W	
3	B	

4	V	-
5	Y	-

Connector No.	B54
Connector Name	4WAS MAIN CONTROL UNIT
Connector Type	A30FW-M4



Terminal No.	Color of Wire	Signal Name [Specification]
1	L	CAN-H
4	Y	R-ANG MAIN SIG
5	W	R-ANG YCC
7	R	R-ANG SUB SIG
8	P	CAN-L
15	G	R-ANG GND
22	GR	STOP/L SW
25	SB	R-MTR RLY
27	G	IGN
31	BR	BUS-H
32	Y	BUS-L
34	B	GND
36	LG	P/S SOL
37	P	R-MTR PWR SUPPLY
38	R	R-MTR (RH)
39	G	R-MTR (LH)
40	B	R-MTR GND

A
B
C
D
E
F
G
H
I
J
K
L
M
N
O
P

INL

COMBINATION METER

< ECU DIAGNOSIS INFORMATION >

METER

Connector No.	E6
Connector Name	SPW L P-INTELLIGENT POWER DISTRIBUTION MODULE (ENGINE ROOM)
Connector Type	TH02FW-1N1



Terminal No.	Color of Wire	Signal Name [Specification]
39	P	-
40	L	-
41	B/W	-
42	GR	-
43	G	-
44	LG	-
45	V	-
46	SB	-

Connector No.	E7
Connector Name	SPW L P-INTELLIGENT POWER DISTRIBUTION MODULE (ENGINE ROOM)
Connector Type	TH02FW-CS12-M4

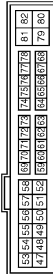

Terminal No.	Color of Wire	Signal Name [Specification]
48	L	-
49	BG	-
51	Y	-
53	W	-
54	P	-
55	SB	-
56	BR	-
57	G	-
58	GR	-
69	BR	-
70	BG	-
73	P	-
74	G	-
75	SB	-

76	Y	-
77	R	-
80	W	-

Connector No.	E52
Connector Name	WASHER LEVEL SWITCH
Connector Type	F202FBR



Terminal No.	Color of Wire	Signal Name [Specification]
1	LG	-
2	B	-

Connector No.	E40
Connector Name	WIRE TO WIRE
Connector Type	SAA36MB-RS3-SHZ3

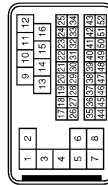

Terminal No.	Color of Wire	Signal Name [Specification]
1	L/Y	-
2	SHIELD	-
3	L/B	-
4	SHIELD	-
5	BR	-
7	G	-
8	W	-
9	W	-
10	Y	-
11	P	-
12	SB	-
13	L	-
14	G	-
15	BG	-
16	BR	-

17	P	-
18	Y	-
19	BG	-
20	B	-
21	SB	-
22	W	-
23	L	-
24	GR	-
25	V	-
27	GR	-
28	V	-
29	P	-
30	R	-
31	BR	-
32	Y	-
33	G	-
34	BG	-
37	SHIELD	-
38	L	-
39	B	-
40	R	-
41	W	-
42	LG	-
43	G	-
45	GR	-
46	SHIELD	-
47	W	-
48	BR	-
49	G	-
50	B	-
51	SB	-
52	R	-

Connector No.	E41
Connector Name	ABS ACTUATOR AND ELECTRIC UNIT (CONTROL UNIT)
Connector Type	BAA42FB-AN24-LH



Terminal No.	Color of Wire	Signal Name [Specification]
1	B	GND
2	GR	UBMR
3	BG	LUVR
4	B	GND

5	Y	DS FL
6	BG	DP RL
7	BR	DP RR
8	B	DP FR
9	W	DS FR
10	V	DIAG-K
11	V	CAN-L
14	P	BUS-L
25	Y	DP FL
26	LG	DS RL
27	GR	UZ
28	G	DS RR
29	P	BLS
30	SB	VDC OFF SW
31	R	CAN-H
35	L	BUS-H
45	B	-

Connector No.	E47
Connector Name	BRAKE FLUID LEVEL SWITCH
Connector Type	YY02FGY



Terminal No.	Color of Wire	Signal Name [Specification]
1	R	-
2	B	-

COMBINATION METER

< ECU DIAGNOSIS INFORMATION >

METER

Connector No.	E51
Connector Name	ICC BRAKE HOLD RELAY
Connector Type	MS2FL-MZ-LC

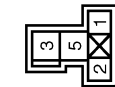

Terminal No.	Color of Wire	Signal Name [Specification]
1	B	
2	SB	
3	L	
5	W	

Connector No.	E67
Connector Name	ICC SENSOR INTEGRATED UNIT
Connector Type	RS26FB-PR



Terminal No.	Color of Wire	Signal Name [Specification]
1	Y	IGNITION
2	SB	BRAKE HOLD RLY DRIVE SIGNAL
3	L	CAN-H
4	B	GND
6	P	CAN-L

Connector No.	E176
Connector Name	AMBIENT SENSOR
Connector Type	RS26FB



Terminal No.	Color of Wire	Signal Name [Specification]
1	G	
2	P	

Connector No.	E103
Connector Name	FUSE BLOCK (J/B)
Connector Type	NS16FY-CS



Terminal No.	Color of Wire	Signal Name [Specification]
1F	SB	
2F	W	
4F	G	
6F	BR	
8F	L	
9F	P	

Connector No.	E106
Connector Name	WIRE TO WIRE
Connector Type	TH80FY-CS16-TM4



Terminal No.	Color of Wire	Signal Name [Specification]
1	V	
2	SB	
3	EG	
5	W	
6	P	
7	L	
11	V	
12	P	
13	R	
14	W	
15	L	
16	GR	
17	SB	
18	LG	
28	G	
31	L	
32	EG	
33	P	
34	V	
35	W	
36	BG	
37	G	
38	R	
40	R	
41	LG	
42	SB	
43	G	
44	LG	
45	GR	
46	BR	
47	B	
48	Y	
49	Y	
50	B	
51	SB	
52	P	
53	G	
54	B	
57	GR	
58	V	
80	R	
81	P	
82	G	
83	V	
84	L	
85	W	
86	GR	
87	LG	
88	L	
89	BR	

91	W	
92	LG	
93	GR	
94	SB	
95	GR	
96	R	
97	Y	
98	SHIELD	
99	L	
100	P	

Connector No.	E107
Connector Name	PARKING BRAKE SWITCH
Connector Type	TEB01FW



Terminal No.	Color of Wire	Signal Name [Specification]
1	BG	

Connector No.	E110
Connector Name	STOP LAMP SWITCH
Connector Type	MM4FW-LC



Terminal No.	Color of Wire	Signal Name [Specification]
1	L	
2	W	
3	L	
4	SB	

A
B
C
D
E
F
G
H
I
J
K
L
M
N
O
P

INL

COMBINATION METER

< ECU DIAGNOSIS INFORMATION >

METER

Connector No.	E119
Connector Name	STOP LAMP SWITCH
Connector Type	MO4W-LC



Terminal No.	Color of Wire	Signal Name [Specification]
1	L	
2	W	
3	G	
4	V	

Connector No.	F36
Connector Name	ALTERNATOR
Connector Type	HS03FB



Terminal No.	Color of Wire	Signal Name [Specification]
2	G	
3	V	L
4	W	S

Connector No.	F37
Connector Name	OIL PRESSURE SWITCH
Connector Type	ED1FGY-RS-AR



Terminal No.	Color of Wire	Signal Name [Specification]
1	Y	

Connector No.	F39
Connector Name	WIRE TO WIRE
Connector Type	SAA30FB-RS8-SHZ3

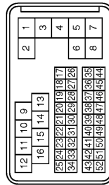

Terminal No.	Color of Wire	Signal Name [Specification]
1	L/Y	
2	SHIELD	
3	L/B	
4	SHIELD	
5	BR	
7	G	
8	W	
9	W	
10	G	
11	R	
12	P	
13	L	
14	LG	
15	R	
16	Y	
17	W	
18	LG	
19	P	
20	O	
21	Y	
22	G	
23	Y	
24	LG	
25	V	
27	GR	
28	BR	
29	L	
30	R	
31	P	
32	W	
33	SS	
34	O	
37	SHIELD	

38	W	
39	Y	
40	G	
41	B	
42	GR	
43	R	
45	O	
46	SHIELD	
47	W/L	
48	LG	
49	O/L	
50	L/Y	
51	W	
52	L/G	

Connector No.	F51
Connector Name	A/T ASSEMBLY
Connector Type	RK10FG-DCY

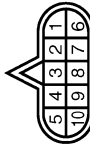

Terminal No.	Color of Wire	Signal Name [Specification]
1	Y	
2	R	
3	L	
4	V	
5	B	
6	B	
7	R	
8	P	
9	GR	
10	B	

Connector No.	F103
Connector Name	WIRE TO WIRE
Connector Type	TK26FW-NS10

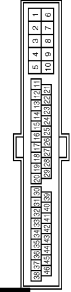

Terminal No.	Color of Wire	Signal Name [Specification]
2	G	
3	W	
4	R	
5	B	
9	Y	
10	GR	
19	O	
20	Y	
28	B	
29	LG	
30	R	
31	R	
33	B	
34	B	
35	L	
36	P	
37	Y	
38	G	
41	O	
42	BR	
43	P	
44	L	
45	G	
46	V	

COMBINATION METER

< ECU DIAGNOSIS INFORMATION >

METER

Connector No.	F108
Connector Name	AWD CONTROL UNIT
Connector Type	TH16FV-NH

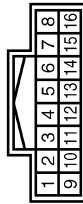

Terminal No.	Color of Wire	Signal Name [Specification]
1	BR	AWD SOL (+)
2	Y	AWD SOL (-)
3	W	OIL TEMP (-)
7	G	IGN
8	L	CAN-H
9	O	AWD SOL BAT
10	B	B
11	B	GND
13	LG	GND
15	Y	OIL TEMP (+)
16	P	YB, CAN-L

Connector No.	F157
Connector Name	TCM (TRANSMISSION CONTROL MODULE)
Connector Type	SP10FG

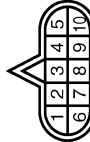

Terminal No.	Color of Wire	Signal Name [Specification]
1	W	VIGN
2	B	BATT
3	R	CAN-H
4	O	K-LINE
5	G	GND
6	GR	GND
7	L	VIGN
8	BR	REV LAMP RLY
9	Y	CAN-L
10	W/B	STARTER RLY
		GND

Connector No.	M1
Connector Name	FUSE BLOCK (J/B)
Connector Type	NS3GFF-M2

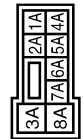

Terminal No.	Color of Wire	Signal Name [Specification]
1A	V	
2A	G	
3A	L	
4A	P	
5A	L	
6A	Y	
7A	R	
8A	L	

Connector No.	M2
Connector Name	FUSE BLOCK (J/B)
Connector Type	NS10FV-CS



Terminal No.	Color of Wire	Signal Name [Specification]
1B	SB	
2B	P	
3B	G	
4B	G	
5B	BG	
6B	Y	
7B	P	
8B	R	
9B	SB	
10B	SB	

Connector No.	M3
Connector Name	FUSE BLOCK (J/B)
Connector Type	NS12FW-CS

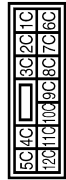

Terminal No.	Color of Wire	Signal Name [Specification]
6C	SB	
7C	B	
8C	W	
9C	BG	
10C	L	
11C	LG	
12C	G	

Connector No.	M6
Connector Name	WIRE TO WIRE
Connector Type	TH80MW-CS16-TM4

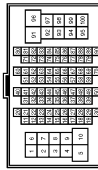

Terminal No.	Color of Wire	Signal Name [Specification]
1	W	
2	GR	
3	R	
4	W	
5	W	
6	P	
7	L	
8	L	
9	V	
10	P	
11	P	
12	P	
13	R	
14	W	
15	L	
16	GR	
17	BR	
18	L	
19	L	
20	G	

31	L	
32	Y	
33	BG	
34	W	
35	BR	
36	P	
37	P	
38	G	
40	V	
41	LG	
42	R	
44	G	
43	G	
45	B	
45	R	
46	BG	
47	SB	
48	Y	
49	L	
50	R	
51	R	
52	W	
53	G	
54	B	
57	B	
58	LG	
80	SB	
81	B	
82	V	
83	W	
84	L	
85	GR	
86	Y	
87	G	
88	G	
89	R	
91	W	
92	Y	
93	BG	
94	L	
95	Y	
96	R	
97	L	
98	SHIELD	
99	V	
100	SB	

A
B
C
D
E
F
G
H
I
J
K
L
M
N
O
P

INL

COMBINATION METER

< ECU DIAGNOSIS INFORMATION >

METER

Connector No.	M7
Connector Name	WIRE TO WIRE
Connector Type	TH80MW-CS (E-TIM)



Terminal No.	Color of Wire	Signal Name [Specification]
1	GR	-
2	P	-
3	SB	- [With automatic drive positioner]
4	P	- [Without automatic drive positioner]
5	Y	-
6	L	-
7	Y	-
8	G	-
9	Y	-
10	R	-
11	BR	-
12	P	-
13	V	-
14	L	-
15	P	-
16	L	-
17	P	-
18	V	-
19	L	-
20	L	-
21	P	-
22	L	-
23	P	-
24	V	-
25	LG	-
26	BR	-
27	BG	-
28	LG	-
29	V	-
30	V	-
31	V	-
32	LG	-
33	SHIELD	-
34	GR	-
35	BR	-
36	Y	-
37	SHIELD	-
38	SB	-
39	LG	-
40	O	-
41	W	-
42	SHIELD	-
43	R	-
44	G	-
45	SHIELD	-
46	SB	-
47	W	-

56	B	-
57	V	-
58	Y	-
59	Y	-
60	Y	-
61	W	-
62	R	-
63	G	-
64	B	-
65	SHIELD	-
71	V	-
72	P	-
73	SB	-
74	V	-
81	W	-
82	BR	-
84	LG	-
85	BG	-
86	SB	-
87	G	-
88	GR	-
89	L	-
90	P	-
91	BG	-
92	L	-
93	P	-
95	BG	-
96	Y	-
100	P	-

Connector No.	M24
Connector Name	DATA LINK CONNECTOR
Connector Type	BD16FW-P

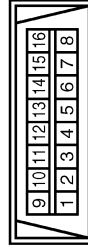

Terminal No.	Color of Wire	Signal Name [Specification]
3	LG	-
4	B	-
5	B	-
6	L	-
7	V	-
8	G	-
11	SB	-
14	P	-

16	R	-
----	---	---

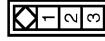

Connector No.	M32
Connector Name	PADDLE SHIFTER (SHIFT-DOWN)
Connector Type	A03FW

Terminal No.	Color of Wire	Signal Name [Specification]
1	B	-
3	G	-



Connector No.	M39
Connector Name	PADDLE SHIFTER (SHIFT-UP)
Connector Type	A03FW



Terminal No.	Color of Wire	Signal Name [Specification]
1	B	-
3	BG	-

Connector No.	M53
Connector Name	COMBINATION METER
Connector Type	SAB40FW



Terminal No.	Color of Wire	Signal Name [Specification]
1	V	BATTERY POWER SUPPLY
2	LG	COMMUNICATION SIGNAL (METER->AMP.)
3	GR	COMMUNICATION SIGNAL (AMP->METER)
5	B	GROUND
6	W	ALTERNATOR SIGNAL
7	LG	AIR BAG SIGNAL
10	W	SECURITY SIGNAL
15	B	GROUND
16	BR	METER CONTROL SWITCH GROUND
18	GR	ILL. GND
19	B	ILL.
20	R	ILL.
21	G	IGNITION SIGNAL
22	B	GROUND
24	BR	COMMUNICATION SIGNAL (LCD->AMP.)
25	Y	COMMUNICATION SIGNAL (AMP->LCD)
26	R	VEHICLE SPEED SIGNAL (S-PULSE)
27	P	PARKING BRAKE SWITCH SIGNAL
28	SB	BRAKE FLUID LEVEL SWITCH
29	P	SEAT BELT BUCKLE SW SIGNAL (DRIVER SIDE)
30	G	SEAT BELT BUCKLE SWITCH SIGNAL (PASSENGER SIDE)
31	L	WASHER LEVEL SWITCH SIGNAL
33	R	ILLUMINATION CONTROL SIGNAL
36	LG	SELECT SWITCH SIGNAL
37	Y	ENTER SWITCH SIGNAL
38	G	TRIP A/B RESET SWITCH SIGNAL
39	P	ILLUMINATION CONTROL SWITCH SIGNAL (-)
40	BG	ILLUMINATION CONTROL SWITCH SIGNAL (+)

COMBINATION METER

< ECU DIAGNOSIS INFORMATION >

METER

Connector No.	M54
Connector Name	METER CONTROL SWITCH
Connector Type	TH12FW-NH



1	2	3	4	5	6
7	8	9	10	11	12

Terminal No.	Color of Wire	Signal Name [Specification]
1	Y	-
2	LG	-
3	B	-
4	R	-
5	G	-
7	BR	-
8	GR	-
9	BG	-
10	P	-

Connector No.	M66
Connector Name	UNIFIED METER AND A/C AMP.
Connector Type	TH40FW-NH



1	2	3	4	5	6	7	8	9	10	11	12	13	14	15	16	17	18	19	20
21	22	23	24	25	26	27	28	29	30	31	32	33	34	35	36	37	38	39	40

Terminal No.	Color of Wire	Signal Name [Specification]
4	G	STOP LAMP SWITCH SIGNAL
5	L	MANUAL MODE SHIFT UP SIGNAL
6	BG	PADDLE SHIFTER UP SIGNAL
7	GR	COMMUNICATION SIGNAL (AMP->METER)
8	L	VEHICLE SPEED SIGNAL (2-PULSE)
9	SB	SEAT BELT BUCKLE SWITCH SIGNAL (DRIVER SIDE)
10	W	MANUAL MODE SIGNAL
11	G	NON-MANUAL MODE SIGNAL
14	BR	COMMUNICATION SIGNAL (LCD->AMP)
20	BR	ION ON / OFF SIGNAL
23	Y	AT SNOW SWITCH SIGNAL
25	V	MANUAL MODE SHIFT DOWN SIGNAL
26	G	PADDLE SHIFTER DOWN SIGNAL

27	LG	COMMUNICATION SIGNAL (METER->AMP)
28	R	VEHICLE SPEED SIGNAL (6-PULSE)
30	V	PARKING BRAKE SWITCH SIGNAL
34	Y	COMMUNICATION SIGNAL (AMP->LCD)
38	P	BLOWER MOTOR CONTROL SIGNAL

Connector No.	M67
Connector Name	UNIFIED METER AND A/C AMP.
Connector Type	TH32FW-NH



1	2	3	4	5	6	7	8	9	10	11	12	13	14	15	16	17	18	19	20
21	22	23	24	25	26	27	28	29	30	31	32	33	34	35	36	37	38	39	40

Terminal No.	Color of Wire	Signal Name [Specification]
41	L	ACC POWER SUPPLY
42	BR	FUEL LEVEL SENSOR SIGNAL
43	BR	INTAKE SENSOR SIGNAL
44	LG	IN-VEHICLE SENSOR SIGNAL
45	V	AMBIENT SENSOR SIGNAL
46	Y	SUNLOAD SENSOR SIGNAL
47	G	GAS SENSOR SIGNAL
53	W	IGNITION POWER SUPPLY
54	SB	BATTERY POWER SUPPLY
55	B	GROUND
56	L	CAN-H
57	LG	BRAKE FLUID LEVEL SWITCH
58	Y	FUEL LEVEL SENSOR GROUND
59	GR	INTAKE SENSOR GROUND
60	W	IN-VEHICLE SENSOR GROUND
61	B	AMBIENT SENSOR GROUND
62	SB	SUNLOAD SENSOR GROUND
63	L	ION CONTROL MODE OUTPUT SIGNAL
65	BG	ECV SIGNAL
69	P	A/C LAM SIGNAL
70	R	EACH DOOR MOTOR POWER SUPPLY
71	GR	GROUND
72	P	CAN-L

Connector No.	M83
Connector Name	AV CONTROL UNIT
Connector Type	TH24FW-NH



47	46	45	44	43	42	41	40	39	38	37	36
59	58	57	56	55	54	53	52	51	50	49	48

Terminal No.	Color of Wire	Signal Name [Specification]
36	BR	COMPOSITE IMAGE SIGNAL
37	Y	COMPOSITE IMAGE GND
38	P	RGR (R/BLUE) SIGNAL
39	L	RGB (G/GREEN) SIGNAL
40	G	RGB (R/RED) SIGNAL
41	W	RGB SYNC
42	SHIELD	SHIELD
43	B	RGB AREA (VS) SIGNAL
44	L	COMM (DISP->CONT)
45	R	HP
46	LG	SIGNAL GND
47	BG	SIGNAL VCC
48	BR	COMP SYNC
49	Y	SHIELD
50	SHIELD	SHIELD
55	B	SHIELD
56	LG	COMM (CONT->DISP)
57	G	VP
58	BR	INVERTER GND
59	Y	INVERTER VCC

Connector No.	M85
Connector Name	AV CONTROL UNIT
Connector Type	TH22FW-NH



51	50	49	48	47	46	45	44	43	42	41	40	39	38	37	36
47	46	45	44	43	42	41	40	39	38	37	36	35	34	33	32

Terminal No.	Color of Wire	Signal Name [Specification]
84	SHIELD	SHIELD
85	B	GND

86	L	CAN-H
87	P	CAN-L
88	SB	AV COMM (H)
89	LG	AV COMM (L)
90	SB	AV COMM (H)
91	LG	AV COMM (L)
95	R	AUX SOUND SIGNAL RH (+)
96	W	AUX SOUND SIGNAL LH (+)
97	B	AUX SOUND SIGNAL GND
101	BR	SW GND
103	V	EJECT SIGNAL
104	G	IGNITION
105	BG	REVERSE
106	SB	PARKING BRAKE
107	R	PARKING BRAKE

A
B
C
D
E
F
G
H
I
J
K
L
M
N
O
P

INL

COMBINATION METER

< ECU DIAGNOSIS INFORMATION >

METER

Connector No.	M107
Connector Name	ECM
Connector Type	RH24FGY-R26-R-LH-Z

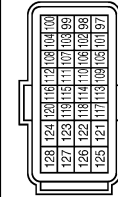

Terminal No.	Color of Wire	Signal Name [Specification]
97	R	APS 1
98	P	APS 2
99	L	AVCC-APS 1
100	W	GND-APS 1
101	SB	ASCD SW
102	LG	FTPRS
103	GR	AVCC-APS 2
104	V	GND-APS 2
105	L	PDPRESS
106	W	TF
107	GR	AVCC-FTPRS
108	Y	GND-ASCD
109	G	NEUT-H
110	R	TACHO
112	V	GND-A
113	P	VEH CAN-L
114	L	VEH CAN-H
117	V	KLINE
121	LG	GDCV
122	P	BRAKE
123	B	GND
124	B	GND
125	R	VEBP
126	BR	ENG SW
127	B	GND
128	B	GND

Connector No.	M110
Connector Name	PRE-SPASH SEAT BELT CONTROL UNIT
Connector Type	TH20FWY-TB6

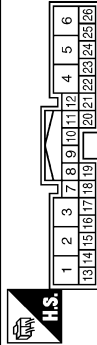

Terminal No.	Color of Wire	Signal Name [Specification]
1	P	MOTOR (RH) (RELEASE)
2	W	+B
3	L	MOTOR (RH) (FASTEN)
4	BG	MOTOR (LH) (FASTEN)
5	W	GND (DRIVE)
6	Y	MOTOR (LH) (RELEASE)
7	G	INDICATOR
8	LG	BUCKLE SW RH
10	SB	BUCKLE SW LH
13	W	IGN
16	W	SENS OUTPUT 1
18	R	SENS POWER
20	G	SENS OUTPUT 2
21	B	SENS GND
22	P	CAN-L
24	L	CAN-H
26	B	GND (CONT)

Connector No.	M116
Connector Name	WIRE TO WIRE
Connector Type	TK38MP-NS10

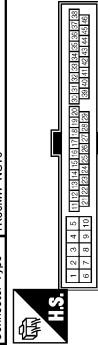

Terminal No.	Color of Wire	Signal Name [Specification]
2	W	-
3	BG	-
4	P	-
5	B	-
9	R	-

Terminal No.	Color of Wire	Signal Name [Specification]
92	LG	KEY SLOT ILL ON IND
93	GR	ACC RELAY CONT
95	BG	ACC RELAY CONT
96	GR	A/T SHIFT SELECTOR POWER SUPPLY
97	L	S/L CONDITION 1
98	P	S/L CONDITION 2
99	R	SHIFT P [With A/T]
99	BR	ICC CLUTCH SW [With M/T and ICC]
99	BR	ASCD CLUTCH SW [With M/T without ICC]
100	Y	PASSENGER DOOR REQUEST SW
101	P	DRIVER DOOR REQUEST SW
102	BG	BLOWER FAN MOTOR RELAY CONT
103	P	KEYLESS ENTRY RECEIVER POWER SUPPLY
106	SB	S/L UNIT POWER SUPPLY
107	LG	COMBI SW INPUT 1
108	R	COMBI SW INPUT 4
109	W	COMBI SW INPUT 2
110	G	HAZARD SW
111	Y	S/L UNIT COMM

Terminal No.	Color of Wire	Signal Name [Specification]
10	R	-
19	BG	-
20	Y	-
22	B	-
28	LG	-
30	LG	-
31	W	-
33	B	-
34	B	-
35	L	-
36	P	-
37	R	-
38	SB	-
41	BG	-
42	G	-
43	P	-
44	L	-
45	Y	-
46	SB	-

Connector No.	M122
Connector Name	BCM (BODY CONTROL MODULE)
Connector Type	TH40FB-NH

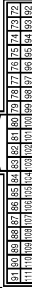

Terminal No.	Color of Wire	Signal Name [Specification]
72	R	ROOM ANT 2-
72	G	ROOM ANT 2+
74	SB	PASSENGER DOOR ANT-
75	BR	PASSENGER DOOR ANT+
76	V	DRIVER DOOR ANT-
77	LG	DRIVER DOOR ANT+
78	Y	ROOM ANT 1-
79	BR	ROOM ANT 1+
80	GR	NATS ANT AMP
81	W	INATS ANT AMP
82	SB	IGN RELAY (F/B) CONT
83	Y	KEYLESS ENTRY RECEIVER COMM
87	Y	COMBI SW INPUT 5
88	BG	COMBI SW INPUT 3
89	BR	PUSH SW
90	P	CAN-L
91	L	CAN-H

COMBINATION METER

< ECU DIAGNOSIS INFORMATION >

METER

Connector No.	M123
Connector Name	BCM BODY CONTROL MODULE
Connector Type	TH40FG-NH

78	79	80	81	82	83	84	85	86	87	88	89	90	91	92	93	94	95	96	97	98	99	100	101	102	103	104	105	106	107	108	109	110	111	112
----	----	----	----	----	----	----	----	----	----	----	----	----	----	----	----	----	----	----	----	----	----	-----	-----	-----	-----	-----	-----	-----	-----	-----	-----	-----	-----	-----

Terminal No.	Color of Wire	Signal Name [Specification]
112	R	RAIN SENSOR SERIAL LINK
113	BG	OPTICAL SENSOR
114	R	CLUTCH INTERLOCK SW
116	SB	STOP LAMP SW 1
118	BR	STOP LAMP SW 2
119	SB	DR DOOR UNLOCK SENSOR
121	SB	KEY SLOT SW
123	V	IGN P/B
124	R	PASSENGER DOOR SW
129	BG	TRUNK LID OPENER CANCEL SW
132	V	POWER WINDOW SW COMM
133	L	PUSH-BUTTON IGNITION SW ILL POWER
134	LG	LOCK IND
137	BG	RECEIVER / SENSOR GND
138	V	RECEIVER / SENSOR POWER SUPPLY
139	L	TIRE PRESSURE RECEIVER COMM
140	B	SHIFT N/P
141	W	SECURITY INDICATOR LAMP
142	BR	COMBI SW OUTPUT 5
143	P	COMBI SW OUTPUT 1
144	G	COMBI SW OUTPUT 2
145	L	COMBI SW OUTPUT 3
146	SB	COMBI SW OUTPUT 4
149	W	TIRE PRESSURE WARN CHECK SW
150	GR	DRIVER DOOR SW
151	G	REAR WINDOW DEFOGGER RELAY COINT

Connector No.	M137
Connector Name	A/T SHIFT SELECTOR
Connector Type	TH12FP-NH

1	2	3	4	5	6
7	8	9	10	11	12

Terminal No.	Color of Wire	Signal Name [Specification]
1	W	-
2	V	-
3	L	-
4	B	-
5	G	-
7	Y	-
8	LG	-
9	B	-
10	GR	-
11	R	-

Connector No.	M147
Connector Name	AIR BAG DIAGNOSIS SENSOR UNIT
Connector Type	TK28FY-EX-SC

20	21	17	24	49	1
22	11	46	48	47	45
16	12	19	15	14	151
					23
					18
					62
					2
					5

Terminal No.	Color of Wire	Signal Name [Specification]
1	LG	IGN
2	B	GND
3	Y	DR 1 (-)
4	Y	DR 1 (-) DR 2 (-)
5	Y	AS 1 (+)
6	Y	AS 1 (-)
11	SB	ECZS (+)
12	V	ECZS (-)
15	LG	AIR BAG W/L
16	SHIELD	GND
18	R	CUTOFF TELLTALE
21	L	CAN-H

24	G	SEAT BELT
45	Y	DR 2 (+)
46	P	CAN-L
47	Y	AS 2 (+)
48	Y	AS 2 (-)
49	L	ODS INPUT

Connector No.	M202
Connector Name	AV CONTROL UNIT
Connector Type	TH24FW-AH

36	37	38	39	40	41	42	43	44	45	46	47
48	49	50	51	52	53	54	55	56	57	58	59

Terminal No.	Color of Wire	Signal Name [Specification]
36	BG	SIGNAL VCC
37	LG	SIGNAL GND
38	R	HP
39	L	COMM (DISP->CONT)
40	B	RGB AREA (YS) SIGNAL
41	SHIELD	SHIELD
42	W	RGB SYNC
43	G	RGB (R/RED) SIGNAL
44	L	RGB (G/GREEN) SIGNAL
45	P	RGB (B/BLUE) SIGNAL
46	Y	COMPOSITE IMAGE GND
47	BR	COMPOSITE IMAGE SIGNAL
48	Y	INVERTER VCC
49	BR	INVERTER GND
50	G	V/F
51	LG	COMM (CONT->DISP)
52	B	SHIELD
57	SHIELD	SHIELD
58	SHIELD	SHIELD

Connector No.	M204
Connector Name	AV CONTROL UNIT
Connector Type	TH32FW-NH

76	77	78	79	80	81	82	83	84	85	86	87	88	89	90	91
92	93	94	95	96	97	98	99	100	101	102	103	104	105	106	107

Terminal No.	Color of Wire	Signal Name [Specification]
76	LG	AV GOMM (L)
77	SB	AV GOMM (H)
78	LG	AV GOMM (L)
79	SB	AV GOMM (H)
80	P	CAN-L
81	L	CAN-H
82	BR	SW GND
86	SHIELD	SHIELD
87	L	TEL VOICE SIGNAL (+)
88	P	TEL VOICE SIGNAL (-)
92	R	VEHICLE SPEED (8-PULSE)
93	SB	PARKING BRAKE
94	BG	REVERSE
95	G	IGNITION
96	V	DISK EJECT SIGNAL

A B C D E F G H I J K L M N O P

INL

COMBINATION METER

< ECU DIAGNOSIS INFORMATION >

Terminal No.	Color of Wire	Signal Name [Specification]
65	SB	PARKING BRAKE
67	P	COMPOSITE IMAGE GND
68	L	COMPOSITE IMAGE SIGNAL
71	SHIELD	MICROPHONE GND
72	G	MICROPHONE VCC
73	LG	COMM (CONT->DISP)
74	P	CAN-L
75	LG	AV COMM (L)
76	LG	AV COMM (L)
79	L	ILLUMINATION
80	G	IGNITION
81	BG	REVERSE
82	R	VEHICLE SPEED (8-PULSE)
83	SHIELD	SHIELD
87	R	MICROPHONE SIGNAL
88	B	SHIELD
89	L	COMM (DISP->CONT)
90	L	CAN-H
91	SB	AV COMM (H)
92	SB	AV COMM (H)

Connector No.	M210
Connector Name	AV CONTROL UNIT
Connector Type	TH22FW-NH

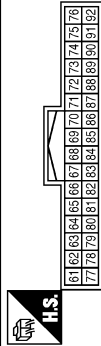

JCNWM3679GI

Fail-safe

INFOID:000000005880611

FAIL-SAFE

Combination meter performs fail-safe operation when unified meter and A/C amp. communication is malfunction.

Solution for communication error between the unified meter and A/C amp. and combination meter.

COMBINATION METER

< ECU DIAGNOSIS INFORMATION >

Function		Specifications	
Speedometer		Reset to zero by suspending communication.	A
Tachometer			B
Fuel gauge			C
Water temperature gauge			D
Illumination control		When suspending communication, change to nighttime mode.	E
Information display		The display turns off by suspending communication.	F
Buzzer		The buzzer turns off by suspending communication.	G
Warning lamp/indicator lamp	ABS warning lamp	The lamp turns on by suspending communication.	H
	VDC OFF indicator lamp		I
	SLIP indicator lamp		J
	Brake warning lamp		K
	CRUISE warning lamp		L
	Malfunction indicator lamp		M
	High beam indicator	The lamp turns off by suspending communication.	N
	Turn signal indicator lamp		O
	Oil pressure warning lamp		P
	A/T CHECK warning lamp		Q
	AWD warning lamp		R
	Low tire pressure warning lamp		S
	Key warning lamp		T
	AFS OFF indicator lamp		U
	4WAS warning lamp		V
	Master warning lamp		W
Tail lamp indicator lamp	X		
Front fog lamp indicator lamp	Y		

DTC Index

INFOID:000000005880612

Refer to [MWI-107. "DTC Index"](#).

INL

M

N

O

P

INTERIOR LIGHTING SYSTEM SYMPTOMS

< SYMPTOM DIAGNOSIS >

SYMPTOM DIAGNOSIS

INTERIOR LIGHTING SYSTEM SYMPTOMS

Symptom Table

INFOID:000000005628289

CAUTION:

Perform the self-diagnosis with CONSULT-III before the symptom diagnosis. Perform the trouble diagnosis if any DTC is detected.

Symptom	Possible cause	Inspection item
All the following lamps do not turn ON. <ul style="list-style-type: none"> • Map lamp • Personal lamp • Trunk room lamp • Step lamp • Vanity mirror lamp 	<ul style="list-style-type: none"> • Harness between BCM and each interior room lamp • BCM 	Interior room lamp power supply circuit Refer to INL-20 .
<ul style="list-style-type: none"> • Interior room lamp does not turn ON even though the door is open. (It turns ON when turning the interior room lamp ON.) • Interior room lamp does not turn OFF even though the door is closed. 	<ul style="list-style-type: none"> • Harness between BCM and each door switch • Harness between BCM and each interior room lamp • BCM 	Door switch circuit Refer to DLK-66 . Interior room lamp control circuit Refer to INL-22 .
Interior room lamp timer does not activate. (It turns ON/ OFF when the door opens/closes.)	—	Check the interior room lamp setting. Refer to INL-16 .
Step lamps (driver side and passenger side) do not turn ON. (Map lamp and personal lamp turn ON.) Step lamps (driver side and passenger side) do not turn OFF. (Map lamp and personal lamp turn OFF.)	<ul style="list-style-type: none"> • Harness between BCM and each step lamp • BCM 	Step lamp circuit Refer to INL-24 .
<ul style="list-style-type: none"> • Trunk room lamp does not turn ON. (Bulb is normal.) • Trunk room lamp does not turn OFF. 	<ul style="list-style-type: none"> • Harness between BCM and trunk room lamp switch • Harness between BCM and trunk room lamp • BCM 	Trunk room lamp switch circuit Refer to DLK-78 . Trunk room lamp circuit Refer to INL-26 .
Push-button ignition switch illumination does not illuminate.	<ul style="list-style-type: none"> • Harness between BCM and push-button ignition switch • BCM 	Push-button ignition switch illumination circuit Refer to INL-28 .
Interior room lamp battery saver does not activate.	—	Check the interior room lamp battery saver setting. Refer to INL-17 .

PRECAUTIONS

< PRECAUTION >

PRECAUTION

PRECAUTIONS

Precaution for Supplemental Restraint System (SRS) "AIR BAG" and "SEAT BELT PRE-TENSIONER"

INFOID:000000005628290

The Supplemental Restraint System such as "AIR BAG" and "SEAT BELT PRE-TENSIONER", used along with a front seat belt, helps to reduce the risk or severity of injury to the driver and front passenger for certain types of collision. This system includes seat belt switch inputs and dual stage front air bag modules. The SRS system uses the seat belt switches to determine the front air bag deployment, and may only deploy one front air bag, depending on the severity of a collision and whether the front occupants are belted or unbelted. Information necessary to service the system safely is included in the "SRS AIR BAG" and "SEAT BELT" of this Service Manual.

WARNING:

- To avoid rendering the SRS inoperative, which could increase the risk of personal injury or death in the event of a collision which would result in air bag inflation, all maintenance must be performed by an authorized NISSAN/INFINITI dealer.
- Improper maintenance, including incorrect removal and installation of the SRS, can lead to personal injury caused by unintentional activation of the system. For removal of Spiral Cable and Air Bag Module, see the "SRS AIR BAG".
- Do not use electrical test equipment on any circuit related to the SRS unless instructed to in this Service Manual. SRS wiring harnesses can be identified by yellow and/or orange harnesses or harness connectors.

PRECAUTIONS WHEN USING POWER TOOLS (AIR OR ELECTRIC) AND HAMMERS

WARNING:

- When working near the Air Bag Diagnosis Sensor Unit or other Air Bag System sensors with the ignition ON or engine running, DO NOT use air or electric power tools or strike near the sensor(s) with a hammer. Heavy vibration could activate the sensor(s) and deploy the air bag(s), possibly causing serious injury.
- When using air or electric power tools or hammers, always switch the ignition OFF, disconnect the battery, and wait at least 3 minutes before performing any service.

A

B

C

D

E

F

G

H

I

J

K

INL

M

N

O

P

MAP LAMP

< REMOVAL AND INSTALLATION >

REMOVAL AND INSTALLATION

MAP LAMP

Exploded View

INFOID:000000005628291

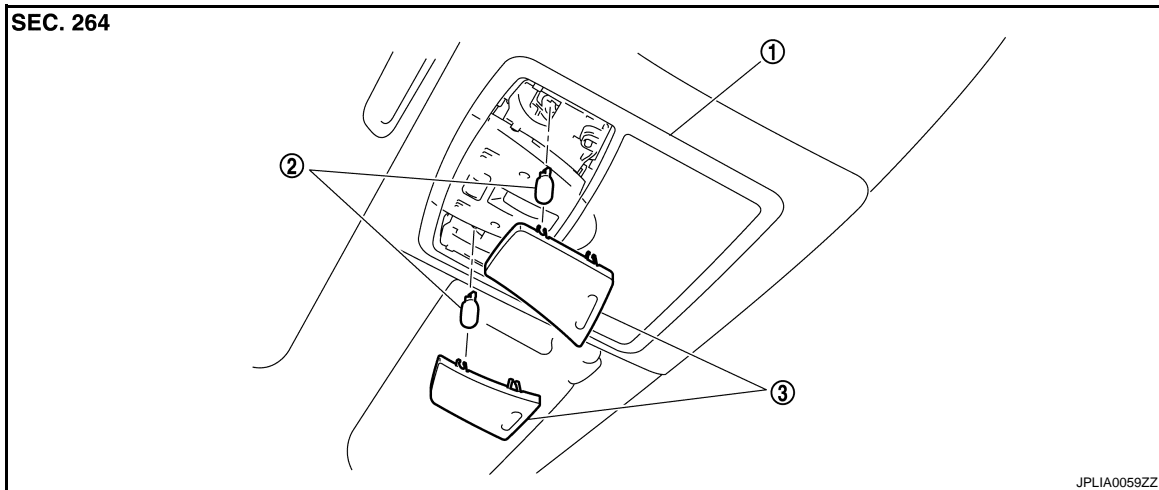

1. Map lamp assembly

2. Bulb

3. Lens

Removal and Installation

INFOID:000000005628292

Refer to [INL-108, "Exploded View"](#) for the map lamp assembly installation/removal.

Replacement

INFOID:000000005628293

CAUTION:

- **Disconnect negative battery terminal or remove the fuse.**
- **Never touch the glass of bulb directly by hand. Keep grease and other oily matters away from it.**
- **Never touch bulb by hand while it is lit or right after being turned off.**
- **Never leave bulb out of lamp reflector for a long time because dust, moisture smoke, etc. may affect the performance of lamp. When replacing bulb, be sure to replace it with new one.**

MAP LAMP BULB

1. Insert any appropriate tool into the gap between the lens. Remove the lens.
2. Remove the bulb.

VANITY MIRROR LAMP

< REMOVAL AND INSTALLATION >

VANITY MIRROR LAMP

Exploded View

INFOID:000000005628294

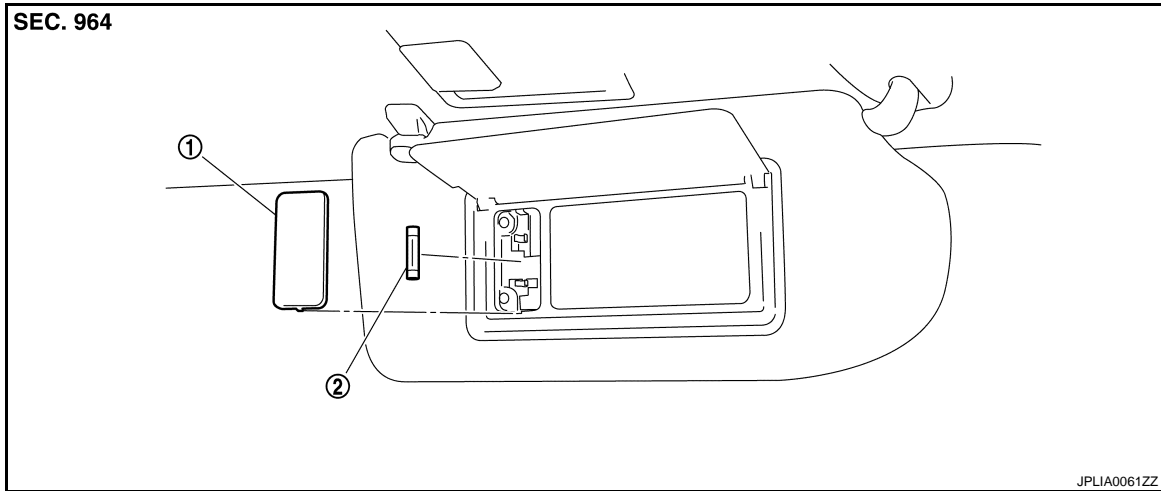

1. Lens

2. Bulb

Replacement

INFOID:000000005628295

CAUTION:

- Disconnect negative battery terminal or remove the fuse.
- Never touch the glass of bulb directly by hand. Keep grease and other oily matters away from it.
- Never touch bulb by hand while it is lit or right after being turned off.
- Never leave bulb out of lamp reflector for a long time because dust, moisture smoke, etc. may affect the performance of lamp. When replacing bulb, be sure to replace it with new one.

VANITY MIRROR LAMP BULB

1. Insert any appropriate tool into the gap between the lens. Remove the lens.
2. Remove the bulb.

A
B
C
D
E
F
G
H
I
J
K
L
M
N
O
P

INL

CIGARETTE LIGHTER ILLUMINATION

< REMOVAL AND INSTALLATION >

CIGARETTE LIGHTER ILLUMINATION

Exploded View

INFOID:000000005628296

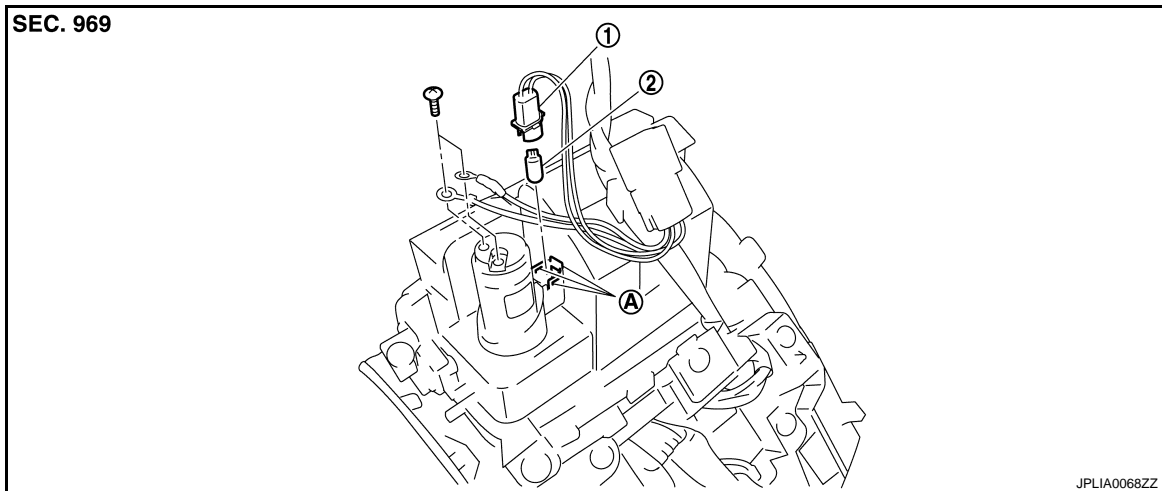

1. Bulb socket

2. Bulb
(Share with the ashtray illumination)

A Hooks

Replacement

INFOID:000000005628297

CAUTION:

- Disconnect negative battery terminal or remove the fuse.
- Never touch the glass of bulb directly by hand. Keep grease and other oily matters away from it.
- Never touch bulb by hand while it is lit or right after being turned off.
- Never leave bulb out of lamp reflector for a long time because dust, moisture smoke, etc. may affect the performance of lamp. When replacing bulb, be sure to replace it with new one.

CIGARETTE LIGHTER ILLUMINATION BULB

1. Remove the console finisher. Refer to [JP-33. "A/T MODELS : Exploded View"](#).
2. Insert any appropriate tool into the gap of the bulb socket. Widen the hooks and remove the bulb socket.
3. Remove the bulb.

GLOVE BOX LAMP

< REMOVAL AND INSTALLATION >

GLOVE BOX LAMP

Exploded View

INFOID:000000005628298

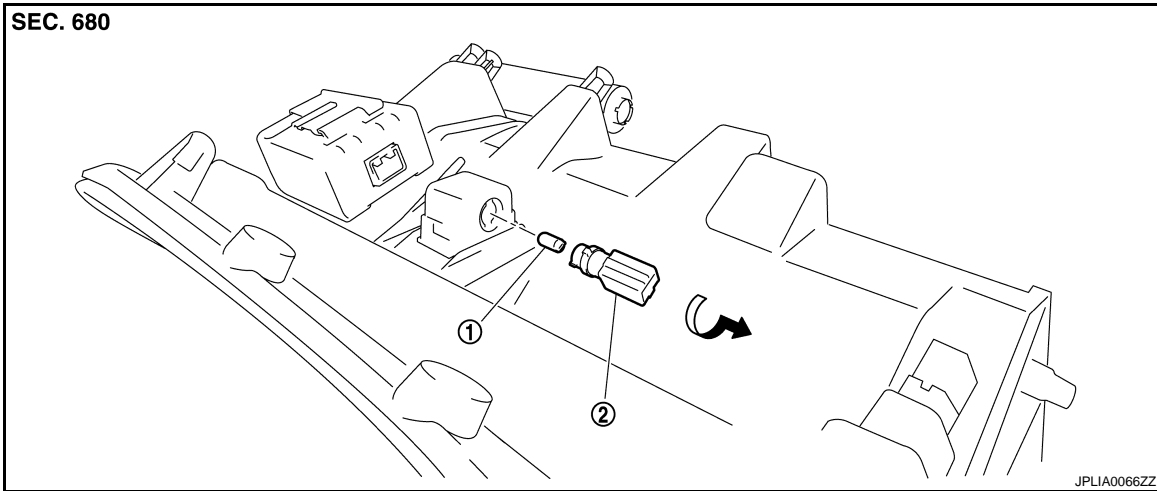

1. Bulb

2. Bulb socket

Replacement

INFOID:000000005628299

CAUTION:

- Disconnect negative battery terminal or remove the fuse.
- Never touch the glass of bulb directly by hand. Keep grease and other oily matters away from it.
- Never touch bulb by hand while it is lit or right after being turned off.
- Never leave bulb out of lamp reflector for a long time because dust, moisture smoke, etc. may affect the performance of lamp. When replacing bulb, be sure to replace it with new one.

GLOVE BOX LAMP BULB

1. Remove the instrument assist lower panel. Refer to [IP-12, "A/T MODELS : Exploded View"](#).
2. Rotate the bulb socket counterclockwise and unlock it.
3. Remove the bulb.

A
B
C
D
E
F
G
H
I
J
K
L
M
N
O
P

INL

STEP LAMP

< REMOVAL AND INSTALLATION >

STEP LAMP

Exploded View

INFOID:000000005628300

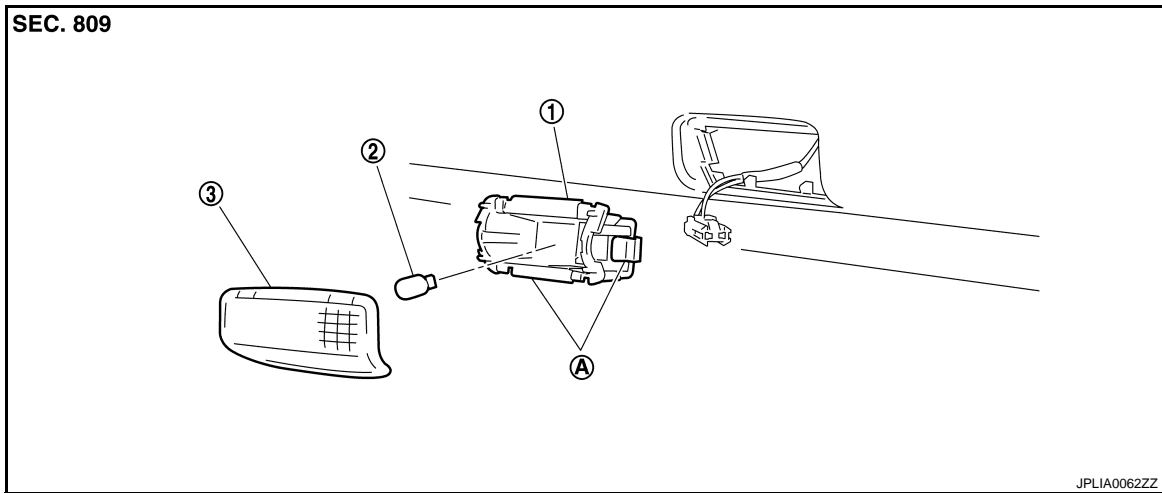

1. Step lamp case
A Metal clip
2. Bulb
3. Lens

Removal and Installation

INFOID:000000005628301

CAUTION:

Disconnect the battery negative terminal or remove the fuse.

REMOVAL

1. Insert any appropriate tool into the gap between the step lamp and the door trim. Remove the step lamp.
2. Disconnect the connector.

INSTALLATION

Install in the reverse order of removal.

Replacement

INFOID:000000005628302

CAUTION:

- **Disconnect negative battery terminal or remove the fuse.**
- **Never touch the glass of bulb directly by hand. Keep grease and other oily matters away from it.**
- **Never touch bulb by hand while it is lit or right after being turned off.**
- **Never leave bulb out of lamp reflector for a long time because dust, moisture smoke, etc. may affect the performance of lamp. When replacing bulb, be sure to replace it with new one.**

STEP LAMP BULB

1. Remove the step lamp. Refer to [INL-112, "Exploded View"](#).
2. Remove the lens.
3. Remove the bulb.

PERSONAL LAMP

< REMOVAL AND INSTALLATION >

PERSONAL LAMP

Exploded View

INFOID:000000005628303

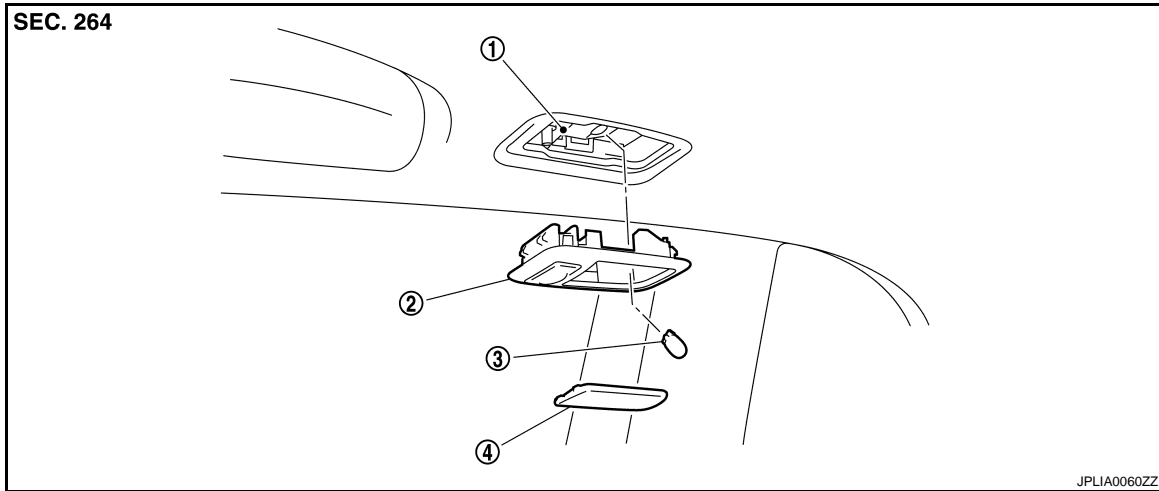

1. Personal lamp case
2. Personal lamp finisher
3. Bulb
4. Lens

NOTE:

Replace the personal lamp case as a set (right and left). Before installing the headlining assembly, remove the personal lamp case. Refer to [INL-113, "Removal and Installation"](#).

Removal and Installation

INFOID:000000005628304

CAUTION:

Disconnect the battery negative terminal or remove the fuse.

REMOVAL

1. Insert any appropriate tool into the gap between the lens. Remove the lens.
2. Press the both side pawls (A) to the arrow direction (←). Remove the personal lamp finisher.

NOTE:

Replace the personal lamp case as a set (right and left). Remove the personal lamp case after installing the headlining assembly. Refer to [INT-24, "NORMAL ROOF : Exploded View"](#) (normal roof), [INT-27, "SUNROOF : Exploded View"](#) (sun roof).

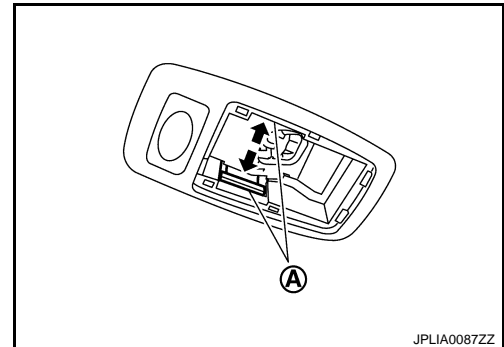

INSTALLATION

Install in the reverse order of removal.

NOTE:

The following is easier to install the personal lamp finisher with the headlining installed.

A
B
C
D
E
F
G
H
I
J
K
INL
M
N
O
P

PERSONAL LAMP

< REMOVAL AND INSTALLATION >

- Press the personal lamp finisher to the headlining. Pull the personal lamp case pawl to the arrow direction (←) with any appropriate tool.

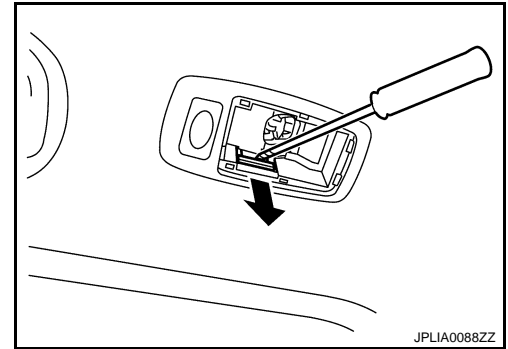

Replacement

INFOID:000000005628305

CAUTION:

- **Disconnect negative battery terminal or remove the fuse.**
- **Never touch the glass of bulb directly by hand. Keep grease and other oily matters away from it.**
- **Never touch bulb by hand while it is lit or right after being turned off.**
- **Never leave bulb out of lamp reflector for a long time because dust, moisture smoke, etc. may affect the performance of lamp. When replacing bulb, be sure to replace it with new one.**

PERSONAL LAMP BULB

1. Insert any appropriate tool into the gap between the lens. Remove the lens.
2. Remove the bulb.

TRUNK ROOM LAMP

< REMOVAL AND INSTALLATION >

TRUNK ROOM LAMP

Exploded View

INFOID:000000005628306

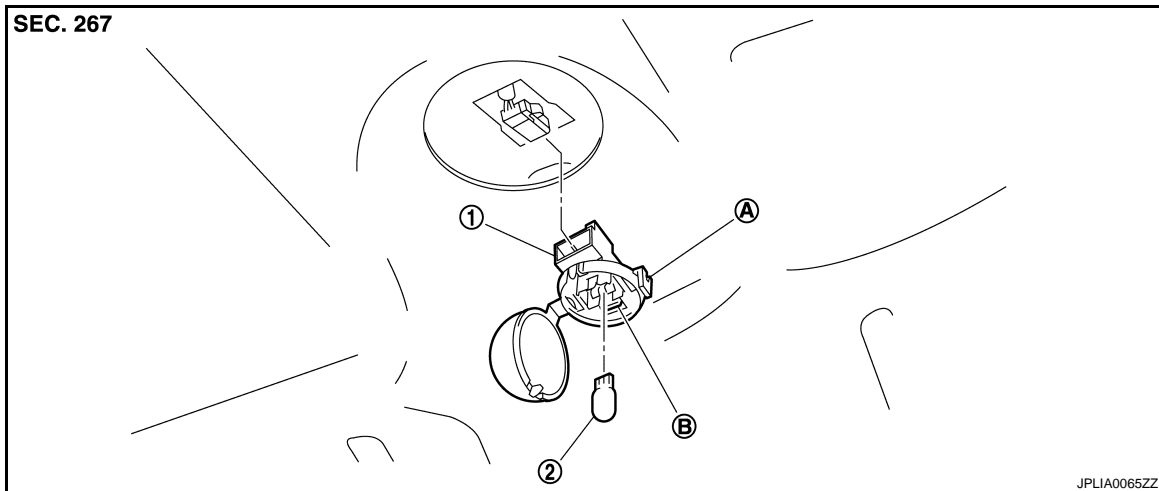

- | | |
|--------------------------|---------------------------------|
| 1. Trunk room lamp | 2. Bulb |
| A Pawl (for lens fixing) | B. Pawl (for case installation) |

Removal and Installation

INFOID:000000005628307

CAUTION:

Disconnect the battery negative terminal or remove the fuse.

REMOVAL

1. Widen the pawl (A). Open the lens (1).
2. Remove the bulb.
3. Pressing the pawl (B) to the arrow direction (←). Pull out the trunk room lamp.
4. Disconnect the connector.
5. Remove the trunk room lamp.

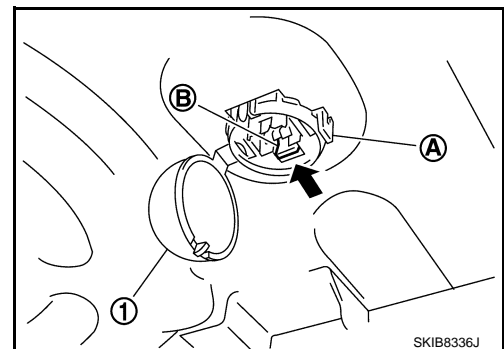

INSTALLATION

Install in the reverse order of removal.

Replacement

INFOID:000000005628308

CAUTION:

- **Disconnect negative battery terminal or remove the fuse.**
- **Never touch the glass of bulb directly by hand. Keep grease and other oily matters away from it.**
- **Never touch bulb by hand while it is lit or right after being turned off.**
- **Never leave bulb out of lamp reflector for a long time because dust, moisture smoke, etc. may affect the performance of lamp. When replacing bulb, be sure to replace it with new one.**

TRUNK ROOM LAMP BULB

1. Widen the lens pawl. Open the lens.
2. Remove the bulb.

SERVICE DATA AND SPECIFICATIONS (SDS)

< SERVICE DATA AND SPECIFICATIONS (SDS)

SERVICE DATA AND SPECIFICATIONS (SDS)

SERVICE DATA AND SPECIFICATIONS (SDS)

Bulb Specifications

INFOID:000000005628309

Item	Type	Wattage (W)
Push-button ignition switch illumination	LED	—
Map lamp	Wedge	8
Center console indirect illumination (Integrated into the map lamp assembly)	LED	—
Vanity mirror lamp	—	2
Glove box lamp	—	1.4
Cigarette lighter illumination (Shared with ash tray illumination)	—	1.4
Step lamp	Wedge	8
Personal lamp	Wedge	8
Trunk room lamp	Wedge	3.4