

MAIN LINE BETWEEN ADP AND ABS CIRCUIT	46	MAIN LINE BETWEEN AV AND DLC CIRCUIT	68
Diagnosis Procedure	46	Diagnosis Procedure	68
MAIN LINE BETWEEN ADP AND RAS CIRCUIT	48	MAIN LINE BETWEEN DLC AND ADP CIRCUIT	69
Diagnosis Procedure	48	Diagnosis Procedure	69
MAIN LINE BETWEEN RAS AND ABS CIRCUIT	49	MAIN LINE BETWEEN ADP AND ABS CIRCUIT	70
Diagnosis Procedure	49	Diagnosis Procedure	70
ECM BRANCH LINE CIRCUIT	51	ECM BRANCH LINE CIRCUIT	72
Diagnosis Procedure	51	Diagnosis Procedure	72
4WD BRANCH LINE CIRCUIT	52	AV BRANCH LINE CIRCUIT	73
Diagnosis Procedure	52	Diagnosis Procedure	73
AV BRANCH LINE CIRCUIT	53	A-BAG BRANCH LINE CIRCUIT	74
Diagnosis Procedure	53	Diagnosis Procedure	74
PSB BRANCH LINE CIRCUIT	54	BCM BRANCH LINE CIRCUIT	75
Diagnosis Procedure	54	Diagnosis Procedure	75
TCM BRANCH LINE CIRCUIT	55	DLC BRANCH LINE CIRCUIT	76
Diagnosis Procedure	55	Diagnosis Procedure	76
A-BAG BRANCH LINE CIRCUIT	56	M&A BRANCH LINE CIRCUIT	77
Diagnosis Procedure	56	Diagnosis Procedure	77
BCM BRANCH LINE CIRCUIT	57	STRG BRANCH LINE CIRCUIT	78
Diagnosis Procedure	57	Diagnosis Procedure	78
DLC BRANCH LINE CIRCUIT	58	ADP BRANCH LINE CIRCUIT	79
Diagnosis Procedure	58	Diagnosis Procedure	79
M&A BRANCH LINE CIRCUIT	59	ABS BRANCH LINE CIRCUIT	80
Diagnosis Procedure	59	Diagnosis Procedure	80
STRG BRANCH LINE CIRCUIT	60	IPDM-E BRANCH LINE CIRCUIT	81
Diagnosis Procedure	60	Diagnosis Procedure	81
ADP BRANCH LINE CIRCUIT	61	CAN COMMUNICATION CIRCUIT	82
Diagnosis Procedure	61	Diagnosis Procedure	82
RAS BRANCH LINE CIRCUIT	62	CAN SYSTEM (TYPE 3)	
Diagnosis Procedure	62	DTC/CIRCUIT DIAGNOSIS	84
ABS BRANCH LINE CIRCUIT	63	MAIN LINE BETWEEN AV AND DLC CIRCUIT	84
Diagnosis Procedure	63	Diagnosis Procedure	84
ICC BRANCH LINE CIRCUIT	64	MAIN LINE BETWEEN DLC AND ADP CIRCUIT	85
Diagnosis Procedure	64	Diagnosis Procedure	85
IPDM-E BRANCH LINE CIRCUIT	65	MAIN LINE BETWEEN ADP AND RAS CIRCUIT	86
Diagnosis Procedure	65	Diagnosis Procedure	86
CAN COMMUNICATION CIRCUIT	66	MAIN LINE BETWEEN RAS AND ABS CIRCUIT	87
Diagnosis Procedure	66		
CAN SYSTEM (TYPE 1)			
DTC/CIRCUIT DIAGNOSIS	68		

Diagnosis Procedure	87	Diagnosis Procedure	109	A
ECM BRANCH LINE CIRCUIT	89	BCM BRANCH LINE CIRCUIT	110	B
Diagnosis Procedure	89	Diagnosis Procedure	110	
AV BRANCH LINE CIRCUIT	90	DLC BRANCH LINE CIRCUIT	111	C
Diagnosis Procedure	90	Diagnosis Procedure	111	
A-BAG BRANCH LINE CIRCUIT	91	M&A BRANCH LINE CIRCUIT	112	D
Diagnosis Procedure	91	Diagnosis Procedure	112	
BCM BRANCH LINE CIRCUIT	92	STRG BRANCH LINE CIRCUIT	113	E
Diagnosis Procedure	92	Diagnosis Procedure	113	
DLC BRANCH LINE CIRCUIT	93	ADP BRANCH LINE CIRCUIT	114	F
Diagnosis Procedure	93	Diagnosis Procedure	114	
M&A BRANCH LINE CIRCUIT	94	ABS BRANCH LINE CIRCUIT	115	G
Diagnosis Procedure	94	Diagnosis Procedure	115	
STRG BRANCH LINE CIRCUIT	95	ICC BRANCH LINE CIRCUIT	116	H
Diagnosis Procedure	95	Diagnosis Procedure	116	
ADP BRANCH LINE CIRCUIT	96	IPDM-E BRANCH LINE CIRCUIT	117	I
Diagnosis Procedure	96	Diagnosis Procedure	117	
RAS BRANCH LINE CIRCUIT	97	CAN COMMUNICATION CIRCUIT	118	J
Diagnosis Procedure	97	Diagnosis Procedure	118	
ABS BRANCH LINE CIRCUIT	98	CAN SYSTEM (TYPE 5)		K
Diagnosis Procedure	98	DTC/CIRCUIT DIAGNOSIS	120	
IPDM-E BRANCH LINE CIRCUIT	99	MAIN LINE BETWEEN AV AND DLC CIR-	120	L
Diagnosis Procedure	99	CUIT	120	
CAN COMMUNICATION CIRCUIT	100	Diagnosis Procedure	120	
Diagnosis Procedure	100	MAIN LINE BETWEEN DLC AND ADP CIR-	121	
CAN SYSTEM (TYPE 4)		CUIT	121	
DTC/CIRCUIT DIAGNOSIS	102	Diagnosis Procedure	121	
MAIN LINE BETWEEN AV AND DLC CIR-	102	MAIN LINE BETWEEN ADP AND RAS CIR-	122	
CUIT	102	CUIT	122	
Diagnosis Procedure	102	Diagnosis Procedure	122	
MAIN LINE BETWEEN DLC AND ADP CIR-	103	MAIN LINE BETWEEN RAS AND ABS CIR-	123	LAN
CUIT	103	CUIT	123	
Diagnosis Procedure	103	Diagnosis Procedure	123	
MAIN LINE BETWEEN ADP AND ABS CIR-	104	ECM BRANCH LINE CIRCUIT	125	N
CUIT	104	Diagnosis Procedure	125	
Diagnosis Procedure	104	AV BRANCH LINE CIRCUIT	126	O
ECM BRANCH LINE CIRCUIT	106	Diagnosis Procedure	126	
Diagnosis Procedure	106	PSB BRANCH LINE CIRCUIT	127	P
AV BRANCH LINE CIRCUIT	107	Diagnosis Procedure	127	
Diagnosis Procedure	107	A-BAG BRANCH LINE CIRCUIT	128	
PSB BRANCH LINE CIRCUIT	108	Diagnosis Procedure	128	
Diagnosis Procedure	108	BCM BRANCH LINE CIRCUIT	129	
A-BAG BRANCH LINE CIRCUIT	109	Diagnosis Procedure	129	

DLC BRANCH LINE CIRCUIT	130	ABS BRANCH LINE CIRCUIT	150
Diagnosis Procedure	130	Diagnosis Procedure	150
M&A BRANCH LINE CIRCUIT	131	IPDM-E BRANCH LINE CIRCUIT	151
Diagnosis Procedure	131	Diagnosis Procedure	151
STRG BRANCH LINE CIRCUIT	132	CAN COMMUNICATION CIRCUIT	152
Diagnosis Procedure	132	Diagnosis Procedure	152
ADP BRANCH LINE CIRCUIT	133	CAN SYSTEM (TYPE 7)	
Diagnosis Procedure	133	DTC/CIRCUIT DIAGNOSIS	154
RAS BRANCH LINE CIRCUIT	134	MAIN LINE BETWEEN AV AND DLC CIR-	
Diagnosis Procedure	134	CUIT	154
ABS BRANCH LINE CIRCUIT	135	Diagnosis Procedure	154
Diagnosis Procedure	135	MAIN LINE BETWEEN DLC AND ADP CIR-	
ICC BRANCH LINE CIRCUIT	136	CUIT	155
Diagnosis Procedure	136	Diagnosis Procedure	155
IPDM-E BRANCH LINE CIRCUIT	137	MAIN LINE BETWEEN ADP AND ABS CIR-	
Diagnosis Procedure	137	CUIT	156
CAN COMMUNICATION CIRCUIT	138	Diagnosis Procedure	156
Diagnosis Procedure	138	ECM BRANCH LINE CIRCUIT	158
CAN SYSTEM (TYPE 6)		Diagnosis Procedure	158
DTC/CIRCUIT DIAGNOSIS	140	AV BRANCH LINE CIRCUIT	159
MAIN LINE BETWEEN AV AND DLC CIR-		Diagnosis Procedure	159
CUIT	140	TCM BRANCH LINE CIRCUIT	160
Diagnosis Procedure	140	Diagnosis Procedure	160
MAIN LINE BETWEEN DLC AND ABS CIR-		A-BAG BRANCH LINE CIRCUIT	161
CUIT	141	Diagnosis Procedure	161
Diagnosis Procedure	141	BCM BRANCH LINE CIRCUIT	162
ECM BRANCH LINE CIRCUIT	142	Diagnosis Procedure	162
Diagnosis Procedure	142	DLC BRANCH LINE CIRCUIT	163
AV BRANCH LINE CIRCUIT	143	Diagnosis Procedure	163
Diagnosis Procedure	143	M&A BRANCH LINE CIRCUIT	164
TCM BRANCH LINE CIRCUIT	144	Diagnosis Procedure	164
Diagnosis Procedure	144	STRG BRANCH LINE CIRCUIT	165
A-BAG BRANCH LINE CIRCUIT	145	Diagnosis Procedure	165
Diagnosis Procedure	145	ADP BRANCH LINE CIRCUIT	166
BCM BRANCH LINE CIRCUIT	146	Diagnosis Procedure	166
Diagnosis Procedure	146	ABS BRANCH LINE CIRCUIT	167
DLC BRANCH LINE CIRCUIT	147	Diagnosis Procedure	167
Diagnosis Procedure	147	IPDM-E BRANCH LINE CIRCUIT	168
M&A BRANCH LINE CIRCUIT	148	Diagnosis Procedure	168
Diagnosis Procedure	148	CAN COMMUNICATION CIRCUIT	169
STRG BRANCH LINE CIRCUIT	149	Diagnosis Procedure	169
Diagnosis Procedure	149	CAN SYSTEM (TYPE 8)	
		DTC/CIRCUIT DIAGNOSIS	171

MAIN LINE BETWEEN AV AND DLC CIRCUIT	171	
Diagnosis Procedure	171	
MAIN LINE BETWEEN DLC AND ADP CIRCUIT	172	
Diagnosis Procedure	172	
MAIN LINE BETWEEN ADP AND RAS CIRCUIT	173	
Diagnosis Procedure	173	
MAIN LINE BETWEEN RAS AND ABS CIRCUIT	174	
Diagnosis Procedure	174	
ECM BRANCH LINE CIRCUIT	176	
Diagnosis Procedure	176	
AV BRANCH LINE CIRCUIT	177	
Diagnosis Procedure	177	
TCM BRANCH LINE CIRCUIT	178	
Diagnosis Procedure	178	
A-BAG BRANCH LINE CIRCUIT	179	
Diagnosis Procedure	179	
BCM BRANCH LINE CIRCUIT	180	
Diagnosis Procedure	180	
DLC BRANCH LINE CIRCUIT	181	
Diagnosis Procedure	181	
M&A BRANCH LINE CIRCUIT	182	
Diagnosis Procedure	182	
STRG BRANCH LINE CIRCUIT	183	
Diagnosis Procedure	183	
ADP BRANCH LINE CIRCUIT	184	
Diagnosis Procedure	184	
RAS BRANCH LINE CIRCUIT	185	
Diagnosis Procedure	185	
ABS BRANCH LINE CIRCUIT	186	
Diagnosis Procedure	186	
IPDM-E BRANCH LINE CIRCUIT	187	
Diagnosis Procedure	187	
CAN COMMUNICATION CIRCUIT	188	
Diagnosis Procedure	188	
CAN SYSTEM (TYPE 9)		
DTC/CIRCUIT DIAGNOSIS	190	
MAIN LINE BETWEEN AV AND DLC CIRCUIT	190	
Diagnosis Procedure	190	
MAIN LINE BETWEEN DLC AND ADP CIRCUIT	191	
Diagnosis Procedure	191	
MAIN LINE BETWEEN ADP AND ABS CIRCUIT	192	
Diagnosis Procedure	192	
ECM BRANCH LINE CIRCUIT	194	
Diagnosis Procedure	194	
AV BRANCH LINE CIRCUIT	195	
Diagnosis Procedure	195	
PSB BRANCH LINE CIRCUIT	196	
Diagnosis Procedure	196	
TCM BRANCH LINE CIRCUIT	197	
Diagnosis Procedure	197	
A-BAG BRANCH LINE CIRCUIT	198	
Diagnosis Procedure	198	
BCM BRANCH LINE CIRCUIT	199	
Diagnosis Procedure	199	
DLC BRANCH LINE CIRCUIT	200	
Diagnosis Procedure	200	
M&A BRANCH LINE CIRCUIT	201	
Diagnosis Procedure	201	
STRG BRANCH LINE CIRCUIT	202	
Diagnosis Procedure	202	
ADP BRANCH LINE CIRCUIT	203	
Diagnosis Procedure	203	
ABS BRANCH LINE CIRCUIT	204	
Diagnosis Procedure	204	
ICC BRANCH LINE CIRCUIT	205	
Diagnosis Procedure	205	
IPDM-E BRANCH LINE CIRCUIT	206	
Diagnosis Procedure	206	
CAN COMMUNICATION CIRCUIT	207	
Diagnosis Procedure	207	
CAN SYSTEM (TYPE 10)		
DTC/CIRCUIT DIAGNOSIS	209	
MAIN LINE BETWEEN AV AND DLC CIRCUIT	209	
Diagnosis Procedure	209	
MAIN LINE BETWEEN DLC AND ADP CIRCUIT	210	
Diagnosis Procedure	210	
MAIN LINE BETWEEN ADP AND RAS CIRCUIT	211	

A

B

C

D

E

F

G

H

I

J

K

L

LAN

N

O

P

Diagnosis Procedure	211	Diagnosis Procedure	232
MAIN LINE BETWEEN RAS AND ABS CIR- CUIT	212	4WD BRANCH LINE CIRCUIT	233
Diagnosis Procedure	212	Diagnosis Procedure	233
ECM BRANCH LINE CIRCUIT	214	AV BRANCH LINE CIRCUIT	234
Diagnosis Procedure	214	Diagnosis Procedure	234
AV BRANCH LINE CIRCUIT	215	TCM BRANCH LINE CIRCUIT	235
Diagnosis Procedure	215	Diagnosis Procedure	235
PSB BRANCH LINE CIRCUIT	216	A-BAG BRANCH LINE CIRCUIT	236
Diagnosis Procedure	216	Diagnosis Procedure	236
TCM BRANCH LINE CIRCUIT	217	BCM BRANCH LINE CIRCUIT	237
Diagnosis Procedure	217	Diagnosis Procedure	237
A-BAG BRANCH LINE CIRCUIT	218	DLC BRANCH LINE CIRCUIT	238
Diagnosis Procedure	218	Diagnosis Procedure	238
BCM BRANCH LINE CIRCUIT	219	M&A BRANCH LINE CIRCUIT	239
Diagnosis Procedure	219	Diagnosis Procedure	239
DLC BRANCH LINE CIRCUIT	220	STRG BRANCH LINE CIRCUIT	240
Diagnosis Procedure	220	Diagnosis Procedure	240
M&A BRANCH LINE CIRCUIT	221	ABS BRANCH LINE CIRCUIT	241
Diagnosis Procedure	221	Diagnosis Procedure	241
STRG BRANCH LINE CIRCUIT	222	IPDM-E BRANCH LINE CIRCUIT	242
Diagnosis Procedure	222	Diagnosis Procedure	242
ADP BRANCH LINE CIRCUIT	223	CAN COMMUNICATION CIRCUIT	243
Diagnosis Procedure	223	Diagnosis Procedure	243
RAS BRANCH LINE CIRCUIT	224	CAN SYSTEM (TYPE 12)	
Diagnosis Procedure	224	DTC/CIRCUIT DIAGNOSIS	245
ABS BRANCH LINE CIRCUIT	225	MAIN LINE BETWEEN AV AND DLC CIR- CUIT	245
Diagnosis Procedure	225	Diagnosis Procedure	245
ICC BRANCH LINE CIRCUIT	226	MAIN LINE BETWEEN DLC AND ADP CIR- CUIT	246
Diagnosis Procedure	226	Diagnosis Procedure	246
IPDM-E BRANCH LINE CIRCUIT	227	MAIN LINE BETWEEN ADP AND ABS CIR- CUIT	247
Diagnosis Procedure	227	Diagnosis Procedure	247
CAN COMMUNICATION CIRCUIT	228	ECM BRANCH LINE CIRCUIT	249
Diagnosis Procedure	228	Diagnosis Procedure	249
CAN SYSTEM (TYPE 11)		4WD BRANCH LINE CIRCUIT	250
DTC/CIRCUIT DIAGNOSIS	230	Diagnosis Procedure	250
MAIN LINE BETWEEN AV AND DLC CIR- CUIT	230	AV BRANCH LINE CIRCUIT	251
Diagnosis Procedure	230	Diagnosis Procedure	251
MAIN LINE BETWEEN DLC AND ABS CIR- CUIT	231	TCM BRANCH LINE CIRCUIT	252
Diagnosis Procedure	231	Diagnosis Procedure	252
ECM BRANCH LINE CIRCUIT	232	A-BAG BRANCH LINE CIRCUIT	253

Diagnosis Procedure	253	4WD BRANCH LINE CIRCUIT	268	
BCM BRANCH LINE CIRCUIT	254	Diagnosis Procedure	268	A
Diagnosis Procedure	254	AV BRANCH LINE CIRCUIT	269	
DLC BRANCH LINE CIRCUIT	255	Diagnosis Procedure	269	B
Diagnosis Procedure	255	PSB BRANCH LINE CIRCUIT	270	
M&A BRANCH LINE CIRCUIT	256	Diagnosis Procedure	270	C
Diagnosis Procedure	256	TCM BRANCH LINE CIRCUIT	271	
STRG BRANCH LINE CIRCUIT	257	Diagnosis Procedure	271	D
Diagnosis Procedure	257	A-BAG BRANCH LINE CIRCUIT	272	
ADP BRANCH LINE CIRCUIT	258	Diagnosis Procedure	272	E
Diagnosis Procedure	258	BCM BRANCH LINE CIRCUIT	273	
ABS BRANCH LINE CIRCUIT	259	Diagnosis Procedure	273	F
Diagnosis Procedure	259	DLC BRANCH LINE CIRCUIT	274	
IPDM-E BRANCH LINE CIRCUIT	260	Diagnosis Procedure	274	G
Diagnosis Procedure	260	M&A BRANCH LINE CIRCUIT	275	
CAN COMMUNICATION CIRCUIT	261	Diagnosis Procedure	275	H
Diagnosis Procedure	261	STRG BRANCH LINE CIRCUIT	276	
CAN SYSTEM (TYPE 13)		Diagnosis Procedure	276	I
DTC/CIRCUIT DIAGNOSIS	263	ADP BRANCH LINE CIRCUIT	277	
MAIN LINE BETWEEN AV AND DLC CIR-		Diagnosis Procedure	277	J
CUIT	263	ABS BRANCH LINE CIRCUIT	278	
Diagnosis Procedure	263	Diagnosis Procedure	278	K
MAIN LINE BETWEEN DLC AND ADP CIR-		ICC BRANCH LINE CIRCUIT	279	
CUIT	264	Diagnosis Procedure	279	L
Diagnosis Procedure	264	IPDM-E BRANCH LINE CIRCUIT	280	
MAIN LINE BETWEEN ADP AND ABS CIR-		Diagnosis Procedure	280	
CUIT	265	CAN COMMUNICATION CIRCUIT	281	
Diagnosis Procedure	265	Diagnosis Procedure	281	
ECM BRANCH LINE CIRCUIT	267			
Diagnosis Procedure	267			

LAN

N

O

P

PRECAUTION

PRECAUTIONS

Precautions for Trouble Diagnosis

INFOID:000000005622669

CAUTION:

- Never apply 7.0 V or more to the measurement terminal.
- Use a tester with open terminal voltage of 7.0 V or less.
- Turn the ignition switch OFF and disconnect the battery cable from the negative terminal when checking the harness.

Precautions for Harness Repair

INFOID:000000005622670

- Solder the repaired area and wrap tape around the soldered area.

NOTE:

A fray of twisted lines must be within 110 mm (4.33 in).

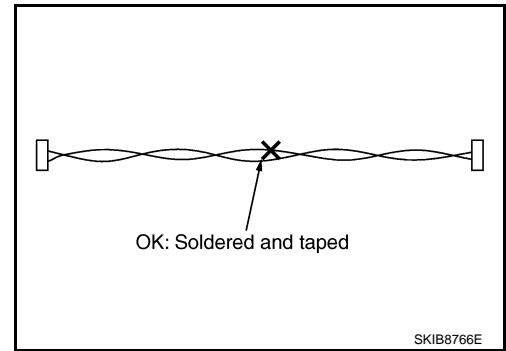

- Bypass connection is never allowed at the repaired area.

NOTE:

Bypass connection may cause CAN communication error. The spliced wire becomes separated and the characteristics of twisted line are lost.

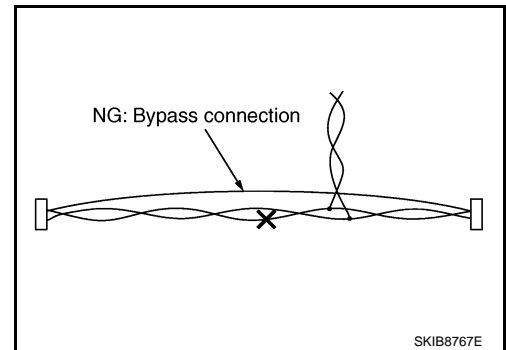

- Replace the applicable harness as an assembly if error is detected on the shield lines of CAN communication line.

SYSTEM DESCRIPTION

CAN COMMUNICATION SYSTEM

System Description

INFOID:000000005622671

- CAN communication is a multiplex communication system. This enables the system to transmit and receive large quantities of data at high speed by connecting control units with two communication lines (CAN-H and CAN-L).
- Control units on the CAN network transmit signals using the CAN communication control circuit. They receive only necessary signals from other control units to operate various functions.
- CAN communication lines adopt twisted-pair line style (two lines twisted) for noise immunity.

System Diagram

INFOID:000000005622672

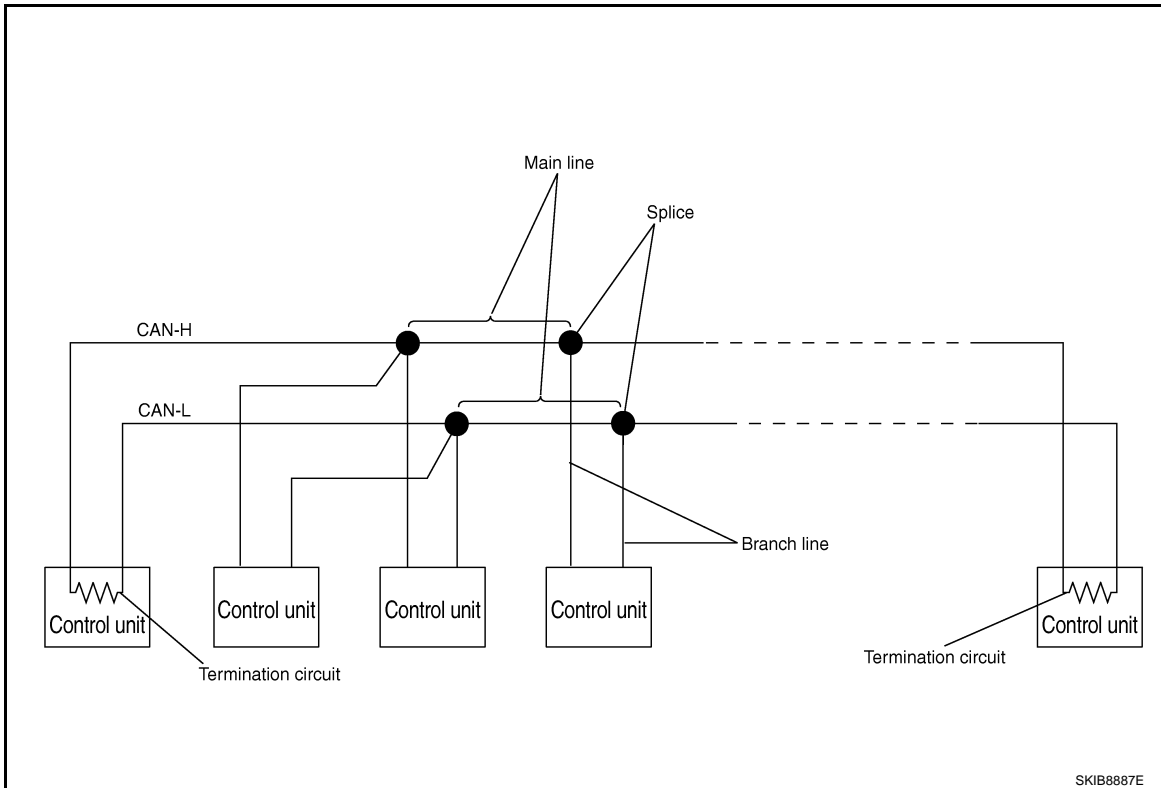

Each control unit passes an electric current to the termination circuits when transmitting CAN communication signal. The termination circuits produce an electrical potential difference between CAN-H and CAN-L. CAN communication system transmits and receives CAN communication signals by the potential difference.

Component	Description
Main line	CAN communication line between splices
Branch line	CAN communication line between splice and a control unit
Splice	A point connecting a branch line with a main line
Termination circuit	Refer to LAN-10, "CAN Communication Control Circuit" .

LAN

CAN COMMUNICATION SYSTEM

< SYSTEM DESCRIPTION >

[CAN FUNDAMENTAL]

CAN Communication Control Circuit

INFOID:000000005622673

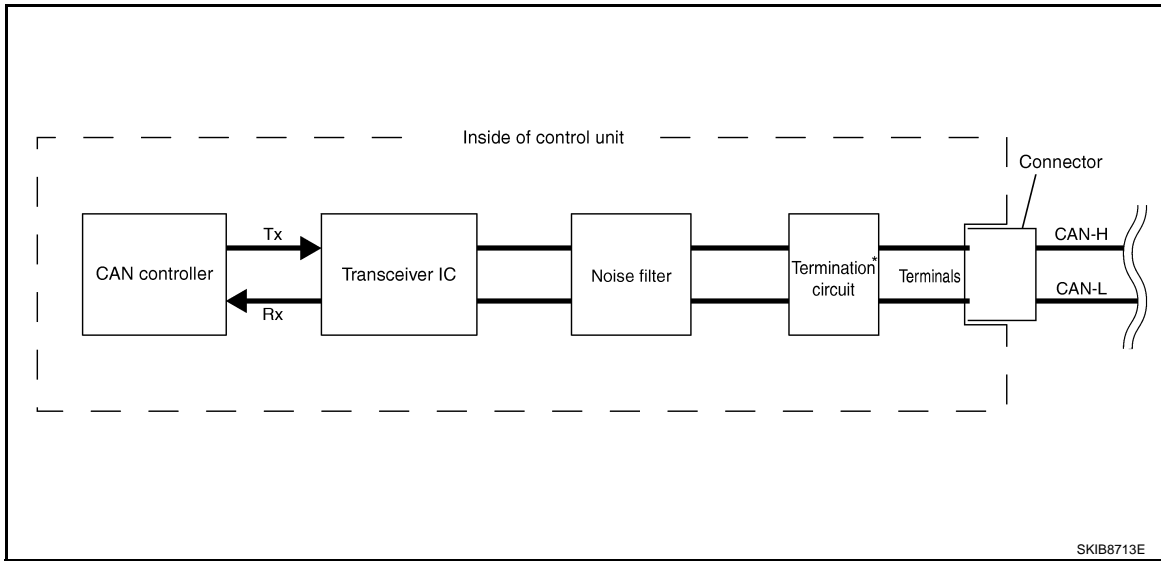

Component	System description
CAN controller	It controls CAN communication signal transmission and reception, error detection, etc.
Transceiver IC	It converts digital signal into CAN communication signal, and CAN communication signal into digital signal.
Noise filter	It eliminates noise of CAN communication signal.
Termination circuit* (Resistance of approx. 120 Ω)	It produces potential difference.

*: These are the only control units wired with both ends of CAN communication system.

DIAG ON CAN

Description

INFOID:000000005622674

“Diag on CAN” is a diagnosis using CAN communication instead of previous DDL1 and DDL2 communication lines, between control units and diagnosis unit.

System Diagram

INFOID:000000005622675

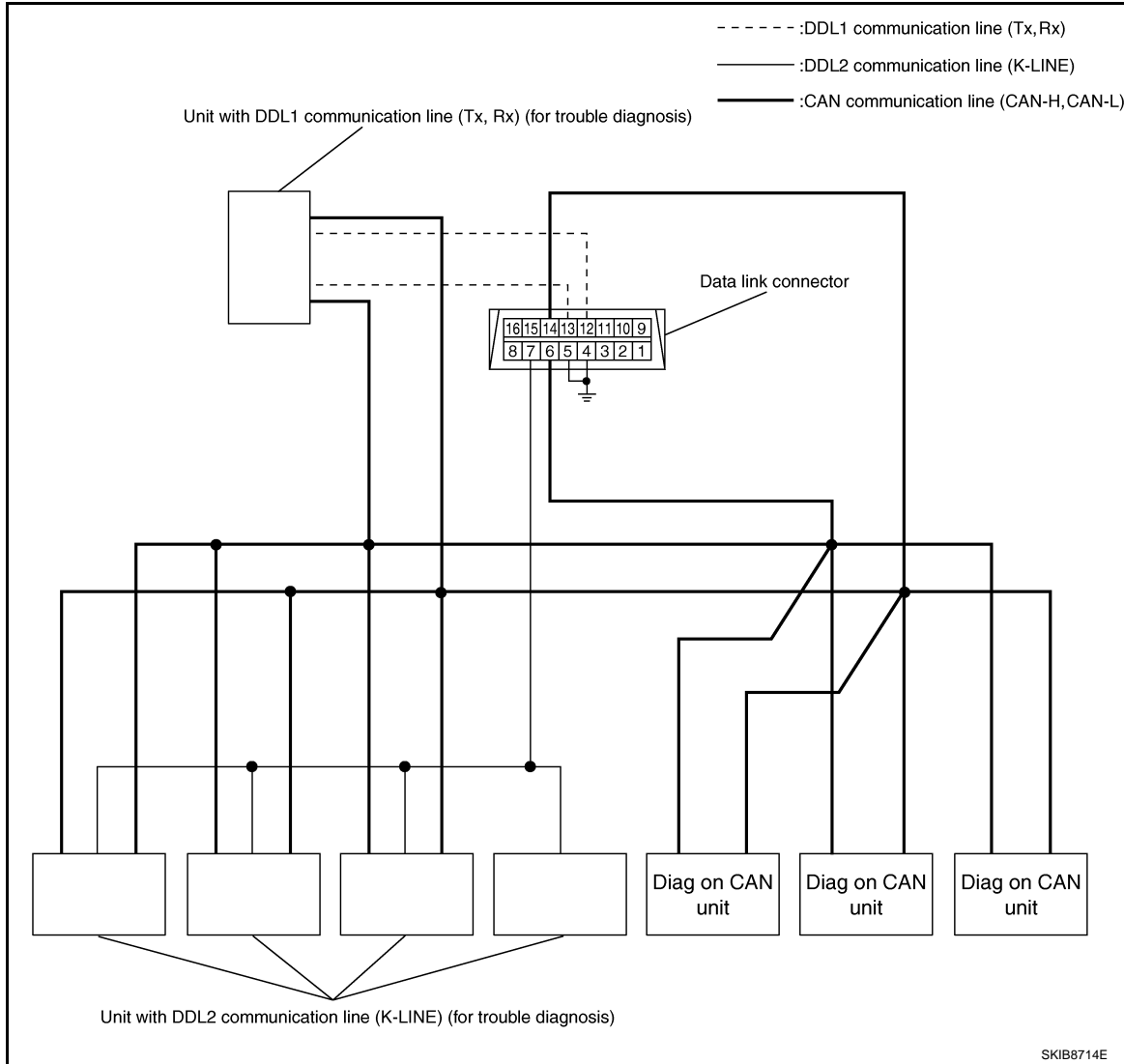

Name	Harness	Description
DDL1	Tx Rx	It is used for trouble diagnosis. (CAN-H and CAN-L are used for controlling)
DDL2	K-LINE	It is used for trouble diagnosis. (CAN-H and CAN-L are used for controlling)
Diag on CAN	CAN-H CAN-L	It is used for trouble diagnosis and control.

A
B
C
D
E
F
G
H
I
J
K
L

LAN

N
O
P

TROUBLE DIAGNOSIS

Condition of Error Detection

INFOID:000000005778919

DTC of CAN communication is indicated on SELF-DIAG RESULTS on CONSULT-III if a CAN communication signal is not transmitted or received between units for 2 seconds or more.

NOTE:

DTCs of CAN communication are as follows:

- U0101
- U0140
- U0164
- U1000
- U1001

CAN COMMUNICATION SYSTEM ERROR

- CAN communication line open (CAN-H, CAN-L, or both)
- CAN communication line short (ground, between CAN communication lines, other harnesses)
- Error of CAN communication control circuit of the unit connected to CAN communication line

WHEN DTC OF CAN COMMUNICATION IS INDICATED EVEN THOUGH CAN COMMUNICATION SYSTEM IS NORMAL

- Removal/installation of parts: Error may be detected when removing and installing CAN communication unit and related parts while turning the ignition switch ON. (A DTC except for CAN communication may be detected.)
- Fuse blown out (removed): CAN communication of the unit may cease.
- Voltage drop: Error may be detected if voltage drops due to discharged battery when turning the ignition switch ON (Depending on the control unit which carries out CAN communication).
- Error may be detected if the power supply circuit of the control unit, which carries out CAN communication, malfunctions (Depending on the control unit which carries out CAN communication).
- Error may be detected if reprogramming is not completed normally.

CAUTION:

CAN communication system is normal if DTC of CAN communication is indicated on SELF-DIAG RESULTS of CONSULT-III under the above conditions. Erase the memory of the self-diagnosis of each unit.

Symptom When Error Occurs in CAN Communication System

INFOID:000000005622677

In CAN communication system, multiple units mutually transmit and receive signals. Each unit cannot transmit and receive signals if any error occurs on CAN communication line. Under this condition, multiple control units related to the root cause malfunction or go into fail-safe mode.

ERROR EXAMPLE

NOTE:

- Each vehicle differs in symptom of each unit under fail-safe mode and CAN communication line wiring.
- Refer to [LAN-24, "Abbreviation List"](#) for the unit abbreviation.

TROUBLE DIAGNOSIS

< SYSTEM DESCRIPTION >

[CAN FUNDAMENTAL]

Example: TCM branch line open circuit

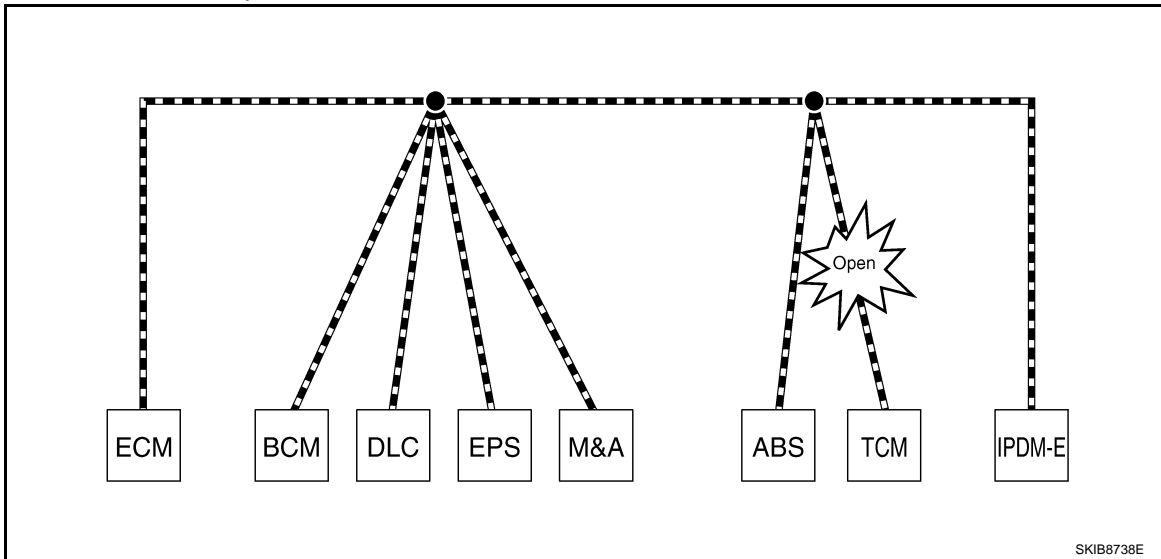

Unit name	Symptom
ECM	Engine torque limiting is affected, and shift harshness increases.
BCM	Reverse warning chime does not sound.
EPS control unit	Normal operation.
Combination meter	<ul style="list-style-type: none"> • Shift position indicator and OD OFF indicator turn OFF. • Warning lamps turn ON.
ABS actuator and electric unit (control unit)	Normal operation.
TCM	No impact on operation.
IPDM E/R	Normal operation.

Example: Data link connector branch line open circuit

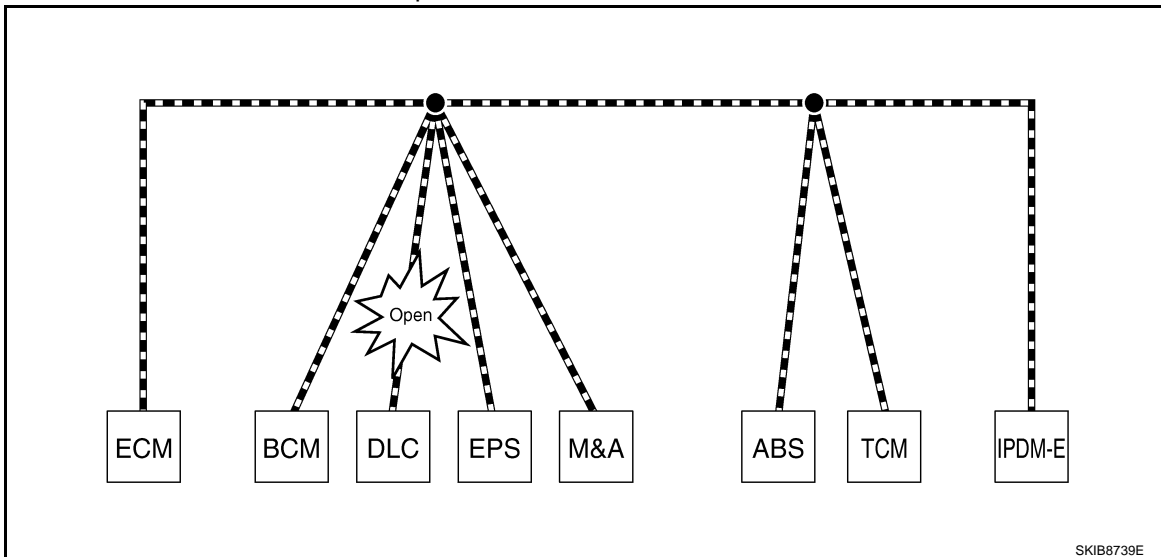

A
B
C
D
E
F
G
H
I
J
K
L
N
O
P

LAN

TROUBLE DIAGNOSIS

< SYSTEM DESCRIPTION >

[CAN FUNDAMENTAL]

Unit name	Symptom
ECM	Normal operation.
BCM	
EPS control unit	
Combination meter	
ABS actuator and electric unit (control unit)	
TCM	
IPDM E/R	

NOTE:

- When data link connector branch line is open, transmission and reception of CAN communication signals are not affected. Therefore, no symptoms occur. However, be sure to repair malfunctioning circuit.
- The model (all units on CAN communication system are Diag on CAN) cannot perform CAN diagnosis with CONSULT-III if the following error occurs. The error is judged by the symptom.

Error	Difference of symptom
Data link connector branch line open circuit	Normal operation.
CAN-H, CAN-L harness short-circuit	Most of the units which are connected to the CAN communication system enter fail-safe mode or are deactivated.

Example: Main Line Between Data Link Connector and ABS Actuator and Electric Unit (Control Unit) Open Circuit

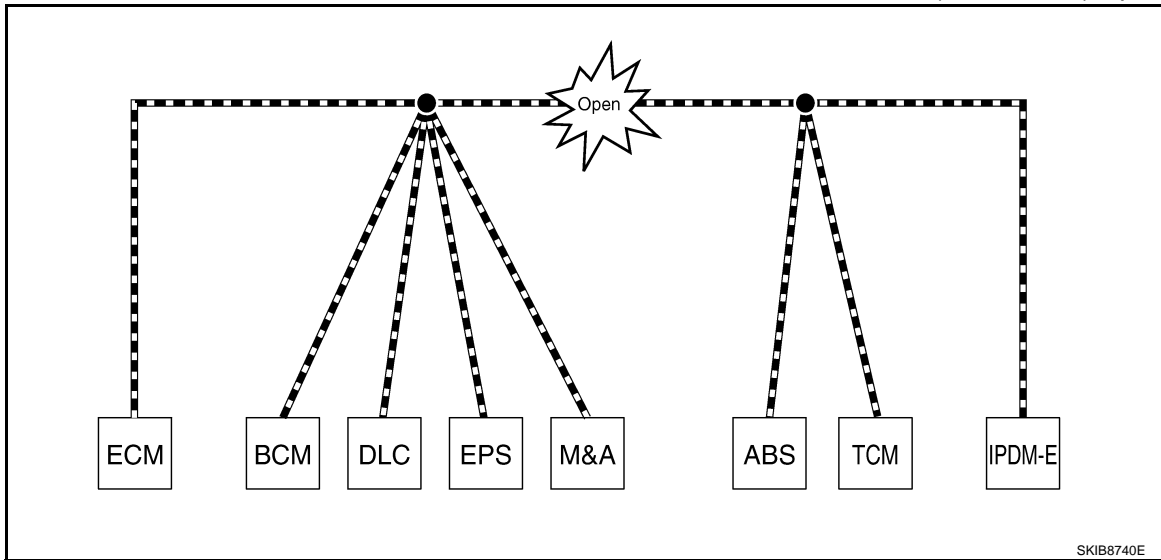

Unit name	Symptom
ECM	Engine torque limiting is affected, and shift harshness increases.
BCM	<ul style="list-style-type: none"> • Reverse warning chime does not sound. • The front wiper moves under continuous operation mode even though the front wiper switch being in the intermittent position.
EPS control unit	The steering effort increases.
Combination meter	<ul style="list-style-type: none"> • The shift position indicator and OD OFF indicator turn OFF. • The speedometer is inoperative. • The odo/trip meter stops.
ABS actuator and electric unit (control unit)	Normal operation.
TCM	No impact on operation.
IPDM E/R	When the ignition switch is ON, <ul style="list-style-type: none"> • The headlamps (Lo) turn ON. • The cooling fan continues to rotate.

TROUBLE DIAGNOSIS

< SYSTEM DESCRIPTION >

[CAN FUNDAMENTAL]

Example: CAN-H, CAN-L Harness Short Circuit

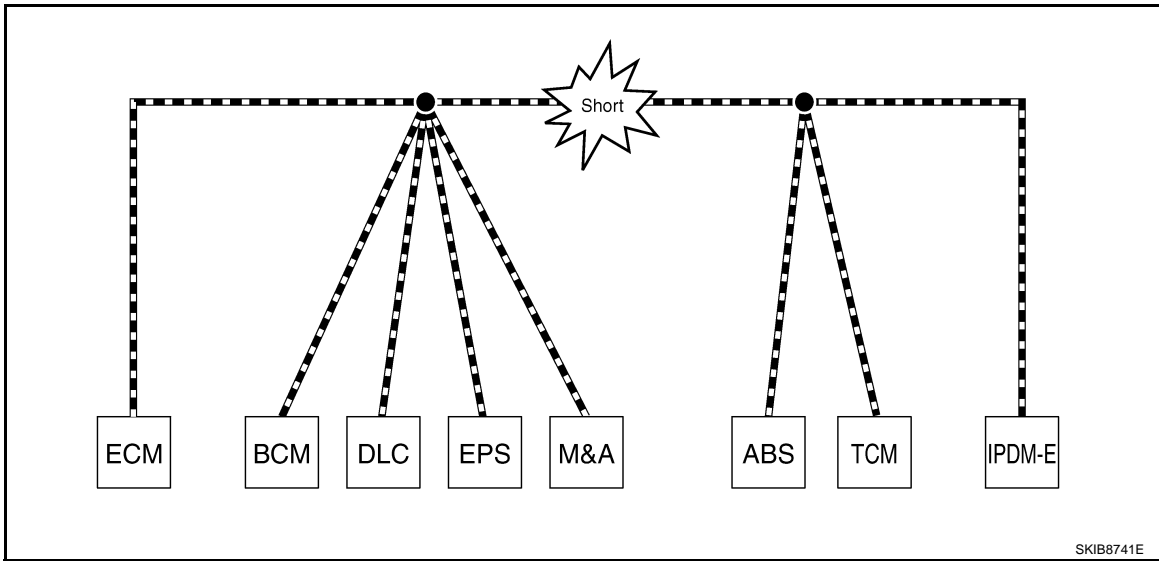

Unit name	Symptom
ECM	<ul style="list-style-type: none"> • Engine torque limiting is affected, and shift harshness increases. • Engine speed drops.
BCM	<ul style="list-style-type: none"> • Reverse warning chime does not sound. • The front wiper moves under continuous operation mode even though the front wiper switch being in the intermittent position. • The room lamp does not turn ON. • The engine does not start (if an error or malfunction occurs while turning the ignition switch OFF.) • The steering lock does not release (if an error or malfunction occurs while turning the ignition switch OFF.)
EPS control unit	The steering effort increases.
Combination meter	<ul style="list-style-type: none"> • The tachometer and the speedometer do not move. • Warning lamps turn ON. • Indicator lamps do not turn ON.
ABS actuator and electric unit (control unit)	Normal operation.
TCM	No impact on operation.
IPDM E/R	When the ignition switch is ON, <ul style="list-style-type: none"> • The headlamps (Lo) turn ON. • The cooling fan continues to rotate.

CAN Diagnosis with CONSULT-III

INFOID:000000005622678

LAN

CAN diagnosis on CONSULT-III extracts the root cause by receiving the following information.

- Response to the system call
- Control unit diagnosis information
- Self-diagnosis
- CAN diagnostic support monitor

TROUBLE DIAGNOSIS

< SYSTEM DESCRIPTION >

[CAN FUNDAMENTAL]

Self-Diagnosis

INFOID:000000005867050

DTC	Self-diagnosis item (CONSULT-III indication)	DTC detection condition	Inspection/Action	
U0101	LOST COMM (TCM)	When ECM is not transmitting or receiving CAN communication signal of OBD (emission-related diagnosis) from TCM for 2 seconds or more.	Start the inspection. Refer to the applicable section of the indicated control unit.	
U0140	LOST COMM (BCM)	When ECM is not transmitting or receiving CAN communication signal of OBD (emission-related diagnosis) from BCM for 2 seconds or more.		
U0164	LOST COMM (HVAC)	When ECM is not transmitting or receiving CAN communication signal of OBD (emission-related diagnosis) from A/C auto amp. or unified meter and A/C amp. for 2 seconds or more.		
U1000	CAN COMM CIRCUIT	ECM		When ECM is not transmitting or receiving CAN communication signal of OBD (emission-related diagnosis) for 2 seconds or more.
		Except for ECM		When a control unit (except for ECM) is not transmitting or receiving CAN communication signal for 2 seconds or more.
U1001	CAN COMM CIRCUIT	When ECM is not transmitting or receiving CAN communication signal other than OBD (emission-related diagnosis) for 2 seconds or more.		
U1002	SYSTEM COMM	When a control unit is not transmitting or receiving CAN communication signal for 2 seconds or less.		
U1010	CONTROL UNIT(CAN)	When an error is detected during the initial diagnosis for CAN controller of each control unit.	Replace the control unit indicating "U1010" or "P0607".	
P0607	ECM			

CAN Diagnostic Support Monitor

INFOID:000000005622680

MONITOR ITEM (CONSULT-III)

Example: CAN DIAG SUPPORT MNTR indication

Without PAST				With PAST				
ECM				ECM				
	PRSENT	PAST		PRSENT	PAST		PRSENT	PAST
INITIAL DIAG	OK		TRANSMIT DIAG	OK	OK			
TRANSMIT DIAG	OK		VDC/TCS/ABS	-	-			
TCM	OK		METER/M&A	OK	OK			
VDC/TCS/ABS	UNKWN		BCM/SEC	OK	OK			
METER/M&A	OK		ICC	-	-			
ICC	UNKWN		HVAC	-	-			
BCM/SEC	OK		TCM	OK	OK			
IPDM E/R	OK		EPS	-	-			
			IPDM E/R	OK	OK			
			e4WD	-	-			
			AWD/4WD	OK	OK			

JSMIA0015GB

Without PAST

Item	PRSENT	Description
Initial diagnosis	OK	Normal at present
	NG	Control unit error (Except for some control units)

TROUBLE DIAGNOSIS

< SYSTEM DESCRIPTION >

[CAN FUNDAMENTAL]

Item	PRSNT	Description
Transmission diagnosis	OK	Normal at present
	UNKWN	Unable to transmit signals for 2 seconds or more.
		Diagnosis not performed
Control unit name (Reception diagnosis)	OK	Normal at present
	UNKWN	Unable to receive signals for 2 seconds or more.
		Diagnosis not performed
		No control unit for receiving signals. (No applicable optional parts)

With PAST

Item	PRSNT	PAST	Description
Transmission diagnosis	OK	OK	Normal at present and in the past
		1 – 39	Normal at present, but unable to transmit signals for 2 seconds or more in the past. (The number indicates the number of ignition switch cycles from OFF to ON.)
	UNKWN	0	Unable to transmit signals for 2 seconds or more at present.
Control unit name (Reception diagnosis)	OK	OK	Normal at present and in the past
		1 – 39	Normal at present, but unable to receive signals for 2 seconds or more in the past. (The number indicates the number of ignition switch cycles from OFF to ON.)
	UNKWN	0	Unable to receive signals for 2 seconds or more at present.
	-	-	Diagnosis not performed.
			No control unit for receiving signals. (No applicable optional parts)

MONITOR ITEM (ON-BOARD DIAGNOSIS)

NOTE:

For some models, CAN communication diagnosis result is received from the vehicle monitor.

Example: Vehicle Display

Item	Result indicated	Error counter	Description
CAN_COMM (Initial diagnosis)	OK	0	Normal at present
	NG	1 – 50	Control unit error (The number indicates how many times diagnosis has been run.)
CAN_CIRC_1 (Transmission diagnosis)	OK	0	Normal at present
	UNKWN	1 – 50	Unable to transmit for 2 seconds or more at present. (The number indicates how many times diagnosis has been run.)
CAN_CIRC_2 – 9 (Reception diagnosis of each unit)	OK	0	Normal at present
	UNKWN	1 – 50	Unable to transmit for 2 seconds or more at present. (The number indicates how many times diagnosis has been run.)
			Diagnosis not performed.
		No control unit for receiving signals. (No applicable optional parts)	

TROUBLE DIAGNOSIS

< SYSTEM DESCRIPTION >

[CAN FUNDAMENTAL]

How to Use CAN Communication Signal Chart

INFOID:000000005622681

The CAN communication signal chart lists the signals needed for trouble diagnosis. It is useful for detecting the root cause by finding a signal related to the symptom, and by checking transmission and reception unit.

Example: Tachometer does not move even though the engine rotates.

T: Transmit R: Receive

Signal name/Connecting unit	ECM	BCM	M&A	STRG	ABS	IPDM-E
A/C compressor feedback signal	T		R			
A/C compressor request signal	T					R
Accelerator pedal position signal	T				R	
Cooling fan motor operation signal	T					R
Engine coolant temperature signal	T		R			
Engine speed signal	T		R		R	
Fuel consumption monitor signal	T		R			
Malfunction indicator lamp signal	T		R			
A/C switch signal	R	T				
Ignition switch signal		T				R
Sleep/wake up signal		T	R			R

It indicates that an error occurs between ECM and M&A (Shaded area).

SKIB8715E

BASIC INSPECTION

DIAGNOSIS AND REPAIR WORKFLOW

Trouble Diagnosis Flow Chart

INFOID:000000005622682

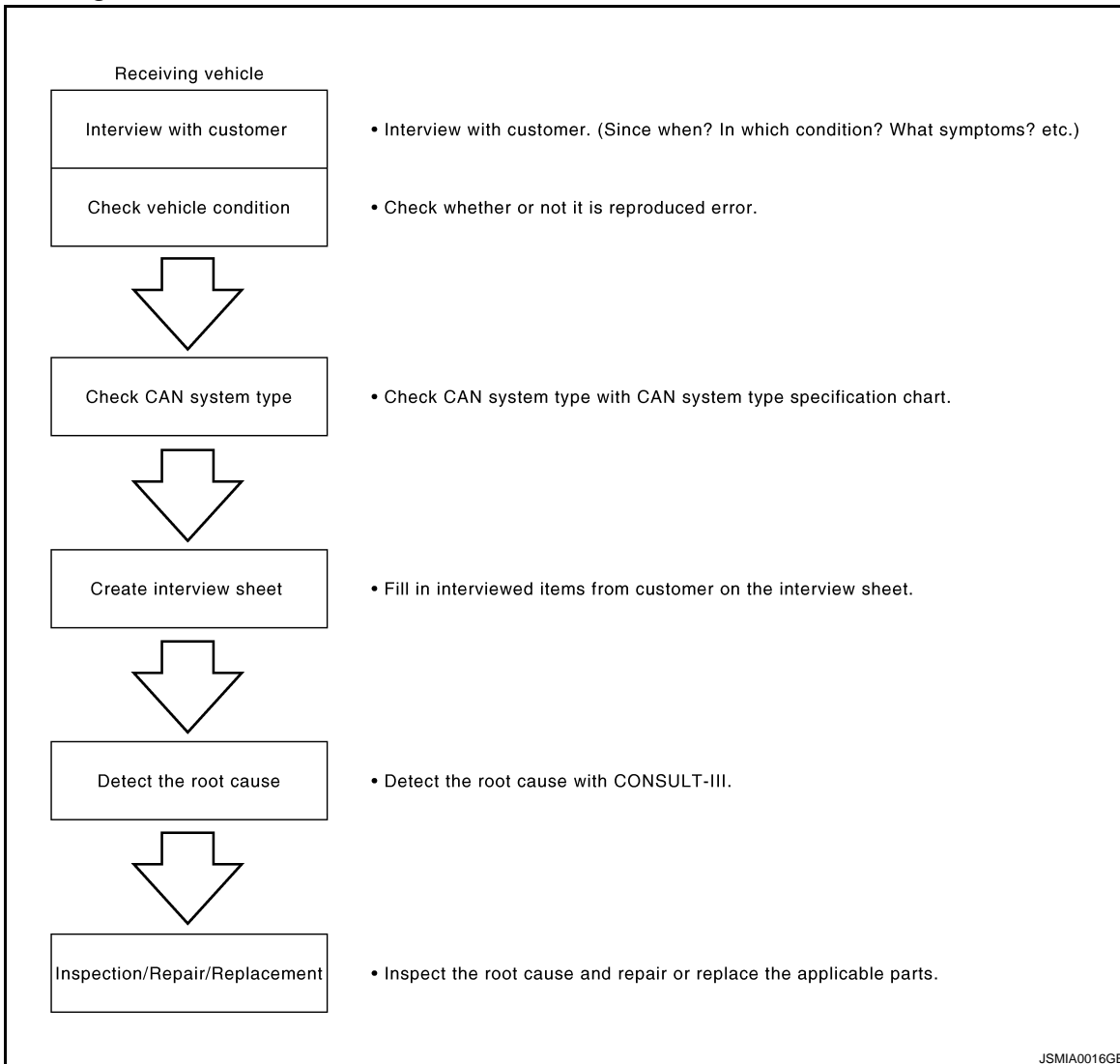

Trouble Diagnosis Procedure

INFOID:000000005622683

INTERVIEW WITH CUSTOMER

Interview with the customer is important to detect the root cause of CAN communication system errors and to understand vehicle condition and symptoms for proper trouble diagnosis.

Points in interview

- What: Parts name, system name
- When: Date, Frequency
- Where: Road condition, Place
- In what condition: Driving condition/environment
- Result: Symptom

NOTE:

- Check normal units as well as error symptoms.
- Example: Circuit between ECM and the combination meter is judged normal if the customer indicates tachometer functions normally.
- When a CAN communication system error is present, multiple control units may malfunction or go into fail-safe mode.

A
B
C
D
E
F
G
H
I
J
K
L

LAN

N
O
P

DIAGNOSIS AND REPAIR WORKFLOW

< BASIC INSPECTION >

[CAN FUNDAMENTAL]

- Indication of the combination meter is important to detect the root cause because it is the most obvious to the customer, and it performs CAN communication with many units.

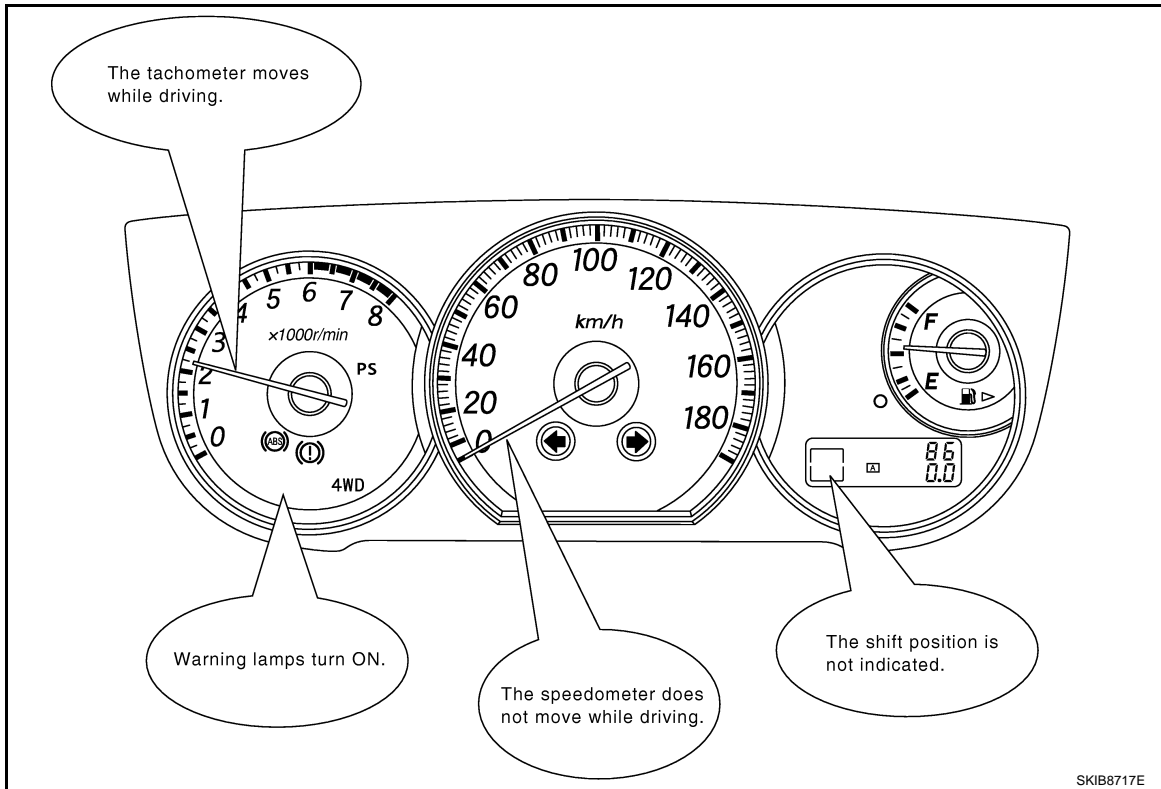

INSPECTION OF VEHICLE CONDITION

Check whether the symptom is reproduced or not.

NOTE:

Do not turn the ignition switch OFF or disconnect the battery cable while reproducing the error. The error may temporarily correct itself, making it difficult to determine the root cause.

CHECK OF CAN SYSTEM TYPE (HOW TO USE CAN SYSTEM TYPE SPECIFICATION CHART)

Determine CAN system type based on vehicle equipment.

NOTE:

- This chart is used if CONSULT-III does not automatically recognize CAN system type.
- There are two styles for CAN system type specification charts. Depending on the number of available system types, either style A or style B may be used.

CAN System Type Specification Chart (Style A)

NOTE:

DIAGNOSIS AND REPAIR WORKFLOW

< BASIC INSPECTION >

[CAN FUNDAMENTAL]

CAN system type is easily checked with the vehicle equipment identification information shown in the chart.

Example:
Vehicle is equipped as follows: Wagon, AWD, VQ35DE, CVT, VDC, and Intelligent Key system. (○ shows an example of CAN system type.)

CAN System Specification Chart
Determine CAN system type from the following specification chart.

Body type	Wagon					
Axle	2WD			AWD		
Engine	QR25DE		VQ35DE			
Transmission	A/T			CVT		
Brake control	ABS			VDC		
Intelligent Key system		X		X		X
CAN system type	1	2	3	4	5	6
CAN communication signal chart	XX-XX. "TYPE 1/TYPE 2"		XX-XX. "TYPE 3/TYPE 4"		XX-XX. "TYPE 5/TYPE 6"	

X : Applicable

VEHICLE EQUIPMENT IDENTIFICATION INFORMATION
NOTE:
Check CAN system type from the vehicle shape and equipment.

With VDC

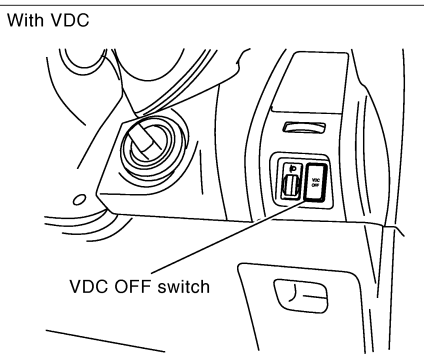

VDC OFF switch

With Intelligent Key system

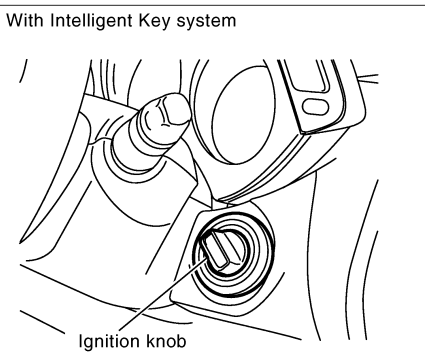

Ignition knob

[For the above case, CAN system type is "6".]

JSMIA0017GB

A
B
C
D
E
F
G
H
I
J
K
L

CAN System Type Specification Chart (Style B)
NOTE:

LAN

N
O
P

DIAGNOSIS AND REPAIR WORKFLOW

< BASIC INSPECTION >

[CAN FUNDAMENTAL]

CAN system type is easily checked with the vehicle equipment identification information shown in the chart.

Example:

Vehicle is equipped as follows: Sedan, 2WD, MR20DE, CVT, ABS, Active AFS, Intelligent Key system, Navigation system and Automatic drive positioner. (○ shows an example of CAN system type.)

CAN System Specification Chart

Refer to the specification as shown in the chart.

Body type	Sedan		
Axle	2WD		AWD
Engine	HR15DE	MR20DE	HR15DE
Transmission	AT	CVT	AT
Brake control	ABS		
Specification chart	XXX SPECIFICATION CHART A	YYY SPECIFICATION CHART B	XXX SPECIFICATION CHART C

Check the vehicle equipment with the vehicle identification number plate.

Check the vehicle equipment.

Select the applicable vehicle equipment. Refer to the specification chart.

x: Applicable

SPECIFICATION CHART B

Determine CAN system type from the following specification chart.

Body type	Sedan											
Axle	2WD											
Engine	MR20DE											
Transmission	CVT											
Brake control	ABS											
Active AFS	x			x	x			x	x	x		
Intelligent Key system		x		x		x	x	x	x	x		
Navigation system			x			x	x		x	x		
Automatic drive positioner								x	x	x		
CAN system type	9	10	11	12	13	14	15	16	17	18	19	20
CAN communication signal chart	XXX SPECIFICATION CHART A											

Check the vehicle equipment.

The number indicates the CAN system type of the vehicle.

x: Applicable

VEHICLE EQUIPMENT IDENTIFICATION INFORMATION

NOTE:

Check CAN system type from the vehicle shape and equipment.

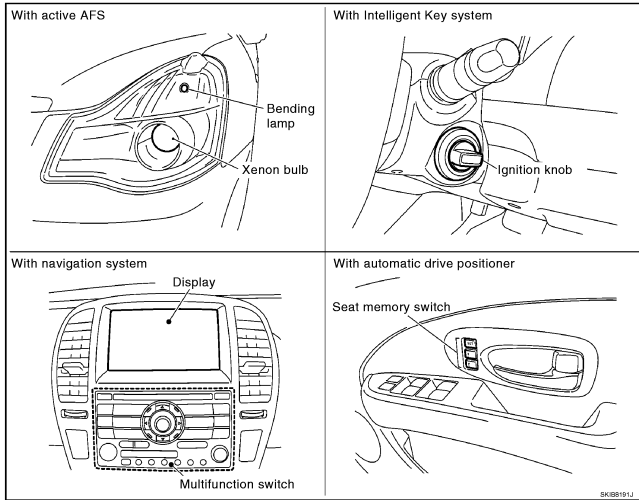

In the above example,

- Checking Xenon bulb and bending lamp lead to judge whether or not Active AFS is equipped.
- Checking the ignition knob leads to judge whether or not Intelligent Key system is equipped.
- Checking display and multifunction switch lead to judge whether or not Navigation system is equipped.
- Checking seat memory switch leads to judge whether or not Automatic drive positioner is equipped.

[For the above case, CAN system type is "20".]

JSMIA0018GB

CREATE INTERVIEW SHEET

Fill out the symptom described by the customer, vehicle condition, and CAN system type on the interview sheet.

DIAGNOSIS AND REPAIR WORKFLOW

< BASIC INSPECTION >

[CAN FUNDAMENTAL]

Interview Sheet (Example)

CAN Communication System Diagnosis Interview Sheet	
Date received:	3, Feb. 2006
Type: DBA-KG11	VIN No.: KG11-005040
Model: BDRARGZ397EDA-E-J-	
First registration: 10, Jan. 2001	Mileage: 62,140
CAN system type: Type 19	
Symptom (Results from interview with customer)	
<ul style="list-style-type: none">• Headlamps suddenly turn ON while driving the vehicle.• The engine does not restart after stopping the vehicle and turning the ignition switch OFF.• The cooling fan continues rotating while turning the ignition switch ON.	
Condition at inspection	
Error Symptom: Present / Past	
<p>The engine does not start. While turning the ignition switch ON,</p> <ul style="list-style-type: none">• The headlamps (Lo) turn ON, and the cooling fan continues rotating.• The interior lamp does not turn ON.	
<small>JSMIA0019GB</small>	

DETECT THE ROOT CAUSE

CAN diagnosis function of CONSULT-III detects the root cause.

A
B
C
D
E
F
G
H
I
J
K
L
N
O
P

LAN

HOW TO USE THIS MANUAL

HOW TO USE THIS SECTION

Caution

INFOID:000000005622684

- This section describes information peculiar to a vehicle and inspection procedures.
- For trouble diagnosis procedure, refer to [LAN-19, "Trouble Diagnosis Procedure"](#).

Abbreviation List

INFOID:000000005622685

Unit name abbreviations in CONSULT-III CAN diagnosis and in this section are as per the following list.

Abbreviation	Unit name
4WD	AWD control unit
A-BAG	Air bag diagnosis sensor unit
ABS	ABS actuator and electric unit (control unit)
ADP	Driver seat control unit
AV	AV control unit
BCM	BCM
DLC	Data link connector
ECM	ECM
ICC	ICC sensor integrated unit
IPDM-E	IPDM E/R
M&A	Unified meter and A/C amp.
PSB	Pre-crash seat belt control unit
RAS	4WAS main control unit
STRG	Steering angle sensor
TCM	TCM

PRECAUTION

PRECAUTIONS

Precaution for Supplemental Restraint System (SRS) "AIR BAG" and "SEAT BELT PRE-TENSIONER"

INFOID:000000005622686

The Supplemental Restraint System such as "AIR BAG" and "SEAT BELT PRE-TENSIONER", used along with a front seat belt, helps to reduce the risk or severity of injury to the driver and front passenger for certain types of collision. This system includes seat belt switch inputs and dual stage front air bag modules. The SRS system uses the seat belt switches to determine the front air bag deployment, and may only deploy one front air bag, depending on the severity of a collision and whether the front occupants are belted or unbelted. Information necessary to service the system safely is included in the "SRS AIR BAG" and "SEAT BELT" of this Service Manual.

WARNING:

- To avoid rendering the SRS inoperative, which could increase the risk of personal injury or death in the event of a collision which would result in air bag inflation, all maintenance must be performed by an authorized NISSAN/INFINITI dealer.
- Improper maintenance, including incorrect removal and installation of the SRS, can lead to personal injury caused by unintentional activation of the system. For removal of Spiral Cable and Air Bag Module, see the "SRS AIR BAG".
- Do not use electrical test equipment on any circuit related to the SRS unless instructed to in this Service Manual. SRS wiring harnesses can be identified by yellow and/or orange harnesses or harness connectors.

PRECAUTIONS WHEN USING POWER TOOLS (AIR OR ELECTRIC) AND HAMMERS

WARNING:

- When working near the Air Bag Diagnosis Sensor Unit or other Air Bag System sensors with the ignition ON or engine running, DO NOT use air or electric power tools or strike near the sensor(s) with a hammer. Heavy vibration could activate the sensor(s) and deploy the air bag(s), possibly causing serious injury.
- When using air or electric power tools or hammers, always switch the ignition OFF, disconnect the battery, and wait at least 3 minutes before performing any service.

Precautions for Trouble Diagnosis

INFOID:000000005622687

CAUTION:

- Never apply 7.0 V or more to the measurement terminal.
- Use a tester with open terminal voltage of 7.0 V or less.
- Turn the ignition switch OFF and disconnect the battery cable from the negative terminal when checking the harness.

Precautions for Harness Repair

INFOID:000000005622688

- Solder the repaired area and wrap tape around the soldered area.

NOTE:

A fray of twisted lines must be within 110 mm (4.33 in).

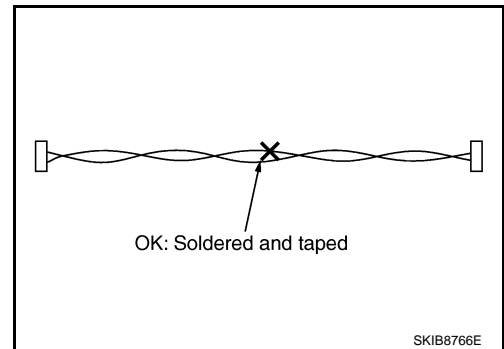

A
B
C
D
E
F
G
H
I
J
K
L
LAN
N
O
P

PRECAUTIONS

< PRECAUTION >

[CAN]

- Bypass connection is never allowed at the repaired area.

NOTE:

Bypass connection may cause CAN communication error. The spliced wire becomes separated and the characteristics of twisted line are lost.

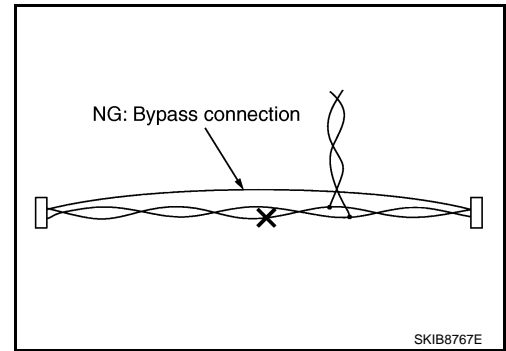

- Replace the applicable harness as an assembly if error is detected on the shield lines of CAN communication line.

DIAGNOSIS AND REPAIR WORKFLOW

< BASIC INSPECTION >

[CAN]

BASIC INSPECTION

DIAGNOSIS AND REPAIR WORKFLOW

Interview Sheet

INFOID:0000000005622689

CAN Communication System Diagnosis Interview Sheet	
Date received: <input type="text"/>	
Type: <input type="text"/>	VIN No.: <input type="text"/>
Model: <input type="text"/>	
First registration: <input type="text"/>	Mileage: <input type="text"/>
CAN system type: <input type="text"/>	
Symptom (Results from interview with customer)	
<input type="text"/>	
Condition at inspection	
Error symptom : Present / Past	
<input type="text"/>	

SKIB8898E

A
B
C
D
E
F
G
H
I
J
K
L
LAN
N
O
P

CAN COMMUNICATION SYSTEM

[CAN]

< SYSTEM DESCRIPTION >

SYSTEM DESCRIPTION

CAN COMMUNICATION SYSTEM

CAN System Specification Chart

INFOID:000000005622690

Determine CAN system type from the following specification chart.

NOTE:

Refer to [LAN-19. "Trouble Diagnosis Procedure"](#) for how to use CAN system specification chart.

Body type	Sedan												
Axle	2WD										AWD		
Engine	VQ37VHR												
Transmission	M/T						A/T						
Brake control	VDC												
Automatic drive positioner	×	×	×	×		×	×	×	×		×	×	
4WAS		×		×			×		×				
ICC system			×	×				×	×			×	
CAN system type	1	3	4	5	6	7	8	9	10	11	12	13	

×: Applicable

VEHICLE EQUIPMENT IDENTIFICATION INFORMATION

NOTE:

Check CAN system type from the vehicle shape and equipment.

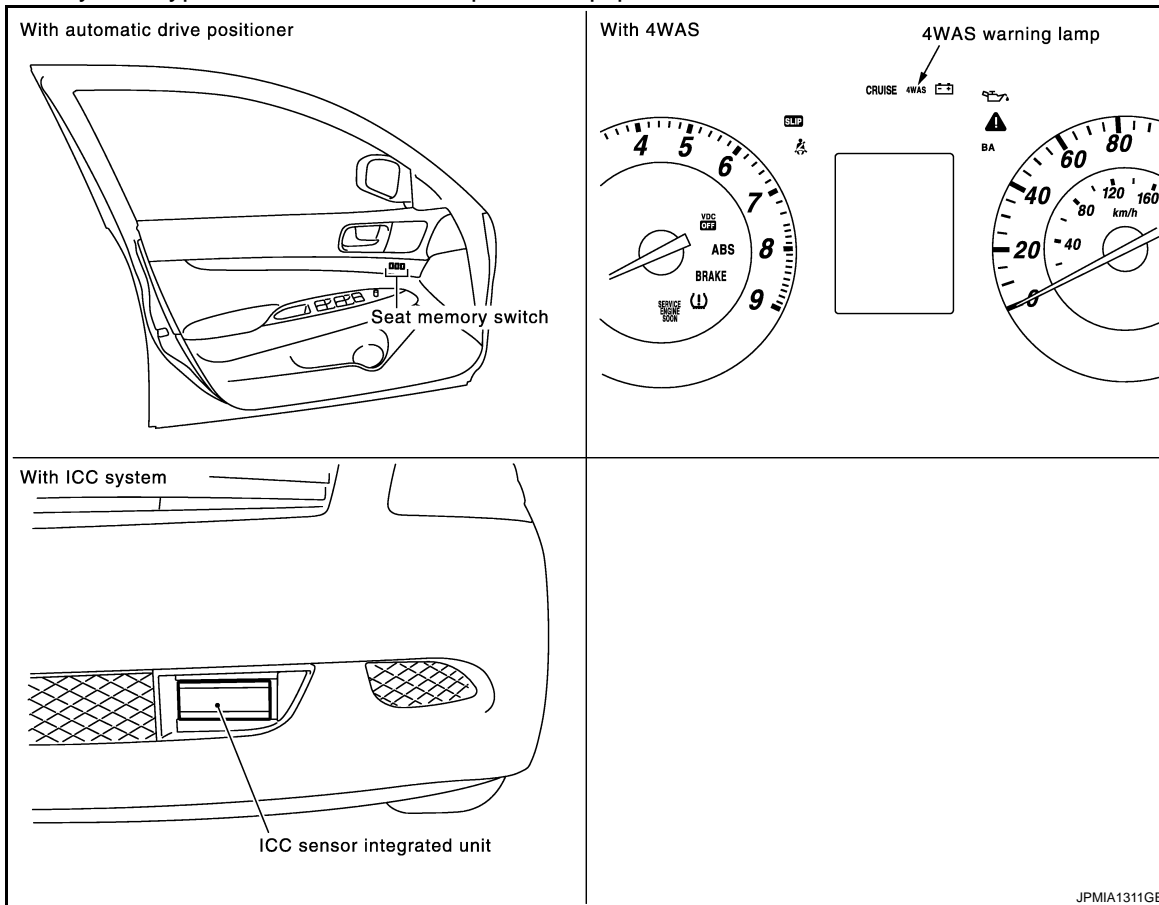

JPMIA1311GB

CAN Communication Signal Chart

INFOID:000000005622691

Refer to [LAN-18. "How to Use CAN Communication Signal Chart"](#) for how to use CAN communication signal chart.

CAN COMMUNICATION SYSTEM

[CAN]

< SYSTEM DESCRIPTION >

NOTE:

Refer to [LAN-24, "Abbreviation List"](#) for the abbreviations of the connecting units.

T: Transmit R: Receive

Signal name/Connecting unit	ECM	4WD	AV	BCM	PSB	TCM	M&A	STRG	ADP	RAS	ABS	ICC	IPDM-E
A/C compressor request signal	T												R
Accelerator pedal position signal	T	R				R					R	R	
ASCD OD cancel request signal	T					R							
ASCD operation signal	T					R							
ASCD status signal	T						R						
ASCD SET indicator signal	T						R						
Closed throttle position signal	T					R						R	
Cooling fan speed request signal	T												R
Engine and A/T integrated control signal	T					R							
	R					T							
Engine coolant temperature signal	T						R						
Engine speed signal	T	R				R	R			R	R	R	
Engine status signal	T		R	R									
Fuel consumption monitor signal	T		R				R						
ICC brake switch signal	T											R	
ICC prohibition signal	T											R	
ICC steering switch signal	T											R	
Malfunctioning indicator lamp signal	T						R						
Park/neutral position switch signal*1	T											R	
Power generation command value signal	T												R
Snow mode switch signal	T										R	R	
	R						T						
Stop lamp switch signal	T											R	
		R									T	R	
				T		R							
Wide open throttle position signal	T					R							
AWD signal		T									R		
AWD warning lamp signal		T					R						
A/C switch/indicator signal			T				R						
			R				T						
A/C switch operation signal			T				R						
Rear window defogger switch signal			T	R									
System setting signal			T	R									
			R	T									
Voice recognition signal*2			T				R						
Buzzer output signal				T			R						
							R					T	
Door switch signal				T			R		R				R
Door unlock signal				T					R				
Front fog light request signal				T			R						R

A
B
C
D
E
F
G
H
I
J
K
L
N
O
P

LAN

CAN COMMUNICATION SYSTEM

< SYSTEM DESCRIPTION >

[CAN]

Signal name/Connecting unit	ECM	4WD	AV	BCM	PSB	TCM	M&A	STRG	ADP	RAS	ABS	ICC	IPDM-E
Front wiper request signal				T								R	R
High beam request signal				T			R						R
Horn reminder signal				T									R
Ignition switch ON signal				T									R
				R									T
Ignition switch signal				T					R				
Interlock/PNP switch signal				T									R
				R									T
Key ID signal				T					R				
Key switch signal				T					R				
Key warning lamp signal				T			R						
Low beam request signal				T									R
Low tire pressure warning lamp signal				T			R						
Meter display signal				T			R						
							R					T	
Oil pressure switch signal				T			R						
				R									T
Position light request signal				T			R						R
Rear window defogger control signal				T									R
	R		R	R									T
Sleep wake up signal				T			R		R				R
Starter control relay signal				T									R
Starter relay status signal				R									T
				T									R
Starting mode signal				T					R				
Steering lock relay signal				R									T
				T									R
Theft warning horn request signal				T									R
Trunk switch signal				T			R						
Turn indicator signal				T			R						
A/T CHECK indicator lamp signal						T	R						
A/T self-diagnosis signal	R					T							
Current gear position signal						T					R	R	
Input speed signal	R					T						R	
Manual mode indicator signal						T	R						
N range signal				R		T							
Output shaft revolution signal	R					T						R	
P range signal				R		T					R		
Shift position signal					R ³	T	R		R		R	R	
A/C evaporator temperature signal	R						T						
A/C switch signal	R						T						
Blower fan motor switch signal	R						T						
Distance to empty signal			R				T						

CAN COMMUNICATION SYSTEM

< SYSTEM DESCRIPTION >

[CAN]

Signal name/Connecting unit	ECM	4WD	AV	BCM	PSB	TCM	M&A	STRG	ADP	RAS	ABS	ICC	IPDM-E
Fuel level low warning signal			R				T						
Fuel level sensor signal	R						T						
Manual mode shift down signal						R	T						
Manual mode shift up signal						R	T						
Manual mode signal						R	T						
Non-manual mode signal						R	T						
Odometer signal				R			T						
Paddle shifter shift down signal*4						R	T						
Paddle shifter shift up signal*4						R	T						
Parking brake switch signal		R		R			T						
Seat belt buckle switch signal				R			T						
Sleep-ready signal				R			T						T
Target A/C evaporator temperature signal	R						T						
Vehicle speed signal	R		R	R	R	R	T		R				R
Wake up signal		R		R			R			R	T	R	
Steering angle sensor signal			R					T		R	R		
4WAS signal										T	R		
4WAS warning lamp signal							R			T			
A/T shift schedule change demand signal						R					T		
ABS malfunction signal											T	R	
ABS operation signal						R					T	R	
ABS warning lamp signal							R				T		
Brake pressure control signal											T	R	
Brake warning lamp signal							R				T		
Side G sensor signal						R					T		
SLIP indicator lamp signal							R				T		
TCS gear keep request signal						R					T		
TCS malfunction signal											T	R	
TCS operation signal											T	R	
VDC malfunction signal						R					T	R	
VDC OFF indicator lamp signal							R				T		
VDC OFF switch signal											T	R	
VDC operation signal											T	R	
Deceleration degree commandment value signal											R	T	
ICC operation signal	R											T	
ICC warning lamp signal							R					T	
A/C compressor feedback signal	R						R						T
Detention switch signal				R					R				T
Front wiper stop position signal				R									T
High beam status signal	R												T

A
B
C
D
E
F
G
H
I
J
K
L
LAN
N
O
P

CAN COMMUNICATION SYSTEM

< SYSTEM DESCRIPTION >

[CAN]

Signal name/Connecting unit	ECM	4WD	AV	BCM	PSB	TCM	M&A	STRG	ADP	RAS	ABS	ICC	IPDM-E
Hood switch signal				R									T
Low beam status signal	R												T
Push-button ignition switch status signal				R									T
Steering lock unit status signal				R									T

*1: M/T models only

*2: Models with navigation system

*3: Receive reverse position signal only

*4: Models with paddle shifter

NOTE:

CAN data of the air bag diagnosis sensor unit is not used by usual service work, thus it is omitted.

DTC/CIRCUIT DIAGNOSIS

CAN COMMUNICATION SYSTEM

Component Parts Location

INFOID:000000005622692

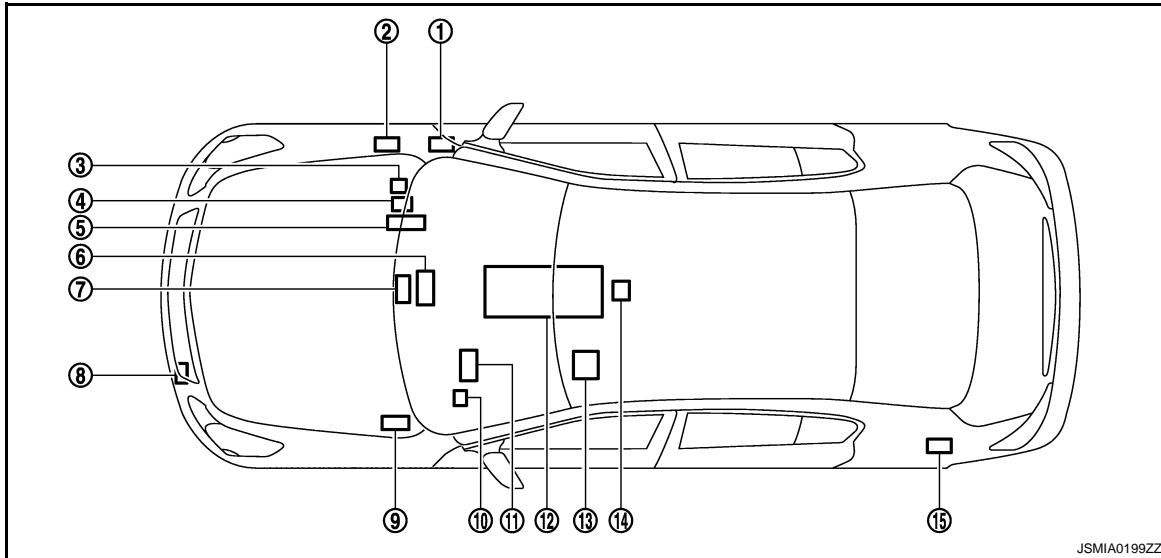

- | | | |
|--|---|--|
| <p>1. BCM M122</p> <p>4. AWD control unit F108</p>
<p>7. Unified meter and A/C amp. M67</p> <p>10. Data link connector M24</p> <p>13. Driver seat control unit B451</p> | <p>2. IPDM E/R E6</p> <p>5. ECM M107</p>
<p>8. ICC sensor integrated unit E67</p> <p>11. Steering angle sensor M37</p> <p>14. Air bag diagnosis sensor unit M147</p> | <p>3. Pre-crash seat belt control unit M110</p> <p>6. AV control unit
M85: Without navigation system
(Without rear view monitor)
M204: Without navigation system
(With rear view monitor)
M210: With navigation system</p> <p>9. ABS actuator and electric unit (control unit) E41</p> <p>12. A/T assembly F51</p> <p>15. 4WAS main control unit B54</p> |
|--|---|--|

A
B
C
D
E
F
G
H
I
J
K
L

LAN

CAN COMMUNICATION SYSTEM

[CAN]

< DTC/CIRCUIT DIAGNOSIS >

Wiring Diagram - CAN SYSTEM -

INFOID:000000005622693

CAN SYSTEM

- <A> : With A/T
- <AW> : AWD models
- <NV> : With NAVI
- <ON> : Without NAVI
- <FM> : With rear view monitor
- <OM> : Without rear view monitor
- <PC> : With pre-crash seat belt
- *1 86 : <OM>
- 81 : <RM>
- *2 87 : <OM>
- 80 : <RM>

* : This connector is not shown in "Harness Layout".

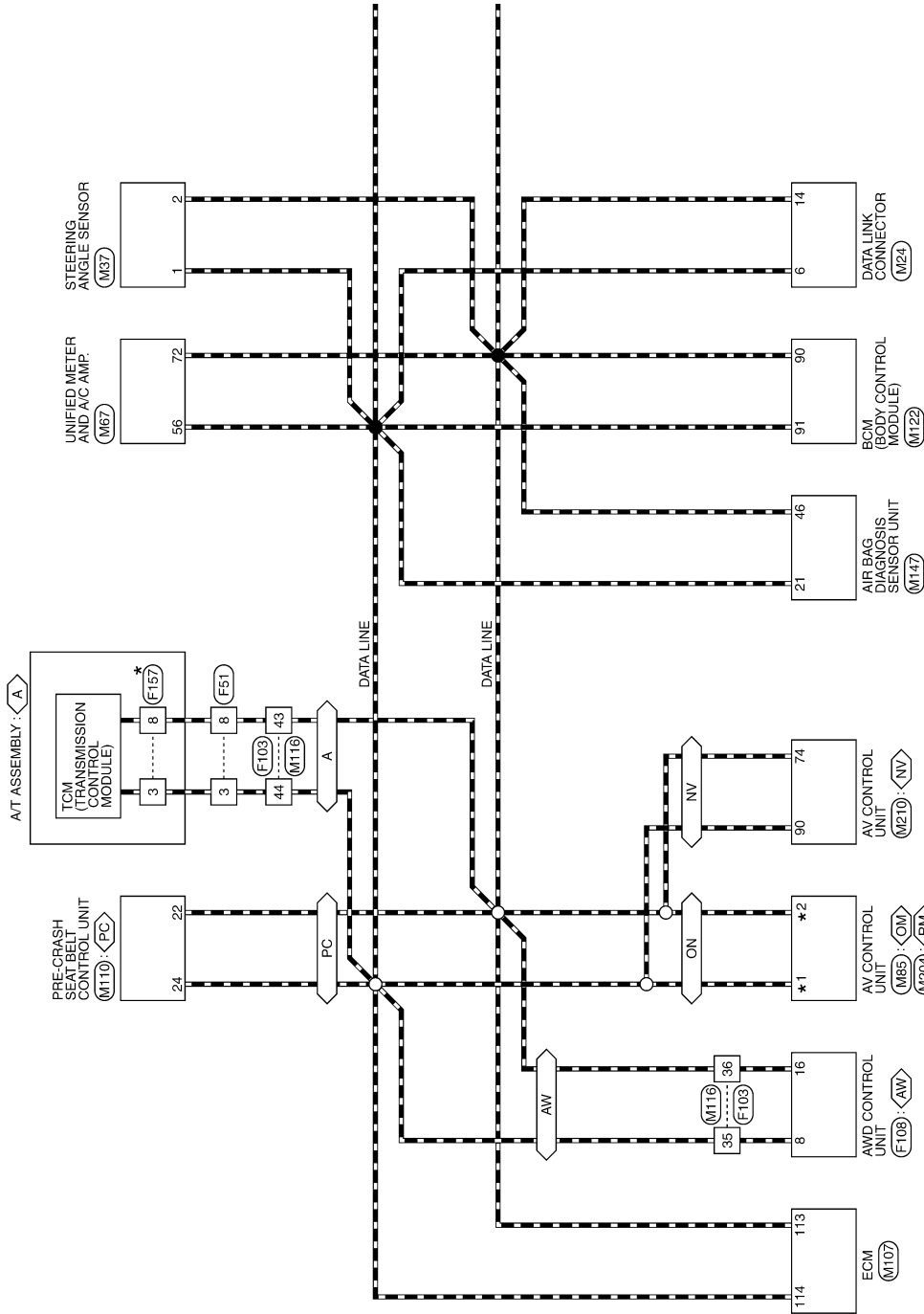

2009/10/30

JCMWM5784G

CAN COMMUNICATION SYSTEM

< DTC/CIRCUIT DIAGNOSIS >

[CAN]

- ◁ FM ▷ : With automatic drive positioner
- ◁ AS ▷ : With 4WAS
- ◁ PA ▷ : With automatic drive positioner or 4WAS
- ◁ AP ▷ : Without automatic drive positioner and 4WAS
- ◁ IC ▷ : With ICC

*: This connector is not shown in "Harness Layout".

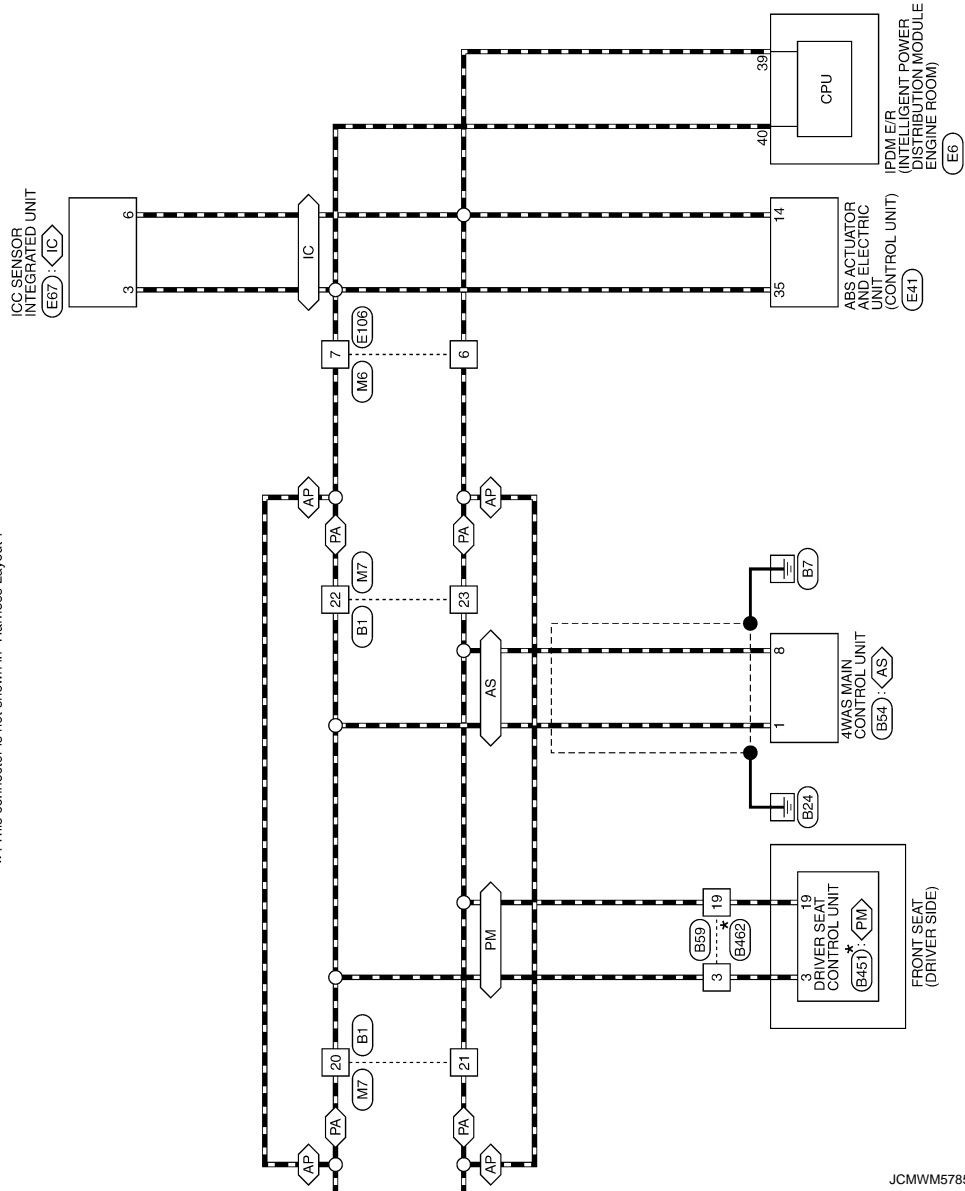

JCMWM5785G1

A
B
C
D
E
F
G
H
I
J
K
L
N
O
P

LAN

CAN COMMUNICATION SYSTEM

< DTC/CIRCUIT DIAGNOSIS >

[CAN]

CAN SYSTEM

Connector No.	B1
Connector Name	WIRE TO WIRE
Connector Type	TH80FW-CS16-TM4



Terminal No.	Color of Wire	Signal Name [Specification]
1	GR	
2	BG	
3	L	
4	Y	
6	R	
8	W	
9	V	
15	Y	
16	BR	
17	LG	
18	BG	
20	L	
21	P	
22	L	
23	P	
24	V	
25	SB	
26	G	
28	R	
31	V	
32	SB	
33	SHIELD	
34	W	
35	BR	
36	Y	
37	SHIELD	
38	Y	
39	SB	
40	P	
41	L	
42	SHIELD	
43	R	
44	G	
45	SHIELD	
46	SB	
55	BR	
56	R	

58	V	
59	SR	
60	BR	
61	W	
62	R	
63	L	
64	Y	
65	SHIELD	
71	BG	
72	GR	
73	P	
74	L	
81	V	
82	B	
84	Y	
85	G	
86	W	
87	R	
88	BR	
89	Y	
90	SB	
91	BG	
92	BR	
93	P	
95	BG	
96	Y	
100	GR	

Connector No.	B54
Connector Name	4MS MAIN CONTROL UNIT
Connector Type	A36FW-MA

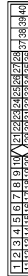

Terminal No.	Color of Wire	Signal Name [Specification]
1	L	CAN-H
4	Y	R-ANG MAIN SIG
5	W	R-ANG YCC
7	R	R-ANG SUB SIG
8	P	CAN-L
15	G	R-ANG GND
22	GR	STOP/L SW
25	SR	R-MTR RLY
27	G	IGN

31	BR	BUS-H
32	Y	BUS-L
34	B	GND
36	LG	P/S SOL
37	P	R-MTR PWR SUPPLY
38	R	R-MTR (RH)
39	G	R-MTR (LH)
40	B	R-MTR GND

Connector No.	B59
Connector Name	WIRE TO WIRE
Connector Type	NS16FW-CS



Terminal No.	Color of Wire	Signal Name [Specification]
1	BG	
3	L	
8	Y	
17	LG	
19	P	
21	Y	
32	B	
33	L	
40	BR	
48	B	
67	BG	
68	GR	
69	R	

Connector No.	B451
Connector Name	DRIVER SEAT CONTROL UNIT
Connector Type	TH52FW



Terminal No.	Color of Wire	Signal Name [Specification]
1	L/W	RX
3	R/Y	CAN-H
8	LG	PARKING BRAKE SW
9	W/G	PULSE (RECLINING)
10	P/B	PULSE (RR LIFTING)
11	BR	SLIDING SW (BACKWARD)
12	SB	RECLINING SW (BACKWARD)
13	LG/R	FRONT LIFTING SW (DOWNWARD)
14	G/B	REAR LIFTING SW (DOWNWARD)
16	O	VCC
17	Y/R	TX
19	V	CAN-L
21	L/Y	P RANGE SW
24	R	PULSE (SLIDING)
25	Y/B	PULSE (FR LIFTING)
26	Y	SLIDING SW (FORWARD)
27	R/G	RECLINING SW (FORWARD)
28	W/B	FRONT LIFTING SW (UPWARD)
29	P/L	REAR LIFTING SW (UPWARD)
31	GR	SENSOR GND
32	B/W	GND (SIGNAL)

Connector No.	B462
Connector Name	WIRE TO WIRE
Connector Type	NS16MW-LC



Terminal No.	Color of Wire	Signal Name [Specification]
1	L/W	
3	R/Y	
8	LG	
17	Y/R	
19	V	
21	L/Y	
32	B/W	
33	R	
40	R/W	
48	B	
67	R	
68	L	
69	BR/W	

CAN COMMUNICATION SYSTEM

< DTC/CIRCUIT DIAGNOSIS >

[CAN]

CAN SYSTEM

Connector No.	E6
Connector Name	SWAY L INTELLIGENT POWER DISTRIBUTION MODULE ENGINE ROOM
Connector Type	TH80FW-NH

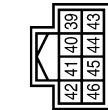

Terminal No.	Color of Wire	Signal Name [Specification]
39	P	-
40	L	-
41	B/W	-
42	GR	-
43	G	-
44	LG	-
45	V	-
46	SB	-

Connector No.	E41
Connector Name	ABS ACTUATOR AND ELECTRIC UNIT (CONTROL UNIT)
Connector Type	BAA42FE-AH24-LH

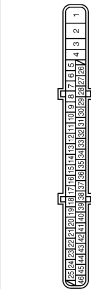

Terminal No.	Color of Wire	Signal Name [Specification]
1	B	GND
2	GR	UBVR
3	BG	UBVR
4	B	GND
5	Y	DS FL
6	BG	DP RL
7	BR	DP RR
9	B	DP FR
10	W	DS FR
11	V	DIAG-K
14	P	CAN-L
25	Y	BUS-L
26	LG	DP FL
27	GR	DS RL

28	G	UZ
29	P	DS PR
30	SB	BLS
31	R	VDC OFF SW
35	L	CAN-H
45	B	BUS-H

Connector No.	E67
Connector Name	ICC SENSOR INTEGRATED UNIT
Connector Type	RS00FE-PR



Terminal No.	Color of Wire	Signal Name [Specification]
1	Y	IGNITION
2	SB	BRAKE HOLD RLY DRIVE SIGNAL
3	L	CAN-H
4	B	GND
6	P	CAN-L

Connector No.	E108
Connector Name	WIRE TO WIRE
Connector Type	TH80FW-CS16-TM4

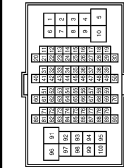

Terminal No.	Color of Wire	Signal Name [Specification]
1	V	-
2	SB	-
3	BG	-
5	W	-
6	P	-
7	L	-
11	V	-
12	P	-
13	R	-

Connector No.	E61
Connector Name	A/T ASSEMBLY
Connector Type	PK10FG-DGY

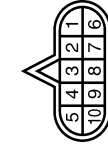

Terminal No.	Color of Wire	Signal Name [Specification]
1	Y	-
2	R	-
3	L	-
4	V	-
5	B	-
6	G	-
7	R	-
8	P	-
9	GR	-
10	B	-

14	W	-
15	L	-
16	GR	-
17	SB	-
18	LG	-
29	G	-
31	L	-
32	BG	-
33	P	-
34	V	-
35	W	-
36	BG	-
37	G	-
38	R	-
40	R	-
41	LG	-
42	SB	-
43	G	-
44	LG	-
45	GR	-
46	BR	-
47	B	-
48	Y	-
49	V	-
50	R	-
51	SB	-
52	P	-
53	G	-
54	B	-
57	GR	-
59	V	-
80	R	-
81	P	-
82	G	-
83	V	-
84	L	-
85	W	-
86	GR	-
87	LG	-
88	L	-
89	BR	-
91	W	-
92	LG	-
93	GR	-
94	SB	-
95	GR	-
96	R	-
97	Y	-
98	SHIELD	-
99	L	-
100	P	-

A
B
C
D
E
F
G
H
I
J
K
L
N
O
P

LAN

CAN COMMUNICATION SYSTEM

< DTC/CIRCUIT DIAGNOSIS >

[CAN]

CAN SYSTEM

Connector No.	F103
Connector Name	WIRE TO WIRE
Connector Type	TH16FW-NS10

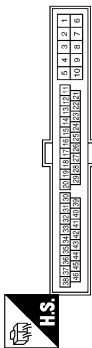

Terminal No.	Color of Wire	Signal Name [Specification]
1	G	
2	G	
3	W	
4	R	
5	B	
6	Y	
7	Y	
8	GR	
9	O	
10	Y	
11	O	
12	Y	
13	B	
14	LG	
15	R	
16	R	
17	R	
18	B	
19	B	
20	Y	
21	B	
22	LG	
23	R	
24	R	
25	R	
26	B	
27	Y	
28	Y	
29	G	
30	O	
31	BR	
32	P	
33	G	
34	O	
35	BR	
36	P	
37	Y	
38	G	
39	G	
40	O	
41	O	
42	BR	
43	P	
44	L	
45	G	
46	V	

Connector No.	F108
Connector Name	AWD CONTROL UNIT
Connector Type	TH16FW-NH

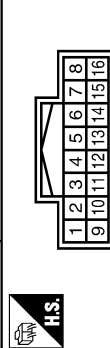

Terminal No.	Color of Wire	Signal Name [Specification]
1	BR	AMD SOL (+)
2	Y	AMD SOL (-)
3	W	OIL TEMP (-)
4	G	IGN
5	L	CAN-H
6	O	AMD SOL BAT
7	B	GND
8	B	GND
9	B	OIL TEMP (-)
10	Y	VB
11	P	CAN-L

Connector No.	F157
Connector Name	TGM (TRANSMISSION CONTROL MODULE)
Connector Type	SP10FG

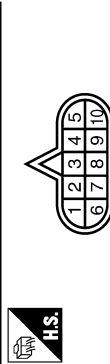

Terminal No.	Color of Wire	Signal Name [Specification]
1	W	VIGN
2	B	BATT
3	R	CAN-H
4	O	K-LINE
5	G	GND
6	GR	VIGN
7	L	REV LAMP RLY
8	BR	CAN-L
9	W/B	STARTER RLY
10	GND	

Connector No.	M6
Connector Name	WIRE TO WIRE
Connector Type	TH16MW-CS16-TM4

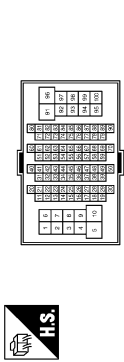

Terminal No.	Color of Wire	Signal Name [Specification]
1	W	
2	GR	
3	R	
4	Y	
5	W	
6	P	
7	L	
8	V	
9	P	
10	R	
11	W	
12	L	
13	W	
14	L	
15	L	
16	GR	
17	BR	
18	L	
19	G	
20	L	
21	Y	
22	Y	
23	BG	
24	W	
25	BR	
26	BR	
27	P	
28	P	
29	G	
30	V	
31	LG	
32	R	
33	G	
34	G	
35	B	
36	R	
37	BG	
38	SB	
39	Y	
40	L	
41	R	
42	W	
43	G	
44		
45		
46		
47		
48		
49		
50		
51		
52		
53		

54	B	
57	B	
58	LG	
60	SS	
81	B	
82	V	
83	W	
84	L	
85	GR	
86	Y	
87	G	
88	G	
89	R	
91	W	
92	Y	
93	BG	
94	L	
95	Y	
96	R	
97	LG	
98	SHIELD	
99	V	
100	SB	

CAN COMMUNICATION SYSTEM

< DTC/CIRCUIT DIAGNOSIS >

[CAN]

CAN SYSTEM

Connector No.	M7
Connector Name	WIRE TO WIRE
Connector Type	TH80MW-CS-E-TM4

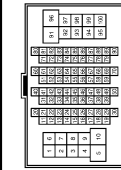

Terminal No.	Color of Wire	Signal Name [Specification]
1	GR	-
2	P	-
3	SB	- [With automatic drive positioner]
4	Y	- [Without automatic drive positioner]
6	L	-
8	G	-
9	Y	-
15	R	-
16	BR	-
17	P	-
18	V	-
20	L	-
21	P	-
22	L	-
23	P	-
24	V	-
25	LG	-
26	BR	-
27	BG	-
28	LG	-
31	V	-
32	LG	-
33	SHIELD	-
34	GR	-
35	BR	-
36	Y	-
37	SHIELD	-
38	SB	-
39	LG	-
40	O	-
41	W	-
42	SHIELD	-
43	R	-
44	G	-
45	SHIELD	-
46	SB	-
55	W	-

16	R	-
----	---	---



Connector No.	M37
Connector Name	STEERING ANGLE SENSOR
Connector Type	TH108FW-NH

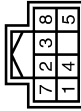

Terminal No.	Color of Wire	Signal Name [Specification]
1	L	CAN-H
2	P	CAN-L
7	B	GND
8	G	IGN

Connector No.	M67
Connector Name	UNIFIED METER AND A/C AMP.
Connector Type	TH192FW-NH



Terminal No.	Color of Wire	Signal Name [Specification]
41	L	ACC POWER SUPPLY
42	BR	FUEL LEVEL SENSOR SIGNAL
43	BR	INTAKE SENSOR SIGNAL
44	LG	IN-VEHICLE SENSOR SIGNAL
45	V	AMBIENT SENSOR SIGNAL
46	Y	SUNLOAD SENSOR SIGNAL
47	G	GAS SENSOR SIGNAL
53	W	IGNITION POWER SUPPLY
54	SB	BATTERY POWER SUPPLY
55	B	GROUND
56	L	CAN-H
57	LG	BRAKE FLUID LEVEL SWITCH
58	Y	FUEL LEVEL SENSOR GROUND
59	GR	INTAKE SENSOR GROUND
60	W	IN-VEHICLE SENSOR GROUND

61	B	AMBIENT SENSOR GROUND
62	SB	SUNLOAD SENSOR GROUND
63	L	ION CONTROL MOBE OUTPUT SIGNAL
65	BG	ECV SIGNAL
69	P	A/C LAMP SIGNAL
70	R	EACH DOOR MOTOR POWER SUPPLY
71	GR	GROUND
72	P	CAN-L

Connector No.	M85
Connector Name	AV CONTROL UNIT
Connector Type	TH132FW-NH



Terminal No.	Color of Wire	Signal Name [Specification]
84	SHIELD	SHIELD
85	B	GND
86	L	CAN-H
87	P	CAN-L
88	SB	AV COMM (H)
89	LG	AV COMM (L)
90	SB	AV COMM (H)
91	LG	AV COMM (L)
95	R	AUX SOUND SIGNAL RH (+)
96	W	AUX SOUND SIGNAL LH (+)
97	B	AUX SOUND SIGNAL GND
101	BR	SW GND
103	V	EJECT SIGNAL
104	G	IGNITION
105	BG	REVERSE
106	SB	PARKING BRAKE
107	R	PARKING BRAKE

Connector No.	M24
Connector Name	DATA LINK CONNECTOR
Connector Type	BD10FW-P

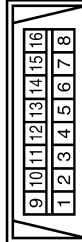

Terminal No.	Color of Wire	Signal Name [Specification]
3	LG	-
4	B	-
5	B	-
6	L	-
7	V	-
8	G	-
11	SB	-
14	P	-

A
B
C
D
E
F
G
H
I
J
K
L
N
O
P

LAN

CAN COMMUNICATION SYSTEM

< DTC/CIRCUIT DIAGNOSIS >

[CAN]

CAN SYSTEM

Connector No.	M107
Connector Name	ECM
Connector Type	RH24FGY-R26-R-LH-Z

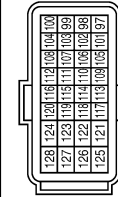

Terminal No.	Color of Wire	Signal Name [Specification]
97	R	APS 1
98	P	APS 2
99	L	AVCC-APS 1
100	W	GND-APS 1
101	SB	ASCDISW
102	LG	FTPRS
103	GR	AVCC-APS 2
104	V	GND-APS 2
105	L	PDPRESS
106	W	TF
107	GR	AVCC-FTPRS
108	Y	GND-ASCD
109	G	NEUT-H
110	R	TACHO
112	V	GND-A
113	P	VEHCAN-L
114	L	VEHCAN-H
117	V	KLINE
121	LG	GDCV
122	P	BRAKE
123	B	GND
124	B	GND
125	R	VRP
126	BR	BNG SW
127	B	GND
128	B	GND

Connector No.	M110
Connector Name	PRE-SPASH SEAT BELT CONTROL UNIT
Connector Type	TH2DFW-TB6

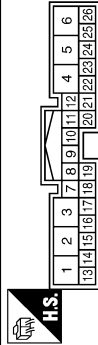

Terminal No.	Color of Wire	Signal Name [Specification]
1	P	MOTOR (RH) (RELEASE)
2	W	+B
3	L	MOTOR (RH) (FASTEN)
4	BG	MOTOR (LH) (FASTEN)
5	W	GND (DRIVE)
6	Y	MOTOR (LH) (RELEASE)
7	G	INDICATOR
8	LG	BUCKLE SW RH
10	SB	BUCKLE SW LH
13	W	IGN
16	R	SENS OUTPUT 1
18	R	SENS POWER
20	G	SENS OUTPUT 2
21	B	SENS GND
22	P	CAN-L
24	L	CAN-H
26	B	GND (CONT)

Connector No.	M116
Connector Name	WIRE TO WIRE
Connector Type	TK38MW-NS10

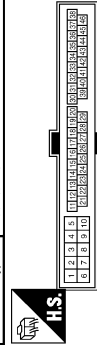

Terminal No.	Color of Wire	Signal Name [Specification]
2	W	-
3	BG	-
4	P	-
5	B	-
9	R	-

Terminal No.	Color of Wire	Signal Name [Specification]
10	R	-
19	BG	-
20	Y	-
22	B	-
28	LG	-
30	LG	-
31	W	-
33	B	-
34	B	-
35	L	-
36	P	-
37	R	-
38	SB	-
41	BG	-
42	G	-
43	P	-
44	L	-
45	Y	-
46	SB	-

Connector No.	M122
Connector Name	BCM (BODY CONTROL MODULE)
Connector Type	TH40FB-NH



Terminal No.	Color of Wire	Signal Name [Specification]
72	R	ROOM ANT 2-
72	G	ROOM ANT 2+
74	SB	PASSENGER DOOR ANT-
75	BR	PASSENGER DOOR ANT+
76	V	DRIVER DOOR ANT-
77	LG	DRIVER DOOR ANT+
78	Y	ROOM ANT 1-
79	BR	ROOM ANT 1+
80	GR	NATS ANT AMP.
81	W	INATS ANT AMP.
82	SB	IGN RELAY (F/B) CONT
83	Y	KEYLESS ENTRY RECEIVER COMM
87	Y	COMBI SW INPUT 5
88	BG	COMBI SW INPUT 3
89	BR	PUSH SW
90	P	CAN-L
91	L	CAN-H

Terminal No.	Color of Wire	Signal Name [Specification]
92	LG	KEY SLOT ILL ON IND
93	GR	ACC RELAY CONT
95	BG	ACC RELAY CONT
96	GR	A/T SHIFT SELECTOR POWER SUPPLY
97	L	S/L CONDITION 1
98	P	S/L CONDITION 2
99	R	SHIFT P (With A/T)
99	BR	ICC CLUTCH SW (With M/T and ICC)
99	BR	ASCD CLUTCH SW (With M/T without ICC)
100	Y	PASSENGER DOOR REQUEST SW
101	P	DRIVER DOOR REQUEST SW
102	BG	BLOWER FAN MOTOR RELAY CONT
103	P	KEYLESS ENTRY RECEIVER POWER SUPPLY
106	SB	S/L UNIT POWER SUPPLY
107	LG	COMBI SW INPUT 1
108	R	COMBI SW INPUT 4
109	W	COMBI SW INPUT 2
110	G	HAZARD SW
111	Y	S/L UNIT COMM

CAN COMMUNICATION SYSTEM

< DTC/CIRCUIT DIAGNOSIS >

[CAN]

CAN SYSTEM

Connector No.	M147
Connector Name	AIR BAG DIAGNOSIS SENSOR UNIT
Connector Type	TK28FY-EX-SC



20	21	17	24	49	1
22	11	48	47	45	13
3	4	6	5	8	1
16	12	19	15	14	51
					23
					50
					18
					52
					2

Terminal No.	Color of Wire	Signal Name [Specification]
1	LG	IGN
2	B	GND
3	Y	DR 1 (+)
4	Y	DR 1 (-) DR 2 (-)
5	Y	AS 1 (+)
6	Y	AS 1 (-)
11	SB	ECZS (+)
12	V	ECZS (-)
15	LG	AIR BAG W/L
16	SHIELD	GND
18	R	CUTOFF TELLTALE
21	L	CAN-H
24	G	SEAT BELT
45	Y	DR 2 (+)
46	P	CAN-L
47	Y	AS 2 (+)
48	Y	AS 2 (-)
49	L	ODS INPUT

Connector No.	M204
Connector Name	AV CONTROL UNIT
Connector Type	TH32FW-NH



76	77	78	81	82	83	84	85	86	87	88	89	90	91
82	93	94	95	96	97	98	99	100	101	102	103	104	105

Terminal No.	Color of Wire	Signal Name [Specification]
76	LG	AV COMM (L)
77	SB	AV COMM (H)
78	LG	AV COMM (L)
79	SB	AV COMM (H)

80	P	CAN-L
81	L	CAN-H
82	BR	SW GND
86	SHIELD	SHIELD
87	L	TEL VOICE SIGNAL (+)
88	P	TEL VOICE SIGNAL (-)
92	R	VEHICLE SPEED (8-PULSE)
93	SB	PARKING BRAKE REVERSE
94	BG	IGNITION
95	G	DISK EJECT SIGNAL
96	V	

Connector No.	M210
Connector Name	AV CONTROL UNIT
Connector Type	TH32FW-NH



65	66	67	68	69	70	71	72	73	74	75
77	78	79	80	81	82	83	84	85	86	87
										88
										89
										90
										91
										92

Terminal No.	Color of Wire	Signal Name [Specification]
65	SB	PARKING BRAKE
67	P	COMPOSITE IMAGE GND
68	L	COMPOSITE IMAGE SIGNAL
71	SHIELD	MICROPHONE GND
72	G	MICROPHONE YCC
73	LG	COMM (CONT->DISP)
74	P	CAN-L
75	LG	AV COMM (L)
76	LG	AV COMM (L)
78	L	ILLUMINATION
80	G	IGNITION
81	BG	REVERSE
82	R	VEHICLE SPEED (8-PULSE)
83	SHIELD	SHIELD
87	R	MICROPHONE SIGNAL
88	B	SHIELD
89	L	COMM (DISP->CONT)
90	L	CAN-H
91	SB	AV COMM (H)
92	SB	AV COMM (H)

A
B
C
D
E
F
G
H
I
J
K
L
N
O
P

LAN

MALFUNCTION AREA CHART

< DTC/CIRCUIT DIAGNOSIS >

[CAN]

MALFUNCTION AREA CHART

Main Line

INFOID:000000005622694

Malfunction area	Reference
Main line between AV control unit and data link connector	LAN-43, "Diagnosis Procedure"
Main line between data link connector and ABS actuator and electric unit (control unit)	LAN-44, "Diagnosis Procedure"
Main line between data link connector and driver seat control unit	LAN-45, "Diagnosis Procedure"
Main line between driver seat control unit and ABS actuator and electric unit (control unit)	LAN-46, "Diagnosis Procedure"
Main line between driver seat control unit and 4WAS main control unit	LAN-48, "Diagnosis Procedure"
Main line between 4WAS main control unit and ABS actuator and electric unit (control unit)	LAN-49, "Diagnosis Procedure"

Branch Line

INFOID:000000005622695

Malfunction area	Reference
ECM branch line circuit	LAN-51, "Diagnosis Procedure"
AWD control unit branch line circuit	LAN-52, "Diagnosis Procedure"
AV control unit branch line circuit	LAN-53, "Diagnosis Procedure"
Pre-crash seat belt control unit branch line circuit	LAN-54, "Diagnosis Procedure"
TCM branch line circuit	LAN-55, "Diagnosis Procedure"
Air bag diagnosis sensor unit branch line circuit	LAN-56, "Diagnosis Procedure"
BCM branch line circuit	LAN-57, "Diagnosis Procedure"
Data link connector branch line circuit	LAN-58, "Diagnosis Procedure"
Unified meter and A/C amp. branch line circuit	LAN-59, "Diagnosis Procedure"
Steering angle sensor branch line circuit	LAN-60, "Diagnosis Procedure"
Driver seat control unit branch line circuit	LAN-61, "Diagnosis Procedure"
4WAS main control unit branch line circuit	LAN-62, "Diagnosis Procedure"
ABS actuator and electric unit (control unit) branch line circuit	LAN-63, "Diagnosis Procedure"
ICC sensor integrated unit branch line circuit	LAN-64, "Diagnosis Procedure"
IPDM E/R branch line circuit	LAN-65, "Diagnosis Procedure"

Short Circuit

INFOID:000000005622696

Malfunction area	Reference
CAN communication circuit	LAN-66, "Diagnosis Procedure"

MAIN LINE BETWEEN AV AND DLC CIRCUIT

< DTC/CIRCUIT DIAGNOSIS >

[CAN]

MAIN LINE BETWEEN AV AND DLC CIRCUIT

Diagnosis Procedure

INFOID:000000005622697

1. CHECK HARNESS CONTINUITY (OPEN CIRCUIT)

1. Turn the ignition switch OFF.
2. Disconnect the battery cable from the negative terminal.
3. Disconnect the following harness connectors.
 - ECM
 - AV control unit
4. Check the continuity between the AV control unit harness connector and the data link connector.
 - With navigation system

AV control unit harness connector		Data link connector		Continuity
Connector No.	Terminal No.	Connector No.	Terminal No.	
M210	90	M24	6	Existed
	74		14	Existed

- Without navigation system (With rear view monitor)

AV control unit harness connector		Data link connector		Continuity
Connector No.	Terminal No.	Connector No.	Terminal No.	
M204	81	M24	6	Existed
	80		14	Existed

- Without navigation system (Without rear view monitor)

AV control unit harness connector		Data link connector		Continuity
Connector No.	Terminal No.	Connector No.	Terminal No.	
M85	86	M24	6	Existed
	87		14	Existed

Is the inspection result normal?

YES (Present error)>>Check CAN system type decision again.

YES (Past error)>>Error was detected in the main line between the AV control unit and the data link connector.

NO >> Repair the main line between the AV control unit and the data link connector.

A
B
C
D
E
F
G
H
I
J
K
L

LAN

MAIN LINE BETWEEN DLC AND ABS CIRCUIT

< DTC/CIRCUIT DIAGNOSIS >

[CAN]

MAIN LINE BETWEEN DLC AND ABS CIRCUIT

Diagnosis Procedure

INFOID:000000005622698

1. CHECK CONNECTOR

1. Turn the ignition switch OFF.
2. Disconnect the battery cable from the negative terminal.
3. Check the following terminals and connectors for damage, bend and loose connection (connector side and harness side).
 - Harness connector M6
 - Harness connector E106

Is the inspection result normal?

YES >> GO TO 2.

NO >> Repair the terminal and connector.

2. CHECK HARNESS CONTINUITY (OPEN CIRCUIT)

1. Disconnect the harness connectors M6 and E106.
2. Check the continuity between the data link connector and the harness connector.

Data link connector		Harness connector		Continuity
Connector No.	Terminal No.	Connector No.	Terminal No.	
M24	6	M6	7	Existed
	14		6	Existed

Is the inspection result normal?

YES >> GO TO 3.

NO >> Repair the main line between the data link connector and the harness connector M6.

3. CHECK HARNESS CONTINUITY (OPEN CIRCUIT)

1. Disconnect the connector of ABS actuator and electric unit (control unit).
2. Check the continuity between the harness connector and the ABS actuator and electric unit (control unit) harness connector.

Harness connector		ABS actuator and electric unit (control unit) harness connector		Continuity
Connector No.	Terminal No.	Connector No.	Terminal No.	
E106	7	E41	35	Existed
	6		14	Existed

Is the inspection result normal?

YES (Present error)>>Check CAN system type decision again.

YES (Past error)>>Error was detected in the main line between the data link connector and the ABS actuator and electric unit (control unit).

NO >> Repair the main line between the harness connector E106 and the ABS actuator and electric unit (control unit).

MAIN LINE BETWEEN DLC AND ADP CIRCUIT

< DTC/CIRCUIT DIAGNOSIS >

[CAN]

MAIN LINE BETWEEN DLC AND ADP CIRCUIT

Diagnosis Procedure

INFOID:000000005622699

1.CHECK CONNECTOR

1. Turn the ignition switch OFF.
2. Disconnect the battery cable from the negative terminal.
3. Check the following terminals and connectors for damage, bend and loose connection (connector side and harness side).
 - Harness connector M7
 - Harness connector B1

Is the inspection result normal?

YES >> GO TO 2.

NO >> Repair the terminal and connector.

2.CHECK HARNESS CONTINUITY (OPEN CIRCUIT)

1. Disconnect the harness connectors M7 and B1.
2. Check the continuity between the data link connector and the harness connector.

Data link connector		Harness connector		Continuity
Connector No.	Terminal No.	Connector No.	Terminal No.	
M24	6	M7	20	Existed
	14		21	Existed

Is the inspection result normal?

YES >> GO TO 3.

NO >> Repair the main line between the data link connector and the harness connector M7.

3.CHECK HARNESS CONTINUITY (OPEN CIRCUIT)

Check the continuity between the harness connector terminals.

Connector No.	Terminal No.		Continuity
B1	20	22	Existed
	21	23	Existed

Is the inspection result normal?

YES (Present error)>>Check CAN system type decision again.

YES (Past error)>>Error was detected in the main line between the data link connector and the driver seat control unit.

NO >> Repair the main line between the harness connector B1 and the driver seat control unit.

A
B
C
D
E
F
G
H
I
J
K
L
N
O
P

LAN

MAIN LINE BETWEEN ADP AND ABS CIRCUIT

< DTC/CIRCUIT DIAGNOSIS >

[CAN]

MAIN LINE BETWEEN ADP AND ABS CIRCUIT

Diagnosis Procedure

INFOID:000000005779060

1. CHECK CONNECTOR

1. Turn the ignition switch OFF.
2. Disconnect the battery cable from the negative terminal.
3. Check the following terminals and connectors for damage, bend and loose connection (connector side and harness side).
 - Harness connector B1
 - Harness connector M7
 - Harness connector M6
 - Harness connector E106

Is the inspection result normal?

YES >> GO TO 2.

NO >> Repair the terminal and connector.

2. CHECK HARNESS CONTINUITY (OPEN CIRCUIT)

1. Disconnect the harness connectors B1 and M7.
2. Check the continuity between the harness connector terminals.

Connector No.	Terminal No.		Continuity
B1	20	22	Existed
	21	23	Existed

Is the inspection result normal?

YES >> GO TO 3.

NO >> Repair the main line between the driver seat control unit and the harness connector B1.

3. CHECK HARNESS CONTINUITY (OPEN CIRCUIT)

1. Disconnect the harness connectors M6 and E106.
2. Check the continuity between the harness connectors.

Harness connector		Harness connector		Continuity
Connector No.	Terminal No.	Connector No.	Terminal No.	
M7	22	M6	7	Existed
	23		6	Existed

Is the inspection result normal?

YES >> GO TO 4.

NO >> Repair the main line between the harness connector M7 and M6.

4. CHECK HARNESS CONTINUITY (OPEN CIRCUIT)

1. Disconnect the connector of ABS actuator and electric unit (control unit).
2. Check the continuity between the harness connector and the ABS actuator and electric unit (control unit) harness connector.

Harness connector		ABS actuator and electric unit (control unit) harness connector		Continuity
Connector No.	Terminal No.	Connector No.	Terminal No.	
E106	7	E41	35	Existed
	6		14	Existed

Is the inspection result normal?

YES (Present error)>>Check CAN system type decision again.

YES (Past error)>>Error was detected in the main line between the driver seat control unit and the ABS actuator and electric unit (control unit).

MAIN LINE BETWEEN ADP AND ABS CIRCUIT

< DTC/CIRCUIT DIAGNOSIS >

[CAN]

NO >> Repair the main line between the harness connector E106 and the ABS actuator and electric unit (control unit).

A

B

C

D

E

F

G

H

I

J

K

L

LAN

N

O

P

MAIN LINE BETWEEN ADP AND RAS CIRCUIT

< DTC/CIRCUIT DIAGNOSIS >

[CAN]

MAIN LINE BETWEEN ADP AND RAS CIRCUIT

Diagnosis Procedure

INFOID:000000005622701

1. CHECK HARNESS CONTINUITY (OPEN CIRCUIT)

1. Turn the ignition switch OFF.
2. Disconnect the battery cable from the negative terminal.
3. Disconnect the harness connectors M7 and B1.
4. Check the continuity between the harness connector terminals.

Connector No.	Terminal No.		Continuity
B1	20	22	Existed
	21	23	Existed

Is the inspection result normal?

YES (Present error)>>Check CAN system type decision again.

YES (Past error)>>Error was detected in the main line between the 4WAS main control unit and the driver seat control unit.

NO >> Repair the main line between the 4WAS main control unit and the driver seat control unit.

MAIN LINE BETWEEN RAS AND ABS CIRCUIT

< DTC/CIRCUIT DIAGNOSIS >

[CAN]

MAIN LINE BETWEEN RAS AND ABS CIRCUIT

Diagnosis Procedure

INFOID:000000005622703

1. CHECK CONNECTOR

1. Turn the ignition switch OFF.
2. Disconnect the battery cable from the negative terminal.
3. Check the following terminals and connectors for damage, bend and loose connection (connector side and harness side).
 - Harness connector B1
 - Harness connector M7
 - Harness connector M6
 - Harness connector E106

Is the inspection result normal?

YES >> GO TO 2.

NO >> Repair the terminal and connector.

2. CHECK HARNESS CONTINUITY (OPEN CIRCUIT)

1. Disconnect the harness connectors B1 and M7.
2. Check the continuity between the harness connector terminals.

Connector No.	Terminal No.		Continuity
B1	20	22	Existed
	21	23	Existed

Is the inspection result normal?

YES >> GO TO 3.

NO >> Repair the main line between the 4WAS main control unit and the harness connector B1.

3. CHECK HARNESS CONTINUITY (OPEN CIRCUIT)

1. Disconnect the harness connectors M6 and E106.
2. Check the continuity between the harness connectors.

Harness connector		Harness connector		Continuity
Connector No.	Terminal No.	Connector No.	Terminal No.	
M7	22	M6	7	Existed
	23		6	Existed

Is the inspection result normal?

YES >> GO TO 4.

NO >> Repair the main line between the harness connector M7 and M6.

4. CHECK HARNESS CONTINUITY (OPEN CIRCUIT)

1. Disconnect the connector of ABS actuator and electric unit (control unit).
2. Check the continuity between the harness connector and the ABS actuator and electric unit (control unit) harness connector.

Harness connector		ABS actuator and electric unit (control unit) harness connector		Continuity
Connector No.	Terminal No.	Connector No.	Terminal No.	
E106	7	E41	35	Existed
	6		14	Existed

Is the inspection result normal?

YES (Present error)>>Check CAN system type decision again.

YES (Past error)>>Error was detected in the main line between the 4WAS main control unit and the ABS actuator and electric unit (control unit).

MAIN LINE BETWEEN RAS AND ABS CIRCUIT

< DTC/CIRCUIT DIAGNOSIS >

[CAN]

NO >> Repair the main line between the harness connector E106 and the ABS actuator and electric unit (control unit).

ECM BRANCH LINE CIRCUIT

< DTC/CIRCUIT DIAGNOSIS >

[CAN]

ECM BRANCH LINE CIRCUIT

Diagnosis Procedure

INFOID:000000005622704

1. CHECK CONNECTOR

1. Turn the ignition switch OFF.
2. Disconnect the battery cable from the negative terminal.
3. Check the terminals and connectors of the ECM for damage, bend and loose connection (unit side and connector side).

Is the inspection result normal?

- YES >> GO TO 2.
NO >> Repair the terminal and connector.

2. CHECK HARNESS FOR OPEN CIRCUIT

1. Disconnect the connector of ECM.
2. Check the resistance between the ECM harness connector terminals.

ECM harness connector			Resistance (Ω)
Connector No.	Terminal No.		
M107	114	113	Approx. 108 – 132

Is the measurement value within the specification?

- YES >> GO TO 3.
NO >> Repair the ECM branch line.

3. CHECK POWER SUPPLY AND GROUND CIRCUIT

Check the power supply and the ground circuit of the ECM. Refer to [EC-144, "Diagnosis Procedure"](#).

Is the inspection result normal?

YES (Present error)>>Replace the ECM. Refer to [EC-17, "ADDITIONAL SERVICE WHEN REPLACING CONTROL UNIT \(ECM\) : Special Repair Requirement"](#).

YES (Past error)>>Error was detected in the ECM branch line.

NO >> Repair the power supply and the ground circuit.

A
B
C
D
E
F
G
H
I
J
K
L

LAN

N
O
P

4WD BRANCH LINE CIRCUIT

< DTC/CIRCUIT DIAGNOSIS >

[CAN]

4WD BRANCH LINE CIRCUIT

Diagnosis Procedure

INFOID:000000005622705

1. CHECK CONNECTOR

1. Turn the ignition switch OFF.
2. Disconnect the battery cable from the negative terminal.
3. Check the following terminals and connectors for damage, bend and loose connection (unit side and connector side).
 - AWD control unit connector
 - Harness connector F103
 - Harness connector M116

Is the inspection result normal?

YES >> GO TO 2.

NO >> Repair the terminal and connector.

2. CHECK HARNESS FOR OPEN CIRCUIT

1. Disconnect the connector of AWD control unit.
2. Check the resistance between the AWD control unit harness connector terminals.

AWD control unit harness connector		Resistance (Ω)
Connector No.	Terminal No.	
F108	8 16	Approx. 54 – 66

Is the measurement value within the specification?

YES >> GO TO 3.

NO >> Repair the AWD control unit branch line.

3. CHECK POWER SUPPLY AND GROUND CIRCUIT

Check the power supply and the ground circuit of the AWD control unit. Refer to [DLN-27, "Diagnosis Procedure"](#).

Is the inspection result normal?

YES (Present error)>>Replace the AWD control unit. Refer to [DLN-55, "Exploded View"](#).

YES (Past error)>>Error was detected in the AWD control unit branch line.

NO >> Repair the power supply and the ground circuit.

AV BRANCH LINE CIRCUIT

< DTC/CIRCUIT DIAGNOSIS >

[CAN]

AV BRANCH LINE CIRCUIT

Diagnosis Procedure

INFOID:000000005622707

1. CHECK CONNECTOR

1. Turn the ignition switch OFF.
2. Disconnect the battery cable from the negative terminal.
3. Check the terminals and connectors of the AV control unit for damage, bend and loose connection (unit side and connector side).

Is the inspection result normal?

- YES >> GO TO 2.
NO >> Repair the terminal and connector.

2. CHECK HARNESS FOR OPEN CIRCUIT

1. Disconnect the connector of AV control unit.
 2. Check the resistance between the AV control unit harness connector terminals.
- Models with navigation system

AV control unit harness connector			Resistance (Ω)
Connector No.	Terminal No.		
M210	90	74	Approx. 54 – 66

- Models without navigation system (With rear view monitor)

AV control unit harness connector			Resistance (Ω)
Connector No.	Terminal No.		
M204	81	80	Approx. 54 – 66

- Models without navigation system (Without rear view monitor)

AV control unit harness connector			Resistance (Ω)
Connector No.	Terminal No.		
M85	86	87	Approx. 54 – 66

Is the measurement value within the specification?

- YES >> GO TO 3.
NO >> Repair the AV control unit branch line.

3. CHECK POWER SUPPLY AND GROUND CIRCUIT

Check the power supply and the ground circuit of the AV control unit. Refer to the following.

- Base audio without rear view monitor: [AV-40, "AV CONTROL UNIT : Diagnosis Procedure"](#)
- Base audio with rear view monitor: [AV-173, "AV CONTROL UNIT : Diagnosis Procedure"](#)
- BOSE audio without navigation: [AV-297, "AV CONTROL UNIT : Diagnosis Procedure"](#)
- BOSE audio with navigation: [AV-448, "AV CONTROL UNIT : Diagnosis Procedure"](#)

Is the inspection result normal?

- YES (Present error)>>Replace the AV control unit. Refer to the following.
- Base audio without rear view monitor: [AV-90, "Exploded View"](#)
 - Base audio with rear view monitor: [AV-202, "Exploded View"](#)
 - BOSE audio without navigation: [AV-328, "Exploded View"](#)
 - BOSE audio with navigation: [AV-474, "Exploded View"](#)

YES (Past error)>>Error was detected in the AV control unit branch line.

- NO >> Repair the power supply and the ground circuit.

PSB BRANCH LINE CIRCUIT

< DTC/CIRCUIT DIAGNOSIS >

[CAN]

PSB BRANCH LINE CIRCUIT

Diagnosis Procedure

INFOID:000000005622709

1. CHECK CONNECTOR

1. Turn the ignition switch OFF.
2. Disconnect the battery cable from the negative terminal.
3. Check the terminals and connectors of the pre-crash seat belt control unit for damage, bend and loose connection (unit side and connector side).

Is the inspection result normal?

- YES >> GO TO 2.
NO >> Repair the terminal and connector.

2. CHECK HARNESS FOR OPEN CIRCUIT

1. Disconnect the connector of pre-crash seat belt control unit.
2. Check the resistance between the pre-crash seat belt control unit harness connector terminals.

Pre-crash seat belt control unit harness connector			Resistance (Ω)
Connector No.	Terminal No.		
M110	24	22	Approx. 54 – 66

Is the measurement value within the specification?

- YES >> GO TO 3.
NO >> Repair the pre-crash seat belt control unit branch line.

3. CHECK POWER SUPPLY AND GROUND CIRCUIT

Check the power supply and the ground circuit of the pre-crash seat belt control unit. Refer to [SBC-24, "Diagnosis Procedure"](#).

Is the inspection result normal?

- YES (Present error)>>Replace the pre-crash seat belt control unit. Refer to [SBC-39, "Exploded View"](#).
YES (Past error)>>Error was detected in the pre-crash seat belt control unit branch line.
NO >> Repair the power supply and the ground circuit.

TCM BRANCH LINE CIRCUIT

< DTC/CIRCUIT DIAGNOSIS >

[CAN]

TCM BRANCH LINE CIRCUIT

Diagnosis Procedure

INFOID:000000005622710

1. CHECK CONNECTOR

1. Turn the ignition switch OFF.
2. Disconnect the battery cable from the negative terminal.
3. Check the following terminals and connectors for damage, bend and loose connection (unit side and connector side).
 - A/T assembly
 - Harness connector F103
 - Harness connector M116

Is the inspection result normal?

- YES >> GO TO 2.
NO >> Repair the terminal and connector.

2. CHECK HARNESS FOR OPEN CIRCUIT

1. Disconnect the connector of A/T assembly.
2. Check the resistance between the A/T assembly harness connector terminals.

A/T assembly harness connector		Resistance (Ω)
Connector No.	Terminal No.	
F51	3 8	Approx. 54 – 66

Is the measurement value within the specification?

- YES >> GO TO 3.
NO >> Repair the TCM branch line.

3. CHECK POWER SUPPLY AND GROUND CIRCUIT

Check the power supply and the ground circuit of the TCM. Refer to [TM-212, "Diagnosis Procedure"](#).

Is the inspection result normal?

- YES (Present error)>>Replace the control valve with TCM. Refer to [TM-99, "Component Parts Location"](#).
(Replace A/T assembly if control valve with TCM is not listed in the latest parts list.)
YES (Past error)>>Error was detected in the TCM branch line.
NO >> Repair the power supply and the ground circuit.

A
B
C
D
E
F
G
H
I
J
K
L

LAN

A-BAG BRANCH LINE CIRCUIT

< DTC/CIRCUIT DIAGNOSIS >

[CAN]

A-BAG BRANCH LINE CIRCUIT

Diagnosis Procedure

INFOID:000000005868915

WARNING:

- Before servicing, turn ignition switch OFF, disconnect battery negative terminal, and wait 3 minutes or more. (To discharge backup capacitor.)
- Never use unspecified tester or other measuring device.

1.CHECK CONNECTOR

1. Turn the ignition switch OFF.
2. Disconnect the battery cable from the negative terminal.
3. Check the terminals and connectors of the air bag diagnosis sensor unit for damage, bend and loose connection (unit side and connector side).

Is the inspection result normal?

- YES >> GO TO 2.
NO >> Replace the main harness.

2.CHECK AIR BAG DIAGNOSIS SENSOR UNIT

Check the air bag diagnosis sensor unit. Refer to [SRC-5, "Work Flow"](#).

Is the inspection result normal?

- YES >> Replace the main harness.
NO >> Replace parts whose air bag system has a malfunction.

BCM BRANCH LINE CIRCUIT

< DTC/CIRCUIT DIAGNOSIS >

[CAN]

BCM BRANCH LINE CIRCUIT

Diagnosis Procedure

INFOID:000000005622708

1. CHECK CONNECTOR

1. Turn the ignition switch OFF.
2. Disconnect the battery cable from the negative terminal.
3. Check the terminals and connectors of the BCM for damage, bend and loose connection (unit side and connector side).

Is the inspection result normal?

- YES >> GO TO 2.
NO >> Repair the terminal and connector.

2. CHECK HARNESS FOR OPEN CIRCUIT

1. Disconnect the connector of BCM.
2. Check the resistance between the BCM harness connector terminals.

BCM harness connector			Resistance (Ω)
Connector No.	Terminal No.		
M122	91	90	Approx. 54 – 66

Is the measurement value within the specification?

- YES >> GO TO 3.
NO >> Repair the BCM branch line.

3. CHECK POWER SUPPLY AND GROUND CIRCUIT

Check the power supply and the ground circuit of the BCM. Refer to [BCS-37, "Diagnosis Procedure"](#).

Is the inspection result normal?

- YES (Present error)>>Replace the BCM. Refer to [BCS-80, "Exploded View"](#).
YES (Past error)>>Error was detected in the BCM branch line.
NO >> Repair the power supply and the ground circuit.

A
B
C
D
E
F
G
H
I
J
K
L

LAN

N
O
P

DLC BRANCH LINE CIRCUIT

< DTC/CIRCUIT DIAGNOSIS >

[CAN]

DLC BRANCH LINE CIRCUIT

Diagnosis Procedure

INFOID:000000005622712

1. CHECK CONNECTOR

1. Turn the ignition switch OFF.
2. Disconnect the battery cable from the negative terminal.
3. Check the terminals and connectors of the data link connector for damage, bend and loose connection (connector side and harness side).

Is the inspection result normal?

- YES >> GO TO 2.
NO >> Repair the terminal and connector.

2. CHECK HARNESS FOR OPEN CIRCUIT

Check the resistance between the data link connector terminals.

Data link connector			Resistance (Ω)
Connector No.	Terminal No.		
M24	6	14	Approx. 54 – 66

Is the measurement value within the specification?

- YES (Present error)>>Check CAN system type decision again.
YES (Past error)>>Error was detected in the data link connector branch line circuit.
NO >> Repair the data link connector branch line.

M&A BRANCH LINE CIRCUIT

< DTC/CIRCUIT DIAGNOSIS >

[CAN]

M&A BRANCH LINE CIRCUIT

Diagnosis Procedure

INFOID:000000005622713

1.CHECK CONNECTOR

1. Turn the ignition switch OFF.
2. Disconnect the battery cable from the negative terminal.
3. Check the terminals and connectors of the unified meter and A/C amp. for damage, bend and loose connection (unit side and connector side).

Is the inspection result normal?

- YES >> GO TO 2.
NO >> Repair the terminal and connector.

2.CHECK HARNESS FOR OPEN CIRCUIT

1. Disconnect the connector of unified meter and A/C amp.
2. Check the resistance between the unified meter and A/C amp. harness connector terminals.

Unified meter and A/C amp. harness connector			Resistance (Ω)
Connector No.	Terminal No.		
M67	56	72	Approx. 54 – 66

Is the measurement value within the specification?

- YES >> GO TO 3.
NO >> Repair the unified meter and A/C amp. branch line.

3.CHECK POWER SUPPLY AND GROUND CIRCUIT

Check the power supply and the ground circuit of the unified meter and A/C amp. Refer to [MWI-51, "UNIFIED METER AND A/C AMP. : Diagnosis Procedure"](#).

Is the inspection result normal?

- YES (Present error)>>Replace the unified meter and A/C amp. Refer to [MWI-136, "Exploded View"](#).
YES (Past error)>>Error was detected in the unified meter and A/C amp. branch line.
NO >> Repair the power supply and the ground circuit.

A
B
C
D
E
F
G
H
I
J
K
L

LAN

N
O
P

STRG BRANCH LINE CIRCUIT

< DTC/CIRCUIT DIAGNOSIS >

[CAN]

STRG BRANCH LINE CIRCUIT

Diagnosis Procedure

INFOID:000000005622714

1. CHECK CONNECTOR

1. Turn the ignition switch OFF.
2. Disconnect the battery cable from the negative terminal.
3. Check the terminals and connectors of the steering angle sensor for damage, bend and loose connection (unit side and connector side).

Is the inspection result normal?

- YES >> GO TO 2.
NO >> Repair the terminal and connector.

2. CHECK HARNESS FOR OPEN CIRCUIT

1. Disconnect the connector of steering angle sensor.
2. Check the resistance between the steering angle sensor harness connector terminals.

Steering angle sensor harness connector			Resistance (Ω)
Connector No.	Terminal No.		
M37	1	2	Approx. 54 – 66

Is the measurement value within the specification?

- YES >> GO TO 3.
NO >> Repair the steering angle sensor branch line.

3. CHECK POWER SUPPLY AND GROUND CIRCUIT

Check the power supply and the ground circuit of the steering angle sensor. Refer to [BRC-83, "Wiring Diagram - BRAKE CONTROL SYSTEM -"](#).

Is the inspection result normal?

- YES (Present error)>>Replace the steering angle sensor. Refer to [BRC-110, "Exploded View"](#).
YES (Past error)>>Error was detected in the steering angle sensor branch line.
NO >> Repair the power supply and the ground circuit.

ADP BRANCH LINE CIRCUIT

< DTC/CIRCUIT DIAGNOSIS >

[CAN]

ADP BRANCH LINE CIRCUIT

Diagnosis Procedure

INFOID:000000005622716

1. CHECK CONNECTOR

1. Turn the ignition switch OFF.
2. Disconnect the battery cable from the negative terminal.
3. Check the following terminals and connectors for damage, bend and loose connection (unit side and connector side).
 - Driver seat control unit
 - Harness connector B462
 - Harness connector B59

Is the inspection result normal?

- YES >> GO TO 2.
NO >> Repair the terminal and connector.

2. CHECK HARNESS FOR OPEN CIRCUIT

1. Disconnect the connector of driver seat control unit.
2. Check the resistance between the driver seat control unit harness connector terminals.

Driver seat control unit harness connector			Resistance (Ω)
Connector No.	Terminal No.		
B451	3	19	Approx. 54 – 66

Is the measurement value within the specification?

- YES >> GO TO 3.
NO >> Repair the driver seat control unit branch line.

3. CHECK POWER SUPPLY AND GROUND CIRCUIT

Check the power supply and the ground circuit of the driver seat control unit. Refer to [ADP-65, "DRIVER SEAT CONTROL UNIT : Diagnosis Procedure"](#).

Is the inspection result normal?

- YES (Present error)>>Replace the driver seat control unit. Refer to [ADP-228, "Exploded View"](#).
YES (Past error)>>Error was detected in the driver seat control unit branch line.
NO >> Repair the power supply and the ground circuit.

A
B
C
D
E
F
G
H
I
J
K
L

LAN

RAS BRANCH LINE CIRCUIT

< DTC/CIRCUIT DIAGNOSIS >

[CAN]

RAS BRANCH LINE CIRCUIT

Diagnosis Procedure

INFOID:000000005622715

1.CHECK CONNECTOR

1. Turn the ignition switch OFF.
2. Disconnect the battery cable from the negative terminal.
3. Check the terminals and connectors of the 4WAS main control unit for damage, bend and loose connection (unit side and connector side).

Is the inspection result normal?

- YES >> GO TO 2.
NO >> Repair the terminal and connector.

2.CHECK HARNESS FOR OPEN CIRCUIT

1. Disconnect the connector of 4WAS main control unit.
2. Check the resistance between the 4WAS main control unit harness connector terminals.

4WAS main control unit harness connector			Resistance (Ω)
Connector No.	Terminal No.		
B54	1	8	Approx. 54 – 66

Is the measurement value within the specification?

- YES >> GO TO 3.
NO >> Replace the body harness.

3.CHECK POWER SUPPLY AND GROUND CIRCUIT

Check the power supply and the ground circuit of the 4WAS main control unit. Refer to [STC-136, "Diagnosis Procedure \(4WAS Main Control Unit\)"](#).

Is the inspection result normal?

- YES (Present error)>>Replace the 4WAS main control unit. Refer to [STC-185, "Exploded View"](#).
YES (Past error)>>Error was detected in the 4WAS main control unit branch line.
NO >> Repair the power supply and the ground circuit.

ABS BRANCH LINE CIRCUIT

< DTC/CIRCUIT DIAGNOSIS >

[CAN]

ABS BRANCH LINE CIRCUIT

Diagnosis Procedure

INFOID:000000005622717

1. CHECK CONNECTOR

1. Turn the ignition switch OFF.
2. Disconnect the battery cable from the negative terminal.
3. Check the terminals and connectors of the ABS actuator and electric unit (control unit) for damage, bend and loose connection (unit side and connector side).

Is the inspection result normal?

- YES >> GO TO 2.
NO >> Repair the terminal and connector.

2. CHECK HARNESS FOR OPEN CIRCUIT

1. Disconnect the connector of ABS actuator and electric unit (control unit).
2. Check the resistance between the ABS actuator and electric unit (control unit) harness connector terminals.

ABS actuator and electric unit (control unit) harness connector			Resistance (Ω)
Connector No.	Terminal No.		
E41	35	14	Approx. 54 – 66

Is the measurement value within the specification?

- YES >> GO TO 3.
NO >> Repair the ABS actuator and electric unit (control unit) branch line.

3. CHECK POWER SUPPLY AND GROUND CIRCUIT

Check the power supply and the ground circuit of the ABS actuator and electric unit (control unit). Refer to [BRC-69, "Diagnosis Procedure"](#).

Is the inspection result normal?

- YES (Present error)>>Replace the ABS actuator and electric unit (control unit). Refer to [BRC-107, "Exploded View"](#).
YES (Past error)>>Error was detected in the ABS actuator and electric unit (control unit) branch line.
NO >> Repair the power supply and the ground circuit.

A
B
C
D
E
F
G
H
I
J
K
L

LAN

ICC BRANCH LINE CIRCUIT

< DTC/CIRCUIT DIAGNOSIS >

[CAN]

ICC BRANCH LINE CIRCUIT

Diagnosis Procedure

INFOID:000000005622718

1. CHECK CONNECTOR

1. Turn the ignition switch OFF.
2. Disconnect the battery cable from the negative terminal.
3. Check the terminals and connectors of the ICC sensor integrated unit for damage, bend and loose connection (unit side and connector side).

Is the inspection result normal?

- YES >> GO TO 2.
NO >> Repair the terminal and connector.

2. CHECK HARNESS FOR OPEN CIRCUIT

1. Disconnect the connector of ICC sensor integrated unit.
2. Check the resistance between the ICC sensor integrated unit harness connector terminals.

ICC sensor integrated unit harness connector			Resistance (Ω)
Connector No.	Terminal No.		
E67	3	6	Approx. 54 – 66

Is the measurement value within the specification?

- YES >> GO TO 3.
NO >> Repair the ICC sensor integrated unit branch line.

3. CHECK POWER SUPPLY AND GROUND CIRCUIT

Check the power supply and the ground circuit of the ICC sensor integrated unit. Refer to [CCS-102, "Diagnosis Procedure"](#).

Is the inspection result normal?

- YES (Present error)>>Replace the ICC sensor integrated unit. Refer to [CCS-134, "Exploded View"](#).
YES (Past error)>>Error was detected in the ICC sensor integrated unit branch line.
NO >> Repair the power supply and the ground circuit.

IPDM-E BRANCH LINE CIRCUIT

< DTC/CIRCUIT DIAGNOSIS >

[CAN]

IPDM-E BRANCH LINE CIRCUIT

Diagnosis Procedure

INFOID:000000005622719

1. CHECK CONNECTOR

1. Turn the ignition switch OFF.
2. Disconnect the battery cable from the negative terminal.
3. Check the terminals and connectors of the IPDM E/R for damage, bend and loose connection (unit side and connector side).

Is the inspection result normal?

- YES >> GO TO 2.
NO >> Repair the terminal and connector.

2. CHECK HARNESS FOR OPEN CIRCUIT

1. Disconnect the connector of IPDM E/R.
2. Check the resistance between the IPDM E/R harness connector terminals.

IPDM E/R harness connector			Resistance (Ω)
Connector No.	Terminal No.		
E6	40	39	Approx. 108 – 132

Is the measurement value within the specification?

- YES >> GO TO 3.
NO >> Repair the IPDM E/R branch line.

3. CHECK POWER SUPPLY AND GROUND CIRCUIT

Check the power supply and the ground circuit of the IPDM E/R. Refer to [PCS-18, "Diagnosis Procedure"](#).

Is the inspection result normal?

- YES (Present error)>>Replace the IPDM E/R. Refer to [PCS-33, "Exploded View"](#).
YES (Past error)>>Error was detected in the IPDM E/R branch line.
NO >> Repair the power supply and the ground circuit.

A
B
C
D
E
F
G
H
I
J
K
L

LAN

N
O
P

CAN COMMUNICATION CIRCUIT

[CAN]

< DTC/CIRCUIT DIAGNOSIS >

CAN COMMUNICATION CIRCUIT

Diagnosis Procedure

INFOID:00000000562720

1. CONNECTOR INSPECTION

1. Turn the ignition switch OFF.
2. Disconnect the battery cable from the negative terminal.
3. Disconnect all the unit connectors on CAN communication system.
4. Check terminals and connectors for damage, bend and loose connection.

Is the inspection result normal?

- YES >> GO TO 2.
NO >> Repair the terminal and connector.

2. CHECK HARNESS CONTINUITY (SHORT CIRCUIT)

Check the continuity between the data link connector terminals.

Data link connector			Continuity
Connector No.	Terminal No.		
M24	6	14	Not existed

Is the inspection result normal?

- YES >> GO TO 3.
NO >> Check the harness and repair the root cause.

3. CHECK HARNESS CONTINUITY (SHORT CIRCUIT)

Check the continuity between the data link connector and the ground.

Data link connector		Ground	Continuity
Connector No.	Terminal No.		
M24	6		Not existed
	14		Not existed

Is the inspection result normal?

- YES >> GO TO 4.
NO >> Check the harness and repair the root cause.

4. CHECK ECM AND IPDM E/R TERMINATION CIRCUIT

1. Remove the ECM and the IPDM E/R.
2. Check the resistance between the ECM terminals.

ECM		Resistance (Ω)
Terminal No.		
114	113	Approx. 108 – 132

3. Check the resistance between the IPDM E/R terminals.

IPDM E/R		Resistance (Ω)
Terminal No.		
40	39	Approx. 108 – 132

Is the measurement value within the specification?

- YES >> GO TO 5.
NO >> Replace the ECM and/or the IPDM E/R.

5. CHECK SYMPTOM

Connect all the connectors. Check if the symptoms described in the "Symptom (Results from interview with customer)" are reproduced.

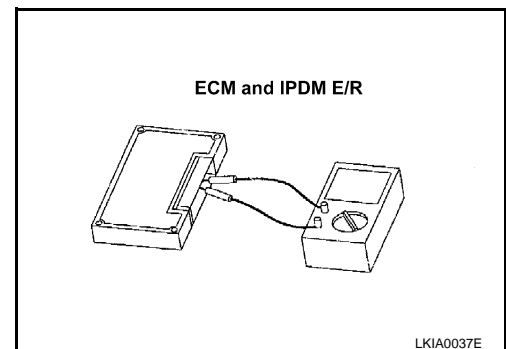

CAN COMMUNICATION CIRCUIT

[CAN]

< DTC/CIRCUIT DIAGNOSIS >

Inspection result

Reproduced>>GO TO 6.

Non-reproduced>>Start the diagnosis again. Follow the trouble diagnosis procedure when past error is detected.

6.CHECK UNIT REPRODUCTION

Perform the reproduction test as per the following procedure for each unit.

1. Turn the ignition switch OFF.
2. Disconnect the battery cable from the negative terminal.
3. Disconnect one of the unit connectors of CAN communication system.

NOTE:

ECM and IPDM E/R have a termination circuit. Check other units first.

4. Connect the battery cable to the negative terminal. Check if the symptoms described in the "Symptom (Results from interview with customer)" are reproduced.

NOTE:

Although unit-related error symptoms occur, do not confuse them with other symptoms.

Inspection result

Reproduced>>Connect the connector. Check other units as per the above procedure.

Non-reproduced>>Replace the unit whose connector was disconnected.

A
B
C
D
E
F
G
H
I
J
K
L

LAN

N
O
P

MAIN LINE BETWEEN AV AND DLC CIRCUIT

< DTC/CIRCUIT DIAGNOSIS >

[CAN SYSTEM (TYPE 1)]

DTC/CIRCUIT DIAGNOSIS

MAIN LINE BETWEEN AV AND DLC CIRCUIT

Diagnosis Procedure

INFOID:000000005779061

1. CHECK HARNESS CONTINUITY (OPEN CIRCUIT)

1. Turn the ignition switch OFF.
2. Disconnect the battery cable from the negative terminal.
3. Disconnect the following harness connectors.
 - ECM
 - AV control unit
4. Check the continuity between the AV control unit harness connector and the data link connector.
 - With navigation system

AV control unit harness connector		Data link connector		Continuity
Connector No.	Terminal No.	Connector No.	Terminal No.	
M210	90	M24	6	Existed
	74		14	Existed

- Without navigation system (With rear view monitor)

AV control unit harness connector		Data link connector		Continuity
Connector No.	Terminal No.	Connector No.	Terminal No.	
M204	81	M24	6	Existed
	80		14	Existed

- Without navigation system (Without rear view monitor)

AV control unit harness connector		Data link connector		Continuity
Connector No.	Terminal No.	Connector No.	Terminal No.	
M85	86	M24	6	Existed
	87		14	Existed

Is the inspection result normal?

YES (Present error)>>Check CAN system type decision again.

YES (Past error)>>Error was detected in the main line between the AV control unit and the data link connector.

NO >> Repair the main line between the AV control unit and the data link connector.

MAIN LINE BETWEEN DLC AND ADP CIRCUIT

< DTC/CIRCUIT DIAGNOSIS >

[CAN SYSTEM (TYPE 1)]

MAIN LINE BETWEEN DLC AND ADP CIRCUIT

Diagnosis Procedure

INFOID:000000005779062

1.CHECK CONNECTOR

1. Turn the ignition switch OFF.
2. Disconnect the battery cable from the negative terminal.
3. Check the following terminals and connectors for damage, bend and loose connection (connector side and harness side).
 - Harness connector M7
 - Harness connector B1

Is the inspection result normal?

YES >> GO TO 2.

NO >> Repair the terminal and connector.

2.CHECK HARNESS CONTINUITY (OPEN CIRCUIT)

1. Disconnect the harness connectors M7 and B1.
2. Check the continuity between the data link connector and the harness connector.

Data link connector		Harness connector		Continuity
Connector No.	Terminal No.	Connector No.	Terminal No.	
M24	6	M7	20	Existed
	14		21	Existed

Is the inspection result normal?

YES >> GO TO 3.

NO >> Repair the main line between the data link connector and the harness connector M7.

3.CHECK HARNESS CONTINUITY (OPEN CIRCUIT)

Check the continuity between the harness connector terminals.

Connector No.	Terminal No.		Continuity
B1	20	22	Existed
	21	23	Existed

Is the inspection result normal?

YES (Present error)>>Check CAN system type decision again.

YES (Past error)>>Error was detected in the main line between the data link connector and the driver seat control unit.

NO >> Repair the main line between the harness connector B1 and the driver seat control unit.

A
B
C
D
E
F
G
H
I
J
K
L
N
O
P

LAN

MAIN LINE BETWEEN ADP AND ABS CIRCUIT

< DTC/CIRCUIT DIAGNOSIS >

[CAN SYSTEM (TYPE 1)]

MAIN LINE BETWEEN ADP AND ABS CIRCUIT

Diagnosis Procedure

INFOID:000000005779063

1. CHECK CONNECTOR

1. Turn the ignition switch OFF.
2. Disconnect the battery cable from the negative terminal.
3. Check the following terminals and connectors for damage, bend and loose connection (connector side and harness side).
 - Harness connector B1
 - Harness connector M7
 - Harness connector M6
 - Harness connector E106

Is the inspection result normal?

YES >> GO TO 2.

NO >> Repair the terminal and connector.

2. CHECK HARNESS CONTINUITY (OPEN CIRCUIT)

1. Disconnect the harness connectors B1 and M7.
2. Check the continuity between the harness connector terminals.

Connector No.	Terminal No.		Continuity
B1	20	22	Existed
	21	23	Existed

Is the inspection result normal?

YES >> GO TO 3.

NO >> Repair the main line between the driver seat control unit and the harness connector B1.

3. CHECK HARNESS CONTINUITY (OPEN CIRCUIT)

1. Disconnect the harness connectors M6 and E106.
2. Check the continuity between the harness connectors.

Harness connector		Harness connector		Continuity
Connector No.	Terminal No.	Connector No.	Terminal No.	
M7	22	M6	7	Existed
	23		6	Existed

Is the inspection result normal?

YES >> GO TO 4.

NO >> Repair the main line between the harness connector M7 and M6.

4. CHECK HARNESS CONTINUITY (OPEN CIRCUIT)

1. Disconnect the connector of ABS actuator and electric unit (control unit).
2. Check the continuity between the harness connector and the ABS actuator and electric unit (control unit) harness connector.

Harness connector		ABS actuator and electric unit (control unit) harness connector		Continuity
Connector No.	Terminal No.	Connector No.	Terminal No.	
E106	7	E41	35	Existed
	6		14	Existed

Is the inspection result normal?

YES (Present error)>>Check CAN system type decision again.

YES (Past error)>>Error was detected in the main line between the driver seat control unit and the ABS actuator and electric unit (control unit).

MAIN LINE BETWEEN ADP AND ABS CIRCUIT

< DTC/CIRCUIT DIAGNOSIS >

[CAN SYSTEM (TYPE 1)]

NO >> Repair the main line between the harness connector E106 and the ABS actuator and electric unit (control unit).

A

B

C

D

E

F

G

H

I

J

K

L

LAN

N

O

P

ECM BRANCH LINE CIRCUIT

< DTC/CIRCUIT DIAGNOSIS >

[CAN SYSTEM (TYPE 1)]

ECM BRANCH LINE CIRCUIT

Diagnosis Procedure

INFOID:000000005779064

1. CHECK CONNECTOR

1. Turn the ignition switch OFF.
2. Disconnect the battery cable from the negative terminal.
3. Check the terminals and connectors of the ECM for damage, bend and loose connection (unit side and connector side).

Is the inspection result normal?

- YES >> GO TO 2.
NO >> Repair the terminal and connector.

2. CHECK HARNESS FOR OPEN CIRCUIT

1. Disconnect the connector of ECM.
2. Check the resistance between the ECM harness connector terminals.

ECM harness connector			Resistance (Ω)
Connector No.	Terminal No.		
M107	114	113	Approx. 108 – 132

Is the measurement value within the specification?

- YES >> GO TO 3.
NO >> Repair the ECM branch line.

3. CHECK POWER SUPPLY AND GROUND CIRCUIT

Check the power supply and the ground circuit of the ECM. Refer to [EC-144, "Diagnosis Procedure"](#).

Is the inspection result normal?

- YES (Present error)>>Replace the ECM. Refer to [EC-17, "ADDITIONAL SERVICE WHEN REPLACING CONTROL UNIT \(ECM\) : Special Repair Requirement"](#).
YES (Past error)>>Error was detected in the ECM branch line.
NO >> Repair the power supply and the ground circuit.

AV BRANCH LINE CIRCUIT

Diagnosis Procedure

INFOID:000000005779065

1. CHECK CONNECTOR

1. Turn the ignition switch OFF.
2. Disconnect the battery cable from the negative terminal.
3. Check the terminals and connectors of the AV control unit for damage, bend and loose connection (unit side and connector side).

Is the inspection result normal?

- YES >> GO TO 2.
 NO >> Repair the terminal and connector.

2. CHECK HARNESS FOR OPEN CIRCUIT

1. Disconnect the connector of AV control unit.
 2. Check the resistance between the AV control unit harness connector terminals.
- Models with navigation system

AV control unit harness connector			Resistance (Ω)
Connector No.	Terminal No.		
M210	90	74	Approx. 54 – 66

- Models without navigation system (With rear view monitor)

AV control unit harness connector			Resistance (Ω)
Connector No.	Terminal No.		
M204	81	80	Approx. 54 – 66

- Models without navigation system (Without rear view monitor)

AV control unit harness connector			Resistance (Ω)
Connector No.	Terminal No.		
M85	86	87	Approx. 54 – 66

Is the measurement value within the specification?

- YES >> GO TO 3.
 NO >> Repair the AV control unit branch line.

3. CHECK POWER SUPPLY AND GROUND CIRCUIT

Check the power supply and the ground circuit of the AV control unit. Refer to the following.

- Base audio without rear view monitor: [AV-40, "AV CONTROL UNIT : Diagnosis Procedure"](#)
- Base audio with rear view monitor: [AV-173, "AV CONTROL UNIT : Diagnosis Procedure"](#)
- BOSE audio without navigation: [AV-297, "AV CONTROL UNIT : Diagnosis Procedure"](#)
- BOSE audio with navigation: [AV-448, "AV CONTROL UNIT : Diagnosis Procedure"](#)

Is the inspection result normal?

- YES (Present error)>>Replace the AV control unit. Refer to the following.
- Base audio without rear view monitor: [AV-90, "Exploded View"](#)
 - Base audio with rear view monitor: [AV-202, "Exploded View"](#)
 - BOSE audio without navigation: [AV-328, "Exploded View"](#)
 - BOSE audio with navigation: [AV-474, "Exploded View"](#)

- YES (Past error)>>Error was detected in the AV control unit branch line.
 NO >> Repair the power supply and the ground circuit.

A
B
C
D
E
F
G
H
I
J
K
L

LAN

N
O
P

A-BAG BRANCH LINE CIRCUIT

< DTC/CIRCUIT DIAGNOSIS >

[CAN SYSTEM (TYPE 1)]

A-BAG BRANCH LINE CIRCUIT

Diagnosis Procedure

INFOID:000000005869038

WARNING:

- Before servicing, turn ignition switch OFF, disconnect battery negative terminal, and wait 3 minutes or more. (To discharge backup capacitor.)
- Never use unspecified tester or other measuring device.

1. CHECK CONNECTOR

1. Turn the ignition switch OFF.
2. Disconnect the battery cable from the negative terminal.
3. Check the terminals and connectors of the air bag diagnosis sensor unit for damage, bend and loose connection (unit side and connector side).

Is the inspection result normal?

YES >> GO TO 2.

NO >> Replace the main harness.

2. CHECK AIR BAG DIAGNOSIS SENSOR UNIT

Check the air bag diagnosis sensor unit. Refer to [SRC-5, "Work Flow"](#).

Is the inspection result normal?

YES >> Replace the main harness.

NO >> Replace parts whose air bag system has a malfunction.

BCM BRANCH LINE CIRCUIT

< DTC/CIRCUIT DIAGNOSIS >

[CAN SYSTEM (TYPE 1)]

BCM BRANCH LINE CIRCUIT

Diagnosis Procedure

INFOID:000000005779067

1. CHECK CONNECTOR

1. Turn the ignition switch OFF.
2. Disconnect the battery cable from the negative terminal.
3. Check the terminals and connectors of the BCM for damage, bend and loose connection (unit side and connector side).

Is the inspection result normal?

- YES >> GO TO 2.
NO >> Repair the terminal and connector.

2. CHECK HARNESS FOR OPEN CIRCUIT

1. Disconnect the connector of BCM.
2. Check the resistance between the BCM harness connector terminals.

BCM harness connector			Resistance (Ω)
Connector No.	Terminal No.		
M122	91	90	Approx. 54 – 66

Is the measurement value within the specification?

- YES >> GO TO 3.
NO >> Repair the BCM branch line.

3. CHECK POWER SUPPLY AND GROUND CIRCUIT

Check the power supply and the ground circuit of the BCM. Refer to [BCS-37, "Diagnosis Procedure"](#).

Is the inspection result normal?

- YES (Present error)>>Replace the BCM. Refer to [BCS-80, "Exploded View"](#).
YES (Past error)>>Error was detected in the BCM branch line.
NO >> Repair the power supply and the ground circuit.

A
B
C
D
E
F
G
H
I
J
K
L

LAN

N
O
P

DLC BRANCH LINE CIRCUIT

< DTC/CIRCUIT DIAGNOSIS >

[CAN SYSTEM (TYPE 1)]

DLC BRANCH LINE CIRCUIT

Diagnosis Procedure

INFOID:000000005779068

1. CHECK CONNECTOR

1. Turn the ignition switch OFF.
2. Disconnect the battery cable from the negative terminal.
3. Check the terminals and connectors of the data link connector for damage, bend and loose connection (connector side and harness side).

Is the inspection result normal?

- YES >> GO TO 2.
NO >> Repair the terminal and connector.

2. CHECK HARNESS FOR OPEN CIRCUIT

Check the resistance between the data link connector terminals.

Data link connector			Resistance (Ω)
Connector No.	Terminal No.		
M24	6	14	Approx. 54 – 66

Is the measurement value within the specification?

- YES (Present error)>>Check CAN system type decision again.
YES (Past error)>>Error was detected in the data link connector branch line circuit.
NO >> Repair the data link connector branch line.

M&A BRANCH LINE CIRCUIT

Diagnosis Procedure

INFOID:000000005779069

1.CHECK CONNECTOR

1. Turn the ignition switch OFF.
2. Disconnect the battery cable from the negative terminal.
3. Check the terminals and connectors of the unified meter and A/C amp. for damage, bend and loose connection (unit side and connector side).

Is the inspection result normal?

- YES >> GO TO 2.
 NO >> Repair the terminal and connector.

2.CHECK HARNESS FOR OPEN CIRCUIT

1. Disconnect the connector of unified meter and A/C amp.
2. Check the resistance between the unified meter and A/C amp. harness connector terminals.

Unified meter and A/C amp. harness connector			Resistance (Ω)
Connector No.	Terminal No.		
M67	56	72	Approx. 54 – 66

Is the measurement value within the specification?

- YES >> GO TO 3.
 NO >> Repair the unified meter and A/C amp. branch line.

3.CHECK POWER SUPPLY AND GROUND CIRCUIT

Check the power supply and the ground circuit of the unified meter and A/C amp. Refer to [MWI-51, "UNIFIED METER AND A/C AMP. : Diagnosis Procedure"](#).

Is the inspection result normal?

- YES (Present error)>>Replace the unified meter and A/C amp. Refer to [MWI-136, "Exploded View"](#).
 YES (Past error)>>Error was detected in the unified meter and A/C amp. branch line.
 NO >> Repair the power supply and the ground circuit.

LAN

STRG BRANCH LINE CIRCUIT

< DTC/CIRCUIT DIAGNOSIS >

[CAN SYSTEM (TYPE 1)]

STRG BRANCH LINE CIRCUIT

Diagnosis Procedure

INFOID:000000005779070

1. CHECK CONNECTOR

1. Turn the ignition switch OFF.
2. Disconnect the battery cable from the negative terminal.
3. Check the terminals and connectors of the steering angle sensor for damage, bend and loose connection (unit side and connector side).

Is the inspection result normal?

- YES >> GO TO 2.
NO >> Repair the terminal and connector.

2. CHECK HARNESS FOR OPEN CIRCUIT

1. Disconnect the connector of steering angle sensor.
2. Check the resistance between the steering angle sensor harness connector terminals.

Steering angle sensor harness connector			Resistance (Ω)
Connector No.	Terminal No.		
M37	1	2	Approx. 54 – 66

Is the measurement value within the specification?

- YES >> GO TO 3.
NO >> Repair the steering angle sensor branch line.

3. CHECK POWER SUPPLY AND GROUND CIRCUIT

Check the power supply and the ground circuit of the steering angle sensor. Refer to [BRC-83, "Wiring Diagram - BRAKE CONTROL SYSTEM -"](#).

Is the inspection result normal?

- YES (Present error)>>Replace the steering angle sensor. Refer to [BRC-110, "Exploded View"](#).
YES (Past error)>>Error was detected in the steering angle sensor branch line.
NO >> Repair the power supply and the ground circuit.

ADP BRANCH LINE CIRCUIT

< DTC/CIRCUIT DIAGNOSIS >

[CAN SYSTEM (TYPE 1)]

ADP BRANCH LINE CIRCUIT

Diagnosis Procedure

INFOID:000000005779071

1. CHECK CONNECTOR

1. Turn the ignition switch OFF.
2. Disconnect the battery cable from the negative terminal.
3. Check the following terminals and connectors for damage, bend and loose connection (unit side and connector side).
 - Driver seat control unit
 - Harness connector B462
 - Harness connector B59

Is the inspection result normal?

- YES >> GO TO 2.
NO >> Repair the terminal and connector.

2. CHECK HARNESS FOR OPEN CIRCUIT

1. Disconnect the connector of driver seat control unit.
2. Check the resistance between the driver seat control unit harness connector terminals.

Driver seat control unit harness connector			Resistance (Ω)
Connector No.	Terminal No.		
B451	3	19	Approx. 54 – 66

Is the measurement value within the specification?

- YES >> GO TO 3.
NO >> Repair the driver seat control unit branch line.

3. CHECK POWER SUPPLY AND GROUND CIRCUIT

Check the power supply and the ground circuit of the driver seat control unit. Refer to [ADP-65, "DRIVER SEAT CONTROL UNIT : Diagnosis Procedure"](#).

Is the inspection result normal?

- YES (Present error)>>Replace the driver seat control unit. Refer to [ADP-228, "Exploded View"](#).
YES (Past error)>>Error was detected in the driver seat control unit branch line.
NO >> Repair the power supply and the ground circuit.

A
B
C
D
E
F
G
H
I
J
K
L

LAN

ABS BRANCH LINE CIRCUIT

< DTC/CIRCUIT DIAGNOSIS >

[CAN SYSTEM (TYPE 1)]

ABS BRANCH LINE CIRCUIT

Diagnosis Procedure

INFOID:000000005779072

1. CHECK CONNECTOR

1. Turn the ignition switch OFF.
2. Disconnect the battery cable from the negative terminal.
3. Check the terminals and connectors of the ABS actuator and electric unit (control unit) for damage, bend and loose connection (unit side and connector side).

Is the inspection result normal?

- YES >> GO TO 2.
NO >> Repair the terminal and connector.

2. CHECK HARNESS FOR OPEN CIRCUIT

1. Disconnect the connector of ABS actuator and electric unit (control unit).
2. Check the resistance between the ABS actuator and electric unit (control unit) harness connector terminals.

ABS actuator and electric unit (control unit) harness connector			Resistance (Ω)
Connector No.	Terminal No.		
E41	35	14	Approx. 54 – 66

Is the measurement value within the specification?

- YES >> GO TO 3.
NO >> Repair the ABS actuator and electric unit (control unit) branch line.

3. CHECK POWER SUPPLY AND GROUND CIRCUIT

Check the power supply and the ground circuit of the ABS actuator and electric unit (control unit). Refer to [BRC-69. "Diagnosis Procedure"](#).

Is the inspection result normal?

- YES (Present error)>>Replace the ABS actuator and electric unit (control unit). Refer to [BRC-107. "Exploded View"](#).
YES (Past error)>>Error was detected in the ABS actuator and electric unit (control unit) branch line.
NO >> Repair the power supply and the ground circuit.

IPDM-E BRANCH LINE CIRCUIT

< DTC/CIRCUIT DIAGNOSIS >

[CAN SYSTEM (TYPE 1)]

IPDM-E BRANCH LINE CIRCUIT

Diagnosis Procedure

INFOID:000000005779073

1. CHECK CONNECTOR

1. Turn the ignition switch OFF.
2. Disconnect the battery cable from the negative terminal.
3. Check the terminals and connectors of the IPDM E/R for damage, bend and loose connection (unit side and connector side).

Is the inspection result normal?

- YES >> GO TO 2.
NO >> Repair the terminal and connector.

2. CHECK HARNESS FOR OPEN CIRCUIT

1. Disconnect the connector of IPDM E/R.
2. Check the resistance between the IPDM E/R harness connector terminals.

IPDM E/R harness connector			Resistance (Ω)
Connector No.	Terminal No.		
E6	40	39	Approx. 108 – 132

Is the measurement value within the specification?

- YES >> GO TO 3.
NO >> Repair the IPDM E/R branch line.

3. CHECK POWER SUPPLY AND GROUND CIRCUIT

Check the power supply and the ground circuit of the IPDM E/R. Refer to [PCS-18, "Diagnosis Procedure"](#).

Is the inspection result normal?

- YES (Present error)>>Replace the IPDM E/R. Refer to [PCS-33, "Exploded View"](#).
YES (Past error)>>Error was detected in the IPDM E/R branch line.
NO >> Repair the power supply and the ground circuit.

A
B
C
D
E
F
G
H
I
J
K
L

LAN

CAN COMMUNICATION CIRCUIT

< DTC/CIRCUIT DIAGNOSIS >

[CAN SYSTEM (TYPE 1)]

CAN COMMUNICATION CIRCUIT

Diagnosis Procedure

INFOID:000000005779074

1. CONNECTOR INSPECTION

1. Turn the ignition switch OFF.
2. Disconnect the battery cable from the negative terminal.
3. Disconnect all the unit connectors on CAN communication system.
4. Check terminals and connectors for damage, bend and loose connection.

Is the inspection result normal?

- YES >> GO TO 2.
NO >> Repair the terminal and connector.

2. CHECK HARNESS CONTINUITY (SHORT CIRCUIT)

Check the continuity between the data link connector terminals.

Data link connector			Continuity
Connector No.	Terminal No.		
M24	6	14	Not existed

Is the inspection result normal?

- YES >> GO TO 3.
NO >> Check the harness and repair the root cause.

3. CHECK HARNESS CONTINUITY (SHORT CIRCUIT)

Check the continuity between the data link connector and the ground.

Data link connector		Ground	Continuity
Connector No.	Terminal No.		
M24	6		Not existed
	14		Not existed

Is the inspection result normal?

- YES >> GO TO 4.
NO >> Check the harness and repair the root cause.

4. CHECK ECM AND IPDM E/R TERMINATION CIRCUIT

1. Remove the ECM and the IPDM E/R.
2. Check the resistance between the ECM terminals.

ECM		Resistance (Ω)
Terminal No.		
114	113	Approx. 108 – 132

3. Check the resistance between the IPDM E/R terminals.

IPDM E/R		Resistance (Ω)
Terminal No.		
40	39	Approx. 108 – 132

Is the measurement value within the specification?

- YES >> GO TO 5.
NO >> Replace the ECM and/or the IPDM E/R.

5. CHECK SYMPTOM

Connect all the connectors. Check if the symptoms described in the "Symptom (Results from interview with customer)" are reproduced.

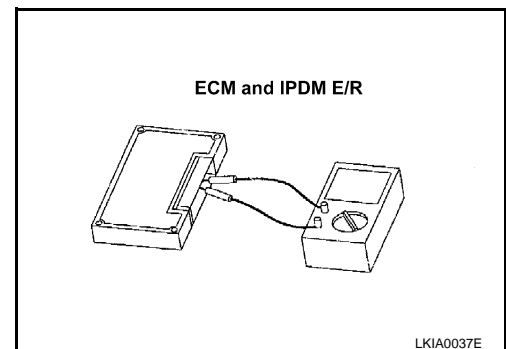

CAN COMMUNICATION CIRCUIT

< DTC/CIRCUIT DIAGNOSIS >

[CAN SYSTEM (TYPE 1)]

Inspection result

Reproduced>>GO TO 6.

Non-reproduced>>Start the diagnosis again. Follow the trouble diagnosis procedure when past error is detected.

6.CHECK UNIT REPRODUCTION

Perform the reproduction test as per the following procedure for each unit.

1. Turn the ignition switch OFF.
2. Disconnect the battery cable from the negative terminal.
3. Disconnect one of the unit connectors of CAN communication system.

NOTE:

ECM and IPDM E/R have a termination circuit. Check other units first.

4. Connect the battery cable to the negative terminal. Check if the symptoms described in the "Symptom (Results from interview with customer)" are reproduced.

NOTE:

Although unit-related error symptoms occur, do not confuse them with other symptoms.

Inspection result

Reproduced>>Connect the connector. Check other units as per the above procedure.

Non-reproduced>>Replace the unit whose connector was disconnected.

A
B
C
D
E
F
G
H
I
J
K
L
N
O
P

LAN

MAIN LINE BETWEEN AV AND DLC CIRCUIT

< DTC/CIRCUIT DIAGNOSIS >

[CAN SYSTEM (TYPE 3)]

DTC/CIRCUIT DIAGNOSIS

MAIN LINE BETWEEN AV AND DLC CIRCUIT

Diagnosis Procedure

INFOID:000000005779087

1. CHECK HARNESS CONTINUITY (OPEN CIRCUIT)

1. Turn the ignition switch OFF.
2. Disconnect the battery cable from the negative terminal.
3. Disconnect the following harness connectors.
 - ECM
 - AV control unit
4. Check the continuity between the AV control unit harness connector and the data link connector.
 - With navigation system

AV control unit harness connector		Data link connector		Continuity
Connector No.	Terminal No.	Connector No.	Terminal No.	
M210	90	M24	6	Existed
	74		14	Existed

- Without navigation system (With rear view monitor)

AV control unit harness connector		Data link connector		Continuity
Connector No.	Terminal No.	Connector No.	Terminal No.	
M204	81	M24	6	Existed
	80		14	Existed

- Without navigation system (Without rear view monitor)

AV control unit harness connector		Data link connector		Continuity
Connector No.	Terminal No.	Connector No.	Terminal No.	
M85	86	M24	6	Existed
	87		14	Existed

Is the inspection result normal?

YES (Present error)>>Check CAN system type decision again.

YES (Past error)>>Error was detected in the main line between the AV control unit and the data link connector.

NO >> Repair the main line between the AV control unit and the data link connector.

MAIN LINE BETWEEN DLC AND ADP CIRCUIT

< DTC/CIRCUIT DIAGNOSIS >

[CAN SYSTEM (TYPE 3)]

MAIN LINE BETWEEN DLC AND ADP CIRCUIT

Diagnosis Procedure

INFOID:000000005779088

1. CHECK CONNECTOR

1. Turn the ignition switch OFF.
2. Disconnect the battery cable from the negative terminal.
3. Check the following terminals and connectors for damage, bend and loose connection (connector side and harness side).
 - Harness connector M7
 - Harness connector B1

Is the inspection result normal?

YES >> GO TO 2.

NO >> Repair the terminal and connector.

2. CHECK HARNESS CONTINUITY (OPEN CIRCUIT)

1. Disconnect the harness connectors M7 and B1.
2. Check the continuity between the data link connector and the harness connector.

Data link connector		Harness connector		Continuity
Connector No.	Terminal No.	Connector No.	Terminal No.	
M24	6	M7	20	Existed
	14		21	Existed

Is the inspection result normal?

YES >> GO TO 3.

NO >> Repair the main line between the data link connector and the harness connector M7.

3. CHECK HARNESS CONTINUITY (OPEN CIRCUIT)

Check the continuity between the harness connector terminals.

Connector No.	Terminal No.		Continuity
B1	20	22	Existed
	21	23	Existed

Is the inspection result normal?

YES (Present error)>>Check CAN system type decision again.

YES (Past error)>>Error was detected in the main line between the data link connector and the driver seat control unit.

NO >> Repair the main line between the harness connector B1 and the driver seat control unit.

A
B
C
D
E
F
G
H
I
J
K
L
N
O
P

LAN

MAIN LINE BETWEEN ADP AND RAS CIRCUIT

< DTC/CIRCUIT DIAGNOSIS >

[CAN SYSTEM (TYPE 3)]

MAIN LINE BETWEEN ADP AND RAS CIRCUIT

Diagnosis Procedure

INFOID:000000005779089

1. CHECK HARNESS CONTINUITY (OPEN CIRCUIT)

1. Turn the ignition switch OFF.
2. Disconnect the battery cable from the negative terminal.
3. Disconnect the harness connectors M7 and B1.
4. Check the continuity between the harness connector terminals.

Connector No.	Terminal No.		Continuity
B1	20	22	Existed
	21	23	Existed

Is the inspection result normal?

YES (Present error)>>Check CAN system type decision again.

YES (Past error)>>Error was detected in the main line between the 4WAS main control unit and the driver seat control unit.

NO >> Repair the main line between the 4WAS main control unit and the driver seat control unit.

MAIN LINE BETWEEN RAS AND ABS CIRCUIT

< DTC/CIRCUIT DIAGNOSIS >

[CAN SYSTEM (TYPE 3)]

MAIN LINE BETWEEN RAS AND ABS CIRCUIT

Diagnosis Procedure

INFOID:000000005779090

1. CHECK CONNECTOR

1. Turn the ignition switch OFF.
2. Disconnect the battery cable from the negative terminal.
3. Check the following terminals and connectors for damage, bend and loose connection (connector side and harness side).
 - Harness connector B1
 - Harness connector M7
 - Harness connector M6
 - Harness connector E106

Is the inspection result normal?

YES >> GO TO 2.

NO >> Repair the terminal and connector.

2. CHECK HARNESS CONTINUITY (OPEN CIRCUIT)

1. Disconnect the harness connectors B1 and M7.
2. Check the continuity between the harness connector terminals.

Connector No.	Terminal No.		Continuity
B1	20	22	Existed
	21	23	Existed

Is the inspection result normal?

YES >> GO TO 3.

NO >> Repair the main line between the 4WAS main control unit and the harness connector B1.

3. CHECK HARNESS CONTINUITY (OPEN CIRCUIT)

1. Disconnect the harness connectors M6 and E106.
2. Check the continuity between the harness connectors.

Harness connector		Harness connector		Continuity
Connector No.	Terminal No.	Connector No.	Terminal No.	
M7	22	M6	7	Existed
	23		6	Existed

Is the inspection result normal?

YES >> GO TO 4.

NO >> Repair the main line between the harness connector M7 and M6.

4. CHECK HARNESS CONTINUITY (OPEN CIRCUIT)

1. Disconnect the connector of ABS actuator and electric unit (control unit).
2. Check the continuity between the harness connector and the ABS actuator and electric unit (control unit) harness connector.

Harness connector		ABS actuator and electric unit (control unit) harness connector		Continuity
Connector No.	Terminal No.	Connector No.	Terminal No.	
E106	7	E41	35	Existed
	6		14	Existed

Is the inspection result normal?

YES (Present error)>>Check CAN system type decision again.

YES (Past error)>>Error was detected in the main line between the 4WAS main control unit and the ABS actuator and electric unit (control unit).

A
B
C
D
E
F
G
H
I
J
K
L

LAN

N
O
P

MAIN LINE BETWEEN RAS AND ABS CIRCUIT

< DTC/CIRCUIT DIAGNOSIS >

[CAN SYSTEM (TYPE 3)]

NO >> Repair the main line between the harness connector E106 and the ABS actuator and electric unit (control unit).

ECM BRANCH LINE CIRCUIT

< DTC/CIRCUIT DIAGNOSIS >

[CAN SYSTEM (TYPE 3)]

ECM BRANCH LINE CIRCUIT

Diagnosis Procedure

INFOID:000000005779091

1. CHECK CONNECTOR

1. Turn the ignition switch OFF.
2. Disconnect the battery cable from the negative terminal.
3. Check the terminals and connectors of the ECM for damage, bend and loose connection (unit side and connector side).

Is the inspection result normal?

- YES >> GO TO 2.
NO >> Repair the terminal and connector.

2. CHECK HARNESS FOR OPEN CIRCUIT

1. Disconnect the connector of ECM.
2. Check the resistance between the ECM harness connector terminals.

ECM harness connector			Resistance (Ω)
Connector No.	Terminal No.		
M107	114	113	Approx. 108 – 132

Is the measurement value within the specification?

- YES >> GO TO 3.
NO >> Repair the ECM branch line.

3. CHECK POWER SUPPLY AND GROUND CIRCUIT

Check the power supply and the ground circuit of the ECM. Refer to [EC-144, "Diagnosis Procedure"](#).

Is the inspection result normal?

YES (Present error)>>Replace the ECM. Refer to [EC-17, "ADDITIONAL SERVICE WHEN REPLACING CONTROL UNIT \(ECM\) : Special Repair Requirement"](#).

YES (Past error)>>Error was detected in the ECM branch line.

NO >> Repair the power supply and the ground circuit.

A
B
C
D
E
F
G
H
I
J
K
L

LAN

N
O
P

AV BRANCH LINE CIRCUIT

Diagnosis Procedure

INFOID:000000005779092

1. CHECK CONNECTOR

1. Turn the ignition switch OFF.
2. Disconnect the battery cable from the negative terminal.
3. Check the terminals and connectors of the AV control unit for damage, bend and loose connection (unit side and connector side).

Is the inspection result normal?

- YES >> GO TO 2.
 NO >> Repair the terminal and connector.

2. CHECK HARNESS FOR OPEN CIRCUIT

1. Disconnect the connector of AV control unit.
 2. Check the resistance between the AV control unit harness connector terminals.
- Models with navigation system

AV control unit harness connector			Resistance (Ω)
Connector No.	Terminal No.		
M210	90	74	Approx. 54 – 66

- Models without navigation system (With rear view monitor)

AV control unit harness connector			Resistance (Ω)
Connector No.	Terminal No.		
M204	81	80	Approx. 54 – 66

- Models without navigation system (Without rear view monitor)

AV control unit harness connector			Resistance (Ω)
Connector No.	Terminal No.		
M85	86	87	Approx. 54 – 66

Is the measurement value within the specification?

- YES >> GO TO 3.
 NO >> Repair the AV control unit branch line.

3. CHECK POWER SUPPLY AND GROUND CIRCUIT

Check the power supply and the ground circuit of the AV control unit. Refer to the following.

- Base audio without rear view monitor: [AV-40, "AV CONTROL UNIT : Diagnosis Procedure"](#)
- Base audio with rear view monitor: [AV-173, "AV CONTROL UNIT : Diagnosis Procedure"](#)
- BOSE audio without navigation: [AV-297, "AV CONTROL UNIT : Diagnosis Procedure"](#)
- BOSE audio with navigation: [AV-448, "AV CONTROL UNIT : Diagnosis Procedure"](#)

Is the inspection result normal?

- YES (Present error)>>Replace the AV control unit. Refer to the following.
- Base audio without rear view monitor: [AV-90, "Exploded View"](#)
 - Base audio with rear view monitor: [AV-202, "Exploded View"](#)
 - BOSE audio without navigation: [AV-328, "Exploded View"](#)
 - BOSE audio with navigation: [AV-474, "Exploded View"](#)

YES (Past error)>>Error was detected in the AV control unit branch line.

- NO >> Repair the power supply and the ground circuit.

A-BAG BRANCH LINE CIRCUIT

< DTC/CIRCUIT DIAGNOSIS >

[CAN SYSTEM (TYPE 3)]

A-BAG BRANCH LINE CIRCUIT

Diagnosis Procedure

INFOID:000000005869039

WARNING:

- Before servicing, turn ignition switch OFF, disconnect battery negative terminal, and wait 3 minutes or more. (To discharge backup capacitor.)
- Never use unspecified tester or other measuring device.

1. CHECK CONNECTOR

1. Turn the ignition switch OFF.
2. Disconnect the battery cable from the negative terminal.
3. Check the terminals and connectors of the air bag diagnosis sensor unit for damage, bend and loose connection (unit side and connector side).

Is the inspection result normal?

- YES >> GO TO 2.
NO >> Replace the main harness.

2. CHECK AIR BAG DIAGNOSIS SENSOR UNIT

Check the air bag diagnosis sensor unit. Refer to [SRC-5, "Work Flow"](#).

Is the inspection result normal?

- YES >> Replace the main harness.
NO >> Replace parts whose air bag system has a malfunction.

A
B
C
D
E
F
G
H
I
J
K
L
N
O
P

LAN

BCM BRANCH LINE CIRCUIT

< DTC/CIRCUIT DIAGNOSIS >

[CAN SYSTEM (TYPE 3)]

BCM BRANCH LINE CIRCUIT

Diagnosis Procedure

INFOID:000000005779097

1.CHECK CONNECTOR

1. Turn the ignition switch OFF.
2. Disconnect the battery cable from the negative terminal.
3. Check the terminals and connectors of the BCM for damage, bend and loose connection (unit side and connector side).

Is the inspection result normal?

- YES >> GO TO 2.
NO >> Repair the terminal and connector.

2.CHECK HARNESS FOR OPEN CIRCUIT

1. Disconnect the connector of BCM.
2. Check the resistance between the BCM harness connector terminals.

BCM harness connector			Resistance (Ω)
Connector No.	Terminal No.		
M122	91	90	Approx. 54 – 66

Is the measurement value within the specification?

- YES >> GO TO 3.
NO >> Repair the BCM branch line.

3.CHECK POWER SUPPLY AND GROUND CIRCUIT

Check the power supply and the ground circuit of the BCM. Refer to [BCS-37, "Diagnosis Procedure"](#).

Is the inspection result normal?

- YES (Present error)>>Replace the BCM. Refer to [BCS-80, "Exploded View"](#).
YES (Past error)>>Error was detected in the BCM branch line.
NO >> Repair the power supply and the ground circuit.

DLC BRANCH LINE CIRCUIT

< DTC/CIRCUIT DIAGNOSIS >

[CAN SYSTEM (TYPE 3)]

DLC BRANCH LINE CIRCUIT

Diagnosis Procedure

INFOID:000000005779098

1. CHECK CONNECTOR

1. Turn the ignition switch OFF.
2. Disconnect the battery cable from the negative terminal.
3. Check the terminals and connectors of the data link connector for damage, bend and loose connection (connector side and harness side).

Is the inspection result normal?

- YES >> GO TO 2.
NO >> Repair the terminal and connector.

2. CHECK HARNESS FOR OPEN CIRCUIT

Check the resistance between the data link connector terminals.

Data link connector			Resistance (Ω)
Connector No.	Terminal No.		
M24	6	14	Approx. 54 – 66

Is the measurement value within the specification?

- YES (Present error)>>Check CAN system type decision again.
YES (Past error)>>Error was detected in the data link connector branch line circuit.
NO >> Repair the data link connector branch line.

A
B
C
D
E
F
G
H
I
J
K
L

LAN

N
O
P

M&A BRANCH LINE CIRCUIT

Diagnosis Procedure

INFOID:000000005779099

1.CHECK CONNECTOR

1. Turn the ignition switch OFF.
2. Disconnect the battery cable from the negative terminal.
3. Check the terminals and connectors of the unified meter and A/C amp. for damage, bend and loose connection (unit side and connector side).

Is the inspection result normal?

- YES >> GO TO 2.
 NO >> Repair the terminal and connector.

2.CHECK HARNESS FOR OPEN CIRCUIT

1. Disconnect the connector of unified meter and A/C amp.
2. Check the resistance between the unified meter and A/C amp. harness connector terminals.

Unified meter and A/C amp. harness connector			Resistance (Ω)
Connector No.	Terminal No.		
M67	56	72	Approx. 54 – 66

Is the measurement value within the specification?

- YES >> GO TO 3.
 NO >> Repair the unified meter and A/C amp. branch line.

3.CHECK POWER SUPPLY AND GROUND CIRCUIT

Check the power supply and the ground circuit of the unified meter and A/C amp. Refer to [MWI-51, "UNIFIED METER AND A/C AMP. : Diagnosis Procedure"](#).

Is the inspection result normal?

- YES (Present error)>>Replace the unified meter and A/C amp. Refer to [MWI-136, "Exploded View"](#).
 YES (Past error)>>Error was detected in the unified meter and A/C amp. branch line.
 NO >> Repair the power supply and the ground circuit.

STRG BRANCH LINE CIRCUIT

< DTC/CIRCUIT DIAGNOSIS >

[CAN SYSTEM (TYPE 3)]

STRG BRANCH LINE CIRCUIT

Diagnosis Procedure

INFOID:000000005779100

1. CHECK CONNECTOR

1. Turn the ignition switch OFF.
2. Disconnect the battery cable from the negative terminal.
3. Check the terminals and connectors of the steering angle sensor for damage, bend and loose connection (unit side and connector side).

Is the inspection result normal?

- YES >> GO TO 2.
NO >> Repair the terminal and connector.

2. CHECK HARNESS FOR OPEN CIRCUIT

1. Disconnect the connector of steering angle sensor.
2. Check the resistance between the steering angle sensor harness connector terminals.

Steering angle sensor harness connector			Resistance (Ω)
Connector No.	Terminal No.		
M37	1	2	Approx. 54 – 66

Is the measurement value within the specification?

- YES >> GO TO 3.
NO >> Repair the steering angle sensor branch line.

3. CHECK POWER SUPPLY AND GROUND CIRCUIT

Check the power supply and the ground circuit of the steering angle sensor. Refer to [BRC-83, "Wiring Diagram - BRAKE CONTROL SYSTEM -"](#).

Is the inspection result normal?

- YES (Present error)>>Replace the steering angle sensor. Refer to [BRC-110, "Exploded View"](#).
YES (Past error)>>Error was detected in the steering angle sensor branch line.
NO >> Repair the power supply and the ground circuit.

A
B
C
D
E
F
G
H
I
J
K
L

LAN

N
O
P

ADP BRANCH LINE CIRCUIT

Diagnosis Procedure

INFOID:000000005779101

1. CHECK CONNECTOR

1. Turn the ignition switch OFF.
2. Disconnect the battery cable from the negative terminal.
3. Check the following terminals and connectors for damage, bend and loose connection (unit side and connector side).
 - Driver seat control unit
 - Harness connector B462
 - Harness connector B59

Is the inspection result normal?

- YES >> GO TO 2.
 NO >> Repair the terminal and connector.

2. CHECK HARNESS FOR OPEN CIRCUIT

1. Disconnect the connector of driver seat control unit.
2. Check the resistance between the driver seat control unit harness connector terminals.

Driver seat control unit harness connector			Resistance (Ω)
Connector No.	Terminal No.		
B451	3	19	Approx. 54 – 66

Is the measurement value within the specification?

- YES >> GO TO 3.
 NO >> Repair the driver seat control unit branch line.

3. CHECK POWER SUPPLY AND GROUND CIRCUIT

Check the power supply and the ground circuit of the driver seat control unit. Refer to [ADP-65, "DRIVER SEAT CONTROL UNIT : Diagnosis Procedure"](#).

Is the inspection result normal?

- YES (Present error)>>Replace the driver seat control unit. Refer to [ADP-228, "Exploded View"](#).
 YES (Past error)>>Error was detected in the driver seat control unit branch line.
 NO >> Repair the power supply and the ground circuit.

RAS BRANCH LINE CIRCUIT

< DTC/CIRCUIT DIAGNOSIS >

[CAN SYSTEM (TYPE 3)]

RAS BRANCH LINE CIRCUIT

Diagnosis Procedure

INFOID:000000005779102

1. CHECK CONNECTOR

1. Turn the ignition switch OFF.
2. Disconnect the battery cable from the negative terminal.
3. Check the terminals and connectors of the 4WAS main control unit for damage, bend and loose connection (unit side and connector side).

Is the inspection result normal?

- YES >> GO TO 2.
NO >> Repair the terminal and connector.

2. CHECK HARNESS FOR OPEN CIRCUIT

1. Disconnect the connector of 4WAS main control unit.
2. Check the resistance between the 4WAS main control unit harness connector terminals.

4WAS main control unit harness connector			Resistance (Ω)
Connector No.	Terminal No.		
B54	1	8	Approx. 54 – 66

Is the measurement value within the specification?

- YES >> GO TO 3.
NO >> Replace the body harness.

3. CHECK POWER SUPPLY AND GROUND CIRCUIT

Check the power supply and the ground circuit of the 4WAS main control unit. Refer to [STC-136, "Diagnosis Procedure \(4WAS Main Control Unit\)"](#).

Is the inspection result normal?

- YES (Present error)>>Replace the 4WAS main control unit. Refer to [STC-185, "Exploded View"](#).
YES (Past error)>>Error was detected in the 4WAS main control unit branch line.
NO >> Repair the power supply and the ground circuit.

A
B
C
D
E
F
G
H
I
J
K
L

LAN

N
O
P

ABS BRANCH LINE CIRCUIT

< DTC/CIRCUIT DIAGNOSIS >

[CAN SYSTEM (TYPE 3)]

ABS BRANCH LINE CIRCUIT

Diagnosis Procedure

INFOID:000000005779103

1. CHECK CONNECTOR

1. Turn the ignition switch OFF.
2. Disconnect the battery cable from the negative terminal.
3. Check the terminals and connectors of the ABS actuator and electric unit (control unit) for damage, bend and loose connection (unit side and connector side).

Is the inspection result normal?

- YES >> GO TO 2.
NO >> Repair the terminal and connector.

2. CHECK HARNESS FOR OPEN CIRCUIT

1. Disconnect the connector of ABS actuator and electric unit (control unit).
2. Check the resistance between the ABS actuator and electric unit (control unit) harness connector terminals.

ABS actuator and electric unit (control unit) harness connector			Resistance (Ω)
Connector No.	Terminal No.		
E41	35	14	Approx. 54 – 66

Is the measurement value within the specification?

- YES >> GO TO 3.
NO >> Repair the ABS actuator and electric unit (control unit) branch line.

3. CHECK POWER SUPPLY AND GROUND CIRCUIT

Check the power supply and the ground circuit of the ABS actuator and electric unit (control unit). Refer to [BRC-69. "Diagnosis Procedure"](#).

Is the inspection result normal?

- YES (Present error)>>Replace the ABS actuator and electric unit (control unit). Refer to [BRC-107. "Exploded View"](#).
YES (Past error)>>Error was detected in the ABS actuator and electric unit (control unit) branch line.
NO >> Repair the power supply and the ground circuit.

IPDM-E BRANCH LINE CIRCUIT

< DTC/CIRCUIT DIAGNOSIS >

[CAN SYSTEM (TYPE 3)]

IPDM-E BRANCH LINE CIRCUIT

Diagnosis Procedure

INFOID:000000005779105

1. CHECK CONNECTOR

1. Turn the ignition switch OFF.
2. Disconnect the battery cable from the negative terminal.
3. Check the terminals and connectors of the IPDM E/R for damage, bend and loose connection (unit side and connector side).

Is the inspection result normal?

- YES >> GO TO 2.
NO >> Repair the terminal and connector.

2. CHECK HARNESS FOR OPEN CIRCUIT

1. Disconnect the connector of IPDM E/R.
2. Check the resistance between the IPDM E/R harness connector terminals.

IPDM E/R harness connector			Resistance (Ω)
Connector No.	Terminal No.		
E6	40	39	Approx. 108 – 132

Is the measurement value within the specification?

- YES >> GO TO 3.
NO >> Repair the IPDM E/R branch line.

3. CHECK POWER SUPPLY AND GROUND CIRCUIT

Check the power supply and the ground circuit of the IPDM E/R. Refer to [PCS-18, "Diagnosis Procedure"](#).

Is the inspection result normal?

- YES (Present error)>>Replace the IPDM E/R. Refer to [PCS-33, "Exploded View"](#).
YES (Past error)>>Error was detected in the IPDM E/R branch line.
NO >> Repair the power supply and the ground circuit.

A
B
C
D
E
F
G
H
I
J
K
L

LAN

N
O
P

CAN COMMUNICATION CIRCUIT

< DTC/CIRCUIT DIAGNOSIS >

[CAN SYSTEM (TYPE 3)]

CAN COMMUNICATION CIRCUIT

Diagnosis Procedure

INFOID:000000005779106

1. CONNECTOR INSPECTION

1. Turn the ignition switch OFF.
2. Disconnect the battery cable from the negative terminal.
3. Disconnect all the unit connectors on CAN communication system.
4. Check terminals and connectors for damage, bend and loose connection.

Is the inspection result normal?

- YES >> GO TO 2.
NO >> Repair the terminal and connector.

2. CHECK HARNESS CONTINUITY (SHORT CIRCUIT)

Check the continuity between the data link connector terminals.

Data link connector			Continuity
Connector No.	Terminal No.		
M24	6	14	Not existed

Is the inspection result normal?

- YES >> GO TO 3.
NO >> Check the harness and repair the root cause.

3. CHECK HARNESS CONTINUITY (SHORT CIRCUIT)

Check the continuity between the data link connector and the ground.

Data link connector		Ground	Continuity
Connector No.	Terminal No.		
M24	6		Not existed
	14		Not existed

Is the inspection result normal?

- YES >> GO TO 4.
NO >> Check the harness and repair the root cause.

4. CHECK ECM AND IPDM E/R TERMINATION CIRCUIT

1. Remove the ECM and the IPDM E/R.
2. Check the resistance between the ECM terminals.

ECM		Resistance (Ω)
Terminal No.		
114	113	Approx. 108 – 132

3. Check the resistance between the IPDM E/R terminals.

IPDM E/R		Resistance (Ω)
Terminal No.		
40	39	Approx. 108 – 132

Is the measurement value within the specification?

- YES >> GO TO 5.
NO >> Replace the ECM and/or the IPDM E/R.

5. CHECK SYMPTOM

Connect all the connectors. Check if the symptoms described in the "Symptom (Results from interview with customer)" are reproduced.

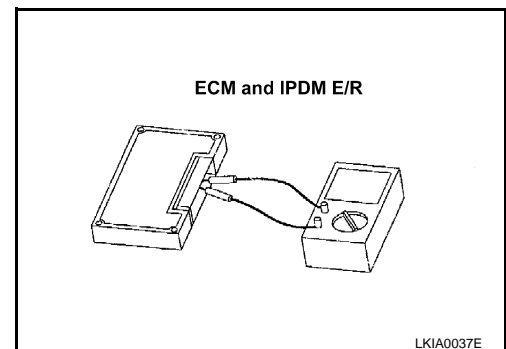

CAN COMMUNICATION CIRCUIT

< DTC/CIRCUIT DIAGNOSIS >

[CAN SYSTEM (TYPE 3)]

Inspection result

Reproduced>>GO TO 6.

Non-reproduced>>Start the diagnosis again. Follow the trouble diagnosis procedure when past error is detected.

6.CHECK UNIT REPRODUCTION

Perform the reproduction test as per the following procedure for each unit.

1. Turn the ignition switch OFF.
2. Disconnect the battery cable from the negative terminal.
3. Disconnect one of the unit connectors of CAN communication system.

NOTE:

ECM and IPDM E/R have a termination circuit. Check other units first.

4. Connect the battery cable to the negative terminal. Check if the symptoms described in the “Symptom (Results from interview with customer)” are reproduced.

NOTE:

Although unit-related error symptoms occur, do not confuse them with other symptoms.

Inspection result

Reproduced>>Connect the connector. Check other units as per the above procedure.

Non-reproduced>>Replace the unit whose connector was disconnected.

A
B
C
D
E
F
G
H
I
J
K
L

LAN

N
O
P

MAIN LINE BETWEEN AV AND DLC CIRCUIT

< DTC/CIRCUIT DIAGNOSIS >

[CAN SYSTEM (TYPE 4)]

DTC/CIRCUIT DIAGNOSIS

MAIN LINE BETWEEN AV AND DLC CIRCUIT

Diagnosis Procedure

INFOID:000000005779107

1. CHECK HARNESS CONTINUITY (OPEN CIRCUIT)

1. Turn the ignition switch OFF.
2. Disconnect the battery cable from the negative terminal.
3. Disconnect the following harness connectors.
 - ECM
 - AV control unit
4. Check the continuity between the AV control unit harness connector and the data link connector.
 - With navigation system

AV control unit harness connector		Data link connector		Continuity
Connector No.	Terminal No.	Connector No.	Terminal No.	
M210	90	M24	6	Existed
	74		14	Existed

- Without navigation system (With rear view monitor)

AV control unit harness connector		Data link connector		Continuity
Connector No.	Terminal No.	Connector No.	Terminal No.	
M204	81	M24	6	Existed
	80		14	Existed

- Without navigation system (Without rear view monitor)

AV control unit harness connector		Data link connector		Continuity
Connector No.	Terminal No.	Connector No.	Terminal No.	
M85	86	M24	6	Existed
	87		14	Existed

Is the inspection result normal?

YES (Present error)>>Check CAN system type decision again.

YES (Past error)>>Error was detected in the main line between the AV control unit and the data link connector.

NO >> Repair the main line between the AV control unit and the data link connector.

MAIN LINE BETWEEN DLC AND ADP CIRCUIT

< DTC/CIRCUIT DIAGNOSIS >

[CAN SYSTEM (TYPE 4)]

MAIN LINE BETWEEN DLC AND ADP CIRCUIT

Diagnosis Procedure

INFOID:000000005779108

1. CHECK CONNECTOR

1. Turn the ignition switch OFF.
2. Disconnect the battery cable from the negative terminal.
3. Check the following terminals and connectors for damage, bend and loose connection (connector side and harness side).
 - Harness connector M7
 - Harness connector B1

Is the inspection result normal?

YES >> GO TO 2.

NO >> Repair the terminal and connector.

2. CHECK HARNESS CONTINUITY (OPEN CIRCUIT)

1. Disconnect the harness connectors M7 and B1.
2. Check the continuity between the data link connector and the harness connector.

Data link connector		Harness connector		Continuity
Connector No.	Terminal No.	Connector No.	Terminal No.	
M24	6	M7	20	Existed
	14		21	Existed

Is the inspection result normal?

YES >> GO TO 3.

NO >> Repair the main line between the data link connector and the harness connector M7.

3. CHECK HARNESS CONTINUITY (OPEN CIRCUIT)

Check the continuity between the harness connector terminals.

Connector No.	Terminal No.		Continuity
B1	20	22	Existed
	21	23	Existed

Is the inspection result normal?

YES (Present error)>>Check CAN system type decision again.

YES (Past error)>>Error was detected in the main line between the data link connector and the driver seat control unit.

NO >> Repair the main line between the harness connector B1 and the driver seat control unit.

LAN

MAIN LINE BETWEEN ADP AND ABS CIRCUIT

< DTC/CIRCUIT DIAGNOSIS >

[CAN SYSTEM (TYPE 4)]

MAIN LINE BETWEEN ADP AND ABS CIRCUIT

Diagnosis Procedure

INFOID:000000005779109

1. CHECK CONNECTOR

1. Turn the ignition switch OFF.
2. Disconnect the battery cable from the negative terminal.
3. Check the following terminals and connectors for damage, bend and loose connection (connector side and harness side).
 - Harness connector B1
 - Harness connector M7
 - Harness connector M6
 - Harness connector E106

Is the inspection result normal?

YES >> GO TO 2.

NO >> Repair the terminal and connector.

2. CHECK HARNESS CONTINUITY (OPEN CIRCUIT)

1. Disconnect the harness connectors B1 and M7.
2. Check the continuity between the harness connector terminals.

Connector No.	Terminal No.		Continuity
B1	20	22	Existed
	21	23	Existed

Is the inspection result normal?

YES >> GO TO 3.

NO >> Repair the main line between the driver seat control unit and the harness connector B1.

3. CHECK HARNESS CONTINUITY (OPEN CIRCUIT)

1. Disconnect the harness connectors M6 and E106.
2. Check the continuity between the harness connectors.

Harness connector		Harness connector		Continuity
Connector No.	Terminal No.	Connector No.	Terminal No.	
M7	22	M6	7	Existed
	23		6	Existed

Is the inspection result normal?

YES >> GO TO 4.

NO >> Repair the main line between the harness connector M7 and M6.

4. CHECK HARNESS CONTINUITY (OPEN CIRCUIT)

1. Disconnect the connector of ABS actuator and electric unit (control unit).
2. Check the continuity between the harness connector and the ABS actuator and electric unit (control unit) harness connector.

Harness connector		ABS actuator and electric unit (control unit) harness connector		Continuity
Connector No.	Terminal No.	Connector No.	Terminal No.	
E106	7	E41	35	Existed
	6		14	Existed

Is the inspection result normal?

YES (Present error)>>Check CAN system type decision again.

YES (Past error)>>Error was detected in the main line between the driver seat control unit and the ABS actuator and electric unit (control unit).

MAIN LINE BETWEEN ADP AND ABS CIRCUIT

< DTC/CIRCUIT DIAGNOSIS >

[CAN SYSTEM (TYPE 4)]

NO >> Repair the main line between the harness connector E106 and the ABS actuator and electric unit (control unit).

A

B

C

D

E

F

G

H

I

J

K

L

LAN

N

O

P

ECM BRANCH LINE CIRCUIT

< DTC/CIRCUIT DIAGNOSIS >

[CAN SYSTEM (TYPE 4)]

ECM BRANCH LINE CIRCUIT

Diagnosis Procedure

INFOID:000000005779112

1. CHECK CONNECTOR

1. Turn the ignition switch OFF.
2. Disconnect the battery cable from the negative terminal.
3. Check the terminals and connectors of the ECM for damage, bend and loose connection (unit side and connector side).

Is the inspection result normal?

- YES >> GO TO 2.
NO >> Repair the terminal and connector.

2. CHECK HARNESS FOR OPEN CIRCUIT

1. Disconnect the connector of ECM.
2. Check the resistance between the ECM harness connector terminals.

ECM harness connector			Resistance (Ω)
Connector No.	Terminal No.		
M107	114	113	Approx. 108 – 132

Is the measurement value within the specification?

- YES >> GO TO 3.
NO >> Repair the ECM branch line.

3. CHECK POWER SUPPLY AND GROUND CIRCUIT

Check the power supply and the ground circuit of the ECM. Refer to [EC-144, "Diagnosis Procedure"](#).

Is the inspection result normal?

YES (Present error)>>Replace the ECM. Refer to [EC-17, "ADDITIONAL SERVICE WHEN REPLACING CONTROL UNIT \(ECM\) : Special Repair Requirement"](#).

YES (Past error)>>Error was detected in the ECM branch line.

NO >> Repair the power supply and the ground circuit.

AV BRANCH LINE CIRCUIT

Diagnosis Procedure

INFOID:000000005779113

1. CHECK CONNECTOR

1. Turn the ignition switch OFF.
2. Disconnect the battery cable from the negative terminal.
3. Check the terminals and connectors of the AV control unit for damage, bend and loose connection (unit side and connector side).

Is the inspection result normal?

- YES >> GO TO 2.
 NO >> Repair the terminal and connector.

2. CHECK HARNESS FOR OPEN CIRCUIT

1. Disconnect the connector of AV control unit.
 2. Check the resistance between the AV control unit harness connector terminals.
- Models with navigation system

AV control unit harness connector			Resistance (Ω)
Connector No.	Terminal No.		
M210	90	74	Approx. 54 – 66

- Models without navigation system (With rear view monitor)

AV control unit harness connector			Resistance (Ω)
Connector No.	Terminal No.		
M204	81	80	Approx. 54 – 66

- Models without navigation system (Without rear view monitor)

AV control unit harness connector			Resistance (Ω)
Connector No.	Terminal No.		
M85	86	87	Approx. 54 – 66

Is the measurement value within the specification?

- YES >> GO TO 3.
 NO >> Repair the AV control unit branch line.

3. CHECK POWER SUPPLY AND GROUND CIRCUIT

Check the power supply and the ground circuit of the AV control unit. Refer to the following.

- Base audio without rear view monitor: [AV-40, "AV CONTROL UNIT : Diagnosis Procedure"](#)
- Base audio with rear view monitor: [AV-173, "AV CONTROL UNIT : Diagnosis Procedure"](#)
- BOSE audio without navigation: [AV-297, "AV CONTROL UNIT : Diagnosis Procedure"](#)
- BOSE audio with navigation: [AV-448, "AV CONTROL UNIT : Diagnosis Procedure"](#)

Is the inspection result normal?

- YES (Present error)>>Replace the AV control unit. Refer to the following.
- Base audio without rear view monitor: [AV-90, "Exploded View"](#)
 - Base audio with rear view monitor: [AV-202, "Exploded View"](#)
 - BOSE audio without navigation: [AV-328, "Exploded View"](#)
 - BOSE audio with navigation: [AV-474, "Exploded View"](#)

- YES (Past error)>>Error was detected in the AV control unit branch line.
 NO >> Repair the power supply and the ground circuit.

A
B
C
D
E
F
G
H
I
J
K
L

LAN

N
O
P

PSB BRANCH LINE CIRCUIT

Diagnosis Procedure

INFOID:000000005779114

1.CHECK CONNECTOR

1. Turn the ignition switch OFF.
2. Disconnect the battery cable from the negative terminal.
3. Check the terminals and connectors of the pre-crash seat belt control unit for damage, bend and loose connection (unit side and connector side).

Is the inspection result normal?

- YES >> GO TO 2.
 NO >> Repair the terminal and connector.

2.CHECK HARNESS FOR OPEN CIRCUIT

1. Disconnect the connector of pre-crash seat belt control unit.
2. Check the resistance between the pre-crash seat belt control unit harness connector terminals.

Pre-crash seat belt control unit harness connector		Resistance (Ω)
Connector No.	Terminal No.	
M110	24 22	Approx. 54 – 66

Is the measurement value within the specification?

- YES >> GO TO 3.
 NO >> Repair the pre-crash seat belt control unit branch line.

3.CHECK POWER SUPPLY AND GROUND CIRCUIT

Check the power supply and the ground circuit of the pre-crash seat belt control unit. Refer to [SBC-24, "Diagnosis Procedure"](#).

Is the inspection result normal?

- YES (Present error)>>Replace the pre-crash seat belt control unit. Refer to [SBC-39, "Exploded View"](#).
 YES (Past error)>>Error was detected in the pre-crash seat belt control unit branch line.
 NO >> Repair the power supply and the ground circuit.

A-BAG BRANCH LINE CIRCUIT

< DTC/CIRCUIT DIAGNOSIS >

[CAN SYSTEM (TYPE 4)]

A-BAG BRANCH LINE CIRCUIT

Diagnosis Procedure

INFOID:000000005869040

WARNING:

- Before servicing, turn ignition switch OFF, disconnect battery negative terminal, and wait 3 minutes or more. (To discharge backup capacitor.)
- Never use unspecified tester or other measuring device.

1.CHECK CONNECTOR

1. Turn the ignition switch OFF.
2. Disconnect the battery cable from the negative terminal.
3. Check the terminals and connectors of the air bag diagnosis sensor unit for damage, bend and loose connection (unit side and connector side).

Is the inspection result normal?

- YES >> GO TO 2.
NO >> Replace the main harness.

2.CHECK AIR BAG DIAGNOSIS SENSOR UNIT

Check the air bag diagnosis sensor unit. Refer to [SRC-5, "Work Flow"](#).

Is the inspection result normal?

- YES >> Replace the main harness.
NO >> Replace parts whose air bag system has a malfunction.

A
B
C
D
E
F
G
H
I
J
K
L
N
O
P

LAN

BCM BRANCH LINE CIRCUIT

< DTC/CIRCUIT DIAGNOSIS >

[CAN SYSTEM (TYPE 4)]

BCM BRANCH LINE CIRCUIT

Diagnosis Procedure

INFOID:000000005779116

1.CHECK CONNECTOR

1. Turn the ignition switch OFF.
2. Disconnect the battery cable from the negative terminal.
3. Check the terminals and connectors of the BCM for damage, bend and loose connection (unit side and connector side).

Is the inspection result normal?

- YES >> GO TO 2.
NO >> Repair the terminal and connector.

2.CHECK HARNESS FOR OPEN CIRCUIT

1. Disconnect the connector of BCM.
2. Check the resistance between the BCM harness connector terminals.

BCM harness connector			Resistance (Ω)
Connector No.	Terminal No.		
M122	91	90	Approx. 54 – 66

Is the measurement value within the specification?

- YES >> GO TO 3.
NO >> Repair the BCM branch line.

3.CHECK POWER SUPPLY AND GROUND CIRCUIT

Check the power supply and the ground circuit of the BCM. Refer to [BCS-37, "Diagnosis Procedure"](#).

Is the inspection result normal?

- YES (Present error)>>Replace the BCM. Refer to [BCS-80, "Exploded View"](#).
YES (Past error)>>Error was detected in the BCM branch line.
NO >> Repair the power supply and the ground circuit.

DLC BRANCH LINE CIRCUIT

< DTC/CIRCUIT DIAGNOSIS >

[CAN SYSTEM (TYPE 4)]

DLC BRANCH LINE CIRCUIT

Diagnosis Procedure

INFOID:000000005779117

1. CHECK CONNECTOR

1. Turn the ignition switch OFF.
2. Disconnect the battery cable from the negative terminal.
3. Check the terminals and connectors of the data link connector for damage, bend and loose connection (connector side and harness side).

Is the inspection result normal?

- YES >> GO TO 2.
NO >> Repair the terminal and connector.

2. CHECK HARNESS FOR OPEN CIRCUIT

Check the resistance between the data link connector terminals.

Data link connector			Resistance (Ω)
Connector No.	Terminal No.		
M24	6	14	Approx. 54 – 66

Is the measurement value within the specification?

- YES (Present error)>>Check CAN system type decision again.
YES (Past error)>>Error was detected in the data link connector branch line circuit.
NO >> Repair the data link connector branch line.

A
B
C
D
E
F
G
H
I
J
K
L
N
O
P

LAN

M&A BRANCH LINE CIRCUIT

Diagnosis Procedure

INFOID:000000005779118

1. CHECK CONNECTOR

1. Turn the ignition switch OFF.
2. Disconnect the battery cable from the negative terminal.
3. Check the terminals and connectors of the unified meter and A/C amp. for damage, bend and loose connection (unit side and connector side).

Is the inspection result normal?

- YES >> GO TO 2.
 NO >> Repair the terminal and connector.

2. CHECK HARNESS FOR OPEN CIRCUIT

1. Disconnect the connector of unified meter and A/C amp.
2. Check the resistance between the unified meter and A/C amp. harness connector terminals.

Unified meter and A/C amp. harness connector			Resistance (Ω)
Connector No.	Terminal No.		
M67	56	72	Approx. 54 – 66

Is the measurement value within the specification?

- YES >> GO TO 3.
 NO >> Repair the unified meter and A/C amp. branch line.

3. CHECK POWER SUPPLY AND GROUND CIRCUIT

Check the power supply and the ground circuit of the unified meter and A/C amp. Refer to [MWI-51, "UNIFIED METER AND A/C AMP. : Diagnosis Procedure"](#).

Is the inspection result normal?

- YES (Present error)>>Replace the unified meter and A/C amp. Refer to [MWI-136, "Exploded View"](#).
 YES (Past error)>>Error was detected in the unified meter and A/C amp. branch line.
 NO >> Repair the power supply and the ground circuit.

STRG BRANCH LINE CIRCUIT

< DTC/CIRCUIT DIAGNOSIS >

[CAN SYSTEM (TYPE 4)]

STRG BRANCH LINE CIRCUIT

Diagnosis Procedure

INFOID:000000005779119

1.CHECK CONNECTOR

1. Turn the ignition switch OFF.
2. Disconnect the battery cable from the negative terminal.
3. Check the terminals and connectors of the steering angle sensor for damage, bend and loose connection (unit side and connector side).

Is the inspection result normal?

- YES >> GO TO 2.
NO >> Repair the terminal and connector.

2.CHECK HARNESS FOR OPEN CIRCUIT

1. Disconnect the connector of steering angle sensor.
2. Check the resistance between the steering angle sensor harness connector terminals.

Steering angle sensor harness connector			Resistance (Ω)
Connector No.	Terminal No.		
M37	1	2	Approx. 54 – 66

Is the measurement value within the specification?

- YES >> GO TO 3.
NO >> Repair the steering angle sensor branch line.

3.CHECK POWER SUPPLY AND GROUND CIRCUIT

Check the power supply and the ground circuit of the steering angle sensor. Refer to [BRC-83, "Wiring Diagram - BRAKE CONTROL SYSTEM -"](#).

Is the inspection result normal?

- YES (Present error)>>Replace the steering angle sensor. Refer to [BRC-110, "Exploded View"](#).
YES (Past error)>>Error was detected in the steering angle sensor branch line.
NO >> Repair the power supply and the ground circuit.

A
B
C
D
E
F
G
H
I
J
K
L

LAN

N
O
P

ADP BRANCH LINE CIRCUIT

< DTC/CIRCUIT DIAGNOSIS >

[CAN SYSTEM (TYPE 4)]

ADP BRANCH LINE CIRCUIT

Diagnosis Procedure

INFOID:000000005779120

1. CHECK CONNECTOR

1. Turn the ignition switch OFF.
2. Disconnect the battery cable from the negative terminal.
3. Check the following terminals and connectors for damage, bend and loose connection (unit side and connector side).
 - Driver seat control unit
 - Harness connector B462
 - Harness connector B59

Is the inspection result normal?

YES >> GO TO 2.

NO >> Repair the terminal and connector.

2. CHECK HARNESS FOR OPEN CIRCUIT

1. Disconnect the connector of driver seat control unit.
2. Check the resistance between the driver seat control unit harness connector terminals.

Driver seat control unit harness connector			Resistance (Ω)
Connector No.	Terminal No.		
B451	3	19	Approx. 54 – 66

Is the measurement value within the specification?

YES >> GO TO 3.

NO >> Repair the driver seat control unit branch line.

3. CHECK POWER SUPPLY AND GROUND CIRCUIT

Check the power supply and the ground circuit of the driver seat control unit. Refer to [ADP-65, "DRIVER SEAT CONTROL UNIT : Diagnosis Procedure"](#).

Is the inspection result normal?

YES (Present error)>>Replace the driver seat control unit. Refer to [ADP-228, "Exploded View"](#).

YES (Past error)>>Error was detected in the driver seat control unit branch line.

NO >> Repair the power supply and the ground circuit.

ABS BRANCH LINE CIRCUIT

< DTC/CIRCUIT DIAGNOSIS >

[CAN SYSTEM (TYPE 4)]

ABS BRANCH LINE CIRCUIT

Diagnosis Procedure

INFOID:000000005779122

1. CHECK CONNECTOR

1. Turn the ignition switch OFF.
2. Disconnect the battery cable from the negative terminal.
3. Check the terminals and connectors of the ABS actuator and electric unit (control unit) for damage, bend and loose connection (unit side and connector side).

Is the inspection result normal?

- YES >> GO TO 2.
NO >> Repair the terminal and connector.

2. CHECK HARNESS FOR OPEN CIRCUIT

1. Disconnect the connector of ABS actuator and electric unit (control unit).
2. Check the resistance between the ABS actuator and electric unit (control unit) harness connector terminals.

ABS actuator and electric unit (control unit) harness connector			Resistance (Ω)
Connector No.	Terminal No.		
E41	35	14	Approx. 54 – 66

Is the measurement value within the specification?

- YES >> GO TO 3.
NO >> Repair the ABS actuator and electric unit (control unit) branch line.

3. CHECK POWER SUPPLY AND GROUND CIRCUIT

Check the power supply and the ground circuit of the ABS actuator and electric unit (control unit). Refer to [BRC-69, "Diagnosis Procedure"](#).

Is the inspection result normal?

- YES (Present error)>>Replace the ABS actuator and electric unit (control unit). Refer to [BRC-107, "Exploded View"](#).
YES (Past error)>>Error was detected in the ABS actuator and electric unit (control unit) branch line.
NO >> Repair the power supply and the ground circuit.

A
B
C
D
E
F
G
H
I
J
K
L

LAN

ICC BRANCH LINE CIRCUIT

Diagnosis Procedure

INFOID:000000005779123

1. CHECK CONNECTOR

1. Turn the ignition switch OFF.
2. Disconnect the battery cable from the negative terminal.
3. Check the terminals and connectors of the ICC sensor integrated unit for damage, bend and loose connection (unit side and connector side).

Is the inspection result normal?

- YES >> GO TO 2.
 NO >> Repair the terminal and connector.

2. CHECK HARNESS FOR OPEN CIRCUIT

1. Disconnect the connector of ICC sensor integrated unit.
2. Check the resistance between the ICC sensor integrated unit harness connector terminals.

ICC sensor integrated unit harness connector			Resistance (Ω)
Connector No.	Terminal No.		
E67	3	6	Approx. 54 – 66

Is the measurement value within the specification?

- YES >> GO TO 3.
 NO >> Repair the ICC sensor integrated unit branch line.

3. CHECK POWER SUPPLY AND GROUND CIRCUIT

Check the power supply and the ground circuit of the ICC sensor integrated unit. Refer to [CCS-102, "Diagnosis Procedure"](#).

Is the inspection result normal?

- YES (Present error)>>Replace the ICC sensor integrated unit. Refer to [CCS-134, "Exploded View"](#).
 YES (Past error)>>Error was detected in the ICC sensor integrated unit branch line.
 NO >> Repair the power supply and the ground circuit.

IPDM-E BRANCH LINE CIRCUIT

< DTC/CIRCUIT DIAGNOSIS >

[CAN SYSTEM (TYPE 4)]

IPDM-E BRANCH LINE CIRCUIT

Diagnosis Procedure

INFOID:000000005779124

1. CHECK CONNECTOR

1. Turn the ignition switch OFF.
2. Disconnect the battery cable from the negative terminal.
3. Check the terminals and connectors of the IPDM E/R for damage, bend and loose connection (unit side and connector side).

Is the inspection result normal?

- YES >> GO TO 2.
NO >> Repair the terminal and connector.

2. CHECK HARNESS FOR OPEN CIRCUIT

1. Disconnect the connector of IPDM E/R.
2. Check the resistance between the IPDM E/R harness connector terminals.

IPDM E/R harness connector			Resistance (Ω)
Connector No.	Terminal No.		
E6	40	39	Approx. 108 – 132

Is the measurement value within the specification?

- YES >> GO TO 3.
NO >> Repair the IPDM E/R branch line.

3. CHECK POWER SUPPLY AND GROUND CIRCUIT

Check the power supply and the ground circuit of the IPDM E/R. Refer to [PCS-18, "Diagnosis Procedure"](#).

Is the inspection result normal?

- YES (Present error)>>Replace the IPDM E/R. Refer to [PCS-33, "Exploded View"](#).
YES (Past error)>>Error was detected in the IPDM E/R branch line.
NO >> Repair the power supply and the ground circuit.

A
B
C
D
E
F
G
H
I
J
K
L

LAN

N
O
P

CAN COMMUNICATION CIRCUIT

< DTC/CIRCUIT DIAGNOSIS >

[CAN SYSTEM (TYPE 4)]

CAN COMMUNICATION CIRCUIT

Diagnosis Procedure

INFOID:000000005779125

1. CONNECTOR INSPECTION

1. Turn the ignition switch OFF.
2. Disconnect the battery cable from the negative terminal.
3. Disconnect all the unit connectors on CAN communication system.
4. Check terminals and connectors for damage, bend and loose connection.

Is the inspection result normal?

- YES >> GO TO 2.
NO >> Repair the terminal and connector.

2. CHECK HARNESS CONTINUITY (SHORT CIRCUIT)

Check the continuity between the data link connector terminals.

Data link connector		Continuity
Connector No.	Terminal No.	
M24	6 14	Not existed

Is the inspection result normal?

- YES >> GO TO 3.
NO >> Check the harness and repair the root cause.

3. CHECK HARNESS CONTINUITY (SHORT CIRCUIT)

Check the continuity between the data link connector and the ground.

Data link connector		Ground	Continuity
Connector No.	Terminal No.		
M24	6		Not existed
	14		Not existed

Is the inspection result normal?

- YES >> GO TO 4.
NO >> Check the harness and repair the root cause.

4. CHECK ECM AND IPDM E/R TERMINATION CIRCUIT

1. Remove the ECM and the IPDM E/R.
2. Check the resistance between the ECM terminals.

ECM		Resistance (Ω)
Terminal No.		
114	113	Approx. 108 – 132

3. Check the resistance between the IPDM E/R terminals.

IPDM E/R		Resistance (Ω)
Terminal No.		
40	39	Approx. 108 – 132

Is the measurement value within the specification?

- YES >> GO TO 5.
NO >> Replace the ECM and/or the IPDM E/R.

5. CHECK SYMPTOM

Connect all the connectors. Check if the symptoms described in the "Symptom (Results from interview with customer)" are reproduced.

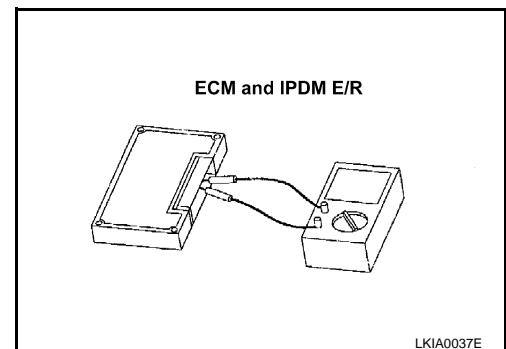

LKIA0037E

CAN COMMUNICATION CIRCUIT

< DTC/CIRCUIT DIAGNOSIS >

[CAN SYSTEM (TYPE 4)]

Inspection result

Reproduced>>GO TO 6.

Non-reproduced>>Start the diagnosis again. Follow the trouble diagnosis procedure when past error is detected.

6.CHECK UNIT REPRODUCTION

Perform the reproduction test as per the following procedure for each unit.

1. Turn the ignition switch OFF.
2. Disconnect the battery cable from the negative terminal.
3. Disconnect one of the unit connectors of CAN communication system.

NOTE:

ECM and IPDM E/R have a termination circuit. Check other units first.

4. Connect the battery cable to the negative terminal. Check if the symptoms described in the "Symptom (Results from interview with customer)" are reproduced.

NOTE:

Although unit-related error symptoms occur, do not confuse them with other symptoms.

Inspection result

Reproduced>>Connect the connector. Check other units as per the above procedure.

Non-reproduced>>Replace the unit whose connector was disconnected.

A
B
C
D
E
F
G
H
I
J
K
L

LAN

N
O
P

MAIN LINE BETWEEN AV AND DLC CIRCUIT

< DTC/CIRCUIT DIAGNOSIS >

[CAN SYSTEM (TYPE 5)]

DTC/CIRCUIT DIAGNOSIS

MAIN LINE BETWEEN AV AND DLC CIRCUIT

Diagnosis Procedure

INFOID:000000005779133

1. CHECK HARNESS CONTINUITY (OPEN CIRCUIT)

1. Turn the ignition switch OFF.
2. Disconnect the battery cable from the negative terminal.
3. Disconnect the following harness connectors.
 - ECM
 - AV control unit
4. Check the continuity between the AV control unit harness connector and the data link connector.
 - With navigation system

AV control unit harness connector		Data link connector		Continuity
Connector No.	Terminal No.	Connector No.	Terminal No.	
M210	90	M24	6	Existed
	74		14	Existed

- Without navigation system (With rear view monitor)

AV control unit harness connector		Data link connector		Continuity
Connector No.	Terminal No.	Connector No.	Terminal No.	
M204	81	M24	6	Existed
	80		14	Existed

- Without navigation system (Without rear view monitor)

AV control unit harness connector		Data link connector		Continuity
Connector No.	Terminal No.	Connector No.	Terminal No.	
M85	86	M24	6	Existed
	87		14	Existed

Is the inspection result normal?

YES (Present error)>>Check CAN system type decision again.

YES (Past error)>>Error was detected in the main line between the AV control unit and the data link connector.

NO >> Repair the main line between the AV control unit and the data link connector.

MAIN LINE BETWEEN DLC AND ADP CIRCUIT

< DTC/CIRCUIT DIAGNOSIS >

[CAN SYSTEM (TYPE 5)]

MAIN LINE BETWEEN DLC AND ADP CIRCUIT

Diagnosis Procedure

INFOID:000000005779134

1.CHECK CONNECTOR

1. Turn the ignition switch OFF.
2. Disconnect the battery cable from the negative terminal.
3. Check the following terminals and connectors for damage, bend and loose connection (connector side and harness side).
 - Harness connector M7
 - Harness connector B1

Is the inspection result normal?

YES >> GO TO 2.

NO >> Repair the terminal and connector.

2.CHECK HARNESS CONTINUITY (OPEN CIRCUIT)

1. Disconnect the harness connectors M7 and B1.
2. Check the continuity between the data link connector and the harness connector.

Data link connector		Harness connector		Continuity
Connector No.	Terminal No.	Connector No.	Terminal No.	
M24	6	M7	20	Existed
	14		21	Existed

Is the inspection result normal?

YES >> GO TO 3.

NO >> Repair the main line between the data link connector and the harness connector M7.

3.CHECK HARNESS CONTINUITY (OPEN CIRCUIT)

Check the continuity between the harness connector terminals.

Connector No.	Terminal No.		Continuity
B1	20	22	Existed
	21	23	Existed

Is the inspection result normal?

YES (Present error)>>Check CAN system type decision again.

YES (Past error)>>Error was detected in the main line between the data link connector and the driver seat control unit.

NO >> Repair the main line between the harness connector B1 and the driver seat control unit.

LAN

MAIN LINE BETWEEN ADP AND RAS CIRCUIT

< DTC/CIRCUIT DIAGNOSIS >

[CAN SYSTEM (TYPE 5)]

MAIN LINE BETWEEN ADP AND RAS CIRCUIT

Diagnosis Procedure

INFOID:000000005779135

1. CHECK HARNESS CONTINUITY (OPEN CIRCUIT)

1. Turn the ignition switch OFF.
2. Disconnect the battery cable from the negative terminal.
3. Disconnect the harness connectors M7 and B1.
4. Check the continuity between the harness connector terminals.

Connector No.	Terminal No.		Continuity
B1	20	22	Existed
	21	23	Existed

Is the inspection result normal?

YES (Present error)>>Check CAN system type decision again.

YES (Past error)>>Error was detected in the main line between the 4WAS main control unit and the driver seat control unit.

NO >> Repair the main line between the 4WAS main control unit and the driver seat control unit.

MAIN LINE BETWEEN RAS AND ABS CIRCUIT

< DTC/CIRCUIT DIAGNOSIS >

[CAN SYSTEM (TYPE 5)]

MAIN LINE BETWEEN RAS AND ABS CIRCUIT

Diagnosis Procedure

INFOID:000000005779136

1. CHECK CONNECTOR

1. Turn the ignition switch OFF.
2. Disconnect the battery cable from the negative terminal.
3. Check the following terminals and connectors for damage, bend and loose connection (connector side and harness side).
 - Harness connector B1
 - Harness connector M7
 - Harness connector M6
 - Harness connector E106

Is the inspection result normal?

YES >> GO TO 2.

NO >> Repair the terminal and connector.

2. CHECK HARNESS CONTINUITY (OPEN CIRCUIT)

1. Disconnect the harness connectors B1 and M7.
2. Check the continuity between the harness connector terminals.

Connector No.	Terminal No.		Continuity
B1	20	22	Existed
	21	23	Existed

Is the inspection result normal?

YES >> GO TO 3.

NO >> Repair the main line between the 4WAS main control unit and the harness connector B1.

3. CHECK HARNESS CONTINUITY (OPEN CIRCUIT)

1. Disconnect the harness connectors M6 and E106.
2. Check the continuity between the harness connectors.

Harness connector		Harness connector		Continuity
Connector No.	Terminal No.	Connector No.	Terminal No.	
M7	22	M6	7	Existed
	23		6	Existed

Is the inspection result normal?

YES >> GO TO 4.

NO >> Repair the main line between the harness connector M7 and M6.

4. CHECK HARNESS CONTINUITY (OPEN CIRCUIT)

1. Disconnect the connector of ABS actuator and electric unit (control unit).
2. Check the continuity between the harness connector and the ABS actuator and electric unit (control unit) harness connector.

Harness connector		ABS actuator and electric unit (control unit) harness connector		Continuity
Connector No.	Terminal No.	Connector No.	Terminal No.	
E106	7	E41	35	Existed
	6		14	Existed

Is the inspection result normal?

YES (Present error)>>Check CAN system type decision again.

YES (Past error)>>Error was detected in the main line between the 4WAS main control unit and the ABS actuator and electric unit (control unit).

A
B
C
D
E
F
G
H
I
J
K
L

LAN

N
O
P

MAIN LINE BETWEEN RAS AND ABS CIRCUIT

< DTC/CIRCUIT DIAGNOSIS >

[CAN SYSTEM (TYPE 5)]

NO >> Repair the main line between the harness connector E106 and the ABS actuator and electric unit (control unit).

ECM BRANCH LINE CIRCUIT

< DTC/CIRCUIT DIAGNOSIS >

[CAN SYSTEM (TYPE 5)]

ECM BRANCH LINE CIRCUIT

Diagnosis Procedure

INFOID:000000005779137

1. CHECK CONNECTOR

1. Turn the ignition switch OFF.
2. Disconnect the battery cable from the negative terminal.
3. Check the terminals and connectors of the ECM for damage, bend and loose connection (unit side and connector side).

Is the inspection result normal?

- YES >> GO TO 2.
NO >> Repair the terminal and connector.

2. CHECK HARNESS FOR OPEN CIRCUIT

1. Disconnect the connector of ECM.
2. Check the resistance between the ECM harness connector terminals.

ECM harness connector			Resistance (Ω)
Connector No.	Terminal No.		
M107	114	113	Approx. 108 – 132

Is the measurement value within the specification?

- YES >> GO TO 3.
NO >> Repair the ECM branch line.

3. CHECK POWER SUPPLY AND GROUND CIRCUIT

Check the power supply and the ground circuit of the ECM. Refer to [EC-144, "Diagnosis Procedure"](#).

Is the inspection result normal?

YES (Present error)>>Replace the ECM. Refer to [EC-17, "ADDITIONAL SERVICE WHEN REPLACING CONTROL UNIT \(ECM\) : Special Repair Requirement"](#).

YES (Past error)>>Error was detected in the ECM branch line.

NO >> Repair the power supply and the ground circuit.

A
B
C
D
E
F
G
H
I
J
K
L

LAN

N
O
P

AV BRANCH LINE CIRCUIT

Diagnosis Procedure

INFOID:000000005779138

1. CHECK CONNECTOR

1. Turn the ignition switch OFF.
2. Disconnect the battery cable from the negative terminal.
3. Check the terminals and connectors of the AV control unit for damage, bend and loose connection (unit side and connector side).

Is the inspection result normal?

- YES >> GO TO 2.
 NO >> Repair the terminal and connector.

2. CHECK HARNESS FOR OPEN CIRCUIT

1. Disconnect the connector of AV control unit.
 2. Check the resistance between the AV control unit harness connector terminals.
- Models with navigation system

AV control unit harness connector			Resistance (Ω)
Connector No.	Terminal No.		
M210	90	74	Approx. 54 – 66

- Models without navigation system (With rear view monitor)

AV control unit harness connector			Resistance (Ω)
Connector No.	Terminal No.		
M204	81	80	Approx. 54 – 66

- Models without navigation system (Without rear view monitor)

AV control unit harness connector			Resistance (Ω)
Connector No.	Terminal No.		
M85	86	87	Approx. 54 – 66

Is the measurement value within the specification?

- YES >> GO TO 3.
 NO >> Repair the AV control unit branch line.

3. CHECK POWER SUPPLY AND GROUND CIRCUIT

Check the power supply and the ground circuit of the AV control unit. Refer to the following.

- Base audio without rear view monitor: [AV-40, "AV CONTROL UNIT : Diagnosis Procedure"](#)
- Base audio with rear view monitor: [AV-173, "AV CONTROL UNIT : Diagnosis Procedure"](#)
- BOSE audio without navigation: [AV-297, "AV CONTROL UNIT : Diagnosis Procedure"](#)
- BOSE audio with navigation: [AV-448, "AV CONTROL UNIT : Diagnosis Procedure"](#)

Is the inspection result normal?

- YES (Present error)>>Replace the AV control unit. Refer to the following.
- Base audio without rear view monitor: [AV-90, "Exploded View"](#)
 - Base audio with rear view monitor: [AV-202, "Exploded View"](#)
 - BOSE audio without navigation: [AV-328, "Exploded View"](#)
 - BOSE audio with navigation: [AV-474, "Exploded View"](#)

YES (Past error)>>Error was detected in the AV control unit branch line.

- NO >> Repair the power supply and the ground circuit.

PSB BRANCH LINE CIRCUIT

< DTC/CIRCUIT DIAGNOSIS >

[CAN SYSTEM (TYPE 5)]

PSB BRANCH LINE CIRCUIT

Diagnosis Procedure

INFOID:000000005779139

1. CHECK CONNECTOR

1. Turn the ignition switch OFF.
2. Disconnect the battery cable from the negative terminal.
3. Check the terminals and connectors of the pre-crash seat belt control unit for damage, bend and loose connection (unit side and connector side).

Is the inspection result normal?

- YES >> GO TO 2.
NO >> Repair the terminal and connector.

2. CHECK HARNESS FOR OPEN CIRCUIT

1. Disconnect the connector of pre-crash seat belt control unit.
2. Check the resistance between the pre-crash seat belt control unit harness connector terminals.

Pre-crash seat belt control unit harness connector			Resistance (Ω)
Connector No.	Terminal No.		
M110	24	22	Approx. 54 – 66

Is the measurement value within the specification?

- YES >> GO TO 3.
NO >> Repair the pre-crash seat belt control unit branch line.

3. CHECK POWER SUPPLY AND GROUND CIRCUIT

Check the power supply and the ground circuit of the pre-crash seat belt control unit. Refer to [SBC-24, "Diagnosis Procedure"](#).

Is the inspection result normal?

- YES (Present error)>>Replace the pre-crash seat belt control unit. Refer to [SBC-39, "Exploded View"](#).
YES (Past error)>>Error was detected in the pre-crash seat belt control unit branch line.
NO >> Repair the power supply and the ground circuit.

A
B
C
D
E
F
G
H
I
J
K
L

LAN

N
O
P

A-BAG BRANCH LINE CIRCUIT

< DTC/CIRCUIT DIAGNOSIS >

[CAN SYSTEM (TYPE 5)]

A-BAG BRANCH LINE CIRCUIT

Diagnosis Procedure

INFOID:000000005869081

WARNING:

- Before servicing, turn ignition switch OFF, disconnect battery negative terminal, and wait 3 minutes or more. (To discharge backup capacitor.)
- Never use unspecified tester or other measuring device.

1. CHECK CONNECTOR

1. Turn the ignition switch OFF.
2. Disconnect the battery cable from the negative terminal.
3. Check the terminals and connectors of the air bag diagnosis sensor unit for damage, bend and loose connection (unit side and connector side).

Is the inspection result normal?

YES >> GO TO 2.

NO >> Replace the main harness.

2. CHECK AIR BAG DIAGNOSIS SENSOR UNIT

Check the air bag diagnosis sensor unit. Refer to [SRC-5, "Work Flow"](#).

Is the inspection result normal?

YES >> Replace the main harness.

NO >> Replace parts whose air bag system has a malfunction.

BCM BRANCH LINE CIRCUIT

< DTC/CIRCUIT DIAGNOSIS >

[CAN SYSTEM (TYPE 5)]

BCM BRANCH LINE CIRCUIT

Diagnosis Procedure

INFOID:000000005779141

1. CHECK CONNECTOR

1. Turn the ignition switch OFF.
2. Disconnect the battery cable from the negative terminal.
3. Check the terminals and connectors of the BCM for damage, bend and loose connection (unit side and connector side).

Is the inspection result normal?

- YES >> GO TO 2.
NO >> Repair the terminal and connector.

2. CHECK HARNESS FOR OPEN CIRCUIT

1. Disconnect the connector of BCM.
2. Check the resistance between the BCM harness connector terminals.

BCM harness connector			Resistance (Ω)
Connector No.	Terminal No.		
M122	91	90	Approx. 54 – 66

Is the measurement value within the specification?

- YES >> GO TO 3.
NO >> Repair the BCM branch line.

3. CHECK POWER SUPPLY AND GROUND CIRCUIT

Check the power supply and the ground circuit of the BCM. Refer to [BCS-37, "Diagnosis Procedure"](#).

Is the inspection result normal?

- YES (Present error)>>Replace the BCM. Refer to [BCS-80, "Exploded View"](#).
YES (Past error)>>Error was detected in the BCM branch line.
NO >> Repair the power supply and the ground circuit.

A
B
C
D
E
F
G
H
I
J
K
L

LAN

N
O
P

DLC BRANCH LINE CIRCUIT

< DTC/CIRCUIT DIAGNOSIS >

[CAN SYSTEM (TYPE 5)]

DLC BRANCH LINE CIRCUIT

Diagnosis Procedure

INFOID:000000005779142

1. CHECK CONNECTOR

1. Turn the ignition switch OFF.
2. Disconnect the battery cable from the negative terminal.
3. Check the terminals and connectors of the data link connector for damage, bend and loose connection (connector side and harness side).

Is the inspection result normal?

- YES >> GO TO 2.
NO >> Repair the terminal and connector.

2. CHECK HARNESS FOR OPEN CIRCUIT

Check the resistance between the data link connector terminals.

Data link connector			Resistance (Ω)
Connector No.	Terminal No.		
M24	6	14	Approx. 54 – 66

Is the measurement value within the specification?

- YES (Present error)>>Check CAN system type decision again.
YES (Past error)>>Error was detected in the data link connector branch line circuit.
NO >> Repair the data link connector branch line.

M&A BRANCH LINE CIRCUIT

Diagnosis Procedure

INFOID:000000005779143

1.CHECK CONNECTOR

1. Turn the ignition switch OFF.
2. Disconnect the battery cable from the negative terminal.
3. Check the terminals and connectors of the unified meter and A/C amp. for damage, bend and loose connection (unit side and connector side).

Is the inspection result normal?

- YES >> GO TO 2.
 NO >> Repair the terminal and connector.

2.CHECK HARNESS FOR OPEN CIRCUIT

1. Disconnect the connector of unified meter and A/C amp.
2. Check the resistance between the unified meter and A/C amp. harness connector terminals.

Unified meter and A/C amp. harness connector		Resistance (Ω)
Connector No.	Terminal No.	
M67	56 72	Approx. 54 – 66

Is the measurement value within the specification?

- YES >> GO TO 3.
 NO >> Repair the unified meter and A/C amp. branch line.

3.CHECK POWER SUPPLY AND GROUND CIRCUIT

Check the power supply and the ground circuit of the unified meter and A/C amp. Refer to [MWI-51, "UNIFIED METER AND A/C AMP. : Diagnosis Procedure"](#).

Is the inspection result normal?

- YES (Present error)>>Replace the unified meter and A/C amp. Refer to [MWI-136, "Exploded View"](#).
 YES (Past error)>>Error was detected in the unified meter and A/C amp. branch line.
 NO >> Repair the power supply and the ground circuit.

LAN

STRG BRANCH LINE CIRCUIT

< DTC/CIRCUIT DIAGNOSIS >

[CAN SYSTEM (TYPE 5)]

STRG BRANCH LINE CIRCUIT

Diagnosis Procedure

INFOID:000000005779144

1. CHECK CONNECTOR

1. Turn the ignition switch OFF.
2. Disconnect the battery cable from the negative terminal.
3. Check the terminals and connectors of the steering angle sensor for damage, bend and loose connection (unit side and connector side).

Is the inspection result normal?

- YES >> GO TO 2.
NO >> Repair the terminal and connector.

2. CHECK HARNESS FOR OPEN CIRCUIT

1. Disconnect the connector of steering angle sensor.
2. Check the resistance between the steering angle sensor harness connector terminals.

Steering angle sensor harness connector			Resistance (Ω)
Connector No.	Terminal No.		
M37	1	2	Approx. 54 – 66

Is the measurement value within the specification?

- YES >> GO TO 3.
NO >> Repair the steering angle sensor branch line.

3. CHECK POWER SUPPLY AND GROUND CIRCUIT

Check the power supply and the ground circuit of the steering angle sensor. Refer to [BRC-83, "Wiring Diagram - BRAKE CONTROL SYSTEM -"](#).

Is the inspection result normal?

- YES (Present error)>>Replace the steering angle sensor. Refer to [BRC-110, "Exploded View"](#).
YES (Past error)>>Error was detected in the steering angle sensor branch line.
NO >> Repair the power supply and the ground circuit.

ADP BRANCH LINE CIRCUIT

< DTC/CIRCUIT DIAGNOSIS >

[CAN SYSTEM (TYPE 5)]

ADP BRANCH LINE CIRCUIT

Diagnosis Procedure

INFOID:000000005779145

1. CHECK CONNECTOR

1. Turn the ignition switch OFF.
2. Disconnect the battery cable from the negative terminal.
3. Check the following terminals and connectors for damage, bend and loose connection (unit side and connector side).
 - Driver seat control unit
 - Harness connector B462
 - Harness connector B59

Is the inspection result normal?

- YES >> GO TO 2.
NO >> Repair the terminal and connector.

2. CHECK HARNESS FOR OPEN CIRCUIT

1. Disconnect the connector of driver seat control unit.
2. Check the resistance between the driver seat control unit harness connector terminals.

Driver seat control unit harness connector			Resistance (Ω)
Connector No.	Terminal No.		
B451	3	19	Approx. 54 – 66

Is the measurement value within the specification?

- YES >> GO TO 3.
NO >> Repair the driver seat control unit branch line.

3. CHECK POWER SUPPLY AND GROUND CIRCUIT

Check the power supply and the ground circuit of the driver seat control unit. Refer to [ADP-65, "DRIVER SEAT CONTROL UNIT : Diagnosis Procedure"](#).

Is the inspection result normal?

- YES (Present error)>>Replace the driver seat control unit. Refer to [ADP-228, "Exploded View"](#).
YES (Past error)>>Error was detected in the driver seat control unit branch line.
NO >> Repair the power supply and the ground circuit.

A
B
C
D
E
F
G
H
I
J
K
L

LAN

N
O
P

RAS BRANCH LINE CIRCUIT

< DTC/CIRCUIT DIAGNOSIS >

[CAN SYSTEM (TYPE 5)]

RAS BRANCH LINE CIRCUIT

Diagnosis Procedure

INFOID:000000005779146

1. CHECK CONNECTOR

1. Turn the ignition switch OFF.
2. Disconnect the battery cable from the negative terminal.
3. Check the terminals and connectors of the 4WAS main control unit for damage, bend and loose connection (unit side and connector side).

Is the inspection result normal?

- YES >> GO TO 2.
NO >> Repair the terminal and connector.

2. CHECK HARNESS FOR OPEN CIRCUIT

1. Disconnect the connector of 4WAS main control unit.
2. Check the resistance between the 4WAS main control unit harness connector terminals.

4WAS main control unit harness connector			Resistance (Ω)
Connector No.	Terminal No.		
B54	1	8	Approx. 54 – 66

Is the measurement value within the specification?

- YES >> GO TO 3.
NO >> Replace the body harness.

3. CHECK POWER SUPPLY AND GROUND CIRCUIT

Check the power supply and the ground circuit of the 4WAS main control unit. Refer to [STC-136, "Diagnosis Procedure \(4WAS Main Control Unit\)"](#).

Is the inspection result normal?

- YES (Present error)>>Replace the 4WAS main control unit. Refer to [STC-185, "Exploded View"](#).
YES (Past error)>>Error was detected in the 4WAS main control unit branch line.
NO >> Repair the power supply and the ground circuit.

ABS BRANCH LINE CIRCUIT

< DTC/CIRCUIT DIAGNOSIS >

[CAN SYSTEM (TYPE 5)]

ABS BRANCH LINE CIRCUIT

Diagnosis Procedure

INFOID:000000005779147

1. CHECK CONNECTOR

1. Turn the ignition switch OFF.
2. Disconnect the battery cable from the negative terminal.
3. Check the terminals and connectors of the ABS actuator and electric unit (control unit) for damage, bend and loose connection (unit side and connector side).

Is the inspection result normal?

- YES >> GO TO 2.
NO >> Repair the terminal and connector.

2. CHECK HARNESS FOR OPEN CIRCUIT

1. Disconnect the connector of ABS actuator and electric unit (control unit).
2. Check the resistance between the ABS actuator and electric unit (control unit) harness connector terminals.

ABS actuator and electric unit (control unit) harness connector			Resistance (Ω)
Connector No.	Terminal No.		
E41	35	14	Approx. 54 – 66

Is the measurement value within the specification?

- YES >> GO TO 3.
NO >> Repair the ABS actuator and electric unit (control unit) branch line.

3. CHECK POWER SUPPLY AND GROUND CIRCUIT

Check the power supply and the ground circuit of the ABS actuator and electric unit (control unit). Refer to [BRC-69, "Diagnosis Procedure"](#).

Is the inspection result normal?

- YES (Present error)>>Replace the ABS actuator and electric unit (control unit). Refer to [BRC-107, "Exploded View"](#).
YES (Past error)>>Error was detected in the ABS actuator and electric unit (control unit) branch line.
NO >> Repair the power supply and the ground circuit.

A
B
C
D
E
F
G
H
I
J
K
L

LAN

ICC BRANCH LINE CIRCUIT

Diagnosis Procedure

INFOID:000000005779148

1. CHECK CONNECTOR

1. Turn the ignition switch OFF.
2. Disconnect the battery cable from the negative terminal.
3. Check the terminals and connectors of the ICC sensor integrated unit for damage, bend and loose connection (unit side and connector side).

Is the inspection result normal?

- YES >> GO TO 2.
 NO >> Repair the terminal and connector.

2. CHECK HARNESS FOR OPEN CIRCUIT

1. Disconnect the connector of ICC sensor integrated unit.
2. Check the resistance between the ICC sensor integrated unit harness connector terminals.

ICC sensor integrated unit harness connector			Resistance (Ω)
Connector No.	Terminal No.		
E67	3	6	Approx. 54 – 66

Is the measurement value within the specification?

- YES >> GO TO 3.
 NO >> Repair the ICC sensor integrated unit branch line.

3. CHECK POWER SUPPLY AND GROUND CIRCUIT

Check the power supply and the ground circuit of the ICC sensor integrated unit. Refer to [CCS-102, "Diagnosis Procedure"](#).

Is the inspection result normal?

- YES (Present error)>>Replace the ICC sensor integrated unit. Refer to [CCS-134, "Exploded View"](#).
 YES (Past error)>>Error was detected in the ICC sensor integrated unit branch line.
 NO >> Repair the power supply and the ground circuit.

IPDM-E BRANCH LINE CIRCUIT

< DTC/CIRCUIT DIAGNOSIS >

[CAN SYSTEM (TYPE 5)]

IPDM-E BRANCH LINE CIRCUIT

Diagnosis Procedure

INFOID:000000005779149

1. CHECK CONNECTOR

1. Turn the ignition switch OFF.
2. Disconnect the battery cable from the negative terminal.
3. Check the terminals and connectors of the IPDM E/R for damage, bend and loose connection (unit side and connector side).

Is the inspection result normal?

- YES >> GO TO 2.
NO >> Repair the terminal and connector.

2. CHECK HARNESS FOR OPEN CIRCUIT

1. Disconnect the connector of IPDM E/R.
2. Check the resistance between the IPDM E/R harness connector terminals.

IPDM E/R harness connector			Resistance (Ω)
Connector No.	Terminal No.		
E6	40	39	Approx. 108 – 132

Is the measurement value within the specification?

- YES >> GO TO 3.
NO >> Repair the IPDM E/R branch line.

3. CHECK POWER SUPPLY AND GROUND CIRCUIT

Check the power supply and the ground circuit of the IPDM E/R. Refer to [PCS-18, "Diagnosis Procedure"](#).

Is the inspection result normal?

- YES (Present error)>>Replace the IPDM E/R. Refer to [PCS-33, "Exploded View"](#).
YES (Past error)>>Error was detected in the IPDM E/R branch line.
NO >> Repair the power supply and the ground circuit.

A
B
C
D
E
F
G
H
I
J
K
L

LAN

N
O
P

CAN COMMUNICATION CIRCUIT

< DTC/CIRCUIT DIAGNOSIS >

[CAN SYSTEM (TYPE 5)]

CAN COMMUNICATION CIRCUIT

Diagnosis Procedure

INFOID:000000005779150

1. CONNECTOR INSPECTION

1. Turn the ignition switch OFF.
2. Disconnect the battery cable from the negative terminal.
3. Disconnect all the unit connectors on CAN communication system.
4. Check terminals and connectors for damage, bend and loose connection.

Is the inspection result normal?

- YES >> GO TO 2.
NO >> Repair the terminal and connector.

2. CHECK HARNESS CONTINUITY (SHORT CIRCUIT)

Check the continuity between the data link connector terminals.

Data link connector		Continuity
Connector No.	Terminal No.	
M24	6 14	Not existed

Is the inspection result normal?

- YES >> GO TO 3.
NO >> Check the harness and repair the root cause.

3. CHECK HARNESS CONTINUITY (SHORT CIRCUIT)

Check the continuity between the data link connector and the ground.

Data link connector		Ground	Continuity
Connector No.	Terminal No.		
M24	6		Not existed
	14		Not existed

Is the inspection result normal?

- YES >> GO TO 4.
NO >> Check the harness and repair the root cause.

4. CHECK ECM AND IPDM E/R TERMINATION CIRCUIT

1. Remove the ECM and the IPDM E/R.
2. Check the resistance between the ECM terminals.

ECM		Resistance (Ω)
Terminal No.		
114	113	Approx. 108 – 132

3. Check the resistance between the IPDM E/R terminals.

IPDM E/R		Resistance (Ω)
Terminal No.		
40	39	Approx. 108 – 132

Is the measurement value within the specification?

- YES >> GO TO 5.
NO >> Replace the ECM and/or the IPDM E/R.

5. CHECK SYMPTOM

Connect all the connectors. Check if the symptoms described in the "Symptom (Results from interview with customer)" are reproduced.

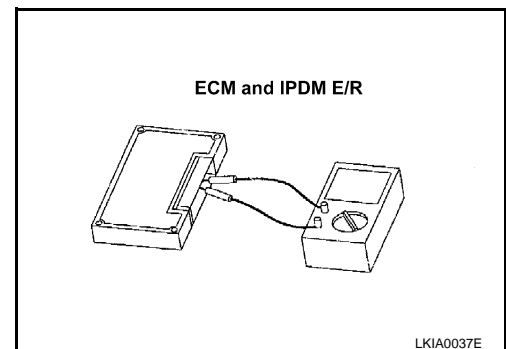

LKIA0037E

CAN COMMUNICATION CIRCUIT

< DTC/CIRCUIT DIAGNOSIS >

[CAN SYSTEM (TYPE 5)]

Inspection result

Reproduced>>GO TO 6.

Non-reproduced>>Start the diagnosis again. Follow the trouble diagnosis procedure when past error is detected.

6.CHECK UNIT REPRODUCTION

Perform the reproduction test as per the following procedure for each unit.

1. Turn the ignition switch OFF.
2. Disconnect the battery cable from the negative terminal.
3. Disconnect one of the unit connectors of CAN communication system.

NOTE:

ECM and IPDM E/R have a termination circuit. Check other units first.

4. Connect the battery cable to the negative terminal. Check if the symptoms described in the “Symptom (Results from interview with customer)” are reproduced.

NOTE:

Although unit-related error symptoms occur, do not confuse them with other symptoms.

Inspection result

Reproduced>>Connect the connector. Check other units as per the above procedure.

Non-reproduced>>Replace the unit whose connector was disconnected.

A
B
C
D
E
F
G
H
I
J
K
L

LAN

N
O
P

MAIN LINE BETWEEN AV AND DLC CIRCUIT

< DTC/CIRCUIT DIAGNOSIS >

[CAN SYSTEM (TYPE 6)]

DTC/CIRCUIT DIAGNOSIS

MAIN LINE BETWEEN AV AND DLC CIRCUIT

Diagnosis Procedure

INFOID:000000005779160

1. CHECK HARNESS CONTINUITY (OPEN CIRCUIT)

1. Turn the ignition switch OFF.
2. Disconnect the battery cable from the negative terminal.
3. Disconnect the following harness connectors.
 - ECM
 - AV control unit
4. Check the continuity between the AV control unit harness connector and the data link connector.
 - With navigation system

AV control unit harness connector		Data link connector		Continuity
Connector No.	Terminal No.	Connector No.	Terminal No.	
M210	90	M24	6	Existed
	74		14	Existed

- Without navigation system (With rear view monitor)

AV control unit harness connector		Data link connector		Continuity
Connector No.	Terminal No.	Connector No.	Terminal No.	
M204	81	M24	6	Existed
	80		14	Existed

- Without navigation system (Without rear view monitor)

AV control unit harness connector		Data link connector		Continuity
Connector No.	Terminal No.	Connector No.	Terminal No.	
M85	86	M24	6	Existed
	87		14	Existed

Is the inspection result normal?

YES (Present error)>>Check CAN system type decision again.

YES (Past error)>>Error was detected in the main line between the AV control unit and the data link connector.

NO >> Repair the main line between the AV control unit and the data link connector.

MAIN LINE BETWEEN DLC AND ABS CIRCUIT

< DTC/CIRCUIT DIAGNOSIS >

[CAN SYSTEM (TYPE 6)]

MAIN LINE BETWEEN DLC AND ABS CIRCUIT

Diagnosis Procedure

INFOID:000000005779161

1. CHECK CONNECTOR

1. Turn the ignition switch OFF.
2. Disconnect the battery cable from the negative terminal.
3. Check the following terminals and connectors for damage, bend and loose connection (connector side and harness side).
 - Harness connector M6
 - Harness connector E106

Is the inspection result normal?

YES >> GO TO 2.

NO >> Repair the terminal and connector.

2. CHECK HARNESS CONTINUITY (OPEN CIRCUIT)

1. Disconnect the harness connectors M6 and E106.
2. Check the continuity between the data link connector and the harness connector.

Data link connector		Harness connector		Continuity
Connector No.	Terminal No.	Connector No.	Terminal No.	
M24	6	M6	7	Existed
	14		6	Existed

Is the inspection result normal?

YES >> GO TO 3.

NO >> Repair the main line between the data link connector and the harness connector M6.

3. CHECK HARNESS CONTINUITY (OPEN CIRCUIT)

1. Disconnect the connector of ABS actuator and electric unit (control unit).
2. Check the continuity between the harness connector and the ABS actuator and electric unit (control unit) harness connector.

Harness connector		ABS actuator and electric unit (control unit) harness connector		Continuity
Connector No.	Terminal No.	Connector No.	Terminal No.	
E106	7	E41	35	Existed
	6		14	Existed

Is the inspection result normal?

YES (Present error)>>Check CAN system type decision again.

YES (Past error)>>Error was detected in the main line between the data link connector and the ABS actuator and electric unit (control unit).

NO >> Repair the main line between the harness connector E106 and the ABS actuator and electric unit (control unit).

A
B
C
D
E
F
G
H
I
J
K
L
N
O
P

LAN

ECM BRANCH LINE CIRCUIT

< DTC/CIRCUIT DIAGNOSIS >

[CAN SYSTEM (TYPE 6)]

ECM BRANCH LINE CIRCUIT

Diagnosis Procedure

INFOID:000000005779162

1. CHECK CONNECTOR

1. Turn the ignition switch OFF.
2. Disconnect the battery cable from the negative terminal.
3. Check the terminals and connectors of the ECM for damage, bend and loose connection (unit side and connector side).

Is the inspection result normal?

- YES >> GO TO 2.
NO >> Repair the terminal and connector.

2. CHECK HARNESS FOR OPEN CIRCUIT

1. Disconnect the connector of ECM.
2. Check the resistance between the ECM harness connector terminals.

ECM harness connector			Resistance (Ω)
Connector No.	Terminal No.		
M107	114	113	Approx. 108 – 132

Is the measurement value within the specification?

- YES >> GO TO 3.
NO >> Repair the ECM branch line.

3. CHECK POWER SUPPLY AND GROUND CIRCUIT

Check the power supply and the ground circuit of the ECM. Refer to [EC-144, "Diagnosis Procedure"](#).

Is the inspection result normal?

YES (Present error)>>Replace the ECM. Refer to [EC-17, "ADDITIONAL SERVICE WHEN REPLACING CONTROL UNIT \(ECM\) : Special Repair Requirement"](#).

YES (Past error)>>Error was detected in the ECM branch line.

NO >> Repair the power supply and the ground circuit.

AV BRANCH LINE CIRCUIT

Diagnosis Procedure

INFOID:000000005779163

1. CHECK CONNECTOR

1. Turn the ignition switch OFF.
2. Disconnect the battery cable from the negative terminal.
3. Check the terminals and connectors of the AV control unit for damage, bend and loose connection (unit side and connector side).

Is the inspection result normal?

- YES >> GO TO 2.
 NO >> Repair the terminal and connector.

2. CHECK HARNESS FOR OPEN CIRCUIT

1. Disconnect the connector of AV control unit.
 2. Check the resistance between the AV control unit harness connector terminals.
- Models with navigation system

AV control unit harness connector			Resistance (Ω)
Connector No.	Terminal No.		
M210	90	74	Approx. 54 – 66

- Models without navigation system (With rear view monitor)

AV control unit harness connector			Resistance (Ω)
Connector No.	Terminal No.		
M204	81	80	Approx. 54 – 66

- Models without navigation system (Without rear view monitor)

AV control unit harness connector			Resistance (Ω)
Connector No.	Terminal No.		
M85	86	87	Approx. 54 – 66

Is the measurement value within the specification?

- YES >> GO TO 3.
 NO >> Repair the AV control unit branch line.

3. CHECK POWER SUPPLY AND GROUND CIRCUIT

Check the power supply and the ground circuit of the AV control unit. Refer to the following.

- Base audio without rear view monitor: [AV-40, "AV CONTROL UNIT : Diagnosis Procedure"](#)
- Base audio with rear view monitor: [AV-173, "AV CONTROL UNIT : Diagnosis Procedure"](#)
- BOSE audio without navigation: [AV-297, "AV CONTROL UNIT : Diagnosis Procedure"](#)
- BOSE audio with navigation: [AV-448, "AV CONTROL UNIT : Diagnosis Procedure"](#)

Is the inspection result normal?

- YES (Present error)>>Replace the AV control unit. Refer to the following.
- Base audio without rear view monitor: [AV-90, "Exploded View"](#)
 - Base audio with rear view monitor: [AV-202, "Exploded View"](#)
 - BOSE audio without navigation: [AV-328, "Exploded View"](#)
 - BOSE audio with navigation: [AV-474, "Exploded View"](#)

YES (Past error)>>Error was detected in the AV control unit branch line.

- NO >> Repair the power supply and the ground circuit.

A
B
C
D
E
F
G
H
I
J
K
L

LAN

N
O
P

TCM BRANCH LINE CIRCUIT

< DTC/CIRCUIT DIAGNOSIS >

[CAN SYSTEM (TYPE 6)]

TCM BRANCH LINE CIRCUIT

Diagnosis Procedure

INFOID:000000005779164

1. CHECK CONNECTOR

1. Turn the ignition switch OFF.
2. Disconnect the battery cable from the negative terminal.
3. Check the following terminals and connectors for damage, bend and loose connection (unit side and connector side).
 - A/T assembly
 - Harness connector F103
 - Harness connector M116

Is the inspection result normal?

YES >> GO TO 2.

NO >> Repair the terminal and connector.

2. CHECK HARNESS FOR OPEN CIRCUIT

1. Disconnect the connector of A/T assembly.
2. Check the resistance between the A/T assembly harness connector terminals.

A/T assembly harness connector		Resistance (Ω)
Connector No.	Terminal No.	
F51	3	Approx. 54 – 66
	8	

Is the measurement value within the specification?

YES >> GO TO 3.

NO >> Repair the TCM branch line.

3. CHECK POWER SUPPLY AND GROUND CIRCUIT

Check the power supply and the ground circuit of the TCM. Refer to [TM-212, "Diagnosis Procedure"](#).

Is the inspection result normal?

YES (Present error)>>Replace the control valve with TCM. Refer to [TM-99, "Component Parts Location"](#).
(Replace A/T assembly if control valve with TCM is not listed in the latest parts list.)

YES (Past error)>>Error was detected in the TCM branch line.

NO >> Repair the power supply and the ground circuit.

A-BAG BRANCH LINE CIRCUIT

< DTC/CIRCUIT DIAGNOSIS >

[CAN SYSTEM (TYPE 6)]

A-BAG BRANCH LINE CIRCUIT

Diagnosis Procedure

INFOID:000000005869085

WARNING:

- Before servicing, turn ignition switch OFF, disconnect battery negative terminal, and wait 3 minutes or more. (To discharge backup capacitor.)
- Never use unspecified tester or other measuring device.

1. CHECK CONNECTOR

1. Turn the ignition switch OFF.
2. Disconnect the battery cable from the negative terminal.
3. Check the terminals and connectors of the air bag diagnosis sensor unit for damage, bend and loose connection (unit side and connector side).

Is the inspection result normal?

- YES >> GO TO 2.
NO >> Replace the main harness.

2. CHECK AIR BAG DIAGNOSIS SENSOR UNIT

Check the air bag diagnosis sensor unit. Refer to [SRC-5, "Work Flow"](#).

Is the inspection result normal?

- YES >> Replace the main harness.
NO >> Replace parts whose air bag system has a malfunction.

A
B
C
D
E
F
G
H
I
J
K
L
N
O
P

LAN

BCM BRANCH LINE CIRCUIT

< DTC/CIRCUIT DIAGNOSIS >

[CAN SYSTEM (TYPE 6)]

BCM BRANCH LINE CIRCUIT

Diagnosis Procedure

INFOID:000000005779166

1.CHECK CONNECTOR

1. Turn the ignition switch OFF.
2. Disconnect the battery cable from the negative terminal.
3. Check the terminals and connectors of the BCM for damage, bend and loose connection (unit side and connector side).

Is the inspection result normal?

- YES >> GO TO 2.
NO >> Repair the terminal and connector.

2.CHECK HARNESS FOR OPEN CIRCUIT

1. Disconnect the connector of BCM.
2. Check the resistance between the BCM harness connector terminals.

BCM harness connector			Resistance (Ω)
Connector No.	Terminal No.		
M122	91	90	Approx. 54 – 66

Is the measurement value within the specification?

- YES >> GO TO 3.
NO >> Repair the BCM branch line.

3.CHECK POWER SUPPLY AND GROUND CIRCUIT

Check the power supply and the ground circuit of the BCM. Refer to [BCS-37, "Diagnosis Procedure"](#).

Is the inspection result normal?

- YES (Present error)>>Replace the BCM. Refer to [BCS-80, "Exploded View"](#).
YES (Past error)>>Error was detected in the BCM branch line.
NO >> Repair the power supply and the ground circuit.

DLC BRANCH LINE CIRCUIT

< DTC/CIRCUIT DIAGNOSIS >

[CAN SYSTEM (TYPE 6)]

DLC BRANCH LINE CIRCUIT

Diagnosis Procedure

INFOID:000000005779167

1. CHECK CONNECTOR

1. Turn the ignition switch OFF.
2. Disconnect the battery cable from the negative terminal.
3. Check the terminals and connectors of the data link connector for damage, bend and loose connection (connector side and harness side).

Is the inspection result normal?

- YES >> GO TO 2.
NO >> Repair the terminal and connector.

2. CHECK HARNESS FOR OPEN CIRCUIT

Check the resistance between the data link connector terminals.

Data link connector			Resistance (Ω)
Connector No.	Terminal No.		
M24	6	14	Approx. 54 – 66

Is the measurement value within the specification?

- YES (Present error)>>Check CAN system type decision again.
YES (Past error)>>Error was detected in the data link connector branch line circuit.
NO >> Repair the data link connector branch line.

A
B
C
D
E
F
G
H
I
J
K
L
N
O
P

LAN

M&A BRANCH LINE CIRCUIT

Diagnosis Procedure

INFOID:000000005779168

1.CHECK CONNECTOR

1. Turn the ignition switch OFF.
2. Disconnect the battery cable from the negative terminal.
3. Check the terminals and connectors of the unified meter and A/C amp. for damage, bend and loose connection (unit side and connector side).

Is the inspection result normal?

- YES >> GO TO 2.
 NO >> Repair the terminal and connector.

2.CHECK HARNESS FOR OPEN CIRCUIT

1. Disconnect the connector of unified meter and A/C amp.
2. Check the resistance between the unified meter and A/C amp. harness connector terminals.

Unified meter and A/C amp. harness connector			Resistance (Ω)
Connector No.	Terminal No.		
M67	56	72	Approx. 54 – 66

Is the measurement value within the specification?

- YES >> GO TO 3.
 NO >> Repair the unified meter and A/C amp. branch line.

3.CHECK POWER SUPPLY AND GROUND CIRCUIT

Check the power supply and the ground circuit of the unified meter and A/C amp. Refer to [MWI-51, "UNIFIED METER AND A/C AMP. : Diagnosis Procedure"](#).

Is the inspection result normal?

- YES (Present error)>>Replace the unified meter and A/C amp. Refer to [MWI-136, "Exploded View"](#).
 YES (Past error)>>Error was detected in the unified meter and A/C amp. branch line.
 NO >> Repair the power supply and the ground circuit.

STRG BRANCH LINE CIRCUIT

< DTC/CIRCUIT DIAGNOSIS >

[CAN SYSTEM (TYPE 6)]

STRG BRANCH LINE CIRCUIT

Diagnosis Procedure

INFOID:000000005779169

1.CHECK CONNECTOR

1. Turn the ignition switch OFF.
2. Disconnect the battery cable from the negative terminal.
3. Check the terminals and connectors of the steering angle sensor for damage, bend and loose connection (unit side and connector side).

Is the inspection result normal?

- YES >> GO TO 2.
NO >> Repair the terminal and connector.

2.CHECK HARNESS FOR OPEN CIRCUIT

1. Disconnect the connector of steering angle sensor.
2. Check the resistance between the steering angle sensor harness connector terminals.

Steering angle sensor harness connector			Resistance (Ω)
Connector No.	Terminal No.		
M37	1	2	Approx. 54 – 66

Is the measurement value within the specification?

- YES >> GO TO 3.
NO >> Repair the steering angle sensor branch line.

3.CHECK POWER SUPPLY AND GROUND CIRCUIT

Check the power supply and the ground circuit of the steering angle sensor. Refer to [BRC-83, "Wiring Diagram - BRAKE CONTROL SYSTEM -"](#).

Is the inspection result normal?

- YES (Present error)>>Replace the steering angle sensor. Refer to [BRC-110, "Exploded View"](#).
YES (Past error)>>Error was detected in the steering angle sensor branch line.
NO >> Repair the power supply and the ground circuit.

A
B
C
D
E
F
G
H
I
J
K
L

LAN

N
O
P

ABS BRANCH LINE CIRCUIT

< DTC/CIRCUIT DIAGNOSIS >

[CAN SYSTEM (TYPE 6)]

ABS BRANCH LINE CIRCUIT

Diagnosis Procedure

INFOID:000000005779170

1. CHECK CONNECTOR

1. Turn the ignition switch OFF.
2. Disconnect the battery cable from the negative terminal.
3. Check the terminals and connectors of the ABS actuator and electric unit (control unit) for damage, bend and loose connection (unit side and connector side).

Is the inspection result normal?

- YES >> GO TO 2.
NO >> Repair the terminal and connector.

2. CHECK HARNESS FOR OPEN CIRCUIT

1. Disconnect the connector of ABS actuator and electric unit (control unit).
2. Check the resistance between the ABS actuator and electric unit (control unit) harness connector terminals.

ABS actuator and electric unit (control unit) harness connector			Resistance (Ω)
Connector No.	Terminal No.		
E41	35	14	Approx. 54 – 66

Is the measurement value within the specification?

- YES >> GO TO 3.
NO >> Repair the ABS actuator and electric unit (control unit) branch line.

3. CHECK POWER SUPPLY AND GROUND CIRCUIT

Check the power supply and the ground circuit of the ABS actuator and electric unit (control unit). Refer to [BRC-69. "Diagnosis Procedure"](#).

Is the inspection result normal?

- YES (Present error)>>Replace the ABS actuator and electric unit (control unit). Refer to [BRC-107. "Exploded View"](#).
YES (Past error)>>Error was detected in the ABS actuator and electric unit (control unit) branch line.
NO >> Repair the power supply and the ground circuit.

IPDM-E BRANCH LINE CIRCUIT

< DTC/CIRCUIT DIAGNOSIS >

[CAN SYSTEM (TYPE 6)]

IPDM-E BRANCH LINE CIRCUIT

Diagnosis Procedure

INFOID:000000005779171

1. CHECK CONNECTOR

1. Turn the ignition switch OFF.
2. Disconnect the battery cable from the negative terminal.
3. Check the terminals and connectors of the IPDM E/R for damage, bend and loose connection (unit side and connector side).

Is the inspection result normal?

- YES >> GO TO 2.
NO >> Repair the terminal and connector.

2. CHECK HARNESS FOR OPEN CIRCUIT

1. Disconnect the connector of IPDM E/R.
2. Check the resistance between the IPDM E/R harness connector terminals.

IPDM E/R harness connector			Resistance (Ω)
Connector No.	Terminal No.		
E6	40	39	Approx. 108 – 132

Is the measurement value within the specification?

- YES >> GO TO 3.
NO >> Repair the IPDM E/R branch line.

3. CHECK POWER SUPPLY AND GROUND CIRCUIT

Check the power supply and the ground circuit of the IPDM E/R. Refer to [PCS-18, "Diagnosis Procedure"](#).

Is the inspection result normal?

- YES (Present error)>>Replace the IPDM E/R. Refer to [PCS-33, "Exploded View"](#).
YES (Past error)>>Error was detected in the IPDM E/R branch line.
NO >> Repair the power supply and the ground circuit.

A
B
C
D
E
F
G
H
I
J
K
L

LAN

N
O
P

CAN COMMUNICATION CIRCUIT

< DTC/CIRCUIT DIAGNOSIS >

[CAN SYSTEM (TYPE 6)]

CAN COMMUNICATION CIRCUIT

Diagnosis Procedure

INFOID:000000005779172

1. CONNECTOR INSPECTION

1. Turn the ignition switch OFF.
2. Disconnect the battery cable from the negative terminal.
3. Disconnect all the unit connectors on CAN communication system.
4. Check terminals and connectors for damage, bend and loose connection.

Is the inspection result normal?

- YES >> GO TO 2.
NO >> Repair the terminal and connector.

2. CHECK HARNESS CONTINUITY (SHORT CIRCUIT)

Check the continuity between the data link connector terminals.

Data link connector			Continuity
Connector No.	Terminal No.		
M24	6	14	Not existed

Is the inspection result normal?

- YES >> GO TO 3.
NO >> Check the harness and repair the root cause.

3. CHECK HARNESS CONTINUITY (SHORT CIRCUIT)

Check the continuity between the data link connector and the ground.

Data link connector		Ground	Continuity
Connector No.	Terminal No.		
M24	6		Not existed
	14		Not existed

Is the inspection result normal?

- YES >> GO TO 4.
NO >> Check the harness and repair the root cause.

4. CHECK ECM AND IPDM E/R TERMINATION CIRCUIT

1. Remove the ECM and the IPDM E/R.
2. Check the resistance between the ECM terminals.

ECM		Resistance (Ω)
Terminal No.		
114	113	Approx. 108 – 132

3. Check the resistance between the IPDM E/R terminals.

IPDM E/R		Resistance (Ω)
Terminal No.		
40	39	Approx. 108 – 132

Is the measurement value within the specification?

- YES >> GO TO 5.
NO >> Replace the ECM and/or the IPDM E/R.

5. CHECK SYMPTOM

Connect all the connectors. Check if the symptoms described in the "Symptom (Results from interview with customer)" are reproduced.

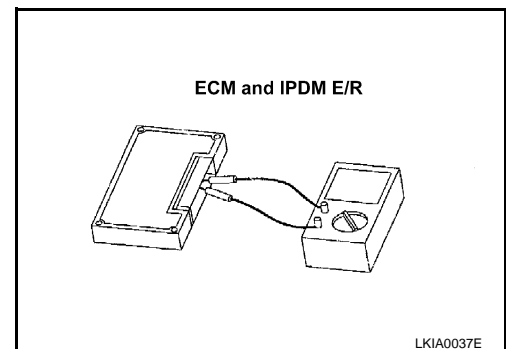

CAN COMMUNICATION CIRCUIT

< DTC/CIRCUIT DIAGNOSIS >

[CAN SYSTEM (TYPE 6)]

Inspection result

Reproduced>>GO TO 6.

Non-reproduced>>Start the diagnosis again. Follow the trouble diagnosis procedure when past error is detected.

6.CHECK UNIT REPRODUCTION

Perform the reproduction test as per the following procedure for each unit.

1. Turn the ignition switch OFF.
2. Disconnect the battery cable from the negative terminal.
3. Disconnect one of the unit connectors of CAN communication system.

NOTE:

ECM and IPDM E/R have a termination circuit. Check other units first.

4. Connect the battery cable to the negative terminal. Check if the symptoms described in the "Symptom (Results from interview with customer)" are reproduced.

NOTE:

Although unit-related error symptoms occur, do not confuse them with other symptoms.

Inspection result

Reproduced>>Connect the connector. Check other units as per the above procedure.

Non-reproduced>>Replace the unit whose connector was disconnected.

A
B
C
D
E
F
G
H
I
J
K
L

LAN

N
O
P

MAIN LINE BETWEEN AV AND DLC CIRCUIT

< DTC/CIRCUIT DIAGNOSIS >

[CAN SYSTEM (TYPE 7)]

DTC/CIRCUIT DIAGNOSIS

MAIN LINE BETWEEN AV AND DLC CIRCUIT

Diagnosis Procedure

INFOID:000000005779174

1. CHECK HARNESS CONTINUITY (OPEN CIRCUIT)

1. Turn the ignition switch OFF.
2. Disconnect the battery cable from the negative terminal.
3. Disconnect the following harness connectors.
 - ECM
 - AV control unit
4. Check the continuity between the AV control unit harness connector and the data link connector.
 - With navigation system

AV control unit harness connector		Data link connector		Continuity
Connector No.	Terminal No.	Connector No.	Terminal No.	
M210	90	M24	6	Existed
	74		14	Existed

- Without navigation system (With rear view monitor)

AV control unit harness connector		Data link connector		Continuity
Connector No.	Terminal No.	Connector No.	Terminal No.	
M204	81	M24	6	Existed
	80		14	Existed

- Without navigation system (Without rear view monitor)

AV control unit harness connector		Data link connector		Continuity
Connector No.	Terminal No.	Connector No.	Terminal No.	
M85	86	M24	6	Existed
	87		14	Existed

Is the inspection result normal?

YES (Present error)>>Check CAN system type decision again.

YES (Past error)>>Error was detected in the main line between the AV control unit and the data link connector.

NO >> Repair the main line between the AV control unit and the data link connector.

MAIN LINE BETWEEN DLC AND ADP CIRCUIT

< DTC/CIRCUIT DIAGNOSIS >

[CAN SYSTEM (TYPE 7)]

MAIN LINE BETWEEN DLC AND ADP CIRCUIT

Diagnosis Procedure

INFOID:000000005779175

1.CHECK CONNECTOR

1. Turn the ignition switch OFF.
2. Disconnect the battery cable from the negative terminal.
3. Check the following terminals and connectors for damage, bend and loose connection (connector side and harness side).
 - Harness connector M7
 - Harness connector B1

Is the inspection result normal?

YES >> GO TO 2.

NO >> Repair the terminal and connector.

2.CHECK HARNESS CONTINUITY (OPEN CIRCUIT)

1. Disconnect the harness connectors M7 and B1.
2. Check the continuity between the data link connector and the harness connector.

Data link connector		Harness connector		Continuity
Connector No.	Terminal No.	Connector No.	Terminal No.	
M24	6	M7	20	Existed
	14		21	Existed

Is the inspection result normal?

YES >> GO TO 3.

NO >> Repair the main line between the data link connector and the harness connector M7.

3.CHECK HARNESS CONTINUITY (OPEN CIRCUIT)

Check the continuity between the harness connector terminals.

Connector No.	Terminal No.		Continuity
B1	20	22	Existed
	21	23	Existed

Is the inspection result normal?

YES (Present error)>>Check CAN system type decision again.

YES (Past error)>>Error was detected in the main line between the data link connector and the driver seat control unit.

NO >> Repair the main line between the harness connector B1 and the driver seat control unit.

A
B
C
D
E
F
G
H
I
J
K
L
N
O
P

LAN

MAIN LINE BETWEEN ADP AND ABS CIRCUIT

< DTC/CIRCUIT DIAGNOSIS >

[CAN SYSTEM (TYPE 7)]

MAIN LINE BETWEEN ADP AND ABS CIRCUIT

Diagnosis Procedure

INFOID:000000005779176

1. CHECK CONNECTOR

1. Turn the ignition switch OFF.
2. Disconnect the battery cable from the negative terminal.
3. Check the following terminals and connectors for damage, bend and loose connection (connector side and harness side).
 - Harness connector B1
 - Harness connector M7
 - Harness connector M6
 - Harness connector E106

Is the inspection result normal?

YES >> GO TO 2.

NO >> Repair the terminal and connector.

2. CHECK HARNESS CONTINUITY (OPEN CIRCUIT)

1. Disconnect the harness connectors B1 and M7.
2. Check the continuity between the harness connector terminals.

Connector No.	Terminal No.		Continuity
B1	20	22	Existed
	21	23	Existed

Is the inspection result normal?

YES >> GO TO 3.

NO >> Repair the main line between the driver seat control unit and the harness connector B1.

3. CHECK HARNESS CONTINUITY (OPEN CIRCUIT)

1. Disconnect the harness connectors M6 and E106.
2. Check the continuity between the harness connectors.

Harness connector		Harness connector		Continuity
Connector No.	Terminal No.	Connector No.	Terminal No.	
M7	22	M6	7	Existed
	23		6	Existed

Is the inspection result normal?

YES >> GO TO 4.

NO >> Repair the main line between the harness connector M7 and M6.

4. CHECK HARNESS CONTINUITY (OPEN CIRCUIT)

1. Disconnect the connector of ABS actuator and electric unit (control unit).
2. Check the continuity between the harness connector and the ABS actuator and electric unit (control unit) harness connector.

Harness connector		ABS actuator and electric unit (control unit) harness connector		Continuity
Connector No.	Terminal No.	Connector No.	Terminal No.	
E106	7	E41	35	Existed
	6		14	Existed

Is the inspection result normal?

YES (Present error)>>Check CAN system type decision again.

YES (Past error)>>Error was detected in the main line between the driver seat control unit and the ABS actuator and electric unit (control unit).

MAIN LINE BETWEEN ADP AND ABS CIRCUIT

< DTC/CIRCUIT DIAGNOSIS >

[CAN SYSTEM (TYPE 7)]

NO >> Repair the main line between the harness connector E106 and the ABS actuator and electric unit (control unit).

A

B

C

D

E

F

G

H

I

J

K

L

LAN

N

O

P

ECM BRANCH LINE CIRCUIT

< DTC/CIRCUIT DIAGNOSIS >

[CAN SYSTEM (TYPE 7)]

ECM BRANCH LINE CIRCUIT

Diagnosis Procedure

INFOID:000000005779177

1. CHECK CONNECTOR

1. Turn the ignition switch OFF.
2. Disconnect the battery cable from the negative terminal.
3. Check the terminals and connectors of the ECM for damage, bend and loose connection (unit side and connector side).

Is the inspection result normal?

- YES >> GO TO 2.
NO >> Repair the terminal and connector.

2. CHECK HARNESS FOR OPEN CIRCUIT

1. Disconnect the connector of ECM.
2. Check the resistance between the ECM harness connector terminals.

ECM harness connector			Resistance (Ω)
Connector No.	Terminal No.		
M107	114	113	Approx. 108 – 132

Is the measurement value within the specification?

- YES >> GO TO 3.
NO >> Repair the ECM branch line.

3. CHECK POWER SUPPLY AND GROUND CIRCUIT

Check the power supply and the ground circuit of the ECM. Refer to [EC-144, "Diagnosis Procedure"](#).

Is the inspection result normal?

- YES (Present error)>>Replace the ECM. Refer to [EC-17, "ADDITIONAL SERVICE WHEN REPLACING CONTROL UNIT \(ECM\) : Special Repair Requirement"](#).
YES (Past error)>>Error was detected in the ECM branch line.
NO >> Repair the power supply and the ground circuit.

AV BRANCH LINE CIRCUIT

Diagnosis Procedure

INFOID:000000005779178

1. CHECK CONNECTOR

1. Turn the ignition switch OFF.
2. Disconnect the battery cable from the negative terminal.
3. Check the terminals and connectors of the AV control unit for damage, bend and loose connection (unit side and connector side).

Is the inspection result normal?

- YES >> GO TO 2.
 NO >> Repair the terminal and connector.

2. CHECK HARNESS FOR OPEN CIRCUIT

1. Disconnect the connector of AV control unit.
 2. Check the resistance between the AV control unit harness connector terminals.
- Models with navigation system

AV control unit harness connector			Resistance (Ω)
Connector No.	Terminal No.		
M210	90	74	Approx. 54 – 66

- Models without navigation system (With rear view monitor)

AV control unit harness connector			Resistance (Ω)
Connector No.	Terminal No.		
M204	81	80	Approx. 54 – 66

- Models without navigation system (Without rear view monitor)

AV control unit harness connector			Resistance (Ω)
Connector No.	Terminal No.		
M85	86	87	Approx. 54 – 66

Is the measurement value within the specification?

- YES >> GO TO 3.
 NO >> Repair the AV control unit branch line.

3. CHECK POWER SUPPLY AND GROUND CIRCUIT

Check the power supply and the ground circuit of the AV control unit. Refer to the following.

- Base audio without rear view monitor: [AV-40, "AV CONTROL UNIT : Diagnosis Procedure"](#)
- Base audio with rear view monitor: [AV-173, "AV CONTROL UNIT : Diagnosis Procedure"](#)
- BOSE audio without navigation: [AV-297, "AV CONTROL UNIT : Diagnosis Procedure"](#)
- BOSE audio with navigation: [AV-448, "AV CONTROL UNIT : Diagnosis Procedure"](#)

Is the inspection result normal?

- YES (Present error)>>Replace the AV control unit. Refer to the following.
- Base audio without rear view monitor: [AV-90, "Exploded View"](#)
 - Base audio with rear view monitor: [AV-202, "Exploded View"](#)
 - BOSE audio without navigation: [AV-328, "Exploded View"](#)
 - BOSE audio with navigation: [AV-474, "Exploded View"](#)

- YES (Past error)>>Error was detected in the AV control unit branch line.
 NO >> Repair the power supply and the ground circuit.

A
B
C
D
E
F
G
H
I
J
K
L

LAN

N
O
P

TCM BRANCH LINE CIRCUIT

< DTC/CIRCUIT DIAGNOSIS >

[CAN SYSTEM (TYPE 7)]

TCM BRANCH LINE CIRCUIT

Diagnosis Procedure

INFOID:000000005779179

1. CHECK CONNECTOR

1. Turn the ignition switch OFF.
2. Disconnect the battery cable from the negative terminal.
3. Check the following terminals and connectors for damage, bend and loose connection (unit side and connector side).
 - A/T assembly
 - Harness connector F103
 - Harness connector M116

Is the inspection result normal?

YES >> GO TO 2.

NO >> Repair the terminal and connector.

2. CHECK HARNESS FOR OPEN CIRCUIT

1. Disconnect the connector of A/T assembly.
2. Check the resistance between the A/T assembly harness connector terminals.

A/T assembly harness connector		Resistance (Ω)
Connector No.	Terminal No.	
F51	3	Approx. 54 – 66
	8	

Is the measurement value within the specification?

YES >> GO TO 3.

NO >> Repair the TCM branch line.

3. CHECK POWER SUPPLY AND GROUND CIRCUIT

Check the power supply and the ground circuit of the TCM. Refer to [TM-212, "Diagnosis Procedure"](#).

Is the inspection result normal?

YES (Present error)>>Replace the control valve with TCM. Refer to [TM-99, "Component Parts Location"](#).
(Replace A/T assembly if control valve with TCM is not listed in the latest parts list.)

YES (Past error)>>Error was detected in the TCM branch line.

NO >> Repair the power supply and the ground circuit.

A-BAG BRANCH LINE CIRCUIT

< DTC/CIRCUIT DIAGNOSIS >

[CAN SYSTEM (TYPE 7)]

A-BAG BRANCH LINE CIRCUIT

Diagnosis Procedure

INFOID:000000005869087

WARNING:

- Before servicing, turn ignition switch OFF, disconnect battery negative terminal, and wait 3 minutes or more. (To discharge backup capacitor.)
- Never use unspecified tester or other measuring device.

1. CHECK CONNECTOR

1. Turn the ignition switch OFF.
2. Disconnect the battery cable from the negative terminal.
3. Check the terminals and connectors of the air bag diagnosis sensor unit for damage, bend and loose connection (unit side and connector side).

Is the inspection result normal?

- YES >> GO TO 2.
NO >> Replace the main harness.

2. CHECK AIR BAG DIAGNOSIS SENSOR UNIT

Check the air bag diagnosis sensor unit. Refer to [SRC-5, "Work Flow"](#).

Is the inspection result normal?

- YES >> Replace the main harness.
NO >> Replace parts whose air bag system has a malfunction.

A
B
C
D
E
F
G
H
I
J
K
L
N
O
P

LAN

BCM BRANCH LINE CIRCUIT

< DTC/CIRCUIT DIAGNOSIS >

[CAN SYSTEM (TYPE 7)]

BCM BRANCH LINE CIRCUIT

Diagnosis Procedure

INFOID:000000005779181

1. CHECK CONNECTOR

1. Turn the ignition switch OFF.
2. Disconnect the battery cable from the negative terminal.
3. Check the terminals and connectors of the BCM for damage, bend and loose connection (unit side and connector side).

Is the inspection result normal?

- YES >> GO TO 2.
NO >> Repair the terminal and connector.

2. CHECK HARNESS FOR OPEN CIRCUIT

1. Disconnect the connector of BCM.
2. Check the resistance between the BCM harness connector terminals.

BCM harness connector			Resistance (Ω)
Connector No.	Terminal No.		
M122	91	90	Approx. 54 – 66

Is the measurement value within the specification?

- YES >> GO TO 3.
NO >> Repair the BCM branch line.

3. CHECK POWER SUPPLY AND GROUND CIRCUIT

Check the power supply and the ground circuit of the BCM. Refer to [BCS-37, "Diagnosis Procedure"](#).

Is the inspection result normal?

- YES (Present error)>>Replace the BCM. Refer to [BCS-80, "Exploded View"](#).
YES (Past error)>>Error was detected in the BCM branch line.
NO >> Repair the power supply and the ground circuit.

DLC BRANCH LINE CIRCUIT

< DTC/CIRCUIT DIAGNOSIS >

[CAN SYSTEM (TYPE 7)]

DLC BRANCH LINE CIRCUIT

Diagnosis Procedure

INFOID:000000005779182

1. CHECK CONNECTOR

1. Turn the ignition switch OFF.
2. Disconnect the battery cable from the negative terminal.
3. Check the terminals and connectors of the data link connector for damage, bend and loose connection (connector side and harness side).

Is the inspection result normal?

- YES >> GO TO 2.
NO >> Repair the terminal and connector.

2. CHECK HARNESS FOR OPEN CIRCUIT

Check the resistance between the data link connector terminals.

Data link connector			Resistance (Ω)
Connector No.	Terminal No.		
M24	6	14	Approx. 54 – 66

Is the measurement value within the specification?

- YES (Present error)>>Check CAN system type decision again.
YES (Past error)>>Error was detected in the data link connector branch line circuit.
NO >> Repair the data link connector branch line.

A
B
C
D
E
F
G
H
I
J
K
L

LAN

N
O
P

M&A BRANCH LINE CIRCUIT

< DTC/CIRCUIT DIAGNOSIS >

[CAN SYSTEM (TYPE 7)]

M&A BRANCH LINE CIRCUIT

Diagnosis Procedure

INFOID:000000005779183

1. CHECK CONNECTOR

1. Turn the ignition switch OFF.
2. Disconnect the battery cable from the negative terminal.
3. Check the terminals and connectors of the unified meter and A/C amp. for damage, bend and loose connection (unit side and connector side).

Is the inspection result normal?

- YES >> GO TO 2.
NO >> Repair the terminal and connector.

2. CHECK HARNESS FOR OPEN CIRCUIT

1. Disconnect the connector of unified meter and A/C amp.
2. Check the resistance between the unified meter and A/C amp. harness connector terminals.

Unified meter and A/C amp. harness connector			Resistance (Ω)
Connector No.	Terminal No.		
M67	56	72	Approx. 54 – 66

Is the measurement value within the specification?

- YES >> GO TO 3.
NO >> Repair the unified meter and A/C amp. branch line.

3. CHECK POWER SUPPLY AND GROUND CIRCUIT

Check the power supply and the ground circuit of the unified meter and A/C amp. Refer to [MWI-51, "UNIFIED METER AND A/C AMP. : Diagnosis Procedure"](#).

Is the inspection result normal?

- YES (Present error)>>Replace the unified meter and A/C amp. Refer to [MWI-136, "Exploded View"](#).
YES (Past error)>>Error was detected in the unified meter and A/C amp. branch line.
NO >> Repair the power supply and the ground circuit.

STRG BRANCH LINE CIRCUIT

< DTC/CIRCUIT DIAGNOSIS >

[CAN SYSTEM (TYPE 7)]

STRG BRANCH LINE CIRCUIT

Diagnosis Procedure

INFOID:000000005779184

1. CHECK CONNECTOR

1. Turn the ignition switch OFF.
2. Disconnect the battery cable from the negative terminal.
3. Check the terminals and connectors of the steering angle sensor for damage, bend and loose connection (unit side and connector side).

Is the inspection result normal?

- YES >> GO TO 2.
NO >> Repair the terminal and connector.

2. CHECK HARNESS FOR OPEN CIRCUIT

1. Disconnect the connector of steering angle sensor.
2. Check the resistance between the steering angle sensor harness connector terminals.

Steering angle sensor harness connector			Resistance (Ω)
Connector No.	Terminal No.		
M37	1	2	Approx. 54 – 66

Is the measurement value within the specification?

- YES >> GO TO 3.
NO >> Repair the steering angle sensor branch line.

3. CHECK POWER SUPPLY AND GROUND CIRCUIT

Check the power supply and the ground circuit of the steering angle sensor. Refer to [BRC-83, "Wiring Diagram - BRAKE CONTROL SYSTEM -"](#).

Is the inspection result normal?

- YES (Present error)>>Replace the steering angle sensor. Refer to [BRC-110, "Exploded View"](#).
YES (Past error)>>Error was detected in the steering angle sensor branch line.
NO >> Repair the power supply and the ground circuit.

A
B
C
D
E
F
G
H
I
J
K
L

LAN

N
O
P

ADP BRANCH LINE CIRCUIT

< DTC/CIRCUIT DIAGNOSIS >

[CAN SYSTEM (TYPE 7)]

ADP BRANCH LINE CIRCUIT

Diagnosis Procedure

INFOID:000000005779185

1. CHECK CONNECTOR

1. Turn the ignition switch OFF.
2. Disconnect the battery cable from the negative terminal.
3. Check the following terminals and connectors for damage, bend and loose connection (unit side and connector side).
 - Driver seat control unit
 - Harness connector B462
 - Harness connector B59

Is the inspection result normal?

YES >> GO TO 2.

NO >> Repair the terminal and connector.

2. CHECK HARNESS FOR OPEN CIRCUIT

1. Disconnect the connector of driver seat control unit.
2. Check the resistance between the driver seat control unit harness connector terminals.

Driver seat control unit harness connector			Resistance (Ω)
Connector No.	Terminal No.		
B451	3	19	Approx. 54 – 66

Is the measurement value within the specification?

YES >> GO TO 3.

NO >> Repair the driver seat control unit branch line.

3. CHECK POWER SUPPLY AND GROUND CIRCUIT

Check the power supply and the ground circuit of the driver seat control unit. Refer to [ADP-65, "DRIVER SEAT CONTROL UNIT : Diagnosis Procedure"](#).

Is the inspection result normal?

YES (Present error)>>Replace the driver seat control unit. Refer to [ADP-228, "Exploded View"](#).

YES (Past error)>>Error was detected in the driver seat control unit branch line.

NO >> Repair the power supply and the ground circuit.

ABS BRANCH LINE CIRCUIT

< DTC/CIRCUIT DIAGNOSIS >

[CAN SYSTEM (TYPE 7)]

ABS BRANCH LINE CIRCUIT

Diagnosis Procedure

INFOID:000000005779186

1. CHECK CONNECTOR

1. Turn the ignition switch OFF.
2. Disconnect the battery cable from the negative terminal.
3. Check the terminals and connectors of the ABS actuator and electric unit (control unit) for damage, bend and loose connection (unit side and connector side).

Is the inspection result normal?

- YES >> GO TO 2.
NO >> Repair the terminal and connector.

2. CHECK HARNESS FOR OPEN CIRCUIT

1. Disconnect the connector of ABS actuator and electric unit (control unit).
2. Check the resistance between the ABS actuator and electric unit (control unit) harness connector terminals.

ABS actuator and electric unit (control unit) harness connector			Resistance (Ω)
Connector No.	Terminal No.		
E41	35	14	Approx. 54 – 66

Is the measurement value within the specification?

- YES >> GO TO 3.
NO >> Repair the ABS actuator and electric unit (control unit) branch line.

3. CHECK POWER SUPPLY AND GROUND CIRCUIT

Check the power supply and the ground circuit of the ABS actuator and electric unit (control unit). Refer to [BRC-69, "Diagnosis Procedure"](#).

Is the inspection result normal?

- YES (Present error)>>Replace the ABS actuator and electric unit (control unit). Refer to [BRC-107, "Exploded View"](#).
YES (Past error)>>Error was detected in the ABS actuator and electric unit (control unit) branch line.
NO >> Repair the power supply and the ground circuit.

A
B
C
D
E
F
G
H
I
J
K
L

LAN

IPDM-E BRANCH LINE CIRCUIT

< DTC/CIRCUIT DIAGNOSIS >

[CAN SYSTEM (TYPE 7)]

IPDM-E BRANCH LINE CIRCUIT

Diagnosis Procedure

INFOID:000000005779187

1. CHECK CONNECTOR

1. Turn the ignition switch OFF.
2. Disconnect the battery cable from the negative terminal.
3. Check the terminals and connectors of the IPDM E/R for damage, bend and loose connection (unit side and connector side).

Is the inspection result normal?

- YES >> GO TO 2.
NO >> Repair the terminal and connector.

2. CHECK HARNESS FOR OPEN CIRCUIT

1. Disconnect the connector of IPDM E/R.
2. Check the resistance between the IPDM E/R harness connector terminals.

IPDM E/R harness connector			Resistance (Ω)
Connector No.	Terminal No.		
E6	40	39	Approx. 108 – 132

Is the measurement value within the specification?

- YES >> GO TO 3.
NO >> Repair the IPDM E/R branch line.

3. CHECK POWER SUPPLY AND GROUND CIRCUIT

Check the power supply and the ground circuit of the IPDM E/R. Refer to [PCS-18, "Diagnosis Procedure"](#).

Is the inspection result normal?

- YES (Present error)>>Replace the IPDM E/R. Refer to [PCS-33, "Exploded View"](#).
YES (Past error)>>Error was detected in the IPDM E/R branch line.
NO >> Repair the power supply and the ground circuit.

CAN COMMUNICATION CIRCUIT

< DTC/CIRCUIT DIAGNOSIS >

[CAN SYSTEM (TYPE 7)]

CAN COMMUNICATION CIRCUIT

Diagnosis Procedure

INFOID:000000005779188

1. CONNECTOR INSPECTION

1. Turn the ignition switch OFF.
2. Disconnect the battery cable from the negative terminal.
3. Disconnect all the unit connectors on CAN communication system.
4. Check terminals and connectors for damage, bend and loose connection.

Is the inspection result normal?

- YES >> GO TO 2.
NO >> Repair the terminal and connector.

2. CHECK HARNESS CONTINUITY (SHORT CIRCUIT)

Check the continuity between the data link connector terminals.

Data link connector		Continuity
Connector No.	Terminal No.	
M24	6 14	Not existed

Is the inspection result normal?

- YES >> GO TO 3.
NO >> Check the harness and repair the root cause.

3. CHECK HARNESS CONTINUITY (SHORT CIRCUIT)

Check the continuity between the data link connector and the ground.

Data link connector		Ground	Continuity
Connector No.	Terminal No.		
M24	6		Not existed
	14		Not existed

Is the inspection result normal?

- YES >> GO TO 4.
NO >> Check the harness and repair the root cause.

4. CHECK ECM AND IPDM E/R TERMINATION CIRCUIT

1. Remove the ECM and the IPDM E/R.
2. Check the resistance between the ECM terminals.

ECM		Resistance (Ω)
Terminal No.		
114	113	Approx. 108 – 132

3. Check the resistance between the IPDM E/R terminals.

IPDM E/R		Resistance (Ω)
Terminal No.		
40	39	Approx. 108 – 132

Is the measurement value within the specification?

- YES >> GO TO 5.
NO >> Replace the ECM and/or the IPDM E/R.

5. CHECK SYMPTOM

Connect all the connectors. Check if the symptoms described in the "Symptom (Results from interview with customer)" are reproduced.

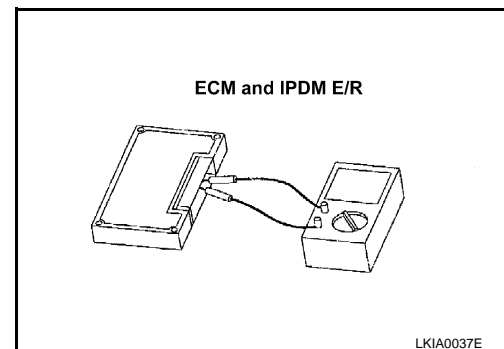

CAN COMMUNICATION CIRCUIT

< DTC/CIRCUIT DIAGNOSIS >

[CAN SYSTEM (TYPE 7)]

Inspection result

Reproduced>>GO TO 6.

Non-reproduced>>Start the diagnosis again. Follow the trouble diagnosis procedure when past error is detected.

6.CHECK UNIT REPRODUCTION

Perform the reproduction test as per the following procedure for each unit.

1. Turn the ignition switch OFF.
2. Disconnect the battery cable from the negative terminal.
3. Disconnect one of the unit connectors of CAN communication system.

NOTE:

ECM and IPDM E/R have a termination circuit. Check other units first.

4. Connect the battery cable to the negative terminal. Check if the symptoms described in the "Symptom (Results from interview with customer)" are reproduced.

NOTE:

Although unit-related error symptoms occur, do not confuse them with other symptoms.

Inspection result

Reproduced>>Connect the connector. Check other units as per the above procedure.

Non-reproduced>>Replace the unit whose connector was disconnected.

MAIN LINE BETWEEN AV AND DLC CIRCUIT

< DTC/CIRCUIT DIAGNOSIS >

[CAN SYSTEM (TYPE 8)]

DTC/CIRCUIT DIAGNOSIS

MAIN LINE BETWEEN AV AND DLC CIRCUIT

Diagnosis Procedure

INFOID:000000005779189

1. CHECK HARNESS CONTINUITY (OPEN CIRCUIT)

1. Turn the ignition switch OFF.
2. Disconnect the battery cable from the negative terminal.
3. Disconnect the following harness connectors.
 - ECM
 - AV control unit
4. Check the continuity between the AV control unit harness connector and the data link connector.
 - With navigation system

AV control unit harness connector		Data link connector		Continuity
Connector No.	Terminal No.	Connector No.	Terminal No.	
M210	90	M24	6	Existed
	74		14	Existed

- Without navigation system (With rear view monitor)

AV control unit harness connector		Data link connector		Continuity
Connector No.	Terminal No.	Connector No.	Terminal No.	
M204	81	M24	6	Existed
	80		14	Existed

- Without navigation system (Without rear view monitor)

AV control unit harness connector		Data link connector		Continuity
Connector No.	Terminal No.	Connector No.	Terminal No.	
M85	86	M24	6	Existed
	87		14	Existed

Is the inspection result normal?

YES (Present error)>>Check CAN system type decision again.

YES (Past error)>>Error was detected in the main line between the AV control unit and the data link connector.

NO >> Repair the main line between the AV control unit and the data link connector.

LAN

MAIN LINE BETWEEN DLC AND ADP CIRCUIT

< DTC/CIRCUIT DIAGNOSIS >

[CAN SYSTEM (TYPE 8)]

MAIN LINE BETWEEN DLC AND ADP CIRCUIT

Diagnosis Procedure

INFOID:000000005779190

1. CHECK CONNECTOR

1. Turn the ignition switch OFF.
2. Disconnect the battery cable from the negative terminal.
3. Check the following terminals and connectors for damage, bend and loose connection (connector side and harness side).
 - Harness connector M7
 - Harness connector B1

Is the inspection result normal?

YES >> GO TO 2.

NO >> Repair the terminal and connector.

2. CHECK HARNESS CONTINUITY (OPEN CIRCUIT)

1. Disconnect the harness connectors M7 and B1.
2. Check the continuity between the data link connector and the harness connector.

Data link connector		Harness connector		Continuity
Connector No.	Terminal No.	Connector No.	Terminal No.	
M24	6	M7	20	Existed
	14		21	Existed

Is the inspection result normal?

YES >> GO TO 3.

NO >> Repair the main line between the data link connector and the harness connector M7.

3. CHECK HARNESS CONTINUITY (OPEN CIRCUIT)

Check the continuity between the harness connector terminals.

Connector No.	Terminal No.		Continuity
B1	20	22	Existed
	21	23	Existed

Is the inspection result normal?

YES (Present error)>>Check CAN system type decision again.

YES (Past error)>>Error was detected in the main line between the data link connector and the driver seat control unit.

NO >> Repair the main line between the harness connector B1 and the driver seat control unit.

MAIN LINE BETWEEN ADP AND RAS CIRCUIT

< DTC/CIRCUIT DIAGNOSIS >

[CAN SYSTEM (TYPE 8)]

MAIN LINE BETWEEN ADP AND RAS CIRCUIT

Diagnosis Procedure

INFOID:000000005779191

1. CHECK HARNESS CONTINUITY (OPEN CIRCUIT)

1. Turn the ignition switch OFF.
2. Disconnect the battery cable from the negative terminal.
3. Disconnect the harness connectors M7 and B1.
4. Check the continuity between the harness connector terminals.

Connector No.	Terminal No.		Continuity
B1	20	22	Existed
	21	23	Existed

Is the inspection result normal?

YES (Present error)>>Check CAN system type decision again.

YES (Past error)>>Error was detected in the main line between the 4WAS main control unit and the driver seat control unit.

NO >> Repair the main line between the 4WAS main control unit and the driver seat control unit.

A
B
C
D
E
F
G
H
I
J
K
L

LAN

N
O
P

MAIN LINE BETWEEN RAS AND ABS CIRCUIT

< DTC/CIRCUIT DIAGNOSIS >

[CAN SYSTEM (TYPE 8)]

MAIN LINE BETWEEN RAS AND ABS CIRCUIT

Diagnosis Procedure

INFOID:000000005779192

1. CHECK CONNECTOR

1. Turn the ignition switch OFF.
2. Disconnect the battery cable from the negative terminal.
3. Check the following terminals and connectors for damage, bend and loose connection (connector side and harness side).
 - Harness connector B1
 - Harness connector M7
 - Harness connector M6
 - Harness connector E106

Is the inspection result normal?

YES >> GO TO 2.

NO >> Repair the terminal and connector.

2. CHECK HARNESS CONTINUITY (OPEN CIRCUIT)

1. Disconnect the harness connectors B1 and M7.
2. Check the continuity between the harness connector terminals.

Connector No.	Terminal No.		Continuity
B1	20	22	Existed
	21	23	Existed

Is the inspection result normal?

YES >> GO TO 3.

NO >> Repair the main line between the 4WAS main control unit and the harness connector B1.

3. CHECK HARNESS CONTINUITY (OPEN CIRCUIT)

1. Disconnect the harness connectors M6 and E106.
2. Check the continuity between the harness connectors.

Harness connector		Harness connector		Continuity
Connector No.	Terminal No.	Connector No.	Terminal No.	
M7	22	M6	7	Existed
	23		6	Existed

Is the inspection result normal?

YES >> GO TO 4.

NO >> Repair the main line between the harness connector M7 and M6.

4. CHECK HARNESS CONTINUITY (OPEN CIRCUIT)

1. Disconnect the connector of ABS actuator and electric unit (control unit).
2. Check the continuity between the harness connector and the ABS actuator and electric unit (control unit) harness connector.

Harness connector		ABS actuator and electric unit (control unit) harness connector		Continuity
Connector No.	Terminal No.	Connector No.	Terminal No.	
E106	7	E41	35	Existed
	6		14	Existed

Is the inspection result normal?

YES (Present error)>>Check CAN system type decision again.

YES (Past error)>>Error was detected in the main line between the 4WAS main control unit and the ABS actuator and electric unit (control unit).

MAIN LINE BETWEEN RAS AND ABS CIRCUIT

< DTC/CIRCUIT DIAGNOSIS >

[CAN SYSTEM (TYPE 8)]

NO >> Repair the main line between the harness connector E106 and the ABS actuator and electric unit (control unit).

A

B

C

D

E

F

G

H

I

J

K

L

LAN

N

O

P

ECM BRANCH LINE CIRCUIT

< DTC/CIRCUIT DIAGNOSIS >

[CAN SYSTEM (TYPE 8)]

ECM BRANCH LINE CIRCUIT

Diagnosis Procedure

INFOID:000000005779193

1. CHECK CONNECTOR

1. Turn the ignition switch OFF.
2. Disconnect the battery cable from the negative terminal.
3. Check the terminals and connectors of the ECM for damage, bend and loose connection (unit side and connector side).

Is the inspection result normal?

- YES >> GO TO 2.
NO >> Repair the terminal and connector.

2. CHECK HARNESS FOR OPEN CIRCUIT

1. Disconnect the connector of ECM.
2. Check the resistance between the ECM harness connector terminals.

ECM harness connector			Resistance (Ω)
Connector No.	Terminal No.		
M107	114	113	Approx. 108 – 132

Is the measurement value within the specification?

- YES >> GO TO 3.
NO >> Repair the ECM branch line.

3. CHECK POWER SUPPLY AND GROUND CIRCUIT

Check the power supply and the ground circuit of the ECM. Refer to [EC-144, "Diagnosis Procedure"](#).

Is the inspection result normal?

YES (Present error)>>Replace the ECM. Refer to [EC-17, "ADDITIONAL SERVICE WHEN REPLACING CONTROL UNIT \(ECM\) : Special Repair Requirement"](#).

YES (Past error)>>Error was detected in the ECM branch line.

NO >> Repair the power supply and the ground circuit.

AV BRANCH LINE CIRCUIT

Diagnosis Procedure

INFOID:000000005779194

1. CHECK CONNECTOR

1. Turn the ignition switch OFF.
2. Disconnect the battery cable from the negative terminal.
3. Check the terminals and connectors of the AV control unit for damage, bend and loose connection (unit side and connector side).

Is the inspection result normal?

- YES >> GO TO 2.
 NO >> Repair the terminal and connector.

2. CHECK HARNESS FOR OPEN CIRCUIT

1. Disconnect the connector of AV control unit.
 2. Check the resistance between the AV control unit harness connector terminals.
- Models with navigation system

AV control unit harness connector			Resistance (Ω)
Connector No.	Terminal No.		
M210	90	74	Approx. 54 – 66

- Models without navigation system (With rear view monitor)

AV control unit harness connector			Resistance (Ω)
Connector No.	Terminal No.		
M204	81	80	Approx. 54 – 66

- Models without navigation system (Without rear view monitor)

AV control unit harness connector			Resistance (Ω)
Connector No.	Terminal No.		
M85	86	87	Approx. 54 – 66

Is the measurement value within the specification?

- YES >> GO TO 3.
 NO >> Repair the AV control unit branch line.

3. CHECK POWER SUPPLY AND GROUND CIRCUIT

Check the power supply and the ground circuit of the AV control unit. Refer to the following.

- Base audio without rear view monitor: [AV-40, "AV CONTROL UNIT : Diagnosis Procedure"](#)
- Base audio with rear view monitor: [AV-173, "AV CONTROL UNIT : Diagnosis Procedure"](#)
- BOSE audio without navigation: [AV-297, "AV CONTROL UNIT : Diagnosis Procedure"](#)
- BOSE audio with navigation: [AV-448, "AV CONTROL UNIT : Diagnosis Procedure"](#)

Is the inspection result normal?

- YES (Present error)>>Replace the AV control unit. Refer to the following.
- Base audio without rear view monitor: [AV-90, "Exploded View"](#)
 - Base audio with rear view monitor: [AV-202, "Exploded View"](#)
 - BOSE audio without navigation: [AV-328, "Exploded View"](#)
 - BOSE audio with navigation: [AV-474, "Exploded View"](#)

- YES (Past error)>>Error was detected in the AV control unit branch line.
 NO >> Repair the power supply and the ground circuit.

A
B
C
D
E
F
G
H
I
J
K
L

LAN

N
O
P

TCM BRANCH LINE CIRCUIT

< DTC/CIRCUIT DIAGNOSIS >

[CAN SYSTEM (TYPE 8)]

TCM BRANCH LINE CIRCUIT

Diagnosis Procedure

INFOID:000000005779195

1. CHECK CONNECTOR

1. Turn the ignition switch OFF.
2. Disconnect the battery cable from the negative terminal.
3. Check the following terminals and connectors for damage, bend and loose connection (unit side and connector side).
 - A/T assembly
 - Harness connector F103
 - Harness connector M116

Is the inspection result normal?

YES >> GO TO 2.

NO >> Repair the terminal and connector.

2. CHECK HARNESS FOR OPEN CIRCUIT

1. Disconnect the connector of A/T assembly.
2. Check the resistance between the A/T assembly harness connector terminals.

A/T assembly harness connector		Resistance (Ω)
Connector No.	Terminal No.	
F51	3 8	Approx. 54 – 66

Is the measurement value within the specification?

YES >> GO TO 3.

NO >> Repair the TCM branch line.

3. CHECK POWER SUPPLY AND GROUND CIRCUIT

Check the power supply and the ground circuit of the TCM. Refer to [TM-212, "Diagnosis Procedure"](#).

Is the inspection result normal?

YES (Present error)>>Replace the control valve with TCM. Refer to [TM-99, "Component Parts Location"](#).
(Replace A/T assembly if control valve with TCM is not listed in the latest parts list.)

YES (Past error)>>Error was detected in the TCM branch line.

NO >> Repair the power supply and the ground circuit.

A-BAG BRANCH LINE CIRCUIT

< DTC/CIRCUIT DIAGNOSIS >

[CAN SYSTEM (TYPE 8)]

A-BAG BRANCH LINE CIRCUIT

Diagnosis Procedure

INFOID:000000005869128

WARNING:

- Before servicing, turn ignition switch OFF, disconnect battery negative terminal, and wait 3 minutes or more. (To discharge backup capacitor.)
- Never use unspecified tester or other measuring device.

1.CHECK CONNECTOR

1. Turn the ignition switch OFF.
2. Disconnect the battery cable from the negative terminal.
3. Check the terminals and connectors of the air bag diagnosis sensor unit for damage, bend and loose connection (unit side and connector side).

Is the inspection result normal?

- YES >> GO TO 2.
NO >> Replace the main harness.

2.CHECK AIR BAG DIAGNOSIS SENSOR UNIT

Check the air bag diagnosis sensor unit. Refer to [SRC-5, "Work Flow"](#).

Is the inspection result normal?

- YES >> Replace the main harness.
NO >> Replace parts whose air bag system has a malfunction.

A
B
C
D
E
F
G
H
I
J
K
L
N
O
P

LAN

BCM BRANCH LINE CIRCUIT

< DTC/CIRCUIT DIAGNOSIS >

[CAN SYSTEM (TYPE 8)]

BCM BRANCH LINE CIRCUIT

Diagnosis Procedure

INFOID:000000005779197

1.CHECK CONNECTOR

1. Turn the ignition switch OFF.
2. Disconnect the battery cable from the negative terminal.
3. Check the terminals and connectors of the BCM for damage, bend and loose connection (unit side and connector side).

Is the inspection result normal?

- YES >> GO TO 2.
NO >> Repair the terminal and connector.

2.CHECK HARNESS FOR OPEN CIRCUIT

1. Disconnect the connector of BCM.
2. Check the resistance between the BCM harness connector terminals.

BCM harness connector			Resistance (Ω)
Connector No.	Terminal No.		
M122	91	90	Approx. 54 – 66

Is the measurement value within the specification?

- YES >> GO TO 3.
NO >> Repair the BCM branch line.

3.CHECK POWER SUPPLY AND GROUND CIRCUIT

Check the power supply and the ground circuit of the BCM. Refer to [BCS-37, "Diagnosis Procedure"](#).

Is the inspection result normal?

- YES (Present error)>>Replace the BCM. Refer to [BCS-80, "Exploded View"](#).
YES (Past error)>>Error was detected in the BCM branch line.
NO >> Repair the power supply and the ground circuit.

DLC BRANCH LINE CIRCUIT

< DTC/CIRCUIT DIAGNOSIS >

[CAN SYSTEM (TYPE 8)]

DLC BRANCH LINE CIRCUIT

Diagnosis Procedure

INFOID:000000005779198

1. CHECK CONNECTOR

1. Turn the ignition switch OFF.
2. Disconnect the battery cable from the negative terminal.
3. Check the terminals and connectors of the data link connector for damage, bend and loose connection (connector side and harness side).

Is the inspection result normal?

- YES >> GO TO 2.
NO >> Repair the terminal and connector.

2. CHECK HARNESS FOR OPEN CIRCUIT

Check the resistance between the data link connector terminals.

Data link connector			Resistance (Ω)
Connector No.	Terminal No.		
M24	6	14	Approx. 54 – 66

Is the measurement value within the specification?

- YES (Present error)>>Check CAN system type decision again.
YES (Past error)>>Error was detected in the data link connector branch line circuit.
NO >> Repair the data link connector branch line.

A
B
C
D
E
F
G
H
I
J
K
L
N
O
P

LAN

M&A BRANCH LINE CIRCUIT

Diagnosis Procedure

INFOID:000000005779199

1. CHECK CONNECTOR

1. Turn the ignition switch OFF.
2. Disconnect the battery cable from the negative terminal.
3. Check the terminals and connectors of the unified meter and A/C amp. for damage, bend and loose connection (unit side and connector side).

Is the inspection result normal?

- YES >> GO TO 2.
 NO >> Repair the terminal and connector.

2. CHECK HARNESS FOR OPEN CIRCUIT

1. Disconnect the connector of unified meter and A/C amp.
2. Check the resistance between the unified meter and A/C amp. harness connector terminals.

Unified meter and A/C amp. harness connector			Resistance (Ω)
Connector No.	Terminal No.		
M67	56	72	Approx. 54 – 66

Is the measurement value within the specification?

- YES >> GO TO 3.
 NO >> Repair the unified meter and A/C amp. branch line.

3. CHECK POWER SUPPLY AND GROUND CIRCUIT

Check the power supply and the ground circuit of the unified meter and A/C amp. Refer to [MWI-51, "UNIFIED METER AND A/C AMP. : Diagnosis Procedure"](#).

Is the inspection result normal?

- YES (Present error)>>Replace the unified meter and A/C amp. Refer to [MWI-136, "Exploded View"](#).
 YES (Past error)>>Error was detected in the unified meter and A/C amp. branch line.
 NO >> Repair the power supply and the ground circuit.

STRG BRANCH LINE CIRCUIT

< DTC/CIRCUIT DIAGNOSIS >

[CAN SYSTEM (TYPE 8)]

STRG BRANCH LINE CIRCUIT

Diagnosis Procedure

INFOID:000000005779200

1. CHECK CONNECTOR

1. Turn the ignition switch OFF.
2. Disconnect the battery cable from the negative terminal.
3. Check the terminals and connectors of the steering angle sensor for damage, bend and loose connection (unit side and connector side).

Is the inspection result normal?

- YES >> GO TO 2.
NO >> Repair the terminal and connector.

2. CHECK HARNESS FOR OPEN CIRCUIT

1. Disconnect the connector of steering angle sensor.
2. Check the resistance between the steering angle sensor harness connector terminals.

Steering angle sensor harness connector			Resistance (Ω)
Connector No.	Terminal No.		
M37	1	2	Approx. 54 – 66

Is the measurement value within the specification?

- YES >> GO TO 3.
NO >> Repair the steering angle sensor branch line.

3. CHECK POWER SUPPLY AND GROUND CIRCUIT

Check the power supply and the ground circuit of the steering angle sensor. Refer to [BRC-83, "Wiring Diagram - BRAKE CONTROL SYSTEM -"](#).

Is the inspection result normal?

- YES (Present error)>>Replace the steering angle sensor. Refer to [BRC-110, "Exploded View"](#).
YES (Past error)>>Error was detected in the steering angle sensor branch line.
NO >> Repair the power supply and the ground circuit.

A
B
C
D
E
F
G
H
I
J
K
L

LAN

N
O
P

ADP BRANCH LINE CIRCUIT

< DTC/CIRCUIT DIAGNOSIS >

[CAN SYSTEM (TYPE 8)]

ADP BRANCH LINE CIRCUIT

Diagnosis Procedure

INFOID:000000005779201

1. CHECK CONNECTOR

1. Turn the ignition switch OFF.
2. Disconnect the battery cable from the negative terminal.
3. Check the following terminals and connectors for damage, bend and loose connection (unit side and connector side).
 - Driver seat control unit
 - Harness connector B462
 - Harness connector B59

Is the inspection result normal?

YES >> GO TO 2.

NO >> Repair the terminal and connector.

2. CHECK HARNESS FOR OPEN CIRCUIT

1. Disconnect the connector of driver seat control unit.
2. Check the resistance between the driver seat control unit harness connector terminals.

Driver seat control unit harness connector			Resistance (Ω)
Connector No.	Terminal No.		
B451	3	19	Approx. 54 – 66

Is the measurement value within the specification?

YES >> GO TO 3.

NO >> Repair the driver seat control unit branch line.

3. CHECK POWER SUPPLY AND GROUND CIRCUIT

Check the power supply and the ground circuit of the driver seat control unit. Refer to [ADP-65, "DRIVER SEAT CONTROL UNIT : Diagnosis Procedure"](#).

Is the inspection result normal?

YES (Present error)>>Replace the driver seat control unit. Refer to [ADP-228, "Exploded View"](#).

YES (Past error)>>Error was detected in the driver seat control unit branch line.

NO >> Repair the power supply and the ground circuit.

RAS BRANCH LINE CIRCUIT

< DTC/CIRCUIT DIAGNOSIS >

[CAN SYSTEM (TYPE 8)]

RAS BRANCH LINE CIRCUIT

Diagnosis Procedure

INFOID:000000005779202

1. CHECK CONNECTOR

1. Turn the ignition switch OFF.
2. Disconnect the battery cable from the negative terminal.
3. Check the terminals and connectors of the 4WAS main control unit for damage, bend and loose connection (unit side and connector side).

Is the inspection result normal?

- YES >> GO TO 2.
NO >> Repair the terminal and connector.

2. CHECK HARNESS FOR OPEN CIRCUIT

1. Disconnect the connector of 4WAS main control unit.
2. Check the resistance between the 4WAS main control unit harness connector terminals.

4WAS main control unit harness connector			Resistance (Ω)
Connector No.	Terminal No.		
B54	1	8	Approx. 54 – 66

Is the measurement value within the specification?

- YES >> GO TO 3.
NO >> Replace the body harness.

3. CHECK POWER SUPPLY AND GROUND CIRCUIT

Check the power supply and the ground circuit of the 4WAS main control unit. Refer to [STC-136, "Diagnosis Procedure \(4WAS Main Control Unit\)"](#).

Is the inspection result normal?

- YES (Present error)>>Replace the 4WAS main control unit. Refer to [STC-185, "Exploded View"](#).
YES (Past error)>>Error was detected in the 4WAS main control unit branch line.
NO >> Repair the power supply and the ground circuit.

A
B
C
D
E
F
G
H
I
J
K
L
N
O
P

LAN

ABS BRANCH LINE CIRCUIT

< DTC/CIRCUIT DIAGNOSIS >

[CAN SYSTEM (TYPE 8)]

ABS BRANCH LINE CIRCUIT

Diagnosis Procedure

INFOID:000000005779203

1. CHECK CONNECTOR

1. Turn the ignition switch OFF.
2. Disconnect the battery cable from the negative terminal.
3. Check the terminals and connectors of the ABS actuator and electric unit (control unit) for damage, bend and loose connection (unit side and connector side).

Is the inspection result normal?

- YES >> GO TO 2.
NO >> Repair the terminal and connector.

2. CHECK HARNESS FOR OPEN CIRCUIT

1. Disconnect the connector of ABS actuator and electric unit (control unit).
2. Check the resistance between the ABS actuator and electric unit (control unit) harness connector terminals.

ABS actuator and electric unit (control unit) harness connector			Resistance (Ω)
Connector No.	Terminal No.		
E41	35	14	Approx. 54 – 66

Is the measurement value within the specification?

- YES >> GO TO 3.
NO >> Repair the ABS actuator and electric unit (control unit) branch line.

3. CHECK POWER SUPPLY AND GROUND CIRCUIT

Check the power supply and the ground circuit of the ABS actuator and electric unit (control unit). Refer to [BRC-69. "Diagnosis Procedure"](#).

Is the inspection result normal?

- YES (Present error)>>Replace the ABS actuator and electric unit (control unit). Refer to [BRC-107. "Exploded View"](#).
YES (Past error)>>Error was detected in the ABS actuator and electric unit (control unit) branch line.
NO >> Repair the power supply and the ground circuit.

IPDM-E BRANCH LINE CIRCUIT

< DTC/CIRCUIT DIAGNOSIS >

[CAN SYSTEM (TYPE 8)]

IPDM-E BRANCH LINE CIRCUIT

Diagnosis Procedure

INFOID:000000005779204

1. CHECK CONNECTOR

1. Turn the ignition switch OFF.
2. Disconnect the battery cable from the negative terminal.
3. Check the terminals and connectors of the IPDM E/R for damage, bend and loose connection (unit side and connector side).

Is the inspection result normal?

- YES >> GO TO 2.
NO >> Repair the terminal and connector.

2. CHECK HARNESS FOR OPEN CIRCUIT

1. Disconnect the connector of IPDM E/R.
2. Check the resistance between the IPDM E/R harness connector terminals.

IPDM E/R harness connector			Resistance (Ω)
Connector No.	Terminal No.		
E6	40	39	Approx. 108 – 132

Is the measurement value within the specification?

- YES >> GO TO 3.
NO >> Repair the IPDM E/R branch line.

3. CHECK POWER SUPPLY AND GROUND CIRCUIT

Check the power supply and the ground circuit of the IPDM E/R. Refer to [PCS-18, "Diagnosis Procedure"](#).

Is the inspection result normal?

- YES (Present error)>>Replace the IPDM E/R. Refer to [PCS-33, "Exploded View"](#).
YES (Past error)>>Error was detected in the IPDM E/R branch line.
NO >> Repair the power supply and the ground circuit.

A
B
C
D
E
F
G
H
I
J
K
L

LAN

CAN COMMUNICATION CIRCUIT

< DTC/CIRCUIT DIAGNOSIS >

[CAN SYSTEM (TYPE 8)]

CAN COMMUNICATION CIRCUIT

Diagnosis Procedure

INFOID:000000005779205

1. CONNECTOR INSPECTION

1. Turn the ignition switch OFF.
2. Disconnect the battery cable from the negative terminal.
3. Disconnect all the unit connectors on CAN communication system.
4. Check terminals and connectors for damage, bend and loose connection.

Is the inspection result normal?

- YES >> GO TO 2.
NO >> Repair the terminal and connector.

2. CHECK HARNESS CONTINUITY (SHORT CIRCUIT)

Check the continuity between the data link connector terminals.

Data link connector			Continuity
Connector No.	Terminal No.		
M24	6	14	Not existed

Is the inspection result normal?

- YES >> GO TO 3.
NO >> Check the harness and repair the root cause.

3. CHECK HARNESS CONTINUITY (SHORT CIRCUIT)

Check the continuity between the data link connector and the ground.

Data link connector		Ground	Continuity
Connector No.	Terminal No.		
M24	6		Not existed
	14		Not existed

Is the inspection result normal?

- YES >> GO TO 4.
NO >> Check the harness and repair the root cause.

4. CHECK ECM AND IPDM E/R TERMINATION CIRCUIT

1. Remove the ECM and the IPDM E/R.
2. Check the resistance between the ECM terminals.

ECM		Resistance (Ω)
Terminal No.		
114	113	Approx. 108 – 132

3. Check the resistance between the IPDM E/R terminals.

IPDM E/R		Resistance (Ω)
Terminal No.		
40	39	Approx. 108 – 132

Is the measurement value within the specification?

- YES >> GO TO 5.
NO >> Replace the ECM and/or the IPDM E/R.

5. CHECK SYMPTOM

Connect all the connectors. Check if the symptoms described in the "Symptom (Results from interview with customer)" are reproduced.

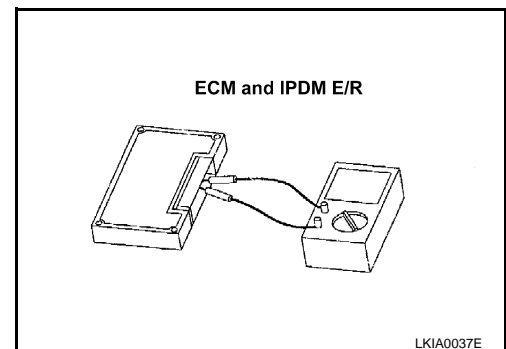

CAN COMMUNICATION CIRCUIT

< DTC/CIRCUIT DIAGNOSIS >

[CAN SYSTEM (TYPE 8)]

Inspection result

Reproduced>>GO TO 6.

Non-reproduced>>Start the diagnosis again. Follow the trouble diagnosis procedure when past error is detected.

6.CHECK UNIT REPRODUCTION

Perform the reproduction test as per the following procedure for each unit.

1. Turn the ignition switch OFF.
2. Disconnect the battery cable from the negative terminal.
3. Disconnect one of the unit connectors of CAN communication system.

NOTE:

ECM and IPDM E/R have a termination circuit. Check other units first.

4. Connect the battery cable to the negative terminal. Check if the symptoms described in the "Symptom (Results from interview with customer)" are reproduced.

NOTE:

Although unit-related error symptoms occur, do not confuse them with other symptoms.

Inspection result

Reproduced>>Connect the connector. Check other units as per the above procedure.

Non-reproduced>>Replace the unit whose connector was disconnected.

A

B

C

D

E

F

G

H

I

J

K

L

LAN

N

O

P

MAIN LINE BETWEEN AV AND DLC CIRCUIT

< DTC/CIRCUIT DIAGNOSIS >

[CAN SYSTEM (TYPE 9)]

DTC/CIRCUIT DIAGNOSIS

MAIN LINE BETWEEN AV AND DLC CIRCUIT

Diagnosis Procedure

INFOID:000000005779206

1. CHECK HARNESS CONTINUITY (OPEN CIRCUIT)

1. Turn the ignition switch OFF.
2. Disconnect the battery cable from the negative terminal.
3. Disconnect the following harness connectors.
 - ECM
 - AV control unit
4. Check the continuity between the AV control unit harness connector and the data link connector.
 - With navigation system

AV control unit harness connector		Data link connector		Continuity
Connector No.	Terminal No.	Connector No.	Terminal No.	
M210	90	M24	6	Existed
	74		14	Existed

- Without navigation system (With rear view monitor)

AV control unit harness connector		Data link connector		Continuity
Connector No.	Terminal No.	Connector No.	Terminal No.	
M204	81	M24	6	Existed
	80		14	Existed

- Without navigation system (Without rear view monitor)

AV control unit harness connector		Data link connector		Continuity
Connector No.	Terminal No.	Connector No.	Terminal No.	
M85	86	M24	6	Existed
	87		14	Existed

Is the inspection result normal?

YES (Present error)>>Check CAN system type decision again.

YES (Past error)>>Error was detected in the main line between the AV control unit and the data link connector.

NO >> Repair the main line between the AV control unit and the data link connector.

MAIN LINE BETWEEN DLC AND ADP CIRCUIT

< DTC/CIRCUIT DIAGNOSIS >

[CAN SYSTEM (TYPE 9)]

MAIN LINE BETWEEN DLC AND ADP CIRCUIT

Diagnosis Procedure

INFOID:000000005779207

1. CHECK CONNECTOR

1. Turn the ignition switch OFF.
2. Disconnect the battery cable from the negative terminal.
3. Check the following terminals and connectors for damage, bend and loose connection (connector side and harness side).
 - Harness connector M7
 - Harness connector B1

Is the inspection result normal?

YES >> GO TO 2.

NO >> Repair the terminal and connector.

2. CHECK HARNESS CONTINUITY (OPEN CIRCUIT)

1. Disconnect the harness connectors M7 and B1.
2. Check the continuity between the data link connector and the harness connector.

Data link connector		Harness connector		Continuity
Connector No.	Terminal No.	Connector No.	Terminal No.	
M24	6	M7	20	Existed
	14		21	Existed

Is the inspection result normal?

YES >> GO TO 3.

NO >> Repair the main line between the data link connector and the harness connector M7.

3. CHECK HARNESS CONTINUITY (OPEN CIRCUIT)

Check the continuity between the harness connector terminals.

Connector No.	Terminal No.		Continuity
B1	20	22	Existed
	21	23	Existed

Is the inspection result normal?

YES (Present error)>>Check CAN system type decision again.

YES (Past error)>>Error was detected in the main line between the data link connector and the driver seat control unit.

NO >> Repair the main line between the harness connector B1 and the driver seat control unit.

LAN

MAIN LINE BETWEEN ADP AND ABS CIRCUIT

< DTC/CIRCUIT DIAGNOSIS >

[CAN SYSTEM (TYPE 9)]

MAIN LINE BETWEEN ADP AND ABS CIRCUIT

Diagnosis Procedure

INFOID:000000005779208

1. CHECK CONNECTOR

1. Turn the ignition switch OFF.
2. Disconnect the battery cable from the negative terminal.
3. Check the following terminals and connectors for damage, bend and loose connection (connector side and harness side).
 - Harness connector B1
 - Harness connector M7
 - Harness connector M6
 - Harness connector E106

Is the inspection result normal?

YES >> GO TO 2.

NO >> Repair the terminal and connector.

2. CHECK HARNESS CONTINUITY (OPEN CIRCUIT)

1. Disconnect the harness connectors B1 and M7.
2. Check the continuity between the harness connector terminals.

Connector No.	Terminal No.		Continuity
B1	20	22	Existed
	21	23	Existed

Is the inspection result normal?

YES >> GO TO 3.

NO >> Repair the main line between the driver seat control unit and the harness connector B1.

3. CHECK HARNESS CONTINUITY (OPEN CIRCUIT)

1. Disconnect the harness connectors M6 and E106.
2. Check the continuity between the harness connectors.

Harness connector		Harness connector		Continuity
Connector No.	Terminal No.	Connector No.	Terminal No.	
M7	22	M6	7	Existed
	23		6	Existed

Is the inspection result normal?

YES >> GO TO 4.

NO >> Repair the main line between the harness connector M7 and M6.

4. CHECK HARNESS CONTINUITY (OPEN CIRCUIT)

1. Disconnect the connector of ABS actuator and electric unit (control unit).
2. Check the continuity between the harness connector and the ABS actuator and electric unit (control unit) harness connector.

Harness connector		ABS actuator and electric unit (control unit) harness connector		Continuity
Connector No.	Terminal No.	Connector No.	Terminal No.	
E106	7	E41	35	Existed
	6		14	Existed

Is the inspection result normal?

YES (Present error)>>Check CAN system type decision again.

YES (Past error)>>Error was detected in the main line between the driver seat control unit and the ABS actuator and electric unit (control unit).

MAIN LINE BETWEEN ADP AND ABS CIRCUIT

< DTC/CIRCUIT DIAGNOSIS >

[CAN SYSTEM (TYPE 9)]

NO >> Repair the main line between the harness connector E106 and the ABS actuator and electric unit (control unit).

A

B

C

D

E

F

G

H

I

J

K

L

LAN

N

O

P

ECM BRANCH LINE CIRCUIT

< DTC/CIRCUIT DIAGNOSIS >

[CAN SYSTEM (TYPE 9)]

ECM BRANCH LINE CIRCUIT

Diagnosis Procedure

INFOID:000000005779209

1. CHECK CONNECTOR

1. Turn the ignition switch OFF.
2. Disconnect the battery cable from the negative terminal.
3. Check the terminals and connectors of the ECM for damage, bend and loose connection (unit side and connector side).

Is the inspection result normal?

- YES >> GO TO 2.
NO >> Repair the terminal and connector.

2. CHECK HARNESS FOR OPEN CIRCUIT

1. Disconnect the connector of ECM.
2. Check the resistance between the ECM harness connector terminals.

ECM harness connector			Resistance (Ω)
Connector No.	Terminal No.		
M107	114	113	Approx. 108 – 132

Is the measurement value within the specification?

- YES >> GO TO 3.
NO >> Repair the ECM branch line.

3. CHECK POWER SUPPLY AND GROUND CIRCUIT

Check the power supply and the ground circuit of the ECM. Refer to [EC-144, "Diagnosis Procedure"](#).

Is the inspection result normal?

YES (Present error)>>Replace the ECM. Refer to [EC-17, "ADDITIONAL SERVICE WHEN REPLACING CONTROL UNIT \(ECM\) : Special Repair Requirement"](#).

YES (Past error)>>Error was detected in the ECM branch line.

NO >> Repair the power supply and the ground circuit.

AV BRANCH LINE CIRCUIT

Diagnosis Procedure

INFOID:000000005779210

1. CHECK CONNECTOR

1. Turn the ignition switch OFF.
2. Disconnect the battery cable from the negative terminal.
3. Check the terminals and connectors of the AV control unit for damage, bend and loose connection (unit side and connector side).

Is the inspection result normal?

- YES >> GO TO 2.
 NO >> Repair the terminal and connector.

2. CHECK HARNESS FOR OPEN CIRCUIT

1. Disconnect the connector of AV control unit.
 2. Check the resistance between the AV control unit harness connector terminals.
- Models with navigation system

AV control unit harness connector			Resistance (Ω)
Connector No.	Terminal No.		
M210	90	74	Approx. 54 – 66

- Models without navigation system (With rear view monitor)

AV control unit harness connector			Resistance (Ω)
Connector No.	Terminal No.		
M204	81	80	Approx. 54 – 66

- Models without navigation system (Without rear view monitor)

AV control unit harness connector			Resistance (Ω)
Connector No.	Terminal No.		
M85	86	87	Approx. 54 – 66

Is the measurement value within the specification?

- YES >> GO TO 3.
 NO >> Repair the AV control unit branch line.

3. CHECK POWER SUPPLY AND GROUND CIRCUIT

Check the power supply and the ground circuit of the AV control unit. Refer to the following.

- Base audio without rear view monitor: [AV-40, "AV CONTROL UNIT : Diagnosis Procedure"](#)
- Base audio with rear view monitor: [AV-173, "AV CONTROL UNIT : Diagnosis Procedure"](#)
- BOSE audio without navigation: [AV-297, "AV CONTROL UNIT : Diagnosis Procedure"](#)
- BOSE audio with navigation: [AV-448, "AV CONTROL UNIT : Diagnosis Procedure"](#)

Is the inspection result normal?

- YES (Present error)>>Replace the AV control unit. Refer to the following.
- Base audio without rear view monitor: [AV-90, "Exploded View"](#)
 - Base audio with rear view monitor: [AV-202, "Exploded View"](#)
 - BOSE audio without navigation: [AV-328, "Exploded View"](#)
 - BOSE audio with navigation: [AV-474, "Exploded View"](#)

- YES (Past error)>>Error was detected in the AV control unit branch line.
 NO >> Repair the power supply and the ground circuit.

A
B
C
D
E
F
G
H
I
J
K
L

LAN

N
O
P

PSB BRANCH LINE CIRCUIT

Diagnosis Procedure

INFOID:000000005779211

1. CHECK CONNECTOR

1. Turn the ignition switch OFF.
2. Disconnect the battery cable from the negative terminal.
3. Check the terminals and connectors of the pre-crash seat belt control unit for damage, bend and loose connection (unit side and connector side).

Is the inspection result normal?

- YES >> GO TO 2.
 NO >> Repair the terminal and connector.

2. CHECK HARNESS FOR OPEN CIRCUIT

1. Disconnect the connector of pre-crash seat belt control unit.
2. Check the resistance between the pre-crash seat belt control unit harness connector terminals.

Pre-crash seat belt control unit harness connector		Resistance (Ω)
Connector No.	Terminal No.	
M110	24 22	Approx. 54 – 66

Is the measurement value within the specification?

- YES >> GO TO 3.
 NO >> Repair the pre-crash seat belt control unit branch line.

3. CHECK POWER SUPPLY AND GROUND CIRCUIT

Check the power supply and the ground circuit of the pre-crash seat belt control unit. Refer to [SBC-24, "Diagnosis Procedure"](#).

Is the inspection result normal?

- YES (Present error)>>Replace the pre-crash seat belt control unit. Refer to [SBC-39, "Exploded View"](#).
 YES (Past error)>>Error was detected in the pre-crash seat belt control unit branch line.
 NO >> Repair the power supply and the ground circuit.

TCM BRANCH LINE CIRCUIT

< DTC/CIRCUIT DIAGNOSIS >

[CAN SYSTEM (TYPE 9)]

TCM BRANCH LINE CIRCUIT

Diagnosis Procedure

INFOID:000000005779212

1. CHECK CONNECTOR

1. Turn the ignition switch OFF.
2. Disconnect the battery cable from the negative terminal.
3. Check the following terminals and connectors for damage, bend and loose connection (unit side and connector side).
 - A/T assembly
 - Harness connector F103
 - Harness connector M116

Is the inspection result normal?

- YES >> GO TO 2.
NO >> Repair the terminal and connector.

2. CHECK HARNESS FOR OPEN CIRCUIT

1. Disconnect the connector of A/T assembly.
2. Check the resistance between the A/T assembly harness connector terminals.

A/T assembly harness connector		Resistance (Ω)
Connector No.	Terminal No.	
F51	3	Approx. 54 – 66
	8	

Is the measurement value within the specification?

- YES >> GO TO 3.
NO >> Repair the TCM branch line.

3. CHECK POWER SUPPLY AND GROUND CIRCUIT

Check the power supply and the ground circuit of the TCM. Refer to [TM-212, "Diagnosis Procedure"](#).

Is the inspection result normal?

- YES (Present error)>>Replace the control valve with TCM. Refer to [TM-99, "Component Parts Location"](#).
(Replace A/T assembly if control valve with TCM is not listed in the latest parts list.)
YES (Past error)>>Error was detected in the TCM branch line.
NO >> Repair the power supply and the ground circuit.

A
B
C
D
E
F
G
H
I
J
K
L

LAN

A-BAG BRANCH LINE CIRCUIT

Diagnosis Procedure

INFOID:000000005869129

WARNING:

- Before servicing, turn ignition switch OFF, disconnect battery negative terminal, and wait 3 minutes or more. (To discharge backup capacitor.)
- Never use unspecified tester or other measuring device.

1.CHECK CONNECTOR

1. Turn the ignition switch OFF.
2. Disconnect the battery cable from the negative terminal.
3. Check the terminals and connectors of the air bag diagnosis sensor unit for damage, bend and loose connection (unit side and connector side).

Is the inspection result normal?

- YES >> GO TO 2.
NO >> Replace the main harness.

2.CHECK AIR BAG DIAGNOSIS SENSOR UNIT

Check the air bag diagnosis sensor unit. Refer to [SRC-5, "Work Flow"](#).

Is the inspection result normal?

- YES >> Replace the main harness.
NO >> Replace parts whose air bag system has a malfunction.

BCM BRANCH LINE CIRCUIT

< DTC/CIRCUIT DIAGNOSIS >

[CAN SYSTEM (TYPE 9)]

BCM BRANCH LINE CIRCUIT

Diagnosis Procedure

INFOID:000000005779214

1. CHECK CONNECTOR

1. Turn the ignition switch OFF.
2. Disconnect the battery cable from the negative terminal.
3. Check the terminals and connectors of the BCM for damage, bend and loose connection (unit side and connector side).

Is the inspection result normal?

- YES >> GO TO 2.
NO >> Repair the terminal and connector.

2. CHECK HARNESS FOR OPEN CIRCUIT

1. Disconnect the connector of BCM.
2. Check the resistance between the BCM harness connector terminals.

BCM harness connector			Resistance (Ω)
Connector No.	Terminal No.		
M122	91	90	Approx. 54 – 66

Is the measurement value within the specification?

- YES >> GO TO 3.
NO >> Repair the BCM branch line.

3. CHECK POWER SUPPLY AND GROUND CIRCUIT

Check the power supply and the ground circuit of the BCM. Refer to [BCS-37, "Diagnosis Procedure"](#).

Is the inspection result normal?

- YES (Present error)>>Replace the BCM. Refer to [BCS-80, "Exploded View"](#).
YES (Past error)>>Error was detected in the BCM branch line.
NO >> Repair the power supply and the ground circuit.

A
B
C
D
E
F
G
H
I
J
K
L

LAN

N
O
P

DLC BRANCH LINE CIRCUIT

< DTC/CIRCUIT DIAGNOSIS >

[CAN SYSTEM (TYPE 9)]

DLC BRANCH LINE CIRCUIT

Diagnosis Procedure

INFOID:0000000057792.15

1. CHECK CONNECTOR

1. Turn the ignition switch OFF.
2. Disconnect the battery cable from the negative terminal.
3. Check the terminals and connectors of the data link connector for damage, bend and loose connection (connector side and harness side).

Is the inspection result normal?

- YES >> GO TO 2.
NO >> Repair the terminal and connector.

2. CHECK HARNESS FOR OPEN CIRCUIT

Check the resistance between the data link connector terminals.

Data link connector			Resistance (Ω)
Connector No.	Terminal No.		
M24	6	14	Approx. 54 – 66

Is the measurement value within the specification?

- YES (Present error)>>Check CAN system type decision again.
YES (Past error)>>Error was detected in the data link connector branch line circuit.
NO >> Repair the data link connector branch line.

M&A BRANCH LINE CIRCUIT

Diagnosis Procedure

INFOID:000000005779216

1.CHECK CONNECTOR

1. Turn the ignition switch OFF.
2. Disconnect the battery cable from the negative terminal.
3. Check the terminals and connectors of the unified meter and A/C amp. for damage, bend and loose connection (unit side and connector side).

Is the inspection result normal?

- YES >> GO TO 2.
 NO >> Repair the terminal and connector.

2.CHECK HARNESS FOR OPEN CIRCUIT

1. Disconnect the connector of unified meter and A/C amp.
2. Check the resistance between the unified meter and A/C amp. harness connector terminals.

Unified meter and A/C amp. harness connector			Resistance (Ω)
Connector No.	Terminal No.		
M67	56	72	Approx. 54 – 66

Is the measurement value within the specification?

- YES >> GO TO 3.
 NO >> Repair the unified meter and A/C amp. branch line.

3.CHECK POWER SUPPLY AND GROUND CIRCUIT

Check the power supply and the ground circuit of the unified meter and A/C amp. Refer to [MWI-51, "UNIFIED METER AND A/C AMP. : Diagnosis Procedure"](#).

Is the inspection result normal?

- YES (Present error)>>Replace the unified meter and A/C amp. Refer to [MWI-136, "Exploded View"](#).
 YES (Past error)>>Error was detected in the unified meter and A/C amp. branch line.
 NO >> Repair the power supply and the ground circuit.

LAN

STRG BRANCH LINE CIRCUIT

< DTC/CIRCUIT DIAGNOSIS >

[CAN SYSTEM (TYPE 9)]

STRG BRANCH LINE CIRCUIT

Diagnosis Procedure

INFOID:000000005779217

1. CHECK CONNECTOR

1. Turn the ignition switch OFF.
2. Disconnect the battery cable from the negative terminal.
3. Check the terminals and connectors of the steering angle sensor for damage, bend and loose connection (unit side and connector side).

Is the inspection result normal?

- YES >> GO TO 2.
NO >> Repair the terminal and connector.

2. CHECK HARNESS FOR OPEN CIRCUIT

1. Disconnect the connector of steering angle sensor.
2. Check the resistance between the steering angle sensor harness connector terminals.

Steering angle sensor harness connector			Resistance (Ω)
Connector No.	Terminal No.		
M37	1	2	Approx. 54 – 66

Is the measurement value within the specification?

- YES >> GO TO 3.
NO >> Repair the steering angle sensor branch line.

3. CHECK POWER SUPPLY AND GROUND CIRCUIT

Check the power supply and the ground circuit of the steering angle sensor. Refer to [BRC-83, "Wiring Diagram - BRAKE CONTROL SYSTEM -"](#).

Is the inspection result normal?

- YES (Present error)>>Replace the steering angle sensor. Refer to [BRC-110, "Exploded View"](#).
YES (Past error)>>Error was detected in the steering angle sensor branch line.
NO >> Repair the power supply and the ground circuit.

ADP BRANCH LINE CIRCUIT

< DTC/CIRCUIT DIAGNOSIS >

[CAN SYSTEM (TYPE 9)]

ADP BRANCH LINE CIRCUIT

Diagnosis Procedure

INFOID:000000005779218

1. CHECK CONNECTOR

1. Turn the ignition switch OFF.
2. Disconnect the battery cable from the negative terminal.
3. Check the following terminals and connectors for damage, bend and loose connection (unit side and connector side).
 - Driver seat control unit
 - Harness connector B462
 - Harness connector B59

Is the inspection result normal?

- YES >> GO TO 2.
NO >> Repair the terminal and connector.

2. CHECK HARNESS FOR OPEN CIRCUIT

1. Disconnect the connector of driver seat control unit.
2. Check the resistance between the driver seat control unit harness connector terminals.

Driver seat control unit harness connector			Resistance (Ω)
Connector No.	Terminal No.		
B451	3	19	Approx. 54 – 66

Is the measurement value within the specification?

- YES >> GO TO 3.
NO >> Repair the driver seat control unit branch line.

3. CHECK POWER SUPPLY AND GROUND CIRCUIT

Check the power supply and the ground circuit of the driver seat control unit. Refer to [ADP-65, "DRIVER SEAT CONTROL UNIT : Diagnosis Procedure"](#).

Is the inspection result normal?

- YES (Present error)>>Replace the driver seat control unit. Refer to [ADP-228, "Exploded View"](#).
YES (Past error)>>Error was detected in the driver seat control unit branch line.
NO >> Repair the power supply and the ground circuit.

A
B
C
D
E
F
G
H
I
J
K
L

LAN

N
O
P

ABS BRANCH LINE CIRCUIT

< DTC/CIRCUIT DIAGNOSIS >

[CAN SYSTEM (TYPE 9)]

ABS BRANCH LINE CIRCUIT

Diagnosis Procedure

INFOID:000000005779219

1. CHECK CONNECTOR

1. Turn the ignition switch OFF.
2. Disconnect the battery cable from the negative terminal.
3. Check the terminals and connectors of the ABS actuator and electric unit (control unit) for damage, bend and loose connection (unit side and connector side).

Is the inspection result normal?

- YES >> GO TO 2.
NO >> Repair the terminal and connector.

2. CHECK HARNESS FOR OPEN CIRCUIT

1. Disconnect the connector of ABS actuator and electric unit (control unit).
2. Check the resistance between the ABS actuator and electric unit (control unit) harness connector terminals.

ABS actuator and electric unit (control unit) harness connector			Resistance (Ω)
Connector No.	Terminal No.		
E41	35	14	Approx. 54 – 66

Is the measurement value within the specification?

- YES >> GO TO 3.
NO >> Repair the ABS actuator and electric unit (control unit) branch line.

3. CHECK POWER SUPPLY AND GROUND CIRCUIT

Check the power supply and the ground circuit of the ABS actuator and electric unit (control unit). Refer to [BRC-69. "Diagnosis Procedure"](#).

Is the inspection result normal?

- YES (Present error)>>Replace the ABS actuator and electric unit (control unit). Refer to [BRC-107. "Exploded View"](#).
YES (Past error)>>Error was detected in the ABS actuator and electric unit (control unit) branch line.
NO >> Repair the power supply and the ground circuit.

ICC BRANCH LINE CIRCUIT

< DTC/CIRCUIT DIAGNOSIS >

[CAN SYSTEM (TYPE 9)]

ICC BRANCH LINE CIRCUIT

Diagnosis Procedure

INFOID:000000005779220

1. CHECK CONNECTOR

1. Turn the ignition switch OFF.
2. Disconnect the battery cable from the negative terminal.
3. Check the terminals and connectors of the ICC sensor integrated unit for damage, bend and loose connection (unit side and connector side).

Is the inspection result normal?

- YES >> GO TO 2.
NO >> Repair the terminal and connector.

2. CHECK HARNESS FOR OPEN CIRCUIT

1. Disconnect the connector of ICC sensor integrated unit.
2. Check the resistance between the ICC sensor integrated unit harness connector terminals.

ICC sensor integrated unit harness connector			Resistance (Ω)
Connector No.	Terminal No.		
E67	3	6	Approx. 54 – 66

Is the measurement value within the specification?

- YES >> GO TO 3.
NO >> Repair the ICC sensor integrated unit branch line.

3. CHECK POWER SUPPLY AND GROUND CIRCUIT

Check the power supply and the ground circuit of the ICC sensor integrated unit. Refer to [CCS-102, "Diagnosis Procedure"](#).

Is the inspection result normal?

- YES (Present error)>>Replace the ICC sensor integrated unit. Refer to [CCS-134, "Exploded View"](#).
YES (Past error)>>Error was detected in the ICC sensor integrated unit branch line.
NO >> Repair the power supply and the ground circuit.

A
B
C
D
E
F
G
H
I
J
K
L

LAN

N
O
P

IPDM-E BRANCH LINE CIRCUIT

< DTC/CIRCUIT DIAGNOSIS >

[CAN SYSTEM (TYPE 9)]

IPDM-E BRANCH LINE CIRCUIT

Diagnosis Procedure

INFOID:000000005779221

1. CHECK CONNECTOR

1. Turn the ignition switch OFF.
2. Disconnect the battery cable from the negative terminal.
3. Check the terminals and connectors of the IPDM E/R for damage, bend and loose connection (unit side and connector side).

Is the inspection result normal?

- YES >> GO TO 2.
NO >> Repair the terminal and connector.

2. CHECK HARNESS FOR OPEN CIRCUIT

1. Disconnect the connector of IPDM E/R.
2. Check the resistance between the IPDM E/R harness connector terminals.

IPDM E/R harness connector			Resistance (Ω)
Connector No.	Terminal No.		
E6	40	39	Approx. 108 – 132

Is the measurement value within the specification?

- YES >> GO TO 3.
NO >> Repair the IPDM E/R branch line.

3. CHECK POWER SUPPLY AND GROUND CIRCUIT

Check the power supply and the ground circuit of the IPDM E/R. Refer to [PCS-18, "Diagnosis Procedure"](#).

Is the inspection result normal?

- YES (Present error)>>Replace the IPDM E/R. Refer to [PCS-33, "Exploded View"](#).
YES (Past error)>>Error was detected in the IPDM E/R branch line.
NO >> Repair the power supply and the ground circuit.

CAN COMMUNICATION CIRCUIT

< DTC/CIRCUIT DIAGNOSIS >

[CAN SYSTEM (TYPE 9)]

CAN COMMUNICATION CIRCUIT

Diagnosis Procedure

INFOID:000000005779222

1. CONNECTOR INSPECTION

1. Turn the ignition switch OFF.
2. Disconnect the battery cable from the negative terminal.
3. Disconnect all the unit connectors on CAN communication system.
4. Check terminals and connectors for damage, bend and loose connection.

Is the inspection result normal?

- YES >> GO TO 2.
NO >> Repair the terminal and connector.

2. CHECK HARNESS CONTINUITY (SHORT CIRCUIT)

Check the continuity between the data link connector terminals.

Data link connector		Continuity
Connector No.	Terminal No.	
M24	6 14	Not existed

Is the inspection result normal?

- YES >> GO TO 3.
NO >> Check the harness and repair the root cause.

3. CHECK HARNESS CONTINUITY (SHORT CIRCUIT)

Check the continuity between the data link connector and the ground.

Data link connector		Ground	Continuity
Connector No.	Terminal No.		
M24	6		Not existed
	14		Not existed

Is the inspection result normal?

- YES >> GO TO 4.
NO >> Check the harness and repair the root cause.

4. CHECK ECM AND IPDM E/R TERMINATION CIRCUIT

1. Remove the ECM and the IPDM E/R.
2. Check the resistance between the ECM terminals.

ECM		Resistance (Ω)
Terminal No.		
114	113	Approx. 108 – 132

3. Check the resistance between the IPDM E/R terminals.

IPDM E/R		Resistance (Ω)
Terminal No.		
40	39	Approx. 108 – 132

Is the measurement value within the specification?

- YES >> GO TO 5.
NO >> Replace the ECM and/or the IPDM E/R.

5. CHECK SYMPTOM

Connect all the connectors. Check if the symptoms described in the "Symptom (Results from interview with customer)" are reproduced.

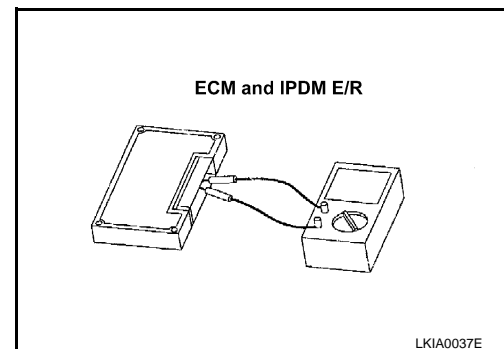

LKIA0037E

CAN COMMUNICATION CIRCUIT

< DTC/CIRCUIT DIAGNOSIS >

[CAN SYSTEM (TYPE 9)]

Inspection result

Reproduced>>GO TO 6.

Non-reproduced>>Start the diagnosis again. Follow the trouble diagnosis procedure when past error is detected.

6.CHECK UNIT REPRODUCTION

Perform the reproduction test as per the following procedure for each unit.

1. Turn the ignition switch OFF.
2. Disconnect the battery cable from the negative terminal.
3. Disconnect one of the unit connectors of CAN communication system.

NOTE:

ECM and IPDM E/R have a termination circuit. Check other units first.

4. Connect the battery cable to the negative terminal. Check if the symptoms described in the "Symptom (Results from interview with customer)" are reproduced.

NOTE:

Although unit-related error symptoms occur, do not confuse them with other symptoms.

Inspection result

Reproduced>>Connect the connector. Check other units as per the above procedure.

Non-reproduced>>Replace the unit whose connector was disconnected.

MAIN LINE BETWEEN AV AND DLC CIRCUIT

< DTC/CIRCUIT DIAGNOSIS >

[CAN SYSTEM (TYPE 10)]

DTC/CIRCUIT DIAGNOSIS

MAIN LINE BETWEEN AV AND DLC CIRCUIT

Diagnosis Procedure

INFOID:000000005779223

1. CHECK HARNESS CONTINUITY (OPEN CIRCUIT)

1. Turn the ignition switch OFF.
2. Disconnect the battery cable from the negative terminal.
3. Disconnect the following harness connectors.
 - ECM
 - AV control unit
4. Check the continuity between the AV control unit harness connector and the data link connector.
 - With navigation system

AV control unit harness connector		Data link connector		Continuity
Connector No.	Terminal No.	Connector No.	Terminal No.	
M210	90	M24	6	Existed
	74		14	Existed

- Without navigation system (With rear view monitor)

AV control unit harness connector		Data link connector		Continuity
Connector No.	Terminal No.	Connector No.	Terminal No.	
M204	81	M24	6	Existed
	80		14	Existed

- Without navigation system (Without rear view monitor)

AV control unit harness connector		Data link connector		Continuity
Connector No.	Terminal No.	Connector No.	Terminal No.	
M85	86	M24	6	Existed
	87		14	Existed

Is the inspection result normal?

YES (Present error)>>Check CAN system type decision again.

YES (Past error)>>Error was detected in the main line between the AV control unit and the data link connector.

NO >> Repair the main line between the AV control unit and the data link connector.

LAN

MAIN LINE BETWEEN DLC AND ADP CIRCUIT

< DTC/CIRCUIT DIAGNOSIS >

[CAN SYSTEM (TYPE 10)]

MAIN LINE BETWEEN DLC AND ADP CIRCUIT

Diagnosis Procedure

INFOID:000000005779224

1. CHECK CONNECTOR

1. Turn the ignition switch OFF.
2. Disconnect the battery cable from the negative terminal.
3. Check the following terminals and connectors for damage, bend and loose connection (connector side and harness side).
 - Harness connector M7
 - Harness connector B1

Is the inspection result normal?

YES >> GO TO 2.

NO >> Repair the terminal and connector.

2. CHECK HARNESS CONTINUITY (OPEN CIRCUIT)

1. Disconnect the harness connectors M7 and B1.
2. Check the continuity between the data link connector and the harness connector.

Data link connector		Harness connector		Continuity
Connector No.	Terminal No.	Connector No.	Terminal No.	
M24	6	M7	20	Existed
	14		21	Existed

Is the inspection result normal?

YES >> GO TO 3.

NO >> Repair the main line between the data link connector and the harness connector M7.

3. CHECK HARNESS CONTINUITY (OPEN CIRCUIT)

Check the continuity between the harness connector terminals.

Connector No.	Terminal No.		Continuity
B1	20	22	Existed
	21	23	Existed

Is the inspection result normal?

YES (Present error)>>Check CAN system type decision again.

YES (Past error)>>Error was detected in the main line between the data link connector and the driver seat control unit.

NO >> Repair the main line between the harness connector B1 and the driver seat control unit.

MAIN LINE BETWEEN ADP AND RAS CIRCUIT

< DTC/CIRCUIT DIAGNOSIS >

[CAN SYSTEM (TYPE 10)]

MAIN LINE BETWEEN ADP AND RAS CIRCUIT

Diagnosis Procedure

INFOID:000000005779225

1. CHECK HARNESS CONTINUITY (OPEN CIRCUIT)

1. Turn the ignition switch OFF.
2. Disconnect the battery cable from the negative terminal.
3. Disconnect the harness connectors M7 and B1.
4. Check the continuity between the harness connector terminals.

Connector No.	Terminal No.		Continuity
B1	20	22	Existed
	21	23	Existed

Is the inspection result normal?

YES (Present error)>>Check CAN system type decision again.

YES (Past error)>>Error was detected in the main line between the 4WAS main control unit and the driver seat control unit.

NO >> Repair the main line between the 4WAS main control unit and the driver seat control unit.

A
B
C
D
E
F
G
H
I
J
K
L

LAN

N
O
P

MAIN LINE BETWEEN RAS AND ABS CIRCUIT

< DTC/CIRCUIT DIAGNOSIS >

[CAN SYSTEM (TYPE 10)]

MAIN LINE BETWEEN RAS AND ABS CIRCUIT

Diagnosis Procedure

INFOID:000000005779226

1. CHECK CONNECTOR

1. Turn the ignition switch OFF.
2. Disconnect the battery cable from the negative terminal.
3. Check the following terminals and connectors for damage, bend and loose connection (connector side and harness side).
 - Harness connector B1
 - Harness connector M7
 - Harness connector M6
 - Harness connector E106

Is the inspection result normal?

YES >> GO TO 2.

NO >> Repair the terminal and connector.

2. CHECK HARNESS CONTINUITY (OPEN CIRCUIT)

1. Disconnect the harness connectors B1 and M7.
2. Check the continuity between the harness connector terminals.

Connector No.	Terminal No.		Continuity
B1	20	22	Existed
	21	23	Existed

Is the inspection result normal?

YES >> GO TO 3.

NO >> Repair the main line between the 4WAS main control unit and the harness connector B1.

3. CHECK HARNESS CONTINUITY (OPEN CIRCUIT)

1. Disconnect the harness connectors M6 and E106.
2. Check the continuity between the harness connectors.

Harness connector		Harness connector		Continuity
Connector No.	Terminal No.	Connector No.	Terminal No.	
M7	22	M6	7	Existed
	23		6	Existed

Is the inspection result normal?

YES >> GO TO 4.

NO >> Repair the main line between the harness connector M7 and M6.

4. CHECK HARNESS CONTINUITY (OPEN CIRCUIT)

1. Disconnect the connector of ABS actuator and electric unit (control unit).
2. Check the continuity between the harness connector and the ABS actuator and electric unit (control unit) harness connector.

Harness connector		ABS actuator and electric unit (control unit) harness connector		Continuity
Connector No.	Terminal No.	Connector No.	Terminal No.	
E106	7	E41	35	Existed
	6		14	Existed

Is the inspection result normal?

YES (Present error)>>Check CAN system type decision again.

YES (Past error)>>Error was detected in the main line between the 4WAS main control unit and the ABS actuator and electric unit (control unit).

MAIN LINE BETWEEN RAS AND ABS CIRCUIT

< DTC/CIRCUIT DIAGNOSIS >

[CAN SYSTEM (TYPE 10)]

NO >> Repair the main line between the harness connector E106 and the ABS actuator and electric unit (control unit).

A

B

C

D

E

F

G

H

I

J

K

L

LAN

N

O

P

ECM BRANCH LINE CIRCUIT

< DTC/CIRCUIT DIAGNOSIS >

[CAN SYSTEM (TYPE 10)]

ECM BRANCH LINE CIRCUIT

Diagnosis Procedure

INFOID:000000005779227

1. CHECK CONNECTOR

1. Turn the ignition switch OFF.
2. Disconnect the battery cable from the negative terminal.
3. Check the terminals and connectors of the ECM for damage, bend and loose connection (unit side and connector side).

Is the inspection result normal?

- YES >> GO TO 2.
NO >> Repair the terminal and connector.

2. CHECK HARNESS FOR OPEN CIRCUIT

1. Disconnect the connector of ECM.
2. Check the resistance between the ECM harness connector terminals.

ECM harness connector			Resistance (Ω)
Connector No.	Terminal No.		
M107	114	113	Approx. 108 – 132

Is the measurement value within the specification?

- YES >> GO TO 3.
NO >> Repair the ECM branch line.

3. CHECK POWER SUPPLY AND GROUND CIRCUIT

Check the power supply and the ground circuit of the ECM. Refer to [EC-144, "Diagnosis Procedure"](#).

Is the inspection result normal?

YES (Present error)>>Replace the ECM. Refer to [EC-17, "ADDITIONAL SERVICE WHEN REPLACING CONTROL UNIT \(ECM\) : Special Repair Requirement"](#).

YES (Past error)>>Error was detected in the ECM branch line.

NO >> Repair the power supply and the ground circuit.

AV BRANCH LINE CIRCUIT

Diagnosis Procedure

INFOID:000000005779228

1. CHECK CONNECTOR

1. Turn the ignition switch OFF.
2. Disconnect the battery cable from the negative terminal.
3. Check the terminals and connectors of the AV control unit for damage, bend and loose connection (unit side and connector side).

Is the inspection result normal?

- YES >> GO TO 2.
 NO >> Repair the terminal and connector.

2. CHECK HARNESS FOR OPEN CIRCUIT

1. Disconnect the connector of AV control unit.
 2. Check the resistance between the AV control unit harness connector terminals.
- Models with navigation system

AV control unit harness connector			Resistance (Ω)
Connector No.	Terminal No.		
M210	90	74	Approx. 54 – 66

- Models without navigation system (With rear view monitor)

AV control unit harness connector			Resistance (Ω)
Connector No.	Terminal No.		
M204	81	80	Approx. 54 – 66

- Models without navigation system (Without rear view monitor)

AV control unit harness connector			Resistance (Ω)
Connector No.	Terminal No.		
M85	86	87	Approx. 54 – 66

Is the measurement value within the specification?

- YES >> GO TO 3.
 NO >> Repair the AV control unit branch line.

3. CHECK POWER SUPPLY AND GROUND CIRCUIT

Check the power supply and the ground circuit of the AV control unit. Refer to the following.

- Base audio without rear view monitor: [AV-40, "AV CONTROL UNIT : Diagnosis Procedure"](#)
- Base audio with rear view monitor: [AV-173, "AV CONTROL UNIT : Diagnosis Procedure"](#)
- BOSE audio without navigation: [AV-297, "AV CONTROL UNIT : Diagnosis Procedure"](#)
- BOSE audio with navigation: [AV-448, "AV CONTROL UNIT : Diagnosis Procedure"](#)

Is the inspection result normal?

- YES (Present error)>>Replace the AV control unit. Refer to the following.
- Base audio without rear view monitor: [AV-90, "Exploded View"](#)
 - Base audio with rear view monitor: [AV-202, "Exploded View"](#)
 - BOSE audio without navigation: [AV-328, "Exploded View"](#)
 - BOSE audio with navigation: [AV-474, "Exploded View"](#)

YES (Past error)>>Error was detected in the AV control unit branch line.

- NO >> Repair the power supply and the ground circuit.

A
B
C
D
E
F
G
H
I
J
K
L

LAN

N
O
P

PSB BRANCH LINE CIRCUIT

Diagnosis Procedure

INFOID:000000005779229

1.CHECK CONNECTOR

1. Turn the ignition switch OFF.
2. Disconnect the battery cable from the negative terminal.
3. Check the terminals and connectors of the pre-crash seat belt control unit for damage, bend and loose connection (unit side and connector side).

Is the inspection result normal?

- YES >> GO TO 2.
 NO >> Repair the terminal and connector.

2.CHECK HARNESS FOR OPEN CIRCUIT

1. Disconnect the connector of pre-crash seat belt control unit.
2. Check the resistance between the pre-crash seat belt control unit harness connector terminals.

Pre-crash seat belt control unit harness connector			Resistance (Ω)
Connector No.	Terminal No.		
M110	24	22	Approx. 54 – 66

Is the measurement value within the specification?

- YES >> GO TO 3.
 NO >> Repair the pre-crash seat belt control unit branch line.

3.CHECK POWER SUPPLY AND GROUND CIRCUIT

Check the power supply and the ground circuit of the pre-crash seat belt control unit. Refer to [SBC-24, "Diagnosis Procedure"](#).

Is the inspection result normal?

- YES (Present error)>>Replace the pre-crash seat belt control unit. Refer to [SBC-39, "Exploded View"](#).
 YES (Past error)>>Error was detected in the pre-crash seat belt control unit branch line.
 NO >> Repair the power supply and the ground circuit.

TCM BRANCH LINE CIRCUIT

< DTC/CIRCUIT DIAGNOSIS >

[CAN SYSTEM (TYPE 10)]

TCM BRANCH LINE CIRCUIT

Diagnosis Procedure

INFOID:000000005779230

1. CHECK CONNECTOR

1. Turn the ignition switch OFF.
2. Disconnect the battery cable from the negative terminal.
3. Check the following terminals and connectors for damage, bend and loose connection (unit side and connector side).
 - A/T assembly
 - Harness connector F103
 - Harness connector M116

Is the inspection result normal?

- YES >> GO TO 2.
NO >> Repair the terminal and connector.

2. CHECK HARNESS FOR OPEN CIRCUIT

1. Disconnect the connector of A/T assembly.
2. Check the resistance between the A/T assembly harness connector terminals.

A/T assembly harness connector		Resistance (Ω)
Connector No.	Terminal No.	
F51	3	Approx. 54 – 66
	8	

Is the measurement value within the specification?

- YES >> GO TO 3.
NO >> Repair the TCM branch line.

3. CHECK POWER SUPPLY AND GROUND CIRCUIT

Check the power supply and the ground circuit of the TCM. Refer to [TM-212, "Diagnosis Procedure"](#).

Is the inspection result normal?

- YES (Present error)>>Replace the control valve with TCM. Refer to [TM-99, "Component Parts Location"](#).
(Replace A/T assembly if control valve with TCM is not listed in the latest parts list.)
YES (Past error)>>Error was detected in the TCM branch line.
NO >> Repair the power supply and the ground circuit.

A
B
C
D
E
F
G
H
I
J
K
L

LAN

A-BAG BRANCH LINE CIRCUIT

Diagnosis Procedure

INFOID:000000005869130

WARNING:

- Before servicing, turn ignition switch OFF, disconnect battery negative terminal, and wait 3 minutes or more. (To discharge backup capacitor.)
- Never use unspecified tester or other measuring device.

1.CHECK CONNECTOR

1. Turn the ignition switch OFF.
2. Disconnect the battery cable from the negative terminal.
3. Check the terminals and connectors of the air bag diagnosis sensor unit for damage, bend and loose connection (unit side and connector side).

Is the inspection result normal?

- YES >> GO TO 2.
NO >> Replace the main harness.

2.CHECK AIR BAG DIAGNOSIS SENSOR UNIT

Check the air bag diagnosis sensor unit. Refer to [SRC-5, "Work Flow"](#).

Is the inspection result normal?

- YES >> Replace the main harness.
NO >> Replace parts whose air bag system has a malfunction.

BCM BRANCH LINE CIRCUIT

< DTC/CIRCUIT DIAGNOSIS >

[CAN SYSTEM (TYPE 10)]

BCM BRANCH LINE CIRCUIT

Diagnosis Procedure

INFOID:000000005779232

1. CHECK CONNECTOR

1. Turn the ignition switch OFF.
2. Disconnect the battery cable from the negative terminal.
3. Check the terminals and connectors of the BCM for damage, bend and loose connection (unit side and connector side).

Is the inspection result normal?

- YES >> GO TO 2.
NO >> Repair the terminal and connector.

2. CHECK HARNESS FOR OPEN CIRCUIT

1. Disconnect the connector of BCM.
2. Check the resistance between the BCM harness connector terminals.

BCM harness connector			Resistance (Ω)
Connector No.	Terminal No.		
M122	91	90	Approx. 54 – 66

Is the measurement value within the specification?

- YES >> GO TO 3.
NO >> Repair the BCM branch line.

3. CHECK POWER SUPPLY AND GROUND CIRCUIT

Check the power supply and the ground circuit of the BCM. Refer to [BCS-37, "Diagnosis Procedure"](#).

Is the inspection result normal?

- YES (Present error)>>Replace the BCM. Refer to [BCS-80, "Exploded View"](#).
YES (Past error)>>Error was detected in the BCM branch line.
NO >> Repair the power supply and the ground circuit.

A
B
C
D
E
F
G
H
I
J
K
L

LAN

N
O
P

DLC BRANCH LINE CIRCUIT

< DTC/CIRCUIT DIAGNOSIS >

[CAN SYSTEM (TYPE 10)]

DLC BRANCH LINE CIRCUIT

Diagnosis Procedure

INFOID:000000005779233

1. CHECK CONNECTOR

1. Turn the ignition switch OFF.
2. Disconnect the battery cable from the negative terminal.
3. Check the terminals and connectors of the data link connector for damage, bend and loose connection (connector side and harness side).

Is the inspection result normal?

- YES >> GO TO 2.
NO >> Repair the terminal and connector.

2. CHECK HARNESS FOR OPEN CIRCUIT

Check the resistance between the data link connector terminals.

Data link connector			Resistance (Ω)
Connector No.	Terminal No.		
M24	6	14	Approx. 54 – 66

Is the measurement value within the specification?

- YES (Present error)>>Check CAN system type decision again.
YES (Past error)>>Error was detected in the data link connector branch line circuit.
NO >> Repair the data link connector branch line.

M&A BRANCH LINE CIRCUIT

< DTC/CIRCUIT DIAGNOSIS >

[CAN SYSTEM (TYPE 10)]

M&A BRANCH LINE CIRCUIT

Diagnosis Procedure

INFOID:000000005779234

1.CHECK CONNECTOR

1. Turn the ignition switch OFF.
2. Disconnect the battery cable from the negative terminal.
3. Check the terminals and connectors of the unified meter and A/C amp. for damage, bend and loose connection (unit side and connector side).

Is the inspection result normal?

- YES >> GO TO 2.
NO >> Repair the terminal and connector.

2.CHECK HARNESS FOR OPEN CIRCUIT

1. Disconnect the connector of unified meter and A/C amp.
2. Check the resistance between the unified meter and A/C amp. harness connector terminals.

Unified meter and A/C amp. harness connector			Resistance (Ω)
Connector No.	Terminal No.		
M67	56	72	Approx. 54 – 66

Is the measurement value within the specification?

- YES >> GO TO 3.
NO >> Repair the unified meter and A/C amp. branch line.

3.CHECK POWER SUPPLY AND GROUND CIRCUIT

Check the power supply and the ground circuit of the unified meter and A/C amp. Refer to [MWI-51, "UNIFIED METER AND A/C AMP. : Diagnosis Procedure"](#).

Is the inspection result normal?

- YES (Present error)>>Replace the unified meter and A/C amp. Refer to [MWI-136, "Exploded View"](#).
YES (Past error)>>Error was detected in the unified meter and A/C amp. branch line.
NO >> Repair the power supply and the ground circuit.

A
B
C
D
E
F
G
H
I
J
K
L

LAN

N
O
P

STRG BRANCH LINE CIRCUIT

< DTC/CIRCUIT DIAGNOSIS >

[CAN SYSTEM (TYPE 10)]

STRG BRANCH LINE CIRCUIT

Diagnosis Procedure

INFOID:000000005779235

1. CHECK CONNECTOR

1. Turn the ignition switch OFF.
2. Disconnect the battery cable from the negative terminal.
3. Check the terminals and connectors of the steering angle sensor for damage, bend and loose connection (unit side and connector side).

Is the inspection result normal?

- YES >> GO TO 2.
NO >> Repair the terminal and connector.

2. CHECK HARNESS FOR OPEN CIRCUIT

1. Disconnect the connector of steering angle sensor.
2. Check the resistance between the steering angle sensor harness connector terminals.

Steering angle sensor harness connector			Resistance (Ω)
Connector No.	Terminal No.		
M37	1	2	Approx. 54 – 66

Is the measurement value within the specification?

- YES >> GO TO 3.
NO >> Repair the steering angle sensor branch line.

3. CHECK POWER SUPPLY AND GROUND CIRCUIT

Check the power supply and the ground circuit of the steering angle sensor. Refer to [BRC-83, "Wiring Diagram - BRAKE CONTROL SYSTEM -"](#).

Is the inspection result normal?

- YES (Present error)>>Replace the steering angle sensor. Refer to [BRC-110, "Exploded View"](#).
YES (Past error)>>Error was detected in the steering angle sensor branch line.
NO >> Repair the power supply and the ground circuit.

ADP BRANCH LINE CIRCUIT

< DTC/CIRCUIT DIAGNOSIS >

[CAN SYSTEM (TYPE 10)]

ADP BRANCH LINE CIRCUIT

Diagnosis Procedure

INFOID:000000005779236

1. CHECK CONNECTOR

1. Turn the ignition switch OFF.
2. Disconnect the battery cable from the negative terminal.
3. Check the following terminals and connectors for damage, bend and loose connection (unit side and connector side).
 - Driver seat control unit
 - Harness connector B462
 - Harness connector B59

Is the inspection result normal?

- YES >> GO TO 2.
NO >> Repair the terminal and connector.

2. CHECK HARNESS FOR OPEN CIRCUIT

1. Disconnect the connector of driver seat control unit.
2. Check the resistance between the driver seat control unit harness connector terminals.

Driver seat control unit harness connector			Resistance (Ω)
Connector No.	Terminal No.		
B451	3	19	Approx. 54 – 66

Is the measurement value within the specification?

- YES >> GO TO 3.
NO >> Repair the driver seat control unit branch line.

3. CHECK POWER SUPPLY AND GROUND CIRCUIT

Check the power supply and the ground circuit of the driver seat control unit. Refer to [ADP-65, "DRIVER SEAT CONTROL UNIT : Diagnosis Procedure"](#).

Is the inspection result normal?

- YES (Present error)>>Replace the driver seat control unit. Refer to [ADP-228, "Exploded View"](#).
YES (Past error)>>Error was detected in the driver seat control unit branch line.
NO >> Repair the power supply and the ground circuit.

A
B
C
D
E
F
G
H
I
J
K
L

LAN

N
O
P

RAS BRANCH LINE CIRCUIT

Diagnosis Procedure

INFOID:000000005779237

1. CHECK CONNECTOR

1. Turn the ignition switch OFF.
2. Disconnect the battery cable from the negative terminal.
3. Check the terminals and connectors of the 4WAS main control unit for damage, bend and loose connection (unit side and connector side).

Is the inspection result normal?

- YES >> GO TO 2.
 NO >> Repair the terminal and connector.

2. CHECK HARNESS FOR OPEN CIRCUIT

1. Disconnect the connector of 4WAS main control unit.
2. Check the resistance between the 4WAS main control unit harness connector terminals.

4WAS main control unit harness connector			Resistance (Ω)
Connector No.	Terminal No.		
B54	1	8	Approx. 54 – 66

Is the measurement value within the specification?

- YES >> GO TO 3.
 NO >> Replace the body harness.

3. CHECK POWER SUPPLY AND GROUND CIRCUIT

Check the power supply and the ground circuit of the 4WAS main control unit. Refer to [STC-136, "Diagnosis Procedure \(4WAS Main Control Unit\)"](#).

Is the inspection result normal?

- YES (Present error)>>Replace the 4WAS main control unit. Refer to [STC-185, "Exploded View"](#).
 YES (Past error)>>Error was detected in the 4WAS main control unit branch line.
 NO >> Repair the power supply and the ground circuit.

ABS BRANCH LINE CIRCUIT

< DTC/CIRCUIT DIAGNOSIS >

[CAN SYSTEM (TYPE 10)]

ABS BRANCH LINE CIRCUIT

Diagnosis Procedure

INFOID:000000005779238

1. CHECK CONNECTOR

1. Turn the ignition switch OFF.
2. Disconnect the battery cable from the negative terminal.
3. Check the terminals and connectors of the ABS actuator and electric unit (control unit) for damage, bend and loose connection (unit side and connector side).

Is the inspection result normal?

- YES >> GO TO 2.
NO >> Repair the terminal and connector.

2. CHECK HARNESS FOR OPEN CIRCUIT

1. Disconnect the connector of ABS actuator and electric unit (control unit).
2. Check the resistance between the ABS actuator and electric unit (control unit) harness connector terminals.

ABS actuator and electric unit (control unit) harness connector			Resistance (Ω)
Connector No.	Terminal No.		
E41	35	14	Approx. 54 – 66

Is the measurement value within the specification?

- YES >> GO TO 3.
NO >> Repair the ABS actuator and electric unit (control unit) branch line.

3. CHECK POWER SUPPLY AND GROUND CIRCUIT

Check the power supply and the ground circuit of the ABS actuator and electric unit (control unit). Refer to [BRC-69, "Diagnosis Procedure"](#).

Is the inspection result normal?

- YES (Present error)>>Replace the ABS actuator and electric unit (control unit). Refer to [BRC-107, "Exploded View"](#).
YES (Past error)>>Error was detected in the ABS actuator and electric unit (control unit) branch line.
NO >> Repair the power supply and the ground circuit.

A
B
C
D
E
F
G
H
I
J
K
L

LAN

ICC BRANCH LINE CIRCUIT

Diagnosis Procedure

INFOID:000000005779239

1. CHECK CONNECTOR

1. Turn the ignition switch OFF.
2. Disconnect the battery cable from the negative terminal.
3. Check the terminals and connectors of the ICC sensor integrated unit for damage, bend and loose connection (unit side and connector side).

Is the inspection result normal?

- YES >> GO TO 2.
 NO >> Repair the terminal and connector.

2. CHECK HARNESS FOR OPEN CIRCUIT

1. Disconnect the connector of ICC sensor integrated unit.
2. Check the resistance between the ICC sensor integrated unit harness connector terminals.

ICC sensor integrated unit harness connector			Resistance (Ω)
Connector No.	Terminal No.		
E67	3	6	Approx. 54 – 66

Is the measurement value within the specification?

- YES >> GO TO 3.
 NO >> Repair the ICC sensor integrated unit branch line.

3. CHECK POWER SUPPLY AND GROUND CIRCUIT

Check the power supply and the ground circuit of the ICC sensor integrated unit. Refer to [CCS-102, "Diagnosis Procedure"](#).

Is the inspection result normal?

- YES (Present error)>>Replace the ICC sensor integrated unit. Refer to [CCS-134, "Exploded View"](#).
 YES (Past error)>>Error was detected in the ICC sensor integrated unit branch line.
 NO >> Repair the power supply and the ground circuit.

IPDM-E BRANCH LINE CIRCUIT

< DTC/CIRCUIT DIAGNOSIS >

[CAN SYSTEM (TYPE 10)]

IPDM-E BRANCH LINE CIRCUIT

Diagnosis Procedure

INFOID:000000005779240

1. CHECK CONNECTOR

1. Turn the ignition switch OFF.
2. Disconnect the battery cable from the negative terminal.
3. Check the terminals and connectors of the IPDM E/R for damage, bend and loose connection (unit side and connector side).

Is the inspection result normal?

- YES >> GO TO 2.
NO >> Repair the terminal and connector.

2. CHECK HARNESS FOR OPEN CIRCUIT

1. Disconnect the connector of IPDM E/R.
2. Check the resistance between the IPDM E/R harness connector terminals.

IPDM E/R harness connector			Resistance (Ω)
Connector No.	Terminal No.		
E6	40	39	Approx. 108 – 132

Is the measurement value within the specification?

- YES >> GO TO 3.
NO >> Repair the IPDM E/R branch line.

3. CHECK POWER SUPPLY AND GROUND CIRCUIT

Check the power supply and the ground circuit of the IPDM E/R. Refer to [PCS-18, "Diagnosis Procedure"](#).

Is the inspection result normal?

- YES (Present error)>>Replace the IPDM E/R. Refer to [PCS-33, "Exploded View"](#).
YES (Past error)>>Error was detected in the IPDM E/R branch line.
NO >> Repair the power supply and the ground circuit.

A
B
C
D
E
F
G
H
I
J
K
L

LAN

N
O
P

CAN COMMUNICATION CIRCUIT

< DTC/CIRCUIT DIAGNOSIS >

[CAN SYSTEM (TYPE 10)]

CAN COMMUNICATION CIRCUIT

Diagnosis Procedure

INFOID:000000005779241

1. CONNECTOR INSPECTION

1. Turn the ignition switch OFF.
2. Disconnect the battery cable from the negative terminal.
3. Disconnect all the unit connectors on CAN communication system.
4. Check terminals and connectors for damage, bend and loose connection.

Is the inspection result normal?

- YES >> GO TO 2.
NO >> Repair the terminal and connector.

2. CHECK HARNESS CONTINUITY (SHORT CIRCUIT)

Check the continuity between the data link connector terminals.

Data link connector			Continuity
Connector No.	Terminal No.		
M24	6	14	Not existed

Is the inspection result normal?

- YES >> GO TO 3.
NO >> Check the harness and repair the root cause.

3. CHECK HARNESS CONTINUITY (SHORT CIRCUIT)

Check the continuity between the data link connector and the ground.

Data link connector		Ground	Continuity
Connector No.	Terminal No.		
M24	6		Not existed
	14		Not existed

Is the inspection result normal?

- YES >> GO TO 4.
NO >> Check the harness and repair the root cause.

4. CHECK ECM AND IPDM E/R TERMINATION CIRCUIT

1. Remove the ECM and the IPDM E/R.
2. Check the resistance between the ECM terminals.

ECM		Resistance (Ω)
Terminal No.		
114	113	Approx. 108 – 132

3. Check the resistance between the IPDM E/R terminals.

IPDM E/R		Resistance (Ω)
Terminal No.		
40	39	Approx. 108 – 132

Is the measurement value within the specification?

- YES >> GO TO 5.
NO >> Replace the ECM and/or the IPDM E/R.

5. CHECK SYMPTOM

Connect all the connectors. Check if the symptoms described in the "Symptom (Results from interview with customer)" are reproduced.

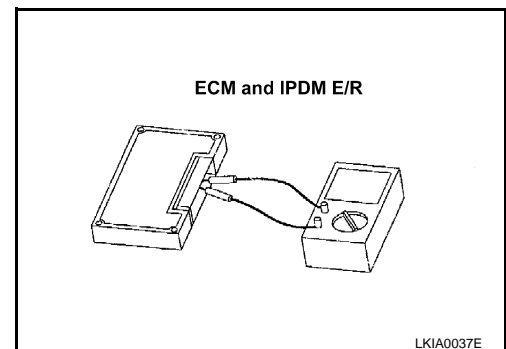

CAN COMMUNICATION CIRCUIT

< DTC/CIRCUIT DIAGNOSIS >

[CAN SYSTEM (TYPE 10)]

Inspection result

Reproduced>>GO TO 6.

Non-reproduced>>Start the diagnosis again. Follow the trouble diagnosis procedure when past error is detected.

6.CHECK UNIT REPRODUCTION

Perform the reproduction test as per the following procedure for each unit.

1. Turn the ignition switch OFF.
2. Disconnect the battery cable from the negative terminal.
3. Disconnect one of the unit connectors of CAN communication system.

NOTE:

ECM and IPDM E/R have a termination circuit. Check other units first.

4. Connect the battery cable to the negative terminal. Check if the symptoms described in the "Symptom (Results from interview with customer)" are reproduced.

NOTE:

Although unit-related error symptoms occur, do not confuse them with other symptoms.

Inspection result

Reproduced>>Connect the connector. Check other units as per the above procedure.

Non-reproduced>>Replace the unit whose connector was disconnected.

A
B
C
D
E
F
G
H
I
J
K
L

LAN

N
O
P

MAIN LINE BETWEEN AV AND DLC CIRCUIT

< DTC/CIRCUIT DIAGNOSIS >

[CAN SYSTEM (TYPE 11)]

DTC/CIRCUIT DIAGNOSIS

MAIN LINE BETWEEN AV AND DLC CIRCUIT

Diagnosis Procedure

INFOID:000000005779243

1. CHECK HARNESS CONTINUITY (OPEN CIRCUIT)

1. Turn the ignition switch OFF.
2. Disconnect the battery cable from the negative terminal.
3. Disconnect the following harness connectors.
 - ECM
 - AV control unit
4. Check the continuity between the AV control unit harness connector and the data link connector.
 - With navigation system

AV control unit harness connector		Data link connector		Continuity
Connector No.	Terminal No.	Connector No.	Terminal No.	
M210	90	M24	6	Existed
	74		14	Existed

- Without navigation system (With rear view monitor)

AV control unit harness connector		Data link connector		Continuity
Connector No.	Terminal No.	Connector No.	Terminal No.	
M204	81	M24	6	Existed
	80		14	Existed

- Without navigation system (Without rear view monitor)

AV control unit harness connector		Data link connector		Continuity
Connector No.	Terminal No.	Connector No.	Terminal No.	
M85	86	M24	6	Existed
	87		14	Existed

Is the inspection result normal?

YES (Present error)>>Check CAN system type decision again.

YES (Past error)>>Error was detected in the main line between the AV control unit and the data link connector.

NO >> Repair the main line between the AV control unit and the data link connector.

MAIN LINE BETWEEN DLC AND ABS CIRCUIT

< DTC/CIRCUIT DIAGNOSIS >

[CAN SYSTEM (TYPE 11)]

MAIN LINE BETWEEN DLC AND ABS CIRCUIT

Diagnosis Procedure

INFOID:000000005779244

1. CHECK CONNECTOR

1. Turn the ignition switch OFF.
2. Disconnect the battery cable from the negative terminal.
3. Check the following terminals and connectors for damage, bend and loose connection (connector side and harness side).
 - Harness connector M6
 - Harness connector E106

Is the inspection result normal?

YES >> GO TO 2.

NO >> Repair the terminal and connector.

2. CHECK HARNESS CONTINUITY (OPEN CIRCUIT)

1. Disconnect the harness connectors M6 and E106.
2. Check the continuity between the data link connector and the harness connector.

Data link connector		Harness connector		Continuity
Connector No.	Terminal No.	Connector No.	Terminal No.	
M24	6	M6	7	Existed
	14		6	Existed

Is the inspection result normal?

YES >> GO TO 3.

NO >> Repair the main line between the data link connector and the harness connector M6.

3. CHECK HARNESS CONTINUITY (OPEN CIRCUIT)

1. Disconnect the connector of ABS actuator and electric unit (control unit).
2. Check the continuity between the harness connector and the ABS actuator and electric unit (control unit) harness connector.

Harness connector		ABS actuator and electric unit (control unit) harness connector		Continuity
Connector No.	Terminal No.	Connector No.	Terminal No.	
E106	7	E41	35	Existed
	6		14	Existed

Is the inspection result normal?

YES (Present error)>>Check CAN system type decision again.

YES (Past error)>>Error was detected in the main line between the data link connector and the ABS actuator and electric unit (control unit).

NO >> Repair the main line between the harness connector E106 and the ABS actuator and electric unit (control unit).

A
B
C
D
E
F
G
H
I
J
K
L
N
O
P

LAN

ECM BRANCH LINE CIRCUIT

< DTC/CIRCUIT DIAGNOSIS >

[CAN SYSTEM (TYPE 11)]

ECM BRANCH LINE CIRCUIT

Diagnosis Procedure

INFOID:000000005779245

1. CHECK CONNECTOR

1. Turn the ignition switch OFF.
2. Disconnect the battery cable from the negative terminal.
3. Check the terminals and connectors of the ECM for damage, bend and loose connection (unit side and connector side).

Is the inspection result normal?

- YES >> GO TO 2.
NO >> Repair the terminal and connector.

2. CHECK HARNESS FOR OPEN CIRCUIT

1. Disconnect the connector of ECM.
2. Check the resistance between the ECM harness connector terminals.

ECM harness connector			Resistance (Ω)
Connector No.	Terminal No.		
M107	114	113	Approx. 108 – 132

Is the measurement value within the specification?

- YES >> GO TO 3.
NO >> Repair the ECM branch line.

3. CHECK POWER SUPPLY AND GROUND CIRCUIT

Check the power supply and the ground circuit of the ECM. Refer to [EC-144, "Diagnosis Procedure"](#).

Is the inspection result normal?

YES (Present error)>>Replace the ECM. Refer to [EC-17, "ADDITIONAL SERVICE WHEN REPLACING CONTROL UNIT \(ECM\) : Special Repair Requirement"](#).

YES (Past error)>>Error was detected in the ECM branch line.

NO >> Repair the power supply and the ground circuit.

4WD BRANCH LINE CIRCUIT

< DTC/CIRCUIT DIAGNOSIS >

[CAN SYSTEM (TYPE 11)]

4WD BRANCH LINE CIRCUIT

Diagnosis Procedure

INFOID:000000005779246

1. CHECK CONNECTOR

1. Turn the ignition switch OFF.
2. Disconnect the battery cable from the negative terminal.
3. Check the following terminals and connectors for damage, bend and loose connection (unit side and connector side).
 - AWD control unit connector
 - Harness connector F103
 - Harness connector M116

Is the inspection result normal?

- YES >> GO TO 2.
NO >> Repair the terminal and connector.

2. CHECK HARNESS FOR OPEN CIRCUIT

1. Disconnect the connector of AWD control unit.
2. Check the resistance between the AWD control unit harness connector terminals.

AWD control unit harness connector			Resistance (Ω)
Connector No.	Terminal No.		
F108	8	16	Approx. 54 – 66

Is the measurement value within the specification?

- YES >> GO TO 3.
NO >> Repair the AWD control unit branch line.

3. CHECK POWER SUPPLY AND GROUND CIRCUIT

Check the power supply and the ground circuit of the AWD control unit. Refer to [DLN-27, "Diagnosis Procedure"](#).

Is the inspection result normal?

- YES (Present error)>>Replace the AWD control unit. Refer to [DLN-55, "Exploded View"](#).
YES (Past error)>>Error was detected in the AWD control unit branch line.
NO >> Repair the power supply and the ground circuit.

A
B
C
D
E
F
G
H
I
J
K
L

LAN

N
O
P

AV BRANCH LINE CIRCUIT

Diagnosis Procedure

INFOID:000000005779247

1. CHECK CONNECTOR

1. Turn the ignition switch OFF.
2. Disconnect the battery cable from the negative terminal.
3. Check the terminals and connectors of the AV control unit for damage, bend and loose connection (unit side and connector side).

Is the inspection result normal?

- YES >> GO TO 2.
 NO >> Repair the terminal and connector.

2. CHECK HARNESS FOR OPEN CIRCUIT

1. Disconnect the connector of AV control unit.
 2. Check the resistance between the AV control unit harness connector terminals.
- Models with navigation system

AV control unit harness connector			Resistance (Ω)
Connector No.	Terminal No.		
M210	90	74	Approx. 54 – 66

- Models without navigation system (With rear view monitor)

AV control unit harness connector			Resistance (Ω)
Connector No.	Terminal No.		
M204	81	80	Approx. 54 – 66

- Models without navigation system (Without rear view monitor)

AV control unit harness connector			Resistance (Ω)
Connector No.	Terminal No.		
M85	86	87	Approx. 54 – 66

Is the measurement value within the specification?

- YES >> GO TO 3.
 NO >> Repair the AV control unit branch line.

3. CHECK POWER SUPPLY AND GROUND CIRCUIT

Check the power supply and the ground circuit of the AV control unit. Refer to the following.

- Base audio without rear view monitor: [AV-40, "AV CONTROL UNIT : Diagnosis Procedure"](#)
- Base audio with rear view monitor: [AV-173, "AV CONTROL UNIT : Diagnosis Procedure"](#)
- BOSE audio without navigation: [AV-297, "AV CONTROL UNIT : Diagnosis Procedure"](#)
- BOSE audio with navigation: [AV-448, "AV CONTROL UNIT : Diagnosis Procedure"](#)

Is the inspection result normal?

- YES (Present error)>>Replace the AV control unit. Refer to the following.
- Base audio without rear view monitor: [AV-90, "Exploded View"](#)
 - Base audio with rear view monitor: [AV-202, "Exploded View"](#)
 - BOSE audio without navigation: [AV-328, "Exploded View"](#)
 - BOSE audio with navigation: [AV-474, "Exploded View"](#)

YES (Past error)>>Error was detected in the AV control unit branch line.

NO >> Repair the power supply and the ground circuit.

TCM BRANCH LINE CIRCUIT

< DTC/CIRCUIT DIAGNOSIS >

[CAN SYSTEM (TYPE 11)]

TCM BRANCH LINE CIRCUIT

Diagnosis Procedure

INFOID:000000005779248

1. CHECK CONNECTOR

1. Turn the ignition switch OFF.
2. Disconnect the battery cable from the negative terminal.
3. Check the following terminals and connectors for damage, bend and loose connection (unit side and connector side).
 - A/T assembly
 - Harness connector F103
 - Harness connector M116

Is the inspection result normal?

- YES >> GO TO 2.
NO >> Repair the terminal and connector.

2. CHECK HARNESS FOR OPEN CIRCUIT

1. Disconnect the connector of A/T assembly.
2. Check the resistance between the A/T assembly harness connector terminals.

A/T assembly harness connector		Resistance (Ω)
Connector No.	Terminal No.	
F51	3	Approx. 54 – 66
	8	

Is the measurement value within the specification?

- YES >> GO TO 3.
NO >> Repair the TCM branch line.

3. CHECK POWER SUPPLY AND GROUND CIRCUIT

Check the power supply and the ground circuit of the TCM. Refer to [TM-212, "Diagnosis Procedure"](#).

Is the inspection result normal?

- YES (Present error)>>Replace the control valve with TCM. Refer to [TM-99, "Component Parts Location"](#).
(Replace A/T assembly if control valve with TCM is not listed in the latest parts list.)
YES (Past error)>>Error was detected in the TCM branch line.
NO >> Repair the power supply and the ground circuit.

A
B
C
D
E
F
G
H
I
J
K
L

LAN

A-BAG BRANCH LINE CIRCUIT

< DTC/CIRCUIT DIAGNOSIS >

[CAN SYSTEM (TYPE 11)]

A-BAG BRANCH LINE CIRCUIT

Diagnosis Procedure

INFOID:000000005869135

WARNING:

- Before servicing, turn ignition switch OFF, disconnect battery negative terminal, and wait 3 minutes or more. (To discharge backup capacitor.)
- Never use unspecified tester or other measuring device.

1.CHECK CONNECTOR

1. Turn the ignition switch OFF.
2. Disconnect the battery cable from the negative terminal.
3. Check the terminals and connectors of the air bag diagnosis sensor unit for damage, bend and loose connection (unit side and connector side).

Is the inspection result normal?

YES >> GO TO 2.

NO >> Replace the main harness.

2.CHECK AIR BAG DIAGNOSIS SENSOR UNIT

Check the air bag diagnosis sensor unit. Refer to [SRC-5, "Work Flow"](#).

Is the inspection result normal?

YES >> Replace the main harness.

NO >> Replace parts whose air bag system has a malfunction.

BCM BRANCH LINE CIRCUIT

< DTC/CIRCUIT DIAGNOSIS >

[CAN SYSTEM (TYPE 11)]

BCM BRANCH LINE CIRCUIT

Diagnosis Procedure

INFOID:000000005779250

1. CHECK CONNECTOR

1. Turn the ignition switch OFF.
2. Disconnect the battery cable from the negative terminal.
3. Check the terminals and connectors of the BCM for damage, bend and loose connection (unit side and connector side).

Is the inspection result normal?

- YES >> GO TO 2.
NO >> Repair the terminal and connector.

2. CHECK HARNESS FOR OPEN CIRCUIT

1. Disconnect the connector of BCM.
2. Check the resistance between the BCM harness connector terminals.

BCM harness connector			Resistance (Ω)
Connector No.	Terminal No.		
M122	91	90	Approx. 54 – 66

Is the measurement value within the specification?

- YES >> GO TO 3.
NO >> Repair the BCM branch line.

3. CHECK POWER SUPPLY AND GROUND CIRCUIT

Check the power supply and the ground circuit of the BCM. Refer to [BCS-37, "Diagnosis Procedure"](#).

Is the inspection result normal?

- YES (Present error)>>Replace the BCM. Refer to [BCS-80, "Exploded View"](#).
YES (Past error)>>Error was detected in the BCM branch line.
NO >> Repair the power supply and the ground circuit.

A
B
C
D
E
F
G
H
I
J
K
L

LAN

DLC BRANCH LINE CIRCUIT

< DTC/CIRCUIT DIAGNOSIS >

[CAN SYSTEM (TYPE 11)]

DLC BRANCH LINE CIRCUIT

Diagnosis Procedure

INFOID:000000005779251

1. CHECK CONNECTOR

1. Turn the ignition switch OFF.
2. Disconnect the battery cable from the negative terminal.
3. Check the terminals and connectors of the data link connector for damage, bend and loose connection (connector side and harness side).

Is the inspection result normal?

- YES >> GO TO 2.
NO >> Repair the terminal and connector.

2. CHECK HARNESS FOR OPEN CIRCUIT

Check the resistance between the data link connector terminals.

Data link connector			Resistance (Ω)
Connector No.	Terminal No.		
M24	6	14	Approx. 54 – 66

Is the measurement value within the specification?

- YES (Present error)>>Check CAN system type decision again.
YES (Past error)>>Error was detected in the data link connector branch line circuit.
NO >> Repair the data link connector branch line.

M&A BRANCH LINE CIRCUIT

Diagnosis Procedure

INFOID:000000005779252

1.CHECK CONNECTOR

1. Turn the ignition switch OFF.
2. Disconnect the battery cable from the negative terminal.
3. Check the terminals and connectors of the unified meter and A/C amp. for damage, bend and loose connection (unit side and connector side).

Is the inspection result normal?

- YES >> GO TO 2.
 NO >> Repair the terminal and connector.

2.CHECK HARNESS FOR OPEN CIRCUIT

1. Disconnect the connector of unified meter and A/C amp.
2. Check the resistance between the unified meter and A/C amp. harness connector terminals.

Unified meter and A/C amp. harness connector			Resistance (Ω)
Connector No.	Terminal No.		
M67	56	72	Approx. 54 – 66

Is the measurement value within the specification?

- YES >> GO TO 3.
 NO >> Repair the unified meter and A/C amp. branch line.

3.CHECK POWER SUPPLY AND GROUND CIRCUIT

Check the power supply and the ground circuit of the unified meter and A/C amp. Refer to [MWI-51, "UNIFIED METER AND A/C AMP. : Diagnosis Procedure"](#).

Is the inspection result normal?

- YES (Present error)>>Replace the unified meter and A/C amp. Refer to [MWI-136, "Exploded View"](#).
 YES (Past error)>>Error was detected in the unified meter and A/C amp. branch line.
 NO >> Repair the power supply and the ground circuit.

A
B
C
D
E
F
G
H
I
J
K
L

LAN

STRG BRANCH LINE CIRCUIT

< DTC/CIRCUIT DIAGNOSIS >

[CAN SYSTEM (TYPE 11)]

STRG BRANCH LINE CIRCUIT

Diagnosis Procedure

INFOID:000000005779253

1. CHECK CONNECTOR

1. Turn the ignition switch OFF.
2. Disconnect the battery cable from the negative terminal.
3. Check the terminals and connectors of the steering angle sensor for damage, bend and loose connection (unit side and connector side).

Is the inspection result normal?

- YES >> GO TO 2.
NO >> Repair the terminal and connector.

2. CHECK HARNESS FOR OPEN CIRCUIT

1. Disconnect the connector of steering angle sensor.
2. Check the resistance between the steering angle sensor harness connector terminals.

Steering angle sensor harness connector			Resistance (Ω)
Connector No.	Terminal No.		
M37	1	2	Approx. 54 – 66

Is the measurement value within the specification?

- YES >> GO TO 3.
NO >> Repair the steering angle sensor branch line.

3. CHECK POWER SUPPLY AND GROUND CIRCUIT

Check the power supply and the ground circuit of the steering angle sensor. Refer to [BRC-83, "Wiring Diagram - BRAKE CONTROL SYSTEM -"](#).

Is the inspection result normal?

- YES (Present error)>>Replace the steering angle sensor. Refer to [BRC-110, "Exploded View"](#).
YES (Past error)>>Error was detected in the steering angle sensor branch line.
NO >> Repair the power supply and the ground circuit.

ABS BRANCH LINE CIRCUIT

< DTC/CIRCUIT DIAGNOSIS >

[CAN SYSTEM (TYPE 11)]

ABS BRANCH LINE CIRCUIT

Diagnosis Procedure

INFOID:000000005779254

1. CHECK CONNECTOR

1. Turn the ignition switch OFF.
2. Disconnect the battery cable from the negative terminal.
3. Check the terminals and connectors of the ABS actuator and electric unit (control unit) for damage, bend and loose connection (unit side and connector side).

Is the inspection result normal?

- YES >> GO TO 2.
NO >> Repair the terminal and connector.

2. CHECK HARNESS FOR OPEN CIRCUIT

1. Disconnect the connector of ABS actuator and electric unit (control unit).
2. Check the resistance between the ABS actuator and electric unit (control unit) harness connector terminals.

ABS actuator and electric unit (control unit) harness connector			Resistance (Ω)
Connector No.	Terminal No.		
E41	35	14	Approx. 54 – 66

Is the measurement value within the specification?

- YES >> GO TO 3.
NO >> Repair the ABS actuator and electric unit (control unit) branch line.

3. CHECK POWER SUPPLY AND GROUND CIRCUIT

Check the power supply and the ground circuit of the ABS actuator and electric unit (control unit). Refer to [BRC-69, "Diagnosis Procedure"](#).

Is the inspection result normal?

- YES (Present error)>>Replace the ABS actuator and electric unit (control unit). Refer to [BRC-107, "Exploded View"](#).
YES (Past error)>>Error was detected in the ABS actuator and electric unit (control unit) branch line.
NO >> Repair the power supply and the ground circuit.

A
B
C
D
E
F
G
H
I
J
K
L

LAN

IPDM-E BRANCH LINE CIRCUIT

< DTC/CIRCUIT DIAGNOSIS >

[CAN SYSTEM (TYPE 11)]

IPDM-E BRANCH LINE CIRCUIT

Diagnosis Procedure

INFOID:000000005779255

1. CHECK CONNECTOR

1. Turn the ignition switch OFF.
2. Disconnect the battery cable from the negative terminal.
3. Check the terminals and connectors of the IPDM E/R for damage, bend and loose connection (unit side and connector side).

Is the inspection result normal?

- YES >> GO TO 2.
NO >> Repair the terminal and connector.

2. CHECK HARNESS FOR OPEN CIRCUIT

1. Disconnect the connector of IPDM E/R.
2. Check the resistance between the IPDM E/R harness connector terminals.

IPDM E/R harness connector			Resistance (Ω)
Connector No.	Terminal No.		
E6	40	39	Approx. 108 – 132

Is the measurement value within the specification?

- YES >> GO TO 3.
NO >> Repair the IPDM E/R branch line.

3. CHECK POWER SUPPLY AND GROUND CIRCUIT

Check the power supply and the ground circuit of the IPDM E/R. Refer to [PCS-18, "Diagnosis Procedure"](#).

Is the inspection result normal?

- YES (Present error)>>Replace the IPDM E/R. Refer to [PCS-33, "Exploded View"](#).
YES (Past error)>>Error was detected in the IPDM E/R branch line.
NO >> Repair the power supply and the ground circuit.

CAN COMMUNICATION CIRCUIT

< DTC/CIRCUIT DIAGNOSIS >

[CAN SYSTEM (TYPE 11)]

CAN COMMUNICATION CIRCUIT

Diagnosis Procedure

INFOID:000000005779256

1. CONNECTOR INSPECTION

1. Turn the ignition switch OFF.
2. Disconnect the battery cable from the negative terminal.
3. Disconnect all the unit connectors on CAN communication system.
4. Check terminals and connectors for damage, bend and loose connection.

Is the inspection result normal?

- YES >> GO TO 2.
NO >> Repair the terminal and connector.

2. CHECK HARNESS CONTINUITY (SHORT CIRCUIT)

Check the continuity between the data link connector terminals.

Data link connector		Continuity
Connector No.	Terminal No.	
M24	6 14	Not existed

Is the inspection result normal?

- YES >> GO TO 3.
NO >> Check the harness and repair the root cause.

3. CHECK HARNESS CONTINUITY (SHORT CIRCUIT)

Check the continuity between the data link connector and the ground.

Data link connector		Ground	Continuity
Connector No.	Terminal No.		
M24	6		Not existed
	14		Not existed

Is the inspection result normal?

- YES >> GO TO 4.
NO >> Check the harness and repair the root cause.

4. CHECK ECM AND IPDM E/R TERMINATION CIRCUIT

1. Remove the ECM and the IPDM E/R.
2. Check the resistance between the ECM terminals.

ECM		Resistance (Ω)
Terminal No.		
114	113	Approx. 108 – 132

3. Check the resistance between the IPDM E/R terminals.

IPDM E/R		Resistance (Ω)
Terminal No.		
40	39	Approx. 108 – 132

Is the measurement value within the specification?

- YES >> GO TO 5.
NO >> Replace the ECM and/or the IPDM E/R.

5. CHECK SYMPTOM

Connect all the connectors. Check if the symptoms described in the "Symptom (Results from interview with customer)" are reproduced.

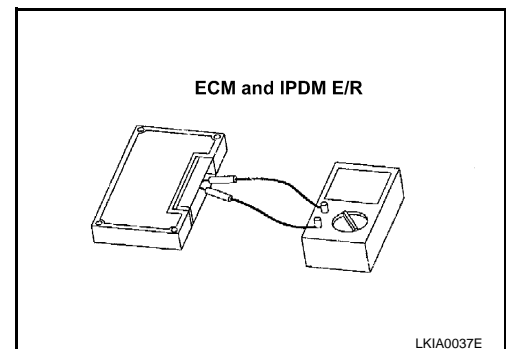

CAN COMMUNICATION CIRCUIT

< DTC/CIRCUIT DIAGNOSIS >

[CAN SYSTEM (TYPE 11)]

Inspection result

Reproduced>>GO TO 6.

Non-reproduced>>Start the diagnosis again. Follow the trouble diagnosis procedure when past error is detected.

6.CHECK UNIT REPRODUCTION

Perform the reproduction test as per the following procedure for each unit.

1. Turn the ignition switch OFF.
2. Disconnect the battery cable from the negative terminal.
3. Disconnect one of the unit connectors of CAN communication system.

NOTE:

ECM and IPDM E/R have a termination circuit. Check other units first.

4. Connect the battery cable to the negative terminal. Check if the symptoms described in the "Symptom (Results from interview with customer)" are reproduced.

NOTE:

Although unit-related error symptoms occur, do not confuse them with other symptoms.

Inspection result

Reproduced>>Connect the connector. Check other units as per the above procedure.

Non-reproduced>>Replace the unit whose connector was disconnected.

MAIN LINE BETWEEN AV AND DLC CIRCUIT

< DTC/CIRCUIT DIAGNOSIS >

[CAN SYSTEM (TYPE 12)]

DTC/CIRCUIT DIAGNOSIS

MAIN LINE BETWEEN AV AND DLC CIRCUIT

Diagnosis Procedure

INFOID:000000005779258

1. CHECK HARNESS CONTINUITY (OPEN CIRCUIT)

1. Turn the ignition switch OFF.
2. Disconnect the battery cable from the negative terminal.
3. Disconnect the following harness connectors.
 - ECM
 - AV control unit
4. Check the continuity between the AV control unit harness connector and the data link connector.
 - With navigation system

AV control unit harness connector		Data link connector		Continuity
Connector No.	Terminal No.	Connector No.	Terminal No.	
M210	90	M24	6	Existed
	74		14	Existed

- Without navigation system (With rear view monitor)

AV control unit harness connector		Data link connector		Continuity
Connector No.	Terminal No.	Connector No.	Terminal No.	
M204	81	M24	6	Existed
	80		14	Existed

- Without navigation system (Without rear view monitor)

AV control unit harness connector		Data link connector		Continuity
Connector No.	Terminal No.	Connector No.	Terminal No.	
M85	86	M24	6	Existed
	87		14	Existed

Is the inspection result normal?

YES (Present error)>>Check CAN system type decision again.

YES (Past error)>>Error was detected in the main line between the AV control unit and the data link connector.

NO >> Repair the main line between the AV control unit and the data link connector.

LAN

MAIN LINE BETWEEN DLC AND ADP CIRCUIT

< DTC/CIRCUIT DIAGNOSIS >

[CAN SYSTEM (TYPE 12)]

MAIN LINE BETWEEN DLC AND ADP CIRCUIT

Diagnosis Procedure

INFOID:000000005779259

1. CHECK CONNECTOR

1. Turn the ignition switch OFF.
2. Disconnect the battery cable from the negative terminal.
3. Check the following terminals and connectors for damage, bend and loose connection (connector side and harness side).
 - Harness connector M7
 - Harness connector B1

Is the inspection result normal?

YES >> GO TO 2.

NO >> Repair the terminal and connector.

2. CHECK HARNESS CONTINUITY (OPEN CIRCUIT)

1. Disconnect the harness connectors M7 and B1.
2. Check the continuity between the data link connector and the harness connector.

Data link connector		Harness connector		Continuity
Connector No.	Terminal No.	Connector No.	Terminal No.	
M24	6	M7	20	Existed
	14		21	Existed

Is the inspection result normal?

YES >> GO TO 3.

NO >> Repair the main line between the data link connector and the harness connector M7.

3. CHECK HARNESS CONTINUITY (OPEN CIRCUIT)

Check the continuity between the harness connector terminals.

Connector No.	Terminal No.		Continuity
B1	20	22	Existed
	21	23	Existed

Is the inspection result normal?

YES (Present error)>>Check CAN system type decision again.

YES (Past error)>>Error was detected in the main line between the data link connector and the driver seat control unit.

NO >> Repair the main line between the harness connector B1 and the driver seat control unit.

MAIN LINE BETWEEN ADP AND ABS CIRCUIT

< DTC/CIRCUIT DIAGNOSIS >

[CAN SYSTEM (TYPE 12)]

MAIN LINE BETWEEN ADP AND ABS CIRCUIT

Diagnosis Procedure

INFOID:000000005779260

1. CHECK CONNECTOR

1. Turn the ignition switch OFF.
2. Disconnect the battery cable from the negative terminal.
3. Check the following terminals and connectors for damage, bend and loose connection (connector side and harness side).
 - Harness connector B1
 - Harness connector M7
 - Harness connector M6
 - Harness connector E106

Is the inspection result normal?

YES >> GO TO 2.

NO >> Repair the terminal and connector.

2. CHECK HARNESS CONTINUITY (OPEN CIRCUIT)

1. Disconnect the harness connectors B1 and M7.
2. Check the continuity between the harness connector terminals.

Connector No.	Terminal No.		Continuity
B1	20	22	Existed
	21	23	Existed

Is the inspection result normal?

YES >> GO TO 3.

NO >> Repair the main line between the driver seat control unit and the harness connector B1.

3. CHECK HARNESS CONTINUITY (OPEN CIRCUIT)

1. Disconnect the harness connectors M6 and E106.
2. Check the continuity between the harness connectors.

Harness connector		Harness connector		Continuity
Connector No.	Terminal No.	Connector No.	Terminal No.	
M7	22	M6	7	Existed
	23		6	Existed

Is the inspection result normal?

YES >> GO TO 4.

NO >> Repair the main line between the harness connector M7 and M6.

4. CHECK HARNESS CONTINUITY (OPEN CIRCUIT)

1. Disconnect the connector of ABS actuator and electric unit (control unit).
2. Check the continuity between the harness connector and the ABS actuator and electric unit (control unit) harness connector.

Harness connector		ABS actuator and electric unit (control unit) harness connector		Continuity
Connector No.	Terminal No.	Connector No.	Terminal No.	
E106	7	E41	35	Existed
	6		14	Existed

Is the inspection result normal?

YES (Present error)>>Check CAN system type decision again.

YES (Past error)>>Error was detected in the main line between the driver seat control unit and the ABS actuator and electric unit (control unit).

A
B
C
D
E
F
G
H
I
J
K
L

LAN

N
O
P

MAIN LINE BETWEEN ADP AND ABS CIRCUIT

< DTC/CIRCUIT DIAGNOSIS >

[CAN SYSTEM (TYPE 12)]

NO >> Repair the main line between the harness connector E106 and the ABS actuator and electric unit (control unit).

ECM BRANCH LINE CIRCUIT

< DTC/CIRCUIT DIAGNOSIS >

[CAN SYSTEM (TYPE 12)]

ECM BRANCH LINE CIRCUIT

Diagnosis Procedure

INFOID:000000005779261

1. CHECK CONNECTOR

1. Turn the ignition switch OFF.
2. Disconnect the battery cable from the negative terminal.
3. Check the terminals and connectors of the ECM for damage, bend and loose connection (unit side and connector side).

Is the inspection result normal?

- YES >> GO TO 2.
NO >> Repair the terminal and connector.

2. CHECK HARNESS FOR OPEN CIRCUIT

1. Disconnect the connector of ECM.
2. Check the resistance between the ECM harness connector terminals.

ECM harness connector			Resistance (Ω)
Connector No.	Terminal No.		
M107	114	113	Approx. 108 – 132

Is the measurement value within the specification?

- YES >> GO TO 3.
NO >> Repair the ECM branch line.

3. CHECK POWER SUPPLY AND GROUND CIRCUIT

Check the power supply and the ground circuit of the ECM. Refer to [EC-144, "Diagnosis Procedure"](#).

Is the inspection result normal?

YES (Present error)>>Replace the ECM. Refer to [EC-17, "ADDITIONAL SERVICE WHEN REPLACING CONTROL UNIT \(ECM\) : Special Repair Requirement"](#).

YES (Past error)>>Error was detected in the ECM branch line.

NO >> Repair the power supply and the ground circuit.

A
B
C
D
E
F
G
H
I
J
K
L

LAN

N
O
P

4WD BRANCH LINE CIRCUIT

< DTC/CIRCUIT DIAGNOSIS >

[CAN SYSTEM (TYPE 12)]

4WD BRANCH LINE CIRCUIT

Diagnosis Procedure

INFOID:000000005779262

1. CHECK CONNECTOR

1. Turn the ignition switch OFF.
2. Disconnect the battery cable from the negative terminal.
3. Check the following terminals and connectors for damage, bend and loose connection (unit side and connector side).
 - AWD control unit connector
 - Harness connector F103
 - Harness connector M116

Is the inspection result normal?

YES >> GO TO 2.

NO >> Repair the terminal and connector.

2. CHECK HARNESS FOR OPEN CIRCUIT

1. Disconnect the connector of AWD control unit.
2. Check the resistance between the AWD control unit harness connector terminals.

AWD control unit harness connector		Resistance (Ω)
Connector No.	Terminal No.	
F108	8 16	Approx. 54 – 66

Is the measurement value within the specification?

YES >> GO TO 3.

NO >> Repair the AWD control unit branch line.

3. CHECK POWER SUPPLY AND GROUND CIRCUIT

Check the power supply and the ground circuit of the AWD control unit. Refer to [DLN-27, "Diagnosis Procedure"](#).

Is the inspection result normal?

YES (Present error)>>Replace the AWD control unit. Refer to [DLN-55, "Exploded View"](#).

YES (Past error)>>Error was detected in the AWD control unit branch line.

NO >> Repair the power supply and the ground circuit.

AV BRANCH LINE CIRCUIT

Diagnosis Procedure

INFOID:000000005779263

1. CHECK CONNECTOR

1. Turn the ignition switch OFF.
2. Disconnect the battery cable from the negative terminal.
3. Check the terminals and connectors of the AV control unit for damage, bend and loose connection (unit side and connector side).

Is the inspection result normal?

- YES >> GO TO 2.
 NO >> Repair the terminal and connector.

2. CHECK HARNESS FOR OPEN CIRCUIT

1. Disconnect the connector of AV control unit.
 2. Check the resistance between the AV control unit harness connector terminals.
- Models with navigation system

AV control unit harness connector			Resistance (Ω)
Connector No.	Terminal No.		
M210	90	74	Approx. 54 – 66

- Models without navigation system (With rear view monitor)

AV control unit harness connector			Resistance (Ω)
Connector No.	Terminal No.		
M204	81	80	Approx. 54 – 66

- Models without navigation system (Without rear view monitor)

AV control unit harness connector			Resistance (Ω)
Connector No.	Terminal No.		
M85	86	87	Approx. 54 – 66

Is the measurement value within the specification?

- YES >> GO TO 3.
 NO >> Repair the AV control unit branch line.

3. CHECK POWER SUPPLY AND GROUND CIRCUIT

Check the power supply and the ground circuit of the AV control unit. Refer to the following.

- Base audio without rear view monitor: [AV-40, "AV CONTROL UNIT : Diagnosis Procedure"](#)
- Base audio with rear view monitor: [AV-173, "AV CONTROL UNIT : Diagnosis Procedure"](#)
- BOSE audio without navigation: [AV-297, "AV CONTROL UNIT : Diagnosis Procedure"](#)
- BOSE audio with navigation: [AV-448, "AV CONTROL UNIT : Diagnosis Procedure"](#)

Is the inspection result normal?

- YES (Present error)>>Replace the AV control unit. Refer to the following.
- Base audio without rear view monitor: [AV-90, "Exploded View"](#)
 - Base audio with rear view monitor: [AV-202, "Exploded View"](#)
 - BOSE audio without navigation: [AV-328, "Exploded View"](#)
 - BOSE audio with navigation: [AV-474, "Exploded View"](#)

YES (Past error)>>Error was detected in the AV control unit branch line.

- NO >> Repair the power supply and the ground circuit.

A
B
C
D
E
F
G
H
I
J
K
L

LAN

N
O
P

TCM BRANCH LINE CIRCUIT

< DTC/CIRCUIT DIAGNOSIS >

[CAN SYSTEM (TYPE 12)]

TCM BRANCH LINE CIRCUIT

Diagnosis Procedure

INFOID:000000005779264

1.CHECK CONNECTOR

1. Turn the ignition switch OFF.
2. Disconnect the battery cable from the negative terminal.
3. Check the following terminals and connectors for damage, bend and loose connection (unit side and connector side).
 - A/T assembly
 - Harness connector F103
 - Harness connector M116

Is the inspection result normal?

YES >> GO TO 2.

NO >> Repair the terminal and connector.

2.CHECK HARNESS FOR OPEN CIRCUIT

1. Disconnect the connector of A/T assembly.
2. Check the resistance between the A/T assembly harness connector terminals.

A/T assembly harness connector		Resistance (Ω)
Connector No.	Terminal No.	
F51	3 8	Approx. 54 – 66

Is the measurement value within the specification?

YES >> GO TO 3.

NO >> Repair the TCM branch line.

3.CHECK POWER SUPPLY AND GROUND CIRCUIT

Check the power supply and the ground circuit of the TCM. Refer to [TM-212, "Diagnosis Procedure"](#).

Is the inspection result normal?

YES (Present error)>>Replace the control valve with TCM. Refer to [TM-99, "Component Parts Location"](#).
(Replace A/T assembly if control valve with TCM is not listed in the latest parts list.)

YES (Past error)>>Error was detected in the TCM branch line.

NO >> Repair the power supply and the ground circuit.

A-BAG BRANCH LINE CIRCUIT

< DTC/CIRCUIT DIAGNOSIS >

[CAN SYSTEM (TYPE 12)]

A-BAG BRANCH LINE CIRCUIT

Diagnosis Procedure

INFOID:000000005869136

WARNING:

- Before servicing, turn ignition switch OFF, disconnect battery negative terminal, and wait 3 minutes or more. (To discharge backup capacitor.)
- Never use unspecified tester or other measuring device.

1.CHECK CONNECTOR

1. Turn the ignition switch OFF.
2. Disconnect the battery cable from the negative terminal.
3. Check the terminals and connectors of the air bag diagnosis sensor unit for damage, bend and loose connection (unit side and connector side).

Is the inspection result normal?

YES >> GO TO 2.

NO >> Replace the main harness.

2.CHECK AIR BAG DIAGNOSIS SENSOR UNIT

Check the air bag diagnosis sensor unit. Refer to [SRC-5, "Work Flow"](#).

Is the inspection result normal?

YES >> Replace the main harness.

NO >> Replace parts whose air bag system has a malfunction.

A
B
C
D
E
F
G
H
I
J
K
L
N
O
P

LAN

BCM BRANCH LINE CIRCUIT

Diagnosis Procedure

INFOID:000000005779266

1. CHECK CONNECTOR

1. Turn the ignition switch OFF.
2. Disconnect the battery cable from the negative terminal.
3. Check the terminals and connectors of the BCM for damage, bend and loose connection (unit side and connector side).

Is the inspection result normal?

- YES >> GO TO 2.
 NO >> Repair the terminal and connector.

2. CHECK HARNESS FOR OPEN CIRCUIT

1. Disconnect the connector of BCM.
2. Check the resistance between the BCM harness connector terminals.

BCM harness connector			Resistance (Ω)
Connector No.	Terminal No.		
M122	91	90	Approx. 54 – 66

Is the measurement value within the specification?

- YES >> GO TO 3.
 NO >> Repair the BCM branch line.

3. CHECK POWER SUPPLY AND GROUND CIRCUIT

Check the power supply and the ground circuit of the BCM. Refer to [BCS-37, "Diagnosis Procedure"](#).

Is the inspection result normal?

- YES (Present error)>>Replace the BCM. Refer to [BCS-80, "Exploded View"](#).
 YES (Past error)>>Error was detected in the BCM branch line.
 NO >> Repair the power supply and the ground circuit.

DLC BRANCH LINE CIRCUIT

< DTC/CIRCUIT DIAGNOSIS >

[CAN SYSTEM (TYPE 12)]

DLC BRANCH LINE CIRCUIT

Diagnosis Procedure

INFOID:000000005779267

1. CHECK CONNECTOR

1. Turn the ignition switch OFF.
2. Disconnect the battery cable from the negative terminal.
3. Check the terminals and connectors of the data link connector for damage, bend and loose connection (connector side and harness side).

Is the inspection result normal?

- YES >> GO TO 2.
NO >> Repair the terminal and connector.

2. CHECK HARNESS FOR OPEN CIRCUIT

Check the resistance between the data link connector terminals.

Data link connector			Resistance (Ω)
Connector No.	Terminal No.		
M24	6	14	Approx. 54 – 66

Is the measurement value within the specification?

- YES (Present error)>>Check CAN system type decision again.
YES (Past error)>>Error was detected in the data link connector branch line circuit.
NO >> Repair the data link connector branch line.

A
B
C
D
E
F
G
H
I
J
K
L

LAN

N
O
P

M&A BRANCH LINE CIRCUIT

Diagnosis Procedure

INFOID:000000005779268

1. CHECK CONNECTOR

1. Turn the ignition switch OFF.
2. Disconnect the battery cable from the negative terminal.
3. Check the terminals and connectors of the unified meter and A/C amp. for damage, bend and loose connection (unit side and connector side).

Is the inspection result normal?

- YES >> GO TO 2.
 NO >> Repair the terminal and connector.

2. CHECK HARNESS FOR OPEN CIRCUIT

1. Disconnect the connector of unified meter and A/C amp.
2. Check the resistance between the unified meter and A/C amp. harness connector terminals.

Unified meter and A/C amp. harness connector			Resistance (Ω)
Connector No.	Terminal No.		
M67	56	72	Approx. 54 – 66

Is the measurement value within the specification?

- YES >> GO TO 3.
 NO >> Repair the unified meter and A/C amp. branch line.

3. CHECK POWER SUPPLY AND GROUND CIRCUIT

Check the power supply and the ground circuit of the unified meter and A/C amp. Refer to [MWI-51, "UNIFIED METER AND A/C AMP. : Diagnosis Procedure"](#).

Is the inspection result normal?

- YES (Present error)>>Replace the unified meter and A/C amp. Refer to [MWI-136, "Exploded View"](#).
 YES (Past error)>>Error was detected in the unified meter and A/C amp. branch line.
 NO >> Repair the power supply and the ground circuit.

STRG BRANCH LINE CIRCUIT

< DTC/CIRCUIT DIAGNOSIS >

[CAN SYSTEM (TYPE 12)]

STRG BRANCH LINE CIRCUIT

Diagnosis Procedure

INFOID:000000005779269

1.CHECK CONNECTOR

1. Turn the ignition switch OFF.
2. Disconnect the battery cable from the negative terminal.
3. Check the terminals and connectors of the steering angle sensor for damage, bend and loose connection (unit side and connector side).

Is the inspection result normal?

- YES >> GO TO 2.
NO >> Repair the terminal and connector.

2.CHECK HARNESS FOR OPEN CIRCUIT

1. Disconnect the connector of steering angle sensor.
2. Check the resistance between the steering angle sensor harness connector terminals.

Steering angle sensor harness connector			Resistance (Ω)
Connector No.	Terminal No.		
M37	1	2	Approx. 54 – 66

Is the measurement value within the specification?

- YES >> GO TO 3.
NO >> Repair the steering angle sensor branch line.

3.CHECK POWER SUPPLY AND GROUND CIRCUIT

Check the power supply and the ground circuit of the steering angle sensor. Refer to [BRC-83, "Wiring Diagram - BRAKE CONTROL SYSTEM -"](#).

Is the inspection result normal?

- YES (Present error)>>Replace the steering angle sensor. Refer to [BRC-110, "Exploded View"](#).
YES (Past error)>>Error was detected in the steering angle sensor branch line.
NO >> Repair the power supply and the ground circuit.

A
B
C
D
E
F
G
H
I
J
K
L

LAN

N
O
P

ADP BRANCH LINE CIRCUIT

< DTC/CIRCUIT DIAGNOSIS >

[CAN SYSTEM (TYPE 12)]

ADP BRANCH LINE CIRCUIT

Diagnosis Procedure

INFOID:000000005779270

1. CHECK CONNECTOR

1. Turn the ignition switch OFF.
2. Disconnect the battery cable from the negative terminal.
3. Check the following terminals and connectors for damage, bend and loose connection (unit side and connector side).
 - Driver seat control unit
 - Harness connector B462
 - Harness connector B59

Is the inspection result normal?

YES >> GO TO 2.

NO >> Repair the terminal and connector.

2. CHECK HARNESS FOR OPEN CIRCUIT

1. Disconnect the connector of driver seat control unit.
2. Check the resistance between the driver seat control unit harness connector terminals.

Driver seat control unit harness connector			Resistance (Ω)
Connector No.	Terminal No.		
B451	3	19	Approx. 54 – 66

Is the measurement value within the specification?

YES >> GO TO 3.

NO >> Repair the driver seat control unit branch line.

3. CHECK POWER SUPPLY AND GROUND CIRCUIT

Check the power supply and the ground circuit of the driver seat control unit. Refer to [ADP-65, "DRIVER SEAT CONTROL UNIT : Diagnosis Procedure"](#).

Is the inspection result normal?

YES (Present error)>>Replace the driver seat control unit. Refer to [ADP-228, "Exploded View"](#).

YES (Past error)>>Error was detected in the driver seat control unit branch line.

NO >> Repair the power supply and the ground circuit.

ABS BRANCH LINE CIRCUIT

< DTC/CIRCUIT DIAGNOSIS >

[CAN SYSTEM (TYPE 12)]

ABS BRANCH LINE CIRCUIT

Diagnosis Procedure

INFOID:000000005779271

1. CHECK CONNECTOR

1. Turn the ignition switch OFF.
2. Disconnect the battery cable from the negative terminal.
3. Check the terminals and connectors of the ABS actuator and electric unit (control unit) for damage, bend and loose connection (unit side and connector side).

Is the inspection result normal?

- YES >> GO TO 2.
NO >> Repair the terminal and connector.

2. CHECK HARNESS FOR OPEN CIRCUIT

1. Disconnect the connector of ABS actuator and electric unit (control unit).
2. Check the resistance between the ABS actuator and electric unit (control unit) harness connector terminals.

ABS actuator and electric unit (control unit) harness connector			Resistance (Ω)
Connector No.	Terminal No.		
E41	35	14	Approx. 54 – 66

Is the measurement value within the specification?

- YES >> GO TO 3.
NO >> Repair the ABS actuator and electric unit (control unit) branch line.

3. CHECK POWER SUPPLY AND GROUND CIRCUIT

Check the power supply and the ground circuit of the ABS actuator and electric unit (control unit). Refer to [BRC-69, "Diagnosis Procedure"](#).

Is the inspection result normal?

- YES (Present error)>>Replace the ABS actuator and electric unit (control unit). Refer to [BRC-107, "Exploded View"](#).
YES (Past error)>>Error was detected in the ABS actuator and electric unit (control unit) branch line.
NO >> Repair the power supply and the ground circuit.

A
B
C
D
E
F
G
H
I
J
K
L

LAN

IPDM-E BRANCH LINE CIRCUIT

< DTC/CIRCUIT DIAGNOSIS >

[CAN SYSTEM (TYPE 12)]

IPDM-E BRANCH LINE CIRCUIT

Diagnosis Procedure

INFOID:000000005779272

1. CHECK CONNECTOR

1. Turn the ignition switch OFF.
2. Disconnect the battery cable from the negative terminal.
3. Check the terminals and connectors of the IPDM E/R for damage, bend and loose connection (unit side and connector side).

Is the inspection result normal?

- YES >> GO TO 2.
NO >> Repair the terminal and connector.

2. CHECK HARNESS FOR OPEN CIRCUIT

1. Disconnect the connector of IPDM E/R.
2. Check the resistance between the IPDM E/R harness connector terminals.

IPDM E/R harness connector			Resistance (Ω)
Connector No.	Terminal No.		
E6	40	39	Approx. 108 – 132

Is the measurement value within the specification?

- YES >> GO TO 3.
NO >> Repair the IPDM E/R branch line.

3. CHECK POWER SUPPLY AND GROUND CIRCUIT

Check the power supply and the ground circuit of the IPDM E/R. Refer to [PCS-18, "Diagnosis Procedure"](#).

Is the inspection result normal?

- YES (Present error)>>Replace the IPDM E/R. Refer to [PCS-33, "Exploded View"](#).
YES (Past error)>>Error was detected in the IPDM E/R branch line.
NO >> Repair the power supply and the ground circuit.

CAN COMMUNICATION CIRCUIT

< DTC/CIRCUIT DIAGNOSIS >

[CAN SYSTEM (TYPE 12)]

CAN COMMUNICATION CIRCUIT

Diagnosis Procedure

INFOID:000000005779273

1. CONNECTOR INSPECTION

1. Turn the ignition switch OFF.
2. Disconnect the battery cable from the negative terminal.
3. Disconnect all the unit connectors on CAN communication system.
4. Check terminals and connectors for damage, bend and loose connection.

Is the inspection result normal?

- YES >> GO TO 2.
NO >> Repair the terminal and connector.

2. CHECK HARNESS CONTINUITY (SHORT CIRCUIT)

Check the continuity between the data link connector terminals.

Data link connector		Continuity
Connector No.	Terminal No.	
M24	6 14	Not existed

Is the inspection result normal?

- YES >> GO TO 3.
NO >> Check the harness and repair the root cause.

3. CHECK HARNESS CONTINUITY (SHORT CIRCUIT)

Check the continuity between the data link connector and the ground.

Data link connector		Ground	Continuity
Connector No.	Terminal No.		
M24	6		Not existed
	14		Not existed

Is the inspection result normal?

- YES >> GO TO 4.
NO >> Check the harness and repair the root cause.

4. CHECK ECM AND IPDM E/R TERMINATION CIRCUIT

1. Remove the ECM and the IPDM E/R.
2. Check the resistance between the ECM terminals.

ECM		Resistance (Ω)
Terminal No.		
114	113	Approx. 108 – 132

3. Check the resistance between the IPDM E/R terminals.

IPDM E/R		Resistance (Ω)
Terminal No.		
40	39	Approx. 108 – 132

Is the measurement value within the specification?

- YES >> GO TO 5.
NO >> Replace the ECM and/or the IPDM E/R.

5. CHECK SYMPTOM

Connect all the connectors. Check if the symptoms described in the "Symptom (Results from interview with customer)" are reproduced.

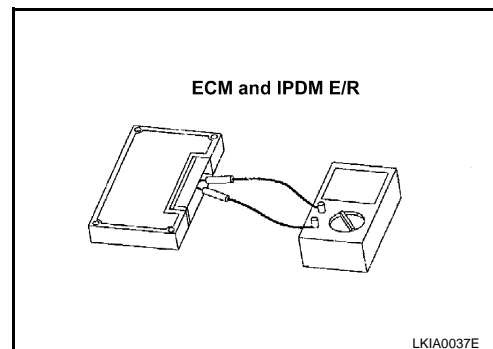

CAN COMMUNICATION CIRCUIT

< DTC/CIRCUIT DIAGNOSIS >

[CAN SYSTEM (TYPE 12)]

Inspection result

Reproduced>>GO TO 6.

Non-reproduced>>Start the diagnosis again. Follow the trouble diagnosis procedure when past error is detected.

6.CHECK UNIT REPRODUCTION

Perform the reproduction test as per the following procedure for each unit.

1. Turn the ignition switch OFF.
2. Disconnect the battery cable from the negative terminal.
3. Disconnect one of the unit connectors of CAN communication system.

NOTE:

ECM and IPDM E/R have a termination circuit. Check other units first.

4. Connect the battery cable to the negative terminal. Check if the symptoms described in the "Symptom (Results from interview with customer)" are reproduced.

NOTE:

Although unit-related error symptoms occur, do not confuse them with other symptoms.

Inspection result

Reproduced>>Connect the connector. Check other units as per the above procedure.

Non-reproduced>>Replace the unit whose connector was disconnected.

MAIN LINE BETWEEN AV AND DLC CIRCUIT

< DTC/CIRCUIT DIAGNOSIS >

[CAN SYSTEM (TYPE 13)]

DTC/CIRCUIT DIAGNOSIS

MAIN LINE BETWEEN AV AND DLC CIRCUIT

Diagnosis Procedure

INFOID:000000005779274

1. CHECK HARNESS CONTINUITY (OPEN CIRCUIT)

1. Turn the ignition switch OFF.
2. Disconnect the battery cable from the negative terminal.
3. Disconnect the following harness connectors.
 - ECM
 - AV control unit
4. Check the continuity between the AV control unit harness connector and the data link connector.
 - With navigation system

AV control unit harness connector		Data link connector		Continuity
Connector No.	Terminal No.	Connector No.	Terminal No.	
M210	90	M24	6	Existed
	74		14	Existed

- Without navigation system (With rear view monitor)

AV control unit harness connector		Data link connector		Continuity
Connector No.	Terminal No.	Connector No.	Terminal No.	
M204	81	M24	6	Existed
	80		14	Existed

- Without navigation system (Without rear view monitor)

AV control unit harness connector		Data link connector		Continuity
Connector No.	Terminal No.	Connector No.	Terminal No.	
M85	86	M24	6	Existed
	87		14	Existed

Is the inspection result normal?

YES (Present error)>>Check CAN system type decision again.

YES (Past error)>>Error was detected in the main line between the AV control unit and the data link connector.

NO >> Repair the main line between the AV control unit and the data link connector.

LAN

MAIN LINE BETWEEN DLC AND ADP CIRCUIT

< DTC/CIRCUIT DIAGNOSIS >

[CAN SYSTEM (TYPE 13)]

MAIN LINE BETWEEN DLC AND ADP CIRCUIT

Diagnosis Procedure

INFOID:000000005779275

1. CHECK CONNECTOR

1. Turn the ignition switch OFF.
2. Disconnect the battery cable from the negative terminal.
3. Check the following terminals and connectors for damage, bend and loose connection (connector side and harness side).
 - Harness connector M7
 - Harness connector B1

Is the inspection result normal?

YES >> GO TO 2.

NO >> Repair the terminal and connector.

2. CHECK HARNESS CONTINUITY (OPEN CIRCUIT)

1. Disconnect the harness connectors M7 and B1.
2. Check the continuity between the data link connector and the harness connector.

Data link connector		Harness connector		Continuity
Connector No.	Terminal No.	Connector No.	Terminal No.	
M24	6	M7	20	Existed
	14		21	Existed

Is the inspection result normal?

YES >> GO TO 3.

NO >> Repair the main line between the data link connector and the harness connector M7.

3. CHECK HARNESS CONTINUITY (OPEN CIRCUIT)

Check the continuity between the harness connector terminals.

Connector No.	Terminal No.		Continuity
B1	20	22	Existed
	21	23	Existed

Is the inspection result normal?

YES (Present error)>>Check CAN system type decision again.

YES (Past error)>>Error was detected in the main line between the data link connector and the driver seat control unit.

NO >> Repair the main line between the harness connector B1 and the driver seat control unit.

MAIN LINE BETWEEN ADP AND ABS CIRCUIT

< DTC/CIRCUIT DIAGNOSIS >

[CAN SYSTEM (TYPE 13)]

MAIN LINE BETWEEN ADP AND ABS CIRCUIT

Diagnosis Procedure

INFOID:000000005779276

1. CHECK CONNECTOR

1. Turn the ignition switch OFF.
2. Disconnect the battery cable from the negative terminal.
3. Check the following terminals and connectors for damage, bend and loose connection (connector side and harness side).
 - Harness connector B1
 - Harness connector M7
 - Harness connector M6
 - Harness connector E106

Is the inspection result normal?

YES >> GO TO 2.

NO >> Repair the terminal and connector.

2. CHECK HARNESS CONTINUITY (OPEN CIRCUIT)

1. Disconnect the harness connectors B1 and M7.
2. Check the continuity between the harness connector terminals.

Connector No.	Terminal No.		Continuity
B1	20	22	Existed
	21	23	Existed

Is the inspection result normal?

YES >> GO TO 3.

NO >> Repair the main line between the driver seat control unit and the harness connector B1.

3. CHECK HARNESS CONTINUITY (OPEN CIRCUIT)

1. Disconnect the harness connectors M6 and E106.
2. Check the continuity between the harness connectors.

Harness connector		Harness connector		Continuity
Connector No.	Terminal No.	Connector No.	Terminal No.	
M7	22	M6	7	Existed
	23		6	Existed

Is the inspection result normal?

YES >> GO TO 4.

NO >> Repair the main line between the harness connector M7 and M6.

4. CHECK HARNESS CONTINUITY (OPEN CIRCUIT)

1. Disconnect the connector of ABS actuator and electric unit (control unit).
2. Check the continuity between the harness connector and the ABS actuator and electric unit (control unit) harness connector.

Harness connector		ABS actuator and electric unit (control unit) harness connector		Continuity
Connector No.	Terminal No.	Connector No.	Terminal No.	
E106	7	E41	35	Existed
	6		14	Existed

Is the inspection result normal?

YES (Present error)>>Check CAN system type decision again.

YES (Past error)>>Error was detected in the main line between the driver seat control unit and the ABS actuator and electric unit (control unit).

A
B
C
D
E
F
G
H
I
J
K
L

LAN

N
O
P

MAIN LINE BETWEEN ADP AND ABS CIRCUIT

< DTC/CIRCUIT DIAGNOSIS >

[CAN SYSTEM (TYPE 13)]

NO >> Repair the main line between the harness connector E106 and the ABS actuator and electric unit (control unit).

ECM BRANCH LINE CIRCUIT

< DTC/CIRCUIT DIAGNOSIS >

[CAN SYSTEM (TYPE 13)]

ECM BRANCH LINE CIRCUIT

Diagnosis Procedure

INFOID:000000005779277

1. CHECK CONNECTOR

1. Turn the ignition switch OFF.
2. Disconnect the battery cable from the negative terminal.
3. Check the terminals and connectors of the ECM for damage, bend and loose connection (unit side and connector side).

Is the inspection result normal?

- YES >> GO TO 2.
NO >> Repair the terminal and connector.

2. CHECK HARNESS FOR OPEN CIRCUIT

1. Disconnect the connector of ECM.
2. Check the resistance between the ECM harness connector terminals.

ECM harness connector			Resistance (Ω)
Connector No.	Terminal No.		
M107	114	113	Approx. 108 – 132

Is the measurement value within the specification?

- YES >> GO TO 3.
NO >> Repair the ECM branch line.

3. CHECK POWER SUPPLY AND GROUND CIRCUIT

Check the power supply and the ground circuit of the ECM. Refer to [EC-144, "Diagnosis Procedure"](#).

Is the inspection result normal?

- YES (Present error)>>Replace the ECM. Refer to [EC-17, "ADDITIONAL SERVICE WHEN REPLACING CONTROL UNIT \(ECM\) : Special Repair Requirement"](#).
YES (Past error)>>Error was detected in the ECM branch line.
NO >> Repair the power supply and the ground circuit.

A
B
C
D
E
F
G
H
I
J
K
L

LAN

4WD BRANCH LINE CIRCUIT

Diagnosis Procedure

INFOID:000000005779278

1. CHECK CONNECTOR

1. Turn the ignition switch OFF.
2. Disconnect the battery cable from the negative terminal.
3. Check the following terminals and connectors for damage, bend and loose connection (unit side and connector side).
 - AWD control unit connector
 - Harness connector F103
 - Harness connector M116

Is the inspection result normal?

- YES >> GO TO 2.
 NO >> Repair the terminal and connector.

2. CHECK HARNESS FOR OPEN CIRCUIT

1. Disconnect the connector of AWD control unit.
2. Check the resistance between the AWD control unit harness connector terminals.

AWD control unit harness connector			Resistance (Ω)
Connector No.	Terminal No.		
F108	8	16	Approx. 54 – 66

Is the measurement value within the specification?

- YES >> GO TO 3.
 NO >> Repair the AWD control unit branch line.

3. CHECK POWER SUPPLY AND GROUND CIRCUIT

Check the power supply and the ground circuit of the AWD control unit. Refer to [DLN-27, "Diagnosis Procedure"](#).

Is the inspection result normal?

- YES (Present error)>>Replace the AWD control unit. Refer to [DLN-55, "Exploded View"](#).
 YES (Past error)>>Error was detected in the AWD control unit branch line.
 NO >> Repair the power supply and the ground circuit.

AV BRANCH LINE CIRCUIT

Diagnosis Procedure

INFOID:000000005779279

1. CHECK CONNECTOR

1. Turn the ignition switch OFF.
2. Disconnect the battery cable from the negative terminal.
3. Check the terminals and connectors of the AV control unit for damage, bend and loose connection (unit side and connector side).

Is the inspection result normal?

- YES >> GO TO 2.
 NO >> Repair the terminal and connector.

2. CHECK HARNESS FOR OPEN CIRCUIT

1. Disconnect the connector of AV control unit.
 2. Check the resistance between the AV control unit harness connector terminals.
- Models with navigation system

AV control unit harness connector			Resistance (Ω)
Connector No.	Terminal No.		
M210	90	74	Approx. 54 – 66

- Models without navigation system (With rear view monitor)

AV control unit harness connector			Resistance (Ω)
Connector No.	Terminal No.		
M204	81	80	Approx. 54 – 66

- Models without navigation system (Without rear view monitor)

AV control unit harness connector			Resistance (Ω)
Connector No.	Terminal No.		
M85	86	87	Approx. 54 – 66

Is the measurement value within the specification?

- YES >> GO TO 3.
 NO >> Repair the AV control unit branch line.

3. CHECK POWER SUPPLY AND GROUND CIRCUIT

Check the power supply and the ground circuit of the AV control unit. Refer to the following.

- Base audio without rear view monitor: [AV-40, "AV CONTROL UNIT : Diagnosis Procedure"](#)
- Base audio with rear view monitor: [AV-173, "AV CONTROL UNIT : Diagnosis Procedure"](#)
- BOSE audio without navigation: [AV-297, "AV CONTROL UNIT : Diagnosis Procedure"](#)
- BOSE audio with navigation: [AV-448, "AV CONTROL UNIT : Diagnosis Procedure"](#)

Is the inspection result normal?

- YES (Present error)>>Replace the AV control unit. Refer to the following.
- Base audio without rear view monitor: [AV-90, "Exploded View"](#)
 - Base audio with rear view monitor: [AV-202, "Exploded View"](#)
 - BOSE audio without navigation: [AV-328, "Exploded View"](#)
 - BOSE audio with navigation: [AV-474, "Exploded View"](#)

YES (Past error)>>Error was detected in the AV control unit branch line.

- NO >> Repair the power supply and the ground circuit.

A
B
C
D
E
F
G
H
I
J
K
L

LAN

N
O
P

PSB BRANCH LINE CIRCUIT

Diagnosis Procedure

INFOID:000000005779280

1.CHECK CONNECTOR

1. Turn the ignition switch OFF.
2. Disconnect the battery cable from the negative terminal.
3. Check the terminals and connectors of the pre-crash seat belt control unit for damage, bend and loose connection (unit side and connector side).

Is the inspection result normal?

- YES >> GO TO 2.
 NO >> Repair the terminal and connector.

2.CHECK HARNESS FOR OPEN CIRCUIT

1. Disconnect the connector of pre-crash seat belt control unit.
2. Check the resistance between the pre-crash seat belt control unit harness connector terminals.

Pre-crash seat belt control unit harness connector			Resistance (Ω)
Connector No.	Terminal No.		
M110	24	22	Approx. 54 – 66

Is the measurement value within the specification?

- YES >> GO TO 3.
 NO >> Repair the pre-crash seat belt control unit branch line.

3.CHECK POWER SUPPLY AND GROUND CIRCUIT

Check the power supply and the ground circuit of the pre-crash seat belt control unit. Refer to [SBC-24, "Diagnosis Procedure"](#).

Is the inspection result normal?

- YES (Present error)>>Replace the pre-crash seat belt control unit. Refer to [SBC-39, "Exploded View"](#).
 YES (Past error)>>Error was detected in the pre-crash seat belt control unit branch line.
 NO >> Repair the power supply and the ground circuit.

TCM BRANCH LINE CIRCUIT

< DTC/CIRCUIT DIAGNOSIS >

[CAN SYSTEM (TYPE 13)]

TCM BRANCH LINE CIRCUIT

Diagnosis Procedure

INFOID:000000005779281

1. CHECK CONNECTOR

1. Turn the ignition switch OFF.
2. Disconnect the battery cable from the negative terminal.
3. Check the following terminals and connectors for damage, bend and loose connection (unit side and connector side).
 - A/T assembly
 - Harness connector F103
 - Harness connector M116

Is the inspection result normal?

- YES >> GO TO 2.
NO >> Repair the terminal and connector.

2. CHECK HARNESS FOR OPEN CIRCUIT

1. Disconnect the connector of A/T assembly.
2. Check the resistance between the A/T assembly harness connector terminals.

A/T assembly harness connector		Resistance (Ω)
Connector No.	Terminal No.	
F51	3	Approx. 54 – 66
	8	

Is the measurement value within the specification?

- YES >> GO TO 3.
NO >> Repair the TCM branch line.

3. CHECK POWER SUPPLY AND GROUND CIRCUIT

Check the power supply and the ground circuit of the TCM. Refer to [TM-212, "Diagnosis Procedure"](#).

Is the inspection result normal?

- YES (Present error)>>Replace the control valve with TCM. Refer to [TM-99, "Component Parts Location"](#).
(Replace A/T assembly if control valve with TCM is not listed in the latest parts list.)
YES (Past error)>>Error was detected in the TCM branch line.
NO >> Repair the power supply and the ground circuit.

A
B
C
D
E
F
G
H
I
J
K
L

LAN

A-BAG BRANCH LINE CIRCUIT

< DTC/CIRCUIT DIAGNOSIS >

[CAN SYSTEM (TYPE 13)]

A-BAG BRANCH LINE CIRCUIT

Diagnosis Procedure

INFOID:000000005869137

WARNING:

- Before servicing, turn ignition switch OFF, disconnect battery negative terminal, and wait 3 minutes or more. (To discharge backup capacitor.)
- Never use unspecified tester or other measuring device.

1. CHECK CONNECTOR

1. Turn the ignition switch OFF.
2. Disconnect the battery cable from the negative terminal.
3. Check the terminals and connectors of the air bag diagnosis sensor unit for damage, bend and loose connection (unit side and connector side).

Is the inspection result normal?

YES >> GO TO 2.

NO >> Replace the main harness.

2. CHECK AIR BAG DIAGNOSIS SENSOR UNIT

Check the air bag diagnosis sensor unit. Refer to [SRC-5, "Work Flow"](#).

Is the inspection result normal?

YES >> Replace the main harness.

NO >> Replace parts whose air bag system has a malfunction.

BCM BRANCH LINE CIRCUIT

< DTC/CIRCUIT DIAGNOSIS >

[CAN SYSTEM (TYPE 13)]

BCM BRANCH LINE CIRCUIT

Diagnosis Procedure

INFOID:000000005779283

1. CHECK CONNECTOR

1. Turn the ignition switch OFF.
2. Disconnect the battery cable from the negative terminal.
3. Check the terminals and connectors of the BCM for damage, bend and loose connection (unit side and connector side).

Is the inspection result normal?

- YES >> GO TO 2.
NO >> Repair the terminal and connector.

2. CHECK HARNESS FOR OPEN CIRCUIT

1. Disconnect the connector of BCM.
2. Check the resistance between the BCM harness connector terminals.

BCM harness connector			Resistance (Ω)
Connector No.	Terminal No.		
M122	91	90	Approx. 54 – 66

Is the measurement value within the specification?

- YES >> GO TO 3.
NO >> Repair the BCM branch line.

3. CHECK POWER SUPPLY AND GROUND CIRCUIT

Check the power supply and the ground circuit of the BCM. Refer to [BCS-37, "Diagnosis Procedure"](#).

Is the inspection result normal?

- YES (Present error)>>Replace the BCM. Refer to [BCS-80, "Exploded View"](#).
YES (Past error)>>Error was detected in the BCM branch line.
NO >> Repair the power supply and the ground circuit.

A
B
C
D
E
F
G
H
I
J
K
L

LAN

N
O
P

DLC BRANCH LINE CIRCUIT

< DTC/CIRCUIT DIAGNOSIS >

[CAN SYSTEM (TYPE 13)]

DLC BRANCH LINE CIRCUIT

Diagnosis Procedure

INFOID:000000005779284

1.CHECK CONNECTOR

1. Turn the ignition switch OFF.
2. Disconnect the battery cable from the negative terminal.
3. Check the terminals and connectors of the data link connector for damage, bend and loose connection (connector side and harness side).

Is the inspection result normal?

- YES >> GO TO 2.
NO >> Repair the terminal and connector.

2.CHECK HARNESS FOR OPEN CIRCUIT

Check the resistance between the data link connector terminals.

Data link connector			Resistance (Ω)
Connector No.	Terminal No.		
M24	6	14	Approx. 54 – 66

Is the measurement value within the specification?

- YES (Present error)>>Check CAN system type decision again.
YES (Past error)>>Error was detected in the data link connector branch line circuit.
NO >> Repair the data link connector branch line.

M&A BRANCH LINE CIRCUIT

Diagnosis Procedure

INFOID:000000005779285

1.CHECK CONNECTOR

1. Turn the ignition switch OFF.
2. Disconnect the battery cable from the negative terminal.
3. Check the terminals and connectors of the unified meter and A/C amp. for damage, bend and loose connection (unit side and connector side).

Is the inspection result normal?

- YES >> GO TO 2.
 NO >> Repair the terminal and connector.

2.CHECK HARNESS FOR OPEN CIRCUIT

1. Disconnect the connector of unified meter and A/C amp.
2. Check the resistance between the unified meter and A/C amp. harness connector terminals.

Unified meter and A/C amp. harness connector			Resistance (Ω)
Connector No.	Terminal No.		
M67	56	72	Approx. 54 – 66

Is the measurement value within the specification?

- YES >> GO TO 3.
 NO >> Repair the unified meter and A/C amp. branch line.

3.CHECK POWER SUPPLY AND GROUND CIRCUIT

Check the power supply and the ground circuit of the unified meter and A/C amp. Refer to [MWI-51, "UNIFIED METER AND A/C AMP. : Diagnosis Procedure"](#).

Is the inspection result normal?

- YES (Present error)>>Replace the unified meter and A/C amp. Refer to [MWI-136, "Exploded View"](#).
 YES (Past error)>>Error was detected in the unified meter and A/C amp. branch line.
 NO >> Repair the power supply and the ground circuit.

A
B
C
D
E
F
G
H
I
J
K
L

LAN

STRG BRANCH LINE CIRCUIT

< DTC/CIRCUIT DIAGNOSIS >

[CAN SYSTEM (TYPE 13)]

STRG BRANCH LINE CIRCUIT

Diagnosis Procedure

INFOID:000000005779286

1. CHECK CONNECTOR

1. Turn the ignition switch OFF.
2. Disconnect the battery cable from the negative terminal.
3. Check the terminals and connectors of the steering angle sensor for damage, bend and loose connection (unit side and connector side).

Is the inspection result normal?

- YES >> GO TO 2.
NO >> Repair the terminal and connector.

2. CHECK HARNESS FOR OPEN CIRCUIT

1. Disconnect the connector of steering angle sensor.
2. Check the resistance between the steering angle sensor harness connector terminals.

Steering angle sensor harness connector			Resistance (Ω)
Connector No.	Terminal No.		
M37	1	2	Approx. 54 – 66

Is the measurement value within the specification?

- YES >> GO TO 3.
NO >> Repair the steering angle sensor branch line.

3. CHECK POWER SUPPLY AND GROUND CIRCUIT

Check the power supply and the ground circuit of the steering angle sensor. Refer to [BRC-83, "Wiring Diagram - BRAKE CONTROL SYSTEM -"](#).

Is the inspection result normal?

- YES (Present error)>>Replace the steering angle sensor. Refer to [BRC-110, "Exploded View"](#).
YES (Past error)>>Error was detected in the steering angle sensor branch line.
NO >> Repair the power supply and the ground circuit.

ADP BRANCH LINE CIRCUIT

< DTC/CIRCUIT DIAGNOSIS >

[CAN SYSTEM (TYPE 13)]

ADP BRANCH LINE CIRCUIT

Diagnosis Procedure

INFOID:000000005779287

1. CHECK CONNECTOR

1. Turn the ignition switch OFF.
2. Disconnect the battery cable from the negative terminal.
3. Check the following terminals and connectors for damage, bend and loose connection (unit side and connector side).
 - Driver seat control unit
 - Harness connector B462
 - Harness connector B59

Is the inspection result normal?

YES >> GO TO 2.

NO >> Repair the terminal and connector.

2. CHECK HARNESS FOR OPEN CIRCUIT

1. Disconnect the connector of driver seat control unit.
2. Check the resistance between the driver seat control unit harness connector terminals.

Driver seat control unit harness connector			Resistance (Ω)
Connector No.	Terminal No.		
B451	3	19	Approx. 54 – 66

Is the measurement value within the specification?

YES >> GO TO 3.

NO >> Repair the driver seat control unit branch line.

3. CHECK POWER SUPPLY AND GROUND CIRCUIT

Check the power supply and the ground circuit of the driver seat control unit. Refer to [ADP-65, "DRIVER SEAT CONTROL UNIT : Diagnosis Procedure"](#).

Is the inspection result normal?

YES (Present error)>>Replace the driver seat control unit. Refer to [ADP-228, "Exploded View"](#).

YES (Past error)>>Error was detected in the driver seat control unit branch line.

NO >> Repair the power supply and the ground circuit.

A
B
C
D
E
F
G
H
I
J
K
L

LAN

ABS BRANCH LINE CIRCUIT

< DTC/CIRCUIT DIAGNOSIS >

[CAN SYSTEM (TYPE 13)]

ABS BRANCH LINE CIRCUIT

Diagnosis Procedure

INFOID:000000005779289

1. CHECK CONNECTOR

1. Turn the ignition switch OFF.
2. Disconnect the battery cable from the negative terminal.
3. Check the terminals and connectors of the ABS actuator and electric unit (control unit) for damage, bend and loose connection (unit side and connector side).

Is the inspection result normal?

- YES >> GO TO 2.
NO >> Repair the terminal and connector.

2. CHECK HARNESS FOR OPEN CIRCUIT

1. Disconnect the connector of ABS actuator and electric unit (control unit).
2. Check the resistance between the ABS actuator and electric unit (control unit) harness connector terminals.

ABS actuator and electric unit (control unit) harness connector			Resistance (Ω)
Connector No.	Terminal No.		
E41	35	14	Approx. 54 – 66

Is the measurement value within the specification?

- YES >> GO TO 3.
NO >> Repair the ABS actuator and electric unit (control unit) branch line.

3. CHECK POWER SUPPLY AND GROUND CIRCUIT

Check the power supply and the ground circuit of the ABS actuator and electric unit (control unit). Refer to [BRC-69. "Diagnosis Procedure"](#).

Is the inspection result normal?

- YES (Present error)>>Replace the ABS actuator and electric unit (control unit). Refer to [BRC-107. "Exploded View"](#).
YES (Past error)>>Error was detected in the ABS actuator and electric unit (control unit) branch line.
NO >> Repair the power supply and the ground circuit.

ICC BRANCH LINE CIRCUIT

Diagnosis Procedure

INFOID:000000005779290

1. CHECK CONNECTOR

1. Turn the ignition switch OFF.
2. Disconnect the battery cable from the negative terminal.
3. Check the terminals and connectors of the ICC sensor integrated unit for damage, bend and loose connection (unit side and connector side).

Is the inspection result normal?

- YES >> GO TO 2.
 NO >> Repair the terminal and connector.

2. CHECK HARNESS FOR OPEN CIRCUIT

1. Disconnect the connector of ICC sensor integrated unit.
2. Check the resistance between the ICC sensor integrated unit harness connector terminals.

ICC sensor integrated unit harness connector			Resistance (Ω)
Connector No.	Terminal No.		
E67	3	6	Approx. 54 – 66

Is the measurement value within the specification?

- YES >> GO TO 3.
 NO >> Repair the ICC sensor integrated unit branch line.

3. CHECK POWER SUPPLY AND GROUND CIRCUIT

Check the power supply and the ground circuit of the ICC sensor integrated unit. Refer to [CCS-102, "Diagnosis Procedure"](#).

Is the inspection result normal?

- YES (Present error)>>Replace the ICC sensor integrated unit. Refer to [CCS-134, "Exploded View"](#).
 YES (Past error)>>Error was detected in the ICC sensor integrated unit branch line.
 NO >> Repair the power supply and the ground circuit.

A
B
C
D
E
F
G
H
I
J
K
L

LAN

IPDM-E BRANCH LINE CIRCUIT

< DTC/CIRCUIT DIAGNOSIS >

[CAN SYSTEM (TYPE 13)]

IPDM-E BRANCH LINE CIRCUIT

Diagnosis Procedure

INFOID:000000005779291

1. CHECK CONNECTOR

1. Turn the ignition switch OFF.
2. Disconnect the battery cable from the negative terminal.
3. Check the terminals and connectors of the IPDM E/R for damage, bend and loose connection (unit side and connector side).

Is the inspection result normal?

- YES >> GO TO 2.
NO >> Repair the terminal and connector.

2. CHECK HARNESS FOR OPEN CIRCUIT

1. Disconnect the connector of IPDM E/R.
2. Check the resistance between the IPDM E/R harness connector terminals.

IPDM E/R harness connector			Resistance (Ω)
Connector No.	Terminal No.		
E6	40	39	Approx. 108 – 132

Is the measurement value within the specification?

- YES >> GO TO 3.
NO >> Repair the IPDM E/R branch line.

3. CHECK POWER SUPPLY AND GROUND CIRCUIT

Check the power supply and the ground circuit of the IPDM E/R. Refer to [PCS-18, "Diagnosis Procedure"](#).

Is the inspection result normal?

- YES (Present error)>>Replace the IPDM E/R. Refer to [PCS-33, "Exploded View"](#).
YES (Past error)>>Error was detected in the IPDM E/R branch line.
NO >> Repair the power supply and the ground circuit.

CAN COMMUNICATION CIRCUIT

< DTC/CIRCUIT DIAGNOSIS >

[CAN SYSTEM (TYPE 13)]

CAN COMMUNICATION CIRCUIT

Diagnosis Procedure

INFOID:000000005779292

1.CONNECTOR INSPECTION

1. Turn the ignition switch OFF.
2. Disconnect the battery cable from the negative terminal.
3. Disconnect all the unit connectors on CAN communication system.
4. Check terminals and connectors for damage, bend and loose connection.

Is the inspection result normal?

- YES >> GO TO 2.
NO >> Repair the terminal and connector.

2.CHECK HARNESS CONTINUITY (SHORT CIRCUIT)

Check the continuity between the data link connector terminals.

Data link connector		Continuity
Connector No.	Terminal No.	
M24	6 14	Not existed

Is the inspection result normal?

- YES >> GO TO 3.
NO >> Check the harness and repair the root cause.

3.CHECK HARNESS CONTINUITY (SHORT CIRCUIT)

Check the continuity between the data link connector and the ground.

Data link connector		Ground	Continuity
Connector No.	Terminal No.		
M24	6		Not existed
	14		Not existed

Is the inspection result normal?

- YES >> GO TO 4.
NO >> Check the harness and repair the root cause.

4.CHECK ECM AND IPDM E/R TERMINATION CIRCUIT

1. Remove the ECM and the IPDM E/R.
2. Check the resistance between the ECM terminals.

ECM		Resistance (Ω)
Terminal No.		
114	113	Approx. 108 – 132

3. Check the resistance between the IPDM E/R terminals.

IPDM E/R		Resistance (Ω)
Terminal No.		
40	39	Approx. 108 – 132

Is the measurement value within the specification?

- YES >> GO TO 5.
NO >> Replace the ECM and/or the IPDM E/R.

5.CHECK SYMPTOM

Connect all the connectors. Check if the symptoms described in the "Symptom (Results from interview with customer)" are reproduced.

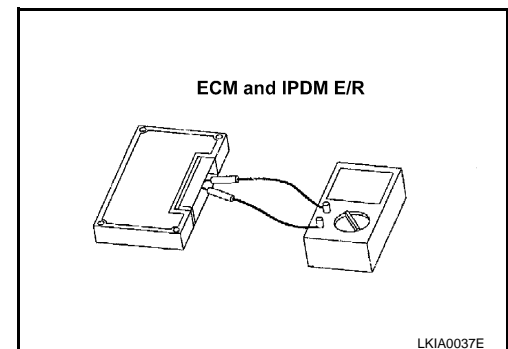

CAN COMMUNICATION CIRCUIT

< DTC/CIRCUIT DIAGNOSIS >

[CAN SYSTEM (TYPE 13)]

Inspection result

Reproduced>>GO TO 6.

Non-reproduced>>Start the diagnosis again. Follow the trouble diagnosis procedure when past error is detected.

6.CHECK UNIT REPRODUCTION

Perform the reproduction test as per the following procedure for each unit.

1. Turn the ignition switch OFF.
2. Disconnect the battery cable from the negative terminal.
3. Disconnect one of the unit connectors of CAN communication system.

NOTE:

ECM and IPDM E/R have a termination circuit. Check other units first.

4. Connect the battery cable to the negative terminal. Check if the symptoms described in the "Symptom (Results from interview with customer)" are reproduced.

NOTE:

Although unit-related error symptoms occur, do not confuse them with other symptoms.

Inspection result

Reproduced>>Connect the connector. Check other units as per the above procedure.

Non-reproduced>>Replace the unit whose connector was disconnected.