

# SECTION **PWC**

## POWER WINDOW CONTROL SYSTEM

A  
B  
C  
D  
E  
F  
G  
H  
I  
J  
K  
L  
M  
N  
O  
P

### CONTENTS

<b>BASIC INSPECTION</b> .....	4	<b>BCM</b> .....	13
<b>DIAGNOSIS AND REPAIR WORK FLOW</b> .....	4	BCM : Diagnosis Procedure .....	13
Work Flow .....	4	<b>POWER WINDOW MAIN SWITCH</b> .....	13
<b>INSPECTION AND ADJUSTMENT</b> .....	5	POWER WINDOW MAIN SWITCH : Diagnosis	
<b>ADDITIONAL SERVICE WHEN REMOVING BATTERY NEGATIVE TERMINAL</b> .....	5	Procedure .....	13
ADDITIONAL SERVICE WHEN REMOVING BATTERY NEGATIVE TERMINAL : Description .....	5	<b>FRONT POWER WINDOW SWITCH (PASSENGER SIDE)</b> .....	14
ADDITIONAL SERVICE WHEN REMOVING BATTERY NEGATIVE TERMINAL : Special Repair Requirement .....	5	FRONT POWER WINDOW SWITCH (PASSENGER SIDE) : Diagnosis Procedure .....	14
<b>ADDITIONAL SERVICE WHEN REPLACING CONTROL UNIT</b> .....	5	<b>REAR POWER WINDOW SWITCH</b> .....	15
ADDITIONAL SERVICE WHEN REPLACING CONTROL UNIT : Description .....	5	REAR POWER WINDOW SWITCH : Diagnosis Procedure .....	15
ADDITIONAL SERVICE WHEN REPLACING CONTROL UNIT : Special Repair Requirement .....	6	<b>POWER WINDOW MOTOR</b> .....	17
<b>SYSTEM DESCRIPTION</b> .....	7	<b>DRIVER SIDE</b> .....	17
<b>POWER WINDOW SYSTEM</b> .....	7	DRIVER SIDE : Description .....	17
System Diagram .....	7	DRIVER SIDE : Component Function Check .....	17
System Description .....	7	DRIVER SIDE : Diagnosis Procedure .....	17
Component Parts Location .....	9	DRIVER SIDE : Component Inspection .....	18
Component Description .....	9	<b>PASSENGER SIDE</b> .....	18
<b>DIAGNOSIS SYSTEM (BCM)</b> .....	11	PASSENGER SIDE : Description .....	18
<b>COMMON ITEM</b> .....	11	PASSENGER SIDE : Component Function Check .....	18
COMMON ITEM : CONSULT-III Function (BCM - COMMON ITEM) .....	11	PASSENGER SIDE : Diagnosis Procedure .....	18
<b>RETAIND PWR</b> .....	12	PASSENGER SIDE : Component Inspection .....	19
RETAIND PWR : CONSULT-III Function (BCM - RETAINED PWR) .....	12	<b>REAR LH</b> .....	20
<b>DTC/CIRCUIT DIAGNOSIS</b> .....	13	REAR LH : Description .....	20
<b>POWER SUPPLY AND GROUND CIRCUIT</b> .....	13	REAR LH : Component Function Check .....	20
		REAR LH : Diagnosis Procedure .....	20
		REAR LH : Component Inspection .....	21
		<b>REAR RH</b> .....	21
		REAR RH : Description .....	21
		REAR RH : Component Function Check .....	21
		REAR RH : Diagnosis Procedure .....	21
		REAR RH : Component Inspection .....	22

PWC

<b>ENCODER</b> .....	<b>24</b>	Reference Value .....	75
<b>DRIVER SIDE</b> .....	<b>24</b>	Wiring Diagram - POWER WINDOW CONTROL SYSTEM - .....	77
DRIVER SIDE : Description .....	24	Fail-safe .....	84
DRIVER SIDE : Component Function Check .....	24	<b>FRONT POWER WINDOW SWITCH</b> .....	<b>86</b>
DRIVER SIDE : Diagnosis Procedure .....	24	Reference Value .....	86
<b>PASSENGER SIDE</b> .....	<b>26</b>	Wiring Diagram - POWER WINDOW CONTROL SYSTEM - .....	88
PASSENGER SIDE : Description .....	26	Fail-safe .....	95
PASSENGER SIDE : Component Function Check .....	26	<b>REAR POWER WINDOW SWITCH</b> .....	<b>97</b>
PASSENGER SIDE : Diagnosis Procedure .....	26	Reference Value .....	97
<b>REAR LH</b> .....	<b>28</b>	Wiring Diagram - POWER WINDOW CONTROL SYSTEM - .....	99
REAR LH : Description .....	28	Fail-safe .....	106
REAR LH : Component Function Check .....	28	<b>SYMPTOM DIAGNOSIS</b> .....	<b>108</b>
REAR LH : Diagnosis Procedure .....	28	<b>POWER WINDOWS DO NOT OPERATE WITH ANY POWER WINDOW SWITCHES</b> ....	<b>108</b>
<b>REAR RH</b> .....	<b>30</b>	Diagnosis Procedure .....	108
REAR RH : Description .....	30	<b>DRIVER SIDE POWER WINDOW ALONE DOES NOT OPERATE</b> .....	<b>109</b>
REAR RH : Component Function Check .....	30	Diagnosis Procedure .....	109
REAR RH : Diagnosis Procedure .....	31	<b>FRONT PASSENGER SIDE POWER WINDOW DOES NOT OPERATE</b> .....	<b>110</b>
<b>POWER WINDOW SERIAL LINK</b> .....	<b>33</b>	<b>WHEN POWER WINDOW MAIN SWITCH IS OPERATED</b> .....	<b>110</b>
<b>POWER WINDOW MAIN SWITCH</b> .....	<b>33</b>	WHEN POWER WINDOW MAIN SWITCH IS OPERATED : Diagnosis Procedure .....	110
POWER WINDOW MAIN SWITCH : Description ...	33	<b>WHEN FRONT POWER WINDOW SWITCH (PASSENGER SIDE) IS OPERATED</b> .....	<b>110</b>
POWER WINDOW MAIN SWITCH : Component Function Check .....	33	WHEN FRONT POWER WINDOW SWITCH (PASSENGER SIDE) IS OPERATED : Diagnosis Procedure .....	110
POWER WINDOW MAIN SWITCH : Diagnosis Procedure .....	33	<b>WHEN BOTH POWER WINDOW MAIN SWITCH AND FRONT POWER WINDOW SWITCH ARE OPERATED</b> .....	<b>110</b>
<b>FRONT POWER WINDOW SWITCH (PASSENGER SIDE)</b> .....	<b>34</b>	WHEN BOTH POWER WINDOW MAIN SWITCH AND FRONT POWER WINDOW SWITCH ARE OPERATED : Diagnosis Procedure .....	110
FRONT POWER WINDOW SWITCH (PASSENGER SIDE) : Description .....	34	<b>REAR LH SIDE POWER WINDOW ALONE DOES NOT OPERATE</b> .....	<b>111</b>
FRONT POWER WINDOW SWITCH (PASSENGER SIDE) : Component Function Check .....	34	<b>WHEN POWER WINDOW MAIN SWITCH IS OPERATED</b> .....	<b>111</b>
FRONT POWER WINDOW SWITCH (PASSENGER SIDE) : Diagnosis Procedure .....	35	WHEN POWER WINDOW MAIN SWITCH IS OPERATED : Diagnosis Procedure .....	111
<b>REAR LH</b> .....	<b>36</b>	<b>WHEN REAR POWER WINDOW SWITCH LH IS OPERATED</b> .....	<b>111</b>
REAR LH : Description .....	36	WHEN REAR POWER WINDOW SWITCH LH IS OPERATED : Diagnosis Procedure .....	111
REAR LH : Component Function Check .....	36		
REAR LH : Diagnosis Procedure .....	36		
<b>REAR RH</b> .....	<b>37</b>		
REAR RH : Description .....	37		
REAR RH : Component Function Check .....	37		
REAR RH : Diagnosis Procedure .....	37		
<b>ECU DIAGNOSIS INFORMATION</b> .....	<b>39</b>		
<b>BCM (BODY CONTROL MODULE)</b> .....	<b>39</b>		
Reference Value .....	39		
Wiring Diagram - BCM - .....	63		
Fail-safe .....	69		
DTC Inspection Priority Chart .....	71		
DTC Index .....	72		
<b>POWER WINDOW MAIN SWITCH</b> .....	<b>75</b>		

<b>WHEN BOTH POWER WINDOW MAIN SWITCH AND REAR POWER WINDOW SWITCH LH ARE OPERATED</b> .....	111	<b>REAR LH</b> .....	115	
WHEN BOTH POWER WINDOW MAIN SWITCH AND REAR POWER WINDOW SWITCH LH ARE OPERATED : Diagnosis Procedure .....	111	REAR LH : Diagnosis Procedure .....	116	A
<b>REAR RH SIDE POWER WINDOW ALONE DOES NOT OPERATE</b> .....	112	<b>REAR RH</b> .....	116	
<b>WHEN POWER WINDOW MAIN SWITCH IS OPERATED</b> .....	112	REAR RH : Diagnosis Procedure .....	116	B
WHEN POWER WINDOW MAIN SWITCH IS OPERATED : Diagnosis Procedure .....	112	<b>POWER WINDOW RETAINED POWER FUNCTION DOES NOT OPERATE NORMALLY</b> .....	117	
<b>WHEN REAR POWER WINDOW SWITCH RH IS OPERATED</b> .....	112	Diagnosis Procedure .....	117	C
WHEN REAR POWER WINDOW SWITCH RH IS OPERATED : Diagnosis Procedure .....	112	<b>DOOR KEY CYLINDER SWITCH DOES NOT OPERATE POWER WINDOWS</b> .....	118	
<b>WHEN BOTH POWER WINDOW MAIN SWITCH AND REAR POWER WINDOW SWITCH RH ARE OPERATED</b> .....	112	Diagnosis Procedure .....	118	D
WHEN BOTH POWER WINDOW MAIN SWITCH AND REAR POWER WINDOW SWITCH RH ARE OPERATED : Diagnosis Procedure .....	112	<b>KEYLESS POWER WINDOW DOWN DOES NOT OPERATE</b> .....	119	
<b>ANTI-PINCH FUNCTION DOES NOT OPERATE NORMALLY</b> .....	113	Description .....	119	E
<b>DRIVER SIDE</b> .....	113	Diagnosis Procedure .....	119	F
DRIVER SIDE : Diagnosis Procedure .....	113	<b>POWER WINDOW LOCK SWITCH DOES NOT FUNCTION</b> .....	120	
<b>PASSENGER SIDE</b> .....	113	Diagnosis Procedure .....	120	G
PASSENGER SIDE : Diagnosis Procedure .....	113	<b>POWER WINDOW SWITCH ILLUMINATION DOES NOT ILLUMINATE</b> .....	121	
<b>REAR LH</b> .....	113	<b>DRIVER SIDE</b> .....	121	H
REAR LH : Diagnosis Procedure .....	113	DRIVER SIDE : Diagnosis Procedure .....	121	
<b>REAR RH</b> .....	113	<b>PASSENGER SIDE</b> .....	121	I
REAR RH : Diagnosis Procedure .....	113	PASSENGER SIDE : Diagnosis Procedure .....	121	
<b>AUTO OPERATION DOES NOT OPERATE BUT MANUAL OPERATES NORMALLY</b> .....	115	<b>REAR LH</b> .....	121	J
<b>DRIVER SIDE</b> .....	115	REAR LH : Diagnosis Procedure .....	121	
DRIVER SIDE : Diagnosis Procedure .....	115	<b>REAR RH</b> .....	121	
<b>PASSENGER SIDE</b> .....	115	REAR RH : Diagnosis Procedure .....	121	PWC
PASSENGER SIDE : Diagnosis Procedure .....	115	<b>PRECAUTION</b> .....	122	
<b>REAR LH</b> .....	115	<b>PRECAUTIONS</b> .....	122	L
REAR LH : Diagnosis Procedure .....	115	Precaution for Supplemental Restraint System (SRS) "AIR BAG" and "SEAT BELT PRE-TENSIONER" .....	122	
<b>REAR RH</b> .....	115	<b>REMOVAL AND INSTALLATION</b> .....	123	M
REAR RH : Diagnosis Procedure .....	115	<b>POWER WINDOW MAIN SWITCH</b> .....	123	
<b>AUTO OPERATION DOES NOT OPERATE BUT MANUAL OPERATES NORMALLY</b> .....	115	Removal and Installation .....	123	N
<b>DRIVER SIDE</b> .....	115			O
DRIVER SIDE : Diagnosis Procedure .....	115			
<b>PASSENGER SIDE</b> .....	115			P
PASSENGER SIDE : Diagnosis Procedure .....	115			

# DIAGNOSIS AND REPAIR WORK FLOW

< BASIC INSPECTION >

## BASIC INSPECTION

### DIAGNOSIS AND REPAIR WORK FLOW

Work Flow

INFOID:000000005891505

DETAILED FLOW

#### 1.OBTAIN INFORMATION ABOUT SYMPTOM

Interview the customer to obtain the malfunction information (conditions and environment when the malfunction occurred) as much as possible when the customer brings the vehicle in.

>> GO TO 2.

#### 2.REPRODUCE THE MALFUNCTION INFORMATION

Check the malfunction on the vehicle that the customer describes.  
Inspect the relation of the symptoms and the condition when the symptoms occur.

>> GO TO 3.

#### 3.IDENTIFY THE MALFUNCTIONING SYSTEM WITH "SYMPTOM DIAGNOSIS"

Use "Symptom diagnosis" from the symptom inspection result in step 2. Then identify where to start performing the diagnosis based on possible causes and symptoms.

>> GO TO 4.

#### 4.IDENTIFY MALFUNCTIONING PARTS WITH "COMPONENT DIAGNOSIS"

Perform the diagnosis with "Component diagnosis" of the applicable system.

>> GO TO 5.

#### 5.REPAIR OR REPLACE THE MALFUNCTIONING PARTS

Repair or replace the specified malfunctioning parts.

>> GO TO 6.

#### 6.FINAL CHECK

Check that malfunctions are not reproduced when obtaining the malfunction information from the customer, referring to the symptom inspection result in step 2.

Is the malfunctioning part repaired or replaced?

YES >> Trouble diagnosis is completed.

NO >> GO TO 3.

# INSPECTION AND ADJUSTMENT

< BASIC INSPECTION >

## INSPECTION AND ADJUSTMENT

### ADDITIONAL SERVICE WHEN REMOVING BATTERY NEGATIVE TERMINAL

#### ADDITIONAL SERVICE WHEN REMOVING BATTERY NEGATIVE TERMINAL : Description

INFOID:000000005891506

When battery negative terminal is disconnected, initialization is necessary.

If any of the following operations are performed, initialization is necessary as well as when battery negative terminal is disconnected.

- Power supply to the power window control unit is cut off by the removal of battery terminal or the battery fuse is blown.
- Disconnection and connection of power window control unit harness connector.
- Removal and installation of motor from regulator assembly.
- Operation of regulator assembly as an independent unit.
- Removal and installation of rear power window control unit.
- Removal and installation of door glass.
- Removal and installation of door glass run.

The operations as per the following cannot be performed while initialization is not complete.

- AUTO-UP operation
- Anti-pinch function
- Door key cylinder power window function

#### ADDITIONAL SERVICE WHEN REMOVING BATTERY NEGATIVE TERMINAL : Special Repair Requirement

INFOID:000000005891507

#### INITIALIZATION PROCEDURE

1. Disconnect battery negative terminal or power window control unit connector. Reconnect it after a minute or more.
2. Turn ignition switch ON.
3. Operate power window switch to fully open door glass. (This operation is unnecessary if door glass is already fully open.)
4. Pull and hold power window switch UP (AUTO-UP operation). Even after door glass stops at the fully closed position, pull the switch for 2 seconds or more.
5. Initialization procedure is complete.
6. Inspect anti-pinch function.

#### CHECK ANTI-PINCH FUNCTION

1. Fully open door glass.
  2. Place a piece of wood near the fully closed position.
  3. Close door glass completely using AUTO-UP.
- Check that door glass lowers approximately 150 mm (5.9 in) without pinching piece of wood and stops.
  - Check that door glass does not rise when operating power window main switch while lowering.

#### **CAUTION:**

- Perform initialization when AUTO-UP operation or anti-pinch function does not operate normally.
- Check that AUTO-UP operates before inspection when initialization is performed.
- Never check with hands or other body parts because they may be pinched. Never get pinched.
- It may switch to the fail-safe mode if open/close operation is performed continuously without fully closing door glass. Perform initialization in the above situation. Refer to [PWC-84, "Fail-safe"](#).
- Finish initialization. Otherwise, the next operation cannot be done.

1. AUTO-UP operation
2. Anti-pinch function
3. Door key cylinder power window function

#### ADDITIONAL SERVICE WHEN REPLACING CONTROL UNIT

#### ADDITIONAL SERVICE WHEN REPLACING CONTROL UNIT : Description

INFOID:000000005891508

When the control unit is replaced, initialization is necessary.

If any of the following operations are performed, initialization is necessary as well as when the control unit is disconnected.

# INSPECTION AND ADJUSTMENT

## < BASIC INSPECTION >

- Power supply to the power window control unit is cut off by the removal of battery terminal or the battery fuse is blown.
- Disconnection and connection of power window control unit harness connector.
- Removal and installation of motor from regulator assembly.
- Disconnection and connection of battery negative terminal.
- Removal and installation of rear power window control unit.
- Removal and installation of door glass.
- Removal and installation of door glass run.

The following specified operations cannot be performed while initialization is not complete.

- AUTO-UP operation
- Anti-pinch function
- Door key cylinder power window function

## ADDITIONAL SERVICE WHEN REPLACING CONTROL UNIT : Special Repair Requirement

INFOID:000000005891509

### INITIALIZATION PROCEDURE

1. Disconnect battery negative terminal or power window control unit connector. Reconnect it after a minute or more.
2. Turn ignition switch ON.
3. Operate power window switch to fully open door glass. (This operation is unnecessary if door glass is already fully open.)
4. Pull and hold power window switch UP (AUTO-UP operation). Even after door glass stops at the fully closed position, pull the switch for 2 seconds or more.
5. Initialization procedure is complete.
6. Inspect anti-pinch function.

### CHECK ANTI-PINCH FUNCTION

1. Fully open door glass.
  2. Place a piece of wood near the fully closed position.
  3. Close door glass completely using AUTO-UP.
- Check that door glass lowers approximately 150 mm (5.9 in) without pinching piece of wood and stops.
  - Check that door glass does not rise when operating power window main switch while lowering.

#### **CAUTION:**

- **Perform initialization when AUTO-UP operation or anti-pinch function does not operate normally.**
  - **Check that AUTO-UP operates before inspection when initialization is performed.**
  - **Never check with hands or other body parts because they may be pinched. Never get pinched.**
  - **It may switch to the fail-safe mode if open/close operation is performed continuously without fully closing. Perform initialization in the above situation. Refer to [PWC-84, "Fail-safe"](#).**
  - **Finish initialization. Otherwise, the next operation cannot be done.**
1. **AUTO-UP operation**
  2. **Anti-pinch function**
  3. **Door key cylinder power window function**

# POWER WINDOW SYSTEM

< SYSTEM DESCRIPTION >

## SYSTEM DESCRIPTION

### POWER WINDOW SYSTEM

#### System Diagram

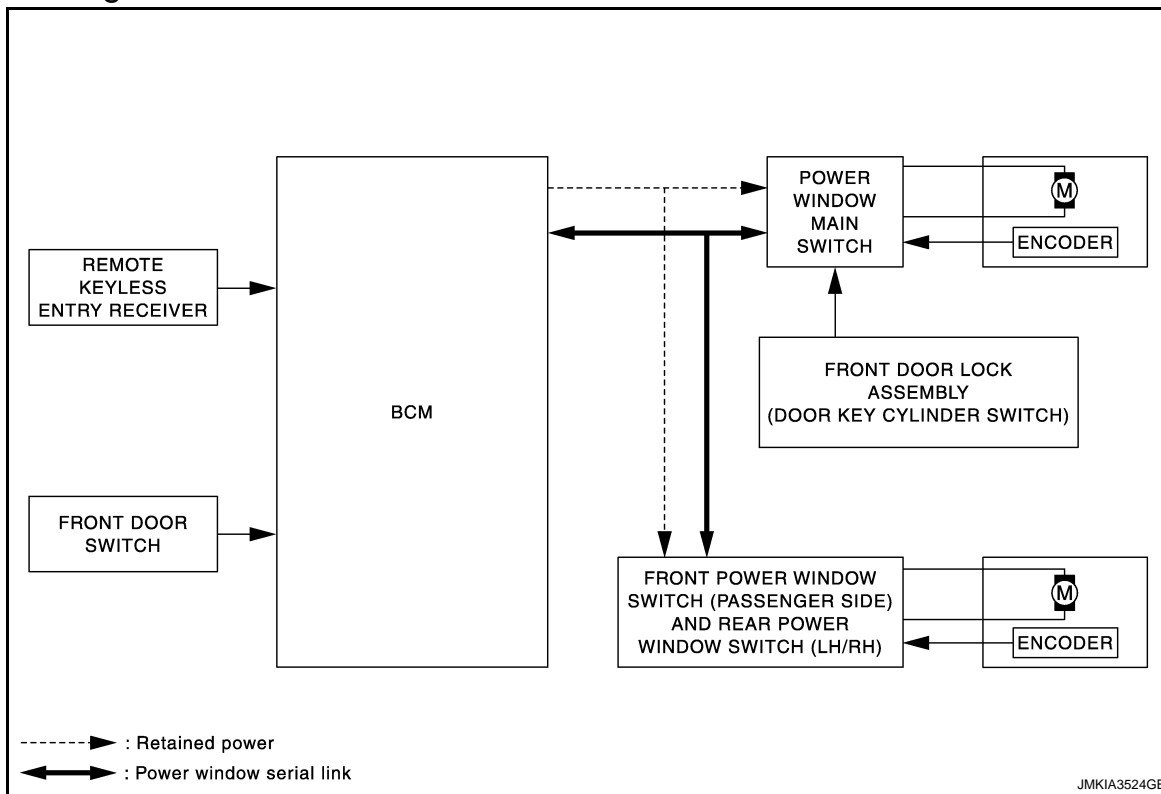

#### System Description

INFOID:000000005891511

#### POWER WINDOW SYSTEM

- Power window system is operable during the retained power operation timer after turning ignition switch OFF.
- Power window main switch can open/close door glass.
- Front and rear power window switch can open/close the corresponding door glass.
- AUTO UP/DOWN operation can be performed when front power window switch turns to AUTO.
- Power window serial link transmits the signals from power window main switch to each module.
- Power window lock switch can lock all power windows other than driver seat.
- If door glass receives resistance that is the specified value or more while power window of each seat is in AUTO-UP operation, power window of each seat operates in the reverse direction.
- Hold the door key cylinder to the LOCK or UNLOCK direction for 1 second or more to OPEN or CLOSE all power windows when ignition switch OFF.
- All power windows open when pressing Intelligent Key unlock button for 3 seconds.

#### POWER WINDOW AUTO-OPERATION

- AUTO UP/DOWN operation can be performed when each power window motor turns to AUTO.
- Encoder continues detecting the movement of power window motor and transmits to power window switch as the encoder pulse signal while power window motor is operating.
- Power window switch reads the changes of encoder signal and stops AUTO operation when door glass is at fully opened/closed position.
- Power window motor is operable in case encoder is malfunctioning.

#### RETAINED POWER OPERATION

Retained power operation is an additional power supply function that enables power window system to operate for 45 seconds after ignition switch turns OFF.

#### RETAINED POWER FUNCTION CANCEL CONDITIONS

A

B

C

D

E

F

G

H

I

J

PWC

L

M

N

O

P

# POWER WINDOW SYSTEM

## < SYSTEM DESCRIPTION >

---

- Front door CLOSE (door switch OFF) → OPEN (door switch ON).
- When ignition switch turns ON again.
- When timer times out. (45 seconds)

### POWER WINDOW LOCK FUNCTION

Ground circuit inside power window main switch shuts off when power window lock switch is ON. This inhibits power window switch operation except with the power window main switch.

### POWER WINDOW SERIAL LINK

- All power window switches and BCM transmit and receive the power window serial link.
- Power window serial link transmits the power window main switch operation signals and IGN signal to power window main switch module, front power window switch (passenger side) module, and rear power window switches.

### ANTI-PINCH OPERATION

- Pinch the foreign matter in the door glass during AUTO-UP operation is the anti-pinch function that lowers the door glass 150 mm (5.9 in) when detected.
- Encoder continues detecting the movement of power window motor and transmits to power window switch as the encoder pulse signal while power window motor is operating.
- Resistance is applied to the power window motor rotation that changes the frequency of encoder pulse signal if foreign material is trapped in the door glass.
- Power window switch controls to lower the door glass for 150 mm (5.9 in) after it detects encoder pulse signal frequency change.

### OPERATION CONDITION

- When all door glass AUTO-UP operation is performed (anti-pinch function does not operate just before the door glass closes and is fully closed)

#### **NOTE:**

Depending on environment and driving conditions, if a similar impact or load is applied to the door glass, it may lower.

### DOOR KEY CYLINDER SWITCH POWER WINDOW FUNCTION

Hold the door key cylinder to the LOCK or UNLOCK direction for 1.5 seconds or more to OPEN or CLOSE all power windows when ignition switch is OFF. In addition, it stops when key position is moved to NEUTRAL when operating.

### OPERATION CONDITION

- Ignition switch OFF.
- Hold door key cylinder to LOCK position for 1.5 seconds or more to perform CLOSE operation of the door glass.
- Hold door key cylinder to UNLOCK position for 1.5 seconds or more to perform OPEN operation of the door glass.

### KEYLESS POWER WINDOW DOWN FUNCTION

All power windows open when the unlock button on Intelligent Key is activated and kept pressed for more than 3\* seconds with the ignition switch OFF. The windows keep opening if the unlock button is continuously pressed.

The power window opening stops when the following operations are performed.

- When the unlock button is kept pressed more than 15 seconds.
- When the ignition switch is turned ON while the power window opening is operated.
- When the unlock button is released.

While retained power operation activate, keyless power window down function cannot be operated.

Keyless power window down operation mode can be changed by "PW DOWN SET" mode in "WORK SUPPORT". Refer to [DLK-52. "INTELLIGENT KEY : CONSULT-III Function \(BCM - INTELLIGENT KEY\)".](#)

#### **NOTE:**

Use CONSULT-III to change settings.

MODE 1 (3 sec) / MODE 2 (OFF) / MODE 3 (5 sec)



# POWER WINDOW SYSTEM

< SYSTEM DESCRIPTION >

## Component Parts Location

INFOID:000000005891512

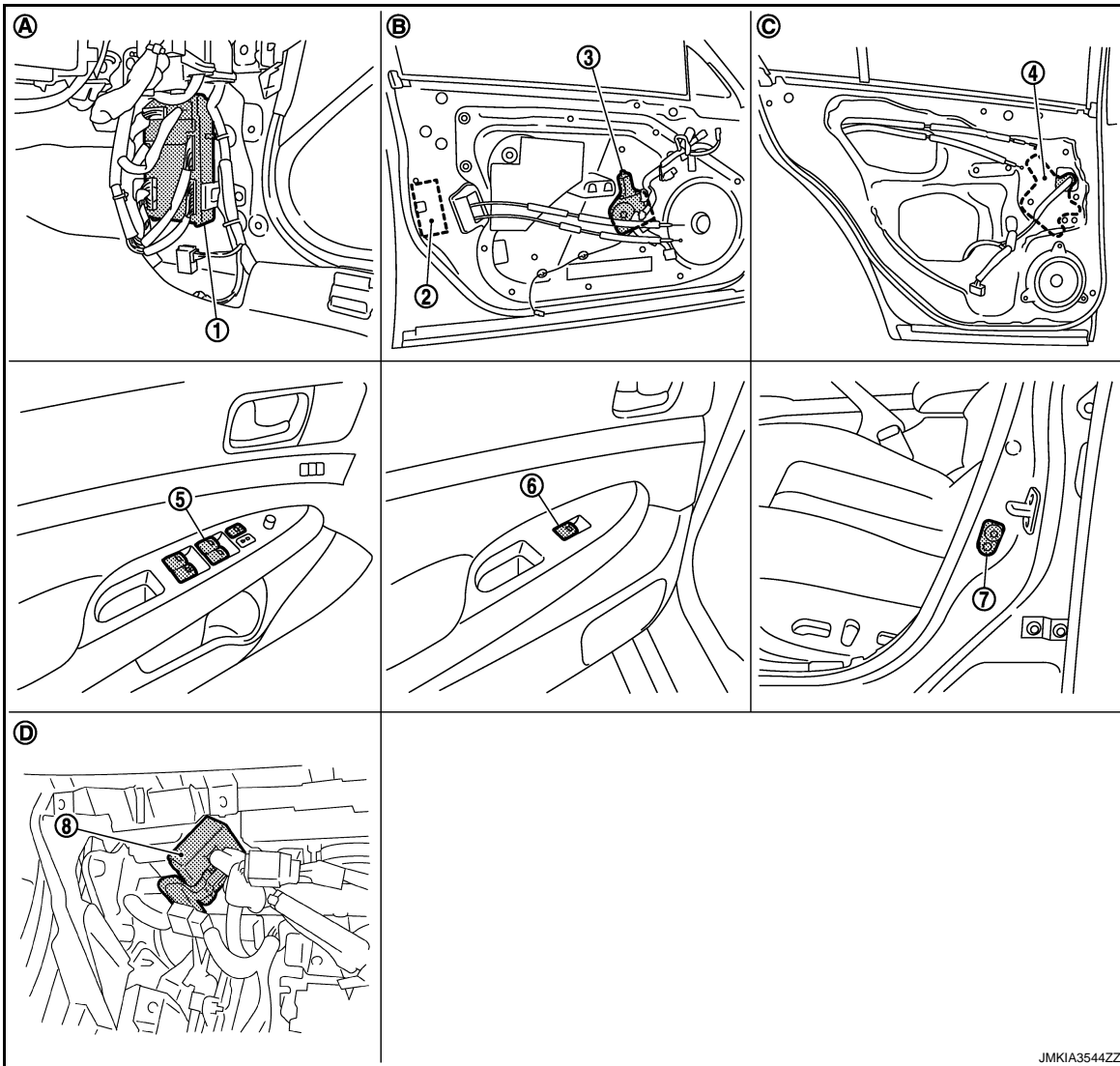

- |  |  |   |
|--|--|---|
| 1. BCM   | 2. Front door lock assembly (driver side) (door key cylinder switch) | 3. Front power window motor (driver side) |
| 4. Rear power window motor LH                                | 5. Power window main switch  | 6. Rear power window switch LH            |
| 7. Front door switch (driver side)                           | 8. Remote keyless entry receiver                                     |   |
| A. View with dash side lower (passenger side)                | B. View with front door finisher removed                             | C. View with rear door finisher removed   |
| D. View with instrument lower panel (passenger side) removed |  |   |

## Component Description

INFOID:000000005891513

Component	Function
BCM	<ul style="list-style-type: none"> <li>Supplies power supply to power window switch.</li> <li>Controls retained power function.</li> </ul>
Power window main switch	<ul style="list-style-type: none"> <li>Directly controls all power window motor of all doors.</li> <li>Controls anti-pinch operation of power window.</li> </ul>
Front power window switch	<ul style="list-style-type: none"> <li>Controls anti-pinch operation of power window.</li> <li>Controls power window motor of passenger door.</li> </ul>

A  
B  
C  
D  
E  
F  
G  
H  
I  
J  
K  
L  
M  
N  
O  
P

PWC

JMKIA3544ZZ

## POWER WINDOW SYSTEM

### < SYSTEM DESCRIPTION >

Component	Function
Rear power window switch	<ul style="list-style-type: none"><li>• Controls anti-pinch operation of power window.</li><li>• Controls power window motor of rear right and left doors.</li></ul>
Power window motor	<ul style="list-style-type: none"><li>• Integrates the ENCODER and WINDOW MOTOR.</li><li>• Starts operating with signals from each power window switch.</li><li>• Transmits power window motor rotation as a pulse signal to power window switch.</li></ul>
Front door lock assembly (door key cylinder switch)	Transmits operation condition of key cylinder switch to power window main switch.
Front door switch	Detects door open/close condition and transmits to BCM.
Remote keyless entry receiver	Receives lock/unlock signal from the intelligent Key, and then transmits to BCM.

# DIAGNOSIS SYSTEM (BCM)

< SYSTEM DESCRIPTION >

## DIAGNOSIS SYSTEM (BCM)

### COMMON ITEM

### COMMON ITEM : CONSULT-III Function (BCM - COMMON ITEM)

INFOID:000000005897272

### APPLICATION ITEM

CONSULT-III performs the following functions via CAN communication with BCM.

Diagnosis mode	Function Description
Work Support	Changes the setting for each system function.
Self Diagnostic Result	Displays the diagnosis results judged by BCM.
CAN Diag Support Monitor	Monitors the reception status of CAN communication viewed from BCM. Refer to CONSULT-III operation manual.
Data Monitor	The BCM input/output signals are displayed.
Active Test	The signals used to activate each device are forcibly supplied from BCM.
Ecu Identification	The BCM part number is displayed.
Configuration	This function is not used even though it is displayed.

### SYSTEM APPLICATION

BCM can perform the following functions for each system.

#### NOTE:

It can perform the diagnosis modes except the following for all sub system selection items.

×: Applicable item

System	Sub system selection item	Diagnosis mode		
		Work Support	Data Monitor	Active Test
Door lock	DOOR LOCK	×	×	×
Rear window defogger	REAR DEFOGGER		×	×
Warning chime	BUZZER		×	×
Interior room lamp timer	INT LAMP	×	×	×
Exterior lamp	HEAD LAMP	×	×	×
Wiper and washer	WIPER	×	×	×
Turn signal and hazard warning lamps	FLASHER	×	×	×
—	AIR CONDITONER*			
<ul style="list-style-type: none"> <li>• Intelligent Key system</li> <li>• Engine start system</li> </ul>	INTELLIGENT KEY	×	×	×
Combination switch	COMB SW		×	
Body control system	BCM	×		
IVIS - NATS	IMMU		×	×
Interior room lamp battery saver	BATTERY SAVER	×	×	×
Trunk lid open	TRUNK		×	×
Vehicle security system	THEFT ALM	×	×	×
RAP system	RETAINED PWR		×	
Signal buffer system	SIGNAL BUFFER		×	×
TPMS	TPMS (AIR PRESSURE MONITOR)	×	×	×

#### NOTE:

\*: This item is displayed, but is not used.

### FREEZE FRAME DATA (FFD)

The BCM records the following vehicle condition at the time a particular DTC is detected, and displays on CONSULT-III.

# DIAGNOSIS SYSTEM (BCM)

## < SYSTEM DESCRIPTION >

CONSULT screen item	Indication/Unit	Description	
Vehicle Speed	km/h	Vehicle speed of the moment a particular DTC is detected	
Odo/Trip Meter	km	Total mileage (Odometer value) of the moment a particular DTC is detected	
Vehicle Condition	SLEEP>LOCK	Power position status of the moment a particular DTC is detected	While turning BCM status from low power consumption mode to normal mode (Power supply position is "LOCK")
	SLEEP>OFF		While turning BCM status from low power consumption mode to normal mode (Power supply position is "OFF".)
	LOCK>ACC		While turning power supply position from "LOCK" to "ACC"
	ACC>ON		While turning power supply position from "ACC" to "IGN"
	RUN>ACC		While turning power supply position from "RUN" to "ACC" (Vehicle is stopping and selector lever is except P position.)
	CRANK>RUN		While turning power supply position from "CRANKING" to "RUN" (From cranking up the engine to run it)
	RUN>URGENT		While turning power supply position from "RUN" to "ACC" (Emergency stop operation)
	ACC>OFF		While turning power supply position from "ACC" to "OFF"
	OFF>LOCK		While turning power supply position from "OFF" to "LOCK"
	OFF>ACC		While turning power supply position from "OFF" to "ACC"
	ON>CRANK		While turning power supply position from "IGN" to "CRANKING"
	OFF>SLEEP		While turning BCM status from normal mode (Power supply position is "OFF".) to low power consumption mode
	LOCK>SLEEP		While turning BCM status from normal mode (Power supply position is "LOCK".) to low power consumption mode
	LOCK		Power supply position is "LOCK" (Ignition switch OFF with steering is locked.)
	OFF		Power supply position is "OFF" (Ignition switch OFF with steering is unlocked.)
	ACC		Power supply position is "ACC" (Ignition switch ACC)
	ON		Power supply position is "IGN" (Ignition switch ON with engine stopped)
ENGINE RUN	Power supply position is "RUN" (Ignition switch ON with engine running)		
CRANKING	Power supply position is "CRANKING" (At engine cranking)		
IGN Counter	0 - 39	The number of times that ignition switch is turned ON after DTC is detected <ul style="list-style-type: none"> <li>• The number is 0 when a malfunction is detected now.</li> <li>• The number increases like 1 → 2 → 3...38 → 39 after returning to the normal condition whenever ignition switch OFF → ON.</li> <li>• The number is fixed to 39 until the self-diagnosis results are erased if it is over 39.</li> </ul>	

## RETAINED PWR

### RETAINED PWR : CONSULT-III Function (BCM - RETAINED PWR)

INFOID:000000005897273

#### Data monitor

Monitor Item	Description
DOOR SW-DR	Indicates [ON/OFF] condition of driver side door switch.
DOOR SW-AS	Indicates [ON/OFF] condition of passenger side door switch.

# POWER SUPPLY AND GROUND CIRCUIT

< DTC/CIRCUIT DIAGNOSIS >

## DTC/CIRCUIT DIAGNOSIS

### POWER SUPPLY AND GROUND CIRCUIT

#### BCM

#### BCM : Diagnosis Procedure

INFOID:000000005891516

#### 1. CHECK FUSE AND FUSIBLE LINK

Check that the following fuse and fusible link are not blown.

Terminal No.	Signal name	Fuse and fusible link No.
1	Battery power supply	K (40 A)
11		10 (10A)

#### Is the fuse fusing?

YES >> Replace the blown fuse or fusible link after repairing the affected circuit if a fuse or fusible link is blown.

NO >> GO TO 2.

#### 2. CHECK POWER SUPPLY CIRCUIT

1. Turn ignition switch OFF.
2. Disconnect BCM connectors.
3. Check voltage between BCM harness connector and ground.

(+)		(-)	Voltage (Approx.)
BCM			
Connector	Terminal	Ground	Battery voltage
M118	1		
M119	11		

#### Is the measurement value normal?

YES >> GO TO 3.

NO >> Repair harness or connector.

#### 3. CHECK GROUND CIRCUIT

Check continuity between BCM harness connector and ground.

BCM		Ground	Continuity
Connector	Terminal		Existed
M119	13		Existed

#### Does continuity exist?

YES >> INSPECTION END

NO >> Repair harness or connector.

### POWER WINDOW MAIN SWITCH

#### POWER WINDOW MAIN SWITCH : Diagnosis Procedure

INFOID:000000005891517

#### 1. CHECK POWER SUPPLY CIRCUIT 1

1. Turn ignition switch OFF.
2. Disconnect power window main switch connectors.
3. Turn ignition switch ON.
4. Check voltage between power window main switch harness connector and ground.

A  
B  
C  
D  
E  
F  
G  
H  
I  
J  
L  
M  
N  
O  
P

PWC

# POWER SUPPLY AND GROUND CIRCUIT

## < DTC/CIRCUIT DIAGNOSIS >

(+)		(-)	Voltage (V) (Approx.)
Power window main switch			
Connector	Terminal	Ground	Battery voltage
D8	10		
D9	19		

Is the measurement value within the specification?

YES >> GO TO 3.

NO >> GO TO 2.

### 2. CHECK POWER SUPPLY CIRCUIT 2

1. Turn ignition switch OFF.
2. Disconnect BCM connector.
3. Check continuity between BCM harness connector and power window main switch harness connector.

BCM		Power window main switch		Continuity
Connector	Terminal	Connector	Terminal	
M118	2	D9	19	Existed
	3	D8	10	

4. Check continuity between BCM harness connector and ground.

BCM		Ground	Continuity
Connector	Terminal		
M118	2		Not existed
	3		

Is the inspection result normal?

YES >> Replace BCM. Refer to [BCS-80, "Exploded View"](#).

NO >> Repair or replace harness.

### 3. CHECK GROUND CIRCUIT

1. Turn ignition switch OFF.
2. Check continuity between power window main switch harness connector and ground.

Power window main switch		Ground	Continuity
Connector	Terminal		
D9	17		Existed

Is the inspection result normal?

YES >> INSPECTION END

NO >> Repair or replace harness.

## FRONT POWER WINDOW SWITCH (PASSENGER SIDE)

### FRONT POWER WINDOW SWITCH (PASSENGER SIDE) : Diagnosis Procedure

INFOID:000000005891518

#### 1. CHECK POWER SUPPLY CIRCUIT 1

1. Turn ignition switch OFF.
2. Disconnect front power window switch (passenger side) connector.
3. Check voltage between front power window switch (passenger side) harness connector and ground.

# POWER SUPPLY AND GROUND CIRCUIT

< DTC/CIRCUIT DIAGNOSIS >

(+)		(-)	Voltage (V) (Approx.)
Front power window switch (passenger side)			
Connector	Terminal	Ground	Battery voltage
D38	10		

Is the measurement value within the specification?

- YES >> GO TO 3.  
NO >> GO TO 2.

## 2. CHECK POWER SUPPLY CIRCUIT 2

1. Disconnect BCM connector.
2. Check continuity between BCM harness connector and front power window switch (passenger side) harness connector.

BCM		Front power window switch (passenger side)		Continuity
Connector	Terminal	Connector	Terminal	
M118	2	D38	10	Existed

3. Check continuity between BCM harness connector and ground.

BCM		Ground	Continuity
Connector	Terminal		
M118	2		Not existed

Is the inspection result normal?

- YES >> Replace BCM. Refer to [BCS-80, "Exploded View"](#).  
NO >> Repair or replace harness.

## 3. CHECK GROUND CIRCUIT

Check continuity between front power window switch (passenger side) harness connector and ground.

Front power window switch (passenger side)		Ground	Continuity
Connector	Terminal		
D38	11		Existed

Is the inspection result normal?

- YES >> INSPECTION END  
NO >> Repair or replace harness.

## REAR POWER WINDOW SWITCH

### REAR POWER WINDOW SWITCH : Diagnosis Procedure

INFOID:000000005891519

#### 1. CHECK POWER SUPPLY CIRCUIT 1

1. Turn ignition switch OFF.
2. Disconnect rear power window switch LH connector or power window switch RH connector.
3. Turn ignition switch ON.
4. Check voltage between rear power window switch harness connector and ground.

(+)		(-)	Voltage (V) (Approx.)
Rear power window switch			
Connector	Terminal	Ground	Battery voltage
LH	D57		
RH	D77		

# POWER SUPPLY AND GROUND CIRCUIT

## < DTC/CIRCUIT DIAGNOSIS >

Is the measurement value within the specification?

YES >> GO TO 3.

NO >> GO TO 2.

### 2. CHECK POWER SUPPLY CIRCUIT 2

1. Turn ignition switch OFF.
2. Disconnect BCM connector.
3. Check continuity between BCM harness connector and rear power window switch harness connector.

BCM		Rear power window switch		Continuity
Connector	Terminal	Connector	Terminal	
M118	2	LH	D57	Existed
		RH	D77	

4. Check continuity between BCM harness connector and ground.

BCM		Ground	Continuity
Connector	Terminal		
M118	2		Not existed

Is the inspection result normal?

YES >> Replace BCM. Refer to [BCS-80. "Exploded View"](#).

NO >> Repair or replace harness.

### 3. CHECK GROUND CIRCUIT

1. Turn ignition switch OFF.
2. Check continuity between rear power window switch harness connector and ground.

Rear power window switch		Ground	Continuity
Connector	Terminal		
LH	D57	11	Existed
RH	D77		

Is the inspection result normal?

YES >> INSPECTION END

NO >> Repair or replace harness.



# POWER WINDOW MOTOR

< DTC/CIRCUIT DIAGNOSIS >

## POWER WINDOW MOTOR DRIVER SIDE

### DRIVER SIDE : Description

INFOID:000000005891520

Door glass moves UP/DOWN by receiving the signal from power window main switch.

### DRIVER SIDE : Component Function Check

INFOID:000000005891521

## 1.CHECK POWER WINDOW MOTOR (DRIVER SIDE) OPERATION

Check front power window motor (driver side) operation with power window main switch.

Is the inspection result normal?

YES >> Power window motor (driver side) is OK.

NO >> Refer to [PWC-17, "DRIVER SIDE : Diagnosis Procedure"](#).

### DRIVER SIDE : Diagnosis Procedure

INFOID:000000005891522

## 1.CHECK FRONT POWER WINDOW MOTOR INPUT SIGNAL

1. Turn ignition switch OFF.
2. Disconnect front power window motor (driver side) connector.
3. Turn ignition switch ON.
4. Check voltage between front power window motor (driver side) harness connector and ground.

(+)		(-)	Condition	Voltage (V) (Approx.)	
Connector	Terminal				
D10	2	Ground	Power window main switch	UP	Battery voltage
			DOWN	0	
	1		UP	0	
			DOWN	Battery voltage	

Is the measurement value within the specification?

YES >> GO TO 3.

NO >> GO TO 2.

## 2.CHECK POWER WINDOW MOTOR CIRCUIT

1. Turn ignition switch OFF.
2. Disconnect power window main switch connector.
3. Check continuity between power window main switch harness connector and front power window motor (driver side) harness connector.

Power window main switch		Front power window motor (driver side)		Continuity
Connector	Terminal	Connector	Terminal	
D8	8	D10	2	Existed
	11		1	

4. Check continuity between power window main switch harness connector and ground.

Power window main switch		Ground	Continuity
Connector	Terminal		
D8	8		Not existed
	11		

Is the inspection result normal?

YES >> Replace power window main switch. Refer to [PWC-123, "Removal and Installation"](#).

A  
B  
C  
D  
E  
F  
G  
H  
I  
J  
L  
M  
N  
O  
P

PWC

# POWER WINDOW MOTOR

## < DTC/CIRCUIT DIAGNOSIS >

NO >> Repair or replace harness.

### 3. CHECK POWER WINDOW MOTOR

Check front power window motor (driver side).

Refer to [PWC-18. "DRIVER SIDE : Component Inspection"](#).

Is the inspection result normal?

YES >> GO TO 4.

NO >> Replace front power window motor (driver side). Refer to [GW-16. "Removal and Installation"](#).

### 4. CHECK INTERMITTENT INCIDENT

Refer to [GI-38. "Intermittent Incident"](#).

>> INSPECTION END

## DRIVER SIDE : Component Inspection

INFOID:000000005891523

### 1. CHECK POWER WINDOW MOTOR (DRIVER SIDE)

1. Turn ignition switch OFF.
2. Disconnect front power window motor (driver side) connector.
3. Check motor operation by connecting the battery voltage directly to front power window motor (driver side) connector.

Front power window motor (driver side) connector	Terminal		Motor operation
	(+)	(-)	
D10	1	2	DOWN
	2	1	UP

Is the inspection result normal?

YES >> Driver side power window motor is OK.

NO >> Replace driver side power window motor. Refer to [GW-16. "Removal and Installation"](#).

## PASSENGER SIDE

### PASSENGER SIDE : Description

INFOID:000000005891524

Door glass moves UP/DOWN by receiving the signal power window main switch or front power window switch (passenger side).

### PASSENGER SIDE : Component Function Check

INFOID:000000005891525

### 1. CHECK POWER WINDOW MOTOR (PASSENGER SIDE) OPERATION

Check front power window motor (passenger side) operation with power window main switch or front power window switch (passenger side).

Is the inspection result normal?

YES >> Power window motor (passenger side) is OK.

NO >> Refer to [PWC-18. "PASSENGER SIDE : Diagnosis Procedure"](#).

### PASSENGER SIDE : Diagnosis Procedure

INFOID:000000005891526

### 1. CHECK FRONT POWER WINDOW MOTOR INPUT SIGNAL

1. Turn ignition switch OFF.
2. Disconnect front power window motor (passenger side) connector.
3. Turn ignition switch ON.
4. Check voltage between front power window motor (passenger side) harness connector and ground.

# POWER WINDOW MOTOR

## < DTC/CIRCUIT DIAGNOSIS >

(+)		(-)	Condition	Voltage (V) (Approx.)	
Front power window motor (passenger side)					
Connector	Terminal				
D40	1	Ground	Front power window switch (passenger side)	UP	Battery voltage
				DOWN	0
	2			UP	0
				DOWN	Battery voltage

Is the measurement value within the specification?

YES >> GO TO 3.

NO >> GO TO 2.

## 2.CHECK POWER WINDOW MOTOR CIRCUIT

- Turn ignition switch OFF.
- Disconnect front power window switch (passenger side) connector.
- Check continuity between front power window switch (passenger side) harness connector and front power window motor (passenger side) harness connector.

Front power window switch (passenger side)		Front power window motor (passenger side)		Continuity
Connector	Terminal	Connector	Terminal	
D38	9	D40	1	Existed
	8		2	

- Check continuity between front power window switch (passenger side) connector and ground.

Front power window switch (passenger side)		Ground	Continuity
Connector	Terminal		
D38	8		Not existed
	9		

Is the inspection result normal?

YES >> Replace front power window switch (passenger side). Refer to [PWC-123, "Removal and Installation"](#).

NO >> Repair or replace harness.

## 3.CHECK POWER WINDOW MOTOR

Check front power window motor (passenger side).

Refer to [PWC-19, "PASSENGER SIDE : Component Inspection"](#).

Is the inspection result normal?

YES >> GO TO 4.

NO >> Replace front power window motor (passenger side). Refer to [GW-16, "Removal and Installation"](#).

## 4.CHECK INTERMITTENT INCIDENT

Refer to [GI-38, "Intermittent Incident"](#).

>> INSPECTION END

## PASSENGER SIDE : Component Inspection

INFOID:000000005891527

### 1.CHECK POWER WINDOW MOTOR (PASSENGER SIDE)

- Turn ignition switch OFF.
- Disconnect front power window motor (passenger side) connector.
- Check motor operation by connecting the battery voltage directly to front power window motor (passenger side) connector.

# POWER WINDOW MOTOR

## < DTC/CIRCUIT DIAGNOSIS >

Front power window motor (passenger side) connector	Terminal		Motor condition
	(+)	(-)	
D40	2	1	DOWN
	1	2	UP

### Is the inspection result normal?

YES >> Passenger side power window motor is OK.

NO >> Replace passenger side power window motor. Refer to [GW-16, "Removal and Installation"](#).

## REAR LH

### REAR LH : Description

INFOID:000000005891528

Door glass moves UP/DOWN by receiving the signal from power window main switch or rear power window switch LH.

### REAR LH : Component Function Check

INFOID:000000005891529

#### 1.CHECK POWER WINDOW MOTOR LH OPERATION

Check rear power window motor LH operation with power window main switch or rear power window switch LH.

### Is the inspection result normal?

YES >> Power window motor LH is OK.

NO >> Refer to [PWC-20, "REAR LH : Diagnosis Procedure"](#).

### REAR LH : Diagnosis Procedure

INFOID:000000005891530

#### 1.CHECK REAR POWER WINDOW MOTOR INPUT SIGNAL

1. Turn ignition switch OFF.
2. Disconnect rear power window motor LH connector.
3. Turn ignition switch ON.
4. Check voltage between rear power window motor LH harness connector and ground.

(+) Rear power window motor LH Connector		Terminal	(-) Ground	Condition Rear power window switch LH	Voltage (V) (Approx.)
D52	1				
		DOWN	0		
	3	UP	0		
		DOWN	Battery voltage		

### Is the measurement value within the specification?

YES >> GO TO 3.

NO >> GO TO 2.

#### 2.CHECK POWER WINDOW MOTOR CIRCUIT

1. Turn ignition switch OFF.
2. Disconnect rear power window switch LH connector.
3. Check continuity between rear power window switch LH harness connector and rear power window motor LH harness connector.

Rear power window switch LH Connector		Terminal	Rear power window motor LH Connector		Continuity
Connector	Terminal		Connector	Terminal	
D57	8	D52	1	Existed	
	9		3		

4. Check continuity between rear power window switch LH harness connector and ground.

# POWER WINDOW MOTOR

## < DTC/CIRCUIT DIAGNOSIS >

Rear power window switch LH		Ground	Continuity
Connector	Terminal		
D57	8		Not existed
	9		

Is the inspection result normal?

- YES >> Replace rear power window switch LH. Refer to [PWC-123, "Removal and Installation"](#).  
 NO >> Repair or replace harness.

### 3.CHECK REAR POWER WINDOW MOTOR

Check rear power window motor LH.

Refer to [PWC-21, "REAR LH : Component Inspection"](#).

Is the inspection result normal?

- YES >> GO TO 4.  
 NO >> Replace rear power window motor LH. Refer to [GW-21, "Removal and Installation"](#).

### 4.CHECK INTERMITTENT INCIDENT

Refer to [GI-38, "Intermittent Incident"](#).

>> INSPECTION END

## REAR LH : Component Inspection

INFOID:000000005891531

### 1.CHECK REAR POWER WINDOW MOTOR LH

- Turn ignition switch OFF.
- Disconnect rear power window motor LH connector.
- Check motor operation by connecting the battery voltage directly to rear power window motor LH connector.

Rear power window motor LH connector	Terminal		Motor condition
	(+)	(-)	
D52	1	3	UP
	3	1	DOWN

Is the inspection result normal?

- YES >> Power window motor is OK.  
 NO >> Replace rear power window motor LH. Refer to [GW-21, "Removal and Installation"](#).

## REAR RH

### REAR RH : Description

INFOID:000000005891532

Door glass moves UP/DOWN by receiving the signal from power window main switch or rear power window switch RH.

### REAR RH : Component Function Check

INFOID:000000005891533

#### 1. CHECK POWER WINDOW MOTOR RH OPERATION

Check rear power window motor RH operation with power window main switch or rear power window switch RH.

Is the inspection result normal?

- YES >> Power window motor RH is OK.  
 NO >> Refer to [PWC-21, "REAR RH : Diagnosis Procedure"](#).

### REAR RH : Diagnosis Procedure

INFOID:000000005891534

#### 1.CHECK REAR POWER WINDOW MOTOR INPUT SIGNAL

# POWER WINDOW MOTOR

## < DTC/CIRCUIT DIAGNOSIS >

1. Turn ignition switch OFF.
2. Disconnect rear power window motor RH connector.
3. Turn ignition switch ON.
4. Check voltage between rear power window motor RH harness connector and ground.

(+)		(-)	Condition	Voltage (V) (Approx.)	
Connector	Terminal				
D72	1	Ground	Rear power window switch RH	UP	Battery voltage
			DOWN	0	
	3		UP	0	
			DOWN	Battery voltage	

Is the measurement value within the specification?

YES >> GO TO 3.

NO >> GO TO 2.

## 2.CHECK POWER WINDOW MOTOR CIRCUIT

1. Turn ignition switch OFF.
2. Disconnect rear power window switch RH connector.
3. Check continuity between rear power window switch RH harness connector and rear power window motor RH harness connector.

Rear power window switch RH		Rear power window motor RH		Continuity
Connector	Terminal	Connector	Terminal	
D77	8	D72	1	Existed
	9		3	

4. Check continuity between rear power window switch RH harness connector and ground.

Rear power window switch RH		Ground	Continuity
Connector	Terminal		
D77	8		Not existed
	9		

Is the inspection result normal?

YES >> Replace rear power window switch RH. Refer to [GW-21, "Removal and Installation"](#).

NO >> Repair or replace harness.

## 3.CHECK REAR POWER WINDOW MOTOR RH

Check rear power window motor RH.

Refer to [PWC-22, "REAR RH : Component Inspection"](#).

Is the inspection result normal?

YES >> GO TO 4.

NO >> Replace rear power window motor RH. Refer to [GW-21, "Removal and Installation"](#).

## 4.CHECK INTERMITTENT INCIDENT

Refer to [GI-38, "Intermittent Incident"](#).

>> INSPECTION END

## REAR RH : Component Inspection

INFOID:000000005891535

### 1.CHECK REAR POWER WINDOW MOTOR RH

1. Turn ignition switch OFF.
2. Disconnect rear power window motor RH connector.

# POWER WINDOW MOTOR

## < DTC/CIRCUIT DIAGNOSIS >

3. Check motor operation by connecting the battery voltage directly to rear power window motor RH connector.

Rear power window motor RH connector	Terminal		Motor condition
	(+)	(-)	
D72	1	3	UP
	3	1	DOWN

### Is the inspection result normal?

YES >> Power window motor is OK.

NO >> Replace rear power window motor RH. Refer to [GW-21. "Removal and Installation"](#).

A  
B  
C  
D  
E  
F  
G  
H  
I  
J  
L  
M  
N  
O  
P

PWC

# ENCODER

< DTC/CIRCUIT DIAGNOSIS >

## ENCODER DRIVER SIDE

### DRIVER SIDE : Description

INFOID:000000005891536

Detects condition of the front power window motor (driver side) operation and transmits to power window main switch as the pulse signal.

### DRIVER SIDE : Component Function Check

INFOID:000000005891537

#### 1.CHECK ENCODER OPERATION

Check driver side door glass perform AUTO open/close operation normally by power window main switch.

Is the inspection result normal?

YES >> Encoder operation is OK.

NO >> Refer to [PWC-24, "DRIVER SIDE : Diagnosis Procedure"](#).

### DRIVER SIDE : Diagnosis Procedure

INFOID:000000005891538

#### 1.CHECK ENCODER SIGNAL

1. Turn ignition switch ON.
2. Check signal between power window main switch harness connector and ground using oscilloscope.

(+)		(-)	Signal (Reference value)
Power window main switch			
Connector	Terminal	Ground	Refer to following signal
D8	9		
	13		

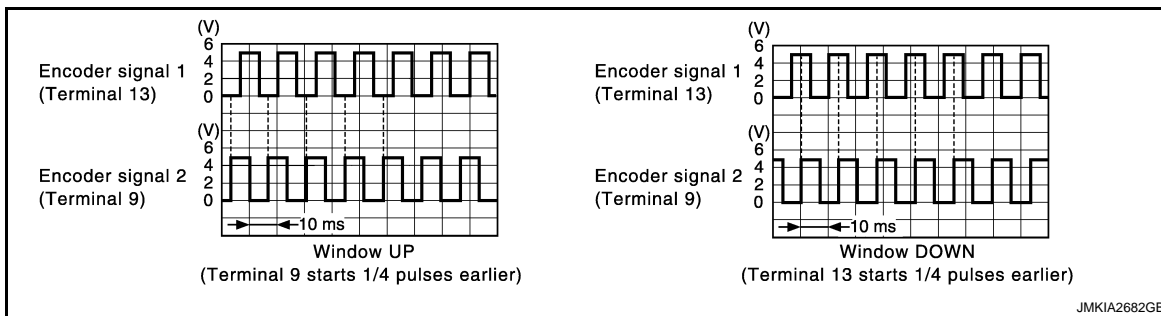

Is the inspection result normal?

YES >> Replace power window main switch. Refer to [PWC-123, "Removal and Installation"](#).

NO >> GO TO 2.

#### 2.CHECK ENCODER SIGNAL CIRCUIT

1. Turn ignition switch OFF.
2. Disconnect power window main switch connector and front power window motor (driver side) connector.
3. Check continuity between power window main switch harness connector and front power window motor (driver side) harness connector.

Power window main switch		Front power window motor (driver side)		Continuity
Connector	Terminal	Connector	Terminal	
D8	9	D10	3	Existed
	13		5	

4. Check continuity between power window main switch harness connector and ground.



# ENCODER

## < DTC/CIRCUIT DIAGNOSIS >

Power window main switch		Ground	Continuity
Connector	Terminal		
D8	9		
	13		Not existed

Is the inspection result normal?

YES >> GO TO 3.

NO >> Repair or replace harness.

### 3. CHECK ENCODER POWER SUPPLY CIRCUIT 1

1. Connect power window main switch connector.
2. Turn ignition switch ON.
3. Check voltage between front power window motor (driver side) harness connector and ground.

(+)		(-)	Voltage (V) (Approx.)
Front power window motor (driver side)			
Connector	Terminal		
D10	4	Ground	Battery voltage

Is the inspection result normal?

YES >> GO TO 5.

NO >> GO TO 4.

### 4. CHECK ENCODER POWER SUPPLY CIRCUIT 2

1. Turn ignition switch OFF.
2. Disconnect power window main switch connector.
3. Check continuity between power window main switch harness connector and front power window motor (driver side) harness connector.

Power window main switch		Front power window motor (driver side)		Continuity
Connector	Terminal	Connector	Terminal	
D8	15	D10	4	Existed

4. Check continuity between power window main switch harness connector and ground.

Power window main switch		Ground	Continuity
Connector	Terminal		
D8	15		

Is the inspection result normal?

YES >> Replace power window main switch. Refer to [PWC-123. "Removal and Installation"](#).

NO >> Repair or replace harness.

### 5. CHECK GROUND CIRCUIT 1

1. Turn ignition switch OFF.
2. Disconnect power window main switch connector.
3. Check continuity between power window main switch harness connector and front power window motor (driver side) harness connector.

Power window main switch		Front power window motor (driver side)		Continuity
Connector	Terminal	Connector	Terminal	
D8	2	D10	6	Existed

Is the inspection result normal?

YES >> GO TO 6.

NO >> Repair or replace harness.

### 6. CHECK GROUND CIRCUIT 2

A  
B  
C  
D  
E  
F  
G  
H  
I  
J  
L  
M  
N  
O  
P

PWC

# ENCODER

## < DTC/CIRCUIT DIAGNOSIS >

1. Connect power window main switch connector.
2. Check continuity between power window main switch harness connector and ground.

Power window main switch		Ground	Continuity
Connector	Terminal		
D8	2		Existed

Is the inspection result normal?

YES >> Replace front power window motor (driver side). Refer to [GW-16, "Removal and Installation"](#).

NO >> Replace power window main switch. Refer to [PWC-123, "Removal and Installation"](#).

## PASSENGER SIDE

### PASSENGER SIDE : Description

INFOID:000000005891539

Detects condition of the front power window motor (passenger side) operation and transmits to front power window switch (passenger side) as the pulse signal.

### PASSENGER SIDE : Component Function Check

INFOID:000000005891540

#### 1.CHECK ENCODER OPERATION

Check passenger side door glass perform AUTO open/close operation normally by power window main switch or front power window switch (passenger side).

Is the inspection result normal?

YES >> Encoder operation is OK.

NO >> Refer to [PWC-26, "PASSENGER SIDE : Diagnosis Procedure"](#).

### PASSENGER SIDE : Diagnosis Procedure

INFOID:000000005891541

#### 1.CHECK ENCODER SIGNAL

1. Turn ignition switch ON.
2. Check signal between front power window switch (passenger side) harness connector and ground using oscilloscope.

(+)		(-)	Signal (Reference value)
Front power window switch (passenger side)			
Connector	Terminal		
D38	12	Ground	Refer to following signal
	15		

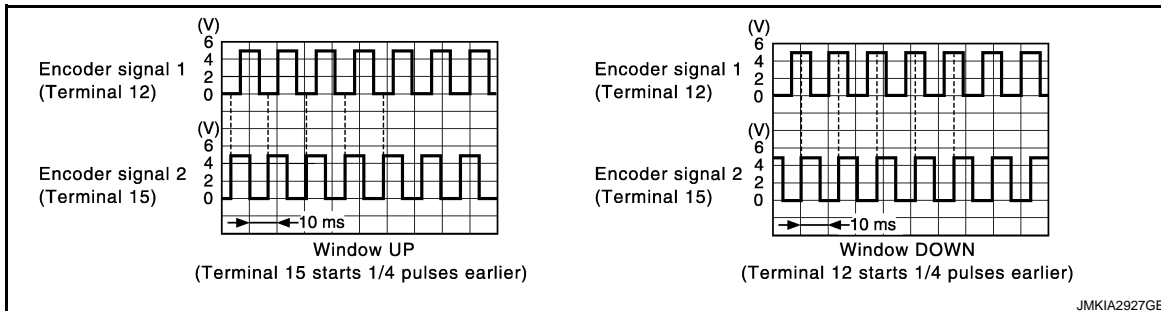

Is the inspection result normal?

YES >> Replace front power window switch (passenger side). Refer to [PWC-123, "Removal and Installation"](#).

NO >> GO TO 2.

#### 2.CHECK ENCODER SIGNAL CIRCUIT

1. Turn ignition switch OFF.

# ENCODER

## < DTC/CIRCUIT DIAGNOSIS >

2. Disconnect front power window switch (passenger side) connector and front power window motor (passenger side) connector.
3. Check continuity between front power window switch (passenger side) harness connector and front power window motor (passenger side) harness connector.

Front power window switch (passenger side)		Front power window motor (passenger side)		Continuity
Connector	Terminal	Connector	Terminal	
D38	12	D40	5	Existed
	15		3	

4. Check continuity between front power window switch (passenger side) harness connector and ground.

Front power window switch (passenger side)		Ground	Continuity
Connector	Terminal		
D38	12		Not existed
	15		

Is the inspection result normal?

YES >> GO TO 3.

NO >> Repair or replace harness.

### 3.CHECK ENCODER POWER SUPPLY CIRCUIT 1

1. Connect front power window switch (passenger side) connector.
2. Turn ignition switch ON.
3. Check voltage between front power window motor (passenger side) harness connector and ground.

(+)		(-)	Voltage (V) (Approx.)
Front power window motor (passenger side)			
Connector	Terminal	Ground	Battery voltage
D40	4		

Is the inspection result normal?

YES >> GO TO 5.

NO >> GO TO 4.

### 4.CHECK ENCODER POWER SUPPLY CIRCUIT 2

1. Turn ignition switch OFF.
2. Disconnect front power window switch (passenger side) connector.
3. Check continuity between front power window switch (passenger side) harness connector and front power window motor (passenger side) harness connector.

Front power window switch (passenger side)		Front power window motor (passenger side)		Continuity
Connector	Terminal	Connector	Terminal	
D38	4	D40	4	Existed

4. Check continuity between front power window switch (passenger side) harness connector and ground.

Front power window switch (passenger side)		Ground	Continuity
Connector	Terminal		
D38	4		Not existed

Is the inspection result normal?

YES >> Replace front power window switch (passenger side). Refer to [PWC-123. "Removal and Installation"](#).

NO >> Repair or replace harness.

### 5.CHECK GROUND CIRCUIT 1

1. Turn ignition switch OFF.

# ENCODER

## < DTC/CIRCUIT DIAGNOSIS >

2. Disconnect front power window switch (passenger side) connector.
3. Check continuity between front power window switch (passenger side) harness connector and front power window motor (passenger side) harness connector.

Front power window switch (passenger side)		Front power window motor (passenger side)		Continuity
Connector	Terminal	Connector	Terminal	
D38	3	D40	6	Existed

Is the inspection result normal?

- YES >> GO TO 6.  
 NO >> Repair or replace harness.

## 6.CHECK GROUND CIRCUIT 2

1. Connect front power window switch (passenger side) connector.
2. Check continuity between front power window switch (passenger side) harness connector and ground.

Front power window switch (passenger side)		Ground	Continuity
Connector	Terminal		
D38	3		Existed

Is the inspection result normal?

- YES >> Replace front power window motor (passenger side). Refer to [GW-16, "Removal and Installation"](#).  
 NO >> Replace front power window switch (passenger side). Refer to [PWC-123, "Removal and Installation"](#).

## REAR LH

### REAR LH : Description

INFOID:000000005891542

Detects condition of the rear power window motor LH operation and transmits to rear power window switch LH as the pulse signal.

### REAR LH : Component Function Check

INFOID:000000005891543

## 1.CHECK ENCODER OPERATION

Check rear door LH glass perform AUTO open/close operation normally by power window main switch or rear power window switch LH.

Is the inspection result normal?

- YES >> Encoder operation is OK.  
 NO >> Refer to [PWC-28, "REAR LH : Diagnosis Procedure"](#).

### REAR LH : Diagnosis Procedure

INFOID:000000005891544

## 1.CHECK ENCODER SIGNAL

1. Turn ignition switch ON.
2. Check signal between rear power window switch LH harness connector and ground using oscilloscope.

(+)		(-)	Signal (Reference value)
Rear power window switch LH			
Connector	Terminal		
D57	12	Ground	Refer to following signal
	15		

# ENCODER

## < DTC/CIRCUIT DIAGNOSIS >

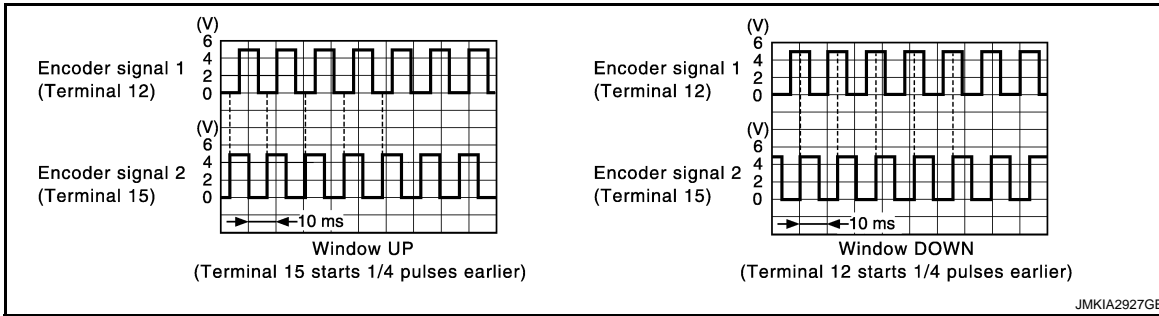

Is the inspection result normal?

- YES >> Replace rear power window switch LH. Refer to [PWC-123, "Removal and Installation"](#).  
 NO >> GO TO 2.

### 2.CHECK ENCODER SIGNAL CIRCUIT

- Turn ignition switch OFF.
- Disconnect rear power window switch LH connector and rear power window motor LH connector.
- Check continuity between rear power window switch LH harness connector and rear power window motor LH harness connector.

Rear power window switch LH		Rear power window motor LH		Continuity
Connector	Terminal	Connector	Terminal	
D57	12	D52	5	Existed
	15		6	

- Check continuity rear power window switch LH harness connector and ground.

Rear power window switch LH		Ground	Continuity
Connector	Terminal		
D57	12		Not existed
	15		

Is the inspection result normal?

- YES >> GO TO 3.  
 NO >> Repair or replace harness.

### 3.CHECK ENCODER POWER SUPPLY CIRCUIT 1

- Connect rear power window switch LH connector.
- Turn ignition switch ON.
- Check voltage between rear power window motor LH harness connector and ground.

(+)		(-)	Voltage (V) (Approx.)
Rear power window motor LH			
Connector	Terminal		
D52	2	Ground	Battery voltage

Is the inspection result normal?

- YES >> GO TO 5.  
 NO >> GO TO 4.

### 4.CHECK ENCODER POWER SUPPLY CIRCUIT 2

- Turn ignition switch OFF.
- Disconnect rear power window switch LH connector.
- Check continuity between rear power window switch LH harness connector and rear power window motor LH harness connector.

# ENCODER

## < DTC/CIRCUIT DIAGNOSIS >

Rear power window switch LH		Rear power window motor LH		Continuity
Connector	Terminal	Connector	Terminal	
D57	4	D52	2	Existed

4. Check continuity between rear power window switch LH harness connector and ground.

Rear power window switch LH		Ground	Continuity
Connector	Terminal		
D57	4		Not existed

Is the inspection result normal?

- YES >> Replace rear power window switch LH. Refer to [PWC-123, "Removal and Installation"](#).  
NO >> Repair or replace harness.

### 5.CHECK GROUND CIRCUIT 1

1. Turn ignition switch OFF.
2. Disconnect rear power window switch LH harness connector.
3. Check continuity between rear power window switch LH harness connector and rear power window motor LH harness connector.

Rear power window switch LH		Rear power window motor LH		Continuity
Connector	Terminal	Connector	Terminal	
D57	3	D52	4	Existed

Is the inspection result normal?

- YES >> GO TO 6.  
NO >> Repair or replace harness.

### 6.CHECK GROUND CIRCUIT 2

1. Connect rear power window switch LH harness connector.
2. Check continuity between rear power window switch LH harness connector and ground.

Rear power window switch LH		Ground	Continuity
Connector	Terminal		
D57	3		Existed

Is the inspection result normal?

- YES >> Replace rear power window motor LH. Refer to [GW-21, "Removal and Installation"](#).  
NO >> Replace rear power window switch LH. Refer to [PWC-123, "Removal and Installation"](#).

## REAR RH

### REAR RH : Description

INFOID:000000005891545

Detects condition of the rear power window motor RH operation and transmits to rear power window switch RH as the pulse signal.

### REAR RH : Component Function Check

INFOID:000000005891546

### 1.CHECK ENCODER OPERATION

Check rear door RH glass perform AUTO open/close operation normally by power window main switch or rear power window switch RH.

Is the inspection result normal?

- YES >> Encoder operation is OK.  
NO >> Refer to [PWC-31, "REAR RH : Diagnosis Procedure"](#).

# ENCODER

< DTC/CIRCUIT DIAGNOSIS >

## REAR RH : Diagnosis Procedure

INFOID:000000005891547

### 1.CHECK ENCODER SIGNAL

1. Turn ignition switch ON.
2. Check signal between rear power window switch RH harness connector and ground using oscilloscope.

(+)		(-)	Signal (Reference value)
Rear power window switch RH			
Connector	Terminal	Ground	Refer to following signal
D77	12		
	15		

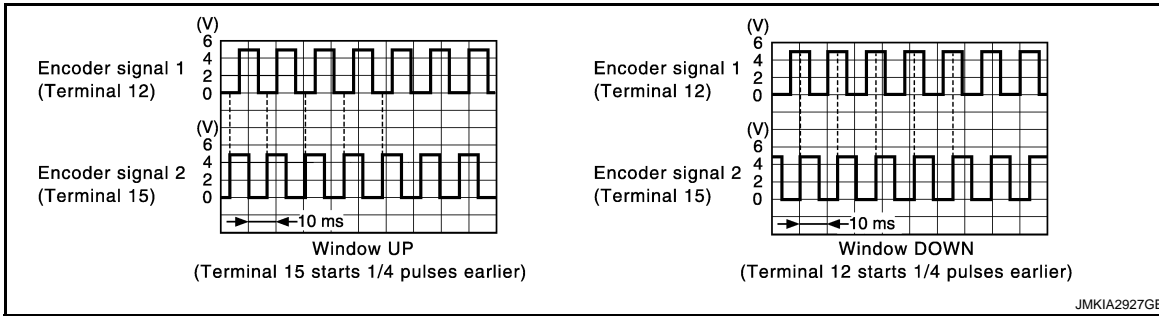

Is the inspection result normal?

- YES >> Replace rear power window switch RH. Refer to [PWC-123. "Removal and Installation"](#).  
 NO >> GO TO 2.

### 2.CHECK ENCODER SIGNAL CIRCUIT

1. Turn ignition switch OFF.
2. Disconnect rear power window switch RH connector and rear power window motor RH connector.
3. Check continuity between rear power window switch RH harness connector and rear power window motor RH harness connector.

Rear power window switch RH		Rear power window motor RH		Continuity
Connector	Terminal	Connector	Terminal	
D77	12	D72	5	Existed
	15		6	

4. Check continuity rear power window switch RH harness connector and ground.

Rear power window switch RH		Ground	Continuity
Connector	Terminal		
D77	12		Not existed
	15		

Is the inspection result normal?

- YES >> GO TO 3.  
 NO >> Repair or replace harness.

### 3.CHECK ENCODER POWER SUPPLY CIRCUIT 1

1. Connect rear power window switch RH connector.
2. Turn ignition switch ON.
3. Check voltage between rear power window motor RH harness connector and ground.

# ENCODER

## < DTC/CIRCUIT DIAGNOSIS >

(+)		(-)	Voltage (V) (Approx.)
Rear power window motor RH			
Connector	Terminal		
D72	2	Ground	Battery voltage

Is the inspection result normal?

YES >> GO TO 5.

NO >> GO TO 4.

### 4.CHECK ENCODER POWER SUPPLY CIRCUIT 2

1. Turn ignition switch OFF.
2. Disconnect rear power window switch RH connector.
3. Check continuity between rear power window switch RH harness connector and rear power window motor RH harness connector.

Rear power window switch RH		Rear power window motor RH		Continuity
Connector	Terminal	Connector	Terminal	
D77	4	D72	2	Existed

4. Check continuity between rear power window switch RH harness connector and ground.

Rear power window switch RH		Ground	Continuity
Connector	Terminal		
D77	4		Not existed

Is the inspection result normal?

YES >> Replace rear power window switch RH. Refer to [PWC-123, "Removal and Installation"](#).

NO >> Repair or replace harness.

### 5.CHECK GROUND CIRCUIT 1

1. Turn ignition switch OFF.
2. Disconnect rear power window switch RH harness connector.
3. Check continuity between rear power window switch RH harness connector and rear power window motor RH harness connector.

Rear power window switch RH		Rear power window motor RH		Continuity
Connector	Terminal	Connector	Terminal	
D77	3	D72	4	Existed

Is the inspection result normal?

YES >> GO TO 6.

NO >> Repair or replace harness.

### 6.CHECK GROUND CIRCUIT 2

1. Connect rear power window switch RH harness connector.
2. Check continuity between rear power window switch RH harness connector and ground.

Rear power window switch RH		Ground	Continuity
Connector	Terminal		
D77	3		Existed

Is the inspection result normal?

YES >> Replace rear power window motor RH. Refer to [GW-21, "Removal and Installation"](#).

NO >> Replace rear power window switch RH. Refer to [PWC-123, "Removal and Installation"](#).



# POWER WINDOW SERIAL LINK

< DTC/CIRCUIT DIAGNOSIS >

## POWER WINDOW SERIAL LINK

### POWER WINDOW MAIN SWITCH

#### POWER WINDOW MAIN SWITCH : Description

INFOID:000000005891548

Power window main switch, front power window switch (passenger side), rear power window switch and BCM transmit and receive the signal by power window serial link.

The signal mentioned below is transmitted from BCM to power window main switch, front power window switch (passenger side) and rear power window switch.

- Keyless power window down signal

The signal mentioned below is transmitted from power window main switch to front power window switch (passenger side) and rear power window switch.

- Front passenger side door window and rear door window operation signal
- Power window control by key cylinder switch signal
- Power window lock switch signal
- Retained power operation signal

#### POWER WINDOW MAIN SWITCH : Component Function Check

INFOID:000000005891549

##### 1.CHECK POWER WINDOW SWITCH OUTPUT SIGNAL

###### With CONSULT-III

Check ("CDL LOCK SW ", "CDL UNLOCK SW") in "DATA MONITOR" mode for "POWER DOOR LOCK SYSTEM" with CONSULT-III. Refer to [DLK-51, "DOOR LOCK : CONSULT-III Function \(BCM - DOOR LOCK\)"](#).

Monitor item	Condition
CDL LOCK SW	LOCK : ON
	UNLOCK : OFF
CDL UNLOCK SW	LOCK : OFF
	UNLOCK : ON

Is the inspection result normal?

YES >> Power window serial link is OK.

NO >> Refer to [PWC-33, "POWER WINDOW MAIN SWITCH : Diagnosis Procedure"](#).

#### POWER WINDOW MAIN SWITCH : Diagnosis Procedure

INFOID:000000005891550

##### 1.CHECK POWER WINDOW SWITCH OUTPUT SIGNAL

1. Turn ignition switch ON.
2. Check signal between power window main switch harness connector and ground.

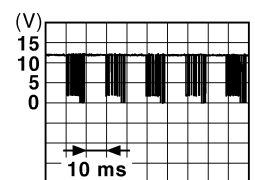
(+)		(-)	Signal (Reference value)
Connector	Terminal		
D8	14	Ground	 <p>JPMIA0013GB</p>

Is the inspection result normal?

YES >> GO TO 4.

NO >> GO TO 2.

##### 2.CHECK POWER WINDOW SERIAL LINK SIGNAL

A  
B  
C  
D  
E  
F  
G  
H  
I  
J  
L  
M  
N  
O  
P

PWC

# POWER WINDOW SERIAL LINK

## < DTC/CIRCUIT DIAGNOSIS >

1. Turn ignition switch OFF.
2. Disconnect power window main switch connector.
3. Turn ignition switch ON.
4. Check voltage between power window main switch harness connector and ground.

(+)		(-)	Voltage (V) (Approx.)
Power window main switch			
Connector	Terminal	Ground	Battery voltage
D8	14		

Is the measurement value within the specification?

- YES >> Replace power window main switch. Refer to [PWC-123, "Removal and Installation"](#).  
 NO >> GO TO 3.

### 3.CHECK POWER WINDOW SERIAL LINK CIRCUIT

1. Turn ignition switch OFF.
2. Disconnect BCM connector.
3. Check continuity between BCM connector and power window main switch connector.

BCM		Power window main switch		Continuity
Connector	Terminal	Connector	Terminal	
M123	132	D8	14	Existed

4. Check continuity between BCM connector and ground.

BCM		Ground	Continuity
Connector	Terminal		
M123	132		Not existed

Is the inspection result normal?

- YES >> Replace BCM. Refer to [BCS-80, "Removal and Installation"](#).  
 NO >> Repair or replace harness.

### 4.CHECK INTERMITTENT INCIDENT

Refer to [GI-38, "Intermittent Incident"](#).

>> INSPECTION END

## FRONT POWER WINDOW SWITCH (PASSENGER SIDE)

### FRONT POWER WINDOW SWITCH (PASSENGER SIDE) : Description

INFOID:000000005891551

Power window main switch, front power window switch (passenger side), rear power window switch and BCM transmit and receive the signal by power window serial link.

The signal mentioned below is transmitted from BCM to power window main switch, front power window switch (passenger side) and rear power window switch.

- Keyless power window down signal

The signal mentioned below is transmitted from power window main switch to front power window switch (passenger side) and rear power window switch.

- Front passenger side door window and rear door window operation signal
- Power window control by key cylinder switch signal
- Power window lock switch signal
- Retained power operation signal

### FRONT POWER WINDOW SWITCH (PASSENGER SIDE) : Component Function

#### Check

INFOID:000000005891552

### 1.CHECK POWER WINDOW SWITCH OUTPUT SIGNAL

# POWER WINDOW SERIAL LINK

## < DTC/CIRCUIT DIAGNOSIS >

### With CONSULT-III

Check ("CDL LOCK SW", "CDL UNLOCK SW") in "DATA MONITOR" mode for "POWER DOOR LOCK SYSTEM" with CONSULT-III. Refer to [DLK-51, "DOOR LOCK : CONSULT-III Function \(BCM - DOOR LOCK\)"](#).

Monitor item	Condition
CDL LOCK SW	LOCK : ON
	UNLOCK : OFF
CDL UNLOCK SW	LOCK : OFF
	UNLOCK : ON

Is the inspection result normal?

YES >> Power window serial link is OK.

NO >> Refer to [PWC-35, "FRONT POWER WINDOW SWITCH \(PASSENGER SIDE\) : Diagnosis Procedure"](#).

## FRONT POWER WINDOW SWITCH (PASSENGER SIDE) : Diagnosis Procedure

INFOID:000000005891553

### 1. CHECK POWER WINDOW SWITCH OUTPUT SIGNAL

- Turn ignition switch ON.
- Check signal between front power window switch (passenger side) harness connector and ground.

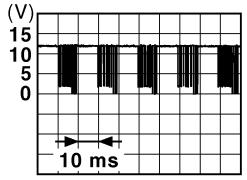
(+)		(-)	Signal (Reference value)
Connector	Terminal		
D38	16	Ground	 <p>JPMA0013GB</p>

Is the inspection result normal?

YES >> Replace front power window switch (passenger side). Refer to [PWC-123, "Removal and Installation"](#).

NO >> GO TO 2.

### 2. CHECK POWER WINDOW SERIAL LINK CIRCUIT

- Turn ignition switch OFF.
- Disconnect BCM connector and front power window switch (passenger side) connector.
- Check continuity between BCM harness connector and front power window switch (passenger side) harness connector.

BCM		Front power window switch (passenger side)		Continuity
Connector	Terminal	Connector	Terminal	
M123	132	D38	16	Existed

- Check continuity between BCM connector and ground.

BCM		Ground	Continuity
Connector	Terminal		
M123	132		Not existed

Is the inspection result normal?

YES >> Replace BCM. Refer to [BCS-80, "Removal and Installation"](#).

# POWER WINDOW SERIAL LINK

## < DTC/CIRCUIT DIAGNOSIS >

NO >> Repair or replace harness.

### REAR LH

#### REAR LH : Description

INFOID:000000005891554

Power window main switch, front power window switch (passenger side), rear power window switch and BCM transmit and receive the signal by power window serial link.

The signal mentioned below is transmitted from BCM to power window main switch, front power window switch (passenger side) and rear power window switch.

- Keyless power window down signal

The signal mentioned below is transmitted from power window main switch to front power window switch (passenger side) and rear power window switch.

- Front passenger side door window and rear door window operation signal
- Power window control by key cylinder switch signal
- Power window lock switch signal
- Retained power operation signal

#### REAR LH : Component Function Check

INFOID:000000005891555

### 1.CHECK POWER WINDOW SWITCH OUTPUT SIGNAL

#### Ⓟ With CONSULT-III

Check ("CDL LOCK SW ", "CDL UNLOCK SW") in "DATA MONITOR" mode for "POWER DOOR LOCK SYSTEM" with CONSULT-III. Refer to [DLK-51, "DOOR LOCK : CONSULT-III Function \(BCM - DOOR LOCK\)"](#).

Monitor item	Condition
CDL LOCK SW	LOCK : ON
	UNLOCK : OFF
CDL UNLOCK SW	LOCK : OFF
	UNLOCK : ON

#### Is the inspection result normal?

YES >> Power window serial link is OK.

NO >> Refer to [PWC-36, "REAR LH : Diagnosis Procedure"](#).

#### REAR LH : Diagnosis Procedure

INFOID:000000005891556

### 1.CHECK POWER WINDOW SWITCH OUTPUT SIGNAL

1. Turn ignition switch OFF.
2. Check signal between rear power window switch LH harness connector and ground.

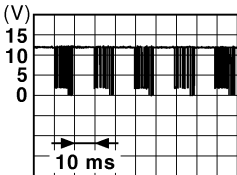
(+)		(-)	Signal (Reference value)
Connector	Terminal		
D57	16	Ground	 <p style="text-align: right;">JPMIA0013GB</p>

#### Is the inspection result normal?

YES >> Replace rear power window switch LH. Refer to [PWC-123, "Removal and Installation"](#).

NO >> GO TO 2.

# POWER WINDOW SERIAL LINK

< DTC/CIRCUIT DIAGNOSIS >

## 2. CHECK POWER WINDOW SERIAL LINK CIRCUIT

1. Turn ignition switch OFF.
2. Disconnect BCM connector and rear power window switch LH connector.
3. Check continuity between BCM harness connector and rear power window switch LH harness connector.

BCM		Rear power window switch LH		Continuity
Connector	Terminal	Connector	Terminal	
M123	132	D57	16	Existed

4. Check continuity between BCM harness connector and ground.

BCM		Ground	Continuity
Connector	Terminal		
M123	132		Not existed

Is the inspection result normal?

- YES >> Replace BCM. Refer to [BCS-80, "Removal and Installation"](#).  
 NO >> Repair or replace harness.

## REAR RH

### REAR RH : Description

INFOID:000000005891557

Power window main switch, front power window switch (passenger side), rear power window switch and BCM transmit and receive the signal by power window serial link.

The signal mentioned below is transmitted from BCM to power window main switch, front power window switch (passenger side) and rear power window switch.

- Keyless power window down signal

The signal mentioned below is transmitted from power window main switch to front power window switch (passenger side) and rear power window switch.

- Front passenger side door window and rear door window operation signal
- Power window control by key cylinder switch signal
- Power window lock switch signal
- Retained power operation signal

### REAR RH : Component Function Check

INFOID:000000005891558



## 1. CHECK POWER WINDOW SWITCH OUTPUT SIGNAL

### With CONSULT-III

Check ("CDL LOCK SW ", "CDL UNLOCK SW") in "DATA MONITOR" mode for "POWER DOOR LOCK SYSTEM" with CONSULT-III. Refer to [DLK-51, "DOOR LOCK : CONSULT-III Function \(BCM - DOOR LOCK\)"](#).

Monitor item	Condition	
CDL LOCK SW	LOCK	: ON
	UNLOCK	: OFF
CDL UNLOCK SW	LOCK	: OFF
	UNLOCK	: ON

Is the inspection result normal?

- YES >> Power window serial link is OK.  
 NO >> Refer to [PWC-37, "REAR RH : Diagnosis Procedure"](#).

### REAR RH : Diagnosis Procedure

INFOID:000000005891559

## 1. CHECK POWER WINDOW SWITCH OUTPUT SIGNAL

1. Turn ignition switch OFF.
2. Check signal between rear power window switch RH harness connector and ground.

# POWER WINDOW SERIAL LINK

## < DTC/CIRCUIT DIAGNOSIS >

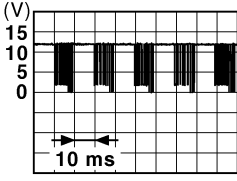
(+)		(-)	Signal (Reference value)
Rear power window switch RH			
Connector	Terminal		
D77	16	Ground	 <p>(V) 15 10 5 0</p> <p>10 ms</p> <p>JPMIA0013GB</p>

Is the inspection result normal?

- YES >> Replace rear power window switch RH. Refer to [PWC-123, "Removal and Installation"](#).  
 NO >> GO TO 2.

## 2. CHECK POWER WINDOW SERIAL LINK CIRCUIT

- Turn ignition switch OFF.
- Disconnect BCM connector and rear power window switch RH connector.
- Check continuity between BCM harness connector and rear power window switch RH harness connector.

BCM		Rear power window switch RH		Continuity
Connector	Terminal	Connector	Terminal	
M123	132	D77	16	Existed

- Check continuity between BCM harness connector and ground.

BCM		Ground	Continuity
Connector	Terminal		
M123	132		Not existed

Is the inspection result normal?

- YES >> Replace BCM. Refer to [BCS-80, "Removal and Installation"](#).  
 NO >> Repair or replace harness.

## BCM (BODY CONTROL MODULE)

< ECU DIAGNOSIS INFORMATION >

# ECU DIAGNOSIS INFORMATION

## BCM (BODY CONTROL MODULE)

Reference Value

INFOID:000000005891866

### VALUES ON THE DIAGNOSIS TOOL

CONSULT-III MONITOR ITEM

Monitor Item	Condition	Value/Status
FR WIPER HI	Other than front wiper switch HI	Off
	Front wiper switch HI	On
FR WIPER LOW	Other than front wiper switch LO	Off
	Front wiper switch LO	On
FR WASHER SW	Front washer switch OFF	Off
	Front washer switch ON	On
FR WIPER INT	Other than front wiper switch INT/AUTO	Off
	Front wiper switch INT/AUTO	On
FR WIPER STOP	Front wiper is not in STOP position	Off
	Front wiper is in STOP position	On
INT VOLUME	Wiper volume dial is in a dial position 1 - 7	Wiper volume dial position
TURN SIGNAL R	Other than turn signal switch RH	Off
	Turn signal switch RH	On
TURN SIGNAL L	Other than turn signal switch LH	Off
	Turn signal switch LH	On
TAIL LAMP SW	Other than lighting switch 1ST and 2ND	Off
	Lighting switch 1ST or 2ND	On
HI BEAM SW	Other than lighting switch HI	Off
	Lighting switch HI	On
HEAD LAMP SW 1	Other than lighting switch 2ND	Off
	Lighting switch 2ND	On
HEAD LAMP SW 2	Other than lighting switch 2ND	Off
	Lighting switch 2ND	On
PASSING SW	Other than lighting switch PASS	Off
	Lighting switch PASS	On
AUTO LIGHT SW	Other than lighting switch AUTO	Off
	Lighting switch AUTO	On
FR FOG SW	Front fog lamp switch OFF	Off
	Front fog lamp switch ON	On
RR FOG SW	<b>NOTE:</b> The item is indicated, but not monitored.	Off
DOOR SW-DR	Driver door closed	Off
	Driver door opened	On
DOOR SW-AS	Passenger door closed	Off
	Passenger door opened	On
DOOR SW-RR	Rear RH door closed	Off
	Rear LH door opened	On

A

B

C

D

E

F

G

H

I

J

PWC

L

M

N

O

P

## BCM (BODY CONTROL MODULE)

### < ECU DIAGNOSIS INFORMATION >

Monitor Item	Condition	Value/Status
DOOR SW-RL	Rear LH door closed	Off
	Rear LH door opened	On
DOOR SW-BK	<b>NOTE:</b> The item is indicated, but not monitored.	Off
CDL LOCK SW	Other than power door lock switch LOCK	Off
	Power door lock switch LOCK	On
CDL UNLOCK SW	Other than power door lock switch UNLOCK	Off
	Power door lock switch UNLOCK	On
KEY CYL LK-SW	Other than driver door key cylinder LOCK	Off
	Driver door key cylinder LOCK	On
KEY CYL UN-SW	Other than driver door key cylinder UNLOCK	Off
	Driver door key cylinder LOCK	On
KEY CYL SW-TR	<b>NOTE:</b> The item is indicated, but not monitored.	Off
HAZARD SW	Hazard switch is OFF	Off
	Hazard switch is ON	On
REAR DEF SW	<b>NOTE:</b> The item is indicated, but not monitored.	Off
H/L WASH SW	<b>NOTE:</b> The item is indicated, but not monitored.	Off
TR CANCEL SW	Trunk lid opener cancel switch OFF	Off
	Trunk lid opener cancel switch ON	On
TR/BD OPEN SW	Trunk lid opener switch OFF	Off
	While the trunk lid opener switch is turned ON	On
TRNK/HAT MNTR	Trunk lid closed	Off
	Trunk lid opened	On
RKE-LOCK	LOCK button of the Intelligent Key is not pressed	Off
	LOCK button of the Intelligent Key is pressed	On
RKE-UNLOCK	UNLOCK button of the Intelligent Key is not pressed	Off
	UNLOCK button of the Intelligent Key is pressed	On
RKE-TR/BD	TRUNK OPEN button of the Intelligent Key is not pressed	Off
	TRUNK OPEN button of the Intelligent Key is pressed	On
RKE-PANIC	PANIC button of the Intelligent Key is not pressed	Off
	PANIC button of the Intelligent Key is pressed	On
RKE-P/W OPEN	UNLOCK button of the Intelligent Key is not pressed	Off
	UNLOCK button of the Intelligent Key is pressed and held	On
RKE-MODE CHG	LOCK/UNLOCK button of the Intelligent Key is not pressed and held simultaneously	Off
	LOCK/UNLOCK button of the Intelligent Key is pressed and held simultaneously	On
OPTICAL SENSOR	Bright outside of the vehicle	Close to 5 V
	Dark outside of the vehicle	Close to 0 V
REQ SW -DR	Driver door request switch is not pressed	Off
	Driver door request switch is pressed	On
REQ SW -AS	Passenger door request switch is not pressed	Off
	Passenger door request switch is pressed	On



## BCM (BODY CONTROL MODULE)

### < ECU DIAGNOSIS INFORMATION >

Monitor Item	Condition	Value/Status	
REQ SW -RR	<b>NOTE:</b> The item is indicated, but not monitored.	Off	A
REQ SW -RL	<b>NOTE:</b> The item is indicated, but not monitored.	Off	B
REQ SW -BD/TR	Trunk lid opener request switch is not pressed	Off	C
	Trunk lid opener request switch is pressed	On	
PUSH SW	Push-button ignition switch (push switch) is not pressed	Off	D
	Push-button ignition switch (push switch) is pressed	On	
IGN RLY2 -F/B	Ignition switch in OFF or ACC position	Off	E
	Ignition switch in ON position	On	
ACC RLY -F/B	<b>NOTE:</b> The item is indicated, but not monitored.	Off	F
CLUCH SW	The clutch pedal is not depressed	Off	G
	The clutch pedal is depressed	On	
BRAKE SW 1	The brake pedal is depressed when No. 7 fuse is blown	Off	H
	The brake pedal is not depressed when No. 7 fuse is blown, or No. 7 fuse is normal	On	
BRAKE SW 2	The brake pedal is not depressed	Off	I
	The brake pedal is depressed	On	
DETE/CANCL SW	<ul style="list-style-type: none"> <li>• Selector lever in P position (Except M/T models)</li> <li>• The clutch pedal is depressed (M/T models)</li> </ul>	Off	J
	<ul style="list-style-type: none"> <li>• Selector lever in any position other than P (Except M/T models)</li> <li>• The clutch pedal is not depressed (M/T models)</li> </ul>	On	
SFT PN/N SW	Selector lever in any position other than P and N	Off	K
	Selector lever in P or N position	On	
S/L -LOCK	Steering is unlocked	Off	L
	Steering is locked	On	
S/L -UNLOCK	Steering is locked	Off	M
	Steering is unlocked	On	
S/L RELAY-F/B	Ignition switch in OFF or ACC position	Off	N
	Ignition switch in ON position	On	
UNLK SEN -DR	Driver door is unlocked	Off	O
	Driver door is locked	On	
PUSH SW -IPDM	Push-button ignition switch (push-switch) is not pressed	Off	P
	Push-button ignition switch (push-switch) is pressed	On	
IGN RLY1 -F/B	Ignition switch in OFF or ACC position	Off	Q
	Ignition switch in ON position	On	
DETE SW -IPDM	Selector lever in any position other than P	Off	R
	Selector lever in P position	On	
SFT PN -IPDM	<ul style="list-style-type: none"> <li>• Selector lever in any position other than P and N (Except M/T models)</li> <li>• The clutch pedal is not depressed (M/T models)</li> </ul>	Off	S
	<ul style="list-style-type: none"> <li>• Selector lever in P or N position (Except M/T models)</li> <li>• The clutch pedal is depressed (M/T models)</li> </ul>	On	
SFT P -MET	Selector lever in any position other than P	Off	T
	Selector lever in P position	On	
SFT N -MET	Selector lever in any position other than N	Off	U
	Selector lever in N position	On	

PWC

## BCM (BODY CONTROL MODULE)

### < ECU DIAGNOSIS INFORMATION >

Monitor Item	Condition	Value/Status
ENGINE STATE	Engine stopped	Stop
	While the engine stalls	Stall
	At engine cranking	Crank
	Engine running	Run
S/L LOCK-IPDM	Steering is unlocked	Off
	Steering is locked	On
S/L UNLK-IPDM	Steering is locked	Off
	Steering is unlocked	On
S/L RELAY-REQ	Steering lock system is not the LOCK condition and the changing condition from LOCK to UNLOCK	Off
	Steering lock system is the LOCK condition or the changing condition from LOCK to UNLOCK	On
VEH SPEED 1	While driving	Equivalent to speedometer reading
VEH SPEED 2	While driving	Equivalent to speedometer reading
DOOR STAT-DR	Driver door is locked	LOCK
	Wait with selective UNLOCK operation (60 seconds)	READY
	Driver door is unlocked	UNLOCK
DOOR STAT-AS	Passenger door is locked	LOCK
	Wait with selective UNLOCK operation (60 seconds)	READY
	Passenger door is unlocked	UNLOCK
ID OK FLAG	Steering is locked	Reset
	Steering is unlocked	Set
PRMT ENG STRT	The engine start is prohibited	Reset
	The engine start is permitted	Set
PRMT RKE STRT	<b>NOTE:</b> The item is indicated, but not monitored.	Reset
KEY SW -SLOT	The Intelligent Key is not inserted into key slot	Off
	The Intelligent Key is inserted into key slot	On
RKE OPE COUN1	During the operation of the Intelligent Key	Operation frequency of the Intelligent Key
RKE OPE COUN2	<b>NOTE:</b> The item is indicated, but not monitored.	—
CONFIRM ID ALL	The key ID that the key slot receives is not recognized by any key ID registered to BCM.	Yet
	The key ID that the key slot receives is recognized by any key ID registered to BCM.	Done
CONFIRM ID4	The key ID that the key slot receives is not recognized by the fourth key ID registered to BCM.	Yet
	The key ID that the key slot receives is recognized by the fourth key ID registered to BCM.	Done
CONFIRM ID3	The key ID that the key slot receives is not recognized by the third key ID registered to BCM.	Yet
	The key ID that the key slot receives is recognized by the third key ID registered to BCM.	Done

## BCM (BODY CONTROL MODULE)

### < ECU DIAGNOSIS INFORMATION >

Monitor Item	Condition	Value/Status	
CONFIRM ID2	The key ID that the key slot receives is not recognized by the second key ID registered to BCM.	Yet	A
	The key ID that the key slot receives is recognized by the second key ID registered to BCM.	Done	B
CONFIRM ID1	The key ID that the key slot receives is not recognized by the first key ID registered to BCM.	Yet	C
	The key ID that the key slot receives is recognized by the first key ID registered to BCM.	Done	
TP 4	The ID of fourth Intelligent Key is not registered to BCM	Yet	D
	The ID of fourth Intelligent Key is registered to BCM	Done	
TP 3	The ID of third Intelligent Key is not registered to BCM	Yet	E
	The ID of third Intelligent Key is registered to BCM	Done	
TP 2	The ID of second Intelligent Key is not registered to BCM	Yet	F
	The ID of second Intelligent Key is registered to BCM	Done	
TP 1	The ID of first Intelligent Key is not registered to BCM	Yet	
	The ID of first Intelligent Key is registered to BCM	Done	
AIR PRESS FL	Ignition switch ON (Only when the signal from the transmitter is received)	Air pressure of front LH tire	G
AIR PRESS FR	Ignition switch ON (Only when the signal from the transmitter is received)	Air pressure of front RH tire	H
AIR PRESS RR	Ignition switch ON (Only when the signal from the transmitter is received)	Air pressure of rear RH tire	I
AIR PRESS RL	Ignition switch ON (Only when the signal from the transmitter is received)	Air pressure of rear LH tire	
ID REGST FL1	ID of front LH tire transmitter is registered	Done	J
	ID of front LH tire transmitter is not registered	Yet	
ID REGST FR1	ID of front RH tire transmitter is registered	Done	
	ID of front RH tire transmitter is not registered	Yet	
ID REGST RR1	ID of rear RH tire transmitter is registered	Done	PWC
	ID of rear RH tire transmitter is not registered	Yet	
ID REGST RL1	ID of rear LH tire transmitter is registered	Done	L
	ID of rear LH tire transmitter is not registered	Yet	
WARNING LAMP	Tire pressure indicator OFF	Off	M
	Tire pressure indicator ON	On	
BUZZER	Tire pressure warning alarm is not sounding	Off	N
	Tire pressure warning alarm is sounding	On	

# BCM (BODY CONTROL MODULE)

< ECU DIAGNOSIS INFORMATION >

## TERMINAL LAYOUT

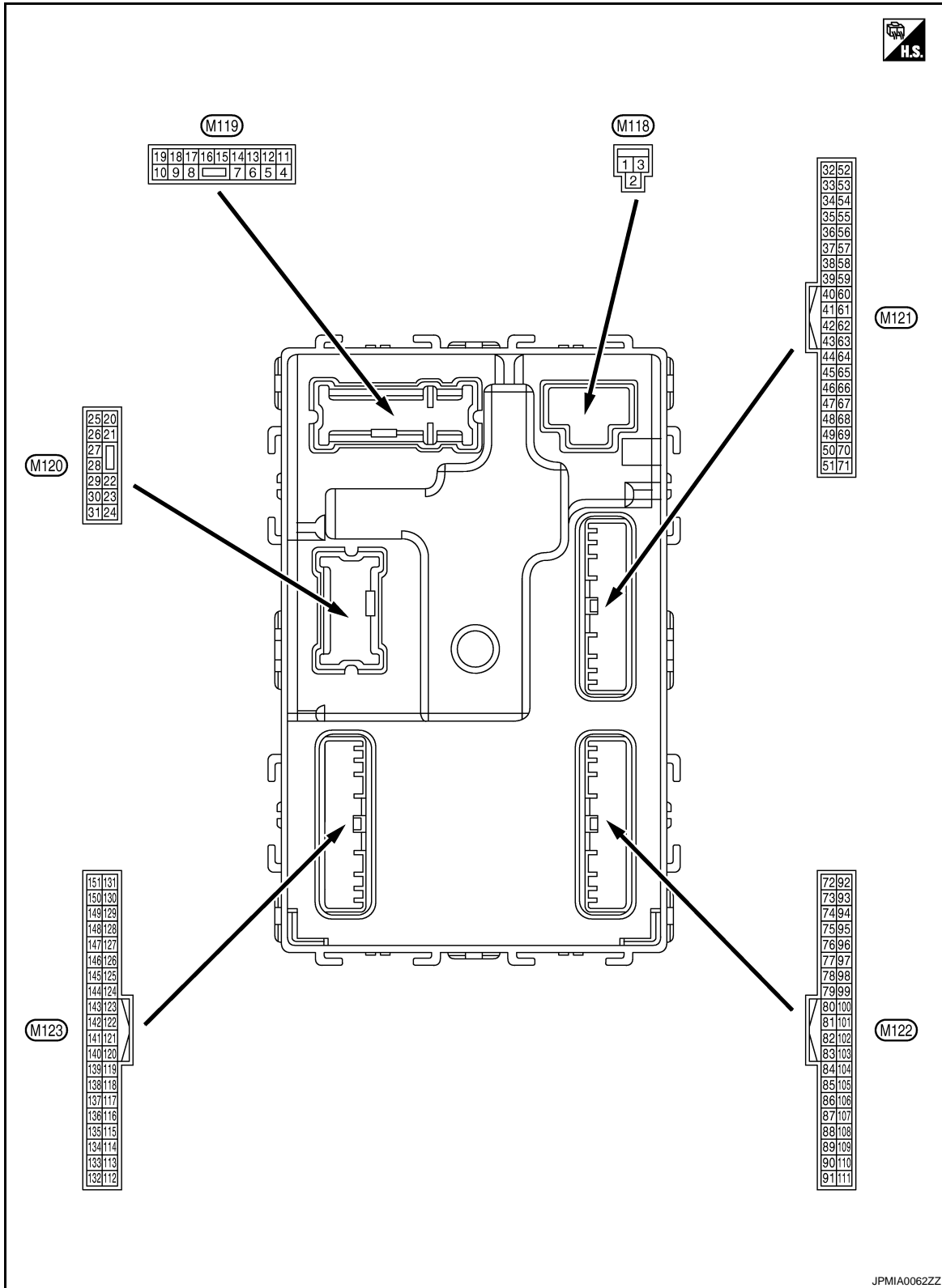

## PHYSICAL VALUES

# BCM (BODY CONTROL MODULE)

## < ECU DIAGNOSIS INFORMATION >

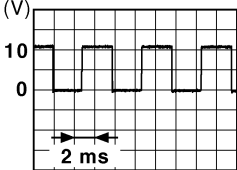
Terminal No. (Wire color)		Description		Condition		Value (Approx.)
+	-					
1 (W)	Ground	Battery power supply	Input	Ignition switch OFF		Battery voltage
2 (Y)	Ground	P/W power supply (BAT)	Output	Ignition switch OFF		12 V
3 (BG)	Ground	P/W power supply (RAP)	Output	Ignition switch ON		12 V
4 (LG)	Ground	Interior room lamp power supply	Output	Interior room lamp battery saver is activated. (Cuts the interior room lamp power supply)		0 V
				Interior room lamp battery saver is not activated. (Outputs the interior room lamp power supply)		12 V
5 (P)	Ground	Passenger door UN- LOCK	Output	Passenger door	UNLOCK (Actuator is activated)	12 V
					Other than UNLOCK) Ac- tuator is not activated	0 V
7 (SB)	Ground	Step lamp	Output	Step lamp	ON	0 V
					OFF	12 V
8 (V)	Ground	All doors, fuel lid LOCK	Output	All doors, fuel lid	LOCK (Actuator is activated)	12 V
					Other than LOCK (Actuator is not activated)	0 V
9 (G)	Ground	Driver door, fuel lid UNLOCK	Output	Driver door, fuel lid	UNLOCK (Actuator is activated)	12 V
					Other than UNLOCK (Actuator is not activated)	0 V
10 (P)	Ground	Rear RH door and rear LH door UN- LOCK	Output	Rear RH door and rear LH door	UNLOCK (Actuator is activated)	12 V
					Other than UNLOCK (Actuator is not activated)	0 V
11 (R)	Ground	Battery power supply	Input	Ignition switch OFF		Battery voltage
13 (B)	Ground	Ground	—	Ignition switch ON		0 V
14 (W)	Ground	Push-button ignition switch illumination ground	Output	Tail lamp	OFF	0 V
					ON	<p><b>NOTE:</b> When the illumination brightening/dimming level is in the neutral position</p>  <p style="text-align: right; font-size: small;">JSNIA0010GB</p>
15 (BG)	Ground	ACC indicator lamp	Output	Ignition switch	OFF (LOCK indicator is not illuminated)	Battery voltage
					ACC	0 V

A  
B  
C  
D  
E  
F  
G  
H  
I  
J  
PWC  
L  
M  
N  
O  
P

# BCM (BODY CONTROL MODULE)

## < ECU DIAGNOSIS INFORMATION >

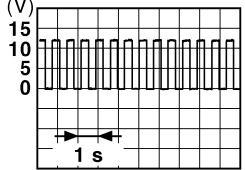
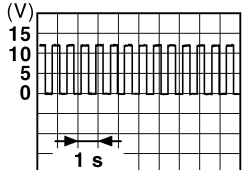
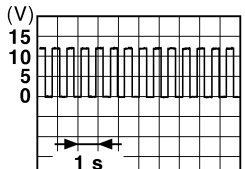
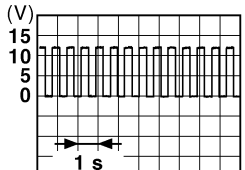
Terminal No. (Wire color)		Description		Condition	Value (Approx.)	
		Signal name	Input/ Output			
+	-					
17 (W)	Ground	Turn signal RH (Front)	Output	Ignition switch ON	Turn signal switch OFF	0 V
				Turn signal switch RH	 <p style="text-align: right; font-size: small;">PKID0926E</p>	
18 (BG)	Ground	Turn signal LH (Front)	Output	Ignition switch ON	Turn signal switch OFF	0 V
				Turn signal switch LH	 <p style="text-align: right; font-size: small;">PKID0926E</p>	
19 (V)	Ground	Room lamp timer control	Output	Interior room lamp	OFF	12 V
				ON	0 V	
20 (V)	Ground	Turn signal RH (Rear)	Output	Ignition switch ON	Turn signal switch OFF	0 V
				Turn signal switch RH	 <p style="text-align: right; font-size: small;">PKID0926E</p>	
23 (LG)	Ground	Trunk lid open	Output	Trunk lid	OPEN (Trunk lid opener actuator is activated)	12 V
				Other than OPEN (Trunk lid opener actuator is not activated)	0 V	
25 (Y)	Ground	Turn signal LH (Rear)	Output	Ignition switch ON	Turn signal switch OFF	0 V
				Turn signal switch LH	 <p style="text-align: right; font-size: small;">PKID0926E</p>	
30 (P)	Ground	Trunk room lamp	Output	Trunk room lamp	ON	0 V
				OFF	12 V	

# BCM (BODY CONTROL MODULE)

## < ECU DIAGNOSIS INFORMATION >

Terminal No. (Wire color)		Description		Condition	Value (Approx.)
+	-	Signal name	Input/ Output		
34 (SB)	Ground	Trunk room antenna (-)	Output	Ignition switch OFF	<p>JMKIA0062GB</p>
				When Intelligent Key is not in the passenger compart- ment	<p>JMKIA0063GB</p>
35 (V)	Ground	Trunk room antenna (+)	Output	Ignition switch OFF	<p>JMKIA0062GB</p>
				When Intelligent Key is not in the passenger compart- ment	<p>JMKIA0063GB</p>
38 (B)	Ground	Rear bumper anten- na (-)	Output	When the trunk lid opener re- quest switch is operated with ignition switch OFF	<p>JMKIA0062GB</p>
				When Intelligent Key is not in the antenna detection area	<p>JMKIA0063GB</p>

A  
B  
C  
D  
E  
F  
G  
H  
I  
J  
L  
M  
N  
O  
P

PWC

# BCM (BODY CONTROL MODULE)

## < ECU DIAGNOSIS INFORMATION >

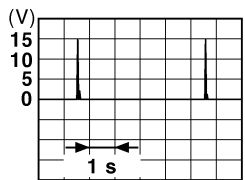
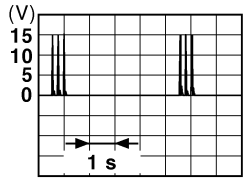
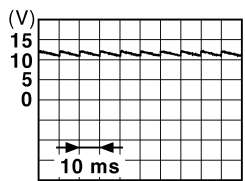
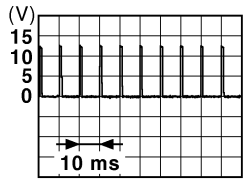
Terminal No. (Wire color)		Description		Condition	Value (Approx.)
		Signal name	Input/ Output		
+	-				
39 (W)	Ground	Rear bumper antenna (+)	Output	When Intelligent Key is in the antenna detection area	 <small>JMKIA0062GB</small>
				When the trunk lid opener request switch is operated with ignition switch OFF	 <small>JMKIA0063GB</small>
47 (Y)	Ground	Ignition relay (IPDM E/R) control	Output	Ignition switch OFF or ACC	12 V
				ON	0 V
50 (BG)	Ground	Trunk room lamp switch	Input	Trunk room lamp switch OFF (Trunk lid is closed)	 <small>JPMIA0011GB</small> 11.8 V
				ON (Trunk lid is opened)	0 V
52 (R)	Ground	Starter relay control	Output	Ignition switch ON (A/T models) When selector lever is in P or N position	12 V
				When selector lever is not in P or N position	0 V
				Ignition switch ON (M/T models) When the clutch pedal is depressed	Battery voltage
				When the clutch pedal is not depressed	0 V
61 (SB)	Ground	Trunk lid opener request switch	Input	Trunk lid opener request switch ON (Pressed)	0 V
				OFF (Not pressed)	 <small>JPMIA0016GB</small> 1.0 V
64 (G)	Ground	Intelligent Key warning buzzer (Engine room)	Output	Intelligent Key warning buzzer (Engine room) Sounding	0 V
				Not sounding	12 V



# BCM (BODY CONTROL MODULE)

## < ECU DIAGNOSIS INFORMATION >

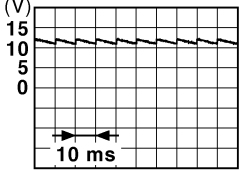
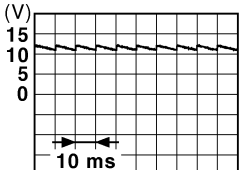
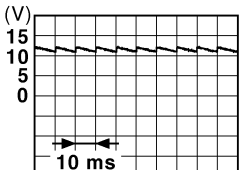
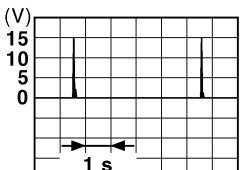
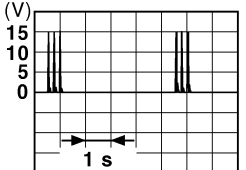
Terminal No. (Wire color)		Description		Condition	Value (Approx.)	
+	-	Signal name	Input/ Output			
67 (GR)	Ground	Trunk lid opener switch	Input	Trunk lid opener switch	Pressed	0 V
					Not pressed	 <p style="text-align: right; font-size: small;">JPMIA0011GB</p>
68 (BG)	Ground	Rear RH door switch	Input	Rear RH door switch	OFF (When rear RH door closes)	 <p style="text-align: right; font-size: small;">JPMIA0011GB</p>
					ON (When rear RH door opens)	0 V
69 (L)	Ground	Rear LH door switch	Input	Rear LH door switch	OFF (When rear LH door closes)	 <p style="text-align: right; font-size: small;">JPMIA0011GB</p>
					ON (When rear LH door opens)	0 V
72 (R)	Ground	Room antenna 2 (-) (Center console)	Output	Ignition switch OFF	When Intelligent Key is in the passenger compartment	 <p style="text-align: right; font-size: small;">JMKIA0062GB</p>
					When Intelligent Key is not in the passenger compartment	 <p style="text-align: right; font-size: small;">JMKIA0063GB</p>

A  
B  
C  
D  
E  
F  
G  
H  
I  
J  
L  
M  
N  
O  
P

PWC

# BCM (BODY CONTROL MODULE)

## < ECU DIAGNOSIS INFORMATION >

Terminal No. (Wire color)		Description		Condition	Value (Approx.)
+	-	Signal name	Input/ Output		
73 (G)	Ground	Room antenna 2 (+) (Center console)	Output	Ignition switch OFF	<p style="text-align: right; font-size: small;">JMKIA0062GB</p>
				When Intelligent Key is not in the passenger compart- ment	<p style="text-align: right; font-size: small;">JMKIA0063GB</p>
74 (SB)	Ground	Passenger door an- tenna (-)	Output	When the pas- senger door re- quest switch is operated with ignition switch OFF	<p style="text-align: right; font-size: small;">JMKIA0062GB</p>
				When Intelligent Key is not in the antenna detection area	<p style="text-align: right; font-size: small;">JMKIA0063GB</p>
75 (BR)	Ground	Passenger door an- tenna (+)	Output	When the pas- senger door re- quest switch is operated with ignition switch OFF	<p style="text-align: right; font-size: small;">JMKIA0062GB</p>
				When Intelligent Key is not in the antenna detection area	<p style="text-align: right; font-size: small;">JMKIA0063GB</p>

# BCM (BODY CONTROL MODULE)

## < ECU DIAGNOSIS INFORMATION >

Terminal No. (Wire color)		Description		Condition	Value (Approx.)
+	-	Signal name	Input/ Output		
76 (V)	Ground	Driver door antenna (-)	Output	When the driver door request switch is operated with ignition switch OFF	<p>JMKIA0062GB</p>
				When Intelligent Key is not in the antenna detection area	<p>JMKIA0063GB</p>
77 (LG)	Ground	Driver door antenna (+)	Output	When the driver door request switch is operated with ignition switch OFF	<p>JMKIA0062GB</p>
				When Intelligent Key is not in the antenna detection area	<p>JMKIA0063GB</p>
78 (Y)	Ground	Room antenna 1 (-) (Instrument panel)	Output	Ignition switch OFF	<p>JMKIA0062GB</p>
				When Intelligent Key is not in the passenger compartment	<p>JMKIA0063GB</p>

A  
B  
C  
D  
E  
F  
G  
H  
I  
J  
L  
M  
N  
O  
P

PWC

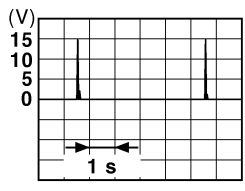
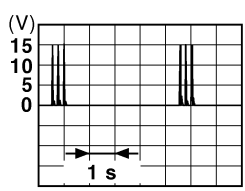
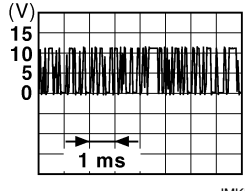
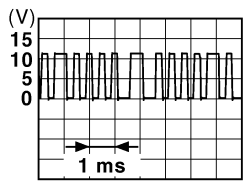

# BCM (BODY CONTROL MODULE)

## < ECU DIAGNOSIS INFORMATION >

Terminal No. (Wire color)		Description		Condition	Value (Approx.)	
		Signal name	Input/ Output			
+	-					
79 (BR)	Ground	Room antenna 1 (+) (Instrument panel)	Output	Ignition switch OFF	When Intelligent Key is in the passenger compart- ment	 <p style="text-align: right; font-size: small;">JMKIA0062GB</p>
					When Intelligent Key is not in the passenger compart- ment	 <p style="text-align: right; font-size: small;">JMKIA0063GB</p>
80 (GR)	Ground	NATS antenna amp.	Input/ Output	During waiting	Ignition switch is pressed while inserting the Intelli- gent Key into the key slot.	Just after pressing ignition switch. Pointer of tester should move.
81 (W)	Ground	NATS antenna amp.	Input/ Output	During waiting	Ignition switch is pressed while inserting the Intelli- gent Key into the key slot.	Just after pressing ignition switch. Pointer of tester should move.
82 (SB)	Ground	Ignition relay [Fuse block (J/B)] control	Output	Ignition switch	OFF or ACC	0 V
					ON	12 V
83 (Y)	Ground	Remote keyless entry receiver communica- tion	Input/ Output	During waiting	 <p style="text-align: right; font-size: small;">JMKIA0064GB</p>	
				When operating either button on the Intelli- gent Key	 <p style="text-align: right; font-size: small;">JMKIA0065GB</p>	

# BCM (BODY CONTROL MODULE)

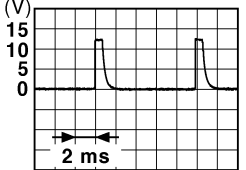
## < ECU DIAGNOSIS INFORMATION >

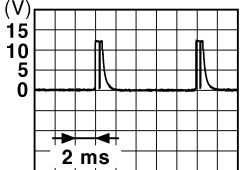

Terminal No. (Wire color)		Description		Condition	Value (Approx.)
+	-	Signal name	Input/ Output		
87 (Y)	Ground	Combination switch INPUT 5	Input	Combination switch	All switches OFF (Wiper volume dial 4)  <small>JPMIA0041GB</small> 1.4 V
					Front fog lamp switch ON (Wiper volume dial 4)  <small>JPMIA0037GB</small> 1.3 V
					Any of the conditions be- low with all switches OFF <ul style="list-style-type: none"> <li>• Wiper volume dial 1</li> <li>• Wiper volume dial 2</li> <li>• Wiper volume dial 6</li> <li>• Wiper volume dial 7</li> </ul>  <small>JPMIA0040GB</small> 1.3 V

A  
B  
C  
D  
E  
F  
G  
H  
I  
J  
L  
M  
N  
O  
P

PWC

# BCM (BODY CONTROL MODULE)

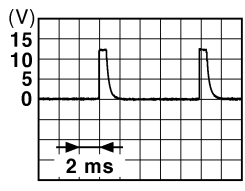
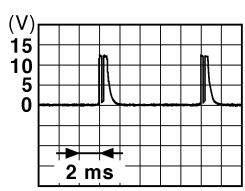
## < ECU DIAGNOSIS INFORMATION >

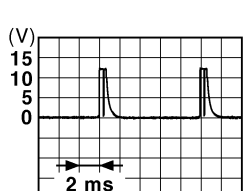
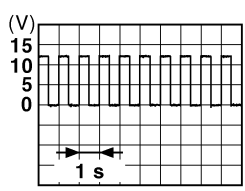
Terminal No. (Wire color)		Description		Condition	Value (Approx.)	
+	-	Signal name	Input/ Output			
88 (BG)	Ground	Combination switch INPUT 3	Input	Combination switch	All switches OFF (Wiper volume dial 4)	 <p style="text-align: right; font-size: small;">JPMIA0041GB</p> <p style="text-align: center;">1.4 V</p>
					Lighting switch HI (Wiper volume dial 4)	 <p style="text-align: right; font-size: small;">JPMIA0036GB</p> <p style="text-align: center;">1.3 V</p>
					Lighting switch 2ND (Wiper volume dial 4)	 <p style="text-align: right; font-size: small;">JPMIA0037GB</p> <p style="text-align: center;">1.3 V</p>
					Any of the conditions below with all switches OFF <ul style="list-style-type: none"> <li>• Wiper volume dial 1</li> <li>• Wiper volume dial 2</li> <li>• Wiper volume dial 3</li> </ul>	 <p style="text-align: right; font-size: small;">JPMIA0040GB</p> <p style="text-align: center;">1.3 V</p>
89 (BR)	Ground	Push-button ignition switch (Push switch)	Input	Push-button ignition switch (push switch)	Pressed	0 V
					Not pressed	Battery voltage
90 (P)	Ground	CAN-L	Input/ Output	—	—	
91 (L)	Ground	CAN-H	Input/ Output	—	—	
92 (LG)	Ground	Key slot illumination	Output	Key slot illumina- tion	OFF	0 V
					Blinking	 <p style="text-align: right; font-size: small;">JPMIA0015GB</p> <p style="text-align: center;">6.5 V</p>
					ON	12 V

# BCM (BODY CONTROL MODULE)

## < ECU DIAGNOSIS INFORMATION >

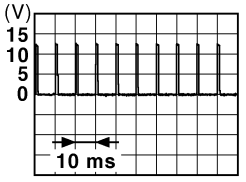
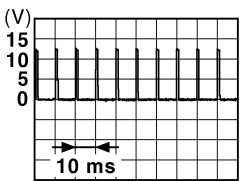

Terminal No. (Wire color)		Description		Condition		Value (Approx.)
+	-	Signal name	Input/ Output			
93 (GR)	Ground	ON indicator lamp	Output	Ignition switch	OFF (LOCK indicator is not illuminated)	Battery voltage
					ON	0 V
95 (BG)	Ground	ACC relay control	Output	Ignition switch	OFF	0 V
					ACC or ON	12 V
96 (GR)	Ground	A/T shift selector (Detention switch) power supply	Output	—		12 V
97 (L)	Ground	Steering lock condition No. 1	Input	Steering lock	LOCK status	0 V
					UNLOCK status	12 V
98 (P)	Ground	Steering lock condition No. 2	Input	Steering lock	LOCK status	12 V
					UNLOCK status	0 V
99 (R)*1 (BR)*2	Ground	Selector lever P position switch (A/T models)	Input	Selector lever	P position	0 V
					Any position other than P	12 V
		ASCD clutch switch (M/T models without ICC)		ASCD clutch switch	OFF (Clutch pedal is depressed)	0 V
					ON (Clutch pedal is not depressed)	12 V
		ICC clutch switch (M/T models with ICC)		ICC clutch switch	OFF (Clutch pedal is depressed)	0 V
					ON (Clutch pedal is not depressed)	12 V
100 (Y)	Ground	Passenger door request switch	Input	Passenger door request switch	ON (Pressed)	0 V
					OFF (Not pressed)	 1.0 V JPMA0016GB
101 (P)	Ground	Driver door request switch	Input	Driver door request switch	ON (Pressed)	0 V
					OFF (Not pressed)	 1.0 V JPMA0016GB
102 (BG)	Ground	Blower fan motor relay control	Output	Ignition switch	OFF or ACC	0 V
					ON	12 V
103 (P)	Ground	Remote keyless entry receiver power supply	Output	Ignition switch OFF		12 V
106 (SB)	Ground	Steering lock unit power supply	Output	Ignition switch	OFF or ACC	12 V
					ON	0 V

A  
B  
C  
D  
E  
F  
G  
H  
I  
J  
L  
M  
N  
O  
P

PWC

# BCM (BODY CONTROL MODULE)

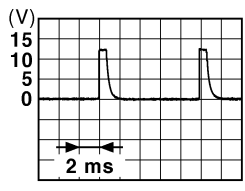
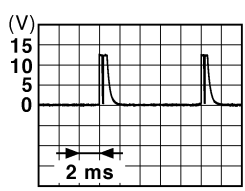

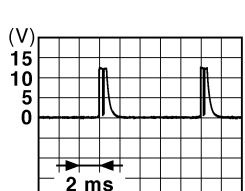
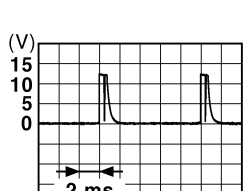
## < ECU DIAGNOSIS INFORMATION >

Terminal No. (Wire color)		Description		Condition	Value (Approx.)	
+	-	Signal name	Input/ Output			
107 (LG)	Ground	Combination switch INPUT 1	Input	Combination switch (Wiper volume dial 4)	All switches OFF	 <p style="text-align: right; margin-right: 20px;">JPMIA0041GB</p> <p style="text-align: center;">1.4 V</p>
					Turn signal switch LH	 <p style="text-align: right; margin-right: 20px;">JPMIA0037GB</p> <p style="text-align: center;">1.3 V</p>
					Turn signal switch RH	 <p style="text-align: right; margin-right: 20px;">JPMIA0036GB</p> <p style="text-align: center;">1.3 V</p>
					Front wiper switch LO	 <p style="text-align: right; margin-right: 20px;">JPMIA0038GB</p> <p style="text-align: center;">1.3 V</p>
					Front washer switch ON	 <p style="text-align: right; margin-right: 20px;">JPMIA0039GB</p> <p style="text-align: center;">1.3 V</p>

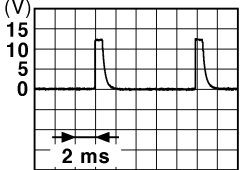

# BCM (BODY CONTROL MODULE)

## < ECU DIAGNOSIS INFORMATION >

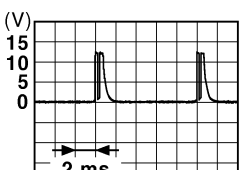
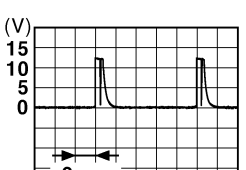



Terminal No. (Wire color)		Description		Condition	Value (Approx.)	
		Signal name	Input/ Output			
+	-					
108 (R)	Ground	Combination switch INPUT 4	Input	Combination switch	All switches OFF (Wiper volume dial 4)	 <p style="text-align: right;">1.4 V</p>
					Lighting switch AUTO (Wiper volume dial 4)	 <p style="text-align: right;">1.3 V</p>
					Lighting switch 1ST (Wiper volume dial 4)	 <p style="text-align: right;">1.3 V</p>
					Any of the conditions below with all switches OFF <ul style="list-style-type: none"> <li>• Wiper volume dial 1</li> <li>• Wiper volume dial 5</li> <li>• Wiper volume dial 6</li> </ul>	 <p style="text-align: right;">1.3 V</p>

A  
B  
C  
D  
E  
F  
G  
H  
I  
J  
L  
M  
N  
O  
P

PWC

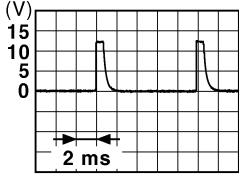
# BCM (BODY CONTROL MODULE)

## < ECU DIAGNOSIS INFORMATION >

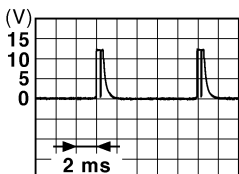
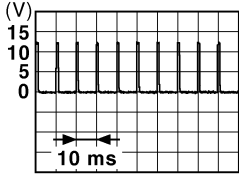
Terminal No. (Wire color)		Description		Condition	Value (Approx.)	
+	-	Signal name	Input/ Output			
109 (W)	Ground	Combination switch INPUT 2	Input	Combination switch (Wiper volume dial 4)	All switches OFF	 <p style="text-align: right; font-size: small;">JPMIA0041GB</p> <p style="text-align: center;">1.4 V</p>
					Lighting switch PASS	 <p style="text-align: right; font-size: small;">JPMIA0037GB</p> <p style="text-align: center;">1.3 V</p>
					Lighting switch 2ND	 <p style="text-align: right; font-size: small;">JPMIA0036GB</p> <p style="text-align: center;">1.3 V</p>
					Front wiper switch INT/ AUTO	 <p style="text-align: right; font-size: small;">JPMIA0038GB</p> <p style="text-align: center;">1.3 V</p>
					Front wiper switch HI	 <p style="text-align: right; font-size: small;">JPMIA0040GB</p> <p style="text-align: center;">1.3 V</p>
					ON	0 V
110 (G)	Ground	Hazard switch	Input	Hazard switch	OFF	 <p style="text-align: right; font-size: small;">JPMIA0012GB</p> <p style="text-align: center;">1.1 V</p>

# BCM (BODY CONTROL MODULE)

## < ECU DIAGNOSIS INFORMATION >

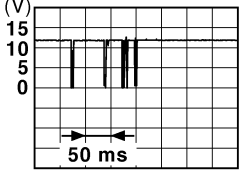
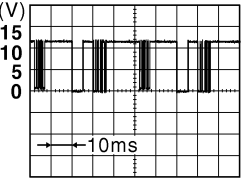
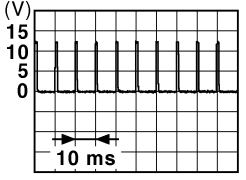
Terminal No. (Wire color)		Description		Condition	Value (Approx.)	
+	-	Signal name	Input/ Output			
111 (Y)	Ground	Steering lock unit communication	Input/ Output	Steering lock	LOCK status	12 V
					LOCK or UNLOCK	 <p style="text-align: right; font-size: small;">JMKIA0066GB</p>
					For 15 seconds after UN- LOCK	12 V
				15 seconds or later after UNLOCK	0 V	
112 (R)	Ground	Light and rain sensor serial link	Input/ Output	Ignition switch ON	 <p style="text-align: right; font-size: small;">JPMIA0156GB</p>	
113 (BG)	Ground	Optical sensor	Input	Ignition switch ON	When bright outside of the vehicle	Close to 5 V
				When dark outside of the vehicle	Close to 0 V	
114 (R)	Ground	Clutch interlock switch	Input	Clutch interlock switch	OFF (Clutch pedal is not depressed)	0 V
					ON (Clutch pedal is de- pressed)	Battery voltage
116 (SB)	Ground	Stop lamp switch 1	Input	—	Battery voltage	
118 (BR)	Ground	Stop lamp switch 2 (Without ICC)	Input	Stop lamp switch	OFF (Brake pedal is not depressed)	0 V
					ON (Brake pedal is de- pressed)	Battery voltage
		Stop lamp switch 2 (With ICC)		Stop lamp switch OFF (Brake pedal is not depressed) and ICC brake hold relay OFF	0 V	
				Stop lamp switch ON (Brake pedal is de- pressed) or ICC brake hold relay ON	Battery voltage	
119 (SB)	Ground	Front door lock as- sembly driver side (Unlock sensor)	Input	Driver door	LOCK status (Unlock sensor switch OFF)	 <p style="text-align: right; font-size: small;">JPMIA0012GB</p>
					UNLOCK status (Unlock switch sensor ON)	0 V

A  
B  
C  
D  
E  
F  
G  
H  
I  
J  
L  
M  
N  
O  
P

PWC

# BCM (BODY CONTROL MODULE)

## < ECU DIAGNOSIS INFORMATION >

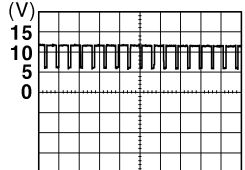
Terminal No. (Wire color)		Description		Condition	Value (Approx.)	
+	-	Signal name	Input/ Output			
121 (SB)	Ground	Key slot switch	Input	When the Intelligent Key is inserted into key slot	12 V	
				When the Intelligent Key is not inserted into key slot	0 V	
123 (V)	Ground	IGN feedback	Input	Ignition switch	OFF or ACC	
					ON	Battery voltage
124 (R)	Ground	Passenger door switch	Input	Passenger door switch	OFF (Door close)	
					ON (Door open)	0 V
129 (BG)	Ground	Trunk lid opener cancel switch	Input	Trunk lid opener cancel switch	CANCEL	
					ON	0 V
132 (V)	Ground	Power window switch communication	Input/ Output	Ignition switch ON	10.2 V	
					Ignition switch OFF or ACC	12 V
133 (L)	Ground	Push-button ignition switch illumination	Output	Push-button ignition switch illumination	ON (Tail lamps OFF)	
					ON (Tail lamps ON)	<p><b>NOTE:</b> The pulse width of this wave is varied by the illumination brightening/dimming level.</p>  <p style="text-align: right;"><small>JPMIA0159GB</small></p>
					OFF	0 V
134 (LG)	Ground	LOCK indicator lamp	Output	LOCK indicator lamp	OFF	
					ON	0 V
137 (BG)	Ground	Receiver and sensor ground	Input	Ignition switch ON	0 V	

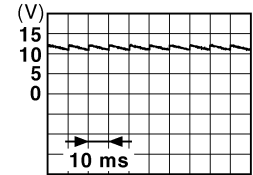

JPMIA0011GB

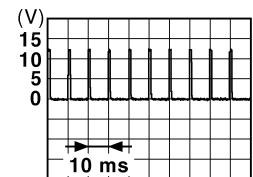

JPMIA0012GB

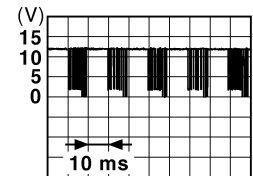

JPMIA0013GB

# BCM (BODY CONTROL MODULE)

## < ECU DIAGNOSIS INFORMATION >

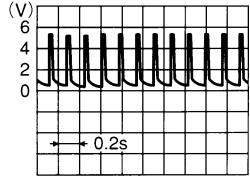
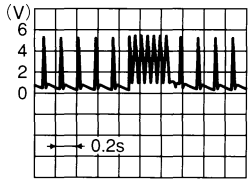
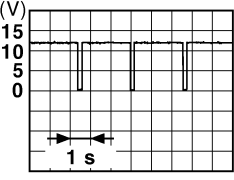
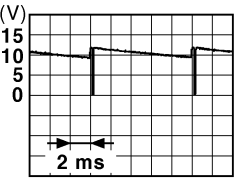
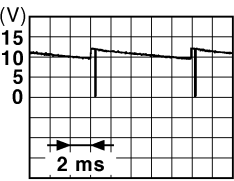
Terminal No. (Wire color)		Description		Condition		Value (Approx.)
		Signal name	Input/ Output			
+	-					
138 (V)	Ground	Receiver and sensor power supply	Output	Ignition switch	OFF	0 V
					ACC or ON	5.0 V
139 (L)	Ground	Tire pressure receiver communication	Input/ Output	Ignition switch ON	Standby state	 OCC3881D
					When receiving the signal from the transmitter	 OCC3880D
140 (B)	Ground	Selector lever P/N position	Input	Selector lever	P or N position	12 V
					Except P and N positions	0 V
141 (W)	Ground	Security indicator	Output	Security indicator	ON	0 V
					Blinking	 JPMA0014GB
					OFF	12 V
142 (BR)	Ground	Combination switch OUTPUT 5	Output	Combination switch (Wiper volume dial 4)	All switches OFF	0 V
					Lighting switch 1ST	 JPMA0031GB
					Lighting switch HI	
					Lighting switch 2ND	
					Turn signal switch RH	
143 (P)	Ground	Combination switch OUTPUT 1	Output	Combination switch	All switches OFF (Wiper volume dial 4)	0 V
					Front wiper switch HI (Wiper volume dial 4)	 JPMA0032GB
					Any of the conditions below with all switches OFF <ul style="list-style-type: none"> <li>• Wiper volume dial 1</li> <li>• Wiper volume dial 2</li> <li>• Wiper volume dial 3</li> <li>• Wiper volume dial 6</li> <li>• Wiper volume dial 7</li> </ul>	

A

B

C

D

E

F

G

H

I

J

PWC

L

M

N

O

P

# BCM (BODY CONTROL MODULE)

## < ECU DIAGNOSIS INFORMATION >

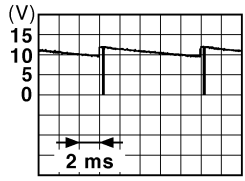
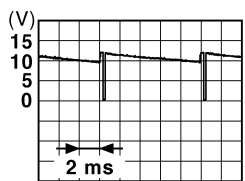
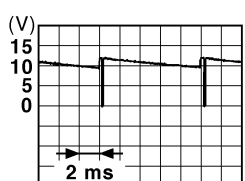
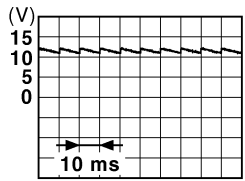
Terminal No. (Wire color)		Description		Condition	Value (Approx.)
+	-	Signal name	Input/ Output		
144 (G)	Ground	Combination switch OUTPUT 2	Output	Combination switch	0 V
				All switches OFF (Wiper volume dial 4)  Front washer switch ON (Wiper volume dial 4)  Any of the conditions below with all switches OFF <ul style="list-style-type: none"> <li>• Wiper volume dial 1</li> <li>• Wiper volume dial 5</li> <li>• Wiper volume dial 6</li> </ul>	 <p style="text-align: right; font-size: small;">JPMAI0033GB</p>
145 (L)	Ground	Combination switch OUTPUT 3	Output	Combination switch (Wiper volume dial 4)	0 V
				All switches OFF  Front wiper switch INT/ AUTO  Front wiper switch LO  Lighting switch AUTO	 <p style="text-align: right; font-size: small;">JPMAI0034GB</p>
146 (SB)	Ground	Combination switch OUTPUT 4	Output	Combination switch (Wiper volume dial 4)	0 V
				All switches OFF  Front fog lamp switch ON  Lighting switch 2ND  Lighting switch PASS  Turn signal switch LH	 <p style="text-align: right; font-size: small;">JPMAI0035GB</p>
149 (W)	Ground	Tire pressure warning check switch	Input	—	12 V
150 (GR)	Ground	Driver door switch	Input	Driver door switch	11.8 V
				OFF (Door close)	 <p style="text-align: right; font-size: small;">JPMAI0011GB</p>
151 (G)	Ground	Rear window defogger relay control	Output	Rear window defogger	0 V
				Active	Battery voltage
				ON (Door open)	0 V
				Not activated	Battery voltage

- \*1: A/T models
- \*2: M/T models



# BCM (BODY CONTROL MODULE)

< ECU DIAGNOSIS INFORMATION >

A : With A/T  
M : With M/T  
IC : With ICC  
OI : Without ICC

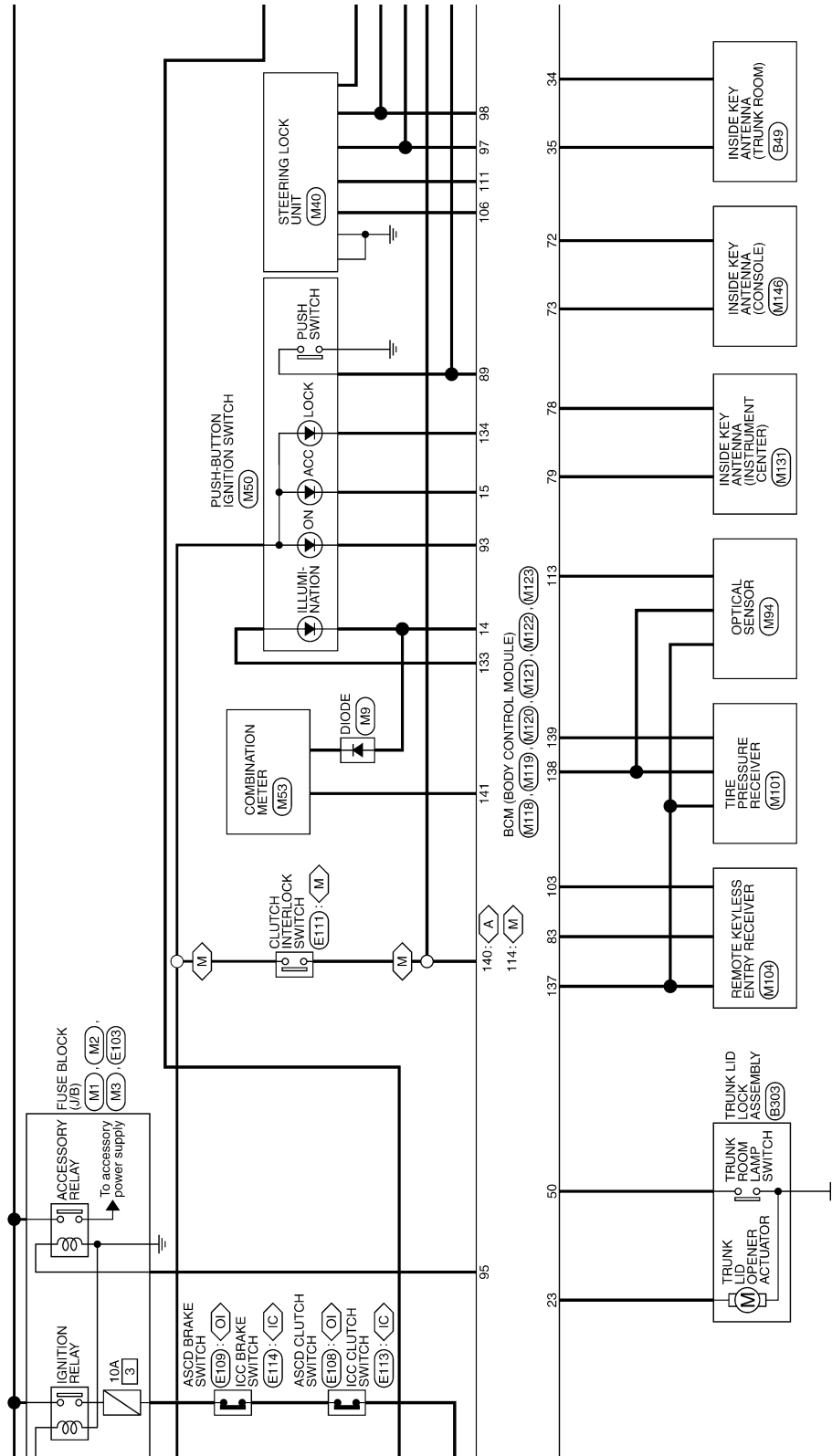

JCMWM5778G





# BCM (BODY CONTROL MODULE)

< ECU DIAGNOSIS INFORMATION >

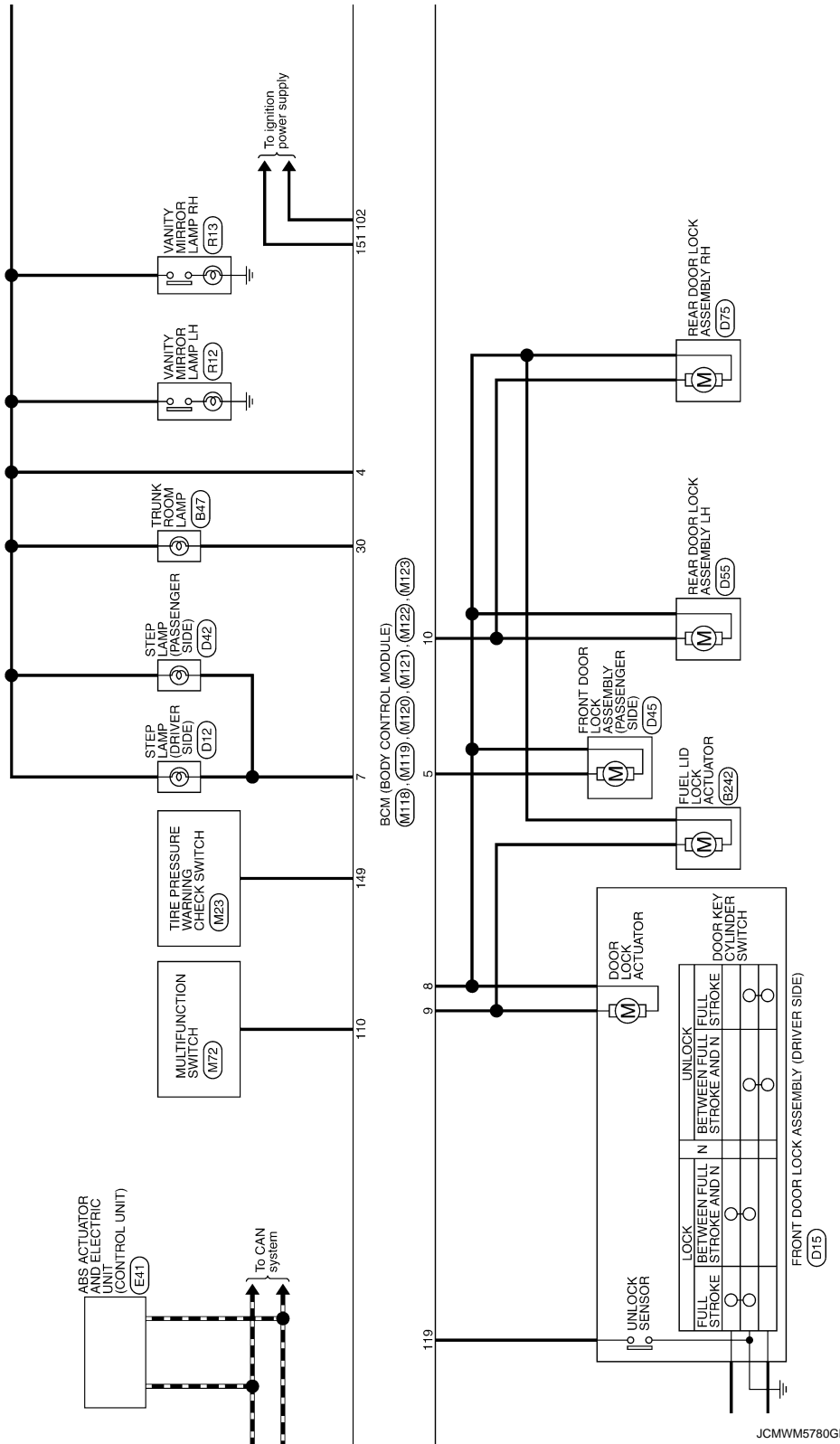

# BCM (BODY CONTROL MODULE)

< ECU DIAGNOSIS INFORMATION >

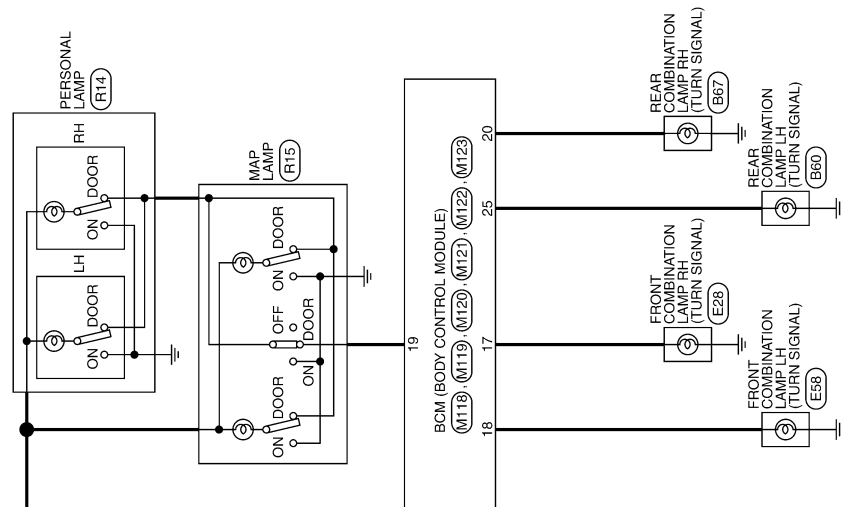

JCMWM5781G1

A  
B  
C  
D  
E  
F  
G  
H  
I  
J  
L  
M  
N  
O  
P

PWC

# BCM (BODY CONTROL MODULE)

< ECU DIAGNOSIS INFORMATION >

## BCM (BODY CONTROL MODULE)

Connector No.	M33
Connector Name	COMBINATION SWITCH
Connector Type	TH16FW-NH

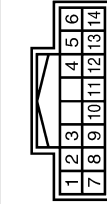

Terminal No.	Color of Wire	Signal Name [Specification]
1	GR	FR WASHER (-)
2	SB	OUTPUT 4
5	L	OUTPUT 3
6	B	GND
7	BG	INPUT 3
8	BR	OUTPUT 5
9	W	INPUT 2
10	R	INPUT 4
11	LG	INPUT 1
12	P	OUTPUT 1
13	Y	INPUT 5
14	G	OUTPUT 2

Connector No.	M18
Connector Name	BCM (BODY CONTROL MODULE)
Connector Type	M03FB-LC



Terminal No.	Color of Wire	Signal Name [Specification]
1	W	BAT (F/L)
2	Y	POWER WINDOW POWER SUPPLY (BAT)
3	BG	POWER WINDOW POWER SUPPLY (RAP)

Connector No.	M119
Connector Name	BCM (BODY CONTROL MODULE)
Connector Type	NS12FW-CS

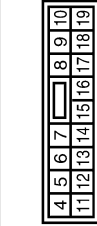

Terminal No.	Color of Wire	Signal Name [Specification]
4	LG	INTERIOR ROOM LAMP POWER SUPPLY
5	P	PASSENGER DOOR UNLOCK OUTPUT
7	SB	STEP LAMP OUTPUT
8	V	ALL DOOR FUEL LID LOCK OUTPUT
9	G	DRIVER DOOR FUEL LID UNLOCK OUTPUT
10	P	REAR DOOR UNLOCK OUTPUT
11	R	BAT (FUSE)
13	B	GND
14	W	PUSH-BUTTON IGNITION SW ILL GND
15	BG	ACC IND
17	W	TURN SIGNAL RH (FRONT)
18	BG	TURN SIGNAL LH (FRONT)
19	V	ROOM LAMP TIMER CONTROL

Connector No.	M120
Connector Name	BCM (BODY CONTROL MODULE)
Connector Type	NS12FW-CS

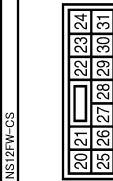

Terminal No.	Color of Wire	Signal Name [Specification]
20	V	TURN SIGNAL RH (REAR)
23	LG	TRUNK LID OPEN OUTPUT
25	Y	TURN SIGNAL LH (REAR)
30	P	TRUNK ROOM LAMP

Connector No.	M121
Connector Name	BCM (BODY CONTROL MODULE)
Connector Type	TH40FGY-NH

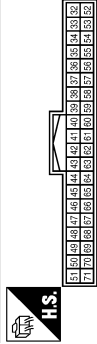

Terminal No.	Color of Wire	Signal Name [Specification]
34	SB	TRUNK ROOM ANT-
35	V	REAR BUMPER ANT-
38	B	REAR BUMPER ANT+
47	W	IGN RELAY (RDM E/P) CONT
50	BG	TRUNK ROOM LAMP SW
52	R	STARTER RELAY CONT
61	SB	TRUNK LID OPENER REQUEST SW
64	G	I-KEY WARN BUZZER (ENG ROOM)
67	GR	TRUNK LID OPENER SW
68	BG	REAR RH DOOR SW
69	L	REAR LH DOOR SW

Connector No.	M122
Connector Name	BCM (BODY CONTROL MODULE)
Connector Type	TH40FB-NH

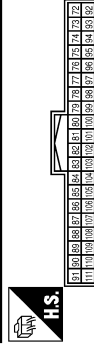

Terminal No.	Color of Wire	Signal Name [Specification]
72	R	ROOM ANT 2-
73	G	ROOM ANT 2+
74	SB	PASSENGER DOOR ANT-
75	BR	PASSENGER DOOR ANT+
76	V	DRIVER DOOR ANT-
77	LG	DRIVER DOOR ANT+
78	Y	ROOM ANT 1-
79	BR	ROOM ANT 1+
80	GR	NATS ANT AMP
81	W	INATS ANT AMP

82	SB	IGN RELAY (F/B) CONT
83	Y	KEYLESS ENTRY RECEIVER COMM
87	Y	COMBI SW INPUT 5
88	BG	COMBI SW INPUT 3
89	BR	PUSH SW
90	P	CAN-L
91	L	CAN-H
92	LG	KEY SLOT ILL
93	GR	ON IND
95	BG	ACC RELAY CONT
96	GR	A/T SHIFT SELECTOR POWER SUPPLY
97	L	S/L CONDITION 1
98	P	S/L CONDITION 2
99	R	SHIFT P [With A/T]
99	BR	ICC CLUTCH SW [With M/T and ICC]
99	BR	ASGD CLUTCH SW [With M/T without ICC]
100	Y	PASSENGER DOOR REQUEST SW
101	P	DRIVER DOOR REQUEST SW
102	BG	BLOWER FAN MOTOR RELAY CONT
103	P	KEYLESS ENTRY RECEIVER POWER SUPPLY
106	SB	S/L UNIT POWER SUPPLY
107	LG	COMBI SW INPUT 1
108	R	COMBI SW INPUT 4
109	W	COMBI SW INPUT 2
110	G	HAZARD SW
111	Y	S/L UNIT COMM

# BCM (BODY CONTROL MODULE)

< ECU DIAGNOSIS INFORMATION >

A  
B  
C  
D  
E  
F  
G  
H  
I  
J  
L  
M  
N  
O  
P

PWC

**BCM (BODY CONTROL MODULE)**

Connector No.	M123
Connector Name	BCM (BODY CONTROL MODULE)
Connector Type	TH40FG-NH

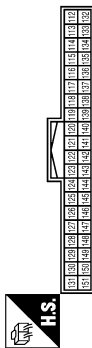

Terminal No.	Color of Wire	Signal Name [Specification]
112	R	RAIN SENSOR SERIAL LINK
113	BG	OPTICAL SENSOR
114	R	CLUTCH INTERLOCK SW
116	SB	STOP LAMP SW 1
118	BR	STOP LAMP SW 2
119	SB	DR DOOR UNLOCK SENSOR
121	SB	KEY SLOT SW
123	V	IGN P/B
124	R	PASSENGER DOOR SW
129	BG	TRUNK LID OPENER CANCEL SW
132	V	POWER WINDOW SW COMM
133	L	PUSH-BUTTON IGNITION SW ILL POWER
134	LG	LOCK IND
137	BG	RECEIVER / SENSOR GND
138	V	RECEIVER / SENSOR POWER SUPPLY
139	L	TIRE PRESSURE RECEIVER COMM
140	B	SHIFT N/P
141	W	SECURITY INDICATOR LAMP
142	BR	COMBI SW OUTPUT 5
143	P	COMBI SW OUTPUT 1
144	G	COMBI SW OUTPUT 2
145	L	COMBI SW OUTPUT 3
146	SB	COMBI SW OUTPUT 4
149	W	TIRE PRESSURE WARN CHECK SW
150	GR	DRIVER DOOR SW
151	G	REAR WINDOW DEFOGGER RELAY COINT

## Fail-safe

### FAIL-SAFE CONTROL BY DTC

BCM performs fail-safe control when any DTC are detected.

JCMW5783G1

INFOID:000000005891868

## BCM (BODY CONTROL MODULE)

### < ECU DIAGNOSIS INFORMATION >

Display contents of CONSULT	Fail-safe	Cancellation
B2013: ID DISCORD BCM-S/L	Inhibit engine cranking	Erase DTC
B2014: CHAIN OF S/L-BCM	Inhibit engine cranking	Erase DTC
B2190: NATS ANTENNA AMP	Inhibit engine cranking	Erase DTC
B2191: DIFFERENCE OF KEY	Inhibit engine cranking	Erase DTC
B2192: ID DISCORD BCM-ECM	Inhibit engine cranking	Erase DTC
B2193: CHAIN OF BCM-ECM	Inhibit engine cranking	Erase DTC
B2195: ANTI-SCANNING	Inhibit engine cranking	Ignition switch ON → OFF
B2557: VEHICLE SPEED	Inhibit steering lock	When normal vehicle speed signals are received from ABS actuator and electric unit (control unit) for 500 ms
B2560: STARTER CONT RELAY	Inhibit engine cranking	500 ms after the following CAN signal communication status becomes consistent <ul style="list-style-type: none"> <li>• Starter control relay signal</li> <li>• Starter relay status signal</li> </ul>
B2601: SHIFT POSITION	Inhibit steering lock	500 ms after the following signal reception status becomes consistent <ul style="list-style-type: none"> <li>• Selector lever P position switch signal</li> <li>• P range signal (CAN)</li> </ul>
B2602: SHIFT POSITION	Inhibit steering lock	5 seconds after the following BCM recognition conditions are fulfilled <ul style="list-style-type: none"> <li>• Ignition switch is in the ON position</li> <li>• Selector lever P position switch signal: Except P position (12 V)</li> <li>• Vehicle speed: 4 km/h (2.5 MPH) or more</li> </ul>
B2603: SHIFT POSI STATUS	Inhibit steering lock	500 ms after the following BCM recognition conditions are fulfilled <ul style="list-style-type: none"> <li>• Ignition switch is in the ON position</li> <li>• Selector lever P position switch signal: Except P position (12 V)</li> <li>• Selector lever P/N position signal: Except P and N positions (0 V)</li> </ul>
B2604: PNP/CLUTCH SW	Inhibit steering lock	500 ms after any of the following BCM recognition conditions are fulfilled <ul style="list-style-type: none"> <li>• Status 1 <ul style="list-style-type: none"> <li>- Ignition switch is in the ON position</li> <li>- Selector lever P/N position signal: P and N position (12 V)</li> <li>- P range signal or N range signal (CAN): ON</li> </ul> </li> <li>• Status 2 <ul style="list-style-type: none"> <li>- Ignition switch is in the ON position</li> <li>- Selector lever P/N position signal: Except P and N positions (0 V)</li> <li>- P range signal and N range signal (CAN): OFF</li> </ul> </li> </ul>
B2605: PNP/CLUTCH SW	Inhibit steering lock	500 ms after any of the following BCM recognition conditions are fulfilled <ul style="list-style-type: none"> <li>• Status 1 <ul style="list-style-type: none"> <li>- Ignition switch is in the ON position</li> <li>- Selector lever P/N position signal: Except P and N positions (0 V)</li> <li>- Interlock/PNP switch signal (CAN): OFF</li> </ul> </li> <li>• Status 2 <ul style="list-style-type: none"> <li>- Ignition switch is in the ON position</li> <li>- Selector lever P/N position signal: P or N position (12 V)</li> <li>- PNP switch signal (CAN): ON</li> </ul> </li> </ul>
B2606: S/L RELAY	Inhibit engine cranking	500 ms after the following CAN signal communication status becomes consistent <ul style="list-style-type: none"> <li>• Steering lock relay signal (Request signal)</li> <li>• Steering lock relay signal (Condition signal)</li> </ul>
B2607: S/L RELAY	Inhibit engine cranking	500 ms after the following CAN signal communication status has become consistent <ul style="list-style-type: none"> <li>• Steering lock relay signal (Request signal)</li> <li>• Steering lock relay signal (Condition signal)</li> </ul>

## BCM (BODY CONTROL MODULE)

### < ECU DIAGNOSIS INFORMATION >

Display contents of CONSULT	Fail-safe	Cancellation
B2608: STARTER RELAY	Inhibit engine cranking	500 ms after the following signal communication status becomes consistent <ul style="list-style-type: none"> <li>• Starter motor relay control signal</li> <li>• Starter relay status signal (CAN)</li> </ul>
B2609: S/L STATUS	<ul style="list-style-type: none"> <li>• Inhibit engine cranking</li> <li>• Inhibit steering lock</li> </ul>	When the following steering lock conditions agree <ul style="list-style-type: none"> <li>• BCM steering lock control status</li> <li>• Steering lock condition No. 1 signal status</li> <li>• Steering lock condition No. 2 signal status</li> </ul>
B260A: IGNITION RELAY	Inhibit engine cranking	500 ms after the following conditions are fulfilled <ul style="list-style-type: none"> <li>• IGN relay (IPDM E/R) control signal: OFF (12 V)</li> <li>• Ignition ON signal (CAN to IPDM E/R): OFF (Request signal)</li> <li>• Ignition ON signal (CAN from IPDM E/R): OFF (Condition signal)</li> </ul>
B260F: ENG STATE SIG LOST	Maintains the power supply position attained at the time of DTC detection	When any of the following conditions are fulfilled <ul style="list-style-type: none"> <li>• Power position changes to ACC</li> <li>• Receives engine status signal (CAN)</li> </ul>
B2612: S/L STATUS	<ul style="list-style-type: none"> <li>• Inhibit engine cranking</li> <li>• Inhibit steering lock</li> </ul>	When any of the following conditions are fulfilled <ul style="list-style-type: none"> <li>• Steering lock unit status signal (CAN) is received normally</li> <li>• The BCM steering lock control status matches the steering lock status recognized by the steering lock unit status signal (CAN from IPDM E/R)</li> </ul>
B2617: BCM	Inhibit engine cranking	1 second after the starter motor relay control inside BCM becomes normal
B2618: BCM	Inhibit engine cranking	1 second after the ignition relay (IPDM E/R) control inside BCM becomes normal
B2619: BCM	Inhibit engine cranking	1 second after the steering lock unit power supply output control inside BCM becomes normal
B261E: VEHICLE TYPE	Inhibit engine cranking	BCM initialization
B26E8: CLUTCH SW	Inhibit engine cranking	When any of the following BCM recognition conditions are fulfilled <ul style="list-style-type: none"> <li>• Status 1                             <ul style="list-style-type: none"> <li>- Clutch switch signal (CAN from ECM): ON</li> <li>- Clutch interlock switch signal: OFF (0 V)</li> </ul> </li> <li>• Status 2                             <ul style="list-style-type: none"> <li>- Clutch switch signal (CAN from ECM): OFF</li> <li>- Clutch interlock switch signal: ON (Battery voltage)</li> </ul> </li> </ul>
B26E9: S/L STATUS	<ul style="list-style-type: none"> <li>• Inhibit engine cranking</li> <li>• Inhibit steering lock</li> </ul>	When BCM transmits the LOCK request signal to steering lock unit, and receives LOCK response signal from steering lock unit, the following conditions are fulfilled <ul style="list-style-type: none"> <li>• Steering condition No. 1 signal: LOCK (0 V)</li> <li>• Steering condition No. 2 signal: LOCK (12 V)</li> </ul>

### DTC Inspection Priority Chart

INFOID:000000005891869

If some DTCs are displayed at the same time, perform inspections one by one based on the following priority chart.

Priority	DTC
1	B2562: LOW VOLTAGE
2	<ul style="list-style-type: none"> <li>• U1000: CAN COMM</li> <li>• U1010: CONTROL UNIT(CAN)</li> </ul>
3	<ul style="list-style-type: none"> <li>• B2190: NATS ANTENNA AMP</li> <li>• B2191: DIFFERENCE OF KEY</li> <li>• B2192: ID DISCORD BCM-ECM</li> <li>• B2193: CHAIN OF BCM-ECM</li> <li>• B2195: ANTI-SCANNING</li> </ul>

# BCM (BODY CONTROL MODULE)

## < ECU DIAGNOSIS INFORMATION >

Priority	DTC
4	<ul style="list-style-type: none"> <li>• B2013: ID DISCORD BCM-S/L</li> <li>• B2014: CHAIN OF S/L-BCM</li> <li>• B2553: IGNITION RELAY</li> <li>• B2555: STOP LAMP</li> <li>• B2556: PUSH-BTN IGN SW</li> <li>• B2557: VEHICLE SPEED</li> <li>• B2560: STARTER CONT RELAY</li> <li>• B2601: SHIFT POSITION</li> <li>• B2602: SHIFT POSITION</li> <li>• B2603: SHIFT POSI STATUS</li> <li>• B2604: PNP/CLUTCH SW</li> <li>• B2605: PNP/CLUTCH SW</li> <li>• B2606: S/L RELAY</li> <li>• B2607: S/L RELAY</li> <li>• B2608: STARTER RELAY</li> <li>• B2609: S/L STATUS</li> <li>• B260A: IGNITION RELAY</li> <li>• B260B: STEERING LOCK UNIT</li> <li>• B260C: STEERING LOCK UNIT</li> <li>• B260D: STEERING LOCK UNIT</li> <li>• B260F: ENG STATE SIG LOST</li> <li>• B2612: S/L STATUS</li> <li>• B2614: BCM</li> <li>• B2615: BCM</li> <li>• B2616: BCM</li> <li>• B2617: BCM</li> <li>• B2618: BCM</li> <li>• B2619: BCM</li> <li>• B261A: PUSH-BTN IGN SW</li> <li>• B261E: VEHICLE TYPE</li> <li>• B26E8: CLUTCH SW</li> <li>• B26E9: S/L STATUS</li> <li>• B26EA: KEY REGISTRATION</li> <li>• C1729: VHCL SPEED SIG ERR</li> <li>• U0415: VEHICLE SPEED</li> </ul>
5	<ul style="list-style-type: none"> <li>• C1704: LOW PRESSURE FL</li> <li>• C1705: LOW PRESSURE FR</li> <li>• C1706: LOW PRESSURE RR</li> <li>• C1707: LOW PRESSURE RL</li> <li>• C1708: [NO DATA] FL</li> <li>• C1709: [NO DATA] FR</li> <li>• C1710: [NO DATA] RR</li> <li>• C1711: [NO DATA] RL</li> <li>• C1716: [PRESSDATA ERR] FL</li> <li>• C1717: [PRESSDATA ERR] FR</li> <li>• C1718: [PRESSDATA ERR] RR</li> <li>• C1719: [PRESSDATA ERR] RL</li> <li>• C1734: CONTROL UNIT</li> </ul>
6	<ul style="list-style-type: none"> <li>• B2621: INSIDE ANTENNA</li> <li>• B2622: INSIDE ANTENNA</li> <li>• B2623: INSIDE ANTENNA</li> </ul>

### DTC Index

INFOID:000000005891870

#### NOTE:

The details of time display are as follows.

- CRNT: A malfunction is detected now.
- PAST: A malfunction was detected in the past.

IGN counter is displayed on Freeze Frame Data. For details of Freeze Frame Data, refer to [BCS-14, "COMMON ITEM : CONSULT-III Function \(BCM - COMMON ITEM\)"](#).



## BCM (BODY CONTROL MODULE)

< ECU DIAGNOSIS INFORMATION >

CONSULT display	Fail-safe	Freeze Frame Data •Vehicle Speed •Odo/Trip Meter •Vehicle condition	Intelligent Key warning lamp ON	Tire pressure monitor warning lamp ON	Refer- ence page
No DTC is detected. further testing may be required.	—	—	—	—	—
U1000: CAN COMM	—	—	—	—	<a href="#">BCS-33</a>
U1010: CONTROL UNIT(CAN)	—	—	—	—	<a href="#">BCS-34</a>
U0415: VEHICLE SPEED	—	—	—	—	<a href="#">BCS-35</a>
B2013: ID DISCORD BCM-S/L	×	×	—	—	<a href="#">SEC-55</a>
B2014: CHAIN OF S/L-BCM	×	×	—	—	<a href="#">SEC-56</a>
B2190: NATS ANTENNA AMP	×	—	—	—	<a href="#">SEC-47</a>
B2191: DIFFERENCE OF KEY	×	—	—	—	<a href="#">SEC-50</a>
B2192: ID DISCORD BCM-ECM	×	—	—	—	<a href="#">SEC-51</a>
B2193: CHAIN OF BCM-ECM	×	—	—	—	<a href="#">SEC-53</a>
B2195: ANTI-SCANNING	×	—	—	—	<a href="#">SEC-54</a>
B2553: IGNITION RELAY	—	×	—	—	<a href="#">PCS-49</a>
B2555: STOP LAMP	—	×	—	—	<a href="#">SEC-59</a>
B2556: PUSH-BTN IGN SW	—	×	×	—	<a href="#">SEC-61</a>
B2557: VEHICLE SPEED	×	×	×	—	<a href="#">SEC-63</a>
B2560: STARTER CONT RELAY	×	×	×	—	<a href="#">SEC-64</a>
B2562: LOW VOLTAGE	—	×	—	—	<a href="#">BCS-36</a>
B2601: SHIFT POSITION	×	×	×	—	<a href="#">SEC-65</a>
B2602: SHIFT POSITION	×	×	×	—	<a href="#">SEC-68</a>
B2603: SHIFT POSI STATUS	×	×	×	—	<a href="#">SEC-70</a>
B2604: PNP/CLUTCH SW	×	×	×	—	<a href="#">SEC-73</a>
B2605: PNP/CLUTCH SW	×	×	×	—	<a href="#">SEC-75</a>
B2606: S/L RELAY	×	×	×	—	<a href="#">SEC-77</a>
B2607: S/L RELAY	×	×	×	—	<a href="#">SEC-78</a>
B2608: STARTER RELAY	×	×	×	—	<a href="#">SEC-80</a>
B2609: S/L STATUS	×	×	×	—	<a href="#">SEC-82</a>
B260A: IGNITION RELAY	×	×	×	—	<a href="#">PCS-51</a>
B260B: STEERING LOCK UNIT	—	×	×	—	<a href="#">SEC-86</a>
B260C: STEERING LOCK UNIT	—	×	×	—	<a href="#">SEC-87</a>
B260D: STEERING LOCK UNIT	—	×	×	—	<a href="#">SEC-88</a>
B260F: ENG STATE SIG LOST	×	×	×	—	<a href="#">SEC-89</a>
B2612: S/L STATUS	×	×	×	—	<a href="#">SEC-94</a>
B2614: BCM	—	×	×	—	<a href="#">PCS-53</a>
B2615: BCM	—	×	×	—	<a href="#">PCS-55</a>
B2616: BCM	—	×	×	—	<a href="#">PCS-57</a>
B2617: BCM	×	×	×	—	<a href="#">SEC-98</a>
B2618: BCM	×	×	×	—	<a href="#">PCS-59</a>
B2619: BCM	×	×	×	—	<a href="#">SEC-100</a>
B261A: PUSH-BTN IGN SW	—	×	×	—	<a href="#">PCS-60</a>
B261E: VEHICLE TYPE	×	×	× (Turn ON for 15 seconds)	—	<a href="#">SEC-101</a>

A

B

C

D

E

F

G

H

I

J

PWC

L

M

N

O

P

## BCM (BODY CONTROL MODULE)

### < ECU DIAGNOSIS INFORMATION >

CONSULT display	Fail-safe	Freeze Frame Data •Vehicle Speed •Odo/Trip Meter •Vehicle condition	Intelligent Key warning lamp ON	Tire pressure monitor warning lamp ON	Refer- ence page
B2621: INSIDE ANTENNA	—	×	—	—	<a href="#">DLK-59</a>
B2622: INSIDE ANTENNA	—	×	—	—	<a href="#">DLK-61</a>
B2623: INSIDE ANTENNA	—	×	—	—	<a href="#">DLK-63</a>
B26E8: CLUTCH SW	×	×	×	—	<a href="#">SEC-90</a>
B26E9: S/L STATUS	×	×	× (Turn ON for 15 seconds)	—	<a href="#">SEC-92</a>
B26EA: KEY REGISTRATION	—	×	× (Turn ON for 15 seconds)	—	<a href="#">SEC-93</a>
C1704: LOW PRESSURE FL	—	—	—	×	<a href="#">WT-26</a>
C1705: LOW PRESSURE FR	—	—	—	×	
C1706: LOW PRESSURE RR	—	—	—	×	
C1707: LOW PRESSURE RL	—	—	—	×	
C1708: [NO DATA] FL	—	—	—	×	<a href="#">WT-28</a>
C1709: [NO DATA] FR	—	—	—	×	
C1710: [NO DATA] RR	—	—	—	×	
C1711: [NO DATA] RL	—	—	—	×	
C1716: [PRESSDATA ERR] FL	—	—	—	×	<a href="#">WT-31</a>
C1717: [PRESSDATA ERR] FR	—	—	—	×	
C1718: [PRESSDATA ERR] RR	—	—	—	×	
C1719: [PRESSDATA ERR] RL	—	—	—	×	
C1729: VHCL SPEED SIG ERR	—	—	—	×	<a href="#">WT-33</a>
C1734: CONTROL UNIT	—	—	—	×	<a href="#">WT-35</a>

# POWER WINDOW MAIN SWITCH

< ECU DIAGNOSIS INFORMATION >

## POWER WINDOW MAIN SWITCH

Reference Value

INFOID:000000005891566

### TERMINAL LAYOUT

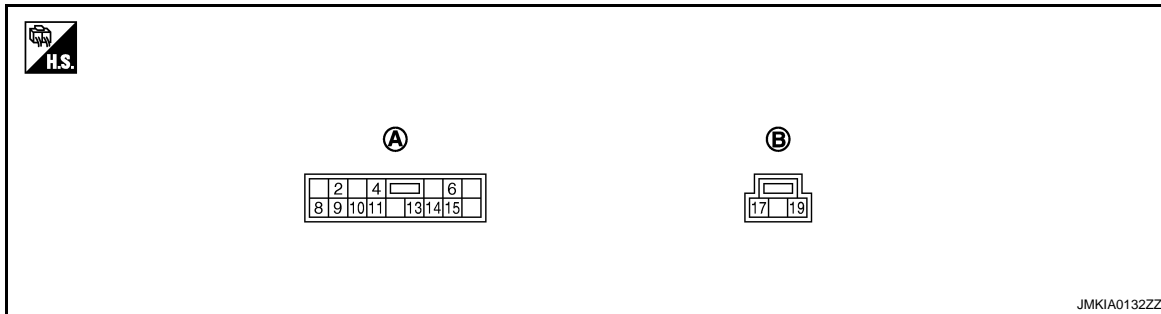

A. D8

B. D9

### PHYSICAL VALUES

Power Window Main Switch

Terminal No. (wire color)		Description		Condition	Voltage (V) (Approx.)
+	-	Signal name	Input/ Output		
2 (LG)	Ground	Encoder ground	—	—	0
4 (V)	Ground	Door key cylinder switch LOCK signal	Input	Key position (Neutral → Locked)	5 → 0
6 (Y)	Ground	Door key cylinder switch UNLOCK signal	Input	Key position (Neutral → Unlocked)	5 → 0
8 (L)	Ground	Front driver side power win- dow motor UP signal	Output	When front LH switch in power window main switch is UP at operated.	Battery voltage
9 (O)	Ground	Encoder pulse signal 2	Input	When power window mo- tor operates.	
10 (SB)	Ground	Rap signal	Input	Ignition switch ON	Battery voltage
				Within 45 second after ig- nition switch is turned to OFF	Battery voltage
				When driver side or pas- senger side door is opened during retained power operation	0
11 (G)	Ground	Front driver side power win- dow motor DOWN signal	Output	When front LH switch in power window main switch is DOWN at operated.	Battery voltage

A  
B  
C  
D  
E  
F  
G  
H  
I  
J  
L  
M  
N  
O  
P

PWC

# POWER WINDOW MAIN SWITCH

## < ECU DIAGNOSIS INFORMATION >

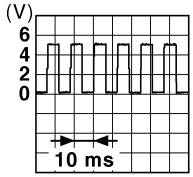
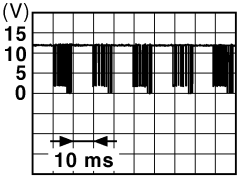
Terminal No. (wire color)		Description		Condition	Voltage (V) (Approx.)
+	-	Signal name	Input/ Output		
13 (P)	Ground	Encoder pulse signal 1	Input	When power window motor operates.	 <p style="text-align: right; font-size: small;">JMKIA0070GB</p>
14 (V)	Ground	Power window serial link	Input/ Output	Ignition switch ON or power window timer operating.	 <p style="text-align: right; font-size: small;">JPMIA0013GB</p>
15 (B)	Ground	Encoder power supply	Output	When ignition switch ON or power window timer operates.	Battery voltage
17 (B)	Ground	Ground	—	—	0
19 (Y)	Ground	Battery power supply	Input	—	Battery voltage

# POWER WINDOW MAIN SWITCH

< ECU DIAGNOSIS INFORMATION >

## Wiring Diagram - POWER WINDOW CONTROL SYSTEM -

INFOID:000000005891567

### POWER WINDOW SYSTEM

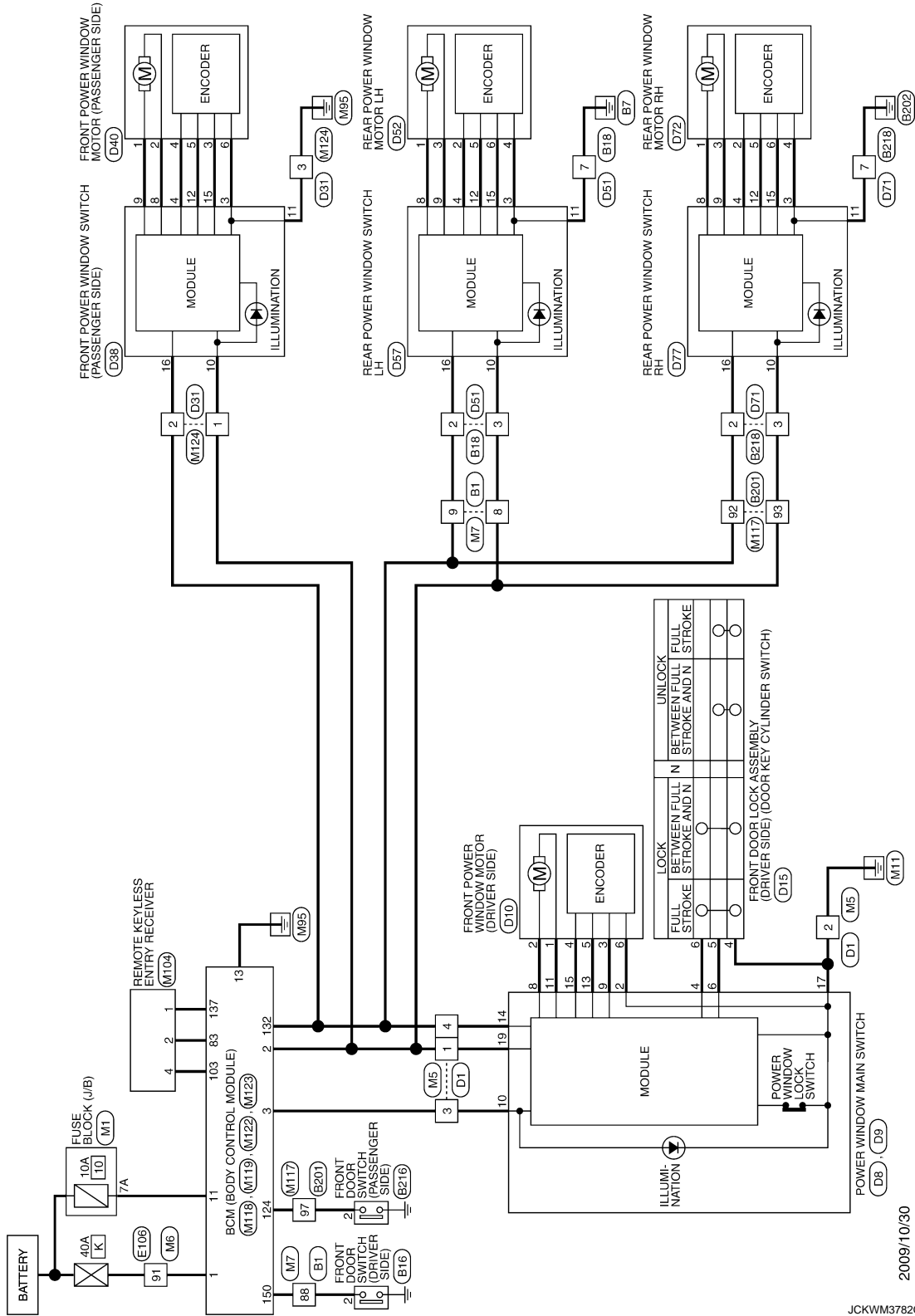

A  
B  
C  
D  
E  
F  
G  
H  
I  
J  
L  
M  
N  
O  
P



# POWER WINDOW MAIN SWITCH

< ECU DIAGNOSIS INFORMATION >

## POWER WINDOW SYSTEM

Connector No.	B1
Connector Name	WIRE TO WIRE
Connector Type	TH80FW-CS16-TM4



Terminal No.	Color of Wire	Signal Name [Specification]
1	GR	
2	BG	
3	L	
4	Y	
6	R	
8	W	
9	Y	
15	Y	
16	BR	
17	LG	
18	BG	
20	L	
21	P	
22	L	
23	P	
24	V	
25	SB	
26	G	
27	W	
28	R	
31	V	
32	SB	
33	SHIELD	
34	W	
35	BR	
36	Y	
37	SHIELD	
38	Y	
39	SB	
40	P	
41	L	
42	SHIELD	
43	R	
44	G	
45	SHIELD	
46	SB	
55	BR	
56	R	

Connector No.	B18
Connector Name	WIRE TO WIRE
Connector Type	TH10FW-CS10

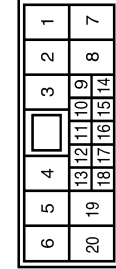

Terminal No.	Color of Wire	Signal Name [Specification]
2	V	
3	W	
5	G	
6	V	
7	B	
19	L	
18	SB	- [With BOSE system]
20	P	- [Without BOSE system]
20	Y	- [With BOSE system]
20	Y	- [Without BOSE system]

Connector No.	B201
Connector Name	WIRE TO WIRE
Connector Type	TH80FW-CS16-TM4

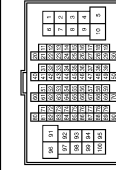

Terminal No.	Color of Wire	Signal Name [Specification]
1	BR	
5	P	
6	L	
7	V	
9	LG	
10	L	
31	L	
32	P	
33	G	
34	R	
40	GR	
41	LG	
42	BG	

43	R	
45	G	
46	SHIELD	
47	G	
48	Y	
49	SHIELD	
50	W	
71	R	
72	V	
80	BG	
81	SHIELD	
82	G	
83	P	
84	L	
85	SHIELD	
86	G	
87	R	
88	W	
89	B	
90	Y	
91	V	
92	W	
93	BG	
94	R	
95	SB	
96	G	
97	GR	
98	BR	
99	P	
100	L	

Connector No.	B216
Connector Name	FRONT DOOR SWITCH (PASSENGER SIDE)
Connector Type	A03FW

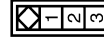

Terminal No.	Color of Wire	Signal Name [Specification]
2	GR	

JCKW3783G1

# POWER WINDOW MAIN SWITCH

< ECU DIAGNOSIS INFORMATION >

## POWER WINDOW SYSTEM

Connector No.	B218
Connector Name	WIRE TO WIRE
Connector Type	TH40FW-CS10

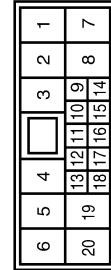

Terminal No.	Color of Wire	Signal Name [Specification]
2	W	-
3	BG	-
5	P	-
6	LG	-
7	B	-
18	L	-
20	P	-

Connector No.	D1
Connector Name	WIRE TO WIRE
Connector Type	TH40FW-CS15

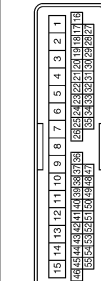

Terminal No.	Color of Wire	Signal Name [Specification]
1	Y	-
2	B	-
3	SB	-
4	V	-
8	L	-
9	P	-
10	LG	-
12	L	-
13	W	-
14	G	-
15	R	-
16	GR	-
17	L	-
18	BR	-
	BG	-

20	P	-
21	R	-
25	V	-
26	R	-
27	BR	-
28	W	-
29	Y	-
30	G	-
31	LG	-
32	GR	-
33	B	-
36	W	-
37	P	-
38	V	-
39	BR	-
42	G	-
43	GR	-
44	BG	-
47	V	-
48	R	-
49	SB	-
50	W	-
51	P	-
52	V	-

Connector No.	DB
Connector Name	POWER WINDOW MAIN SWITCH
Connector Type	NS16FW-CS

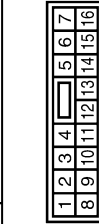

Terminal No.	Color of Wire	Signal Name [Specification]
2	LG	-
4	V	-
6	Y	-
8	L	-
9	BG	-
10	SB	-
11	G	-
13	P	-
14	V	-
15	B	-

Connector No.	D9
Connector Name	POWER WINDOW MAIN SWITCH
Connector Type	MS36FW-CS



Terminal No.	Color of Wire	Signal Name [Specification]
17	B	-
19	Y	-

Connector No.	D10
Connector Name	FRONT POWER WINDOW MOTOR (DRIVER SIDE)
Connector Type	MS36FW-CS

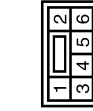

Terminal No.	Color of Wire	Signal Name [Specification]
1	G	-
2	L	-
3	BG	-
4	B	-
5	P	-
6	LG	-

Connector No.	D15
Connector Name	FRONT DOOR LOCK ASSEMBLY (DRIVER SIDE)
Connector Type	ED6FGY-RS

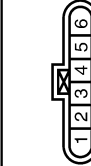

Terminal No.	Color of Wire	Signal Name [Specification]
1	LG	-
2	P	-
3	L	-
4	B	-
5	Y	-
6	V	-

Connector No.	D31
Connector Name	WIRE TO WIRE
Connector Type	TH40FW-CS15

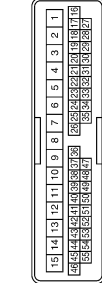

Terminal No.	Color of Wire	Signal Name [Specification]
1	Y	-
2	V	-
3	B	-
7	LG	-
8	P	-
10	L	-
11	W	-
12	G	-
13	R	-
36	W	-
37	P	-
38	V	-
39	BR	-
42	L	-
43	GR	-
44	BG	-
45	G	-
47	R	-
48	SB	-
49	W	-
50	P	-
51	V	-
52	GR	-
53	BG	-
54	G	-

A  
B  
C  
D  
E  
F  
G  
H  
I  
J  
K  
L  
M  
N  
O  
P

PWC

# POWER WINDOW MAIN SWITCH

< ECU DIAGNOSIS INFORMATION >

## POWER WINDOW SYSTEM

Connector No.	D38
Connector Name	FRONT POWER WINDOW SWITCH (PASSENGER SIDE)
Connector Type	NS16FW-CS



1	2	3	4	5	6	7		
8	9	10	11	12	13	14	15	16

Terminal No.	Color of Wire	Signal Name [Specification]
3	LG	-
4	B	-
8	L	-
9	G	-
10	Y	-
11	B	-
12	B	-
13	BG	-
16	V	-

Connector No.	D40
Connector Name	FRONT POWER WINDOW MOTOR (PASSENGER SIDE)
Connector Type	NS06FW-CS



1	2		
3	4	5	6

Terminal No.	Color of Wire	Signal Name [Specification]
1	G	-
2	L	-
3	BG	-
4	B	-
5	P	-
6	LG	-

Connector No.	D51
Connector Name	WIRE TO WIRE
Connector Type	NH10MW-CS10



1	2	3	4	5	6								
7	8	9	10	11	12	13	14	15	16	17	18	19	20

Terminal No.	Color of Wire	Signal Name [Specification]
2	Y	-
3	W	-
5	P	-
6	BR	-
7	B	-
19	L	-
20	P	-

Connector No.	D52
Connector Name	REAR POWER WINDOW MOTOR LH
Connector Type	RS06FG



1	2	3
4	5	6

Terminal No.	Color of Wire	Signal Name [Specification]
1	W	-
2	SB	-
3	L	-
4	BR	-
5	GR	-
6	BG	-

Connector No.	D57
Connector Name	REAR POWER WINDOW SWITCH LH
Connector Type	NS16FW-CS



1	2	3	4	5	6	7		
8	9	10	11	12	13	14	15	16

Terminal No.	Color of Wire	Signal Name [Specification]
3	BR	-
4	SB	-
8	W	-
9	L	-
10	W	-
11	B	-
12	GR	-
13	BG	-
16	Y	-

Connector No.	D71
Connector Name	WIRE TO WIRE
Connector Type	NH10MW-CS10



1	2	3	4	5	6								
7	8	9	10	11	12	13	14	15	16	17	18	19	20

Terminal No.	Color of Wire	Signal Name [Specification]
2	Y	-
3	W	-
5	G	-
6	V	-
7	B	-
19	L	-
20	P	-

Connector No.	D72
Connector Name	REAR POWER WINDOW MOTOR RH
Connector Type	RS06FG



1	2	3
4	5	6

Terminal No.	Color of Wire	Signal Name [Specification]
1	W	-
2	SB	-
3	L	-
4	BR	-
5	GR	-
6	BG	-

Connector No.	D77
Connector Name	REAR POWER WINDOW SWITCH RH
Connector Type	NS16FW-CS



1	2	3	4	5	6	7		
8	9	10	11	12	13	14	15	16

Terminal No.	Color of Wire	Signal Name [Specification]
3	BR	-
4	SB	-
8	W	-
9	L	-
10	W	-
11	B	-
12	GR	-
15	BG	-
16	Y	-



# POWER WINDOW MAIN SWITCH

< ECU DIAGNOSIS INFORMATION >

## POWER WINDOW SYSTEM

Connector No.	E106
Connector Name	WIRE TO WIRE
Connector Type	TH80FW-CS16-TM4



Terminal No.	Color of Wire	Signal Name [Specification]
1	V	
2	SB	
3	BG	
4	W	
5	P	
6	P	
7	L	
11	V	
12	P	
13	R	
14	W	
15	L	
16	GR	
17	SB	
18	LG	
29	G	
31	L	
32	BG	
33	P	
34	V	
35	W	
36	BG	
37	G	
38	R	
40	R	
41	LG	
42	SB	
43	G	
44	LG	
45	GR	
46	BR	
47	B	
48	Y	
49	V	
50	R	
51	SB	
52	P	
53	G	
54	B	

57	GR	
58	V	
60	R	
61	P	
62	G	
63	V	
64	L	
65	W	
66	GR	
67	LG	
68	L	
69	BR	
91	W	
92	LG	
93	GR	
94	SB	
95	GR	
96	R	
97	Y	
98	SHIELD	
99	L	
100	P	

Connector No.	M1
Connector Name	FUSE BLOCK (J/B)
Connector Type	NS06FW-M2



Terminal No.	Color of Wire	Signal Name [Specification]
1A	V	
2A	G	
3A	L	
4A	P	
5A	L	
6A	Y	
7A	R	
8A	L	

Connector No.	M5
Connector Name	WIRE TO WIRE
Connector Type	TH40MW-CS15

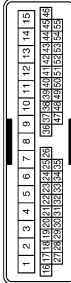

Terminal No.	Color of Wire	Signal Name [Specification]
1	Y	
2	B	
3	BG	
4	V	
8	SB	
9	G	
10	V	
12	L	
13	W	
14	B	
15	W	
16	R	
17	BR	
18	V	
19	BG	
20	P	
21	W	
25	Y	
26	G	
27	L	
28	Y	
29	G	
30	SB	
31	LG	
32	W	
33	B	
36	W	
37	GR	
38	Y	
39	B	
42	Y	
43	L	
44	G	
44	L	
47	L	
48	GR	
49	SB	
50	P	

51	LG	
52	V	

A  
B  
C  
D  
E  
F  
G  
H  
I  
J  
L  
M  
N  
O  
P

PWC

# POWER WINDOW MAIN SWITCH

< ECU DIAGNOSIS INFORMATION >

## POWER WINDOW SYSTEM

Connector No.	M6
Connector Name	WIRE TO WIRE
Connector Type	TH80MW-CS16-TM4

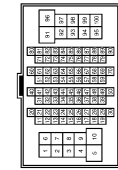

Terminal No.	Color of Wire	Signal Name [Specification]
1	W	-
2	GR	-
3	R	-
5	W	-
6	P	-
7	L	-
11	V	-
12	P	-
13	R	-
14	W	-
15	L	-
16	GR	-
17	BR	-
18	L	-
28	G	-
31	L	-
32	Y	-
33	BG	-
34	W	-
35	BR	-
36	P	-
37	P	-
38	G	-
40	V	-
41	LG	-
42	R	-
43	G	-
44	B	-
45	R	- [With A/T]
46	BG	- [With M/T]
47	SB	-
48	Y	-
49	L	-
50	R	-
51	R	-
52	W	-
53	G	-

54	B	-
57	B	-
58	LG	-
60	SB	-
61	B	-
82	W	-
83	W	-
84	L	-
85	GR	-
86	Y	-
87	G	-
88	G	-
89	R	-
91	W	-
92	Y	-
93	BG	-
94	L	-
95	Y	-
96	R	-
97	LG	-
98	SHIELD	-
99	V	-
100	SB	-

Connector No.	M7
Connector Name	WIRE TO WIRE
Connector Type	TH80MW-CS16-TM4



Terminal No.	Color of Wire	Signal Name [Specification]
1	GR	-
2	P	-
3	SB	- [With automatic drive positioner]
3	P	- [Without automatic drive positioner]
4	Y	-
6	L	-
8	G	-
9	Y	-
15	R	-
16	BR	-
17	P	-
18	V	-
20	L	-

21	P	-
22	L	-
23	P	-
24	V	-
25	LG	-
26	BR	-
27	BG	-
28	LG	-
31	V	-
32	LG	-
33	SHIELD	-
34	GR	-
35	BR	-
36	Y	-
37	SHIELD	-
38	SB	-
39	LG	-
40	O	-
41	W	-
42	SHIELD	-
43	R	-
44	G	-
45	SHIELD	-
46	SB	-
55	W	-
56	B	-
58	V	-
59	Y	-
60	Y	-
61	W	-
62	R	-
63	G	-
64	B	-
65	SHIELD	-
71	V	-
72	P	-
72	SB	-
74	V	-
81	W	-
82	BR	-
84	LG	-
85	BG	-
86	SB	-
87	G	-
88	GR	-
89	L	-
90	P	-
91	BG	-
92	L	-
93	P	-
95	BG	-
96	Y	-

100	P	-
-----	---	---

Connector No.	M104
Connector Name	REMOTE KEYLESS ENTRY RECEIVER
Connector Type	JABMFB



Terminal No.	Color of Wire	Signal Name [Specification]
1	BG	GND
2	Y	SIGNAL OUTPUT
4	P	BATTERY

# POWER WINDOW MAIN SWITCH

< ECU DIAGNOSIS INFORMATION >

## POWER WINDOW SYSTEM

Connector No.	M117
Connector Name	WIRE TO WIRE
Connector Type	TH80MW-CS (E-TM4)

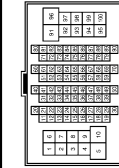

Terminal No.	Color of Wire	Signal Name [Specification]
1	LG	-
5	P	-
6	G	-
7	SB	-
8	LG	-
10	L	-
31	SB	-
32	LG	-
33	SB	-
34	LG	-
40	Y	-
41	G	-
42	LG	-
43	R	-
45	G	-
46	SHIELD	-
47	P	-
48	L	-
48	SHIELD	-
50	V	-
71	R	-
72	L	-
80	W	-
81	SHIELD	-
82	P	-
83	L	-
84	G	-
85	SHIELD	-
86	W	-
87	B	-
88	R	-
89	G	-
90	Y	-
91	V	-
92	BR	-
93	V	-
94	Y	-
95	G	-

96	G	-
97	R	-
98	EG	-
99	P	-
100	L	-

Connector No.	M118
Connector Name	BCM (BODY CONTROL MODULE)
Connector Type	M03FB-LC



Terminal No.	Color of Wire	Signal Name [Specification]
1	W	BAT (F/L)
2	Y	POWER WINDOW POWER SUPPLY (BAT)
3	EG	POWER WINDOW POWER SUPPLY (RAP)

Connector No.	M119
Connector Name	BCM (BODY CONTROL MODULE)
Connector Type	NS16FW-CS

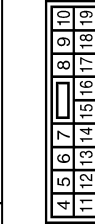

Terminal No.	Color of Wire	Signal Name [Specification]
4	LG	INTERIOR ROOM LAMP POWER SUPPLY
5	P	PASSENGER DOOR UNLOCK OUTPUT
7	SB	STEP LAMP OUTPUT
8	V	ALL DOOR FUEL LID LOCK OUTPUT
9	G	DRIVER DOOR FUEL LID UNLOCK OUTPUT
10	P	REAR DOOR UNLOCK OUTPUT
11	R	BAT (FUSE)
13	B	GND
14	W	PUSH-BUTTON IGNITION SW ILL GND
15	EG	ACC IND
17	W	TURN SIGNAL RH (FRONT)
18	EG	TURN SIGNAL LH (FRONT)

19	V	ROOM LAMP TIMER CONTROL
----	---	-------------------------

Connector No.	M122
Connector Name	BCM (BODY CONTROL MODULE)
Connector Type	TH40FB-NH

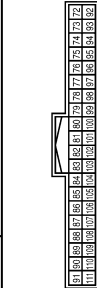

Terminal No.	Color of Wire	Signal Name [Specification]
72	R	ROOM ANT 2-
72	G	ROOM ANT 2+
74	SB	PASSENGER DOOR ANT-
75	BR	PASSENGER DOOR ANT+
76	V	DRIVER DOOR ANT-
77	LG	DRIVER DOOR ANT+
78	Y	ROOM ANT 1-
79	BR	ROOM ANT 1+
80	GR	NATS ANT AMP
81	W	INATS ANT AMP
82	SB	IGN RELAY (F/B) CONT
83	Y	KEYLESS ENTRY RECEIVER COMM
87	Y	COMBI SW INPUT 5
88	BR	COMBI SW INPUT 3
89	BR	PUSH SW
90	P	CAN-L
91	L	CAN-H
92	LG	KEY SLOT ILL
93	GR	ON IND
93	GR	ON IND
95	EG	ACC RELAY CONT
97	L	A/T SHIFT SELECTOR POWER SUPPLY
98	P	S/L CONDITION 1
98	P	S/L CONDITION 2
99	R	SHIFT P [With A/T]
99	BR	ASC D CLUTCH SW [With M/T and ICC]
100	Y	PASSENGER DOOR REQUEST SW
101	P	DRIVER DOOR REQUEST SW
102	EG	BLOWER FAN MOTOR RELAY COINT
103	P	KEYLESS ENTRY RECEIVER POWER SUPPLY
106	SB	S/L UNIT POWER SUPPLY
107	LG	COMBI SW INPUT 1
108	R	COMBI SW INPUT 4
108	W	COMBI SW INPUT 2
110	G	HAZARD SW

111	Y	S/L UNIT COMM
-----	---	---------------

Connector No.	M123
Connector Name	BCM (BODY CONTROL MODULE)
Connector Type	TH40FG-NH

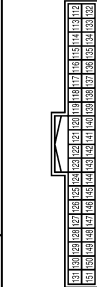

Terminal No.	Color of Wire	Signal Name [Specification]
112	R	RAIN SENSOR SERIAL LINK
113	EG	OPTICAL SENSOR
114	R	CLUTCH INTERLOCK SW
116	SB	STOP LAMP SW 1
118	BR	STOP LAMP SW 2
119	SB	DR DOOR UNLOCK SENSOR
121	SB	KEY SLOT SW
123	V	IGN F/B
124	R	PASSENGER DOOR SW
129	BG	TRUNK LID OPENER CANCEL SW
132	V	POWER WINDOW SW COMM
133	L	PUSH-BUTTON IGNITION SW ILL POWER
134	LG	LOCK IND
137	BG	RECEIVER / SENSOR GND
138	V	RECEIVER / SENSOR POWER SUPPLY
139	L	TIRE PRESSURE RECEIVER COMM
140	B	SHIFT N/P
141	W	SECURITY INDICATOR LAMP
142	BR	COMBI SW OUTPUT 5
143	P	COMBI SW OUTPUT 1
144	G	COMBI SW OUTPUT 2
145	L	COMBI SW OUTPUT 3
148	SB	COMBI SW OUTPUT 4
149	W	TIRE PRESSURE WARN CHECK SW
150	GR	DRIVER DOOR SW
150	GR	REAR WINDOW DEFOGGER RELAY CONT

A B C D E F G H I J L M N O P



# POWER WINDOW MAIN SWITCH

< ECU DIAGNOSIS INFORMATION >

POWER WINDOW SYSTEM	
Connector No.	M124
Connector Name	WIRE TO WIRE
Connector Type	TH40MW-CS15

1	2	3	4	5	6	7	8	9	10	11	12	13	14	15
16	17	18	19	20	21	22	23	24	25	26	27	28	29	30

Terminal No.	Color of Wire	Signal Name [Specification]
1	W	-
2	GR	-
3	B	-
7	V	-
8	P	-
10	BR	-
11	R	-
12	G	-
13	R	-
36	G	-
37	R	-
38	GR	-
39	L	-
42	BG	-
43	BG	-
44	W	-
45	SB	-
47	LG	-
48	P	-
48	Y	-
50	BR	-
51	SB	-
52	L	-
53	L	-
54	Y	-

JCKWM3789G1

INFOID:000000005891568

## Fail-safe

### FAIL-SAFE CONTROL

Switches to fail-safe control when malfunction is detected in encoder signal that detects up/down speed and direction of door glass. Switches to fail-safe control when a signal that is out of the specified value is detected between the fully closed position and the actual position of the glass.

# POWER WINDOW MAIN SWITCH

## < ECU DIAGNOSIS INFORMATION >

Malfunction	Malfunction condition
Pulse sensor malfunction	When one pulse signal that is the specified value or more is detected continuously for the specified time or more, while door glass is being operated UP or DOWN.
Both pulse sensors malfunction	When both pulse signals are not detected continuously for the specified time or more, while door glass is being operated UP or DOWN.
Pulse direction malfunction	When a pulse signal indicating that window is moving in the opposite direction against the power window motor is detected for the specified value or more, while door glass is being operated UP or DOWN.
Glass recognition position malfunction 1	When the actual door glass position that is out of specified value is detected compared to the door glass fully closed position memorized in module, while door glass is being operated UP or DOWN.
Glass recognition position malfunction 2	When pulse count that is out of the door glass full stroke value or more is detected, while door glass is being operated UP or DOWN.

If fail-safe control, the system changes to a non-initialized condition and the following function do not operate.

- Auto-up operation
- Anti-pinch function
- Door key cylinder switch power window function

When fail-safe control is activated, perform initialization procedure to recover. If a malfunction is detected in power window switch or more, fail-safe control is activated again.

A  
B  
C  
D  
E  
F  
G  
H  
I  
J  
L  
M  
N  
O  
P

PWC

# FRONT POWER WINDOW SWITCH

< ECU DIAGNOSIS INFORMATION >

## FRONT POWER WINDOW SWITCH

Reference Value

INFOID:000000005891569

TERMINAL LAYOUT

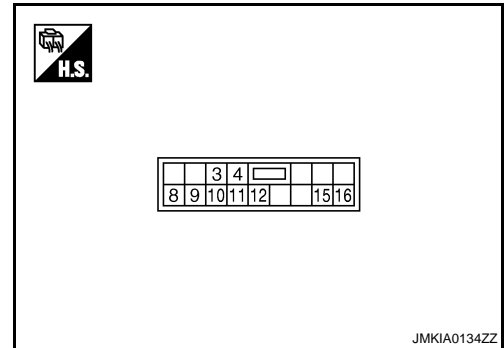

## PHYSICAL VALUES

Front Power Window Switch

Terminal No. (wire color)		Description		Condition	Voltage (V) (Approx.)
+	-	Signal name	Input/ Output		
3 (LG)	Ground	Encoder ground	—	—	0
4 (B)	Ground	Encoder power supply	Output	When ignition switch ON or power window timer operates	Battery voltage
8 (L)	Ground	Power window motor DOWN signal	Output	When power window motor is DOWN at operated.	Battery voltage
9 (G)	Ground	Power window motor UP signal	Output	When power window motor is UP at operated.	Battery voltage
10 (Y)	Ground	Battery power supply	Input	—	Battery voltage
11 (B)	Ground	Ground	—	—	0
12 (P)	Ground	Encoder pulse signal 1	Input	When power window motor operates.	

JMKIA0070GB

# FRONT POWER WINDOW SWITCH

## < ECU DIAGNOSIS INFORMATION >

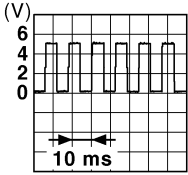
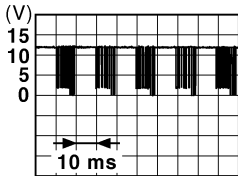
Terminal No. (wire color)		Description		Condition	Voltage (V) (Approx.)
+	-	Signal name	Input/ Output		
15 (O)	Ground	Encoder pulse signal 2	Input	When power window motor operates.	 <p style="text-align: right; font-size: small;">JMKIA0070GB</p>
16 (V)	Ground	Power window serial link	Input/ Output	Ignition switch ON or power window timer operating.	 <p style="text-align: right; font-size: small;">JPMIA0013GB</p>

A  
B  
C  
D  
E  
F  
G  
H  
I  
J  
L  
M  
N  
O  
P

PWC

# FRONT POWER WINDOW SWITCH

< ECU DIAGNOSIS INFORMATION >

## Wiring Diagram - POWER WINDOW CONTROL SYSTEM -

INFOID:000000005897283

### POWER WINDOW SYSTEM

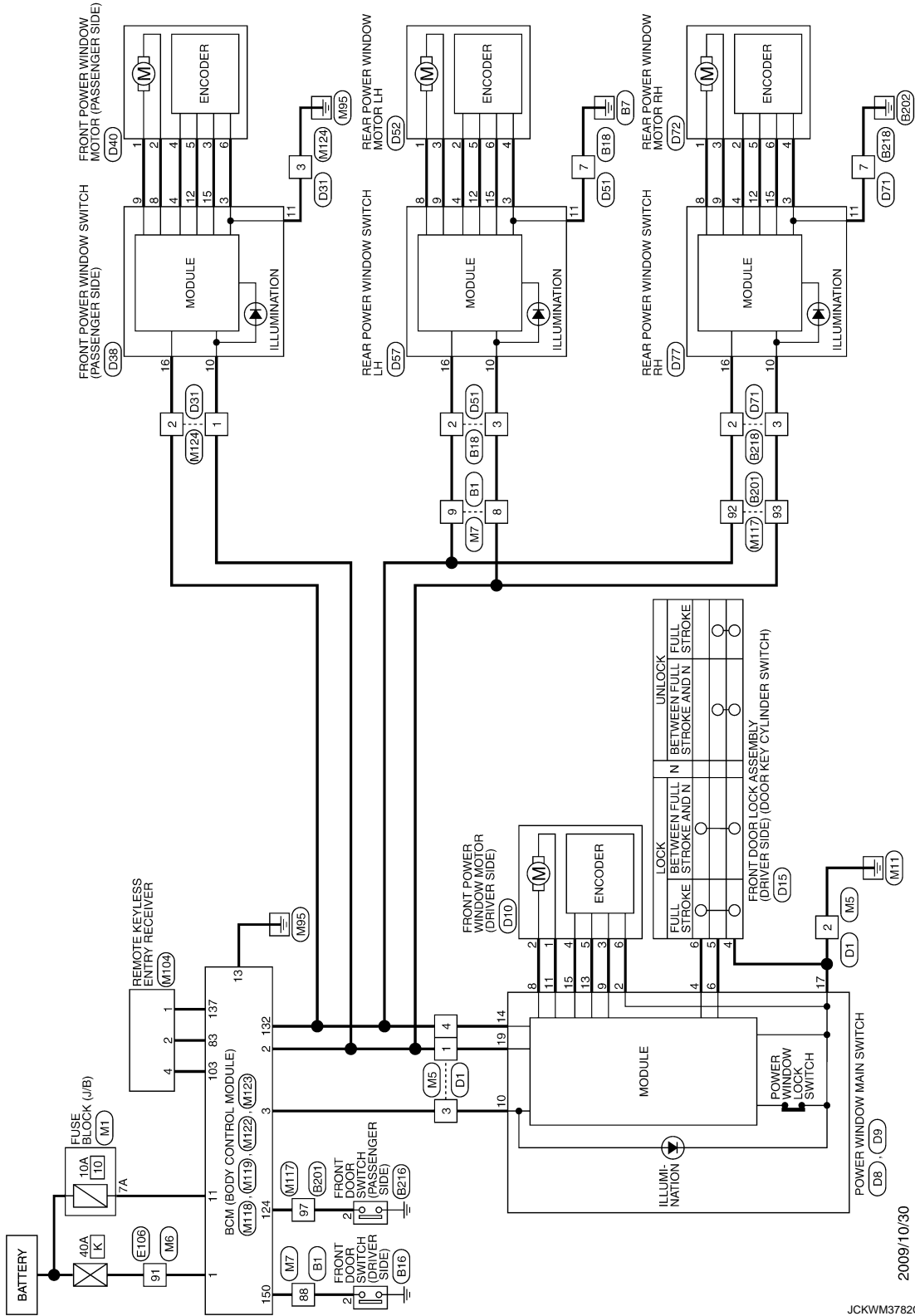

2009/10/30

JCKWM3782GI



# FRONT POWER WINDOW SWITCH

< ECU DIAGNOSIS INFORMATION >

## POWER WINDOW SYSTEM

Connector No.	B1
Connector Name	WIRE TO WIRE
Connector Type	TH80FW-CS16-TM4

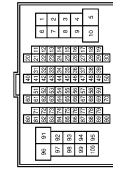

Terminal No.	Color of Wire	Signal Name [Specification]
1	GR	
2	EG	
3	L	
4	Y	
6	R	
8	W	
9	V	
15	Y	
16	BR	
17	LG	
18	BG	
20	L	
21	P	
22	L	
23	P	
24	V	
25	SB	
26	G	
27	W	
28	R	
31	V	
32	SB	
33	SHIELD	
34	W	
35	BR	
36	Y	
37	SHIELD	
38	Y	
39	SB	
40	P	
41	L	
42	SHIELD	
43	R	
44	G	
45	SHIELD	
46	SB	
55	BR	
56	R	

Connector No.	B18
Connector Name	WIRE TO WIRE
Connector Type	MH10FW-CS10

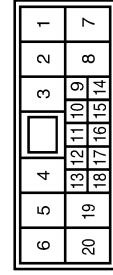

Terminal No.	Color of Wire	Signal Name [Specification]
2	V	
3	W	
5	G	
6	V	
7	B	
18	L	- [With BOSE system]
19	SB	- [Without BOSE system]
20	P	- [With BOSE system]
20	Y	- [Without BOSE system]

Connector No.	B201
Connector Name	WIRE TO WIRE
Connector Type	TH80FW-CS16-TM4

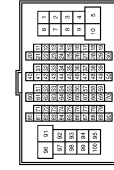

Terminal No.	Color of Wire	Signal Name [Specification]
1	BR	
5	P	
6	L	
7	V	
9	LG	
10	L	
31	L	
32	P	
33	G	
34	R	
40	GR	
41	LG	
42	BG	

43	R	
45	G	
46	SHIELD	
47	G	
48	Y	
49	SHIELD	
50	W	
71	R	
72	V	
80	BG	
81	SHIELD	
82	G	
83	P	
84	L	
85	SHIELD	
86	G	
87	R	
88	W	
89	B	
90	Y	
91	V	
92	W	
93	BG	
94	R	
95	SB	
96	G	
97	GR	
98	BR	
99	P	
100	L	

Connector No.	B216
Connector Name	FRONT DOOR SWITCH (PASSENGER SIDE)
Connector Type	A03FW

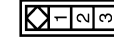

Terminal No.	2	GR	
Color of Wire			Signal Name [Specification]

Connector No.	B16
Connector Name	FRONT DOOR SWITCH (DRIVER SIDE)
Connector Type	A03FW

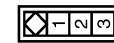

Terminal No.	2	BR	
Color of Wire			Signal Name [Specification]

A  
B  
C  
D  
E  
F  
G  
H  
I  
J  
L  
M  
N  
O  
P

PWC

# FRONT POWER WINDOW SWITCH

< ECU DIAGNOSIS INFORMATION >

## POWER WINDOW SYSTEM

Connector No.	B218
Connector Name	WIRE TO WIRE
Connector Type	TH4DFW-CS10

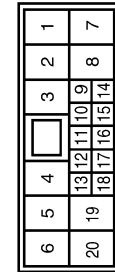

Terminal No.	Color of Wire	Signal Name [Specification]
2	W	-
3	BG	-
5	P	-
6	LG	-
7	B	-
18	L	-
20	P	-

Connector No.	D1
Connector Name	WIRE TO WIRE
Connector Type	TH4DFW-CS15

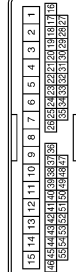

Terminal No.	Color of Wire	Signal Name [Specification]
1	Y	-
2	B	-
3	SB	-
4	V	-
8	L	-
9	P	-
10	LG	-
12	L	-
13	W	-
14	G	-
15	R	-
16	GR	-
17	L	-
18	BR	-
19	BG	-

20	P	-
21	R	-
25	R	-
26	V	-
27	BR	-
28	W	-
29	Y	-
30	G	-
31	LG	-
32	GR	-
33	B	-
36	W	-
37	P	-
38	V	-
39	BR	-
42	G	-
43	GR	-
44	BG	-
47	V	-
48	R	-
49	SB	-
50	W	-
51	P	-
52	V	-

Connector No.	D8
Connector Name	POWER WINDOW MAIN SWITCH
Connector Type	NS16FW-CS



Terminal No.	Color of Wire	Signal Name [Specification]
2	LG	-
4	V	-
6	Y	-
8	L	-
9	BG	-
10	SB	-
11	G	-
13	P	-
14	V	-
15	B	-

Connector No.	D9
Connector Name	POWER WINDOW MAIN SWITCH
Connector Type	NS8DFW-CS



Terminal No.	Color of Wire	Signal Name [Specification]
17	B	-
19	Y	-

Connector No.	D10
Connector Name	FRONT POWER WINDOW MOTOR (DRIVER SIDE)
Connector Type	NS8DFW-CS

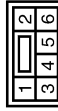

Terminal No.	Color of Wire	Signal Name [Specification]
1	G	-
2	L	-
3	BG	-
4	B	-
5	P	-
8	LG	-

Connector No.	D15
Connector Name	FRONT DOOR LOCK ASSEMBLY (DRIVER SIDE)
Connector Type	ED8FY-RS



Terminal No.	Color of Wire	Signal Name [Specification]
1	LG	-
2	P	-
3	L	-
4	B	-
5	Y	-
6	V	-

Connector No.	D31
Connector Name	WIRE TO WIRE
Connector Type	TH4DFW-CS15

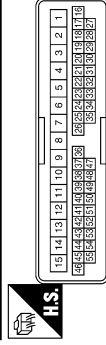

Terminal No.	Color of Wire	Signal Name [Specification]
1	Y	-
2	V	-
3	B	-
7	LG	-
8	P	-
10	L	-
12	G	-
13	R	-
36	W	-
37	P	-
38	V	-
39	BR	-
42	L	-
43	GR	-
44	BG	-
45	G	-
47	R	-
48	SB	-
49	W	-
50	P	-
51	V	-
52	GR	-
53	BG	-
54	G	-

# FRONT POWER WINDOW SWITCH

< ECU DIAGNOSIS INFORMATION >

## POWER WINDOW SYSTEM

Connector No.	D38
Connector Name	FRONT POWER WINDOW SWITCH (PASSENGER SIDE)
Connector Type	NS16FW-CS



1	2	3	4	5	6	7
8	9	10	11	12	13	14
15	16	17	18	19	20	

Terminal No.	Color of Wire	Signal Name [Specification]
3	LG	-
4	B	-
8	L	-
9	G	-
10	Y	-
11	B	-
12	P	-
15	BG	-
16	V	-

Connector No.	D40
Connector Name	FRONT POWER WINDOW MOTOR (PASSENGER SIDE)
Connector Type	NS06FW-CS



1	2
3	4
5	6

Terminal No.	Color of Wire	Signal Name [Specification]
1	G	-
2	L	-
3	BG	-
4	B	-
5	P	-
6	LG	-

Connector No.	D51
Connector Name	WIRE TO WIRE
Connector Type	NH10MW-CS10



1	2	3	4	5	6
7	8	9	10	11	12
13	14	15	16	17	18
19	20				

Terminal No.	Color of Wire	Signal Name [Specification]
2	Y	-
3	W	-
5	P	-
6	BR	-
7	B	-
19	L	-
20	P	-

Connector No.	D52
Connector Name	REAR POWER WINDOW MOTOR LH
Connector Type	RS06FG



1	2	3
4	5	6

Terminal No.	Color of Wire	Signal Name [Specification]
1	W	-
2	SB	-
3	L	-
4	BR	-
5	GR	-
6	BG	-

Connector No.	D57
Connector Name	REAR POWER WINDOW SWITCH LH
Connector Type	NS16FW-CS



1	2	3	4	5	6	7
8	9	10	11	12	13	14
15	16					

Terminal No.	Color of Wire	Signal Name [Specification]
3	BR	-
4	SB	-
8	W	-
9	L	-
10	W	-
11	B	-
12	GR	-
15	BG	-
16	Y	-

Connector No.	D71
Connector Name	WIRE TO WIRE
Connector Type	NH10MW-CS10



1	2	3	4	5	6
7	8	9	10	11	12
13	14	15	16	17	18
19	20				

Terminal No.	Color of Wire	Signal Name [Specification]
2	Y	-
3	W	-
5	G	-
6	V	-
7	B	-
19	L	-
20	P	-

Connector No.	D72
Connector Name	REAR POWER WINDOW MOTOR RH
Connector Type	RS06FG



1	2	3
4	5	6

Terminal No.	Color of Wire	Signal Name [Specification]
1	W	-
2	SB	-
3	L	-
4	BR	-
5	GR	-
6	BG	-

Connector No.	D77
Connector Name	REAR POWER WINDOW SWITCH RH
Connector Type	NS16FW-CS



1	2	3	4	5	6	7
8	9	10	11	12	13	14
15	16					

Terminal No.	Color of Wire	Signal Name [Specification]
3	BR	-
4	SB	-
8	W	-
9	L	-
10	W	-
11	B	-
12	GR	-
15	BG	-
16	Y	-

A  
B  
C  
D  
E  
F  
G  
H  
I  
J  
K  
L  
M  
N  
O  
P

PWC

# FRONT POWER WINDOW SWITCH

< ECU DIAGNOSIS INFORMATION >

## POWER WINDOW SYSTEM

Connector No.	E106
Connector Name	WIRE TO WIRE
Connector Type	TH80FW-CS16-TM4



Terminal No.	Color of Wire	Signal Name [Specification]
1	V	-
2	SB	-
3	EG	-
5	W	-
6	P	-
7	L	-
11	V	-
12	P	-
13	R	-
14	W	-
15	L	-
16	GR	-
17	SB	-
18	LG	-
28	G	-
31	L	-
32	EG	-
33	P	-
34	V	-
35	W	-
36	EG	-
37	G	-
38	R	-
40	R	-
41	LG	-
42	SB	-
43	G	-
44	LG	-
45	GR	-
46	BR	-
47	B	-
48	Y	-
49	V	-
50	R	-
51	SB	-
52	P	-
53	G	-
54	B	-

57	GR	-
58	V	-
60	R	-
61	P	-
62	G	-
63	V	-
64	L	-
65	W	-
66	GR	-
67	LG	-
68	L	-
69	BR	-
91	W	-
92	LG	-
93	GR	-
94	SB	-
95	GR	-
96	R	-
97	Y	-
98	SHIELD	-
99	L	-
100	P	-

Connector No.	M1
Connector Name	FUSE BLOCK (J/B)
Connector Type	NS06FW-M2



Terminal No.	Color of Wire	Signal Name [Specification]
1A	V	-
2A	G	-
3A	L	-
4A	P	-
5A	L	-
6A	Y	-
7A	R	-
8A	L	-

Connector No.	M5
Connector Name	WIRE TO WIRE
Connector Type	TH80MW-CS15

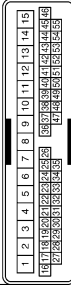

Terminal No.	Color of Wire	Signal Name [Specification]
1	Y	-
2	B	-
3	BG	-
4	V	-
8	SB	-
9	G	-
10	V	-
12	L	-
13	W	-
14	B	-
15	W	-
16	R	-
17	BR	-
18	V	-
19	BG	-
20	P	-
21	W	-
25	Y	-
26	G	-
27	L	-
28	Y	-
29	G	-
30	SB	-
31	LG	-
32	W	-
33	B	-
36	W	-
37	GR	-
38	Y	-
39	B	-
42	Y	-
43	L	-
44	G	-
44	L	-
47	L	-
48	GR	-
49	SB	-
50	P	-

51	LG	-
52	V	-

# FRONT POWER WINDOW SWITCH

< ECU DIAGNOSIS INFORMATION >

## POWER WINDOW SYSTEM

Connector No.	M6
Connector Name	WIRE TO WIRE
Connector Type	TH80MW-CS16-TM4

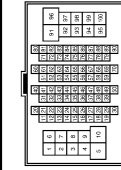

Terminal No.	Color of Wire	Signal Name [Specification]
1	W	-
2	GR	-
3	R	-
4	W	-
5	W	-
6	P	-
7	L	-
11	V	-
12	P	-
13	R	-
14	W	-
15	L	-
16	GR	-
17	BR	-
18	L	-
29	G	-
31	L	-
32	Y	-
33	EG	-
34	W	-
35	BR	-
36	P	-
37	P	-
38	G	-
40	V	-
41	LG	-
42	R	-
43	G	-
44	B	-
45	R	- [With A/T]
46	EG	- [With M/T]
47	SB	-
48	Y	-
49	L	-
50	R	-
51	R	-
52	W	-
53	G	-

54	B	-
57	B	-
58	LG	-
60	SB	-
81	B	-
82	V	-
83	W	-
84	L	-
85	GR	-
86	Y	-
87	G	-
88	G	-
89	R	-
91	W	-
92	Y	-
93	EG	-
94	L	-
95	Y	-
96	R	-
97	LG	-
98	SHIELD	-
99	V	-
100	SB	-

Connector No.	M7
Connector Name	WIRE TO WIRE
Connector Type	TH80MW-CS16-TM4

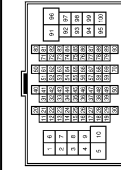

Terminal No.	Color of Wire	Signal Name [Specification]
1	GR	-
2	P	-
3	SB	- [With automatic drive positioner]
4	Y	- [Without automatic drive positioner]
6	L	-
8	G	-
9	Y	-
15	R	-
16	BR	-
17	P	-
18	V	-
20	L	-

21	P	-
22	L	-
23	P	-
24	V	-
25	LG	-
26	BR	-
27	BG	-
28	LG	-
31	V	-
32	LG	-
33	SHIELD	-
34	GR	-
35	BR	-
36	Y	-
37	SHIELD	-
38	SB	-
39	LG	-
40	O	-
41	W	-
42	SHIELD	-
43	R	-
44	G	-
45	SHIELD	-
46	SB	-
55	W	-
56	B	-
58	V	-
59	Y	-
60	Y	-
61	W	-
62	R	-
63	G	-
64	B	-
65	SHIELD	-
71	V	-
72	P	-
73	SB	-
74	V	-
81	W	-
82	BR	-
84	LG	-
85	BG	-
86	SB	-
87	G	-
88	GR	-
89	L	-
90	P	-
91	BG	-
92	L	-
93	P	-
95	BG	-
96	Y	-

100	P	-
-----	---	---



Connector No.	M104
Connector Name	REMOTE KEYLESS ENTRY RECEIVER
Connector Type	JABMFB



Terminal No.	Color of Wire	Signal Name [Specification]
1	EG	GND
2	V	SIGNAL OUTPUT
4	P	BATTERY

A  
B  
C  
D  
E  
F  
G  
H  
I  
J  
L  
M  
N  
O  
P



# FRONT POWER WINDOW SWITCH

< ECU DIAGNOSIS INFORMATION >

## POWER WINDOW SYSTEM

Connector No.	M117
Connector Name	WIRE TO WIRE
Connector Type	TH80MW-CS (F-TIM4)

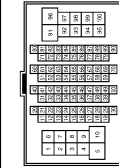

Terminal No.	Color of Wire	Signal Name [Specification]
1	LG	-
5	P	-
6	G	-
7	SB	-
9	LG	-
10	L	-
31	SB	-
32	LG	-
33	SB	-
34	LG	-
40	Y	-
41	G	-
42	LG	-
43	R	-
45	G	-
46	SHIELD	-
47	P	-
48	L	-
49	SHIELD	-
50	V	-
71	R	-
72	L	-
80	W	-
81	SHIELD	-
82	P	-
83	L	-
84	G	-
85	SHIELD	-
86	W	-
87	B	-
88	R	-
89	G	-
90	Y	-
91	V	-
92	BR	-
93	V	-
94	Y	-
95	G	-

96	G	-
97	R	-
98	BG	-
99	P	-
100	L	-

Connector No.	M118
Connector Name	BCM (BODY CONTROL MODULE)
Connector Type	M03FB-LC



Terminal No.	Color of Wire	Signal Name [Specification]
1	W	BAT (F/L)
2	Y	POWER WINDOW POWER SUPPLY (BAT)
3	BG	POWER WINDOW POWER SUPPLY (RAP)

Connector No.	M119
Connector Name	BCM (BODY CONTROL MODULE)
Connector Type	NS18FY-CS

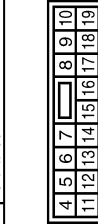

Terminal No.	Color of Wire	Signal Name [Specification]
4	LG	INTERIOR ROOM LAMP POWER SUPPLY
5	P	PASSENGER DOOR UNLOCK OUTPUT
7	SB	STEP LAMP OUTPUT
8	V	ALL DOOR FUEL LID LOCK OUTPUT
9	G	DRIVER DOOR FUEL LID UNLOCK OUTPUT
10	P	REAR DOOR UNLOCK OUTPUT
11	R	BAT (FUSE)
13	B	GND
14	W	PUSH-BUTTON IGNITION SW ILL GND
15	BG	ACC IND
17	W	TURN SIGNAL RH (FRONT)
18	BG	TURN SIGNAL LH (FRONT)

19	V	ROOM LAMP TIMER CONTROL
----	---	-------------------------

Connector No.	M122
Connector Name	BCM (BODY CONTROL MODULE)
Connector Type	TH40FB-NH



Terminal No.	Color of Wire	Signal Name [Specification]
72	R	ROOM ANT 2-
73	G	ROOM ANT 2+
74	SB	PASSENGER DOOR ANT-
75	BR	PASSENGER DOOR ANT+
76	V	DRIVER DOOR ANT-
77	LG	DRIVER DOOR ANT+
78	Y	ROOM ANT 1-
79	BR	ROOM ANT 1+
80	GR	INATS ANT AMP
81	W	INATS ANT AMP
82	SB	IGN RELAY (F/B) CONT
83	Y	KEYLESS ENTRY RECEIVER COMM
87	Y	COMBI SW INPUT 5
88	BG	COMBI SW INPUT 3
89	BR	PUSH SW
90	P	CAN-L
91	L	CAN-H
92	LG	KEY SLOT ILL
93	GR	ON IND
95	BG	ACC RELAY CONT
96	GR	A/T SHIFT SELECTOR POWER SUPPLY
97	L	S/L CONDITION 1
98	P	S/L CONDITION 2
99	R	SHIFT P [With A/T]
99	BR	ICC CLUTCH SW [With M/T and ICC]
100	Y	PASSENGER DOOR REQUEST SW
101	P	DRIVER DOOR REQUEST SW
102	BG	BLOWER FAN MOTOR RELAY CONT
103	P	KEYLESS ENTRY RECEIVER POWER SUPPLY
106	SB	S/L UNIT POWER SUPPLY
107	LG	COMBI SW INPUT 1
108	R	COMBI SW INPUT 4
109	W	COMBI SW INPUT 2
110	G	HAZARD SW

111	Y	S/L UNIT COMM
-----	---	---------------

Connector No.	M123
Connector Name	BCM (BODY CONTROL MODULE)
Connector Type	TH40FG-NH



Terminal No.	Color of Wire	Signal Name [Specification]
112	R	RAIN SENSOR SERIAL LINK
113	BG	OPTICAL SENSOR
114	R	CLUTCH INTERLOCK SW
116	SB	STOP LAMP SW 1
118	BR	STOP LAMP SW 2
119	SB	DR DOOR UNLOCK SENSOR
121	SB	KEY SLOT SW
123	V	IGN F/B
124	R	PASSENGER DOOR SW
129	BG	TRUNK LID OPENER CANCEL SW
132	V	POWER WINDOW SW COMM
133	L	PUSH-BUTTON IGNITION SW ILL POWER
134	LG	LOCK IND
137	BG	RECEIVER / SENSOR GND
138	V	RECEIVER / SENSOR POWER SUPPLY
139	L	TIRE PRESSURE RECEIVER COMM
140	B	SHIFT N/P
141	W	SECURITY INDICATOR LAMP
142	BR	COMBI SW OUTPUT 5
143	P	COMBI SW OUTPUT 1
144	G	COMBI SW OUTPUT 2
145	L	COMBI SW OUTPUT 3
146	SB	COMBI SW OUTPUT 4
149	W	TIRE PRESSURE WARN CHECK SW
150	GR	DRIVER DOOR SW
151	G	REAR WINDOW DEFOGGER RELAY CONT

# FRONT POWER WINDOW SWITCH

< ECU DIAGNOSIS INFORMATION >

A  
B  
C  
D  
E  
F  
G  
H  
I  
J  
L  
M  
N  
O  
P

PWC

**POWER WINDOW SYSTEM**

Connector No.	M124
Connector Name	WIRE TO WIRE
Connector Type	TH40MM-CS 15



1	2	3	4	5	6	7	8	9	10	11	12	13	14	15
16	17	18	19	20	21	22	23	24	25	26	27	28	29	30
31	32	33	34	35	36	37	38	39	40	41	42	43	44	45
46	47	48	49	50	51	52	53	54						

Terminal No.	Color of Wire	Signal Name [Specification]
1	W	-
2	GR	-
3	B	-
7	V	-
8	P	-
10	BR	-
11	R	-
12	G	-
13	R	-
36	G	-
37	R	-
38	GR	-
39	L	-
42	BG	-
43	BG	-
44	W	-
45	SB	-
47	LG	-
48	P	-
49	Y	-
50	BR	-
51	SB	-
52	L	-
53	L	-
54	Y	-

JCKWM3789G1

INFOID:000000005891571

## Fail-safe

### FAIL-SAFE CONTROL

Switches to fail-safe control when malfunction is detected in encoder signal that detects up/down speed and direction of door glass. Switches to fail-safe control when a signal that is out of the specified value is detected between the fully closed position and the actual position of the glass.

## FRONT POWER WINDOW SWITCH

### < ECU DIAGNOSIS INFORMATION >

Malfunction	Malfunction condition
Pulse sensor malfunction	When one pulse signal that is the specified value or more is detected continuously for the specified time or more, while door glass is being operated UP or DOWN.
Both pulse sensors malfunction	When both pulse signals are not detected continuously for the specified time or more, while door glass is being operated UP or DOWN.
Pulse direction malfunction	When a pulse signal indicating that window is moving in the opposite direction against the power window motor is detected for the specified value or more, while door glass is being operated UP or DOWN.
Glass recognition position malfunction 1	When the actual door glass position that is out of specified value is detected compared to the door glass fully closed position memorized in module, while door glass is being operated UP or DOWN.
Glass recognition position malfunction 2	When pulse count that is out of the door glass full stroke value or more is detected, while door glass is being operated UP or DOWN.

If fail-safe control, the system changes to a non-initialized condition and the following function do not operate.

- Auto-up operation
- Anti-pinch function
- Door key cylinder switch power window function

When fail-safe control is activated, perform initialization procedure to recover. If a malfunction is detected in power window switch or more, fail-safe control is activated again.



# REAR POWER WINDOW SWITCH

< ECU DIAGNOSIS INFORMATION >

## REAR POWER WINDOW SWITCH

Reference Value

INFOID:000000005891572

TERMINAL LAYOUT

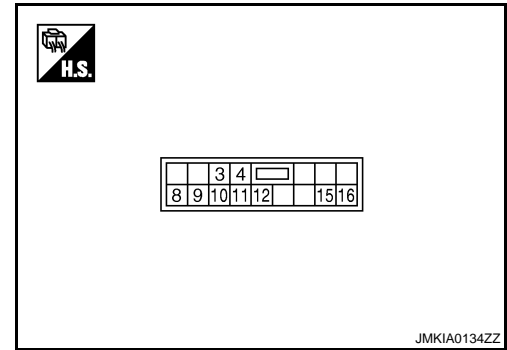

## PHYSICAL VALUES

Rear Power Window Switch

Terminal No. (wire color)		Description		Condition	Voltage (V) (Approx.)
+	-	Signal name	Input/ Output		
3 (W)	Ground	Encoder ground	—	—	0
4 (SB)	Ground	Encoder power supply	Output	When ignition switch ON or power window timer operates	Battery voltage
8 (G)	Ground	Power window motor UP signal	Output	When power window motor is UP at operated.	Battery voltage
9 (L)	Ground	Power window motor DOWN signal	Output	When power window motor is DOWN at operated.	Battery voltage
10 (W)	Ground	Battery power supply	Input	—	Battery voltage
11 (B)	Ground	Ground	—	—	0
12 (GR)	Ground	Encoder pulse signal 1	Input	When power window motor operates.	

JMKIA0070GB

A  
B  
C  
D  
E  
F  
G  
H  
I  
J  
L  
M  
N  
O  
P

PWC

# REAR POWER WINDOW SWITCH

## < ECU DIAGNOSIS INFORMATION >

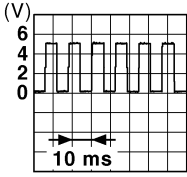
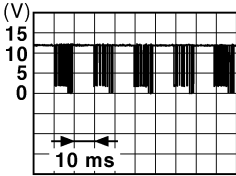
Terminal No. (wire color)		Description		Condition	Voltage (V) (Approx.)
+	-	Signal name	Input/ Output		
15 (O)	Ground	Encoder pulse signal 2	Input	When power window motor operates.	 <p style="text-align: right; font-size: small;">JMKIA0070GB</p>
16 (R)	Ground	Power window serial link	Input/ Output	Ignition switch ON or power window timer operating.	 <p style="text-align: right; font-size: small;">JPMIA0013GB</p>

# REAR POWER WINDOW SWITCH

< ECU DIAGNOSIS INFORMATION >

## Wiring Diagram - POWER WINDOW CONTROL SYSTEM -

INFOID:000000005897284

### POWER WINDOW SYSTEM

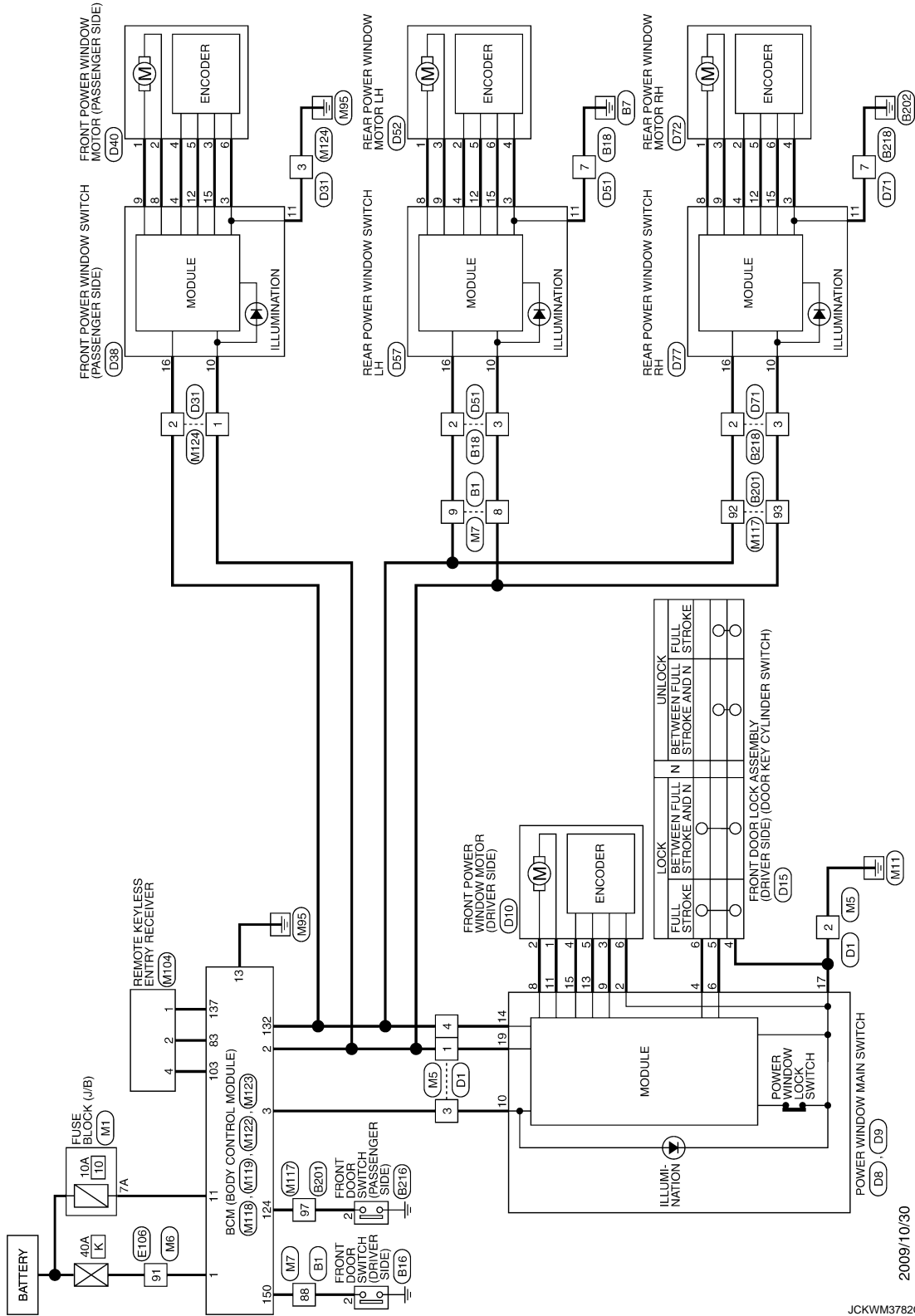

A  
B  
C  
D  
E  
F  
G  
H  
I  
J  
L  
M  
N  
O  
P



# REAR POWER WINDOW SWITCH

< ECU DIAGNOSIS INFORMATION >

## POWER WINDOW SYSTEM

Connector No.	B1
Connector Name	WIRE TO WIRE
Connector Type	TH80FW-CS16-TM4



Terminal No.	Color of Wire	Signal Name [Specification]
1	GR	-
2	BG	-
3	L	-
4	Y	-
6	R	-
8	W	-
9	Y	-
15	Y	-
16	BR	-
17	LG	-
18	BG	-
20	L	-
21	P	-
22	L	-
23	P	-
24	V	-
25	SB	-
26	G	-
27	W	-
28	R	-
31	V	-
32	SB	-
33	SHIELD	-
34	W	-
35	BR	-
36	Y	-
37	SHIELD	-
38	Y	-
39	SB	-
40	P	-
41	L	-
42	SHIELD	-
43	R	-
44	G	-
45	SHIELD	-
46	SB	-
55	BR	-
56	R	-

Connector No.	B18
Connector Name	WIRE TO WIRE
Connector Type	NH10FW-CS10

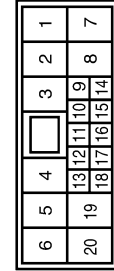

Terminal No.	Color of Wire	Signal Name [Specification]
2	V	-
3	W	-
5	G	-
6	R	-
7	B	-
19	L	- [With BOSE system]
18	SB	- [Without BOSE system]
20	P	- [Midt BOSE system]
20	Y	- [Without BOSE system]

Connector No.	B201
Connector Name	WIRE TO WIRE
Connector Type	TH80FW-CS16-TM4

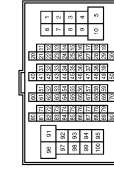

Terminal No.	Color of Wire	Signal Name [Specification]
1	BR	-
5	P	-
6	L	-
7	V	-
9	LG	-
10	L	-
31	L	-
32	P	-
33	G	-
34	R	-
40	GR	-
41	LG	-
42	BG	-

43	R	-
45	G	-
46	SHIELD	-
47	G	-
48	Y	-
49	SHIELD	-
50	W	-
71	R	-
72	V	-
80	BG	-
81	SHIELD	-
82	G	-
83	P	-
84	L	-
85	SHIELD	-
86	G	-
87	R	-
88	W	-
89	B	-
90	Y	-
91	V	-
92	W	-
93	BG	-
94	R	-
95	SB	-
96	G	-
97	GR	-
98	BR	-
99	P	-
100	L	-

Connector No.	B216
Connector Name	FRONT DOOR SWITCH (PASSENGER SIDE)
Connector Type	A03FW

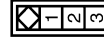

Terminal No.	Color of Wire	Signal Name [Specification]
2	GR	-

# REAR POWER WINDOW SWITCH

< ECU DIAGNOSIS INFORMATION >

## POWER WINDOW SYSTEM

Connector No.	B218
Connector Name	WIRE TO WIRE
Connector Type	TH40FW-CS10

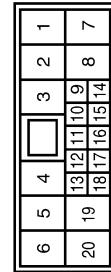

Terminal No.	Color of Wire	Signal Name [Specification]
1	LG	
2	P	
3	L	
4	B	
5	Y	
6	W	
7	BR	
8		
9		
10		
11		
12		
13		
14		
15		
16		
17		
18		
19		
20		

Connector No.	D1
Connector Name	WIRE TO WIRE
Connector Type	TH40FW-CS15

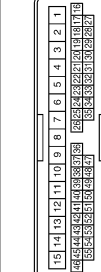

Terminal No.	Color of Wire	Signal Name [Specification]
1	LG	
2	P	
3	L	
4	B	
5	Y	
6	W	
7	BR	
8	G	
9	GR	
10	SB	
11	R	
12	V	
13	BG	
14	R	
15	G	
16		
17		
18		
19		
20		

20	P	
21	R	
25	V	
26	R	
27	BR	
28	W	
29	Y	
30	G	
31	LG	
32	GR	
33	B	
36	W	
37	P	
38	V	
39	BR	
42	G	
43	GR	
44	BG	
47	V	
48	R	
49	SB	
50	W	
51	P	
52	V	

Connector No.	DB
Connector Name	POWER WINDOW MAIN SWITCH
Connector Type	NS16FW-CS

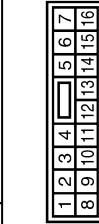

Terminal No.	Color of Wire	Signal Name [Specification]
2	LG	
4	V	
6	Y	
8	L	
9	BG	
10	SB	
11	G	
13	P	
14	V	
15	B	

Connector No.	D9
Connector Name	POWER WINDOW MAIN SWITCH
Connector Type	MS03FW-CS



Terminal No.	Color of Wire	Signal Name [Specification]
17	B	
19	Y	

Connector No.	D10
Connector Name	FRONT POWER WINDOW MOTOR (DRIVER SIDE)
Connector Type	MS08FW-CS

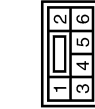

Terminal No.	Color of Wire	Signal Name [Specification]
1	G	
2	L	
3	BG	
4	B	
5	P	
6	LG	

Connector No.	D15
Connector Name	FRONT DOOR LOCK ASSEMBLY (DRIVER SIDE)
Connector Type	ED06FY-RS

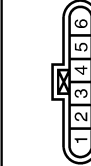

Terminal No.	Color of Wire	Signal Name [Specification]
1	LG	
2	P	
3	L	
4	B	
5	Y	
6	V	

Connector No.	D31
Connector Name	WIRE TO WIRE
Connector Type	TH40FW-CS15

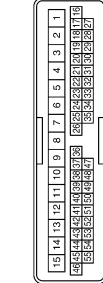

Terminal No.	Color of Wire	Signal Name [Specification]
1	Y	
2	V	
3	B	
7	LG	
8	P	
10	L	
11	W	
12	G	
13	R	
36	W	
37	P	
38	V	
39	BR	
42	L	
43	GR	
44	BG	
45	G	
47	R	
48	SB	
49	W	
50	P	
51	V	
52	GR	
53	BG	
54	G	

A  
B  
C  
D  
E  
F  
G  
H  
I  
J  
K  
L  
M  
N  
O  
P

# REAR POWER WINDOW SWITCH

< ECU DIAGNOSIS INFORMATION >

## POWER WINDOW SYSTEM

Connector No.	D38
Connector Name	FRONT POWER WINDOW SWITCH (PASSENGER SIDE)
Connector Type	NS16FW-CS



1	2	3	4	5	6
8	9	10	11	12	13
14	15	16	17	18	19
20					

Terminal No.	Color of Wire	Signal Name [Specification]
3	LG	-
4	B	-
8	L	-
9	G	-
10	Y	-
11	B	-
12	D	-
13	BG	-
16	V	-

Connector No.	D40
Connector Name	FRONT POWER WINDOW MOTOR (PASSENGER SIDE)
Connector Type	NS06FW-CS



1	2
3	4
5	6

Terminal No.	Color of Wire	Signal Name [Specification]
1	G	-
2	L	-
3	BG	-
4	B	-
5	P	-
6	LG	-

Connector No.	D51
Connector Name	WIRE TO WIRE
Connector Type	NH10MW-CS10



1	2	3	4	5	6
7	8	9	10	11	12
13	14	15	16	17	18
19	20				

Terminal No.	Color of Wire	Signal Name [Specification]
2	Y	-
3	W	-
5	P	-
6	BR	-
7	B	-
19	L	-
20	P	-

Connector No.	D52
Connector Name	REAR POWER WINDOW MOTOR LH
Connector Type	RS06FG



1	2	3
4	5	6

Terminal No.	Color of Wire	Signal Name [Specification]
1	W	-
2	SB	-
3	L	-
4	BR	-
5	GR	-
6	BG	-

Connector No.	D57
Connector Name	REAR POWER WINDOW SWITCH LH
Connector Type	NS16FW-CS



1	2	3	4	5	6
7	8	9	10	11	12
13	14	15	16	17	18
19	20				

Terminal No.	Color of Wire	Signal Name [Specification]
3	BR	-
4	SB	-
8	W	-
9	L	-
10	W	-
11	B	-
12	GR	-
13	BG	-
16	Y	-

Connector No.	D71
Connector Name	WIRE TO WIRE
Connector Type	NH10MW-CS10



1	2	3	4	5	6
7	8	9	10	11	12
13	14	15	16	17	18
19	20				

Terminal No.	Color of Wire	Signal Name [Specification]
2	Y	-
3	W	-
5	G	-
6	V	-
7	B	-
19	L	-
20	P	-

Connector No.	D72
Connector Name	REAR POWER WINDOW MOTOR RH
Connector Type	RS06FG



1	2	3
4	5	6

Terminal No.	Color of Wire	Signal Name [Specification]
1	W	-
2	SB	-
3	L	-
4	BR	-
5	GR	-
6	BG	-

Connector No.	D77
Connector Name	REAR POWER WINDOW SWITCH RH
Connector Type	NS16FW-CS



1	2	3	4	5	6
7	8	9	10	11	12
13	14	15	16	17	18

Terminal No.	Color of Wire	Signal Name [Specification]
3	BR	-
4	SB	-
8	W	-
9	L	-
10	W	-
11	B	-
12	GR	-
15	BG	-
16	Y	-

# REAR POWER WINDOW SWITCH

< ECU DIAGNOSIS INFORMATION >

## POWER WINDOW SYSTEM

Connector No.	E106
Connector Name	WIRE TO WIRE
Connector Type	TH80FW-CS16-TM4



Terminal No.	Color of Wire	Signal Name [Specification]
1	V	
2	SB	
3	BG	
5	W	
6	P	
7	L	
11	V	
12	P	
13	R	
14	W	
15	L	
16	GR	
17	SB	
18	LG	
29	G	
31	L	
32	BG	
33	P	
34	V	
35	W	
36	BG	
37	G	
38	R	
40	R	
41	LG	
42	SB	
43	G	
44	LG	
45	GR	
46	BR	
47	B	
48	Y	
49	V	
50	R	
51	SB	
52	P	
53	G	
54	B	

57	GR	
58	V	
60	R	
61	P	
62	G	
63	V	
64	L	
65	W	
66	GR	
67	LG	
68	L	
69	BR	
91	W	
92	LG	
93	GR	
94	SB	
95	GR	
96	R	
97	Y	
98	SHIELD	
99	L	
100	P	

Connector No.	M1
Connector Name	FUSE BLOCK (J/B)
Connector Type	NS06FW-M2



Terminal No.	Color of Wire	Signal Name [Specification]
1A	V	
2A	G	
3A	L	
4A	P	
5A	L	
6A	Y	
7A	R	
8A	L	

Connector No.	M5
Connector Name	WIRE TO WIRE
Connector Type	TH40MW-CS15

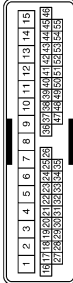

Terminal No.	Color of Wire	Signal Name [Specification]
1	Y	
2	B	
3	BG	
4	V	
8	SB	
9	G	
10	V	
12	L	
13	W	
14	B	
15	W	
16	R	
17	BR	
18	V	
19	BG	
20	P	
21	W	
25	Y	
26	G	
27	L	
28	Y	
29	G	
30	SB	
31	LG	
32	W	
33	B	
36	W	
37	GR	
38	Y	
39	B	
42	Y	
43	L	
44	G	
44	L	
47	L	
48	GR	
49	SB	
50	P	

51	LG
52	V

A  
B  
C  
D  
E  
F  
G  
H  
I  
J  
L  
M  
N  
O  
P

PWC

# REAR POWER WINDOW SWITCH

< ECU DIAGNOSIS INFORMATION >

## POWER WINDOW SYSTEM

Connector No.	M6
Connector Name	WIRE TO WIRE
Connector Type	TH80MW-CS16-TM4

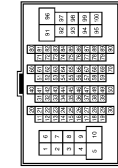

Terminal No.	Color of Wire	Signal Name [Specification]
1	W	-
2	GR	-
3	R	-
5	W	-
6	P	-
7	L	-
11	V	-
12	P	-
13	R	-
14	W	-
15	L	-
16	GR	-
17	BR	-
18	L	-
28	G	-
31	L	-
32	Y	-
33	BG	-
34	W	-
35	BR	-
36	P	-
37	P	-
38	G	-
40	V	-
41	LG	-
42	R	-
43	G	-
44	B	-
45	B	- [With A/T]
46	BG	- [With M/T]
47	SB	-
48	Y	-
49	L	-
50	R	-
51	R	-
52	W	-
53	G	-

54	B	-
57	B	-
58	LG	-
60	SB	-
61	B	-
62	V	-
63	W	-
64	L	-
65	GR	-
66	Y	-
67	G	-
68	G	-
69	R	-
70	W	-
71	Y	-
72	SB	-
73	SB	-
74	W	-
75	W	-
76	BR	-
77	LG	-
78	BG	-
79	SB	-
80	SB	-
81	G	-
82	GR	-
83	L	-
84	L	-
85	GR	-
86	Y	-
87	G	-
88	G	-
89	R	-
90	W	-
91	W	-
92	Y	-
93	BG	-
94	L	-
95	Y	-
96	R	-
97	LG	-
98	SHIELD	-
99	V	-
100	SB	-

Connector No.	M7
Connector Name	WIRE TO WIRE
Connector Type	TH80MW-CS16-TM4



Terminal No.	Color of Wire	Signal Name [Specification]
1	GR	-
2	P	-
3	SB	- [With automatic drive positioner]
3	P	- [Without automatic drive positioner]
4	Y	-
6	L	-
8	G	-
9	Y	-
15	R	-
16	BR	-
17	P	-
18	V	-
20	L	-

21	P	-
22	L	-
23	P	-
24	V	-
25	LG	-
26	BR	-
27	BG	-
28	LG	-
31	V	-
32	LG	-
33	SHIELD	-
34	GR	-
35	BR	-
36	Y	-
37	SHIELD	-
38	SB	-
39	LG	-
40	O	-
41	W	-
42	SHIELD	-
43	R	-
44	G	-
45	SHIELD	-
46	SB	-
55	W	-
56	B	-
58	V	-
59	Y	-
60	Y	-
61	W	-
62	R	-
63	G	-
64	B	-
65	SHIELD	-
71	V	-
72	P	-
72	SB	-
74	V	-
81	W	-
82	BR	-
84	LG	-
85	BG	-
86	SB	-
87	G	-
88	GR	-
89	L	-
90	P	-
91	BG	-
92	L	-
93	P	-
95	BG	-
96	Y	-

100	P	-
-----	---	---

Connector No.	M104
Connector Name	REMOTE KEYLESS ENTRY RECEIVER
Connector Type	JABMFB



Terminal No.	Color of Wire	Signal Name [Specification]
1	BG	GND
2	Y	SIGNAL OUTPUT
4	P	BATTERY



# REAR POWER WINDOW SWITCH

< ECU DIAGNOSIS INFORMATION >

## POWER WINDOW SYSTEM

Connector No.	M117
Connector Name	WIRE TO WIRE
Connector Type	TH80MW-CS (E-TM4)

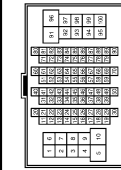

Terminal No.	Color of Wire	Signal Name [Specification]
1	LG	-
5	P	-
6	G	-
7	SB	-
8	LG	-
10	L	-
31	SB	-
32	LG	-
33	SB	-
34	LG	-
40	Y	-
41	G	-
42	LG	-
43	R	-
45	G	-
46	SHIELD	-
47	P	-
48	L	-
48	SHIELD	-
50	V	-
71	R	-
72	L	-
80	W	-
81	SHIELD	-
82	P	-
83	L	-
84	G	-
85	SHIELD	-
86	W	-
87	B	-
88	R	-
89	G	-
90	Y	-
91	V	-
92	BR	-
93	V	-
94	Y	-
95	G	-

96	G	-
97	R	-
98	EG	-
99	P	-
100	L	-

Connector No.	M118
Connector Name	BCM (BODY CONTROL MODULE)
Connector Type	M03FB-LC



Terminal No.	Color of Wire	Signal Name [Specification]
1	W	BAT (F/L)
2	Y	POWER WINDOW POWER SUPPLY (BAT)
3	EG	POWER WINDOW POWER SUPPLY (RAP)

Connector No.	M119
Connector Name	BCM (BODY CONTROL MODULE)
Connector Type	NS16FW-CS

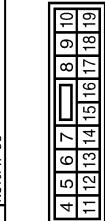

Terminal No.	Color of Wire	Signal Name [Specification]
4	LG	INTERIOR ROOM LAMP POWER SUPPLY
5	P	PASSENGER DOOR UNLOCK OUTPUT
7	SB	STEP LAMP OUTPUT
8	V	ALL DOOR FUEL LID LOCK OUTPUT
9	G	DRIVER DOOR FUEL LID UNLOCK OUTPUT
10	P	REAR DOOR UNLOCK OUTPUT
11	R	BAT (FUSE)
13	B	GND
14	W	PUSH-BUTTON IGNITION SW ILL GND
15	EG	ACC IND
17	W	TURN SIGNAL RH (FRONT)
18	EG	TURN SIGNAL LH (FRONT)

19	V	ROOM LAMP TIMER CONTROL
----	---	-------------------------

Connector No.	M122
Connector Name	BCM (BODY CONTROL MODULE)
Connector Type	TH40FB-NH

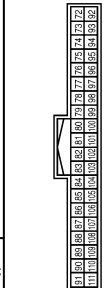

Terminal No.	Color of Wire	Signal Name [Specification]
72	R	ROOM ANT 2-
72	G	ROOM ANT 2+
74	SB	PASSENGER DOOR ANT-
74	BR	PASSENGER DOOR ANT+
76	V	DRIVER DOOR ANT-
77	LG	DRIVER DOOR ANT+
78	Y	ROOM ANT 1-
79	BR	ROOM ANT 1+
80	GR	NATS ANT AMP
81	W	INATS ANT AMP
82	SB	IGN RELAY (F/B) CONT
83	Y	KEYLESS ENTRY RECEIVER COMM
87	Y	COMBI SW INPUT 5
88	BR	COMBI SW INPUT 3
89	BR	PUSH SW
90	P	CAN-L
91	L	CAN-H
92	LG	KEY SLOT ILL
93	GR	ON IND
93	GR	ON IND
95	EG	ACC RELAY CONT
97	L	A/T SHIFT SELECTOR POWER SUPPLY
98	P	S/L CONDITION 1
98	P	S/L CONDITION 2
99	R	SHIFT P [With A/T]
99	BR	ASC D CLUTCH SW [With M/T and I/O]
100	Y	PASSENGER DOOR REQUEST SW
101	P	DRIVER DOOR REQUEST SW
102	EG	BLOWER FAN MOTOR RELAY COINT
103	P	KEYLESS ENTRY RECEIVER POWER SUPPLY
106	SB	S/L UNIT POWER SUPPLY
107	LG	COMBI SW INPUT 1
108	R	COMBI SW INPUT 4
108	W	COMBI SW INPUT 2
110	G	HAZARD SW

111	Y	S/L UNIT COMM
-----	---	---------------

Connector No.	M123
Connector Name	BCM (BODY CONTROL MODULE)
Connector Type	TH40FG-NH

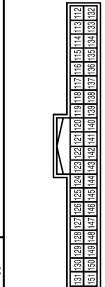

Terminal No.	Color of Wire	Signal Name [Specification]
112	R	RAIN SENSOR SERIAL LINK
113	EG	OPTICAL SENSOR
114	R	CLUTCH INTERLOCK SW
116	SB	STOP LAMP SW 1
118	BR	STOP LAMP SW 2
119	SB	DR DOOR UNLOCK SENSOR
121	SB	KEY SLOT SW
123	V	IGN F/B
124	R	PASSENGER DOOR SW
129	BG	TRUNK LID OPENER CANCEL SW
132	V	POWER WINDOW SW COMM
133	L	PUSH-BUTTON IGNITION SW ILL POWER
134	LG	LOCK IND
137	BG	RECEIVER / SENSOR GND
138	V	RECEIVER / SENSOR POWER SUPPLY
139	L	TIRE PRESSURE RECEIVER COMM
140	B	SHIFT N/P
141	W	SECURITY INDICATOR LAMP
142	BR	COMBI SW OUTPUT 5
143	P	COMBI SW OUTPUT 1
144	G	COMBI SW OUTPUT 2
145	L	COMBI SW OUTPUT 3
148	SB	COMBI SW OUTPUT 4
149	W	TIRE PRESSURE WARN CHECK SW
150	GR	DRIVER DOOR SW
150	GR	REAR WINDOW DEFOGGER RELAY CONT

A B C D E F G H I J L M N O P



# REAR POWER WINDOW SWITCH

< ECU DIAGNOSIS INFORMATION >

POWER WINDOW SYSTEM	
Connector No.	M124
Connector Name	WIRE TO WIRE
Connector Type	TH40MW-CS15

	<table border="1" style="border-collapse: collapse; width: 100%;"> <tr> <td style="width: 15%;">1</td><td style="width: 15%;">2</td><td style="width: 15%;">3</td><td style="width: 15%;">4</td><td style="width: 15%;">5</td><td style="width: 15%;">6</td><td style="width: 15%;">7</td><td style="width: 15%;">8</td><td style="width: 15%;">9</td><td style="width: 15%;">10</td><td style="width: 15%;">11</td><td style="width: 15%;">12</td><td style="width: 15%;">13</td><td style="width: 15%;">14</td><td style="width: 15%;">15</td> </tr> <tr> <td style="text-align: center;">13</td><td style="text-align: center;">14</td><td style="text-align: center;">15</td><td style="text-align: center;">16</td><td style="text-align: center;">17</td><td style="text-align: center;">18</td><td style="text-align: center;">19</td><td style="text-align: center;">20</td><td style="text-align: center;">21</td><td style="text-align: center;">22</td><td style="text-align: center;">23</td><td style="text-align: center;">24</td><td style="text-align: center;">25</td><td style="text-align: center;">26</td><td style="text-align: center;">27</td> </tr> </table>	1	2	3	4	5	6	7	8	9	10	11	12	13	14	15	13	14	15	16	17	18	19	20	21	22	23	24	25	26	27
1	2	3	4	5	6	7	8	9	10	11	12	13	14	15																	
13	14	15	16	17	18	19	20	21	22	23	24	25	26	27																	

Terminal No.	Color of Wire	Signal Name [Specification]
1	W	-
2	GR	-
3	B	-
7	V	-
8	P	-
10	BR	-
11	R	-
12	G	-
13	R	-
36	G	-
37	R	-
38	GR	-
39	L	-
42	BG	-
43	BG	-
44	W	-
45	SB	-
47	LG	-
48	P	-
48	Y	-
50	BR	-
51	SB	-
52	L	-
53	L	-
54	Y	-

JCKWM3789G1

INFOID:000000005891574

## Fail-safe

### FAIL-SAFE CONTROL

Switches to fail-safe control when malfunction is detected in encoder signal that detects up/down speed and direction of door glass. Switches to fail-safe control when a signal that is out of the specified value is detected between the fully closed position and the actual position of the glass.

# REAR POWER WINDOW SWITCH

## < ECU DIAGNOSIS INFORMATION >

Malfunction	Malfunction condition
Pulse sensor malfunction	When one pulse signal that is the specified value or more is detected continuously for the specified time or more, while door glass is being operated UP or DOWN.
Both pulse sensors malfunction	When both pulse signals are not detected continuously for the specified time or more, while door glass is being operated UP or DOWN.
Pulse direction malfunction	When a pulse signal indicating that window is moving in the opposite direction against the power window motor is detected for the specified value or more, while door glass is being operated UP or DOWN.
Glass recognition position malfunction 1	When the actual door glass position that is out of specified value is detected compared to the door glass fully closed position memorized in module, while door glass is being operated UP or DOWN.
Glass recognition position malfunction 2	When pulse count that is out of the door glass full stroke value or more is detected, while door glass is being operated UP or DOWN.

If fail-safe control, the system changes to a non-initialized condition and the following function do not operate.

- Auto-up operation
- Anti-pinch function
- Door key cylinder switch power window function

When fail-safe control is activated, perform initialization procedure to recover. If a malfunction is detected in power window switch or more, fail-safe control is activated again.

A  
B  
C  
D  
E  
F  
G  
H  
I  
J  
L  
M  
N  
O  
P

PWC

# POWER WINDOWS DO NOT OPERATE WITH ANY POWER WINDOW SWITCHES

< SYMPTOM DIAGNOSIS >

---

## SYMPTOM DIAGNOSIS

### POWER WINDOWS DO NOT OPERATE WITH ANY POWER WINDOW SWITCHES

#### Diagnosis Procedure

INFOID:000000005891579

#### 1. CHECK BCM POWER SUPPLY AND GROUND CIRCUIT

---

Check BCM power supply and ground circuit.

[PWC-13, "BCM : Diagnosis Procedure"](#).

Is the inspection result normal?

YES >> GO TO 2.

NO >> Repair or replace the malfunctioning parts.

#### 2. CHECK POWER WINDOW MAIN SWITCH SERIAL LINK CIRCUIT

---

Check power window serial link circuit.

Refer to [PWC-33, "POWER WINDOW MAIN SWITCH : Component Function Check"](#).

Is the inspection result normal?

YES >> GO TO 3.

NO >> Repair or replace the malfunctioning parts.

#### 3. CONFIRM THE OPERATION

---

Confirm the operation again.

Is the result normal?

YES >> Check intermittent incident. Refer to [GI-38, "Intermittent Incident"](#).

NO >> GO TO 1.

# DRIVER SIDE POWER WINDOW ALONE DOES NOT OPERATE

< SYMPTOM DIAGNOSIS >

## DRIVER SIDE POWER WINDOW ALONE DOES NOT OPERATE

### Diagnosis Procedure

INFOID:000000005891580

#### 1. CHECK POWER WINDOW MAIN SWITCH POWER SUPPLY AND GROUND CIRCUIT

Check power window switch power supply and ground circuit.

Refer to [PWC-13, "POWER WINDOW MAIN SWITCH : Diagnosis Procedure"](#).

Is the inspection result normal?

YES >> GO TO 2.

NO >> Repair or replace the malfunctioning parts.

#### 2. CHECK DRIVER SIDE POWER WINDOW MOTOR

Check driver side power window motor.

Refer to [PWC-17, "DRIVER SIDE : Component Function Check"](#).

Is the measurement value within the specification?

YES >> GO TO 3.

NO >> Repair or replace the malfunctioning parts.

#### 3. CONFIRM THE OPERATION

Confirm the operation again.

Is the result normal?

YES >> Check intermittent incident. Refer to [GI-38, "Intermittent Incident"](#).

NO >> GO TO 1.

A  
B  
C  
D  
E  
F  
G  
H  
I  
J  
L  
M  
N  
O  
P

PWC

# FRONT PASSENGER SIDE POWER WINDOW DOES NOT OPERATE

< SYMPTOM DIAGNOSIS >

---

## FRONT PASSENGER SIDE POWER WINDOW DOES NOT OPERATE WHEN POWER WINDOW MAIN SWITCH IS OPERATED

WHEN POWER WINDOW MAIN SWITCH IS OPERATED : Diagnosis Procedure

INFOID:000000005891581

### 1. CHECK FRONT POWER WINDOW SWITCH (PASSENGER SIDE) SERIAL LINK CIRCUIT

Check front power window switch (passenger side) serial link circuit.

Refer to [PWC-34. "FRONT POWER WINDOW SWITCH \(PASSENGER SIDE\) : Component Function Check"](#).

Is the inspection result normal?

YES >> GO TO 2.

NO >> Repair or replace the malfunctioning parts.

### 2. CONFIRM THE OPERATION

Confirm the operation again.

Is the result normal?

YES >> Check intermittent incident. Refer to [GI-38. "Intermittent Incident"](#).

NO >> GO TO 1.

WHEN FRONT POWER WINDOW SWITCH (PASSENGER SIDE) IS OPERATED

WHEN FRONT POWER WINDOW SWITCH (PASSENGER SIDE) IS OPERATED :  
Diagnosis Procedure

INFOID:000000005891582

### 1. REPLACE FRONT POWER WINDOW SWITCH (PASSENGER SIDE)

Replace front power window switch (passenger side).

Refer to [PWC-123. "Removal and Installation"](#)

>> INSPECTION END

WHEN BOTH POWER WINDOW MAIN SWITCH AND FRONT POWER WINDOW  
SWITCH ARE OPERATED

WHEN BOTH POWER WINDOW MAIN SWITCH AND FRONT POWER WINDOW  
SWITCH ARE OPERATED : Diagnosis Procedure

INFOID:000000005891583

### 1. CHECK FRONT POWER WINDOW SWITCH (PASSENGER SIDE) POWER SUPPLY AND GROUND CIRCUIT

Check front power window switch (passenger side) power supply and ground circuit.

Refer to [PWC-14. "FRONT POWER WINDOW SWITCH \(PASSENGER SIDE\) : Diagnosis Procedure"](#).

Is the inspection result normal?

YES >> GO TO 2.

NO >> Repair or replace the malfunctioning parts.

### 2. CHECK PASSENGER SIDE POWER WINDOW MOTOR CIRCUIT

Check passenger side power window motor circuit.

Refer to [PWC-18. "PASSENGER SIDE : Component Function Check"](#).

Is the inspection result normal?

YES >> GO TO 3.

NO >> Repair or replace the malfunctioning parts.

### 3. CONFIRM THE OPERATION

Confirm the operation again.

Is the result normal?

YES >> Check intermittent incident. Refer to [GI-38. "Intermittent Incident"](#).

NO >> GO TO 1.

# REAR LH SIDE POWER WINDOW ALONE DOES NOT OPERATE

< SYMPTOM DIAGNOSIS >

## REAR LH SIDE POWER WINDOW ALONE DOES NOT OPERATE WHEN POWER WINDOW MAIN SWITCH IS OPERATED

WHEN POWER WINDOW MAIN SWITCH IS OPERATED : Diagnosis Procedure

INFOID:000000005891584

### 1. CHECK REAR POWER WINDOW SWITCH LH SERIAL LINK CIRCUIT

Check rear power window switch LH serial link circuit.

Refer to [PWC-36, "REAR LH : Component Function Check"](#).

Is the inspection result normal?

YES >> GO TO 2.

NO >> Repair or replace the malfunctioning parts.

### 2. CONFIRM THE OPERATION

Confirm the operation again.

Is the result normal?

YES >> Check intermittent incident. Refer to [GI-38, "Intermittent Incident"](#).

NO >> GO TO 1.

## WHEN REAR POWER WINDOW SWITCH LH IS OPERATED

WHEN REAR POWER WINDOW SWITCH LH IS OPERATED : Diagnosis Procedure

INFOID:000000005891585

### 1. REPLACE REAR POWER WINDOW SWITCH LH

Replace rear power window switch LH.

Refer to [PWC-123, "Removal and Installation"](#)

>> INSPECTION END

## WHEN BOTH POWER WINDOW MAIN SWITCH AND REAR POWER WINDOW SWITCH LH ARE OPERATED

WHEN BOTH POWER WINDOW MAIN SWITCH AND REAR POWER WINDOW  
SWITCH LH ARE OPERATED : Diagnosis Procedure

INFOID:000000005891586

PWC

### 1. CHECK REAR POWER WINDOW SWITCH POWER SUPPLY AND GROUND CIRCUIT

Check rear power window switch power supply and ground circuit.

Refer to [PWC-15, "REAR POWER WINDOW SWITCH : Diagnosis Procedure"](#).

Is the inspection result normal?

YES >> GO TO 2.

NO >> Repair or replace the malfunctioning parts.

### 2. CHECK REAR POWER WINDOW MOTOR LH

Check rear power window motor LH.

Refer to [PWC-20, "REAR LH : Component Function Check"](#).

Is the inspection result normal?

YES >> GO TO 3.

NO >> Repair or replace the malfunctioning parts.

### 3. CONFIRM THE OPERATION

Confirm the operation again.

Is the result normal?

YES >> Check intermittent incident. Refer to [GI-38, "Intermittent Incident"](#).

NO >> GO TO 1.

## REAR RH SIDE POWER WINDOW ALONE DOES NOT OPERATE

< SYMPTOM DIAGNOSIS >

### REAR RH SIDE POWER WINDOW ALONE DOES NOT OPERATE WHEN POWER WINDOW MAIN SWITCH IS OPERATED

WHEN POWER WINDOW MAIN SWITCH IS OPERATED : Diagnosis Procedure

INFOID:000000005891587

#### 1.CHECK REAR POWER WINDOW SWITCH RH SERIAL LINK CIRCUIT

Check rear power window switch RH serial link circuit.

Refer to [PWC-37, "REAR RH : Component Function Check"](#).

Is the inspection result normal?

YES >> GO TO 2.

NO >> Repair or replace the malfunctioning parts.

#### 2.CONFIRM THE OPERATION

Confirm the operation again.

Is the result normal?

YES >> Check intermittent incident. Refer to [GI-38, "Intermittent Incident"](#).

NO >> GO TO 1.

### WHEN REAR POWER WINDOW SWITCH RH IS OPERATED

WHEN REAR POWER WINDOW SWITCH RH IS OPERATED : Diagnosis Procedure

INFOID:000000005891588

#### 1.REPLACE REAR POWER WINDOW SWITCH RH

Replace rear power window switch RH.

Refer to [PWC-123, "Removal and Installation"](#)

>> INSPECTION END

### WHEN BOTH POWER WINDOW MAIN SWITCH AND REAR POWER WINDOW SWITCH RH ARE OPERATED

WHEN BOTH POWER WINDOW MAIN SWITCH AND REAR POWER WINDOW  
SWITCH RH ARE OPERATED : Diagnosis Procedure

INFOID:000000005891589

#### 1.CHECK REAR POWER WINDOW SWITCH POWER SUPPLY AND GROUND CIRCUIT

Check rear power window switch power supply and ground circuit.

Refer to [PWC-15, "REAR POWER WINDOW SWITCH : Diagnosis Procedure"](#).

Is the inspection result normal?

YES >> GO TO 2.

NO >> Repair or replace the malfunctioning parts.

#### 2.CHECK REAR POWER WINDOW MOTOR RH

Check rear power window motor RH.

Refer to [PWC-21, "REAR RH : Component Function Check"](#).

Is the inspection result normal?

YES >> GO TO 3.

NO >> Repair or replace the malfunctioning parts.

#### 3.CONFIRM THE OPERATION

Confirm the operation again.

Is the result normal?

YES >> Check intermittent incident. Refer to [GI-38, "Intermittent Incident"](#).

NO >> GO TO 1.



# ANTI-PINCH FUNCTION DOES NOT OPERATE NORMALLY

< SYMPTOM DIAGNOSIS >

## ANTI-PINCH FUNCTION DOES NOT OPERATE NORMALLY

### DRIVER SIDE

#### DRIVER SIDE : Diagnosis Procedure

INFOID:000000005891590

#### 1.CHECK POWER WINDOW AUTO OPERATION

Check power window auto operation.

Is the inspection result normal?

YES >> GO TO 2.

NO >> Refer to [PWC-115. "DRIVER SIDE : Diagnosis Procedure"](#).

#### 2.CONFIRM THE OPERATION

Confirm the operation again.

Is the result normal?

YES >> Check intermittent incident. Refer to [GI-38. "Intermittent Incident"](#).

NO >> GO TO 1.

### PASSENGER SIDE

#### PASSENGER SIDE : Diagnosis Procedure

INFOID:000000005891591

#### 1.CHECK POWER WINDOW AUTO OPERATION

Check power window auto operation.

Is the inspection result normal?

YES >> GO TO 2.

NO >> Refer to [PWC-115. "PASSENGER SIDE : Diagnosis Procedure"](#).

#### 2.CONFIRM THE OPERATION

Confirm the operation again.

Is the result normal?

YES >> Check intermittent incident. Refer to [GI-38. "Intermittent Incident"](#).

NO >> GO TO 1.

### REAR LH

#### REAR LH : Diagnosis Procedure

INFOID:000000005891592

#### 1.CHECK POWER WINDOW AUTO OPERATION

Check power window auto operation.

Is the inspection result normal?

YES >> GO TO 2.

NO >> Refer to [PWC-116. "REAR LH : Diagnosis Procedure"](#).

#### 2.CONFIRM THE OPERATION

Confirm the operation again.

Is the result normal?

YES >> Check intermittent incident. Refer to [GI-38. "Intermittent Incident"](#).

NO >> GO TO 1.

### REAR RH

#### REAR RH : Diagnosis Procedure

INFOID:000000005891593

#### 1.CHECK POWER WINDOW AUTO OPERATION

Check power window auto operation.

Is the inspection result normal?

YES >> GO TO 2.

A  
B  
C  
D  
E  
F  
G  
H  
I  
J  
L  
M  
N  
O  
P

PWC

## ANTI-PINCH FUNCTION DOES NOT OPERATE NORMALLY

### < SYMPTOM DIAGNOSIS >

---

NO >> Refer to [PWC-116. "REAR RH : Diagnosis Procedure"](#).

### 2.CONFIRM THE OPERATION

---

Confirm the operation again.

#### Is the result normal?

YES >> Check intermittent incident. Refer to [GI-38. "Intermittent Incident"](#).

NO >> GO TO 1.

# AUTO OPERATION DOES NOT OPERATE BUT MANUAL OPERATES NORMALLY

< SYMPTOM DIAGNOSIS >

## AUTO OPERATION DOES NOT OPERATE BUT MANUAL OPERATES NORMALLY

### DRIVER SIDE

#### DRIVER SIDE : Diagnosis Procedure

INFOID:000000005891594

#### 1.PERFORM INITIALIZATION PROCEDURE

Initialization procedure is executed and operation is confirmed.

Refer to [PWC-5, "ADDITIONAL SERVICE WHEN REMOVING BATTERY NEGATIVE TERMINAL : Special Repair Requirement"](#).

Is the inspection result normal?

YES >> INSPECTION END

NO >> GO TO 2.

#### 2.CHECK ENCODER (DRIVER SIDE) CIRCUIT

Check encoder (driver side) circuit.

Refer to [PWC-24, "DRIVER SIDE : Component Function Check"](#).

Is the inspection result normal?

YES >> GO TO 3.

NO >> Repair or replace the malfunctioning parts.

#### 3.CONFIRM THE OPERATION

Confirm the operation again.

Is the result normal?

YES >> Check intermittent incident. Refer to [GI-38, "Intermittent Incident"](#).

NO >> GO TO 1.

### PASSENGER SIDE

#### PASSENGER SIDE : Diagnosis Procedure

INFOID:000000005891595

#### 1.PERFORM INITIALIZAITON PROCEDURE

Initialization procedure is executed and operation is confirmed.

Refer to [PWC-5, "ADDITIONAL SERVICE WHEN REMOVING BATTERY NEGATIVE TERMINAL : Special Repair Requirement"](#).

Is the inspection result normal?

YES >> INSPECTION END

NO >> GO TO 2.

#### 2.CHECK ENCODER (PASSENGER SIDE) CIRCUIT

Check encoder (passenger side) circuit.

Refer to [PWC-26, "PASSENGER SIDE : Component Function Check"](#).

Is the inspection result normal?

YES >> GO TO 3.

NO >> Repair or replace the malfunctioning parts.

#### 3.CONFIRM THE OPERATION

Confirm the operation again.

Is the result normal?

YES >> Check intermittent incident. Refer to [GI-38, "Intermittent Incident"](#).

NO >> GO TO 1.

### REAR LH

A

B

C

D

E

F

G

H

I

J

PWC

L

M

N

O

P

# AUTO OPERATION DOES NOT OPERATE BUT MANUAL OPERATES NORMALLY

< SYMPTOM DIAGNOSIS >

## REAR LH : Diagnosis Procedure

INFOID:000000005891596

### 1.PERFORM INITIALIZATION PROCEDURE

Initialization procedure is executed and operation is confirmed.

Refer to [PWC-5. "ADDITIONAL SERVICE WHEN REMOVING BATTERY NEGATIVE TERMINAL : Special Repair Requirement"](#).

Is the inspection result normal?

YES >> INSPECTION END  
NO >> GO TO 2.

### 2.CHECK ENCODER (REAR LH) CIRCUIT

Check encoder (rear LH) circuit.

Refer to [PWC-28. "REAR LH : Component Function Check"](#).

Is the inspection result normal?

YES >> GO TO 3.  
NO >> Repair or replace the malfunctioning parts.

### 3.CONFIRM THE OPERATION

Confirm the operation again.

Is the result normal?

YES >> Check intermittent incident. Refer to [GI-38. "Intermittent Incident"](#).  
NO >> GO TO 1.

## REAR RH

## REAR RH : Diagnosis Procedure

INFOID:000000005891597

### 1.PERFORM INITIALIZATION PROCEDURE

Initialization procedure is executed and operation is confirmed.

Refer to [PWC-5. "ADDITIONAL SERVICE WHEN REMOVING BATTERY NEGATIVE TERMINAL : Special Repair Requirement"](#).

Is the inspection result normal?

YES >> INSPECTION END  
NO >> GO TO 2.

### 2.CHECK ENCODER (REAR RH) CIRCUIT

Check encoder (rear RH) circuit.

Refer to [PWC-30. "REAR RH : Component Function Check"](#).

Is the inspection result normal?

YES >> GO TO 3.  
NO >> Repair or replace the malfunctioning parts.

### 3.CONFIRM THE OPERATION

Confirm the operation again.

Is the result normal?

YES >> Check intermittent incident. Refer to [GI-38. "Intermittent Incident"](#).  
NO >> GO TO 1.

# POWER WINDOW RETAINED POWER FUNCTION DOES NOT OPERATE NORMALLY

< SYMPTOM DIAGNOSIS >

## POWER WINDOW RETAINED POWER FUNCTION DOES NOT OPERATE NORMALLY

### Diagnosis Procedure

INFOID:000000005891598

#### 1. CHECK DOOR SWITCH

Check door switch.

Refer to [DLK-66, "Component Function Check"](#).

Is the inspection result normal?

YES >> GO TO 2.

NO >> Repair or replace the malfunctioning parts.

#### 2. CONFIRM THE OPERATION

Confirm the operation again.

Is the result normal?

YES >> Check intermittent incident. Refer to [GI-38, "Intermittent Incident"](#).

NO >> GO TO 1.

A  
B  
C  
D  
E  
F  
G  
H  
I  
J  
L  
M  
N  
O  
P

PWC

# DOOR KEY CYLINDER SWITCH DOES NOT OPERATE POWER WINDOWS

< SYMPTOM DIAGNOSIS >

## DOOR KEY CYLINDER SWITCH DOES NOT OPERATE POWER WINDOWS

### Diagnosis Procedure

INFOID:000000005891599

#### 1. PERFORM INITIALIZATION PROCEDURE

---

Initialization procedure is executed and operation is confirmed.

Refer to [PWC-5, "ADDITIONAL SERVICE WHEN REMOVING BATTERY NEGATIVE TERMINAL : Special Repair Requirement"](#).

Is the inspection result normal?

YES >> INSPECTION END  
NO >> GO TO 2.

#### 2. CHECK DRIVER SIDE DOOR LOCK ASSEMBLY (DOOR KEY CYLINDER SWITCH)

---

Check driver side door lock assembly (door key cylinder switch).

Refer to [DLK-80, "Component Function Check"](#).

Is the inspection result normal?

YES >> GO TO 3.  
NO >> Repair or replace the malfunctioning parts.

#### 3. CONFIRM THE OPERATION

---

Confirm the operation again.

Is the result normal?

YES >> Check intermittent incident. Refer to [GI-38, "Intermittent Incident"](#).  
NO >> GO TO 1.

# KEYLESS POWER WINDOW DOWN DOES NOT OPERATE

< SYMPTOM DIAGNOSIS >

## KEYLESS POWER WINDOW DOWN DOES NOT OPERATE

### Description

INFOID:000000005891600

Power window down does not operate when pressing unlock button on Intelligent Key.

### Diagnosis Procedure

INFOID:000000005891601

#### 1. CHECK REMOTE KEYLESS ENTRY FUNCTION

Check remote keyless entry function.

Does door lock/unlock with Intelligent Key button?

YES >> GO TO 2.

NO >> Refer to [DLK-186, "Description"](#).

#### 2. CHECK POWER WINDOW OPERATION

Check power window operation.

Does power window operate up/down using power window main switch?

YES >> GO TO 3.

NO >> Refer to [PWC-109, "Diagnosis Procedure"](#).

#### 3. CHECK "PW DOWN SET" SETTING IN "WORK SUPPORT"

Check "PW DOWN SET" setting in "WORK SUPPORT".

Refer to [DLK-52, "INTELLIGENT KEY : CONSULT-III Function \(BCM - INTELLIGENT KEY\)"](#).

Is the inspection result normal?

YES >> GO TO 4.

NO >> Set "PW DOWN SET" setting in "WORK SUPPORT".

#### 4. CONFIRM THE OPERATION

Confirm the operation again.

Is the result normal?

YES >> Check intermittent incident. Refer to [GI-38, "Intermittent Incident"](#).

NO >> GO TO 1.

A  
B  
C  
D  
E  
F  
G  
H  
I  
J  
L  
M  
N  
O  
P

PWC

## POWER WINDOW LOCK SWITCH DOES NOT FUNCTION

< SYMPTOM DIAGNOSIS >

---

### POWER WINDOW LOCK SWITCH DOES NOT FUNCTION

#### Diagnosis Procedure

INFOID:000000005891602

#### 1. REPLACE POWER WINDOW MAIN SWITCH

---

Replace power window main switch.

>> Refer to [PWC-123. "Removal and Installation"](#).



# POWER WINDOW SWITCH ILLUMINATION DOES NOT ILLUMINATE

< SYMPTOM DIAGNOSIS >

## POWER WINDOW SWITCH ILLUMINATION DOES NOT ILLUMINATE DRIVER SIDE

DRIVER SIDE : Diagnosis Procedure

INFOID:000000005891603

### 1. REPLACE POWER WINDOW MAIN SWITCH

Replace power window main switch.  
Refer to [PWC-123, "Removal and Installation"](#).

>> INSPECTION END

## PASSENGER SIDE

PASSENGER SIDE : Diagnosis Procedure

INFOID:000000005891604

### 1. REPLACE FRONT POWER WINDOW SWITCH (PASSENGER SIDE)

Replace front power window switch (passenger side).  
Refer to [PWC-123, "Removal and Installation"](#).

>> INSPECTION END

## REAR LH

REAR LH : Diagnosis Procedure

INFOID:000000005891605

### 1. REPLACE REAR POWER WINDOW SWITCH LH

Replace rear power window switch LH.  
Refer to [PWC-123, "Removal and Installation"](#).

>> INSPECTION END

## REAR RH

REAR RH : Diagnosis Procedure

INFOID:000000005891606

### 1. REPLACE REAR POWER WINDOW SWITCH RH

Replace rear power window switch RH.  
Refer to [PWC-123, "Removal and Installation"](#).

>> INSPECTION END

A  
B  
C  
D  
E  
F  
G  
H  
I  
J  
L  
M  
N  
O  
P

PWC

# PRECAUTIONS

< PRECAUTION >

## PRECAUTION

### PRECAUTIONS

#### Precaution for Supplemental Restraint System (SRS) "AIR BAG" and "SEAT BELT PRE-TENSIONER"

INFOID:000000005891627

The Supplemental Restraint System such as "AIR BAG" and "SEAT BELT PRE-TENSIONER", used along with a front seat belt, helps to reduce the risk or severity of injury to the driver and front passenger for certain types of collision. This system includes seat belt switch inputs and dual stage front air bag modules. The SRS system uses the seat belt switches to determine the front air bag deployment, and may only deploy one front air bag, depending on the severity of a collision and whether the front occupants are belted or unbelted. Information necessary to service the system safely is included in the "SRS AIR BAG" and "SEAT BELT" of this Service Manual.

#### **WARNING:**

- To avoid rendering the SRS inoperative, which could increase the risk of personal injury or death in the event of a collision which would result in air bag inflation, all maintenance must be performed by an authorized NISSAN/INFINITI dealer.
- Improper maintenance, including incorrect removal and installation of the SRS, can lead to personal injury caused by unintentional activation of the system. For removal of Spiral Cable and Air Bag Module, see the "SRS AIR BAG".
- Do not use electrical test equipment on any circuit related to the SRS unless instructed to in this Service Manual. SRS wiring harnesses can be identified by yellow and/or orange harnesses or harness connectors.

#### PRECAUTIONS WHEN USING POWER TOOLS (AIR OR ELECTRIC) AND HAMMERS

#### **WARNING:**

- When working near the Air Bag Diagnosis Sensor Unit or other Air Bag System sensors with the ignition ON or engine running, DO NOT use air or electric power tools or strike near the sensor(s) with a hammer. Heavy vibration could activate the sensor(s) and deploy the air bag(s), possibly causing serious injury.
- When using air or electric power tools or hammers, always switch the ignition OFF, disconnect the battery, and wait at least 3 minutes before performing any service.

# POWER WINDOW MAIN SWITCH

< REMOVAL AND INSTALLATION >

## REMOVAL AND INSTALLATION

### POWER WINDOW MAIN SWITCH

#### Removal and Installation

INFOID:000000005891636

#### REMOVAL

1. Remove the power window main switch finisher (2).  
Refer to [INT-12, "Removal and Installation"](#).
2. Power window main switch (1) is removed from power window main switch finisher (2) using flat-head screw driver (A) etc.

 : Pawl

#### CAUTION:

**Do not fold the pawl of power window main switch finisher.**

#### NOTE:

The same procedure is also performed for front power window switch (passenger side) and rear power window switch (LH & RH).

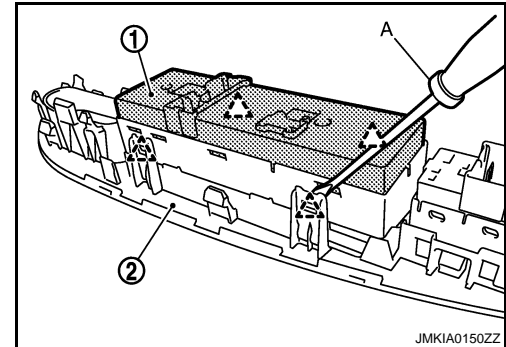

#### INSTALLATION

Install in the reverse order of removal.

#### NOTE:

Power window main switch is exchanged or is detached it is necessary to do the initialization procedure.  
Refer to [PWC-6, "ADDITIONAL SERVICE WHEN REPLACING CONTROL UNIT : Special Repair Requirement"](#).

A  
B  
C  
D  
E  
F  
G  
H  
I  
J  
L  
M  
N  
O  
P

PWC