

SECTION **RF**  
ROOF

A  
B  
C

D

E

F

G

H

I

J

RF

L

M

N

O

P

CONTENTS

<b>BASIC INSPECTION</b> .....	3	Component Inspection .....	12
<b>DIAGNOSIS AND REPAIR WORKFLOW</b> .....	3	<b>DOOR SWITCH</b> .....	13
WorkFlow .....	3	Description .....	13
<b>INSPECTION AND ADJUSTMENT</b> .....	4	Component Function Check .....	13
<b>ADDITIONAL SERVICE WHEN REPLACING CONTROL UNIT</b> .....	4	Diagnosis Procedure .....	13
ADDITIONAL SERVICE WHEN REPLACING CONTROL UNIT : Description .....	4	Component Inspection .....	14
ADDITIONAL SERVICE WHEN REPLACING CONTROL UNIT : Special Repair Requirement .....	4	<b>ECU DIAGNOSIS INFORMATION</b> .....	15
<b>SYSTEM DESCRIPTION</b> .....	5	<b>BCM (BODY CONTROL MODULE)</b> .....	15
<b>SUNROOF SYSTEM</b> .....	5	Reference Value .....	15
System Diagram .....	5	Wiring Diagram - BCM - .....	39
System Description .....	5	Fail-safe .....	45
Component Parts Location .....	6	DTC Inspection Priority Chart .....	47
Component Description .....	6	DTC Index .....	48
<b>DIAGNOSIS SYSTEM (BCM)</b> .....	7	<b>SUNROOF MOTOR ASSEMBLY</b> .....	51
<b>COMMON ITEM</b> .....	7	Reference Value .....	51
COMMON ITEM : CONSULT-III Function (BCM - COMMON ITEM) .....	7	Wiring Diagram - SUNROOF CONTROL SYSTEM - .....	52
<b>RETAIND PWR</b> .....	8	<b>SYMPTOM DIAGNOSIS</b> .....	58
RETAIND PWR : CONSULT-III Function (BCM - RETAINED PWR) .....	8	<b>SUNROOF DOES NOT OPERATE PROPERLY</b> .....	58
<b>DTC/CIRCUIT DIAGNOSIS</b> .....	9	Diagnosis Procedure .....	58
<b>POWER SUPPLY AND GROUND CIRCUIT</b> .....	9	<b>AUTO OPERATION DOES NOT OPERATE</b> .....	59
<b>BCM</b> .....	9	Diagnosis Procedure .....	59
BCM : Diagnosis Procedure .....	9	<b>DOES NOT STOP FULLY-OPEN OR FULLY-CLOSED POSITION</b> .....	60
<b>SUNROOF</b> .....	10	Diagnosis Procedure .....	60
Description .....	10	<b>RETAINED POWER OPERATION DOES NOT OPERATE PROPERLY</b> .....	61
Component Function Check .....	10	Diagnosis Procedure .....	61
Diagnosis Procedure .....	10	<b>SUNROOF DOES NOT OPERATE ANTI-PINCH FUNCTION</b> .....	62
		Diagnosis Procedure .....	62

<b>SQUEAK AND RATTLE TROUBLE DIAG- NOSES</b> .....	<b>63</b>	<b>REMOVAL AND INSTALLATION</b> .....	<b>72</b>
Work Flow .....	63	<b>GLASS LID</b> .....	<b>72</b>
Inspection Procedure .....	65	Exploded View .....	72
Diagnostic Worksheet .....	67	Removal and Installation .....	73
<b>PRECAUTION</b> .....	<b>69</b>	Adjustment .....	73
<b>PRECAUTIONS</b> .....	<b>69</b>	<b>SUNROOF MOTOR ASSEMBLY</b> .....	<b>75</b>
Precaution for Supplemental Restraint System (SRS) "AIR BAG" and "SEAT BELT PRE-TEN- SIONER" .....	69	Exploded View .....	75
Service Notice .....	69	Removal and Installation .....	75
Precaution for Work .....	69	<b>SUNROOF UNIT ASSEMBLY</b> .....	<b>77</b>
<b>PREPARATION</b> .....	<b>71</b>	Exploded View .....	77
<b>PREPARATION</b> .....	<b>71</b>	Removal and Installation .....	78
Special Service Tool .....	71	Disassembly and Assembly .....	79
Commercial Service Tool .....	71	<b>SUNSHADE</b> .....	<b>80</b>
		Exploded View .....	80
		Removal and Installation .....	80

# DIAGNOSIS AND REPAIR WORKFLOW

< BASIC INSPECTION >

## BASIC INSPECTION

### DIAGNOSIS AND REPAIR WORKFLOW

WorkFlow

INFOID:000000005630475

DETAILED FLOW

#### 1.OBTAIN INFORMATION ABOUT SYMPTOM

Interview the customer to obtain the malfunction information (conditions and environment when the malfunction occurred) as much as possible when the customer brings the vehicle in.

>> GO TO 2.

#### 2.REPRODUCE THE MALFUNCTION INFORMATION

Check the malfunction on the vehicle that the customer describes.  
Inspect the relation of the symptoms and the condition when the symptoms occur.

>> GO TO 3.

#### 3.IDENTIFY THE MALFUNCTIONING SYSTEM WITH "SYMPTOM DIAGNOSIS"

Use "Symptom diagnosis" from the symptom inspection result in step 2 and then identify where to start performing the diagnosis based on possible causes and symptoms.

>> GO TO 4.

#### 4.IDENTIFY THE MALFUNCTIONING PARTS WITH "COMPONENT DIAGNOSIS"

Perform the diagnosis with "Component diagnosis" of the applicable system.

>> GO TO 5.

#### 5.REPAIR OR REPLACE THE MALFUNCTIONING PARTS

Repair or replace the specified malfunctioning parts.

>> GO TO 6.

#### 6.FINAL CHECK

Check that malfunctions are not reproduced when obtaining the malfunction information from the customer, referring to the symptom inspection result in step 2.

Are the malfunctions corrected?

YES >> INSPECTION END

NO >> GO TO 3.

A  
B  
C  
D  
E  
F  
G  
H  
I  
J  
RF  
L  
M  
N  
O  
P

# INSPECTION AND ADJUSTMENT

< BASIC INSPECTION >

## INSPECTION AND ADJUSTMENT

### ADDITIONAL SERVICE WHEN REPLACING CONTROL UNIT

#### ADDITIONAL SERVICE WHEN REPLACING CONTROL UNIT : Description

INFOID:000000005630476

#### MEMORY RESET PROCEDURE

1. Please observe the following instructions at confirming the sunroof operation.

**NOTE:**

Do not disconnect the electronic power while the sunroof is operating or within 5 seconds after the sunroof stops (to wipe-out the memory of lid position and operating friction).

2. Initialization of system should be conducted after the following conditions.
  - When the sunroof motor is changed.
  - When the sunroof does not operate normally. (Incomplete initialization conditions)

#### ADDITIONAL SERVICE WHEN REPLACING CONTROL UNIT : Special Repair Requirement

INFOID:000000005630477

#### INITIALIZATION PROCEDURE

If the sunroof does not close or open automatically, use the following procedure to return sunroof operation to normal.

1. Press the tilt up switch and start the tilt up operation.
2. Release the tilt up switch once, press the tilt up switch again, press and hold the switch until lid pops up.
3. The glass lid moves slight toward tilt up direction then stop. (Press and hold the switch during this operation)
4. Release the switch again, and press the tilt up switch within the first 10 seconds. (Press and hold the switch)
5. After 4 seconds, the glass lid will be automatically operated in sequence of tilt down, slide open and slide close.
6. After the glass lid stops, release the switch 0.5 second later. (Press and hold the switch during this operation)
7. If slide switch operates normally, this initialization is done.

#### ANTI-PINCH FUNCTION

1. Full open the sunroof.
2. Place a wooden piece (wooden hammer handle, etc.) at near fully closed position.
3. Close the sunroof completely with auto-slide close.

Check that sunroof lowers for approximately 150 mm (5.91in) or 2 seconds with out pinching a wooden piece and stops.

**CAUTION:**

- Do not check with hands and other part of body because they may be pinched. Do not get pinched.
- Depending on environment and driving conditions, if a similar impact or load is applied to the sunroof it may lower.
- Check that auto-slide operates before inspection when system initialization is performed.
- Perform initial setting when auto-slide operation or anti-pinch function does not operate normally.

# SUNROOF SYSTEM

< SYSTEM DESCRIPTION >

## SYSTEM DESCRIPTION

### SUNROOF SYSTEM

#### System Diagram

INFOID:000000005630478

#### SUNROOF

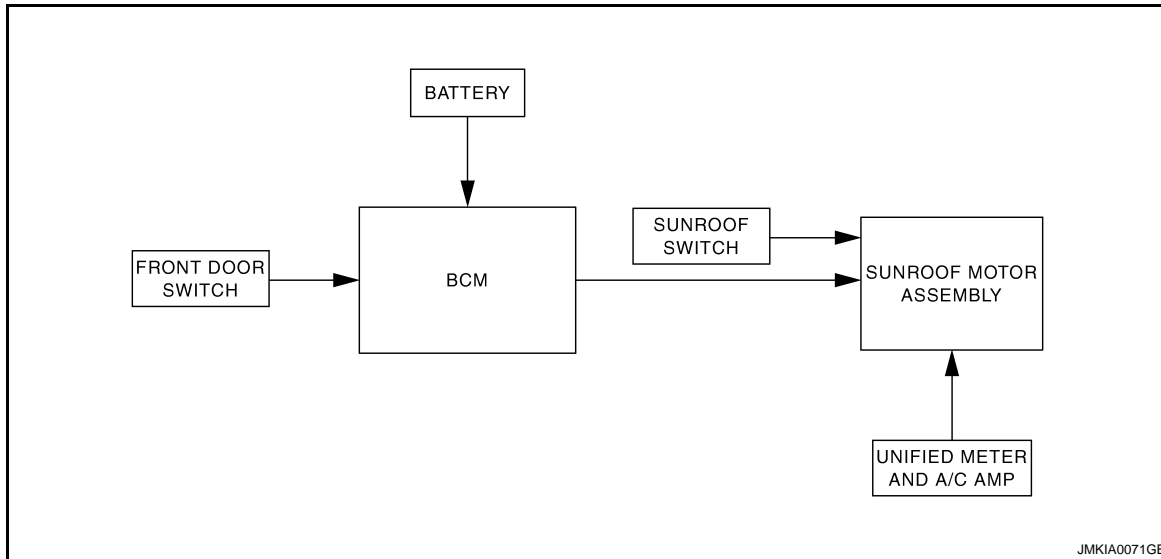

#### System Description

INFOID:000000005630479

### SUNROOF SYSTEM

#### INPUT/OUTPUT SIGNAL CHART

Item	Input signal to sunroof motor assembly	Sunroof motor function	Actuator
Sunroof switch	Sunroof switch signal (tilt down or slide open)	Sunroof control	Sunroof motor
	Sunroof switch signal (tilt up or slide close)		
Unified meter and A/C amp.	Vehicle speed signal		
BCM	RAP signal		

#### SUNROOF OPERATION

- Sunroof motor assembly operates with the power supply that is output from BCM while ignition switch is ON or retained power is operating.
- Tilt up/down & slide open/close signals from sunroof switch enables operate sunroof motor to move arbitrarily.
- Sunroof motor assembly receives a vehicle speed signal from unified meter and A/C amp. and controls the sunroof motor torque of tilt-down at the time of high speed operation.

#### AUTO OPERATION

Sunroof AUTO feature makes it possible to slide open and slide close or tilt up and tilt down the sunroof without holding the sunroof switch in the slide open/tilt down or slide close/tilt up position.

#### RETAINED POWER OPERATION

- Retained power operation is an additional power supply function that enables sunroof system to operate during 45 seconds even when ignition switch is turned OFF.

Retained power function cancel conditions

- Front door CLOSE (door switch OFF)→OPEN (door switch ON).
- When ignition switch is ON again.
- When timer time passes. (45 seconds)

# SUNROOF SYSTEM

## < SYSTEM DESCRIPTION >

### ANTI-PINCH FUNCTION

The CPU of sunroof motor assembly monitors the sunroof motor operation and the sunroof position (fully-closed or other) by the signals from sunroof motor.

When sunroof motor detects an interruption during the following slide close and tilt down operation, sunroof switch controls the motor for open and the sunroof will operate until full up position (when tilt down operate) or 150 mm (5.91 in) or more in an open direction (when slide close operate):

- close operation and tilt down when ignition switch is in the "ON" position

### Component Parts Location

INFOID:000000005630480

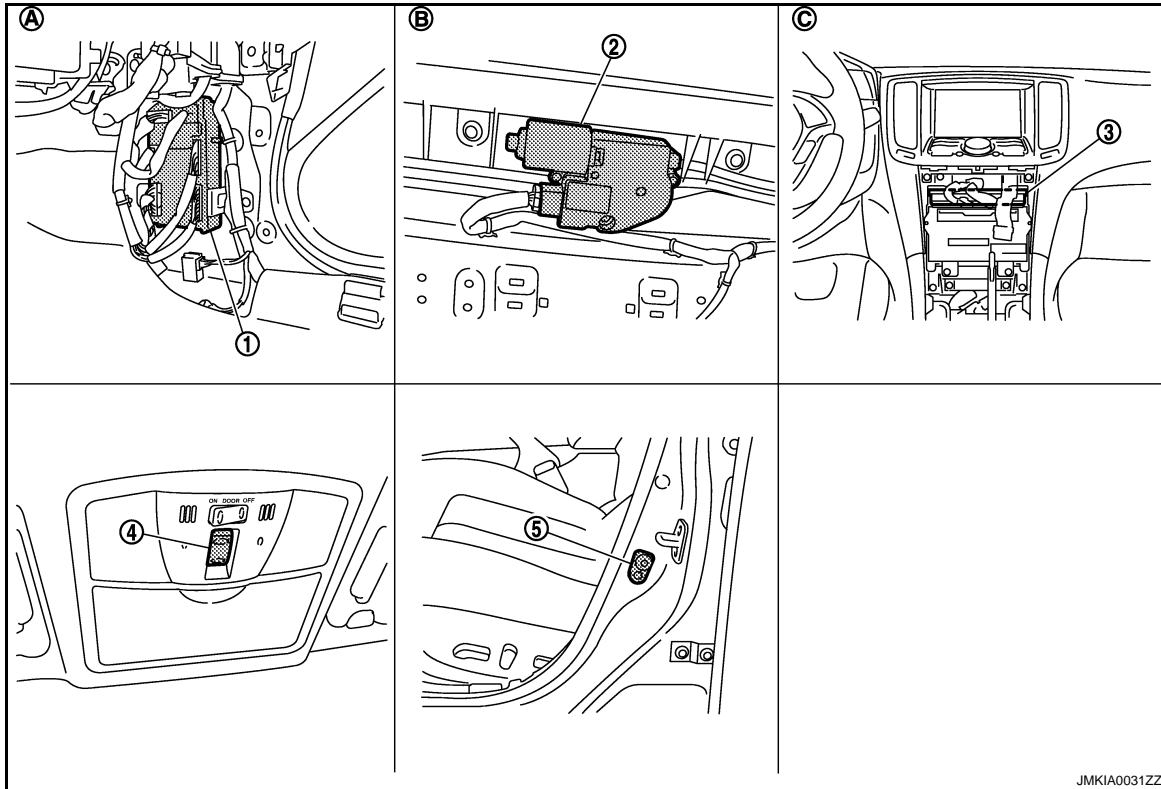

JMKIA0031ZZ

- |                         |  |                                   |
|-------------------------|--|-----------------------------------|
| 1. BCM M118, M119, M123 | 2. Sunroof motor assembly R4           | 3. Unified meter and A/C amp. M66 |
| 4. Sunroof switch R16   | 5. Front door switch (driver side) B16 |                                   |

- |  |                                 |                         |
|--|---------------------------------|-------------------------|
| A. View with dash side finisher RH removed | B. View with headlining removed | C. Behind cluster lid C |
|--|---------------------------------|-------------------------|

### Component Description

INFOID:000000005630481

Component	Function
BCM	Supplies the power supply to sunroof motor assembly.
Sunroof switch	Transmits tilt up/down & slides open/close operation signal to sunroof motor assembly.
Sunroof motor assembly	It is sunroof motor and CPU integrated type that enables tilt up/down & slide open/close by sunroof switch operation
Front door switch	Detects door open/close condition and transmits to BCM.
Unified meter and A/C amp.	Transmits vehicle speed signal to sunroof motor assembly.

# DIAGNOSIS SYSTEM (BCM)

< SYSTEM DESCRIPTION >

## DIAGNOSIS SYSTEM (BCM)

### COMMON ITEM

### COMMON ITEM : CONSULT-III Function (BCM - COMMON ITEM)

INFOID:000000005630482

### APPLICATION ITEM

CONSULT-III performs the following functions via CAN communication with BCM.

Diagnosis mode	Function Description
Work Support	Changes the setting for each system function.
Self Diagnostic Result	Displays the diagnosis results judged by BCM.
CAN Diag Support Monitor	Monitors the reception status of CAN communication viewed from BCM. Refer to CONSULT-III operation manual.
Data Monitor	The BCM input/output signals are displayed.
Active Test	The signals used to activate each device are forcibly supplied from BCM.
Ecu Identification	The BCM part number is displayed.
Configuration	This function is not used even though it is displayed.

### SYSTEM APPLICATION

BCM can perform the following functions for each system.

#### NOTE:

It can perform the diagnosis modes except the following for all sub system selection items.

×: Applicable item

System	Sub system selection item	Diagnosis mode		
		Work Support	Data Monitor	Active Test
Door lock	DOOR LOCK	×	×	×
Rear window defogger	REAR DEFOGGER		×	×
Warning chime	BUZZER		×	×
Interior room lamp timer	INT LAMP	×	×	×
Exterior lamp	HEAD LAMP	×	×	×
Wiper and washer	WIPER	×	×	×
Turn signal and hazard warning lamps	FLASHER	×	×	×
—	AIR CONDITONER*		×	
Intelligent Key system	INTELLIGENT KEY	×	×	×
Combination switch	COMB SW		×	
Body control system	BCM	×		
IVIS - NATS	IMMU		×	×
Interior room lamp battery saver	BATTERY SAVER	×	×	×
Trunk open	TRUNK		×	
Vehicle security system	THEFT ALM	×	×	×
RAP system	RETAINED PWR		×	
Signal buffer system	SIGNAL BUFFER		×	×
TPMS	TPMS (AIR PRESSURE MONITOR)	×	×	×

\*: This item is displayed, but is not used.

### FREEZE FRAME DATA (FFD) AND IGN COUNTER

#### Freeze Frame Data

The BCM records the following condition at the moment a particular DTC is detected.

- Vehicle Speed
- Odo/Trip Meter

# DIAGNOSIS SYSTEM (BCM)

## < SYSTEM DESCRIPTION >

- Vehicle Condition (BCM detected condition)

CONSULT screen terms	Description
SLEEP>LOCK	While turning BCM status from low power consumption mode to normal mode (Power supply position is "LOCK")
SLEEP>OFF	While turning BCM status from low power consumption mode to normal mode (Power supply position is "OFF".)
LOCK>ACC	While turning power supply position from "LOCK" to "ACC"
ACC>ON	While turning power supply position from "ACC" to "IGN"
RUN>ACC	While turning power supply position from "RUN" to "ACC" (Vehicle is stopping and selector lever is except P position.)
CRANK>RUN	While turning power supply position from "CRANKING" to "RUN" (From cranking up the engine to run it)
RUN>URGENT	While turning power supply position from "RUN" to "ACC" (Emergency stop operation)
ACC>OFF	While turning power supply position from "ACC" to "OFF"
OFF>LOCK	While turning power supply position from "OFF" to "LOCK"
OFF>ACC	While turning power supply position from "OFF" to "ACC"
ON>CRANK	While turning power supply position from "IGN" to "CRANKING"
OFF>SLEEP	While turning BCM status from normal mode (Power supply position is "OFF".) to low power consumption mode
LOCK>SLEEP	While turning BCM status from normal mode (Power supply position is "LOCK".) to low power consumption mode
LOCK	Power supply position is "LOCK" (Ignition switch OFF with steering is locked.)
OFF	Power supply position is "OFF" (Ignition switch OFF with steering is unlocked.)
ACC	Power supply position is "ACC" (Ignition switch ACC)
ON	Power supply position is "IGN" (Ignition switch ON with engine stopped)
ENGINE RUN	Power supply position is "RUN" (Ignition switch ON with engine running)
CRANKING	Power supply position is "CRANKING" (At engine cranking)

### IGN Counter

IGN counter indicates the number of times that ignition switch is turned ON after DTC is detected.

- The number is 0 when a malfunction is detected now.
- The number increases like 1 → 2 → 3...38 → 39 after returning to the normal condition whenever ignition switch OFF → ON.
- The number is fixed to 39 until the self-diagnosis results are erased if it is over 39.

### RETAINED PWR

#### RETAINED PWR : CONSULT-III Function (BCM - RETAINED PWR)

INFOID:000000005630483

#### Data monitor

Monitor Item	Description
DOOR SW-DR	Indicates [ON/OFF] condition of driver side door switch.
DOOR SW-AS	Indicates [ON/OFF] condition of passenger side door switch.



# POWER SUPPLY AND GROUND CIRCUIT

< DTC/CIRCUIT DIAGNOSIS >

## DTC/CIRCUIT DIAGNOSIS

### POWER SUPPLY AND GROUND CIRCUIT

#### BCM

#### BCM : Diagnosis Procedure

INFOID:000000005630484

#### 1. CHECK FUSE AND FUSIBLE LINK

Check that the following fuse and fusible link are not blown.

Terminal No.	Signal name	Fuse and fusible link No.
1	Battery power supply	K (40A)
11		10 (10A)

Is the fuse fusing?

YES >> Replace the blown fuse or fusible link after repairing the affected circuit if a fuse or fusible link is blown.

NO >> GO TO 2.

#### 2. CHECK POWER SUPPLY CIRCUIT

1. Turn ignition switch OFF.
2. Disconnect BCM connectors.
3. Check voltage between BCM harness connector and ground.

(+)		(-)	Voltage (Approx.)
BCM			
Connector	Terminal	Ground	Battery voltage
M118	1		
M119	11		

Is the measurement value normal?

YES >> GO TO 3.

NO >> Repair the harness or connector.

#### 3. CHECK GROUND CIRCUIT

Check continuity between BCM harness connector and ground.

BCM		Ground	Continuity
Connector	Terminal		
M119	13		Existed

Does continuity exist?

YES >> INSPECTION END

NO >> Repair the harness or connector.

A  
B  
C  
D  
E  
F  
G  
H  
I  
J  
RF  
L  
M  
N  
O  
P

# SUNROOF

< DTC/CIRCUIT DIAGNOSIS >

## SUNROOF

### Description

INFOID:000000005630485

- BCM supplies power.
- Sunroof motor assembly is sunroof motor and CPU integrated type.
- Tilts up/down & slides open/close by sunroof switch operation.
- In order to close sunroof lid certainly with the signal from unified meter and A/C amp. at the time of high speed run, the sunroof motor torque at the time of tilt-down operation is controlled.

### Component Function Check

INFOID:000000005630486

#### 1.CHECK SUNROOF FUNCTION

Check tilt up/down & slide open/close operations with sunroof switch.

Is the inspection result normal?

- YES >> Sunroof function is OK.  
NO >> Refer to [RF-10, "Diagnosis Procedure"](#).

### Diagnosis Procedure

INFOID:000000005630487

#### 1.CHECK POWER SUPPLY CIRCUIT

1. Turn ignition switch OFF.
2. Disconnect sunroof motor assembly connector.
3. Turn ignition switch ON.
4. Check voltage between sunroof motor assembly connector and ground.

(+)		(-)	Voltage (V) (Approx.)
Sunroof motor assembly			
Connector	Terminal	Ground	Battery voltage
R4	7		
	9		

Is the measurement value within the specification?

- YES >> GO TO 2.  
NO >> GO TO 3.

#### 2.CHECK GROUND CIRCUIT

1. Turn ignition switch OFF.
2. Check continuity between sunroof motor assembly connector and ground.

Sunroof motor assembly		Ground	Continuity
Connector	Terminal		
R4	10		Existed

Is the inspection result normal?

- YES >> GO TO 4.  
NO >> Repair or replace harness.

#### 3.CHECK SONROOF MOTOR CIRCUIT

1. Turn ignition switch OFF.
2. Disconnect BCM connector.
3. Check continuity between BCM connector and sunroof motor assembly connector.

BCM		Sunroof motor assembly		Continuity
Connector	Terminal	Connector	Terminal	
M118	2	R4	7	Existed
	3		9	

# SUNROOF

## < DTC/CIRCUIT DIAGNOSIS >

4. Check continuity between BCM connector and ground.

BCM		Ground	Continuity
Connector	Terminal		
M118	2		Not existed
	3		

Is the inspection result normal?

YES >> Replace BCM. Refer to [BCS-80. "Exploded View"](#).

NO >> Repair or replace harness.

## 4.CHECK SUNROOF SWITCH INPUT SIGNAL

1. Connect sunroof motor assembly connector.
2. Turn ignition switch ON.
3. Check voltage between sunroof motor assembly connector and ground.

(+)		(-)	Condition	Voltage (V) (Approx.)
Connector	Terminal			
R4	5	Ground	Sunroof switch is operated TILT DOWN or SLIDE OPEN	0
			Other than above	Battery voltage
	1		Sunroof switch is operated TILT UP or SLIDE CLOSE	0
			Other than above	Battery voltage

Is the measurement value within the specification?

YES >> Replace sunroof motor assembly.

NO >> GO TO 5.

## 5.CHECK SUNROOF SWITCH CIRCUIT

1. Turn ignition switch OFF.
2. Disconnect sunroof motor assembly connector and sunroof switch connector.
3. Check continuity between sunroof motor assembly connector and sunroof switch connector.

Sunroof motor assembly		Sunroof switch		Continuity
Connector	Terminal	Connector	Terminal	
R4	5	R16	1	Existed
	1		3	

4. Check continuity between sunroof motor assembly connector and ground.

Sunroof motor assembly		Ground	Continuity
Connector	Terminal		
R4	5		Not existed
	1		

Is the inspection result normal?

YES >> GO TO 6.

NO >> Repair or replace harness.

## 6.CHECK SUNROOF SWITCH GROUND CIRCUIT

Check continuity between sunroof switch connector and ground.

# SUNROOF

## < DTC/CIRCUIT DIAGNOSIS >

Sunroof switch		Ground	Continuity
Connector	Terminal		Existed
R16	2		

Is the inspection result normal?

YES >> GO TO 7.

NO >> Repair or replace harness.

### 7.CHECK SUNROOF SWITCH

Check sunroof switch.

Refer to [RF-12, "Component Inspection"](#).

Is the inspection normal?

YES >> GO TO 8.

NO >> Replace sunroof switch.

### 8.CHECK INTERMITTENT INCIDENT

Refer to [GI-38, "Intermittent Incident"](#).

>> INSPECTION END

## Component Inspection

INFOID:000000005630488

### SUNROOF SWITCH

#### 1.CHECK SUNROOF SWITCH

1. Turn ignition switch OFF.
2. Disconnect sunroof switch connector.
3. Check continuity sunroof switch terminals.

Terminals		Condition	Continuity
1	2	Sunroof switch is operated TILT DOWN or SLIDE OPEN	Existed
		Other than above	Not existed
3		Sunroof switch is operated TILT UP or SLIDE CLOSE	Existed
		Other than above	Not existed

Is the inspection result normal?

YES >> INSPECTION END

NO >> Replace sunroof switch.

# DOOR SWITCH

< DTC/CIRCUIT DIAGNOSIS >

## DOOR SWITCH

### Description

INFOID:000000005630489

Detects door open/close condition.

### Component Function Check

INFOID:000000005630490

### 1. CHECK FUNCTION

#### With CONSULT-III

Check door switches ("DOOR SW-DR", "DOOR SW-AS") in Data Monitor" mode with CONSULT-III.

Monitor item	Condition
DOOR SW-DR	CLOSE → OPEN: OFF → ON
DOOR SW-AS	

Is the inspection result normal?

YES >> Door switch is OK.

NO >> Refer to [RF-13, "Diagnosis Procedure"](#).

### Diagnosis Procedure

INFOID:000000005630491

### 1. CHECK DOOR SWITCH INPUT SIGNAL

1. Turn ignition switch OFF.
2. Disconnect door switch connector.
3. Check signal between door switch harness connector and ground with oscilloscope.

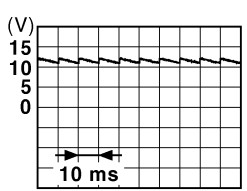
(+)		(-)	Voltage (V) (Approx.)
Door switch			
Connector	Terminal	Ground	 <small>JPMIA0011GB</small>
Front door switch (driver side)	B16		
Front door switch (passenger side)	B216	2	

Is the inspection result normal?

YES >> GO TO 3.

NO >> GO TO 2.

### 2. CHECK DOOR SWITCH CIRCUIT

1. Disconnect BCM connector and door switch connector.
2. Check continuity between BCM harness connector and door switch harness connector.

# DOOR SWITCH

## < DTC/CIRCUIT DIAGNOSIS >

BCM		Door switch		Continuity
Connector	Terminal	Connector	Terminal	
M123	150	B16 (Driver side)	2	Existed
	124	B216 (Passenger side)		

3. Check continuity between BCM harness connector and ground.

BCM		Ground	Continuity
Connector	Terminal		
M123	150		Not existed
	124		

Is the inspection result normal?

- YES >> Replace BCM. Refer to [BCS-80. "Exploded View"](#).  
 NO >> Repair or replace harness between BCM and door switch.

### 3.CHECK DOOR SWITCH

Refer to [RF-14. "Component Inspection"](#).

Is the inspection result normal?

- YES >> GO TO 4.  
 NO >> Replace malfunctioning door switch. Refer to [DLK-251. "Removal and Installation"](#).

### 4.CHECK INTERMITTENT INCIDENT

Refer to [GI-38. "Intermittent Incident"](#).

>> INSPECTION END

## Component Inspection

INFOID:000000005630492

### 1.CHECK DOOR SWITCH

1. Turn ignition switch OFF.  
 2. Disconnect door switch connector.  
 3. Check continuity between door switch terminal and ground.

Terminal		Door switch condition	Continuity
Door switch			
2	Ground part of door switch	Pressed	Not existed
		Released	Existed

Is the inspection result normal?

- YES >> INSPECTION END  
 NO >> Replace malfunctioning door switch. Refer to [DLK-251. "Removal and Installation"](#).

## BCM (BODY CONTROL MODULE)

< ECU DIAGNOSIS INFORMATION >

# ECU DIAGNOSIS INFORMATION

## BCM (BODY CONTROL MODULE)

Reference Value

INFOID:000000005883720

### VALUES ON THE DIAGNOSIS TOOL

CONSULT-III MONITOR ITEM

Monitor Item	Condition	Value/Status
FR WIPER HI	Other than front wiper switch HI	Off
	Front wiper switch HI	On
FR WIPER LOW	Other than front wiper switch LO	Off
	Front wiper switch LO	On
FR WASHER SW	Front washer switch OFF	Off
	Front washer switch ON	On
FR WIPER INT	Other than front wiper switch INT/AUTO	Off
	Front wiper switch INT/AUTO	On
FR WIPER STOP	Front wiper is not in STOP position	Off
	Front wiper is in STOP position	On
INT VOLUME	Wiper volume dial is in a dial position 1 - 7	Wiper volume dial position
TURN SIGNAL R	Other than turn signal switch RH	Off
	Turn signal switch RH	On
TURN SIGNAL L	Other than turn signal switch LH	Off
	Turn signal switch LH	On
TAIL LAMP SW	Other than lighting switch 1ST and 2ND	Off
	Lighting switch 1ST or 2ND	On
HI BEAM SW	Other than lighting switch HI	Off
	Lighting switch HI	On
HEAD LAMP SW 1	Other than lighting switch 2ND	Off
	Lighting switch 2ND	On
HEAD LAMP SW 2	Other than lighting switch 2ND	Off
	Lighting switch 2ND	On
PASSING SW	Other than lighting switch PASS	Off
	Lighting switch PASS	On
AUTO LIGHT SW	Other than lighting switch AUTO	Off
	Lighting switch AUTO	On
FR FOG SW	Front fog lamp switch OFF	Off
	Front fog lamp switch ON	On
RR FOG SW	<b>NOTE:</b> The item is indicated, but not monitored.	Off
DOOR SW-DR	Driver door closed	Off
	Driver door opened	On
DOOR SW-AS	Passenger door closed	Off
	Passenger door opened	On
DOOR SW-RR	Rear RH door closed	Off
	Rear LH door opened	On

## BCM (BODY CONTROL MODULE)

### < ECU DIAGNOSIS INFORMATION >

Monitor Item	Condition	Value/Status
DOOR SW-RL	Rear LH door closed	Off
	Rear LH door opened	On
DOOR SW-BK	<b>NOTE:</b> The item is indicated, but not monitored.	Off
CDL LOCK SW	Other than power door lock switch LOCK	Off
	Power door lock switch LOCK	On
CDL UNLOCK SW	Other than power door lock switch UNLOCK	Off
	Power door lock switch UNLOCK	On
KEY CYL LK-SW	Other than driver door key cylinder LOCK	Off
	Driver door key cylinder LOCK	On
KEY CYL UN-SW	Other than driver door key cylinder UNLOCK	Off
	Driver door key cylinder LOCK	On
KEY CYL SW-TR	<b>NOTE:</b> The item is indicated, but not monitored.	Off
HAZARD SW	Hazard switch is OFF	Off
	Hazard switch is ON	On
REAR DEF SW	<b>NOTE:</b> The item is indicated, but not monitored.	Off
H/L WASH SW	<b>NOTE:</b> The item is indicated, but not monitored.	Off
TR CANCEL SW	Trunk lid opener cancel switch OFF	Off
	Trunk lid opener cancel switch ON	On
TR/BD OPEN SW	Trunk lid opener switch OFF	Off
	While the trunk lid opener switch is turned ON	On
TRNK/HAT MNTR	Trunk lid closed	Off
	Trunk lid opened	On
RKE-LOCK	LOCK button of the Intelligent Key is not pressed	Off
	LOCK button of the Intelligent Key is pressed	On
RKE-UNLOCK	UNLOCK button of the Intelligent Key is not pressed	Off
	UNLOCK button of the Intelligent Key is pressed	On
RKE-TR/BD	TRUNK OPEN button of the Intelligent Key is not pressed	Off
	TRUNK OPEN button of the Intelligent Key is pressed	On
RKE-PANIC	PANIC button of the Intelligent Key is not pressed	Off
	PANIC button of the Intelligent Key is pressed	On
RKE-P/W OPEN	UNLOCK button of the Intelligent Key is not pressed	Off
	UNLOCK button of the Intelligent Key is pressed and held	On
RKE-MODE CHG	LOCK/UNLOCK button of the Intelligent Key is not pressed and held simultaneously	Off
	LOCK/UNLOCK button of the Intelligent Key is pressed and held simultaneously	On
OPTICAL SENSOR	Bright outside of the vehicle	Close to 5 V
	Dark outside of the vehicle	Close to 0 V
REQ SW -DR	Driver door request switch is not pressed	Off
	Driver door request switch is pressed	On
REQ SW -AS	Passenger door request switch is not pressed	Off
	Passenger door request switch is pressed	On



## BCM (BODY CONTROL MODULE)

### < ECU DIAGNOSIS INFORMATION >

Monitor Item	Condition	Value/Status	
REQ SW -RR	<b>NOTE:</b> The item is indicated, but not monitored.	Off	A
REQ SW -RL	<b>NOTE:</b> The item is indicated, but not monitored.	Off	B
REQ SW -BD/TR	Trunk lid opener request switch is not pressed	Off	C
	Trunk lid opener request switch is pressed	On	
PUSH SW	Push-button ignition switch (push switch) is not pressed	Off	D
	Push-button ignition switch (push switch) is pressed	On	
IGN RLY2 -F/B	Ignition switch in OFF or ACC position	Off	E
	Ignition switch in ON position	On	
ACC RLY -F/B	<b>NOTE:</b> The item is indicated, but not monitored.	Off	E
CLUCH SW	The clutch pedal is not depressed	Off	F
	The clutch pedal is depressed	On	
BRAKE SW 1	The brake pedal is depressed when No. 7 fuse is blown	Off	G
	The brake pedal is not depressed when No. 7 fuse is blown, or No. 7 fuse is normal	On	
BRAKE SW 2	The brake pedal is not depressed	Off	H
	The brake pedal is depressed	On	
DETE/CANCL SW	<ul style="list-style-type: none"> <li>• Selector lever in P position (Except M/T models)</li> <li>• The clutch pedal is depressed (M/T models)</li> </ul>	Off	I
	<ul style="list-style-type: none"> <li>• Selector lever in any position other than P (Except M/T models)</li> <li>• The clutch pedal is not depressed (M/T models)</li> </ul>	On	
SFT PN/N SW	Selector lever in any position other than P and N	Off	J
	Selector lever in P or N position	On	
S/L -LOCK	Steering is unlocked	Off	RF
	Steering is locked	On	
S/L -UNLOCK	Steering is locked	Off	
	Steering is unlocked	On	
S/L RELAY-F/B	Ignition switch in OFF or ACC position	Off	L
	Ignition switch in ON position	On	
UNLK SEN -DR	Driver door is unlocked	Off	M
	Driver door is locked	On	
PUSH SW -IPDM	Push-button ignition switch (push-switch) is not pressed	Off	N
	Push-button ignition switch (push-switch) is pressed	On	
IGN RLY1 -F/B	Ignition switch in OFF or ACC position	Off	O
	Ignition switch in ON position	On	
DETE SW -IPDM	Selector lever in any position other than P	Off	P
	Selector lever in P position	On	
SFT PN -IPDM	<ul style="list-style-type: none"> <li>• Selector lever in any position other than P and N (Except M/T models)</li> <li>• The clutch pedal is not depressed (M/T models)</li> </ul>	Off	
	<ul style="list-style-type: none"> <li>• Selector lever in P or N position (Except M/T models)</li> <li>• The clutch pedal is depressed (M/T models)</li> </ul>	On	
SFT P -MET	Selector lever in any position other than P	Off	
	Selector lever in P position	On	
SFT N -MET	Selector lever in any position other than N	Off	
	Selector lever in N position	On	

## BCM (BODY CONTROL MODULE)

### < ECU DIAGNOSIS INFORMATION >

Monitor Item	Condition	Value/Status
ENGINE STATE	Engine stopped	Stop
	While the engine stalls	Stall
	At engine cranking	Crank
	Engine running	Run
S/L LOCK-IPDM	Steering is unlocked	Off
	Steering is locked	On
S/L UNLK-IPDM	Steering is locked	Off
	Steering is unlocked	On
S/L RELAY-REQ	Steering lock system is not the LOCK condition and the changing condition from LOCK to UNLOCK	Off
	Steering lock system is the LOCK condition or the changing condition from LOCK to UNLOCK	On
VEH SPEED 1	While driving	Equivalent to speedometer reading
VEH SPEED 2	While driving	Equivalent to speedometer reading
DOOR STAT-DR	Driver door is locked	LOCK
	Wait with selective UNLOCK operation (60 seconds)	READY
	Driver door is unlocked	UNLOCK
DOOR STAT-AS	Passenger door is locked	LOCK
	Wait with selective UNLOCK operation (60 seconds)	READY
	Passenger door is unlocked	UNLOCK
ID OK FLAG	Steering is locked	Reset
	Steering is unlocked	Set
PRMT ENG STRT	The engine start is prohibited	Reset
	The engine start is permitted	Set
PRMT RKE STRT	<b>NOTE:</b> The item is indicated, but not monitored.	Reset
KEY SW -SLOT	The Intelligent Key is not inserted into key slot	Off
	The Intelligent Key is inserted into key slot	On
RKE OPE COUN1	During the operation of the Intelligent Key	Operation frequency of the Intelligent Key
RKE OPE COUN2	<b>NOTE:</b> The item is indicated, but not monitored.	—
CONFIRM ID ALL	The key ID that the key slot receives is not recognized by any key ID registered to BCM.	Yet
	The key ID that the key slot receives is recognized by any key ID registered to BCM.	Done
CONFIRM ID4	The key ID that the key slot receives is not recognized by the fourth key ID registered to BCM.	Yet
	The key ID that the key slot receives is recognized by the fourth key ID registered to BCM.	Done
CONFIRM ID3	The key ID that the key slot receives is not recognized by the third key ID registered to BCM.	Yet
	The key ID that the key slot receives is recognized by the third key ID registered to BCM.	Done

## BCM (BODY CONTROL MODULE)

### < ECU DIAGNOSIS INFORMATION >

Monitor Item	Condition	Value/Status	
CONFIRM ID2	The key ID that the key slot receives is not recognized by the second key ID registered to BCM.	Yet	A
	The key ID that the key slot receives is recognized by the second key ID registered to BCM.	Done	B
CONFIRM ID1	The key ID that the key slot receives is not recognized by the first key ID registered to BCM.	Yet	C
	The key ID that the key slot receives is recognized by the first key ID registered to BCM.	Done	
TP 4	The ID of fourth Intelligent Key is not registered to BCM	Yet	D
	The ID of fourth Intelligent Key is registered to BCM	Done	
TP 3	The ID of third Intelligent Key is not registered to BCM	Yet	E
	The ID of third Intelligent Key is registered to BCM	Done	
TP 2	The ID of second Intelligent Key is not registered to BCM	Yet	F
	The ID of second Intelligent Key is registered to BCM	Done	
TP 1	The ID of first Intelligent Key is not registered to BCM	Yet	
	The ID of first Intelligent Key is registered to BCM	Done	
AIR PRESS FL	Ignition switch ON (Only when the signal from the transmitter is received)	Air pressure of front LH tire	G
AIR PRESS FR	Ignition switch ON (Only when the signal from the transmitter is received)	Air pressure of front RH tire	H
AIR PRESS RR	Ignition switch ON (Only when the signal from the transmitter is received)	Air pressure of rear RH tire	I
AIR PRESS RL	Ignition switch ON (Only when the signal from the transmitter is received)	Air pressure of rear LH tire	
ID REGST FL1	ID of front LH tire transmitter is registered	Done	J
	ID of front LH tire transmitter is not registered	Yet	
ID REGST FR1	ID of front RH tire transmitter is registered	Done	
	ID of front RH tire transmitter is not registered	Yet	
ID REGST RR1	ID of rear RH tire transmitter is registered	Done	RF
	ID of rear RH tire transmitter is not registered	Yet	
ID REGST RL1	ID of rear LH tire transmitter is registered	Done	L
	ID of rear LH tire transmitter is not registered	Yet	
WARNING LAMP	Tire pressure indicator OFF	Off	M
	Tire pressure indicator ON	On	
BUZZER	Tire pressure warning alarm is not sounding	Off	N
	Tire pressure warning alarm is sounding	On	

# BCM (BODY CONTROL MODULE)

< ECU DIAGNOSIS INFORMATION >

## TERMINAL LAYOUT

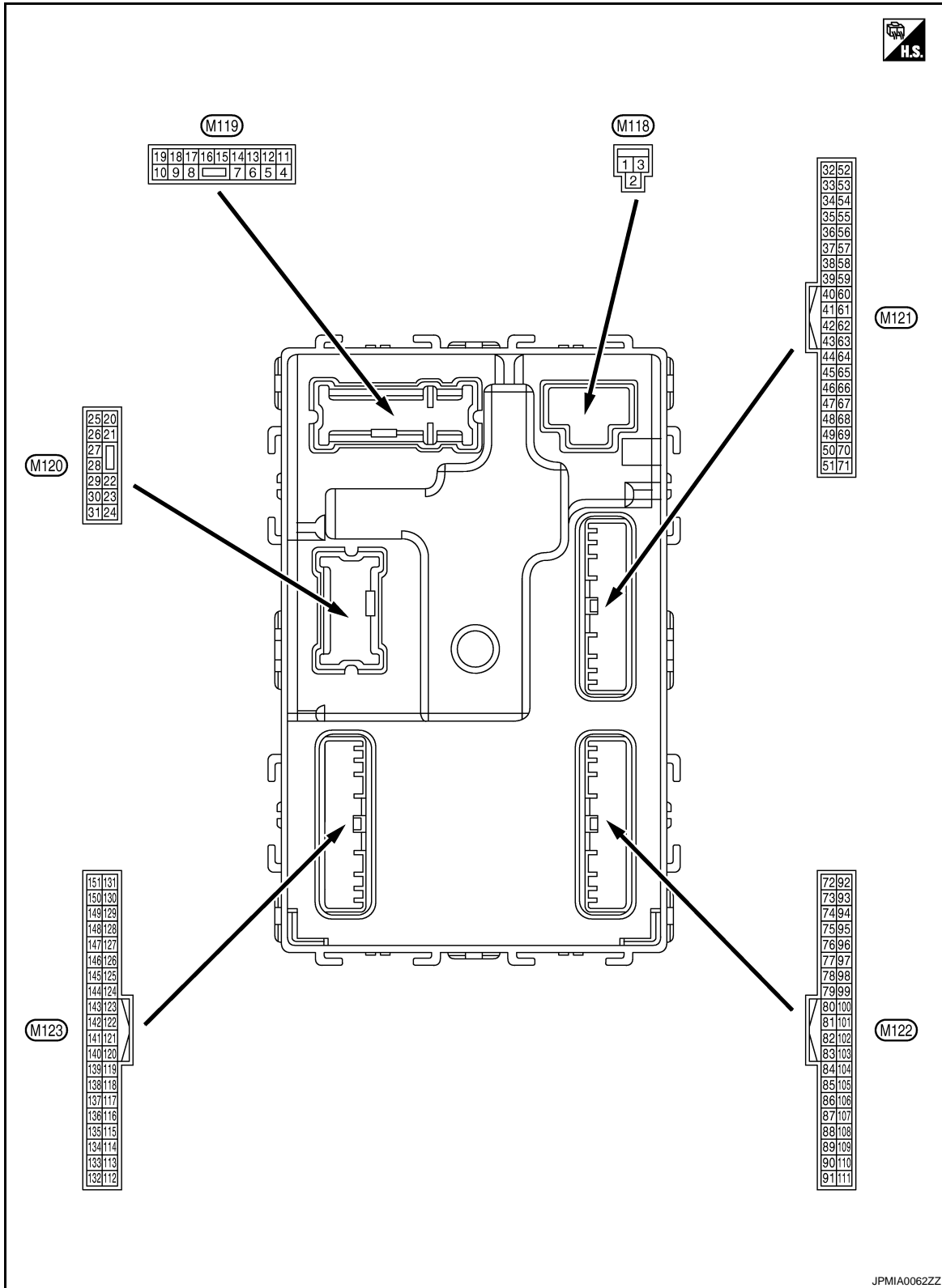

## PHYSICAL VALUES

# BCM (BODY CONTROL MODULE)

## < ECU DIAGNOSIS INFORMATION >

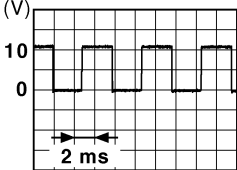
Terminal No. (Wire color)		Description		Condition		Value (Approx.)
+	-					
1 (W)	Ground	Battery power supply	Input	Ignition switch OFF		Battery voltage
2 (Y)	Ground	P/W power supply (BAT)	Output	Ignition switch OFF		12 V
3 (BG)	Ground	P/W power supply (RAP)	Output	Ignition switch ON		12 V
4 (LG)	Ground	Interior room lamp power supply	Output	Interior room lamp battery saver is activated. (Cuts the interior room lamp power supply)		0 V
				Interior room lamp battery saver is not activated. (Outputs the interior room lamp power supply)		12 V
5 (P)	Ground	Passenger door UN- LOCK	Output	Passenger door	UNLOCK (Actuator is activated)	12 V
					Other than UNLOCK) Ac- tuator is not activated	0 V
7 (SB)	Ground	Step lamp	Output	Step lamp	ON	0 V
					OFF	12 V
8 (V)	Ground	All doors, fuel lid LOCK	Output	All doors, fuel lid	LOCK (Actuator is activated)	12 V
					Other than LOCK (Actuator is not activated)	0 V
9 (G)	Ground	Driver door, fuel lid UNLOCK	Output	Driver door, fuel lid	UNLOCK (Actuator is activated)	12 V
					Other than UNLOCK (Actuator is not activated)	0 V
10 (P)	Ground	Rear RH door and rear LH door UN- LOCK	Output	Rear RH door and rear LH door	UNLOCK (Actuator is activated)	12 V
					Other than UNLOCK (Actuator is not activated)	0 V
11 (R)	Ground	Battery power supply	Input	Ignition switch OFF		Battery voltage
13 (B)	Ground	Ground	—	Ignition switch ON		0 V
14 (W)	Ground	Push-button ignition switch illumination ground	Output	Tail lamp	OFF	0 V
					ON	<p><b>NOTE:</b> When the illumination brighten- ing/dimming level is in the neutral position</p> 
15 (BG)	Ground	ACC indicator lamp	Output	Ignition switch	OFF (LOCK indicator is not illuminated)	Battery voltage
					ACC	0 V

A  
B  
C  
D  
E  
F  
G  
H  
I  
J  
RF  
L  
M  
N  
O  
P

# BCM (BODY CONTROL MODULE)

## < ECU DIAGNOSIS INFORMATION >

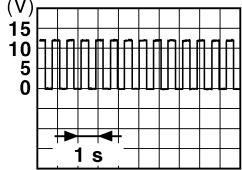
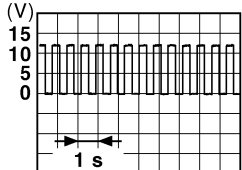
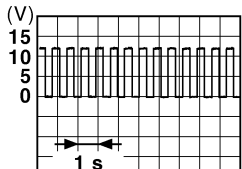
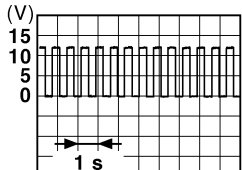
Terminal No. (Wire color)		Description		Condition	Value (Approx.)
+	-	Signal name	Input/ Output		
17 (W)	Ground	Turn signal RH (Front)	Output	Ignition switch ON	Turn signal switch OFF 0 V
				Turn signal switch RH	 <small>PKID0926E</small> 6.5 V
18 (BG)	Ground	Turn signal LH (Front)	Output	Ignition switch ON	Turn signal switch OFF 0 V
				Turn signal switch LH	 <small>PKID0926E</small> 6.5 V
19 (V)	Ground	Room lamp timer control	Output	Interior room lamp	OFF 12 V
				ON	0 V
20 (V)	Ground	Turn signal RH (Rear)	Output	Ignition switch ON	Turn signal switch OFF 0 V
				Turn signal switch RH	 <small>PKID0926E</small> 6.5 V
23 (LG)	Ground	Trunk lid open	Output	Trunk lid	OPEN (Trunk lid opener actuator is activated) 12 V
				Other than OPEN (Trunk lid opener actuator is not activated)	0 V
25 (Y)	Ground	Turn signal LH (Rear)	Output	Ignition switch ON	Turn signal switch OFF 0 V
				Turn signal switch LH	 <small>PKID0926E</small> 6.5 V
30 (P)	Ground	Trunk room lamp	Output	Trunk room lamp	ON 0 V
				OFF	12 V

# BCM (BODY CONTROL MODULE)

## < ECU DIAGNOSIS INFORMATION >

Terminal No. (Wire color)		Description		Condition	Value (Approx.)
+	-	Signal name	Input/ Output		
34 (SB)	Ground	Trunk room antenna (-)	Output	Ignition switch OFF	<p style="text-align: right; font-size: small;">JMKIA0062GB</p>
				When Intelligent Key is not in the passenger compart- ment	<p style="text-align: right; font-size: small;">JMKIA0063GB</p>
35 (V)	Ground	Trunk room antenna (+)	Output	Ignition switch OFF	<p style="text-align: right; font-size: small;">JMKIA0062GB</p>
				When Intelligent Key is not in the passenger compart- ment	<p style="text-align: right; font-size: small;">JMKIA0063GB</p>
38 (B)	Ground	Rear bumper anten- na (-)	Output	When the trunk lid opener re- quest switch is operated with ignition switch OFF	<p style="text-align: right; font-size: small;">JMKIA0062GB</p>
				When Intelligent Key is not in the antenna detection area	<p style="text-align: right; font-size: small;">JMKIA0063GB</p>

A  
B  
C  
D  
E  
F  
G  
H  
I  
J  
L  
M  
N  
O  
P

RF

# BCM (BODY CONTROL MODULE)

## < ECU DIAGNOSIS INFORMATION >

Terminal No. (Wire color)		Description		Condition	Value (Approx.)
+	-	Signal name	Input/ Output		
39 (W)	Ground	Rear bumper antenna (+)	Output	When Intelligent Key is in the antenna detection area	
				When the trunk lid opener request switch is operated with ignition switch OFF	
47 (Y)	Ground	Ignition relay (IPDM E/R) control	Output	Ignition switch	OFF or ACC ON
				OFF or ACC ON	12 V 0 V
50 (BG)	Ground	Trunk room lamp switch	Input	Trunk room lamp switch	OFF (Trunk lid is closed)
				OFF (Trunk lid is closed)	
52 (R)	Ground	Starter relay control	Output	Ignition switch ON (A/T models)	When selector lever is in P or N position When selector lever is not in P or N position
				Ignition switch ON (M/T models)	When the clutch pedal is depressed When the clutch pedal is not depressed
				When selector lever is in P or N position	12 V 0 V
				When the clutch pedal is depressed When the clutch pedal is not depressed	Battery voltage 0 V
61 (SB)	Ground	Trunk lid opener request switch	Input	Trunk lid opener request switch	ON (Pressed) OFF (Not pressed)
				OFF (Not pressed)	
64 (G)	Ground	Intelligent Key warning buzzer (Engine room)	Output	Intelligent Key warning buzzer (Engine room)	Sounding Not sounding
				Sounding Not sounding	0 V 12 V



# BCM (BODY CONTROL MODULE)

## < ECU DIAGNOSIS INFORMATION >

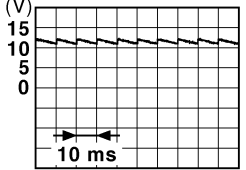
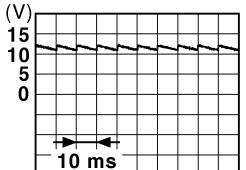
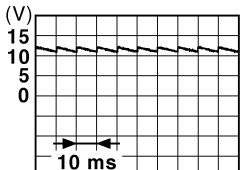
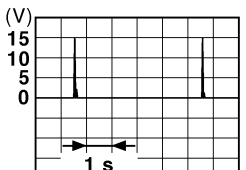
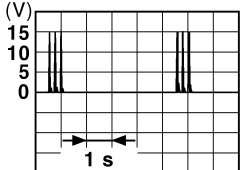
Terminal No. (Wire color)		Description		Condition	Value (Approx.)	
+	-	Signal name	Input/ Output			
67 (GR)	Ground	Trunk lid opener switch	Input	Trunk lid opener switch	Pressed	0 V
					Not pressed	 11.8 V
68 (BG)	Ground	Rear RH door switch	Input	Rear RH door switch	OFF (When rear RH door closes)	 11.8 V
					ON (When rear RH door opens)	0 V
69 (L)	Ground	Rear LH door switch	Input	Rear LH door switch	OFF (When rear LH door closes)	 11.8 V
					ON (When rear LH door opens)	0 V
72 (R)	Ground	Room antenna 2 (-) (Center console)	Output	Ignition switch OFF	When Intelligent Key is in the passenger compartment	 
					When Intelligent Key is not in the passenger compartment	 

A  
B  
C  
D  
E  
F  
G  
H  
I  
J  
RF  
L  
M  
N  
O  
P

# BCM (BODY CONTROL MODULE)

## < ECU DIAGNOSIS INFORMATION >

Terminal No. (Wire color)		Description		Condition	Value (Approx.)
+	-	Signal name	Input/ Output		
73 (G)	Ground	Room antenna 2 (+) (Center console)	Output	Ignition switch OFF	<p style="text-align: right; font-size: small;">JMKIA0062GB</p>
				When Intelligent Key is not in the passenger compart- ment	<p style="text-align: right; font-size: small;">JMKIA0063GB</p>
74 (SB)	Ground	Passenger door an- tenna (-)	Output	When the pas- senger door re- quest switch is operated with ignition switch OFF	<p style="text-align: right; font-size: small;">JMKIA0062GB</p>
				When Intelligent Key is not in the antenna detection area	<p style="text-align: right; font-size: small;">JMKIA0063GB</p>
75 (BR)	Ground	Passenger door an- tenna (+)	Output	When the pas- senger door re- quest switch is operated with ignition switch OFF	<p style="text-align: right; font-size: small;">JMKIA0062GB</p>
				When Intelligent Key is not in the antenna detection area	<p style="text-align: right; font-size: small;">JMKIA0063GB</p>

# BCM (BODY CONTROL MODULE)

## < ECU DIAGNOSIS INFORMATION >

Terminal No. (Wire color)		Description		Condition	Value (Approx.)
+	-	Signal name	Input/ Output		
76 (V)	Ground	Driver door antenna (-)	Output	When the driver door request switch is operated with ignition switch OFF	<p style="text-align: right; font-size: small;">JMKIA0062GB</p>
				When Intelligent Key is not in the antenna detection area	<p style="text-align: right; font-size: small;">JMKIA0063GB</p>
77 (LG)	Ground	Driver door antenna (+)	Output	When the driver door request switch is operated with ignition switch OFF	<p style="text-align: right; font-size: small;">JMKIA0062GB</p>
				When Intelligent Key is not in the antenna detection area	<p style="text-align: right; font-size: small;">JMKIA0063GB</p>
78 (Y)	Ground	Room antenna 1 (-) (Instrument panel)	Output	Ignition switch OFF	<p style="text-align: right; font-size: small;">JMKIA0062GB</p>
				When Intelligent Key is not in the passenger compartment	<p style="text-align: right; font-size: small;">JMKIA0063GB</p>

A  
B  
C  
D  
E  
F  
G  
H  
I  
J  
RF  
L  
M  
N  
O  
P

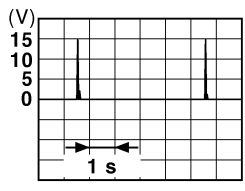
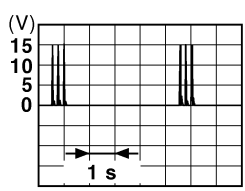
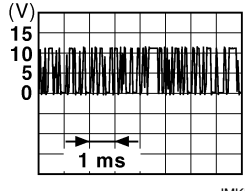
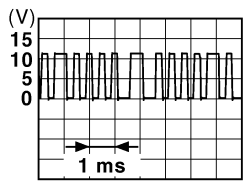

# BCM (BODY CONTROL MODULE)

## < ECU DIAGNOSIS INFORMATION >

Terminal No. (Wire color)		Description		Condition	Value (Approx.)	
+	-	Signal name	Input/ Output			
79 (BR)	Ground	Room antenna 1 (+) (Instrument panel)	Output	Ignition switch OFF		
				When Intelligent Key is not in the passenger compart- ment		
80 (GR)	Ground	NATS antenna amp.	Input/ Output	During waiting	Ignition switch is pressed while inserting the Intelli- gent Key into the key slot.	Just after pressing ignition switch. Pointer of tester should move.
81 (W)	Ground	NATS antenna amp.	Input/ Output	During waiting	Ignition switch is pressed while inserting the Intelli- gent Key into the key slot.	Just after pressing ignition switch. Pointer of tester should move.
82 (SB)	Ground	Ignition relay [Fuse block (J/B)] control	Output	Ignition switch	OFF or ACC	0 V
					ON	12 V
83 (Y)	Ground	Remote keyless entry receiver communica- tion	Input/ Output	During waiting		
				When operating either button on the Intelli- gent Key		

# BCM (BODY CONTROL MODULE)

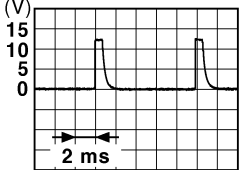
## < ECU DIAGNOSIS INFORMATION >

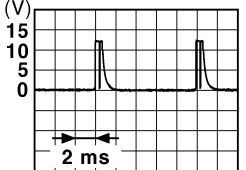

Terminal No. (Wire color)		Description		Condition	Value (Approx.)	
		Signal name	Input/ Output			
+	-					
87 (Y)	Ground	Combination switch INPUT 5	Input	Combination switch	All switches OFF (Wiper volume dial 4)	 <p style="text-align: right;">1.4 V</p>
					Front fog lamp switch ON (Wiper volume dial 4)	 <p style="text-align: right;">1.3 V</p>
					Any of the conditions below with all switches OFF <ul style="list-style-type: none"> <li>• Wiper volume dial 1</li> <li>• Wiper volume dial 2</li> <li>• Wiper volume dial 6</li> <li>• Wiper volume dial 7</li> </ul>	 <p style="text-align: right;">1.3 V</p>

A  
B  
C  
D  
E  
F  
G  
H  
I  
J

RF

# BCM (BODY CONTROL MODULE)

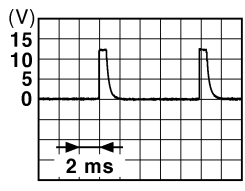
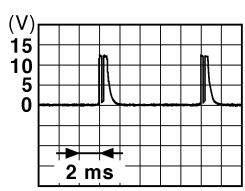
## < ECU DIAGNOSIS INFORMATION >

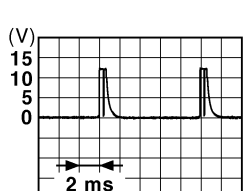
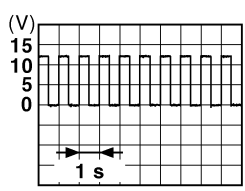
Terminal No. (Wire color)		Description		Condition	Value (Approx.)	
+	-	Signal name	Input/ Output			
88 (BG)	Ground	Combination switch INPUT 3	Input	Combination switch	All switches OFF (Wiper volume dial 4)	 <p style="text-align: right; font-size: small;">JPMIA0041GB</p> <p style="text-align: center;">1.4 V</p>
					Lighting switch HI (Wiper volume dial 4)	 <p style="text-align: right; font-size: small;">JPMIA0036GB</p> <p style="text-align: center;">1.3 V</p>
					Lighting switch 2ND (Wiper volume dial 4)	 <p style="text-align: right; font-size: small;">JPMIA0037GB</p> <p style="text-align: center;">1.3 V</p>
					Any of the conditions below with all switches OFF <ul style="list-style-type: none"> <li>• Wiper volume dial 1</li> <li>• Wiper volume dial 2</li> <li>• Wiper volume dial 3</li> </ul>	 <p style="text-align: right; font-size: small;">JPMIA0040GB</p> <p style="text-align: center;">1.3 V</p>
89 (BR)	Ground	Push-button ignition switch (Push switch)	Input	Push-button ignition switch (push switch)	Pressed	0 V
					Not pressed	Battery voltage
90 (P)	Ground	CAN-L	Input/ Output	—	—	
91 (L)	Ground	CAN-H	Input/ Output	—	—	
92 (LG)	Ground	Key slot illumination	Output	Key slot illumina- tion	OFF	0 V
					Blinking	 <p style="text-align: right; font-size: small;">JPMIA0015GB</p> <p style="text-align: center;">6.5 V</p>
					ON	12 V

# BCM (BODY CONTROL MODULE)

## < ECU DIAGNOSIS INFORMATION >

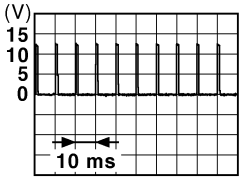
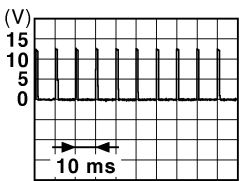

Terminal No. (Wire color)		Description		Condition		Value (Approx.)
+	-	Signal name	Input/ Output			
93 (GR)	Ground	ON indicator lamp	Output	Ignition switch	OFF (LOCK indicator is not illuminated)	Battery voltage
					ON	0 V
95 (BG)	Ground	ACC relay control	Output	Ignition switch	OFF	0 V
					ACC or ON	12 V
96 (GR)	Ground	A/T shift selector (Detention switch) power supply	Output	—		12 V
97 (L)	Ground	Steering lock condition No. 1	Input	Steering lock	LOCK status	0 V
					UNLOCK status	12 V
98 (P)	Ground	Steering lock condition No. 2	Input	Steering lock	LOCK status	12 V
					UNLOCK status	0 V
99 (R)*1 (BR)*2	Ground	Selector lever P position switch (A/T models)	Input	Selector lever	P position	0 V
					Any position other than P	12 V
		ASCD clutch switch (M/T models without ICC)		ASCD clutch switch	OFF (Clutch pedal is depressed)	0 V
					ON (Clutch pedal is not depressed)	12 V
		ICC clutch switch (M/T models with ICC)		ICC clutch switch	OFF (Clutch pedal is depressed)	0 V
					ON (Clutch pedal is not depressed)	12 V
100 (Y)	Ground	Passenger door request switch	Input	Passenger door request switch	ON (Pressed)	0 V
					OFF (Not pressed)	 1.0 V
101 (P)	Ground	Driver door request switch	Input	Driver door request switch	ON (Pressed)	0 V
					OFF (Not pressed)	 1.0 V
102 (BG)	Ground	Blower fan motor relay control	Output	Ignition switch	OFF or ACC	0 V
					ON	12 V
103 (P)	Ground	Remote keyless entry receiver power supply	Output	Ignition switch OFF		12 V
106 (SB)	Ground	Steering lock unit power supply	Output	Ignition switch	OFF or ACC	12 V
					ON	0 V

A  
B  
C  
D  
E  
F  
G  
H  
I  
J  
L  
M  
N  
O  
P

RF

# BCM (BODY CONTROL MODULE)

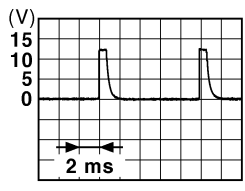
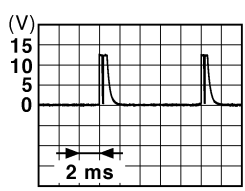

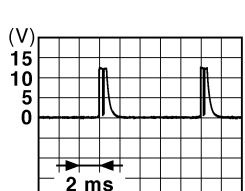
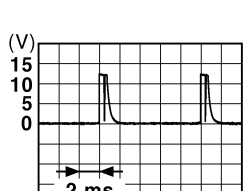
## < ECU DIAGNOSIS INFORMATION >

Terminal No. (Wire color)		Description		Condition	Value (Approx.)	
+	-	Signal name	Input/ Output			
107 (LG)	Ground	Combination switch INPUT 1	Input	Combination switch (Wiper volume dial 4)	All switches OFF	 <p style="text-align: right;">JPMIA0041GB</p> <p style="text-align: center;">1.4 V</p>
					Turn signal switch LH	 <p style="text-align: right;">JPMIA0037GB</p> <p style="text-align: center;">1.3 V</p>
					Turn signal switch RH	 <p style="text-align: right;">JPMIA0036GB</p> <p style="text-align: center;">1.3 V</p>
					Front wiper switch LO	 <p style="text-align: right;">JPMIA0038GB</p> <p style="text-align: center;">1.3 V</p>
					Front washer switch ON	 <p style="text-align: right;">JPMIA0039GB</p> <p style="text-align: center;">1.3 V</p>

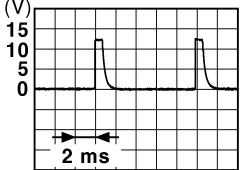

# BCM (BODY CONTROL MODULE)

## < ECU DIAGNOSIS INFORMATION >

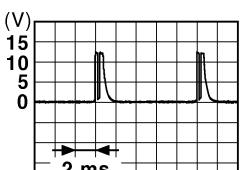
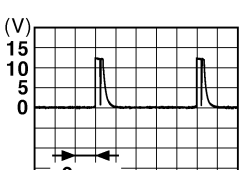



Terminal No. (Wire color)		Description		Condition	Value (Approx.)
		Signal name	Input/ Output		
+	-				
108 (R)	Ground	Combination switch INPUT 4	Input	Combination switch	All switches OFF (Wiper volume dial 4) <div style="text-align: right;">  <p>1.4 V</p> </div>
					Lighting switch AUTO (Wiper volume dial 4) <div style="text-align: right;">  <p>1.3 V</p> </div>
					Lighting switch 1ST (Wiper volume dial 4) <div style="text-align: right;">  <p>1.3 V</p> </div>
					Any of the conditions below with all switches OFF <ul style="list-style-type: none"> <li>• Wiper volume dial 1</li> <li>• Wiper volume dial 5</li> <li>• Wiper volume dial 6</li> </ul> <div style="text-align: right;">  <p>1.3 V</p> </div>

A  
B  
C  
D  
E  
F  
G  
H  
I  
J  
L  
M  
N  
O  
P

RF

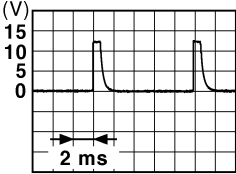
# BCM (BODY CONTROL MODULE)

## < ECU DIAGNOSIS INFORMATION >

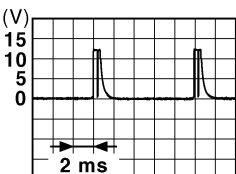
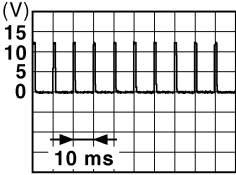
Terminal No. (Wire color)		Description		Condition	Value (Approx.)	
+	-	Signal name	Input/ Output			
109 (W)	Ground	Combination switch INPUT 2	Input	Combination switch (Wiper volume dial 4)	All switches OFF	 <p style="text-align: right; font-size: small;">JPMIA0041GB</p> <p style="text-align: center;">1.4 V</p>
					Lighting switch PASS	 <p style="text-align: right; font-size: small;">JPMIA0037GB</p> <p style="text-align: center;">1.3 V</p>
					Lighting switch 2ND	 <p style="text-align: right; font-size: small;">JPMIA0036GB</p> <p style="text-align: center;">1.3 V</p>
					Front wiper switch INT/ AUTO	 <p style="text-align: right; font-size: small;">JPMIA0038GB</p> <p style="text-align: center;">1.3 V</p>
					Front wiper switch HI	 <p style="text-align: right; font-size: small;">JPMIA0040GB</p> <p style="text-align: center;">1.3 V</p>
					ON	0 V
110 (G)	Ground	Hazard switch	Input	Hazard switch	OFF	 <p style="text-align: right; font-size: small;">JPMIA0012GB</p> <p style="text-align: center;">1.1 V</p>

# BCM (BODY CONTROL MODULE)

## < ECU DIAGNOSIS INFORMATION >

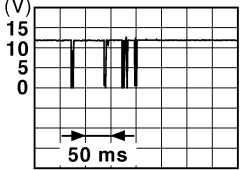
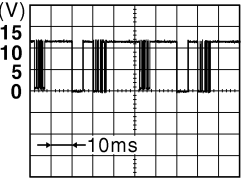
Terminal No. (Wire color)		Description		Condition	Value (Approx.)	
+	-	Signal name	Input/ Output			
111 (Y)	Ground	Steering lock unit communication	Input/ Output	Steering lock	LOCK status	12 V
					LOCK or UNLOCK	 <p style="text-align: right; font-size: small;">JMKIA0066GB</p>
					For 15 seconds after UN- LOCK	12 V
				15 seconds or later after UNLOCK	0 V	
112 (R)	Ground	Light and rain sensor serial link	Input/ Output	Ignition switch ON	 <p style="text-align: right; font-size: small;">JPMIA0156GB</p>	
113 (BG)	Ground	Optical sensor	Input	Ignition switch ON	Close to 5 V	
				When dark outside of the vehicle	Close to 0 V	
114 (R)	Ground	Clutch interlock switch	Input	Clutch interlock switch	OFF (Clutch pedal is not depressed)	
				ON (Clutch pedal is de- pressed)	Battery voltage	
116 (SB)	Ground	Stop lamp switch 1	Input	—	Battery voltage	
118 (BR)	Ground	Stop lamp switch 2 (Without ICC)	Input	Stop lamp switch	OFF (Brake pedal is not depressed)	
				ON (Brake pedal is de- pressed)	Battery voltage	
		Stop lamp switch 2 (With ICC)		Stop lamp switch OFF (Brake pedal is not depressed) and ICC brake hold relay OFF	0 V	
				Stop lamp switch ON (Brake pedal is de- pressed) or ICC brake hold relay ON	Battery voltage	
119 (SB)	Ground	Front door lock as- sembly driver side (Unlock sensor)	Input	Driver door	LOCK status (Unlock sensor switch OFF)	
				UNLOCK status (Unlock switch sensor ON)	0 V	

A  
B  
C  
D  
E  
F  
G  
H  
I  
J  
RF  
L  
M  
N  
O  
P

# BCM (BODY CONTROL MODULE)

## < ECU DIAGNOSIS INFORMATION >

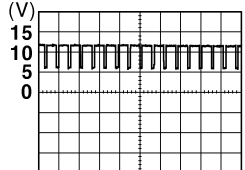
Terminal No. (Wire color)		Description		Condition	Value (Approx.)	
+	-	Signal name	Input/ Output			
121 (SB)	Ground	Key slot switch	Input	When the Intelligent Key is inserted into key slot	12 V	
				When the Intelligent Key is not inserted into key slot	0 V	
123 (V)	Ground	IGN feedback	Input	Ignition switch	OFF or ACC	
					ON	Battery voltage
124 (R)	Ground	Passenger door switch	Input	Passenger door switch	OFF (Door close)	
					ON (Door open)	0 V
129 (BG)	Ground	Trunk lid opener cancel switch	Input	Trunk lid opener cancel switch	CANCEL	
					ON	0 V
132 (V)	Ground	Power window switch communication	Input/ Output	Ignition switch ON	10.2 V	
				Ignition switch OFF or ACC	12 V	
133 (L)	Ground	Push-button ignition switch illumination	Output	Push-button ignition switch illumination	ON (Tail lamps OFF)	
					ON (Tail lamps ON)	<p><b>NOTE:</b> The pulse width of this wave is varied by the illumination brightening/dimming level.</p> 
					OFF	0 V
134 (LG)	Ground	LOCK indicator lamp	Output	LOCK indicator lamp	OFF	
					ON	0 V
137 (BG)	Ground	Receiver and sensor ground	Input	Ignition switch ON	0 V	

# BCM (BODY CONTROL MODULE)

## < ECU DIAGNOSIS INFORMATION >

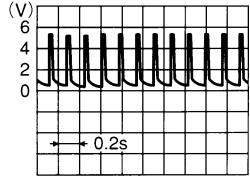
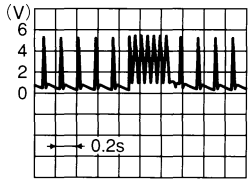
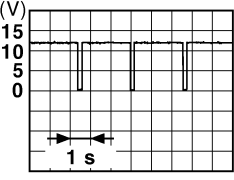
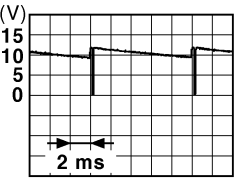
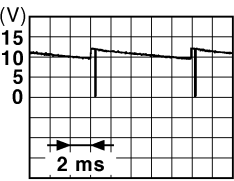
Terminal No. (Wire color)		Description		Condition		Value (Approx.)
		Signal name	Input/ Output			
+	-					
138 (V)	Ground	Receiver and sensor power supply	Output	Ignition switch	OFF	0 V
					ACC or ON	5.0 V
139 (L)	Ground	Tire pressure receiver communication	Input/ Output	Ignition switch ON	Standby state	 OCC3881D
					When receiving the signal from the transmitter	 OCC3880D
140 (B)	Ground	Selector lever P/N position	Input	Selector lever	P or N position	12 V
					Except P and N positions	0 V
141 (W)	Ground	Security indicator	Output	Security indicator	ON	0 V
					Blinking	 JPMA0014GB
					OFF	12 V
142 (BR)	Ground	Combination switch OUTPUT 5	Output	Combination switch (Wiper volume dial 4)	All switches OFF	0 V
					Lighting switch 1ST	 JPMA0031GB
					Lighting switch HI	
					Lighting switch 2ND	
					Turn signal switch RH	
143 (P)	Ground	Combination switch OUTPUT 1	Output	Combination switch	All switches OFF (Wiper volume dial 4)	0 V
					Front wiper switch HI (Wiper volume dial 4)	 JPMA0032GB
					Any of the conditions below with all switches OFF <ul style="list-style-type: none"> <li>• Wiper volume dial 1</li> <li>• Wiper volume dial 2</li> <li>• Wiper volume dial 3</li> <li>• Wiper volume dial 6</li> <li>• Wiper volume dial 7</li> </ul>	

A  
B  
C  
D  
E  
F  
G  
H  
I  
J  
L  
M  
N  
O  
P

RF

# BCM (BODY CONTROL MODULE)

## < ECU DIAGNOSIS INFORMATION >

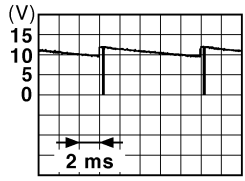
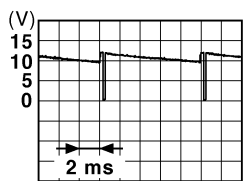
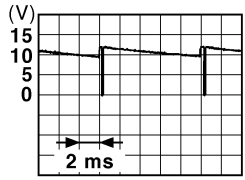
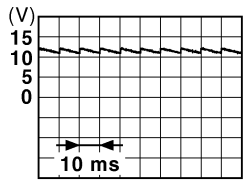
Terminal No. (Wire color)		Description		Condition	Value (Approx.)	
+	-	Signal name	Input/ Output			
144 (G)	Ground	Combination switch OUTPUT 2	Output	Combination switch	All switches OFF (Wiper volume dial 4)	0 V
					Front washer switch ON (Wiper volume dial 4)	 <p style="text-align: right; font-size: small;">JPMAI0033GB</p>
Any of the conditions below with all switches OFF					10.7 V	
<ul style="list-style-type: none"> <li>• Wiper volume dial 1</li> <li>• Wiper volume dial 5</li> <li>• Wiper volume dial 6</li> </ul>						
145 (L)	Ground	Combination switch OUTPUT 3	Output	Combination switch (Wiper volume dial 4)	All switches OFF	0 V
					Front wiper switch INT/ AUTO	 <p style="text-align: right; font-size: small;">JPMAI0034GB</p>
					Front wiper switch LO	
Lighting switch AUTO					10.7 V	
146 (SB)	Ground	Combination switch OUTPUT 4	Output	Combination switch (Wiper volume dial 4)	All switches OFF	0 V
					Front fog lamp switch ON	 <p style="text-align: right; font-size: small;">JPMAI0035GB</p>
					Lighting switch 2ND	
					Lighting switch PASS	
Turn signal switch LH					10.7 V	
149 (W)	Ground	Tire pressure warning check switch	Input	—	12 V	
150 (GR)	Ground	Driver door switch	Input	Driver door switch	OFF (Door close)	 <p style="text-align: right; font-size: small;">JPMAI0011GB</p>
					ON (Door open)	0 V
151 (G)	Ground	Rear window defog- ger relay control	Output	Rear window defogger	Active	0 V
				Not activated	Battery voltage	

- \*1: A/T models
- \*2: M/T models



# BCM (BODY CONTROL MODULE)

< ECU DIAGNOSIS INFORMATION >

A : With A/T  
M : With M/T  
IC : With ICC  
OI : Without ICC

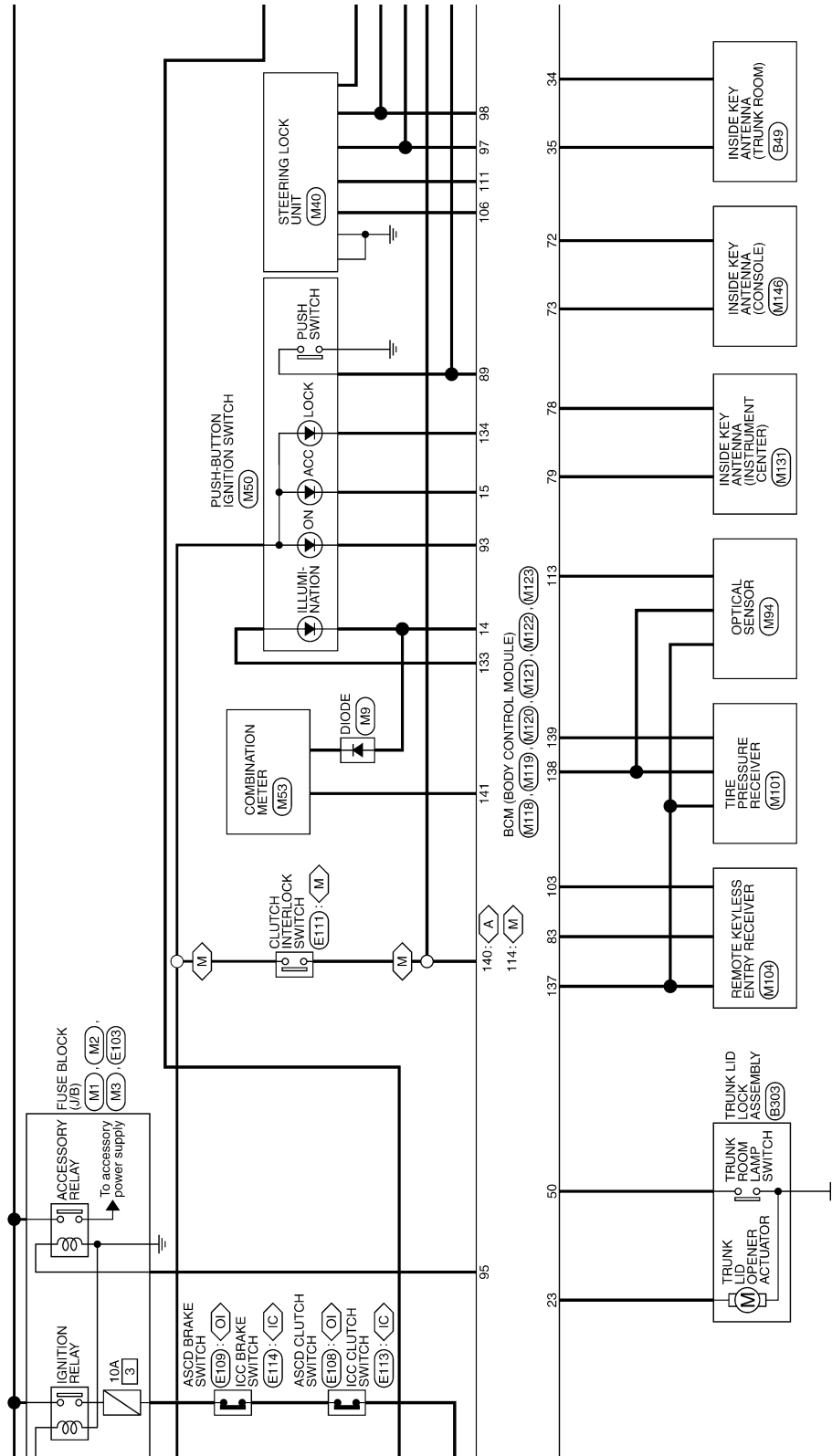

JCMWM5778G



# BCM (BODY CONTROL MODULE)

< ECU DIAGNOSIS INFORMATION >

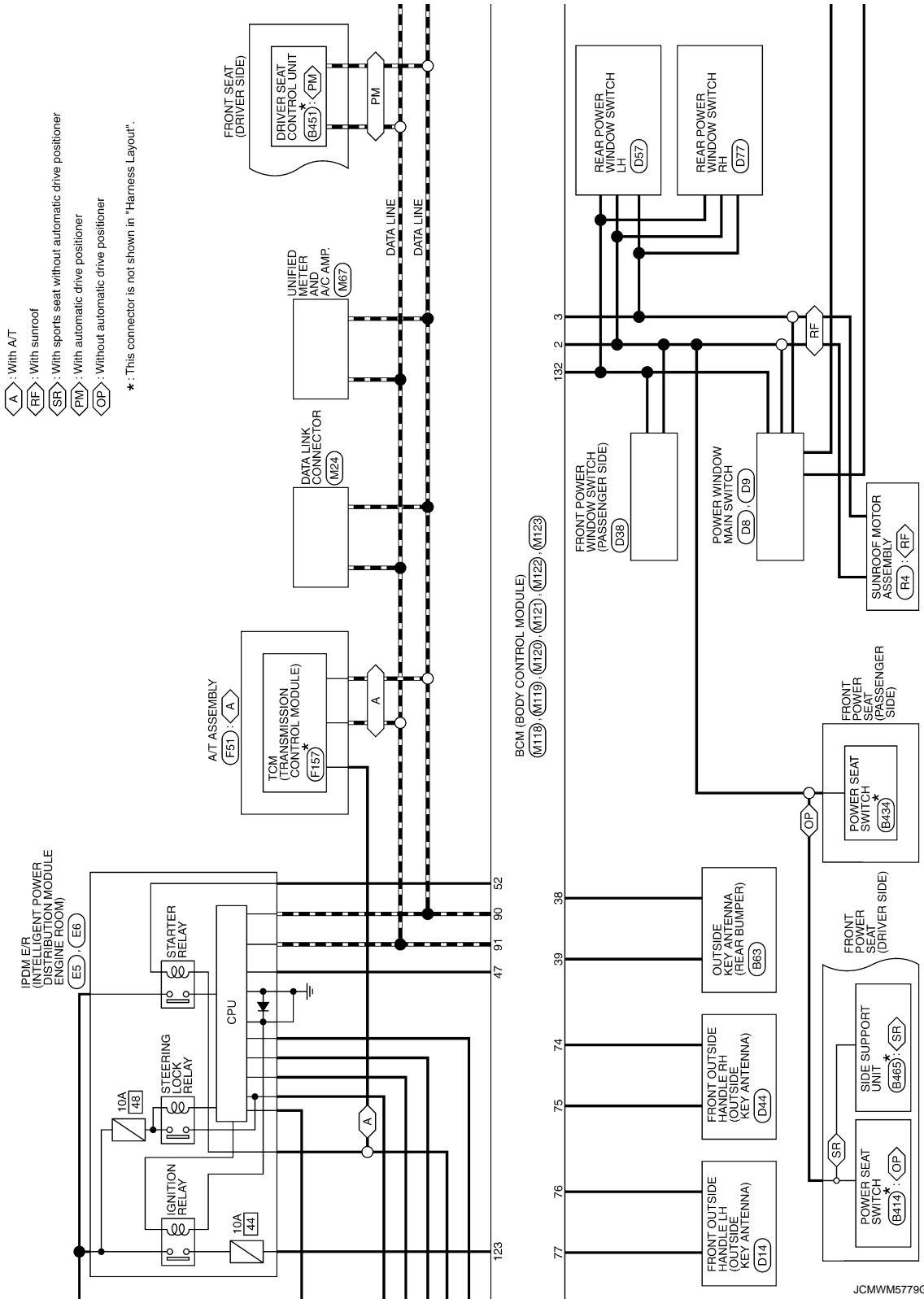

A  
B  
C  
D  
E  
F  
G  
H  
I  
J  
K  
L  
M  
N  
O  
P

RF

# BCM (BODY CONTROL MODULE)

< ECU DIAGNOSIS INFORMATION >

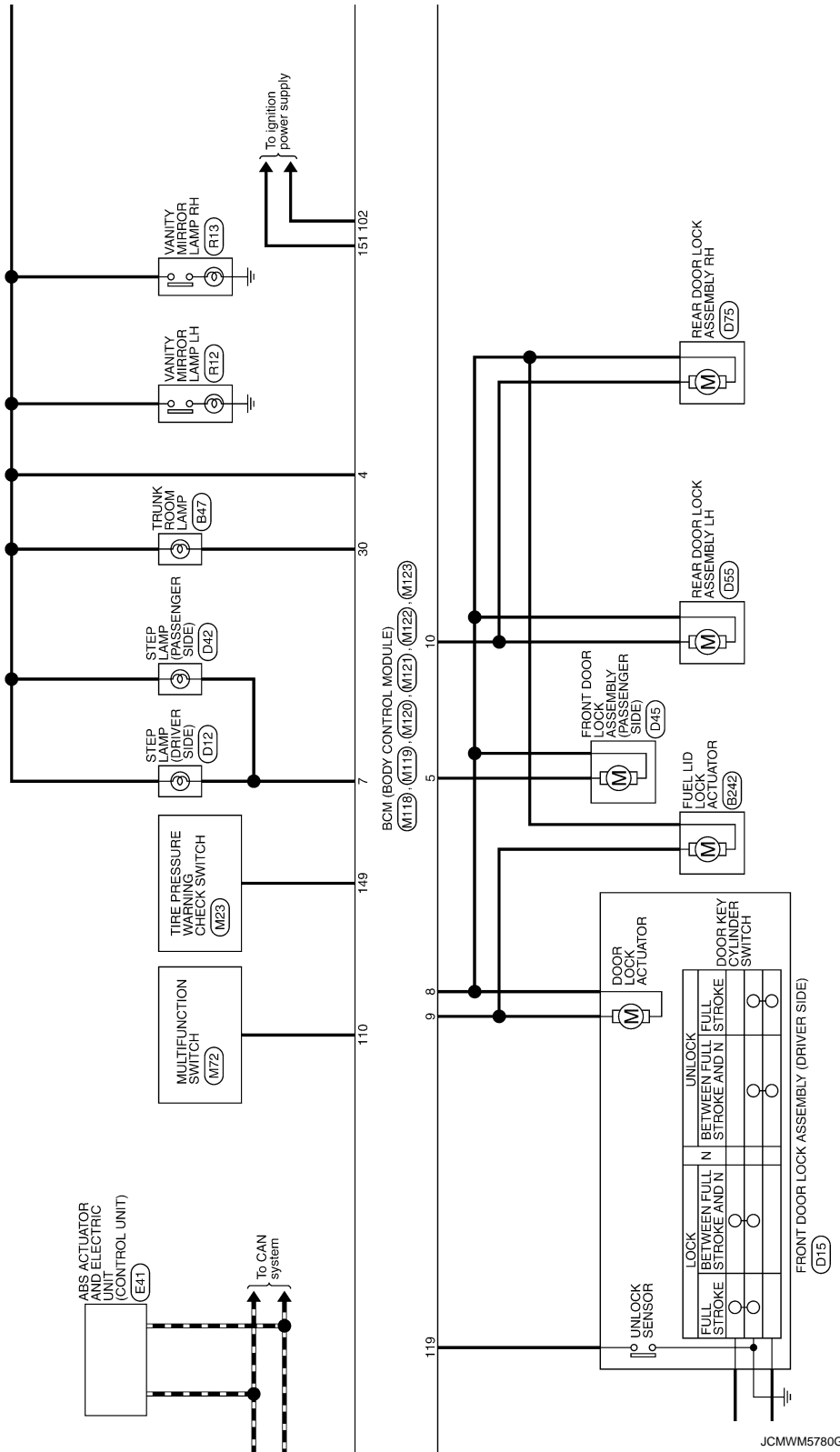

# BCM (BODY CONTROL MODULE)

< ECU DIAGNOSIS INFORMATION >

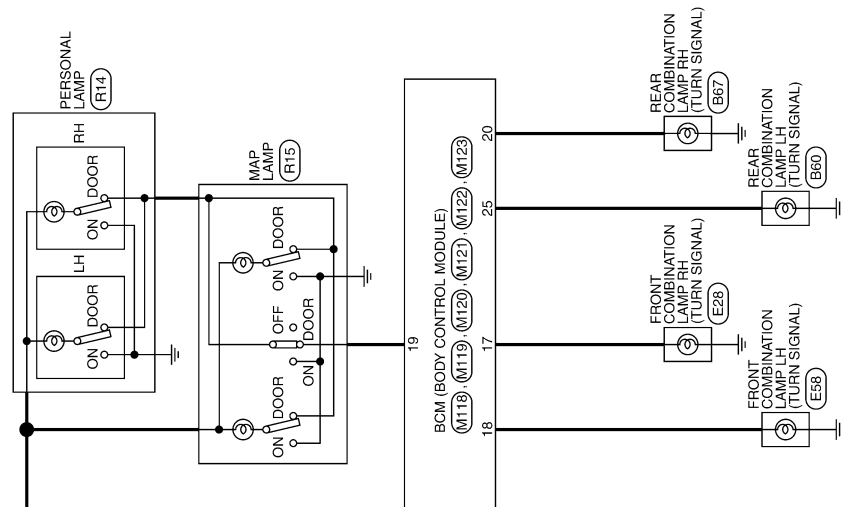

JCMWM5781G1

A  
B  
C  
D  
E  
F  
G  
H  
I  
J  
RF  
L  
M  
N  
O  
P

# BCM (BODY CONTROL MODULE)

< ECU DIAGNOSIS INFORMATION >

## BCM (BODY CONTROL MODULE)

Connector No.	M33
Connector Name	COMBINATION SWITCH
Connector Type	TH16FW-NH

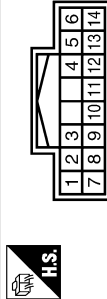

Terminal No.	Color of Wire	Signal Name [Specification]
1	GR	FR WASHER (-)
2	SB	OUTPUT 4
5	L	OUTPUT 3
6	B	GND
7	BG	INPUT 3
8	ER	OUTPUT 5
9	W	INPUT 2
10	R	INPUT 4
11	LG	INPUT 1
12	P	OUTPUT 1
13	Y	INPUT 5
14	G	OUTPUT 2

Connector No.	M18
Connector Name	BCM (BODY CONTROL MODULE)
Connector Type	M03FB-LC

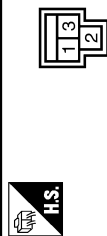

Terminal No.	Color of Wire	Signal Name [Specification]
1	W	BAT (F/L)
2	Y	POWER WINDOW POWER SUPPLY (BAT)
3	BG	POWER WINDOW POWER SUPPLY (RAP)

Connector No.	M119
Connector Name	BCM (BODY CONTROL MODULE)
Connector Type	NS12FW-CS

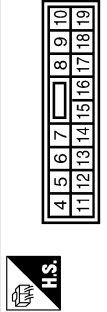

Terminal No.	Color of Wire	Signal Name [Specification]
4	LG	INTERIOR ROOM LAMP POWER SUPPLY
5	P	PASSENGER DOOR UNLOCK OUTPUT
7	SB	STEP LAMP OUTPUT
8	V	ALL DOOR FUEL LID LOCK OUTPUT
9	G	DRIVER DOOR FUEL LID UNLOCK OUTPUT
10	P	REAR DOOR UNLOCK OUTPUT
11	R	BAT (FUSE)
13	B	GND
14	W	PUSH-BUTTON IGNITION SW ILL GND
15	BG	ACC IND
17	W	TURN SIGNAL RH (FRONT)
18	BG	TURN SIGNAL LH (FRONT)
19	V	ROOM LAMP TIMER CONTROL

Connector No.	M120
Connector Name	BCM (BODY CONTROL MODULE)
Connector Type	NS12FW-CS

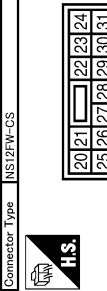

Terminal No.	Color of Wire	Signal Name [Specification]
20	V	TURN SIGNAL RH (REAR)
23	LG	TRUNK LID OPEN OUTPUT
25	Y	TURN SIGNAL LH (REAR)
30	P	TRUNK ROOM LAMP

Connector No.	M121
Connector Name	BCM (BODY CONTROL MODULE)
Connector Type	TH40FGY-NH

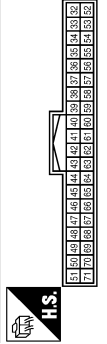

Terminal No.	Color of Wire	Signal Name [Specification]
34	SB	TRUNK ROOM ANT-
35	V	REAR BUMPER ANT-
38	B	REAR BUMPER ANT+
47	W	IGN RELAY (RPM E/P) CONT
50	BG	TRUNK ROOM LAMP SW
52	R	STARTER RELAY CONT
61	SB	TRUNK LID OPENER REQUEST SW
64	G	I-KEY WARN BUZZER (ENG ROOM)
67	GR	TRUNK LID OPENER SW
68	BG	REAR RH DOOR SW
69	L	REAR LH DOOR SW

Connector No.	M122
Connector Name	BCM (BODY CONTROL MODULE)
Connector Type	TH40FB-NH

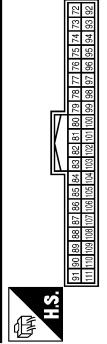

Terminal No.	Color of Wire	Signal Name [Specification]
72	R	ROOM ANT 2-
73	G	ROOM ANT 2+
74	SB	PASSENGER DOOR ANT-
75	BR	PASSENGER DOOR ANT+
76	V	DRIVER DOOR ANT-
77	LG	DRIVER DOOR ANT+
78	Y	ROOM ANT 1-
79	BR	ROOM ANT 1+
80	GR	NATS ANT AMP
81	W	INATS ANT AMP

82	SB	IGN RELAY (F/B) CONT
83	Y	KEYLESS ENTRY RECEIVER COMM
87	Y	COMBI SW INPUT 5
88	BG	COMBI SW INPUT 3
89	BR	PUSH SW
90	P	CAN-L
91	L	CAN-H
92	LG	KEY SLOT ILL
93	GR	ON IND
95	BG	ACC RELAY CONT
96	GR	A/T SHIFT SELECTOR POWER SUPPLY
97	L	S/L CONDITION 1
98	P	S/L CONDITION 2
99	R	SHIFT P [With A/T]
99	BR	ICC CLUTCH SW [With M/T and ICC]
99	BR	ASGD CLUTCH SW [With M/T without ICC]
100	Y	PASSENGER DOOR REQUEST SW
101	P	DRIVER DOOR REQUEST SW
102	BG	BLOWER FAN MOTOR RELAY CONT
103	P	KEYLESS ENTRY RECEIVER POWER SUPPLY
106	SB	S/L UNIT POWER SUPPLY
107	LG	COMBI SW INPUT 1
108	R	COMBI SW INPUT 4
109	W	COMBI SW INPUT 2
110	G	HAZARD SW
111	Y	S/L UNIT COMM

# BCM (BODY CONTROL MODULE)

< ECU DIAGNOSIS INFORMATION >

A  
B  
C  
D  
E  
F  
G  
H  
I  
J  
RF  
L  
M  
N  
O  
P

**BCM (BODY CONTROL MODULE)**

Connector No.	M123
Connector Name	BCM (BODY CONTROL MODULE)
Connector Type	TH40FG-NH

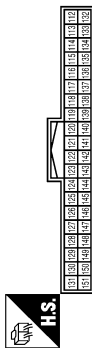

Terminal No.	Color of Wire	Signal Name [Specification]
112	R	RAIN SENSOR SERIAL LINK
113	BG	OPTICAL SENSOR
114	R	CLUTCH INTERLOCK SW
116	SB	STOP LAMP SW 1
118	BR	STOP LAMP SW 2
119	SB	DR DOOR UNLOCK SENSOR
121	SB	KEY SLOT SW
123	V	IGN P/B
124	R	PASSENGER DOOR SW
129	BG	TRUNK LID OPENER CANCEL SW
132	V	POWER WINDOW SW COMM
133	L	PUSH-BUTTON IGNITION SW ILL POWER
134	LG	LOCK IND
137	BG	RECEIVER / SENSOR GND
138	V	RECEIVER / SENSOR POWER SUPPLY
139	L	TIRE PRESSURE RECEIVER COMM
140	B	SHIFT N/P
141	W	SECURITY INDICATOR LAMP
142	BR	COMBI SW OUTPUT 5
143	P	COMBI SW OUTPUT 1
144	G	COMBI SW OUTPUT 2
145	L	COMBI SW OUTPUT 3
146	SB	COMBI SW OUTPUT 4
149	W	TIRE PRESSURE WARN CHECK SW
150	GR	DRIVER DOOR SW
151	G	REAR WINDOW DEFOGGER RELAY COINT

## Fail-safe

### FAIL-SAFE CONTROL BY DTC

BCM performs fail-safe control when any DTC are detected.

JCMWWM5783GI

INFOID:0000000005883722

## BCM (BODY CONTROL MODULE)

### < ECU DIAGNOSIS INFORMATION >

Display contents of CONSULT	Fail-safe	Cancellation
B2013: ID DISCORD BCM-S/L	Inhibit engine cranking	Erase DTC
B2014: CHAIN OF S/L-BCM	Inhibit engine cranking	Erase DTC
B2190: NATS ANTENNA AMP	Inhibit engine cranking	Erase DTC
B2191: DIFFERENCE OF KEY	Inhibit engine cranking	Erase DTC
B2192: ID DISCORD BCM-ECM	Inhibit engine cranking	Erase DTC
B2193: CHAIN OF BCM-ECM	Inhibit engine cranking	Erase DTC
B2195: ANTI-SCANNING	Inhibit engine cranking	Ignition switch ON → OFF
B2557: VEHICLE SPEED	Inhibit steering lock	When normal vehicle speed signals are received from ABS actuator and electric unit (control unit) for 500 ms
B2560: STARTER CONT RELAY	Inhibit engine cranking	500 ms after the following CAN signal communication status becomes consistent <ul style="list-style-type: none"> <li>• Starter control relay signal</li> <li>• Starter relay status signal</li> </ul>
B2601: SHIFT POSITION	Inhibit steering lock	500 ms after the following signal reception status becomes consistent <ul style="list-style-type: none"> <li>• Selector lever P position switch signal</li> <li>• P range signal (CAN)</li> </ul>
B2602: SHIFT POSITION	Inhibit steering lock	5 seconds after the following BCM recognition conditions are fulfilled <ul style="list-style-type: none"> <li>• Ignition switch is in the ON position</li> <li>• Selector lever P position switch signal: Except P position (12 V)</li> <li>• Vehicle speed: 4 km/h (2.5 MPH) or more</li> </ul>
B2603: SHIFT POSI STATUS	Inhibit steering lock	500 ms after the following BCM recognition conditions are fulfilled <ul style="list-style-type: none"> <li>• Ignition switch is in the ON position</li> <li>• Selector lever P position switch signal: Except P position (12 V)</li> <li>• Selector lever P/N position signal: Except P and N positions (0 V)</li> </ul>
B2604: PNP/CLUTCH SW	Inhibit steering lock	500 ms after any of the following BCM recognition conditions are fulfilled <ul style="list-style-type: none"> <li>• Status 1 <ul style="list-style-type: none"> <li>- Ignition switch is in the ON position</li> <li>- Selector lever P/N position signal: P and N position (12 V)</li> <li>- P range signal or N range signal (CAN): ON</li> </ul> </li> <li>• Status 2 <ul style="list-style-type: none"> <li>- Ignition switch is in the ON position</li> <li>- Selector lever P/N position signal: Except P and N positions (0 V)</li> <li>- P range signal and N range signal (CAN): OFF</li> </ul> </li> </ul>
B2605: PNP/CLUTCH SW	Inhibit steering lock	500 ms after any of the following BCM recognition conditions are fulfilled <ul style="list-style-type: none"> <li>• Status 1 <ul style="list-style-type: none"> <li>- Ignition switch is in the ON position</li> <li>- Selector lever P/N position signal: Except P and N positions (0 V)</li> <li>- Interlock/PNP switch signal (CAN): OFF</li> </ul> </li> <li>• Status 2 <ul style="list-style-type: none"> <li>- Ignition switch is in the ON position</li> <li>- Selector lever P/N position signal: P or N position (12 V)</li> <li>- PNP switch signal (CAN): ON</li> </ul> </li> </ul>
B2606: S/L RELAY	Inhibit engine cranking	500 ms after the following CAN signal communication status becomes consistent <ul style="list-style-type: none"> <li>• Steering lock relay signal (Request signal)</li> <li>• Steering lock relay signal (Condition signal)</li> </ul>
B2607: S/L RELAY	Inhibit engine cranking	500 ms after the following CAN signal communication status has become consistent <ul style="list-style-type: none"> <li>• Steering lock relay signal (Request signal)</li> <li>• Steering lock relay signal (Condition signal)</li> </ul>

# BCM (BODY CONTROL MODULE)

## < ECU DIAGNOSIS INFORMATION >

Display contents of CONSULT	Fail-safe	Cancellation
B2608: STARTER RELAY	Inhibit engine cranking	500 ms after the following signal communication status becomes consistent <ul style="list-style-type: none"> <li>• Starter motor relay control signal</li> <li>• Starter relay status signal (CAN)</li> </ul>
B2609: S/L STATUS	<ul style="list-style-type: none"> <li>• Inhibit engine cranking</li> <li>• Inhibit steering lock</li> </ul>	When the following steering lock conditions agree <ul style="list-style-type: none"> <li>• BCM steering lock control status</li> <li>• Steering lock condition No. 1 signal status</li> <li>• Steering lock condition No. 2 signal status</li> </ul>
B260A: IGNITION RELAY	Inhibit engine cranking	500 ms after the following conditions are fulfilled <ul style="list-style-type: none"> <li>• IGN relay (IPDM E/R) control signal: OFF (12 V)</li> <li>• Ignition ON signal (CAN to IPDM E/R): OFF (Request signal)</li> <li>• Ignition ON signal (CAN from IPDM E/R): OFF (Condition signal)</li> </ul>
B260F: ENG STATE SIG LOST	Maintains the power supply position attained at the time of DTC detection	When any of the following conditions are fulfilled <ul style="list-style-type: none"> <li>• Power position changes to ACC</li> <li>• Receives engine status signal (CAN)</li> </ul>
B2612: S/L STATUS	<ul style="list-style-type: none"> <li>• Inhibit engine cranking</li> <li>• Inhibit steering lock</li> </ul>	When any of the following conditions are fulfilled <ul style="list-style-type: none"> <li>• Steering lock unit status signal (CAN) is received normally</li> <li>• The BCM steering lock control status matches the steering lock status recognized by the steering lock unit status signal (CAN from IPDM E/R)</li> </ul>
B2617: BCM	Inhibit engine cranking	1 second after the starter motor relay control inside BCM becomes normal
B2618: BCM	Inhibit engine cranking	1 second after the ignition relay (IPDM E/R) control inside BCM becomes normal
B2619: BCM	Inhibit engine cranking	1 second after the steering lock unit power supply output control inside BCM becomes normal
B261E: VEHICLE TYPE	Inhibit engine cranking	BCM initialization
B26E8: CLUTCH SW	Inhibit engine cranking	When any of the following BCM recognition conditions are fulfilled <ul style="list-style-type: none"> <li>• Status 1               <ul style="list-style-type: none"> <li>- Clutch switch signal (CAN from ECM): ON</li> <li>- Clutch interlock switch signal: OFF (0 V)</li> </ul> </li> <li>• Status 2               <ul style="list-style-type: none"> <li>- Clutch switch signal (CAN from ECM): OFF</li> <li>- Clutch interlock switch signal: ON (Battery voltage)</li> </ul> </li> </ul>
B26E9: S/L STATUS	<ul style="list-style-type: none"> <li>• Inhibit engine cranking</li> <li>• Inhibit steering lock</li> </ul>	When BCM transmits the LOCK request signal to steering lock unit, and receives LOCK response signal from steering lock unit, the following conditions are fulfilled <ul style="list-style-type: none"> <li>• Steering condition No. 1 signal: LOCK (0 V)</li> <li>• Steering condition No. 2 signal: LOCK (12 V)</li> </ul>

## DTC Inspection Priority Chart

INFOID:000000005883723

If some DTCs are displayed at the same time, perform inspections one by one based on the following priority chart.

Priority	DTC
1	B2562: LOW VOLTAGE
2	<ul style="list-style-type: none"> <li>• U1000: CAN COMM</li> <li>• U1010: CONTROL UNIT(CAN)</li> </ul>
3	<ul style="list-style-type: none"> <li>• B2190: NATS ANTENNA AMP</li> <li>• B2191: DIFFERENCE OF KEY</li> <li>• B2192: ID DISCORD BCM-ECM</li> <li>• B2193: CHAIN OF BCM-ECM</li> <li>• B2195: ANTI-SCANNING</li> </ul>

# BCM (BODY CONTROL MODULE)

## < ECU DIAGNOSIS INFORMATION >

Priority	DTC
4	<ul style="list-style-type: none"> <li>• B2013: ID DISCORD BCM-S/L</li> <li>• B2014: CHAIN OF S/L-BCM</li> <li>• B2553: IGNITION RELAY</li> <li>• B2555: STOP LAMP</li> <li>• B2556: PUSH-BTN IGN SW</li> <li>• B2557: VEHICLE SPEED</li> <li>• B2560: STARTER CONT RELAY</li> <li>• B2601: SHIFT POSITION</li> <li>• B2602: SHIFT POSITION</li> <li>• B2603: SHIFT POSI STATUS</li> <li>• B2604: PNP/CLUTCH SW</li> <li>• B2605: PNP/CLUTCH SW</li> <li>• B2606: S/L RELAY</li> <li>• B2607: S/L RELAY</li> <li>• B2608: STARTER RELAY</li> <li>• B2609: S/L STATUS</li> <li>• B260A: IGNITION RELAY</li> <li>• B260B: STEERING LOCK UNIT</li> <li>• B260C: STEERING LOCK UNIT</li> <li>• B260D: STEERING LOCK UNIT</li> <li>• B260F: ENG STATE SIG LOST</li> <li>• B2612: S/L STATUS</li> <li>• B2614: BCM</li> <li>• B2615: BCM</li> <li>• B2616: BCM</li> <li>• B2617: BCM</li> <li>• B2618: BCM</li> <li>• B2619: BCM</li> <li>• B261A: PUSH-BTN IGN SW</li> <li>• B261E: VEHICLE TYPE</li> <li>• B26E8: CLUTCH SW</li> <li>• B26E9: S/L STATUS</li> <li>• B26EA: KEY REGISTRATION</li> <li>• C1729: VHCL SPEED SIG ERR</li> <li>• U0415: VEHICLE SPEED</li> </ul>
5	<ul style="list-style-type: none"> <li>• C1704: LOW PRESSURE FL</li> <li>• C1705: LOW PRESSURE FR</li> <li>• C1706: LOW PRESSURE RR</li> <li>• C1707: LOW PRESSURE RL</li> <li>• C1708: [NO DATA] FL</li> <li>• C1709: [NO DATA] FR</li> <li>• C1710: [NO DATA] RR</li> <li>• C1711: [NO DATA] RL</li> <li>• C1716: [PRESSDATA ERR] FL</li> <li>• C1717: [PRESSDATA ERR] FR</li> <li>• C1718: [PRESSDATA ERR] RR</li> <li>• C1719: [PRESSDATA ERR] RL</li> <li>• C1734: CONTROL UNIT</li> </ul>
6	<ul style="list-style-type: none"> <li>• B2621: INSIDE ANTENNA</li> <li>• B2622: INSIDE ANTENNA</li> <li>• B2623: INSIDE ANTENNA</li> </ul>

### DTC Index

INFOID:000000005883724

#### NOTE:

The details of time display are as follows.

- CRNT: A malfunction is detected now.
- PAST: A malfunction was detected in the past.

IGN counter is displayed on Freeze Frame Data. For details of Freeze Frame Data, refer to [BCS-14, "COMMON ITEM : CONSULT-III Function \(BCM - COMMON ITEM\)"](#).



# BCM (BODY CONTROL MODULE)

## < ECU DIAGNOSIS INFORMATION >

CONSULT display	Fail-safe	Freeze Frame Data •Vehicle Speed •Odo/Trip Meter •Vehicle condition	Intelligent Key warning lamp ON	Tire pressure monitor warning lamp ON	Refer- ence page
No DTC is detected. further testing may be required.	—	—	—	—	—
U1000: CAN COMM	—	—	—	—	<a href="#">BCS-33</a>
U1010: CONTROL UNIT(CAN)	—	—	—	—	<a href="#">BCS-34</a>
U0415: VEHICLE SPEED	—	—	—	—	<a href="#">BCS-35</a>
B2013: ID DISCORD BCM-S/L	×	×	—	—	<a href="#">SEC-55</a>
B2014: CHAIN OF S/L-BCM	×	×	—	—	<a href="#">SEC-56</a>
B2190: NATS ANTENNA AMP	×	—	—	—	<a href="#">SEC-47</a>
B2191: DIFFERENCE OF KEY	×	—	—	—	<a href="#">SEC-50</a>
B2192: ID DISCORD BCM-ECM	×	—	—	—	<a href="#">SEC-51</a>
B2193: CHAIN OF BCM-ECM	×	—	—	—	<a href="#">SEC-53</a>
B2195: ANTI-SCANNING	×	—	—	—	<a href="#">SEC-54</a>
B2553: IGNITION RELAY	—	×	—	—	<a href="#">PCS-49</a>
B2555: STOP LAMP	—	×	—	—	<a href="#">SEC-59</a>
B2556: PUSH-BTN IGN SW	—	×	×	—	<a href="#">SEC-61</a>
B2557: VEHICLE SPEED	×	×	×	—	<a href="#">SEC-63</a>
B2560: STARTER CONT RELAY	×	×	×	—	<a href="#">SEC-64</a>
B2562: LOW VOLTAGE	—	×	—	—	<a href="#">BCS-36</a>
B2601: SHIFT POSITION	×	×	×	—	<a href="#">SEC-65</a>
B2602: SHIFT POSITION	×	×	×	—	<a href="#">SEC-68</a>
B2603: SHIFT POSI STATUS	×	×	×	—	<a href="#">SEC-70</a>
B2604: PNP/CLUTCH SW	×	×	×	—	<a href="#">SEC-73</a>
B2605: PNP/CLUTCH SW	×	×	×	—	<a href="#">SEC-75</a>
B2606: S/L RELAY	×	×	×	—	<a href="#">SEC-77</a>
B2607: S/L RELAY	×	×	×	—	<a href="#">SEC-78</a>
B2608: STARTER RELAY	×	×	×	—	<a href="#">SEC-80</a>
B2609: S/L STATUS	×	×	×	—	<a href="#">SEC-82</a>
B260A: IGNITION RELAY	×	×	×	—	<a href="#">PCS-51</a>
B260B: STEERING LOCK UNIT	—	×	×	—	<a href="#">SEC-86</a>
B260C: STEERING LOCK UNIT	—	×	×	—	<a href="#">SEC-87</a>
B260D: STEERING LOCK UNIT	—	×	×	—	<a href="#">SEC-88</a>
B260F: ENG STATE SIG LOST	×	×	×	—	<a href="#">SEC-89</a>
B2612: S/L STATUS	×	×	×	—	<a href="#">SEC-94</a>
B2614: BCM	—	×	×	—	<a href="#">PCS-53</a>
B2615: BCM	—	×	×	—	<a href="#">PCS-55</a>
B2616: BCM	—	×	×	—	<a href="#">PCS-57</a>
B2617: BCM	×	×	×	—	<a href="#">SEC-98</a>
B2618: BCM	×	×	×	—	<a href="#">PCS-59</a>
B2619: BCM	×	×	×	—	<a href="#">SEC-100</a>
B261A: PUSH-BTN IGN SW	—	×	×	—	<a href="#">PCS-60</a>
B261E: VEHICLE TYPE	×	×	× (Turn ON for 15 seconds)	—	<a href="#">SEC-101</a>

A  
B  
C  
D  
E  
F  
G  
H  
I  
J  
RF  
L  
M  
N  
O  
P

## BCM (BODY CONTROL MODULE)

### < ECU DIAGNOSIS INFORMATION >

CONSULT display	Fail-safe	Freeze Frame Data •Vehicle Speed •Odo/Trip Meter •Vehicle condition	Intelligent Key warning lamp ON	Tire pressure monitor warning lamp ON	Refer- ence page
B2621: INSIDE ANTENNA	—	×	—	—	<a href="#">DLK-59</a>
B2622: INSIDE ANTENNA	—	×	—	—	<a href="#">DLK-61</a>
B2623: INSIDE ANTENNA	—	×	—	—	<a href="#">DLK-63</a>
B26E8: CLUTCH SW	×	×	×	—	<a href="#">SEC-90</a>
B26E9: S/L STATUS	×	×	× (Turn ON for 15 seconds)	—	<a href="#">SEC-92</a>
B26EA: KEY REGISTRATION	—	×	× (Turn ON for 15 seconds)	—	<a href="#">SEC-93</a>
C1704: LOW PRESSURE FL	—	—	—	×	<a href="#">WT-26</a>
C1705: LOW PRESSURE FR	—	—	—	×	
C1706: LOW PRESSURE RR	—	—	—	×	
C1707: LOW PRESSURE RL	—	—	—	×	
C1708: [NO DATA] FL	—	—	—	×	<a href="#">WT-28</a>
C1709: [NO DATA] FR	—	—	—	×	
C1710: [NO DATA] RR	—	—	—	×	
C1711: [NO DATA] RL	—	—	—	×	
C1716: [PRESSDATA ERR] FL	—	—	—	×	<a href="#">WT-31</a>
C1717: [PRESSDATA ERR] FR	—	—	—	×	
C1718: [PRESSDATA ERR] RR	—	—	—	×	
C1719: [PRESSDATA ERR] RL	—	—	—	×	
C1729: VHCL SPEED SIG ERR	—	—	—	×	<a href="#">WT-33</a>
C1734: CONTROL UNIT	—	—	—	×	<a href="#">WT-35</a>

# SUNROOF MOTOR ASSEMBLY

< ECU DIAGNOSIS INFORMATION >

## SUNROOF MOTOR ASSEMBLY

Reference Value

INFOID:000000005630498

TERMINAL LAYOUT

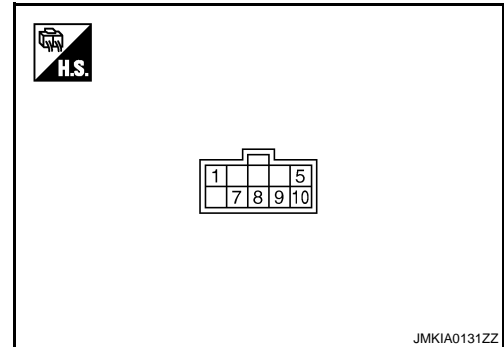

PHYSICAL VALUES

Terminal No. (Wire color)		Description		Condition	Voltage (V) (Approx.)
+	-	Signal name	Input/ Output		
1 (GR)	Ground	Sunroof close switch (BIT 1) signal	Input	Sunroof switch in following position • TILT UP • SLIDE CLOSE	0
				Other than above	Battery voltage
5 (P)	Ground	Sunroof open switch (BIT 0) signal	Input	Sunroof switch in following position • TILT DOWN • SLIDE OPEN	0
				Other than above	Battery voltage
7 (W)	Ground	Sunroof power supply	Input	—	Battery voltage
8 (L)	Ground	Vehicle speed signal (2-pulse)	Input	Speedometer operated [When vehicle speed is approx. 40km/h (25MPH)]	
9 (Y)	Ground	RAP signal	Input	Ignition switch ON	Battery voltage
				Within 45 second after ignition switch is turned to OFF.	Battery voltage
				When driver side or passenger side door is opened during retained power operation.	0
10 (B)	Ground	Ground	—	—	0

# SUNROOF MOTOR ASSEMBLY

< ECU DIAGNOSIS INFORMATION >

## Wiring Diagram - SUNROOF CONTROL SYSTEM -

INFOID:000000005630499

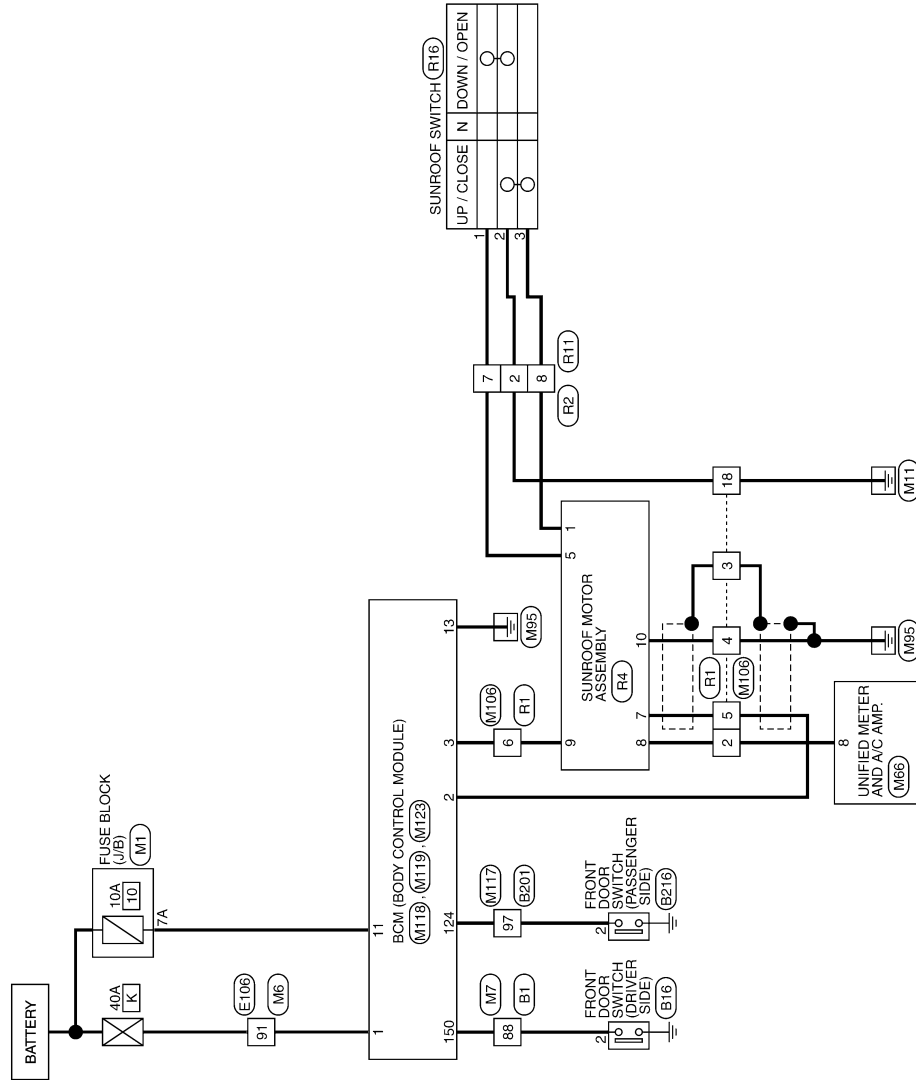

SUNROOF

2009/10/30

JCKWM3790GI

# SUNROOF MOTOR ASSEMBLY

< ECU DIAGNOSIS INFORMATION >

## SUNROOF

Connector No.	B1
Connector Name	WIRE TO WIRE
Connector Type	TH80FW-CS16-TM4

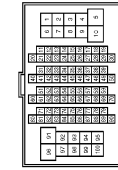

Terminal No.	Color of Wire	Signal Name [Specification]
1	GR	-
2	BG	-
3	L	-
4	Y	-
6	R	-
8	W	-
9	V	-
15	Y	-
16	BR	-
17	LG	-
18	BG	-
20	L	-
21	P	-
22	L	-
23	P	-
24	V	-
25	SB	-
26	G	-
27	W	-
28	R	-
31	V	-
32	SB	-
33	SHIELD	-
34	W	-
35	BR	-
36	Y	-
37	SHIELD	-
38	Y	-
39	SB	-
40	P	-
41	L	-
42	SHIELD	-
43	R	-
44	G	-
45	SHIELD	-
46	SB	-
55	BR	-
56	R	-

58	V	-
59	SB	-
60	BR	-
61	W	-
62	R	-
63	L	-
64	Y	-
65	SHIELD	-
71	BG	-
72	GR	-
73	P	-
74	L	-
81	V	-
82	B	-
84	Y	-
85	G	-
86	W	-
87	R	-
88	BR	-
89	Y	-
90	SB	-
91	BG	-
92	BR	-
93	P	-
95	BG	-
96	Y	-
100	GR	-

Connector No.	B16
Connector Name	FRONT DOOR SWITCH (DRIVER SIDE)
Connector Type	AQ3FW



Terminal No.	Color of Wire	Signal Name [Specification]
2	BR	-

Connector No.	B201
Connector Name	WIRE TO WIRE
Connector Type	TH80FW-CS16-TM4

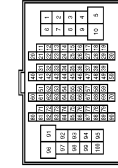

Terminal No.	Color of Wire	Signal Name [Specification]
1	BR	-
5	P	-
6	L	-
7	V	-
9	LG	-
10	L	-
31	L	-
32	P	-
33	G	-
34	R	-
40	GR	-
41	LG	-
42	BG	-
43	R	-
45	G	-
46	SHIELD	-
47	G	-
48	Y	-
49	SHIELD	-
50	W	-
71	R	-
72	V	-
80	BG	-
81	SHIELD	-
82	G	-
83	P	-
84	L	-
85	SHIELD	-
86	G	-
87	R	-
88	W	-
89	B	-
90	Y	-
91	V	-
92	W	-
93	BG	-
94	R	-
95	SB	-

96	G	-
97	GR	-
98	BR	-
99	P	-
100	L	-

Connector No.	B216
Connector Name	FRONT DOOR SWITCH (PASSENGER SIDE)
Connector Type	AQ3FW



Terminal No.	Color of Wire	Signal Name [Specification]
2	GR	-

A  
B  
C  
D  
E  
F  
G  
H  
I  
J  
RF  
L  
M  
N  
O  
P

# SUNROOF MOTOR ASSEMBLY

< ECU DIAGNOSIS INFORMATION >

## SUNROOF

Connector No.	E106
Connector Name	WIRE TO WIRE
Connector Type	TH80FY-CS16-TM4

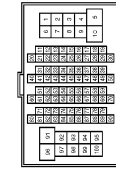

Terminal No.	Color of Wire	Signal Name [Specification]
1	V	
2	SB	
3	EG	
5	W	
6	P	
7	L	
11	V	
12	P	
13	R	
14	W	
15	L	
16	GR	
17	SB	
18	LG	
29	G	
31	L	
32	EG	
33	V	
34	V	
35	W	
36	EG	
37	G	
38	R	
40	R	
41	LG	
42	SB	
43	G	
44	LG	
45	GR	
46	BR	
47	B	
48	Y	
49	V	
50	R	
51	SB	
52	P	
53	G	
54	B	

57	GR	
58	V	
60	R	
61	P	
62	G	
63	V	
64	L	
65	W	
66	GR	
67	LG	
68	L	
69	BR	
91	W	
92	LG	
93	GR	
94	SB	
95	GR	
96	R	
97	Y	
98	SHIELD	
99	L	
100	P	

Connector No.	M1
Connector Name	FUSE BLOCK (J/B)
Connector Type	NS06FY-M2



Terminal No.	Color of Wire	Signal Name [Specification]
1A	V	
2A	G	
3A	L	
4A	P	
5A	L	
6A	Y	
7A	R	
8A	L	

Connector No.	M6
Connector Name	WIRE TO WIRE
Connector Type	TH80MW-CS16-TM4

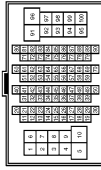

Terminal No.	Color of Wire	Signal Name [Specification]
1	W	
2	GR	
3	R	
5	W	
6	P	
7	L	
11	V	
12	P	
13	R	
14	W	
15	L	
16	GR	
17	BR	
18	L	
29	G	
31	L	
32	Y	
33	EG	
34	W	
35	BR	
36	P	
37	P	
38	G	
40	V	
41	LG	
42	R	
43	G	
44	G	
45	B	
46	R	
47	SB	
48	Y	
49	L	
50	R	
51	R	
52	W	
53	G	

54	B	
57	B	
58	LG	
60	SB	
61	B	
62	V	
63	W	
64	L	
65	GR	
66	Y	
67	G	
68	G	
69	R	
91	W	
92	Y	
93	EG	
94	L	
95	Y	
96	R	
97	LG	
98	SHIELD	
99	V	
100	SB	

# SUNROOF MOTOR ASSEMBLY

< ECU DIAGNOSIS INFORMATION >

## SUNROOF

Connector No.	M7
Connector Name	WIRE TO WIRE
Connector Type	TH80MW-CS (E-TM4)

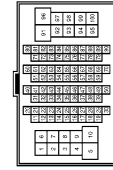

Terminal No.	Color of Wire	Signal Name [Specification]
1	GR	-
2	P	-
3	SB	- [With automatic drive positioner]
4	P	- [Without automatic drive positioner]
5	Y	-
6	L	-
7	G	-
8	Y	-
9	Y	-
10	R	-
11	R	-
12	BR	-
13	P	-
14	V	-
15	V	-
16	V	-
17	P	-
18	V	-
19	L	-
20	L	-
21	P	-
22	L	-
23	P	-
24	V	-
25	LG	-
26	BR	-
27	BG	-
28	LG	-
29	V	-
30	V	-
31	V	-
32	LG	-
33	SHIELD	-
34	GR	-
35	BR	-
36	Y	-
37	SHIELD	-
38	SB	-
39	LG	-
40	O	-
41	W	-
42	SHIELD	-
43	R	-
44	G	-
45	SHIELD	-
46	SB	-
47	W	-

56	B	-
58	V	-
59	Y	-
60	Y	-
61	W	-
62	R	-
63	G	-
64	B	-
65	SHIELD	-
71	V	-
72	P	-
73	SB	-
74	V	-
81	W	-
82	BR	-
84	LG	-
85	BG	-
86	SB	-
87	G	-
88	GR	-
89	L	-
90	P	-
91	BG	-
92	L	-
93	P	-
95	BG	-
96	Y	-
100	P	-

Connector No.	M65
Connector Name	UNIFIED METER AND A/C AMP.
Connector Type	TH4QFW-NH



Terminal No.	Color of Wire	Signal Name [Specification]
4	G	STOP LAMP SWITCH SIGNAL
5	L	MANUAL MODE SHIFT UP SIGNAL
6	BG	PADDLE SHIFTER UP SIGNAL
7	GR	COMMUNICATION SIGNAL (AMP->METER)
8	L	VEHICLE SPEED SIGNAL (2-PULSE)
9	SB	SEAT BELT BUCKLE SWITCH SIGNAL (DRIVER SIDE)
10	W	MANUAL MODE SIGNAL
11	G	NON-MANUAL MODE SIGNAL

14	BR	COMMUNICATION SIGNAL (LCD->AMP.)
20	BR	IGN ON / OFF SIGNAL
22	Y	AT SNOW SWITCH SIGNAL
23	V	MANUAL MODE SHIFT DOWN SIGNAL
24	G	PADDLE SHIFTER DOWN SIGNAL
27	LG	COMMUNICATION SIGNAL (METER->AMP.)
28	R	VEHICLE SPEED SIGNAL (8-PULSE)
30	V	PARKING BRAKE SWITCH SIGNAL
34	Y	COMMUNICATION SIGNAL (AMP->LCD)
38	P	BLOWER MOTOR CONTROL SIGNAL

Connector No.	M106
Connector Name	WIRE TO WIRE
Connector Type	NH10MW-CS10

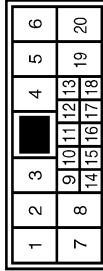

Terminal No.	Color of Wire	Signal Name [Specification]
2	L	-
3	SHIELD	-
4	G	-
5	BR	-
6	BG	-
7	Y	-
8	P	-
9	LG	-
10	V	-
11	B	-
12	B	-
13	R	-
15	R	-
16	G	-
17	SHIELD	-
18	B	-
19	Y	-
20	R	-

A  
B  
C  
D  
E  
F  
G  
H  
I  
J  
K  
L  
M  
N  
O  
P

RF

# SUNROOF MOTOR ASSEMBLY

< ECU DIAGNOSIS INFORMATION >

## SUNROOF

Connector No.	M117
Connector Name	WIRE TO WIRE
Connector Type	THB0MW-CS16-TM4



Terminal No.	Color of Wire	Signal Name [Specification]
1	LG	-
5	P	-
6	G	-
7	SB	-
9	LG	-
10	L	-
31	SB	-
32	LG	-
33	SB	-
34	LG	-
40	Y	-
41	G	-
42	LG	-
43	R	-
45	G	-
46	SHIELD	-
47	P	-
48	L	-
49	SHIELD	-
50	V	-
71	R	-
72	L	-
80	W	-
81	SHIELD	-
82	P	-
83	L	-
84	G	-
85	SHIELD	-
86	W	-
87	B	-
88	R	-
89	G	-
90	Y	-
91	V	-
92	BR	-
93	V	-
94	Y	-
95	G	-

96	G	-
97	R	-
98	BG	-
99	P	-
100	L	-

Connector No.	M118
Connector Name	BCM (BODY CONTROL MODULE)
Connector Type	MD3FB-LC



Terminal No.	Color of Wire	Signal Name [Specification]
1	W	BAT (F/L)
2	Y	POWER WINDOW POWER SUPPLY (BAT)
3	BG	POWER WINDOW POWER SUPPLY (RAP)

Connector No.	M119
Connector Name	BCM (BODY CONTROL MODULE)
Connector Type	NS16FW-CS

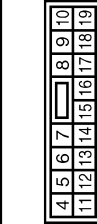

Terminal No.	Color of Wire	Signal Name [Specification]
4	LG	INTERIOR ROOM LAMP POWER SUPPLY
5	P	PASSENGER DOOR UNLOCK OUTPUT
7	SB	STEP LAMP OUTPUT
8	V	ALL DOOR FUEL LID LOCK OUTPUT
9	G	DRIVER DOOR FUEL LID UNLOCK OUTPUT
10	P	REAR DOOR UNLOCK OUTPUT
11	R	BAT (FUSE)
13	B	GND
14	W	PUSH-BUTTON IGNITION SW ILL GND
15	BG	ACC IND
17	W	TURN SIGNAL RH (FRONT)
18	BG	TURN SIGNAL LH (FRONT)

19	V	ROOM LAMP TIMER CONTROL
----	---	-------------------------

Connector No.	M123
Connector Name	BCM (BODY CONTROL MODULE)
Connector Type	TH4UFG-NH

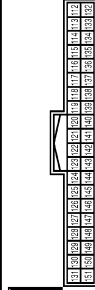

Terminal No.	Color of Wire	Signal Name [Specification]
112	R	RAIN SENSOR SERIAL LINK
113	BG	OPTICAL SENSOR
114	B	CLUTCH INTERLOCK SW
116	SB	STOP LAMP SW 2
118	BR	STOP LAMP SW 1
119	SB	DR DOOR UNLOCK SENSOR
121	SB	KEY SLOT SW
123	V	IGN P/B
124	R	PASSENGER DOOR SW
129	BG	TRUNK LID OPENER CANCEL SW
132	V	POWER WINDOW SW COMM
133	L	PUSH-BUTTON IGNITION SW ILL POWER
134	LG	LOCK IND
137	BG	RECEIVER / SENSOR POWER SUPPLY
138	V	TIRE PRESSURE RECEIVER COMM
139	L	SHIFT N/P
140	B	SECURITY INDICATOR LAMP
141	W	COMB SW OUTPUT 5
142	BR	COMB SW OUTPUT 1
143	P	COMB SW OUTPUT 2
144	G	COMB SW OUTPUT 3
146	L	COMB SW OUTPUT 4
148	W	TIRE PRESSURE WARN CHECK SW
150	GR	DRIVER DOOR SW
151	G	REAR WINDOW DEFOGGER RELAY CONT

Connector No.	RI
Connector Name	WIRE TO WIRE
Connector Type	NH10FW-CS10

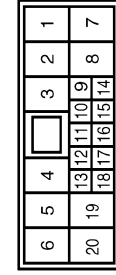

Terminal No.	Color of Wire	Signal Name [Specification]
2	L	-
3	SHIELD	-
4	G	-
5	BR	-
6	Y	-
7	GR	-
8	BR	-
9	R	-
10	V	-
11	B	-
12	B	-
13	Y	-
15	R	-
16	G	-
17	SHIELD	-
18	B	-
19	Y	-
20	R	-



# SUNROOF MOTOR ASSEMBLY

< ECU DIAGNOSIS INFORMATION >

A  
B  
C  
D  
E  
F  
G  
H  
I  
J  
RF  
L  
M  
N  
O  
P

## SUNROOF

Connector No.	R2
Connector Name	WIRE TO WIRE
Connector Type	TH12PV-NH

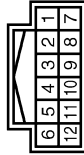

Terminal No.	Color of Wire	Signal Name [Specification]
1	B	-
2	B	-
3	SHIELD	-
4	R	-
5	G	-
6	B	-
7	P	-
8	GR	-
9	V	-
10	Y	-
11	R	-
12	R	-

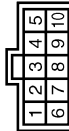

Connector No.	R4
Connector Name	SUNROOF MOTOR ASSEMBLY
Connector Type	YEA10FGY



Connector No.	R16
Connector Name	SUNROOF SWITCH
Connector Type	TK03FW

Connector No.	R11
Connector Name	WIRE TO WIRE
Connector Type	TH12MP-NH

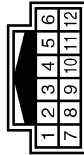

Terminal No.	Color of Wire	Signal Name [Specification]
1	B	-
2	B	-
3	SHIELD	-
4	R	-
5	G	-
6	B	-
7	P	-
8	GR	-
9	V	-
10	Y	-
11	R	-
12	R	-

Terminal No.	Color of Wire	Signal Name [Specification]
1	GR	SW-BIT 1
5	P	SW-BIT 0
7	BR	-B
8	L	SPEED SENSOR (2P)
9	Y	TIMER (+IGN)
10	G	GND

Terminal No.	Color of Wire	Signal Name [Specification]
1	P	-
2	B	-
3	GR	-

# SUNROOF DOES NOT OPERATE PROPERLY

< SYMPTOM DIAGNOSIS >

---

## SYMPTOM DIAGNOSIS

### SUNROOF DOES NOT OPERATE PROPERLY

#### Diagnosis Procedure

INFOID:000000005630500

#### 1. CHECK BCM POWER SUPPLY AND GROUND CIRCUIT

---

Check BCM power supply and ground circuit.  
Refer to [RF-9, "BCM : Diagnosis Procedure"](#)

Is the inspection result normal?

- YES >> GO TO 2.
- NO >> Repair or replace the malfunctioning parts.

#### 2. CHECK SUNROOF

---

Check sunroof.  
Refer to [RF-10, "Component Function Check"](#)

Is the inspection result normal?

- YES >> GO TO 3.
- NO >> Repair or replace the malfunctioning parts.

#### 3. CONFIRM THE OPERATION

---

Confirm the operation again.

Is the result normal?

- YES >> Check intermittent incident. Refer to [GI-38, "Intermittent Incident"](#).
- NO >> GO TO 1.

# AUTO OPERATION DOES NOT OPERATE

< SYMPTOM DIAGNOSIS >

## AUTO OPERATION DOES NOT OPERATE

### Diagnosis Procedure

INFOID:000000005630501

#### 1.PERFORM INITIALIZATION PROCEDURE

Initialization procedure is executed and operation is confirmed.

Refer to [RF-4, "ADDITIONAL SERVICE WHEN REPLACING CONTROL UNIT : Special Repair Requirement"](#).

Is the inspection result normal?

YES >> INSPECTION END

NO >> GO TO 2.

#### 2.CONFIRM THE OPERATION

Confirm the operation again.

Is the result normal?

YES >> Check intermittent incident. Refer to [GI-38, "Intermittent Incident"](#).

NO >> GO TO 1.

A  
B  
C  
D  
E  
F  
G  
H  
I  
J  
RF  
L  
M  
N  
O  
P

# DOES NOT STOP FULLY-OPEN OR FULLY-CLOSED POSITION

< SYMPTOM DIAGNOSIS >

---

## DOES NOT STOP FULLY-OPEN OR FULLY-CLOSED POSITION

### Diagnosis Procedure

INFOID:000000005630502

#### 1. PERFORM INITIALIZATION PROCEDURE

---

Initialization procedure is executed and operation is confirmed.

Refer to [RF-4, "ADDITIONAL SERVICE WHEN REPLACING CONTROL UNIT : Special Repair Requirement"](#).

Is the inspection result normal?

YES >> INSPECTION END

NO >> GO TO 2.

#### 2. CONFIRM THE OPERATION

---

Confirm the operation again.

Is the result normal?

YES >> Check intermittent incident. Refer to [GI-38, "Intermittent Incident"](#).

NO >> GO TO 1.

# RETAINED POWER OPERATION DOES NOT OPERATE PROPERLY

< SYMPTOM DIAGNOSIS >

---

## RETAINED POWER OPERATION DOES NOT OPERATE PROPERLY

### Diagnosis Procedure

INFOID:000000005630503

#### 1.CHECK DOOR SWITCH

Check door switch.

Refer to [RF-13, "Component Function Check"](#).

Is the inspection result normal?

YES >> GO TO 2.

NO >> Repair or replace the malfunctioning parts.

#### 2.CONFIRM THE OPERATION

Confirm the operation again.

Is the result normal?

YES >> Check intermittent incident. Refer to [GI-38, "Intermittent Incident"](#).

NO >> GO TO 1.

A  
B  
C  
D  
E  
F  
G  
H  
I  
J  
RF  
L  
M  
N  
O  
P

# SUNROOF DOES NOT OPERATE ANTI-PINCH FUNCTION

< SYMPTOM DIAGNOSIS >

---

## SUNROOF DOES NOT OPERATE ANTI-PINCH FUNCTION

### Diagnosis Procedure

INFOID:000000005630504

#### 1. PERFORM INITIALIZATION PROCEDURE

---

Initialization procedure is executed and operation is confirmed.

Refer to [RF-4, "ADDITIONAL SERVICE WHEN REPLACING CONTROL UNIT : Special Repair Requirement"](#).

Is the inspection result normal?

YES >> INSPECTION END.

NO >> GO TO 2.

#### 2. CONFIRM THE OPERATION

---

Confirm the operation again.

Is the result normal?

YES >> Check intermittent incident. Refer to [GI-38, "Intermittent Incident"](#).

NO >> GO TO 1.

# SQUEAK AND RATTLE TROUBLE DIAGNOSES

< SYMPTOM DIAGNOSIS >

## SQUEAK AND RATTLE TROUBLE DIAGNOSES

### Work Flow

INFOID:000000005630505

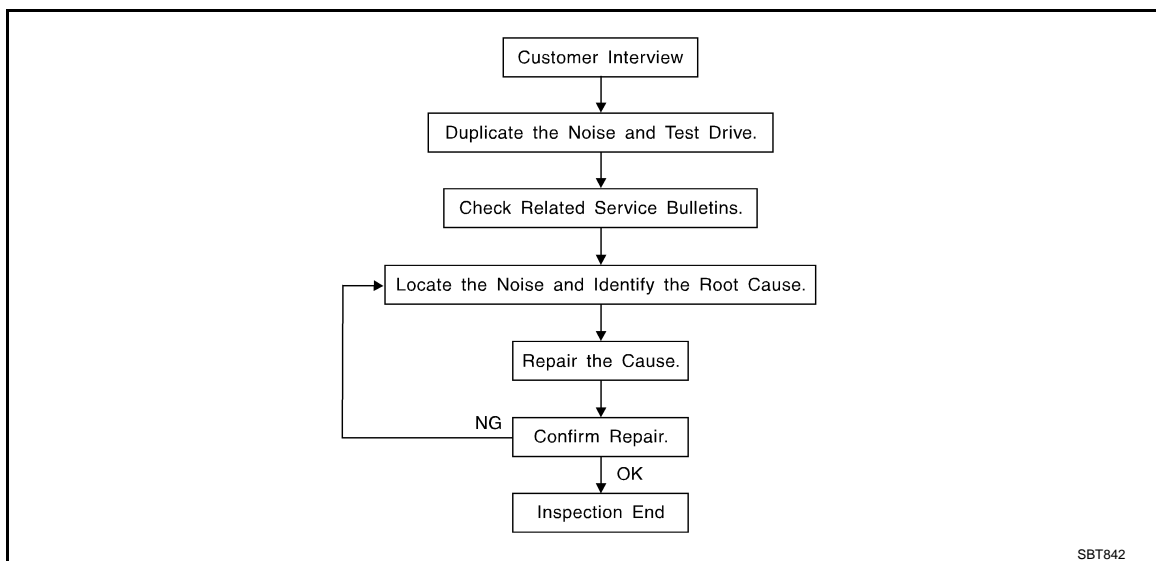

### CUSTOMER INTERVIEW

Interview the customer if possible, to determine the conditions that exist when the noise occurs. Use the Diagnostic Worksheet during the interview to document the facts and conditions when the noise occurs and any of customer's comments; refer to [RF-67, "Diagnostic Worksheet"](#). This information is necessary to duplicate the conditions that exist when the noise occurs.

- The customer may not be able to provide a detailed description or the location of the noise. Attempt to obtain all the facts and conditions that exist when the noise occurs (or does not occur).
- If there is more than one noise in the vehicle, perform a diagnosis and repair the noise that the customer is concerned about. This can be accomplished by performing a cruise test on the vehicle with the customer.
- After identifying the type of noise, isolate the noise in terms of its characteristics. The noise characteristics are provided so the customer, service adviser and technician are all speaking the same language when defining the noise.
- Squeak – (Like tennis shoes on a clean floor)  
Squeak characteristics include the light contact/fast movement/brought on by road conditions/hard surfaces = higher pitch noise/softer surfaces = lower pitch noises/edge to surface = chirping
- Creak – (Like walking on an old wooden floor)  
Creak characteristics include firm contact/slow movement/twisting with a rotational movement/pitch dependent on materials/often brought on by activity.
- Rattle – (Like shaking a baby rattle)  
Rattle characteristics include the fast repeated contact/vibration or similar movement/loose parts/missing clip or fastener/incorrect clearance.
- Knock – (Like a knock on a door)  
Knock characteristics include hollow sounding/sometimes repeating/often brought on by driver action.
- Tick – (Like a clock second hand)  
Tick characteristics include gentle contacting of light materials/loose components/can be caused by driver action or road conditions.
- Thump – (Heavy, muffled knock noise)  
Thump characteristics include softer knock/dead sound often brought on by activity.
- Buzz – (Like a bumblebee)  
Buzz characteristics include high frequency rattle/firm contact.
- Often the degree of acceptable noise level will vary depending up on the person. A noise that a technician may judge as acceptable may be very irritating to the customer.
- Weather conditions, especially humidity and temperature, may have a great effect on noise level.

### DUPLICATE THE NOISE AND TEST DRIVE

If possible, drive the vehicle with the customer until the noise is duplicated. Note any additional information on the Diagnostic Worksheet regarding the conditions or location of the noise. This information can be used to duplicate the same conditions when the repair is reconfirmed.

# SQUEAK AND RATTLE TROUBLE DIAGNOSES

## < SYMPTOM DIAGNOSIS >

If the noise can be duplicated easily during the test drive, to help identify the source of the noise, try to duplicate the noise with the vehicle stopped by doing one or all of the following:

- 1) Close a door.
  - 2) Tap or push/pull around the area where the noise appears to be coming from.
  - 3) Rev the engine.
  - 4) Use a floor jack to recreate vehicle "twist".
  - 5) At idle, apply engine load (electrical load, half-clutch on M/T models, drive position on A/T models).
  - 6) Raise the vehicle on a hoist and hit a tire with a rubber hammer.
- Drive the vehicle and attempt to duplicate the conditions the customer states exist when the noise occurs.
  - If it is difficult to duplicate the noise, drive the vehicle slowly on an undulating or rough road to stress the vehicle body.

## CHECK RELATED SERVICE BULLETINS

After verifying the customer concern or symptom, check ASIST for Technical Service Bulletins (TSBs) related to that concern or symptom.

If a TSB relates to the symptom, follow the procedure to repair the noise.

## LOCATE THE NOISE AND IDENTIFY THE ROOT CAUSE

1. Narrow down the noise to a general area. To help pinpoint the source of the noise, use a listening tool (Chassis ear: J-39570, Engine ear and mechanics stethoscope).
2. Narrow down the noise to a more specific area and identify the cause of the noise by:
  - Removing the components in the area that is are suspected to be the cause of the noise.  
Do not use too much force when removing clips and fasteners, otherwise clips and fastener can be broken or lost during the repair, resulting in the creation of new noise.
  - Tapping or pushing/pulling the component that is are suspected to be the cause of the noise.  
Do not tap or push/pull the component with excessive force, otherwise the noise will be eliminated only temporarily.
  - Feeling for a vibration by hand by touching the component(s) that is are suspected to be the cause of the noise.
  - Placing a piece of paper between components that are suspected to be the cause of the noise.
  - Looking for loose components and contact marks.  
Refer to [RF-65, "Inspection Procedure"](#).

## REPAIR THE CAUSE

- If the cause is a loose component, tighten the component securely.
- If the cause is insufficient clearance between components:
  - Separate components by repositioning or loosening and retightening the component, if possible.
  - Insulate components with a suitable insulator such as urethane pads, foam blocks, felt cloth tape or urethane tape. A Nissan Squeak and Rattle Kit (J-43980) is available through the authorized Nissan Parts Department.

### **CAUTION:**

**Never use excessive force as many components are constructed of plastic and may be damaged.**

### **NOTE:**

Always check with the Parts Department for the latest parts information.

The following materials are contained in the Nissan Squeak and Rattle Kit (J-43980). Each item can be ordered separately as needed.

URETHANE PADS [1.5 mm (0.059 in) thick]

Insulates connectors, harness, etc.

76268-9E005: 100 × 135 mm (3.94 × 5.31 in)/76884-71L01: 60 × 85 mm (2.36 × 3.35 in)/76884-71L02: 15 × 25 mm (0.59 × 0.98 in)

INSULATOR (Foam blocks)

Insulates components from contact. Can be used to fill space behind a panel.

73982-9E000: 45 mm (1.77 in) thick, 50 × 50 mm (1.97 × 1.97 in)/73982-

50Y00: 10 mm (0.39 in) thick, 50 × 50 mm (1.97 × 1.97 in)

INSULATOR (Light foam block)

80845-71L00: 30 mm (1.18 in) thick, 30 × 50 mm (1.18 × 1.97in)

FELT CLOTHTAPE

Used to insulate where movement does not occur. Ideal for instrument panel applications.

68370-4B000: 15 × 25 mm (0.59 × 0.98 in) pad/68239-13E00: 5 mm (0.20 in) wide tape roll

The following materials, not found in the kit, can also be used to repair squeaks and rattles.

UHMW (TEFLON) TAPE



# SQUEAK AND RATTLE TROUBLE DIAGNOSES

## < SYMPTOM DIAGNOSIS >

Insulates where slight movement is present. Ideal for instrument panel applications.

### SILICONE GREASE

Used in place of UHMW tape that is be visible or does not fit. Will only last a few months.

### SILICONE SPRAY

Used when grease cannot be applied.

### DUCT TAPE

Used to eliminate movement.

## CONFIRM THE REPAIR

Confirm that the cause of a noise is repaired by test driving the vehicle. Operate the vehicle under the same conditions as when the noise originally occurred. Refer to the notes on the Diagnostic Worksheet.

## Inspection Procedure

INFOID:000000005630506

Refer to Table of Contents for specific component removal and installation information.

## INSTRUMENT PANEL

Most incidents are caused by contact and movement between:

1. The cluster lid A and instrument panel
2. Acrylic lens and combination meter housing
3. Instrument panel to front pillar garnish
4. Instrument panel to windshield
5. Instrument panel mounting pins
6. Wiring harnesses behind the combination meter
7. A/C defroster duct and duct joint

These incidents can usually be located by tapping or moving the components to duplicate the noise or by pressing on the components while driving to stop the noise. Most of these incidents can be repaired by applying felt cloth tape or silicon spray (in hard to reach areas). Urethane pads can be used to insulate wiring harness.

### **CAUTION:**

**Never use silicone spray to isolate a squeak or rattle. If the area is saturated with silicone, the recheck of repair becomes impossible.**

## CENTER CONSOLE

Components to pay attention to include:

1. Shifter assembly cover to finisher
2. A/C control unit and cluster lid C
3. Wiring harnesses behind audio and A/C control unit

The instrument panel repair and isolation procedures also apply to the center console.

## DOORS

Pay attention to the following:

1. Finisher and inner panel making a slapping noise
2. Inside handle escutcheon to door finisher
3. Wiring harnesses tapping
4. Door striker out of alignment causing a popping noise on starts and stops

Tapping or moving the components or pressing on them while driving to duplicate the conditions can isolate many of these incidents. The areas can usually be insulated with felt cloth tape or insulator foam blocks from the Nissan Squeak and Rattle Kit (J-43980) to repair the noise.

## TRUNK

Trunk noises are often caused by a loose jack or loose items put into the trunk by the customer.

In addition look for the following:

1. Trunk lid dumpers out of adjustment
2. Trunk lid striker out of adjustment
3. The trunk lid torsion bars knocking together
4. A loose license plate or bracket

A  
B  
C  
D  
E  
F  
G  
H  
I  
J  
RF  
L  
M  
N  
O  
P

# SQUEAK AND RATTLE TROUBLE DIAGNOSES

## < SYMPTOM DIAGNOSIS >

---

Most of these incidents can be repaired by adjusting, securing or insulating the item(s) or component(s) causing the noise.

### SUNROOF/HEADLINING

Noises in the sunroof/headlining area can often be traced to one of the following:

1. Sunroof lid, rail, linkage or seals making a rattle or light knocking noise
2. Sunvisor shaft shaking in the holder
3. Front or rear windshield touching headlining and squeaking

Again, pressing on the components to stop the noise while duplicating the conditions can isolate most of these incidents. Repairs usually consist of insulating with felt cloth tape.

### SEATS

When isolating seat noise it's important to note the position the seats in and the load placed on the seat when the noise occurs. These conditions should be duplicated when verifying and isolating the cause of the noise.

Cause of seat noise include:

1. Headrest rods and holder
2. A squeak between the seat pad cushion and frame
3. The rear seatback lock and bracket

These noises can be isolated by moving or pressing on the suspected components while duplicating the conditions under which the noise occurs. Most of these incidents can be repaired by repositioning the component or applying urethane tape to the contact area.

### UNDERHOOD

Some interior noise may be caused by components under the hood or on the engine wall. The noise is then transmitted into the passenger compartment.

Causes of transmitted underhood noise include:

1. Any component mounted to the engine wall
2. Components that pass through the engine wall
3. Engine wall mounts and connectors
4. Loose radiator mounting pins
5. Hood bumpers out of adjustment
6. Hood striker out of adjustment

These noises can be difficult to isolate since they cannot be reached from the interior of the vehicle. The best method is to secure, move or insulate one component at a time and test drive the vehicle. Also, engine RPM or load can be changed to isolate the noise. Repairs can usually be made by moving, adjusting, securing, or insulating the component causing the noise.

# SQUEAK AND RATTLE TROUBLE DIAGNOSES

< SYMPTOM DIAGNOSIS >

## Diagnostic Worksheet

INFOID:000000005630507



### SQUEAK & RATTLE DIAGNOSTIC WORKSHEET

Dear Infiniti Customer:

We are concerned about your satisfaction with your Infiniti vehicle. Repairing a squeak or rattle sometimes can be very difficult. To help us fix your Infiniti right the first time, please take a moment to note the area of the vehicle where the squeak or rattle occurs and under what conditions. You may be asked to take a test drive with a service consultant or technician to ensure we confirm the noise you are hearing.

#### I. WHERE DOES THE NOISE COME FROM? (circle the area of the vehicle)

The illustrations are for reference only, and may not reflect the actual configuration of your vehicle.

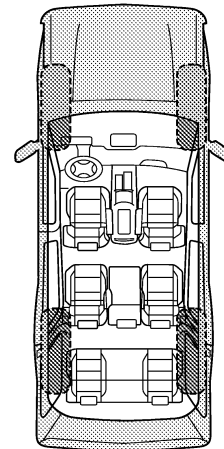
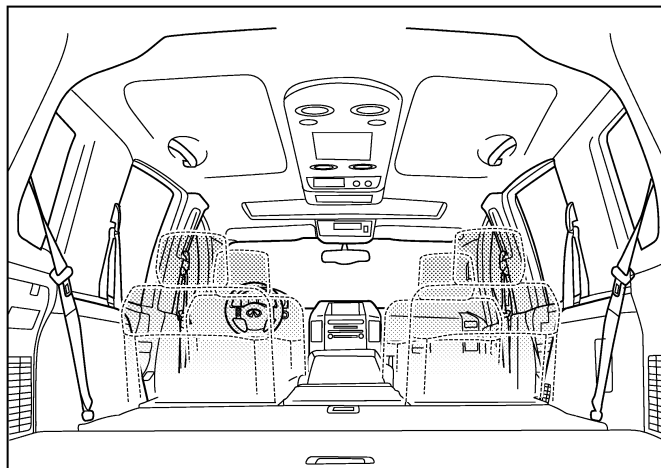
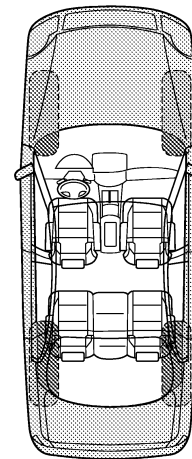
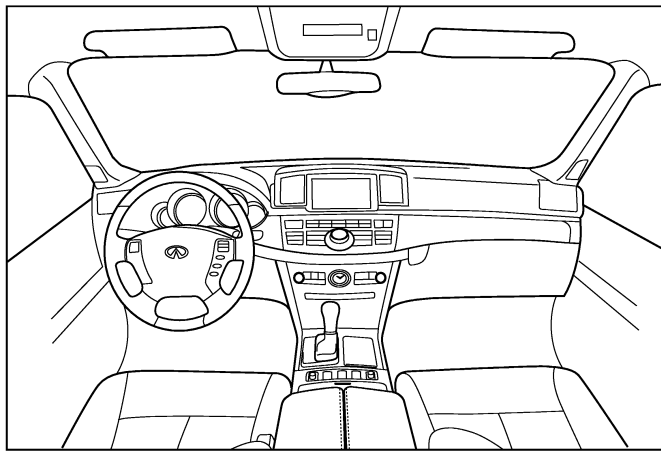

Continue to page 2 of the worksheet and briefly describe the location of the noise or rattle. In addition, please indicate the conditions which are present when the noise occurs.

PIIB8741E

A  
B  
C  
D  
E  
F  
G  
H  
I  
J  
RF  
L  
M  
N  
O  
P

# SQUEAK AND RATTLE TROUBLE DIAGNOSES

< SYMPTOM DIAGNOSIS >

## SQUEAK & RATTLE DIAGNOSTIC WORKSHEET - page 2

Briefly describe the location where the noise occurs:

---

---

### II. WHEN DOES IT OCCUR? (please check the boxes that apply)

- |   |  |
|---|--|
| <input type="checkbox"/> anytime                      | <input type="checkbox"/> after sitting out in the rain |
| <input type="checkbox"/> 1st time in the morning      | <input type="checkbox"/> when it is raining or wet     |
| <input type="checkbox"/> only when it is cold outside | <input type="checkbox"/> dry or dusty conditions       |
| <input type="checkbox"/> only when it is hot outside  | <input type="checkbox"/> other:                        |

### III. WHEN DRIVING:

- through driveways
- over rough roads
- over speed bumps
- only about \_\_\_\_ mph
- on acceleration
- coming to a stop
- on turns: left, right or either (circle)
- with passengers or cargo
- other: \_\_\_\_\_
- after driving \_\_\_\_ miles or \_\_\_\_ minutes

### IV. WHAT TYPE OF NOISE

- squeak (like tennis shoes on a clean floor)
- creak (like walking on an old wooden floor)
- rattle (like shaking a baby rattle)
- knock (like a knock at the door)
- tick (like a clock second hand)
- thump (heavy, muffled knock noise)
- buzz (like a bumble bee)

## TO BE COMPLETED BY DEALERSHIP PERSONNEL

### Test Drive Notes:

---

---

---

	YES	NO	Initials of person performing
Vehicle test driven with customer	<input type="checkbox"/>	<input type="checkbox"/>	_____
- Noise verified on test drive	<input type="checkbox"/>	<input type="checkbox"/>	_____
- Noise source located and repaired	<input type="checkbox"/>	<input type="checkbox"/>	_____
- Follow up test drive performed to confirm repair	<input type="checkbox"/>	<input type="checkbox"/>	_____

VIN: \_\_\_\_\_ Customer Name: \_\_\_\_\_  
W.O.# \_\_\_\_\_ Date: \_\_\_\_\_

This form must be attached to Work Order

PIIB8742E

# PRECAUTIONS

< PRECAUTION >

## PRECAUTION

### PRECAUTIONS

#### Precaution for Supplemental Restraint System (SRS) "AIR BAG" and "SEAT BELT PRE-TENSIONER"

INFOID:000000005630508

The Supplemental Restraint System such as "AIR BAG" and "SEAT BELT PRE-TENSIONER", used along with a front seat belt, helps to reduce the risk or severity of injury to the driver and front passenger for certain types of collision. This system includes seat belt switch inputs and dual stage front air bag modules. The SRS system uses the seat belt switches to determine the front air bag deployment, and may only deploy one front air bag, depending on the severity of a collision and whether the front occupants are belted or unbelted. Information necessary to service the system safely is included in the "SRS AIR BAG" and "SEAT BELT" of this Service Manual.

#### **WARNING:**

- To avoid rendering the SRS inoperative, which could increase the risk of personal injury or death in the event of a collision which would result in air bag inflation, all maintenance must be performed by an authorized NISSAN/INFINITI dealer.
- Improper maintenance, including incorrect removal and installation of the SRS, can lead to personal injury caused by unintentional activation of the system. For removal of Spiral Cable and Air Bag Module, see the "SRS AIR BAG".
- Do not use electrical test equipment on any circuit related to the SRS unless instructed to in this Service Manual. SRS wiring harnesses can be identified by yellow and/or orange harnesses or harness connectors.

#### PRECAUTIONS WHEN USING POWER TOOLS (AIR OR ELECTRIC) AND HAMMERS

#### **WARNING:**

- When working near the Air Bag Diagnosis Sensor Unit or other Air Bag System sensors with the ignition ON or engine running, DO NOT use air or electric power tools or strike near the sensor(s) with a hammer. Heavy vibration could activate the sensor(s) and deploy the air bag(s), possibly causing serious injury.
- When using air or electric power tools or hammers, always switch the ignition OFF, disconnect the battery, and wait at least 3 minutes before performing any service.

#### Service Notice

INFOID:000000005630509

- When removing or installing various parts, place a cloth or padding onto the vehicle body to prevent scratches.
- Handle trim, molding, instruments, grille, etc. carefully during removing or installing. Be careful not to oil or damage them.
- Apply sealing compound where necessary when installing parts.
- When applying sealing compound, be careful that the sealing compound does not protrude from parts.
- When replacing any metal parts (for example body outer panel, members, etc.), be sure to take rust prevention measures.

#### Precaution for Work

INFOID:000000005630510

- When removing or disassembling each component, be careful not to damage or deform it. If a component may be subject to interference, be sure to protect it with a shop cloth.
- When removing (disengaging) components with a screwdriver or similar tool, be sure to wrap the component with a shop cloth or vinyl tape to protect it.
- Protect the removed parts with a shop cloth and keep them.
- Replace a deformed or damaged clip.
- If a part is specified as a non-reusable part, always replace it with new one.
- Be sure to tighten bolts and nuts securely to the specified torque.
- After re-installation is completed, be sure to check that each part works normally.
- Follow the steps below to clean components.
  - Water soluble foul: Dip a soft cloth into lukewarm water, and wring the water out of the cloth to wipe the fouled area.  
Then rub with a soft and dry cloth.

## PRECAUTIONS

### < PRECAUTION >

---

- Oily foul: Dip a soft cloth into lukewarm water with mild detergent (concentration: within 2 to 3%), and wipe the fouled area.  
Then dip a cloth into fresh water, and wring the water out of the cloth to wipe the detergent off. Then rub with a soft and dry cloth.
- Never use organic solvent such as thinner, benzene, alcohol, and gasoline.
- For genuine leather seats, use a genuine leather seat cleaner.

# PREPARATION

< PREPARATION >

## PREPARATION

### PREPARATION

#### Special Service Tool

INFOID:000000005630511

The actual shapes of Kent-Moore tools may differ from those of special service tools illustrated here.

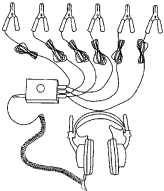
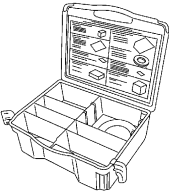
Tool number (Kent-Moore No.) Tool name	Description
<p>(J39570) Chassis ear</p>  <p>SIIA0993E</p>	<p>Locates the noise</p>
<p>(J43980) NISSAN Squeak and Rattle Kit</p>  <p>SIIA0994E</p>	<p>Repairs the cause of noise</p>

#### Commercial Service Tool

INFOID:000000005630512

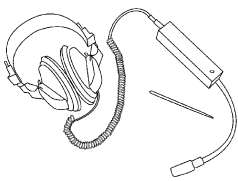
Tool name	Description
<p>Engine ear</p>  <p>SIIA0995E</p>	<p>Locates the noise</p>

A

B

C

D

E

F

G

H

I

J

RF

L

M

N

O

P

# GLASS LID

< REMOVAL AND INSTALLATION >

## REMOVAL AND INSTALLATION

### GLASS LID

Exploded View

INFOID:000000005630513

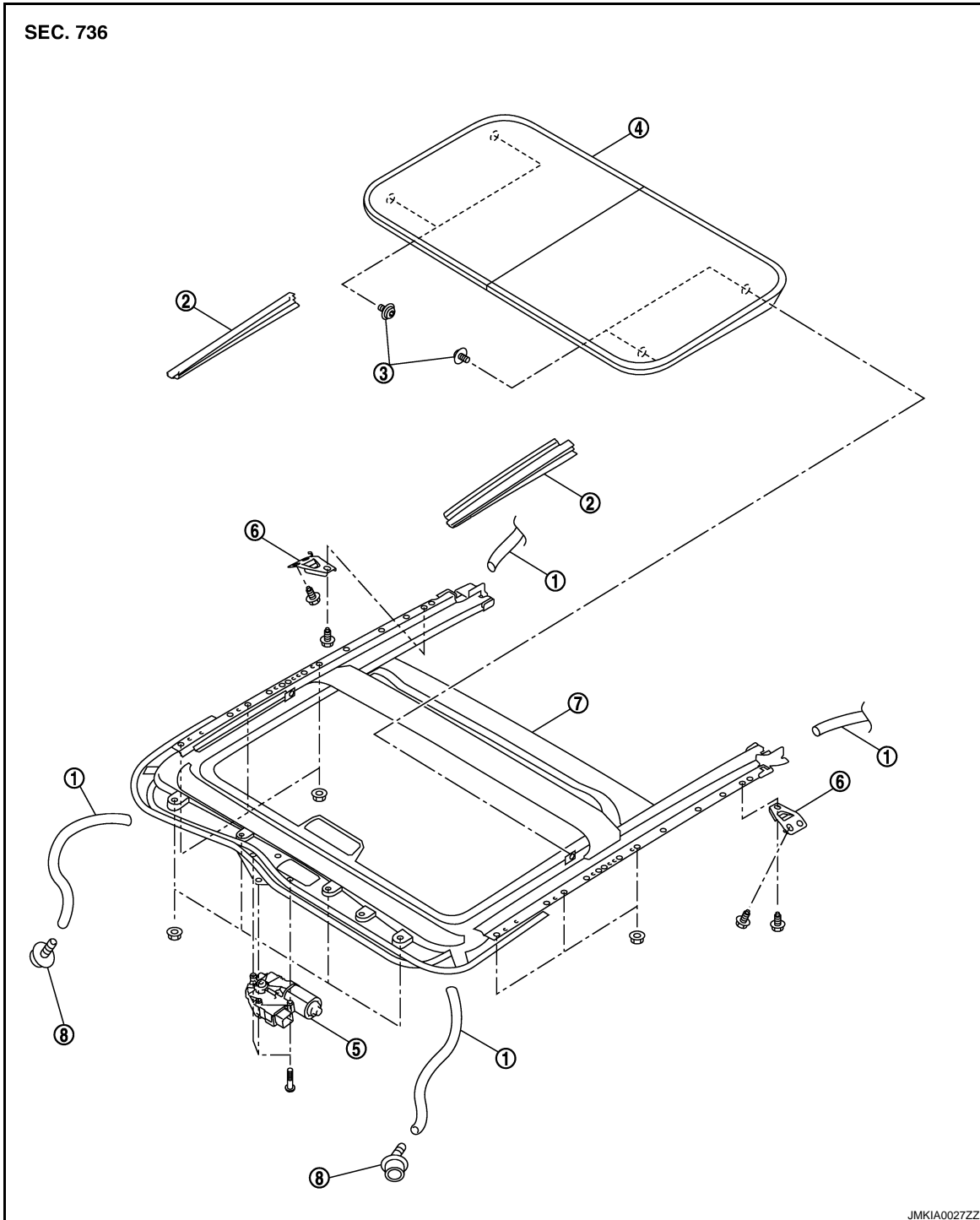

- |                          |                           |                            |
|--------------------------|---------------------------|----------------------------|
| 1. Drain hose            | 2. Side trim              | 3. TORX bolt               |
| 4. Glass lid             | 5. Sunroof motor assembly | 6. Sunroof bracket (LH/RH) |
| 7. Sunroof unit assembly | 8. Drain connector        |                            |



# GLASS LID

## < REMOVAL AND INSTALLATION >

### Removal and Installation

INFOID:000000005630514

#### REMOVAL

1. Remove the side trim.
2. Remove the TORX bolts (A) and remove glass lid.

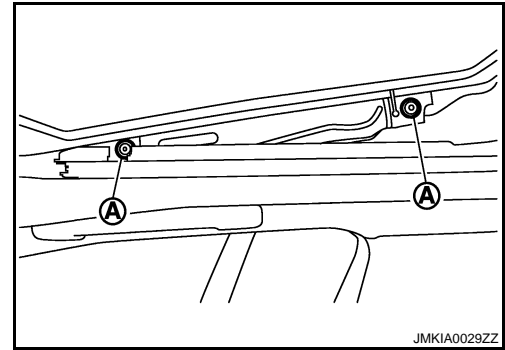

#### INSTALLATION

##### **CAUTION:**

After installing the glass lid, perform the leak test and check that there is no malfunction.

##### **NOTE:**

After installation carry out fitting adjustment. Refer to [RF-73, "Adjustment"](#).

Install in the reverse order of removal.

#### Adjustment

INFOID:000000005630515

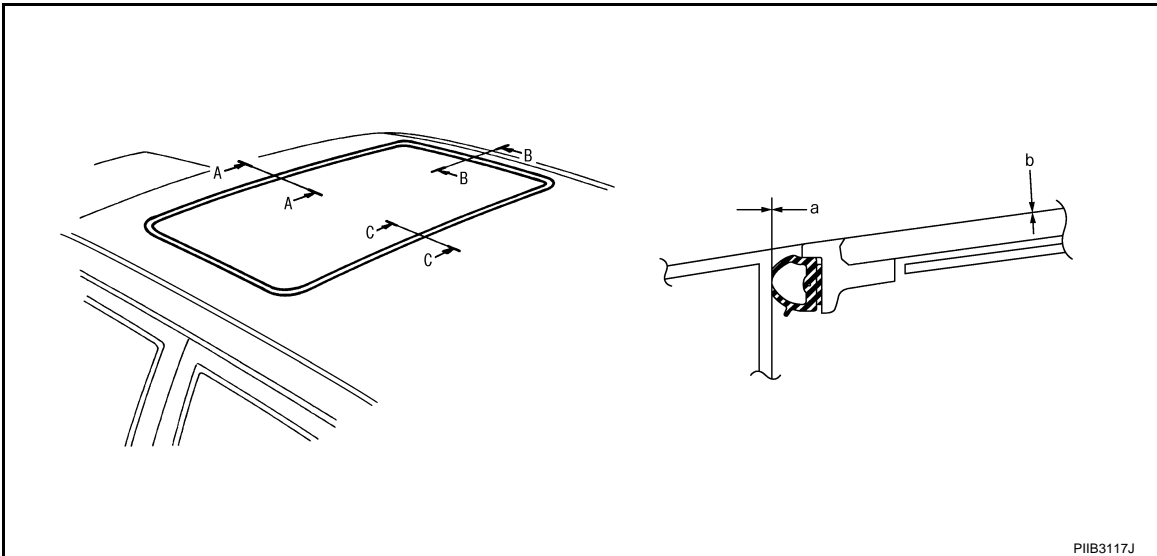

#### Lid Weatherstrip Overlap Adjustment and Surface Mismatch Adjustment

1. Tilt up glass lid, and then remove side trim.
2. After loosening glass lid from TORX bolts (left and right), tilt down glass lid.
3. Adjust glass lid from outside of vehicle so it resembles "A – A" "B – B" "C – C"

	a	b
<b>A – A</b>	<b>0.6 – 2.2 mm (0.024 – 0.087 in)</b>	<b>–2.3 – 0.7 mm (–0.091 – 0.028 in)</b>
<b>B – B</b>	<b>0.6 – 2.2 mm (0.024 – 0.087 in)</b>	<b>–2.3 – 0.7 mm (–0.091 – 0.028 in)</b>
<b>C – C</b>	<b>0.6 – 2.2 mm (0.024 – 0.087 in)</b>	<b>–2.3 – 0.7 mm (–0.091 – 0.028 in)</b>

4. To prevent glass lid from moving after adjustment, first tighten the TORX bolts of front left, and then tighten the TORX bolts of rear right.
5. Tighten remaining TORX bolts, being careful to prevent glass lid from moving.
6. Tilt glass lid up and down several times to check that it moves smoothly.

##### **NOTE:**

## GLASS LID

### < REMOVAL AND INSTALLATION >

After adjustment the sunroof unit assembly, perform additional service. Refer to [RF-4. "ADDITIONAL SERVICE WHEN REPLACING CONTROL UNIT : Description"](#).

# SUNROOF MOTOR ASSEMBLY

< REMOVAL AND INSTALLATION >

## SUNROOF MOTOR ASSEMBLY

Exploded View

INFOID:000000005630516

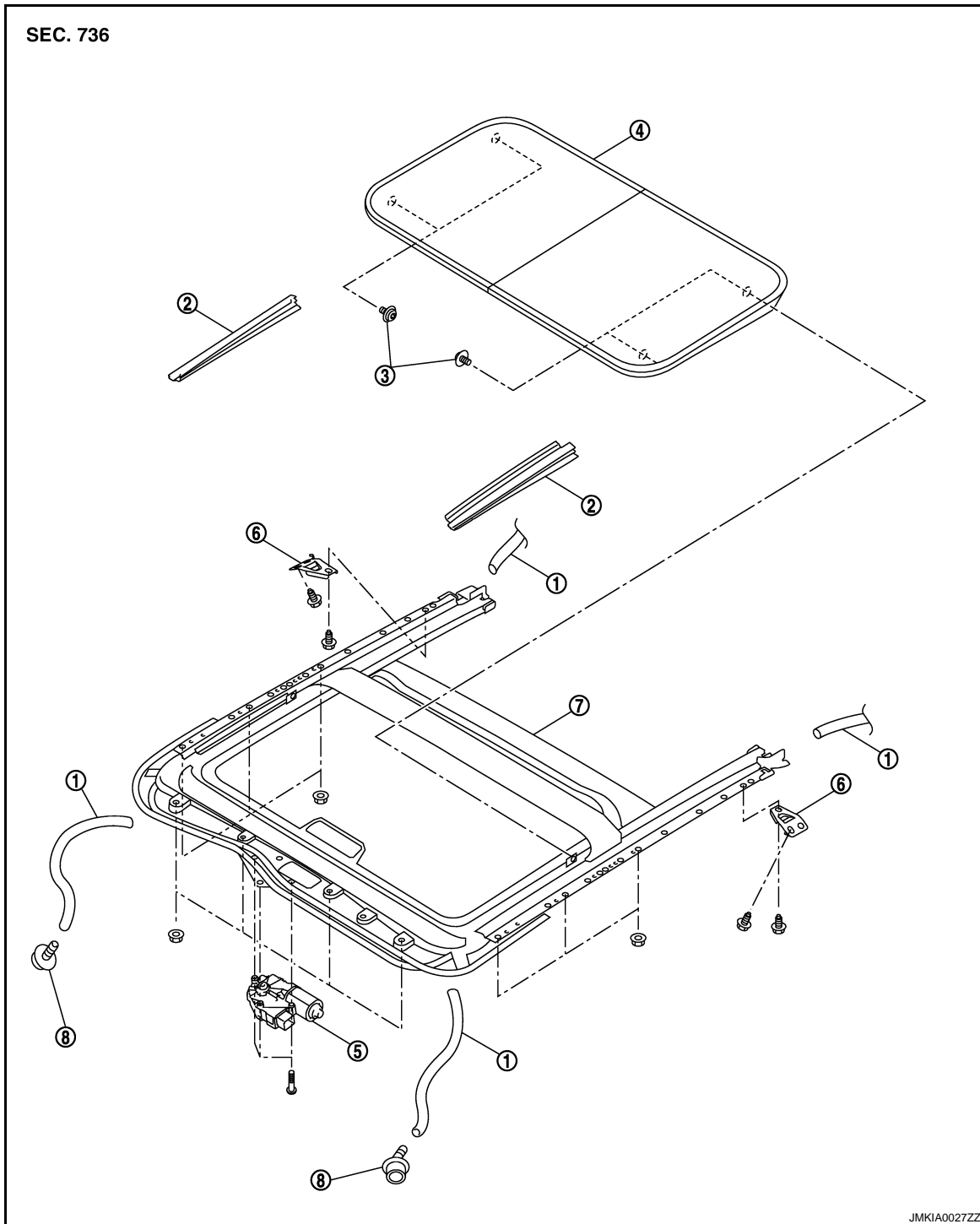

- |                          |                           |                            |
|--------------------------|---------------------------|----------------------------|
| 1. Drain hose            | 2. Side trim              | 3. TORX bolt               |
| 4. Glass lid             | 5. Sunroof motor assembly | 6. Sunroof bracket (LH/RH) |
| 7. Sunroof unit assembly | 8. Drain connector        |                            |

### Removal and Installation

INFOID:000000005630517

#### REMOVAL

A  
B  
C  
D  
E  
F  
G  
H  
I  
J  
RF  
L  
M  
N  
O  
P

# SUNROOF MOTOR ASSEMBLY

## < REMOVAL AND INSTALLATION >

### CAUTION:

- Before removing sunroof motor, check that glass lid is fully closed.
- After removing sunroof motor, never attempt to rotate sunroof motor assembly as a single unit.

1. Remove the headlining. Refer to [INT-27. "SUNROOF : Removal and Installation"](#).
2. Remove sunroof motor assembly mounting screws (A).  
Disconnect connector (B) from sunroof motor assembly and then remove sunroof motor assembly (1).

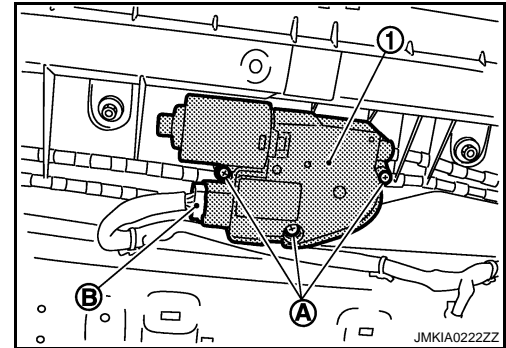

## INSTALLATION

### CAUTION:

Before installing the sunroof motor assembly, be sure to place the link and wire assembly in the symmetrical and fully closed position.

1. Move the sunroof motor assembly laterally by little so that the gear is completely engaged into the wire on the sunroof unit assembly and mounting surface becomes parallel. Then secure the sunroof motor assembly with screw.
2. Install the headlining. Refer to [INT-27. "SUNROOF : Removal and Installation"](#).

# SUNROOF UNIT ASSEMBLY

< REMOVAL AND INSTALLATION >

## SUNROOF UNIT ASSEMBLY

Exploded View

INFOID:000000005630518

REMOVAL

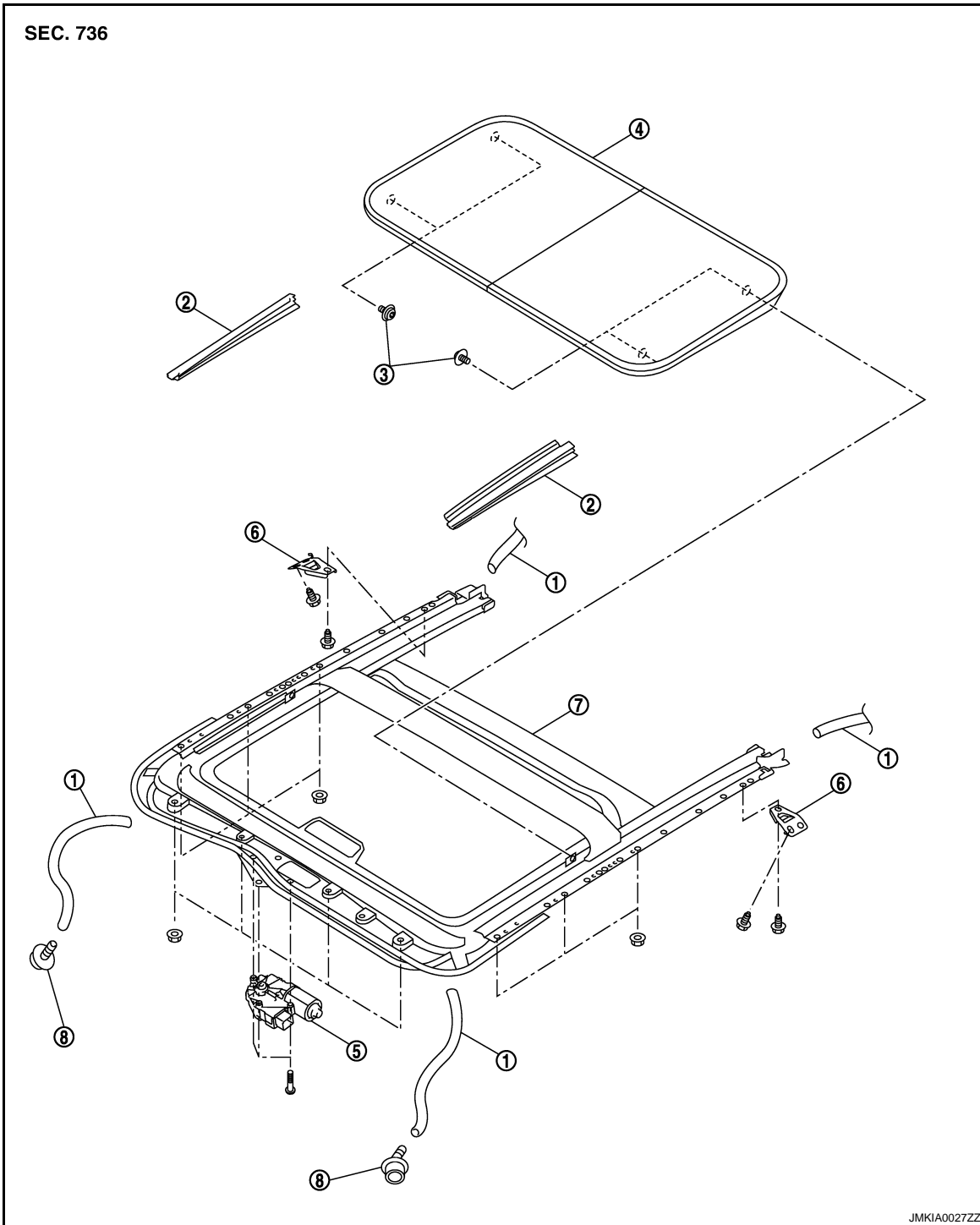

- |                          |                           |                            |
|--------------------------|---------------------------|----------------------------|
| 1. Drain hose            | 2. Side trim (LH/RH)      | 3. TORX bolt               |
| 4. Glass lid             | 5. Sunroof motor assembly | 6. Sunroof bracket (LH/RH) |
| 7. Sunroof unit assembly | 8. Drain connector        |                            |

DISASSEMBLY

# SUNROOF UNIT ASSEMBLY

< REMOVAL AND INSTALLATION >

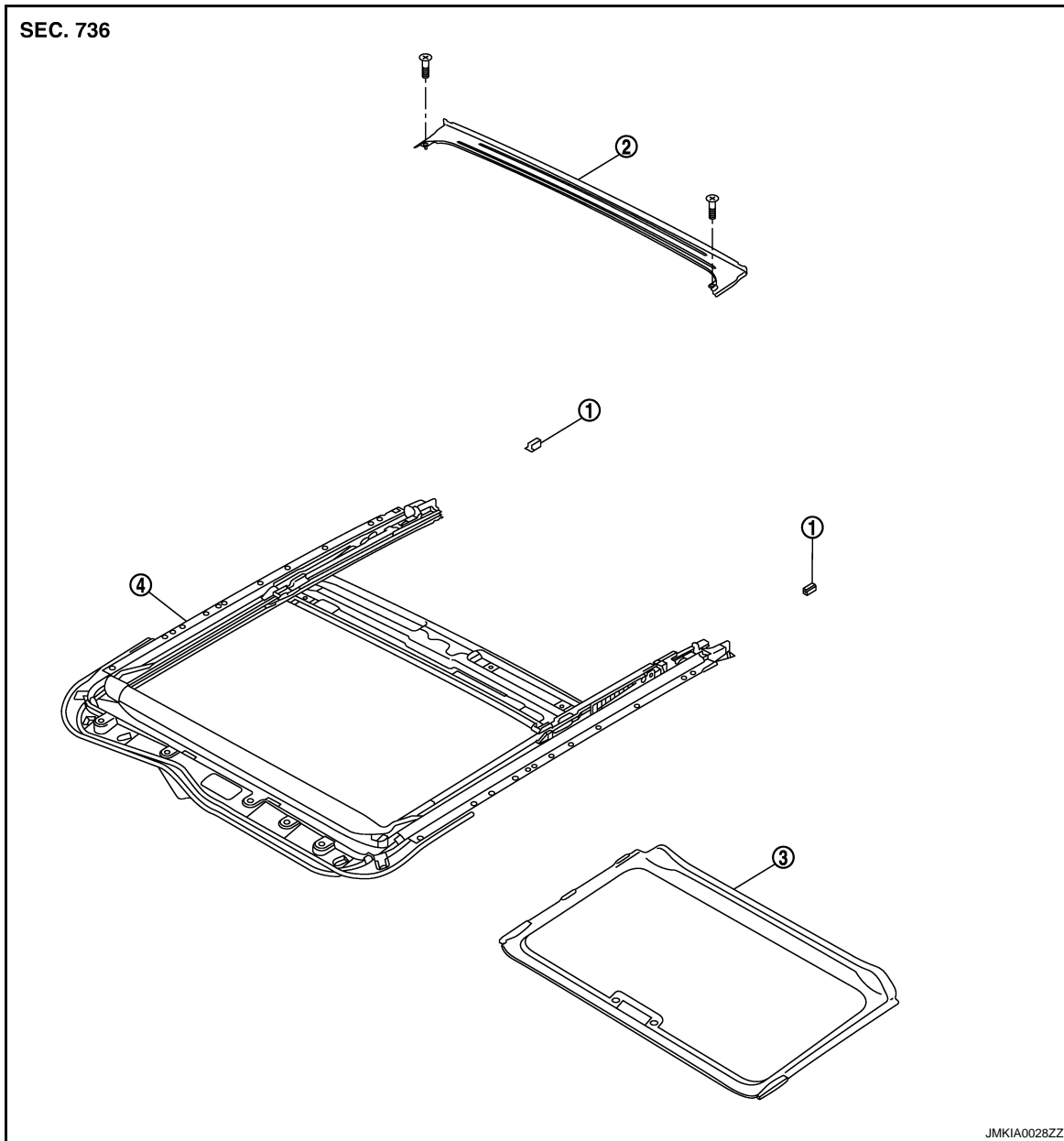

1. Sunshade stopper
2. Rear drain assembly
3. Sunshade
4. Sunroof frame

## Removal and Installation

INFOID:000000005630519

### REMOVAL

#### CAUTION:

- Always work with a helper.
- Fully close the glass lid assembly, before removal, then never operate sunroof motor assembly after removal.
- When taking sunroof unit out, use cloths to protect the seats and trim from damage.
- After installing the sunroof unit and glass lid, perform the leak test and check that there is no malfunction.

1. Remove the headlining. Refer to [INT-27, "SUNROOF : Removal and Installation"](#).
2. Disconnect drain hoses.
3. Remove the glass lid. Refer to [RF-73, "Removal and Installation"](#).
4. Remove the sunroof motor assembly. Refer to [RF-75, "Removal and Installation"](#).

# SUNROOF UNIT ASSEMBLY

## < REMOVAL AND INSTALLATION >

---

5. Remove grip bracket.
6. Remove sunroof bracket bolts. A
7. Remove nuts from the front end and side rail, and then remove sunroof unit assembly from roof panel.
8. Remove sunroof unit assembly through the passenger compartment while being careful not to damage the seats and trim. B

## INSTALLATION

1. Temporarily tighten the mounting bolts to the sunroof brackets (RH/LH). C
2. Bring sunroof unit into passenger compartment, and then place the rear end of the rail onto the sunroof brackets.
3. Temporarily tighten the mounting nuts to the front end of sunroof unit assembly. D
4. Tighten the installation points diagonally excluding the installation point of the sunroof bracket around the roof opening.
5. Tighten the sunroof bracket bolts of the vehicle side, and then tighten the bolt of the rail side. E
6. Tighten the mounting nuts to the front end and side rail.
7. Install the grip bracket.
8. Install the sunroof motor assembly. Refer to [RF-75, "Removal and Installation"](#). F
9. Install glass lid. Refer to [RF-73, "Removal and Installation"](#).
10. Install side trim. G
11. Connect drain hoses.
12. Install headlining. Refer to [INT-27, "SUNROOF : Removal and Installation"](#). H

## Disassembly and Assembly

INFOID:000000005630520

## DISASSEMBLY

1. Remove sunshade stopper mounting from the rear end of sunroof frame. I
2. Remove rear drain assembly from sunroof guide assembly.
3. Remove sunshade from the rear end of sunroof frame. J

## ASSEMBLY

Assemble in the reverse order of disassembly.

RF

L

M

N

O

P

# SUNSHADE

< REMOVAL AND INSTALLATION >

## SUNSHADE

Exploded View

INFOID:000000005630521

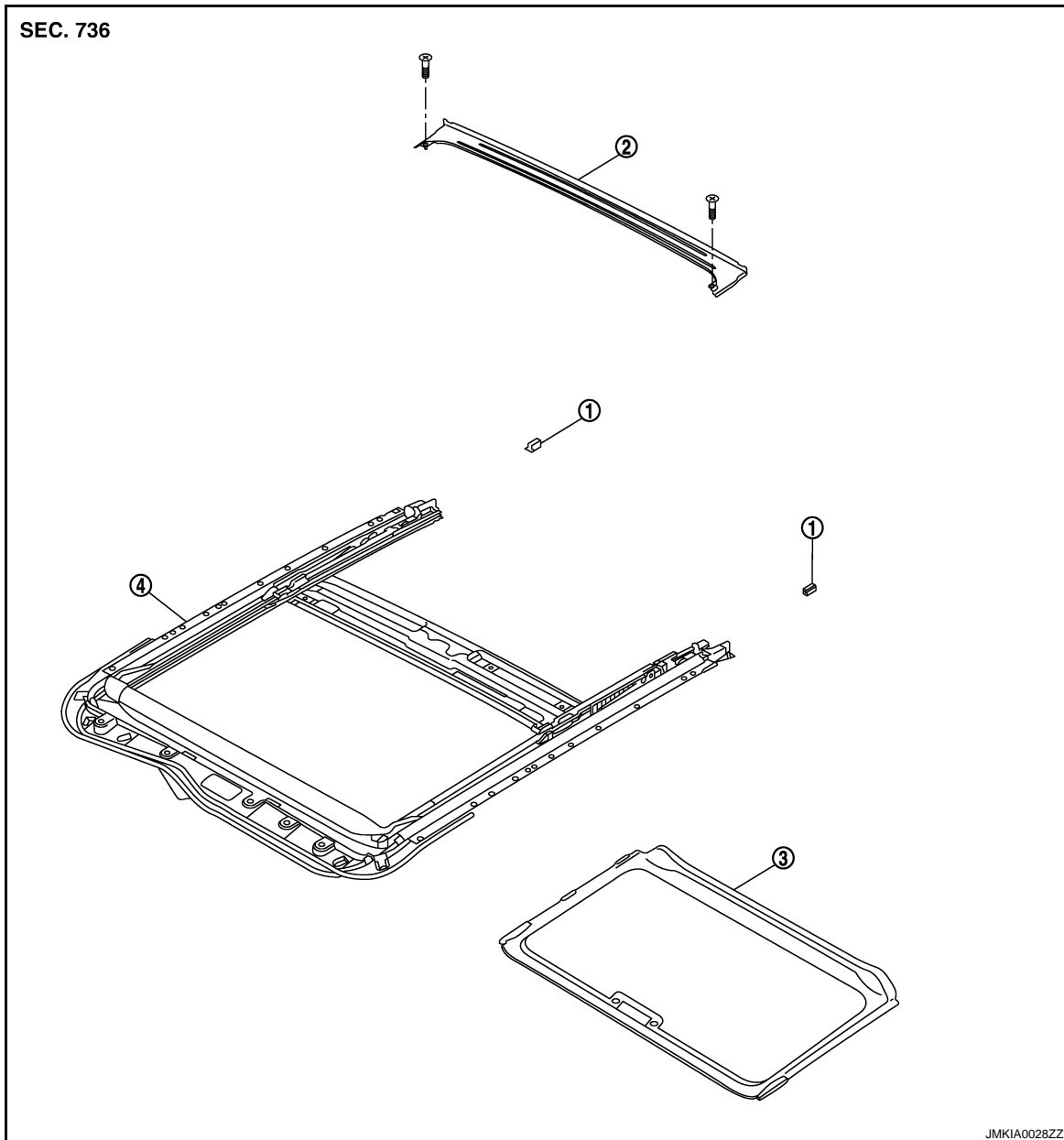

- 1. Sunshade stopper
- 2. Rear drain assembly
- 3. Sunshade
- 4. Sunroof frame

## Removal and Installation

INFOID:000000005630522

### REMOVAL

1. Remove the headlining. Refer to [INT-27, "SUNROOF : Removal and Installation"](#).
2. Remove the sunshade stopper mounting from the rear end of sunroof frame.
3. Remove the sunshade from the rear end of sunroof frame.

### INSTALLATION

Install in the reverse order of removal.